

MR F W PREZIOSI  
8 EASTGATE CRESCENT  
TORONTO 16 ONT

EPM  
OEL  
PEW  
7220

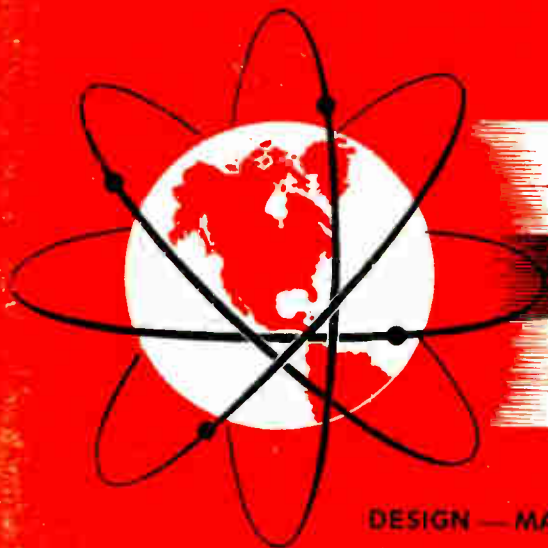

# ELECTRONICS *and* COMMUNICATIONS

DESIGN — MANUFACTURE — ENGINEERING — DISTRIBUTION — APPLICATION

Major Break Through  
In Radar . . . . . 21

Narrow Channel Tests  
In The V.H.F. Band . . . . . 22

Measuring Dielectric  
Constants In The  
3CM Band . . . . . 24

Radiant Energy System  
For Measuring  
Distance . . . . . 25

Selection Of Towers  
& Antennas For  
Microwave System . . . . . 26



WINNIPEG WORKER GAINS NEW SKILL: John Hodge (above right) learns the intricate job of insulating copper wire with strip paper on a new five-head machine being installed at the Telecables & Wires Ltd. plant at Fort Garry, Manitoba. Instructor Vic Wilson, from the Canada Wire and Cable Company Limited plant at Leaside, Toronto, shows him the proper technique. Canada Wire is part owner of the new Telecables plant and operates it under a management contract. The plant is the first communications cable manufacturing unit in Western Canada.

January, 1957 ★ \$5.00 a year

An AGE Publication, Toronto, Canada

Distribution Of This Issue Over 10,000 Copies

World Radio History

# COMPLETE FACILITIES for the Canadian Manufacture of . . . TRANSFORMERS and COILS

## ENGINEERING AND RESEARCH

Our staff have produced thousands of different transformer designs to meet customer requirements and specifications. Continual development and comprehensive knowledge of new techniques and material result in customer satisfaction.

## TESTING

From beginning of production to final inspection, units are subjected to constant testing and checking. Tests are completed to assure you close limits for Resistance — Inductance — Capacitance — Voltage — Current — Temperature Rise — Vibration — Distortion — Frequency — Insulation Resistance and Breakdown. Test equipment is up-to-date and complete.

## PRODUCTION

We have an extensive and completely equipped plant, manned by experienced technical staff and well-trained production personnel. The plant is geared to supply your requirements in large or small quantities. Basic, high-quality materials are on hand to facilitate the rapid production of your order.

## SERVICE

Our Sales, Engineering and Production staff work as a "team" to supply your requirements accurately, efficiently and economically. Samples can be supplied promptly.

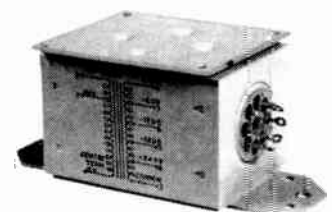
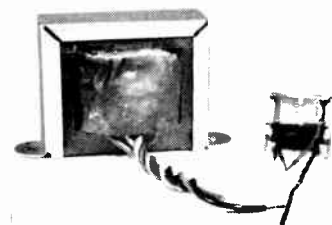
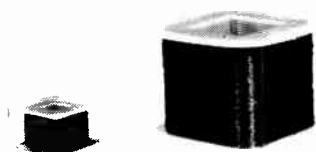

Engineering and Research — 1; Testing — 2; Production — 3; Coil Winding — 4.

MODERN EQUIPMENT — EFFICIENT PRODUCTION — EXPERIENCED PERSONNEL  
We are here for ONE purpose — to render Service to our Customers

# COPPER WIRE PRODUCTS LIMITED

300 CAMPBELL AVE.

TORONTO 9, ONT.

## BRANCH OFFICES

5890 Monkland Ave.  
Montreal

492 Somerset St. W.  
Ottawa

Radiovision Sales Ltd.  
325 10th Ave. W., Calgary, Alta.

For further data on advertised products use page 65.

# NEWS from HUNT

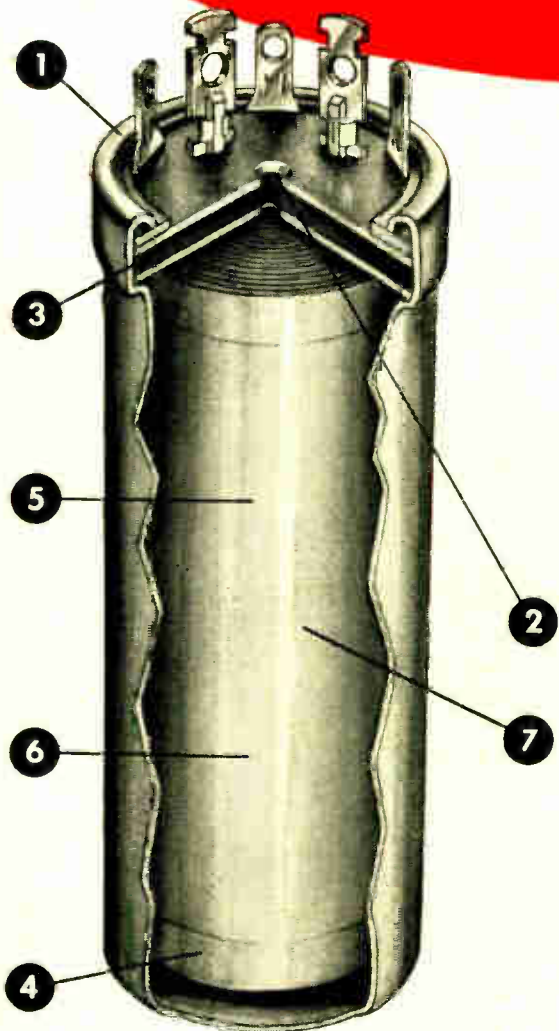

**COMPLETELY  
RE-ENGINEERED**

**HUNT K TYPE TWIST PRONG  
MOUNTING ELECTROLYTICS**

- 1 Mounting ring welded to cathode tab.
- 2 Safety vent.
- 3 Sandwich seal.
- 4 Extended and swaged cathode on all multi-section windings for low power factor and minimum coupling.
- 5 Choice of etched foil or sprayed gauze anodes (both super high purity aluminum)
- 6 Choice of plain, brushed, etched or sprayed cathode according to ripple requirements.
- 7 All windings wet aged at elevated temperatures.



Engineered to exceed all Canadian requirements, perfected through new manufacturing techniques and safeguarded by close quality control and assembly in specially conditioned atmospheres, this new series promises a new standard of performance. Aluminum foil of the highest obtainable purity . . . 99.98 - 99.99% purity . . . is used for the first time in regular capacitor manufacture. Capacitors are produced to specific customer requirements.

## HUNT CAPACITORS (CANADA) LIMITED

630 BAYVIEW AVENUE • TORONTO, ONTARIO  
BRANCHES: Vancouver • Winnipeg • Montreal  
Halifax • St. John's, Nfld.

## DEAD ON TRACK

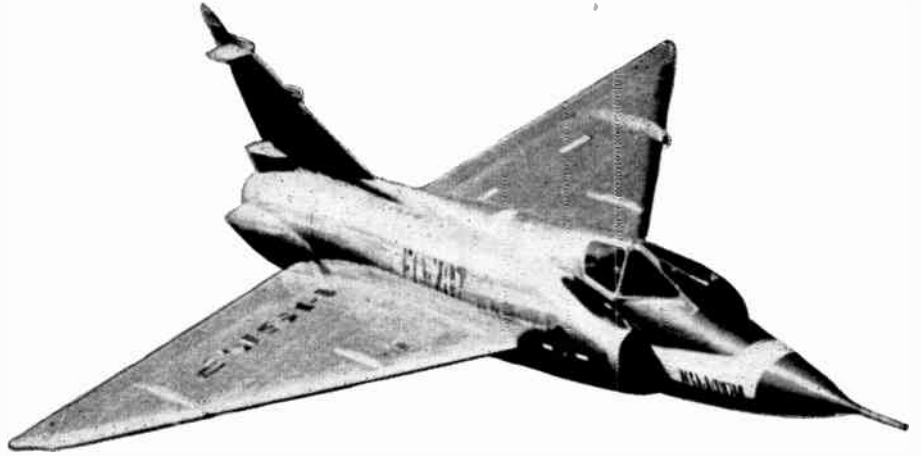

Rapid, accurate frequency control of an aircraft radio is of greatest importance to its navigation and communications.

Snelgrove tested quality crystals have everything you need — maximum stability and rugged proven performance under the most severe operating conditions. Of no less importance is ship and shore radio communications — defence installations and wherever highest standards of efficiency and reliability are demanded.



**C. R. Snelgrove Co. Limited**

141 Bond Avenue, Don Mills (Toronto), Ontario — Phone HI. 4-1107-8

Canada's Foremost Frequency Control Specialist — Licensed Under Bell System Patents

Reach the **ENTIRE**  
Electronics Market  
In Canada!

**IN ELECTRONICS AND COMMUNICATIONS**

You talk to Engineers *and* Management — (you need to).

Examination of enquiries received due to advertisements and editorial material in **ELECTRONICS AND COMMUNICATIONS** prove this impact on both Engineers and Administration. For instance, of the last 1,000 enquiries received, 78.2% were signed by Engineering or Technical personnel and 21.8% by Administrative or Management personnel — a ratio in keeping with the ratio of Management and Engineers in this market.

So use **ELECTRONICS AND COMMUNICATIONS** with its modern approved editorial approach as your first medium in the Canadian field. It talks directly to Engineers, it talks to Management. It has proven that it gets results from both. It has been doing so successfully since 1953.

An editorial approach that is of most value as a constructive factor in the consolidation and development of this still young, yet rapidly expanding market.

Published by  
**AGE PUBLICATIONS  
LIMITED**



**ELECTRONICS & COMMUNICATIONS**  
31 - 35 Willcocks St., Toronto 5, Ont., Canada

# COSSOR-SANDERS

## PRECISION MICROWAVE TEST EQUIPMENT

Designed expressly for precision measurements to the most exacting specifications. All 3-centimeter parts in stock and all standard couplings, bends and twists available.

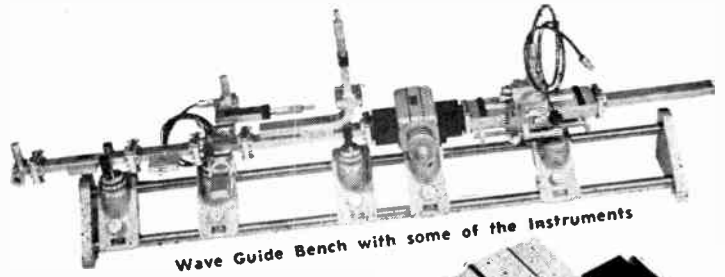

Wave Guide Bench with some of the Instruments

### 3-Centimeter Stock List

Directional Couplings 10 to 40 dB  
 Crystal Mixer Mount  
 Crystal Detector Mount  
 Coaxial Crystal Detector Mount  
 Wavemeter  
 Calibrated Attenuator  
 Matched Termination  
 Matched Load  
 Preset Attenuator  
 Variable Attenuator  
 High Sensitivity Coaxial Detector  
 Crystals  
 Wave Guide Support Bench and Carriages  
 Adjustable Short Circuit  
 Standing Wave Meter  
 Klystron Mount Assemblies  
 Matched Terminations  
 Centimetric Noise Source Unit  
 Klystron Power Unit  
 Waveguide Adaptors



Wide Band Coaxial  
 Crystal Detector  
 (200 to 15000 Mc/s)

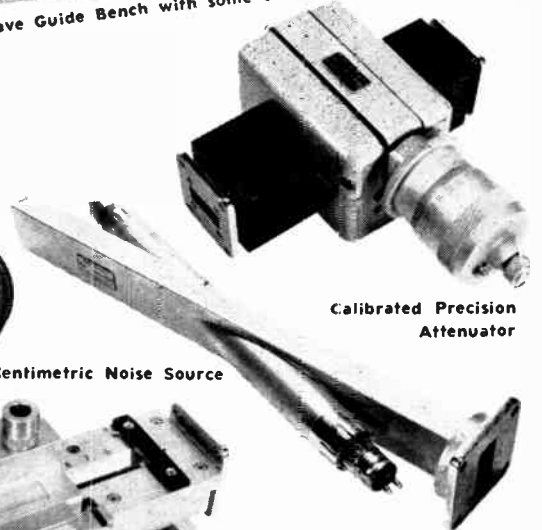

Calibrated Precision  
 Attenuator

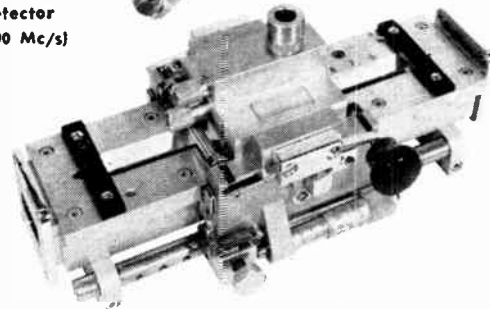

Precision Standing Wave Meter

Centimetric Noise Source



Illustrating method of packing

Equipment for other wave bands available at short notice.



Multi - Purpose  
 Klystron  
 Power Supply

Complete information and specifications from

## COSSOR (CANADA) LIMITED

301 Windsor St.

HALIFAX

Phone 4-6487

OTTAWA

160 Laurier W.  
 5-4306

MONTREAL

8230 Mayrand St., Decarie Boulevard  
 RE 3-6502

TORONTO

648A Yonge St.  
 WA. 4-1226

# proved performers

## IN PLANTS AND LABORATORIES

designed and  
perfected by  
**PANORAMIC**  
...the leader:

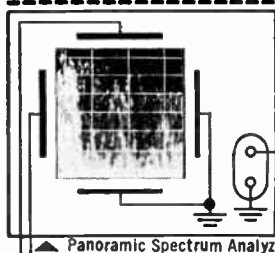

▲ Panoramic Spectrum Analyzer

### PANORAMIC TIME-FREQUENCY ANALYZER, Model TFA-1

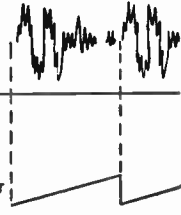

A new instrument designed to perform as a companion instrument to various Panoramic Spectrum and Waveform Analyzers, Panoramic Time-Frequency Analyzer TFA-1 provides a complete history of the time occurrence of transient waveform components, in addition to frequency and amplitude information.

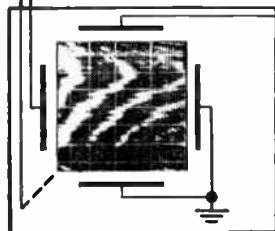

◀ Y-axis scan, synchronized to loop recording represents playback interval. X-axis represents frequency distribution. Intensity indicates component level.

◀ Panoramic Time-Frequency Analyzer, Model TFA-1

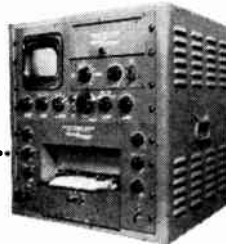

**PANORAMIC SUB-SONIC ANALYZER, Models LF-1 and LF-2** for SUB-SONIC WAVEFORM ANALYSIS 0.5 cps—2250 cps features 0.1 cps resolution, 40 db amplitude range, high sensitivity, permanent-spectrum recordings.



**PANORAMIC SONIC ANALYZER, Models LP-1 and AP-1** for AUDIO FREQUENCY WAVEFORM ANALYSIS 20 cps—20 kc feature direct reading waveform analysis in only one second, 60 db dynamic range, simple operation.

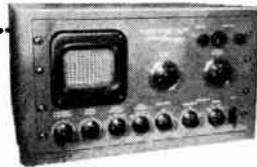

**PANORAMIC ULTRASONIC ANALYZER, Model SB-7a** for ULTRASONIC WAVEFORM ANALYSIS 1 kc—300 kc features continuous variable scan width 0-200 kc continuously variable resolution 2 kc—500 cps, direct reading frequency and amplitude scales.



**PANALYZOR, Model SB-8b and PANADAPTOR, Model SA-8b** for RF, VHF, and UHF SPECTRUM ANALYSIS. Each model available in three types with maximum sweep widths of 200 kc, 1 mc, and 10 mc, and maximum resolution of 50 cps, 200 cps, and 9 kc respectively. Numerous other models and types also available to suit practically every special need.

**PANORAMIC SPECTRUM ANALYZER, Model SPA-1** microwave spectrum analysis 50 mc—4000 mc—Sensitivity: up to -100 dbm; SWEEPWIDTH: 10 mc continuously reducible to 0 mc; RESOLUTION: 9 kc—100 kc, continuously variable; SCAN RATES: 1 cps—60 cps, continuously variable; FREQUENCY COVERAGE: tuning heads RF-2 50—250 mc and RF-3 220—4000 mc.

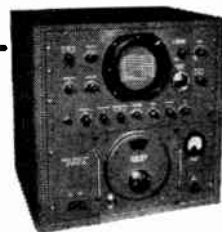

Also makers of Sweep Generators and Frequency Calibrators  
Inquiries invited for development of special Panoramic analyzers.

for accurate  
spectrum  
analysis from  
sub-sonic  
through  
microwaves

Pioneers in the field of spectrum analysis...through the years Panoramic has demonstrated leadership...and Panoramic Instruments have been proven unexcelled for research development and production applications requiring accurate, high-speed spectrum of waveform analysis.

Whatever your problem, from subsonic through microwave analysis, there is a Panoramic analyzer to answer your needs. Operation is simple and reliable. Design and construction are the finest. Many models are used in military applications.

Day in and day out, Panoramic Instruments play a vital part in monitoring communications channels...telemetering analysis...vibration and sound studies...transmitter analysis...FM deviation measurements...microwave spectrum analysis...servo analysis.

Write today for complete  
technical data and prices.



17-19 S. Second Ave., Mount Vernon, N.Y.  
MOunt Vernon 4-3970  
Cables: Panoramic, Mount Vernon, N. Y. S.

For further data on advertised products use page 65.

VALUES TO LOOK FOR IN TWO-WAY RADIO



# HIGH POWER

for greater  
2-way radio  
coverage

Type CMF  
100A Series  
25-54 mc

...in the new RCA *Carfone* for low band!  
**FIFTY**

### 100 WATTS OF POWER

in the new CMF 100A Series for 25-54 mc plus other quality features make it the finest equipment RCA has ever offered for low band coverage! Designed to provide greater range and a better signal at any distance, this sharp increase in power means improved performance, mobile to mobile, and throughout the system.

### HERE'S YOUR ANSWER

to increased reliability, lower maintenance, built-in reserve power, much greater adaptability—the new RCA Carfone Fifty!

### PLUS THESE QUALITY FEATURES

- Built-in 6/12 volt convertibility.
- Best frequency stability.
- Elliptical loud speaker providing 3 times more acoustical power than the ordinary type.
- Color directed "rainbow" tuning.
- Sturdy drawer-type modern design case.
- Functionally perfected, hand fitting "Red Head" Microphone. (Transistorized or carbon type.)



RCA Electron Microscopes are vital research tools of science and industry. They permit clear observation and photography of particles less than 1/5,000,000th of an inch.

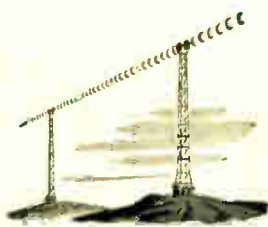

RCA Microwave provides point-to-point communication by radio signals. For pipelines, railroads, utilities, government agencies and other qualified users.

RCA VICTOR COMPANY, LTD.,  
TECHNICAL PRODUCTS DIVISION,  
1001 LENOIR ST., MONTREAL.

Please send me complete information on the new RCA Victor Carfone equipment for

- 25-54 mc.       148-174 mc.       450-470 mc.  
 Have an RCA Victor Communications Specialist call on me.

NAME \_\_\_\_\_ TITLE \_\_\_\_\_  
 COMPANY \_\_\_\_\_  
 ADDRESS \_\_\_\_\_  
 CITY \_\_\_\_\_ ZONE \_\_\_\_\_ PROV. \_\_\_\_\_



TECHNICAL PRODUCTS DIVISION

## RCA VICTOR COMPANY LTD.

MONTREAL • HALIFAX • TORONTO • CALGARY • VANCOUVER

ELECTRONICS & COMMUNICATIONS, JANUARY, 1957

For further data on advertised products use page 65.

Flip your lid... pop your gasket... but...

Don't  
blow your  
top!

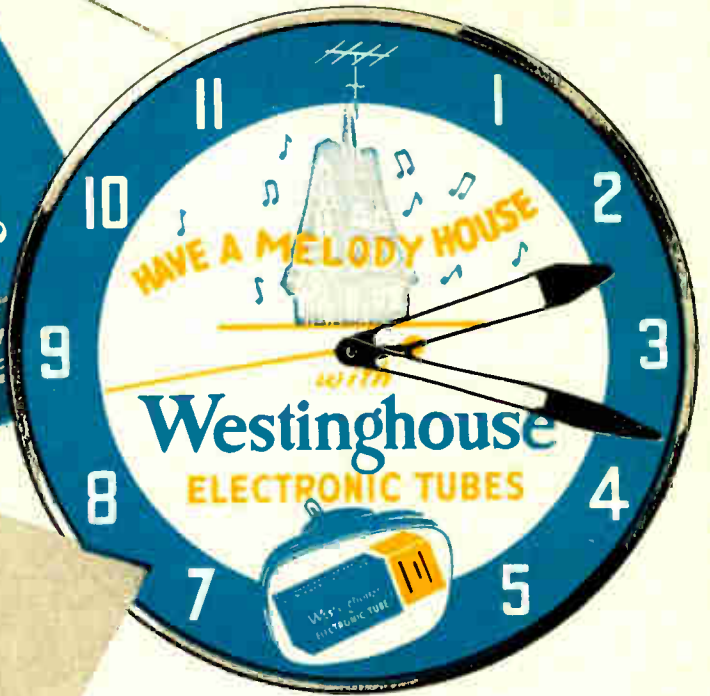

This Handsome Illuminated  
Electric Display Clock is  
yours FREE for only 500  
Westinghouse  
ELECTRONIC TUBE CARTON TOPS

Don't throw away your Westinghouse Tube carton tops! Save them, and get this wonderful Display Clock to advertise your Service. Regular value \$15.00. Mail your order with 500 carton tops to — Sales Promotion, Electronic Tube Division, Canadian Westinghouse Company, Ltd., Hamilton, Ont. Offer good only until Dec. 31st, 1957.

**YOU CAN BE SURE..IF IT'S Westinghouse**  
**CANADIAN WESTINGHOUSE SUPPLY CO. LTD.**  
 Halifax · Moncton · Quebec City · Montreal · Ottawa · Toronto · Hamilton · Windsor · North Bay  
 Fort William · Winnipeg · Regina · Saskatoon · Edmonton · Calgary · Lethbridge · Vancouver

For further data on advertised products use page 65.



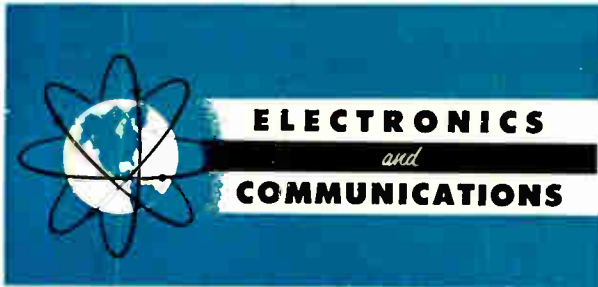

THE ONLY CANADIAN JOURNAL DEVOTED SPECIFICALLY TO THE APPLICATIONS OF COMMUNICATIONS AND ELECTRONICS

**JANUARY • 1957**  
**Vol. 5 No. 1**

# EDITORIAL CONTENTS

## FEATURES

	PAGE
Lollipop-Shaped Balloon Called 'Major Break Through' In Radar . . . . .	21
30 kc/s and 15 kc/s Narrow Channel Tests In The V.H.F. Band . . . . .	22
<i>By D. Roddy.</i>	
An Equipment For Measuring Dielectric Constants In The 3CM Band . . . . .	24
Radiant Energy System For Measuring Distance . . . . .	25
<i>By Leslie L. Hill, Ph.D.</i>	
Selection Of Towers And Antennas For Microwave System Use . . . . .	26
<i>Courtesy Lenkurt Demodulator.</i>	
Electronic Filing Units — A Means Of Easing The Paper Work Of Office Routine . . . . .	28
Semi-Automatic Molding — A Money-Saving Technique For Component Manufacturers . . . . .	28
Modular Constructed Timing-Mechanism . . . . .	32

## DEPARTMENTS

RETMA Report . . . . .	11
Editor's Page . . . . .	15
Editorial . . . . .	17
Electronics In Business And Industry . . . . .	29
New Products . . . . .	36
Business Briefs And Trends . . . . .	47
Book Review . . . . .	50
News . . . . .	52

Printed, Engraved and Produced in its entirety by AGE PRESS  
A Division of AGE PUBLICATIONS LIMITED

*President* NORMAN G. MCHARDY  
*Editor* THOMAS W. LAZENBY  
*Editorial Assistant* D. K. TROWELL  
*Advertising Manager* H. E. DALLYN  
*Sales Representative* W. J. HERON  
*Production Manager* NEVILL A. CAMPLING  
*Business Manager* CLIFFORD A. SPARKS  
*Circulation Manager* PAUL A. IRWIN  
*Art Editor* WM. McREYNOLDS  
*Photo Editor* GUIDO MILANESIO

### PUBLISHED BY AGE PUBLICATIONS LIMITED

Founded by Norton W. Kingsland

Also Publishers of Restaurants and Institutions, Hotel and Tavern, Heating, Plumbing & Air Conditioning AGE, Oil & Gas Heat.

MONTREAL, QUE., CANADA  
Room 504, Dominion Square Building  
1010 St. Catherine Street West  
Tel. UNIVERSITY 6-7897

TORONTO, ONT., CANADA  
31 Willcocks Street  
Tel. WALNUT 2-3115

Member Canadian Circulation Audit Board, Inc.



PRINTED IN CANADA



Subscription Rates: Canada, U.S.A. and British Possessions \$ 5.00 per year  
Foreign \$10.00 per year

Authorized as second class mail, Post Office Department, Ottawa

# WHAT ARE ENGINEERS REALLY LIKE



**ARE THEY STUFFED SHIRTS**



**ARE THEY EGG HEADS**

**ARE THEY  
HIGH BROWS**

Whose interests are confined to  
Diagrams? . . . Equations? . . .  
Graphs? . . . Text Books?



**DO THEY FEED  
ON FIGURES or**



**ARE THEY JUST LIKE**

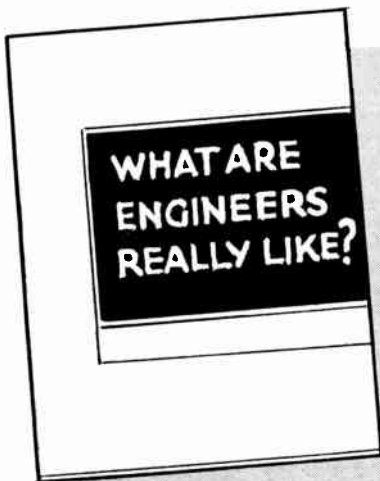

**YOU**

**OR**



**ME**

Electronics and Communications has prepared a 24-page booklet which, we are told, graphically provides a fairly accurate answer to the above questions. It is written with a smile and illustrated as above. Those who have received and read it have found it amusing — many want extra copies. One engineer's wife wanted them for her friends.

So we are reprinting extra copies to take care of requests of this character. If you would like one, just fill in the coupon below, or tick off item 1419 on the return postcard on page 65 of this issue. It's yours with our compliments for the asking.

**Send for it NOW!**

**IT IS FREE**

**ELECTRONICS AND COMMUNICATIONS**  
31 Willcocks Street, Toronto, Canada

Gentlemen:

Please send me a copy of your Booklet **WHAT ARE ENGINEERS REALLY LIKE**

Sign here .....

Address .....

Your Position .....

# RETMA Report

By Basil Jackson, A.R.Ae.S., Tech. M.C.A.I.



## RETMA's 28th Annual Meeting

At the last meeting of the Board of Directors of the Radio-Electronics-Television Manufacturers Association of Canada, it was announced that the 28th annual meeting will take place at the Chantecler Hotel, Ste. Adele en Haut, Que., on Thursday and Friday, June 20 and 21, 1957.

## Town Meetings To Include Color Television

In conjunction with the National Advisory Council on Town Meetings, RETMA will again assist in the operation of the industry television service technician training courses, called Town Meetings, in 1957.

In addition to monochrome television, the courses in some locations will include lectures on color television servicing and transistorized and printed circuits.

Preliminary plans call for Town Meetings to be held in Montreal, Toronto, Winnipeg, Regina, Calgary, and Vancouver, commencing in May, and the instructors will again be from the Ryerson Institute of Technology in Toronto.

Each meeting will consist of intensive 3-day training sessions to help upgrade the technical education of television service technicians. Judging by the very successful meetings held in the past few years, the forthcoming meetings on color television and transistorized and printed circuits should be equally successful.

## Sub-Committee On Safety And CSA Formed

At the last meeting of the Receiver Engineering Committee, a Sub-Committee on Safety and CSA was formed and members appointed. This sub-committee will deal with the field of safety, and CSA requirements on safety, for radio and television receivers.

## RETMA Studying Technical Manpower Utilization

RETMA's Industrial Relations Committee, besides being active in the labor-management relations field, is currently studying how to make better use of technical personnel in the electronics industry. This work has been in progress for some time, and the Industrial Relations Committee has already met with officials of the Federal Department of Labor to discuss problems relating to technical personnel.

The committee reports to the RETMA Board of Directors and has various sub-committees allocated to different aspects of the subject. A Sub-Committee on Apprenticeships is active in developing apprenticeship standards to encourage men and women in the workshops to improve their skills. By this means it is planned to upgrade personnel into more skilled classifications.

Another sub-committee has been formed to survey the field of technical personnel at the "technician" level. Contacts have been made with all Provincial Departments of Education and with educational institutions to help in the survey. A great deal of thought has been devoted to nomenclature and definitions of technical personnel by another sub-committee specializing in these subjects.

# RETMA Report

---

## **C RTPB's 12th Annual Meeting**

The 12th annual meeting of the Canadian Radio Technical Planning Board was held recently in Ottawa.

The CRTPB was established to make recommendations to the Government and to the industry on the allocation of wavebands in the ether, to prevent interference, and to consider the best possible utilization of the ether wavebands for all users. It works in close harmony and co-operation with the Telecommunications Division of the Department of Transport and the Canadian electronics industry, and the engineering consultative man-hours are devoted, free of charge, by top-ranking scientists and engineers who serve on the various committees.

Membership on the Canadian Radio Technical Planning Board is entirely voluntary and consists of non-profit organizations, such as RETMA, which help to plan the orderly unfolding of Canadian electronic development in the public interest. There are currently seventeen sponsors of the Board.

The demands for allocation in the spectrum are ever-increasing. The programs for guided missile control, radar networks, control and telemetry for earth satellites, are just a few of the services which require allocations. The expanding field of communications will further increase these requirements.

The CRTPB is divided into seven main committees, consisting of Standards and Allocation, Television, Broadcast, Communications, Aeronautical, Industrial, and Non-Communications Committees, each of which surveys and makes recommendations on new equipment and practices in its own sphere. The committees ensure that innovations are compatible with existing techniques and make reports and recommendations according to their findings, viewing the whole against the long-range planning requirements of modern electronic development.

Reports from any one committee are passed to the Standards and Allocation Committee so that specialists from the other committees can study the new proposals and coordinate their efforts. Ether space requirements can thus be planned and allocations recommended at an early stage.

The activities of the committees are supervised by an Administrative Committee having representatives from all the sponsoring organizations. A small Executive Committee ensures that the work of all committees is properly coordinated, and is in contact with all external bodies and with the Government regulatory agency.

The work of the Canadian Radio Technical Planning Board ensures that electronic communications in Canada evolve logically and serve, on a basis of equality, all interested groups - the public, users of specialized equipment, the electronics industry, and the public electronic services.

## **CRTPB Elects Officers**

Officers elected at the recent meeting of the Canadian Radio Technical Planning Board were: president, Ralph A. Hackbusch, president, Hackbusch Electronics Limited; vice-president, H. H. R. Pounsett, assistant general manager, Canadian Radio Manufacturing Corporation Ltd.; general co-ordinator and director of publicity, R. C. Poulter, director of education, Radio College of Toronto; secretary-treasurer, F. W. Radcliffe, general manager, Radio-Electronic-Television Manufacturers Association.

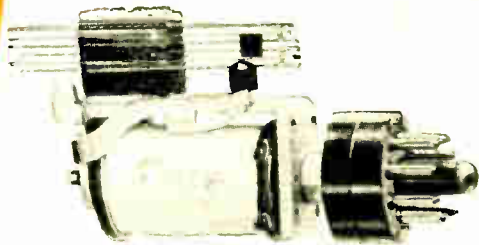
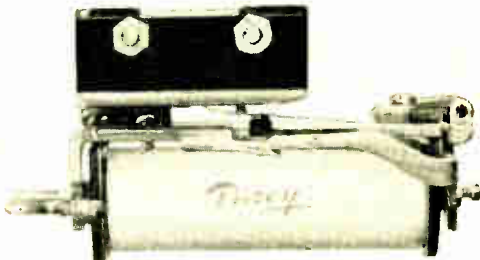

TYPE CK

TYPE CG  
WITH PLUG-IN BASE

TYPE CCMS

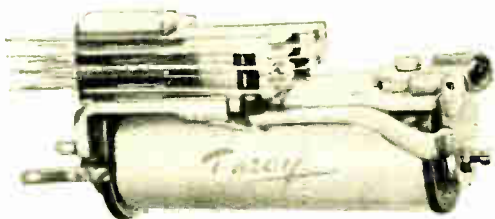

TYPE CC



TYPE CG

# CLM DARCY RELAYS

Now you can get fast delivery with Canadian made relays. All standard types are available and all are electrically and mechanically interchangeable with other makes.

Illustrated are only a few telephone type relays. Other spring and coil combinations are available.

For full information call or write Jack West, Sales Manager, Relectronic Division, **Canadian Line Materials Limited**, Toronto 13 or our nearest sales office.

#### SALES OFFICES and WAREHOUSES

MR. R. WATSON  
624-9th Ave.  
Calgary, Alberta  
Tel.: 2-7328-6-3933

MR. H. L. STUART  
10330-104th Street  
Edmonton, Alberta  
Tel.: 2-4453-2-7418

MR. A. WILLIAMSON  
114 Myles Street  
Fort William, Ontario  
Tel.: 3-3483

MR. D. C. KEDDY  
53-55 Upper Water St.  
Halifax, N.S.  
Tel.: 3-6229

MR. L. A. deSAVOYE  
220 Elm Street  
Montreal, Quebec  
Tel.: GLenview 4297-8

MR. C. R. THORNTON  
168 Charlotte St.  
Ottawa, Ontario  
Tel.: CE. 5-3482

MR. F. HESELTINE  
1120 Broad Street  
Regina, Sask.  
Tel.: 9-5659

MR. G. J. ROONEY  
57-59 Dock Street  
Saint John, N.B.  
Tel.: 3-2503

MR. H. COLLINGWOOD  
243 Water Street  
St. John's, Nfld.  
Tel.: 2101

MR. D. MCKINNON  
125 Bay Street  
Sault Ste. Marie, Ont.  
Tel.: ALgoma 3-1213

MR. D. F. ANDERSON  
3643 Kingsway  
Vancouver, B.C.  
Tel.: DExter 9330

MR. E. M. BRYDON  
292 Princess Street  
Winnipeg, Man.  
Tel.: 93-9019



## CLM-DARCY RELAYS

# BRUEL & KJAER

## MODERN INDUSTRIAL MEASUREMENTS

### ELECTRICAL TEST

**DEVIATION BRIDGE** for testing tolerance and phase angle of components compared to a standard. Resistance 10 ohms - 10 Meg. Capacitance 50  $\mu$ F to 10  $\mu$ F. Inductance 2 mH to 100 H. Interchangeable scales provided, 1 to 25% FSD. 1000 cycle test frequency. Knee operated test jig available.

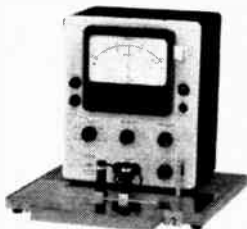

**MEGOhmmETER** range from 100K to 10,000,000 Megohms, test voltage 10 to 100 V. Can be used as D.C. Voltmeter from 1.0mV to 2000 V with 1000 Megohm input impedance. Illustrated with high tension accessory extending range to 100,000,000 Megohms and voltage from 0-1000.

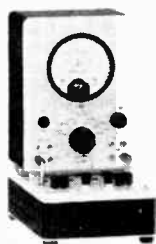

### STRESS AND VIBRATION

**STRAIN INDICATOR** with 25 microinches nch full scale sensitivity (4 active arms). Built-in carrier oscillator used, measuring static and dynamic strains to 300 cycles. D.C. bridge supply accessory permits measurement of dynamic strains up to 50,000 cycles.

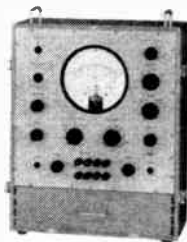

**ACCELEROMETERS** for displacement, velocity and acceleration measurement of any vibrating structure. Output 20 mV g, 5-20,000 cycles. Measures 0.25 to 1000 g with B & K direct-reading self-calibrating amplifiers.

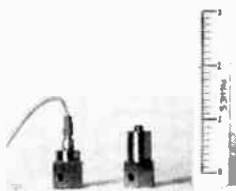

### SOUND AND NOISE

**SPECTRUM RECORDER** is combined spectrometer and level recorder. Spectrometer has 27 fixed  $\frac{1}{3}$  octave filters, 40-16,000 cycles, manual selection or driven by level recorder. Latter has 10 paper speeds, variable writing speed, log scale for wide range. Key instruments for vibration and noise measurements.



**ACOUSTIC ANALYSIS AMPLIFIER**, used with B & K precision mike, measures noise and sound level. Equipped with A.S.A. Standard weighting networks for use as precision noise and sound survey meter. Use B & K Level Recorder to record output.

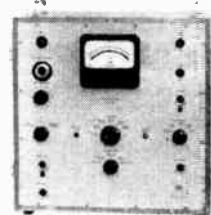

**PRECISION MICROPHONE**, condenser type with built-in cathode follower, low temperature coefficient. Calibrated within 0.5 DB 80-10,000 cycles. Measures noise level from 25 to 140 acoustic DB. Use with acoustic amplifier, spectrometer or frequency analyzer and level recorder.

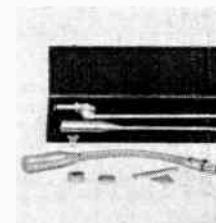

### RADIOACTIVITY

**RADIOACTIVITY COUNTER** — Two channel counter, coincidence, anti-coincidence and straight count. Built-in 0-1500 V G-M tube supplies. Variable resolving time. Two timers, 1 minute to 12 hours. Each channel has scale of 10 and 4 digit register, plus multiplier. Single and dual tube sample holders available.

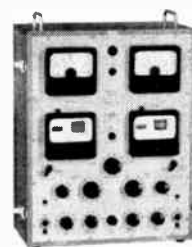

**MEASURE • to speed tomorrow's products and profits • MEASURE**

Bruel & Kjaer offers a complete range of matched units in the electrical, acoustic and vibration fields. B & K instruments are designed to meet exacting research requirements, yet can be operated by

non-technical personnel with equal ease and accuracy. These instruments are now stocked in Canada. Write for full catalog and price list.



R-O-R field engineers can help with your problems—ask for details.

**R-O-R ASSOCIATES LIMITED**  
290 LAWRENCE AVE. W. TORONTO 12

For further data on advertised products use page 65.

# the editor's page

*A commentary on affairs  
pertinent to the electronics  
and communications industries.*

## Plain Language Needed

It is perhaps inevitable that in the fields of research and development there must of necessity be a high degree of specialization. As a result there is developing a situation in which more and more knowledge is being discovered by scientists in our laboratories but less and less is known about it by those persons whose position in life is to control and employ the products that science and technology are providing us with.

Actually this situation has been with us to some extent from the beginning of history but in recent years it has been aggravated by the fact that the advances of science are taking place at such a rapid rate as to leave the non-specialist layman in a state of virtual ignorance.

It has been said that "scientists are becoming illiterate, that they have lost the ability or desire to express the essence of their work in language that can be understood by the layman."

As a consequence, leaders of business and industry are only partially informed with respect to the many new techniques and equipment developments that are being produced in our laboratories and which are seldom described in any other terms but those of the scientist with his natural inclination to employ abstract mathematical terms and phraseology, all of which leaves the ordinary businessman frustrated and uninformed.

Nor is the businessman alone in his frustration at the sight of such abstract dissertations for oft-times the practising engineer himself, long since removed from college and the use of differential and integral calculus, but more immediately concerned with the empirical formulae of applied engineering, is quite frequently dismayed and discouraged at the sight of those profound looking equations the interpretation of which comes without time-consuming labor only to that erudite and esoteric group of persons who fall within the category of specializing scientists.

How then is the knowledge that is being built up by the specializing scientist to be conveyed to the practising engineer and the businessman so that they may put it to profitable use? The solution to the problem is quite simple. Such knowledge can be conveyed by the medium of plain language used to describe the purposes, functions, and end uses of the equipment that science and technology are producing for us.

With this object in view *Electronics and Communications* have added an additional feature entitled *Electronics at Work in Business and Industry*. The feature will appear regularly and will carry condensed descriptive items of the latest devices which have come into production for business and industry.

It is hoped that the new feature will be of particular interest and value to executives and engineers who, due to the ever increasing tempo of scientific progress and the development of new equipment, are finding it increasingly difficult to keep abreast of the times in the matter of information relative to new and better ways of conducting industry and business.

\* \* \*

## Engineers Need Commercial Viewpoint

G. C. Larson, assistant general manager, television radio division, Westinghouse Electric Corporation, recently told more than 500 members of the American Management Association that it is vital in today's competitive business to develop the commercial viewpoint in professional engineers so they will be in a position to produce a "most saleable product".

Discussing the topic "Developing The Technical Man's Commercial Viewpoint", Mr. Larson pointed out that in today's consumer goods market, perhaps the most important goal is to strive to merchandise the most saleable product.

"It is not sufficient to have a well-engineered product —

or even the best engineered product", he said. "The ideal is a happy combination of the ingredients making up the formula for the 'most saleable product'."

He pointed out that in the absence of a complete formula, industry does know that a very important ingredient is having a commercially-minded engineering department.

Mr. Larson defined the essentials necessary to produce a "most saleable product" as follows:

The product must have high consumer acceptance in face of competition, he stated. This involves superior styling; good performance; tangible, saleable; plus competitive features; and competitive in price. Also, the introduction of the product must be properly timed, consistent with the seasonal sales trends of the article.

Further desirable factors include conformance with prevailing trends of public acceptance; ease of manufacturing consistent with existing facilities that should fit into the trend of new and more mechanized facilities.

The engineering department, which is responsible for engineering and designing the product, must know all factors relating to the objectives to do a proper job, Mr. Larson pointed out. This requires a high order of team work with co-operating functions. For this team to really work, he stated, the engineering department must be party to and make contributions to these other functions. It is participation that develops the "commercial viewpoint", he indicated.

Engineering works closely with the product planning and competitive analysis department. Some functions of this latter group are to accumulate data which include development of charts on major competitors showing prices, discounts, distributor costs, and the comparison of thirty features in the case of television receivers. Also, evaluate the performance of competitive receivers; determine trends in styling, features, and pricing; integrate reports from the sales and service departments relative to strong and weak points of the current product line; and finally, to integrate new engineering developments.

To obtain overall engineering leadership, provision must be made to create environment and direction for engineering achievements which will promote leadership. This is the primary purpose of the Advance Development Laboratory, which is a part of engineering. It is the purpose of this group to work on engineering developments aimed generally one to five years in advance for the purpose of creating better performance at lower cost, creating new commercially saleable features, and creating new products and styling.

Thus, through association with existing departments and services, the engineering department is literally surrounded by co-operating functions, Mr. Larson said.

"Their association with these functions is intimate and on a daily basis", he stated. "They are responsible for the co-ordination of many of these functions since they exercise initiative in all areas."

It is through this daily exposure to co-operating departments, their understanding of the other fellow's problems, that develops the commercial viewpoint in the professional engineer, he concluded.

The need for professional engineers to be kept abreast of the commercial developments in their field of activity as expressed by Mr. Larson is another of the growing number of pronouncements indicating the realization of industry generally that management and engineering are becoming more closely integrated. In essence it means that it is no longer sufficient that an engineer be capable of engineering alone but that he must also have a knowledge of the commercial aspects of the business in which he is employed as an engineer.

# ELECTRONIC INSTRUMENTS and COMPONENTS

*Components Division*  
Represented throughout Canada  
by:

**RUSSEL M. RIEGLER & ASSOCIATES**  
14689 EUCLID AVENUE  
CLEVELAND 12, OHIO  
(Main Office for Canadian Export)  
Stock maintained for fast delivery

*Instruments Division*  
Represented in Canada  
through:

**RADIONICS LIMITED**  
8230 MAYRAND STREET  
MONTREAL 9, CANADA  
Qualified nuclear engineers for  
application information and service

## LABORATORY AND FIELD SURVEY METERS



Geiger counters, scintillation counters, combination geiger-scintillation counters, and ion chamber type survey meters in many models and for every purpose and application involving radiation detection and measurement. A wide variety of instruments for alpha, beta and gamma detection and measurement are available to detect leakage, to monitor isotope shipments and for many other survey purposes. Write for Bulletin 3044.

## REACTOR INSTRUMENTATION

Mobile Air Samplers, with Oak Ridge design-approved electronic circuits are now being produced for industrial uses and A.E.C. operating contractors. We can also supply:

- Boron Line Neutron Counters
- Fast Neutron Dosimeters
- Log Count Rate Meters
- Compensated Ionization Chambers
- Single-Channel Analyzers
- Linear Preamplifiers
- Linear Amplifiers
- Log N Amplifiers
- Power Supplies

These instruments can be supplied individually or designed into a complete system to your exact needs.

## REMOTE MONITORING SYSTEMS

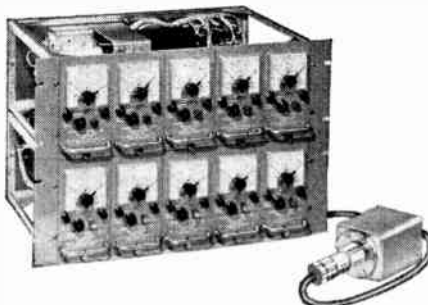

Radiation Monitoring Systems maintain a continuous check on radiation intensity levels of radioactive gases, liquids or solids.

Detection monitors, installed at key locations transmit the radiation intensity measurements to a central control panel and will actuate alarms and interlocks; initiate the action of remote controls, recorders or other devices.

Custom designed from standard components, each Victoreen Remote Monitoring System will exactly meet your requirements.

## MEDICAL RADIOLOGICAL INSTRUMENTS

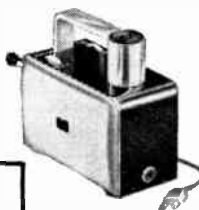

Condenser r-meter (illustrated) and ion chambers—a recognized secondary standard of measurement for x-ray beam calibration; Radium standards for constancy checks. Instruments using thimble ion chambers to monitor roentgen intensity, rate of roentgen delivery, and total roentgen dose. Ionization chambers are available in a wide variety of sensitivities, energies and intensities. Write for Bulletin 3042.

## PERSONAL AND AREA DOSIMETERS



Health safety instruments, used wherever radiation may be a personnel hazard, consist of personal direct reading pocket dosimeters; indirect reading pocket dosimeters and associated charger-reader; portable area dosimeters for making spot checks of radiation; radium standards for affirming dosimeter accuracy. Write for Bulletin 3042.

## COUNTER TUBES

These are self-quenching geiger tubes designed to cover the general field of beta, gamma, X-ray and cosmic ray measurements.

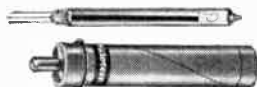

### SPECIFICATIONS

TUBE TYPE	1B85 Beta-Gamma Alum. Wall	1B86 Gamma Ray Glass Wall	6306 Beta-Gamma Bismuth Lined Alum. Wall
Description			
Operating Voltage	900	300	900
Threshold Voltage	800	280	800
Plateau Length Volts	200	60	150
Plateau Slope Per 100 V (% — 100V)	3	10	5
Active Length (inches)	2.75	2.5	2.75
Wall (mg-cm <sup>2</sup> )	30	300	30
Life (counts)	10 <sup>9</sup>	5x10 <sup>7</sup>	10 <sup>8</sup>
Type Base	Coaxial A1-A2	Tinned Leads	Coaxial A1-A2

## SUBMINIATURE ELECTROMETER TUBES

Victoreen has every facility for making diode, triode, tetrode, and pentode tubes to standards of operating performances that will inherently improve the performance of their application. In addition to exceptional quality, Victoreen offers engineering skill to assist in solving your problems and production facilities to meet your requirements.



## CORONA TYPE VOLTAGE REGULATORS

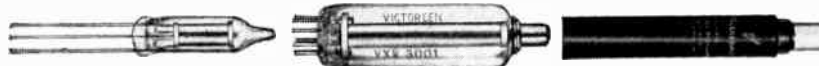

**T-3 GLASS SUBMINIATURE**  
Available voltage range  
400 volts to 2000 volts.

**T-5 1/2 GLASS MINIATURE**  
Available voltage range  
400 volts to 6000 volts.

**METAL TUBES**  
Available voltage range  
7 KV to 27 KV.

## HERMETICALLY SEALED RESISTORS (GLASS ENCAPSULATED)

Victoreen carbon deposited resistors are used in applications where ultra-stability and life requirements exceed the MIL-10509A specifications.

### RESISTOR DATA CHART

Type	Resistance	Tolerance %	Voltage Coeff. %/V.	Temp. Coeff. %/°C.	Max. Work. Volt.	Watt.	Max Temp. °C.	Dimensions (Inches)		
								At	B†	C‡
RX-1	10 <sup>8</sup> to 10 <sup>14</sup> Ohm	*2, 5, 10	-0.03**	±0.15	1000	...	100	1 7/8	.20	1
RX-2	1 - 20 Megs.	1, 2, 5, 10, 20	-0.0002	-0.08	3000	1	125	2	.413	1 1/2
RX-3	1 - 200 Megs.	1, 2, 5, 10, 20	-0.0002	-0.08	10,000	3	125	3 1/16	.413	1 1/2
RX-4	200 Ohm to 1 Meg.	1, 2, 5	-0.0002	-0.05	800	5	200	2	.413	1 1/2
RX-5	200 Ohm to 1 Meg.	1, 2, 5	-0.0002	-0.05	2000	10	200	3 1/16	.413	1 1/2
RX-6	100 Ohm to 500 K	1, 2, 5	-0.0002	-0.05	180	1/2	200	3/4	.156	1 1/2
RX-7	100 Ohm to 1 Meg.	1, 2, 5	-0.0002	-0.05	600	1/2	200	1 1/8	.187	1 1/2
RX-8	100 Ohm to 10 Meg.	1, 2, 5	-0.0002	-0.05	750	2	200	1 1/2	.240	1 1/2 Min

\* Below 10<sup>11</sup> Ohm      \*\* Below 10<sup>13</sup> Ohm      † Max      ‡ Min

CAUTION: The higher resistance values of each type are subject to power derating as determined by the maximum voltage rating.



# The Victoreen Instrument Co.

5806 HOUGH AVENUE • CLEVELAND 3, OHIO

For further data on advertised products use page 65.





## Wanted: A Sponsor For ETV---

Television, as all those who are engaged in it know, is a costly business and were it not for the fact that commercially sponsored programs pay dividends to their backers, or at least pay for the time, talent and production of the shows, it is highly unlikely that the television business would be economically practical. It is, perhaps, for this reason that educational television, a form of television not considered suitable as an advertising medium, has failed to develop as a force in our educational system.

That such a condition should obtain is most unfortunate because the use of television as an educational medium would, without doubt, be one of the strongest tools for good that could be put into the hands of educational authorities. It has been said that the highest service that can be rendered by television is the service of spreading knowledge. It is rather ironical, therefore, that while next to nothing is spent on educational television, millions of dollars are devoted annually to the production of purely entertainment type of programs.

★

Recently, however, the welcome announcement was made by Robert W. Sarnoff, president of the National Broadcasting Company, that NBC has earmarked more than \$300,000 for 1957 to make its facilities and personnel available to provide "live" educational programs on a nation-wide U.S. network. The announcement, as reported in the CHRISTIAN SCIENCE MONITOR, marks a red letter day for the 22 American ETV stations who, up until now, have been struggling valiantly with the idea of putting television to work as an educational medium, only to meet with financial handicaps all along the road.

★

According to Mr. Sarnoff, it is NBC's plan during 1957 to furnish specialized educational programs to all of the U.S. non-commercial educational stations. These programs will be produced in NBC's studios and furnished live to educational stations over NBC's network lines. The programming service will be provided at no charge to the educational stations.

★

Each week there will be three half-hour afternoon programs giving instruction in mathematics, the humanities and government. The programs will be conducted by authorities in these respective fields. James R. Newman, author and editor of "The World of Mathematics" has agreed to supervise the mathematics course. These weekly telecourses will run for 26 weeks, beginning in March for 13 weeks and resuming in October for 13 more weeks. They will also be filmed for later use in schools.

So far as is known, little has been done in Canada to develop television broadcasting as a means of classroom teaching. The reason for the lack of interest, presumably, is that a half-hour program in mathematics or the humanities or government is a pretty poor theme on which to sell soap suds, breakfast food or a tonic for run-down blood. Manufacturers of such commodities, however, cannot be blamed for their lack of interest. They are in business to make a reasonable profit.

There must, however, be some way by which the power of television could be put to use as a means of furthering Canadian education, and there is little doubt that such a means will be worked out in due course. In the meantime all we can do is sit back and wait and perhaps look on with a little envy at our American neighbors who are blessed with sufficiently wealthy and philanthropic organizations capable of putting television to one of its higher purposes, the education of the country's future citizens.

## KEEP UP-TO-DATE ON MAGNETICS



## what are the new Performance-Guaranteed laminations?

Whenever our tungsten-carbide dies have produced enough nickel-iron laminations of a new shape to permit stocking them for immediate delivery, we let you know, because we get so many requests for "what's new in Performance-Guaranteed laminations?"

It's rather sensible, the emphasis our customers put on this "Performance-Guarantee." They know it's a guarantee based upon our *higher* quality hydrogen annealing, vital for high permeability laminations.

You see, small percentages of impurities, particularly carbon, oxygen and sulphur, have a deleterious effect on magnetic properties—and they are present in every alloy at the beginning despite the most rigid control of the metallurgy of the heats. In this as-rolled state, *the steel will develop as little as 5% of its ultimate permeability.*

Now everyone "hydrogen" anneals—but not everyone *dry-hydrogen* anneals. You can't use bottled hydrogen, without leaving a surface oxide injurious to magnetic properties and making soldering virtually impossible. So we dry our hydrogen to a dewpoint of  $-60^{\circ}\text{C}$ , removing

the water vapor which is produced by the reduction of hydrogen. Carbon reduces to methane, sulphur to sulphur dioxide, and both are removed by the continuous flow of dry hydrogen during the 24-hour cycle.

As a result of our superior annealing, *we* develop better magnetic properties and clean lamination surfaces, and you get that valued "Performance-Guarantee."

New Performance-Guaranteed shapes, in stock, immediately available: EE 28-29, UI-312, F-21, DU-1, DU-37, rotor, stator and head laminations. Why not write today for Catalog ML-201 and full information on these and all other clean, flat, *burr-free* laminations we manufacture. *Magnetics, Inc., Dept. EC-33, Butler, Pennsylvania.*

**MAGNETICS inc.**

CABLE: MAGNETICS

For further data on advertised products use page 65.



## Evolution at Eimac

Back in 1946 Eimac developed and produced the 4X150A—a new concept in power tetrodes. Its immediate acceptance by the industry then, has led to even more popularity now.

But today at Eimac the glass 4X150A is virtually obsolete.

Since 1946 Eimac has constantly improved the 4X150A to the point where it has evolved into a family of superior quality 250w and 300w tubes for operation to 500Mc. Small, compact structure has been retained. In fact, the 4X250 series is interchangeable with 4X150

tubes. Ceramic envelopes make possible greater mechanical strength, better production techniques, and higher temperature processing.

Because "good enough" has never been accepted at Eimac, however, this family of air cooled or water cooled, co-axial or conventional socketed tubes (2.5v, 6v, and 26.5v) is again accelerating the pace in quality, design, and performance exactly as the 4X150A did a decade ago.

### EITEL-McCULLOUGH, INC.

SAN BRUNO

CALIFORNIA

The World's Largest Manufacturer of Transmitting Tubes



REPRESENTED IN CANADA BY

**THE AHEARN AND SOPER COMPANY LIMITED**  
P.O. Box 715  
Ottawa, Ontario



#### 4X150A

4X150 Series  
4X150A-1946  
4X150G-1949  
4X150D-1952

4W300 Series  
4W300B-1953

4X250 Series  
4X250B-1955  
4X250F-1955  
4X250M-1955  
4CX250K-1956

4CX300 Series  
4CX300A-1956

# Now in Canada!

## ERICSSON

### miniature, long life

# ELECTRONIC TUBES

The following long life tubes are available

TUBE TYPE	Heater		Plate		Grid No. 2		Cathode Resistor	Plate Resistance	Trans-Cond. Mhos	Power Output Watts
	Volts	Amps	Volts	Ma	Volts	Ma				
<b>TRIODES</b>										
2C51/2C51L	6.3	0.300	150	8.2			240	6500	5500	
6J6L	6.3	0.330	130	7.7			100	7000	5300	
18C51	18.0	0.105	150	8.2			240	6500	5500	
18J6	18.0	0.115	130	7.7			100	7000	5300	
	20.0	0.100								
407A			150	8.2			240	6500	5500	
	40.0	0.050								
5842/417A*	6.3	0.300	150	26.0			62	1800	24000	
<b>H. F. PENTODES</b>										
18AK5	18.0	0.053	120	7.5	120	2.0	200	300 k	5000	
5590/401A	6.3	0.150	90	3.9	90	1.4	820	300 k	2000	
5591/403B	6.3	0.150	120	7.5	120	2.0	200	300 k	5000	
5847/404A	6.3	0.300	150	13.5	150	4.0	110	200 k	13000	
6028/408A	20.0	0.050	120	7.5	120	2.0	200	300 k	5000	
<b>POWER AMPLIFIER PENTODES</b>										
6AQ5L	6.3	0.360	180	32.5	180	3.0	220	80 k	3900	2.1
18AQ5	18.0	0.125	180	32.5	180	3.0	220	80 k	3900	2.1
6760	18.0	0.350	130	70.0	130	3.5	100	25 k	12000	3.0
6761	6.3	1.000	130	70.0	130	3.5	100	25 k	12000	3.0

- ERICSSON warrants more than 10,000 hours average life for every tube type in the long life series.
- Robust mechanical construction with properties far superior to internationally used standards.
- Cathode activated by very long aging.
- 50-hour run in period.
- 100% microscopic inspection of each tube during assembly and after sealing.
- Special quality tests for stability, life, fatigue, vibration, vibration output and glass strain.

Mail this coupon today for Electronic Tube data sheets.

\*Recently developed. Life warranty not stated.

# ERICSSON

TELEPHONE SALES OF CANADA LIMITED  
130 Bates Road - Montreal 8, P.Q.

Ericsson Telephone Sales of Canada Limited,  
130 Bates Road,  
Montreal 8, P.Q.

Please send long life Electronic Tube data sheets to:

NAME .....

COMPANY .....

ADDRESS .....

For further data on advertised products use page 65.

**A lollipop-shaped radar antenna 30 feet high and weighing 1690 pounds — capable of being packed into a few boxes less than 21 cubic feet in volume is claimed as . . . .**

## Major Break Through In Radar

A lightweight, mobile radar set whose revolutionary antenna is a giant lollipop-shaped balloon instead of heavy metal has been described as a "major break-through in the design of ground electronics equipment."

Developed by Westinghouse Electric Corporation's electronics division for the Air Force's Air Research and Development Command, the Paraballoon antenna is collapsible and portable. Resembling a giant lollipop, the Paraballoon antenna stands more than 30 feet high — later production models will tower 50 feet. The fiberglass-cloth balloon is preshaped so that when inflated it forms a double parabolic reflector coated on one inside surface with vaporized aluminum to reflect radar waves.

The new radar antenna weighs only 1690 pounds compared to 10,000 pounds for equivalent existing metal antennas and their support structures. The lightweight unit can be disassembled in minutes, packed into air-lift containers, weighing only 200 pounds each, and the entire radar set air-dropped into tactical areas for detection of hostile aircraft.

Westinghouse and Rome Air Development Center engineers pointed out that the tremendous weight reduction, with no loss in radar performance, has been obtained not only through the use of air-inflated, lightweight fabrics, but also the use of lightweight alloys and air-frame design techniques in the Paraballoon structure. The entire three-story balloon rests on an oblong magnesium pedestal.

### *Balloon Unzips, Pedestal Collapses*

The Paraballoon, when deflated, can be unzipped into sections. The magnesium supporting structure also is collapsible. While such a radar set can be packed into only a few boxes about 21 cubic feet each, antennas of comparable range require three to five large cargo trucks.

Of equal benefit is the fact that the

● This lollipop-shaped balloon is a revolutionary new radar antenna developed for the Air Force. Considered a major break-through in the design of ground electronics equipment, this lightweight, air-inflated Paraballoon antenna was conceived by Coleman Miller, a Westinghouse engineer, on the basis of a requirement submitted by the Air Research and Development Command.

Paraballoon antennas can be erected and dismantled an almost unlimited number of times, handled roughly in transit and still retain the desired reflector contour when inflated. A metal antenna, given such treatment, the engineers say, would be seriously damaged if not rendered useless.

When erected in the field, the Paraballoon will be protected from high winds, rain and snow by an air-supported radome, similar to some now in service as fixed radar sites except that the radome in this case is extremely lightweight, sectionalized and designed for mounting directly on the ground. The radome serves to protect

from the elements the complete radar system including antenna, electronics equipment, and operating personnel.

Engineers explained that neither the Paraballoon antenna nor the radome are easy prey to deflation by gunfire. More than 50 20-mm projectiles can pierce the radome and antenna without affecting normal operations. This is because a constant stream of air is sent into the Paraballoon and radome to maintain their low-pressure (less than .02 pounds per square inch for the Paraballoon).

Production engineers estimate that the cost of the Paraballoon will be comparable to or less than metal reflectors so that replacements can be readily supplied to field units.

In addition to its obvious military advantages, the Paraballoon may also lend itself to peacetime applications in the future, according to its designers.

This is one satisfactory method, for example, of obtaining the extremely large reflectors required for radio astronomy work. Microwave communications links which require that large antenna reflectors be installed in isolated locations where ease of installation is of prime importance, offer another possible application.

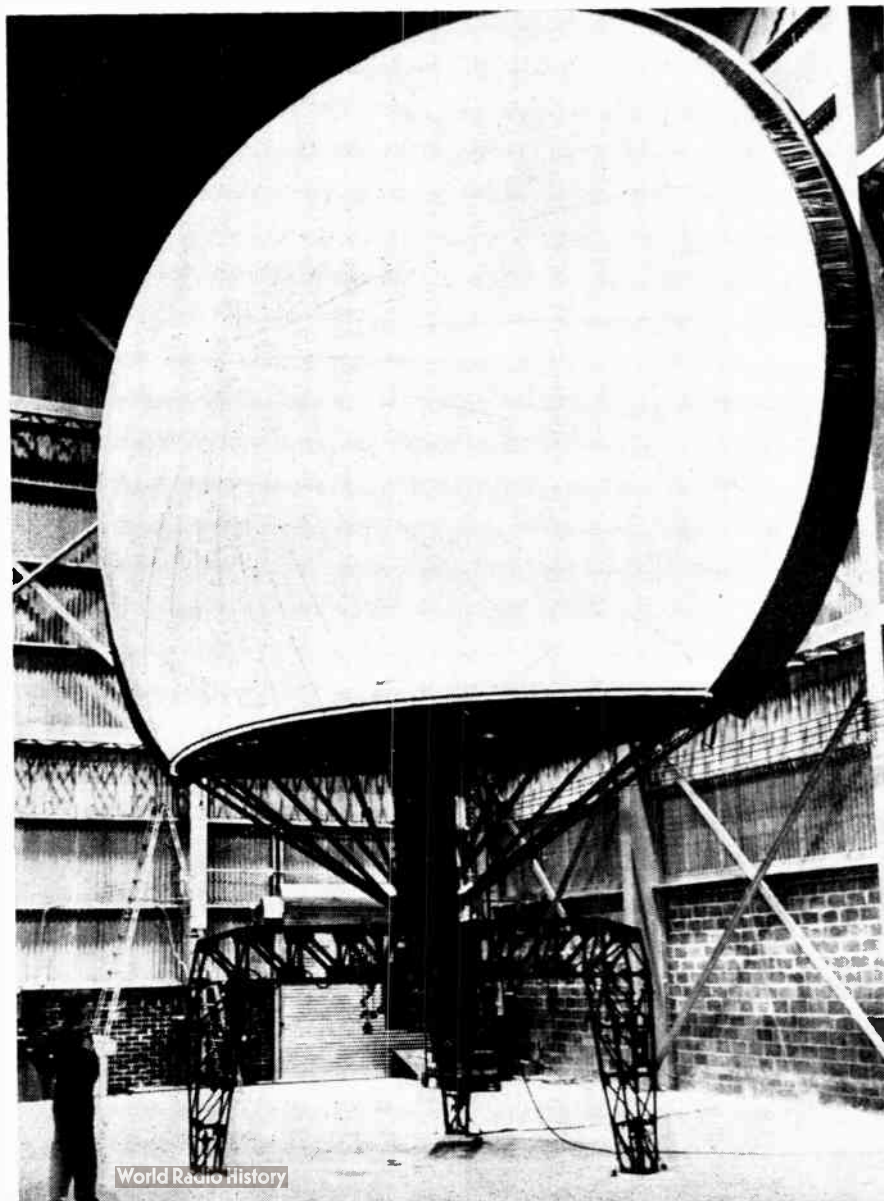

Tests described in this article were made to demonstrate the effectiveness of recently developed equipment under practical conditions and were witnessed by members of the Department of Transport and the Federal Communications Commission of the United States as well as engineers from many of Canada's largest user organizations.

By D. Roddy\*

## 30 Kc/s & 15 Kc/s Narrow Channel Tests In The V.H.F. Band

THE allocation of "split channels" has long been talked about as one method of easing congestion in the 147-174 mc/s communications band. Equipment has now been developed which will allow 30 kc/s same area performance equal to or better than that given by present 60 kc/s channel spacing equipment. With only small modifications, this new equipment will also allow 15 kc/s channelling, some increase in geographical separation being necessary for this latter spacing.

In recent tests of the equipment the interference products looked for were those caused by (a) direct adjacent channel breakthrough, (b) 3rd order intermodulation products, (c) cross modulation, and (d) desensitization. A further test was made to show the effect of a low deviation FM transmission on an adjacent 30 kc/s AM system.

Before describing the tests in detail, a brief description of the equipment will be given, along with the setting-up procedure used.

Pye type PTC-724YV AM base stations were used, these giving 15 watts nominal R.F. output, unmodulated. Modulation limiting is employed on

these to prevent excessive sideband radiation. High audio frequencies produced by speech and by limiting action in the modulator tubes are severely attenuated by a filter, and the modulation on the P.A. tube is limited to approximately 80%. This prevents non-linearity in the P.A. from producing unwanted sidebands directly, as these would be extremely difficult, if not impossible, to reject using a filter.

The frequency accuracy and stability of the base station equipment, taking into account all sources of error such as ambient temperature variations (-30°C to +60°C), voltage variations ( $\pm 10\%$ ), ageing of crystals and circuits, and the I.F. drift in the case of receivers, is approximately  $\pm 0.0008\%$  for the transmitter, and  $\pm 0.002\%$  for the receiver. The transmitter and receiver 1st oscillator crystals are oven controlled. These figures are derived assuming that all sources of error act together in one direction; it is also assumed that the equipment will be periodically renetted to frequency in service.

Two Pye PTC-3/2002YV and one Pye PTC-2002YV AM mobiles were used for the 30 kc/s tests, the differ-

ence between these models being that the former can be switched to any one of three channels, while the latter is a single channel mobile. Power output is 5 watts nominal, unmodulated. These employ modulation limiting similar to that on the base station. The mobile equipment frequency accuracy and stability is approximately  $\pm 0.0023\%$  for the transmitters and  $\pm 0.0035\%$  for the receivers.

The above figures are derived by the same method as that used for the base station.

Oven control is not used however, as the system was considered to be essentially a base to mobile (and vice versa) operation, and not including mobile to mobile. If the latter case was to occur frequently, it would then be necessary to use oven control on the mobiles, giving these the same overall accuracy and stability as the base stations.

The 15 kc/s receivers (base and mobile) have additional I.F. transformers to give the necessary adjacent channel rejection at 15 kc/s. The mobile receiver also has 1st oscillator crystal oven controlled. Otherwise the 15 kc/s receivers are identical to the 30 kc/s receivers. Except for oven controlling the 15 kc/s mobile transmitter, the transmitters in the two systems are identical.

The F.M. base station was a Pye PTC-8701/2YV. This gives 20 watts nominal R.F. output and is phase modulated. High audio frequencies are attenuated, and deviation is limited to 5 kc/s for 30 kc/s channel operation. The frequency accuracy and stability is the same as the A.M. base station.

The overall design of the equipment incorporates modern circuit techniques and component advances which enable it to overcome some, and substantially reduce other interference problems. Low gain grounded grid amplifiers are used in the R.F. stages, having low voltage gain consistent with a good noise factor. This, coupled with the use of R.F. amplifier and mixer tubes having a good degree of linearity reduces intermodulation and cross-modulation interference to a very low

- 15-watt fixed station. This employs the design features described in the Ranger; the drawer type assembly permits rapid and easy servicing.

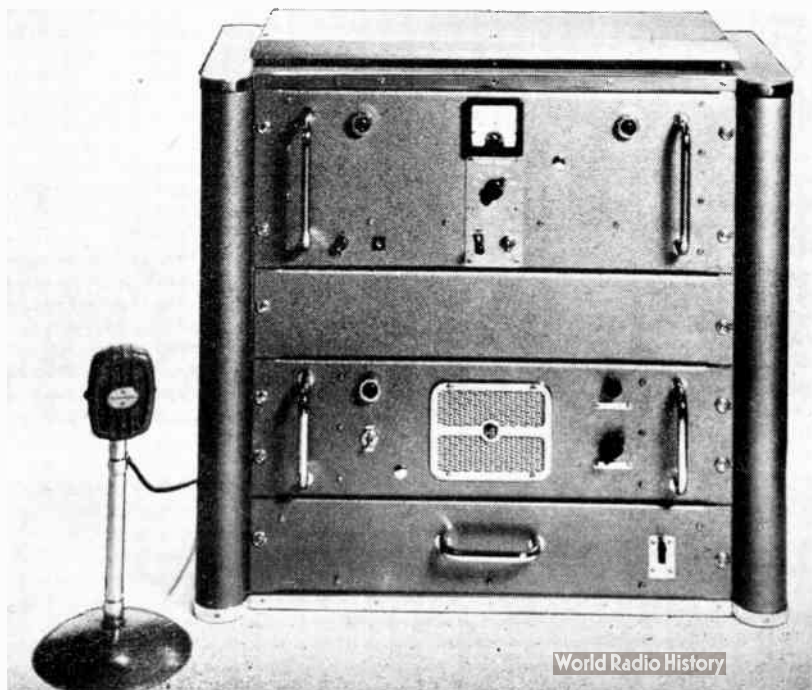

degree. The superior adjacent channel selectivity is due to the advanced design of the I.F. transformers as well as the frequency stability provided by close tolerance A.T. cut crystals and use of miniature crystal ovens as discussed previously. The I.F. transformers mentioned are encapsulated units using ferrite coils and small highly stable capacitors, and these provide the necessary selectivity in a small size, and with the required degree of stability. The I.F. amplifier, having six transformers, has a nose-width of 12 kc/s, a bandwidth factor of 3, and a frequency drift not exceeding 1 kc/s.

Noise limiters are used in the receivers which provide a high degree of freedom from impulse noise, even though the narrower bandwidth increases the receiver's susceptibility to this type of interference. Inherent receiver noise is reduced in direct proportion to receiver bandwidth and the narrow band receiver is noticeably quieter than the 60 kc/s counterpart.

As mentioned, the transmitters employ modulation limiting with subsequent filtering. The overall system, i.e., including transmitter and receiver, therefore requires much less spectrum bandwidth, and a marked advantage is that the good audio quality inherent in properly designed A.M. equipment is maintained even though less bandwidth is being used.

#### Setting Up

The transmitters were netted (by means of a trimmer in the crystal cir-

cuit) to a frequency standard accurate to  $\pm 0.0001\%$ . The receivers were also netted to this standard, but in addition, used a crystal controlled oscillator at I.F. to obtain zero beat. This oscillator is a pocket size transistorized unit, (known as the Pye PTC-422).

The ease by which receiver frequencies could be adjusted in the field was demonstrated using this small portable oscillator. This was plugged into a socket (accessible behind a removable front plate) on a mobile in service. A base transmission, which had been netted to the  $\pm 0.0001\%$  standard, was then received by the mobile and the receiver netting trimmer adjusted for zero beat between the resulting I. F.

and the portable oscillator frequency.

All receivers had their squelch controls set at normal operating level, which is about .5 microvolt. In some tests, however, the mobile receiver squelch was made inoperative, the receiver then being in its most sensitive condition. This is mentioned in the tests where applicable.

#### Installations

The mobile equipments operated into quarter-wave roof-top antennae, and the base stations into quarter-wave ground-plane antennae. Further details of the base stations, shown on the map as 1, 2 and 3 are:

1. Operated as any one of, Channel 1,  $F_n = 161.115$  mc/s A.M. or, Channel 1.5,  $F = 161.30$  mc/s A.M. or, Channel 4,  $F_n = 161.205$  mc/s F.M. Antenna elevation, 590 feet A.S.L.
2. Operated as channel 2,  $F_n = 161.145$  mc/s A.M. Antenna elevation, 580 feet A.S.L.
3. Operated as channel 3,  $F_n = 161.175$  mc/s A.M. Antenna elevation, 520 feet A.S.L.

#### 30 kc/s AM System Tests

**Test 1. Routine Check:-** The three mobiles rendezvoused at point A (see map 1) and there communication was established between mobiles and fixed stations. The two multi-channel mobiles switched to all channels and observed the degree of inter-channel crosstalk. This was found to be negligible.

**Test 2. Direct Adjacent Channel Interference (Mobile-to-Mobile):-** Using mobiles 1 and 2 (both 3 channel mobiles) at point A, mobile 1 first transmitted on channel 2 and mobile 2 listened on all channels in turn. Similarly, mobile 2 transmitted on channel 2 and mobile 1 listened on all channels. The mobiles were less than five yards apart during the test, without interfering with each other.

**Test 3. Intermodulation Interference:-** With mobiles at point A, base

(Continued on page 62)

● Map of the Toronto area in which Pye Canada Limited conducted narrow channel tests in the V.H.F. band,

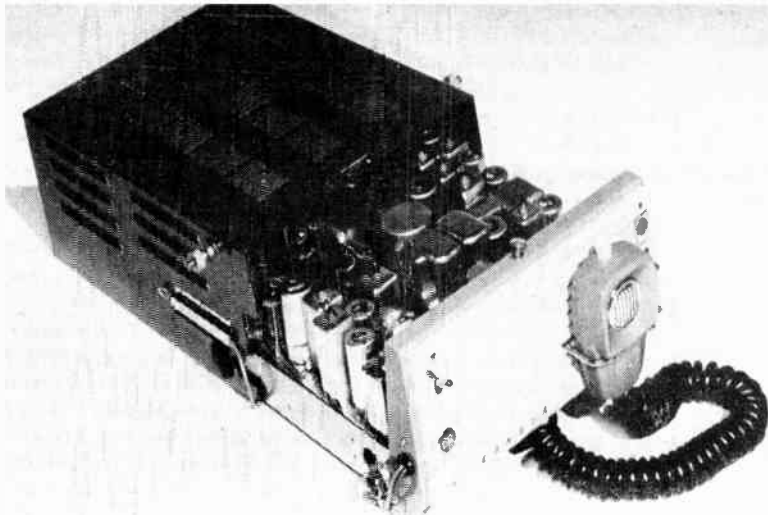

● 5-watt Ranger, designed with a high degree of spurious sideband rejection while still maintaining good audio quality; the sensitive receiver is capable of close range 30 kc/s channel operation; the equipment maintains its performance over temperature variations of  $-30^{\circ}\text{C}$  to  $+60^{\circ}\text{C}$  and up to 95% relative humidity. Note the selector switch at the side which enables 6 channel selection.

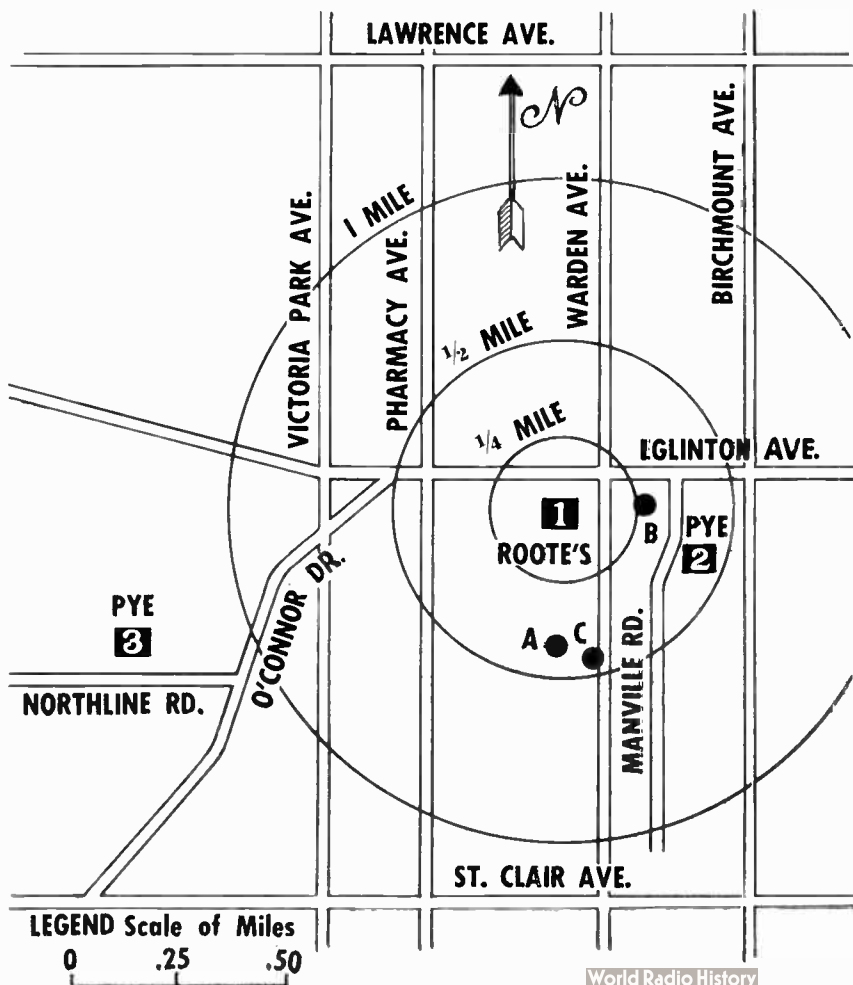

# An Equipment For Measuring Dielectric Constants In The 3CM Band \*

THE measurements involved are the change in resonant length and in Q-factor of a cylindrical cavity, resonating in the  $^{\circ}HO_{14}$  mode, on insertion of a disc of dielectric material.

A block schematic diagram of the circuit is shown in Fig. 1. The oscillator, which is swept through a small range of wavelengths about 3.2 cm., supplies r.f. power through a variable attenuator to the test cavity, and through a 10 db. directional coupler to the reference cavity.

The reference cavity is preset to resonate at a wavelength of 3.2 cm. The response of both cavities is amplified and applied in opposition to the vertical deflection plates of the cathode ray tube. The condition when the cavity is resonant at the same wavelength as the reference cavity is indicated by a null on the cathode ray tube.

The change in Q-factor of the test cavity on insertion of the sample is determined from the change in width

An equipment which enables the relative permittivity (K) and the ratio of loss factor to relative permittivity ( $\tan \delta$ ) of dielectrics to be determined both easily and accurately at a wavelength of 3.2 cm.

of the resonance curve of the cavity at a given power level. A comparison is made between the peak amplitudes of the outputs of the cavities and the difference displayed on a meter. With the test cavity tuned to resonate at the same wavelength as the reference cavity the peak outputs of the cavities may be made equal by adjusting the attenuator until the balance meter reads zero. The peak output of the reference cavity is then reduced a known amount, normally 7 db. thereby providing a reference level at which to measure the width of the test cavity response. The test cavity is then detuned on either side of the reference cavity resonant wavelength until the meter again reads zero. The distance between these balance positions as measured by the micrometer head of

the test cavity, being the width of the resonance curve.

Any variation in amplitude of the oscillator output will affect the measured reference and test cavity outputs in a like manner, therefore the reference level will always be the same fraction of the test cavity peak output.

This method ensures that the measurements are carried out at the correct wavelength and power level.

The tedious calculations usually necessary to obtain the permittivity and  $\tan \delta$  of the dielectric, from the measured values of change in resonant length and Q-factor have been obviated by plotting a series of graphs from which these factors may be directly obtained.

(Continued on page 33)

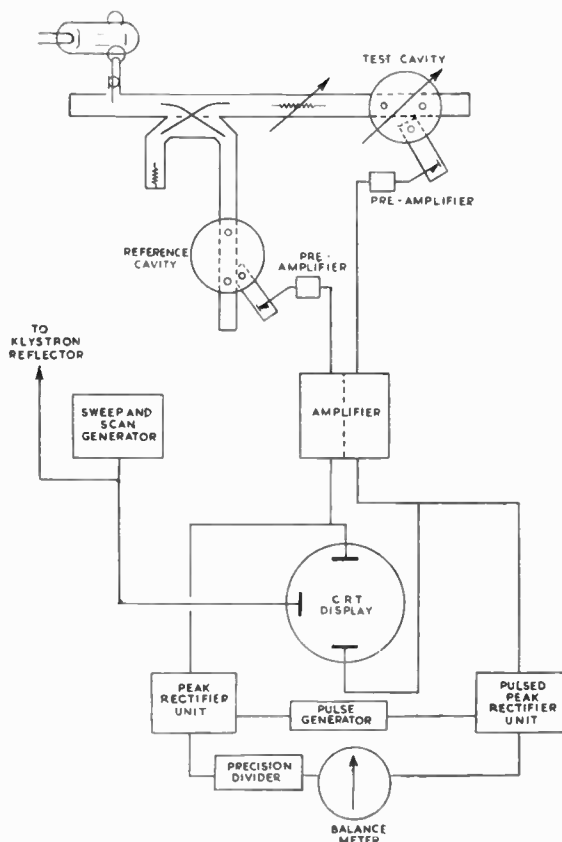

Fig. 1

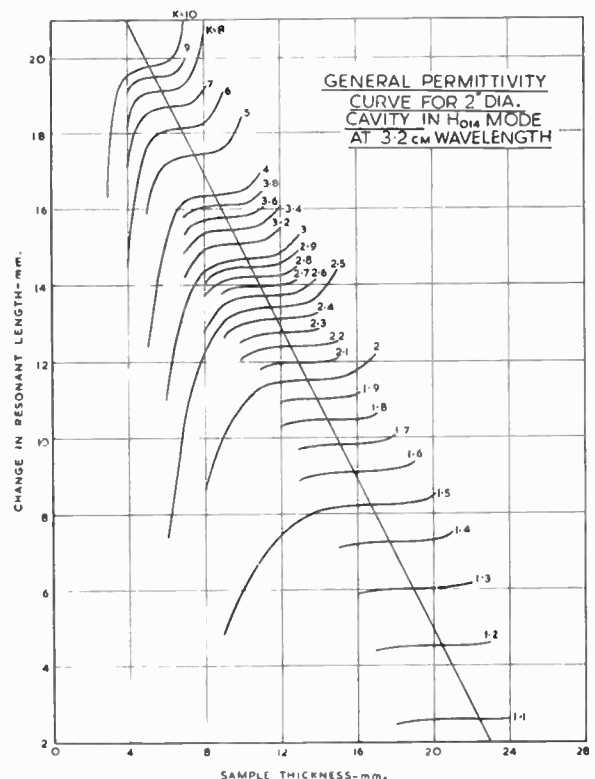

Fig. 2



With the development of electronic tools for use in surveying the mapping of inaccessible areas can be accomplished with speed and efficiency.

By Leslie L. Hill, Ph.D.

# Radiant Energy System For Measuring Distance

**E**LECTRONIC systems used in surveying are usually pulse systems which are somewhat complicated and require considerable time in the training of personnel. The use of sonic waves for measuring distance is also well known, e.g. sonar, depth sounding and sonic thickness gage systems, but the equipment used in these methods tends to be heavy and bulky and therefore not suitable for transporting to remote regions for the purpose of surveying.

Other systems use continuous-wave methods in which a wave of known frequency is transmitted and reflected or re-transmitted from the distant station. The phase difference between the transmitted and received waves is a measure of the distance between the two stations. However, if the phase shift is over  $360^\circ$ , an ambiguity is introduced and if it is under  $360^\circ$  the phase cannot be measured with any great degree of accuracy. To resolve this dilemma it is common to provide that a series of measurements be made at different frequencies, often  $f$ ,  $10f$ ,  $100f$ , etc., these frequencies being used to modulate a high-frequency carrier wave or a beam of light. From the measurements the distance can be accurately computed. Alternatively, two frequencies,  $f$  and  $f + \Delta f$  are simultaneously emitted and the phase of the transmitted beat-rate  $\Delta f$  is compared with that of the received beat note  $\Delta f$ , this being done with several values of  $\Delta f$ .

Disadvantages of these systems are that waves of widely differing frequencies are used. This necessitates the use of apparatus for modulation, demodulation, amplification, or phase-comparison, which will deal with a large range of frequencies without variable phase-shift or loss of accuracy and, in many cases, the use of several oscillators. Circuits must be provided which are capable of equivalent performance over a frequency spectrum, which may comprise frequencies having ratios as great as  $1000 : 1$ .

The foregoing drawbacks may be

avoided by the employment of a narrow range of frequencies. The phase difference at one modulating frequency may be registered on a dial or on paper, and the phase differences at the other modulating frequencies are then compared with the first phase difference in order to eliminate ambiguities.

One of the revised systems incorporates an oscillator the frequency of which is accurately stabilized by one of several quartz crystals, the frequencies of which are, for convenience, ground to be  $f$ ,  $f-f/10$ ,  $f-f/100$ ,  $f-f/1000$ . The oscillator frequency is then modulated onto a transmitter which may be a microwave generator. The radiation is received by a receiver at the distant station and re-transmitted on a different frequency to the first station where it is received by the other receiver, the output of which is connected to one of the inputs of a phase comparator meter. The other input of the comparator is connected directly to the output of the oscillator. Thus, the phases of the outgoing and incoming waves are compared.

Suppose the time taken for a wave to perform the journey to the second station and back again is  $T$ :

at frequency  $f$ , the phase difference =  $T_f$  cycles,  
at frequency  $f-f/10$ , the phase difference =  $T_f - \frac{T_f}{10}$

at frequency  $f-f/100$ , the phase difference =  $T_f - \frac{T_f}{100}$

at frequency  $f-f/1000$ , the phase difference =  $T_f - \frac{T_f}{1000}$

Subtracting the phase at frequency  $f-f/10$  from the phase at frequency  $f$ , we get  $\frac{T_f}{10}$ .

Similarly, we obtain  $T_f/100$ ,  $T_f/1000$ . If  $f$  is chosen to be say  $5 \text{ Mc/s}$ , or close to it,  $T_f$  is equal to the distance in hundreds of feet, with the integral

number of hundreds uncertain;  $T_f/10$  will be a measure of the thousands of feet, with the integral number of thousands uncertain,  $T_f/100$  and  $T_f/1000$  will measure the tens of thousands and hundreds of thousands respectively.

The distance may therefore be measured accurately and without ambiguity if it is less than  $100,000 \text{ ft}$ . Allowances for phase shifts in the apparatus may be made by determining them at a known distance.

This device has a drawback in that the distance must be computed on paper. It is preferred, however, that the subtractions be performed mechanically, and on the completion of some adjustments the distance be read off a series of dials. Interlocked phase-shifters may be used. Each phase-shifter has an input and an output. The phase of the output relative to the input may be varied by the movement of a rotor in such a way that the rotation of the rotor is equal to the rotation of the output vector. The phase-shifters may be inductive goniometers or condensers.

(Continued on page 31)

● Helical Antenna (Helix illuminating parabolic dish with circular polarization to cut out ground reflection).

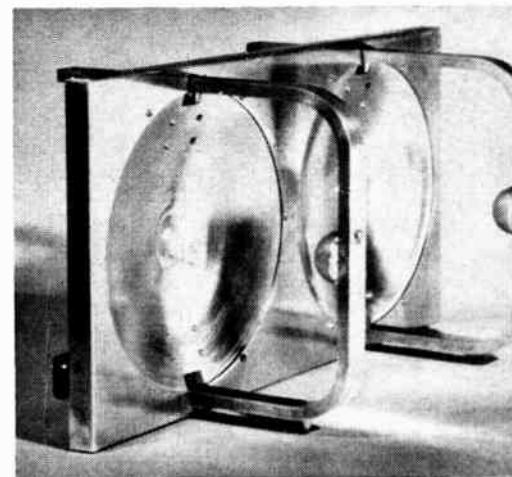

# Selection Of Towers & Antennas For Microwave System Use\*

In microwave installations, tower and antenna equipment should be selected and located so as to assure maximum transmission quality and reliability. Both technical and economic factors are involved. In many cases, the final choice is a compromise between them.

This article discusses some of the technical and economic factors that enter into the selection of towers and antennas.

**M**ICROWAVE systems in the United States operate above 890 megacycles. Because they behave somewhat like light waves, microwaves can be reflected from smooth conducting surfaces and focused by reflectors or lenses. When radio waves pass from one medium to another (as from dry air to moist air) they are bent or refracted in the same manner as light waves are bent by lenses or prisms. Radio waves bend around large obstacles in their path by a process known as diffraction. And at frequencies above 4000 mc, they are scattered by small particles such as rain and snow.

Each of these effects can cause variations in the received signal strength. Consequently, it is necessary that they be considered and allowances made for them when engineering a radio system. The proper selection and location of towers and antennas is an important part of that engineering.

Towers and antennas are generally chosen after surveys have been made of the area where they are to be located. The microwave propagation path, topography of surrounding area, weather conditions, and economic factors are all considered. They determine

which of the many available types of towers and antennas will best meet system requirements.

## Propagation Path Considerations

Adequate clearance for the microwave propagation path and its length are among the most important considerations in system engineering. They determine the number of repeater stations, antenna reflector sizes, and tower heights.

Propagation path clearance and antenna heights are usually established through the use of profile charts. A chart, such as the one shown in Fig. 1, is plotted from contour maps of the proposed area. As trees and buildings are not shown on ordinary contour maps, a visual survey of the area is often made to verify the path. Altimeter readings are also taken to check the accuracy of the profile chart or to plot the chart if contour maps are not available.

After the profile has been checked, the path clearance is determined. On the chart in Fig. 1, point C is the worst obstacle in the system's path. To achieve propagation essentially the same as free space, the line-of-sight path should pass over the obstacle with a clearance of 0.6 of the first Fresnel zone<sup>1</sup>. With this clearance established, point C can then be used

as a "leverage point" to determine the most suitable antenna heights.

## Tower And Antenna Locations

Desirable tower locations will provide a clear, unobstructed path with the necessary clearances. Mountain tops, hills, buildings, and other tall structures can reduce the height requirements for towers. Other factors to be considered are land costs and availability, accessibility for post-installation maintenance and the provision for interconnection with other facilities.

Although sometimes impractical, paths are often planned to bypass certain areas that may later disturb system operation. Large bodies of water, large flat land areas, power plants, high voltage power lines, chemical plants and areas that flood should be avoided if possible.

Towers located near airfields will be subject to stricter requirements. Civil Aeronautics Administration regulations require that all towers within a specified distance of an airfield be equipped with warning lights and a light failure alarm. And in addition, the towers must be painted red and white.

Tower sites are often located in remote or sparsely settled areas. This is especially true of repeater installations. When selecting such a site, it is important to evaluate the expense of building access roads and the obtaining of power to operate equipment. Locations near existing roads and power facilities will reduce both the expense of installation and subsequent maintenance.

## Equipment Strength And Rigidity

When selecting microwave system towers, a primary factor to consider is the tower's ability to safely withstand years of wear under varying weather conditions. The possibility of high winds, heavy ice formations and corrosion should be anticipated.

Present-day tower construction methods follow safety and construction standards agreed to by the industry. The standards recommended and published by the Radio-Electronics-Tele-

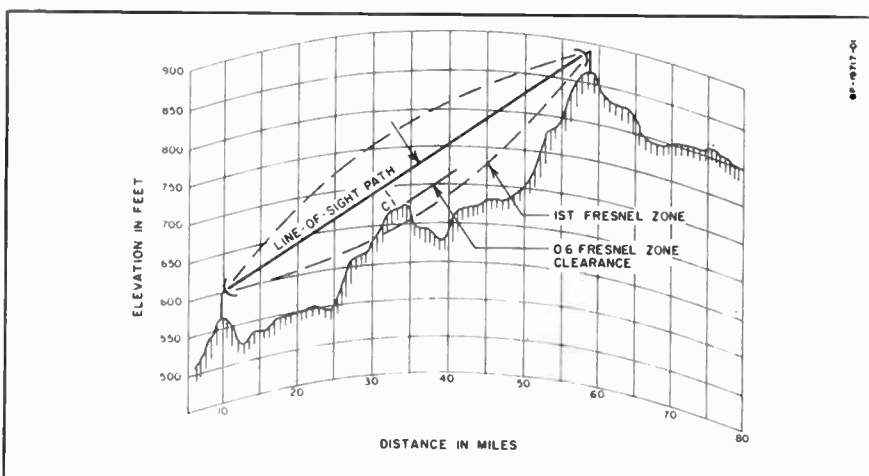

Fig. 1. Profile charts are prepared from contour maps to obtain elevations of points along the propagation path. Adequate path clearance and antenna heights are determined from these charts.

<sup>1</sup>See Lenkurt Demodulator for June, 1954 and January, 1955.

vision Manufacturers Association (RETMA) include loading specifications, unit stress allowances, foundation requirements and quality of materials and workmanship. These are minimum requirements. Most installations will require a greater safety margin.

According to standard specifications, all towers higher than 600 feet and those of any height located within a city's limits must be capable of withstanding 30 pounds per square foot of horizontal wind pressure (equal to an actual wind velocity of about 85 miles per hour). For all other towers, the minimum requirement is 20 pounds per square foot. These requirements apply to antennas as well.

Under certain conditions, towers and antennas will need to be much stronger. In some southern hurricane areas, for instance, local laws require that they be able to withstand 50 pounds per square foot of wind pressure. Local restrictions should be checked when determining tower strength. In all cases, it is advisable to allow a wide safety margin.

Winds present still another problem — torsional twist of the upper portion of the tower. For maximum reception of the transmitted energy, the transmitting and receiving antennas must be aimed directly at each other. In actual practice, however, some torsional twist is unavoidable.

Field tests have determined limits for the maximum torsional twist that can be allowed. For systems operating in the 900 mc region,  $\pm 3$  degrees is allowed. Since the twist is more noticeable at higher frequencies, systems operating in the 6000 mc region have a limit of  $\pm \frac{1}{2}$  of a degree. In general, twists of about  $\frac{1}{3}$  of beam width are permissible.

### Equipment Types And Applications

Supporting structures for microwave antennas vary from tubular frame brackets mounted on the side of a building to large steel towers over 300 feet high. In some cases, the desired antenna height may be low enough to use the radio equipment building itself, or poles such as those used for wire-line facilities, or any other structure strong enough to support antennas and reflectors.

For high antenna elevations where no other suitable structures are available, steel towers are needed. They are available in three general types. These types, shown in Fig. 2, are (a) self-supporting; (b) guyed; and (c) a combination of self-supporting and guyed. The structures vary somewhat from manufacturer to manufacturer, but most conform to RETMA and government standards for safety, wind loading, and quality of construction.

The choice of a tower is largely dependent upon the land area available and the cost of transmission lines from radio equipment to the antenna. For example, self-supporting towers are generally used atop buildings, in

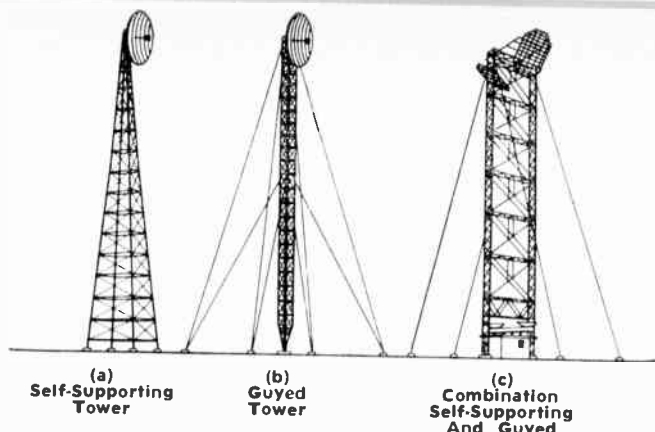

Fig. 2. Three types of steel towers are available for microwave system use. Towers (a) and (b) are shown with parabolic reflectors. Tower (c) supports two passive reflectors with two parabolic reflectors mounted on the roof of the building.

cities, or in any other area where space is limited. When towers are put on buildings, extensive reinforcement of the building may be necessary to support the structure.

Guyed towers are generally less expensive than the self-supporting types. They are used in areas where space is not a limiting factor or when the cost of the transmission line from the central office is less than the cost of a self-supporting installation.

Combination self-supporting and guyed tower installations have many of the better features of the two basic types. As shown in Fig. 2 (c), combination towers can straddle-mount the radio equipment building to utilize the advantages of passive reflectors. The radiating and receiving antennas, located on top of the equipment building, eliminate the need for costly high-frequency transmission lines to the top of the tower. Other types of antennas and reflectors can also be used.

Antenna selection is determined by

the operating frequency, desired gain and directivity, and ability to meet wind loading requirements. Antenna gain and directivity increase with an increase in reflector size or operating frequency. Thus the selection of antennas is usually dependent upon system transmission requirements.

High antenna gain and directivity may be obtained by locating a large parabolic reflector behind the radiating element. The approximate gain of such an arrangement can be determined from Fig. 3. For example, a 10-foot reflector would have a gain of 28 db at 1000 megacycles.

Using the nomograph, antenna gain for a one-half wavelength dipole antenna with a parabolic reflector can be determined for given values of frequency and reflector diameters. The resulting gain is with reference to an isotropic (omnidirectionally radiating) antenna with an assumed efficiency of 65 per cent.

\*Courtesy Lenkurt Demodulator.

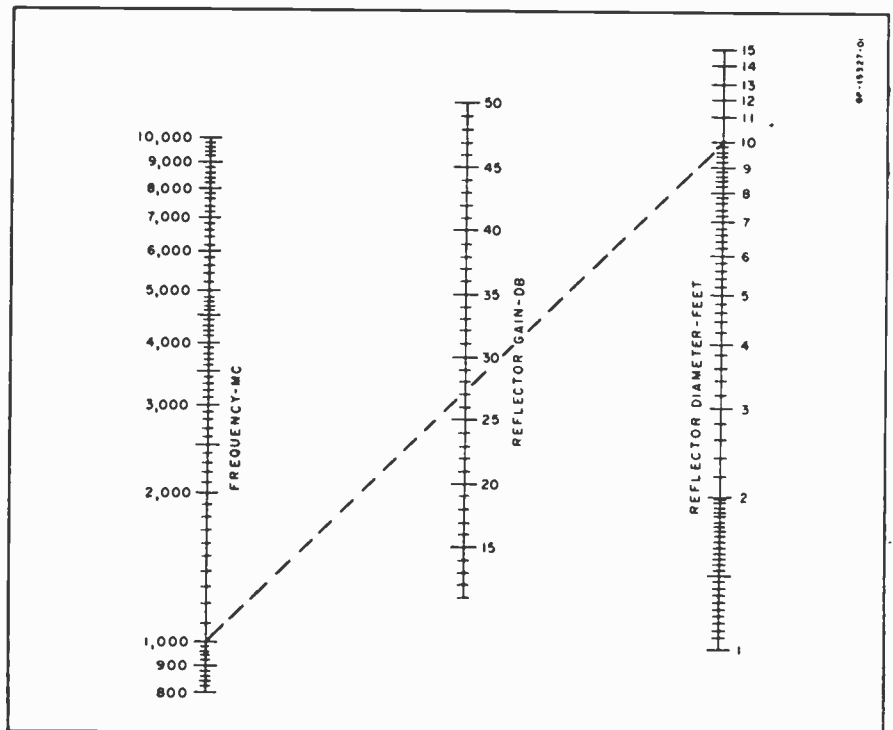

Fig. 3. Antenna gain for one-half wavelength dipole antenna with a parabolic reflector. The gain is with reference to an isotropic antenna with an assumed efficiency of 65 per cent.

Burdened by an ever-increasing volume of paper work, business can now look forward to some relief in the matter of tedious filing routines by the use of modern . . . .

## Electronic Filing Units

**A**N "electronic filing" device — using short lengths of magnetic tape to provide compact storage and rapid access to almost unlimited volumes of business information — was premiered by Burroughs' ElectroData Division at the Eastern Computer Conference held in New York last month.

Used in conjunction with a Datatron electronic computer, the new system supplies 10 times the maximum file capacity of any other data processing equipment now available. According to the manufacturer, it permits volume-handling for the first time of all business records — inventories, payrolls, accounts receivable, etc. — at a fraction of the cost on large-scale computers.

Each unit stores 20-million characters in a single memory unit the size of an ordinary deep-freeze and up to 10 of the units can be integrated into one computer system — stretching its memory to an unprecedented 200-million characters. Any given record can be automatically sorted-out, processed and re-filed in seconds.

The new design concept physically "segmentizes" information by elimi-

nating conventional tape reels. This principle not only affords voluminous file capacity but achieves exceptionally high processing speed.

Fifty 250-foot tapes inside each unit magnetically store the business records at hand. Information is calibrated into addressable blocks of 200 characters each. The tapes, housed in static-free metal bins, move backward or forward over guide-rods at 60 inches a second.

At a single program command from the computer, twin read-write heads are propelled beneath the tapes and stop at the designated position to read or write 1 to 100 blocks of information, at the rate of 46 milliseconds per block. The computer automatically processes the records selected — e.g., invoices, sales commissions, insurance policies — and restores them to their previous locations.

Tape capacity is effectively doubled through the use of two parallel lanes of six information channels each, interlaced across the tape's width. This offers unique flexibility for organizing records within a single unit — serially, in parallel or at random. Tapes can be written on repetitively for spot-

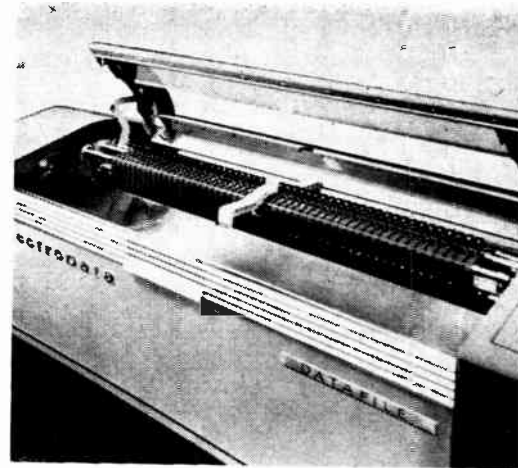

● Fifty short lengths of magnetic tape in the Datafile provide compact storage and rapid access to virtually unlimited volumes of business information in seconds. Datafile's new design concept physically "segmentizes" information by eliminating conventional tape reels.

updating of information.

Records are stored in the unit in the same decimal form as used with the manufacturer's Datatron computer. A built-in checking code and automatic editing process precludes transient errors, such as those caused by dust particles.

Perforations at the end of each tape actuate a vacuum switch which automatically stops the tape. Combined with block addressing, this prevents loss of information due to tape "run-out". The new equipment can search its tapes independently, leaving the computer free for other data processing.

### Electronic Component Manufacturer Cuts Production Cost With Use Of . . . . .

## Semi-Automatic Molding

**S**EMI-AUTOMATIC molding has helped Collins Radio Company reduce the molding time and lower the production cost of a number of the plastic components of their transmitters and receivers for aircraft communication systems.

Engineers in charge of Collins' plastic molding operations give much of the credit for their department's improved efficiency to a Stokes 100-ton semi-automatic transfer molding press installed about 18 months ago.

Among the parts molded on the press are antenna terminal insulators for antenna tuners, antenna mounting insulators, contact strips used in transceivers and many kinds of knobs used in other equipment.

In earlier molding procedures, a large amount of hand labor was required to service complicated multiple-piece sectional dies, and as a result production cycles were rela-

tively long and costs were high. The new semi-automatic procedures made possible by the new press eliminate most of the hand labor and shorten the overall molding cycles.

In addition to the use of preforms, Collins also uses a special oven to pre-heat the plastic material. The operator then weighs out the correct amount for the piece to be molded, pours or rough-forms it by hand, and inserts it in the special press, where heat and pressure are applied for the proper length of time to completely cure (or harden) the plastic. The mold is then opened and the parts are removed.

The glass-reinforced alkyd plastic used to mold terminal insulators is heated to 235 deg. F. and cured for one minute in the press. The phenolic plastic used for the various knobs is heated to 310 deg. F. and cured for 75 seconds.

Besides taking its place on the production line, the new press has been used in the exploration of a number of other applications for plastics, including printed circuit boards and components using foam plastics. Plastic tooling is also being evaluated experimentally.

● Molding press operator at Collins Radio Company, Cedar Rapids, Iowa, weighs out the right amount of the loose plastic material, a glass-reinforced alkyd resin, after it has been pre-heated in a special oven.



# electronics

## in business & industry

### job evaluation . . .

The General Electric Company is employing computers to give assistance in finding the right person for the job in hand. Information on 10,000 General Electric engineers and scientists is stored in a central data processing system called the Engineering Personnel Register. When the company needs a man for specific work, a job description is put into the system, which automatically reveals the men who might well qualify for such work and from whom the final selection may be made.

\* \* \*

### metal working . . .

Airborne Instruments Laboratory, Inc., of Mineola, N.Y., is producing a line of standard devices that can be linked together to do a variety of jobs on many types of metal working machines. This new line of electronic gaging and control equipment is designed to give the smaller shop a slant towards automation. All that is necessary is to break the job down into mechanical sequence and hook up a building block unit for each step of the operation.

\* \* \*

### air conditioning . . .

The Philco Corporation has produced a device, known as the Ionitron, which is built into their air conditioners and which will be a boon to hay fever sufferers. The Ionitron filters dust and pollen out of the air and throws negatively charged ions out into the room. These ions, or molecules with extra electrons, have the effect of helping to relieve the painful symptoms of hay fever.

\* \* \*

### metal testing . . .

A device for testing metal fatigue has been developed by the National Bureau of Standards of the U.S.A. It includes a motion picture camera to record the microscopic changes taking place in the surface of a metal that is being weakened by fatigue.

\* \* \*

### boiler testing . . .

An improved method of conducting boiler tests has been devised by Babcock & Wilcox and Bailey Meter Co. through the use of electronic equipment. "Sensing elements" are connected to analog scanners at various boiler locations to collect data on temperatures, pressures, gas composition, and on air, water and steam flow rates. The information, plus design factors, is punched on tape and teletyped to Babcock & Wilcox's electronic computer in New York City, which rapidly calculates how to set up the boiler for maximum efficiency and lowest fuel rate.

\* \* \*

### computation . . .

A computer that looks like a round slide rule, is said to cost less and do a faster and more accurate job than earlier devices has been developed at the National Bureau of Standards. This hand computer calculates the water content of gases.

\* \* \*

### data processing . . .

A hurdle to be overcome in translating information from machines such as cash registers, adding machines and other standard equipment to modern automatic data processors has been solved by Typatape, Inc., of New York City. The company has produced units that can take information from the oldest standard machines and translate it on to regular punch cards that can be fed into various types of business machines or used in card records and billing.

\* \* \*

### cutting tools . . .

A device, based on the Cavitron process used in dentistry, has been devised which uses high frequency sound waves to activate cutting tools for hard and brittle materials such as steel, glass and ceramics. The oscillation of the tools is almost invisible to the human eye and is harmless to resilient substances and to the hands and fingers. These cutting systems are the products of Sheffield Corporation of Dayton, Ohio.

(Continued on page 47)

## business briefs & trends

★ A province in Western Canada has recognized the urgent need for promoting natural scientific research by establishing a new laboratory and pilot plant for the Research Council of Alberta at a cost exceeding one million dollars.

\* \* \*

★ British aircraft export sales for the first nine months of 1956 totalled over \$200 million, an increase of more than 71 per cent over the same period of the previous year. The British aircraft industry is fast becoming a rival to the United States for the world's aircraft export business.

\* \* \*

★ American machine tool builders have taken orders in the first nine months of 1956 for over \$700 million of new business and have a backlog of months of work. It is estimated that when the year's orders have been totalled, they will approximate one billion dollars.

\* \* \*

★ Following a trip to Japan, the Hon. C. D. Howe, Canada's Minister of Trade and Commerce, revealed that Tokyo is about to launch its program of atomic power development. This suggests the possibility that Canadian uranium might find a ready market in Japan.

\* \* \*

★ A recent survey conducted in the United States to determine the trend of TV-watching and radio-listening habits revealed that the weekly hours spent in watching television have dropped slightly from the peak established in 1955. Radio listening, on the other hand, has picked up gradually during the afternoon and evening hours where television had previously made a bid for preference. Morning radio has not lost its popularity, according to the same survey.

\* \* \*

★ Latin American countries are placing orders for atomic reactors in a \$550 million expansion program. Brazil and Cuba will be among the first countries to get these single-cycle boiling water reactors.

\* \* \*

★ A shortage of executives by 1965 is the prediction of Lawrence L. Ellis, management consultant in the United States, "unless business takes action to improve the rate of growth of the management pool." Mr. Ellis claims that any demonstrable program for development of "executive quotient" has the following four elements: (1) a sound organizational structure; (2) effective appraisal methods; (3) selection of applicable development techniques; and (4) a comprehensive and competitive compensation program.

\* \* \*

★ A hiring plan has been launched in New England to bring hundreds of new workers into air traffic control and communications offices. This is part of a nationwide program to make airways travelling safer in a trend towards higher speeds. Wider ranges of speed have created a safety problem, and it is expected that electronic equipment will increasingly aid in combatting the elements of danger. The Civil Aeronautics Administration in the United States proposes to spend over \$200 million on safety measures in the next three years.

\* \* \*

★ The Babcock & Wilcox Co., New York, has been awarded a contract by the Atomic Energy Commission to equip a U.S. merchant ship with a nuclear power plant. This 20,000 h.p. pressurized water reactor will cost approximately \$20 million, while the hull of the ship will cost a further \$20 million.

\* \* \*

★ It has been noted that there is a noticeable difference in the working techniques of U.S. aeronautical engineers and their counterparts on the Continent. Whereas an engineer in the United States concentrates on the designing of a single portion of a plane, the same grade engineer in France, for instance, would be qualified and assigned to undertake more extensive designing, thus providing him to be more versatile in his profession than his American colleague.

\* \* \*

★ Avco Manufacturing Corporation recently announced its decision to discontinue its Crosley and Bendix home appliance divisions which have proved unprofitable, and to devote its efforts to its "profitable and rapidly expanding commercial, industrial, defense, and broadcasting operations." Victor Emanuel, Avco's president, has advised stockholders that his company "has carefully weighed whether future possibilities would warrant the large expenditure of capital funds necessary to meet competition by investing in large new plants with a high degree of automation. The decision has been made not to do so because of the substantially more promising outlook in other parts of the business."

\* \* \*

★ Automatization presents a challenge to the appraisal of human values. The trend towards automation through electronic efficiency will displace personnel from the work they have been accustomed to, but in many instances they can be trained to better, higher-paid work, with more room for self-expression and greater scope for individual judgment.

\* \* \*

★ It is reported that the U.S. Navy has awarded contracts totalling \$31 million to electronics firms for the production of guidance and control units for its new air-to-air guided missile, Sidewinder.

\* \* \*

★ It is estimated that total sales of television sets in the United States in 1956 should be not far short of the number sold in 1955, which was slightly under 7½ million sets. By 1960 it is anticipated that total sales will amount to over 8 million annually, and that by 1966 sales may reach over 10½ million sets.

\* \* \*

★ The American public purchased 150,000 color sets in 1956, and it is felt that in 1957 color set sales may increase to 250,000. Rapid growth in sales may be expected in succeeding years, jumping from over 2 million sets in 1960 to nearly 8 million by 1966, with black-and-white sales dropping back to 2½ million sets.

\* \* \*

★ Sales of home radio models in the United States are expected to increase moderately in the next ten years, but the percentage of car radio sales is likely to increase considerably in the same period.

\* \* \*

(Continued on page 48)

# Radiant Energy Measuring System

(Continued from page 25)

Another modification might use a beam of light instead of radio waves. The transmitter-receiver chain is replaced by a modulable light source, a retro-directive mirror and a photo multiplier tube with an amplifier. The modulable light source consists of a brilliant source of light, followed by a polarizer which transmits only light polarized in the vertical plane, a Kerr Cell, and a polarizer, which transmits only horizontally-polarized light. When the Kerr Cell is unexcited, no light passes through the system, but when a voltage is applied to it, the plane of polarization is changed and, so, some light is transmitted. The beam of light is thus modulated by the oscillator voltage applied to the Kerr Cell. The retro-directive mirror is a set of three mutually perpendicular mirrors which have the property that light incident upon them is reflected back in exactly the same direction.

As in the previously mentioned systems, the distance is measured directly on the phase-shifted dials.

The same arrangement may be used in underwater sonic ranging systems such as depth finders and sonar systems and thereby successfully replace the pulse technique. By a suitable choice of two closely spaced frequencies any desired unit of distance may be measured.

The advantages of using radiant energy for measuring distances are obvious. Surveys of fairly inaccessible countries could be made and in a reasonably short time.

But, apart from the above, there are other vital applications, where the foregoing principle would be of enormous value.

By a suitable choice of two closely spaced frequencies for the emitted signal energy any distance can be measured, and a single transducer is able to handle the narrow range of frequencies efficiently.

There is a number of methods of aircraft detection where the previously mentioned technique would constitute a considerable improvement. Several "spaced" receiving stations could be arranged to receive broadcast signals over a direct path and also from an aircraft. Both signals could then be compared with regard to their time of arrival at a receiver and, in this way, it could be determined that the aircraft was located upon some particular path in the geographic coordinate system including transmitter and receiver.

The comparison of the information from two receiving stations, i.e. the point of intersection of the two determined paths would establish the actual position of the aircraft. This method would not only use an already existing

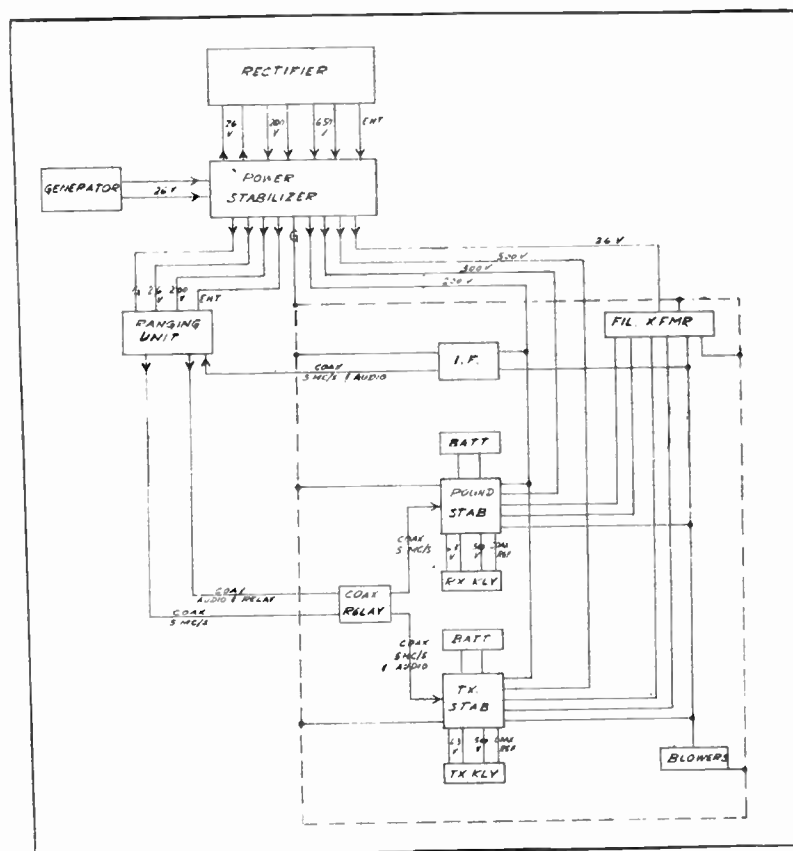

● Block diagram of one embodiment of the ranging system.

high power transmitter but would also constitute an aircraft surveillance system.

With the following modifications a further advantage of such a distance measuring device over previous methods becomes apparent. Standard broadcast television signals include synchronizing pulses providing timing and amplitude information. These pulses are emitted at the maximum power level of the transmitter. Echo signals of these synchronizing pulses may be picked up at a receiver and so the azimuth of the target could be determined. But the distance to the target has still to be found.

Standard pulse repetition rates exclude distance measuring techniques by pulse, since the time separation between horizontal synchronizing pulses limits unambiguous measurement to about 6 miles, whereas vertical pulses, if their echoes could be segregated from the horizontal echoes are so widely separated that they would not give detectable signal in the receiver.

Horizontal pulses last about 5  $\mu$ sec, equivalent to one cycle of a 200 Kc/sec signal. This would represent a distance of  $\frac{1}{2}$  mile. Any system for the detection of aircraft must determine far larger distances with regard to frequencies of only a few kilocycles. It seems fairly obvious that it would be difficult to modulate such a low fre-

quency signal upon the narrow pulse, and, therefore, conservative methods of distance measuring cannot be used.

The present method is particularly suited for measuring of phase-shift of a low frequency signal in the form of repetitive pulses with a duration, which is only a fraction of a cycle of the above low frequency.

A 2 Mc/sec signal may be modulated upon the sync. signal pulse of about 5  $\mu$ sec if possible as FM, whereby it will support one full cycle. The return echo signal may be selected by usual radar gate techniques and then demodulated and compared in phase with the modulating signal.

A second modulation frequency different from the first one may then be used, determining the difference between the two phase measurements. Through this procedure the distance to the target as a fraction of 100 miles may be found.

Further, frequency differences may be used or the original frequency difference may be employed to give the distance as a fraction of a unit of measurement.

Such an arrangement deals with a path involving a two way signal, whereas it is evident that it may be equally well used to establish the length of a path whose input and output are both at the measuring device as, for instance, in measuring a reel of a transmission line.

# Modular Constructed Timing-Mechanism

For Use In—  
Guided Missiles  
Telemetry  
Automatic Process Control

**E**NVIRONMENTAL conditions and the physical extremes imposed upon components and sub-assemblies built into the controlling systems of guided missiles, and in many instances encountered in commercial equipment have led to the recent development by the Hamilton Watch Company of a timing mechanism built on the modular principle which permits an extremely wide range of timing intervals and a wide variety of mechanical or electrical control functions.

Developed primarily for use in weapons, this timer is composed of three cylindrical cartridge units, each of 1¼-inch diameter. One of these cartridges or modules houses a main spring and provides mechanical driving power for operating the entire unit. A second module houses the time measuring mechanism, which is essentially a ruggedized watch. The third module houses the control unit, which comprises a cam driven by the power unit, at a rate controlled by the timing mechanism. This control unit can be provided in a form which permits opening or closing of electrical circuits at desired time intervals; or in a form which provides a powerful mechanical impulse (for triggering detonators, etc.) at the end of a preset time interval.

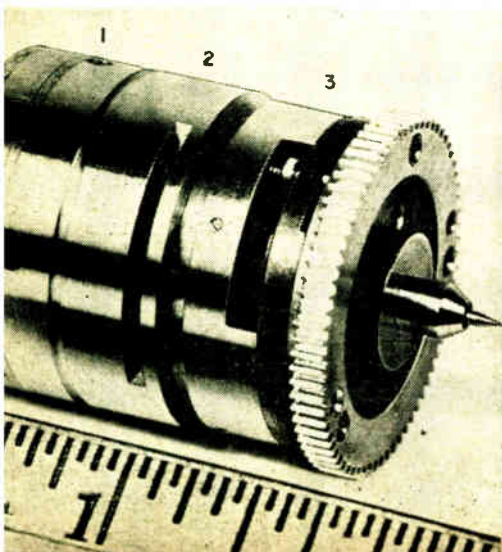

The power supply (mainspring) modules have been designed in several different spring sizes, to provide both different operating torques for the control unit and timer operating periods of different lengths (from 1 hour to 8 days). The watch module is made in several different standard movements which permit different ranges of time interval measurement (from a few seconds to 168 hours). The control element modules have also been designed in a variety of standard forms, to provide a variety of different time delay triggering or timed circuit control actions. The appropriate power supply (spring) modules can be combined with any one of the several time measuring and control modules to provide the desired combination of operating time, timing interval, and control action. Thus, the application of various standard forms of each of the three types of modules makes possible a very large number of different combinations of operating time, timing interval and control action.

### Service Conditions

The enclosed cylindrical construction of each of the three functional components of the timer and their assembly on the same axis forms a compact, exceptionally rugged unit. In addition, due to appropriate engineering and materials selection in each of the modules, the entire timing mechanism can withstand these severe service requirements:

#### (1) Temperature range.

Will time accurately (within

± 1%) from -65° to + 165°F. May be calibrated to time within ±0.1% at any temperature within this range.

#### (2) Shock (impact) resistance.

Will withstand accelerations of up to 3000 G applied for up to 10 milliseconds.

#### (3) Rotation resistance.

Will suffer only slight reduction in accuracy when rotated on its own axis at high speed.

#### (4) Fungus-free.

Made of fungus-proof materials.

#### 5. Long shelf life.

This timing mechanism has been found completely operative after dead storage of nearly two years. Its estimated storage life is of the order of 5 to 10 years.

In addition to the ability to withstand severe service conditions, the mechanism, because of its high torque output, can be made to provide timing control to a number of electrical circuits. Special housings have been developed which enable it to operate effectively from awash to 100-foot depth of sea water, under negative pressure. It can also be readily adapted for remote actuation and for fail-safe operation.

The timing mechanism has been used successfully in field testing, airborne, and ordnance applications and holds good promise of wide application in automatic process control, telemetry, and guided missile applications.



Fig. 2. Timer shown above is designed for low temperature, high-altitude operation. Its control module is an electrical commutator which permits selectable contacting (circuit closing) operations of approximately one-minute duration at either ½ hour, 1 hour or 2 hour time intervals. Components supplied with the timer make possible the selection of the desired contact time interval and ability to switch electrical equipment when a six volt dc source is provided.

Fig. 1. Rugged, versatile, timing mechanism is composed of interchangeable cylindrical modules. Modules are of three functional types — (1) time interval measuring unit; (2) driving unit (spring); and (3) control mechanism actuated by time measuring unit. Different standard forms of all three types of modules can be combined in a single timing unit, thus making possible many different combinations of operating time. Characteristics of the timing mechanism are: wide operating temperature range; high impact resistance; resistance to vibration and fungus; high torque output. With appropriately-designed cases and attendant mechanisms, fail-safe operation and underwater operation are practicable.



## Measuring Equipment For Dielectric Constants

(Continued from page 24)

Fig. 2 is a general graph in which change in resonant length of the cavity is plotted against sample thickness for a range of permittivities. The curves obtained show a marked flat region, where the change in resonant length is substantially constant for a wide range of sample thickness. Thus if the sample thickness is chosen so as to be within this region a wide tolerance may be allowed without affecting the accuracy of the result. This is a considerable advantage when carrying out measurements on a sample over a range of temperatures also on samples of liquids.

### Method of Measurement

The measurements to be made are the resonant length of the test cavity, when air-filled and when containing the sample of dielectric, and the width of the resonance curve at one fifth maximum power level, again when air-filled and when containing the sample.

#### Cavity Air-Filled

1. Vary the length of the test cavity by means of the micrometer screw, until a null is obtained on the cathode ray tube.
2. Adjust the attenuator until the balance meter reads zero.
3. Check (1) and note the micrometer reading  $l_1$ , at which the null reading is obtained.
4. Operate the switch which reduces the output of the reference cavity by 7db.
5. Vary the length of the test cavity by a small amount until the balance meter again reads zero. Two positions of the micrometer screw should be obtained for zero reading of the balance meter, one on each side of the position noted in (3). Note the difference between these two balance positions as measured by the micrometer ( $\Delta l$ ).
6. Return level switch to original position.

#### Cavity Containing Sample.

Repeat the operations listed above in the same order and obtain the readings  $l_2$  and  $\delta l$  for the new resonant length and width of resonance curve respectively.

#### Determination of Dielectric Constant

Apply the change in resonant length ( $l_2 - l_1$ ) to the appropriate sample thickness graph and read off the relative permittivity. Apply the value obtained to the appropriate graphs and read off the values of X and Y. Determine the value of  $\tan \delta$  by substituting these values together with the values obtained for  $\Delta l$  and  $\delta l$  in the equation  $\tan \delta = X(\delta l - Y \Delta l)$ .

\*The British Thomson-Houston Co.  
(Canada) Ltd.

# D-695

## THE **MUIRHEAD** DECADE OSCILLATOR

with all the best features, prominent among which are:—

- $\pm 0.2\%$  frequency accuracy within 5 minutes of switching on
- Exceptional low harmonic content
- Output level constant to  $\pm 0.5\text{dB}$  (20 c/s-30 kc/s)



### SPECIFICATION

#### THE D-695 MUIRHEAD-WIGAN DECADE OSCILLATOR

##### FREQUENCY RANGE

10 c/s-31 200 c/s (continuously variable) in two ranges ( $\times 1$  and  $\times 10$ )

FREQUENCY ACCURACY (within 5 minutes of switching on)

$\pm 0.2\%$  (or better) above 100 c/s, decreasing to  $\pm 0.3\%$  at 10 c/s

HOURLY STABILITY Better than  $\pm 0.02\%$

RESETTING ACCURACY 0.1 c/s on  $\times 1$  range : 1.0 c/s on  $\times 10$  range

HARMONIC CONTENT AT AN OUTPUT LEVEL OF 10 mW

30 c/s-30 kc/s 0.2% into 600 ohm balanced or unbalanced; 0.5% into 10k ohm unbalanced.

Below 30 c/s Increasing gradually to about 0.6% in the two unbalanced conditions and about 4% in the 600 ohm balanced condition at 10 c/s

HUM LEVEL WITH RESPECT TO 10 mW

-70dB (0.03% of the output voltage at 10 mW)

VARIATION OF OUTPUT LEVEL WITH FREQUENCY

50 c/s-10 kc/s Flat within  $\pm 0.1\text{dB}$  20 c/s-30 kc/s Flat within  $\pm 0.5\text{dB}$

Below 30 c/s  $\pm 1\text{dB}$

MAXIMUM UNDISTORTED OUTPUT POWER 10 mW

POWER SUPPLY

95-125V, 60 c/s (D-695-A/100) 190-250V, 50 c/s (D-695-A)

OVERALL DIMENSIONS

17½ in. wide  $\times$  12½ in. high  $\times$  8 in. deep (44.5 cm  $\times$  31.8 cm  $\times$  20.3 cm)

WEIGHT 37 lbs (17 kg)

WRITE NOW FOR PUBLICATION 4718

MUIRHEAD INSTRUMENTS LIMITED • STRATFORD • ONTARIO • CANADA

239/3

# SCIENTIFIC INSTRUMENTS



## THE SCALAMP RANGE OF VOLTMETERS

For high voltage measurement at zero current drain the "Scalamp" Electrostatic Voltmeter is the ideal instrument. With a three-second period and hairline-spot indicator on a clear open scale, measurements can be taken with great rapidity and ease. The instrument is completely self-contained with lamp illumination effected from mains-supply through a built-in transformer or from an external 4V battery. For complete details write for catalogue number 11310.



## GALVANOMETERS

The "Scalamp" Galvanometer is available in a range of sensitivities and is one of the most versatile instruments of its kind. Either mains or battery operated it features slow-motion drive to the zero-control, and an automatic self-shortening foot. For complete details write for brochure number 7900/s.



## FLUXMETERS

The "Scalamp" Fluxmeter features a two-speed "return-to-zero" for rapid and easy measurement. Either battery or mains operated this instrument will give a truly outstanding performance. For complete details write for catalogue number 8834.



INSTRUMENTS DIVISION

CANADA LIMITED

78 BANK ST., OTTAWA

82 Northline Rd., TORONTO 16  
3 Duke St., HALIFAX

193 E. Hastings St., VANCOUVER  
1191 University St., MONTREAL

## Powerful Transmitter Serving Ships Of Canadian Navy

Ships of the Royal Canadian Navy have now been linked with Nova Scotia by what may be one of the most powerful radio transmitters ever to be installed along the entire eastern seaboard of North America.

Reflecting Canada's growing sea power, and far-flung responsibilities as a member of NATO, the huge unit has recently gone into official operation at the site of the RCN's main east coast transmitting station.

Naval officers reported that the transmitter is five times as powerful as one it replaces. This will mean better and more dependable communication with ships at sea, at greater range and under adverse conditions, they said.

A spokesman for RCA Victor Company, Ltd., which supplied the unit, said that never before had one so big been installed in Canada. Adding that it was completely designed and built at Montreal, J. B. Knox, General Manager of the Engineering Products Department, reported that it had been three years in the making.

All told the transmitting station includes more than 30 transmitters of assorted types and sizes. A maze of high frequency directional antennas pierces the sky above it, and the station has its own emergency diesel unit in case of power failures.

Three steel masts reach 550 feet into the air to suspend the antenna unit.

The antenna served the original transmitter, installed by RCA Victor back in 1942 during the Battle of the Atlantic and considered very powerful in its day. On practically uninterrupted service for nearly 13 years, this unit has been modernized and modified to permit the increase in power.

Months were needed to complete the conversion. The face of the transmitter, covered with dials and meters, extends 32 feet along one wall, and is seven feet high.

In behind are the workings. Cables wound around the giant coils are more than an inch and a half thick and contain between 7000 and 8000 individual wires, each one cleaned and soldered. On the average, it took a man a day and a half to terminate the end of one.

## Bogue Electric Of Canada Opens Toronto Office

Grant A. Taylor, general sales manager of Bogue Electric of Canada Ltd., announces that sales offices of the company have been opened in Toronto at 1454a Yonge Street, Suite 3. Mr. Taylor, who was formerly located in Ottawa, has now moved his headquarters to Toronto.

5615

For further data on advertised products use page 65.

# THIS IS HELIAX<sup>®</sup>...

*The truly FLEXIBLE*

*Air dielectric cable*

This latest ANDREW cable, introduced just 18 months ago, has received phenomenal industry acceptance. This is easy to understand, when you consider that HELIAX offers electrical performance equal to that of the finest copper cables, yet is far lower in price and much easier to install.

HELIAX has its own complete series of connectors, matching the superior electrical performance of the cable.

These fittings are pressurized and weatherproofed, and attach easily without special tools.

For a maximum of convenience in the field, HELIAX is normally supplied in complete assemblies, with end fittings factory attached. Available in  $\frac{7}{8}$ " and  $1\frac{1}{8}$ " sizes.

Continuous lengths to 3,000 feet.

*Write now for complete engineering data and a sample of this remarkable cable.*

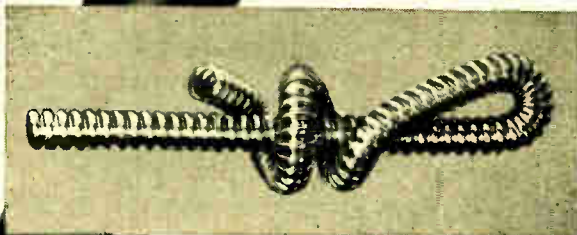

The secret of HELIAX lies in its corrugated outer conductor. As demonstrated at the left, this by itself can be bent on its own diameter without breaking, kinking or going out of round. These qualities give HELIAX its unusual flexibility, strength and ease of handling.

**Andrew**  
A N T E N N A

C O R P O R A T I O N L T D.  
606 BEECH ST., WHITBY, ONTARIO

Offices:

Chicago - New York - Boston - Los Angeles

ANTENNAS • ANTENNA SYSTEMS • TRANSMISSION LINES



# new products

New Product specifications published in Electronics and Communications have been briefed for your convenience. If you require further information on any of the items published you may readily obtain such by using our Readers' Service, Page 65. Just mark the products you are interested in on the coupon on Page 65 and the information will be in your hands within a few days.

## ● Miniature Magnetic Circuit Breaker

Item 1401

Airpax Products Co., Baltimore 20, Md. announces several significant improvements in its miniature magnetic circuit breaker. This breaker is specially built for use in protecting electronic equipment.

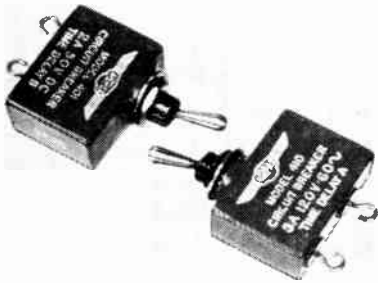

Improvements over earlier units include extending the vibration resistance. On earlier units it was 0.06 inch total excursion from 10 to 55 CPS. Newer production units also withstand 10 G at 55 to 1000 CPS. The trip level has also been raised to 135 per cent of rated load current. Thus the breaker is more tolerant of fluctuations in load current due to normal variations in line voltage. A revised specification describes these and other improvements. Units are available for interrupting 50 DC volts at currents from 0.05 to 10 amperes and for interrupting 120 RMS volts, 60 or 400 CPS, at current from 1.0 to 10 amperes. The toggle bushing of this breaker is the same as on conventional ON-OFF switches. Thus, this miniature breaker can replace switches on electronic equipment and provide circuit protection as well.

Airpax Products Co., Baltimore 20, Maryland, U.S.A.

## ● Miniature D.C. Voltage Transformer

Item 1402

Bendix Aviation Corporation has announced a new D.C. Voltage Transformer designated the Bendix Red Bank Type 38B3-1 DYNA-PAK (trade mark). The DYNA-PAK, with a D.C. input of 28 volts and a D.C. output of 250 volts, 100 watts, is approximately one-eighth the weight of a comparable piece of rotary equipment with only one-sixth of its volume.

It is completely static, using two junction transistors, compared with the limited life-hours of its counterpart, the dynamotor. Bendix claims that the DYNA-PAK is practically maintenance-free and will give thousands of hours of trouble-free operation and that its inherent regulation exceeds that of the dynamotor.

As a source of D.C. voltage, the DYNA-PAK is a small, lightweight, efficient power supply for modern aircraft and missiles, meeting military environmental requirements for shock, vibration, humidity, salt spray, sand and dust, and radio interference.

Complete descriptive details are available from the Canadian affiliate of the Bendix Aviation Corporation: Aviation Electric Limited, 200 Laurentien Blvd., (P.O. Box 6102) Montreal, P.Q.

## ● New Concept Of Marine Radar

Item 1403

Decca Radar Limited has developed an entirely new concept of marine radar for use at sea through the introduction of the Decca True Motion T.M. 46.

The company announces that this new equipment differs from any other commercial marine radar as yet available anywhere in the world because it shows directly on the cathode ray tube the true movement of all objects within radar range as opposed to the conventional relative movement. This means that "own ship" actually travels across the face of the screen with all other targets correctly moving at their true course and speed and all stationary targets such as buoys, light vessels, anchored vessels and landmarks clearly shown to be stationary. Thus the navigator now has what is virtually a bird's eye view of every situation and can see at a glance what is really happening around his ship in any condition of visibility.

The equipment incorporates a Trackmaster Unit which is either fixed to the display unit or sited immediately adjacent to it. This unit accepts information of the course and speed of "own ship" and passes the true motion information to the display unit. By causing the electrical center to move on the face of the tube in sympathy with the ship's movement, the effect of displaying true motion of all echoes is achieved.

Decca Radar (Canada) Limited, 272 Dalesford Road, Toronto 14, Ontario, Canada.

## ● Microphone Connectors Eliminate Soldering

Item 1404

Two Microphone Connectors with wide terminals with broad headed screws (similar to those used in phone plugs) for fast and convenient attachment of leads without soldering have been introduced by Switchcraft, Inc.

Both connectors fit standard single contact microphone connectors such as Switchcraft 2501MP.

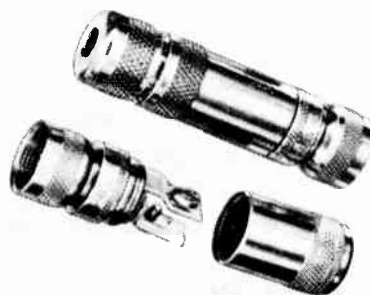

No. 2501FI. has long nickel plated handle with built in cable clamp in the end cap, overall length is 2 5/8", cable opening on end of handle is 1/4". No. 2501FS has short nickel plated handle, overall length 1-13/16", cable opening 9/32".

Further details may be had by addressing Canadian Factory Representatives, Atlas Radio Corporation Ltd., 50 Wingold Avenue, Toronto 10, Canada.

## ● Lenkurt Line Filters

Item 1405

A new Lenkurt publication is available on the subject of "Engineering Considerations of Lenkurt Line Filters." It replaces Bulletin EB-100, originally issued in December, 1952.

In the introduction to the booklet it states "this bulletin provides a brief description of the characteristics of the filters by means of tables and curves, and includes block diagrams illustrating typical operating arrangements."

Copies of the bulletin may be obtained upon application to Automatic Electric Sales (Canada) Limited, 185 Bartley Drive, Toronto 16, Ontario.

## ● Variable Frequency Blower Motor

Item 1406

A new smaller single phase 4-pole variable frequency blower motor with a fairly constant speed over a wide frequency range through the use of two small external capacitors is now available from John Oster Manufacturing Co., Avionic Division, Racine, Wisconsin.



With a 2" blade fan, frequencies between 400 - 1800 cps, speed is between 7800 - 11,000 r.p.m. With a 3" blade fan, frequencies between 300 - 1000 cps, speed is between 4400 - 5200 r.p.m. Excitation is 115V, continuous duty and operating ambient temperature range -54°C to +70°C. The motor can be made to withstand higher temperatures if required. Housing and bearings are stainless steel, laminations No. 4750 steel and lead wires Teflon. Maximum length is 2.015", OD 1.046" and weight 5 oz. Type 11-A-8223-01 is designed to run a fan which cools electronic and other equipment.

Canadian Representative: S. M. Murray, 27 Broadpath Rd., Don Mills, Ont. Canada.

## ● Cat. 4360-1 Grounding Connector

Item 1407

A new 15A-125V grounding connector, Cat. 4360-1, featuring a sturdy, simplified locking mechanism, is now available.

Simply plugging in the grounding cap operates the locking mechanism, gripping the grounding blade of the cap and securely locking cap and connector together. The lock can be immediately released and the cap freed for removal by pressing the thumb release at the side of the connector.

Further information on Cat. 4360-1 grounding connector may be obtained from Wiring Device Sales, Canadian General Electric Co. Ltd., 224 Wallace Avenue, Toronto, Canada.

● **Very Low Frequency**

**Oscillator**

Item 1408

The V.L.F. Oscillator is a precision grade instrument having an unusual degree of flexibility for measurements at sub-audio frequencies. The wide frequency range and constant output level make the instrument ideal for measuring the frequency response characteristics of low frequency amplifiers used, for example, in geophysical and electro-medical research. The rapid



response of the automatic amplitude control circuit, combined with the ability to tune continuously from 0.1 c/s through subsonic and audio frequencies is essential for vibration and strain investigations in machines and structures and for checking the response of low frequency recorders. The provision of two output signals in quadrature is particularly valuable for the testing of servo systems. In addition, the instrument can be used for all normal audio frequency work.

The frequency range of the instrument is 0.1 c/s to 10,000 c/s in five ranges. The output signals at both 0 degree and 90 degree outputs are 25 volts into 10,000 ohms, and are monitored by a miniature cathode ray tube. Available for bench or rack mounting.

Dawe Instruments Limited (Canadian Division), 1654 Bank St., Ottawa, Ontario, (Turn to page 38)

**VIBRATION ISOLATORS...**

by **ROBINSON AVIATION** \*

... are designed for vibration isolation and shock protection of airborne equipment, instruments and controls.



MET-L-FLEX UNIT MOUNT

● MET-L-FLEX unit mount by Robinson is an all-metal resilient element made of stainless steel which is . . . rugged and compact . . . unaffected by oils, hydraulic fuels, temperature, altitude, vibration or moisture. High damping stability is maintained at all altitudes.

● MET-L-FLEX mounts are designed and built for the operating life of the equipment on which they are installed.

IN CANADA

AT 41

**AVIATION ELECTRIC LIMITED**

MONTREAL

VANCOUVER

**WE KNOW SATURABLE REACTORS INSIDE OUT**

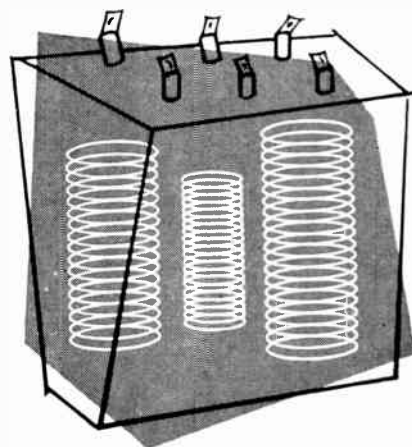

Chicago Electronic engineers have led in research and development work on saturable reactors for eighteen years, resulting in the production of the most consistently accurate and closely controlled components available today.

**CHICAGO MAGNETIC CONTROL**

1616 NORTH DAMEN AVENUE  
CHICAGO 47, ILLINOIS

**Compact Oscillator Drives 400 CPS Chopper**

Enables you to obtain advantages of high-frequency chopper in equipment powered from 60 CPS or from batteries, is small, self-contained.

- Operates from conventional filament and plate voltages
- Separates chopper frequency from hum frequency
- Gives faster response to chopper amplifier

Uses standard or ruggedized vacuum tube

Circuit components are potted for long life

Plugs into octal socket

4 3/16" OVERALL

1 1/2"

**AIRPAX PRODUCTS COMPANY ENGINEERS**

DESIGNERS

CAMBRIDGE DIVISION  
JACKTOWN ROAD  
CAMBRIDGE  
MARYLAND

## NEW PRODUCTS

(Continued from page 37)

### ● TCA Thermistor Test Kit For Design Engineers

Item 1409

Thermistor Corporation of America, Metuchen, New Jersey, has announced the availability of a new series of thermistor test kits that will enable design engineers to economically investigate and evaluate the potentialities of employing these versatile semi-conductor ceramic units in the latest circuit designs. The kits, available in three sizes priced from \$9.95 to \$39.95, include representative units in a wide range of resistances, temperature co-efficients and sizes. Mountings and styles incorporated in the sets include wafer thermistors in addition to bead, bead-in-probe and bead-in-can elements.

The manufacturer supplies with each kit methods for designing thermistor tempera-

ture-correcting networks as well as curves, helpful hints for using thermistors, and other important engineering information. Canadian Representative: Lake Engineering Co. Ltd., 36 Upton Road, Scarborough, Ont., Canada.

### ● Catalog On Transformers And Fabricated Metal Parts

Item 1410

The Hammond Manufacturing Company Limited, Guelph, Ontario, has issued Catalog No. 67 in which are listed various types of transformers, approved by C.S.A., and fabricated metal parts for use in the electronics industry. An explanatory note at the end of the catalog states that, in addition to the stock items listed, the company is prepared to produce transformers for special work, whether the specifications be simple or complicated.

For copy of Catalog No. 67 write The Hammond Manufacturing Company Limited, Guelph, Ontario, Canada.

### ● Super Fireball TV Tuner

Item 1411

Standard Coil Products (Canada) Limited has announced the introduction of a completely new approach in television tuning devices. Identified as the Super Fireball Tuner, this tuning unit employs Standard's own Neutrode circuitry and is miniaturized for adaptability to all TV tuner mechanical and electrical applications.

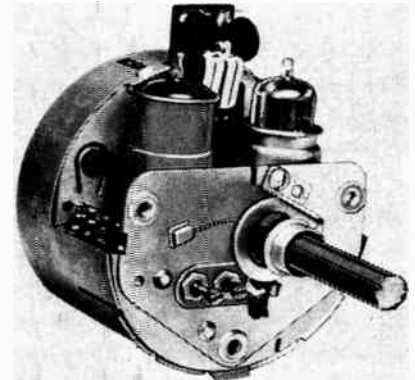

The Super Fireball is 2 3/4" by 4" in size and features a very unique application to all channel tuning in both VHF and UHF spectrum. Simplicity of design ensures better stability and lower cost in production, which offers the Super Fireball at very competitive prices to the TV industry.

Standard Coil Products (Canada) Limited, 37 Drummond St., Mimico, Ontario.

### ● Electronic Thickness Tester

Item 1412

The Kocour Electronic Thickness Tester "Model 955" determines the thickness of plating and other metallic coatings deposited over various metals and non-metallic base materials with an accuracy of 90-95 per cent. Operation is very simple and virtually automatic. Readings are direct.

A multiple position switch indicates the plating to be tested. The thickness of decorative and heavy chromium, silver, tin, cadmium, zinc, copper, brass, nickel, lead, lead-tin, and tin-zinc alloy can be determined on steel, copper, brass, aluminum and other metals, and on non-metallic materials such as ceramics and plastics.

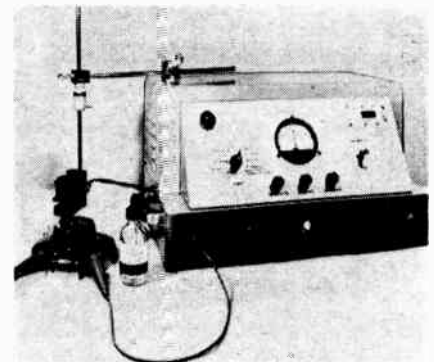

A new calibration feature in conjunction with Kocour Thickness Standards ensures "long term accuracy." Not only can the accuracy of the instrument be checked at any time, but a calibration adjustment will automatically correct high or low readings.

A constant pressure device which automatically maintains a uniform pressure between test cell and specimen is one of the new features. This eliminates previous reliance on operator's judgment.

For further details and literature write to Kocour Company, Dept. C-4, 4800 S. St. Louis Ave., Chicago 32, Illinois, USA.

(Turn to page 40)



**CLM  
RECTIFIERS  
nurse  
your  
batteries**

You'll protect your investment in station-type batteries when you install CLM Electronic Regulated Selenium Rectifiers.

**CONSTANT OUTPUT VOLTAGE.** In a CLM rectifier the output voltage is kept constant from no load to full load which increases battery life.

**SELF-PROTECTING.** CLM rectifiers are self-protecting on overload as the voltage curve drops off rapidly after 115 percent load is reached. CLM electronic regulated rectifiers are convection cooled, noiseless and require a minimum of maintenance.

**FREE BULLETIN.** For your free copy of Bulletin SR-14 which describes in detail, the performance characteristics of CLM rectifiers for station-type batteries write: Jack West, Sales Manager, Rectronic Division, Canadian Line Materials Limited, Toronto 13, Canada.



## SELENIUM RECTIFIERS

For further data on advertised products use page 65.

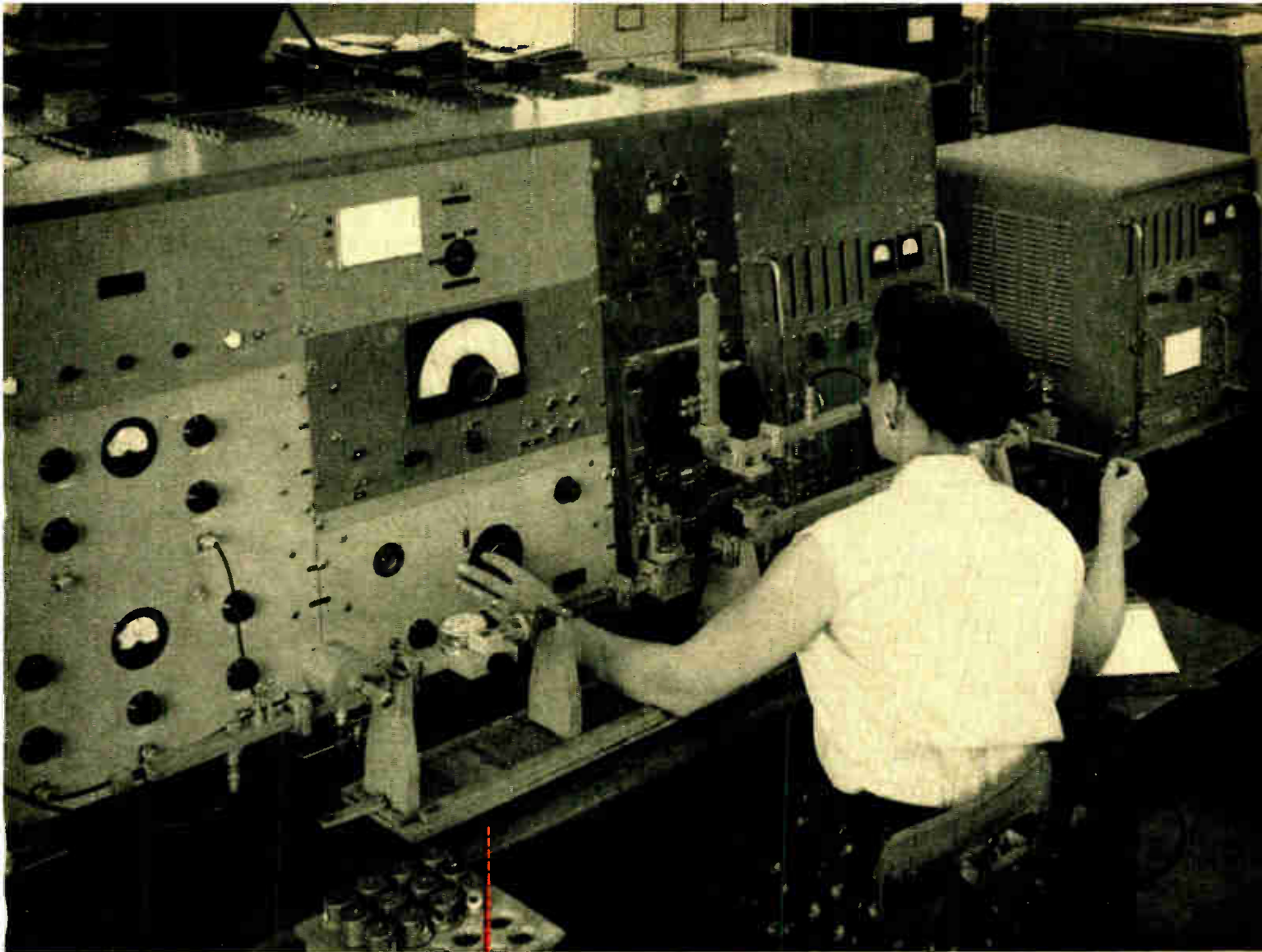

MARGIN FOR ERROR - 1 IN 1,000,000



The special equipment for calibrating and testing radar components used here is precisely accurate to within 1 cycle in 1,000,000

Designed and built by Bomac test engineers, it typifies Bomac's painstaking emphasis on testing and quality control . . . an emphasis which is largely responsible for the extra measure of dependability in all Bomac microwave products.

***Bomac*** LABORATORIES, INC.  
Beverly, Mass.

R. O. R. ASSOCIATES LTD., 290 Lawrence Ave. West, Toronto 12, Canada • Tel. RUssell 1-9391

*Positions now open for both junior and senior engineers in microwave tube design and development. The work is challenging, advancement opportunities unlimited, and benefits liberal.*

Offices in major cities: — Chicago • Kansas City  
Los Angeles • Dallas • Dayton • Washington  
Seattle • San Francisco • Toronto

Export: — Maurice I. Parisier, 1860 Broadway, N. Y. C.

## NEW PRODUCTS

(Continued from page 38)

### ● Trylon Ice Indicator Item 1413

The Trylon Ice Indicator with its Ice Detector, by reason of its design, is able to detect quickly the presence of ice-forming moisture at the time ice starts to form. This is important. It takes only two ounces of ice deposit on the small collector wires to operate a relay which in turn energizes the control mechanism for cutting in the power supply for de-icing circuits or electric de-icing units.

The ice-collector wires of the TRYLON Ice Indicator are so small that the moisture laden wind continues on its course and is not deflected. The momentum of the ice-forming water droplets is sufficient to cause them to impinge on these ice-collector wires. There are enough of these ice-collector wires so that in a few minutes sufficient ice

is accumulated to operate the unit.

Electrical contacts are all enclosed inside of a weathertight cylinder which employs a very thin beryllium-copper diaphragm to seal the operating rod, which moves downward by the force of gravity. No gaskets are used and consequently there is no friction in this downward movement, only the pressure of the diaphragm which also acts as a restoring spring.

The interior mechanism is mounted on jewelled bearings and is carefully adjusted. Parts are of stainless steel or bronze, while silver contacts are employed to make and break the electrical circuit. When the contacts are closed, current flows through the ice-collector wires and causes them to heat up, melt the ice and then restore the unit to the original or up position.

The entire construction is light, rugged and positive. The mechanism is particularly sensitive and is subject to adjustment.

For further information, write to The Wind Turbine Company of Canada Ltd., 51 McCormack St., Toronto 9, Ontario.

### ● Portable Impedance Meters Item 1414

Six new portable slotted lines, Models 319 to 324, incorporating a carriage drive mechanism that is integral with the waveguide assembly, thus insuring minimum slope and eliminating the need for later adjustment, re-alignment or correction, have been developed by The Narda Corporation, Mineola, L.I., New York. These impedance meters can be used to measure VSWRs and impedances from 2600 to 18,000 megacycles per second covering the waveguide sizes from 3 x 1½ inches to .702 x .391 inches.

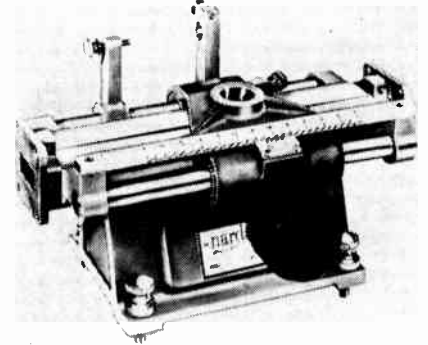

The complete impedance meter is supported by a removable pedestal casting, with the carriage riding on two stainless steel shafts supported by the waveguide casting. This type of integral assembly insures the precision necessary to obtain minimum slope by original machining rather than by proper assembly of mating parts or a very critical adjustment at assembly. By the use of precision ball bushings the carriage is always symmetrically supported and provides rigid mounting for the probe regardless of position.

Since the entire mechanism is incorporated in the waveguide itself, Narda impedance meters can be used with the pedestal removed where space is restricted. The precisely engraved scale and vernier are mounted at an angle for easy viewing even in poor illumination. The residual VSWR is under 1.01 and both slope and slot leakage are imperceptible. The carriage is provided with a mounting hole for use with all standard military and commercial RF probes and detectors including the Narda Model 229.

Measurement Engineering Ltd., Arnprior, Ontario, Canada.

### ● Cost Savings In Buying Parts Item 1415

A new 12-page booklet entitled "Fabricated Parts and Components . . . Management Decision For Profit" is available from National Vulcanized Fibre Company. It deals with the cost advantages gained by dealing with a single responsible source for fabricated parts made from vulcanized fiber, Phenolite laminated plastic, nylon and combinations of these materials.

This booklet is designed for rapid scanning by management men, purchasing agents and engineering men who are concerned not only with new parts made of the right engineering material, but also with their company's over-all profit picture.

Thirty-six illustrations are used to show machining operations and products made. Property and application charts help the designer or engineer select the best grade of these basic engineering materials. The booklet also points out economies that can be effected by buying parts from a company that controls quality from making the materials, through machining to delivery of 100 per cent usable parts. It also points up the value of the research, design and engineering facilities that are available to give unbiased assistance in selecting materials and methods and to establish that the part can be economically produced.

Copies of this booklet are available, without cost, from National Fibre Co. of Canada, 107 Atlantic Avenue, Toronto, Canada.

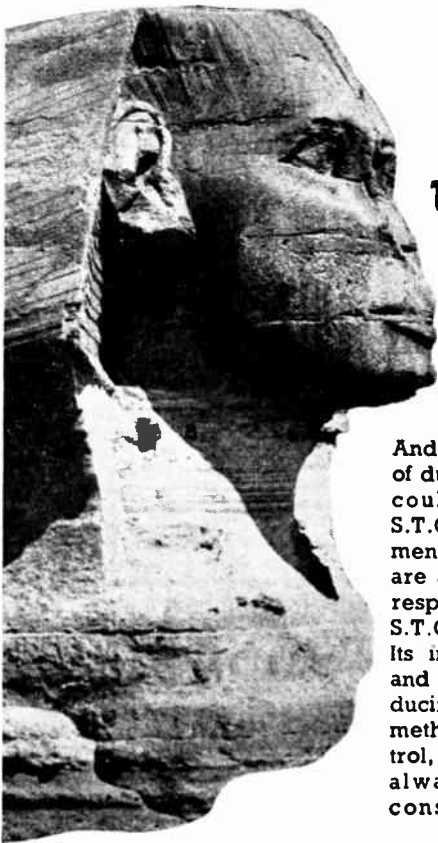

## The Great Sphinx

*Largest of all the Sphinxes. The Great Sphinx at Giza, near Cairo, is undoubtedly the most famous. Its origin is shrouded in mystery, although it is known to be so old that in these modern times it has become a symbol of durability.*

And in this matter of durability the Sphinx could almost symbolize S.T.C., whose systems and equipments for communications and control are a by-word amongst those whose responsibility it is to plan for the future. S.T.C. is a world wide organisation. Its immense resources for research and manufacture are constantly producing new and yet more efficient methods of communication and control, and its engineers are always available for consultation.

**Standard**  
communication and  
control systems

Telephone	Railway Communication
Telegraph	Railway Control
Teletypewriter	Power Cable
Radio Broadcasting	Communication Cable
Radio Communication	Airfield Lighting Control
Radio Navigation	Street Lighting Control
Sound Reproduction	Fire Alarm
Remote Control	Totalisator
Remote Indication	Public Indicator
Telemetering	Signalling (Office & Factory)



**Standard Telephones & Cables**  
Mfg. Co. (Canada) Ltd.

9600 ST. LAWRENCE BLVD., MONTREAL



## ● Two-Pole Telemetering Commutator

Item 1416

Instrument Development Laboratories, Inc. announces the developing of a new telemetering commutator with a life expectancy exceeding 500 hours without servicing. It is contained in a hermetically sealed case to overcome most of the usual military environmental conditions. Powered by a 400 cycle, 115 volt, two phase motor, this unit requires only 7 watts to provide 10 rps pole speeds, and only 15 watts for 30 rps pole speeds. The brushes or poles are special metallic alloys dynamically balanced and mounted on jewel pivoted bearings with low spring rates. The commutating surfaces are comprised of internally segmented cylindrical sections. Prior to assembly, these sections are slotted with the accuracy of an index head on a milling machine, so that inter pole phasing accuracies of .2 milliseconds can be maintained at 30 rps pole speeds. Contact resistances of less than .25 ohms are practically invariant during the entire use of the commutator. Inter contact impedances exceed 100 meg ohms for the life of the instrument.



Measuring only 2½" in diameter by 5¾" long, this two pole unit has exceeded 1000 hours life at 10 rps and has withstood 2000 cps vibration frequencies at 16g amplitude. Each pole provides 27 BBM contacts plus one master contact with a duty cycle which can be made from 30 per cent ON to 70 per cent ON times. Other combinations are available upon request.

For further information, write to Measurement Engineering Limited, Arr-prior, Ontario, Canada.

## ● Manual Describes Proximity Meter

Item 1417

The proximity meter, a precision electronic instrument that measures without touching the specimen, is described in a new 28-page booklet offered free by the manufacturer, Fielden Instrument Division of Robertshaw-Fulton Controls Company.

The new booklet is aimed at helping industry and research installations find solutions to a wide variety of problems in precision measurement.

Of outstanding flexibility, the instrument can detect a change in temperature of one thousandth of one degree centigrade, or variations as minute as one millionth of an inch.

For use in specialized measurements, the proximity meter will determine vibrations of one millionth of an inch in amplitude at frequencies from 0 to 20,000 c.p.s.; moisture content of 300 parts in one million; and

pressures of one hundred thousandth of an inch of water.

The operating principle of the device is based on electrical capacitance, or measuring the changes in the electrical field located between the specimen and the electrode of the instrument. These measurements are interpreted on a convenient scale.

Also described in the booklet are applications of the proximity meter as a non-contacting micrometer (internal and external); concentricity gage, surface finish gage (internal and external); strain gage; torque meter; vibration meter; automatic weighing; breaking strain gage; paint or insulation thickness gage; micro thermometer; pressure gage; and moisture content or product composition by means of dielectric measurement.

Copies of the proximity meter technical and application manual may be obtained upon request. Keith Mercer Company, Ltd., Suite 101, 5165 Sherbrooke Street West, Montreal 28, Quebec, Canada.

## ● Synchro Test Equipment

Item 1418

D-725-C Synchro Test Fixture (Patents pending)

This test fixture enables the angular position of the rotor of the test element to be set in 10° steps with very great accuracy. The control arm is located at 10° intervals by means of studs which are placed on a circle to within 15 seconds of arc. The angular error of the test element is determined by adjusting a micrometer screw calibrated in minutes of arc, no tiresome optical system being employed. The Synchro spindle is relieved of the weight of the control arm by being coupled to it by a light spring-loaded secondary arm. Adapters are provided to accommodate size 18, 15 and 11 Synchros. The overall accuracy of the test fixture is ± ½ minute.

Muirhead Instruments Limited, Stratford, Ontario. (Turn to page 44)

## The latest UNIVERSAL BRIDGE

with dual-frequency internal oscillator/detector



BY **Marconi**

### Provides instant, directly-read, more accurate L, C and R measurement

Through this completely self-contained unit, measurement of inductance, capacitance and resistance values of practically all electronic equipment components may be instantly ascertained.

Through the use of a single L, C and R dial, a system of rotatable discs is viewed through windows automatically showing the actual value of the component under test . . . eliminates human error . . . no multiplying factors involved . . . no confusion.

You can get all the information on the new Marconi Universal Bridge by writing to us today.

Inductance: 1μH to 100 henrys  
Capacitance: 1μfd. to 100 μfd.  
Resistance: 0.1 ohm to 10MΩ  
Dimensions: 11½" x 19" x 10"  
Weight 33 lbs.

Marconi Instruments Department

**Marconi**



CANADIAN MARCONI COMPANY

CANADA'S LARGEST ELECTRONIC SPECIALISTS  
MONTREAL 16. QUE.

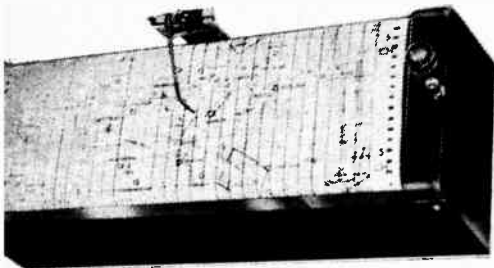

● Photo above shows the stylus unit of the Bendix Decca navigation system by which the position of the aircraft is plotted.

A fully developed navigation and potential air traffic control system capable of handling the rapidly growing volume of today's air traffic has met with wide success in the United States and Europe. The system first developed in Great Britain by two Americans was first used in the Normandy invasion and today is in current use in the greater part of the European area and covers two million square miles of land and sea area.

The system is of the area coverage type and operates on low frequency radio waves in the range of 100 KC. The use of this low frequency transmission provides a system which is usable behind hills, in valleys, beyond line-of-sight and below the curvature of the earth. Good reception and high accuracy is provided from ground level to the highest altitudes, thus making the system ideal for helicopter as well as fixed-wing use.

The system operates by transmissions from a master station and three slave stations. The master controls the

## Aerial Navigation & Control

Greater Need For Accuracy And Reliability Spurs Manufacturers To Produce High Quality Equipment.

accurate emission of radio waves from the slave stations which results in a network pattern of hyperbolic waves which occupy precisely known and stable geographic positions. The location of the aircraft is, of course, basically determined by making a phase comparison of the signals from two of the transmitting stations. The system provides a position fix by deriving the arbitrary index numbers on an appropriate pair of ordinates which intersect at the point of position. With this information the position can be automatically and instantaneously displayed on a chart through the medium of a moving ink stylus.

Using this system, an air track for lateral separation can be assigned to each aircraft and the pilot will be able to change altitude while flying an assigned track without running the risk of interference with other aircraft. In the cockpit the pilot has a pictorial display which accurately plots the flight course at all times. The pilot thus has continuous, precise and graphic information as to his present location, direction of flight, and track.

This system will expedite landing procedures by having aircraft approach the airport on parallel tracks separated at minimum intervals. Approaches can be made more quickly

and safely by using this system, according to engineers. Knowing the exact time of arrival, traffic flow in the terminal area can be handled much more expeditiously which, in turn, will eliminate long periods of awaiting clearance for landing. These waiting periods are particularly hazardous for turboprop and turbojet powered aircraft because of their excessive consumption of fuel at low altitudes.

The Bendix-Decca System, as it is known, is extremely accurate and, in fact, has accuracies of better than 25 yards under normal conditions at distances of up to 50 miles from transmitting stations. The system is designed for short and medium range navigation, although a similar system, called Dectra, has also been developed for long range use. The pilot, with one set of receiving equipment aboard his aircraft, could use the system after takeoff and during approach to his terminal area and Dectra while flying at his selected cruising altitude.

The system is a proved system which fully meets the requirements of the common system serving helicopters, ships, fixed-wing aircraft and ground vehicles with equal facility. It is a fully developed system which has been proved in operation over many years and its use is constantly expanding throughout the world.

## Secoder Segregates Signals

An Instrument Designed To Silence The Ringing Of Uncalled Party-Line Rural Telephones.

AN electro-mechanical device which is electrically connected in place of the bell on magneto and other types of party-line telephones where coded ringing is employed is a recent development that will be of wide interest to the rural telephone industry.

Known as the "Secoder" it counts and differentiates between long and short ringing signals. A built-in bell rings only when a ringing combination is intercepted which matches the code wheel in the Secoder. The bell is silent at all other times and is not actuated by any other ringing signals on the line. The duration of the ring may be set to any desired value between one and four seconds.

The principal application is on rural party-line telephones and in private telephone systems utilizing magneto telephones. The unit permits individual ringing of telephones on the

same line without requiring additional central office equipment.

It contains a line relay, a Secode type 48WC1 selector and a bell housed in a gray hammertone metal enclosure 10" long, 4½" wide and 6¾" high. The assembly weighs 11 pounds and may be mounted horizontally or vertically on a flat surface. The dust cover is easily removed to permit access to the mechanism and circuitry.

The selector is actuated by the line relay which responds to low frequency ringing signals. Power for the operation of the selector mechanism is derived from a 117 volt ac source through a built-in rectifier. At locations where utility power is not available, a battery

● The Secoder shown at right, designed for use on rural party-line telephones, counts and differentiates between long and short ringing signals.

operated model may be used. No power is required during stand-by.

The instrument has a code wheel cut to respond to any specific code out of over 250 code combinations. Code wheels may be easily replaced to change the code combination.

An "all call" arrangement which permits simultaneous ringing of all Secoder equipped telephones on the same line without affecting the ability to ring each telephone individually is a feature of the instrument.

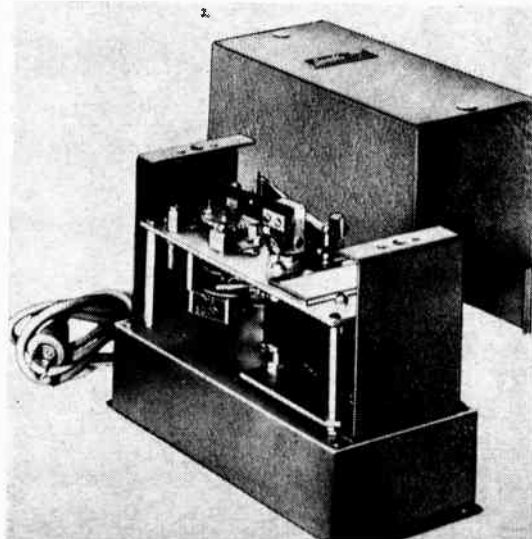

Use Easter Seals



A worthy project that calls for our support as well as our sympathy. Gratitude for sound limbs is best shown in helping those who are handicapped.

# ADCOLA

PRODUCTS LIMITED  
REGD. TRADE MARK

## SOLDERING EQUIPMENT

Soldering instrument detachable bit model 3/16" List No. 64

Protective Shield List No. 68

All voltages supplied

CSA Approvals No. 11910

Canadian, British and Foreign Pats., Registered Designs, etc.

Canadian Rep:  
L. J. Lamb  
Box 103  
Weston, Ont.

U.S. AGENTS  
Stratford Electronics Inc.  
P.O. Box 1114, New York 1, N.Y.

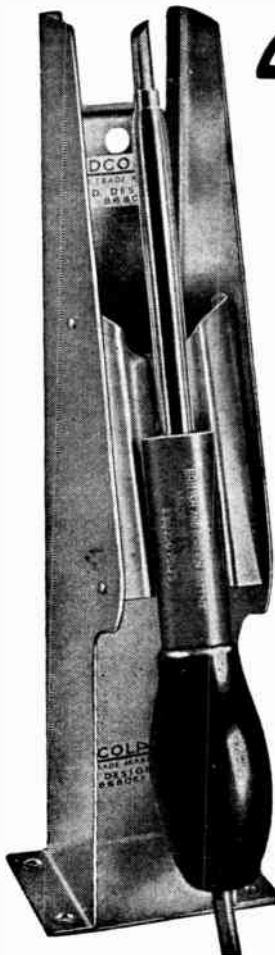

# True Hermetic Sealing assures Maximum Stability in

# AMPERITE

## RELAYS and REGULATORS

Simplest • Most Compact • Most Economical

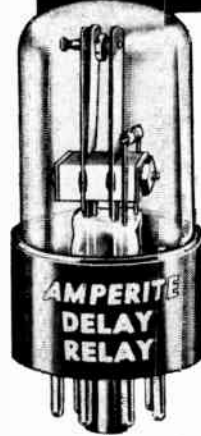

STANDARD

PROBLEM? Send for Bulletin No. TR-81

## Thermostatic DELAY RELAYS

### 2 to 180 Seconds



MINIATURE

- Actuated by a heater, they operate on A.C., D.C., or Pulsating Current.
- Hermetically sealed Not affected by altitude, moisture, or other climate changes.
- Circuits: SPST only — normally open or normally closed.

Amperite Thermostatic Delay Relays are compensated for ambient temperature changes from -55° to +70°C. Heaters

consume approximately 2 W. and may be operated continuously. The units are most compact, rugged, explosion-proof, long-lived, and — very inexpensive!

TYPES: Standard Radio Octal, and 9-Pin Miniature.

Also — Amperite Differential Relays: Used for automatic overload, under-voltage or under-current protection.

## BALLAST REGULATORS

Amperite Regulators are designed to keep the current in a circuit automatically regulated at a definite value (for example, 0.5 amp.) ... For currents of 60 ma. to 5 amps. Operate on A.C. D.C., Pulsating Current.

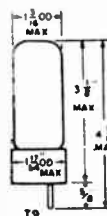
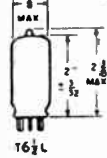

Hermetically sealed, they are not affected by changes in altitude, ambient temperature (-55° to +90° C.), or humidity. Rugged, light, compact, most inexpensive.

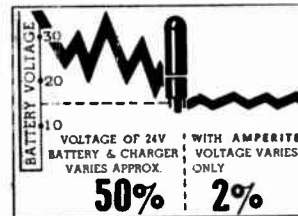

Write for 4-page Bulletin No. AB-51

AMPERITE CO., Inc.

561 Broadway, New York 12, N. Y.

Telephone: CAnal 6-1446

In Canada: Atlas Radio Corp. Ltd.

50 Wingold Ave., Toronto 10

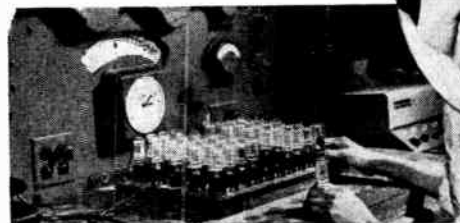

Individual inspection and double-checking assures top quality of Amperite products

## NEW PRODUCTS

(Continued from page 41)

### ● What Are Engineers Really Like? *Item 1419*

If you've ever wondered what engineers are really like we suggest that you send away for a copy of the booklet entitled *What Are Engineers Really Like?* The booklet poses the questions: Are Engineers Egg-Heads? Are They Stuffed Shirts? Are They Highbrows? It poses many other questions in connection with what engineers are like and goes on to answer these questions in down-to-earth language



illustrated with drawings such as the Humpty-Dumpty type of fellow shown in this release. Maybe you're an engineer yourself and have wondered just what other people are thinking about you. If so send away for a copy of this revealing booklet and let it answer your friends' questions for you. It's free for the asking and we suggest that you will get a great kick out of it.

Electronics and Communications, 35 Willcocks Street, Toronto 5, Ontario.

### ● Armored Mercury Plunger Relays *Item 1420*

Now available from Ebert Electronics Corp., are a full line of accident-proof Armored Mercury Plunger Relays.

These rugged encapsulated-tube Relays were specifically designed to withstand shocks, blows and physical impact. To gain this wanted feature Ebert's Standard 35-Ampere or Heavy Duty 60-Ampere hermetically sealed, mercury-to-mercury action contact tubes are potted in special high temperature material and plastic coated, rigid aluminum shells. "Though they may be had so protected against possible abuse, Ebert Relay tubes are of themselves most durable", advises the maker, "and provide the clear advantage of visual inspection. The basic tubes are carefully made of tempered, heavy Nonex and double-dipped in plastic shatter-proofing material for uncontaminable, trouble-free long life in normal usage."

For corrosive atmospheres Ebert's relay coils are also available in all standard operating voltages, fully encapsulated in approved polyester resin compound. Thus Ebert's moisture-resistant interweave coils are further protected from the rigors of duty under deteriorative conditions.

By carrying their own Armor and having hermetically sealed non-wearing contacts, Ebert Mercury Plunger Relays require no more than ordinary general-purpose enclosures in most applications. The use of these rugged, low cost Relays thereby eliminates the need for bulky, expensive housings. Their compact design and up-front terminals also make for fast, simple installation.

Available in a wide variety of one, two and three-pole models, these Armored Ebert Relays should be of great interest to those who demand the finest, and the highest degree of protection for every component

in their equipment.

For detailed information and prices write Ebert Electronics Corp., 212-31P Jamaica Ave., Queens Village 28, N.Y., USA.

### ● Portable DC Overpotential Testers *Item 1421*

MJS Electronic Sales Ltd., Ajax, Ontario, introduces a new line of high voltage power supplies produced by Beta Electric Corporation.

The Portable Series 3000 DC Overpotential Tester has a continuously variable output, zero start interlock, over voltage protection, automatic output shorting mechanism, protected voltage and current meters, reversible polarity. The ripple on all units is less than 1/3 per cent RMS at no load. Standard models are available with maximum output voltages of 15KV up to 150KV, custom models up to 250KV, DC.

An informative resume on DC Overpotential Testing and complete Beta catalogs are available from MJS Electronic Sales Ltd., Box 240, Ajax, Ontario, Canada.

### ● System Description Type 45BN1 *Item 1422*

Automatic Electric Sales (Canada) Limited, 185 Bartley Drive, Toronto 16, Ontario, has recently issued a booklet giving technical information on Lenkurt Type 45BN1 cable carrier equipment. This booklet supersedes all previous system descriptions on this equipment.

For copy of booklet write Automatic Electric Sales (Canada) Limited, 185 Bartley Drive, Toronto 16, Ontario.

### ● Ferrite Core For 110° Picture Tubes *Item 1423*

Development by the Allen-Bradley Company of a new method of molding full-round ferrite deflection yoke cores has led to still another improvement — a flared ferrite core for use with the new 110° picture tubes.

The new flared yokes make possible a weight reduction of 30 per cent over conventional cylindrical cores heretofore used for these new picture tubes. The reduction in material comes from shaping the outer surface so that the cross section is approximately uniform from top to bottom.

The new flared cores for the 110° picture tubes are available in Allen-Bradley Class WO-1 ferrites, preferred because of uniform permeability and flux density.



The flared "full-round" ferrite yoke cores are made as a full 360° ring, then "cracked" by a special process into two mated halves, which are rejoined and mechanically held together for shipping. The "full-round" construction has also the advantage that there is no need for grinding and matching, as is required when quarter sections are used.

Allen-Bradley Company, 136 West Greenfield Ave., Milwaukee, Wisconsin, USA.

### ● 16 mm Films Available On Loan *Item 1424*

A new catalog listing 16 mm motion picture films available on loan from the company's film library is announced by Rogers Majestic Electronics Limited. Subjects include: Ultrasonics, Electron Microscopy, X-Ray Diffractometry and X-Ray Spectrography.

Write: Promotion Department, Rogers Majestic Electronics Limited, 11-19 Brentcliffe Road, Leaside, Toronto 17, Ontario, Canada.

### ● High Pressure Switch And Shaft Seals *Item 1425*

A line of high pressure sealing devices, originally designed by Automatic & Precision Manufacturing Co., to meet stringent military requirements, has been modified to suit the less critical needs of commercial users. Called Hexseals, ® the units are switch "boots" which fit over standard push-button, toggle and rotary switches to prevent the entry of dust, moisture, vapors, or other contaminants into the switch or at the mounting hole.

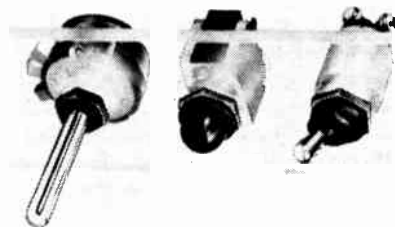

Commercial versions afford original equipment manufacturers a combination of pressure sealing and vibration resistance at only a negligible increase in cost. Use of Hexseals will also increase the service life of standard switches by eliminating switch failures due to the entry of foreign matter.

All Hexseals are constructed around an integral nut. When installed, they replace standard panel mounting hardware on all three types of switches — thus acting as both locknut and sealing device. Being of one-piece construction, there are no extra parts to stock or assemble.

The basic sealing material offers excellent resistance to attack by petroleum or petro-chemical products, remains effective at high temperatures, and has good abrasion resistance. Weathering, sunlight, or salt water will not impair sealing efficiency. Hexseals are recommended for applications in the marine, air conditioning and refrigeration, food and chemical, portable tool and home appliance fields.

A complete range of sizes, colors and special threads is available in each item. For further information, write A.P.R. Armstrong Ltd., 700 Weston Rd., Toronto 9, Ontario, Canada.

### ● High Fidelity Ferrograph Tape Recorder *Item 1426*

Now available in Canada is the High Fidelity Ferrograph Tape Recorder. This sturdy, precision-built recorder features three independent drive motors operating on 110 volts at 60 cycles. Three separate motors are incorporated. An extremely precise hysteresis synchronous unit is used in the capstan drive. The entire recorder reflects the care of assembly which is associated with studio and professional type equipment. Completely portable and equipped with play back loudspeaker. These motors are designed for positive speed stability with non-friction, non-slip drives giving 100 per cent faithful sound reproduction. Auto stop switch automatically cuts off the motor if the spool is empty or the tape breaks while the recorder is in operation. Separate tone controls for bass and treble cuts.

Recording medium is Standard 1/4" dual track plastic coated type. 8 3/4" diameter reels permit the use of 2,600 ft. of "Long Play" tape equivalent of over 2 1/4 hours playing time per reel. Entire reel rewinds in less than 60 seconds. Recorder dimensions are: 17 1/2" x 17 1/2" x 9", weighs 45 lbs. and is attractively finished in gold and bronze with contrasting cream knobs.

The new Ferrograph is distributed in Canada by Astral Electric Limited, 44 Danforth Road, Toronto 13, Ont., Canada.

• **Trop-Arctic Twin For Component Testing**

Item 1427

Trop-Arctic, Inc. of Muncie, Indiana, manufacturers of a quality line of environmental test equipment introduced its new Trop-Arctic Twin to the industry at the Canadian I.R.E. Show in October last.

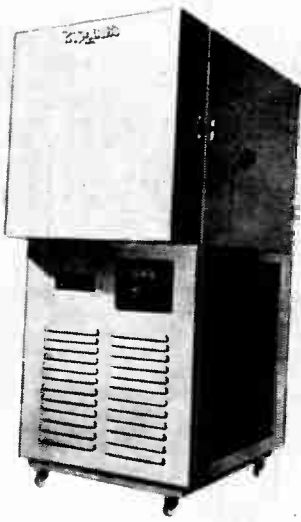

An ideal unit for small component testing. 2 cu. ft. clear working space, measuring 16" wide x 16" high x 14" deep. It is precision built and a practical piece of equipment for a laboratory, because its overall exterior dimensions measure 28" wide x 58" high x 28" deep, allowing it to fit into small spaces between test benches. Operates on a 110 Volt, one phase, 60 cycle electrical power supply with an air-cooled condenser. This is a full cascade Freon 13 — Freon 22 system which will dissipate a 1000 B.T.U.'s at minus 70°F. Obtainable in ranges between minus 100°F. and plus 300°F. Available in gravity cold, cold forced air and hot and cold forced air. Priced from \$1,695.00 with a controller indicator thermal type instrument. Other instrumentation available. Practically any accessories can be added to the basic model such as ports, terminal pads, windows, lights, shelves, etc.

Write for Bulletin No. 291 or send detailed specifications to Trop-Arctic, Inc., P.O. Box 334, Mishawaka, Indiana, U.S.A.

• **Multi-Duty Gin**

Item 1428

The A. B. Chance Company of Canada Ltd. now has available a multi-duty Gin which can be used for pole-top mounting, down-pole mounting, or for lifting single transformers.

When the gin is clamped on top of the pole, the gin beam can be rotated in a complete circle, swinging the load away from under-build obstructions and positioning it for mounting. Rocker-action of the beam, up or down 60 degrees, controls the distance of the load from the pole.

On ridge pins and other types of construction where a gin cannot be mounted on top of the pole, the multi-duty Gin can be mounted down the pole without changing the mounting bracket.

With the beam removed, the bracket can be used by itself for hanging single transformers or transformer clusters. The bracket will straddle a cross arm. Light-duty and heavy-duty models, with rated working loads of 1500 and 2500 pounds, respectively, are available. The bracket, rated at 2500 pounds, is available as a separate item, with or without the pulley-wheel assembly.

The A. B. Chance Company of Canada Ltd., 1206 Kingston Road, Toronto, Ontario, Canada.

(Turn to page 46)

# Teflon...\*

## Your Best Source Is

# JOHN CRANE

Thickness Inches	Nominal Size
1/16	12 x 12
3/32	18 x 18
1/8	24 x 24
3/16	36 x 36*
1/4	48 x 48*
3/8	
1/2 & Up	

\* Can be furnished in 1/2 sheets



### SHEET

DIAMETER INCHES	
1/4	1
3/16	1 1/16
3/8	1 1/4
7/16	1 1/2
1/2	1 3/4
5/8	2
3/4	2 1/4
7/8	2 1/2
	3

Other diameters on specification

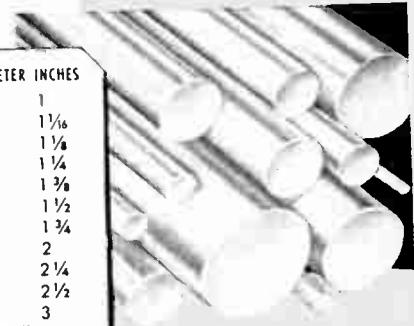

### ROD

TYPICAL SIZES INCHES	
O. D.	I. D.
3/4	1/4
1/2	3/8
3/4	1/2
1	3/4
1 1/2	1
2 1/2	1 1/2
3	1 3/4

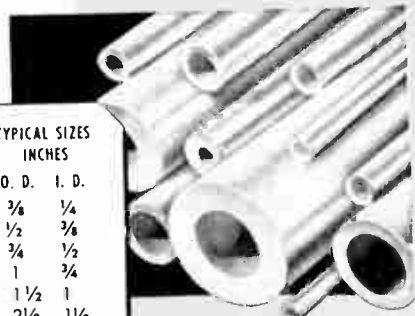

### TUBING

#### Characteristics of Teflon

- CHEMICAL**  
Completely inert.
- ELECTRICAL**  
Very high dielectric strength.  
Extremely low power factor.
- THERMAL**  
Temperature range  
-300° to +500° F.
- MECHANICAL**  
Strong, flexible, weather resistant.
- LOW COEFFICIENT OF FRICTION**  
Absolutely non-stick.

\* DuPont Trademark

**HERE'S WHY:** You can order in quantity and in a wide variety of sizes—and be certain of complete uniformity throughout. Our strict density control assures you thoroughly non-porous Teflon—free from any flaws which might possibly affect your end use or product. Dimensions are accurate to your most critical tolerances—no rejects, waste of material or loss of time. You get product purity—Teflon at its best in every one of its remarkable characteristics. Delivery is prompt—you get the quantity you want when you want it.

Since the availability of Teflon, "John Crane" engineers have worked with Industry to successfully solve innumerable problems and develop new applications. *You can benefit from their experience and know-how.*

Request full information and ask for our bulletin, **The Best in Teflon.** Crane Packing Company, Ltd., 627 Parkdale Ave. North, Hamilton, Ontario, Canada.



## CRANE PACKING COMPANY



## NEW PRODUCTS

(Continued from page 45)

### ● Type 1420 Variable Air Capacitor

Item 1429

Improvements in electrical and mechanical properties have been obtained in the new General Radio Type 1420 Variable Air Capacitors by machining them from solid metal. Both rotors and stators are gang milled from shaped extruded aluminum rods. This method of manufacture allows close mechanical tolerances to be held, and makes a sturdy structure with high mechanical stability.

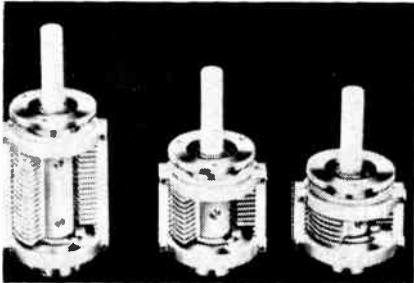

Electrical gains include good linearity, lower metallic resistance and inductance (than even a soldered stack), low thermal drift, and a minimizing of microphonic tendencies. The insulators used are machined from a cast bar of cross-linked polystyrene for thermal adequacy. They are stressed in compression to eliminate crazing or structural failure. The rotor shaft is of glass-reinforced polyester with exceptional strength and stability as well as being good electrically. Double-shielded, full size ball bearings are used, making the capacitors suitable for continuous motor drives.

Commercial Products Division, Canadian Marconi Company, 2442 Trenton Avenue, Montreal 16, Quebec, Canada.

### ● Magnetic Laminations Catalog ML-201

Item 1430

Magnetics, Inc. has issued a four-page supplement to its Performance-Guaranteed Magnetic Laminations Catalog ML-201.

The supplement gives physical lamination constants and core stack design factors for four new high permeability laminations made by the Butler, Pennsylvania, concern. These are lamination shapes DU-1, DU-37, UI-312, and F-21.

All of these laminations are available in both 48 Alloy and Hy Mu 80.

Copies of the catalog supplement, as well as the revised index, may be obtained by writing Magnetics, Inc., Butler, Pa., USA.

### ● D-52 Ultrasonic Sonicell For Large Tanks

Item 1431

The General Ultrasonics Company of Hartford, Connecticut have developed an all-welded stainless steel ultrasonic immersion transducer providing 52 square inches of radiating area for tanks and vats of unlimited volume. It is claimed that this is the largest immersion transducer now available.

A new method of coupling and reinforcing the crystal transducers through solid metal matching elements results in nearly 90 per cent conversion of energy and exceptional ruggedness and long life. Production and performance tests indicate that the use of seam-welding construction, rather than solder, eliminates the former hazards of chemical and cavitation erosion, and that the new D-52 Sonicell will work 24 hours a day efficiently and indefinitely in all known solvents.

Groups of these Sonicells are currently in use in conveyerized automatic cleaning machines handling thousands of pounds of parts per hour. GU officials state that the stronger construction, greater efficiency,

and low cost of this unit now permit economical and practical applications of ultrasonic energy to larger processing tanks for cleaning, pickling and plating operations.

Double units will operate with a single Model 700 electronic Type Generator. Groups or arrays of D-52 Sonicells are powered with GU motor-alternator power sources. The D-52 Sonicells operate at 20,000 cycles per second. This frequency has proved to be most effective for cleaning, pickling, and plating processes and is well above the audible range.

For further information or a demonstration write The General Ultrasonics Company, Hartford, Connecticut, USA.

### ● Miniaturized Sphere Resolver

Item 1432

Vectron, Inc. of Waltham, Mass. announces a new miniaturized precision mechanical Ball Resolver for analog computation applications. The 0.1248-inch diameter input shaft may be driven up to 100 r.p.m. and requires less than 5 inch-ounces at 25 degrees Centigrade for an output of 1 to 2 inch-ounces at the 0.187-inch diameter sine and cosine output shafts. The 0.500-inch orientation shaft is concentric with the input and establishes the output relation with an accuracy of  $\pm 0.5$  per cent over a 360-degree range.

This rugged precision component is in the form of a block  $1\frac{1}{2}$  inches square and  $2\frac{1}{8}$  inches long, weighing less than  $\frac{3}{4}$  pound. Output shafts on the standard unit

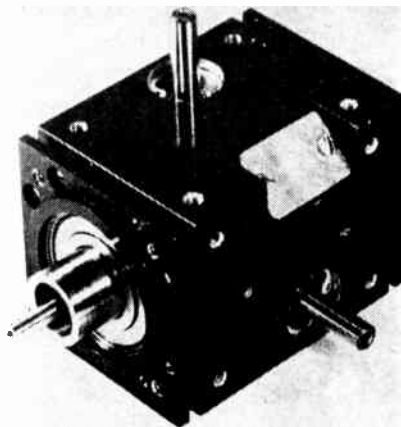

extend  $\frac{1}{2}$  inch from adjacent faces, each of which has precision mounting provisions. The orientation input protrudes  $\frac{1}{8}$  inch beyond the end mounting surface, while the rotational input shaft extends another  $\frac{1}{8}$  of an inch. Full material certification is available for military applications.

Vectron, Inc., 1584 Trapelo Rd., Waltham 54, Mass., USA.

### ● Synchro Test Equipment

Item 1433

D-767-A Synchro Electrical Test Set. This is a comprehensive unit designed to determine with the greatest facility the following parameters of CX, CT and CDX Synchros:

- Electrical zero
- Electrical error
- Transformation ratio
- Open circuit current and power.

The test to be performed is selected by a master selector switch engraved TEST which carries out all the necessary circuit changes. Provision is made for connecting an external ammeter for current measurement and an external wattmeter for power measurement. For angular error measurement, the Synchro is connected to a phantom circuit comprising three resistors connected in delta formation, one arm of

which is variable in steps, each corresponding to ten degrees of angle, from 0-60°. Used in conjunction with a range switch, this circuit determines the electrical angular error of a Synchro in 10° steps over 360° by a simple null measurement, the null point being indicated by the D-760-A Selective Phase Sensitive Detector. A feature of the set is that the Synchro under test is not energized until an appropriate spring-loaded key switch is operated and, furthermore, if two switches are inadvertently operated simultaneously, again the Synchro will not be energized. This is a very valuable safety precaution when routine testing is carried out by semi-skilled operators.

Muirhead Instruments Limited, Stratford, Ontario.

### ● Electronic Components Catalog

Item 1434

A new 228-page catalog, "Electronic Components for Industry," is available from Electro Sonic Supply Co. Ltd., Toronto. Designed for the engineer, technician and manufacturer engaged in the fields of industrial, military or laboratory electronics, this catalog lists a full line of radio and electronic parts, components and equipment. Shown are tubes, transistors, capacitors, resistors, rheostats, transformers, switches, connectors, relays, tools, test equipment, wire and cable, public address equipment and many other items for use in manufacturing, repair and plant maintenance.

This catalog fills a long felt need for a listing, under one cover, of many specialized electronic products normally available only from a great number of sources. A free copy of this Catalog No. 561 may be obtained by writing to Electro Sonic Supply Co. Ltd., 543 Yonge St., Toronto 5, Ontario.

### ● Transistorized D.C. Voltage Regulator

Item 1435

Western Gear Corporation, Electro Products Division, announces a new transistorized D.C. voltage regulator offered in two models of varying current capacities. This precision regulator is designed for use under rugged environmental conditions where performance, spacing and weight are at a premium. The circuitry employs a series power transistor and a temperature compensated Zener diode reference voltage. Voltage, current, regulation, size and other parameters may be widely varied to suit specific applications. Input voltage is 27.5 V.D.C. plus or minus 15 per cent. Output Model 7VR09 20V.D.C. at 50 to 250 MA; Model 7VR08 20V.D.C. at 10 to 150 MA. Regulation less than plus or minus one per cent for combined variations input voltage, load current, temperature, drift, vibration.

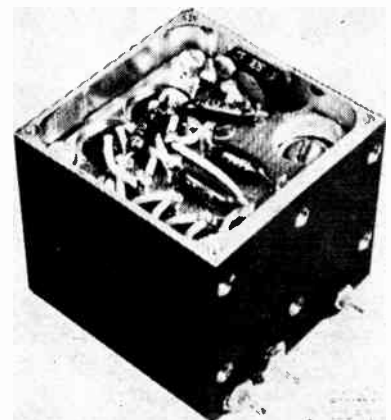

Shunt loss is less than 25 MA. Temperature range from 32°F. to 150°F. Dimensions 2 x 2 x 2 inches. For further details write Western Gear Corporation, Electro Products Division, 132 West Colorado, Pasadena 1, California, USA.

# electronics

## in business & industry

### communications . . .

Inter-communication between store and stock-room of such establishments as grocery chain units has been simplified by means of sound-powered telephones. A large U.S. supermarket organization has installed U.S. Instrument sound-powered handsets, equipped with 25-foot retractile cords and plugs. The sales clerk who is running short of items of merchandise simply plugs his telephone handset into one of the outlets along the aisle where he is serving, and converses with the clerk in the stockroom where merchandise is stored in bays which correspond exactly with the arrangement in the store. Thus the stockroom clerk is able to follow intelligently the requirements of the sales clerk, stocks are replenished, customer service is improved and time and effort are saved.

\* \* \*

### office machines . . .

Word comes from France that an electric typewriter has been invented than can operate with the speed of thought. It is claimed that a whole sentence can be typewritten by the pressing of one button. Memory circuits built into the machine can store up 16 sentences of 50 letters each, and any one of these may be typed automatically simply by pressing a button. The Electrostyl can transmit at the rate of 140 words per minute, which is comparable to rapid speech.

\* \* \*

### railroads . . .

Experiments are being made in West Germany with a radio-controlled electric shunting locomotive which can be operated without an engineer. The operator sits in front of a control panel in a freight yard control center keeping in contact with the locomotive by ultra-short-wave radio. Thirteen different sets of instructions can be transmitted by radio impulses to the engine's mechanism, including the changing of five sets of gears.

\* \* \*

### engine testing . . .

Testing automobile engines for true balance can now be accomplished by means of electronic analyzers. This is done while the engine itself is running at 1500 rpm, the analyzer singling out vibrations of the right frequency, measuring them and determining the amount of correction needed to put them in proper balance.

\* \* \*

### railway control . . .

A greater measure of safety for railroad traffic will be assured to travellers on British railways when a new safety device, approved by the British Government, is put into use. This automatic train control, which can be used on either electric or steam trains, is an electromagnetic device which stops a train automatically if the engineer fails to heed a danger signal.

\* \* \*

### hospitals . . .

Shortages in hospital nursing service may be counteracted to some extent by the installation of an "electronic eye" in the floor nurse's office. By watching the monitor, the nurse would be able to see what is going on in each hospital room in which a small camera unit has been installed, possibly in a concealed location.

Not only does this application of electronics permit the nurse to watch the patient, but with the picture of the patient's room she is notified on an illuminated strip, of the patient's name, room number and attending doctor's name.

\* \* \*

### sonar . . .

A system has been developed for automatic processing of sonar data at sea. The Digiter prints automatically the acoustic level of a sonar signal in decibels, accurate to  $\pm 0.2$  db with a dynamic range of 50 db. The system could no doubt be applied in studies other than sonar.

## business briefs & trends

★ A survey by the Atomic Industrial Forum of New York reveals that the number of industrial users of radioactive isotopes has jumped by more than 500 per cent in the past five years. The use of radio-isotope applications now represents a \$200 million annual saving to industry as a result of their use in gaging and control operations and the manufacture of a wide variety of consumer products.

★ A transistorized fuel injection system for automobile engines known as the "Electrojector" promises to provide more power with less fuel and will assist automobile designers to produce lower slung automobiles. The new injection system is claimed to be capable of eliminating vapor locks and to reduce the volume of smog created by gasoline exhaust fumes.

★ RETMA in the United States reports that 6,959,000 transistors were produced in the first eight months of 1956 as against 1,715,000 in 1955.

★ K. R. Patrick, president of Canadian Aviation Electronics Limited, told a recent gathering of the Canadian Club that it would cost Canada probably \$2 billion during the next 10 years for an automatic control system to tie together radar warning systems with interceptor aircraft and guided missiles. In addition to the \$2 billion Canadian expenditure, Mr. Patrick said that the United States will probably commit from \$8 billion to \$10 billion for such a program also within a 10-year period.

★ Reports by leading automobile radio manufacturers claim that nearly one-third of all car radios produced in 1956 used transistors and it is anticipated that this figure will increase this year by 60 per cent. It is stated, however, that most of the transistorized car radios now in production are not fully transistorized but rather hybrid sets using one power transistor.

★ Korea now has television. A recent telecast over Station HLKZ-TV is estimated to have been received on 45 television sets, most of them in public places.

★ Canada is now rated as one of the world's major TV markets. With well over 2,000,000 sets in use, it ranks only behind the United States and Great Britain in this respect. Canada now has 33 television stations, a number exceeded only by the United States.

★ One of the latest applications of ultrasonics is the arresting of hiccoughs. This discovery has been made by two Brazilian doctors. Among many other medical applications of ultrasonics is the slicing of brain tissue with a higher degree of accuracy than can be achieved with a surgeon's scalpel.

★ Automation in the TV manufacturing industry has been found to cost more than ordinary methods of production, this being due to the fact that present-day components are not designed to conform to automatic handling.

★ Mr. Gerard Picard, president of the Canadian and Catholic Confederation of Labor, does not look upon automation as a bogey. Speaking to the

C.C.C.L.'s 35th convention in Montreal, Mr. Picard expressed the view that organized labor should welcome automation as a means to a new industrial age which will bring higher standards of living for everyone.

★ When Britain's first nuclear power station, Calder Hall, which was officially opened in October 1956, is working at full capacity in 1957, the station will have a capacity of 96,000 kw. Plans are under way for seven nuclear stations to be under construction in Britain this year, to provide for 5 million kw. capacity by 1965.

★ A new research building has recently been opened at Enfield, near London, England, by The Sylvania-Thorn Color Television Laboratories. It is hoped that British research in conjunction with U.S. production techniques will bring color television to the British public within ten years. The objective of the new laboratories is to produce a color receiver comparable in cost to a black-and-white receiver and easy to operate and maintain. To do so may require the invention of a completely new type of color tube.

★ A business survey in the United States has revealed that of salary increases given by companies to their personnel, the percentage rise among engineers was the highest in the last year.

★ During 1957 the B.C. Telephone Company anticipates an expenditure of approximately \$40 million to expand and improve its facilities. This will represent an increase of over 40 per cent compared with the actual amount spent for this purpose in 1956. The forecast for the three-year period — 1956 to 1958 inclusive — is that over \$100 million will have been expended on expansion and improvement to meet the heavy demands for telephone service in British Columbia.

★ According to a survey made by the Dominion Bureau of Statistics during the latter part of 1956, 96 per cent of all Canadian families are equipped with radio receiving sets, while about 75 per cent of all homes have telephones. In each instance the percentage has risen slightly since the previous year. A greater percentage increase was observed in 1956 over 1955, however, in households possessing television sets; out of almost four million households, 54 per cent had become equipped with television as against 39 per cent in the previous year.

★ Hughes Aircraft predicts a steady growth in the semi-conductor business in the years up to 1960. Sales of transistors, diodes and rectifiers are estimated to be \$100 million in 1957 and to reach a volume three times as great by 1960.

★ A flat, shadow-mask color television tube is being developed in London, England, which it is hoped will eliminate some of the manufacturing problems existing in color kinescopes today. National Research Development Corporation of London has been assigned the British rights on this product and the patent will be pooled with Kaiser Aircraft and Electronics Corporation in the United States.



# Strowger Type 11 M-A-X GROWS WITH YOUR COMMUNITY—ECONOMICALLY!

➤ **Add a Switch** and you take care of moderate growth, quickly, easily. Just jack it into place on one of the numerous extra banks provided with your initial equipment. No wiring. No soldering!

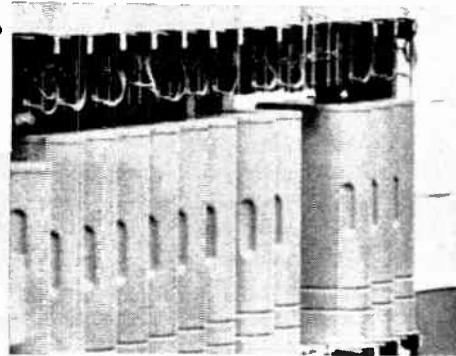
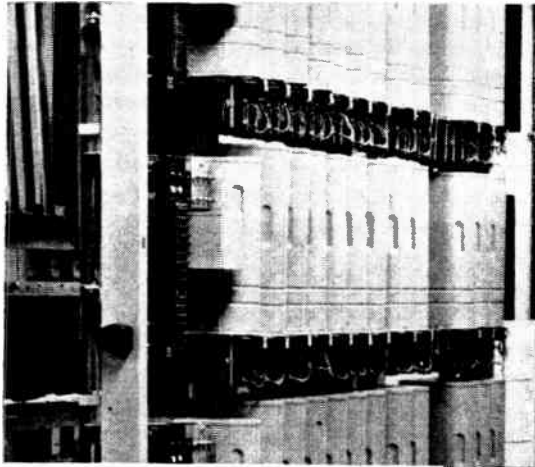

◀ **Add a Shelf** of switches when larger growth occurs. Each shelf is complete with pre-wired banks. Your men can install it quickly and inexpensively.

➤ **Add a Frame** with as many shelves of switches as you need, to meet heavy growth. There are no capacity limits to Strowger expansion.

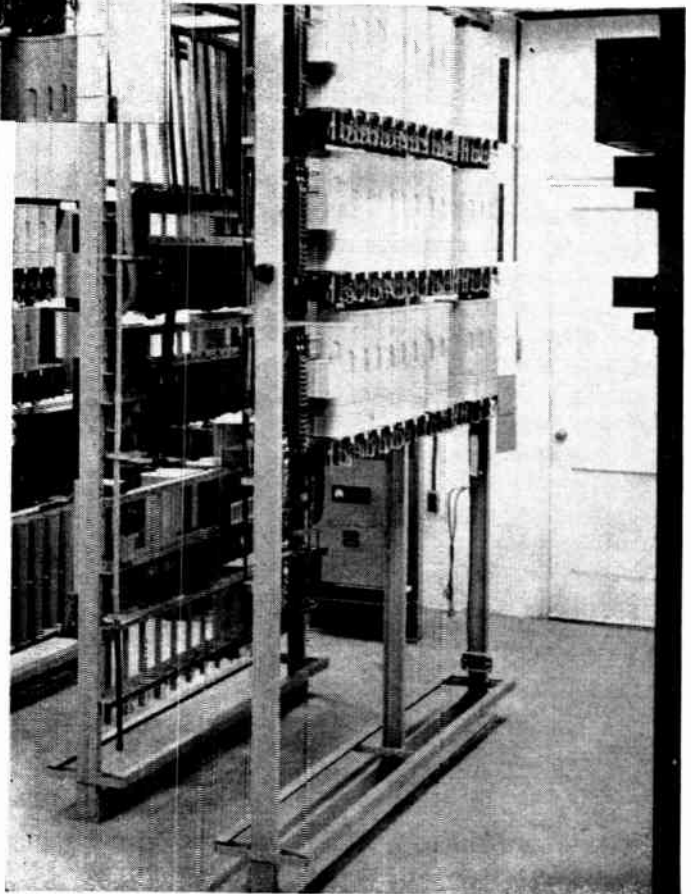

5602

For installations up to 400 lines, with prospects of expansion, a Strowger Automatic Type 11 M-A-X is your best investment by far. Experience proves it expands economically to meet any need.

You will have no technical worries when you expand, no capacity limits to fret about. Merely order additional equipment when you need it—and put it in. It's as simple as that! Economical too, when you consider that each switch, each shelf, each frame is a pre-wired *unit*—made so more can be added with minimum time and labour.

Arrange for a

consultation today!



**AUTOMATIC**  **ELECTRIC**

ORIGINATORS OF THE DIAL TELEPHONE



Distributor in Canada

**AUTOMATIC ELECTRIC SALES (CANADA) LIMITED**

Head Office: 185 Bartley Drive, Toronto 16

MONTREAL • OTTAWA • BRIDGEVILLE • HAMILTON • WINNIPEG • REGINA • EDMONTON • VANCOUVER

**New!****MEASUREMENTS'****FM****Standard****Signal****Generators****MODEL 210 SERIES**

Measurements' Model 210 Series of Standard FM Signal Generators is designed for FM receiver measurements in the standard FM band; for measurements on railroad and automobile FM radio systems, research on FM, multiplexing and telemetering equipment. Models are available for use within the limits of 30 to 200 Mc each with a tuning range of approx. 1.2; for example, Model 210-A, 86 to 108 Mc.

**FEATURES:**

- Wide deviation with low distortion.
- Low spurious residual FM.
- Models coverings 30 to 200 Mc.
- Accurate output voltage calibration — low VSWR.
- Operates at fundamental carrier frequencies.
- Vernier electronic tuning.

**SPECIFICATIONS:**

**FREQUENCY RANGE:** Five different models, each with tuning ratio of approx. 1.2, cover range from 30 to 200 Mc.

**TUNING:** Vernier frequency dial, and electronic tuning for frequency deviation.

**OUTPUT VOLTAGE:** 0.1 to 100,000  $\mu$ v.

**OUTPUT SYSTEM:** Mutual-inductance attenuator with 50-ohm source impedance with a low VSWR.

**MODULATION:** Selectable 400 and 1000 cycle internal audio oscillator. Other modulation frequencies available.

**MODULATION FIDELITY:** Frequency deviation response within  $\pm 0.5$  db from d.c. to 15,000 cycles, within 3 db to 70 Kc.

**RESIDUAL FM:** Spurious residual FM 60 db below 75 Kc. deviation.

**POWER SUPPLY:** 117 v., 50-60 cycles, 45 watts.

(complete data on request)

*Laboratory Standards* **MEASUREMENTS CORPORATION****BOONTON • NEW JERSEY**

In Canada: H. ROY GRAY LTD.,  
46 Danforth Road, Toronto, Ont.

# Book Review

**Office Work And Automation** by Howard S. Levin. In this book Mr. Levin describes in non-technical language how recent developments are bringing about a challenging re-appraisal of the business office. Information handling is the central theme of the book. The author views the office as a kind of "information factory", turning raw information into processed information that serves a management objective. Integrated data processing facilitates the initial handling of information . . . electronic computers aid in the processing of information . . . and operations research contributes to the use of information. These are the three fundamental tools of the "information engineer". These key tools are discussed in an authoritative but easy-to-understand manner by Mr. Levin, who addresses his book primarily to the management profession, and presupposes little direct association with office machines or office methods. Broad in scope, the volume gives greater emphasis to guiding principles than to specific techniques. Included are useful illustrations, charts and tables.

**Office Work And Automation** is published by John Wiley & Sons, Inc., 440 Fourth Avenue, New York 16, N.Y., contains 203 pages, hard cover bound, price \$4.50.

**Principles Of Color Television** by The Hazeltine Laboratories Staff — compiled and edited by Knox McIlwain, E.E., and Charles E. Dean, Ph. D.

Prompted by the urgent need for more information to meet the rapid advance of color television, the Hazeltine Corporation initiated a series of general reports covering the various aspects. These reports laid the foundation for the book.

The reports have already proved their growth in numerous industrial laboratories. Expanded and brought up to date, the material has been organized into a unified presentation of the design of color television equipment and its underlying theory.

Following a sound basis of principles, including a clear discussion of the quantitative handling of color, the book presents the features of transmitting, receiving, and measuring equipment. The complete description of the engineering design of receivers includes questions of synchronization, RF, IF, video amplifiers, and decoders.

A study of FCC transmission standards, a glossary of color television terms, and several appendices complete the work.

**Principles of Color Television** is published by John Wiley & Sons, Inc., 440 Fourth Avenue, New York 16, N.Y., contains 595 pages, hard cover bound, price \$13.00.

**How To Make Good Tape Recordings** by C. J. LeBel, Vice-President of Audio Devices, Inc.

This completely new handbook of tape recording contains up-to-the-minute information of interest and real practical value to every tape recordist.

The author, Mr. C. J. LeBel, is one of the foremost authorities on sound recording in general and tape recording in particular.

The book is written in simple, non-technical language. It can be read and easily understood by even the most inexperienced of home recordists. Yet it contains such a wealth of practical information that it will be a valuable aid to professional tape recordists as well.

The following chapter headings indicate the scope of the material covered: How a Tape Recorder Works . . . Characteristics of a Tape Recorder . . . Selecting a Tape Recorder . . . Selecting a Recording Tape . . . Using the Tape Recorder . . . Making a Microphone Recording . . . Acoustically Treating the Studio . . . Tape Editing . . .

Putting Together a Recording Show . . . Glossary of Tape Recording Terms.

**How To Make Good Tape Recordings** is published by Audio Devices, Inc., 444 Madison Avenue, New York 22, N.Y., contains 159 pages, obtainable either hard cover bound at \$2.50, or paper bound at \$1.50.

**Principles of Communications Systems** by W. D. Hershberger. This one book presents the principles underlying all communication systems, and shows their application to specific systems.

*Principles of Communication Systems* places emphasis not on the "hardware" of any particular system, but on topics such as signals and their spectra, information theory, noise, modulation, and detection. Dr. Hershberger includes topics often omitted in current undergraduate training: noise, Fourier integrals, signal distortion by the method of paired echoes (in the chapter on transmission lines), and correlation function (in the chapter on radar).

After considering the characteristics of channels useful in communication—radio and transmission lines, in particular—the author examines human and other factors which determine the design and limit the performance of any given system.

Treating systems diverse in signal spectra, in information theory, and other elements, Hershberger examines audio, television, and radar systems in detail. Through the presentation of these different systems, the reader is familiarized with a wide range of topics, always with the emphasis on the informational capacity of any particular system.

W. D. Hershberger (Ph.D., University of Pennsylvania) has been teaching at the University of California, in Los Angeles, since 1949. His outstanding pioneer work with the RCA Research Laboratories from 1937-1949 won him the grade of Fellow in the Institute of Radio Engineers "for early contribution to the development of radar, and to frequency stabilization using microwave absorption lines."

**Principles of Communications** is published by Prentice-Hall Inc., 70 Fifth Avenue, New York 11, N.Y., contains 253 pages, hard cover bound, price \$6.65.

**Hi-Fi Loudspeakers And Enclosures** by Abraham B. Cohen.

Here is a long-awaited book dealing with one of the most important sections of a hi-fi system. This book, destined to become a classic in its field, will answer all questions of the hi-fi enthusiast and audio technician that pertain to high-fidelity loudspeakers and enclosures. It will be of interest both to the man who wants to assemble his own hi-fi system from separate units and to the man who is interested in "packaged" or pre-assembled systems.

The book is divided into three main sections: "The Loudspeaker", "The Enclosure", and "The Room". In the first of these sections the reader is taken in easy steps from the basic loudspeaker principles toward an appreciation of those variations which lead toward the specialized high efficiency, high quality reproducers of today. The second section of the book analyzes and develops types of loudspeaker baffles and enclosures from the simplest flat baffle to the most complex folded horn enclosures.

The third section of the book deals with the listening room as part of the acoustic circuit and includes information on enclosure placement and room treatment and adjustment for best hi-fi reproduction.

**Hi-Fi Loudspeakers And Enclosures** is published by John F. Rider Publisher, Inc., 480 Canal Street, New York 13, N.Y., contains 368 pages, paper cover bound, price \$4.60.

For further data on advertised products use page 65.

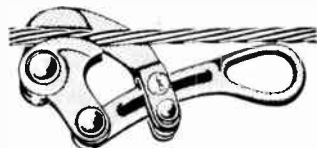
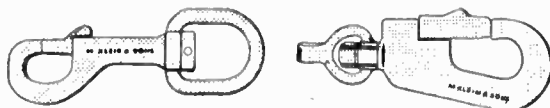

**linemen** (*naturally*)



**electronic  
assemblers**  
(*without a doubt*)

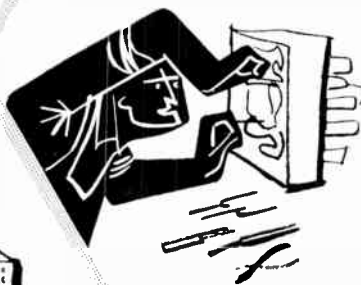

(*and even*) **lab technicians**

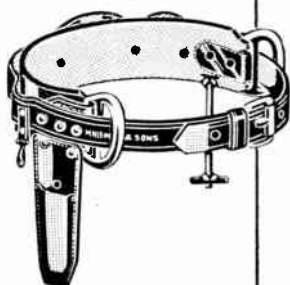
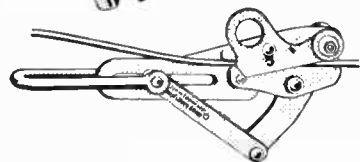
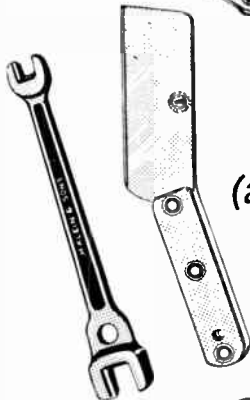
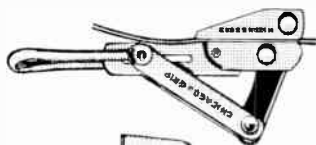

**all  
agree...**

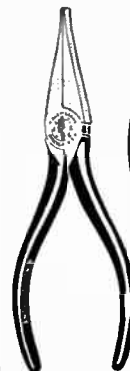
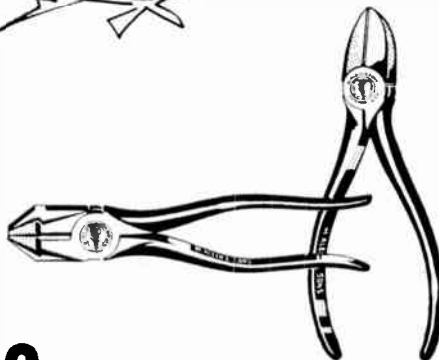

**— the very best in tools and equipment  
for their jobs come from**

**AUTOMATIC ELECTRIC**

**SALES (CANADA) LIMITED**

185 Bartley Drive, Toronto 16

MONTREAL • OTTAWA • BROCKVILLE • HAMILTON  
WINNIPEG • REGINA • EDMONTON • VANCOUVER

# NEWS



## Canadian Westinghouse Assists University's Engineering Program

Announcement was made recently that the Canadian Westinghouse Company Limited will make a capital grant of \$200,000 to McMaster University, Hamilton, to assist the university's recently-announced nuclear reactor project and expanded engineering program.

George L. Wilcox, president of the Westinghouse Company, said that the grant reflects his company's recognition of the urgent need for broader facilities to train nuclear scientists and technicians in Canada.

Dr. George P. Gilmour, president of McMaster University, in commenting on the announcement said: "The interest of Canadian Westinghouse and other companies in McMaster's expansion is most encouraging, because these capital grants from industry assist us to advance further in the fields of nuclear studies and engineering, and will benefit the whole of Canada."

## J. Bruce Elder Represents Radio Frequency Co.

The Radio Frequency Company of Medfield, Massachusetts has announced that J. Bruce Elder has been appointed as engineering and sales representative of that organization in the provinces of Ontario and Quebec.

Mr. Elder will represent this firm in the application of high frequency induction heaters to the brazing, soldering, hardening, annealing etc. of metals, and also the heating of non-metals, curing of plastics etc. by means of high frequency generators.

Mr. Elder will be contacted at 2 Robert St., Burlington, Ontario — Nelson 4-0511.



● Shown above are officers of Standard Coil Products (Canada) Limited discussing the features of their new Super Fireball Tuner. From left to right are Frank Hedemark, sales engineer; C. W. (Chuck) Peterson, sales manager; Jim Leakey, plant superintendent; Bill Doenges, chief engineer; and Will James, general manager.

## Sales Engineer For Muirhead Instruments

Muirhead Instruments Limited of Stratford, Ontario, announce that E. G. Enns has been appointed sales engineer of the company and that Mr. Enns is currently engaged in visiting companies in Ontario and Quebec. In making his calls, Mr. Enns is prepared to demonstrate the Muirhead range of precision instruments, particularly wave analyzer, oscillator, new impedance angle meter, standard cells and synchros.

## Electrovert Ltd. To Represent Critchley Bros.

Announcement has recently been made of the appointment of Electrovert Ltd. of 265 Craig Street West, Montreal 1, Que., as sole agents for Critchley Bros. Ltd., of Brimscombe, Stroud, Glos., England.

## New Appointment By Canadian Admiral

Stuart D. Brownlee, executive vice-president, recently announced the appointment of Guy Bell as assistant general sales manager of Canadian Admiral Corporation Ltd., eastern division. Mr. Bell is also vice-president of Canadian Admiral Sales Ltd., distributing subsidiary of the corporation. Prior to his new appointment, Mr. Bell was manager of the Montreal branch.

## CDC Speeds Radiation Pattern Calculations

Radiation patterns that formerly required months of tedious work are now solved in a fraction of the time with the aid of a digital computer in the Data Processing Centre of Computing Devices of Canada Limited.

CDC mathematicians are now working on a contract for the Department of Transport to determine the radiation patterns for a number of CBC and privately owned radio broadcasting stations in Canada. Old methods of obtaining this pattern involved an approximate graphical solution that is not always accurate enough for the requirements of the present crowded broadcasting spectrum.

The present work being done by CDC represents a backlog accumulated by Department of Transport, and will take nearly a year to complete. Once the initial group of patterns are completed, it is expected that studies will be necessary only when a new station applies for a license.

(Turn to page 54)

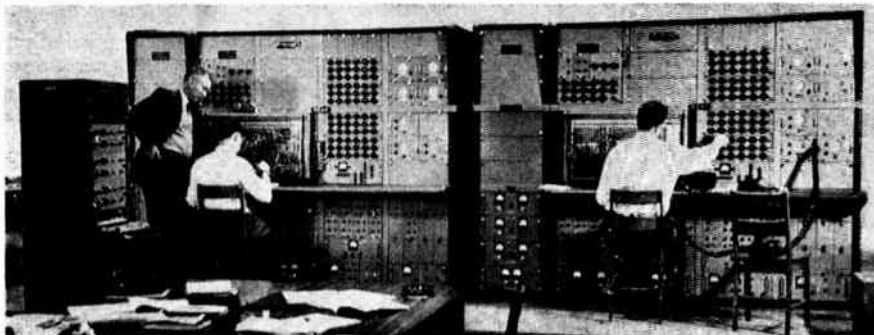

● Shown above is Computing Devices of Canada Limited's REAC which is really two identical computers that can be used independently, or connected together and used as a unit for exceptionally complex problems. All together it contains 20 integrators, 36 summers, 40 invertors, and 14 servos for multiplication and other uses. Power consumption of the computer exceeds 17 kilowatts. At the extreme left is a recording voltmeter used to make permanent records of the results of the computations.

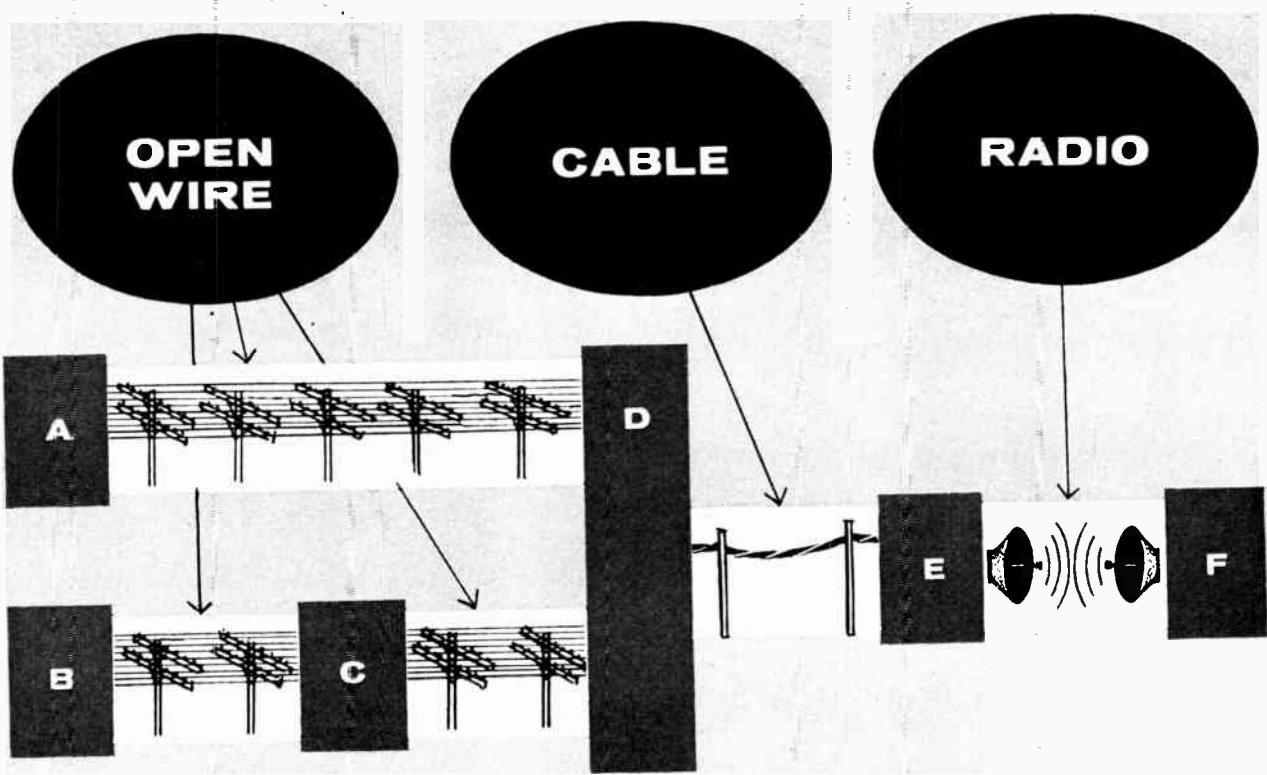

**45-CLASS CARRIER NETWORKS**  
**give you direct interconnection**

**AT CARRIER FREQUENCIES**

**ABOVE NETWORK INCLUDES:**

- LOCATION A**  
Type 45A
- LOCATION B**  
Type 45CB
- LOCATION C**  
Type 45CB base group terminal  
Type 45A terminal  
1 pre-group connector
- LOCATION D**  
2 Type 45A base group terminals  
Type 45BN base group terminal  
2 base group connectors
- LOCATION E**  
Type 45BN base group terminal  
Type 45BX terminal  
2 base group connectors  
Radio terminal
- LOCATION F**  
Type 45BX terminal  
Radio terminal

*Direct interconnection* is the basis of Lenkurt's famous 45 "universal" class of carrier systems. Each of these carrier systems—open-wire, cable and radio—is designed to connect directly with the others *at carrier frequencies*. Thus, your entire carrier network can be completely coordinated. Think of the savings and improved performance this means to you! Expensive back-to-back equipment arrangements to convert carrier to voice frequencies, and then back to carrier, are no longer needed. Maintenance is simpler. Distortion is reduced. Here is a new approach to planning and engineering your toll routes.

The systems of the 45 class offer other important savings, too. *Miniaturized components* permit a maximum number of channels in minimum space. *Plug-in construction* means more flexibility in applications and fewer parts to stock. And you save on installation labor because Lenkurt 45-class carrier comes factory-assembled, rack-mounted and tested as a system.

*Learn how Lenkurt Carrier systems can economically help solve your communication problems. Contact Automatic Electric Engineers for their specific recommendations. Address: Automatic Electric Sales (Canada) Limited, 185 Bartley Drive, Toronto 16, Ontario. Branches in Montreal, Ottawa, Brockville, Hamilton, Winnipeg, Regina, Edmonton, Vancouver.*

5635



PIONEERS IN AUTOMATIC CONTROL



**AUTOMATIC ELECTRIC • LEADERS IN CARRIER COMMUNICATIONS • LENKURT**

# KESTER



Absolutely non-corrosive and non-conductive, KESTER "RESIN-FIVE" CORE SOLDER contains an activated type of resin that gives you that fast, positive action on all your jobs . . . including the most difficult.

**KESTER SOLDER COMPANY OF CANADA, LTD.**  
Dept. U - Brantford, Canada

# SOLDER

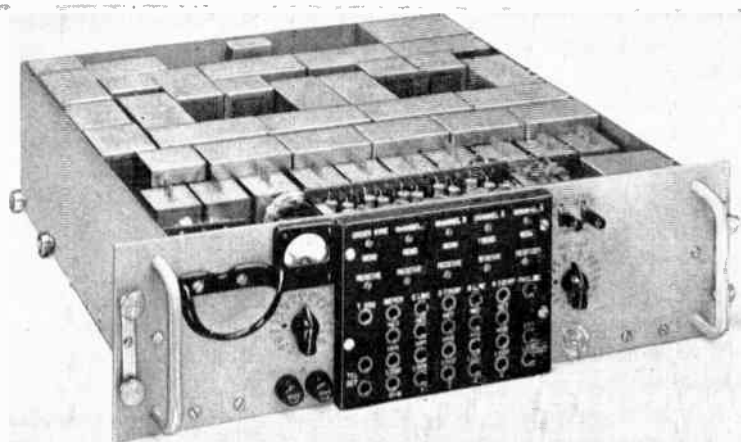

## FOUR-CHANNEL CARRIER-TELEPHONE TERMINAL FOR RADIO LINKS

This is a miniaturized unit of advanced design which provides four voice channels on a frequency-division basis above a voice-frequency order-wire channel. Each of these five channels is provided with a 4-wire 2-wire termination and a voice-frequency ringing circuit for d-c or 20-cycle signals. Adjustable attenuators are provided in the 4-wire side of all channels, and a built-in test oscillator and meter permit complete line-up, maintenance and trouble-shooting checks to be made. Channel levels are from -9 to 0 dbm and line levels from -30 to 0 dbm. Channel width is 300 to 3500 cycles within 1 db.

This unit is only 5 1/4" high by 19" wide by 14" deep. It mounts on a standard rack and operates from 115 volts 50-60 cycles a.c.

**RADIO ENGINEERING PRODUCTS**  
1080 UNIVERSITY ST., MONTREAL 3, CANADA  
TELEPHONE UNIVERSITY 6-6887  
CABLES RADENPRO, MONTREAL

## NEWS

(Continued from page 52)

### Ted Graham Joins Hackbusch Organization

Ted Graham, a sales engineer who recently joined Hackbusch Electronics Limited in Toronto, will extend the operation of that company to the communications field.



TED GRAHAM

Mr. Graham was brought up-to-date on TACO developments by Chief Engineer, Robert T. Leitner during a recent visit to the TACO plant at Sherburne, N.Y.

Immediately prior to joining the Hackbusch organization, Mr. Graham had put in three years operating his own appliance store in Toronto.

### Aviation Electric Sales Appointments

To further the current expansion program, A. Bandi, president of Aviation Electric Limited, has announced the following new appointments, effective immediately:

Christopher N. Watts as assistant sales manager — Instruments and Electronics Division; C. Durham Garbutt as assistant sales manager — Mechanical Accessories Division; A. Jack Warwick as assistant sales manager — Manufacturing Division.

Mr. Watts, Mr. Garbutt and Mr. Warwick were previously supervisors of their respective departments and are backed by many years of extensive experience in their particular fields.

### Electrolabs Is Canadian Rep. For Aerolite Corp.

The appointment of Electrolabs of 7385 St. Lawrence Boulevard, Montreal 16, as sole Canadian representative for Aerolite Corporation was recently announced.

Aerolite Corporation manufactures a high quality line of electronic hardware components and assemblies for radio, television and electronic equipment manufacturers.

### CGE Appoints Two New Directors

The election of B. M. Hoffmeister and J. M. Breen to the Board of Directors of Canadian General Electric Company Limited was announced following a recent meeting of the Board.

Mr. Hoffmeister is chairman of the board of MacMillan and Bloedel Limited, Vancouver.

Mr. Breen is president and general manager of Canada Cement Company Limited, Montreal.

(Turn to page 56)

**FOR PRECISION LABORATORY OR PRODUCTION TESTING**



**FREED 1110-AB INCREMENTAL INDUCTANCE BRIDGE AND ACCESSORIES**

Accurate inductance measurement with or without superimposed D.C., for all types of iron core components.

- INDUCTANCE — 1 Millihenry to 1000 Henry
- FREQUENCY — 20 to 10,000 Cycles
- ACCURACY — 1% to 1000 Cycle, 2% to 10K
- CONDUCTANCE — 1 Micromho to 1 MHO
- "Q" — 0.5 to 100
- SUPERIMPOSED D.C. — Up to 1 Ampere
- DIRECT READING — For use by unskilled operators.

**ACCESSORIES AVAILABLE:**

- 1140-A Null Detector, 1210-A Null Detector — V.T.V.M.,
- 1170 D.C. Supply and 1180 A.C. Supply.

**INSTRUMENT DIVISION**

**FREED TRANSFORMER CO., INC.**

1716 Weirfield St., Brooklyn (Ridgewood) 27, N.Y.

**FOR SALE**

General Electric Television Slide Projector Type PF-4A. Provides for dissolves between dual sections and accepts slides, cards, small objects and strips of the following size:

- 1 — 3¼" x 4", mat opening; 2¼" x 3", standard transparent glass slides or opaques.
- 2 — Opaque strip material 4" wide and any length.
- 3 — Display material not exceeding 2¼" x 3" in area and up to 1" in thickness.

Dimensions: H—52", L—33⅝", W—20"; weight 195 lbs.; projection 43" for iconoscope; input 110 volts, 60 cycles, 1800 watts maximum.

Original cost \$3,953.50.

This unit is in new condition but has been replaced in our operation by a 2¼" x 2¼" slide projector. Will sacrifice. Offers considered. Address:

**Canadian Broadcasting Corporation,**  
701 Hornby Street,  
Vancouver, B.C.

**HAMMOND**

**gives you SERVICE on standard or special items**

**TRANSFORMERS**

- FOR REPLACEMENT WORK
- FOR SOUND EQUIPMENT
- FOR TRANSMITTING EQUIPMENT
- FOR INDUSTRIAL APPLICATIONS
- FOR TEST AND DEVELOPMENT PURPOSES

DISTRIBUTED FROM COAST TO COAST  
CANADA'S LEADING PARTS JOBBERS

HAMMOND MANUFACTURING COMPANY LIMITED, Guelph, Ont.

*this*  
**G-V**  
**time delay**  
**relay**

*does many jobs*



*other thermal relays cannot do...*

- For military or industrial use
- Miniature and octal sizes
- Plug-in or flanged mounting
- Hermetically sealed
- Adjustable or non-adjustable
- Delay intervals 1/4 sec. to 5 minutes
- Unaffected by ambient temperatures -70° to 100°C

*Our facilities assure prompt deliveries*

Write for bulletin and help with your particular problems



**G-V CONTROLS INC.**

54 Hollywood Plaza  
East Orange, N.J.

Represented in Canada by:  
LEONARD ELECTRIC, LTD., 346 Bering Ave., Toronto 18

# New Honeywell High Gain Weld-Seal TRANSISTORS

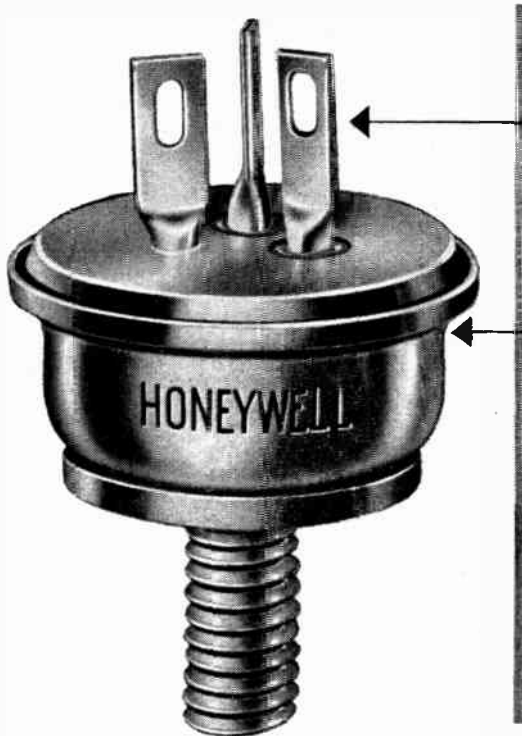

New rugged terminals permit easy soldering of connections without harming the transistor.

New welded case — hermetically sealed for superior ruggedness and durability.



**TYPES H5, H6, H7, AVAILABLE NOW!**

**They're welded**—so you can build new ruggedness and durability into your equipment! And the new line of Honeywell transistors gives you superior electrical performance and high, uniform power gain over a wide range of collector current values. You get long life, outstanding stability and performance. Take advantage of these new and improved transistors *now*. Mail coupon for full information today!

**A COMPLETE LINE OF POWER TRANSISTORS TO MEET YOUR SPECIFIC NEEDS.**

	H5	H6	H7
Input Resistance	24-48 ohms	27-54 ohms	30-60 ohms
Power Conductance	17.5-35 mhos	35-71 mhos	71-141 mhos
Current Gain, Median	30	40	60

(for collector current of 2 amps.)

# Honeywell



Power Transistors

**HONEYWELL CONTROLS LIMITED,**  
DEPT. 500, TORONTO 17, ONTARIO.  
*Please send data sheet TR-14 on Honeywell Weld-Seal Power Transistor.*

NAME .....

FIRM NAME .....

ADDRESS .....

CITY ..... PROVINCE .....

For further data on advertised products use page 65.

**NEWS**

(Continued from page 54)

**Automatic Electric Sales  
Appoints Staff Engineer**

C. E. Marshall, P.Eng., has been appointed staff engineer of Automatic Electric Sales (Canada) Ltd., Brockville, Ontario.

Formerly supervisor of equipment engineering, Mr. Marshall has had wide experience in the design and layout of automatic telephone exchanges and switching systems in Canada. In his new position he will be assigned to field engineering service and will be available to independent telephone systems for technical assistance and advice.

**Canadian Marconi Appoints  
Internal Auditor**



● André Mineau, B. Com., C. A., has been appointed Internal Auditor of Canadian Marconi Company, according to an announcement by T. C. Adams, Comptroller of the company. Prior to this present appointment, Mr. Mineau was connected with the firm of Price Waterhouse & Co., chartered accountants, for some years.

**Measurements Engineering  
Represents Keithley  
Instruments**

J. L. Gibson, sales manager of Keithley Instruments Inc., recently announced the appointment of Measurement Engineering Limited, Arnprior, Ontario, as their exclusive Canadian representatives.

The personnel of Measurement Engineering Limited will receive factory training on the Keithley line of electro-meters, D.C. amplifiers, decade isolation amplifiers, static detectors, microammeters and megohmmeters, and voltmeters. The instruments are widely used in nuclear and electronic laboratories, in addition to the industrial field.

(Turn to page 58)



tested for  
quality and  
performance

# Phillips

## TELEPHONE WIRES & CABLES

Throughout the manufacturing operation, Phillips Telephone Wires and Cables are constantly checked—to ensure uniformity of insulation resistance, mutual capacitance and dielectric strength. As a result, the Phillips Wires and Cables you buy are of a consistently high standard.

**TELEPHONE CABLES**—For every type of telephone system, from a few stations in a small exchange, to the largest communications network.

**Telephone Cable**—paper insulated, lead-sheathed for aerial, underground or submarine use.

**Terminating Cable**—textile insulated, lead-sheathed for terminating exchange cables.

**Switchboard Cable**—textile or plastic insulated, braid or plastic sheath for local interconnections.

**Supervisory Control Cable**—paper, textile, plastic or rubber insulation with lead or plastic sheath for control purposes.

Conductors in the above cables can be supplied in concentric, unit, quads and composite constructions. For extra protection, steel wire armour, steel tape armour, neoprene jacket or jute wrap can be supplied.

# Phillips

ELECTRICAL COMPANY LIMITED

## WIRES & CABLES

THE CANADIAN AFFILIATE OF THE B. I. C. C. GROUP

Head Office — Brockville, Ont.

MONTREAL • OTTAWA • TORONTO • HAMILTON  
WINNIPEG • REGINA • EDMONTON • VANCOUVER

Phillips Telephone Wires & Cables are also distributed throughout Canada by Automatic Electric Sales (Canada) Ltd.

ELECTRONICS & COMMUNICATIONS, JANUARY, 1957



- A. Telephone Cable
- B. Neoprene Drop Wire
- C. Switchboard Cable
- D. Submarine Cable

**TELEPHONE WIRES AND DROP CABLES**—Phillips Telephone Wires and Drop Cables have the durability and long life expectancy required for dependable service under the toughest conditions.

Drop Wire—parallel or twisted, neoprene or braided

Inside Telephone Wire—PVC or rubber

Distributing Frame Wire

Switchboard Wire

Bare Line Wire

Interphone Wire

Drop Cable—neoprene or polyethylene

Rural Distribution Cable

Telephone and Switchboard Cordage

Any Phillips Telephone Wires and Cables can be supplied to your specification.

5411X

For further data on advertised products use page 65.

**High Quality at Low Cost**

**Maximum Performance**

**Proven Dependability**

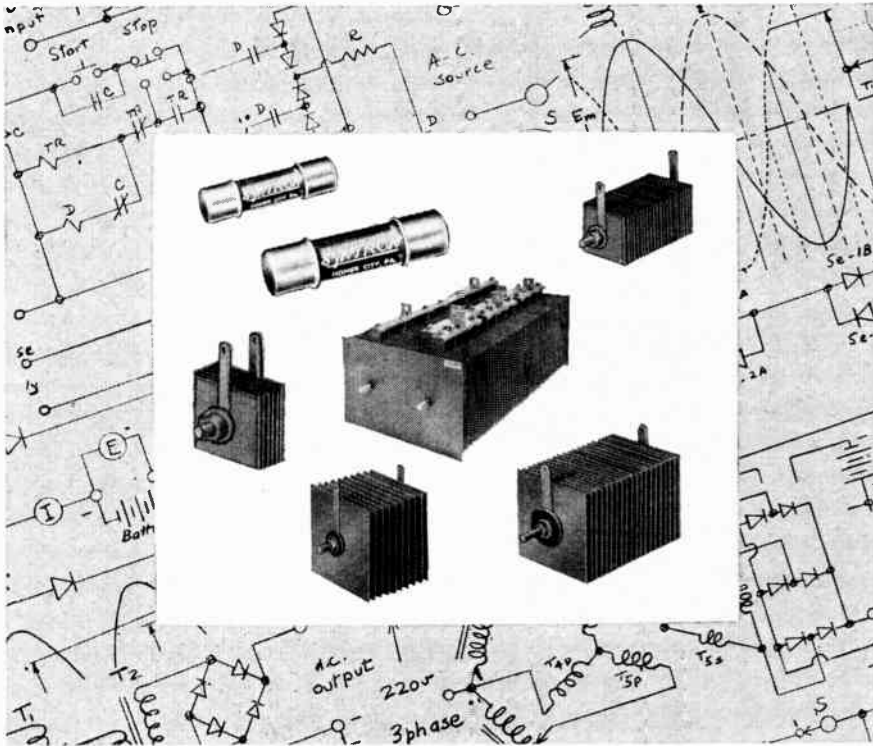

# ***SYNTRON* Vacuum Process SELENIUM RECTIFIERS**

Through their unique vapor deposit process and quality control methods SYNTRON is able to provide Rectifiers of extreme uniformity, long life and stability. Engineered to meet the most rigid requirements. Constructed from quality materials, able to withstand shock and vibration and treated against adverse climatic conditions. Designed for continuous, dependable, trouble-free, maintenance free operation. Operation is instantaneous — no warm-up time required. Their low forward voltage drop means longer life and lower operating temperature. SYNTRON builds the largest variety of Selenium cell sizes in the industry. Let our application Engineers recommend the best rectifier for your application.

**SYNTRON Selenium Rectifiers are NOW  
made in Canada**

SYNTRON manufactures the largest range of Selenium cells in the industry. They range in plate size from a small 1" x 1" to a large 12" x 16". Also available are the high voltage cartridge type rectifiers and complete line of radio and television stacks.

Write for complete catalogue  
data — FREE

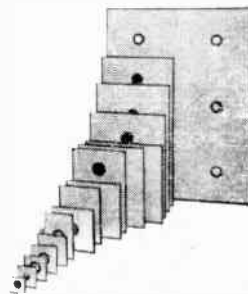

**SYNTRON (CANADA) LIMITED**  
12 MAIN STREET EAST • Dept. K • STONEY CREEK, ONTARIO

For further data on advertised products use page 65.

**NEWS**

(Continued from page 56)

**Standard Telephones And  
Cables Appointments**

F. Tomlinson, executive vice-president, Standard Telephones & Cables Mfg. Co. (Canada) Ltd., Montreal announces the appointment of Robert A. McEwen as comptroller and secretary, and Eric Bace, treasurer and assistant secretary, of the company.



R. A. McEWEN

E. BACE

S.T. & C. is the Canadian operation of International Telephone and Telegraph Corporation, New York, N.Y., worldwide electronics and telecommunications manufacturers, and is associated with Standard Telephones & Cables Limited, London, England.

**National Electrical Week  
In Canada**

The electrical industry is promoting a National Electrical Week in Canada for February 10-16, 1957. This announcement came from the Canadian Electrical Council, who met in December to consider appropriate means of conducting such an effort to tie in with a similar activity in the United States. National Electrical Week has been planned as a means of strengthening the role of electrical industry in Canada and further emphasizing the importance of electricity in the national economy.

**Industrial Wire And Cable Ltd.  
Opens New Plant**

Industrial Wire and Cable Limited announces that its new plant in Toronto was officially opened in December, 1956. The new building greatly increases manufacturing facilities of the company which has been serving the electrical industry in Canada for more than two decades.

The modern, one story building embodies all the latest design and engineering developments and was built to meet the current increased production demands caused by the continuous growth in volume and development of new electrical wire and cable products. Future expansion can easily be carried out on the new property which offers ample space for new development when required.

## W. Evan-Jones To Age Publications Ltd.

Norman McHardy, president of Age Publications Ltd., has announced that Mr. Walter Evan-Jones will shortly be joining the staff of **ELECTRONICS AND COMMUNICATIONS** magazine.

Mr. Evan-Jones, who was born and received his education in Toronto, has been actively engaged in the radio, communications and electronics fields for the past eighteen years. During this time he has served with Northern Electric, Rogers-Majestic Ltd., the Hydro-Electric Power Commission of Ontario, the Canadian Marconi Company, the Commercial Electronics Division of the Canadian Westinghouse Company Ltd. and leaves the position of branch manager, Central Ontario Sales District, of Measurement Engineering Ltd. to come to **ELECTRONICS AND COMMUNICATIONS** magazine.

In his new position on the staff of **Electronics and Communications** magazine, Mr. Jones will be occupied in both the advertising and editorial departments.

## Fourth Annual Canadian Room For New York

The fourth annual Canadian Room will be held in Suites 114-116 at the Commodore Hotel, New York during the forthcoming Institute of Radio Engineers, National Convention and I.R.E. Show to be held in New York from March 18 to 21.

The Canadian Room held each year during the IRE National Convention is to provide Canadian visitors to the show with a central meeting place in which they may arrange to meet their business colleagues and friends. Last year more than 250 Canadians engaged in the electronics and communications industries visited the Canadian Room. In addition many American officials of firms engaged in these industries visited the room to meet their Canadian representatives.

Personnel in charge of the room this year will be made up from the staff of **ELECTRONICS AND COMMUNICATIONS** magazine. They are Bud Dallyn, advertising manager, W. J. Heron, advertising representative, and T. W. Lazenby, editor.

It is expected that last year's Canadian Room attendance will be greatly exceeded during the forthcoming New York I.R.E. Show.

## Airtron Operates Canadian Plant

Airtron Canada, Ltd. is a new organization developed as part of an aggressive expansion program by Airtron, Inc. of Linden, N.J. The Canadian plant is located at Renfrew, Ontario, and the sales operation is directed from the main office at 300 Campbell Avenue, Toronto. Airtron make a wide range of electronic components and aircraft accessories.

(Turn to page 60)

# WHY SETTLE FOR LESS?

## WHEN YOU SPECIFY POWER SUPPLIES

... you are entitled to all of the benefits of complete facilities, thoroughly experienced engineers, wide product range, prompt delivery and competitive prices.

## WHY SETTLE FOR LESS?

Take a standard DC requirement, anywhere between 6 and 1000 volts. You need a good, reliable standard DC source — you want to be able to install it and forget it. You want it promptly and, since it's a standard item, you want it for a reasonable price.

If you investigate Sorensen's "Nobatron" group — more than 70 models available "off the shelf" — and look a bit deeper than the electrical and mechanical specs, here's what you'll find:

\*Reg. U.S. Pat. Off. (NO BATTERIES — ELECTRONIC CONTROL)

### THE OUTSIDE APPEARANCE —

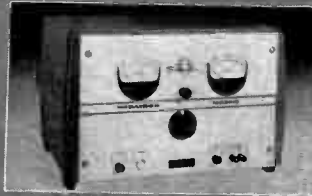

clean, functional, careful attention to small details. Not always vital, but indicators of quality design, workmanship, and materials.

### INSIDE, TOP QUALITY COMPONENTS —

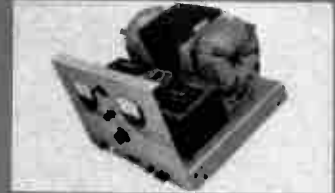

rugged construction — sound engineering proved by tens of thousands of successful units.

### NEAT, UNCLUTTERED WIRING —

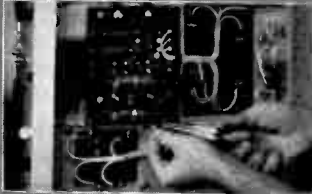

firm, long lasting connections — hallmarks of skilled people. You don't learn this workmanship overnight, but it's the key to a reputation for precision.

### IF WE CAN MAKE A COMPONENT BETTER, WE DO.



If somebody else can do it better, more economically and faster — like we make power supplies — we buy it. Either way, it means better quality for you.

### THE ACCUMULATED EXPERIENCE OF SORENSEN'S ENGINEERING STAFF —



specializing in power control — is more than 215 man-years. That means less "second guessing," less engineering time, faster delivery, lower cost. And better units.

### OUR SALES ENGINEERING STAFF AND MANUFACTURERS REPRESENTATIVES



work together to put all of these facilities, all of this experience, at your immediate disposal. All it takes is a phone call.

In short, don't just buy "a power supply." Whether it's a precision regulated source for a special job, or a standard low cost unit, start with Sorensen . . .



SORENSEN & COMPANY, INC. 375 FAIRFIELD AVE., STAMFORD, CONN.

"The authority on controlled power for research and industry"

POLARIZED  
TRADE & MARK  
ANODIZED  
TRIPPING POINTS  
MAGNETIC LATCH-IN

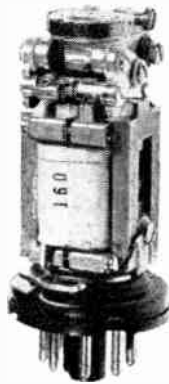

ELECTRICAL SYMMETRY  
LOAD CIRCUIT PARAMETERS  
PERSONAL BIAS  
DIFFERENTIAL OPERATION  
CENTER STABLE SIDE SADDLE  
PERCENT-BREAK  
NIP AND TUCK  
75% CONTACT EFFICIENCY

## Lest confusion reign

Once there was a Prospect who wanted a small, fast relay that would respond to the direction of flow of current, and which would do it at least a few million times. He journeyed from Source to Source, asking his questions with straightforward hopefulness. But everywhere the answers were equivocal, with nary a single "Yes" or "No." There were moments when he *thought* a center off type for differential operation was just what he wanted, but he became uncertain after losing the ability to distinguish between spring bias and the everyday human variety. At other times, also, in the company of other Sources, his hopes rose when answers about "speed" began "will handle 750 pulses per second . . ." (here was the way *he* liked to hear people talk), only to sink again when followed by such words as ". . . depending, of course, on the amount of excitation expressed as a net pulse level." Long before, he had abandoned Pinning Down, and had begun a desperate attempt at Keeping Up. But finally he realized he sought in vain; a relay to meet his requirements could not possibly be described simply. He wandered away, head bowed — crumpled fragments of data sheets fluttering after him.

### Series 72 HIGH SPEED RELAY

With what may seem like undue pride, we only wish this wretched soul had stumbled on one of our devices, namely the Sigma 72 relay. Not that the language of our literature is so pristine, wholly untouched by the jargon of the Trade, but we could have told him that our 72

Is an SPDT relay which responds to direction of current flow.

In correctly designed circuits, takes about 0.2 milliseconds for transferring its contacts and is intended for high speed switching up to 500 pulses per second.

Gives practical value to its high operating speed by switching a 60 ma. 110VDC inductive load half a billion times on the average without maintenance.

Allows repair and adjustment by the user (detailed manual and test set available).

By comparison, takes up little space (1 7/16" dia. x 2 5/8" high) and is lightweight.

Bulletin on request.

# SIGMA

SIGMA INSTRUMENTS, INC.,

85 Pearl Street, So. Braintree, Boston 85, Mass.

Canadian Representatives:

SAMUEL C. HOOKER (CAN.) LTD., Montreal and Toronto • RON MERRITT, Vancouver, B.C.

For further data on advertised products use page 65.



## NEWS

(Continued from page 59)

### Professional Engineers Elect President

John Holloway Fox, P.Eng., O.B.E., of Toronto, has been elected president of the Association of Professional Engineers of Ontario, whose members number some 15,000. Mr. Fox succeeds Merritt W. Hotchkin, P.Eng., of Kirkland Lake, Ont., as chief executive of Canada's largest professional society which serves as the



J. H. FOX

licensing body for the province's engineering profession.

Mr. Fox has been a member of the A.P.E.O.'s executive council since 1953, serving last year as 1st vice-president.

The annual meeting of the A.P.E.O. will be held in Toronto on January 26.

### International Telex Makes Its Debut

International Telex — a new overseas telegraph development for Canada — was inaugurated on December 3 from the new Montreal headquarters building of Canadian Overseas Telecommunication Corporation.

Opening of this new overseas telegraph service from Canada now provides Canadian business with direct teleprinter connection between International Telex subscribers in many parts of the world and permits two-way printed conversations.

At the outset the service was made available to subscribers in Montreal, Ottawa, Toronto, Winnipeg and Vancouver, and it will be extended to other parts of Canada as soon as possible.

### CDC To Market Bendix Aviation Equipment

Airborne electronic communications and navigation equipment made by Bendix Aviation Corporation will in future be handled exclusively by Computing Devices of Canada Limited. This agreement, recently announced by C. F. Hembury, CDC President, is part of the comprehensive arrangements concluded during last summer between Bendix and CDC, whereby Bendix acquired a minority interest in CDC, and CDC received exclusive rights to Canadian sale of a wide range of Bendix products.

Servicing of equipment covered in the agreement will be handled by CDC.

(Turn to page 62)

*The Canadian Room*  
*Suites 114 and 116*  
*Hotel Commodore, New York City*

**E**LECTRONICS & COMMUNICATIONS MAGAZINE invites you to make the Canadian Room your headquarters while attending the Institute of Radio Engineers' Convention and I.R.E. Show in New York from March 18 to 21.

The Canadian Room will be open from Sunday afternoon, March 17, and every day thereafter from 4 in the afternoon until 10 p.m. during the course of the Convention.

ELECTRONICS & COMMUNICATIONS - 31-35 Willcocks Street, Toronto 5, Ontario

There's a dependable

**Bendix**\* **AN**  
**SCINFLEX CONNECTOR**  
 for every electrical circuit

These electrical connectors are designed and built to provide maximum performance under the most rugged operating conditions.

Well recognized for outstanding characteristics of resistance to moisture and vibration, these connectors are provided in a variety of AN types.

Our Sales Department will be glad to furnish complete information on request.

\*Trademark

*For further information write:*  
 200 Laurentien Blvd., Montreal

**AVIATION**  **ELECTRIC**  
 LIMITED

CANADIAN AFFILIATE OF BENDIX AVIATION CORPORATION

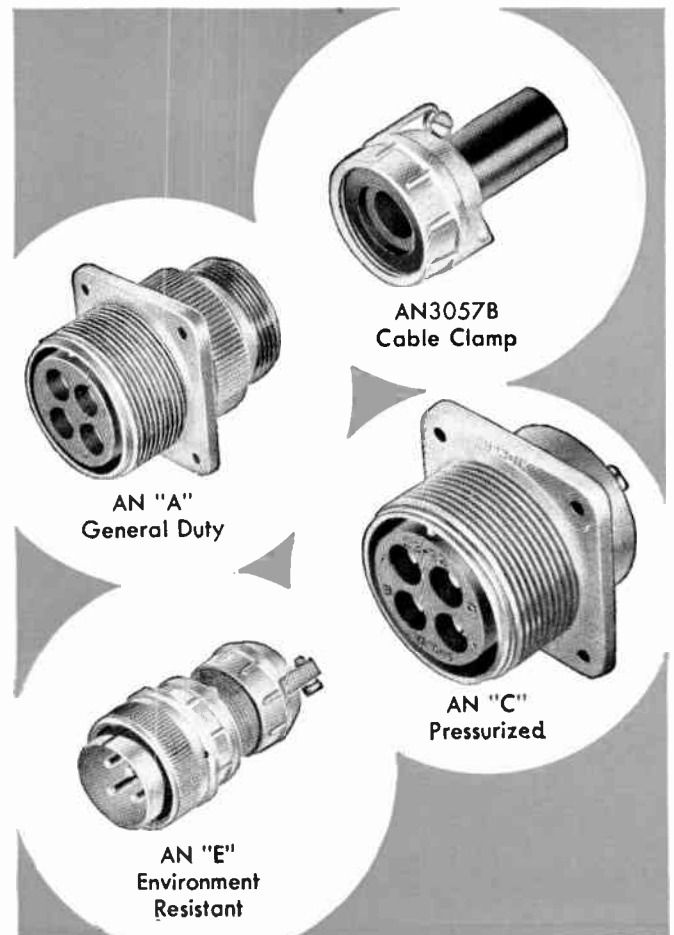

## NARROW CHANNEL TESTS

(Continued from page 23)

transmitters 1 and 2 transmitted and mobiles 1 and 2 observed intermodulation product on channel 3. This was weak but not negligible. Test 4 below however, showed that this point was close to the limit of the interference area. There was no cross modulation interference between channel 1 and 2 at this point.

**Test 4. Limit of Intermodulation Area:** This test was carried out at a distance approximately 100 yards west of point A and the interference on channel 3 was seen to disappear. The test was repeated with the squelch inoperative, but again, no interference was observed.

**Test 5. Cross Modulation and Intermodulation:** This test was carried out at point B (see map) where the field strengths of base stations 1 and 2 were large and approximately equal and where the field strength of base station 3 was comparatively small.

With base transmitter 2 modulated, mobiles listened on channel 1 and observed the cross modulation as the carrier of base transmitter 1 was periodically switched.

With base transmitters 1 and 2 both modulated, mobiles observed the intermodulation product on channel 3 (this carried both modulations). The base transmitter 3 then transmitted a carrier which produced a heterodyne whistle on channel 3.

Both types of interference were quite strong at this point. A further test was made here with the squelch inoperative, to ensure that the interference was not partly masked by direct adjacent channel breakthrough, or desensitization; neither of these effects could be observed however on testing for them.

**Test 6. Direct Adjacent Channel Interference (Base to Mobile):** With mobiles at point R (site of base station channel 1), the mobiles listened on channel 2 while base station transmitted on channel 1. The test was

repeated with the squelch inoperative. In both cases no interference was observed.

### 15 kc/s AM System Tests

(Intermodulation and cross modulation tests were not repeated since these are independent of channel spacing.)

**Test 7. Direct Adjacent Channel Breakthrough (Mobile-to-Mobile):** With two mobiles at point R, mobile 2 transmitted on channel 2 and mobile 1 listened on channel 1.5. This was repeated with mobile 2 transmitting on channel 1. For this test the mobiles drove slowly away from each other until no interference was noted. Interference disappeared at a spacing of approximately 200 yards.

**Test 8. Direct Adjacent Channel (Base to Mobile):** With mobile at point C, base station transmitted on channel 1 while the mobile listened on channel 1.5. Point C represented the limit of adjacent channel interference from base station 1.

### F.M. Test

**Test 9. Direct Adjacent Channel Breakthrough (F.M. Base to A.M. mobile):** With an A.M. mobile located at point R, no interference was experienced when listening on channel 3, while the base station F.M. was transmitting on channel 4. (Note this was located at point R and was actually base 1 operating on 161.205 F.M.) When the squelch was made inoperative some noise was heard from the F.M. transmission, this being sideband noise.

### Conclusions

It was shown that adjacent 30 kc/s A.M. systems operating in the same area were quite practicable. There was no interference from adjacent channel breakthrough. In fact, intermodulation, which is independent of channel spacing, was one of the limiting factors; since this equipment embodied the latest design techniques to reduce intermodulation, the performance was better than that at present

obtained from many 60 kc/s systems.

The 15 kc/s tests showed that such a system would be practicable, but adjacent channels would require some degree of geographical spacing. Channel allocations on a 15 kc/s basis therefore, would require careful study by the appropriate licensing authority.

Direct adjacent channel interference caused in an A.M. system by a 30 kc/s adjacent F.M. system, was found to be negligible. More comprehensive tests would have to be made, however, to fully assess interference problems caused in adjacent channel dissimilar systems.

Finally, it is felt that 30 kc/s equipment, (operating on 60 kc/s channels), should be introduced now into existing 60 kc/s systems, as this would considerably simplify the future changeover to 30 kc/s spacing. Some compatibility problems within the 60 kc/s system will arise, but can be easily overcome with reasonable technical planning. The successful operation, however, of 30 kc/s equipment in any system, will require the use of accurate test equipment and well trained personnel to periodically check frequency and to do general maintenance on the equipment.

## NEWS

(Continued from page 60)

### C.G.E. Announces New Research Laboratories

A major new engineering laboratory devoted to applied research and advance engineering is being set up by Canadian General Electric Company at its Peterborough plant.

Announcement of the new 22,000 square foot laboratory was made by company president James H. Goss. He said the new engineering laboratory, together with the control laboratories that contribute to its work in Peterborough, represent an investment of about \$1,000,000.

Mr. Goss indicated that, while the laboratory would assist all technical groups within the company, its main function would be concerned with the technical activities of the company's capital goods business.

He defined the laboratory's function as "applied research, engineering development, consulting and control."

The laboratory staff numbers 52, including electrical and mechanical engineers, chemists, metallurgists, physicists, mathematicians and laboratory apprentices. Manager of the laboratory is Charles K. Fraser.

Included in equipment ordered for the laboratory is an IBM650 computer, first of its kind to be put in use by any industry in Canada outside the defence field.

Mr. Goss said the laboratory was another indication of the "coming of age" of Canadian engineering.



**Beatty Telemasts**

**FOR COMMERCIAL COMMUNICATIONS**

Masts to 200 ft.—single, twin-H, and quadruple — designed to CSA specifications. Hot galvanized steel, resistance welded to Canadian Welding Bureau standards, in accurate jigs that insure easy and perfect erection. 10-foot sections completely hot galvanized after all fabrication. Galvanized hinged steel base and complete line of attachment fittings.

**BEATTY BROS. LIMITED**  
Fergus, Ont. Est. 1874

For further data on advertised products use page 65.

## Change Of Name For Foundry In Kitchener

The company formerly known as Hayward-Taylor Foundries, Ltd., of Kitchener, Ontario, has been acquired by Indiana Steel Products Co., of Val-

paraiso, Indiana, and will in future be known as The Indiana Steel Products Company of Canada Ltd., Kitchener, Ontario.

The company produces permanent magnets of cast and sintered Alnico, Indox ceramic types, Cunife, Cunico, and formed magnets, also stainless steel as well as other special high alloy castings.

### ELECTRONIC INSTRUMENT MECHANICS

For the testing, installation and maintenance of a wide range of electronic equipment used in research and in industrial processes, including nuclear counting and measuring equipment, electronic regulators and controllers, intercommunication systems and test equipment.

Applicants must have High School graduation or the equivalent and a thorough knowledge of basic electronics, plus five years' related practical experience.

\$2.04 per hour — 40 hour, 5-day week, employee benefits.

Regular bus service between project and Deep River, Chalk River, Petawawa and Pembroke.

State all particulars in first letter to File 7G.

### ATOMIC ENERGY OF CANADA LIMITED

Chalk River, Ontario

### SPACE TO RENT

#### RADIO FIRMS PREFERRED

4000 feet

Next door to Canadian Tire Corp. Sprinkler, bright 3rd floor light assembly warehouse or showrooms. Complete living quarters included. Apply:

Canadian Electrical Supply  
877 Yonge St. Toronto  
WA. 1-5111

### INSTRUMENTATION ENGINEERS

Excellent opportunity and interesting work is available with our rapidly expanding organization handling special electronic instruments and components. We require:

Sales Engineers  
Service Technicians  
Telemetering Systems Engineers  
System Application Engineers  
System Design Engineers

All replies and inquiries held in strict confidence. For further information write, phone or visit:

A. G. SHACK  
Electromechanical Products  
Markham Road and 401 Highway  
Aglincourt, Ontario  
Phone: Bus. AX. 3-7011  
Home AX. 3-5761

### Raytheon Canada Ltd. Appoints Sales Manager

The appointment of R. S. Williams as commercial sales manager has been announced by Raytheon Canada Limited, recently established by Dominion Electrohome Industries Limited and the Raytheon Manufacturing Company, internationally known electronics manufacturers.

Mr. Williams has had broad experience in the marketing and sale of electronics in Canada, having served as manager of sales in the radio tube division of Rogers Majestic Electronics Limited prior to joining the Raytheon firm. Utilizing his first-hand knowledge of the industry and intimate contacts with both manufacturers and distributors in Canada, his first duty will be the organization of a nationwide distributing organization.

### C. Wesley Carnahan Re-locates In Palo Alto

C. Wesley Carnahan, vice president and general manager of Varian of Canada Ltd. since the firm's opening in October, 1955, has relocated in Palo Alto where he was called to serve as technical assistant to H. Myrl Stearns, executive vice president and general manager of Varian Associates, leading peninsula electronics firm. In making the announcement, Stearns said that in addition to his new post, Carnahan will continue as vice-president of Varian Associates' Canadian operation.

### Crane Packing Company Expands Hamilton Plant

Crane Packing Company of Chicago, Ill., has recently completed a 3-year expansion and construction program to make its manufacturing and service facilities immediately available to important industrial areas throughout the United States and Canada. This program has included considerably expanded offices and factory at Hamilton, Ontario, which give immediate access to Canadian enterprise.

Products and accompanying engineering services of the company are the responsibility of five divisions, namely: mechanical packings, mechanical seals, Chemlon products, Lapmaster lapping machines and compounds. Each is supplemented by research, design and development laboratory facilities.

(Turn to page 64)

## Representative Wanted

Outstanding U.S. firm, manufacturing a complete line of standard cabinets - racks - panels and chassis for the electronic industry, seeks Canadian Representative — one already handling components and with good connections with distributors and manufacturers.

Write Box 503

### ELECTRONICS AND COMMUNICATIONS

31 Willcocks St.  
Toronto 5 - Ontario



- ▶ DELIVERY IS RIGHT
- ▶ PRICE IS COMPETITIVE
- ▶ QUALITY IS TOPS

BENDIX-SCINTILLA connectors are now available in Canada. Profit from the dependable performance of these famous connectors.

Fast delivery of AN Types A, C and E from Montreal stock.

**AVIATION ELECTRIC LIMITED**

CANADIAN AFFILIATE OF BENDIX AVIATION CORPORATION

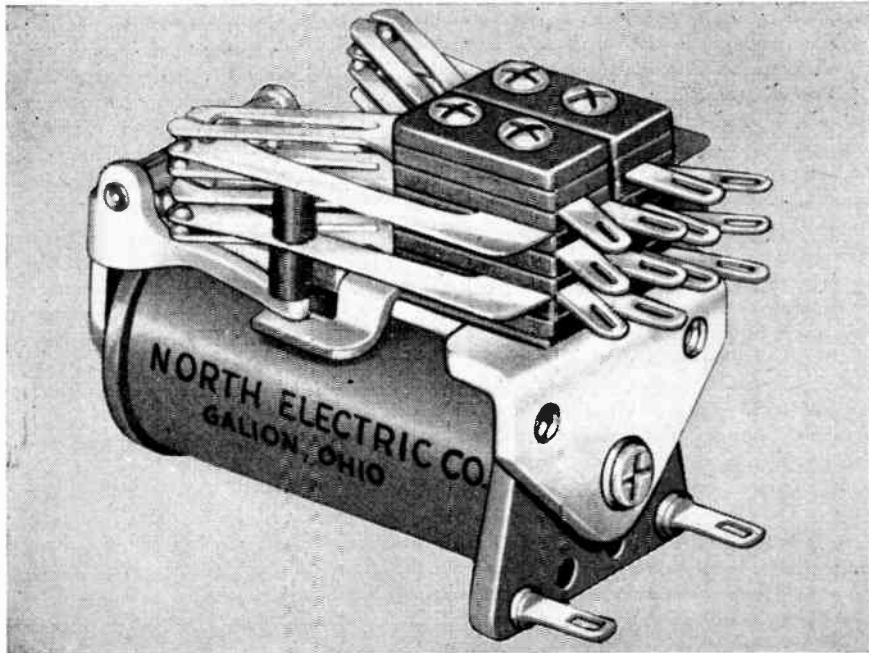

## NORTH TYPE "E" RELAYS FOR INDUSTRY in production for early delivery

North's new addition to its extensive line of relays, the industrial standard Type E Relay, is now in production and available for delivery. The large scale production and engineering facilities of NORTH assure you a reliable source of supply to meet your requirements for Type E Relays.

- Available with:  
Solder Terminals  
8-11-20 pin plug-in terminals  
Taper pin coil terminals  
Taper tab spring terminals
- Up to 10 springs maximum per pile-up.
- Contact Materials:  
Gold, Palladium, Silver
- Overall length with solder terminals  
2 1/4".
- With adjustable screw-type residual  
and fixed nylon flap-type residuals.
- Standard range of coil resistances from  
5 to 21,000 ohms.
- Mountings:  
Two #6-32 screws on 3/4" spacing.  
Standard plug-in mountings available  
with or without auxiliary hold-down  
brackets.

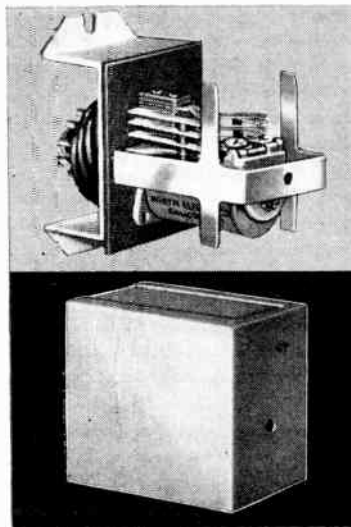

Canadian Distributors for NORTH ELECTRIC CO.

# ERICSSON

TELEPHONE SALES OF CANADA LIMITED

Industrial Division • 130 Bates Road, Montreal 8, P.Q. REgent 1-6428

**NEWS**  
(Continued from page 63)

### Phillips Announces Two Appointments

D. C. Brasier (Toronto) manager, central region of the Phillips Electrical Company Limited, recently announced two new appointments.



C. F. JARDIM

C. F. Jardim, B.Eng.E., P.Eng., becomes the new manager of the Toronto branch, covering Toronto and Northern Ontario. Mr. Jardim was formerly in the company's wiring development section before becoming sales engineer with the Toronto office.



R. H. PITFIELD

R. H. Pitfield, B.Eng.M., is appointed manager of magnet wire sales for the company throughout Canada. Although his area of activity will primarily be in Ontario, Mr. Pitfield will be available to assist other company offices across Canada. Mr. Pitfield was formerly sales engineer with the company in Toronto.

(Turn to page 67)

For further data on advertised products use page 65.



# INDEX TO ADVERTISERS

Page number is on the right.  
Key number for use with  
READER SERVICE CARDS is  
on the left.

Key No.	Name	Page No.
1.	Adcola Products Ltd.	13
2.	The Ahearn & Soper Co. Ltd.	19
3.	Airpax Products Co.	37
4.	Amperite Co.	43
5.	Andrew Corp.	35
6.	Automatic Electric Sales (Canada) Ltd.	49
7.	Automatic Electric Sales (Canada) Ltd.	51
8.	Automatic Electric Sales (Canada) Ltd.	53
9.	Aviation Electric Ltd.	37
10.	Aviation Electric Ltd.	63
11.	Beatty Bros. Ltd.	62
12.	Bell Telephone Co. of Canada Ltd., The	68
13.	Bendix Aviation Corp.	61
14.	Bomac Laboratories Inc.	39
15.	Canadian Broadcasting Corp.	55
16.	Canadian Line Materials Ltd.	13
17.	Canadian Line Materials Ltd.	38
18.	Canadian Marconi Co.	3
19.	Canadian Marconi Co.	41
20.	Canadian Westinghouse Co Ltd.	8
21.	Centralab (Div. Globe Union Inc.)	67
22.	Chicago Magnetic Control	37
23.	Copper Wire Products Co.	2
24.	Cossor (Canada) Ltd.	5
25.	Crane Packing Co. Ltd.	45
26.	Eitel-McCullough Inc.	19
27.	Ericsson Telephone Sales of Canada Ltd.	64
28.	Ericsson Telephone Sales of Canada Ltd.	20
29.	Freed Transformer Co. Inc.	55
30.	G-V Controls Inc.	55
31.	Hammond Mfg. Co. Ltd.	55
32.	Heath Co.	69-73
33.	Helipot Corp.	74
34.	Helipot Corp.	75
35.	Honeywell Controls Ltd.	56

Mr. Circulation Manager:

My proper address is shown below.  
Check

(My old address is \_\_\_\_\_ City \_\_\_\_\_)

Please add my name to your Electronics & Communications' mailing list.  
Check (No obligation)

Name \_\_\_\_\_ Position \_\_\_\_\_

Company \_\_\_\_\_ Nature of Business \_\_\_\_\_

Company Address \_\_\_\_\_ City \_\_\_\_\_ Prov. \_\_\_\_\_

Signature \_\_\_\_\_  
1-57 (Not valid without signature)

PLEASE SEND FURTHER INFORMATION ON THE FOLLOWING NEW PRODUCT ITEMS AS NUMBERED BELOW — USE PRODUCT ITEM NUMBERS

PLEASE SEND FURTHER INFORMATION ON THE FOLLOWING ADVERTISEMENTS AS NUMBERED BELOW — USE KEY NUMBER

Company \_\_\_\_\_ Nature of Business \_\_\_\_\_

Name \_\_\_\_\_ Position \_\_\_\_\_

Street \_\_\_\_\_ City \_\_\_\_\_ Prov. \_\_\_\_\_  
1-57

PLEASE SEND FURTHER INFORMATION ON THE FOLLOWING NEW PRODUCT ITEMS AS NUMBERED BELOW — USE PRODUCT ITEM NUMBERS

PLEASE SEND FURTHER INFORMATION ON THE FOLLOWING ADVERTISEMENTS AS NUMBERED BELOW — USE KEY NUMBER

Name \_\_\_\_\_ Position \_\_\_\_\_

Company \_\_\_\_\_

Street \_\_\_\_\_ City \_\_\_\_\_ Prov. \_\_\_\_\_  
1-57

**ELECTRONICS & COMMUNICATIONS** Please turn page

**BUSINESS REPLY CARD**  
No Postage Stamp Necessary if Mailed in Canada

5c POSTAGE WILL BE PAID BY

**ELECTRONICS AND COMMUNICATIONS**

31 - 35 Willcocks Street

Toronto 5, Ontario



**BUSINESS REPLY CARD**  
No Postage Stamp Necessary if Mailed in Canada

5c POSTAGE WILL BE PAID BY

**ELECTRONICS AND COMMUNICATIONS**

31 - 35 Willcocks Street

Toronto 5, Ontario



**BUSINESS REPLY CARD**  
No Postage Stamp Necessary if Mailed in Canada

5c POSTAGE WILL BE PAID BY

**ELECTRONICS AND COMMUNICATIONS**

31 - 35 Willcocks Street

Toronto 5, Ontario



**INDEX — Continued**

Key No.	Name	Page No.
36.	Kester Solder Co.	54
37.	Magnetics Inc.	18
38.	Measurements Corp.	50
39.	Muirhead & Co. Ltd.	33
40.	P.S.C. Applied Research Ltd.	78
41.	Panoramic Radio Products Inc.	6
42.	Phillips Electrical Co. Ltd.	57
43.	Pye (Canada) Ltd.	34
44.	R.C.A. Victor Co. Ltd.	7
45.	R.O.R. Associates Ltd.	14
46.	Radio Engineering Products Ltd.	54
47.	Sigma Instruments Inc.	60
48.	Snelgrove & Co. Ltd., C.R.	4
49.	Sorenson & Co. Inc.	59
50.	Standard Telephones & Cables Mfg. Co. (Canada) Ltd.	40
51.	Syntron (Canada) Ltd.	58
52.	Ungar Electric Tool Co. of Canada	74
53.	Victoreen Instrument Co. The	16

Your request for further information on New Product items or additional information concerning advertisements in Electronics and Communications will be promptly acknowledged.

## NEWS

(Continued from page 64)

### IRE Bestows High Honor On Canadian

Dr. J. T. Henderson, head of the electricity and mechanics section of the Division of Applied Physics, National Research Council of Canada, has been elected president of the Institute of Radio Engineers for 1957.

This is the first time a Canadian has been singled out for the distinction of heading this international body which represents 55,000 members of the radio engineering profession.

Dr. Henderson was previously regional director for Canada and was a member of the Advisory Committee to the Canadian IRE Convention held in Toronto in October of this year.

### Adalia Computations Ltd. Installs ALWAC Computer

Adalia Computations Ltd. of Montreal reports the installation of an ALWAC "electronic brain".

The computer, manufactured by Logistics Research, of Redondo Beach, California, will be used by Canadian universities, business and industrial firms for solving complex problems and scientific research.

Sir Robert Watson-Watt, who is president of Adalia Computations Ltd., is famed for discovery of radar, an achievement that brought him knighthood in England and the Medal of Merit in the United States.

Other ALWAC computers are now being used by the U.S. Weather Bureau, U.S. National Security Agency, U.S. Military, Canadian Armament Research, Institute of Gas Technology, oil refineries, aircraft manufacturers, industrial firms, motor manufacturers, business firms and universities throughout the United States and Canada.

### Canada Wire Western Appointments

Appointment of two district sales managers has been announced by vice-president and sales manager L. G. Lumbers of Canada Wire and Cable Company Limited.

Frank Heseltine has been made sales manager for Saskatchewan district and Gordon F. Smith has been named sales manager for Manitoba district.

Mr. Heseltine has been a Western Canada electrical industry sales specialist for nearly a quarter century. He has held Canada Wire posts at Regina and Winnipeg.

Mr. Smith joined Canada Wire's Regina branch in 1939. He later was transferred to Winnipeg and during the war years he served in the navy. In the past ten years he has been assigned to Toronto head office, the Windsor-Sarnia-Chatham area, and Winnipeg.

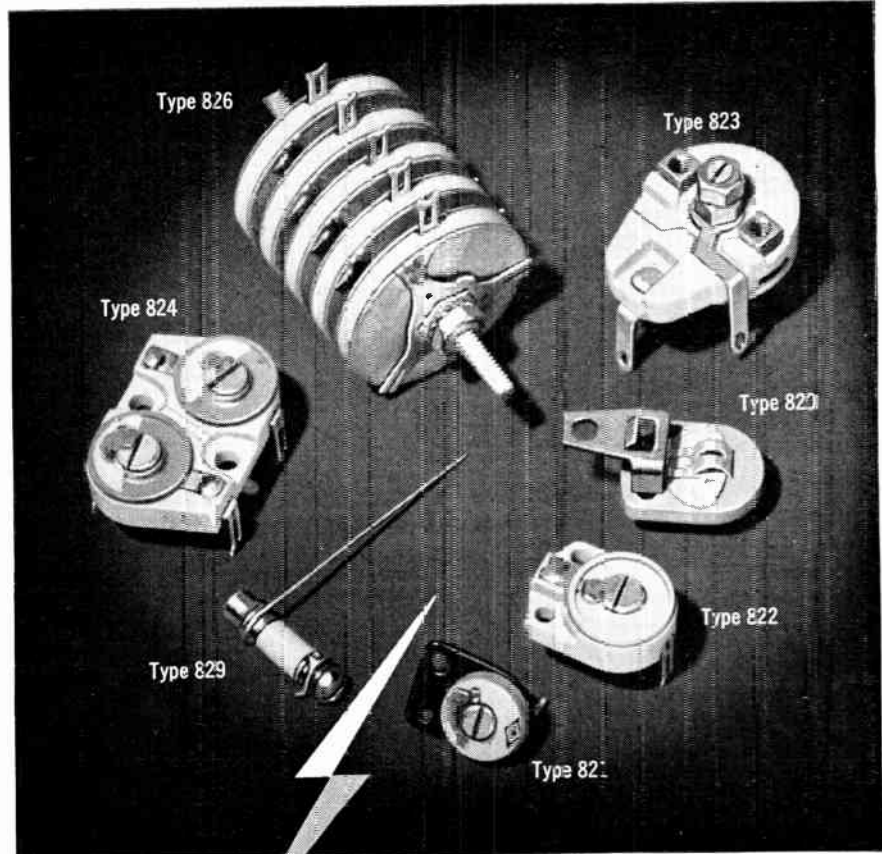

(Turn to page 68)



## The most complete line of Ceramic Trimmer Capacitors

**Eight standard types.  
Special designs engineered  
to specifications.**

All units rated  
600 V. D. C. W.,  
1500 V. D. C. test  
Capacity range from  
.5 to 125 mmf.  
Small size—light weight  
Power factor less than  
0.2% at one megacycle

-  Rotors and stators ground optically flat, to insure dependability and accurate retrace.
-  Lightweight rotors always in balance and under heavy spring pressure. Provide excellent stability under vibration without special locking device.
-  All units easily adjusted. Full capacity range is obtained with 180° rotation. Equal stability is maintained at any position from minimum to maximum.

For further information,  
write for Technical Bulletin 42-101R1.

**Centralab Canada Ltd.**

804 Mt. Pleasant Rd, Toronto 12, Ontario  
D-2356

**A DIVISION OF GLOBE-UNION INC.**

918A East Keefe Avenue Milwaukee 1, Wisconsin  
In Canada: 804 Mt. Pleasant Road, Toronto, Ontario



Represented in Canada by: LEONARD ELECTRIC, LTD., 346 Bering Ave., Toronto 18, Ont.

For further data on advertised products use page 65.

# Consumers' Gas Company matches its expansion program with this "package" of Bell Telephone Communications Services

Conversion to natural gas, construction of new pipe lines, rapid growth of consumer demand — all are part of this Toronto utility's big and busy program. And Bell Telephone's specialized communications are helping it along in three strategic ways:



**Bell 2-way Radiophone** speeds laying of pipe lines, conversion of equipment by providing instant contact between despatcher and the 81 vehicles at work on these jobs.

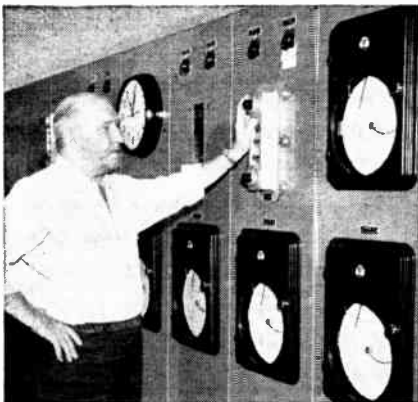

**Bell Telemetry channels** transmit information to and from this control centre shown above, operating the regulators and valves that handle the flow of gas into and through most parts of metropolitan Toronto.



**A new diol PBX system** facilitates the handling of a greatly increased volume of calls. Shown here is part of the special customer contact service which required 24 positions of special answering equipment.

Bell Telephone offers you the newest developments, the most advanced techniques in all aspects of modern business communication. *You pay only for service:* no capital outlay, no problems of maintenance, depreciation or obsolescence. Have Bell's specialists go into *all* your communication needs, without cost or obligation.



**THE BELL TELEPHONE COMPANY OF CANADA**  
Specialized Communications Services

For further data on advertised products use page 65.

## NEWS

(Continued from page 67)

### General Controls (Canadian) Opens Vancouver Branch

With the establishment of a factory branch office in Vancouver, B.C., General Controls (Canadian) Ltd. has opened its second Canadian branch within nine months. This announcement was made by George Crothers, general manager of the automatic controls firm.

Robert Sellers, formerly associated with General Controls British Columbia distributor, Pacific Controls, Ltd. of Vancouver and Victoria, B.C., has been named manager of the new General Controls office, located at 1042 Davie Street in Vancouver.

### McBee Company Enters Electronics Data Field

The McBee Company Limited of Toronto, producers of "Keysort" and other lines of accounting systems, has announced its entry into the field of electronic data and processing equipment.

An off-shoot of the Royal McBee Corporation, the McBee Company has been steadily increasing its sales since its formation in 1947.

A little more than a year ago, the company moved to a new 40,000 ft. plant at 179 Bartley Drive, Toronto 16, which afforded better opportunity for expansion.

With two Canadians, T. P. Lounsbrough and J. W. Bryers, on the board of directors, the McBee company's policy is in line with the current trend, which is for American parent-firms with companies established in Canada to install Canadians as top executives.

### Toronto Section, IRE, Holds January Meeting

At its regular meeting on January 14, The Institute of Radio Engineers heard a paper on 450 mc communications by M. A. Robbins of the Canadian Marconi Company. Mr. Robbins displayed a new Marconi compact mobile 450 mc transmitter-receiver unit. With the aid of slides he explained the principles of circuitry involved and discussed the ability of this unit to accomplish highly efficient mobile communications in built-up cities and industrial areas.

Two I.R.E. meetings will be held in February. On February 7, I.R.E. "Students' Night" will hear 3 final year students from the University of Toronto, who will present papers on three selected subjects in competition for cash prizes.

On February 25 a representative of the Philco Corporation, Philadelphia, will discuss Philco's new "APPLE" color television system . . . a new concept in color reproduction, but still using present day standards of transmission. (Turn to page 74)

*world's finest  
electronic equipment  
in kit form...*

# HEATHKIT

*High Quality  
Advanced Design  
Reliable Performance  
Real Economy*

## Heathkit AMATEUR CW TRANSMITTER KIT

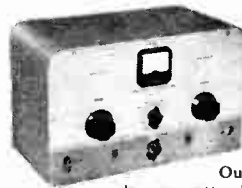

MODEL AT-1  
**\$29.50**  
Shpg. Wt. 15 lbs.

Outstanding dollar-per-watt value! 30-35 watts plate power input, bandswitching for 80, 40, 20, 15, 11, and 10 meters. Crystal or external VFO excitation. 52 ohm output—key click filter—copper-plated chassis—pre-wound coils. Uses 6AG7 oscillator, 6L6 final.

## Heathkit PHONE & CW TRANSMITTER KITS

Both the DX-100 and the DX-35 are designed especially for you—with the features most important to efficient and practical amateur operation!



MODEL DX-100

**\$189.50**

Shpg. Wt. 120 lbs.  
Shipped motor freight unless otherwise specified. \$50.00 deposit required on c.a.d. orders.

This transmitter is rapidly becoming the accepted standard in its price class. An outstanding dollar value!

100 watts RF output—built in power supplies—built in VFO and modulator—bandswitching on 160, 80, 40, 20, 15, 11, and 10 meters—phone or CW operation. 100 watts output on phone, and 120 watts on CW. TVI suppressed—pi network output coupling—extensive shielding—matches 50 to 600 ohms—VFO dial and meter face illuminated—high quality components used throughout. Uses 1625 tubes in push-pull to modulate 6146 tubes in parallel. Complete schematic diagram and technical specifications available on request.



MODEL DX-35

**\$56.95**

Shpg. Wt. 24 lbs.

This exciting new kit features phone and CW operation on 80, 40, 20, 15, 11, and 10 meters. Completely bandswitching. Plate power input up to 65 watts on CW, with controlled carrier modulation peaks to 50 watts on phone. Features built-in modulator, power supplies, pi network output circuit. Separate 12BY7 buffer stage assures plenty of drive to the 6146 final. Switch selection of three crystals, or may be excited from external VFO. Panel meter reads final grid or plate current. Complete schematic and specifications on request.

## Heathkit VFO KIT

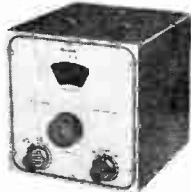

MODEL VF-1  
**\$19.50**

Shpg. Wt. 7 lbs.

Go VFO for added convenience and flexibility. Functions with Heathkit AT-1 or DX-35, or with most modern transmitters. Covers 160-80-40-20-15-11 and 10 meters. Three basic oscillator frequencies provide better than 10 volt average RF output. Plug provided for crystal socket of transmitter. VR tube for stability. Requires only 250 VDC at 15 to 20 ma, and 6.3 VAC at 0.45A.

## Heathkit ALL BAND COMMUNICATIONS TYPE RECEIVER KIT

Unusual sensitivity and selectivity for price. Covers 550 kc to 30 mc in 4 bands. AC power supply—electrical bandspread—antenna trimmer—separate RF and AF gain controls—noise limiter—head-phone jacks—AGC—BFO. Cabinet available separately as shown.

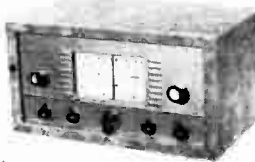

MODEL AR-3  
**\$27.95**  
(less cabinet)  
Shpg. Wt. 12 lbs.

## Heathkit "Q" MULTIPLIER KIT



MODEL QF-1  
**\$9.95** Shpg. Wt. 3 lbs.

function with AC-DC receivers. Requires 6.3 VAC at 300 ma, and 150-250 VDC at 2 ma. Cable and plugs supplied for connection.

Adds selectivity and flexibility to your receiver, and rejects undesired signal or heterodyne. Tunes any signal within IF of receiver with effective Q of approximately 4,000. Provides sharp "Peak" or "null." Surpasses crystal filter in flexibility of operation. Use with receiver having 450-460 kc IF. Will not

## Heathkit GRID DIP METER KIT



MODEL GD-1B  
**\$19.50**

Shpg. Wt. 4 lbs.

Use as a signal source, for determining unknown frequency, for checking resonance of tuned circuits, or for adjusting wave traps. Equally valuable in ham shack, service shop, or laboratory. Features 500 ua meter with sensitivity control, for indication. Covers 2 mc to 250 mc with five coils, supplied with kit. Coils pre-wound, dial scale pre-calibrated. Easy to build, and extremely valuable for literally hundreds of jobs.

Use as a signal source, for determining unknown frequency, for checking resonance of tuned circuits, or for adjusting wave traps. Equally valuable in ham shack, service shop, or laboratory. Features 500 ua meter with sensitivity control, for indication. Covers 2 mc to 250 mc with five coils, supplied with kit. Coils pre-wound, dial scale pre-calibrated. Easy to build, and extremely valuable for literally hundreds of jobs.

## Heathkit ANTENNA COUPLER KIT



MODEL AC-1  
**\$14.50**  
Shpg. Wt. 4 lbs.

This coupler matches between the transmitter, and a long-wire end-fed antenna, and incorporates an L-type filter to attenuate signals above 36 mc and reduce TVI. 52 ohm coaxial input. Tapped inductor and variable capacitor for matching antenna. Neon RF indicator—copper-plated chassis—simple to build. Handles power up to 75 watts, 10 through 80 meters. Use with Heathkit AT-1 or DX-35

## Heathkit ANTENNA IMPEDANCE METER KIT

Use this instrument, with a source of RF signal, to determine antenna impedance, line impedance, and to solve impedance matching problems with fixed or mobile antennas or transmission lines. Also, will double as field strength indicator, or phone monitor. Uses 100 ua meter and features calibrated impedance scale on control knob. Covers 0 to 600 ohms. A valuable device in any ham shack.



**\$14.50** MODEL AM-1  
Shpg. Wt. 2 lbs.

**HEATH COMPANY** A Subsidiary of Doystrom, Inc. **BENTON HARBOR 3, MICH.**

### Heathkit HARMONIC DISTORTION METER KIT



MODEL HD-1

**\$49.50**

Shpg. Wt. 13 Lbs.

Use with low-distortion audio generator to measure harmonic distortion of audio amplifiers. Reads distortion on meter as percentage of input signal. Operates between 20 and 20,000 cps. High impedance VTVM built in for initial reference settings and final distortion readings. VTVM ranges are 0-1, 3, 10, and 30 volts full scale. 1% precision resistors employed. Distortion scales are 0-1, 3, 10, 30, and 100% full scale.

### Heathkit 6-12 VOLT BATTERY ELIMINATOR KIT

MODEL BE-4

**\$31.50**

Shpg. Wt. 17 Lbs.



Will supply either 6 or 12 volt output to take care of auto radios on even the most modern cars. Output voltage is variable from zero to 8 volts DC or 0 to 16 volts DC. Will deliver up to 15 amperes at 6 volts or up to 7 amperes at 12 volts. Two 10,000 microfarad output filter capacitors insure smooth DC output. Panel meters monitor output current and voltage. Will double as a battery charger.

### HEATHKIT AUDIO TEST EQUIPMENT

You can equip your shop for complete analysis and test of high fidelity audio equipment by employing Heathkit instruments. Professional equipment you can afford!

### AUDIO OSCILLATOR KIT (SINE-WAVE - SQUARE WAVE)



MODEL AO-1

**\$24.50**

Shpg. Wt. 10 Lbs.

Produces sine wave or square wave signals from 20 to 20,000 cps in three ranges. Designed for use in service shop, or home workshop. Employs thermister for output regulation. Features high level output, low distortion, and low impedance output. Produces sine waves for audio testing, or will produce good, clean square waves with a rise time of only 2 microseconds. Very simple to build from complete instructions supplied.

### AUDIO GENERATOR

MODEL AG-9

**\$34.50**

Shpg. Wt. 8 Lbs.



This generator features low distortion (less than .1%). Ideal for use with Model HD-1, or in other applications requiring low signal distortion. Frequency accuracy within  $\pm 5\%$ . Features step-type tuning from 10 cps to 100 kc, with three rotary switches to provide two significant figures and a multiplier. Output monitored on a large  $4\frac{1}{2}''$  meter. Meter calibrated for output voltage or db. Output ranges are—.003, .01, .03, .1, .3, 1, 3, and 10 volts.

### AUDIO ANALYZER KIT



MODEL AA-1

**\$59.50**

Shpg. Wt. 13 Lbs.

This combination instrument provides the functions of an AC VTVM, audio wattmeter, and intermodulation analyzer. Includes built-in high and low frequency oscillators for intermodulation distortion tests. VTVM ranges are .01, .03, .1, .3, 1, 3, 10, 30, 100, and 300 volts rms. Wattmeter ranges are .15 mw, 1.5 mw, 15 mw, 150 mw, 1.5 w, 15 w, and 150 w. IM scales are 1%, 3%, 10%, 30%, and 100%. Provides internal loads of 4, 8, 16, or 600 ohms. An extremely valuable instrument for the audio engineer, or serious audiophile.

### Heathkit HANDITESTER KIT

This compact model easily slips into tool box, glove compartment, or coat pocket. Valuable as "extra" instrument in service shop, and ideal for the home experimenter. Very popular with appliance repairmen and electricians. Measures AC or DC voltage at 0-10, 30, 300, 1000, 5000 volts full scale. Direct current ranges are 0-10 ma and 0-100 ma. Attractive black bakelite case. Ohmmeter ranges are 0-3000 and 0-300,000 ohms.



MODEL M-1

**\$14.50**

Shpg. Wt. 3 Lbs.

### Heathkit VARIABLE VOLTAGE REGULATED POWER SUPPLY KIT

MODEL PS-3

**\$35.50**

Shpg. Wt. 17 Lbs.



Supplies regulated DC output that can be manually controlled from 0 to 500 volts. It will supply up to 130 ma at 200 VDC, and up to 10 ma at 450 VDC. Large panel meter monitors output voltage or current. Also provides filament voltage at 6.3 volts AC, up to 4 amperes. Filament and B+ circuits are isolated from ground. Ideal lab power supply.

### Heathkit "Q" METER KIT

The Model QM-1 measures the Q of inductances and RF resistance and distributed capacity of coils. Employs a  $4\frac{1}{2}''$  50 microampere meter for direct indication. Features built-in signal source for tests at frequencies of 150 kc to 18 mc in 4 ranges. Measures capacity from 40 mmf to 450 mmf within  $\pm 3$  mmf. Indispensable for coil winding, and for determining unknown capacitor values.



MODEL QM-1

**\$44.50**

Shpg. Wt. 14 Lbs.

### Heathkit IMPEDANCE BRIDGE KIT

MODEL IB-2

**\$59.50**

Shpg. Wt. 12 Lbs.



Features a built-in oscillator and amplifier. Measures resistance, capacitance, inductance, dissipation factors of condensers, and storage factor of inductance. D, Q, and DQ functions combined in one control. Employs  $\frac{1}{2}\%$  resistors and  $\frac{1}{2}\%$  silvermica capacitors. 100-0-100 ua. meter indicates null. Two section CRL dial provides ten separate units with accuracy of .5%. Fractions of units read on variable control.

### Heathkit CRYSTAL RECEIVER KIT



MODEL CR-1

**\$79.5**

Shpg. Wt. 3 Lbs.

This crystal radio covers the standard broadcast band from 540 to 1600 kc. It employs two high Q tank circuits that are tuned separately for the desired station. A sealed germanium diode is featured for detection. No critical "cat's whisker" to adjust. Kit includes a pair of high impedance head sets, and is easy to build, even for a beginner. Construction manual takes "educational" approach and explains theory of signal reception. Requires no external power for operation. Ideal standby unit for emergency reception of civil defense signals in case of power failure.

### Heathkit BROADCAST BAND RECEIVER KIT

You can build your own radio receiver with confidence, even if you are a beginner. Complete step-by-step instructions insure success. Features transformer-type power supply, high gain miniature tubes, built-in antenna,  $5\frac{1}{2}''$  speaker, and planetary tuning from 550 kc to 1600 kc.

CABINET: Fabric covered plywood cabinet with aluminum panel as shown. Part #91-9A, shipping weight 5 lbs. \$4.50.

MODEL BR-2

**\$17.50**

(less cabinet)

Shpg. Wt. 10 Lbs.



**HEATH COMPANY** A Subsidiary of Daystrom, Inc. **BENTON HARBOR 3, MICH.**

For further data on advertised products use page 65.

# HEATHKIT HIGH FIDELITY AMPLIFIER KITS

Proven circuit designs and step-by-step instructions insure successful construction, even if you have never built a kit before.



## Heathkit 25-WATT ADVANCED-DESIGN

This 25 watt amplifier incorporates the "extra" features required for really outstanding performance. Employs KT66 output tubes in push-pull, and features a Peerless output transformer. Response is within  $\pm 1$  db from 5 cps to 160 kc at 1 watt. Harmonic distortion only 1% at 25 watts, 20 to 20,000 cps. 1M distortion only 1% at 20 watts. Output impedance is 4, 8, or 16 ohms. Hum and noise are 99 db below rated output.

### KIT COMBINATIONS:

**W-5M Amplifier Kit:** Consists of main amplifier and power supply, all on one chassis. Complete with all necessary parts, tubes, and comprehensive manual. Shpg. Wt. 31 lbs. **\$59<sup>75</sup>** Express only.

**W-5 Combination Amplifier Kit:** Consists of W-5M amplifier kit listed above plus Heathkit Model WA-P2 Preamplifier kit. Complete with all necessary parts, tubes, and construction manuals. Shpg. Wt. **\$79<sup>50</sup>** 38 lbs. Express only.

## Heathkit 7-WATT

Using a tapped-screen output transformer of new design, frequency response of this unit is  $\pm 1\frac{1}{2}$  db from 20 to 20,000 cps. It provides good sensitivity, with surprisingly low distortion. Transformer tapped at 4, 8, and 16 ohms. Push-pull output. Separate bass and treble tone controls. Shpg. Wt. 10 lbs.

**MODEL A-7E:** Same as Model A-7D, but with stage of preamplification. Extra gain for low-level cartridges. RIAA compensation. Shipping weight 10 lbs. **\$18<sup>50</sup>**



**\$16<sup>95</sup>** MODEL A-7D

## Heathkit 20-WATT DUAL-CHASSIS WILLIAMSON TYPE

Features the famous Acrosound TO-300 "ultra linear" output transformer. Uses 5881 tubes and has a frequency response within  $\pm 1$  db from 6 cps to 150 kc at 1 watt. Harmonic distortion only 1% at 21 watts. 1M distortion at 20 watts only 1.3%. Output impedance is 4, 8, or 16 ohms. Hum and noise is 88 db below 20 watts.

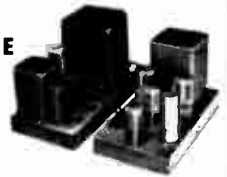

### KIT COMBINATIONS

**W-3M:** Consists of main amplifier and power supply for separate chassis construction. Includes all tubes and components necessary for assembly. Shpg. Wt. 29 lbs. **\$49<sup>75</sup>** Express only.

**W-3:** Consists of W-3M kit listed above plus Heathkit Model WA-P2 Preamplifier described on this page. Shpg. Wt. 37 lbs. **\$69<sup>50</sup>** Express only.



## Heathkit 20-WATT SINGLE-CHASSIS WILLIAMSON TYPE

The original low-priced Williamson Amplifier kit. A Chicago output transformer and 5881 output tubes are featured. Frequency response is  $\pm 1$  db from 10 cps to 100 kc at 1 watt. Harmonic distortion only 1.5% at 20 watts. 1M distortion only 2.7%. Output at 4, 8, or 16 ohms. Hum and noise 95 db below 20 watts.

### KIT COMBINATIONS

**W-4AM:** Consists of main amplifier and power supply for single chassis construction. Includes all tubes and components necessary for assembly. Shpg. Wt. 28 lbs. **\$39<sup>75</sup>** Express only.

**W-4A:** Consists of W-4AM Kit listed above plus Heathkit Model WA-P2 Preamplifier described on this page. Shpg. Wt. 35 lbs. **\$59<sup>50</sup>** Express only.

## Heathkit 20-WATT

This amplifier can provide you with high fidelity at a surprisingly low price. Preamplifier built into same chassis as main amplifier. Four switch selected, compensated inputs are available, as are bass and treble controls. Features full 20-watt output using push-pull 6L6 tubes. Frequency response is  $\pm 1$  db from 20 to 20,000 cps. Harmonic distortion only 1% at full output.



MODEL A-9B **\$35<sup>50</sup>** Shpg. Wt. 23 lbs.

## Heathkit HIGH FIDELITY PREAMPLIFIER KIT

MODEL WA-P2

**\$19<sup>75</sup>**

(with cabinet) Shpg. Wt. 7 lbs.



Designed for use with Heathkit main amplifiers. Features five separate switch-selected input channels, each with its own input level control. Four-position turnover and roll-off controls for record equalization. Separate bass and treble tone controls. Special hum control to insure minimum hum level. Will do justice to finest program sources. Beautiful satin-gold finish.

## Heathkit TUNER KITS

These tuners measure only 12 9/16" long x 3 5/8" high x 5 7/8" deep, and are finished in beautiful satin-gold enamel. Easily stack one over another to form compact control unit.

### FM HIGH FIDELITY

MODEL FM-3

**\$24<sup>50</sup>**

(With cabinet) Shpg. Wt. 7 lbs.



This FM tuner offers sensitivity, selectivity, and stability, not expected at this price level. Efficient 7-tube circuit is entirely new, and incorporates AGC, cascade front end, temperature-compensated oscillator, built-in power supply, and other outstanding design features. Pre-aligned IF and ratio transformers. Sensitivity is better than 10 microvolts for 20 db of quieting. Covers 88 to 108 mc.

### AM BROAD BANDWIDTH

MODEL BC-1

**\$24<sup>50</sup>**

(With cabinet) Shpg. Wt. 8 lbs.



Designed for use with high fidelity systems. Low distortion voltage-doubler detector. Covers 550 to 1600 kc. 20 kc IF bandwidth. Audio response  $\pm 1$  db from 20 cps to 2 kc. 6 db signal-to-noise ratio at 2.5 microvolts. RF and IF coils pre-aligned. Power supply built-in. Efficient, modern circuit. Matches WA-P2 and FM-3 in color and style.

## Heathkit SPEAKER SYSTEM KITS

The models SS-1 and SS-1B are matched so that when the smaller unit is placed on top of the larger unit, the appearance of a single piece of furniture is achieved.

### SS-1 HIGH FIDELITY

MODEL SS-1 **\$39<sup>95</sup>**

Shpg. Wt. 30 lbs.



Employs two Jensen speakers to cover from 50 to 12,000 cps. Response is within  $\pm 5$  db. Built-in crossover functions at 1600 cps. System rated at 25 watts, with nominal impedance of 16 ohms. Enclosure is ducted-port bass reflex type. Merely assemble the cabinet, wire the speakers and crossover network, and finish to your taste.

### SS-1B HIGH FIDELITY RANGE EXTENDING

Employs woofer and super tweeter to cover 35 to 600 cps, and 4000 to 16,000 cps. Extends frequency range of SS-1 at both ends of the spectrum, for total of  $\pm 5$  db from 35 to 16,000 cps. The kit includes necessary crossover circuits and balance control. Power rating is 35 watts for speech and music. Impedance is 16 ohms.



MODEL SS-1B **\$99<sup>95</sup>** Shpg. Wt. 80 lbs.

## Heathkit ELECTRONIC CROSS-OVER KIT

The XO-1 separates high and low frequencies at selectable crossover points, to feed two separate power amplifiers, one for high frequencies and one for low frequencies. Speakers are then connected to the amplifiers directly, without the usual LC crossover. Separate level controls provided for both outputs. The XO-1 consumes no audio power. Crossover frequencies are 100, 200, 400, 700, 1200, 2000, and 3500 cps. Attenuation is 12 db per octave.



MODEL XO-1

**\$18<sup>95</sup>**

Shpg. Wt. 6 lbs.

**HEATH COMPANY** A Subsidiary of Daystrom, Inc. **BENTON HARBOR 3, MICH.**

## NEW *Heathkit* PROFESSIONAL RADIATION COUNTER KIT



MODEL RC-1

**\$79<sup>95</sup>**

 Shpg. Wt.  
8 Lbs.

- ▶ Completely modern design for maximum sensitivity and reliability.
- ▶ Both visual (4½" meter) and aural (panel-mounted speaker) indicators for radiation level.
- ▶ Meter calibrated in CPM and mR/hr. Four measuring ranges.
- ▶ Employs 900-volt Bismuth tube in beta/gamma sensitive probe.

This radiation counter provides design advantages found only in units costing several times its low kit price. It incorporates features essential to the serious prospector. High sensitivity is provided, with ranges of 0-100, 600, 6,000, and 60,000 counts per minute, and 0.02, .1, 1, and 10 milliroentgens per hour. A type 6306 Bismuth tube is employed in the probe, and the probe and a radiation sample are included in the kit price. The circuit employs 5 tubes (plus a transistor) to assure stable and reliable operation. High quality, 4½" 200 microampere meter eliminates "guess work" and indicates radiation level directly in cpm, or mR/hr. In addition, transistor oscillator provides aural signal from panel-mounted speaker. High voltage power supply is "packaged" pre-built unit with reserve capacity above 900 volt level at which it is regulated. Merely changing regulator tube would allow use of scintillation probe if desired.

Fulfills requirements of those who want a prospecting instrument that can be relied upon. Has selectable time constant, to allow for different rates of travel over the area being investigated. Measures only 9½" high x 6½" wide x 5¼" deep, and weighs only 6½ lbs. Not to be confused with novelty radiation detection devices on the market. A top-quality instrument, yet simple to build.

## *Heathkit* TUBE CHECKER KIT

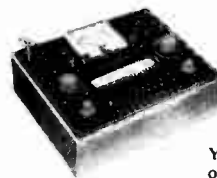

MODEL TC-2

**\$29<sup>50</sup>**

 Shpg. Wt.  
12 Lbs.

You can afford your own tube tester, even if you only do part-time service work. Uses a 4½" meter with 3-color meter face for simple "good-bad" indications of tube quality, on the basis of emission. Tests all tubes commonly encountered in radio and TV service work. 14 different filament voltages—built-in roll chart—ten 3-position lever switches for open or short tests on each tube element.

## *Heathkit* CATHODE RAY TUBE CHECKER KIT

Indicates condition of CRT on large "good-bad" scale. Spring-loaded switches protect operator. Checks all electromagnetic deflection picture tubes normally encountered in TV servicing. Supplies all operating potentials and tests for shorts, leakage, and emission on the work bench, in the carton, or in the set. Features shadowgraph test to indicate tube condition.



MODEL CC-1

**\$22<sup>50</sup>**

Shpg. Wt. 10 Lbs.

## *Heathkit* VISUAL-AURAL SIGNAL TRACER KIT



MODEL T-3

**\$23<sup>50</sup>**

Shpg. Wt. 9 Lbs.

Features a high-gain RF input channel for signal tracing and troubleshooting from the receiver antenna input clear through all RF and IF stages. Separate low-gain channel for audio circuit exploration. Built-in loudspeaker provides audio response, while electron beam "eye" tube gives visual indication. Ideal for signal tracing in AM, FM, and TV receivers.

## *Heathkit* TV ALIGNMENT SWEEP GENERATOR KIT

All-electronic sweep eliminates mechanical hum or vibration. Features improved linearity—effective AGC—flat output—0 to 40 mc sweep. Covers all frequencies in FM, monochrome TV and color TV. Plenty of RF output for alignment of tuners, IF strips, boosters, etc. Fundamental output from 4 to 220 mc in four bands. Incorporates crystal oscillator (4.5 mc and multiples thereof), and variable marker covering 19 to 60 mc on fundamentals—up to 180 mc on harmonics. Effective two-way blanking.

MODEL TS-4

**\$49<sup>50</sup>**

Shpg. Wt. 16 Lbs.



## *Heathkit* SIGNAL GENERATOR KIT



MODEL SG-8

**\$19<sup>50</sup>**

Shpg. Wt. 8 Lbs.

This tried and proven generator covers 160 kc to 110 mc on fundamentals in five bands, and calibrated harmonics extend to 220 mc. Very popular in service shops, laboratories, and home workshops. RF output is in excess of 100,000 microvolts, controlled by a variable and a fixed-step attenuator. Output is pure RF, RF modulated at 400 cps, or 400 cps audio for amplifier testing.

## *Heathkit* CONDENSER CHECKER KIT

Measures paper, mica, ceramic, and electrolytic capacitors in 4 ranges from .00001 to 1,000 microfarads. It indicates condenser value and quality. Also measures resistance from 100 ohms to 5 megohms. All values indicated directly on panel scale, after adjusting for null on electron beam "eye" tube. No calculations necessary. A valuable instrument in service or laboratory applications.



MODEL C-3

**\$19<sup>50</sup>**

Shpg. Wt. 7 Lbs.

## *Heathkit* LINEARITY PATTERN GENERATOR KIT



MODEL LP-2

**\$22<sup>50</sup>**

 Shpg. Wt.  
7 Lbs.

Supplies information for white dots, cross-hatch pattern, horizontal bar pattern, or vertical bar pattern. Use for adjustment of vertical and horizontal linearity, picture size, aspect ratio and focus. Dot pattern is a *must* for color convergence adjustments. Clip merely connects to antenna terminals of TV set. Panel provision for external sync if desired. Covers channels 2 to 13. 5 to 6 vert. bars and 4 to 5 hor. bars.

## *Heathkit* LABORATORY GENERATOR KIT

MODEL LG-1

**\$39<sup>50</sup>**

Shpg. Wt. 16 Lbs.



This signal generator covers from 100 kc to 30 mc on fundamentals in 5 bands. 400 cycle modulation variable from 0 to 50% RF output up to 100,000 microvolts. Meter reads RF output or percentage of modulation. Fixed step and variable output attenuation. Voltage regulation, double copper-plated shielding for stability, and other "extras." Provision for external modulation. Output impedance 50 ohms.

**HEATH COMPANY** A Subsidiary of Daystrom, Inc. **BENTON HARBOR 3, MICH.**

For further data on advertised products use page 65.



## HEATHKIT ETCHED CIRCUIT OSCILLOSCOPE KITS

You may choose from three different oscilloscope models when you purchase a Heathkit scope. All three units employ printed circuit boards for increased circuit efficiency and simplified assembly. Construction time cut almost in half. Outstanding dollar values for you!

### 5" COLOR TV

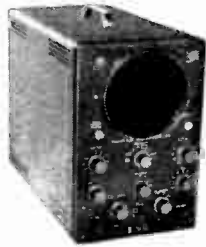

MODEL O-10  
**\$69.50**

Shpg. Wt. 21 Lbs.

Amplifier response essentially flat from plus 2 db -5 db from 5

mc down to 2 cps without extra switching. Extended sweep oscillator range allows single-cycle observation of signals up to 500,000 cps, and will sync signals even higher. Uses etched metal circuit boards. Push-pull vertical and horizontal amplifiers—built in peak-to-peak calibrating source—step attenuated input—performed and cabled wiring harness. A professional oscilloscope, ideal for color TV work in the lab or service shop. The 11-tube circuit features 5UP1 CRT.

### FULL SIZE 5"

The Model OM-1 with a 5", 5BP1 cathode ray tube has many big scope features—yet it is priced reasonably. Features etched-metal circuit boards. Incorporates 3-step input attenuator—phasing control—built-in peak-to-peak voltage calibrator—and push-pull vertical and horizontal amplifiers. Vertical amplifier flat within ±3 db from 2 cps to 200 kc. Sweep circuit functions from 20 cps to 100,000 cps.

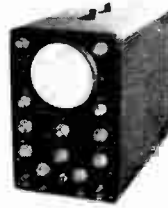

MODEL OM-1  
**\$49.50**

Shpg. Wt. 21 Lbs.

### 3" PORTABLE

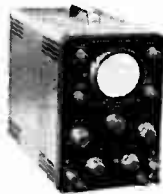

Has many of the features of the Model OM-1, yet is smaller in physical size. Employs etched-metal circuit boards. Features vertical frequency response within ±3 db from 2 cps to 200 kc. Sweep generator operates from 20 to 100,000 cps. The 8-tube circuit features a type 3GP1 CRT.

MODEL OL-1  
**\$29.50**

Shpg. Wt. 14 Lbs.

## Heathkit AC VACUUM TUBE VOLTMETER KIT



MODEL AV-2  
**\$29.50**

Shpg. Wt. 5 Lbs.

This VTVM combines high impedance, wide frequency range, and high sensitivity. It is designed especially for audio work. Frequency response is substantially flat from 10 cps to 50 kc. Sensitivity allows measurements as low as 1 mv at high impedance. Ranges are .01, .03, .1, .3, 1, 3, 10, 30, 100, and 300 volts rms. Total db range is -52 to +52 db. 1 megohm input impedance at 1 kc. An outstanding instrument for your laboratory, service shop, or home workshop.

## Heathkit ETCHED CIRCUIT VACUUM TUBE VOLTMETER KIT



MODEL V-7A  
**\$24.50**

Shpg. Wt. 7 Lbs.

The Heathkit Model V-7A features a 200 ua meter, 1% precision resistors, and an etched metal circuit board. Very simple to build. Measures DC voltage, ACV (rms) ACV (peak-to-peak), and resistance. AC (rms) and DC voltage ranges are 0-1.5, 5, 15, 50, 150, 500, and 1500 volts. Peak-to-peak ranges are 4, 14, 40, 140, 400, 1400, 4000 volts. Ohmmeter ranges provide multipliers of X1, X10, X100, X1000, X10K, X100K, and X1 megohm. DB scale also provided. 11-megohm input impedance.

## Heathkit 20,000 OHMS/VOLT VOM KIT



MODEL MM-1  
**\$29.50**

Shpg. Wt. 6 Lbs.

pliers are X1, X100, and X10,000. DB range from -10 db to +65 db.

This instrument is especially valuable for portable applications where AC power is not available. Sensitivity is 20,000 ohms-per-volt DC and 5,000 ohms-per-volt AC. Black bakelite case -4½" 50 ua. meter-1% precision resistors. AC and DC ranges are 0-1.5, 5, 50, 150, 500, 1500, and 5000 volts. Direct current ranges are 0-150 ua., 15 ma., 150 ma, 500 ma, and 15 a. Resistance multi-

## Heathkit DIRECT-READING CAPACITY METER KIT



MODEL CM-1  
**\$29.50**

Shpg. Wt. 7 Lbs.

This unique measuring instrument indicates capacitor values in mmf, or mfd, directly on a large 4½" 50 ua meter. It provides ranges of 0-100 mmf, 0-1,000 mmf, 0-0.1 mfd, and 0-1 mfd. Residual capacity less than 1 mmf. Scales are linear. Merely connect the capacitor to the instrument and read its value directly on the scale. Instrument not susceptible to hand capacity effects. Will measure even small value trimmers or variable air capacitors.

## Heathkit ELECTRONIC SWITCH KIT



MODEL S-3  
**\$21.95**

Shpg. Wt. 8 Lbs.

This new instrument design allows simultaneous oscilloscope observation of two input signals by producing both signals, alternately, at its output. The all-electronic circuit provides 4 switching rates, selected by a panel switch. Provides actual gain for input signals, and features frequency response of ±1 db from 0 to 100 kc. Employs 7 miniature tubes, Sync output provided to control scope sweep. Functions at signal levels as low as 0.1 volt. Ideal for observing amplifier input and output simultaneously for comparison purposes.

## ORDER BLANK

NOTE: All prices subject to change without notice.

Enclosed find ( ) check ( ) money order for

Please ship C.O.D. ( ) postage enclosed for \_\_\_\_\_ pounds.

On Express orders do not include transportation charges — they will be collected by the express agency at time of delivery.

ON PARCEL POST ORDERS include postage for weight shown. ORDERS FROM CANADA and APO's must include full remittance.

Name \_\_\_\_\_

Address \_\_\_\_\_

City & Zone \_\_\_\_\_ State \_\_\_\_\_

(PLEASE PRINT)

SHIP VIA

- Parcel Post
- Express
- Freight
- Best Way

QUANTITY	ITEM	MODEL NO.	PRICE

**HEATH COMPANY** A Subsidiary of Daystrom, Inc BENTON HARBOR 3, MICH.

## Ungar

### COMPLETE PENCIL SOLDERING IRONS

#### SUPER HI-HEAT TIPS



**NO. 4033**  
SUPER HI-HEAT CHISEL TIP  
47½ watts, 900 degrees Tip Temperature. Net wt. 1 oz. ea. ¼" rd. at tip.

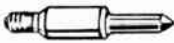

**NO. 4036**  
SUPER HI-HEAT PYRAMID TIP  
47½ watts, 1000 degrees Tip Temperature. Net wt. 1 oz. ea. ⅜" rd.

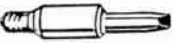

**NO. 4039**  
SUPER HI-HEAT HEAVY CHISEL TIP  
47½ watts, 1000 degrees Tip Temperature. Net wt. 1 oz. ea. ⅜" rd.

---

#### 500 STANDARD SERIES



**NO. 536**  
PYRAMID TIP  
23½ watts, 700 degrees Tip Temperature. Net wt. ¾ oz. ea. ⅜" rd.



**NO. 539**  
CHISEL TIP  
23½ watts, 700 degrees Tip Temperature. Net wt. ¾ oz. ea. ⅜" rd.

---

#### 1200 HI-HEAT SERIES



**NO. 1236**  
HI-HEAT PYRAMID TIP  
37½ watts, 800 degrees Tip Temperature. Net wt. 1 oz. ea. ⅜" rd.



**NO. 1239**  
HI-HEAT CHISEL TIP  
37½ watts, 800 degrees Tip Temperature. Net wt. 1 oz. ea. ⅜" rd.

---

#### THREADED HEATING UNITS and TIPLETS

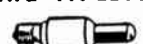

**NO. 535**  
STANDARD THREADED UNIT  
23½ watts, 650° Tip Temperature. Net wt. ¾ oz. ea. ⅜" rd.



**NO. 1235**  
HI-HEAT THREADED UNIT  
37½ watts, 750° Tip Temperature. Net wt. 1 oz. ea. ⅜" rd.

---

#### TIPLETS ELKALOY

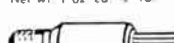

**NO. 331**  
ELKALOY PENCIL TIPLET



**NO. 332**  
ELKALOY OFFSET PENCIL TIPLET

---

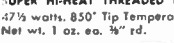

**NO. 333**  
ELKALOY CHISEL TIPLET



**NO. 776**  
SOLDERING PENCIL HANDLE WITH CORD SET  
For use with all Ungar Tips. 47½ watts—Net wt. 3 oz. ea.



**ELECTRIC TOOL CO. OF CANADA**  
44 DANFORTH ROAD, TORONTO 13, ONT.

## Marconi To Represent Merged Instrument Companies

A merger of the firms of Baird Associates Inc. and Atomic Instrument Company, both of Cambridge, Mass., under the name of Baird Associates — Atomic Instrument Company has been announced. Two of the largest and best-known instrument manufacturers in the United States, the new company will be represented in Canada by Canadian Marconi Company. The Marconi Company has been acting as Canadian representative for Atomic Instrument Company for some time, and will continue in the same capacity for the newly organized instrument company.

The merger of these two companies provides an enlarged engineering staff, greater and more efficient use of sales and service departments and increased production facilities for further efficiencies in design and manufacturing.

Arthur Kingsnorth, supervisor of instrumentation for the commercial products division of Canadian Marconi Company, 2442 Trenton Avenue, Montreal 16, Que., will be handling all enquiries regarding the sale of Baird Associates — Atomic Instrument Company's equipment.

## Canadian Rep. Sees World's Largest Electron Tube

A giant, super power klystron, the largest electron tube ever developed, has been announced in San Bruno, California, by Eitel-McCullough, Inc., manufacturers of Eimac electron tubes.

The new tube, the X626, is capable of generating 100,000 watts of average radio frequency power and more than 1,000,000 watts of peak pulse power. It will be used in radar and linear accelerator operation.

In announcing the super klystron, Mr. W. W. Eitel, president and co-founder of the company, observed, "The X626 is another indication of the power that can be easily and reliably generated by klystrons at specific frequencies and the new applications the combination affords. It will increase the effectiveness of certain radar applications and offer new advantages to the processing of food, chemicals, plastics and petroleum."

The king-size tube, 10 feet five inches in length, is the first of a series of super power Eimac klystron tubes. Other Eimac klystrons are already extensively employed in the northern Distant Early Warning system, commercial television and communication service.

Klystrons such as those used in DEW line were exhibited in Toronto at the Canadian Institute of Radio Engineers Show and Convention, October 1-3. Eimac is represented in Canada by Ahearn and Soper Co., Ltd., Ottawa.

**Beckman®**

## Servomotor-Rate Generator

Snug as two bugs in their unitized stainless steel housing, motor and generator work hand-in-hand on the same shaft... to improve response characteristics of suffering servo systems.

Where the trouble is in the dynamics of your system components, watch this purposeful pair roll up their sleeves and go to work. The high torque-to-inertia motor, for instance, responds quickly and accurately to error signals... with acceleration at stall up to 100,000 radians/sec.<sup>2</sup>. Signal-to-noise ratio of the linear generator is 25:1 or better. Aiding and abetting each other in their dedicated mission, they'll operate continuously at stall and at total unit temperature from -55°C to 200°C.

Right now, our corrosion-resistant, completely encapsulated Servomotor-Rate Generators are available in sizes 11, 15 and 18. (We'll soon add size 8; eventually, other sizes.) We've got descriptive literature available too. It's data file 137.

**Beckman® Helipot Corporation**  
a division of Beckman Instruments, Inc.

Canadian Factory:  
No. 3 Six Points Rd., Toronto 18, Ont.  
Sales Representative: R-O-R Associates, Ltd.,  
290 Lawrence Ave. West, Toronto 12, Ont.

889

For further data on advertised products use page 65.

World Radio History

Another product *surprise* from Helipot!



Fire burn and cauldron bubble! Cook our new **HELIPOT®** Model 50 trimming-type potentiometer to a fare-thee well. Fish it out . . . shake it . . . kick it over the goalposts. And it works as good as new.

*Question:*

How come this amphibious trim-type miracle?

*Answer:*

Fusing and housing. The resistance element "slip ring" and terminals are fused to the Steatite (high-grade, mechanically stable porcelain) frame . . . enclosed in a one-piece stainless-steel seamless-

tubing housing . . . to form an indefatigable unit that laughs off heat and moisture, sneers at shock and vibration.

For a trimming-type potentiometer with nominal resistance values from 1,000 to 25,000 ohms . . . that remains stubbornly stable after being set . . . for airborne applications, where weight and space are critical, stability and resistance to vibration vital . . . there's only one answer: Model 50.

Model 50 and the encapsulated Model 51 are both fully described in data file 127.

**Helipot** Corporation: a division of Beckman Instruments, Inc.

Canadian Factory: No. 3 Six Points Rd., Toronto 18, Ont.

Sales Representative: R-O-R Associates, Ltd., 290 Lawrence Ave. West, Toronto 12, Ont.

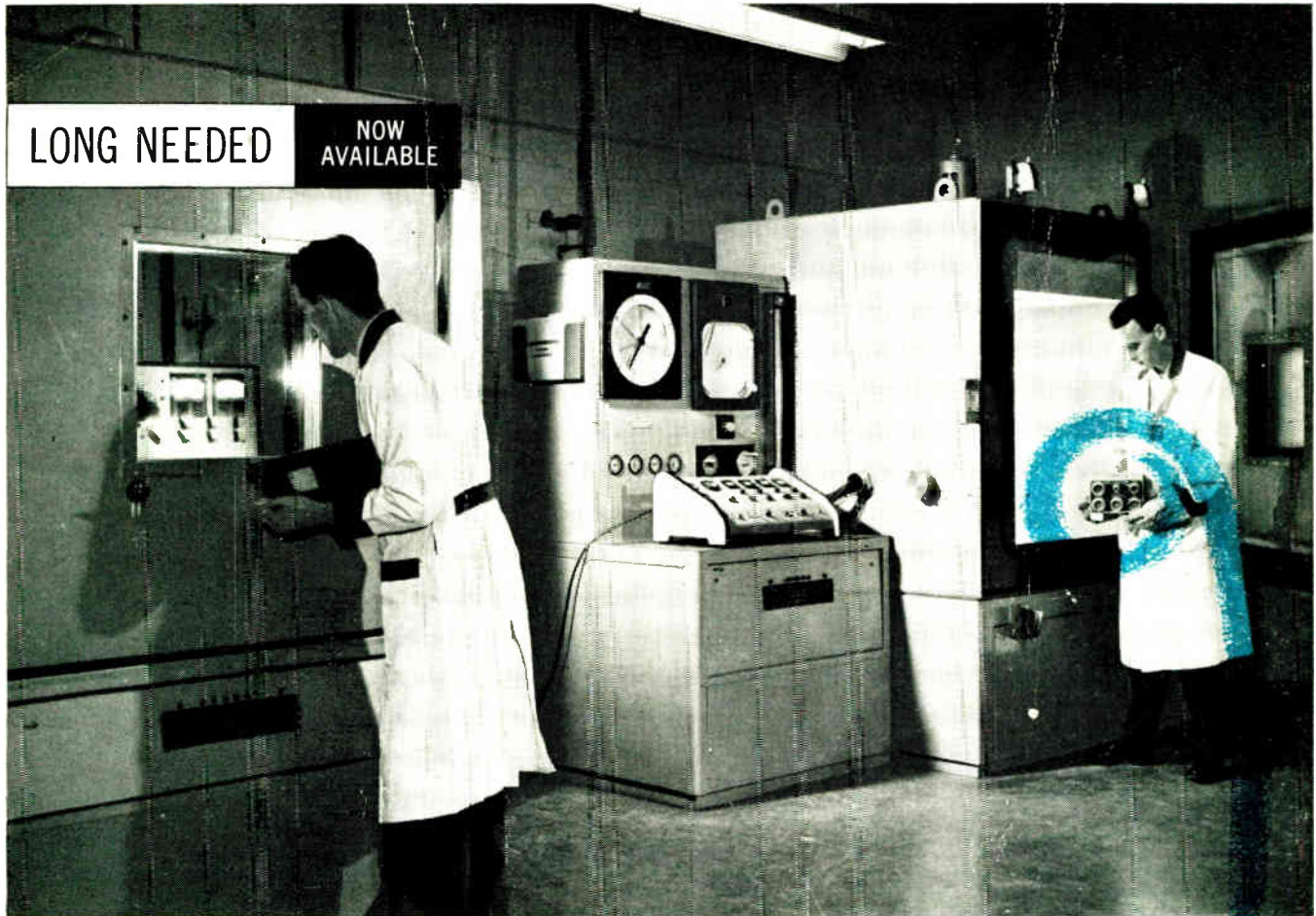

Preparing to test a Company produced rocket-firing intervalometer at  $-65^{\circ}$  F. at 60,000 feet altitude

## A commercial environmental test lab in Canada!

One of Canada's first privately owned and commercially available environmental test laboratories is ready now—at your service. It is designed to test components and systems to military and commercial specifications. Here are two of the many test chambers. The left chamber tests at temperatures from  $-35^{\circ}$  F. to  $300^{\circ}$  F., and at humidities from 20% to 98%. The right chamber provides temperatures from  $-100^{\circ}$  F. to  $300^{\circ}$  F., at altitudes from sea level to 100,000 feet. If you have a qualification testing problem write for information on this new service to Canadian industry. Quotations are available on request.

Qualification testing for your products and research problems to current MIL Specs.:

- low temperature
- high temperature
- altitude
- humidity
- shock
- vibration
- salt spray
- sand and dust
- radio interference
- explosion
- fungus
- wind-tunnel



**PSC APPLIED RESEARCH LTD.**

1500 O'CONNOR DRIVE  
PLYMOUTH 5-3371

TORONTO 16, ONTARIO, CANADA





MR J W PRELIONI  
8 EASTDALE CRESCENT  
TORONTO 16 ONT

EPV  
QSL  
FEX  
7220

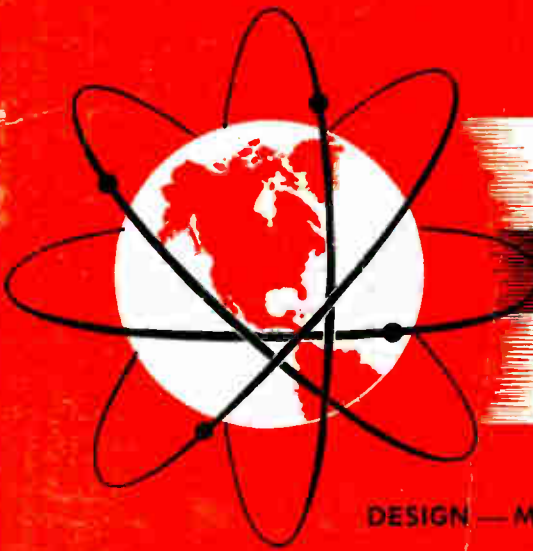

# ELECTRONICS *and* COMMUNICATIONS

DESIGN — MANUFACTURE — ENGINEERING — DISTRIBUTION — APPLICATION

The Spark Gap — Old  
Component — New Circuit . 26

Measurement Of Sensitivity  
On AM Communication  
Receivers . . . . . 28

Feedback — Servomechanisms  
— And The Nyquist Diagram . 30

Quality Control Of Printed  
Circuit Board Manufacturing 32

The Use Of The Beta Gage  
As A Control Actuator . . 42

Atomic Powered Battery  
Achievement In  
Miniaturization . . . . . 47

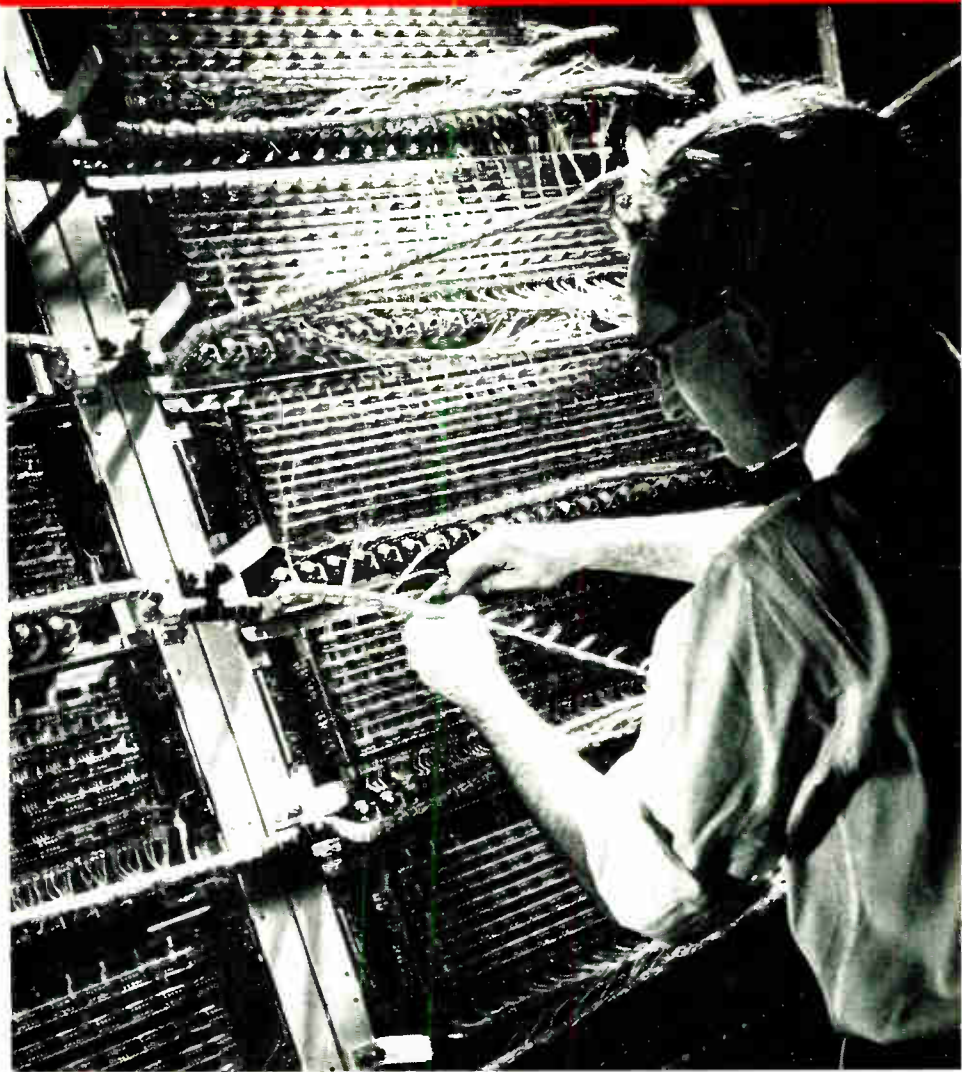

An installer is shown "skinning" some of the 1,108,661 wire ends which were connected during the installation of the Bell Telephone's 4-A crossbar system. The work was done on one of the 30 "sender" bays. These receive a dialed telephone number and "remember" the information while an electronic card index seeks out available routes.

February, 1957 ★ \$5.00 a year

An AGE Publication, Toronto, Canada

Distribution Of This Issue Over 10,000 Copies

World Radio History

# NEW "B" COATED\* POWER WIREWOUND RESISTORS

Approved for V Characteristic under MIL-R-26A

**ADJUSTABLE WIREWOUND RESISTORS AT BEST ARE A POTENTIAL SOURCE OF TROUBLE**

**If You Are Having Trouble, Investigate IRC!**



**IRC Exclusive NEW "B" Coating Features:**

Low-temperature curing eliminates hot spots, brittle resistance wire, wire fatigue, "bunching" and change in resistance due to temperature variations

Gives good protection mechanically to the resistance wire

Coating will stand a wide range of temperature variations and shock

Black in color — best for heat dissipation

Coating permits the resistor to "breathe"

Fungus-resistant

Good appearance

Marking is clear and permanent

When Dependability Is Essential



**THE COMPLETE LINE**

- Types: TUBULAR & FLAT — Fixed, Tapped, Adjustable, Stacked
- Sizes: All Standard MIL-R-26A sizes
- Watts: 5 watts to 225 watts
- Ranges: .1 ohms to 465,000 ohms
- Tolerance: To your requirement. 5% standard
- Terminals: Wire Leads, Flexible Leads, Soldering Lugs, Mounting Lugs, Ferrules, Specials

Write for Bulletin C1a. 12 pages with complete Types, Specifications, Characteristics, Illustrations.

**INTERNATIONAL RESISTANCE COMPANY LIMITED**

349 CARLAW AVE.

TORONTO 8, ONTARIO

Radiovision Sales Ltd.  
325 Tenth Ave. West  
Calgary, Alta.

SALES OFFICES:  
492 Somerset St. West  
Ottawa  
Ont.

1500 St. Catherine St. West  
Montreal  
Que.



# MAGNETRONS

## FROM CANADIAN MARCONI

### Vital electronic components now produced in this country

A million dollar production plant, complete with micro-wave tube development laboratories, now assures Canada of a domestic supply of magnetrons for vital defence and navigation equipment.

These same laboratories are being staffed and equipped to deal with advanced work on magnetrons and other micro-wave devices. We would welcome the opportunity to help you with any of your micro-wave tube problems.

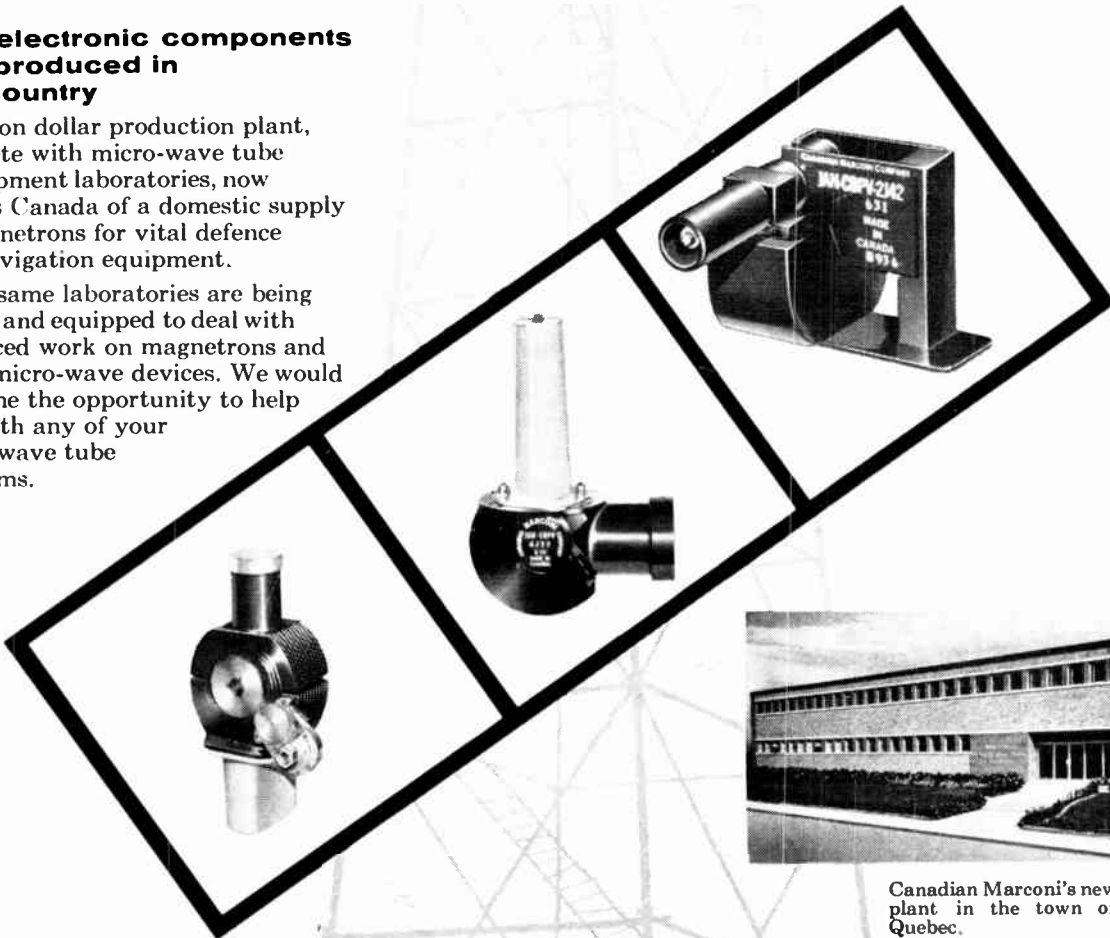

Canadian Marconi's new Electronic Tube plant in the town of Mount Royal, Quebec.

Electronic Tube and Components Division

CANADIAN **Marconi** COMPANY

830 Bayview Avenue, Toronto, Ontario

BRANCHES: Vancouver • Winnipeg • Montreal • Halifax • St John's, Nfld.

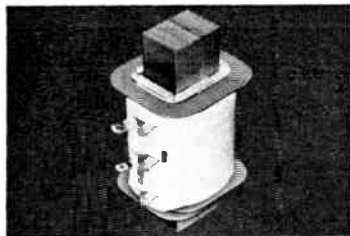

**DIELECTRIC STRENGTH.** National Vulcanized Fibre gives electrical parts high dielectric strength—plus toughness and excellent forming properties. Has ideal application as insulation.

**NATIONAL  
VULCANIZED  
FIBRE**

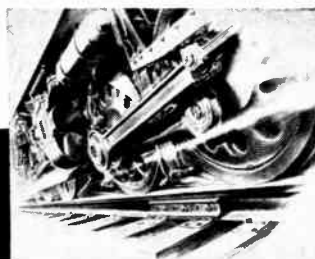

**DURABLE—TOUGH—RUGGED.** National Vulcanized Fibre rail joint insulation withstands years of continuous exposure and heavy pounding of today's high-speed railroading. Will not corrode or deteriorate.

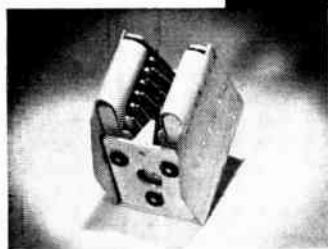

**ARC RESISTANCE.** In circuit breakers, National Vulcanized Fibre safely curbs electrical arcing without carbonizing or tracking. Easy to bend, punch and form. Light in weight. Heat-and-shock resistant.

## FOR MEN WITH IMAGINATION...

two  
materials  
of  
unlimited  
application

**MACHINABILITY—MECHANICAL STRENGTH.** New paper-base PHENOLITE not only has excellent arc resistance, but superior machining qualities as well. Great compressive and tensile strength.

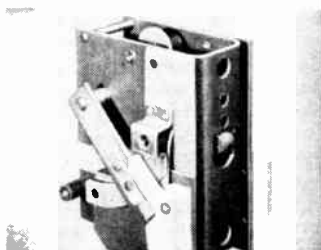

**CHEMICAL RESISTANCE.** Chemical-resisting grades of PHENOLITE are unaffected by most corrosive fluids and atmospheres. Retain high strength, resiliency and dimensional stability.

Here are six ideas to spur your imagination. They only suggest the many things that are being done better at lower cost with versatile Vulcanized Fibre and PHENOLITE® Laminated Plastic.

The full list of current and new uses for National Laminates would more than fill this page and many more! These are coming up almost every day. For the property range of National Laminates is a designer's dream. Over 80 basic materials grades available in sheets, rods, tubes, rolls, coils or fabricated parts.

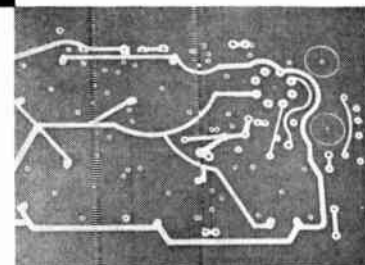

**COMPACT DESIGN—ECONOMY—HIGH TEMPERATURE RESISTANCE.** Printed circuits made of Copper Clad PHENOLITE permit compact design, simplify production, reduce assembly time.

### FREE GUIDE TO LAMINATED PLASTICS

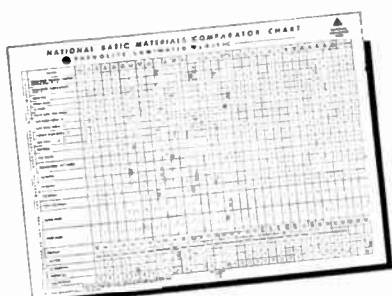

National's new materials comparator chart directs you quickly and easily to the right material for your application.

Compares specific properties of 35 basic materials grades—over 600 property values!

For your FREE copy, write direct to Dept. O.



**NATIONAL**

FIBRE COMPANY OF CANADA, LTD.

ATLANTIC & HANNA AVENUES, TORONTO  
1411 CRESCENT STREET, MONTREAL

In Canada: National Fibre Company of Canada, Ltd. • Toronto 3, Ont.

VULCANIZED FIBRE • PHENOLITE LAMINATED PLASTIC • NATIONAL NYLON • PEERLESS INSULATION • KENNETT MATERIALS HANDLING RECEPTACLES • VUL-COT WASTEBASKETS • LESTERSHIRE TEXTILE BOBBINS • VUL-COT PRODUCTS FOR THE HOME

# COSSOR-SANDERS

## PRECISION MICROWAVE TEST EQUIPMENT

Designed expressly for precision measurements to the most exacting specifications. All 3-centimeter parts in stock and all standard couplings, bends and twists available.

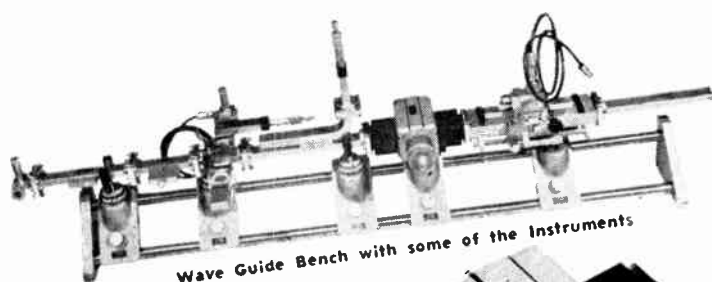

Wave Guide Bench with some of the Instruments

### 3-Centimeter Stock List

Directional Couplings 10 to 40 dB  
 Crystal Mixer Mount  
 Crystal Detector Mount  
 Coaxial Crystal Detector Mount  
 Wavemeter  
 Calibrated Attenuator  
 Matched Termination  
 Matched Load  
 Preset Attenuator  
 Variable Attenuator  
 High Sensitivity Coaxial Detector Crystals  
 Wave Guide Support Bench and Carriages  
 Adjustable Short Circuit  
 Standing Wave Meter  
 Klystron Mount Assemblies  
 Matched Terminations  
 Centimetric Noise Source Unit  
 Klystron Power Unit  
 Waveguide Adaptors



Wide Band Coaxial  
 Crystal Detector  
 (200 to 15000 Mc/s)

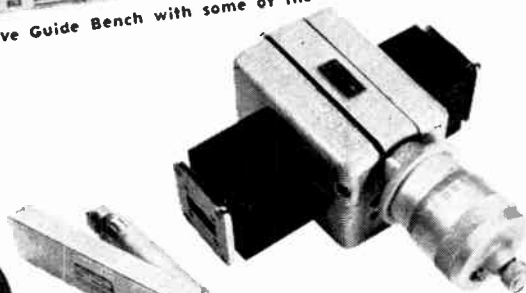

Calibrated Precision  
 Attenuator

Centimetric Noise Source

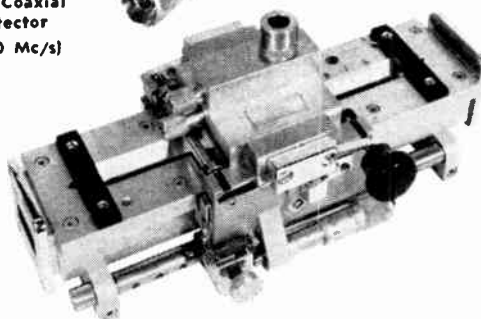

Precision Standing Wave Meter



Illustrating method of packing

Equipment for other wave bands available at short notice.

Complete information and specifications from



Multi - Purpose  
 Klystron  
 Power Supply

## COSSOR (CANADA) LIMITED

301 Windsor St.  
 OTTAWA  
 160 Laurier W.  
 5-4306

— HALIFAX —  
 MONTREAL  
 8230 Mayrand St., Decarie Boulevard  
 RE 3-6502

Phone 4-6487  
 TORONTO  
 648A Yonge St.  
 WA. 4-1226

# *the Measurement of Industry...*

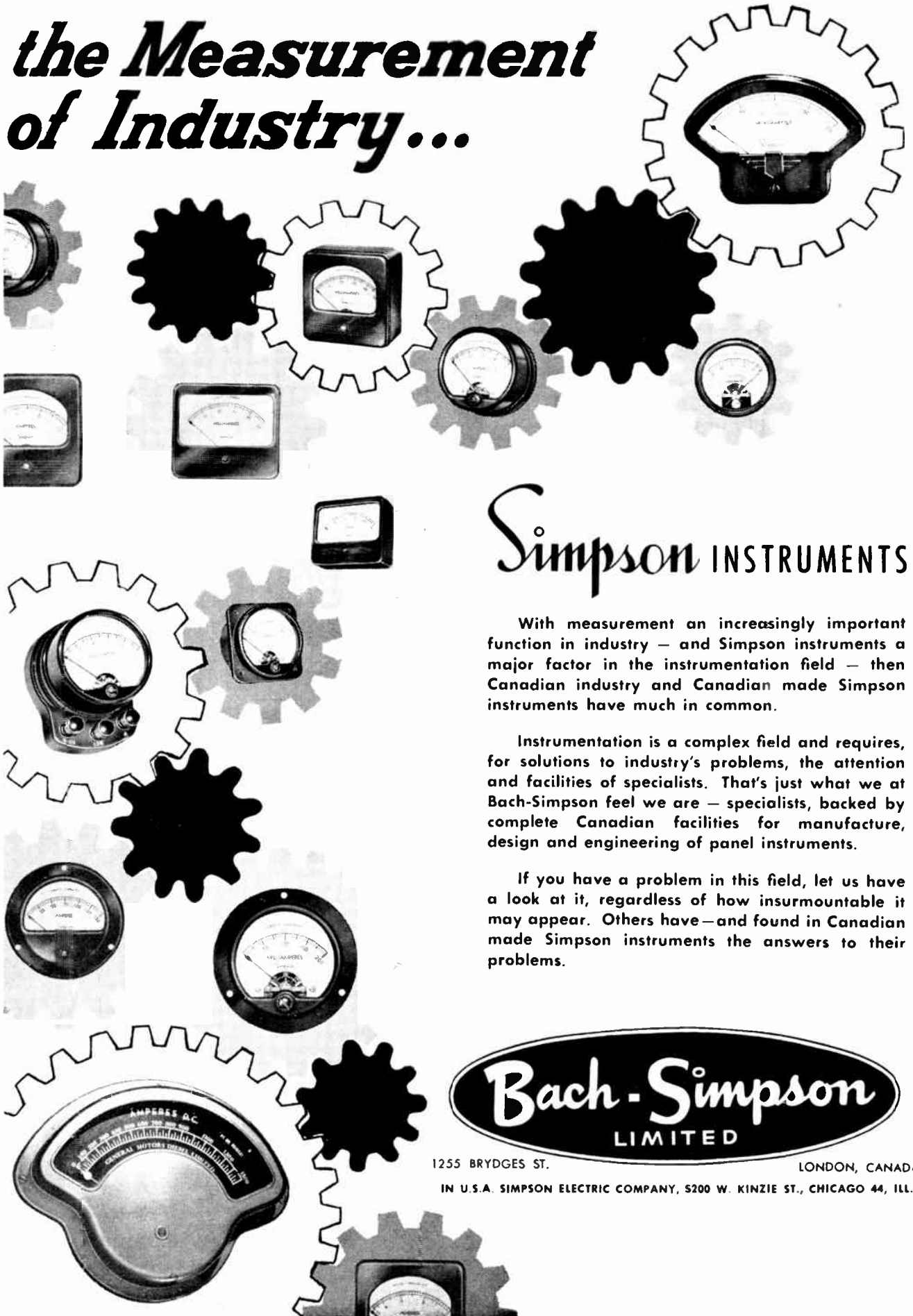

## Simpson INSTRUMENTS

With measurement an increasingly important function in industry — and Simpson instruments a major factor in the instrumentation field — then Canadian industry and Canadian made Simpson instruments have much in common.

Instrumentation is a complex field and requires, for solutions to industry's problems, the attention and facilities of specialists. That's just what we at Bach-Simpson feel we are — specialists, backed by complete Canadian facilities for manufacture, design and engineering of panel instruments.

If you have a problem in this field, let us have a look at it, regardless of how insurmountable it may appear. Others have—and found in Canadian made Simpson instruments the answers to their problems.

**Bach-Simpson**  
LIMITED

1255 BRYDGES ST.

LONDON, CANADA

IN U.S.A. SIMPSON ELECTRIC COMPANY, 5200 W. KINZIE ST., CHICAGO 44, ILL.

For further data on advertised products use page 81.

# electronics

## in business & industry

### business machines . . .

The International Business Machines Corporation has introduced an electronic control unit on its standard electric typewriter. This is mounted beneath the keyboard and makes tabulation automatic. In the case of billing or accounting forms conductive ink is used instead of regular printing ink. Contact for "tab sensing" is made by a conducting brush as it passes over the ink line, thus operating the relay which is hooked up to the tabulator. It is predicted by IBM officials that other electronic applications to typewriters may be developed, thus creating a growing market for electronic components and equipment in this particular field.

\* \* \*

### commercial fishing . . .

Special equipment for detecting fish shoals in the open sea has been devised by Kelvin & Hughes (Marine) Ltd. of Great Britain. This equipment, called the Fisherman's Asdic, can operate over a range of 0 to 2,000 yards and includes provision for automatic step training over any sector between 10° and 180°. The equipment consists of a mill unit, a wheelhouse control unit, with separate loudspeaker, and a rotary converter. Transducers are incorporated in the device for echo-ranging and echo-sounding purposes. Plans are going forward to bring this equipment onto the market.

\* \* \*

### automobiles . . .

Closed-circuit television has been introduced into the private automobile, as demonstrated at a recent motor show in London, England. The Buick "Centurion" model was equipped with a closed-circuit TV rear-view "mirror".

\* \* \*

### machine control . . .

Magnetic tape has found a use in controlling standard machine tools through the development of a system devised by the Autonetics Division of North American Aviation, Inc. Programming of the tape is done from digital computers direct from blueprints and specifications. While the system was originally devised to produce templates and tools for the aircraft industry, it is considered adaptable to other production operations.

\* \* \*

### oil well drilling . . .

An echometer has been developed in Poland to be used in connection with oil well drilling operations in areas that are remote from electricity supplies. This device is portable, is operated by means of an accumulator and a dry battery and incorporates both manual and automatic control mechanisms. It is said to be capable of measuring accurately both the rate of oil flow from the reservoir rock into the well and the level of the oil in the well.

\* \* \*

### flaw detection . . .

A reflectoscope, mounted on a mobile carrier, is saving the Chesapeake and Ohio Railway Company time and money in checking for defects in railway car axles and journal areas without removing the journal from the car. The instrument, a product of the Sperry Rail Service Company, directs a beam of sound energy into the journal area. In the event of there being a crack in the car axle or journal box, this is indicated through energy being reflected back to the reflectoscope's search unit.

\* \* \*

### P.A. systems . . .

A portable public address system, which can be easily carried in an attache case, has been produced by the Antrex Corporation of Chicago. It consists of a transistor amplifier, an 8-inch speaker and microphone, all of which fit into a case 18 x 14 x 6 inches. The system, called the Redcap, runs for fifty hours on two dry cell batteries. The manufacturer claims that it is capable of covering an area of some 6,000 sq. ft. without additional speakers.

\* \* \*

(Continued on page 8)

# electronics

## in business & industry

### printing . . .

Printing has become streamlined through the use of a "Compositron" tube which simulates typesetting. This electron-image tube translates code by selecting the letters and numerals, one by one, from a "font" and projecting them in any desired pattern on the tube's ten-inch face. The pattern is photographed directly from the tube face by means of a 35 mm camera. A film-processing system develops the exposed film at the rate of 10 feet a minute. RCA Commercial Electronic Products, who have devised the printer which uses this tube, claim that the unit is still in the experimental stage and that no plans have been finalized for its commercial use.

\* \* \*

### aviation . . .

Turning two knobs on an automatic control weighing nine lbs. and no bigger than will rest on one's hand will simplify flying on small business aeroplanes equipped with the Tactair T-3 autopilot. This automatic pilot is manufactured by Aircraft Product Co. of Bridgeport, Pa. The unit is simple to operate and uses pneumatic pressure both for sensing and for operation of flight controls.

\* \* \*

### mine safety . . .

Loss of life in mine disasters, caused by falling roofs, may well be averted in the future through use of electronic equipment for measuring vibrations. Testing in the past has depended largely on the ability of the miners themselves to interpret the condition of the overlying strata through striking the rock and listening for vibrations which indicate either soundness or faultiness according to the duration of the vibrations. Recordings have been made in a West Virginia coal mine through the use of electronic gages and microphones, and these have been compared with the estimates of experienced testers. In general, the findings through instruments have agreed with those made by the miners.

\* \* \*

### car manufacturing . . .

The hot test is applied to Ford automobile engines after final assembly and before they leave the overhead assembly conveyor racks from which they are suspended. Gas and oil are fed into each engine which is then set in motion. Sensing probes at the front and rear of the engine pick up its vibrations, and test them through an electronic analyzer, which gives warning if the engine is out of balance. An automatic calculator is used to figure out the amount and position of corrective weights that should be applied to bring the engine within vibration tolerances.

\* \* \*

### telephony . . .

An electronic eye has been developed by telephone scientists for use by blind operators of private telephone switchboards and is being tested at the Canadian National Institute for the Blind. The eye, or light-sensitive phototransistor, is worn on the tip of one finger, as one would wear a thimble. It is connected by a thin cord with the operator's headset. When the operator hears a signal, she runs her eye-clad finger across the rows of lamps until the phototransistor is activated by the lighted lamp on the switchboard. She then hears a signal through her headset and plugs into the jack, thus completing the connection.

\* \* \*

### whaling industry . . .

Buoys, equipped with a built-in radio transmitter, are being used to enable whaling factoryships to locate and process whales killed by the catcher vessels. When a catcher ship harpoons a whale, one of the radio buoys is immediately secured to the whale by a 20-fathom nylon line attached to a barb. The buoy is switched on by means of an external control on the casing and left to float beside the whale. The equipment in the buoy is geared to transmit call signs and direction-finding signals at intervals. The buoys will radiate for 22 hours on one battery charge. The catcher ship radioes the factoryship that a buoy has been attached to a whale and gives the call signal and approximate location of the buoy. This type of equipment, designed by an English electronics firm specifically for the whaling industry, could be adapted for other kinds of fishing operations.

**do  
YOU  
know**

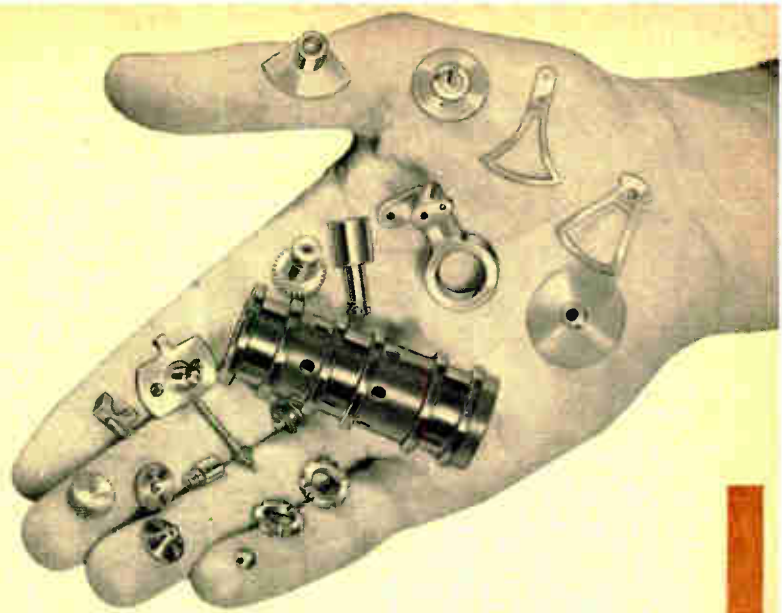

that these small component parts were tooled and manufactured on a production line basis at the Montreal plant of Aviation Electric Limited.

that our continued INDUSTRIAL MANUFACTURING expansion programme plus our wide range of new equipment now make it possible for us to assist you with your manufacturing problems.



Whether your need concerns the production of minute component parts — or large completely assembled products, we can offer complete facilities including design engineering, planning, tooling, manufacturing, assembling, testing and final inspection — all housed in one modern plant and backed by a quarter of a century of experience.

Whatever your problem, large or small, you owe it to yourself to consult

**AVIATION  ELECTRIC  
LIMITED**

200 Laurentien Blvd., Montreal, P. Q.

Halifax • Toronto • Calgary • Vancouver



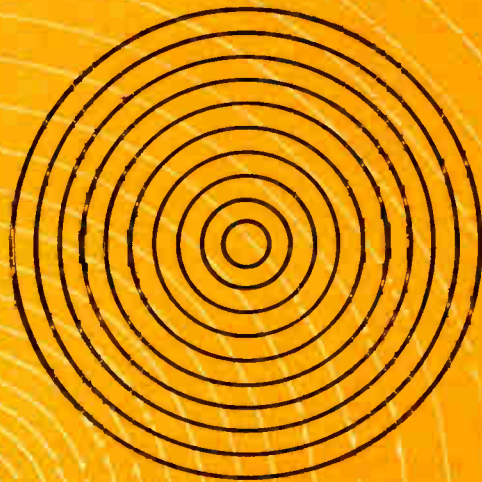

## STANDARDIZE WITH CANNON



**NEW XLR**  
*... an important addition  
to the XL Series*

Standardize with Cannon Audio Connectors . . . designed to meet all audio equipment disconnect needs. Simplify circuitry and cabling. Get quiet, continuous operation with the standard connectors of the industry—Cannon Plugs.

You'll find exactly the type you need in 14 extensive series expressly designed for radio, sound, TV and related fields . . . in cord, rack or panel chassis, audio and low-level, portable, hermetic sealed, miniature and subminiature, and power-supply types. Standard equipment with leading manufacturers of electronic equipment. The old reliable "Latchlock" feature on Cannon microphone connectors . . . standard on top-ranking microphones.

Complete Audio Connector Bulletin is yours for the asking . . . D Series in separate bulletin coded D-6.



**P series**



**X series**



**BRS series**



**UA series**



**D series**



**XL series**



**K series**

# CANNON PLUGS



Write for Cannon Miniature and Sub-Miniature Bulletins  
**CANNON ELECTRIC CANADA LIMITED**, 160 Basile Drive, Toronto 16 Ontario.  
Montreal Office: Montreal Airport, Dorval, P.Q.  
Factories also in Los Angeles, East Haven, London, Melbourne.  
Licences in Paris, Tokyo.

5701



## PUBLISHER'S VIEWPOINT

Recent change in policy of the pioneer United States electronics journal, McGraw-Hill's *Electronics*, which policy increased the frequency of issues from one to three issues a month with only one issue containing truly technical material and the other two devoted to industrial and commercial news, seems to be meeting with the approval of advertisers in the electronics market in the U.S.

During February the two commercial and industrial issues of *Electronics* showed a rapid increase in volume of advertising from outstanding suppliers such as: RCA Victor, General Radio, Standard Record, Servo Corporation, Sangamo Electric, Communication Measurement Laboratories, Airpax Products Corp., Kearfott Co., Maxton Instruments, Rheem Electronic Products, RBM Div., Essex Wire Corp., Instruments Div., Waltham Watch Co., Universal Winding Co., Monsanto Chemical Co., Texas Instruments, Waters Manufacturing Inc., Tung-Sol Electric, IBM Engineering Div., Do-ALL Co., Allen B. Dumont Laboratories, General Electric, Raytheon Mfg. Co., etc.

Advertising featured was primarily of special interest to technical personnel and covered: Micro Wave and Special Tubes, Capacitors, Radar Tubes, Engineers Wanted, Electronic Tubes, Semi-Conductors, Controls, Transistors, Plastics, Coil Winding Machines, Technical Text Books, Relays, Servo Motors, Generators, Oscillators, Variable Frequency Power Supplies, Electrolytic Capacitors, Infrared Detection Systems, etc.

McGraw-Hill's *Electronics*, when announcing their change in publishing policy, explained that: while the engineer's ability to absorb more periodically published technical information may be nearing saturation point, both technical men and their less technically bent associates appear to need and want more commercial and market information.

### Those Engineers

Every once in a long while a publication brings out a promotion piece which really rings a bell. Such has been the case with a recent little booklet sent out by the Advertising Dept. entitled "What are Engineers really like?"

It was not long before requests began to come in from all over Canada and the United States for extra copies — mostly from Heads of Engineering Departments — who wanted extra copies for their staffs.

A reference to the booklet in the January issue of *ELECTRONICS AND COMMUNICATIONS* offering extra copies on request to readers is now bringing in a veritable flood of requests and all will be taken care of when the new print edition comes off the press.

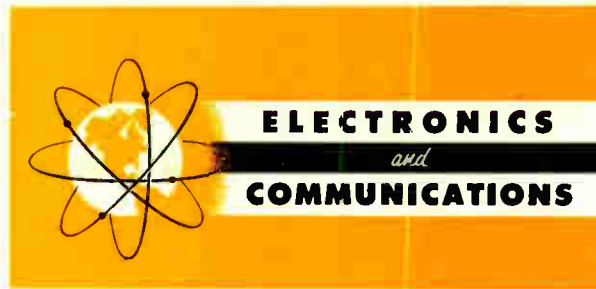

February, 1957

Vol. 5, No. 2

## EDITORIAL CONTENTS

### FEATURES

	PAGE
<b>The Spark Gap — Old Component — New Circuit</b>	26
<i>By L. S. Eggleton.</i>	
<b>Measurement Of Sensitivity On AM Communication Receivers</b>	28
<i>By J.F.G., Marconi Instruments Limited, St. Albans, England.</i>	
<b>Feedback — Servomechanisms— And The Nyquist Diagram</b>	30
<i>By H. M. Wilkinson.</i>	
<b>The Quality Control Of Printed Circuit Board Manufacturing</b>	32
<i>By Frank H. Edwards.</i>	
<b>The Beta Gage In Industry</b>	42
<b>Efficiency In Yard Control</b>	42
<b>Industrial TV Projector</b>	47
<b>Achievement In Miniaturization</b>	47

### DEPARTMENTS

<b>Electronics In Business And Industry</b>	7
<b>Editorial</b>	13
<b>Business Briefs And Trends</b>	17
<b>Editor's Page</b>	21
<b>News</b>	50
<b>New Products</b>	60
<b>RETMA Report</b>	71

President, NORMAN G. McHARDY; Editor, THOMAS W. LAZENBY; Editorial Assistant, D. K. TROWELL; Advertising Manager, H. E. DALLYN; Sales Representative, W. EVAN-JONES; Production Manager, NEVILL A. CAMPBELL; Business Manager, CLIFFORD A. SPARKS; Circulation Manager, PAUL A. IRWIN; Art Editor, Wm. McREYNOLDS; Photo Editor, GUIDO MILANESIO.

### PUBLISHED BY AGE PUBLICATIONS LIMITED

Founded by Norton W. Kingsland

Also Publishers of Restaurants and Institutions, Hotel and Tavern, Heating, Plumbing & Air Conditioning AGE, Oil & Gas Heat.

MONTREAL, QUE., CANADA  
Room 504, Dominion Square Building  
1010 St. Catherine Street West  
Tel. UNIVERSITY 6-7897

TORONTO, ONT., CANADA  
31 Willcocks Street  
Tel. WALnut 2-3115

Subscription Rates: Canada, U.S.A. and British Possessions \$ 5.00 per year  
Foreign \$10.00 per year

Authorized as second class mail. Post Office Department, Ottawa.

Member Canadian Circulation  
Audit Board, Inc.

**CCAB**

PRINTED IN CANADA

60

Printed, Enclosed and Fin-  
dured in its entirety by  
AGE PRESS  
A Division of  
AGE PUBLICATIONS LIMITED

*from this to this...*

*in  $\frac{3}{5}$  of a  
second!\**

Two elements—the rugged, inexpensive FINGRIP, and the fully automatic, easily-loaded TERMATIC—form the new Burndy FINGRIP METHOD, permitting a speed and ease of uniform electrical termination never before possible. NO PEDALS OR LEVERS TO PRESS, and no pre-positioning of wire necessary—insertion of the wire end actuates the TERMATIC, virtually eliminating rejects and minimizing operator fatigue. The machine is quickly and easily loaded (less than 15 seconds) and is completely enclosed for operator's protection. The FINGRIP, an inexpensive, quick-disconnect terminal, has FOUR individual pressure elements—permitting greater flexibility and abuse without damage.

Write Burndy, Canada Ltd., 381 Greenwood Ave., Toronto 8, Ont. for general information or for solutions to specific terminal problems. Our engineers are always available for personal consultation.

\*6000 per hour by actual customer test.

**BURNDY**

# FINGRIP



**BURNDY CANADA LIMITED**

381 Greenwood Ave., Toronto 8, Ont. — Quebec and Maritimes, 1434 St. Catherine St. W., Montreal 8, Que.  
Represented in: Winnipeg by NORMAN L. HANEY & CO.; Calgary and Vancouver by BUNSTON LTD.

5623

# Improved Communications Needed

*A communications network between Canada, Iceland, Greenland, Ireland and the United Kingdom using new radio techniques has been called for by a special North Atlantic Fixed Services Meeting of the International Civil Aviation Organization. The new communications network is required in order to solve many of the point-to-point radio communications problems that have plagued transatlantic flights and which have resulted in serious delays for passengers and have been the cause of additional costs to airline operators. Root of the trouble lies in the fact that existing high frequency radio-teletype circuits connecting these points are subject to frequent radio blackouts characteristic of sub-Arctic altitudes. In order to overcome this handicap a new technique is necessary to guarantee a rapid communication system between air traffic control centers which is essential for effective control of air traffic.*

★ *To overcome existing problems it is understood that a "scatter propagation" communication system be established and recommendations of the I.C.A.O. call for a multiple connection — one direct voice channel and four teletypewriter channels — between Gander, Narssarssuaq in Greenland, Reykjavik in Iceland and Prestwick-Shannon with all links except that between Iceland and Europe using the forward scatter technique. The Iceland-Europe link will be by undersea cable if the governments responsible can give reasonable assurance by May 1, 1957, that the cable will be provided in two years, and if not, by the forward scatter technique.*

★ *Costs of installing and maintaining air navigation facilities are normally met by those nations in whose territories the facilities are located. In some cases, however, where it is not possible for the nation concerned to provide or pay for the facilities, joint financing is arranged by I.C.A.O. and those nations whose airlines make use of the facilities pay their proportionate share of the cost. Arrangements of this sort are already in existence in the North Atlantic between I.C.A.O. and Denmark (for Greenland and the Faroe Islands) and I.C.A.O. and Iceland. Representatives of these countries have stated that they would only be able to provide new forward scatter facilities if joint financing were available. In view of this situation the recent I.C.A.O. meeting recommended that those nations which participate in the present agreements with Iceland and Denmark agree to an annual increase in order that the new communications system may be established.*

★ *Considering the acute and serious air traffic problem now existing in the North Atlantic, together with expected traffic increases and the potential introduction of turbo-jet aircraft in two years' time, the recent special North Atlantic Fixed Services Meeting has asked the Council of I.C.A.O. to take whatever steps are appropriate to assure the implementation of the new communications system with a minimum of delay if government approval of the required funds is not received by May 1, 1957.*

*In view of the growing urgency for adequate air traffic control measures on the North Atlantic routes, it is to be hoped that the governments concerned will provide whatever assistance is required in order that the needed communications services may be established with the least possible delay.*

another basic reason  
why industry prefers

# OHMITE<sup>®</sup> COMPONENTS

better quality  
through more advanced  
research and testing!

Behind every Ohmite component is a bulwark of *advanced* research and testing laboratories. These laboratories use the finest scientific instruments and equipment. Here Ohmite products are tested and retested under the most grueling conditions to detect possible sources of trouble. And these same laboratories are used for the development of new materials, new processes, and new designs . . . to build *reliability* into Ohmite products that set new standards for long life and trouble-free performance.

OHMITE MANUFACTURING CO.  
3689 Howard Street, Skokie, Illinois

*Be Right with..*

# OHMITE<sup>®</sup>

RHEOSTATS • RESISTORS • RELAYS  
TAP SWITCHES • TANTALUM CAPACITORS

A. C. SIMMONDS & SONS  
100 Merton St., Toronto 12

C. M. ROBINSON COMPANY  
189 Market Ave. East, Winnipeg 2

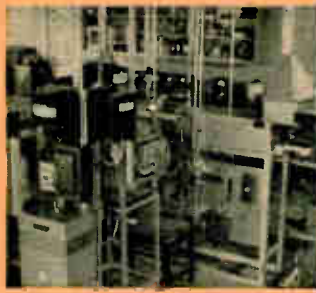

High temperature globar furnace; muffle furnace for enamel testing; hydrogen atmosphere sintering furnace.

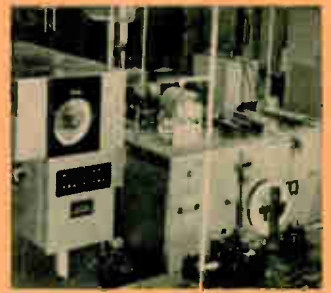

Humidity chambers using program-controlled cycles; here Ohmite products are tested under a wide range of temperature and humidity conditions.



Microscopic and petrographic equipment used in Ohmite laboratories for optical examination of materials and products.



Microscopic analysis of structure using metallograph. Thermal expansion of ceramics and vitreous enamels can be determined with interferometer equipment.



Instruments shown above are used to check and standardize the many pieces of Ohmite electrical test equipment.



This power panel provides AC or DC in a wide range of currents, voltages, and frequencies . . . permits testing Ohmite products under operating conditions.

X-ray Diffractometer and X-ray Fluorescence Spectrometer make possible the determination of crystal structure, as well as elemental composition of materials and products by means of X rays.

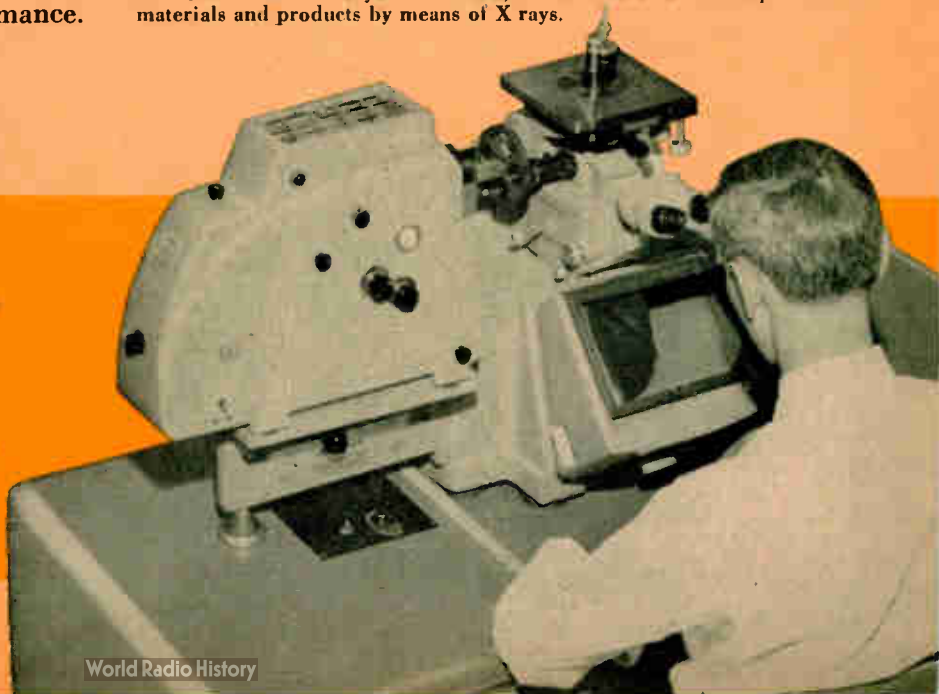

# Canada's longest private commercial microwave system designed and built by **RCA VICTOR**

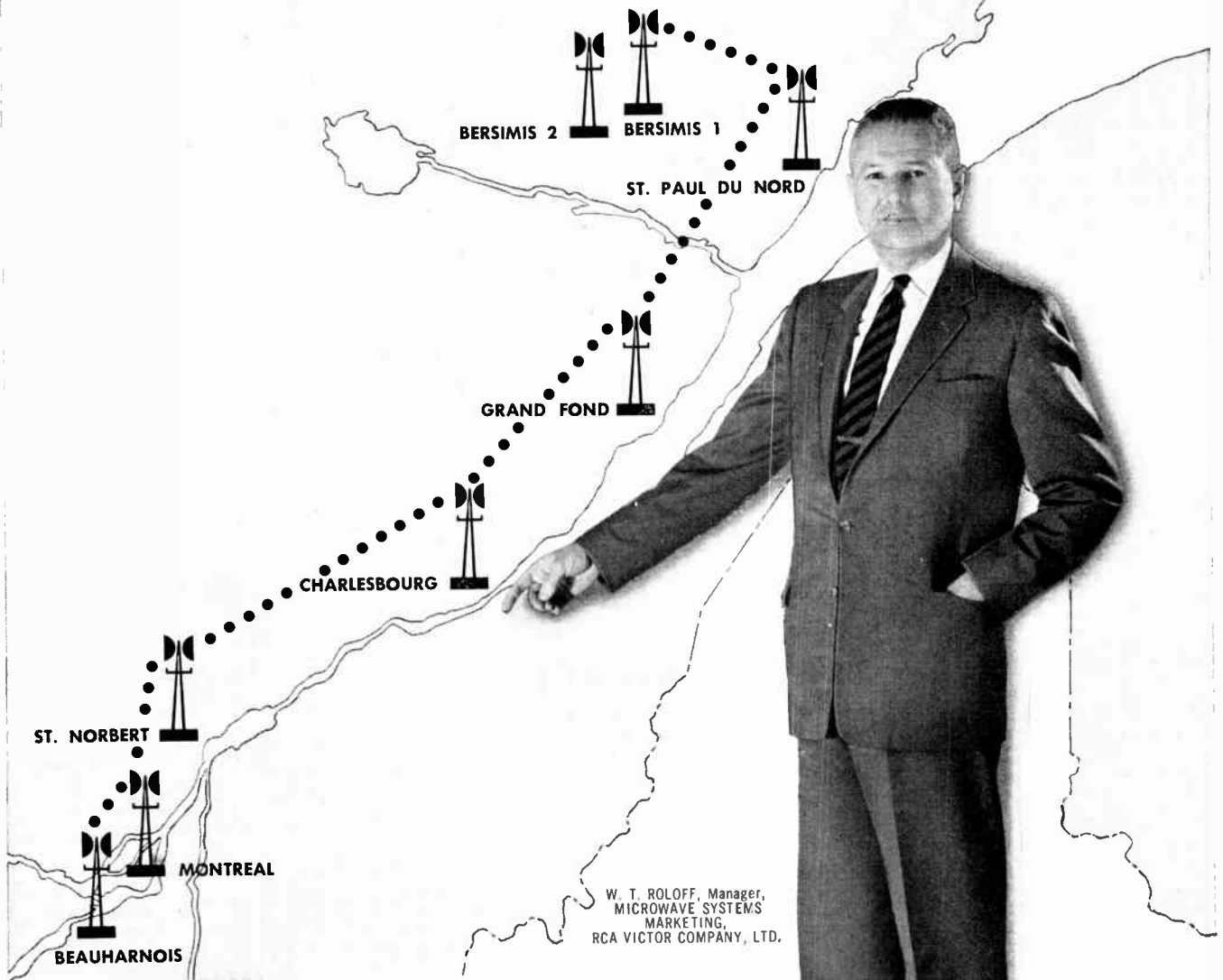

W. T. ROLOFF, Manager,  
MICROWAVE SYSTEMS  
MARKETING,  
RCA VICTOR COMPANY, LTD.

440 miles apart — yet Labrieville and Montreal are as close as neighboring homes — thanks to the new microwave system just completed by RCA Victor for the Quebec-Hydro-Electric Commission. Now, engineers in Montreal can make decisions, on the basis of telemetered information received from Labrieville. They can control the operation by a low frequency control circuit, or use voice circuits, all using microwave for transmission.



This new microwave system — the longest, private microwave system in Canada — consists of 22 telephone circuits as well as teletype, telemetering and load frequency control circuits. The entire system was conceived, designed and built by RCA Victor Company, Ltd.

For free illustrated booklet on this new microwave system, write  
**TECHNICAL PRODUCTS DIVISION**



**RCA VICTOR COMPANY, LTD., 1001 Lenoir St., Montreal**

## TECHNIQUES and DEVELOPMENTS in oscillographic recording

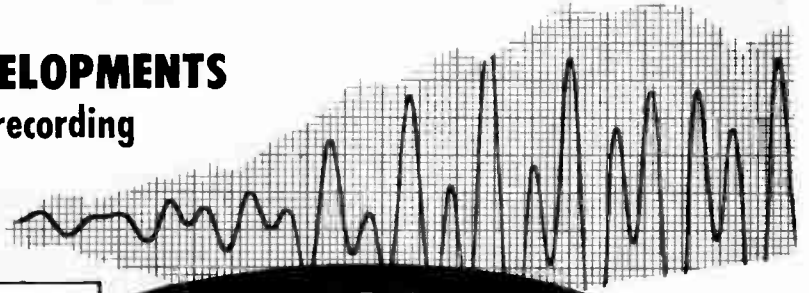

**PHASE SENSITIVE DEMODULATOR PRE-AMPLIFIER PROVIDES A DC VOLTAGE PROPORTIONAL TO AN INPHASE COMPONENT OF AN AC VOLTAGE WITH RESPECT TO A REFERENCE.**

**T**HE measurement of the amplitude of an AC voltage component is often necessary in performance studies of servo systems or of suppressed carrier signals over the carrier frequency range from 60 to 10,000 cps. In such cases the demodulator responds to inphase signals and rejects quadrature signals.

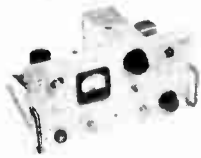

A circuit with these characteristics for use in an oscillographic recording system can be seen in the Model 150-1200 Servo Monitor (Demodulator) Preamplifier. It was developed by Sanborn as one of twelve interchangeable, plug-in front ends for "150" Series equipment.

to be used with the appropriate Driver Amplifier-Power unit in any channel of a "150" system. Elements comprising the circuit from input to output, include: compensated stepped attenuator and cathode follower input circuit, phase inverter, push-pull mixer and demodulator stages, differential DC output amplifier and low pass filter. In addition, the chassis contains a VTVM to facilitate accurate adjustment of the reference voltage, and an overload indicator which lights a warning lamp when excessive quadrature voltages exist.

Adaptability to a fairly wide variety of applications is accomplished through broad input voltage, reference voltage and frequency ranges. In order, these are 50 mv to 50 v (for full scale 5 cm deflection), 10 v to 125 v; 60 cps to 10kc. Rise time with low frequency plug-in demodulation filter is 0.1 seconds; with high frequency filter, 0.01 seconds. Quadrature rejection is better than 100:1; for carrier frequencies up to 5000 cycles.

Two representative uses of the Servo Monitor Preamplifier are in the design and adjustment of servo systems, and with instruments used in the design, development or adjustment of other apparatus. The first is illustrated by use of the Preamplifier and associated equipment in the recording of the output shaft amplitude and driving frequency of an AC positional servo; the second by recordings made with a similar setup of the difference between output signals from a gyroscopically-controlled stabilizing device and the "pitch" and "roll" signals generated by a "Seorsby Table" used for testing the device under dynamic conditions.

For a detailed discussion of the principles and design considerations involved in the Servo Monitor Preamplifier, refer to the February, 1955 issue of the Sanborn RIGHT ANGLE, for Dr. Arthur Miller's article on "Measurements with the Servo Monitor Preamplifier."

Technical literature and engineering assistance on specific problems are always available from our engineering department.

FROM

**SANBORN**

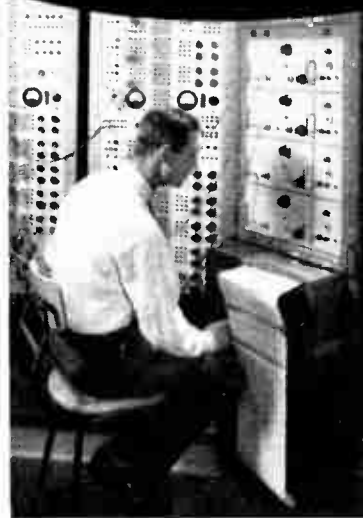

**BASIC  
FACTORS  
IN SELECTING  
OSCILLOGRAPHIC  
RECORDING  
EQUIPMENT**

**W**HEN considering any oscillographic system or equipment for your application, three useful "yardsticks" to apply are (1) the recording method, (2) equipment adaptability, and (3) variety of equipment available. Here are the answers to the three, as they apply to Sanborn systems. In the record, rectangular coordinates accurately correlate multiple traces, simplify interpretation and eliminate errors. Permanent traces, produced by a hot ribbon stylus without ink, provide sharp peaks and notches, and clearly reveal all signal changes. One percent linearity results from current feedback driver amplifiers and high torque galvanometers of new design; maximum error is  $\frac{1}{4}$  mm in middle 4 cm of chart,  $\frac{1}{2}$  mm across entire chart. From the standpoints of "adaptability" and "variety", Sanborn "150" equipment offers the versatility of 13 different plug-in front ends for any basic system . . . the choice of one- to eight-channel systems . . . the variety of nine chart speeds, timing and coding controls, console or individual unit packaging . . . availability of equipment as either complete systems or individual amplifier or recorder units.

Canadian Representative:

**ROR ASSOCIATES**

290 Lawrence Avenue West  
Toronto 12, Ontario, Canada

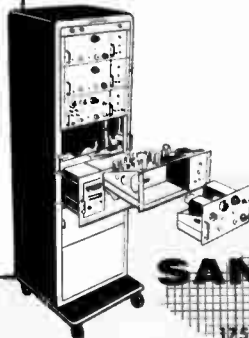

**SANBORN COMPANY**

INDUSTRIAL DIVISION

175 WYMAN STREET, WALTHAM 54, MASS.

For further data on advertised products use page 81.

# business briefs & trends

★ The number of countries and territories now accessible to Canada by telephone communication has recently been increased to a total of 131 through the addition of Ethiopia, Faroe Islands, Lebanon, Libya, Netherlands New Guinea, the city of Doha on the Persian Gulf, Papua and Saudi Arabia.

\* \* \*

★ The University of British Columbia has recently been conducting a course on digital computers for business executives. The University plans to install a high-speed digital computer — the ALWAC III E — in April at a cost of \$68,000. Business and industrial firms of the province have contributed \$20,000 toward the cost of purchasing the equipment, and additional financial help is being sought from the federal government.

\* \* \*

★ Quantity prices on radio transistor kits have been reduced up to 14 per cent, according to an announcement made recently by Texas Instruments Incorporated. These germanium kits include all the transistors required to build tubeless radio receivers.

\* \* \*

★ International Business Machines Corporation has changed its former policy of only renting equipment. Under a new arrangement IBM is now prepared to sell its electric accounting and electronic data processing machines.

\* \* \*

★ Addressing the Canadian Club of Toronto, Frank M. Folsom, chairman of the executive committee of the board of RCA predicted a vast growth in the Canadian electronics industry.

\* \* \*

★ An important group of British engineering companies are devoting their efforts towards developing advanced types of nuclear reactor systems suitable for export. This project is based on a study of the liquid metal fuel type of reactor with which, it is hoped, uranium may be more extensively used.

\* \* \*

★ The U.S. Army is using transistors, rather than vacuum tubes, for receivers and low-power transmitters wherever it is considered that transistors will do an efficient job. It is forecast that transistors to the extent of five million may be required to produce models in approximately two years when present developing and testing operations have been finalized.

\* \* \*

★ Automation has led to the increased production of diodes, which are used by the millions in the electronics industry and which are playing an increasingly important role in automobiles, business machines, home appliances and secret weapons. The United States electronics industry bought 40,000,000 of them in 1956 and it has been estimated that by 1960 more than 100,000,000 of them will be required to satisfy the needs of the industry.

\* \* \*

★ Through the use of a newly developed statistical formula RETMA of the United States have estimated that government procurement of electronic equipment for the defense services amounted to \$2,733 billion during the fiscal year of 1956 and that \$632.6 million has been spent during the first quarter of 1957.

\* \* \*

★ Air traffic controllers will be enabled to visualize the entire upper air space over the United States upon completion of a \$9 million order, placed with the Raytheon Manufacturing Company, for 23 long-range radars.

\* \* \*

★ Aeromagnetic Surveys Limited, of Toronto, reports that 1956 was its record year. It carried out a volume of business in the mining geophysical field which has probably never been surpassed by any other organization.

\* \* \*

★ A new type of union agreement forms part of an automation servicing contract recently awarded to Panellit Service Corporation of Skokie, Ill., by Tidewater Oil Company. Under the contract Panellit agrees to provide and instruct the operating and maintenance personnel for the automatic control system it has installed in Tidewater's new refinery at Delaware City, Del. Panellit officials anticipate that similar union agreements will be included in future service contracts.

\* \* \*

★ It is announced that General Electric Company will convert its TV picture tube plant in Buffalo, N.Y., to the manufacture of transistors during the first part of 1957.

\* \* \*

★ All-transistor cordless radios for the home are now given a five-year guarantee by the Philco Corporation, of Philadelphia. This is a pioneer move in the history of the industry on the part of this manufacturer.

\* \* \*

★ James H. Goss, president of Canadian General Electric Company Ltd., in commenting on developments in the Canadian electrical manufacturing industry in 1956, stated that "electronics manufacturers are expecting heavy increases in demand not only from long-established markets, but also from relatively new ones — especially those where widespread operations and the need for improved efficiency have caused communication problems."

\* \* \*

★ The unprecedented demand for etched circuits by manufacturers of electronic as well as appliance products has convinced Croname, Incorporated, of Chicago, manufacturers of circuit boards, that their production goal must be stepped up to meet the market requirements. According to Lester R. Gasper, president of the company, a production capacity of 14 million etched type printed circuits has been tentatively slated for 1957.

\* \* \*

★ General Electric has announced increases up to 15 per cent in the prices of its two-way radios for mobile communications.

\* \* \*

★ Rear Admiral Thomas P. Wynkoop Jr., U.S. Navy (retired) and now vice-president of Commercial Marine Distribution of the Radio Corp. of America, stated at a recent press conference in Toronto, that the next significant development in radar would be equipment capable of identifying objects coming within its range.

\* \* \*

(Continued on page 18)

## business briefs & trends

★ Sales of radio and television receivers in 1956 rank with the best average year experienced by the industry, according to the Radio-Electronics-Television Manufacturers Association of Canada. Manufacturers' and distributors' inventories have decreased, a healthy sign for 1957 sales. Radio receiver sales increased during 1956. Sales in 1955 totalled 523,066 compared to an estimated 575,000 units for 1956. Television receiver sales, which amounted to 776,536 units in 1955, are calculated to be about 615,000 units for 1956. Complete figures for 1956 have not yet been received.

\* \* \*

★ The Bell Laboratories have under consideration the construction of a new reactor at their laboratories at Whippany, N.J. Study and research will be directed to a better comprehension of transistors and the effect upon them of neutron bombardment.

\* \* \*

★ Since the 21" television receiver was introduced to the market in the fall of 1955, RCA has produced 102,000 color TV sets.

\* \* \*

★ Owners of television sets which were built before 1950, or even four years ago, might be considered as prospects for replacements in 1957. There is likely to be a definite trend towards portable TV sets, the greater sales volume resulting therefrom counteracting the lower price and profit margin.

\* \* \*

★ To insure its continuing ability to meet expanding commitments in an increasingly complex air world, the Sperry Gyroscope Company in 1956 established several new, specialized organizations and divisions. The new organizations include the Sunnyvale Research and Development Center in California, the Sperry Utah Engineering Laboratory in Utah, the Sperry Phoenix Company in Arizona, the Microwave Electronics Division and the Electronic Tube Division both in the State of New York, and the Sperry Semiconductor Division in Connecticut.

\* \* \*

★ The United States Department of Commerce states that Canada is the leading importer of U.S.-made radio-TV receivers and phonographs accounting for more than 45 per cent of all the electrical and electronic consumer products exported by the United States. Canada together with Venezuela and Cuba comprise the three leading markets for the export of United States manufactured consumer goods.

\* \* \*

★ The Radio-Electronics-Television industry, according to Dr. W. R. G. Baker, president of RETMA in the United States, increased its business by 15 per cent in 1956 and he predicted that a further 10 per cent increase could be expected in 1957. Production and sales amounted to \$5.9 billion in the past year, this figure being increased to \$12 billion by the addition of distribution, servicing and broadcasting.

\* \* \*

★ Arthur L. Chapman, president, CBS-Hytron, anticipates that sales in the entertainment field of electronics will continue strong, with television set sales approximating seven million units for the industry and with a considerably higher percentage of portables in the 17" class. Industry sales of receiving tubes, picture tubes, special tubes, semiconductors and other components, Mr. Chapman predicts, will exceed \$900 million in 1957.

\* \* \*

★ The director of a leading British electronic manufacturing group has forecast good prospects for the future for his organization. Factories, he estimates, will become automatic by gradual integration of automatic devices into their existing systems of mechanization rather than being "built from scratch". The firm expects its exports to be trebled in 1957.

\* \* \*

★ The Seventh Region Institute of Radio Engineers will hold its 1957 Regional Conference in San Diego, April 24-25-26. The theme of the conference will be "Electronics in Space" and over 200 technical displays will be featured, while a group of the nation's leading scientists are scheduled to present technical papers.

\* \* \*

★ Production machines and tools, many not previously seen in Canada, will be displayed and demonstrated at the forthcoming Industrial Tool & Production Show, sponsored by the Canadian Council of Foremen's Clubs. The new trade show, the first of its kind since the closing of the Canadian International Trade Fair, will be held in the Industry Building, Exhibition Park, Toronto, from May 6th to May 10th, 1957.

\* \* \*

★ Bell Telephone Laboratories of New York have developed a device which will oscillate at microwave frequencies. The "spin oscillator" will operate in principle as an amplifier and is expected to have very low noise disturbance compared with conventional microwave devices. The device if successful might result in new long distance communications systems for television and cross-country telephone.

\* \* \*

★ Due to higher costs of labor and materials used in the Colorcasters, Hoffman Radio Division of Hoffman Electronics Corporation, has recently increased prices on four models of its color television receivers. James E. Herbert, vice-president in charge of sales, pointed out, however, that the sets are still competitive with those of other manufacturers on the market.

\* \* \*

★ Benjamin Fox, president of Elco Corporation of Philadelphia, manufacturer of electronic, radio and television components, in an article published recently said in part: "The field of electronics is growing by leaps and bounds. We, as components manufacturers, play a vital role in the development of this art. . . . The horizon in our field is vast and fruitful but at the same time treacherous, if approached in the wrong way. . . . Unless the industry comes to the realization that selling below cost is out, it will be committing wholesale suicide. . . . We, as components manufacturers, are dedicated to the necessity of constant research and development to keep pace with the strides being made in the research and development centers of both government and industry."

\* \* \*

★ An installation of a Readix Decimal Electronic Digital Computer has been made at the Data Reduction and Research Branch of the Ballistic Test Facility in Pasadena, California. The Director of Operations at this branch claims that the Readix Computer will facilitate a 300 per cent increase in the speed of reducing the precision bombing reports at substantially lower cost to the Air Force.

\* \* \*





**accuracy,  
0.1 mv to 300 v!**

## **-hp- 400H High-Accuracy Vacuum Tube Voltmeter**

**New! 1% accuracy 50 cps to 500 KC  
Frequency range 10 cps to 4 MC  
10 megohm input resistance  
12 ranges, 0.1 mv to 300 v  
Direct readings in volts or db  
Functions as stable amplifier**

### **OTHER -hp- QUALITY VOLTMETERS**



**-hp- 400AB**, for general ac measurements. Covers 10 cps to 600 KC, 0.3 mv to 300 v. Accuracy  $\pm 2\%$ , 20 cps to 100 KC. 10 megohm input impedance plus  $25 \mu\text{f}$  shunt insures circuits under test against disturbance. Readings direct in volts or dbm. \$200.00



**-hp- 400D**, highest quality, wide range, maximum usefulness. Covers 10 cps to 4 MC, 0.1 mv to 300 v. New amplifier circuit provides 56 db of feedback (mid-range) for ultimate stability. 10 megohm input impedance prevents disturbing circuits. Sealed or long-life electrolytic condensers; rugged, trouble-free. \$225.00



**-hp- 410B**, industry's standard for vhf-uhf voltage measurements. Wide range 20 cps to 700 MC, response flat within 1 db full range. Diode probe places  $1.5 \mu\text{f}$  capacity across circuit under test; this plus 10 megohm input impedance prevents disturbance. Instrument combines highest quality ac voltmeter with dc voltmeter (122 megohm input impedance) and ohmmeter covering 0.2 ohms to 500 megohms. \$245.00

**New -hp- 400H** Vacuum Tube Voltmeter combines broadest usefulness with wide voltage and frequency coverage, and the greatest accuracy ever offered in a multi-purpose voltmeter.

On line voltages of 103 to 127 v, accuracy is  $\pm 1\%$  full scale, 50 cps to 500 KC;  $\pm 2\%$ , 20 cps to 1 MC,  $\pm 5\%$ , 10 cps to 4 MC. Readings are direct in db or volts on 5" mirror scale meter; 12 ranges cover 0.1 mv to 300 v. High 10 megohm input resistance minimizes loading to circuits under test. Stabilized amplifier-rectifier with feedback loop gives high long-term stability; line voltage changes as great as  $\pm 10\%$  cause negligible variation. Overvoltage protection is 600 v on all ranges. Highest quality, rugged construction throughout. \$325.00.

### **HEWLETT-PACKARD COMPANY**

3691G Page Mill Road • Palo Alto, Calif.  
Cable: "HEWPACK"

Represented in Canada by

**ATLAS RADIO CORPORATION, LTD.**

50 Wingold Avenue, Toronto 10, Ontario  
505 McIntyre Bldg., Winnipeg, Manitoba



**Quality, value, complete coverage in voltmeters**

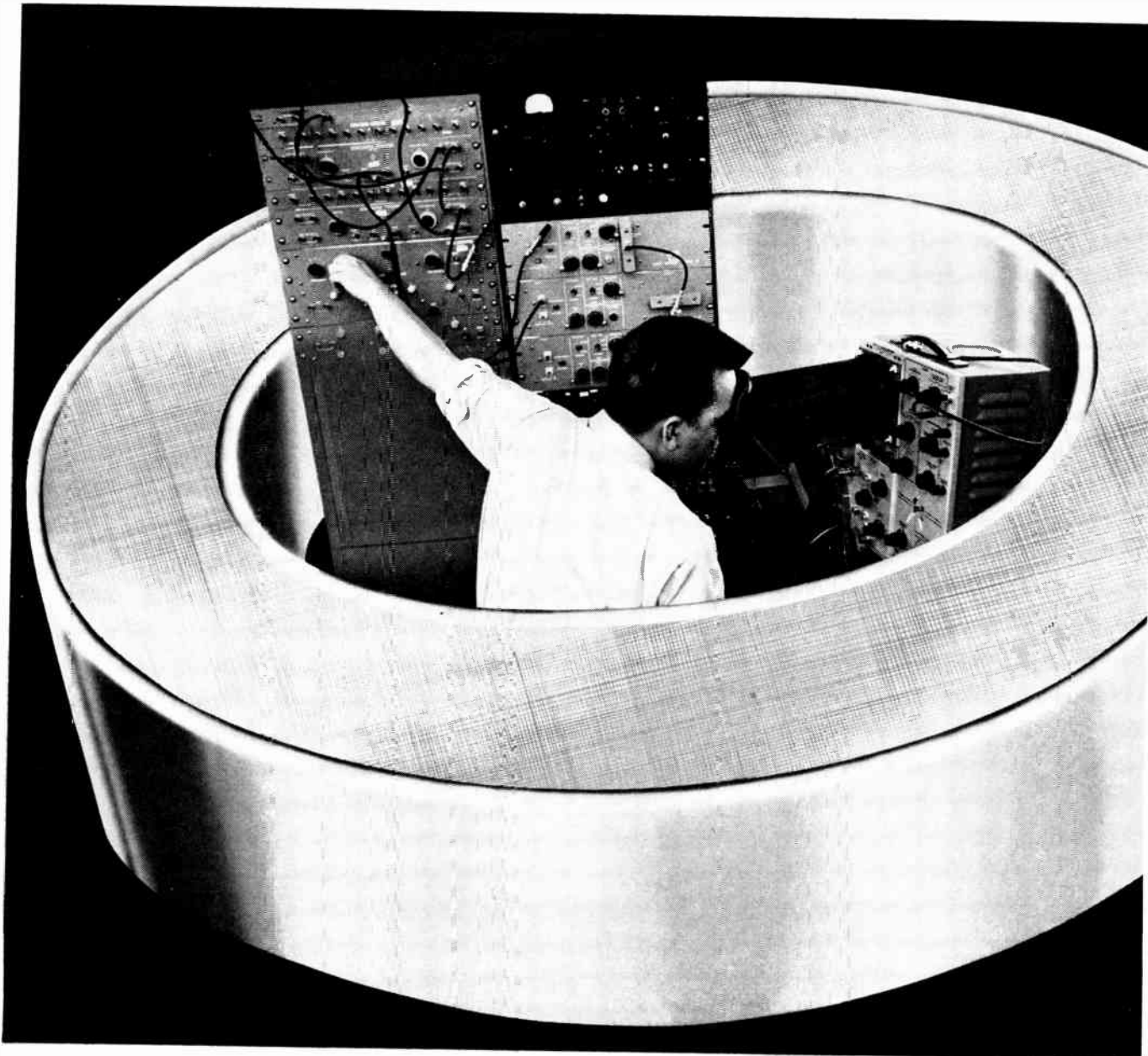

## what makes tape wound cores reliable?

*Reliability demands physical protection.* Magnetic alloys which provide square hysteresis loop characteristics are strain sensitive. Distortion caused by coil winding will disturb precise magnetic characteristics, alter performance. So Magnetics, Inc. has devised a rigid, extra-strong aluminum core box to protect the magnetic core within from winding stresses, thus eliminating distortion.

*Reliability demands electrical stability through the years.* Suppose guided missiles failed to function in a future emergency because the magnetic properties of tape wound cores had changed. Cores must operate just as effectively years from now as they do today, whether or not they have been in use. Vibration, shock, and temperature changes can endanger such performance. That's why Magnetics, Inc. cushions tape windings with a special inert material in the extra-strong aluminum core box. And that's why it is especially important that our tape wound cores enclosed in aluminum boxes will withstand temperatures up to 450°F.

*Reliability demands exacting standards on the part of the manufacturer.* Judge a product by the company that makes it. Take a company that has pioneered a core box so advanced that it even permits vacuum impregnation. Take a company whose attention to design detail permits the offer of the *only* Performance-Guarantee in the industry. That's a real definition of reliability. Why not ask us how it will work for you? *Magnetics, Inc., Dept. E-32, Butler, Pennsylvania.*

For Full Details, Write For  
Catalog TWC-100A

**MAGNETICS inc.**

CABLE: MAGNETICS

For further data on advertised products use page 81.

# the editor's page

*A commentary on affairs  
pertinent to the electronics  
and communications industries.*

## Technology Breeds New Leaders

Both from the United States and the United Kingdom comes evidence of the increasing awareness on the part of senior management executives and leading engineers that the ever-widening effect of technology on business and industry is bound to reshape the requisite make-up of both engineer-executives and business managers. At the present rate with which the duties of both management and engineers are becoming integrated, it is the professed belief of some industrialists that the time is not too distant when a new breed of business executive will be at the helm. Such men will be composites of the engineer and business man and they will be the product of a new course in university training. In effect, they will be engineer-managers, trained in the right degree of technical know-how and business administration.

Edgar Schmued, vice-president in charge of engineering for Northrop Aircraft, Inc., as recently reported in the *Christian Science Monitor*, thinks that the executive with only a business background is in the twilight of his career insofar as leadership in any form of hardware manufacturing is concerned. Mr. Schmued is convinced that the future in this field belongs to the engineer and technician.

Within fifty years, as he sees it, every business that manufactures anything from shoelaces to aircraft ought to be headed by an engineer. He further believes that an individual who heads such a business must have knowledge of technical matters or he will be hopelessly lost in his own corporation.

At the same time Mr. Schmued sternly indicts engineers for whom he forecasts such important futures. In his opinion they are their own worst enemies.

Most engineers, he claims, have a traditional disregard for the importance of business methods and this has kept them from getting ahead as business executives.

Mr. Schmued, himself a brilliant engineer and executive, believes that engineers must eventually recognize that something is missing. A man, he says, who knows only engineering has but part of his tools — only the bandsaw. To complete his toolchest he must learn business — not just management, he emphasizes, but business — its structure and operation.

In like manner Arnold O. Beckman, president of Beckman Instruments, Inc., believes that the changing nature of the American business man may be such that neither engineers nor business men, as they are today conceived, will lead the big manufacturing corporations of the future. In their stead, he believes, there will be specialists known as "managers" or something similar. They would combine the best of both the engineering and business world. They would be trained in a new science that would qualify them to lead a highly technological corporation.

That the changing character of the industry executive has been recognized by astute American publishers of the business and technical press is evidenced by the changing editorial policies of their publications. Realizing that the new type of industry executive is neither engineer nor business executive alone, but rather a mixture of the two, has led experienced publishers to reshape their publications to suit the needs of this new breed of industry executive. One of the measures taken by publishers in this respect has been to reduce the amount of truly technical information contained in their publications leaving the dissemination of this type

of material to the journals of the professional associations, the most efficient and appropriate mediums for directing the right kind of technical information to the specialized groups of engineers who need it. In lieu of this type of information publishers are including more of the information required by the new style industry executive, this hybrid type of fellow who is half engineer and half manager and who, for the lack of a better description might be called a "manager". On his behalf and in keeping with the times publishers are including more industry news, business reports and information on production techniques, essential data for the engineering-management of industry and business in this technological age.

## Discrimination Of Engineers

The Executive Council of the Association of Professional Engineers of Ontario recently called upon the Department of National Defense to end its discrimination of professional engineers who are serving in the armed services, particularly in the Army.

The 19-man Council which represents the Association's 15,500 members asked that professional engineers in the Army be accorded the same financial recognition currently received by medical and dental officers.

Medical and dental officers receive \$60 per month professional pay up to the rank of colonel. There is no provision for professional pay to Army engineers.

The A.P.E.O. also feels that there should be more scope in engineering projects for the Army professional engineers. It noted that, in the United States, the engineering branches of the services are permitted wider scope because they are responsible for arsenals, certain public works and defense construction projects, and wide development programs.

While we are inclined to agree with the A.P.E.O. that engineers serving in the defense forces should be given every possible consideration it should, in fairness, be borne in mind that the doctor or dentist who chooses to follow a service career is forfeiting a considerably more profitable private career than is the case with the average professional engineer. It could, therefore, be considered that the additional \$60 per month paid to doctors and dentists in the services is but a nominal attraction to induce them to enter the services. Considering also the scarcity of doctors and dentists as opposed to engineers, the shortage of engineers notwithstanding, we are inclined to believe that the difference of \$60 per month in salary in favor of doctors and dentists is not entirely unfair.

## Better, Not Necessarily Bigger

We understand that officials of the Canadian IRE Convention and Exposition which is to be held for the second year on October 16th, 17th and 18th are averse to the use of the term 'bigger and better' in describing the show. While it has been stated that the show this year will occupy something like 20 per cent more floor space than last year the emphasis of endeavor on the part of show officials is to make the show better but not necessarily bigger. We are in complete agreement with this viewpoint and sincerely believe, as many others do, that the controlled size of the show in 1956 was one of the important contributing factors to its outstanding success.



**now in Canada!**

## INDIANA HYFLUX ALNICO PERMANENT MAGNETS

*(for the Canadian electronics, instrument, and communications industries)*

Hyflux Alnico permanent magnets . . . used widely by the electronics, instrument, and communications industries in hundreds of products . . . are now being produced in Kitchener by The Indiana Steel Products Company of Canada Limited.

Whether you require loud-speaker magnets weighing only a few ounces or giant, ½-ton assemblies used in nuclear resonance research, we are equipped to meet your every need. Metallurgists, trained technicians, and skilled craftsmen work as a team to produce quality permanent magnets that supply a constant, uniform magnetic field, indefinitely.

And, the complete production and research facilities of the world's largest manufacturer of permanent magnets, The Indiana Steel Products Company of Valparaiso, Indiana, U. S. A., have been combined with the facilities at Kitchener to insure that you receive the finest quality magnets available.

Take advantage of Indiana's 48 years of experience, research leadership, and specialized engineering "know-how" for help in your design problems.

#### LITERATURE AVAILABLE

An 8-page booklet lists available sizes and shapes of Alnico permanent magnets, and suggests how to order catalog magnets . . . request quotations on special designs . . . obtain engineering assistance. Copies available on request.

*Applied Magnetics*, a quarterly publication, is available on request to those interested in or responsible for the design or development of industrial or consumer products using permanent magnets.

# The Indiana Steel Products Company of Canada Limited

KITCHENER, ONTARIO

PERMANENT MAGNETS . . . CORROSION AND HEAT-RESISTANT ALLOY CASTINGS

ANOTHER FIRST BY PSC APPLIED RESEARCH LTD.

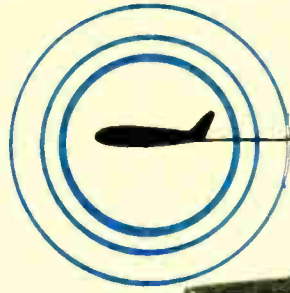

## The World's most efficient Ice Detection System . . .

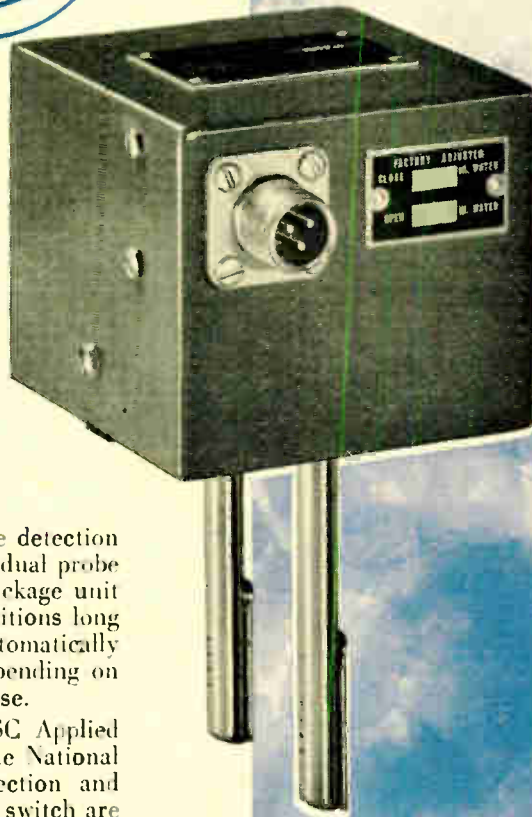

You are looking at the most efficient ice detection system yet developed — the Type T260 dual probe detector. Here is a 1¾-pound, sealed package unit that either warns the pilot of icing conditions long before he can see ice forming, or automatically controls his ice shedding system — depending on the application of the 28 volt output pulse.

Engineered and manufactured by PSC Applied Research Limited, under license from the National Research Council of Canada, the detection and reference probes and associated pressure switch are contained in a sealed unit, eliminating inter-connecting pneumatic tubing and reducing electrical cable requirements. Operationally proven by the RCAF and now standard equipment on the Avro CF-100 and its Orenda jet engines, the ice detection system is now available to private and commercial aircraft operators. Write us for literature and quotations.

### Specifications:

- Size — 3½" x 3½" x 5½"
- Probes — 3" long, ⅜" diameter
- Weight — 1¾ pounds
- Power — 28 volts, 15 amps. Intermittent



**PSC APPLIED RESEARCH LTD.**

1500 O'CONNOR DRIVE  
PLYMOUTH 5-3371

TORONTO 16, ONTARIO, CANADA

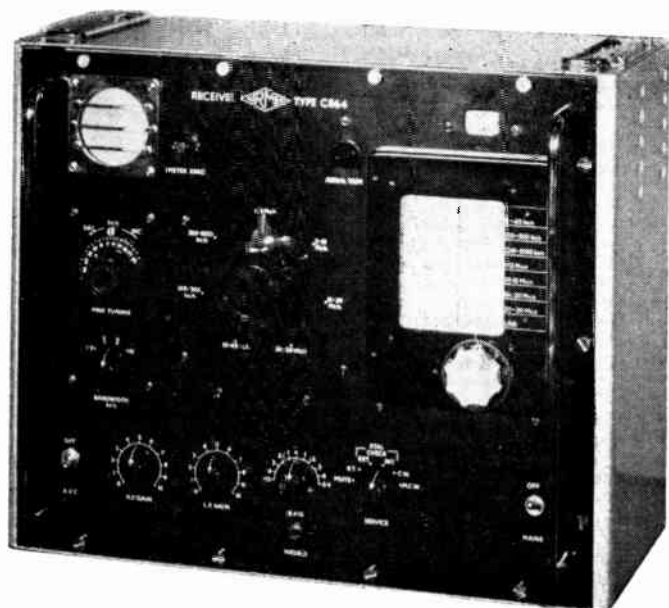

# COMMUNICATION RECEIVER

**type C.864**

**a very high grade general purpose communications receiver operating over frequency range 15 kc/s to 30 mc/s.**

- Frequency Coverage from 15-45 kc/s and 100 kc/s — 30 Mc/s.**
- Film Scale giving actual Scale length of 4 ft. on each frequency range.**
- 90:1 Slow Motion Drive with logging scale.**
- Crystal Calibrator incorporated.**
- Frequency setting accuracy better than 1 kc/s.**
- Separate Incremental tuning control for use with Crystal Calibrator.**
- Double frequency changer circuit.**
- Stabilised Local Oscillator H.T. Voltages.**
- Image rejection over 100 db.**
- Exceptionally high sensitivity and signal/noise ratio.**
- Variable Selectivity - S Meter incorporated.**
- Very stable B.F.O. - Muting facilities provided.**
- Built in Loudspeaker - 2 Watts Output - Turret band switching.**

*Send for illustrated literature*

# RCE

**RADIO COMMUNICATIONS  
EQUIPMENT & ENGINEERING  
LTD.**

475 Metropolitan Blvd.  
Lachine, Montreal 32

For further data on advertised products use page 81.

# DON'T RUN . . . *CALL* with **Hasler PAX**

## private automatic telephone exchange

PAX 12	12 lines
PAX 27	27 lines
PAX 45	45 lines

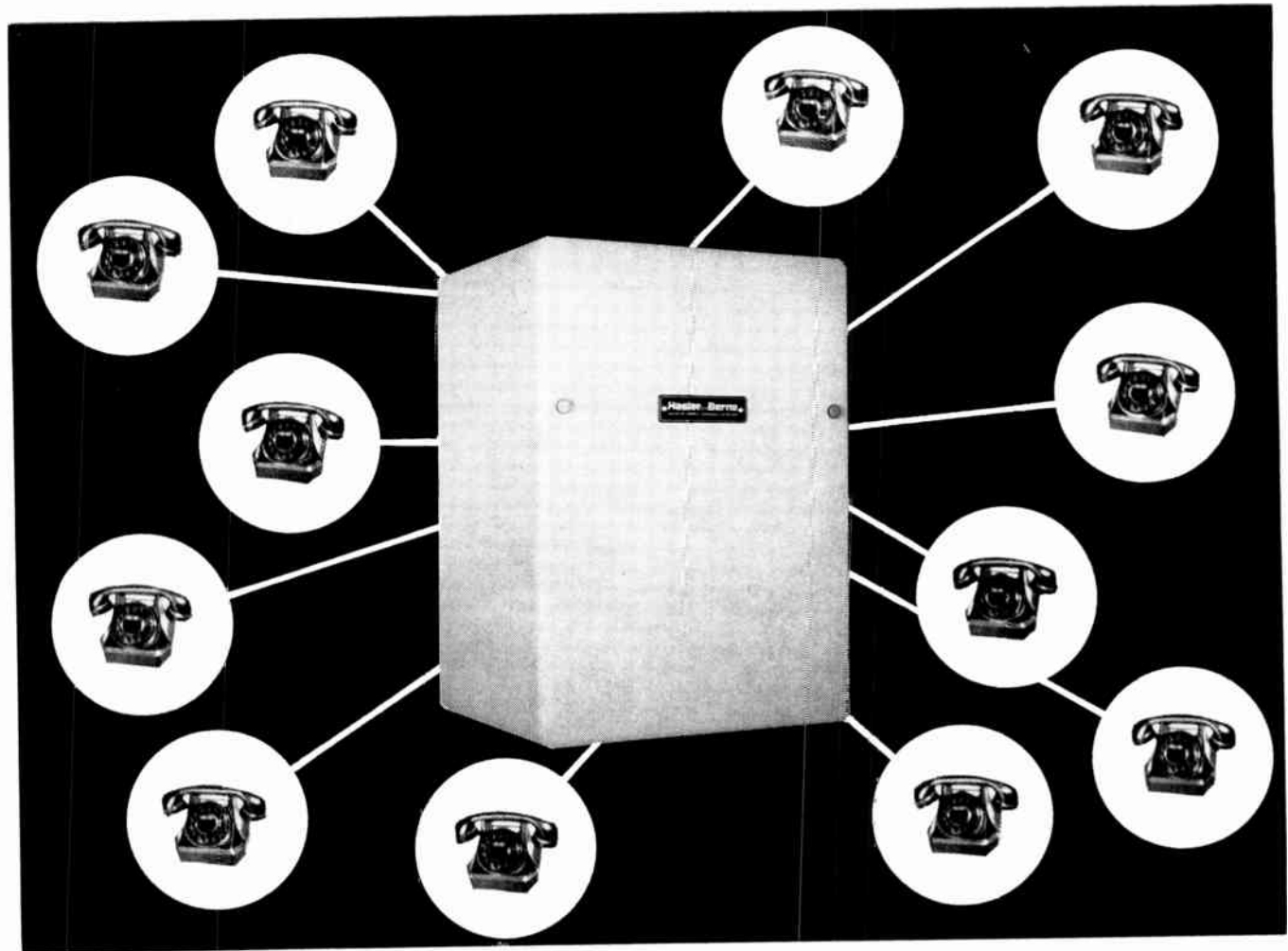

- Completely automatic.
- Completely independent to the normal telephone system.
- No operator required.
- Up to 45 independent lines available.

*Send for illustrated literature*

**RADIO COMMUNICATIONS  
EQUIPMENT & ENGINEERING  
LTD.**

475 Metropolitan Blvd.  
Lachine, Montreal 32



# The Spark Gap:- Old Component – New Circuit

By L. S. EGGLETON

Engineering Department — Aviation Electric Limited\*

TO most individuals the words "spark gap" conjure up a vision of man-made lightning flashing between polished metal balls. Some of the most interesting experiments in the school physics laboratory centered around the induction coil with its spectacular spark, so fascinating to juvenile minds. There is, however, another and more practical aspect if the spark gap is considered as a high voltage switch. An ordinary switch suffers from two major disadvantages, first of all, it is extremely difficult to manufacture economically a switch able to break high voltage circuits and yet be sufficiently small to be capable of being incorporated in modern miniature equipment. Secondly, the characteristics of a switch made to handle high voltages are usually incompatible with those required for high current handling capacity. The modern spark gap is capable of all these conditions and has the additional advantage of being completely automatic. Its appearance, however, is considerably changed from the picture conjured up at the beginning of this article. The electrodes are now sealed within a vacuum tube, enabling the size to be considerably reduced, but retaining the valuable qualities of high voltage operation. At the same time, the enclosure in a vacuum tube makes the modern spark gap relatively insensitive to variations in ambient temperature and also eliminates any problems which may be encountered due to changes in pressure, altitude, or humidity.

The problems facing designers of spark gaps are relatively simple as long as they are required to operate only under D.C. or low frequency A.C. conditions. The flash-over point or breakdown voltage of the gap is then relatively easy to predict. However, if it is required to be subjected to either high frequency A.C. sine waves or D.C. pulses with sharp wave front conditions, the prediction of the breakdown voltage becomes considerably more complicated.

The passage of current through the spark gap depends upon the breakdown of the insulating medium, usually air, forming a conductive path between electrodes. The current takes the form of an "avalanche" of electrons between the electrodes. As long as the breakdown voltage is maintained, the spark will also be maintained, and the passage of current can continue. These conditions apply in the case of direct current being applied to the gap, but if alternating current or other variable waveform is being used, an equivalent effect is that of a rapidly operated switch turning the voltage on and off at the repetition frequency of the waveform. The result of this discrepancy between D.C. and A.C. operating conditions is that the A.C. breakdown voltage is usually higher than that for D.C. breakdown, thus presenting the spark gap designer with one of his previously mentioned problems, for this discrepancy can be minimized by changes in the design for the gap.

## Component Protection

One of the most useful characteristics of spark gaps is their property of being able to apply effective short circuits in parallel with expensive components such as electrical instruments, chokes, and transformers. When used in this way, they can be connected in parallel with the component to be protected and at normal operating voltages an open circuit condition will appear, thus allowing the component to be used in a normal manner. Figure 2 shows the spark gap used as a protective device in parallel with an inductance which, whilst operating into its load, will be well within its normal operating voltages. In the event of either a power surge, or an open circuit load, the windings of the choke would be protected from insulation breakdown. Possible complete destruction of an expensive component would be prevented by the fact that when the breakdown voltage of the spark gap is reached, it will effectively short circuit the windings of the choke. Transformers of various types are particularly susceptible to damage of this nature should an open circuit occur in their normal operating load. A particular example of this type of damage would be in the modulation transformers of high power transmitters. In these applications spark gaps are generally power transmitters, indeed in these applications spark gaps are generally connected across both primary and secondary windings.

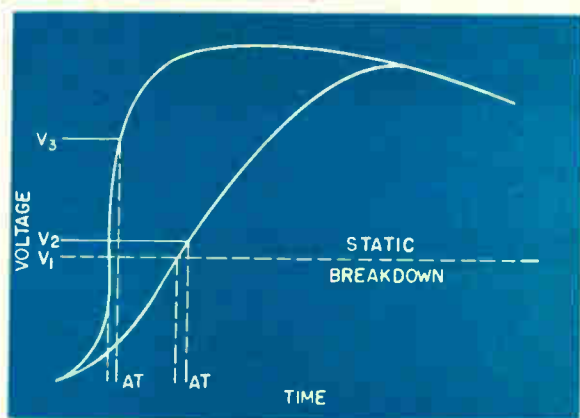

Figure 1

Fast rise rates lead to higher breakdown voltages because of the avalanche effect.

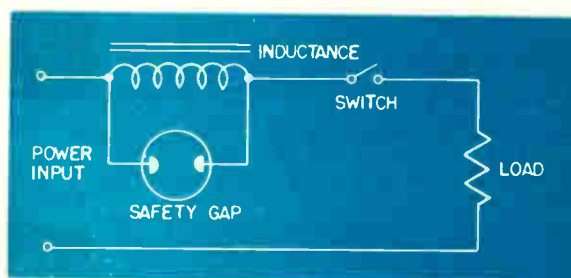

Figure 2

Safety gap protects coil from surge damage.

\* Aviation Electric Limited is the Canadian Affiliate of the Bendix Aviation Corporation.



But to return to the problems facing spark gap designers; we find, due to the "avalanche" effect previously mentioned, in the design of a spark gap intended to be used with a pulsed voltage, that the breakdown voltage of the gap is related to the rise time of the pulse. This is illustrated in Figure 1 where pulse shapes having fast and slow rise times are shown. If T represents the time taken for the formation of the "avalanche" we can readily see that the breakdown voltage V2 for the voltage having the slow rise time, is very considerably less than the voltage V3. The conditions that we have just been considering, however, refer only to voltage excursions of a transient nature, and in the case of repetitive pulses, the discrepancy in breakdown voltage will not be as pronounced. It shows us, nevertheless, that even where the normal voltages are of a repetitive nature and relatively predictable, some consideration should be given by designers to the possibility that components may have their normal operating voltages considerably exceeded by such transients. Rather than try to protect components uneconomically against such hazards by incorporation of these considerations in their normal working characteristics, the spark gap could be included in the circuit with considerable economies in weight and cost. A spark gap such as this should be designed to strike an operating point between the normal circuit voltage and the breakdown voltage of the component. Its breakdown voltage should be sufficiently stable over lengthy periods and its tolerance sufficiently narrow to prevent its firing during normal voltage fluctuations, but yet not allow any damaging voltage surge to penetrate to the component.

Pulse operated high voltage supplies can readily be protected against surges due to load irregularities as in the case of a typical high voltage Magnetron power supply for a radar transmitter. Figures 3 and 4 show typical examples of the protection available in the shape of spark gaps for circuits of this type. Protection like this is particularly valuable in a circuit of this kind as it not only prevents damage to the obvious components, but also can be used to protect the valuable Magnetron of a radar transmitter in the event of damage to the antenna or wave guide.

Figure 5 shows a circuit where any irregularities in the antenna or wave guide system connected to the Magnetron will cause standing waves to appear, which will inevitably be reflected by increases in the Magnetron voltage. The resultant short circuit when the spark gap fires reflects

(Continued on page 35)

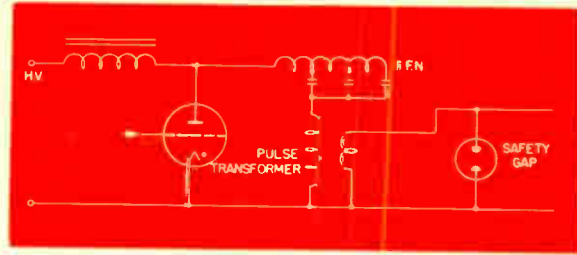

Figure 3

Gap protects pulse transformer from damage in case of load failure.



Figure 4

Safety gap limits surge voltages across pulse forming network.

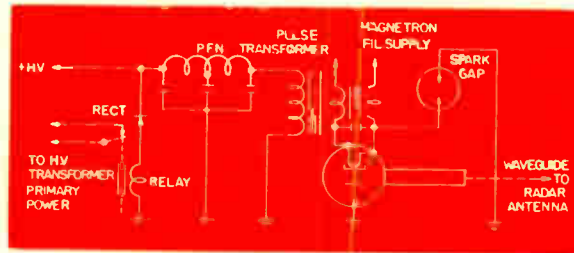

Figure 5

Fault in radar antenna fires spark gap. Short reflected back through pulse transformer energizes protective relay, removes power and protects magnetron.

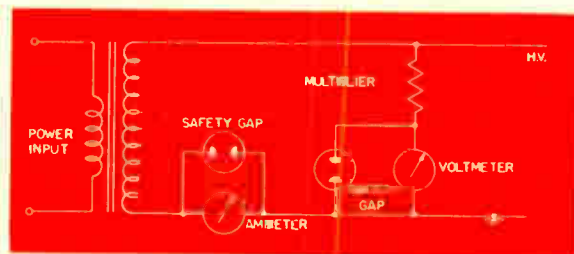

Figure 6

Meter voltages are limited by shunt gaps.

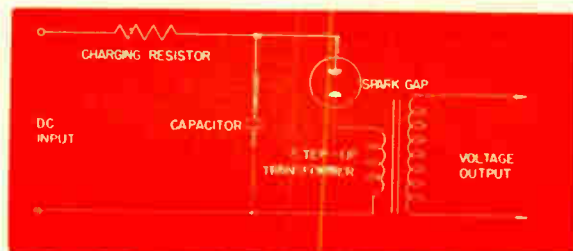

Figure 7

Spark gap pulse-forming circuit.

The author wishes to thank and acknowledge the assistance of Mr. J. H. Johnstone, Bendix Aviation Corporation. (Electronic Tube Division).

# Measurement Of Sensitivity On AM Communication Receivers

THE communication receiver is primarily intended for reproducing messages, not entertainment. It must be capable of presenting to the operator the maximum amount of the intelligence contained in the transmitted signal even under adverse conditions, such as those prevailing when the signal strength is low and possibly masked by interference and externally generated noise.

One of the most important attributes of a communication receiver is its sensitivity; and it is the intention of the author to define the term as applied to this type of receiver, following up the definition with some suggested methods of test.

A.M. communication receivers are in operation over a wide range of carrier frequencies extending up to the microwave bands. Most of the traffic however, is handled by equipment operating between 100 kc/s and 500Mc/s including the fixed-frequency v.h.f. mobile receivers, as well as the more conventional versatile multi-range receivers which are the popular conception of communication instruments. The information which follows applies generally to all receivers in this category.

### Measuring Sensitivity

The sensitivity of a communication receiver is never expressed, as it is for broadcast receivers, in terms of the r.f. input necessary to produce a given output power. That is really a measure of the gain of the receiver; and gain is seldom the limiting factor

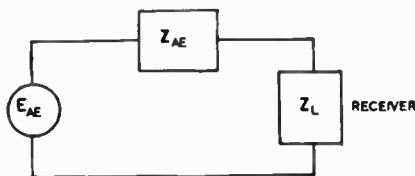

$E_{AE}$  is the aerial e.m.f.  
 $Z_{AE}$  is the aerial impedance  
 $Z_L$  is the input impedance of the receiver

Fig. 1

from the point of view of receiving weak signals. The limit is set by the level of noise generated in the receiver itself. If we assume that the level of external interference is negligible compared with a signal strength of, say,  $1\mu\text{V}$  at the aerial terminal of the receiver, then the output level will correspond to  $1\mu\text{V}$  subjected to the gain of the receiver. Call this output level  $x$  watts. But, if the noise generated in the receiver also gives an output of the order of  $x$  watts, a large part of the intelligence may be lost due to the masking effect of the noise.

It is therefore unusual to quote the sensitivity in terms of the input level necessary for a given signal-to-noise ratio. If the receiver is normally used for radio-telephony the modulation

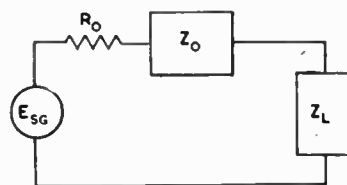

$E_{SG}$  is the Signal Generator e.m.f.  
 $R_0$  is the Signal Generator source resistance  
 $Z_0$  is the correcting impedance (dummy aerial)  
 $Z_L$  is the input impedance of the receiver

Fig. 2

depth should also be specified. For example, a particular receiver sensitivity may be specified as follows:  $20\mu\text{V}$  (30% modulation) for 20dB signal-to-noise ratio. 30% modulation is usually the depth specified. For receivers which are also intended for c.w. reception, an internal beat oscillator being used, the sensitivity is quoted as an unqualified statement of voltage input for a given signal-to-noise ratio; e.g.  $6\mu\text{V}$  for 20dB S/N.

To measure the sensitivity we must feed into the receiver an accurately known signal level — from a signal generator — and compare the a.f. output due to this signal with the noise output of the receiver.

The terms of measurement of the r.f. input to the receiver from the signal generator are worth some consideration. It is often stated that a

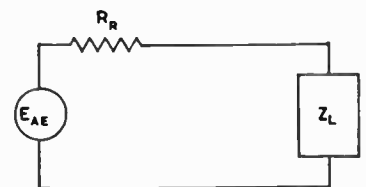

$E_{AE}$  is the aerial e.m.f.  
 $R_R$  is the radiation resistance  
 $Z_L$  is the input impedance of the receiver

Fig. 3

signal generator is an instrument which simulates the action of the aerial system. This definition is most applicable when the signal generator is used for sensitivity measurement.

Now, the aerial, as "seen" by the receiver, is equivalent to a signal source, having an e.m.f. proportional to the field strength, in series with the aerial impedance. (Providing the field strength in volts per metre and the dimensions of the aerial are known, both the e.m.f. and the impedance can be calculated.) This condition is illustrated diagrammatically in Fig. 1.

To simulate the aerial, the signal generator must also behave in the manner illustrated in Fig. 1. At lower radio frequencies, the aerial is short compared with the wavelength of the signal. It therefore presents to the receiver a complex impedance containing resistance and reactance. The signal generator delivers its output via an attenuator and usually has a resistive output impedance. Therefore, if a realistic measurement is to be made it must feed its output to the receiver via a dummy aerial comprising a resistive/reactive network so that the signal generator can be represented by the diagram in Fig. 2, which should be equivalent electrically to the aerial system (Fig. 1) except that  $E_{SG}$  can be accurately controlled whereas  $E_{AE}$  depends upon a great many variables.

By J. F. G.

Marconi Instruments Limited  
St. Albans, England

At higher frequencies, above say, 10 Mc/s, a resonant aerial can be used, such as the half-way dipole. The feed to the receiver is usually taken from a current antinode, so that the impedance presented to the receiver is equal to the radiation resistance of the aerial, and is, therefore, very nearly purely resistive. The system then behaves in the manner of the circuit shown in Fig. 3.

It is merely necessary to arrange that the output impedance of the signal generator is equal to RAE in order that the signal generator may simulate the action of the aerial. The types of aerial in common use above 10 Mc/s usually have resistances of 75 or 52 ohms. For this reason signal generators for use at these frequencies normally have an output impedance of one of these values with provision for converting the output impedance to the other.

Whether the receiver is tested at low frequencies — with a dummy aerial — or at v.h.f. or at even higher frequencies, it is most important that it is fed via an impedance approximating to that of the aerial with which it will be used. (This does not necessarily mean that the signal source is matched to the receiver input impedance.) Also the input-signal level should be quoted in terms of source e.m.f. in series with this impedance.

For purely resistive output impedances which are different from the normal output impedance of the signal generator, series or parallel correcting resistors may be included in the feed to the receiver. Figs. 4 show the method of connecting these resistors. The full analyses of these impedance correction methods are given in earlier *Instrumentation* articles.<sup>1,2</sup>

References

- <sup>1</sup> T. P. Flanagan "Signal Generator Outputs" *Marconi Instrumentation*, 4, p. 105 (March 1954).
- <sup>2</sup> P. E. Dyson "Further Notes on Signal Generator Outputs" *Marconi Instrumentation*, 4, p. 145 (June 1954).

For Tests with Amplitude Modulation

First connect the input of the receiver to the output of the signal generator via the dummy aerial or any other impedance correcting network that may be required; then connect the output terminals of the receiver to an a.f. output power meter.

If an a.g.c. switch is fitted, set this switch to the "off" position; if not, disconnect the a.g.c. line or take any other steps to prevent it operating. Take care not to disconnect the d.c. grid return circuit of the r.f. or i.f. amplifier valves.

With the signal generator connected but delivering no output, tune the receiver to the frequency at which it is to be tested. Turn the r.f. and a.f. gain controls to maximum, and, by means of the output power meter, measure the noise output from the receiver. Make a careful note of this output level.

Set up the signal generator for 30% modulation (or the specified depth if

different from 30%), and inject a signal into the receiver at an r.f. level equal to the specified sensitivity of the receiver; i.e., if, for example, the sensitivity is specified as 1μV for a 10dB signal-to-noise ratio, inject 1μV as indicated by the signal generator's attenuators. Note the a.f. output power with the r.f. input applied.

The signal-to-noise ratio is given by the expression

$$R = \frac{P_s - P_n}{P_n}$$

or expressed in decibels

$$10 \log_{10} \frac{P_s - P_n}{P_n} \dots \dots \dots (1)$$

where R is the signal-to-noise ratio, P<sub>s</sub> is the receiver's output power with the modulated input signal and is due to both noise and signal, P<sub>n</sub> is the output power with zero r.f. input.

(Continued on page 35)



Fig. 4(a)

This is equivalent to:-

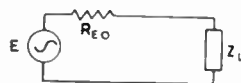

where  $R_{EO} = R_0 + R_s$   
i.e.  $R_s = R_{EO} - R_0$

The use of a series resistance ( $R_s$ ) for producing an effective output impedance ( $R_{EO}$ ) greater than the signal generator source impedance ( $R_0$ ).



Fig. 4(b)

This is equivalent to:-

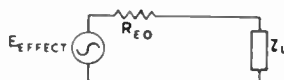

where  $E_{EFFECT} = E \frac{R_p}{R_p + R_0}$   
 $R_{EO} = \frac{R_p R_0}{R_p + R_0}$   
i.e.  $R_p = \frac{R_{EO} R_0}{R_0 - R_{EO}}$

The use of a parallel resistance ( $R_p$ ) for producing an effective output impedance ( $R_{EO}$ ) smaller than the signal generator source impedance ( $R_0$ ).

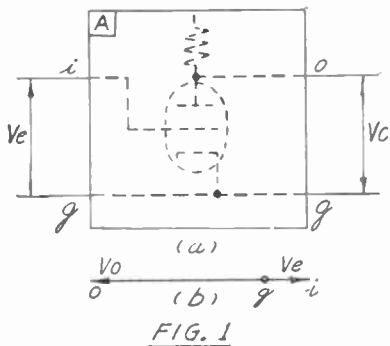

# Feedback, Servomechanisms,

By H. M. Wilkinson

Computing Devices of Canada Ltd.

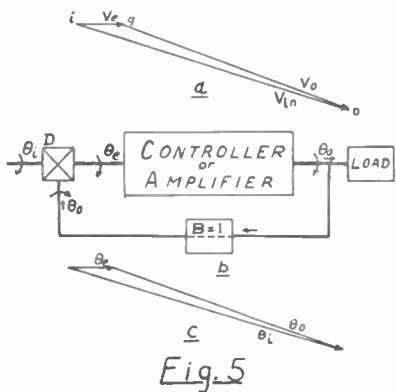
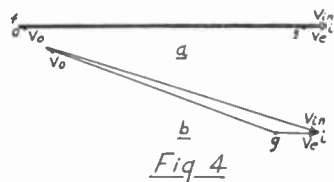
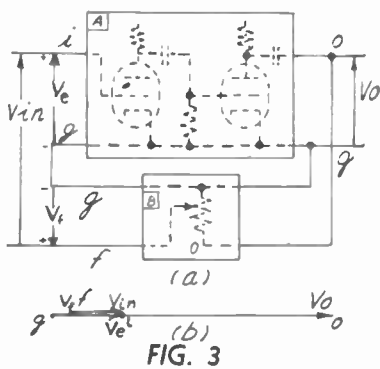
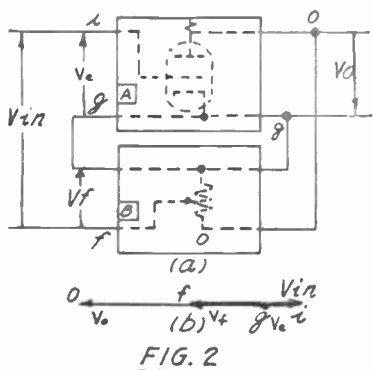

**T**HERE exists a great deal of literature on the subject of feedback and servomechanisms. Very little of it deals with the fundamentals of the subject, and even those thoroughly familiar with the more sophisticated approaches may not completely understand the physical meaning of the Nyquist diagram.

The same rules apply equally to mechanical or hydraulic systems; in what follows we will use mainly electrical circuits as examples.

### Feedback

Feedback is said to exist in an amplifying system when part of the output of the system is fed back and added to the input in such a way as to modify the overall gain characteristics. Figure 1(a) shows a simple electronic amplifier without feedback. Suppose the gain "A" of this amplifier is -4 (the minus indicates a reversal in phase) at some frequency. This is shown graphically in Figure 1(b), in which the output  $V_o$  is 4 times  $V_e$  and is in the opposite direction. The vectors  $V_e$  and  $V_o$  are assumed to be rotating if the input frequency is other than dc.

Now let us assume that a proportion "B" of the output is fed back to the input as shown in Figure 2(a). In this example "B" is a simple potentiometer set at  $\frac{1}{2}$ . The vector diagram is shown in Figure 2(b). For simplicity,

the vector  $V_e$  is assumed equal to unity and all other vectors are expressed in terms of this vector.

Since  $B = \frac{1}{2}$ ,  $V_f$  is  $\frac{1}{2}$  the length of  $V_o$ . The new gain G is as follows:

$$G = \frac{V_{out}}{V_{in}} = \frac{V_o}{V_e - V_f}$$

(since  $V_f + V_{in} = V_e$  or  $V_{in} = V_e - V_f$ . Also  $V_e = 1$ ;  $V_o = A$ ;  $V_f = V_o \cdot B = AB$ ).

$$\text{Therefore } G = \frac{A}{1 - AB}$$

which is the fundamental law of feedback. In our example:

$$G = \frac{-4}{1 - (-4 \times \frac{1}{2})} = \frac{-4}{1 + 2} = \frac{-4}{3}$$

Therefore the gain is only  $\frac{1}{3}$  its previous value. Feedback in this direction is called Negative Feedback.

Positive Feedback could be accomplished by using an amplifier such as a two stage amplifier so the "A" is positive, rather than negative, or alternatively "B" could cause a change in sign. Figure 3(a) shows a circuit with positive feedback. With  $A = +4$ , and  $B = \frac{1}{8}$  the vector diagram is shown in Figure 3(b). The gain is:

$$G = \frac{A}{1 - AB} = \frac{4}{1 - (4 \times \frac{1}{8})} = \frac{4}{1 - \frac{1}{2}} = \frac{4}{\frac{1}{2}} = 8$$

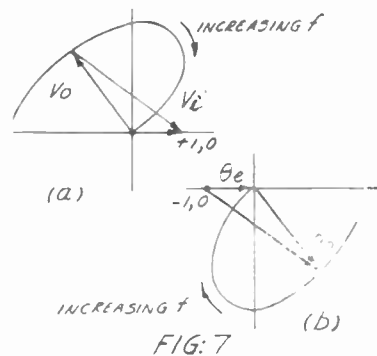
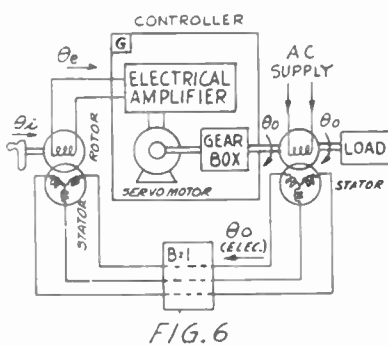

# And The Nyquist Diagram

Thus the gain has been doubled by means of positive feedback. Suppose we increase the feedback by moving the potentiometer slider towards "O." As  $V_f$  increases,  $V_{in}$  becomes smaller with a consequent increase in overall gain. What happens when  $V_f$  is made equal to  $V_o$ , or feedback equals input? According to our formula:

$$G = \frac{4}{1 - 4 \times \frac{1}{4}} = \frac{4}{0} = \text{infinity}$$

In other words, since there is an output with no input the gain is infinite. An amplifier with this gain would be extremely unstable and saturate or possibly oscillate.

However, such positive feedback amplifiers are quite commonly used as analog computer Operational Amplifiers of the less expensive variety. These amplifiers would be quite unstable if used without external negative feedback. However, they are always used with a resistor or condenser (computing element) connected externally. This provides a negative feedback path which stabilizes the amplifier despite the large amount of positive feedback within the amplifier itself. Various figures of dc gain have been quoted for these amplifiers by

different manufacturers, from 100,000 to 100,000,000. However, it should be pointed out that these gain figures do not have too much significance when comparing operational amplifiers, particularly since the gain of many amplifiers can be varied at will and can, as we have seen, be made equal to infinity.

### Servomechanisms

A servomechanism is generally a system which uses only negative feedback and in which the feedback ratio "B" is usually as close as possible to 1. This is because the object of most servo systems is to have the output follow the input as closely as possible, in which case gain in power but no gain in amplitude is required. (There are slight exceptions to this rule, to be described later.) The output follows the input when the overall amplitude gain of the system approaches 1. To achieve this most closely the amplifier gain "A" should be very large. Suppose  $A = 100$  and  $B = -1$ , then:

$$G = \frac{A}{1 - AB} = \frac{100}{1 - (100)(-1)} = \frac{100}{101}$$

which is near unity. Sometimes there may be doubt as to whether the minus

sign should be attached to the "A" or the "B" figure. However, this is unimportant as long as their product is negative.

Figure 4(a) shows the vector diagram for the amplifier of Figure 2(a) with "A" large.  $V_{out}$  is very nearly  $V_{in}$  (but opposite in sign). So far we have assumed zero phase shift in both the amplifier "A" and feedback element "B". However, at frequencies other than zero, (other than dc in electrical circuits), there will certainly be some phase shift. Figure 4(b) could be the vector diagram of the amplifier with input  $V_{in}$  varying sinusoidally at a frequency high enough to cause a certain amount of phase shift. Let us take the vector diagram shown in 4(b), rotate it through 180 degrees, and at the same time redefine the polarities of  $V_o$  and  $V_{in}$  so that the positive direction is in the opposite sense. This results in vector diagram 5(a) which is the conventional arrangement normally used in the servomechanism field. It is simply another variation of the vector triangle for a feedback system. Note that in all these diagrams the amplifier input (known as the error vector) is always length one.

(Continued on page 36)

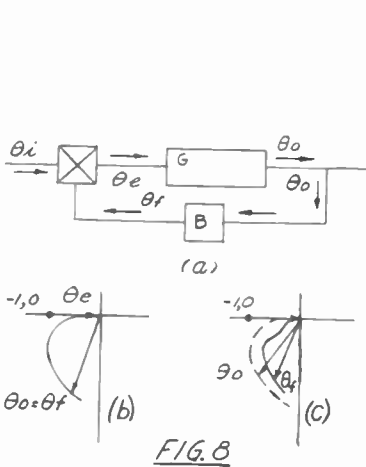

FIG. 8

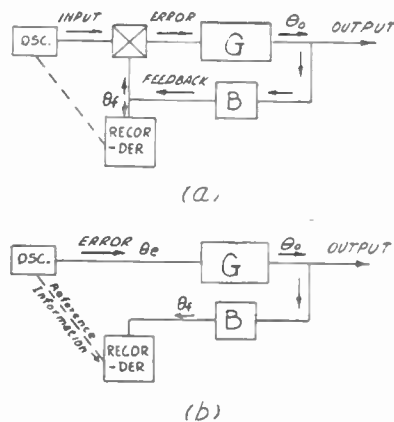

FIG. 9

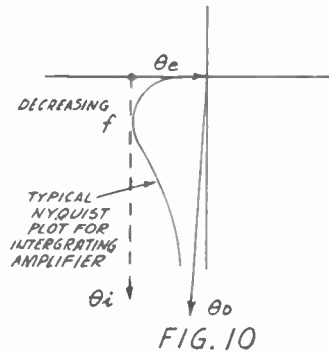

FIG. 10

# The Quality Control Of Printed Circuit Board Manufacturing

By Frank H. Edwards

United-Carr Fastener Co., of Canada Ltd.

IN any manufacturing process a number of variables are present which influence the perfection of the end product. There are four basic variables involved: materials, men, machines, and manufacturing conditions. Only when these factors are systematically regulated can quality

“good quality” is meaningless unless the limits, or in other words, the end use of the product, is defined. For example, an XXXP grade of phenolic laminate might be used to produce a “good quality” printed wiring board for an AC-DC broadcast receiver but would be quite inadequate when used

requirements. In fact, we may define quality control as “a function which insures the proper application of materials, men, machines, and manufacturing conditions to produce a product at the lowest cost, and which will meet the minimum requirements assigned to it”.

It is therefore apparent that the quality control of printed wiring boards begins with the basic design of each given board. If, for example, the board designer specifies tolerances which are closer than those necessary to meet minimum requirements, or if the outside board dimensions chosen with relation to the laminators’ standard sheet sizes, then the end product cannot be produced at the lowest cost and hence true quality control is not achieved. It is therefore imperative, if the full benefits of quality control are to be realized, that the board designer be familiar with the limits imposed by the basic variables involved in the manufacturing process.

The next step in quality control is the responsibility of the laminator. He must supply a material, at the lowest possible cost, which will meet the minimum requirements specified by the design of the end product. How he achieves this, however, will not be discussed in the present article.

Before instituting any type of quality control system it is necessary to have a complete understanding of the manufacturing process. Process control charts must be kept of each

**UNITED-CARR FASTENER COMPANY OF CANADA LIMITED  
PRINTED WIRING DEPT. PROCESS CONTROL DATA  
Operation No. 2 — Screening**

Part Number:	Week Ending:						
Sheet Size:							
Boards/Sheet:							
Supplier:							
Press Number:							
Screen Number:							
Mesh:	Silk or Steel						
Resist:							
Thinner:							
Squeegee:							
	Mon.	Tues.	Wed.	Thurs.	Fri.	Sat.	Total
Screened Hours							
Operator							

Figure 1

control be said to exist. The limits between which variations are permitted to occur set the excellence of the article being manufactured and these limits can only be set after careful consideration of the end product. It follows, therefore, that the term

in certain UHF applications. On the other hand, a radio manufacturer would not consider using an epoxy glass laminate for his AC-DC receiver printed wiring board. This then, leads us to two basic concepts of quality control, minimum cost and minimum

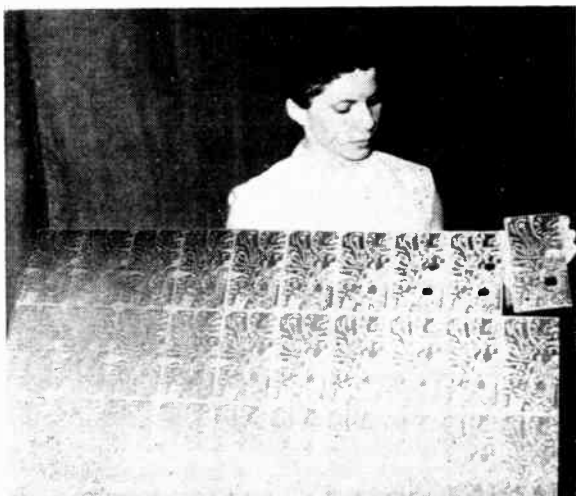

Figure 2

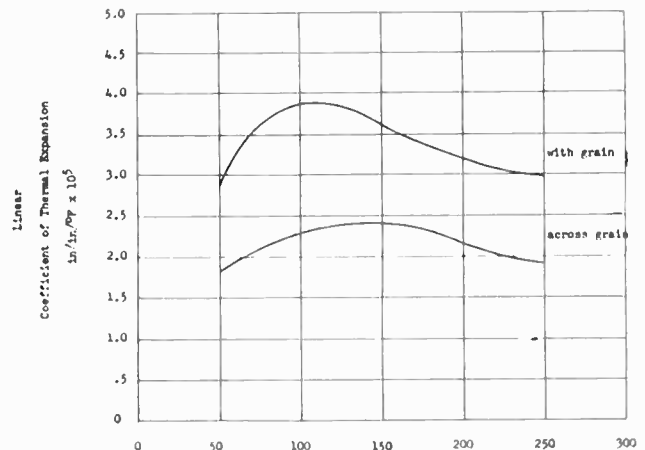

Figure 3

# The Spark Gap:- Old Component-New Circuit

(Continued from page 27)

back to the relay in the primary of the pulse transformer, energizes it, and opens its contacts so that the primary power is immediately disconnected. We now have a completely automatic protective circuit because when circuit conditions return to normal, primary power will again be applied.

## Personnel Protection

Failures of electrical panel instruments can cause dangerously high voltages to lie in wait for their victims at unexpected points in a circuit. In Figure 6 we see a circuit where, should the ammeter or voltmeter develop an "open", the total circuit voltage will suddenly appear across the meter terminals. The strategically placed spark gaps shown will eliminate this hazard to a great extent.

In tailoring the design of a spark gap for specific purposes, the designer should consider the effect of the circuit in which the gap is to be used. If used in a circuit where the normal operating voltage is below extinguishing voltage of the gap, the circuit will

probably recover after the surge has passed. In protecting a circuit such as in Figure 2, the gap need only be designed to carry the surge energy of the choke or inductance. But in Figure 3 or 4, a heavy follow through current may continue after the surge has passed or even a continuous fault current. In these cases, the dissipation rating of the gap should be able to sustain this current long enough to allow the operation of a fuse or protective relay.

The versatility of the modern spark gap is such that it can undertake more creative assignments than that of merely protecting. Connected in a suitable circuit, it can act as a generator of high voltage pulses. In Figure 7 we see a circuit capable of generating such a pulse. The capacitor is charged from a D.C. input voltage through the charging resistor. When the breakdown voltage of the spark gap is reached, the capacitor discharges through the primary of the transformer and the charging cycle is repeated at a repetition frequency determined by the values of the capa-

capacitor and resistor. The resultant pulses can be stepped up to any desired value as they appear across the secondary winding of the transformer.

By adding a third electrode to the spark gap, we can make it behave like a thyatron in that the flash over point can be prematurely initiated by the application of a smaller voltage to the third electrode. Such a circuit would allow us to synchronize the frequency or repetition rate of the spark gap pulse circuit shown in Figure 7, giving us thyatron action but with much higher peak current capacity.

The relatively simple spark gap has thus developed into a component of a great variety of uses under widely varying conditions. It is now possible for spark gaps to be made with an operational temperature range of between +600°F and -100°F, whilst static breakdown voltage tolerances can be generally held to 10 per cent, or, under special circumstances, to those tolerances commonly associated with panel type instruments.

# Measurement Of Sensitivity On AM Communication Receivers

(Continued from page 29)

As an alternative to the above method of test, it may be desirable to regard the signal-to-noise ratio as the reference parameter, and to adjust the input signal level until the specified signal-to-noise ratio is obtained. For example, with the receiver having a specified sensitivity of 1 $\mu$  V for 10dB S/N, calculate the power output required for this ratio from:

$$P_s = P_n \left( 1 + \text{antilog} \frac{R}{10} \right) \dots \dots \dots (2)$$

Then adjust the signal generator output until the correct value for  $P_s$  is obtained. The output level of the signal generator is then the measure of the sensitivity and, for the receiver in the example, should be less than 1 $\mu$ V.

## For Tests with a C.W. Signal

If the receiver has a bandwidth-selector switch, set it for minimum bandwidth. Then find the output power with zero input in the same way as for a modulated signal. Next, inject a c.w. input; tune the signal

generator accurately to the receiver, using the receiver's signal strength meter as an indicator; and adjust the beat-oscillator to produce a 1 kc/s output frequency.

Adjust the output level of the signal generator to produce the specified signal-to-noise ratio using the same formula to calculate  $P_s$  as for the test with amplitude modulation.

Incidentally, the overall gain of the receiver is automatically given by the results of the sensitivity tests. It could, of course, be calculated either as a factor — power output divided by power input — or in decibels. But this is seldom, if ever, done in practice. It is more usual simply to state output power in milliwatts for a particular input level which is too small to operate the a.g.c. system.

A receiver designed for both c.w. and a.m. reception usually has a bandwidth selector switch; the narrowest bandwidth is of the order of 100 c/s effected by means of a 950-1050 c/s band-pass filter in the a.f. circuit for use with c.w. input signals. A different

sensitivity will probably be quoted for each setting of the selector switch. Normally only the widest bandwidth is used for a modulated input.

## Noise Factor

It will be appreciated from the foregoing explanations that sensitivity, specified in terms of minimum input level for a given signal-to-noise ratio, is a conditional form of specification depending, as it does, on bandwidth, modulation depth, and input conditions. Also, one of the factors — either the input voltage or the signal-to-noise ratio — must be chosen arbitrarily according to the purpose for which the receiver is to be used.

The sensitivity specification is therefore being superseded to a certain extent by a statement of the noise factor of the receiver. This gives an unqualified measure of the noise generated in the receiver; and, given other parameters such as the bandwidth, the signal-to-noise ratio can be calculated for any level of input.

The noise factor of a receiver may

(Continued on page 36)

## Measurement Of Sensitivity AM Communication Receivers

(Continued from page 35)

be defined as the ratio of the noise output from the receiver under test to that of an equivalent ideal receiver connected to the same aerial system, an ideal receiver being one that does not generate any noise internally. Alternatively, it may be regarded as the noise output of the receiver divided by the product of the gain and the noise input.

Noise factor is usually confined, as a specification of a performance parameter, to receivers operating at the higher frequencies. It is, therefore, generally applied to receivers operating from resonant aerials where the radiation resistance is also the source impedance of the aerial.

Now, any passive electrical network—including an aerial system—generates noise power. This is known as thermal noise and is given by the expression

$$P_n = kTB \dots\dots\dots (3)$$

where  $P_n$  is the noise power generated.

$k$  is Boltzmann's constant  
 $= 1.38 \times 10^{-23}$  joules per °K,

$T$  is the absolute temperature in °K,

$B$  is the bandwidth in cycles per second.

Referring back to our original definition of noise factor, if the aerial is not receiving any external noise, the noise input to the receiver will be thermal noise for the aerial and input circuit. It is evident from the formula (3) that thermal noise is dependent upon temperature and bandwidth only. The temperature varies by only a few per cent and may be regarded as virtually stable; and the bandwidth is determined by the receiver itself.

The sum of the noise generated in the receiver itself and amplified thermal noise is equivalent to a noise input whose level is given by dividing the noise output by the gain of the receiver. Let us call this equivalent level  $N_{eq}$ .

From the above explanation and our definition of noise factor, it can be argued that noise factor is the ratio of the equivalent noise input level ( $N_{eq}$ ) to thermal noise. Since the bandwidth is necessarily the same for the equivalent noise input and thermal noise it can be neglected.

It is possible to measure noise factor using a signal generator to simulate the aerial system, but it is a rather tedious method involving a number of calculations. The most satisfactory

method of measurement is by means of a noise generator.

This type of instrument generates a noise e.m.f. effectively in series with an impedance equal to that of the aerial with which the receiver is normally used. At frequencies up to about 600 Mc/s, the noise source is usually a specially constructed diode, the noise output being directly proportional to the d.c. diode current. The output meter of the noise generator monitors the diode current and is normally calibrated directly in decibels relative to thermal noise for the impedance of the noise generator.

To test the noise factor of a receiver, connect a noise generator to its aerial terminal, and connect an output power meter to the a.f. output terminals. With the noise generator connected but generating no output, turn the receiver gain to maximum; switch off or disconnect the a.g.c.; and measure the output power due to internal noise. Switch on the noise generator and adjust its output until the a.f. output power from the receiver is doubled. The noise input from the generator is then equal to  $N_{eq}$ . The noise generator, being calibrated in decibels relative to thermal noise, then indicates the noise factor directly.

This measurement is of great value because the noise factor obtained is independent of gain and bandwidth. And, providing the controls of the receiver are not altered during the test, their setting has little effect on the results of the measurement. The noise factor can therefore be regarded as an absolute measure of sensitivity, whereas signal-to-noise ratio is obviously a relative one. In addition to the definitions of noise factor that have been given already, it can be regarded as the relationship between the signal-to-noise ratio at the input of the receiver and the signal-to-noise ratio at its output. So the final S/N can be calculated for any specified conditions by determining the S/N at the aerial for the bandwidth of the receiver and multiplying by the noise factor.

The determination of the signal-to-noise ratio at the aerial for a given field strength and receiver bandwidth is possible from purely theoretical data. It involves a number of somewhat complex calculations however, and is not strictly necessary from the point of view of an engineer testing a particular receiver. Let us be content with the measured noise factor as a figure of merit whereby the actual performance of a receiver can be compared with its specified performance.

It is intended that a further article in this series will appear in the next issue of *Instrumentation*, which will deal with the measurement of receiver bandwidth, the conversion of the actual response of the receiver to equivalent noise-bandwidth, and will include some methods of alignment of the r.f. and i.f. circuits.

J.F.G.

## Feedback — Servomechanisms And The Nyquist Diagram

(Continued from page 31)

The fundamental feedback law

$$\text{which is Gain} = \frac{A}{1 - AB} \text{ has also}$$

been altered by the servo people. The term "Transfer Function" is commonly used instead of Gain. Transfer Function "G" is generally used to describe that which we have called amplification "A". Feedback is always negative, at least in simple servos. Consequently the reversal in phase which we have been associating with the amplifier "A" is considered normal and now carries a + ve sign. This results in a slightly different form for the above formula. The new form is:

$$\text{System Transfer Function} = \frac{G}{1 + GB}$$

Of course this is just another way of describing an exactly analogous system. There is no fundamental difference, only a difference in convention.

Figure 5(b) is a position servo in which the input is  $\Theta_i$ . The output  $\Theta_o$  is subtracted from  $\Theta_i$  by the differential "D" to produce the error voltage  $\Theta_e$ , i.e.  $\Theta_e = \Theta_i - \Theta_o$ . ("D" here is a mechanical differential similar to the standard automobile rear end differential.) The amplifier or controller "A" contains a motor which drives the output shaft  $\Theta_o$ , in one direction if the error shaft  $\Theta_e$  is rotated to the left of a given position, and in the opposite direction if  $\Theta_e$  is rotated to the right of the given position. Figure 5(c) shows the phase relationship between the various shafts if the input shaft is oscillated at some constant angular speed. A more common arrangement of circuit elements which substitutes an electrical differential for the mechanical one is shown in Figure 6. The error  $\Theta_e$  here appears as an ac voltage. However, any system analysis is exactly similar to the previous case.

### The Nyquist Diagram

The Nyquist Diagram is a plot of the locus of the output vector over a range of frequencies. Figure 7(a) shows the assumed vector arrangement commonly used in electronic work. Designers of servo systems on the other hand, as mentioned above, have adopted the convention illustrated by Figure 7(b). In any event

(Continued on page 38)



# BRUEL & KJAER

## MODERN INDUSTRIAL MEASUREMENTS

### ELECTRICAL TEST

**DEVIATION BRIDGE** for testing tolerance and phase angle of components compared to a standard. Resistance 10 ohms-10 Meg. Capacitance 50  $\mu$ F to 10  $\mu$ F. Inductance 2 mH to 100 H. Interchangeable scales provided, 1 to 25% FSD. 1000 cycle test frequency. Knee operated test jig available.



### SOUND AND NOISE

**SPECTRUM RECORDER** is combined spectrometer and level recorder. Spectrometer has 27 fixed  $\frac{1}{3}$  octave filters, 40-16,000 cycles, manual selection or driven by level recorder. Latter has 10 paper speeds, variable writing speed, log scale for wide range. Key instruments for vibration and noise measurements.



**MEGOHMMETER** range from 100K to 10,000,000 Megohms, test voltage 10 to 100 V. Can be used as D.C. Voltmeter from 10mV to 2000 V with 1000 Megohm input impedance. Illustrated with high tension accessory extending range to 100,000,000 Megohms and voltage from 0-1000.



**ACOUSTIC ANALYSIS AMPLIFIER**, used with B & K precision mike, measures noise and sound level. Equipped with A.S.A. Standard weighting networks for use as precision noise and sound survey meter. Use B & K Level Recorder to record output.

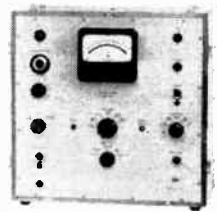

### STRESS AND VIBRATION

**STRAIN INDICATOR** with 25 microinches inch full scale sensitivity (4 active arms). Built-in carrier oscillator used, measuring static and dynamic strains to 300 cycles. D.C. bridge supply accessory permits measurement of dynamic strains up to 50,000 cycles.

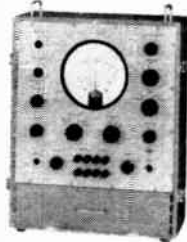

**PRECISION MICROPHONE**, condenser type with built-in cathode follower, low temperature coefficient. Calibrated within 0.5 DB 80-10,000 cycles. Measures noise level from 25 to 140 acoustic DB. Use with acoustic amplifier, spectrometer or frequency analyzer and level recorder.

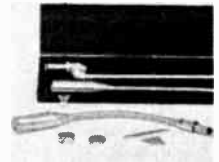

### RADIOACTIVITY

**ACCELEKOMETERS** for displacement, velocity and acceleration measurement of any vibrating structure. Output 20 mV g, 5-20,000 cycles. Measures 0.25 to 1000 g with B & K direct-reading self-calibrating amplifiers.

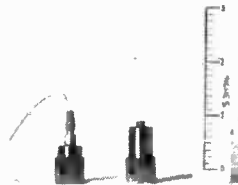

**RADIOACTIVITY COUNTER** - Two channel counter, coincidence, anti-coincidence and straight count. Built-in 0-1500 V G-M tube supplies. Variable resolving time. Two timers, 1 minute to 12 hours. Each channel has scale of 10 and 4 digit register, plus multiplier. Single and dual tube sample holders available.

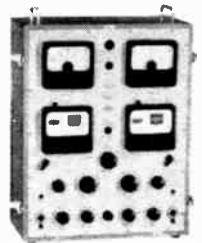

## MEASURE • to speed tomorrow's products and profits • MEASURE

Bruel & Kjaer offers a complete range of matched units in the electrical, acoustic and vibration fields. B & K instruments are designed to meet exacting research requirements, yet can be operated by

non-technical personnel with equal ease and accuracy. These instruments are now stocked in Canada. Write for full catalog and price list.



R-O-R field engineers can help with your problems—ask for details.

**R-O-R ASSOCIATES LIMITED**  
290 LAWRENCE AVE. W. TORONTO 12

## FEEDBACK — SERVOMECHANISMS

(Continued from page 36)

the system becomes more unstable as the Nyquist locus approaches either the +1.0 point in the first case, or the -1.0 point in the second. This is obvious since if at any frequency the locus comes close to, or touches this point there is an output with no input or only a very small input. (Also instability exists if the locus encircles this point.)

Previously it was mentioned that there are exceptions to the case in which  $B = 1$ , or all the output is fed back to the input. This may be so when it is desired to modify "B" at particular frequencies so that the -1.0 point is avoided.

Figure 8(a) shows a position servo similar to that shown in Figure 5(b) except that the feedback quantity  $\Theta_r$  is now  $\Theta_o$ , modified by B. Figure 8(b) shows a Nyquist plot in which  $B = 1$  and which passes very close to the -1.0 point. Now suppose that a network is inserted at such that  $\Theta_r$  is

reduced in magnitude at the higher frequencies. (It may also, incidentally be shifted in phase as shown.) Figure 8(c) shows how this moves the locus away from the -1.0 point resulting in a more stable servo system. Note that a modifying network could also be inserted as the first stage of "A". This is frequently preferable to modifying "B".

It is evident from the above that a design engineer can use the Nyquist diagram to quickly ascertain whether a given servo system will be stable or not, as well as other operational characteristics.

### Obtaining a Nyquist Plot

It would be quite feasible to construct a Nyquist diagram by recording the phase and amplitude of the feedback quantity while operating the servo at various input frequencies if the system were stable as in Figure 9(a). However, most high performance servos are generally unstable at some point in their design and it is obviously impossible to use this system of measurement. Therefore, this is not a practical solution and other means must be used to obtain this diagram. The accepted method is to break the feedback path and feed a constant amplitude variable frequency quantity into the amplifier "G" as in Figure 9(b). This is supplied by an electrical or mechanical oscillator, depending on whether the required input to "G" is an electrical quantity or mechanical shaft position. The output  $\Theta_r$  is fed into a recorder or analyser which measures its phase and amplitude with reference to the input phase and amplitude. A signal must also go directly from the oscillator to the recorder in order to be able to measure the phase difference between  $\Theta_r$  and  $\Theta_o$ .

The Transfer Function of the open loop is the complex ratio  $\Theta_r/\Theta_o$ . When, as is customary,  $\Theta_o$  is made  $1/0^\circ$ , this Transfer Function and  $\Theta_r$  are identical. To determine the system performance, the Transfer Function  $\Theta_o/\Theta_r$  must also be obtained. The system Transfer Function is then:

$$\frac{\Theta_o}{\Theta_r} = \frac{\Theta_o/\Theta_o}{1 + \Theta_o/\Theta_r} = \frac{\Theta_o/\Theta_o}{1 + \Theta_r/\Theta_o}$$

The range of frequencies to obtain a reasonable plot for most mechanical systems is of the order of one cycle every few seconds up to around 100 cycles per second.

### Integrating Amplifiers

Integrating amplifiers are used as servo amplifiers to reduce the steady error between the output and input to negligible proportions. An ordinary amplifier is said to have a gain of five when its output voltage is five times its input. Suppose an amplifier had an output which increased at the rate of "K" volts per second for each volt of input. Such an amplifier would be

## Communications Engineers

**TAKE NOTE . . .** Here is your opportunity to join a progressive carrier manufacturer now expanding operations on Canada's scenic west coast. Climate and location permit year-round golf, hunting, fishing and boating—Canada's finest skiing and swimming. Interesting work, congenial associates, full benefit plan, suburban location.

These are newly created positions involving considerable responsibility and scope. All require experience with telephone carrier or microwave radio equipment at an engineering level.

**SALES ENGINEER**—To manage department servicing major telephone operating companies across Canada.

**SALES ENGINEER**—To join sales engineering staff in the general application of carrier and radio equipment.

**APPLICATIONS ENGINEER**—To perform equipment engineering tasks on carrier and microwave radio equipment.

**APPLICATIONS ENGINEER**—Transmission specialist for planning and application of carrier and microwave radio equipment.

**PROJECT ENGINEER**—To prepare specifications for, supervise and test installations of carrier and microwave equipment.

Please write or phone if you would like more information about these opportunities. Your interest will be confidential.

### LENKURT ELECTRIC CO. OF CANADA LTD.

6960 Lougheed Highway

North Burnaby P.O. Vancouver, B.C.

Telephone: GLENBURN 4000

an integrating amplifier. Its output could be expressed as follows:

$$V_{out} = K_a \int V_{in} dt$$

Another example of an integrating amplifier would be a mechanical controller with one shaft as its input and another as its output (see Figure 5(b)). If the output shaft rotated continuously counter clockwise at a rate proportional to the displacement of the input shaft from one side of a given zero position and continuously clockwise at similar speeds for opposite displacements, this controller is also an integrating amplifier. Its equation is:

$$\Theta_o = K_a \int \Theta_i dt$$

Suppose  $\Theta_i$  is made to vary sinusoidally with a maximum displacement of  $\Theta_m$  and frequency  $\omega$  (i.e.  $\Theta_i = \Theta_m \sin \omega t$ ).

$$\begin{aligned} \text{Then } \Theta_o &= K_a \int \Theta_m \sin \omega t dt \\ &= -K \Theta_m \cos \omega t \end{aligned}$$

This slight excursion into mathematics (which we have been deliberately avoiding for the most part) is to show why the Nyquist plot for many position servo controllers lies along the negative vertical axis. For a perfect integrating amplifier without phase shift it is a straight line coincident with this axis. Also a little thought will show that as the frequency becomes lower the output amplitude becomes larger since it has a longer time to build up.

Consequently at very low frequency or steady state conditions the output approaches infinity;  $\Theta_i$  and  $\Theta_o$  become practically coincident, and the steady state error  $\Theta_e$  practically zero by comparison as shown in Figure 10.

### Conclusion

It has been shown that feedback is fundamentally the same whether it is employed in a mechanical or electrical or electronic system. Also that feedback system gain characteristics can be fairly effectively analyzed by using vector diagrams and a minimum of mathematics. However, it should be noted that some of the complicating factors such as the effects of load inertia and friction on a servo system have been avoided as well as many other refinements.

**PLAN TO ATTEND  
CANADA'S  
IRE SHOW and  
CONVENTION At  
TORONTO  
OCT. 16-17-18, 1957**

*Smallest member of our complete floated gyro family*

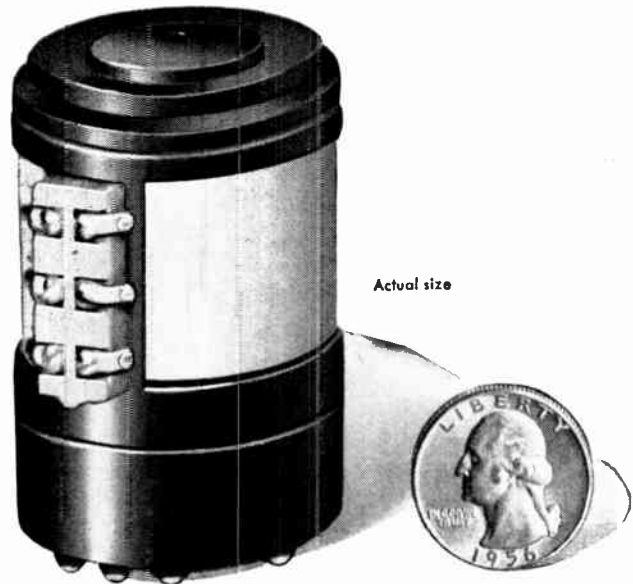

## Ounce for Ounce, Inch for Inch—Honeywell's New Miniature Integrating Gyro (MIG) Has No Equal

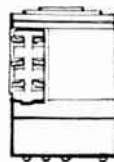

### Specifications of the new Honeywell MIG—

**Power Requirements**—26-volt, 3-phase, 400-cycle spin motor supply and 115-volt a.c. or d.c. heater supply

**Running Power**—2.5 watts spin motor, 25 watts heater

**Angular Momentum**  
100,000 gm-cm<sup>2</sup>/sec

**Viscous Restraint Coefficient**—  
20,000 dyne-cm—/radian/secs

**Gimbal Inertia**—100 gm-cm<sup>2</sup>

**Maximum Zero Signal**—  
0.001 volts

**Drift Rate**—One-half degree/hour or less under all conditions

**Application**—Platform gyro for instrumentation

**Weight**—0.5 lb.

**Size**—1.75 in. diameter by 2.5 in. long

THE NEW Honeywell MIG represents a scientific breakthrough in floated gyro design.

Only 1.75 inches in diameter and weighing but 0.5 pounds, it compares performance-wise to hermetic integrating gyros many times larger and heavier.

The MIG has a drift rate of only one-half degree per hour or less, (under severe vibrational environments) making it ideally suited for instrument platform stabilization in an extremely compact space.

Typical uses for the new Honeywell MIG include semi-inertial and inertial-stellar applications. With redesign, the MIG is also adaptable as a space-saving, lightweight fire control gyro.

The specifications on the new Honeywell MIG are detailed at left. For further information and for information on the full line of Honeywell Gyros, write: Honeywell Aero Division, Dept. 601, Toronto 17, Ontario.

# Honeywell

Aeronautical Division



AIRCRAFT • ORDNANCE •  
CONTROLS AND INSTRUMENTATION

# UTILITIES DEMAND THE STRENGTH AND PERMANENCE OF FABRICATED STEEL

Utilities and particularly electric utilities are always in the news because they are so closely identified with our economic wealth. For example this generating station for the Saskatchewan Power Corporation at Saskatoon. Here Central Bridge erected 529 tons of structural steel – with speed and permanence. Central fabricates and builds bridges, ship bottoms, communication towers and tanks in addition to commercial and industrial structures.

**CENTRAL BRIDGE** *Company, Limited*  
*Trenton, Ontario*



For further data on advertised products use page 81.

**QUALITY CONTROL**

(Continued from page 33)

locate the individual circuits in such a manner that piercing and blanking registers with the circuit pattern. A partially pierced and blanked sheet, together with a completed board, is shown in Figure 3. Since the sheet used in this instance is over three feet long and a three stage progressive die-set has been used, it can be appreciated that the variables affecting registration must be kept under constant control. This is particularly true when hot-punching laminates are used, which have certain advantages over the so-called "cold-punching" grades.

*Inspection*

Figure 3 shows temperature expansion curves of a typical sheet of  $\frac{1}{16}$ " XXXP hot-punching copper-clad laminate. Such curves are used for the calculation of master negative sizes and individual circuit spacings on the step-and-repeat positive. Each supplier's material has a slightly different co-efficient of expansion, and even different batches of material from the same supplier vary somewhat. Also, as shown by the graphs, the coefficient of linear expansion is not the same in both directions of the grain of the material. This produces a distortion in the circuit layout which cannot be corrected unless special photographic techniques are used in preparing the master negative. Fortunately, it is not serious enough to be cause for rejection of the average radio or TV board.

After piercing and blanking, the boards are subjected to 100 per cent visual inspection. Boards are rejected for any one of the following general defects: registration, cracks, open circuits, short circuits, twist and warp and poor finish.

Rejected boards are placed in the appropriate containers in front of the inspector. The rejected boards are examined daily by Quality Control personnel who determine the exact nature of the defects. For example, boards rejected under the general category of "shorts" may have had this defect caused by a number of factors, such as poor printing, careless handling of the sheets before the ink had dried, faulty screen stencil, improper cleaning of the laminate, under etching, etc. While it may appear that the categories used to differentiate rejected boards are neither complete nor accurate, experience has shown them to be quite practical. If a board is rejected for any reason not considered covered by these general conditions, it is immediately reported to Quality Control and appropriate action taken.

The number of rejected boards is recorded daily in the quality control data sheets such as the one illustrated

(Continued on page 48)

# decade counter

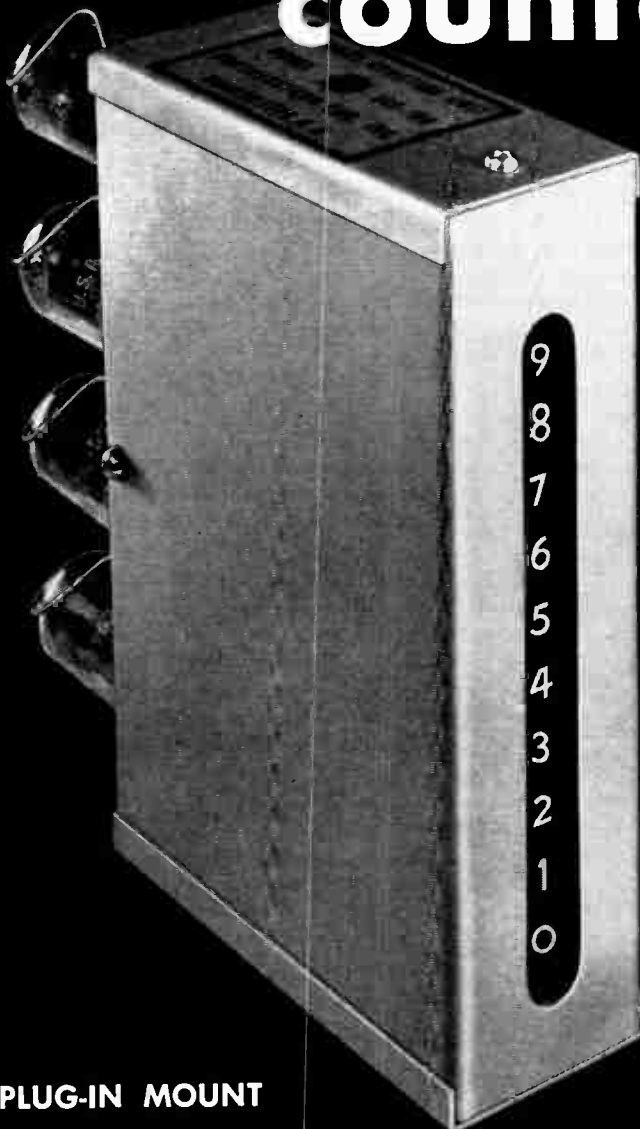

**PLUG-IN MOUNT**

**NEON LIGHT ILLUMINATED DIGIT FROM 0 TO 9.  
AUTOMATIC RECYCLE BUT DISPLAYS REMAINDER  
UNTIL RESET.**

	MODEL	
Max. (Counting) Rate	140-40	140-100
Resolution	40 Kc/sec	100 Kc/sec
Tubes	8 microseconds 4 - 5963	4 microseconds 4 - 5963
Dimensions	1½" x 5½" x 5¼"	

**northeastern engineering**

Manchester

New Hampshire



Canadian Representatives: Computing Devices of Canada Ltd., P.O. Box 508, Ottawa 4, Ont.

# The Beta Gage In Industry

**Its Use As A Control Actuator To Adjust Machine Factors Governing Weight Has Not Been Taken Advantage Of.**

ONE OF the most important factors requiring close control during the manufacture of sheet materials, is the thickness or weight of the sheet. The latest tool available to the production engineer for making this measurement is the Beta Gage.

This instrument makes the required measurement and offers the following important advantages over existing methods:

1. Indication is continuous, may be displayed at several positions remote from the measuring point and may also be recorded.
2. No contact is made with the material under inspection.
3. No moving parts are used in the equipment.
4. The measurement may be "averaged" over a large area to obtain indications for production control, or it may be confined to a small area to investigate process irregularities.
5. Errors due to the human factor are obviated.
6. Very little maintenance is required.
7. Facilities are provided for actuating control mechanisms, to adjust the factors governing thickness or weight when "off gage" conditions arise.
8. The presence of static electricity charges on the sheet, being manu-

factured, do not affect the accuracy or indications of the gage.

The method of operation of a Beta Gage involves the use of a source of radioactive radiation, a suitable detector and the electronic circuits necessary to amplify, control and display the information obtained from the equipment.

The source of radiation is mounted on one side of the material to be inspected, and the detector, an ionisation chamber, is mounted opposite the source on the other side of the material. Radiations from the source, thus penetrate the material and enter the detector unit. The radiations, when passing through the material, are attenuated depending upon the mass of the material, and the energy of the particles from the source.

Several types of source are available so that it is possible to choose a source of radiation which will show a large difference in attenuation for a small difference in the mass of the material being inspected. In this way, it is possible to make accurate and sensitive measurements over a range of materials, from a few grams per square metre, up to 1,200 grams per square metre.

The range of weights of the materials manufactured on any one machine is often such that it is not satisfactory

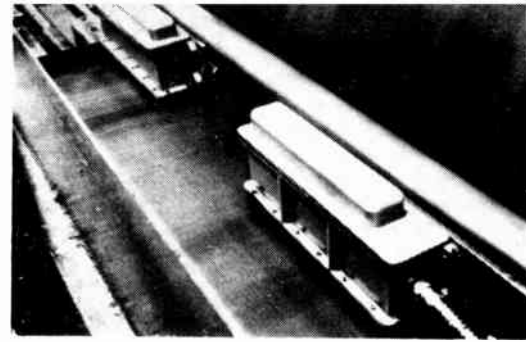

● Material to be inspected is straddled by Beta Gage units comprising radiation source on one side of material and ionization chamber on the other side.

to indicate weight directly on a meter; small variations from any set weight would be extremely difficult to distinguish. For this reason, Beta Gages are usually provided with one control which will set the desired weight, and an "off gage" meter, which will show variations about the selected weight, both positive and negative. This system allows an operator to distinguish quite easily, variations of plus/minus 1 per cent in the material being measured.

The Beta Gage has now been in use for over six years as an indicator of thickness or weight variations in the manufacture of continuously produced sheet materials. However, it would seem that users have been somewhat slow in carrying the application of the gage to its logical conclusion; that is, using the indication given by the gage to actuate controls to adjust the machine factors governing weight.

Beta Gages are carrying out this function at present on plastic calenders in the United States, and one application is known where Beta Gage is used to actuate a mechanism for rejecting off-gage steel sheets.

## Efficiency In Yard Control

**Ultra Modern Equipment Adds To The Efficiency Of Yard Operation — Provides More Effective Control — Reduces Damage To Fragile Ladings.**

TO keep the iron and steel products moving to and from the steel mills and merchandise from other plants which it serves, the Union Railroad has completed and put in service a modern classification facility at its Mon Southern Yard on the outskirts of Pittsburgh. An automatic switching system provided for automatic routing of a cut to any of the 23 classification tracks in accordance with route information fed into the system by push buttons. Later a programmed switching system was installed to accomplish this automatically. With this equipment track destination information is pre-programmed on tape and fed into the automatic switching

system and all switches required to route each cut to its designated track automatically position as the cut advances.

Car movement through electro-pneumatic retarders is controlled from a single tower and the desired speed of car movement leaving the retarders is established by the operator selecting the speed by means of miniature levers on the control panel.

Called Velac Automatic Classification Yard System, it will provide the Mon Southern Yard with true, fully automatic operation, where the operator need not manipulate any button or lever, but exercises supervisory observation only. The equipment will

control the retarder to an accuracy that averages plus or minus 0.1 mile per hour.

The addition of this new ultra-modern equipment will add to the efficiency of yard operation, provide more effective control, and will reduce damage to fragile ladings.

● At the left of picture is the control tower and to the right are three group retarders. The master retarder is in the background. Power switches in the foreground are automatically positioned to route the cars to the various classification tracks.





## Protect vital electronic equipment with continuous stand-by power

Avoid the drastic consequences of power failure with electronic equipment. Automatic Electric offer two stand-by power units that completely eliminate power failure and line voltage variations.

### U.S. Motors Micro-Power

This stand-by power unit consists of a 2 cylinder gasoline (or propane gas) engine, flywheel and magnetic clutch, A.C. Motor and A.C. Generator.

As soon as commercial power fails the magnetic clutch connects the flywheel to the gasoline engine which instantly operates at full speed. This ensures virtually no voltage dip from the generator.

The Micro-Power Unit is available in single or 3 phase models to produce 3, 5 or 10 Kilowatts.

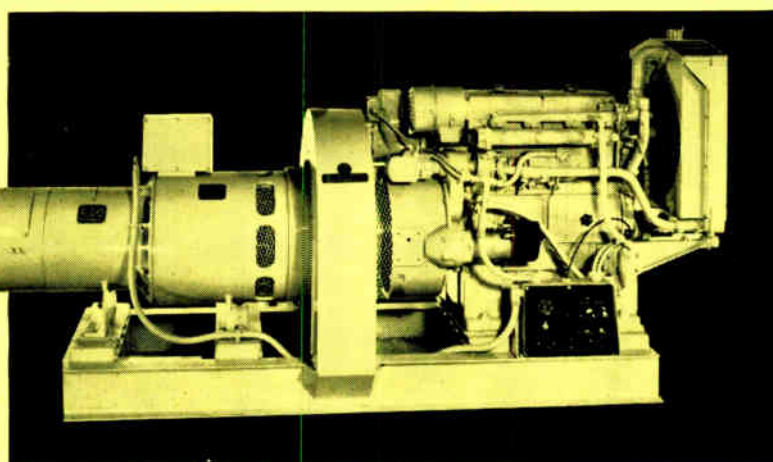

### Mechron Stand-By Power Unit

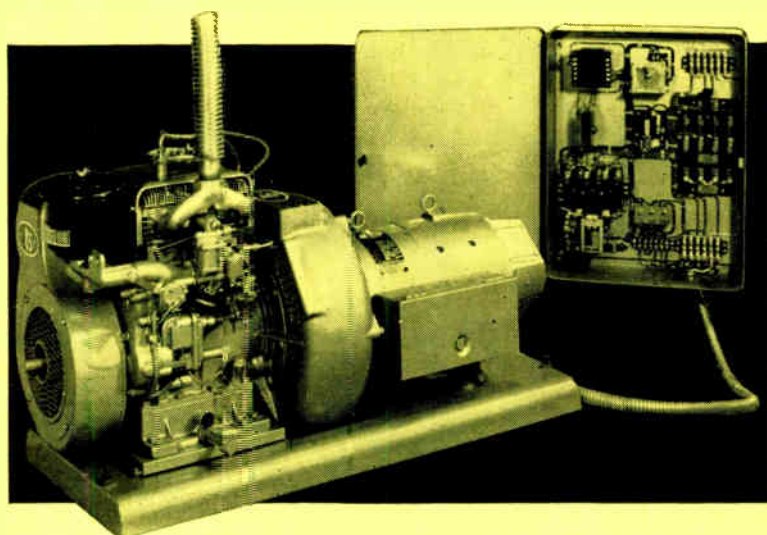

Contains a Dorman or Lister Diesel Engine, heavy flywheel, centrifugal clutch, A.C. Motor and A.C. Generator.

When power failure occurs the inertia in the heavy flywheel will continue to run the generator under full load conditions. During this time the diesel engine, which is cranked by batteries, reaches full speed and closes the centrifugal clutch. There is no voltage dip whatever from the generator. Single phase or three phase with various generator capacities. Apart from these stand-by power units, Automatic Electric supply a complete line of emergency gasoline and diesel generating units. Also many small portable gasoline generators. For all your emergency power requirements contact Automatic Electric.

Automatic Electric Sales (Canada) Limited,  
185 Bartley Drive, Toronto 16, Ontario.  
Branches in Montreal, Ottawa, Brockville,  
Hamilton, Winnipeg, Regina, Edmonton,  
Vancouver.

**AUTOMATIC ELECTRIC**

PIONEERS IN AUTOMATIC CONTROL



# *Reduce Service Costs*

## WITH **AUTOMATIC INTER** **OF PROFITLESS CA**

Now that many dial exchanges are unattended,  
Recorder-Announcer becomes an important factor  
telephone service costs.

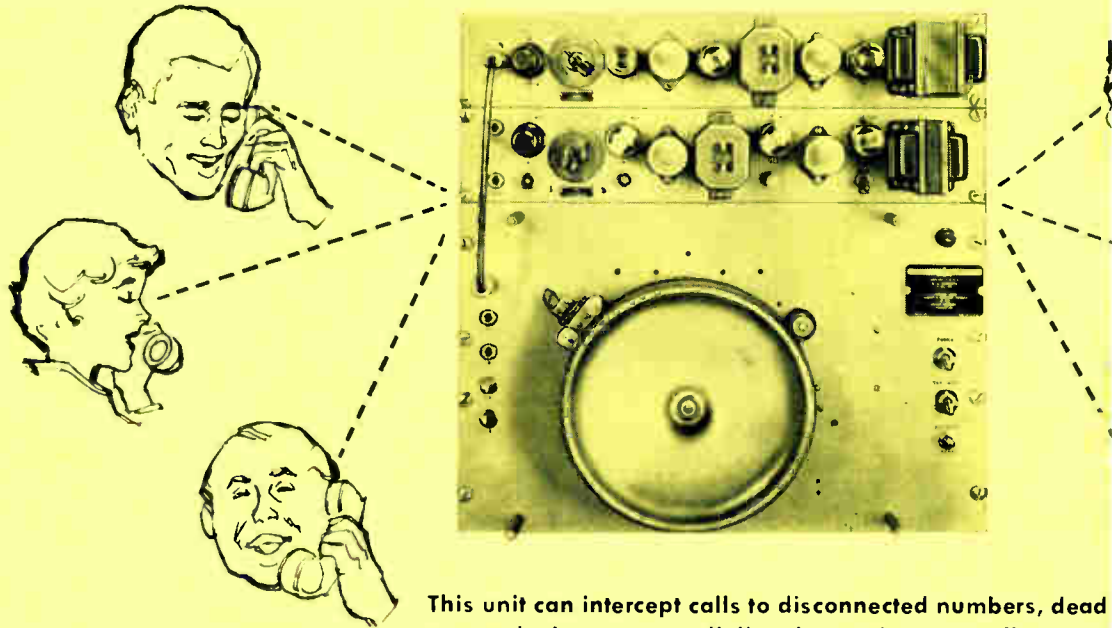

This unit can intercept calls to disconnected numbers, dead  
etc. and gives proper dialing instructions to callers—auto-  
matically, without going through any manual exchange!

### **OPERATION EXPENSES ARE EXTREMELY LOW**

The Type MCF Automatic Recorder-Announcer will repeat five messages each to 30 people at one time. 150 callers could be served simultaneously. Yet, power consumption at the maximum would be only 25 watts! Since magnetic recording is so trouble-free, you can expect to give the Announcer no more attention than you'd give a high-quality radio.

### **COMPLETELY ADAPTABLE TO MEET YOUR EXACT NEEDS**

A basic type MCF Recorder-Announcer consists of the recorder, recording amplifier with microphone, and as many pickup heads and play back amplifiers as there are messages wanted. (A "unit" of one pickup head and one play-back amplifier is required for each message to be played.) You need buy only the equipment you have use for. If your demands increase, the capacity of your original Announcer is easily increased (up to a maximum of 5 messages) by the addition of new "units".

If you decide to install Announcers in several outlying exchanges, for purposes of intercepting calls closest to the point of origin, you don't need a recording amplifier for each installation. Rather, you can order a Portable "Erase and Record" Amplifier, which you carry for use any time you wish to change messages.

If desired, Announcer can be  
recorded message, and cut off.

### **INSTALLATION IS C**

The equipment is designed for  
(if your racks are of a different  
from us). The Type MCF can be  
so apparent, its uses so many  
announcer in your operations.  
Keep your operators free to  
Automatic Recorder-Announcer.

**Address: Automatic Electric  
Toronto 16, Ontario. Branch  
Winnipeg, Regina, Edmonton**

**AUTOMATIC**  **ELECTRIC**

ORIGINATORS OF THE DIAL TELEPHONE



For further data on advertised products use page 81.



# CEPTION ALLS

the MCF  
in cutting

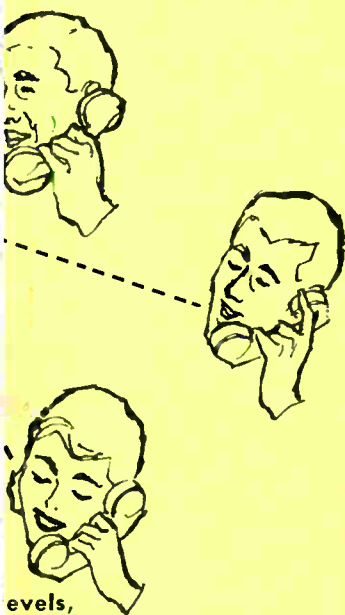

levels,  
omati-

equipped so callers are "cut in" only at beginning of  
at end of message.

## UICK AND EASY

r easy installation on the standard 19-inch relay rack  
at size, adaptors are easily fabricated, or are available  
used by almost any telephone company—its economy is  
We'll be happy to show you how you can best use this

andle revenue-producing calls, cut toll costs with the MCF  
Contact Automatic Electric for full details.

: Sales (Canada) Limited, 185 Bartley Drive,  
es: Montreal, Ottawa, Brockville, Hamilton,  
on and Vancouver.

5712

## 3 more ways to increase telephone service



Give your subscribers all types of information, quickly and efficiently, without calling the operator! Recorder-Announcers relay the messages in clear, lifelike tones, at the least possible cost to you. These three types of Recorder-Announcers improve service and build goodwill.



### AUTOMATIC TIME ANNOUNCER

"Broadcasts" time every 15 seconds automatically. Each "Broadcast" may be preceded by commercial or public service announcements. Up to 6 different announcements, each of 6 seconds duration, can be made and changed at will. 50 callers can listen at once.

### SHORT MESSAGE 'INFORMATION PLEASE' TYPE FML

For installation with fire departments, theatres, transportation companies, etc. Takes 6½ or 12-second messages. 30 callers can listen at once. Batteries provide standby power. Sample: "Fire at Jones Service Station, Main and Centre Streets . . ." or "The feature movie begins at 7.09 and at 9.40 p.m. It is called . . ."

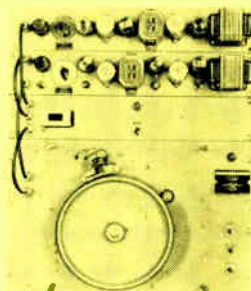

### WEATHER ANNOUNCER AND LONGER MESSAGES TYPE VML

Up to 30 callers at one time can hear weather forecasts, advertising messages, bargain announcements, ship and plane clearances, sports results, etc. Messages, up to 2 minutes in length, are easily recorded and erased. Sample: "Fair with slowly rising temperatures. Low tonight, 64. High tomorrow, 78, with slight haze in afternoon."

Power consumption and maintenance is very low for all three models. For more information write today for Circular 1845.

# For fast delivery of dependable Phillips wire and cable, make **AUTOMATIC ELECTRIC** your one source of supply



## RURAL DISTRIBUTION CABLE

A single bracket at each pole is all that's needed to attach this cable! Available with 2 to 18 twisted pairs of No. 19 gauge copper conductors—wound around a polyethylene insulated steel wire which supports cable spans of up to 200 feet! Conductors have colour-coded thermoplastic jackets and are polyethylene insulated.



## PHILPLEX SWITCHBOARD CABLES

For interconnection of telephone exchange equipment, these plastic insulated cables have higher moisture resistance and are easier to strip than textile insulated types. They also save installation time because the conductor insulation has good flow back characteristics at soldering iron temperatures. The colour coding of conductors is bright and clear. Available in a wide range of sizes.

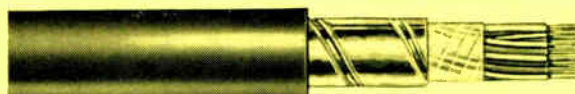

## POLYETHYLENE INSULATED, POLYETHYLENE SHEATHED TELEPHONE CABLES

For aerial messenger and underground duct installation. Light, flexible, economical. P.I.P.S. cables provide excellent transmission with high insulation resistance. Polyethylene sheath is flexible, withstands abrasion and its extremely low water absorption makes it almost impervious to the weather. Available with from 6 to 101 pairs of Nos. 19, 22 or 24 gauge copper conductors.



## STATION WIRE WITH THERMOPLASTIC INSULATION AND JACKET

Provides compact, neat installations on interior wiring jobs. Thermoplastic jacket not only protects the conductors from mechanical injury but from dampness as well. Its smooth surface remains clean and attractive.

For more information, write or call

**AUTOMATIC ELECTRIC SALES (CANADA) LIMITED**

185 Bartley Drive, Toronto 16, Ontario.

Branches in Montreal, Ottawa, Brockville, Hamilton,

Winnipeg, Regina, Edmonton, Vancouver.

**AUTOMATIC ELECTRIC**  
SALES (CANADA) LIMITED

For further data on advertised products use page 81.

# Industrial TV Projector

New Equipment Produces Wall Sized Pictures  
From Six To Sixteen Feet Wide

**D**EVELOPMENT of a new portable television projection system which throws large, brilliant pictures on a wall-sized screen reached the production line at General Precision Laboratory Incorporated. It is suitable for easy viewing of either closed-circuit or broadcast TV programs of special events by groups of 100 or more.

The new model incorporates a newly designed optical system which provides sharp, clear picture detail and greatly increases light output over earlier designs. Bright television pictures can be projected on any size screen suitable for the premises from 6 feet wide up to 16 feet wide or even more. The pictures are approximately four times as bright as those of the manufacturer's earlier portable systems which were used in such nationwide closed-circuit television events as the General Motors' 50 millionth car celebration.

The superior picture clarity and brightness of the new equipment is due to a new reflector and an advanced corrector plate design. The projection barrel uses optical elements 12 inches in diameter providing an aperture of 0.6. It is believed to be the largest aperture that has ever been achieved with good resolution in a system of

this type. The optical system has also been redesigned to simplify adjustment. A new tube support provides easier and more accurate alignment and focusing of the projection tube. Positioning of the tube in any of the three axes without interaction with the others is possible with the new support.

The optical barrel of the new projector is equipped with simple catches to facilitate removal of the covers for cleaning and adjustment. The barrel can be tilted as required to allow for centering of the picture on screen.

The entire equipment is compact and wheel mounted for mobility and can be used for closed-circuit as well as both VHF and UHF signals for TV broadcast projection. It uses a regulated 40KV power supply and is equipped with high quality sound circuits which feed any standard PA system. Special sweep failure protection circuits safeguard the projection tube. Roll-out tracks are provided for the sweep and control, TV receiver and low voltage power supply chassis which may be pivoted upward for access to all circuit components.

Its simplicity and dependability make it ideal for viewing of broadcast TV programs in clubs and hotels and equally well suited for large-screen



● New Model PB-611A television projection system developed by General Precision Laboratory of Pleasantville, N.Y. The portable unit incorporates a newly designed optical system which greatly increases light output over earlier designs.

information display in industry and for closed-circuit tele-sessions. It can also be used directly with studio or industrial TV cameras for visual presentations to overflow audiences or large groups in churches, hospitals and schools.

In addition it has been designed with the capacity to handle theater requirements for closed-circuit televised events which in the past have included championship fights.

## Achievement In Miniaturization

Nuclear Powered Battery Foreseen As Significant Component  
In Rocket Research And Deep Space Experiments

**E**LGIN National Watch Company and Walter Kidde Nuclear Laboratories, Inc., have announced joint development of a miniature nuclear-powered battery capable of delivering continuous electrical power for at least five years.

A new atomic-powered battery, approximately the size of the head of a thumb tack, has a nominal power output of 20 microwatts and is the first such device to be completely safe for extensive personal use without special precautions, according to its inventors. The battery utilizes the decay energy of a beta-emitting radioisotope as its source of energy. The battery has been developed jointly by the Elgin National Watch Company and the Walter Kidde Nuclear Laboratories Inc.

Operation of the battery depends upon a two-step conversion of energy: from beta emissions to light and from light to electricity. The light source

consists of a mixture of finely divided phosphor and an oxide of Promethium 147, one of the most abundant nuclear fission products. Beta particles emitted by the promethium are absorbed by the phosphor and converted into red and infra-red light. This light is captured by two or more photocells and transformed into electrical current.

Although not yet commercially available, the battery will eventually be used in such products as hearing aids, miniature portable radios and civil-defense warning receivers for the home. Robert C. Miller, Elgin's manager of physical research, also predicted the battery will some day be used for an atomic-powered wrist watch. In such an application, the power unit would be as safe as modern radium-treated wrist watch dials.

Additional use for the atom cell is foreseen in military high-altitude missile and rocket work and in scientific

deep space experiments. In contrast to conventional batteries, the nuclear source operates satisfactorily at extremes of environmental conditions. At temperatures as low as 200 degrees Fahrenheit below zero, voltage and power output actually increase. At temperatures up to the boiling point of water, the cell operates with a small decrease in power output.

● Identical in size with a man's shirt button is this tiny atomic-powered battery (shown here without metal shield) designed to operate continually for as long as five years.

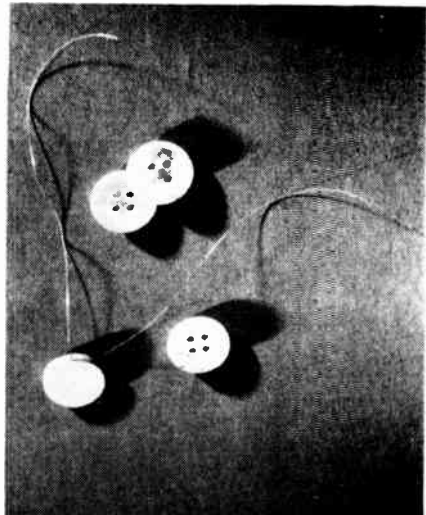

# Quality Control Printed Circuit Boards (Continued from page 41)

in Figure 4, percentage rejects are calculated, and graphs are plotted to show the reject rate from day to day as shown in Figure 5. Limit lines, based on previous experience are added to the chart before the data is obtained. This enables a constant day-by-day picture of the quality level to be made. When the reject percentage approaches or exceeds either limit line, reference is then made to the process control charts for that day's production to determine the cause of the variance.

Since there is an accumulation of between 300 and 500 boards between the time of piercing and blanking and 100 per cent visual inspection, continuous inspection at the press is maintained. This inspection deals mainly with dimensional tolerances, registration and cracks; defects in which can be corrected immediately at this stage of the operation. In addition to dimensional defects and to defects which are detected by visual inspection, there are four major board characteristics which influence the quality of the end product and can only be determined by test. These are: peel strength, heat resistance, solderability and contamination. Specifications for the determination of these characteristics have been prepared and tests are conducted both on samples of the laminate as it enters the plant and during the production stage.

## Contamination

Figure 6 shows the proposed RETMA test patterns used for testing adhesion, conductivity, solderability and temperature rise. In the production of radio and TV printed circuit boards the tests for conductivity and temperature rise are unnecessary but they are useful in circuit development work. The proposed test for solderability has not been found satisfactory and therefore will not be discussed.

The test pattern on the right in Figure 6 is used to process 2 inch square test specimens for the heat resistance test. As shown in Figure 7, these specimens are floated, copper side down in a bath of 60/40 clean molten solder for ten seconds at a temperature of 446°F, plus or minus 9°F. The specimens should show no blistering or delamination after removal from the bath.

The contamination of printed circuit boards by the various processing chemicals has led to a considerable

amount of research in the industry. In the type of board we are discussing, which consists of an unplated copper conductor pattern on a XXXP base, protected by a thin coating of water-dip lacquer, there are two sources of contamination. The first of these takes place in the etching operation and affects primarily the electrical properties of the board, and the second results mainly from the subsequent handling of the lacquered sheets and affects primarily the solderability of the board.

To maintain quality control in the latter instance without resorting to near sterile manufacturing conditions, all operators handling the boards wear clean gloves and handle them by the edges to eliminate contamination by finger prints. Immediately after inspection, the boards are wiped to remove airborne dust and are wrapped in sulphur-free paper in small lots, cartoned and sealed.

Contamination during etching is in the form of a precipitate that adheres to the board which is not explained by the simple oxidation-reduction reaction which takes place. It has been found that the side reactions involved are responsible for this condition.

These reactions are as follows:

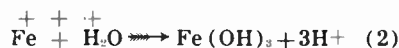
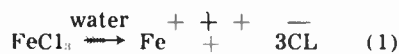

The hydrolysis of ferric chloride as expressed in equations (1) and (2) result in the formation of insoluble ferric hydroxide ( $\text{Fe}(\text{OH})_3$ ) which readily dehydrates to the complex oxide,  $\text{FeO} \cdot (\text{OH})$ . The addition of copper to the solution acts as a catalyst to the reaction with the production of additional ferric ions. It is this complex oxide which precipitates onto the boards and which must be dissolved by suitable cleaning solutions. In addition, ferric ions also adhere to the boards, but these are soluble in water, they may be rinsed off without too much difficulty. Since the boards are only subjected to the ferric chloride bath for short periods of time, the contamination is purely a surface rather than a volume degradation. There are two methods used for detecting the presence of these surface contaminants. The first of these utilizes a test pattern composed of approximately 60 alternately connected interlaced conductors 6 inches long,  $\frac{1}{16}$ " wide and spaced

approximately 0.01 inches. Such a test pattern gives insulation resistance measurements of a relatively low value for boards considered acceptable for radio and TV applications. Such measurements are made under both dry and humid conditions. Presence of ferric contamination is indicated by extremely low resistivity measurements.

The second method of testing for the presence of iron and copper contamination is by the use of a specially prepared test paper which is sensitive to 0.1 microgram of the ferric ion. This test was developed by the Stanford Research Institute under sponsorship of the United States Army Signal Corps. The chemical test paper consists of a photographic dye transfer paper impregnated with zinc acetate and potassium ferrocyanide solutions. Immediately prior to using, the paper is made ionically conductive by soaking in dilute hydrochloric acid. The paper is then placed in contact with the surface to be tested under pressure of 50 p.s.i. for five minutes during which time the metallic ions, if present, migrate into the paper to give (1) a deep blue precipitate of ferric ferrocyanide for iron and (2) a reddish-brown precipitate of cupric ferrocyanide for copper.

These tests, together with the various inspection operations carried out, properly recorded and correlated with process control data, provide a complete quality control program for high-volume production of low-cost printed circuits. This program has been largely responsible for a considerable decrease in the rejection rate of printed circuit boards in one plant since its inception some eighteen months ago. It is now being expanded to include the quality control of low-volume production of commercial and military boards which are manufactured using slightly different techniques. In general, tolerances are closer and additional tests are necessary, but the basic concept of "minimum cost and minimum requirements" remains unchanged as does the object of quality control — to systematically regulate the variables of manufacturing: materials, men, machines, and manufacturing conditions.

## Bibliography:

1. Bethel, L. L., Atwater, F. S., Smith, G.H.E., Stackman, H. A. "Industrial Organization and Management" McGraw-Hill.
2. Gamson, E. R. and Henesian, A., "Preparation of Standards and Test Procedures for Printed Circuits, 1956 I.R.E. Convention Record.

# Canadian IRE Convention-Oct.-16-17-18

phase of manufacturing. Inspection must be carried out in such a way that it is not merely a sorting operation that separates defective parts from satisfactory ones, but is an invaluable tool of Quality Control by providing a systematic tabulation of types of defects.

**Photomaster Drawing**

The first step in printed circuit board manufacturing is the prepara-

and finally, inspected, packed, and shipped to the user. Let us follow each of these operations in detail and consider how a system of quality control must be established.

Since the completed printed circuit board is basically a photographic reproduction of the master drawing, it is essential that this drawing be made to the accuracy dictated by the use of the end product. This drawing is dimensionless with the

serve to register the printing in exactly the same position from sheet to sheet. The sheets are then cleaned and are ready for printing, which is the second operation. A record of a number of items necessary for quality control is kept on production control data sheets such as shown in Figure 1. A separate control chart is designed for each operation.

Recording the sheet size used on each job when correlated to man-hours handling has established the point of diminishing returns as sheet sizes are increased. Similarly, control data on the screening operation has given valuable information on types of resist, mesh size, and squeegee rubber as related to man-hours of production time and quality of the finished board.

After a suitable drying period the sheets are inspected for defects in the printing and retouched by hand where necessary. Again a record of the time spent and the number of sheets requiring retouching is made and correlated with previous data. The sheets are then etched in a solution of ferric chloride which is maintained at a specific temperature and strength. After a thorough cleaning to remove the ferric chloride and the by-products of the etching reaction, the sheets are ready for the finishing operation. This consists of further cleaning to remove the resist, bright dipping, rinsing, and finally, lacquering to prevent oxidation of the copper. Production control data is also recorded during these operations.

After the finishing operation, the multiple sheets are ready for piercing and blanking the individual circuits. This operation is carried out in a press which has an especially designed indexing device to progressively

(Continued on page 41)

**UNITED-CARR FASTENER COMPANY OF CANADA LIMITED  
PRINTED WIRING DEPT. QUALITY CONTROL DATA**

**WEEK ENDING: July 20th, 1956  
PART NUMBER: 66800**

	BOARDS						PERCENT REJECTED					
	Mon.	Tues.	Wed.	Thurs.	Fri.	Sat.	Mon.	Tues.	Wed.	Thurs.	Fri.	Sat.
Inspected	1043	1369	1438	1521	1283	—	—	—	—	—	—	—
Registration	3	7	22	12	8	—	.3	.5	1.5	.8	.6	—
Cracks	2	3	6	3	5	—	.2	.2	.4	.2	.4	—
Opens	1	2	—	—	—	—	.1	.1	—	—	—	—
Shorts	4	1	—	—	2	—	.4	.1	—	—	.2	—
Warp or Twist	—	—	—	—	—	—	—	—	—	—	—	—
Finish	3	7	4	76	2	—	.3	.5	.3	5.0	.2	—
Total Rejected	13	20	32	91	17	—	1.2	1.4	2.2	5.9	1.3	—

Figure 4

tion of a drawing of the actual printed circuit. This drawing is usually made with black ink on a white background and is generally two to four times actual size. The drawing, or photomaster, is then photographed and a multiple positive is made from the negative thus obtained which is used to make a photographic screen stencil. The copper-clad laminated sheets are then screen-printed with acid-resistant ink, dried, etched, and cleaned. The individual circuits are punched and blanked from the multiple sheet

exception of a single reduction dimension at the bottom. The camera operator works from this dimension to produce the master negative. A multiple positive is then made on a step-and-repeat machine which spaces the individual circuits to predetermined positions with high accuracy. The photographic screen stencil is then made from this positive on a silk or metal screen.

The first production operation consists of punching three holes along the bottom edge of the sheet which

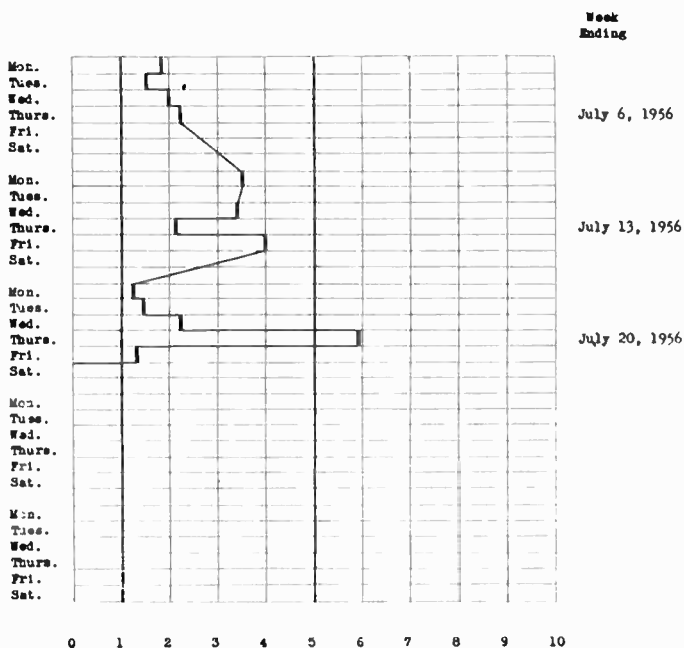

Figure 5

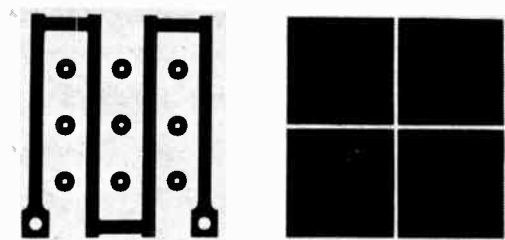

Figure 6



Figure 7

# EHF MICROWAVE GENERATORS AND SOURCES

**18,000 to 50,000 mc**  
with  
**PLUG-IN  
TUNING UNITS**



Now, with the Polarad plug-in interchangeable tuning unit feature you can equip your laboratory with Extremely High Frequency generators and sources covering 18,000 to 50,000 mc permitting wide flexibility of operation at minimum cost. Each of the various tuning units requires no further adjustment after plug-in — all voltages and controls are automatically set for proposed operation.

These new Polarad self-contained instruments operate simply with direct reading, wavemeter dials. They provide cw or modulated signals of known frequency for field, production line and laboratory testing of microwave equipment, components and systems.

Write to Polarad or your nearest representative for complete information.

### EHF Microwave Signal GENERATORS

- 7 plug-in r-f tuning units cover the frequency range from 18,000 to 39,700 mc.
- Direct-reading calibrated attenuator output, accuracy  $\pm 2$  db.
- Frequency calibration accomplished by a  $\pm 0.1\%$  direct-reading wavemeter.
- Internal 1000 cps square-wave modulation.
- Capable of external modulation, both pulse and fm.
- Equipped with integral electronically-regulated power supplies.

### EHF Microwave Signal SOURCES

- 9 plug-in r-f tuning units cover the frequency range from 18,000 to 50,000 mc.
- Internal 1000 cps square-wave modulation.
- Capable of external modulation, both pulse and fm.
- Equipped with integral electronically-regulated power supplies.
- Frequency calibration accomplished by a  $\pm 0.1\%$  direct-reading wavemeter.

SIGNAL GENERATORS Basic Unit Model HU-2		FREQUENCY RANGE	SIGNAL SOURCES Basic Unit Model HU-1	
Plug-In Tuning Unit Model No.	Power Output Catibrated		Plug-In Tuning Unit Model No.	Power Output Average
G1822	-10 to -90 dbm	18,000 — 22,000 mc	S1822	10 mw
G2225		22,000 — 25,000 mc	S2225	10 mw
G2427		24,700 — 27,500 mc	S2427	10 mw
G2730		27,270 — 30,000 mc	S2730	10 mw
G3033		29,700 — 33,520 mc	S3033	10 mw
G3336		33,520 — 36,250 mc	S3336	9 mw
G3540		35,100 — 39,700 mc	S3540	5 mw
		37,100 — 42,600 mc	S3742	Approx. 3 mw
		41,700 — 50,000 mc	S4150	Approx. 3 mw

Model SG-1218, Signal Generator and Model SS-1218 Signal Source are available to cover the frequency range 12,400 to 17,500 mc.

#### MODULATION:

Internal modulating:

Frequency ..... 1000 cps square wave.

Requirements for external pulse modulation:

Pulse repetition frequency... 100 to 10,000 pps.  
Pulse width rate..... 0.5 to 10 microseconds.  
Pulse amplitude..... 10 volts peak, minimum.  
Pulse polarity..... Positive.

Requirements for external frequency modulation:

Waveform ..... Sawtooth or sine wave.  
Frequency ..... 50 to 10,000 cps.  
Amplitude ..... Approx. 10 volts rms, to produce 40 mc deviation.



**ELECTRONICS CORPORATION**  
43-20 34th Street, Long Island City 1, N. Y.

REPRESENTATIVES IN CANADA: Measurements Engineering Limited, Arnprior, Ontario • Toronto, Ontario

For further data on advertised products use page 81.

Reliable maintenance service throughout the country is an important part of the Polarad instrument.



For private demonstration without obligation ask for the

## ELECTRONICS AND COMMUNICATIONS

announces the appointment  
to its Staff of

**WALLY EVAN-JONES**

as Promotion and Marketing Consultant

Norman McHardy, President of Age Publications Limited has announced the appointment of Wally Evan-Jones, as Promotion and Marketing Consultant to the staff of **ELECTRONICS AND COMMUNICATIONS Magazine**.



Mr. Evan-Jones has been actively associated in the electronics industry in the capacity of sales promotion and marketing fields for the past 20 years, having been previously employed with The Northern Electric Co. Ltd., Rogers Majestic Ltd., Canadian Marconi Co. Ltd.,

Canadian Westinghouse Co. Ltd. and prior to his appointment with Age Publications Limited was Branch Manager Central Ontario Sales District for Measurement Engineering Limited, and holds membership in the AIEE and I.R.E. Engineering Societies.

The new position that he will be occupying with **ELECTRONICS AND COMMUNICATIONS**, has been created in order that advertisers and manufacturers in the expanding electronics industry may have available the information and experience on marketing and sales promotion that has been obtained by his wide and extensive experience in the Canadian and American fields.

# WHAT DO YOU WANT IN A TESTING METER



The  
MODEL  
8

# AvoMeter

GIVES YOU . . .

- Automatic cutout protection
- 20,000 ohms per volt movement
- 4 ac current ranges to 10 amps.
- 7 dc current ranges to 10 amps.
- 14 ac-dc voltage ranges to 2500 v.
- 3 resistance ranges zero to 20 megohms
- 4 easy-to-read scales
- polarity reversing button
- anti-parallax mirror
- external accessories for increased ranges.

ACCURATE • PORTABLE • LIGHTWEIGHT

For detailed bulletin write to Dept. z EC2

542A

**R.H. Nichols LIMITED**  
2781 DUFFERIN STREET • TORONTO

NEY'S SMALL PARTS PLAY A BIG PART IN PRECISION INSTRUMENTS

NEY'S SMALL PARTS PLAY A BIG PART IN PRECISION INSTRUMENTS

*Ney's for  
"engineered"  
precious metal  
contacts, slip rings  
and alloys*

Consult Ney's Engineering  
Dept. on any problem  
involving precious metals to  
improve your products.

**THE J. M. NEY COMPANY**  
P.O. BOX 990 DEPT. N HARTFORD 1, CONN.  
*Specialists in Precious Metal Metallurgy since 1872*

# NEWS



## Twenty Per Cent Increase In Floor Space Planned For Canadian IRE Show

A 20 per cent increase in space is planned for the Institute of Radio Engineers' Canadian convention, October 16, 17, 18 in the Automotive Building, Exhibition Park, Toronto, Clare A. Norris, Toronto, convention general chairman, has announced.

"The decision to hold a second annual convention is due to the enormous success of the first one, and to a unanimous request from regional IRE sections across Canada, as well as exhibitors' demands for larger space," Mr. Norris states. One exhibitor who last year represented a number of manufacturers has applied for individual booths for each of those firms this year.

Mr. Norris points out that, although demands call for a jump from 120,000 square feet in 1956 to 145,000 this year, his committee has no intention or wish to produce a "super" show space-wise.

"The quality of the exhibits is a first consideration," he said, adding that the spaciousness and comfort of last year's function would be maintained. He pointed out that this was a feature which strongly impressed visitors from abroad, whose general opinion was that the buildings and surroundings were unparalleled anywhere in the world as a site for such functions.

Last year, more than 10,000 engineers, technicians and members of the public visited the three-day exposition; and 124 convention speakers presented technical papers. Dr. George Sinclair, professor of electrical engineering of the University of Toronto, chairman of the technical program committee, is already selecting papers for this year's agenda.

The convention banquet to be held October 17 in the King Edward Hotel here will again highlight the social program.

## Geo. Welter Joins Len Finkler Organization

Announcement is made by Len Finkler, manufacturer's representative, that George Welter has become associated with his organization.

Mr. Welter has been with Atlas Radio Corporation for the past two years, and previously was with Electro Sonic Supply Company.

Len Finkler and Co. now have an office at 330 Adelaide Street West, Toronto 2B, Ontario.

## Three-Way Conference Via Transatlantic Cable

An inter-continental simultaneous conference between engineers in Canada, the United States and the United Kingdom was made possible by telephone on January 24 via the new transatlantic cable.

This marked the first three-way conference to be held since the inauguration of the transatlantic cable. By using special telephone facilities, members of the Engineering Institute of Canada were able to take part in a symposium with their colleagues in London and New York.

Thomas W. Eadie, president of the Bell Telephone Company of Canada, in addressing the conference described the telephone cable as a milestone in the history of communications as well as being "a most impressive example of international cooperation."

## Collins Radio Company Appoints Secretary

Collins Radio Company of Canada Ltd. announces the appointment of Michael Spohn as secretary of the company.

Mr. Spohn is a native of Regina, Saskatchewan, and graduated from the University of Saskatchewan with B.A. and L.L.B. degrees. He has been admitted to the Bar in Saskatchewan, British Columbia and Ontario.

Mr. Spohn previously was with the British American Oil Company in Toronto.

## Windfinding Radar En Route To Antarctic

Amongst the complex scientific and electronic apparatus carried by the "Magga Dan" now en route to the Antarctic is the first radar specifically designed for the measurement of upper winds.

This new radar is the Decca Windfinding Radar W.F.I., the first of its kind in the world, and is the result of extensive research by Decca Radar Limited, who have pioneered the application of radar to meteorological problems.

The equipment aboard the "Magga Dan" is to be used by members of the Royal Society International Geophysical Year Expedition which will be established at Halle Bay for two years.

One of these Windfinding equipments has been purchased by the Meteorological Branch of the Department of Transport, and is to be tested at Toronto to determine its suitability for operation under Canadian conditions.

## Electro Sonic Supply Rep. For Spirap

Computer Control Company Inc., of Babson Park, Wellesley, Massachusetts, has announced the appointment of Electro Sonic Supply Co. Ltd., of 543 Yonge St., Toronto, as Canadian representative for Spirap electrical cable wrapping.

(Turn to page 52)



● Twelfth Annual Meeting of Canadian Radio Technical Planning Board — Chateau Laurier Hotel, Ottawa, January 17, 1957. Seated (clockwise around the table) F. G. Nixon — Controller of Telecommunications, Department of Transport; J. E. Hayes — Canadian Broadcasting Corporation; R. A. Hackbusch — President, Canadian Radio Technical Planning Board; F. H. R. Pounsett — Vice-President, Canadian Radio Technical Planning Board; W. Ornstein — Chairman, Fixed, Mobile, Land and Maritime Sub-Committee, CRTPB; F. W. Radcliffe — Secretary-Treasurer, Canadian Radio Technical Planning Board. Standing (from left) R. C. Poulter — General Co-ordinator and Director of Publicity, CRTPB; R. R. Robertson — Railway Association of Canada; L. G. Buck — Telephone Association of Canada; C. M. Brant — Department of Transport; C. J. Bridgland — Railway Association of Canada; F. A. Smith — Canadian Overseas Telecommunications Corporation; W. B. Smith — Department of Transport; J. C. R. Punchard — Radio-Electronics-Television Manufacturers Association of Canada; L. E. Coffey — Department of Transport; C. J. Acton — Department of Transport; T. S. Dutton — Canadian Electrical Association; R. Barron — Canadian Electrical Association; H. S. Dawson — Canadian Electrical Manufacturers Association; A. B. Hunt — Engineering Institute of Canada; W. J. Wilson — Department of Transport; C. F. Pattenson — Institute of Radio Engineers.



# XEMPIKA\*

\*EUREKA—It is found (Greek)

**Industry finds a "FOUNTAIN OF YOUTH" in this SELF-REJUVENATING CLARE RELAY**

Ponce de Leon failed in his quest for a "fountain of youth," but modern design engineers find rejuvenation an accomplished fact in CLARE Mercury-wetted Contact Relays... capable of billions of operations.

Contacts of these relays are constantly renewed. By capillary action, like that of a lamp wick, a new film of mercury coats the contacts with every make and break.

The magnetic switch is sealed in a high-pressure hydrogen atmosphere in a glass capsule. Surrounded by the operating coil, the capsule is enclosed in a vacuum-tube-type steel envelope.

Unlike ordinary relay contacts, these contacts never wear out; never get dirty; never lock or weld; never get out of adjustment; never bounce.

Drawings (left) from stroboscopic photographs show the cycle. (a) Filament of mercury forms between the contacts as they separate. (b) This becomes narrower in cross section and (c) finally parts at two points, allowing a globule of mercury to fall out. Mercury flows up the capillary path to replace the amount lost and restore the equilibrium. (d) The momentary bridging of the parting contacts—and the extremely fast break that ends it—minimizes the arc and adds greatly to contact load capacity. Contact closure between the two liquid surfaces bridges mechanical bounce and prevents any chatter from appearing in the electrical circuit.

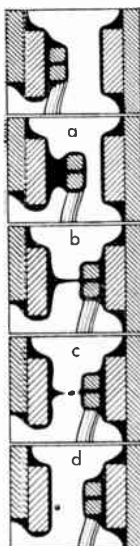

Send for CLARE Engineering Bulletins No. 120 and 122. Address C. P. Clare & Co., 3101 Pratt Blvd., Chicago 45, Illinois. In Canada: C. P. Clare & Co., 659 Bayview Avenue, Toronto 17. Cable Address: CLARELAY.

**CLARE RELAYS**  
FIRST in the industrial field

## MICRO SWITCH PRECISION SWITCHES

Small, rugged, high capacity switches designed to meet requirements of communications and electronic equipment and aircraft

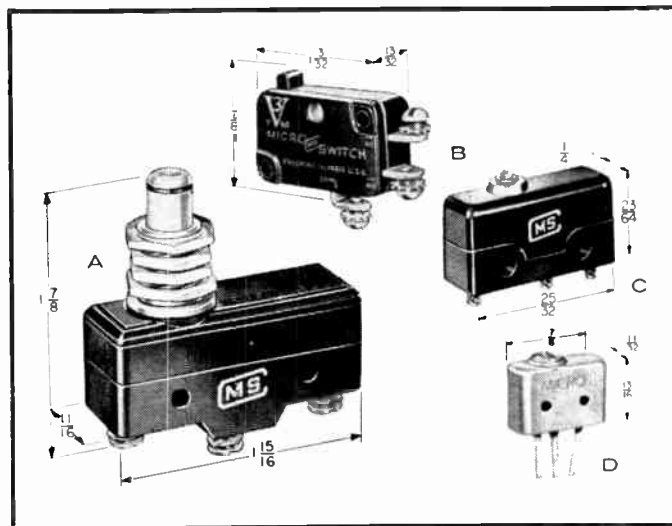

**A. "Q1" Plunger Switches.** Single-pole, double-throw basic switches for mounting through panels as manual or mechanical push button switches, as door switches, or for operation by slow moving cams. Conforms to JAN-S-63.

**B. Type "V3" Basic Switches.** Small, single-pole, double-throw switches. Lightweight with highest electrical capacity. Suitable as limit, control or safety switch where space is limited. Conforms to MIL-S-6743.

**C. Subminiature Pin Plunger Type Basic Switch.** Single-pole, double-throw pin plunger switch for use where travel of actuating mechanism is accurately controlled or with auxiliary actuators and enclosures. Conforms to MIL-S-6743.

**D. Sealed Subminiature Switch.** The smallest lightest weight switch of this type available. Completely sealed... gives trouble-free operation in a temperature range from minus 65° to plus 180° F.

**MICRO SWITCH**  
A PRINCIPLE  
OF GOOD DESIGN

MICRO SWITCH produces a complete line of switches to conform to military specifications. Available with a selection of actuators. Literature on request.

**H** **MICRO SWITCH**  
HONEYWELL A DIVISION OF HONEYWELL CONTROLS LIMITED, TORONTO 17, ONTARIO.

## NEWS

(Continued from page 50)

## Standards Engineers Form Hamilton-Toronto Section

The second section of the Standards Engineers Society to be formed in Canada during 1956 was recently established at Hamilton by twenty-two engineers representing electrical, electronic, aircraft and allied industries as well as the Hydro-Electric Power Commission and the Canadian Standards Association. This will be known as the Hamilton-Toronto Section, the first Canadian section having been formed in Montreal in April last.

Newly elected executive officers are M. J. McKerrow, Hamilton, chairman and section director; Gordon Wells, Toronto, vice-chairman; W. T. Winslow, Toronto, secretary-treasurer; and E. G. Price, Toronto, executive officer.

The Society seeks industry recognition of the standards engineer as a professional identity in partnership with other branches of the profession.

## Government Policy Re TV Rebroadcasting Stations

Transport Minister George C. Marler has recently issued an announcement concerning the development of departmental policy with regard to licensing low power stations who make use of radio transmitting apparatus for rebroadcasting off-the-air pickup of TV programs to provide coverage in areas where normal reception is not feasible.

Applications for licenses for such stations must be made in accordance with the procedure laid down for private commercial broadcasting stations.

In addition to meeting the ordinary technical requirements of the Department of Transport, applications must be able to show technically that other stipulated conditions as to grade of service etc. will be met.

It is further laid down that no application will be considered for a TV rebroadcasting station to function Brzozowski.

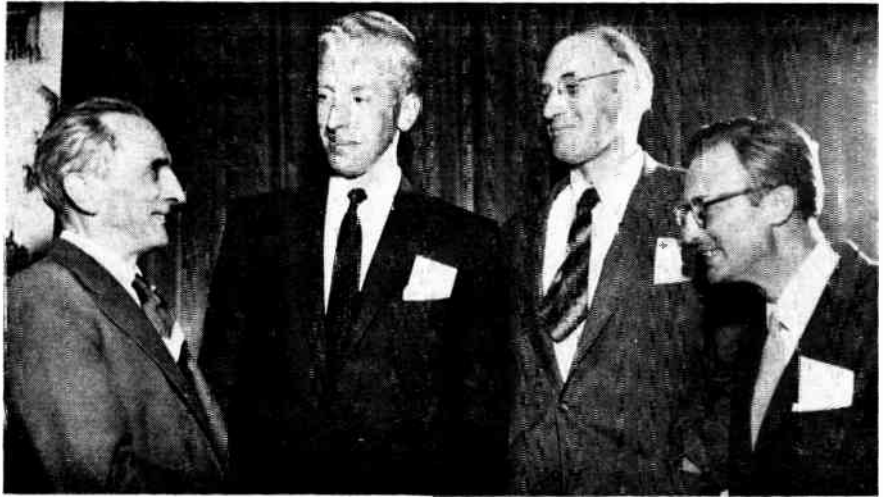

● A slate of officers for the Standards Engineers Society — the second Canadian section to be formed — was elected recently at a Hamilton meeting. The executive of the newly-formed Hamilton-Toronto section is shown above. Reading from left to right, they are: Gordon Wells (Canadian General Electric), vice-chairman; M. J. McKerrow (Canadian Westinghouse), chairman; E. G. Price (Ontario Hydro), executive officer; and W. T. Winslow (Orenda Engines), secretary-treasurer.

in an area within the Grade B coverage of a standard television broadcasting station, and that no rebroadcasting will be permitted of the transmission of any station outside of Canada, nor of any station in Canada without its consent.

The Department is not prepared at this time to consider applications for stations proposing to use "scrambler" or "pay-as-you-see" devices for TV rebroadcasting stations.

## Students' Night At Toronto Section, IRE

On Thursday, February 7th, three final year students from the University of Toronto presented papers to a joint meeting of members of the Toronto Sections of The Institute of Radio Engineers and of the American Institute of Electrical Engineers.

The titles of the papers were: "Automatic Tuning of Aircraft Antennas", by C. S. Mayer; "Model Digital Computers", by W. B. McMinn; "The Economics of Power Generation Scheduling" by J. A.

## CAE Awarded Contract For CPA Flight Simulator

An order recently placed with Canadian Aviation Electronics Limited for the manufacture of a CAE DC-6B Flight Simulator for Canadian Pacific Airlines marks a double event in the Canadian electronics industry. It is the first full Simulator to be contracted for by a Canadian airline, and it will be the first commercial model to be built in Canada.

Production of the DC-6B Flight Simulator will take place in CAE's Montreal plant and installation will be made in a special training center at the Vancouver Airport headquarters of Canadian Pacific Airlines.

This pilot training device will allow for a 50 per cent increase in effective training time for all CPA flight crews. It will permit pilots to be trained more rapidly and to a greater degree of proficiency. Furthermore, it will provide an opportunity for new or modified aircraft equipment to be tested in advance of installation, to determine crew reaction and operational efficiency.

WHEN YOU NEED  
TRANSFORMERS  
COME TO...

Hammond

Manufacturers of: RADIO, ELECTRONIC and INDUSTRIAL TRANSFORMERS

METAL CHASSIS, CABINETS and RACKS, ETC. FOR OVER 25 YEARS!

● If the EXACT type of transformer you need is not among the 1000 and more stock HAMMOND items, the factory will gladly build you a "special"!

HAMMOND MANUFACTURING COMPANY LIMITED ... GUELPH, CANADA

For further data on advertised products use page 81.

## Texas Instruments Opens Ottawa Office

Mark Shepherd, Jr., vice-president of Texas Instruments Incorporated, of Dallas, Texas, has established a semiconductor-components marketing office in Ottawa, Ontario. Mr. Shepherd states that this new office will place Texas Instruments in a better position to supply precision electronic devices to the rapidly expanding Canadian electronics market.

Until recently, Texas Instruments marketed its line of precision electronic components through a Canadian representative. However, all products of the Semiconductor-Components division will now be supplied directly to Canada through the new Ottawa office located at 53 Queen Street, Ottawa 4.

The Ottawa office will supply TI's line of electronic devices, including semiconductors, resistors, meters, and custom-built transformer-type products and will welcome any enquiries regarding other TI products.

## CDC Marketing Division Appointments

Further expansion of the Marketing Division of Computing Devices of Canada Limited has resulted in the appointment of O. P. Dernick and M. G. Goudge to the sales staff, it was recently announced by W. S. Kendall, Marketing Director of CDC.



O. P. DERNICK



M. G. GOUDGE

Peter Dernick is a native of Saskatchewan, and is an electronics graduate of the Ryerson Institute of Technology. Before joining CDC in December of 1955, he was employed as a statistical accountant with TCA, and worked in oil well radioactivity surveying with the Lane-Wells Canadian Company. At CDC he worked in the Field Service Department on digital computer maintenance.

Michael Goudge graduated from Carleton College with a B.Sc. degree. He spent some time in the Arctic doing computations for Canadian Aero Services Limited. More recently he has been a programmer in the CDC Data Processing Center.

Both Dernick and Goudge will specialize in the digital and analog computers and data reduction equipment, working from the Ottawa head office of the company.

(Turn to page 54)



## Deliquescent Domains

Western Electric has announced that their relays will no longer be available for sale to manufacturers. The problem—obviously—will be to find satisfactory equivalents.

The Sigma Type 72AOZ-160TS can replace the WE 255A polar telegraph relay. It is functionally interchangeable by design and mechanically interchangeable by means of an adapter. The "72" has been exposed to such varied field service that comparative experience for most applications can be cited.

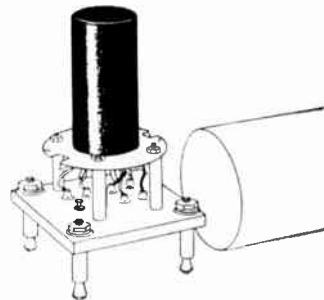
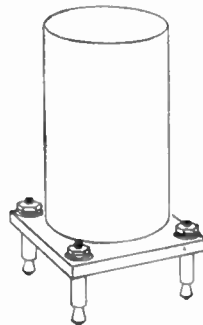

COMPARISON—WE 255A AND SIGMA 72AOZ-160TS		
	255A	72AOZ-160TS
RESISTANCE PER COIL, OHMS	136 ± 10%	160 ± 10%
URNS PER COIL	3200	2400
INDUCTANCE PER COIL, HENRY	0.9	1.0
CONTACT GAP, NORMAL MINIMUM, INCHES	.004	.004
CURRENT SENSITIVITY, ONE COIL, MA.	0.56 - 1.5	0.6 - 1.4
NORMAL RANGE OF SIGNAL LEVEL, MA.	10 - 60	10 - 60
MAXIMUM INTELLIGIBLE SPEED, PULSES/SEC. (70% CONTACT EFFICIENCY)	—	500
	WORDS/MIN. EQUIV.	1350
BIAS DISTORTION ALLOWED, 5 MA. SIGNAL 60 CPS	—	2%
PERCENT BREAK, 100 WORDS/MIN., 20 MA. SIGNAL	—	4%
TOTAL COIL DISSIPATION FOR 40° C. RISE, WATTS	2.2	1.3

\* AS MEASURED IN SIGMA LABORATORY

As for the WE 280, there is no exact Sigma replacement. We do have five different polar relays which, depending on your application, may be equivalent even though not interchangeable.

Thus, if you do not need an exact duplicate of a Western Electric polar relay, there is undoubtedly a suitable Sigma polar relay available immediately. If you do, your comments may be all the incentive we need for providing a new design.

# SIGMA

SIGMA INSTRUMENTS, INC.,

85 Pearl Street, So. Braintree, Boston 85, Massachusetts

Canadian Representatives:

SAMUEL C. HOOKER (CAN.) LTD., Montreal and Toronto • RON MERRITT, Vancouver, B.C.

For further data on advertised products use page 81.

## NEWS

(Continued from page 53)

### Canada's First Private Nuclear Reactor

Canada's first privately owned and operated nuclear research reactor will be designed and built for McMaster University's Hamilton College by AMF Atomics (Canada) Limited.

Of a pool-type design, the reactor will be financed jointly by Federal Government Agencies, the Hydro Electric Power Commission of Ontario and several Ontario Industries.

Denton Massey, general manager of AMF Atomics (Canada) Limited, said that according to present plans the research reactor will be placed in operation in the summer of 1958. tions and other electronics services former students, many thousands of whom had graduated into communica-

According to Dr. H. G. Thode, Principal of Hamilton College, the McMaster reactor will be the nucleus of a research facility which will have the dual purpose of acting as a tool for industrial research and as a training laboratory for nuclear engineers. Chief item in a new \$5,000,000 expansion program for the university, the reactor and its accessory equipment will cost in the neighborhood of \$1,300,000.

As the reactor is of the pool type design, water is the main shielding element. It will be housed in a large thirteen-sided concrete building whose size will make it the dominant feature of the University's campus, and it will adjoin Hamilton College's present nuclear research laboratory building.

### Standard Telephones & Cables Appoints Rep.

Standard Telephones & Cables Mfg. Co. (Canada) Limited have announced the appointment of the E. S. Gould Sales Company of Montreal as their stocking representative on federal miniature selenium rectifiers for Eastern Canada.

### Federated Consultants Limited Multi-Facet Engineering Firm

Provincial cabinet ministers, industrialists and many business officials were among those attending the official opening of Federated Consultants Ltd. (Davenport Rd.) Toronto, recently.

The company, incorporated under federal charter, comprises the five Toronto member firms of Hunting Technical Services Ltd; T. O. Lazarides, Lount & Co.; Karel Rybka & Associates Ltd.; Miller, Naismith, and Amco Furnace Contractors Ltd. Also in the group are eight consultant firms: Gordon S. Adamson & Associates, Toronto; Stanley R. Frost, Toronto; R. A. Hanright & Co. Ltd., St. Catharines; Jens C. Holm, Evanston, Ill.; Dr. G. Ross Lord, U. of T.; Stanley, Grimble, Roblin Ltd., Edmonton; Norman D. Wilson, Toronto; and Clyde Wyant & Associates, Oklahoma.

President of the newly-organized FCL is Dr. T. O. Lazarides, who is also president of Lazarides, Lount & Company, Toronto. Dr. Lazarides is known not only on this continent but also in Europe. One of his projects there was the enormous Dome of Discovery built for the 1951 Festival in Britain.

### Paul Corbell Posted To Varian's N.Y. Office

Paul Corbell, recently with Varian Associates of Canada, Ltd., has been appointed manager of Varian's new field engineering office at 234 East 47th St., New York City. This announcement was made by H. Styrk Stearns, executive vice-president and general manager of the Palo Alto electronics firm.

Mr. Corbell joined the firm in 1952 after eleven years' experience in development, production, and project engineering with various organizations. He is an electrical engineering graduate from the University of California. When Varian of Canada was founded in 1955, Mr. Corbell was one of five men sent from Varian Associates, Palo Alto, California, to direct operations at Georgetown, Ontario.

### Burroughs Corporation Creates New Division

Establishment of Burroughs Division of Burroughs Corporation and the appointment of Carl E. Schneider as vice-president and general manager in charge of the new organization, was recently announced by Ray R. Eppert, executive vice-president. Mr. Schneider has been vice-president in charge of industrial relations.

Appointment of Noel L. Mudd as general manager of marketing of the new division also was announced. Mudd has been director of marketing of the U.S. and Canada Marketing activity.

Formation of the new division, effective February 1, makes it the largest in the corporation, with more than 18,000 employees. More than 10,000 are in the Detroit area.

Burroughs Division responsibilities will include the present functions of the U.S. and Canada Marketing activity, which has 225 branch and area offices, and the operations of the Plymouth Manufacturing and Engineering Division, Plymouth, Mich., the Main plant on Second Avenue, the Schaefer plant, and the Windsor plant.

### Sperry Gyroscope Appoints Director of Contracts

B. W. King, managing director of Sperry Gyroscope Company of Canada, Ltd. and Sperry Gyroscope Ottawa Ltd., recently announced the appointment of R. H. Littlefield as Director of Contracts of the two companies.

Mr. Littlefield has been associated with the Sperry Canadian organizations in an executive capacity since 1952, and prior to this appointment had the position of Manager of Industrial Sales.

(Turn to page 57)



R. H. LITTLEFIELD

### \* ITEM OF THE MONTH . . .



Type 2N95 Junction Transistor.

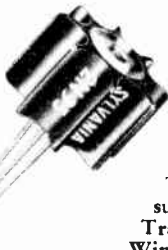

Plus Sylvania Electronic Tubes—Crystal Diodes—Microwave Crystals—Transistors—Strobotrons—Flash Tubes—Klystrons—Thyratrons—Magnetrons—Rocket Tubes—Pencil Tubes—"TR" & "ATR" Tubes—Glow Modulators—Trigger Tubes—Counter Tubes—Gas Pressure Measuring Tubes—Photo Tubes—Travelling Wave Tubes—Waveguide Windows.

Available at

## HACKBUSCH ELECTRONICS LTD.

Call or Write:—

23 Primrose Avenue

TORONTO, ONTARIO

LENNOX 1-2453

• STROMBERG-CARLSON PRODUCTS • SYLVANIA ELECTRIC PRODUCTS (ELECTRONICS DIVISION) • TECHNICAL APPLIANCE CORP. (TACO ANTENNAS) • CALEDONIA ELECTRONICS AND TRANSFORMER CORP. •

For further data on advertised products use page 81.

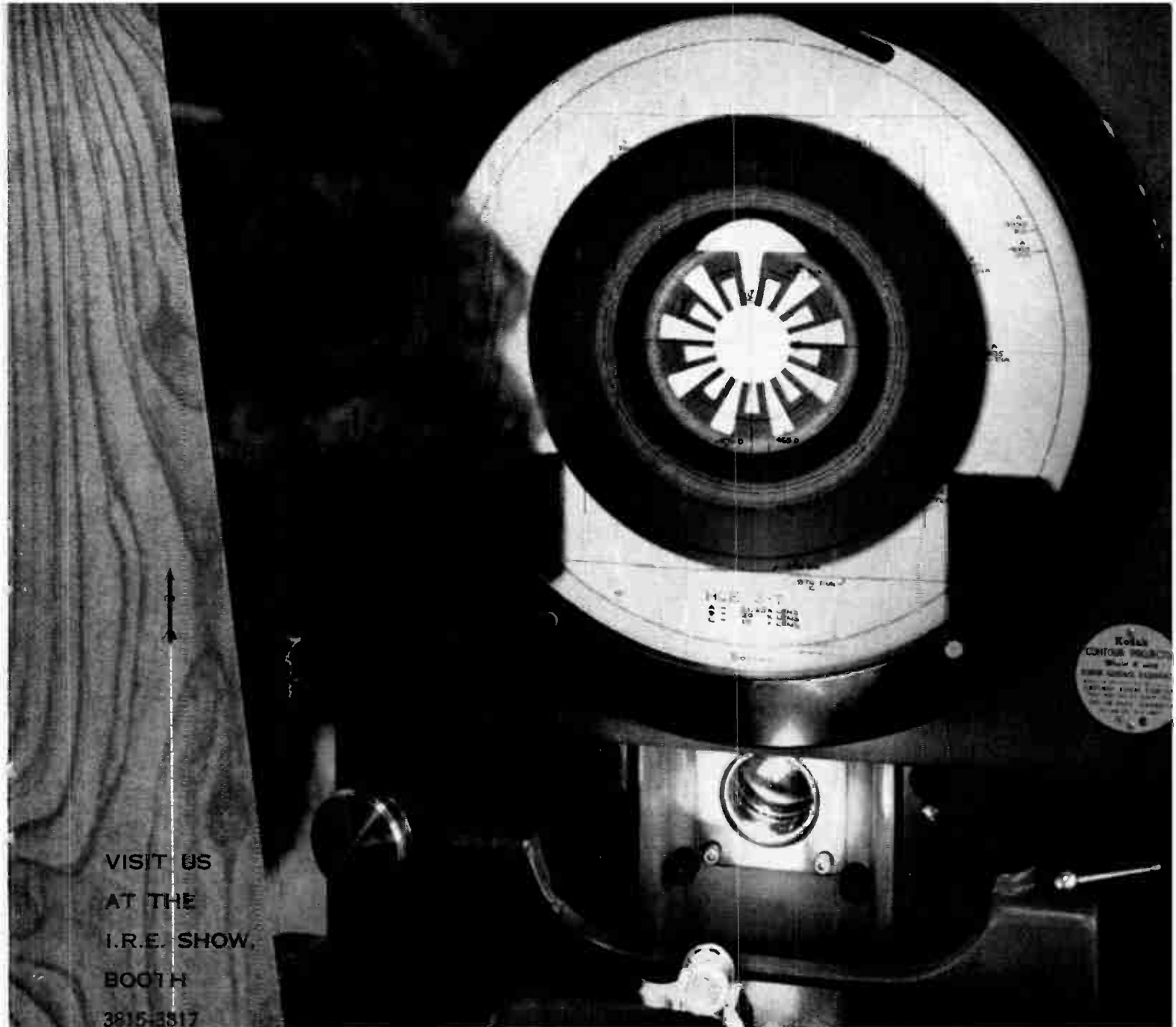

VISIT US  
AT THE  
I.R.E. SHOW,  
BOOTH  
3815-3817



## MEASURING THE "RISING SUN"...

35 times bigger than life, a "rising sun" anode appears on the contour projector screen to undergo an exacting test. To pass it, the dimensions must fall within hairline tolerances of  $\pm 0.0003"$  to  $0.001"$ .

Later, the frequency of this anode will be tested . . . and there will be other careful checks, all along the line, to make sure it measures up to the standards demanded of all Bomac microwave products.

Multiply this series of tests by a few hundred — for each of the 750 types of Bomac products — and you get some idea of the attention given here to testing and quality control. It is this constant control that has helped make Bomac a leader in its field . . . that gives each and every Bomac product an extra measure of dependability.

**Bomac** LABORATORIES, INC.  
Beverly, Mass.

Offices in major cities: — Chicago • Kansas City • Los Angeles • Dallas • Dayton • Washington  
Seattle • San Francisco • Toronto Export: Maurice I. Parisier, 1860 Broadway, N. Y. C.

*Positions now open for both  
junior and senior engineers in  
microwave tube design and devel-  
opment. The work is challeng-  
ing, advancement opportunities  
unlimited, and benefits liberal.*

R. O. R. ASSOCIATES LTD., 290 Lawrence Avenue West, Toronto 12, Canada • Tel. RUssell 1-9391

# ATTENTION, CANADIANS!

A warm welcome awaits you at the exhibits listed on this page  
I.R.E. SHOW, New York — The Coliseum — March 24 - 28.

## Andrew

CORPORATION / ANTENNA CORPORATION LTD.

Booth Nos. 1409 & 1411

New Parabolic and Communication Antennas for microwave, vhf & uhf. HELIAX, the flexible air dielectric cable. Complete rf transmission line systems.

## JFD

JFD Electronics, Corp.

Brooklyn 4, New York

Booth 2333

Components, Second Floor

Piston Capacitors, Military Communication Equipment, TV Antennas and Accessories.

Thompson Products, Inc.  
ELECTRONICS DIVISION

Booths 2527, 2529 and 2531

R. I. Armstrong, B. C. Keach, R. T. Myers, O. D. Page, D. A. Schonmeyer, F. J. Wehmler, R. A. Gardiner, C. F. Schunemann.

New Developments in Airborne Electronic Controls and Countermeasures Transmitters. Also a complete line of Microwave Switches and Accessories.

Cascade Research Corp.

Booth 3607 - 9

Dwight Caswell • Jay Stone  
M. B. Adelson

Complete line Microwave Ferrite Devices, \*5 megawatt S-Band Uniline Load Isolator, Ferrite \*Circulators, \*Duplexers, unique \*Z-Scope Microwave Impedance Plotter, \*Microwave AGC, \*X-Band B.W.O.



VARIAN associates  
OF CANADA, LTD. - GEORGETOWN, ONTARIO

Booths 2530 and 2532

KLYSTRONS for every application

Electronic Tube Corp.

3rd floor, Booth No. 3112 - 3113

K. C. Meinken • R. F. Brunner  
R. T. Rude • W. C. Hill

Presenting a new dual channel high-frequency oscilloscope, and variable-speed 'scope camera (up to 12,000 in./min.). Also a complete line of single- and multi-gun radar and instrumentation cathode ray tubes.

CURTIS

Terminal Blocks

Better Connections  
Economically—Quickly  
A type for every purpose

Booth 2827

AIRTRON, INC.

LINDEN • NEW JERSEY

Booth No. 3318

Canadian Affiliate

Airtron Canada Limited, 300 Campbell Avenue, Toronto 9, Ontario.

Microwave Ferrite Components — Antenna Feeds — Rotary Joints — Flexible Waveguide Assemblies — Precision Cast Mixers, Duplexers, Hybrids, Directional Couplers, Double Ridge Waveguide, Lightweight High Power Terminations. Equipment available in Airtron, Inc. designs or to your specifications.

NEW

Pulse Generator, Klystron Oscillator, Variac® Autotransformer, D-C Amplifier and Electrometer, Impedance Comparator.

Also Signal Generators, Z-Y Bridge, Sweeps, UHF Measuring Equipment



GENERAL RADIO CO.  
CAMBRIDGE, MASS.

251-255 Instruments Aves., at Radio Rd.

LEADERS IN QUALITY,  
AVAILABILITY

For a complete line of  
RECEIVING AND PICTURE TUBES

POWER AND TRANSMITTING TUBES

TRANSISTOR, DIODES AND RECTIFIERS



Electronic  
TUBES

CANADIAN GENERAL ELECTRIC COMPANY LIMITED

For further data on advertised products use page 81.

## NEWS

(Continued from page 54)

### 3M Sales Administration Appointment

The appointment of J. A. Gauthier as manager, sales administration of Minnesota Mining and Manufacturing of Canada Limited, London, Ontario, has been announced by J. V. Powell, director of sales.



J. A. GAUTHIER

Mr. Gauthier will assist in formulating and implementing sales administrative policies. He will co-ordinate these between the director sales and sales managers.

During his 15 years with 3M and associated companies, Mr. Gauthier has acquired a thorough knowledge of the many and diversified 3M products, and has continually accepted increasing responsibilities during this period.

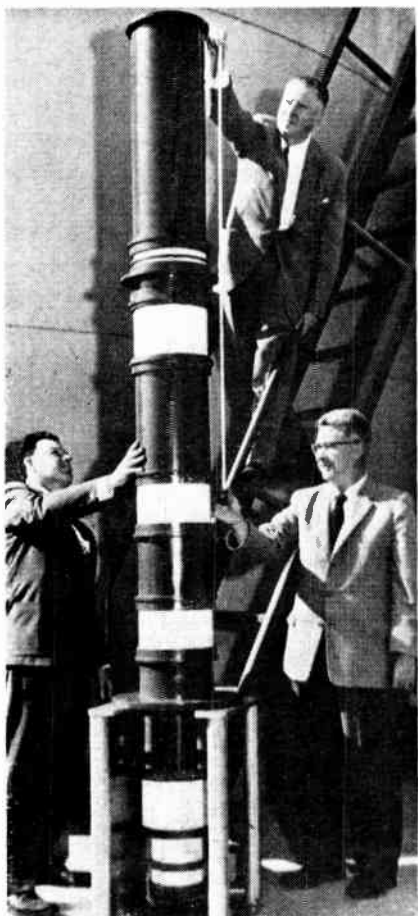

● John Foster (top above) of Ahearn and Soper Co. Ltd., Ottawa, measures the world's largest electron tube, a 40 foot five inch klystron, with J. A. McCullough, executive vice-president of Eitel-McCullough, Inc., manufacturer of Eimac electron tubes, as company president W. W. Eitel looks on. The giant super power tube, developed and introduced in San Bruno, California, will be used in radar and linear accelerator applications. Ahearn and Soper represents Eimac in Canada.

# D-695

THE

MUIRHEAD

DECADE OSCILLATOR

with all the best features, prominent among which are:—

- $\pm 0.2\%$  frequency accuracy within 5 minutes of switching on
- Exceptional low harmonic content
- Output level constant to  $\pm 0.5\text{dB}$  (20 c/s-30 kc/s)



## SPECIFICATION

### THE D-695 MUIRHEAD-WIGAN DECADE OSCILLATOR

#### FREQUENCY RANGE

10 c/s-31 200 c/s (continuously variable) in two ranges ( $\times 1$  and  $\times 10$ )

FREQUENCY ACCURACY (within 5 minutes of switching on)

$\pm 0.2\%$  (or better) above 100 c/s, decreasing to  $\pm 0.3$  c/s at 10 c/s

HOURLY STABILITY Better than  $\pm 0.02\%$

RESETTING ACCURACY 0.1 c/s on  $\times 1$  range : 1.0 c/s on  $\times 10$  range

HARMONIC CONTENT AT AN OUTPUT LEVEL OF 10 mW

30 c/s-30 kc/s  $0.2\%$  into 600 ohm balanced or unbalanced;  $0.5\%$  into 10 k ohm unbalanced.

Below 30 c/s Increasing gradually to about  $0.6\%$  in the two unbalanced conditions and about  $4\%$  in the 600 ohm balanced condition at 10 c/s

HUM LEVEL WITH RESPECT TO 10 mW

$-70\text{dB}$  ( $0.03\%$  of the output voltage at 10 mW)

VARIATION OF OUTPUT LEVEL WITH FREQUENCY

50 c/s-10 kc/s Flat within  $\pm 0.1\text{dB}$  20 c/s-30 kc/s Flat within  $\pm 0.5\text{dB}$   
Below 30 c/s  $\pm 1\text{dB}$

MAXIMUM UNDISTORTED OUTPUT POWER 10 mW

POWER SUPPLY

95-125V, 60 c/s (D-695-A/100) 190-250V, 50 c/s (D-695-A)

OVERALL DIMENSIONS

17½ in. wide  $\times$  12½ in. high  $\times$  8 in. deep (44.5 cm  $\times$  31.8 cm  $\times$  20.3 cm)

WEIGHT 37 lbs (17 kg)

WRITE NOW FOR PUBLICATION 4718

MUIRHEAD INSTRUMENTS LIMITED • STRATFORD • ONTARIO • CANADA

239/3

**NEWS**

(Continued from page 57)

**CAE (Western) Sponsors Radar Defense Meeting**

Canadian Aviation Electronics (Western) in Winnipeg was host recently to a conference which brought together commanders and officers from all eight United States Air Force Pinetree Radar and Warning sites extending from the Pacific Ocean to Eastern Ontario.

The purpose of the meeting was to discuss with the radar officers the enlarged role assumed by the company in the maintenance of the USAF sites within the Pinetree radar chain. Under the extended program CAE (Western) will supply each USAF Pinetree radar site with on-site support through a five-man self-contained group consisting of one resident engineer, two radar, one communication and one diesel technician.

**Electrolabs Represents American Condenser Corp.**

The American Condenser Corporation has announced the appointment of Electrolabs, 7385 St. Lawrence Boulevard, Montreal 16, Que., as its Canadian representative.

This firm has been supplying its

comprehensive line of paper, electrolytic, and oil condensers mainly to the Chicago area and is now in process of expanding its sales organization to include all Canadian and American manufacturers.

**CDC Technical Division Appointments**

Two new appointments in the Technical Division of Computing Devices of Canada Limited have been made necessary by the increased activity of the company.



A. W. DUGUID



R. E. FREEMAN

Mr. A. W. Duguid has been appointed Manager of Engineering and Development, and Mr. R. E. Freeman is the new Manager of Manufacturing. Both will report to Technical Director J. S. Parsons.

Mr. Duguid is a Rhodes Scholar, with a degree in Honour Physics. He served from 1940 to 1946 in the Royal

Canadian Artillery, retiring with the rank of Major. Since graduation from Oxford in 1949, he has been with the Defense Research Board.

Mr. Freeman is a graduate of Queen's University, with postgraduate work in electronics. More recently he has taken courses in executive development and policy formulation and administration at the Executive Development Institute, Montreal.

**G. L. Curtis Joins Federal Telecommunication Lab.**

George L. Curtis has been appointed systems planning engineer in the Palo Alto research and development facility of Federal Telecommunication Laboratories, a division of International Telephone and Telegraph Company.

Prior to joining FTL, Curtis was a member of the application-engineering division of Lynch Carrier Systems in San Francisco and responsible for customer applications and sales engineering in Western U.S.A. and Canada for that company.

In previous years Curtis has been associated with the Ontario Northland Railway as a communications engineer; with the Bell Telephone Company of Canada in exchange, toll, transmission, and mobile-radio engineering; and with the R.C.A.F. as radio-radar officer and pilot.



**ADCOLA**  
PRODUCE LIMITED  
REGD. TRADE MARK

**"SECUNDUS"**  
**SOLDERING INSTRUMENT**

A neat and sturdy instrument specially produced for fine and delicate work.

List No. 70  
1/8" detach. bit  
CSA Approved

Supplied in most voltages or to your own special requirements.

Canadian Rep:  
**LESLIE J. LAMB,**  
Box 103, Weston, Ont.

U.S. Agents: **Stratford Electronics Inc.,** P.O. Box 1114, New York 1, N.Y.



**THE GOAL FOR 1957**

**VISIT HANNOVER**

**THE GERMAN ELECTRICAL INDUSTRIES EXHIBITION**

The greatest market for investment and consumer goods only at the German Industries Fair,

**HANNOVER**  
April 28 - May 7, 1957

Information and Catalogues from:  
The Trimont Corporation Ltd.  
1170 Drummond St., Montreal, P.Q.  
Tel. UN. 63088-89

und Zentralverband der Elektrotechnischen Industrie, Frankfurt/M., Am Hauptbahnhof 12

For further data on advertised products use page 81.



INTRODUCING...

*the first combined*

# G P C AND D D A



\* GENERAL PURPOSE DIGITAL COMPUTER AND DIGITAL DIFFERENTIAL ANALYZER



*ultimate versatility  
in solving complex  
technical  
problems...*

The general purpose digital computer solves most scientific and engineering problems with speed and accuracy... yet easier programming makes the digital differential analyzer a superior choice for solving differential equations. Bendix now combines the advantages of both in the *new* G-15D Computer and its optional DDA accessory. Working together, and supported by a full complement of input-output equipment, these units provide the *best* means of solution. And the rental or purchase cost is far below that of most general purpose computers alone.

*A new brochure tells the details of the G-15D's talent for conserving your scarce engineering manhours. Let us send you a copy.*

5702



**COMPUTING DEVICES OF CANADA LIMITED**  
P.O. BOX 508 • OTTAWA • CANADA

# new products

New Product specifications published in Electronics and Communications have been briefed for your convenience. If you require further information on any of the items published you may readily obtain such by using our Readers' Service, Page 81. Just mark the products you are interested in on the coupon on Page 81 and the information will be in your hands within a few days.

## ● Rectilinear Galvanometric Recorder

Item 1436

Houston Technical Laboratories announce the availability of a new rectilinear galvanometric recorder — The Recti-riter. In addition to true rectilinear writing this instrument boasts a long list of features and improvements over previously available instruments of this type.



Accessory equipments available include internally mounted transistorized input amplifiers, expanded scale power line monitors, shock and rack mounts, marker pens, and gear shift speed change.

The instrument is available in multiple channel versions.

Represented in Canada by Instronics Limited, 11 Spruce St., Stittsville, Ontario.

## ● Broadband Silicon Crystal For Video Detector Use

Item 1437

A new, extremely broadband millimeter waveguide crystal, suitable for mixer or low level video detector use in the range of 26.5 to 75 kilomegacycles, has been announced by Microwave Associates, Inc., Boston. Two of the most important immediate applications will be in the field of high-definition radar and in microwave spectroscopy.

According to the Massachusetts electronics firm, the silicon diode, designated MA-412, is the first truly broadband millimeter waveguide crystal commercially available for military and industrial applications. The new device measures  $\frac{1}{8}$  by  $\frac{3}{4}$  by  $\frac{3}{8}$  inch, and is cased in silver plated brass. The case forms a section of ridged waveguide, with the crystal as an integral part. It may be adapted for high sensitivity broadband performance in standard rectangular waveguide applications, or for broadband ridged waveguide.

Tapered transition sections adapt the ridged waveguide crystal input for use with RG-96, RG-97 or RG-98/U waveguide. The MA-512 transition section is available for use with the new crystal in RG-98/U waveguide over the 50-75 Kmc band.

For further information, write Microwave Associates, Inc., 22 Cummington Street, Boston 15, Massachusetts, U.S.A.

## ● Bulletin B1A Covers BT Resistors

Item 1438

International Resistance Company Ltd., announce the availability of bulletin B1A covering advanced type BT fixed composition resistors. This bulletin covers new design features and reliability data, specifications, characteristics, and complete information and charts in connection with type BT  $\frac{1}{4}$ ,  $\frac{1}{2}$ , 1 and 2 watt fixed composition resistors.

For over the past 25 years IRC have re-designed, re-engineered and re-evaluated these resistors so that today type BT resistors make available improved performance and increased dependability in fixed composition resistors meeting JAN specifications. These advances coupled with results of over 500,000 individual tests by IRC, elevate BT dependability to a point where engineers can predict performance with a reliability never before possible.

For complete information write for bulletin B1A to International Resistance Co. Ltd., 349 Carlow Ave., Toronto, Ontario.

## ● Narda Model 229 Tuneable RF Probe

Item 1439

A new precision, tuneable RF Probe, Narda Model 229, which includes an optional detector for use with all waveguide and coaxial slotted lines provided with a standard  $\frac{3}{4}$  inch diameter mounting hole, has been announced by The Narda Corporation, Mineola, L.I., New York. Insertion loss is 25db. or less in most slotted lines.

The Narda Model 229 has a fine wire probe adjustable in depth over a wide range by a fine-pitch threaded knob. This fine wire probe is an extension of the center conductor of a coaxial line which is provided with shunt and series tuning elements for tuning the probe pickup over the range of 900 to 18,000 megacycles. There are two probe outputs. A detector output, which takes a BNC series connector, has provision for a standard microwave crystal. Series IN21 or IN23, or a Narda N-610B Bolometer. Because of its r-f output, the Model 229 RF Probe can be used with microwave receivers or other internal detectors.

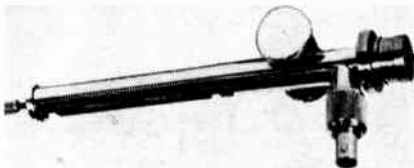

The Narda Model 229 RF Probe is mechanically and electrically equivalent to and interchangeable with the military probe MX-1019/U. Improved contact design in the Narda model permits its use over a wider frequency range than the standard military model.

The Model 229 is recommended for use with Narda Models 219, 220, 221, 222, 223, 224, 231 and 232 waveguide and coaxial impedance meters.

Canadian Representative: Measurement Engineering Limited, Arnprior, Ontario.

## ● Brochure On Infrared Weapons Systems

Item 1440

The eminence of Servo Corporation of America in the development and production of infrared weapons is the result of the company's appraisal, at the close of World War II, of prospective military operations.

The first to adapt the principles of infrared detection to weapons systems, more than 700,000 engineering man-hours have been expended in the development of infrared systems and 21 different infrared systems produced and delivered.

A new eight-page brochure describes infrared applications and research. For further information, request Catalog IR 9902 from Servo Corporation of America, 20-20 Jericho Turnpike, New Hyde Park, N.Y., U.S.A.

## ● Remote Radiation Monitoring System

Item 1441

The Victoreen Remote Radiation Monitoring System is a complete system designed to meet the requirements of the Atomic Energy Commission for monitoring radiation at a number of locations from a single control point. In reactor installations, hospitals and laboratories where radiation is done simultaneously in many different places, this system offers a reliable and convenient method of monitoring the radiation level.

The system covers a wide range of radiation intensities. Ionization chambers are available to cover the ranges from .01 milliroentgens per hour up to 1 million roentgens per hour. Standard chambers are designed to cover a range of any three consecutive decades. Six decade logarithmic scales are available on special request. The system requires negligible maintenance and gives a high degree of reliability over a long period of time.

Incorporated in each plug-in station unit is an alarm type meter which can be pre-set over the sensitivity range of the detector, giving an alarm when the radiation goes beyond the level set on the meter. The system can handle from one to twenty such stations from a single control unit and can be cascaded upward to any desired number of channels. Each channel consists of a plug-in station and a remote radiation sensing element or detector.

Canadian Representative: Radionics Limited, 8230 Mayrand St., Montreal 9, Que.

## ● Sun-Powered Solaradio

Item 1442

Latest electronic achievement in the consumer entertainment field is the new sun-powered Home & Travel Solaradio.

Lifetime usage is built into the Solaradio through the solar battery pack encased in its unique carrying handle. This pack is an array of silicon solar cells which converts sunlight into electricity to power the radio. At the same time, the solar cells recharge the batteries in the set for nighttime operation. In the absence of sunlight, an incandescent light can serve to charge the batteries or operate the radio. Thus, by periodic exposure to sunlight or incandescent light, the Solaradio can provide unlimited operation.

Hoffman Radio Division, Hoffman Electronics Corporation, 3761 S. Hill St., Los Angeles 7, Calif., U.S.A.

## ● *Glide Slope Receiver*

Item 1443

A new aircraft Glide Slope Receiver, featuring a transistor power supply in place of the usual dynamotor or vibrator has been announced by Dare, Inc., Troy, Ohio. The new unit, weighing only 6¾ pounds fits the short ¼ ATR rack. Up to 20 crystal channels are selected by a Ledex Rotary Solenoid, controlled by an Instrument Panel Switch. The entire unit has been designed to the electrical performance requirements of RTCA paper DO-58.

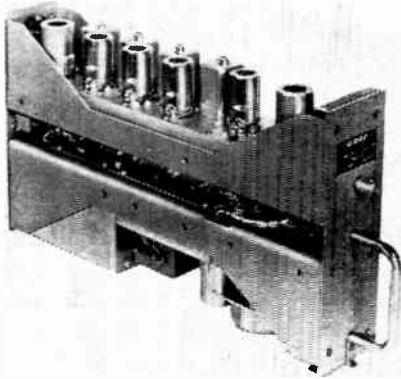

The new transistor power supply replaces the usual power units with an all-electronic means of converting the aircraft battery current to alternating current. Two Dare transistors operating as a multivibrator circuit produce an alternating current with ample power for all requirements of the receiver.

The Dare Model DGS-20 provides a sensitive highly selective circuit for use with as many as 3 indicators at a time. It is supplied with 10 crystals to cover all channels presently used in the 329.3 to 335.0 mc. range. An additional 10 crystals may be used to cover future requirements. Modular design has been employed to simplify servicing. All vacuum tubes are ruggedized.

For additional information write Dare, Inc., Troy, Ohio, U.S.A.

## ● *1 3/4" Attenuator* With 30 Steps

Item 1444

The Daven Company announces the availability of an unbalanced ladder network — the series LA-130. The LA-130 series are low impedance controls for use in broadcast equipment and public address systems. Because of the compact design of these units, they are very well suited for use in portable equipment or in installations where limited mounting space is a factor. They offer a wide range of control (30 steps of attenuation) in a housing only 1¾" in diameter by 1½" deep.

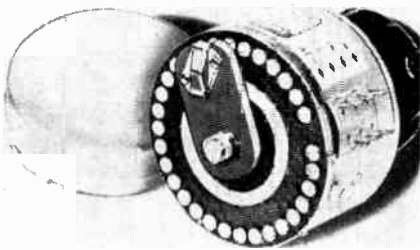

Due to the low price of these attenuators, they may readily be adapted as mixer or master gain controls in popular priced equipment. A large selection of various impedance combinations and decibel losses are available in these units from stock.

Additional data on the new series LA-130 attenuators may be obtained from The Daven Company, 530 West Mt. Pleasant Ave., Livingston, New Jersey, U.S.A.

(Turn to page 63)



## Now - threaded ceramics that permanently hold precision tolerances!

- Centralab  
Engineered  
Ceramics . . .
- can be extruded or molded
  - can be worked before firing the same as metal
  - ground, drilled, threaded, or tapped
  - can be metallized

### Another reason to insist on Centralab

- ⬢ Threads ground into the ceramic itself — after firing. There's no shrinkage to cause variations in width and depth.
- ⬢ Other fired-ceramic precision-grinding operations include centerless, cylindrical, disc, surface, and lap grinding — to precision tolerances previously unavailable.
- ⬢ Ask Centralab to quote on your requirements.

Write for Centralab's Ceramic Buyer's Guide, Bulletin 42-221. Or refer to it in Sweet's Product Design File.

**Centralab Canada Ltd.**

804 Mt. Pleasant Rd., Toronto 12, Ontario

**A DIVISION OF GLOBE-UNION INC.**

964L East Keefe Avenue • Milwaukee 1, Wisconsin  
In Canada: 804 Mt. Pleasant Road, Toronto, Ontario



# Another Esco First!



For the first time anywhere — a Radio Parts Catalogue devoted solely to the specialized electronic components and devices used in the Industrial, Military, Laboratory and Engineering fields. Ensure getting your FREE copy of this unique and informative book — write us today!

**free!**

Industrial Catalogue No. 561

**ELECTRO SONIC**  
SUPPLY CO. LTD.  
543 YONGE ST., TORONTO 5  
WA. 4-9301



## FREED DISTORTION METER



NO.  
1410

### USES

The Type 1410 Distortion Meter may be used in the laboratory or in production testing of receivers, amplifiers and oscillators.

**Frequency Range:** 20 kc to 1 mc.

**Input Impedance:** 500,000 ohms shunted by 70 mmfd. (plus capacity of input cable) on all ranges but the 0.1 volt range. The shunt capacity on this range is 800 mmfd.

**Accuracy:** Harmonic Distortion can be measured accurately to 0.1%.

**Sensitivity:** Distortion levels of 0.1% can be read accurately for a signal input as low as 0.2 volts. Maximum input signal is 1000 volts rms.

**Elimination Characteristics:** Eliminates fundamental completely while attenuating second harmonic approximately 3%.

Send for NEW 48 page transformer catalog. Also ask for complete laboratory test instrument catalog.

**FREED TRANSFORMER CO., INC.**

1716 WEIRFIELD ST., BROOKLYN (RIDGEWOOD) 27, N.Y.

## SPECIFY *Hoyt* METERS



FOR  
**EVERY**  
**APPLICATION**

No. 653  
(illustrated)

A new 3½", clear polystyrene cased meter, specially designed for modern component applications.

Be sure of highest accuracy, dependability, and readability PLUS economy with HOYT precision AC and DC instruments — the complete line of Panel Meters. Moving coil, rectifier, and repulsion types promptly available in a wide variety of sizes, ranges, cases, and colors. Also, custom designed to comply with your specifications.

Write for NEW literature containing descriptions, engineering data, and prices.



**Hoyt** ELECTRICAL INSTRUMENTS  
Sales Div.: BURTON-ROGERS COMPANY  
42 Carleton Street, Cambridge 42, Mass., U.S.A.

## Quick Switches

are a

**DAVEN**

Specialty

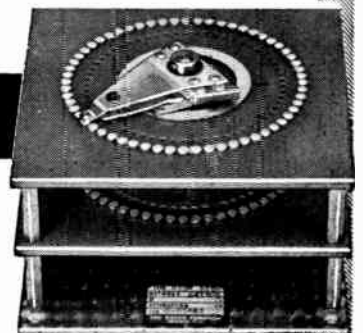

And the "specialty of the house" is double-barreled . . . first, choose from hundreds of standard units to satisfy your needs—for quick switch delivery . . . second, Daven can effect quick 'switches' or changes from standard units to special switches, by using components at hand. That, too, makes for speed, dependability, economy. Write for more detailed data.

IN CANADA:  
**THE DAVEN** Co. Adams Engineering Ltd.  
550 W. Mt. Pleasant Ave., Livingston, N.J. Montreal and Toronto

Write for FREE copy of DAVEN's new, 28-page brochure on SWITCHES!

For further data on advertised products use page 81.

**NEW PRODUCTS**

(Continued from page 61)

● **Technical Manual On G-E Thermistors**

Item 1445

Heat practically any material and its resistance increases. But heat a G-E thermistor and its resistance decreases tremendously.

For a temperature range from -50°C. to 200°C, resistance of copper or platinum, for example, doubles. Over the same temperature range, resistance of thermistors decreases by a factor of 10,000. With some thermistors it is possible to reduce resistance 50 per cent with a temperature increase of 17°C.

Large temperature coefficients and other nonlinear characteristics make thermistors ideal low-cost circuit elements for the measurement and control of minute temperature changes. These electronic semiconductors eliminate costly, fragile components. They never wear out, never need maintenance.

To help designers evaluate the circuit possibilities of thermistors, Canadian General Electric offers engineering assistance, and a 54-page Technical Manual.

Further information may be obtained from Thermistor Sales, Canadian General Electric Co. Ltd., 940 Lansdowne Avenue, Toronto, Ontario.

● **Differential Gain and Phase Analyzer**

Item 1446

Type 2036, a new differential gain and phase analyzer intended primarily for measuring the transmission characteristics of color television networks, has been developed by Tel Instrument Electronics Corporation, of Carlstadt, New Jersey.

The analyzer is designed for use with any standard stair-step generator having a 3.58 megacycle subcarrier. It features a high impedance input, extremely high sensitivity and low noise together with a unique differential gain presentation. A precise continuously variable, 360° phase shifter makes the Type 2036 particularly suitable for color signal certification and large differential phase measurements.



Major features of the TIC analyzer include:

1. A high Z probe input and attenuator for point-by-point analysis, permitting use with any signal from 1 to 600 V, P-P.
2. Unique circuitry enables differential gain display at 2 per cent per cm on ordinary oscilloscopes having sensitivity of 0.5 v/cm.
3. Differential phase output is 0.125 volts per degree.
4. An unusual and precise internal calibration system allows the calibration of a scope linearly for differential phase up to 10 degrees, permitting direct reading.
5. Calibration dial quickly re-set to zero at any desired reference phase.

Canadian Factory Representatives: Atlas Radio Corporation Ltd., 50 Wingold Ave., Toronto 10, Ontario.

(Turn to page 64)

**SPECIALLY BUILT TO WITHSTAND SEVERE OPERATING CONDITIONS**



**HARD GLASS TUBES**

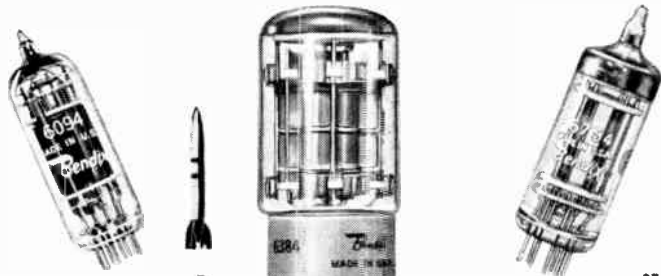

6094  
BEAM POWER AMPLIFIER

6384  
BEAM POWER AMPLIFIER

6754  
FULL-WAVE RECTIFIER

● Ideal for modern high-performance aircraft and missiles.

● Processing at higher vacuum and under the higher heat permitted by the hard glass reduces gas and contamination and provides greater operating stability at higher temperatures.

● Ceramic element separators prevent emission loss from high heat and vibration.

● Solid aluminum oxide heater-cathode insulator eliminates shorts, reduces leakage.

For further information, write AVIATION ELECTRIC LIMITED, 200 LAURENTIEN BLVD., MONTREAL, P.Q.

ELECTRICAL RATINGS*	6094 Beam Power Amplifier	6384 Beam Power Amplifier	6754 Full Wave Rectifier
Heater Voltage (AC or DC)**	6.3 volts	6.3 volts	6.3 volts
Heater Current	0.6 amp.	1.2 amp.	1.0 amp.
Plate Voltage (Maximum DC)	300 volts	750 volts	350 volts
Screen Voltage (Maximum DC)	275 volts	325 volts	—
Peak Plate Voltage (Max. Instantaneous)	550 volts	750 volts	—
Plate Dissipation (Absolute Max.)	14.0 watts	30 watts	—
Screen Dissipation (Absolute Max.)	2.0 watts	3.5 watts	—
Heater-Cathode Voltage (Max.)	±450 volts	±450 volts	±500 volts
Grid Resistance (Maximum)	0.1 Megohm	.1 Megohm	—
Grid Voltage (Maximum)	5.0 volts	0 volts	—
(Minimum)	-200 volts	-200 volts	—
Cathode Warm-up Time	45 sec.	45 sec.	45 sec.

\*For greatest life expectancy, avoid designs which apply all maximums simultaneously.

\*\*Voltage should not fluctuate more than ±5%.

MECHANICAL DATA	6094	6384	6754
Base	Miniature 9-Pin	Octal	Miniature 9-Pin
Bulb	T-6½	T-11	T-6½
Maximum Over-all Length	2½"	3½"	2½"
Maximum Seated Height	2½"	2½"	2½"
Maximum Diameter	¾"	1½"	¾"
Mounting Position	Any	Any	Any
Maximum Altitude	80,000 ft.	80,000 ft.	80,000 ft.
Maximum Bulb Temperature	300°C	300°C	300°C
Maximum Impact Shock	500G	500G	500G
Maximum Vibrational Acceleration	50G	50G	50G



HALIFAX • TORONTO • MONTREAL • CALGARY • VANCOUVER

## NEW PRODUCTS

(Continued from page 63)

### ● Vibration Meter Item 1447

The Vibration Meter is designed for the direct measurement of the three important characteristics of vibration, the displacement, velocity and acceleration. Unwanted, or excessive vibration in machines and structures can be easily located so that the necessary corrective action can be taken before serious damage occurs. The instrument is invaluable at all stages of research, design and production testing, where detrimental effects of wear and noisy operation must be avoided.



It comprises a vibration pickup, which is a moving coil type, giving an output voltage proportional to the velocity of the motion under investigation, a high gain amplifier incorporating integrating and differentiating networks and an adjustable attenuator, together with a direct reading indicating meter. The required characteristic of vibration, displacement, velocity or acceleration is selected by a three way

switch. Inputs are provided for two separate pickups so that the vibration at two separate points can be measured by simply operating a panel switch. An output jack is provided so that the amplified signal can be displayed on a cathode-ray oscilloscope or can be connected to a suitable analyzer.

The instrument can also be used as a sensitive audio frequency amplifier or vacuum tube voltmeter. The maximum sensitivity for full-scale deflection on the meter is as follows: for displacement 0.0003" zero to peak; for velocity 0.003 in/sec. peak; for acceleration 100 in/sec<sup>2</sup> peak. Nine scale ranges are provided reading 0-3 and 0-10 with the total attenuation of 10,000 to 1. Integrating and differentiating networks are accurate to within 3 per cent between 10 c/s and 1,000 c/s.

Dawe Instruments Ltd. (Canadian Division), 1654 Bank Street, Ottawa, Ontario.

### ● Unit For Overpotential Testing Item 1448

A non-destructive, very high potential unit is now available for insulation testing of samples, or full reel tank testing. The unit offers a preferred method of checking the insulation of cables and it meets new IFCFA standards as well as MIL, JAN and ASTM specifications. Many of the outstanding features incorporated in the unit are:

- 0-100 KV voltage output
- Adequate capacity for rapidly charging full reels
- Automatic Output shorting
- External interlock provision
- KV meter and current meter for determining leakage resistance
- Overcurrent trip-out to deenergize HV
- Dual range meters

The unit incorporates all the safety and convenience features of more expensive sets and further information can be obtained by contacting the manufacturer, **Peschel Electronics Inc., 19 Garden Street, New Rochelle, New York, U.S.A.**

### ● Continuously Variable Magnetic Amplifier Power Supply Item 1449

The development of a unique, continuously variable magnetic amplifier power supply — believed to be the only one of its type in production — was recently announced by Engineered Magnetics Co., Culver City, California, a division of Gulton Mfg. Corp., Metuchen, N.J.

Some important design features of this Model EM-117 power supply include: no moving parts, no filaments, and no maintenance. Critical-tolerance engineering of this power supply provides high overload capacity, eliminates warm-up time, and insures long life.

This unit utilizes an input voltage of 105-125 volts AC, 55-65 cycles, single phase, and produces a continuously variable output of 2-300 volts DC, 0-5 amperes with a regulation of 1 per cent or better. Ripple is 0.2 per cent RMS with recovery time of 0.2 seconds. All power supplies come equipped with an easy-to-read 4 inch rectangular voltmeter and ammeter.

Specifically constructed for research and development laboratories, this power supply has many other uses in any application calling for continuously variable power outputs. Now being produced in the standard size of 22" wide by 18" deep by 48" high, other sizes can be supplied to meet particular requirements.

Canadian Representative: **Lake Engineering Co. Ltd., 36 Upton Road, Scarborough, Ontario.**

### ● Precision Molded Taper Pin Terminal Blocks Item 1450

An improved terminal block design featuring precision reamed tapered receptacles to accommodate solderless connections (AMP Series "53" taper pins) has been announced by the Electronic Sales Division of the DeJUR-Amsco Corporation. Positive locking is secured between the taper pin and molded-in machined tapered receptacle.

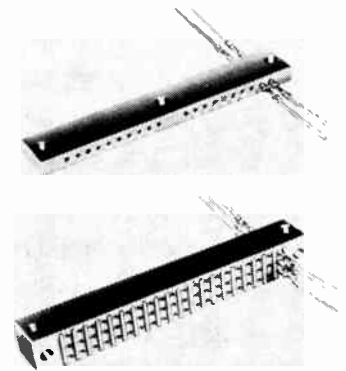

Series 145-58 taper pin terminal blocks are fabricated in a single row of 20 contacts, in 10 dual contacts and in 10 single contacts. These may be ordered in any pair or combination of shorted contacts. Molded or eyelet holes are provided for ease of stacking and assembly. Series 145-48 taper pin terminal blocks are fabricated in 20 rows of triple stacked contacts arranged in any desired shorting combination. This series is supplied with perpendicular and right angle holes for mounting. Taper receptacles are gold plated brass over silver for low contact resistance. Bodies are molded of high impact reinforced glass filled Alkyd, Type 440A. (Other molding materials on request.)

For complete information, specifications and diagrams, write to the Electronic Sales Division, DeJUR-Amsco Corporation, 45-01 Northern Blvd., Long Island City 1, N.Y., U.S.A.

(Turn to page 66)

# MECHRON ENGINEERING PRODUCTS LTD.

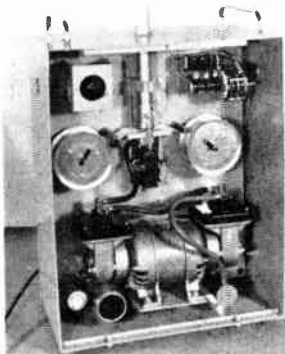

THE FLEMING Automatic Air Pollution Recorder provides samples of air pollution matter suitable for qualitative or quantitative records. Will sample at pre-set intervals and operate unattended for considerable periods. Size approx. 30 x 9 x 18 inches.

Price F.O.B. Ottawa \$577.50 S.T.I.

#### Other FLEMING Products include:

Radio and Nucleonic Instrumentation, Pulse Generators, Logarithmic Ratemeters, Radar and Communication Equipment, Miniature Personnel Radiation Monitors. Complete line of Radiation Laboratory Monitoring Equipment.

## MECHRON ENGINEERING PRODUCTS

LIMITED  
KALADAR AVE. OTTAWA

For further data on advertised products use page 81.

# TRIPLETT

## Reliability... through 15,631 accepted types

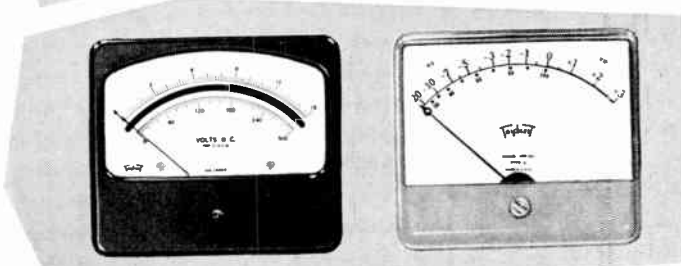
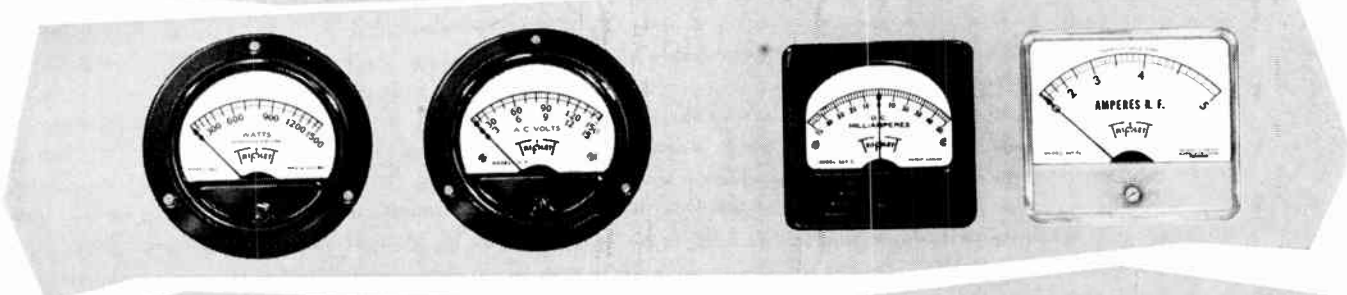
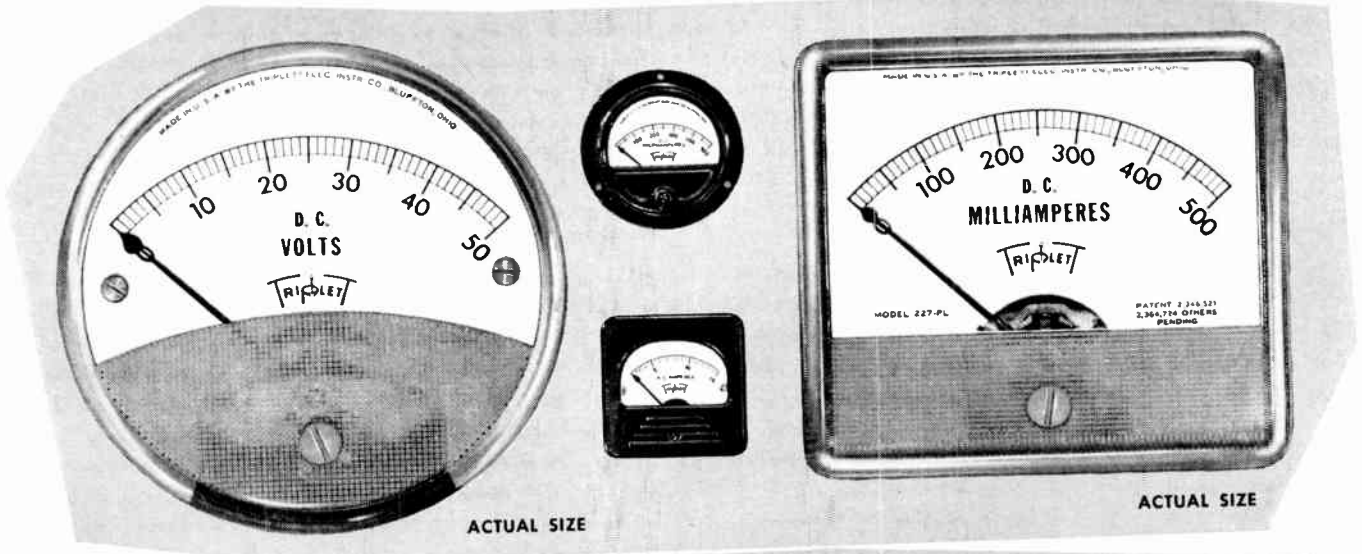

Clear plastic (PL) meters feature;

- Longer scale length
- Visibility unlimited
- Light unobstructed—no shadows
- Interchangeability—universal
- Appearance revolutionized

## UNIQUE FEATURES AND CHARACTERISTICS

These guarantee superior quality in *all* TRIPLETT meters:

- High torque to weight ratio for extra rugged movement. Specially developed bearings withstand severe vibration and reduce friction to a minimum.
- Bearings are microscopically graded not only for depth and radius, but also for *polish*. Only best quality jewels are used.
- Unique hardening method assures uniformly hard pivots.
- High flux scientifically aged alnico magnets for greatest permeability. Micrometrically balanced all metal frame construction protects bearings against vibration from any direction.
- Simplicity of frame construction assures easy, accurate alignment in servicing.
- Dials are all metal—no paper dials are ever used—will not become abrasive, warp, crack or discolor under normal conditions. (Printing presses in Triplet's own plant allow fast, inexpensive service on special dial requirements.)
- Extra strong ribbed pointers precisely balanced with triple "slide and lock" adjusting weights.
- Insulations provide extra allowance for breakdown voltages.
- All metal parts processed, all molded parts pre-cured to eliminate distortions from stresses and strains.

BARTON BACKLINT ADVERTISING

**TRIPLETT ELECTRICAL INSTRUMENT COMPANY • 52 years of experience • BLUFFTON, OHIO**  
*Triplet design and development facilities are available for your special requirements for meters and test equipment.*

**LEN FINKLER & CO.**  
 330 Adelaide Street West  
 Toronto 2B, Ontario  
 EMpire 8-5222

**C. M. ROBINSON COMPANY**  
 189 Market Street, Winnipeg  
 550 Beatty Street, Vancouver

**C. M. ROBINSON COMPANY**  
 189 Market Street, Winnipeg  
 550 Beatty Street, Vancouver

## NEW PRODUCTS

(Continued from page 64)

### ● **Electro-Hydraulic Machine Controls** *Item 1451*

A new transistorized servo amplifier and an electro-hydraulic servo valve which make possible electro-hydraulic control of industrial machinery, has recently been introduced by Honeywell Controls Limited.

According to Honeywell engineers, the (known as XRJ301A) amplifier and the electro-hydraulic servo valve (XVJ300A) make it practical to apply hydraulic power to many applications previously limited to electric drives. They also provide precision control of existing hydraulic equipment which could not previously be controlled automatically.

The fully transistorized amplifier is designed to receive signal inputs from any standard 60-cycle a-c signal source. The user can provide manually variable controls, can make the control source a function of position, velocity or other command variable, or can utilize input signals from tracers or computers. The amplifier is designed for parallel summation, ratio comparison, or series summation of input signals. Output is designed to power a balanced single load, or split loads, of as high as five watts.

The amplifier supplies the driving power for the new electro-hydraulic, three-way servo valve which, in turn, controls the flow of oil to hydraulic linear or rotary motion drives. The single stage servo valve is driven by a high performance torque motor and is available in ratings up to 10 gpm, and 3,000 psi.

Linear motion control can be applied to hydraulic presses, reciprocating drives used in planers, grinders, or saw mill carriages, and in a wide variety of straight line positioning applications. Rotary motion applications include lead screw feeds,

spindle drives, and processing machinery which requires precise control of shaft rotation.

Control combinations possible with the new electro-hydraulic servo "team" include stroke control feedback, pressure or flow feedback, and feedback of load position, velocity, force, torque, etc.

**Honeywell Controls Limited, Vanderhoof Ave., Leaside, Toronto 17, Ontario, Canada.**

### ● **Miniaturized Ferrite Microwave Load Isolator**

*Item 1452*

Cascade Research Corporation announces Model X-125 "Uniline", a miniaturized ferrite microwave load isolator having a total length of only 1 inch and weight of only 9 ounces. This new unit operates over the frequency range 8.5 to 9.6 kilomegacycles.

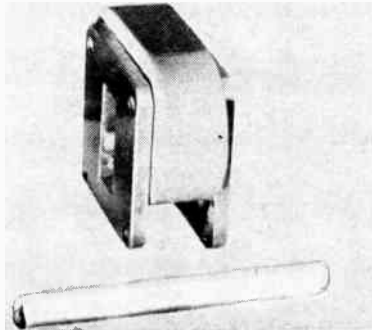

Isolation is 10.0 db over band with an insertion loss of 1.0 db. Peak power is 100 KW, average power 100 watts into 2:1 mismatch. VSWR is 1.15 into matched load. Waveguide size is RG-52/U, flanges UG-39/U.

**Cascade Research Corporation, 53 Victory Lane, Los Gatos, California, U.S.A.**

### ● **Flowmeter Measures With Ultrasonics** *Item 1453*

A new straight-through flowmeter, that achieves accurate flow rate measurements by the modification of an ultrasonic beam, has been announced by the Vibro-Ceramics Division of Gulton Industries, Inc. Because this new instrument offers no obstructions to the fluid flow, pressure drop is eliminated, maintenance is simplified and greater accuracy is consistently attained. Its many features are especially adapted to the measurement of such difficult liquids as kerosene, liquid oxygen, water and similar low viscosity liquids.

This unit designated as GLENNITE® Model UF-100, will measure flow rates in the range of 1000-4000 gallons per minute with an accuracy of better than 1 per cent, and provides 5 volts full-scale output to feed into standard telemetering and recording systems.

Special instruments for the measurement of volumetric flow, and complete control systems designed around the flowmeter, can also be provided.

For further information write: **Gulton Industries, Inc., 212 Durham Ave., Metuchen, New Jersey, U.S.A.**

### ● **Technical Bulletins Describe New Instruments**

*Item 1454*

Measurements Corporation announces the publication of two new technical bulletins describing its latest instruments, the Model 275 Intermediate Frequency Converter and the Model 95 Standard FM Signal Generator.

They also have recently published a revised bulletin describing their Model 505 Standard Test Set for Transistors.

Copies of these bulletins may be obtained by writing to **Measurements Corporation, Boonton, N.J.**

(Turn to page 68)

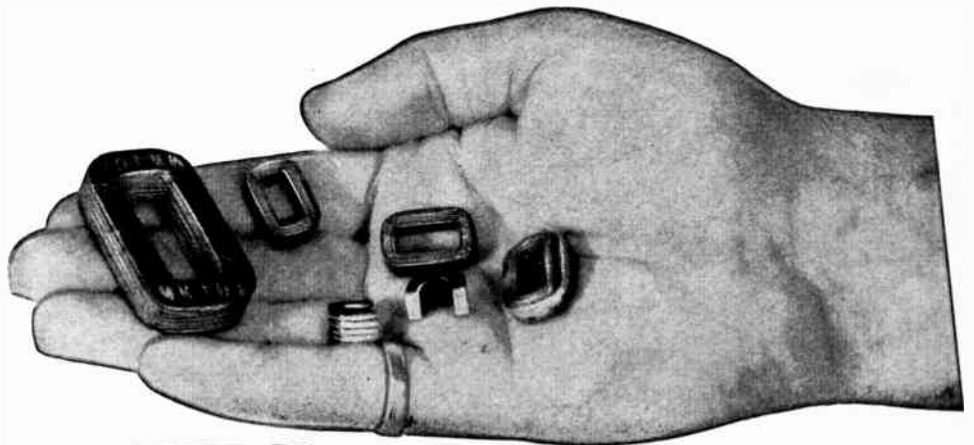
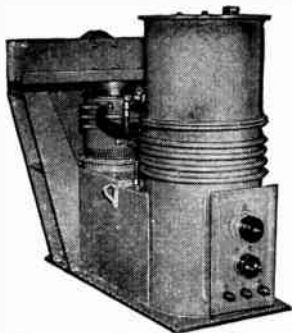
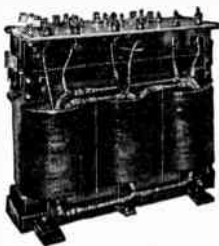

# YES...

**No core too small—No transformer too large!**



Illustrated above and reading counter-clockwise: HyperCores, Chokes, Power, Pulse, Filament, and Plate Transformers.

565

## MOLONEY ELECTRIC COMPANY OF CANADA LIMITED

Factory and Head Office: 213-219 Sterling Road, Toronto 3, Ont., Regional Offices: Montreal, Calgary

For further data on advertised products use page 81.



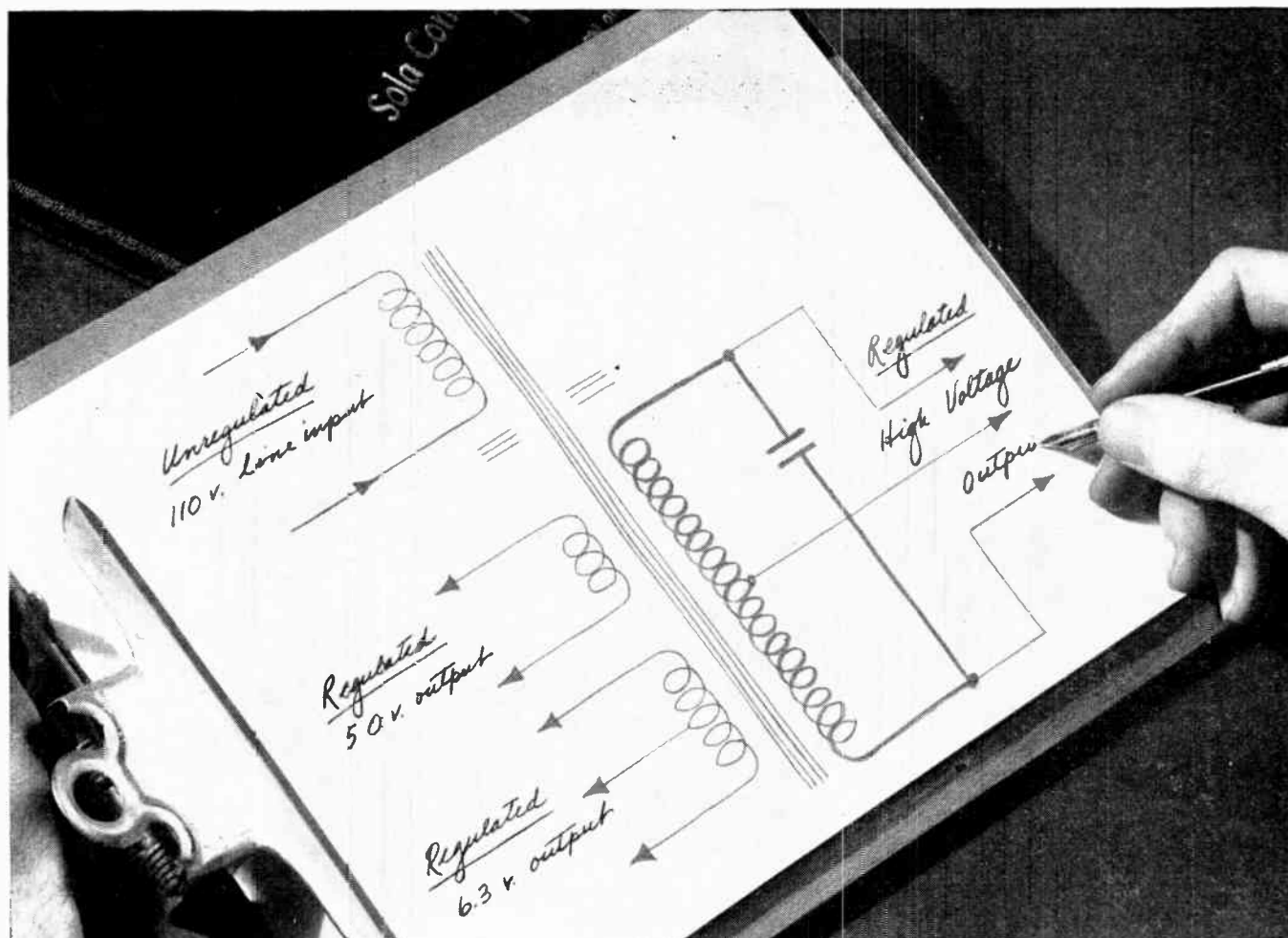

**SCHEMATIC DIAGRAM OF SOLA CIRCUIT** modified to supply regulated plate and filament voltages. Regulation on one stepped-up output and two

stepped-down outputs is within  $\pm 3\%$  for input variations of  $\pm 13\%$ . Other units available regulate as close as  $\pm 1\%$  for input variations of  $\pm 15\%$ .

**YOU GET VOLTAGE REGULATION AND MORE FROM A SOLA:**

## Closely Regulated Voltage Plus Transformer Step-Up or Step-Down with Sola Constant Voltage Transformers

Today's complex electrical and electronic equipment, with its narrow limits for adequate performance, makes a fixed level of input voltage virtually essential. There are many fine voltage regulators available for this duty alone. However, the Sola Constant Voltage Transformer delivers one-to-one, stepped-up, or stepped-down voltages closely regulated. One Sola unit may replace both voltage-regulating circuit or component, and conventional power transformer.

The Sola Constant Voltage Transformer is a static-

magnetic voltage regulator. It offers many important advantages over other stabilizers which depend solely upon saturation of core materials for their regulating action; or electronic types employing tubes.

To meet the exact requirements of many load devices or service conditions, Sola voltage regulators are available in stock models, or custom designs in production quantities. Your Sola representative will be happy to provide you with information on their feasibility for your particular application.

**SOLA** *Constant Voltage*  
**TRANSFORMERS**



Write for Bulletin  
32B-CV-170

SOLA ELECTRIC (CANADA) LTD., 102 LAIRD DRIVE, TORONTO 17, ONTARIO, Mayfair 4554 • CONSTANT VOLTAGE TRANSFORMERS for Regulation of Electronic and Electrical Equipment • LIGHTING TRANSFORMERS for All Types of Fluorescent and Mercury Vapour Lamps

## NEW PRODUCTS

(Continued from page 66)

### ● Flexible Epoxy-Insulating Resin

Item 1455

A new flexible epoxy-insulating resin — flexible because of the structure of its molecules rather than a plasticizing additive — has been announced this month by Minnesota Mining and Manufacturing of Canada Limited.

The new resin, used in production lines casting of coils and other electrical components, is said to withstand extreme temperature changes without cracking because of modifications in the resin molecules, allowing them to "give" with expanding and contracting metals. Because of its inherent flexibility, the resin is capable of absorbing severe physical shocks, even heavy blows from a hammer, without

cracking.

Called "Scotchcast" Brand Electrical insulating resin No. CRP-241, which is filled, and "Scotchcast" Brand resin CRP-239, a dipping resin.

Molecule modifications are made without sacrificing low viscosity, heat resistance, moisture resistance, adhesions to metals, and electrical properties characteristic of epoxy resin, according to the manufacturer.

The new resin has a viscosity of from 1500 to 2000 centipoise at room temperature (250 degrees C.) or about the consistency of transmission grade oil SAE-140. When warmed to 140 degrees F. before pouring, the resin has a viscosity of 60 centipoise — low enough to provide "excellent" impregnation.

The flexible resins are packaged in 1-gallon, 5-gallon, and 55-gallon containers.

Further information may be obtained by writing to **Minnesota Mining and Manufacturing of Canada Limited, P.O. Box 757, London, Ontario.**

### ● Frequency Counter

No. 14-20 Fm Item 1456

The Frequency Counter No. 14-20 FM is an extremely versatile precision type direct reading instrument capable of measuring frequencies, time intervals, periods, time and frequency ratios, frequency drift and similar quantities and of counting and totalizing discreet electrical impulses such as are found in pulse and nuclear work, whether of regular or random occurrence.

Frequency measurements in the range from 10 cps to 10 Mc are displayed to 8 places on counters, 6 places of which are displayed on neon lamp decades and two on meters giving a total of 99,999,999 counts. Count appears in kilocycles with automatic positioning of decimal point. Display time can be held indefinitely or be variable from 0.1 to 10 seconds with automatic reset. Gate time is adjustable in 5 steps of 0.001, 0.01, 0.1, 1 and 10 seconds.



**CLM  
RECTIFIERS  
nurse  
your  
batteries**

You'll protect your investment in station-type batteries when you install CLM Electronic Regulated Selenium Rectifiers.

**CONSTANT OUTPUT VOLTAGE.** In a CLM rectifier the output voltage is kept constant from no load to full load which increases battery life.

**SELF-PROTECTING.** CLM rectifiers are self-protecting on overload as the voltage curve drops off rapidly after 115 percent load is reached. CLM electronic regulated rectifiers are convection cooled, noiseless and require a minimum of maintenance.

**FREE BULLETIN.** For your free copy of Bulletin SR-14 which describes in detail, the performance characteristics of CLM rectifiers for station-type batteries write: Jack West, Sales Manager, Rectronic Division, **Canadian Line Materials Limited, Toronto 13, Canada.**



**SELENIUM RECTIFIERS**

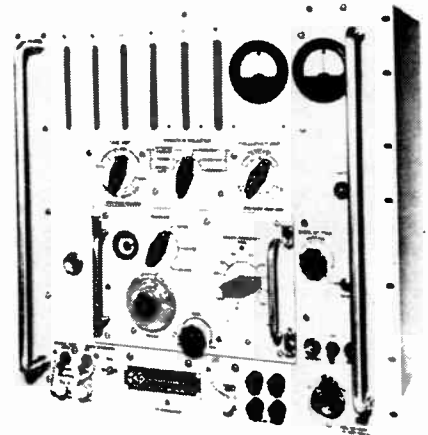

Period measurements are displayed in either seconds, milliseconds, or microseconds on the same counter system with a choice of measuring 1 or 10 complete cycles in the range from 0 to 10 Kc.

Output frequencies which may be used as secondary standard frequencies of 10 cps, 1 Kc (rectangular), 100 Kc (positive pulse), and 10 Mc (sine wave) are provided.

The entire equipment consists of one basic and four auxiliary plug-in units. The plug-in units extend the range and usefulness of the basic unit.

**Computing Devices of Canada Limited, P.O. Box 508, Ottawa, Ontario.**

### ● Model TLD In-Line Magnetic Head

Item 1457

The Nortronics Company Inc. has announced its Model TLD in-line magnetic head for low cost, high quality recording and reproduction in stereophonic sound applications. The head can be compensated for flat response between 30 and 10,000 cps at 7.5 inches per second. It is compact and will provide long wear, negligible oxide accumulation, excellent rejection of surrounding fields, and uniformity of frequency and amplitude response.

This new head features precision ground and lapped gap, balanced electric and magnetic structure, high output, and precise colinear alignment. The active tape surfaces do not pass over any epoxy resin or plastic surfaces, thereby eliminating the need for frequent cleaning even under humid conditions. The head is suited for use in new equipment design, replacement, and for conversion of existing tape recorders to stereophonic tape "phonograph" equipment.

Detailed dimensional drawings, specifications, and prices to manufacturers, distributors and dealers will be furnished upon request. to **The Nortronics Company, Inc., 1015 South Sixth St., Minneapolis 4, Minn., U.S.A.**

(Turn to page 70)

For further data on advertised products use page 81.

# 25,000 EMPLOYEES' PAYROLL CAN BE DONE IN LESS THAN ONE SINGLE HOUR BY ONE MACHINE, DISPENSING WITH ANY LABOUR!

(American Management Association Special Report No. 3)

## How does this affect you?

Excerpt from Dec. 5  
News Item

**350 MEN LAID OFF  
AS YEAR'S WORK DONE  
IN 6 MONTHS**

Executive member Leonard Baker of Local 436, United Auto Workers, blamed the lay-offs on automation.

With the foundry's new machinery, he said, it now can turn out a year's supply of blocks for Ford in a six-month period.

**Fifty Weeks Training . . . One night per week with home study, which permits you to earn a living while learning to become a skilled technician.**

**18 Schools from Halifax to Vancouver.**

**School Open 9 a.m. to 11 p.m. for your inspection.**

**BEFORE INVESTING YOUR TIME AND MONEY  
IN ANY COURSE INVESTIGATE THOROUGHLY.**

## RADIO ELECTRONICS TELEVISION SCHOOLS

OF CANADA LIMITED

(One of the World's Largest Resident Training Schools)

**FOR INFORMATION WRITE OR TELEPHONE**

261 Spadina Avenue  
Toronto  
EM. 6-9618

164 Wellington Street North  
Hamilton  
JA. 7-6658

139 Hunter Street West  
Peterborough  
RI. 5-4303 — RI. 5-5206

381 Richmond Road  
Ottawa  
PA. 2-6558

312 Bagot Street  
Kingston  
2-4436

15 King St. North, Waterloo  
Kitchener-Waterloo  
SHerwood 5-6149 — 5-6140

377 Talbot Street  
London  
2-3438

**SCHOOLS FROM COAST TO COAST**



## NEW PRODUCTS

(Continued from page 68)

### ● *Electronic Insulation Tester*

*Item 1458*

The new "English Electric" Electronic Insulation Tester is the first compact and portable insulation tester that will measure insulation resistance at any desired potential from 500 - 10,000 volts D.C.

This tester has a non-lethal output with stepless voltage adjustment and will measure resistance up to 250,000 megohms. It gives rejection of surface leakage currents, high accuracy on comparative tests and audible indication of ionization.

The instrument is 15" x 10" x 6", weighs 23 lbs., has C.S.A. approval, and is available from the **English Electric Company of Canada Limited**, St. Catharines, Ontario.

### ● *Two Wide-Range Accelerometers*

*Item 1459*

The release of two new wide-range accelerometers Type 4308 and 4309 was announced recently. These accelerometers satisfy the long-felt need for a high frequency accelerometer which makes possible the application of the Briel & Kjaer "automatic measuring technique" in the field of vibration measurements.

Vibrations now form a part of the daily problems encountered by the engineer in modern times. Wherever rotating machinery is mounted this problem exists, and not only do vibration effects irritate the human organism, but in many cases the life-time of expensive machinery is greatly reduced because the problem of vibrations has not been given sufficient consideration.

Accelerometers Type 4308 and 4309 are designed to enable you, through reliable,

quick and easy measurements, to apply an effective insulation technique and thereby reduce the vibration effects of your machinery to a minimum.

The automatic measuring technique may now be applied wherever vibration measurements on constructions subjected to mechanical vibrations, such as machinery, vehicles, ships, aircrafts, etc. are considered. Simple and inexpensive non-selective measurements of vibrations may be used in the production line check of small motors and generators. Measurement and analysis of vibrations in rotating machinery make it possible in an easy way to detect mechanical faults in the machinery which cannot be detected by ordinary "listening-in tests".

Accelerometers Type 4308 and 4309 are precision instruments and each accelerometer is supplied with its individual calibration data and frequency characteristic.

Agent in Canada: **R-O-R Associates Ltd.**, 290 Lawrence Ave. West, Toronto 12, Ont.

### ● *High Speed Relay With Wiping Action*

*Item 1460*

A new high speed relay operating as fast as 2 milliseconds has been announced by the General Automatic Corporation, manufacturers of precision relays. Designed for DC applications, this new relay designated as General Automatic Type 120, is available hermetically sealed, dust cover, or open with contact combinations from SPST to TPDT. The relay is also available for AC operations by using selenium rectifiers or diodes.

The General Automatic Relay Type 120 incorporates a complete wiping action, which has the advantage of eliminating bounce and chatter at normal operating voltages. Power requirement is anywhere from 0.25 to 2.5 watts, depending on the speed requirements. Coil resistance available is from .01 to 30,000 ohms. Special windings up to 100,000 ohms.



## *a comprehensive* **Telecommunication Engineering Enterprise**

One of the largest telecommunication engineering organisations in the Commonwealth, **Standard Telephones and Cables Limited** is engaged in research and the development, manufacture and installation of all types of communication and control systems.

Concerned with every aspect of telecommunications engineering, the Company is in an unrivalled position to undertake, within its own organisation, the co-ordinated planning of complete communication projects involving inter-dependent systems of various types.

### **'Standard' products include:—**

- Telecommunication Line Transmission Equipment
- Radio Broadcasting Equipment
- Radio Communication Equipment
- Air Radio Navigational Aids
- Supervisory and Remote Control Systems
- Railway Communication Apparatus
- Railway Control Equipments
- Telephone Cable
- Sound-Reinforcement Systems
- Public and Private Telephone Systems

**Standard Telephones & Cables**  
*Mfg. Co. (Canada) Ltd.*

9600 ST. LAWRENCE BLVD., MONTREAL



Contact capacity is 1 ampere inductive or 3 amperes resistive at 115 VAC or 29 VDC. It is also available with heavier contacts up to 10 amperes inductive in Relay Type 140. Drop-out can be generally adjusted as high as 85 per cent of pickup.

Armature is designed with friction-free movement. No hinge pins are used. Non-ferrous metals and hydrogen annealing of magnetic components eliminate the ironing and residual magnetism. Contacts available in silver, palladium, gold alloy, and etc. Headers available with plug-in, solder lugs, or other types to customer's specifications. Available in either round or square cans. Round can 1 1/4" x 3 1/4" high above mounting line.

**General Automatic Corporation**, 12 Carlton Avenue, Mountain View, New Jersey, U.S.A.

(Turn to page 74)

For further data on advertised products use page 81.

# RETMA Report



By Basil Jackson, A.R.Ae.S., Tech. M.C.A.I.

## RETMA to Participate in National Radio Week

At a recent meeting of the Receiver Division, it was resolved that the Radio-Electronics-Television Manufacturers Association of Canada should participate in Canadian Radio Week to take place May 5 to May 12 in conjunction with the Canadian Association of Radio and Television Broadcasters. Details of the plan for RETMA's participation are being worked out by the Sales and Merchandising Committee and the Receiver Division.

## Year End Statement by Dr. W. R. G. Baker

The electronics industry in the United States increased in size by 15 per cent during 1956, said Dr. W. R. G. Baker, President of RETMA of U.S., in a year-end statement. It was predicted that it will increase in size by 10 per cent during 1957. In terms of production and sales, about \$5.9 billion volume was reached. When revenues from distribution, servicing, and broadcasting are added, this figure reached the \$12 billion level.

On television receiver sales, Dr. Baker noted that 1956, with 7 million sets sold, was one of the best four years in the history of the industry. Portable television receivers accounted for about 22 per cent of the total.

During 1956, military electronic equipment sales totalled \$2.7 billion, a 10 per cent increase over 1955, and accounted for nearly half the total industry sales.

Radio set sales in 1956 increased about 20 per cent over 1955. However, car radio sales, tied to automobile production, declined 25 per cent. Currently, 90 per cent of automobiles being made today are equipped with radios. Portable radios will lead the radio field in 1957 with a 40 per cent increase as one million transistorized sets will be sold.

Dr. Baker reviewed the industrial electronics field. Three product areas had shown outstanding growth during 1956, and he expected them to continue to grow in the future. These products were semiconductors, industrial or closed circuit television, and computers.

It was expected that final 1956 figures would show that transistor production will have reached the 11.5 million unit mark, compared to 3.6 million in 1955. During 1957, it was expected that 22 million transistors will be made, and that during the following years this figure will multiply several times as new applications are developed. Contrary to some predictions, the increased use of transistors has not displaced the vacuum tube market and does not threaten to do so in the immediate future.

An increasing number of industries have found uses for closed-circuit television and sales have increased in this category.

Electronic computers are replacing adding machines and slide rules. Sales in 1956 amounted to about \$100 million.

## Engineers on RETMA Committees

At a recent meeting of the Electronics Division, it was reported that the Board of Directors had decided to permit engineers from outside the RETMA membership to serve on engineering committees as observers, or as members, to take care of specific assignments. Arrangements for such are to be made through the Division Chairman and the Director of Engineering.

Continued overpage

# RETMA Report

---

## Industrial Relations Panel Discussion

The RETMA Industrial Relations Committee sponsored a panel discussion entitled "Communication with Employees" at a recent meeting of the Components Division in Montreal. Moderator was R. Scott and the two guest panelists were Dr. W. A. Westley, Chairman, Department of Sociology and Anthropology, McGill University, who spoke on "Fundamentals and Barriers in Person-to-Person Communications", and C. H. Cheasley, Manager, Employee Relations Section, Montreal Board of Trade, who spoke on "Effective Communication on the Job".

## Canadian Radio Technical Planning Board

At the 12th annual meeting of the Canadian Radio Technical Planning Board in Ottawa recently, R. A. Hackbusch was re-elected-President, F. H. R. Pounsett Vice-President, R. C. Poulter Co-ordinator and Director of Publicity, and F. W. Radcliffe was appointed Secretary-Treasurer. R. A. Hackbusch is the RETMA Director of Engineering.

In the course of his presidential address, Mr. Hackbusch gave a clear statement of the function and purpose of the CRTPB. He said, in part:-

"The function of the Planning Board is to provide technical advice and engineering know-how to assist the Department of Transport, Telecommunications Branch, to effectively administer their duty of licensing and frequency allocations in the radio spectrum."

"It is also our duty to give specific attention to radio spectrum conservation, as, since its inception, radio communication has been plagued by a shortage of space for ever-increasing numbers of stations and new services from ship to shore wireless in 1902 to color television and scatter techniques in 1957."

"The radio spectrum is a public resource requiring the same wise conservation as is practised with forests, farmlands and mineral wealth. By forward planning, by research and development, more efficient radio communications equipment and the proper use of the equipment, will provide more service to more people and will ensure a healthy economic future for manufacturers, users and the public which they serve."

"At the inception of the Planning Board emphasis was placed on planning for allocations. During the past few years the emphasis has been on preparation of specifications for systems and equipment to assist the Department of Transport to produce specifications for licensing purposes . . ."

"The engineers who assist in the preparation of the specifications, who devote their time and at the expense of some company or association, are providing a real public service."

"These engineers, who are members of professional societies such as I.R.E., A.I.E.E., E.I.C., or any other professional and industrial groups or associations, consult with every possible source to determine what technical information is required to ensure the wise use and regulation of radio facilities and to collect and disseminate such information."

# THE TELEVISION *Story*



**PYE CANADA LIMITED**, pioneers in television development, can supply all the video and audio equipment required for complete television broadcasting — black and white, or colour.

Does the programme originate with the network? From films? As a live studio production? From remote locations? . . . Pye has the equipment to do the complete job, including studio cameras, telecine equipment, completely equipped mobile vans, and all necessary accessories.

Camera control units, sync-generators, switching units, mixers, monitors, complete audio facilities, patching equipment and "talk-back" systems are some of the components of the Pye-equipped control room — complete in every detail including the micro-wave link to the transmitter.

At the transmitter, Pye supplies all the equipment necessary to control and amplify the signals for transmission to home receivers—including the tower and antenna. Going one step further, Pye can install packaged TV stations to give additional area coverage, increased power or frequency change.

Whether you require individual components or a complete system. Pye television broadcasting specialists will provide the engineering know-how and the required equipment — at low cost. Contact us for further information.

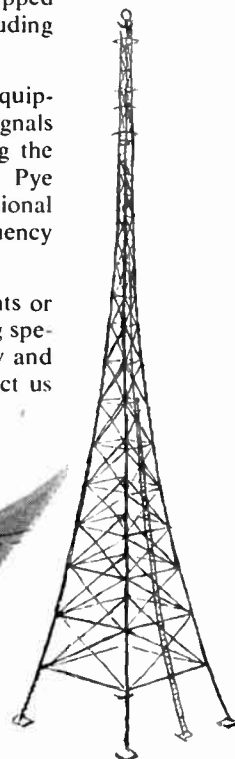

Manufacturers and engineers of H.F., V.H.F., U.H.F. radio systems, telephone apparatus of all kinds, scientific instruments, industrial and commercial television cameras, marine radiotelephones, fish finders and depth sounders.



193 E. Hastings St., VANCOUVER  
1191 University St., MONTREAL

Head Office and Plant  
82 Northline Rd., Toronto 16

78 Bank St., OTTAWA  
3 Duke St., HALIFAX

## NEW PRODUCTS

(Continued from page 70)

### ● Elapsed Time Meters — "Horameter"

Item 1461

The "Horameter," an elapsed time meter with electrically wound mechanical clock movement has been so well received everywhere that the increased sales volume has made it possible to reduce its price quite considerably. As "Horameter 1," this model remains the universal elapsed time meter. But, further to reduce prices, two additional special models have been added to the line: the "Horameter 2" for 6V or 12 24V DC with a rotating armature and balance spring mainly as engine hour meter for

agricultural, construction and road machinery; the "Horameter 3" for 110V or 220V AC, with synchronous motor drive, for industrial plants.

All three models are for panel or dashboard mounting — flat and angular mounting brackets are available for other installations — by means of a stirrup bracket and have a chromium plated front ring of 66 mm (2.6") dia. and cyclometer indication up to 9999.9 hours with white figures for the whole, red figures for the decimal hours. The Horameter 1 has a round, the Horameter 2 has a rectangular dial window with a rotating minute disc, while the Horameter 3 has instead a dial scale with minute graduations and a minute hand. As compared with the case length of 72 mm (2.83") for the Horameter "1" and a weight of 19½ ozs., the case of the Horameter "2" measures only 39 mm (1.53") and that of

the "Horameter 3" only 57 mm (2.24") with the respective weights 12½ ozs. and 14½ ozs.  
The J. W. Ellis Industries, 42 Lombard Street, Toronto 1, Ontario, Canada.

### ● Universal Slotted Line Kit

Item 1462

The DIC-6207 Slotted Lines and Universal Carriage are designed to provide a maximum of flexibility and accuracy for standing wave measurements in the 1.7 to 5.85 Kmc region. The basic design consists of a rugged universal carriage which will

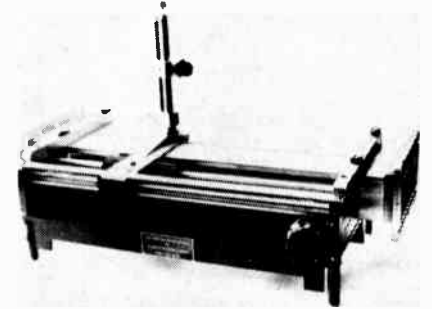

accept interchangeable precision slotted sections in five different waveguide sizes (RG-104/U, 112/U, 48/U, 49/U and WR-229). Other features include a stationary spinner knob for vernier control of probe position, a push button release control for rapid probe positioning, a scale vernier with zero reference at the plane of the load flange, and low residual VSWR.

Diamond Antenna & Microwave Corporation, 7 North Ave., Wakefield, Mass, U.S.A.

### ● Sub-miniature Terminals Speed Assembly

Item 1463

Tri-Point Plastics, Inc. announced recently that its Electronics Division has developed and is now producing new "Trinseel", Teflon-insulated sub-miniature stand-off and feed-thru terminals. Terminal characteristics provide definite advantages in assembly and performance of critical electronics, missile, communications and related equipment. All are based on Tri-Point-developed "TSI" Teflon, a new "electronic grade" fluorocarbon.

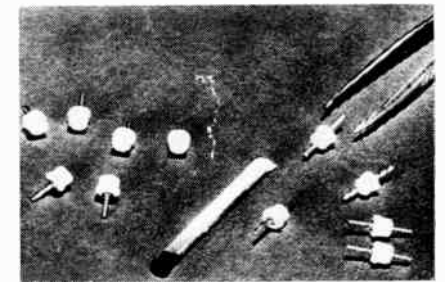

Providing the outstanding electrical and mechanical properties of "TSI" "Teflon", the new, one-piece terminals also allow rapid "anchor & seal" installation by simple "corking" motion and freedom from soldering damage.

Four stand-off and five feed-thru "Trinseel" terminals are now available. Capacitances range from 0.35 to 0.75 with "flash-over" points of better than 500 v AC. Service ratings include 60 cps to 30,000 MC frequencies, temperature range of minus 450°F to plus 500°F. Sizes range from .148" — .218" diameter, with .040" diam. pins. Others to be added include tubular, colored, slotted-pin models.

Specification bulletins, other information available from Pat Ruggieri at Tri-Point Plastics, Inc., Electronics Division, 175-177 I.U. Willets Road, Albertson, L.I., N.Y., U.S.A.

(Turn to page 76)

## A CRYSTAL CALIBRATED A.M. PORTABLE RECEIVER TESTER



Type TF888/3

- ACCURATE
- VERSATILE
- LIGHTWEIGHT

Weighing only 17½ pounds, this low-cost and compact instrument combines a wide-range signal generator, a variable level tone source, and an a.f. power meter. (For battery operation, line power unit can be interchanged with battery unit.)

R.F. range: 70kc/s to 70 Mc/s. With built-in crystal checks at harmonics of 500 kc/s and 5 Mc/s. Attenuator provides calibrated outputs between 1μV and 10 mV at source impedances of 52 and 80 ohms. For general testing — higher, uncalibrated outputs up to 500mV are available.

For full details, write Marconi Instruments Department.

# Marconi



CANADIAN MARCONI

COMPANY — MONTREAL 16, QUEBEC

Canada's Largest Electronic Specialists

For further data on advertised products use page 81.



# NOW...the **accepted standard**

## of the Relay Industry!

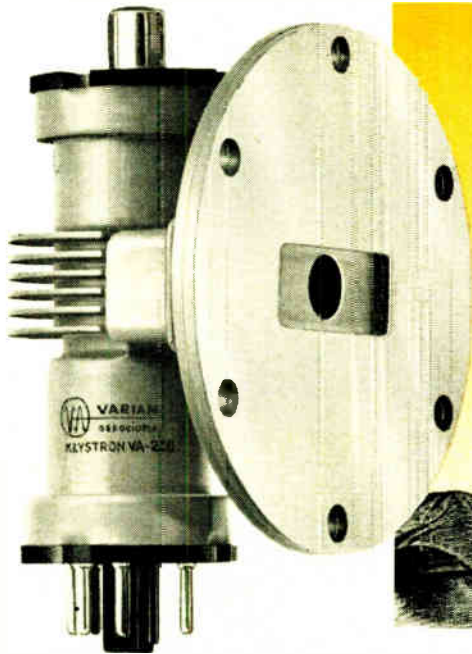

### Varian's high performance relay klystron

It's the VA-220, another outstanding example of Varian design leadership... research and product engineering that brings you optimum reliability plus performance characteristics unsurpassed by any other relay klystron.

**UNSURPASSED  
FOR EVERY  
RELAY APPLICATION**

Microwave relay system designers and equipment buyers have long known that Varian relay klystrons are unmatched for frequency stability, power to override noise, reliability and long life. The VA-220 gives you performance that even exceeds the high standards set by Varian X-26 klystrons... at half the cost.

In the 6000 - 8000 megacycle band, VA-220 klystrons will consistently outperform all others. Here are six reasons why this sensational new klystron is your best buy for all relay applications:

**THESE ADVANTAGES  
MEAN TOP PERFORMANCE**

- **Greater Power**—VA-220 high power klystrons are conservatively rated. They will deliver more than rated power without failure.
- **Greater Frequency Stability**—VA-220 klystrons have negligible frequency drift.
- **Greater Uniformity**—Varian mass production techniques assure uniformity—every klystron is as reliable as a nut and bolt.
- **Longer Life**—VA-220 klystrons can be operated at full power for thousands of hours.
- **Less Distortion, Less Noise**—FM distortion and inherent noise are negligible—60 db below a 1-megacycle deviation.
- **Lower Cost**—VA-220 klystrons cost far less than any other relay klystron with comparable performance characteristics.

TYPE	FREQUENCY RANGE	RESONATOR VOLTAGE	POWER OUTPUT	BANDWIDTH	MODULATION SENSITIVITY
VA-220*	5925 - 7425 mc	750 v	1.2 watts	35 mc	375 kc/v
*VA-220 B, C, D, E and F each cover a frequency range of approximately 300 mc					

**FOR COMPLETE SPECIFICATIONS**

... and technical data on the VA-220 and other Varian klystrons, write to the Varian Application Engineering Department today.

THE  
MARK OF  
LEADERSHIP



**VARIAN associates**

OF CANADA, LTD. • GEORGETOWN, ONTARIO

KLYSTRONS, TRAVELING WAVE TUBES, BACKWARD WAVE OSCILLATORS, LINEAR ACCELERATORS, MICROWAVE SYSTEM COMPONENTS, R. F. SPECTROMETERS, MAGNETS, MAGNETOMETERS, STALOS, POWER AMPLIFIERS, GRAPHIC RECORDERS, RESEARCH AND DEVELOPMENT SERVICES

## NEW PRODUCTS

(Continued from page 74)

### ● Instrumentation Tape Recorders

#### Item 1464

Modular electronic assemblies and tape transport design improvements have been teamed up for greater flexibility and accuracy in a new series of moderate-cost instrumentation tape recorders developed by Ampex Corporation of Redwood City, California.

From one to seven tracks of data may be recorded and reproduced at four tape speeds with the new Series FR1100 equipment. Plug-in record and reproduce amplifiers provide quick interchange between direct, frequency modulation and pulse-width modulation recording modes. Record and reproduce heads in FR1100 equipment are compatible with all three modes, eliminating head changes when switching from one method to another.

Frequency response of the FR1100 extends from DC to 100 kc. Direct recording may be used from 300 cycles to 100 kc, and the D-C to 10,000-cycle range may be recorded with frequency-modulation methods. Pulse-width-modulated signals from 50 microseconds to 10,000 microseconds may be recorded within  $\pm 2$  microseconds.

FR1100 transports are built for either  $\frac{1}{4}$  tape on 10 $\frac{1}{2}$  inch reels, with optional speed ranges of 7 $\frac{1}{2}$ , 15, 30 and 60 inches per second, or 3 $\frac{3}{4}$ , 7 $\frac{1}{2}$ , 15 and 30 ips. Uniformity of tape motion, necessary for low flutter and wow characteristics, is achieved through new structural design in the transport.

Represented in Canada by Ampex American Corp., 1537 The Queensway, Toronto, Ontario.

### ● Differential Pressure Pickup

#### Item 1465

A new differential pickup in which a

dry strain-gage element is isolated from the pressurized fluid has recently been developed. Units are suitable for applications in rocket engines, gas turbines, and chemical processing systems, where differential measuring or pressure control devices are used in conjunction with corrosive or conductive fluids. Pressure differences are transmitted from a single diaphragm through a mechanical linkage to an unbonded strain-gage element capable of high-frequency performance. Only teflon and  $\pm 18-18$  stainless-steel parts come in contact with the pressurized fluid. Models are available for sensing pressure differentials from  $\pm \frac{1}{2}$  psi to  $\pm 1000$  psi at line pressures up to 2000 psi.

Isolation of the strain-gage element is accomplished by a double chamber arrangement. The differential pressure chamber contains a single pressure-sensitive diaphragm and provides fluid inputs on either side of the diaphragm. Diaphragm deflections are transmitted by a hinged linkage through a force-transmitting seal into a separate chamber containing the strain-gage. This linkage-seal system has a high natural frequency and the full sensitivity of an unbonded strain-gage can be utilized. Total linkage travel is about 0.00035 inches.



*When you buy*  
**SPRINGS**  
**SERVICE**  
**COUNTS**

As well as the general headings covered by "SERVICE" such as delivery on schedule, modern manufacturing facilities, etc., Bohne Industries offer their customers Precision Spring Making Experience gained over the years. You can benefit from this experience — send your specifications, blueprint or sample for quotation.



The output signal resulting from a line pressure of 2000 psi is less than 1 per cent of full-scale output. Resolution is better than one part in 2500. Units are easily installed with minimum system modifications. Pressure inputs are made through  $\frac{1}{8}$ -inch pipe thread connections at either end of the pickup case.  $\frac{1}{8}$ -inch #20 straight thread connections can also be provided. Standard units operate with either a-c or d-c excitation at 6, 12 or 15 volts, with bridge resistances at 350, 600 or 800 ohms and minimum full-scale outputs of 20, 40 or 50 millivolts, respectively. Measurements are accurate to 0.5 per cent of full-scale at 70° Fahrenheit. In many applications, output signals are large enough to be used directly without amplification. Insulation resistance from pickup case to ground is 100 megohms minimum, and hysteresis is less than 0.5 per cent of full-scale. Temperature range is  $-65^{\circ}$  to  $+350^{\circ}$  Fahrenheit. The electrical connector is supplied.

Dynamic Instrument Company, Inc., 28 Carleton St., Cambridge, Massachusetts, U.S.A.

**BOHNE INDUSTRIES**  
**LIMITED**  
1153 QUEEN ST. W. • TORONTO 3

To obtain further information  
on New Product items,  
use coupon on page 81.

# book review

**Linear Transient Analysis, Volume II**, by Ernst Weber, Professor of Electrical Engineering at the Polytechnic Institute of Brooklyn, N.Y.

Following logically after Volume I, this work presupposes a knowledge of the functions of a complex variable and familiarity with simple lumped circuits. Five appendices provide mathematical background and help make the work self-sufficient.

It is devoted to transient phenomena in passive and active two-terminal-pair networks, in filters, and in transmission lines. Simple matrix algebra systematizes this presentation and permits considerable generalization of solutions to fourpole problems. Material which has previously been given only sketchy presentation in English is introduced in discussions of active fourpoles, idealized network characteristics, and transmission lines.

**Linear Transient Analysis, Volume II**, is published by John Wiley & Sons, Inc., 440 Fourth Avenue, New York 16, N.Y., contains 452 pages, hard cover bound, price \$10.50.

**Photoconductivity Conference**, edited by R. G. Breckenridge, B. R. Russell and the late E. E. Hahn.

This volume thoroughly explores the available information on photoconductivity. It includes 30 papers by 45 authorities on solid state physics. These papers, prepared for the Conference on Photoconductivity sponsored by the University of Pennsylvania, Radio Corporation of America, and Office of Naval Research, include basic theory, phenomenological theory, interpretation of photoconduction phenomena, and the most recent data on the properties of important photoconducting materials.

**Photoconductivity Conference** is published by John Wiley & Sons, Inc., 440 Fourth Avenue, New York 16, N.Y., contains 633 pages, hard cover bound, price \$13.50.

**Radio Telemetry, Second Edition**, by Myron H. Nichols and Lawrence L. Rauch, professors of aeronautical engineering, University of Michigan.

This book gathers together for the first time the basic theory and a cross-section of current practice in measurement and communication in radio telemetry which hitherto have been widely scattered and uncorrelated. In addition, it includes original contributions by the authors, based on their experience gained in telemetering research and development.

The principal additions to the first edition are in Chapters 15 through 17 and consist of descriptive material covering telemetry systems in current use or development.

**Radio Telemetry, Second Edition**, is published by John Wiley & Sons, Inc., 440 Fourth Avenue, New York 16, N.Y., contains 461 pages, hard cover bound, price \$12.00.

**Progress in Semiconductors, Volume I**, edited by A. F. Gibson, P. Aigrain and R. E. Burgess.

This is the first of a series of volumes designed to bring to readers a limited number of topics annually on semiconductors and allied subjects selected from the hundreds of papers that are written each year on these subjects.

The articles generally are to be critical reviews, giving an assessment of the present state of knowledge, while some will contain significant amounts of original work. All are contributed by leading specialists in particular fields. Each volume is to be fully international, papers being drawn from all available sources, academic and industrial.

**Progress in Semiconductors, Volume I**, is published by John Wiley & Sons, Inc., 440 Fourth Avenue, New York 16, N.Y., contains 220 pages, hard cover bound, price \$8.00.

**The Art and Science of Protective Relaying** by C. Russell Mason.

This is a textbook on protective relaying — one of a series written by General Electric authors for the advancement of engineering practice. It is the outgrowth of notes used in the Power Systems Engineering Course given by the General Electric Company, revised to improve their clarity and to add necessary explanatory material.

The volume deals with relay protection of all elements of a power system against all abnormal operating conditions and discusses the relation of relaying to other power-system elements. It tells how to design systems and to apply relays to get the optimum results.

**The Art and Science of Protective Relaying** is published by John Wiley & Sons, Inc., 440 Fourth Avenue, New York 16, N.Y., contains 410 pages, hard cover bound, price \$12.00.

**Frequency-Modulated Radio** by K. R. Sturley, Ph.D., head of BBC Engineering Training Department.

The purpose of this book is to explain the general principles, theory, design, construction and servicing of VHF/FM receivers, so as to assist the practical man whose job it is to make an FM receiver work. Each stage of a VHF/FM receiver is analyzed in detail, and a chapter is devoted to the special features of combined AM/FM receivers. Information is also given on transmission, using as examples the transmitters used in the BBC VHF broadcasting service.

**Frequency-Modulated Radio** is published by George Newnes Limited of London, England, is distributed in Canada by British Book Service (Canada) Limited, 1068 Broadview Avenue, Toronto 6, Ontario, contains 120 pages (fully indexed and with over 100 illustrations and circuits), hard cover bound, price \$2.60.

**Circuit Theory And Design** by John L. Stewart, Associated Professor of Electrical Engineering, California Institute of Technology.

Avoiding abstract mathematics, this book applies modern network theory to the understanding of vacuum tubes and feedback systems. Pole-zero design methods, founded on an easily grasped pictorial representation, are employed extensively. They are used in developing design methods for a great variety of circuits, both with and without vacuum tubes, and for systems with and without feedback. Included are examples relating to practical system design.

**Circuit Theory And Design** is published by John Wiley & Sons, Inc., 440 Fourth Avenue, New York 16, N.Y., contains 480 pages, hard cover bound, price \$9.50.

**Man of High Fidelity: Edwin Howard Armstrong. A Biography** by Lawrence Lessing.

This book was written around the life of a man considered by many to be one of the great American inventors of our time and the single most important creator of modern radio.

Major Edwin Howard Armstrong was the man who gave the world FM radio. Among his other inventions were the regenerative or feedback circuit and the superheterodyne. His was a life of pure dedication to the industry which would never have reached the heights it was without his contributions.

**Man of High Fidelity: Edwin Howard Armstrong** is published by J. B. Lippincott Company, East Washington Square, Philadelphia, Pa., contains 320 pages, hard cover bound, price \$5.00.

**Applied Analysis** by Cornelius Lanczos, Ph.D., Senior Professor, School of Theoretical Physics at the Dublin Institute for Advanced Studies.

In the preface to this book the author explains that, having been engaged for years in studies of those fields of mathematical analysis that are of primary concern to the engineer and the physicist, his book covers topics encountered almost daily by the engineer and physicist.

The chapters are devoted to such subjects as algebraic equations, matrices and eigenvalue problems, large-scale linear systems, harmonic analysis, data analysis, quadrature methods and power expansions. Fifteen numerical tables are displayed in the Appendix.

**Applied Analysis** is published by Prentice-Hall, Inc., 70 Fifth Avenue, New York 11, N.Y., contains 539 pages, hard cover bound, price \$9.00.

## The Canadian Room

Suites 114 and 116  
Hotel Commodore - New York City

invites you to make use of its hospitality while visiting the Institute of Radio Engineers Convention and Exhibition to be held in New York City from March 18 to 21.

The Canadian Room will be open from Sunday afternoon, March 17 and every day thereafter from 4 in the afternoon until 10 p.m. during the course of the Convention.

## DIESEL ENGINES FOR EVERY PURPOSE

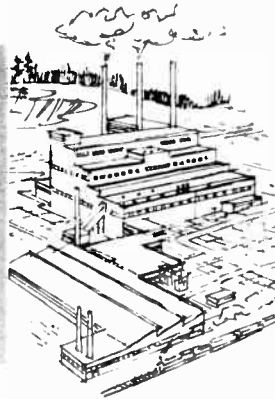
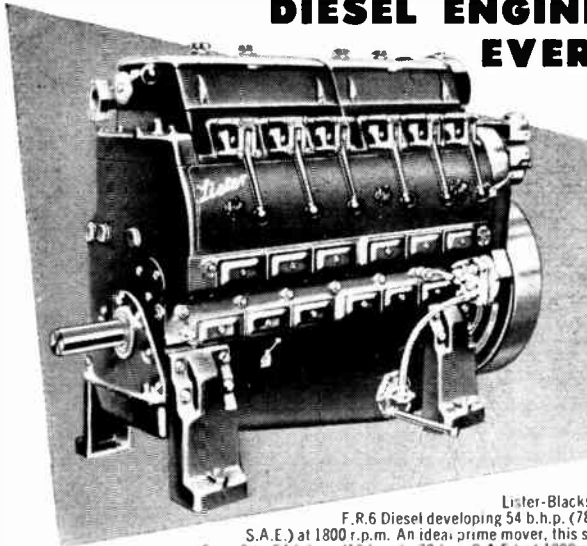

Lister-Blackstone  
F.R.6 Diesel developing 54 b.h.p. (78 h.p. S.A.E.) at 1800 r.p.m. An ideal prime mover, this series ranges from 9 to 54 b.h.p. (13 h.p. to 78 h.p. S.A.E.) at 1800 r.p.m.

Built in a tradition of reliability. Lister-Blackstone engines incorporate the very latest improvements in Diesel design. The full line includes engines from 3½ to 600 h.p. and there are models for every purpose. Ease of maintenance and economical operation are assured when you specify Lister-Blackstone. Service and spare parts are available from coast to coast. Write for Bulletin F.R.1-6.

## CANADIAN LISTER-BLACKSTONE LIMITED

1921 EGLINTON AVE. E., TORONTO 13 • 3135 WEST BROADWAY, VANCOUVER  
25 ST. JAMES ST., VILLE ST. PIERRE, MONTREAL

Distributors: B.C. Equipment Co. Ltd., 551 Howe Street, Vancouver • Bruce Robinson Electric (Edm.) Ltd., 10056-109th Street, Edmonton • Medland Machinery Limited, 576 Wall Street, Winnipeg • Russel-Hipwell Engines Ltd., Owen Sound • Consolidated Engines & Machinery Co. Ltd., 5645 Pare Street, Town of Mount Royal, P.Q. • Russel-Hipwell Engines Ltd., 1298 Barrington Street, Halifax • Clayton Construction Co., Ltd., P.O. Box 118, Muir Bldg., St. John's, Nfld.

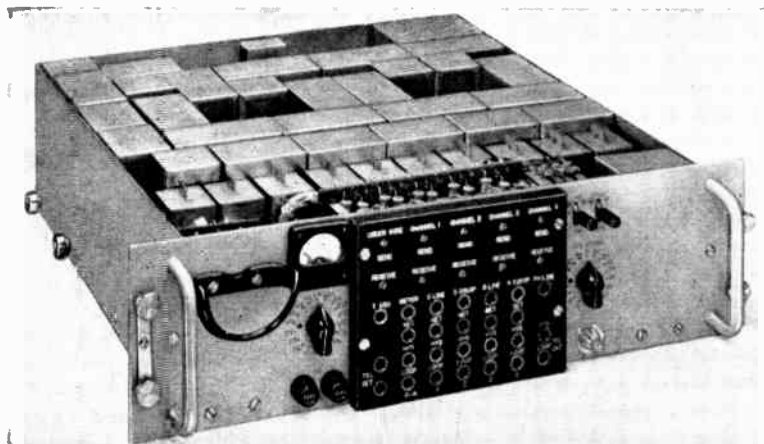

### FOUR-CHANNEL CARRIER-TELEPHONE TERMINAL FOR RADIO LINKS

This is a miniaturized unit of advanced design which provides four voice channels on a frequency-division basis above a voice-frequency order-wire channel. Each of these five channels is provided with a 4-wire 2-wire termination and a voice-frequency ringing circuit for d-c or 20-cycle signals. Adjustable attenuators are provided in the 4-wire side of all channels, and a built-in test oscillator and meter permit complete line-up, maintenance and trouble-shooting checks to be made. Channel levels are from -9 to 0 dbm and line levels from -30 to 0 dbm. Channel width is 300 to 3500 cycles within 1 db.

This unit is only 5¼" high by 19" wide by 14" deep. It mounts on a standard rack and operates from 115 volts 50-60 cycles a.c.

**RADIO ENGINEERING PRODUCTS**  
1080 UNIVERSITY ST., MONTREAL 3, CANADA  
TELEPHONE CABLES  
UNiversity 6-6887 RADENPRO, MONTREAL

## NEW PRODUCTS

(Continued from page 76)

### ● Nylon Thrust Washers

Item 1466

Nylatron "GS" nylon thrust washers are now available from stock in a wide range of sizes from Polypenco, Inc.

The washers are stamped from strip to outside diameters of ¾" to 1½" and inside diameters of ¼" to 1". They are available in thicknesses of 1/64", 1/32" and 1/16". The stamping operation is said to provide close tolerance parts with complete uniformity.

Nylatron "GS" thrust washers are used in a variety of applications where the best possible wear resistance is required under light thrust conditions. A prime example is their use in fractional horsepower motors where they demonstrate long life in contact with metals. The Nylatron washers have a low coefficient of friction and can be used to advantage where lubrication is difficult. While primarily rigid for mechanical applications, noise can be measurably reduced.

Patents have been applied for on Nylatron "GS", a molybdenum disulphide filled nylon formulation, specifically compounded to expand the field for nylon parts. It has better dimensional stability and lower deformation under load than standard nylon, coupled with a lower coefficient of friction and higher wear resistance in many applications.

For specific information on price and sizes write to Polypenco, Inc., Reading, Pennsylvania, U.S.A.

### ● Speed Clip For Capacitor Assembly

Item 1467

A new, unique Speed Clip, announced by Dominion Fasteners Limited, Canadian manufacturer of Tinnerman Speed Nut spring tension fasteners, offers a fast, simplified method of assembling capacitors and similarly shaped components in a wide variety of electronic applications.

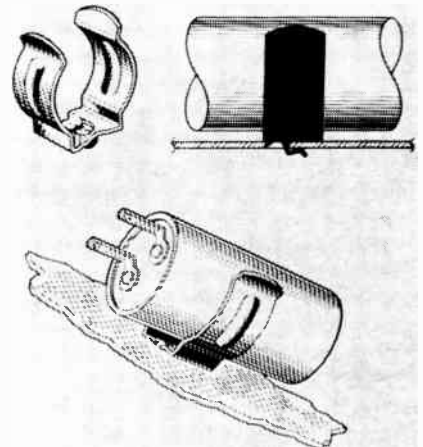

Incorporating a special "heel and toe" spring latching feature in its base, the new Speed Clip is easily pressed by hand into a mounting hole in the chassis where it retains itself securely in position to receive the capacitor. The capacitor is then quickly snapped between the clip's two curved spring fingers where it is held firmly under live spring tension. Former assembly methods required either riveting or welding the fasteners to the chassis.

Available for a wide range of panel thicknesses, the new Tinnerman Speed Clips will accommodate capacitors or similar components with diameters ranging from .357" to 1.500".

Dominion Fasteners Limited, Box 492, Hamilton, Ontario, Canada.

(Turn to page 80)

For further data on advertised products use page 81.

# Point Contact Germanium Diode Test Set

A versatile instrument designed for production testing of germanium point contact diodes and readily adaptable for analyzing the properties of gold bonded diodes and the testing of miniature types such as silicon junction and germanium junction diodes.

Courtesy British Thomson-Houston Co.

A test set designed for production testing and grading of germanium point contact diodes to a specification similar to that laid down by the International Business Machines Corporation constitutes a recently designed piece of equipment that will be of interest to those concerned with the production germanium diodes.

The test set is designed to fulfil two functions:

- To display the dynamic forward and reverse characteristics of the diode at 50 c.p.s. thus enabling tests to be made of forward and reverse resistance, drift, creep and flutter hysteresis and incremental resistance.
- To measure and display the time taken for the reverse current to return to normal when the diode is subjected suddenly to a reverse voltage after passing current in the forward direction.

## Forward and Reverse Diode Characteristics

The maximum forward voltage required to be displayed is about two volts and the maximum reverse voltage about 70 volts. These voltages will produce currents of about 20 mA and 200 micro-amps, respectively. To display the forward and reverse curves simultaneously and of a readily visible size a large change of scale is effected at the origin as the voltage passes through zero. A switch mounted on the front panel substitutes various resistors of known value to enable the graticule to be calibrated. Thus a close approximation to the actual forward and reverse diode resistances can be quickly made.

Fig. 1 (c) shows a typical diode characteristic.

Fig. 1 (a) shows a diode exhibiting the maximum permissible amount of hysteresis (20  $\mu$  A) in the reverse voltage region.

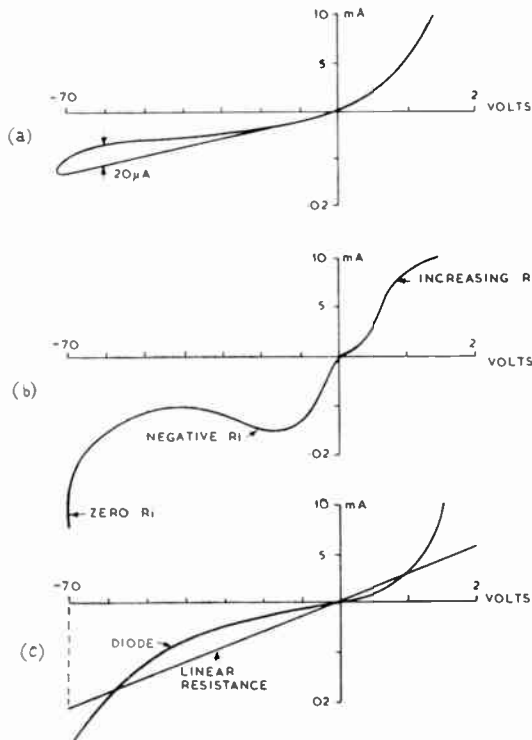

FIG. 1 CHARACTERISTICS OF GERMANIUM DIODES

Fig. 1 (b) shows a diode exhibiting zero and negative incremental resistance in the back voltage region, and increasing incremental resistance with increasing forward voltage.

## Reverse Recovery Time

A square wave is applied to the diode under test and a resultant waveform displayed on a C.R.T. (Fig. 2). The value of the reverse voltage is 35 volts and that of the forward current is 30 mA. The reversal takes place in less than 0.1 microseconds. By means of a switch on the front panel the period of the square wave can be altered. The actual values for this period are one, two and three microseconds. Thus an accurate estimation of recovery time can be made simply by looking at the display in conjunction with the switch position. The reversal time of 0.1 microseconds limits the usefulness of the display to its design function of ensuring that the recovery time is less than half a microsecond. If an accurate assessment of the whole storage effect and instantaneous reverse current were desired the reversal time would necessarily be of the order of 0.01 microseconds.

In its original form the test set is also quite suitable for displaying the properties of gold bonded diodes. The testing of other types of miniature diodes, e.g. silicon junction and germanium junction, could readily be accomplished with minor circuit modifications.

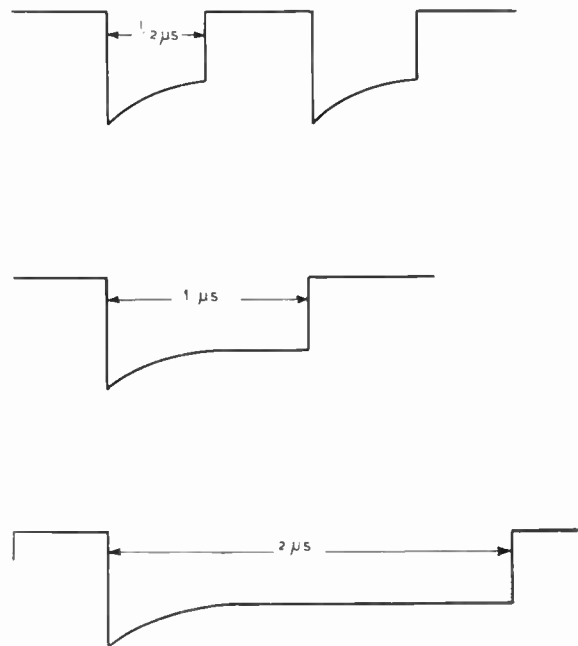

FIG. 2 REVERSE RECOVERY TIME



Start with

**STARK****STARK  
MODEL  
9 - 6 6**

## DYNAMIC MUTUAL CONDUCTANCE TUBE TESTER

### Look at these features:

- Dual Meter Readings, English and True Micromho in Three Ranges: 0-3,000—6,000—15,000.
- Noise Test.
- Tests Grid Controlled Rectifier Tubes, used in Industrial Applications
- Provides Vital Life Test.
- Correctly Tests Gas-filled Rectifier and Starter Tubes.
- Tests All Present Day Tubes including Octal, Laktol, Miniature, Ballast, Magic Eye tubes, and sub-miniature types.
- Gas Test for Rapid Disclosure of Tubes affecting AVC and IF Stages.
- Provision for New Tube Designs is Made—This Tester will remain up-to-date for a long time to come.
- Uses Rectified Current to Energize both Plates and Grids, using Two Rectifiers.
- Tests complete complement of 600 mil series of tubes.
- Facilities for checking of CRT tube with adapter.

**FOR OVER 20 YEARS...  
CANADA'S LARGEST MAKERS  
OF FINE TEST INSTRUMENTS**

Complete Information Available



*four instruments*

**STARK ELECTRONIC  
INSTRUMENTS LIMITED**

Factories and Sales Office: AJAX, ONTARIO

Foreign Division:

276 West 43rd St., New York 36, N.Y. U.S.A.

## NEW PRODUCTS

(Continued from page 78)

### • Mixed-Bed Regenerative Demineralizer

Item 1468

Purification by ion-exchange to produce water with resistance of over 1,000,000 ohms per C.C. is now made possible with the new Barnstead MM-O Mixed-Bed Regenerative Demineralizer. Cation and anion resins are thoroughly mixed in one resin bed thus permitting the ion-exchange process to take place hundreds of times as the water flows through. Water of electrical resistance of over 1,000,000 ohms per cubic centimeter with an almost constant pH level of 7 is thus produced.

The manufacturer states that Model MM-O removes approximately 1100 grains per regeneration. Unit consists of transparent plastic column mounted on a plastic base with molded plastic fittings top and bottom. Shipped as a complete unit with plastic tubing and distributor which aids in regenerating resins. Base is 8" x 8" and height is 51". Flow rate is from 10 to 30 gallons per hour.

For information write manufacturer, Barnstead Still & Demineralizer Co., 262 Lanesville Terrace, Boston 31, Mass., U.S.A.

### • Flexible Iron Powder In Rod And Tape Form

Item 1469

A new flexible ferromagnetic plastic, trademarked Ferrotron, is now available in sample kits.

The flexible iron powder product is in rod and tape form. Rod diameter sizes are 1/8", 1/4" and 3/8". The tape is 1/2" wide and stocked in thicknesses of 4, 8, 16 and 32 thousandths of an inch. These and other sizes are available in production quantities.

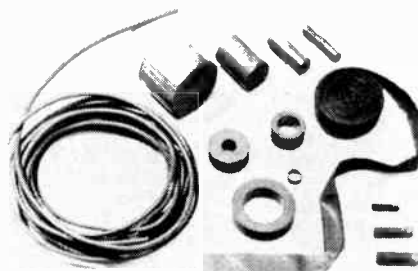

Not a magnetic recording tape, this iron powder product is unique in that it is as flexible as paper and yet possesses such unusual properties as good dielectric strength, constant magnetic permeability over a wide range of frequencies and excellent moisture and temperature resistance. The kits are being offered to electronic designers to facilitate the investigation of new or improved concepts in circuit development. Miniaturization of components is an outstanding possibility in using the flexible forms, since they permit design essentially within "a magnetic atmosphere". Using Ferrotron Type 309 tape in a revolutionary coil structure, a government research activity reduced the component's weight to 25 per cent and its size to 15 per cent of the original coil performing the same function.

Investigations by other agencies, both government and commercial, indicate that the advantages of flexible Ferrotron rod and tape also lend themselves to such items as electromagnetic shielding of critical circuits, radio interference suppression, delay lines and as a magnetic core material.

Complete information on sample kits, as well as technical data, is available on request from Polyenco, Incorporated, Reading, Penna., U.S.A.

(Turn to page 84)

# NOW!

## Flexible Kel-F PRINTED CIRCUIT CABLES



Kel-F®

developed by

Sanders Associates, Inc.

By means of an exclusive Sanders process, the versatile plastic Kel-F can now be laminated with copper in thin sheets to provide a flexible printed circuit cable. This unique development introduces an entirely new concept in the fabrication of multi-conductor cables or wiring harnesses. Excellent electrical and mechanical properties are supplied for operation over a wide range of environmental conditions. The complete encapsulation of the conductors in Kel-F ensures maximum protection against moisture. Glass cloth can also be included in the laminations for increased strength and high temperature stability.

### FEATURES

- Excellent dielectric strength
- High degree of flexibility
- Lighter, thinner than many cables
- Maximum environmental protection
- Adaptable to many connectors
- Multi-layer construction available
- Suitable for chassis harnesses
- Wiring errors are eliminated
- Easily mounted



Exclusive Canadian Representatives  
MEASUREMENT ENGINEERING, LTD.  
Arnprior, Ontario

For further data on advertised products use page 81.

# INDEX TO ADVERTISERS

Page number is on the right. Key number for use with READER SERVICE CARDS is on the left.

Key No.	Name	Page No.
1.	Ahearn & Soper Co. Ltd., The	85
2.	Automatic Electric Sales (Canada) Ltd.	43-46
3.	Aviation Electric Ltd.	9
4.	Aviation Electric Ltd.	63
5.	Bach-Simpson Ltd.	6
6.	Bohne Industries Ltd.	76
7.	Bomac Laboratories Inc.	55
8.	Bud Radio Inc.	83
9.	Burndy Canada Ltd.	12
10.	Burton-Rogers Co.	62
11.	Canadian General Electric Co. Ltd.	56
12.	Canadian Line Materials Ltd.	68
13.	Canadian Lister-Blackstone Ltd.	78
14.	Canadian Marconi Co.	3
15.	Canadian Marconi Co.	74
16.	Canadian Stackpole Ltd.	88
17.	Cannon Electric (Canada) Ltd.	10
18.	Central Bridge Co. Ltd.	40
19.	Centralab (Div. Globe Union Inc.)	61
20.	Clare & Co. C. P.	51
21.	Computing Devices of Canada Ltd.	59
22.	Cossor (Canada) Ltd.	5
23.	Daven Co., The	62
24.	Eitel-McCullough Inc.	85
25.	Electro Sonic Supply Co. Ltd.	62
26.	Freed Transformer Co. Inc.	62
27.	Hackbusch Electronics Ltd.	54
28.	Hammond Mfg. Co. Ltd.	52
29.	Helipot Corp.	86
30.	Helipot Corp.	87
31.	Hewlett-Packard Co.	19
32.	Honeywell Control Ltd.	39
33.	Honeywell Controls Ltd.	51
34.	Indiana Steel Products Co. of Canada Ltd., The	22
35.	International Resistance Co. Ltd.	2
36.	Lamb, L. J.	58
37.	Lenkurt Electric Co. of Canada Ltd.	38

Mr. Circulation Manager:

My proper address is shown below.  
Check

(My old address is ..... City .....

Please add my name to your Electronics & Communications' mailing list.  
Check (No obligation)

Name ..... Position .....

Company ..... Nature of Business .....

Company Address ..... City ..... Prov. ....

Signature .....  
1-57 (Not valid without signature)

PLEASE SEND FURTHER INFORMATION ON THE FOLLOWING NEW PRODUCT ITEMS AS NUMBERED BELOW — USE PRODUCT ITEM NUMBERS

PLEASE SEND FURTHER INFORMATION ON THE FOLLOWING ADVERTISEMENTS AS NUMBERED BELOW — USE KEY NUMBER

Company ..... Nature of Business .....

Name ..... Position .....

Street ..... City ..... Prov. ....  
1-57

PLEASE SEND FURTHER INFORMATION ON THE FOLLOWING NEW PRODUCT ITEMS AS NUMBERED BELOW — USE PRODUCT ITEM NUMBERS

PLEASE SEND FURTHER INFORMATION ON THE FOLLOWING ADVERTISEMENTS AS NUMBERED BELOW — USE KEY NUMBER

Name ..... Position .....

Company ..... Nature of Business .....

Street ..... City ..... Prov. ....  
1-57

**BUSINESS REPLY CARD**  
No Postage Stamp Necessary if Mailed in Canada

5c POSTAGE WILL BE PAID BY

**ELECTRONICS AND COMMUNICATIONS**

31 - 35 Willcocks Street

Toronto 5, Ontario



**BUSINESS REPLY CARD**  
No Postage Stamp Necessary if Mailed in Canada

5c POSTAGE WILL BE PAID BY

**ELECTRONICS AND COMMUNICATIONS**

31 - 35 Willcocks Street

Toronto 5, Ontario



**BUSINESS REPLY CARD**  
No Postage Stamp Necessary if Mailed in Canada

5c POSTAGE WILL BE PAID BY

**ELECTRONICS AND COMMUNICATIONS**

31 - 35 Willcocks Street

Toronto 5, Ontario



**INDEX — Continued**

Key No.	Name	Page No.
38.	Magnetics, Inc. ....	20
39.	Marsland Engineering Ltd. 84	
40.	Mechron Engineering Products Ltd. ....	64
41.	Moloney Electric Co. of Canada Ltd. ....	66
42.	Muirhead & Co. Ltd. ....	57
43.	National Fibre Co. of Canada Ltd. ....	4
44.	Ney Co., The J. M. ....	49
45.	Nichols Ltd., R. H. ....	49
46.	Northeastern Engineering 41	
47.	Ohmite Mfg. Co. ....	14
48.	P.S.C. Applied Research Ltd. ....	23
49.	Polarad Electronics Corp. 34	
50.	Pye Canada Ltd. ....	73
51.	R.C.A. Victor Co. Ltd. ....	15
52.	R.O.R. Associates Ltd. ....	37
53.	Radio Communications Equipment & Engineering Ltd. ....	24
54.	Radio Communications Equipment & Engineering Ltd. ....	25
55.	Radio Electronic Television Schools of Canada Ltd. ....	69
56.	Radio Engineering Products Ltd. ....	78
57.	Sanborn Co. ....	16
58.	Sanders Associates Inc. ....	80
59.	Sigma Instruments Inc. ....	53
60.	Sola Electric Co. ....	67
61.	Sprague International Ltd. 86	
62.	Standard Telephone & Cables Mfg. Co. (Canada) Ltd. ....	70
63.	Stark Electronic Instruments Ltd. ....	80
64.	Tishbein, O. F. ....	58
65.	Triplett Electrical Instrument Co., The ....	65
66.	Varian Assoc. of Canada Ltd. ....	75

Your request for further information on New Product items or additional information concerning advertisements in Electronics and Communications will be promptly acknowledged.



# avings

## come in many shapes and sizes

The hundreds of shapes and sizes in the standard Bud line of Sheet Metal Products and Electronic Components mean substantial savings to you.

Because of our extensive manufacturing capacity we are able to produce all these sizes and models at substantial savings. So whether your needs are for small or large quantities you can save time and money by using Bud Products.

There's extra value in every Bud Product, check their specifications, examine their construction, even the finish is superior in every way. The extra features included make them outstanding in performance and service. Good quality need not be expensive, yet poor quality may be costly. With all these extra features, Bud Products cost no more than ordinary similar products.

For specially fabricated products, Bud offers complete engineering and designing service. Our large facilities, expert workmanship, 28 years of experience and manufacturing "know-how" assure high quality products, expedited delivery and competitive prices.

See the complete Bud line at your nearest distributor or write for catalog.

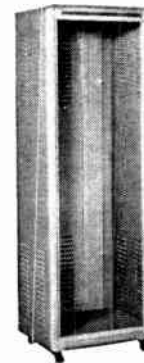

Deluxe Relay Rack



Cabinet Rack



Chassis



Desk Type Relay Rack

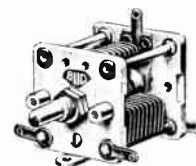

Midget Condenser



Transmitter Coil

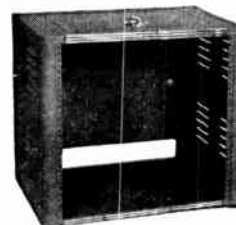

Prestige Cabinet



### TENATRONICS, LTD.

Davis Drive, East

Newmarket, Ontario

Exclusive Canadian Representative for

### BUD RADIO, INC.

2118 East 55th Street

Cleveland 3, Ohio

**TELEVISION TUNERS**

Switch Type  
Licencee of Sarkes-Tarzian Inc.

**LOUDSPEAKERS**

Domestic and Military Types

**WIRE WOUND RESISTORS**

Cement and Vitreous Enamelled  
Coatings - MIL Approved

**VARIABLE TUNING  
CAPACITORS**

Radio Tuning Types - Special  
Units For Military Application

**TRIMMER CAPACITORS**

Conventional Air Dielectric  
Glass and Ceramic  
**LEDEX ROTARY  
SOLENOIDS AND  
SELECTOR SWITCHES**

**PERMEABILITY TUNERS  
PRECISION GEARS AND  
GEAR TRAIN ASSEMBLIES  
SERVO-LOOP SYSTEMS  
MICROWAVE  
COMPONENTS**  
Filters. Antennas

ALL SYSTEMS  
AND  
COMPONENTS  
ENGINEERED

TOOLED AND  
MANUFACTURED IN  
OUR KITCHENER  
PLANT



**marsland  
ENGINEERING  
LIMITED**  
KITCHENER, ONT., CANADA

**NEW PRODUCTS**

(Continued from page 80)

● **"Transi-Pak" —  
Miniature Inverter**  
Item 1470

Bendix Aviation Corporation has announced a new miniature inverter designated the Bendix Red Bank Type 39B3-1 TRANSI-PAK (trade mark). The TRANSI-PAK, with a D.C. input of 28 volts and an A.C. output of 115 volts, 400 cycles, 100 VA, is approximately one-eighth the weight of a comparable piece of rotary equipment with only one-sixth of its volume.

It is completely static, using two junction transistors. Compared with the limited life-hours of its counterpart, the inverter, Bendix claims that the TRANSI-PAK is practically maintenance free and will give thousands of hours of trouble-free operation.

As a source of A.C. voltage, the TRANSI-PAK is a small, lightweight, efficient power supply for modern aircraft and missiles, meeting military environmental requirements for shock, vibration, humidity, salt spray, sand and dust, and radio interference.

Complete descriptive details are available from the Canadian affiliate of the Bendix Aviation Corporation: **Aviation Electric Limited, 200 Laurentien Blvd., (P.O. Box 6102) Montreal, P.Q.**

● **MPR-13 Multi-Channel  
Programmer**  
Item 1471

Meeting an often-expressed need for a small programming device of exceptional accuracy, the MPR-13 Multi-Channel Programmer offers many advantages never before accumulated in one package. It is small in size and light in weight, and yet provides up to 13 channels for any type of electrical programming, either of a repeat cycling or of a random nature.

It has an accuracy of the order of one part in approximately fifty thousand, even though it was designed to withstand the rigors of missile and aircraft usage. For utmost ruggedness, the Programmer is manufactured to extremely close tolerances, and is housed in a magnesium casting for a high degree of strength and resistance to shock and vibration without imposing a high weight penalty.

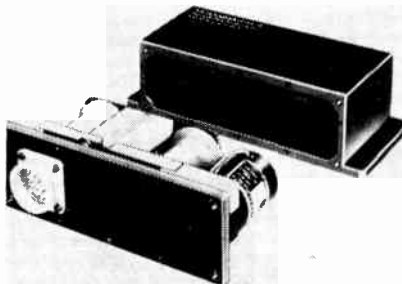

The general operating principle provides for an insulating tape similar to 35mm photographic film to be advanced at a precise rate of speed between 13 contactors. The tape is marked lengthwise in time and divided in 13 channels. Up to thirteen types of signals may be generated by this device for the accurate control of a group of electrically operated equipment—by punching holes in the control tape to allow the contactors to close for a period of time equal to the hole or slot length.

The Programmer MPR-13 is extremely small and compact, weighing only 3 pounds, 10 ounces, and measuring 2" x 3" x 6".

For additional information and prices of the Programmer MPR-13, write direct to the manufacturer, **Photographic Products Inc., 1000 No. Olive Street, Anaheim, Calif., U.S.A.**

(Turn to page 86)

**TECHNICAL PERSONNEL  
AVAILABLE**

**TELEVISION TECHNICIAN** with three years experience on bench work and repair to all makes of television sets desires employment with company engaged in industrial or medical electronics. Prepared to accept company training in either of the above branches of electronic maintenance. Reply to Box 501, Electronics and Communications.

**PROFESSIONAL ENGINEER**, experienced in setting up merchandising operations and sales of new engineering products in Canada, is shortly available for new project. Reply to Box 502, Electronics and Communications.

**15 YEARS** in electronics, P. Eng., presently employed at leading manufacturing company for 3½ years, design and manufacturing of TV sets, immigrant. Reply to Box 503, Electronics and Communications.

**ELECTRONIC ENGINEER**; 25 years experience on design, test, installation and specification of all types of communication equipment is open for offers as head of Quality Control or Reliability section. Specialist in Reliability and statistical quality control. Reply to Box 504, Electronics and Communications.

**ENGINEER** — Secondary education in London, England, followed by professional education with degree from London Electrical Training College, Manor Gardens, London N7. Also certificate proficiency wireless telegraph and telephony as signed by Postmaster General, London, England. Reply to Box 505, Electronics and Communications.

**ENGINEER** — Manager-Consultant: broad experience in technical personnel development; management assignments at top decision level; electrical and electronic engineering (holds several patents); economic analyses and engineering studies. Interest lies in management work requiring technical background. Sen. Mem. I.R.E., Mem. A.I.E.E., Assoc. Mem. O.R.S.A. and P.Eng. Reply to Box 506 Electronics and Communications.

**ELECTRONIC & COMMUNICATION ENGINEER** Member IRE with more than 15 years' experience in electronics, acoustics, ultrasound and telephone equipment, Excellent fundamental background in electrical and electronic engineering, able to do responsible design and development work. Speaking and writing fluently French, German and Italian. Expected to be Canadian citizen 1958. Good organizer, able to undertake new methods, is looking for a situation where his qualities may be utilized full. Reply to Box 507. Electronics and Communications.

For further data on advertised products use page 81.



**New stacked ceramic receiving tubes that can withstand heavy shock and vibration**

**2CL40A** A new, small ceramic high vacuum rectifier or clipper diode that can be air or liquid cooled



**3CX100A5** A premium quality ceramic and metal 100 watt triode



**4CX300A** General purpose tetrode with 300 watts plate dissipation up to 500 MC

**EIMAC FIRST  
with ceramic tubes  
that can take it...**

In recent years equipment manufacturers and users have been introduced by Eimac to a series of ceramic tube firsts unequalled in the industry: klystrons, negative grid tubes, rectifiers and receiving tubes.

Clean, and rugged... these tubes can stand up to shocks and temperatures no glass tube can. Design and production advantages are a boon to equipment manufacturers and users alike.

As first in the field, Eimac has developed ceramic tube manufacturing techniques that have evolved into well established processes.

See this line of "tubes that can take it" at the Eimac exhibit, Booth 2410-12, National I.R.E. Show and Convention in New York, March 18-21.

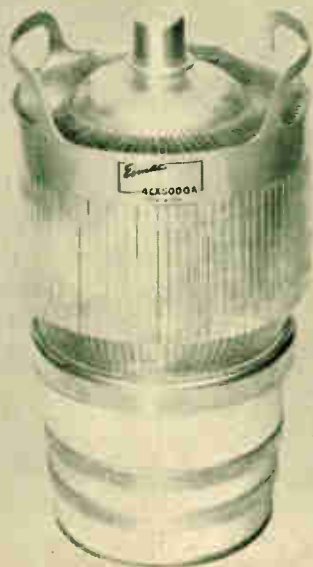

**4CX5000A** High power radial-beam tetrode especially suitable for single sideband operation



**4K50,000LQ** Four cavity klystron that delivers 10,000 watts of power at frequencies of 700 to 1000 MC

**EITEL-McCULLOUGH, INC.**  
SAN BRUNO CALIFORNIA  
The World's Largest Manufacturer of  
Transmitting Tubes



REPRESENTED IN CANADA BY  
**THE AHEARN AND SOPER COMPANY**  
LIMITED  
P.O. Box 715 Ottawa, Ontario



## INSTRUMENTATION ENGINEERS

Excellent opportunity and interesting work is available with our rapidly expanding organization handling special electronic instruments and components.

We require:

- Sales Engineers
- Service Technicians
- Telemetry Systems Engineers
- System Application Engineers
- System Design Engineers

All replies and inquiries held in strict confidence. For further information write, phone or visit:

**A. G. SHACK**  
**Electromechanical Products**  
 Markham Road and 401 Highway  
 Agincourt, Ontario  
 Phone: Bus. AX. 3-7011  
 Home AX. 3-3761



# odds

Eighty-six thousand different electronic components in a typical missile. There's little chance any one will fail. But one failure among all is one too many. The risk is too great to gamble. That's why Sprague high reliability components are specified.

## SPRAGUE<sup>®</sup>

**CANADIAN  
MANUFACTURING  
REPRESENTATIVE**

Micarta Fabrications  
 Limited  
 18 Toronto Street  
 Toronto, Ontario  
 Phone EMpire 8-4251

## NEW PRODUCTS

(Continued from page 84)

### ● A.C. Voltage Regulation Item 1472

Many stabilizers compensate for line voltage variations but do nothing to compensate for the effects of changing load. Stedivolt Voltage Regulators maintain constant voltage independent of load current from zero to the full rated output. A feature of the Stedivolt is that if the supply voltage goes beyond the control range, the unit will continue to supply its maximum correction.

The buck-boost transformer Secondary in the Model P-17 consists of two identical windings, which may be connected either in series or in parallel. Each winding will deliver up to 10 volts at 30 amps. Each is separately fused. In the series connection, maximum correction speed of 30 volts/sec. is obtained. In the parallel connection, speed of regulation is still 15 volts/sec. but up to 60 amps can be handled.

The Stedivolt can be used either on 230V or 115V circuits by simply changing link positions on connection panels. If desired, both sides of a 3 wire 230V circuit may be regulated simultaneously, by connecting buck-boost transformer secondaries in the outside legs.

For further information contact **R-O-R Associates Limited, 290 Lawrence Ave. West, Toronto 12, Ontario, Canada.**

### ● Commercial Signal Markers Item 1473

The first commercial high brightness safety signals and markers to utilize the long-lived radioactive gas — Krypton<sup>85</sup> — have recently been announced by Radelin-Kirk Limited, Toronto, Ontario and United States Radium Corporation, Morristown, New Jersey.

The signals and markers, designed especially for installations where power and maintenance are limited, employ treated phosphor crystals excited to luminescence by Kr<sup>85</sup>. Units, available in a variety of shapes, sizes and brightnesses, are suited for use in mining, transportation, marine and heavy industrial fields, as well as for low-level civil defense marking or other applications where little power is available for illumination of signal lights.



The devices, readily visible at distances in excess of 500 yards, are adaptable to a wide range of signal, directional and marking systems. Colors available include blue, green, yellow, pale orange and orange-red.

Sources are enclosed in hermetically-sealed, transparent capsules which are weather and tamper-proof, requiring no maintenance from the first day of installation. Circuit installation costs are likewise eliminated, as are replacements of transformers, batteries or bulbs. Refueling and cleaning of oil lamps used as signals is no longer required.

For further information, write **Radelin-Kirk Limited, 1168 Bay Street, Toronto 5, Ontario, Canada.**

surprise  
another product from Helipot!

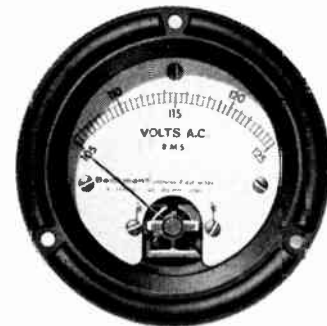

## Beckman AC & DC Expanded Scale Voltmeters

What good's accuracy... if it takes a bug-eyed monster to detect it? That's why we've made our panel-mounting voltmeters as *readable* (by homo sap.) as they're *accurate* (as close as 0.3% of center-scale voltage). And we make 'em as small as 2½" dia.

*Logical question:* Are you kidding? That size, with those features?

*Enthusiastic answer:* S'true! The trick's in the expanded scale. Conventional meters have all the numbers and increments... from zero to full-scale voltage... jammed in with a shoe horn. Not ours. We took the meat part of the scale, expanded it, and made it linear... eliminating the fat and gristle. Now there's room enough for all you need to read... and boy, is it easy! So easy, it would take a conventional meter 12 times larger to achieve the same readability. (Can you imagine the damping factor you'd need for a 2-foot needle?)



**Q.** Who are they for?

**A.** They're as great for groundlings as they're fine for flyboys. The AC voltmeters, incidentally, provide true rms readings.

**Q.** How many models?

**A.** We've got eight basic models in a variety of shapes, sizes, standard scales and accuracies... to suit your mood and installation.

*Interested? Write for data file 247.*

**Beckman<sup>®</sup> Helipot**  
 Corporation

*a division of Beckman Instruments, Inc.*

*Canadian Factory:*

*No. 3 Six Points Rd., Toronto 18, Ont.*

*Sales Representative: R-O-R Associates, Ltd.,  
 290 Lawrence Ave. West, Toronto 12, Ont.*

For further data on advertised products use page 81.

Another product surprise from Helipot!

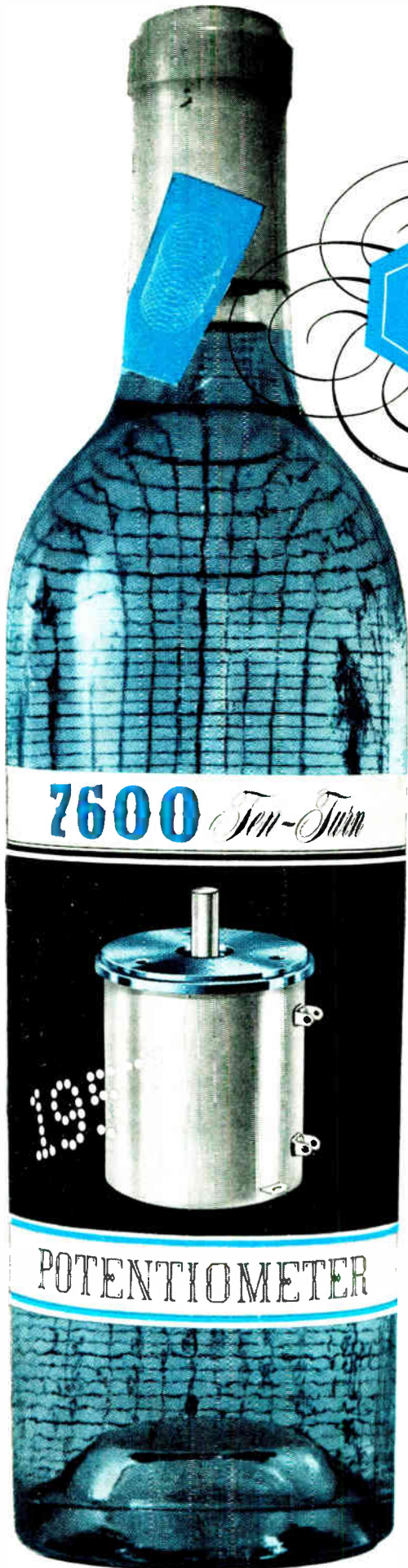

Helipot... *Vintage '57*

*Here's health* to your system . . . when you specify Helipot's series 7600 potentiometer.

*Here's strength* . . . and here's accuracy!

*Here's how* it's done. The robust housing of Resinox 10900 is molded in one shot, lathed in one set-up . . . gives you greater mechanical conformity and stability . . . corks up electrical leakage.

The rotor-and-slider-block design pours ruddy health into the 7600 . . . gives you 38-inch-pound stop-load strength, lowered torque and inertia . . . drains off every last drop of backlash.

*Cheers* for the 90° coil extension that improves end-coil linearity . . . for the internally expanding ring that emphatically clamps lid to housing, eliminates screws.

The full-bodied facts about the 10-turn, 1-13/16" diameter series 7600 are soberly presented in data file 227. Try one today!

Beckman®

**Helipot** Corporation

a division of Beckman Instruments, Inc.

Canadian Factory: No. 3 Six Points Rd., Toronto 18, Ont.

Sales Representative: R-O-R Associates, Ltd.

290 Lawrence Ave. West, Toronto 12, Ont.

# AROUND THE WORLD *again and again!*

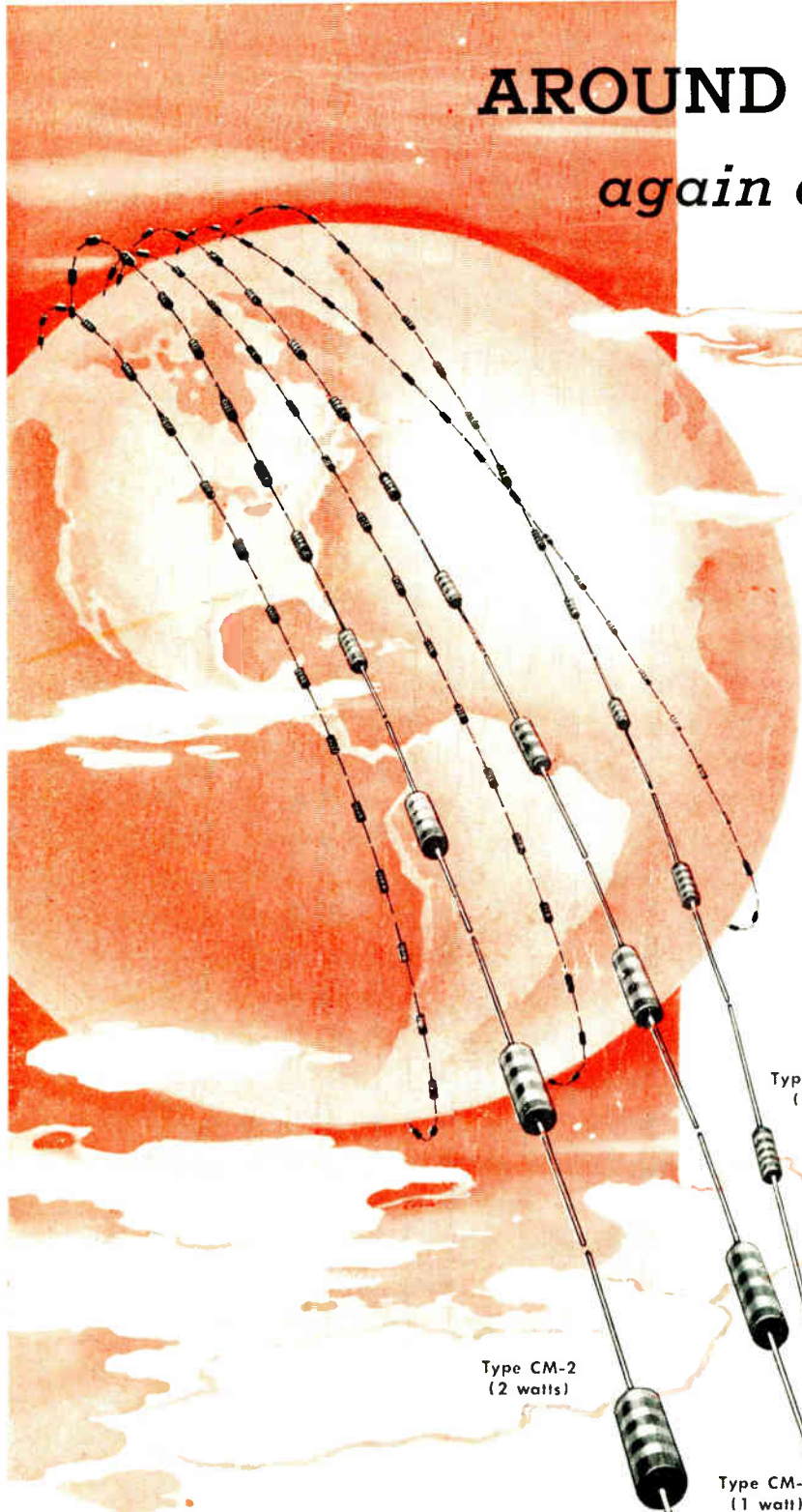

**A** fair idea of the extent to which Stackpole fixed composition resistors are used may be gained from this illustration.

Laid end to end, the total number of these tiny components produced to date by Stackpole would extend many times around the world.

Such acceptance is a tribute, both to the high quality of the resistors and to the dependable, personalized service, that Stackpole puts behind each resistor order.

## CANADIAN STACKPOLE LTD.

550 Evans Ave., Etobicoke  
Toronto 14, Ontario

Type CM-1/32  
( $\frac{1}{2}$  watt)

Made in Canada . . . By  
Canadians . . . In this modern  
21,000 square-foot building.



Type CM-2  
(2 watts)

Type CM-1  
(1 watt)



# STACKPOLE FIXED COMPOSITION RESISTORS

Available for your convenience through leading parts distributors.