

# ELECTRONICS *and* COMMUNICATIONS

DESIGN — MANUFACTURE — ENGINEERING — DISTRIBUTION — APPLICATION

## *New Ideas For Modern Management*

- Canada Shares The Wealth And Responsibility In Providing Electronics For Defense . . . . . page 16
- Electronic Engine Analyzer Promises Faster Trouble Shooting For The Automotive Industry . . . . . page 18
- Automatic Machinery For The Electronic Industry Boosts Output And Increases Quality . . . . . page 21
- I/T/V Coordinates Detached Plant Operations In Linoleum Manufacturing . . . . . page 43
- Remote Control Of Broadcast Transmitters Essential To Economical Operation . . . . . page 44

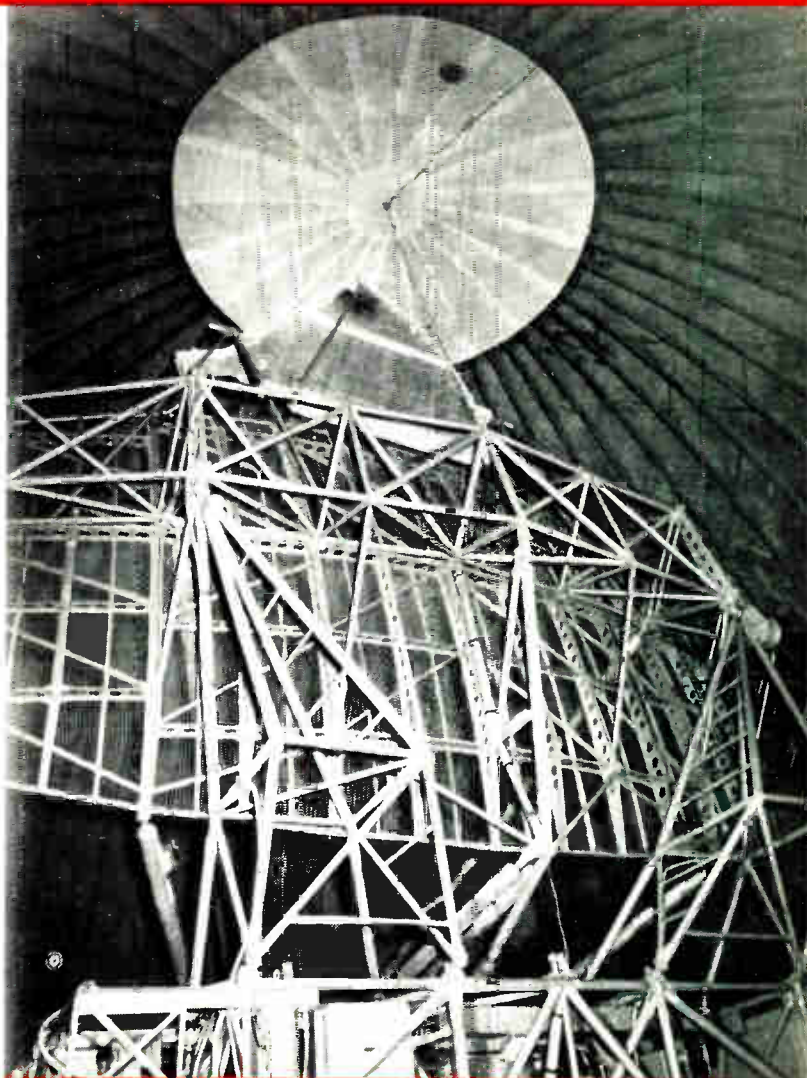

Representing a substantial portion of the millions of dollars being spent on the construction of radar installations in northern Canada is the above radar antenna an important element in the intricate machinery at RCAF radar stations. (See story on page 16.)

May - June, 1955 ★ \$5.00 a year  
An AGE Publication, Toronto, Canada

Distribution Of This Issue  
Over 10,000 Copies

# PRECISION PRODUCTION



Main plate of R Theta navigation computer is checked with a height gauge in the quality control section.

**T**hese armament intervalometers are typical of the work done by PSC Applied Research Limited, where quality is produced in quantity to meticulous standards. Every modern facility needed for the precision manufacture of complex instruments has been invested in the Production division. Quality Control, equipped with a large array of checking instruments, maintains constant vigilance over the quality, tolerances and performance of each product from base material to final check. The production problems pertinent to many different items have been mastered in so many various ways that the division switches readily from project to project. These assets are offered to clients also for sub-contract manufacturing on such work as micro-wave plumbing fabrication and other types of precision production.

Write for our brochure.

PSC Applied Research Limited,  
1500 O'Connor Drive, Toronto 16

Gentlemen:  
I will look forward to receiving your brochure with interest.

Name.....  
Business.....  
Street.....  
City.....  
Position.....



**PSC APPLIED RESEARCH LTD.**

1500 O'CONNOR DRIVE  
TORONTO 16, ONTARIO, CANADA  
**PLYMOUTH 5-3371**

**Severest critic**

In the world of electronics, devices infinitely more sensitive than the human ear can measure the fidelity of sound reproduction. Instruments evaluate television picture tubes, too. They measure output and probable service life. But the human eye is the most difficult critic to satisfy. Marconi RVC tubes, aged and tested, are released only when they have been seen to perform perfectly.

YOUR customers' satisfaction is the dividend Marconi earns by setting higher standards for the industry.

**MARCONI  RADIOTRONS**

Canada's finest radio and television tubes

CANADIAN MARCONI COMPANY

VANCOUVER, WINNIPEG, TORONTO, MONTREAL, HALIFAX, ST. JOHN'S, NFLD

# *faster tube testing!*

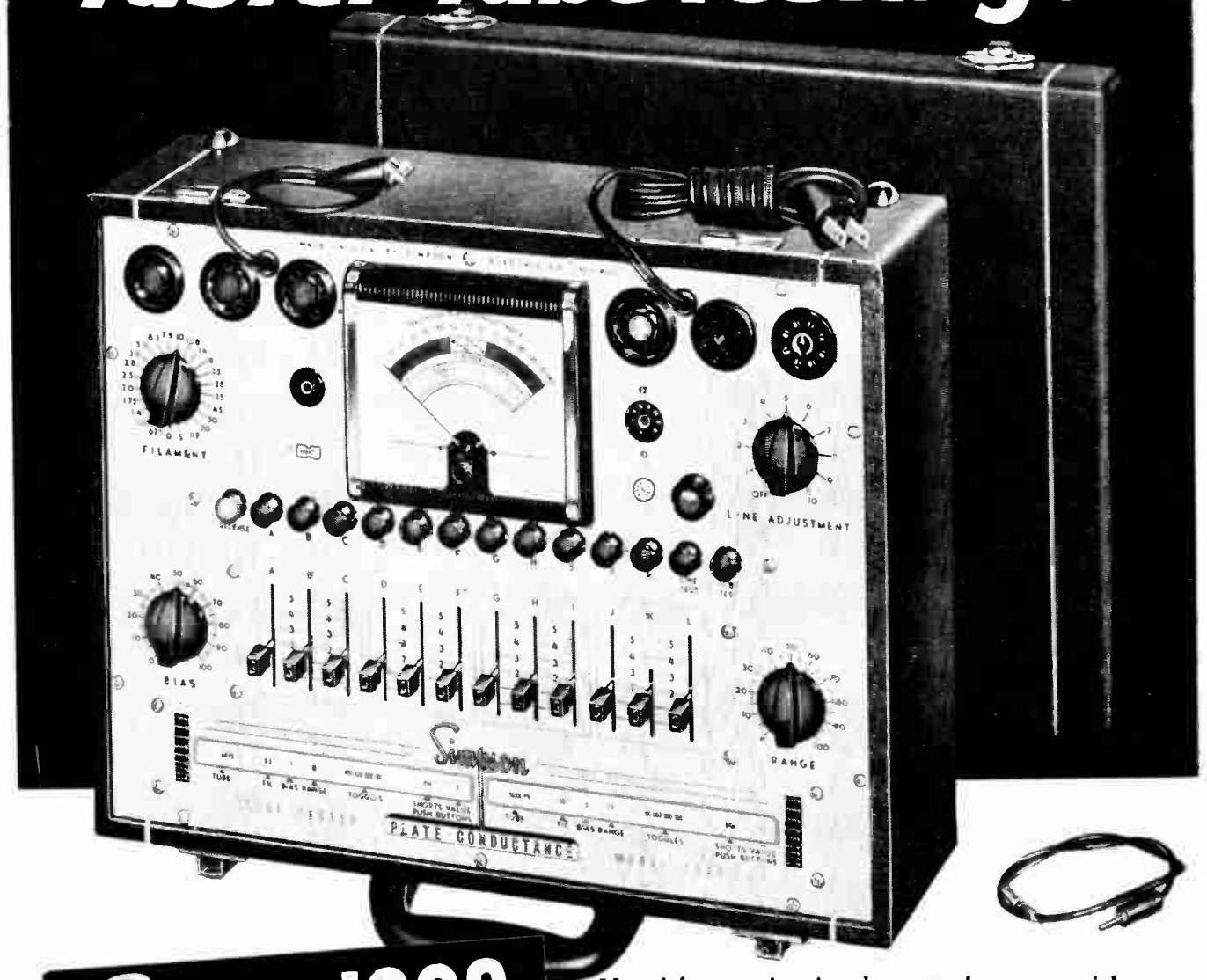

**Simpson  
MODEL 1000**

*Now! fast testing in plate conductance with convenient ohms readings for leakage and shorts.*

- tests any tube—including 9 pin miniatures and subminiatures—for plate conductance. Dial shows percentage of rated plate conductance for more positive, accurate results.
- tests are made under conditions simulating actual use in radio, TV, hearing aids and other electronic circuits.
- gives you reliable short tests because the Simpson 1000 quickly and conveniently shows you the exact ohms values for inter-element leakage and tube shorts.
- Simpson's roll chart service makes a new roll chart available each year and complimentary roll chart supplements are provided at regular intervals.

- and—the Simpson 1000 is as handsome as it is useful. Front panel is finished in non-glare grey hammerloid. Rich burgundy carrying case looks like expensive luggage. Comes complete with Operator's Manual.

**Bach-Simpson**  
LIMITED

1255 BRYDGES ST.

LONDON, CANADA

IN U.S.A. SIMPSON ELECTRIC COMPANY, 5200 W. KINZIE ST., CHICAGO 44, ILL.

For further data on advertised products use page 99.

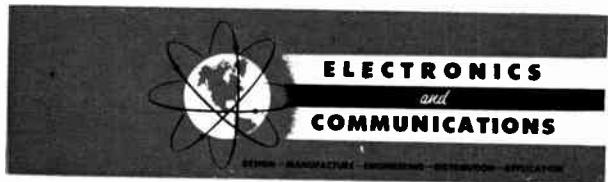

THE ONLY CANADIAN JOURNAL DEVOTED SPECIFICALLY TO THE APPLICATIONS OF COMMUNICATIONS AND ELECTRONICS

**MAY - JUNE 1955**  
**VOL. 3 No. 3**

# EDITORIAL CONTENTS

## FEATURES

	Page
<b>Electronics In Continental Defense</b> <i>by D. A. Golden, Deputy Minister, Department of Defense Production.</i>	16
<b>Electronic Engine Analyzer</b> <i>Diagnoses More Than Sixty-Five Engine Faults.</i>	18
<b>Automatic Machinery For The Electronic Industry</b> <i>Automation Has Made Its Debut For Assembly Operations.</i>	21
<b>The Road Ahead For Canadian Electronics</b> <i>by Joseph Brouillard.</i>	24
<b>Cadmium Sulphide Photoconductive Cells</b> <i>by Z. Szepesi, Ph.D. and D. A. Anderson, Ph.D.</i>	27
<b>Technical Background Requirements For Broadcast Studio Efficiency</b> <i>by Leslie L. Hill, Ph.D.</i>	32
<b>Electronic Needs For The Navy</b> <i>Fighting Efficiency Depends On Electronic Equipment.</i>	40
<b>Industrial TV Co-ordinates Detached Plant Operations</b> <i>Closer Control Of Industrial Processes Achieved With I T V.</i>	43
<b>Broadcast Operations</b> <i>Remote Control Of Transmitters Cuts Costs — Increases Efficiency.</i>	44

## DEPARTMENTS

Editorial . . . . .	11
The Editor's Space . . . . .	13
Business Briefs And Trends . . . . .	15
News . . . . .	48
New Products . . . . .	59
Book Review . . . . .	100

## PUBLISHED BY AGE PUBLICATIONS LIMITED

Also Publishers of Restaurants and Institutions, Hotel and Tavern, Heating, Plumbing & Air Conditioning AGE, and Oil & Gas Heat

MONTREAL, QUE., CANADA  
Room 504, Dominion Square Building  
1010 St. Catherine Street West  
Tel. UNiversity 6-7897

TORONTO, ONT., CANADA  
31 Willcocks Street  
Tel. WALnut 2-3115

Subscription Rates: Canada and British Possessions \$5.00 per year  
United States of America \$7.50 per year • Foreign \$10.00 per year  
Authorized as second class mail, Post Office Department, Ottawa

President and Publisher  
NORTON W. KINGSLAND  
Vice-President and  
Director of Advertising  
NORMAN McHARDY  
Editor  
THOMAS W. LAZENBY  
Editorial Director  
PAUL RODNEY  
Contributing Editor  
LESLIE L. HILL, Ph.D.  
Advertising Manager  
H. E. DALLYN  
Production Manager  
NEVILL A. CAMPING  
Business Manager  
CLIFFORD A. SPARKS  
Circulation Manager  
PAUL A. IRWIN  
West Coast Representative  
DUNCAN R. SCOTT & Co.,  
Mills Building  
San Francisco

Member Canadian Circulation  
Audit Board, Inc.

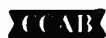

PRINTED IN CANADA



**When the going's too rough for others**

**'Jeep' 4Wheel-drive VEHICLES**

**will get through!**



Wherever the job, regardless of weather or ground conditions, a sure-footed 'Jeep' vehicle will get there, with men, equipment or payload. Shifting instantly from 2-wheel drive to the added traction of all four wheels, they go through sand, mud, snow and navigate the steepest grades with ease.

**The most versatile vehicles ever built!**



**'JEEP' CARGO PERSONNEL CARRIER**



**CJ-5 'JEEP'**



**'JEEP' STATION WAGON**

Every 'Jeep' vehicle has 3 power take-off points available. Each is a mobile power plant, delivers ready auxiliary power anywhere to operate compressors, generators, belt-driven equipment and winches. And there's over fifty pieces of special equipment to make 'Jeep' 4-wheel drive vehicles the handiest, most useful and profitable investment any business could make!



**WINCH**



**'JEEP'-A-TRENCH**

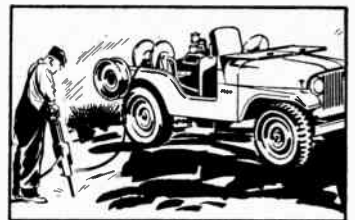

**COMPRESSOR**



**WELDER**

**For the toughest "impossible" jobs  
the world automatically thinks of 'Jeep'**

**KAISER-WILLYS OF CANADA LTD.**

**WINDSOR • ONTARIO  
Canada's most useful vehicles**

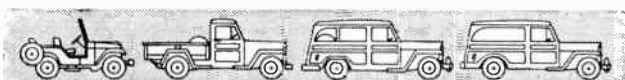

KW-145

For further data on advertised products use page 99.

# Bomac

## SILICON DIODES

Bomac Silicon Diodes are manufactured to exceptionally high standards to assure electrical uniformity and mechanical stability. New design considerations and improved manufacturing techniques have resulted in X- and S-band crystals of increased burnout resistance and higher humidity resistance.

- TOP PERFORMANCE
- UNIFORMITY
- STABILITY

Band	Type	Freq. (MC)	Max. Conversion Loss db	Noise Ratio (Times)	Max. VSWR	IF Impedance (Ohms)
S	1N21B	3060	6.5	2.0	—	—
S	1N21BR	3060	6.5	2.0	—	—
S	1N21C	3060	5.5	1.5	—	—
S	1N21CR	3060	5.5	1.5	—	—
X	1N23B	9375	6.5	2.7	—	—
X	1N23BR	9375	6.5	2.7	—	—
X	1N23C	9375	6.0	2.0	1.50	325-475
X	1N23CR	9375	6.0	2.0	1.50	325-475
X	1N149	9375	5.5	1.5	1.25	325-475
X	1N23D	9375	5.0	1.7	1.25	350-450
X	1N23DR	9375	5.0	1.7	1.25	350-450

The above diodes may be supplied in pairs wherever their characteristics are matched as follows:

Conversion Loss .....  $\pm 10\%$   
 IF Impedance .....  $\pm 15$  ohms  
 Rectified Current .....  $\pm 10\%$   
 RF Impedance (VSWR) ..... Such that unbalance  $\leq 10\%$  of available power



### UNIQUE PACKAGE PROTECTION

For complete protection during shipment and storage Bomac has designed a reusable RF Protective Package\* which conforms with MIL-E1B specification. Diodes stored in this package are completely protected no matter how many times they are handled after the original seal is broken.

\*Pat. applied for

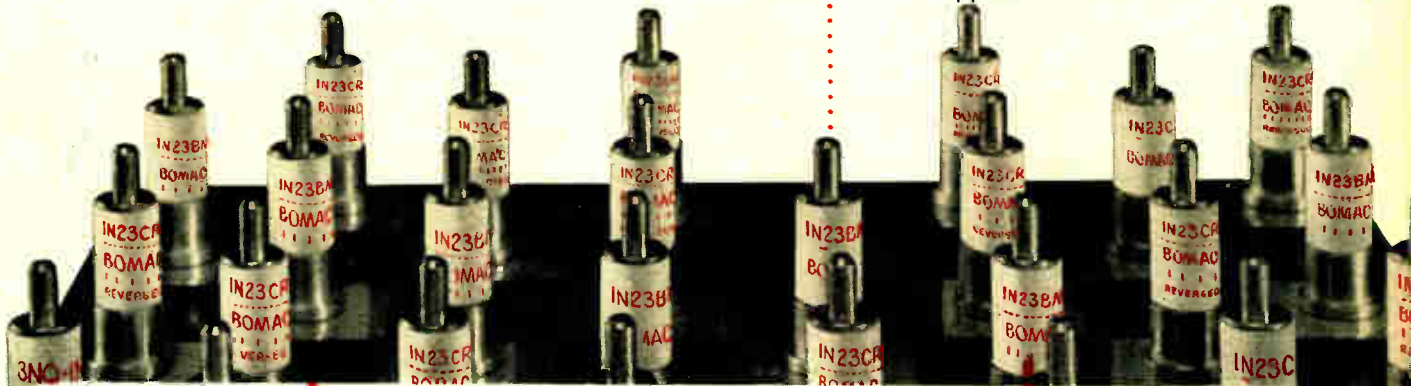

We invite your inquiries regarding

- ENGINEERING
- DEVELOPMENT
- PRODUCTION

## Bomac Laboratories, Inc.

BEVERLY, MASSACHUSETTS

GAS SWITCHING TUBES · DIODES · HYDROGEN THYRATRONS · DUPLEXERS · MAGNETRONS  
 MODULATORS · CAVITIES

Catalog on request.  
 Write (on your company letterhead)  
 Dept. E-56 BOMAC  
 Laboratories, Inc.  
 Beverly, Mass.

# NEW HEIGHTS *of* ACHIEVEMENT

by an All Canadian Company  
*Computing* **DEVICES**  
OF CANADA LIMITED

## The First

TO FIND THE ANSWER TO  
"PUSH-BUTTON"  
GUIDED NAVIGATION  
WITH P.H.I. (POSITION AND HOMING INDICATOR)\*

- No map reading . . . No distance limitations.
- Direction and distance to any pre-selected point shown at any time during flight by merely pushing appropriate button
- Independent of all radio interference or jamming.
- Independent of any ground control.
- Independent of weather conditions.
- Guides plane to destination or any series of destinations or targets and back to home base **REGARDLESS OF VARIATIONS FROM COURSE.**
- Ideally adapted to high speed jet aircraft.
- Has the high degree of miniaturization required to meet the rigid limitations of weight and size for today's aircraft.

This advanced technical knowledge of CDC's research and engineering staff and 300 highly trained employees is also being used continually to develop and produce specialized electronic equipment for our armed forces and for business and industry. A fully qualified staff of field men is available for installation and servicing of equipment.

\* Patent applied for



P.H.I. was developed in co-operation with the R.C.A.F. and is now being operationally tested by the :

**R.C.A.F. U.S.A.F. R.A.F.**

### COMPUTING DEVICES OF CANADA LIMITED

311 RICHMOND ROAD • OTTAWA, ONTARIO



For further data on advertised products use page 99.



automatic cut-out

20,000 ohms/volt d.c.

a.c. & d.c. current ranges

accurate

Model 8

# Universal AvoMeter

for

**ELECTRONICS · RADIO · TELEVISION**

The multi-range instrument with automatic cut-out protection on virtually any overload.

Minimizes costly instrument repairs and delays. If overload occurs, select correct range, reset cut-out button and take the reading.

### OTHER FEATURES:

4 Current Ranges: 100 mA to 10 Amperes A.C.

7 Current Ranges: 50  $\mu$ A to 10 Amperes D.C.

14 Voltage Ranges: 2.5 Volts to 2,500 Volts A.C. & D.C.

3 Resistance Ranges: 0-2,000 Ohms, 200,000 Ohms & 20 Megohms. Ranges may be extended by means of external "AVO" accessories. A movement reversing button changes meter polarity without reversing leads — simplifies discriminator alignment.

Complete factory repair service with all spares in stock, available at our Toronto plant.

**R. H. NICHOLS LTD.,**  
2781 Dufferin St., Toronto, Ont.  
Dept. EC5

Please send me complete information on your AvoMeter Multi-Range Instrument with Automatic Cut-Out Protection.

FIRM .....

ADDRESS .....

REQUESTED BY .....



**2781 DUFFERIN STREET · TORONTO**

Comprehensive Avo-Meter Bulletin available on request. Send for yours to-day.

# BUDELMAN FM-UHF and MICROWAVE RADIO SYSTEMS

are available in a number of versions to suit almost any requirement, and can be supplied as completely assembled terminals or as individual chassis on 19" panels for rack mounting in any combination dictated by your particular requirements.

- 450, 960, or 2000 mc/s.
- Any number of multiplexed voice channels up to ten, plus a directly modulated engineering channel, plus tone channels as required.
- A variety of termination and control panels either two or four wire to meet any need, as well as special racks and cabinets.

◀ Typical 960 mc/s open-type microwave terminal consisting of receiver, transmitter, and three multiplexed voice channels.

*We welcome inquiries which will enable us to engineer custom-built systems to your specifications.*

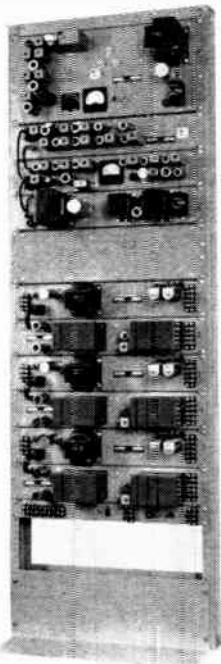

COMMUNICATIONS DIVISION

CANADA LIMITED

HEAD SALES OFFICE: 60 FRONT ST. WEST  
TORONTO

Engineers and consultants on mobile, fixed-to-mobile, point-to-point, multi-channel radio communication systems; suppliers of telephone apparatus of all kinds; manufacturer and supplier of scientific instruments, industrial and commercial television cameras, radios, high-fidelity reproducers and television receivers.

## PYE 60 WATT H.F. STATION

A 4 channel station admirably suited for airport use or for all types of point-to-point communications systems.

- Instantaneous push-button channel selection either locally or remotely up to 15 miles.
- A corresponding control unit is available for extension and remote control of the entire station including channel switching.
- Units designed for 19" rack mounting, housed in a modern steel cabinet with gate switches to disconnect dangerous voltage when rear door is opened.
- Separate aerial feeder plugs for each channel may be connected in parallel when a wide band radiator is desired for two or more channels.

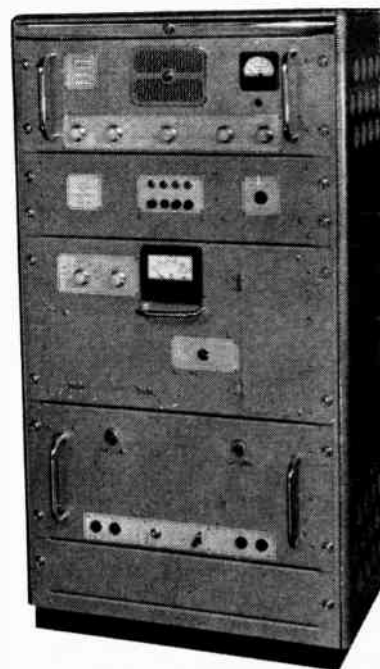

SERVICE FROM COAST TO COAST

193 E. HASTINGS ST.  
VANCOUVER

83 BIRMINGHAM ST.  
HALIFAX

1191 UNIVERSITY ST.  
MONTREAL

Plant: Ajax, Ontario.

For further data on advertised products use page 99.

## A PATTERN FOR

## *Training More Engineers*

Faced with an acute shortage of engineers and technical personnel for the past few years, American industry in general has been casting about wildly in an effort to remedy the situation with little noticeable effect. Now, however, the Ampex Corporation of Redwood City, California, manufacturers of electronic equipment in co-operation with Stanford University, have put into effect a constructive scheme for the training of electronic engineers that will do much to reduce the shortage of engineers in this field.

Advanced degrees in electronic engineering at Stanford University will be made available through the scheme to outstanding electrical engineering graduates on a work-study basis. Participants in the program may obtain a graduate degree at Stanford while earning an adequate wage as employees of the Ampex Corporation. Ampex Corporation will pay the students for a forty hour week, contributing five of these hours toward class attendance, and will permit the students to correlate their work and class schedules.

At Stanford University, Dr. Frederick G. Terman, Dean of Engineering, has arranged a graduate curriculum which permits an academic year's work to be programmed over two years. Each quarter, students of the scheme will carry about 40 per cent of the full time schedule.

To qualify for the course a candidate must be a graduating senior with a major in electrical engineering or physics in the top ten per cent of his class, desire a career in electronics and be an American citizen able to obtain government clearance. He must also be able to meet the entrance requirements of Stanford University.

Both Ampex Corporation and Stanford University are to be commended for their part in combatting the shortage of engineers in such a decisive manner. It is to be hoped that more industries will see the advantages inherent in the scheme.



EDITOR



**cae**\* *electronics serve*

- Agriculture
- Aviation
- Mining
- Manufacturing
- Medicine
- Shipping

Equipment and Systems for:—

Multi-Channel  
Microwave/Communication  
Systems

Flight Simulators

Nuclear Instruments

Moisture Meters

Visual Omni-Direction Radio Range

Aviation Communication Systems

Marine Communication Systems

Radar Systems

Search and Rescue and Homing  
Equipment

Automatic Flight Control Systems

Protection Systems

Hydraulic and Pneumatic Cylinder  
Systems

Sintered Plate Batteries  
(Nickel-Cadmium Type)



*with* FACILITIES FROM COAST-TO-COAST

The science of electronics is one of the major contributors to Canada's unprecedented economic expansion. Almost daily the electronics industry is discovering and developing more efficient and more economical means of performing many vital functions on land, at sea and in the air. Canadians everywhere are enjoying a higher standard of living and a more secure future through the practical application of electronics to every walk of life.

In skilled personnel, in modern precision equipment and in practical experience, CAE is qualified to undertake a wide variety of assignments in practically every phase of electronics.

**CAE CONSUMER PRODUCTS**

*Dumont Television*

*Sonoramic*

*Radio-Phono Combinations*

**cae**

*cae specialists are readily available for consultation  
on your electronic problems*

**\*CANADIAN AVIATION ELECTRONICS, LTD.**

MONTREAL • OTTAWA • TORONTO • WINNIPEG • VANCOUVER

THE LARGEST CANADIAN-OWNED ELECTRONICS COMPANY

3842

For further data on advertised products use page 99.

## The Editor's Space



Proof that the Canadian electronics industry is not only capable of manufacturing the many special types of equipment and components required for use in military equipment but in some instances is capable of anticipating requirements and having the stock on the shelf, so to speak, when approached by defense authorities, came to light recently on a tour of a large Leaside plant. Tests of the particular component in question, which had

been conceived, developed and manufactured, prior to defense authorities voicing their need for such an item, have so far met the required specifications for use in military equipment. Although being one jump ahead of defense requirements obviates the necessity for the government to hand out profitable development contracts, it most certainly lends to the prestige and reputation of the firm concerned. We'd like to mention the name of the firm but — as in so many cases — "it's off the record".

The use of the name "electronic brain" to describe various types of computers has become so prevalent that it is becoming hackneyed to the point of nasseau. Like "hit parade" recordings it is being used so often that it has lost its novelty — if it ever possessed such. An electronic computer is a machine, not a brain. For an inanimate contraption its capabilities are sufficiently phenomenal to impress most people without the added use of the noun brain to enhance its growing popularity.

The 1955 Chicago Electronic Parts Show is over again for another year, but won't likely be forgotten by many who attended it until their natural therapeutic body processes have healed the blisters on their feet. The Conrad Hilton Hotel in Chicago where the show is held is said to be the largest hotel in the world and it, without doubt, one of the best concessions in the world for an astute chiroprapist to set up business, easing the tired feet of conventions delegates who tramp the hotel's seemingly endless corridors and display rooms every day of the year.

Reliable reports have it that a closed circuit television system is to be fitted in one of Canada's new naval vessels. According to the RTMA Monthly Bulletin the system is to be fitted by Pye Canada Limited and will, to the best of our knowledge, be the third closed circuit industrial type television to be employed by the Department of National Defense for armed service requirements.

Transistors have repeatedly been heralded as electronic marvels of the future that will soon replace electronic tubes. Except in a few specialized applications like hearing aids, however, tubes have so far refused to be displaced. There seems to be an increasing number of equipments on the market though that are using a combination of tubes and transistors to good advantage.

The Association of Professional Engineers of Ontario called upon the Department of National Defense recently to take immediate action in bolstering "a dangerously lagging engineering recruitment program". According to the A.P.E.O. there are two major factors contributing to the reluctance of young engineering graduates to enter the services. One was the feeling among young

(Turn to page 63)

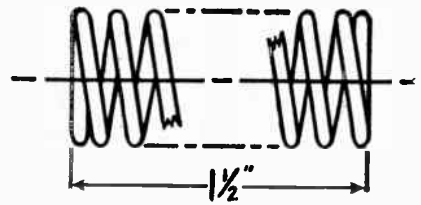

# BOHNE



# BOHNE

PRECISION

# BOHNE

BUILT

# BOHNE

SPRINGS

# BOHNE

FOR INDUSTRY

Send blueprint,  
specifications or  
sample for quotation

# BOHNE

## INDUSTRIES LIMITED

1153 Queen St. W. Toronto

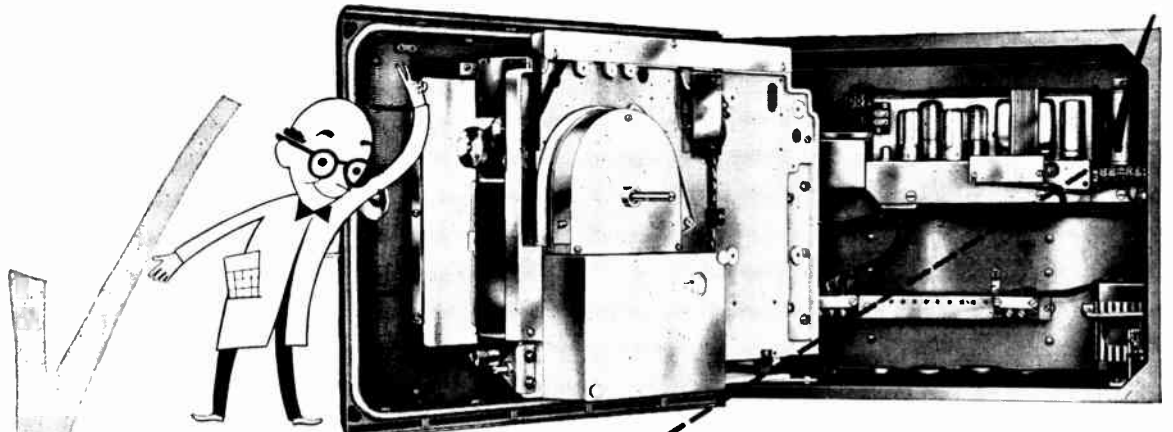

# Check the Components

## of the BRISTOL DYNAMASTER Continuous-Balancing Electronic Recorder

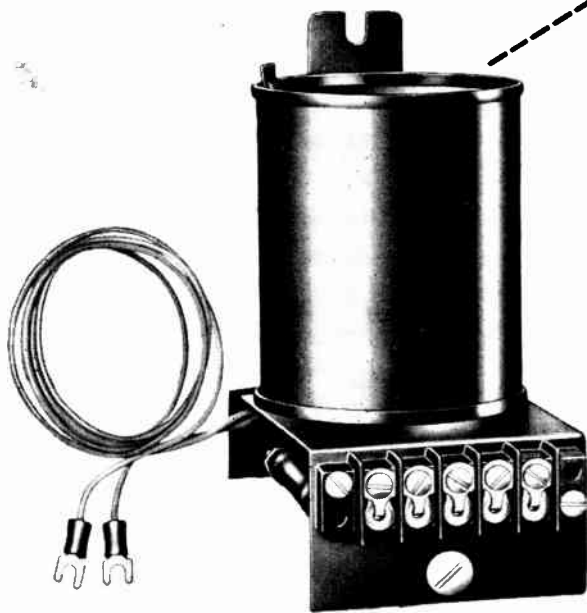

The Dynamaster is a superior recording and controlling instrument because every component part is superior.

Take the Syncroverter\* Switch, pictured above.

This vibrator-type d-c to a-c converter incorporates so many unique improvements that many scientists, laboratories, and manufacturers are using it in their own devices.

Among its advantages are:

- ✓ Extremely long life
- ✓ Shock-proof and vibration-proof
- ✓ Hermetically sealed against dust and corrosion.
- ✓ 1000-to-1 discrimination against external stray currents
- ✓ Dual reeds automatically cancel out thermal-induced emf
- ✓ Has switching symmetry of better than 1/2 of 1 percent.

**BEFORE / BUYING  
CHECK BRISTOL!**

**LEADING  
CANADIAN INDUSTRIES**  
have tested and accepted the  
**BRISTOL DYNAMASTER**

534R

The Syncroverter Switch is only ONE of the important features of the Dynamaster electronic recorder. For full information, send for Catalogue No. P1245

*The* **BRISTOL**

*Company of Canada Limited*



TORONTO • MONTREAL • HAMILTON • VANCOUVER

HALIFAX A. R. WILLIAMS MACHINERY CO. LTD. FORT WILLIAM M. F. MILLS STEEL CONSTRUCTION CO. LTD. WINNIPEG FILER-SMITH MACHINERY CO. LTD. EDMONTON-CALGARY GORMAN'S LTD.

MEASUREMENT OF INDUSTRIAL PROGRESS

For further data on advertised products use page 99.

## business briefs & trends



★ In 1954 the production of automatic machinery (for automation) and other hardware for automatic processes in the field of automation was valued at \$3,000,000,000.

★ The sale of radio receiving sets by Canadian producers during January, 1955, totalled 30,007 units valued at \$2,040,731 at list prices. Home sets totalled 16,466 units; portable and automobile sets totalled 10,354 units and combinations totalled 3,277 units.

★ The production and sale of nearly 10 million cathode ray tubes in 1954 established a new record for the manufacture and sale of this item by the United States electronic industry.

★ The sale of television sets by Canadian producers during January, 1954 totalled 54,788 units of which 31,663 were table models; 22,337 were consoles and 788 were three-way combinations. In dollar value the January 1955 sales of television sets totalled \$17,724,238.

★ In 1954 American manufacturers sold 9,913,504 picture tubes valued at \$209,182,344. During the same year the sale of receiving tubes amounted to 385,098,458 the value of which amounted to \$275,998,903.

★ An industrial teletype system being operated by the Aluminum Company of Canada which stretches 5,200 miles from Montreal to Kitimat, which is 400 miles north of Vancouver, is thought to be the longest private system of its kind in the world. The wire facilities used in the system are rented from several major Canadian telephone companies.

★ Pointing out what he termed the "tremendous possibilities" of industrial television, Mr. Robert S. Bell, Executive Vice-President of the Packard-Bell Company, said that it is being used to assist in railroading where the rolling stock in several yards is being controlled and routed by TV. It is also beginning to be used to control automatic machinery and is sure to be used for security purposes.

★ The Federal Communication Commission of the United States has been requested to give immediate sanction to subscription television because "it is inevitable" and "will be a boon to television advertising". The request has been forwarded to the Commission by the MacFarland and Aveyard advertising agency.

★ It is anticipated that the Trans-Canada Telephone System comprised of the major private and government-owned telephone companies will be completed by early 1958. The 3,800 mile coast-to-coast continent-spanning microwave system is now under construction. It is being built at an estimated cost of \$50,000,000 by the member firms who are responsible for the construction in the areas served by their companies. When completed the system will link publicly owned and private television stations from Vancouver to Sydney as well as provide additional telephone circuits.

★ Pye Limited of Cambridge, England, the largest British Manufacturer of VHF mobile communication equipment has announced the formation of a wholly-owned American subsidiary to be known as Pye Corporation of America. The new company will merchandise their mobile equipment, and other types of communication apparatus in the United States.

★ Signal and wireless equipment costs for the Royal Canadian Navy amounted to \$15 million dollars in the defense estimates for 1954-55 or 4.7 per cent of the gross total expenditure for the navy. Cost of signal and wireless equipment for the Royal Canadian Air Force for the same period amounted to \$35 million or 3.95 per cent of the gross total for the R.C.A.F. It is presumed that these figures do not include the cost of other ship-borne or airborne electronic equipment.

★ A resolution to amend the Radio Act introduced to the House of Commons by the Hon. George C. Marler, has been agreed to. Wording of the resolution which concerns the mechanical features of radio and television antennae is as follows: "That it is expedient to introduce a measure to amend the Radio Act to control the mechanical features of radio antennae for safety purposes and to provide for the appointment of inspectors in relation thereto; and to provide further for certain changes in connection with the administration of the act . . . ."

★ Plans for reliable UHF transmission of television and broadband channels over distances of 200 miles without relay stations, a scheme which will be incorporated in the projected Florida-Cuba link of the American Telephone and Telegraph Co., have been announced. In order to make the over-the-horizon transmission reliable. 10 kilowatt transmitters and 60 foot diameter antennas will be used — 20,000 times the power and 30 times the antenna area used in the company's present continent-wide microwave system.

★ A recent survey in the United States shows that 280 forest product companies are operating 3,925 transmitting units.

★ The Philco Corp. has brought the general use of transistorized radios a step closer by their development of a completely transistorized standard broadcast automobile radio receiver. In the new set 11 transistors replace all electron tubes. Consumption of power of the new set is claimed to be so small as to permit operation of the radio for 100 hours even with the car motor turned off.

★ It has been estimated that the value of electronic equipment fitted in privately owned light aircraft in the United States amounts to \$500 million. There is roughly 70,000 privately owned aircraft in the United States and it has been reasoned that 40,000 of them carry some type of electronic equipment.

★ The Stanford Research Institute sees a twenty-times growth in the computer business by 1960. This according to figures would bring the value of sales of business computing devices up \$500 million.

★ The British Columbia Telephone Company expects to spend \$21,000,000 on additional plant and equipment in 1955. Included in this gross expenditure will be the construction of new buildings, central office equipment, outside exchange plant, subscribers equipment and associated apparatus and long distance and carrier equipment.

★ "Radio In Canada" a recent publication of the Canadian Association of Radio and Television Broadcasters says that there are 6,016,800 radios in use in Canada.

(Turn to page 62)

Developments in the field of electronics and communications in this country over the last few years have been outstanding. While a great deal of progress has been made in the commercial application of electronics to Canada's industrial needs, the requirements of the present day defense program have also played a very important part, particularly in some of the more specialized fields such as . . . . .

# Electronics in Continental Defense

By D. A. GOLDEN

*Deputy Minister, Department of Defense Production*

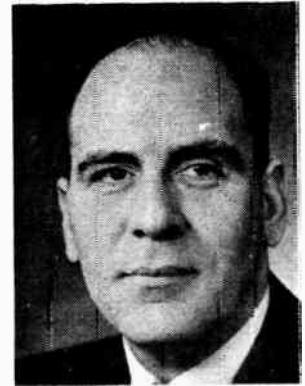

D. A. GOLDEN

**D**EFENSE orders for electronic and communication equipment have been a decisive factor in encouraging the establishment of new facilities to manufacture, for the first time in this country, many complex and highly technical components and parts. As a result, there has been a very decided shift from what were, in the past, primarily assembly operations to more complete manufacture. From a defense standpoint as well as from a more general economic point of view, this trend toward greater self-sufficiency has been most important. So too is the fact that the defense program has

been spread out through sub-contracts, to include a large number of suppliers. A broad, diversified industrial base, together with a strong domestic economy, are prerequisites in building up a defense potential adequate to meet any emergency.

At the present time, continental defense is uppermost in our minds and the construction of three early warning lines across Canadian territory has stirred the imagination of all of us. The impact of these projects on the Canadian economy in construction, electronics, transport and general supplies will be on a large scale, not only

in the period when these lines are being built but also on a continuing basis as operational and maintenance requirements are met.

Because of the part these lines will play in the defense of this continent, there has been the utmost cooperation between Canada and the United States in planning and coordination of the systems, in determining the general location, and in arranging for the construction and operation of each line. While some points in connection with these lines that have not been finally determined, there has been general agreement on responsibility for the construction of the lines. The first early warning line, known as Pinetree, and now in operation, was undertaken jointly by Canada and the United States. The second, known as Mid-Canada, is being built and paid for by Canada. Furthermore, the Canadian Government has undertaken to operate this system. The third project, known as the Distant Early Warning Line, is being constructed and financed by the United States. Whether Canada will eventually share in the cost of this line has been left open for future consideration, as well as the question of operation and manning. In addition, it has been announced that seaward extensions of the complete warning and control system in Canada will be undertaken by the United States.

In general, agreement on those un-



● Radar reporting room — Airmen and Airwomen watching the radar scopes at one of RCAF's radar stations.

— National Defence Photo.





● The photograph at the left shows a part of the equipment fitted in the Monitor Control Room at one of the RCAF's radar stations. Typical of modern military equipment the apparatus is sectionalized and fitted in drawers to facilitate repair and replacement.

— National Defence Photo.

construction and transportation aspects of the project remains with the Canadian Government.

#### Construction And Procurement

Construction is handled by Defense Construction Limited, a Crown Company which has participated in all previous phases of the continental defense system, and whose prime function is to select suitable contractors, award contracts, and be generally responsible for the field control of the construction aspects, as well as certain special phases of the transportation problem.

The Department of Defense Production is charged with the responsibility of providing the major radar, communication, and power equipment for the operation of the line. Contracts for the manufacture and provision of equipment are being placed with Canadian industry. In addition, the Department has contracted with Canadian commercial aviation and steamship companies for the airlift and sealfight of thousands of tons of cargo into hitherto unopened areas. To round out the transportation picture, the Transport Command of the Royal Canadian Air Force will supply movable and fixed wing aircraft to augment the effort of the commercial carriers.

The Mid-Canada Line is just getting under way and it is difficult at this time to estimate in monetary terms what its full impact on Canadian industry will be.

The most northerly line, known as  
(Turn to page 88)

dertakings which involve United States participation is along similar lines to those used in connection with other projects built by the United States on Canadian territory. The conditions include equal consideration for both Canadian and United States contractors in awarding contracts, preference for Canadian labor, the use of electronic equipment manufactured in Canada as far as practicable, as well as a number of other clauses of a general nature.

#### Joint Undertaking

It was in the uncertain days following World War II, that the question of continental air defense first arose and it was realized that a comprehensive early warning system was needed to provide protection for the widely dispersed industrial areas and massed populations of Canada and the United States. As one link in a chain of defenses, the Royal Canadian Air Force, in 1947, undertook the construction and manning of a chain of radar stations to cover specific Canadian areas. In 1951, as a result of planning between Canadian and United States authorities, it was decided to expand the Canadian effort into a joint project called Pinetree. The result was a radar chain extending from the Eastern tip of Newfoundland to the west coast of British Columbia.

Financed jointly by the two countries, the task of building the project was passed to Canada, supplemented by United States effort in those areas which were beyond Canadian capacity to provide in the time allotted. On the mainland, from the Maritimes to the Pacific, Canada undertook the task of building the line and providing the necessary equipment. In Newfoundland and Labrador, the United States undertook the major task of construction, while equipment was provided from Canadian sources. A review of the project, now in operation, gives some indication of its size. Canadian

industry manufactured and supplied some one hundred and fifty million dollars worth of electronic and associated gear. The Canadian construction industry built well over a hundred million dollars worth of construction of all types, including operational buildings, housing, roads, towers, and runways. In addition, the U.S. Corps of Engineers contracted for seventy-five million dollars worth of construction, mainly with Canadian firms.

As an integral part of continental North American defense, the Mid-Canada Line is being constructed by Canada. This is an early warning line stretching from coast to coast across the country and to the north of settled territory. It is a completely Canadian project, built by Canadian labor, from materials and equipments produced in Canada. The initial planning for this line was carried out by a group composed of Canadian Government and industry men. The line, located in almost inaccessible terrain, has created problems of construction, transportation, and communications that are of such magnitude as to require the utmost in effort and team work on the part of both government and industry.

Late in 1953, the decision was taken to implement the project through the medium of a management contractor, and for this purpose Trans-Canada Telephone System was chosen. This System is a combination of the major telephone companies of Canada. The project agent for the Trans-Canada Telephone System is the Special Contract Department of the Bell Telephone Company, with headquarters in Montreal. The project agent has been given responsibility for co-ordination and implementation, while responsibility for procurement on the supply,

● Flying Officer Peter J. O'Neil of Newcastle, N.B., at Radarscope in Duty Controller's Cabin, at one of RCAF's radar stations.

— National Defence Photo.



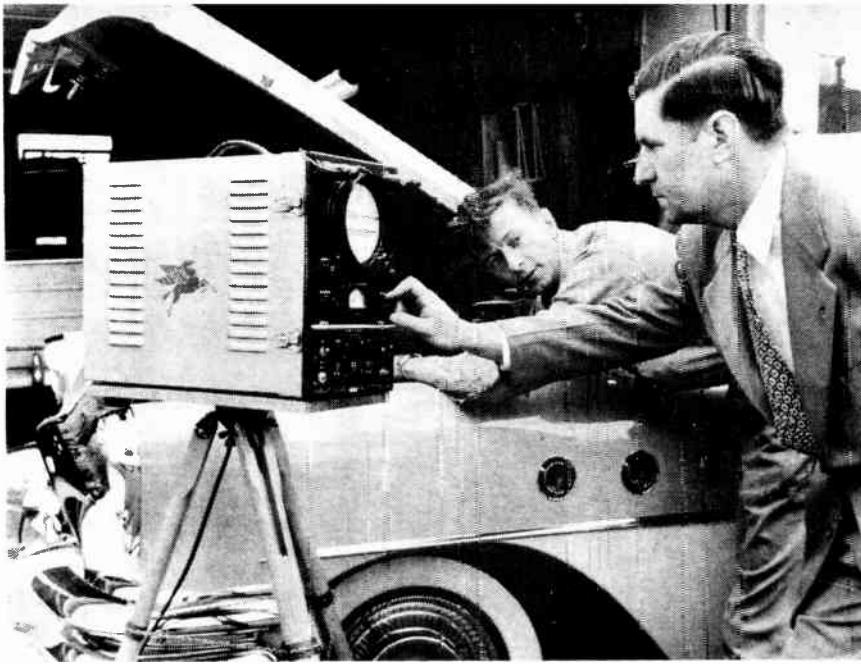

Sixty pound electronic package diagnoses ignition faults in less than one minute and produces picture patterns depicting 65 other engine ailments on remarkable . . . . .

# Electronic Engine Analyzer

**R**ESearch scientists of the Socony-Vacuum Oil Company Inc., have produced an electronic instrument that will diagnose 65 different engine ailments common to the internal combustion engine. The instrument, developed in the first instance for use in the Socony-Vacuum Laboratories, has now been placed on the open market and will be made available for commercial use in garages and automobile manufacturing plants.

Weighing less than 60 pounds, the engine analyzer looks like a portable television set. It "televises" engine performance through a TV-like cathode-ray tube on a oscilloscope screen. Connected to an automobile ignition system by two simple lead wires, it gives simultaneous pictures of the behavior of each cylinder in an operating engine. The instrument can diagnose faults in an automobile ignition system in less than one minute.

The analyzer detects virtually all ignition system troubles, including such common faults as spark-plug fouling and misfiring, broken plugs that are open or short-circuited, defective wiring and switches, worn distri-

butor cam and shaft bearings, and defective coil or condenser.

Burned distributor points — one of the chief causes of poor engine performance — are easily identified by the analyzer. In addition, it will diagnose pre-ignition faults as well as troubles caused by noise and vibration or combustion knock. The instrument may also be used to check ignition timing and operation of intake and exhaust valves.

In all, picture patterns depicting about 65 different engine ailments have been observed and identified by Socony-Vacuum engineers. When a particular engine fault has been detected on the picture screen, portions of the pattern can be blown up for more detailed study.

## Simple To Operate

Power for the engine analyzer may be supplied by the battery of the car being tested, or from any ordinary 110-volt source. The leads are long enough to permit road-testing, with the instrument placed on the floor of the car ahead of the front seat. Its use in road-testing makes it possible to

● New electronic device "televises" as many as 65 different automobile engine ailments on TV-like screen, taking guesswork out of engine maintenance and repair.

detect engine faults that show up only under particular operating conditions.

The instrument is simple to operate. With a short period of instruction, mechanics can learn to identify some of the more common ignition ills. Further training and experience are required, however, to learn to recognize more obscure engine troubles.

The engine analyzer was invented by Albert E. Traver, electronics engineer at Socony-Vacuum's technical service laboratories, Brooklyn, N.Y. Development work was conducted by J. Howell Goffe, research associate at the company's research and development laboratories, Paulsboro, N.J.

Originally developed several years ago, as a research tool, the instrument has been extensively field-tested in recent years by Socony-Vacuum automotive engineers working with automobile manufacturers, car dealers, fleet owners, and individual customers. It was used also to tune up cars for the 1954 Memorial Day race at Indianapolis. The armed services are now considering this type of equipment for use on military vehicles.

In an experiment conducted at the company's Research and Development Laboratories, the analyzer proved that only five out of 35 cars chosen at random were in top running condition. In one car it detected a short circuit that had eluded mechanics for months — caused periodically by the float on a gasoline gauge when it reached a certain fuel level.

## Reliable Diagnosis

As compression ratios go up and automotive engines become more powerful and more efficient, they also become more sensitive to ignition ailments and mechanical faults, therefore something more reliable than the conventional trial-and-error method is needed for the effective servicing and repair of modern automobile engines. It is believed that the engine analyzer will fill this need.

By making possible more accurate experiments in the laboratory and on the road, the instrument has already helped the Socony-Vacuum company to develop better motor fuels. Now that it is to be made available for general use, company officials believe it will be widely used to improve automobile servicing for the motoring public.

The analyzer will also contribute in an important way to the development of better automotive engines. It has already been used by a number of automotive manufacturers for research and development purposes.

Engine analysis by electronic means, may well, as the result of the development of this instrument, become standard practice in service shops geared to volume business, as well as in the fleet garages of commercial and industrial operators.

# 4 FAMOUS *Collins* COMPONENTS ARE READY TO WORK FOR YOU



## AUTOTUNES AND AUTOPOSITIONERS

By means of the Collins Autotune, shafts or devices requiring accurate positioning can be automatically reset to any of several variable positions. Auto-positioners are used where up to 20 or more fixed positions are needed. Rotational reset accuracy .05°; Autotune Channels: 8-12 each independently variable over entire range, this may vary from a fraction of one turn to as many as 20 turns. Output torque is available in the range from 1/2-24 pound-inches. Operation time: as low as 1 sec.; System weights: as low as 2 lbs.; Power supply: 28 v dc, 110 v ac 50/60 cycles or other conventional sources.



## MECHANICAL FILTERS

The Collins Mechanical Filter is an electro-mechanical bandpass filter, smaller than the usual i-f transformer, but providing better i-f selectivity than several stages of conventional tuned i-f circuits. The Mechanical Filter, readily adaptable to existing or new i-f designs, can be supplied with bandwidths from 500 cps to 12 kc for center frequencies from 100 kc to 500 kc, with -60 db bandwidths less than 3 times the -6 db bandwidths. Response variation within the passband is less than 3 db. Performance is dependable from -40°C to +85°C with relative humidities up to 95%.



## PRECISION TUNED OSCILLATORS

Collins Precision Tuned Oscillators are permeability tuned and incorporate a precision lead screw. Mechanically rugged and sealed against atmospheric changes, these accurate R.F. sources are individually compensated for temperature and voltage variations. Fundamental frequencies in the range of 450 kc to 4 mc are covered and frequency multiplication may be employed to attain complete frequency coverage. R.F. output 1-30 v rms depending on model. Output is linear with lead screw rotation making dial design easy. Average short term (24 hr.) stability under specified condition is in the order of .003% after warmup.



## HYSTERESIS SYNCHRONOUS MOTORS

Ideal for driving timing mechanisms, magnetic storage drums, recording charts and automatic frequency controls, Collins precision built hysteresis motors feature high starting torques and superior efficiency. Synchronous performance is possible from zero to as high as 1000 cycles per second. Diameter 2", length 2.3", torque up to 2 oz.-in. Some models have split windings for operation directly from plate circuits of 2 phase, direct-coupled push-pull amplifiers thus eliminating output transformers. Other models for 60 cps and 400 cps fixed-frequency operation from conventional power sources

For complete information on any of these Collins Components contact your nearest Collins office.

**COLLINS RADIO COMPANY OF CANADA, LTD.**

74 Sparks Street  
OTTAWA 4, ONTARIO



# Stand Pat with CLAROSTAT

"Humdinger" Series MH ultra-compact potentiometer. 10 to 2,000 ohms. 1 watt.

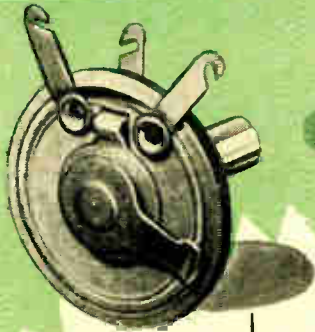

"Humdinger" Series 39 shaftless, screwdriver-adjusted potentiometer. 4 to 5000 ohms. 2 watts.

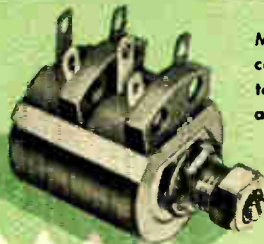

Miniaturized Series 49 wire-wound controls in single and dual units. 10 to 20,000 ohms. 1.5 watts. Switches available.

Series 58 3-watt wire-wound controls. 1 to 50,000 ohms. With or without switch.

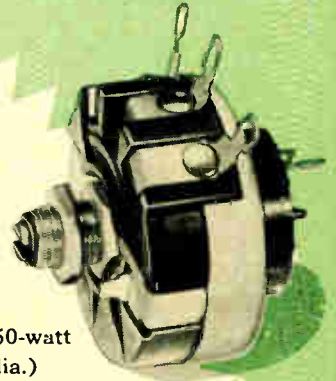

## Wire-Wound CONTROLS

Your wire-wound control needs — *usual* or *unusual* — are readily met by specifying CLAROSTAT. Here's why:

For *usual* needs, the Clarostat line is outstandingly complete. It includes 2-watt (1-1/8" dia.), 3-watt and 4-watt (1-21/32" dia.) types; 25- and 50-watt power rheostats; miniaturized (3/4" dia.) 1.5-watt controls; and the handy, space-saving, cost-reducing "Humdingers"\*. All these types, and many more, are *standard and stocked*, available for your convenience at the local Clarostat distributor or in quantities from Clarostat factory stock.

And for *unusual* needs, Clarostat can design and put into production those *special* types — quickly, satisfactorily, economically — often based on ingenious adaptations of standard features and tooling.

Send those wire-wound control requirements to us for engineering service and quotations. Literature on request.



Smaller or Series 43c 2-watt wire-wound controls. 5 to 50,000 ohms. With or without switch.

Series 10 4-watt wire-wound controls. 1 to 100,000 ohms. With or without switch.

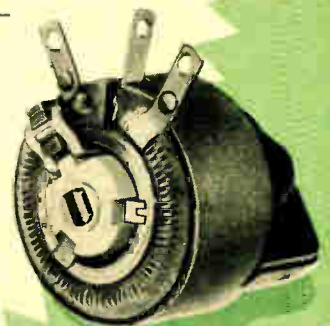
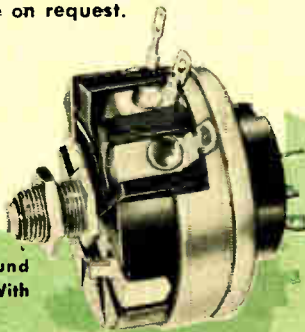

Power rheostats, Series 25 and 50, 25 and 50 watts. 5,000 and 10,000 ohms max., respectively. Also aircraft type, encased in metal housing.



Controls & Resistors

Ask your Distributor now or write to:  
ELECTRONIC TUBE & COMPONENTS DIVISION  
CANADIAN **Marconi** COMPANY  
830 Bayview Avenue, Toronto, Ontario

Branches: Vancouver • Winnipeg • Montreal • Halifax • St. John's, Nfld.

\*Reg. U. S. Pat. Office

For further data on advertised products use page 99.

## Automation

The automatic insertion of millions of components in electronic assemblies over a six month test period constitutes the debut of . . . . .

# Automatic Machinery For Electronic Industry

**A**NY relationship between the shoe machine manufacturing industry and the electronics industry would appear to be quite accidental but this is certainly not the case with the United Shoe Machinery Corporation of Boston, Massachusetts. For the past six months this company has been conducting an intensive production testing program in radio and television plants to try out new equipment developed and built by the United Shoe Machinery Corporation for the automatic assembly of television and radio assemblies. During the six months' trial run the equipment, which is described as a conveyor type machine for the automatic assembly of electronic equipment, inserted millions of components in television and radio assemblies in the plants where the test runs were conducted.

The special equipment is now in daily operation in several major radio and television factories in the United States and it is estimated that the equipment has already inserted components in well over 400,000 printed wiring boards which have been put into commercial sets.

Manufacturers of the equipment are

continuing with the development and production evaluation of a complete line of inserting units designed to handle components such as one- and two-watt resistors; mica, tubular, and disc type capacitors; jumper wires; tube sockets; and I. F. transformers. Included in this system is an advanced method of automatic dip soldering. As rapidly as these additional units pass rigid production testing, they will be made available to the industry.

On the component side of the picture it is expected that the belting of electronic items — now being done by radio and TV manufacturers using the equipment — will be taken over by component producers.

These are the latest developments in the electronic equipment program announced last summer by the fifty-six year old shoe machinery firm. While production of assembly equipment for the electronic industry is a new venture for United, the know-how that the firm has acquired in more than fifty years of designing, building, and servicing high production machinery for the greatly diversified products of the shoe industry has been invaluable. Additionally the company has been

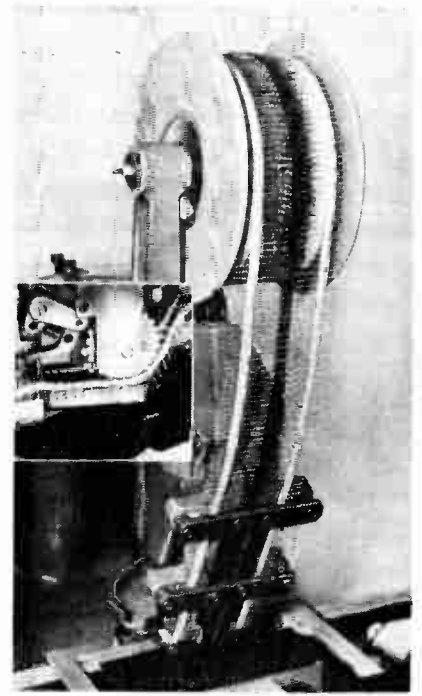

● The better than 99.5 per cent reliability of United's equipment under actual operating conditions is credited to the combination of positive component feed and accurate PW board location.

able to rely on its extensive background of research and development work for the shoe industry and Department of Defense as well as its production experience for the machine tool industry.

### Almost Perfect Performance

Reliability of the company's equipment under actual production conditions has been reported by users to be better than 99.5 per cent. This high degree of dependability or performance reliability — essential to the success of any automation program — is attributed by the shoe machinery firm to its concept of positive component feed coupled with accurate board location.

(Turn to page 28)

● *Left:* Accuracy of board location and ability to handle varying sizes and shapes of PW panels are primary advantages of United's pallet system. *Center:* Button or wafer type tube sockets are automatically inserted at this station on United's conveyor-assembler. *Right:* United conveyor-assembler illustrated automatically locates PW boards on pallets which feed automatically from magazine at left.

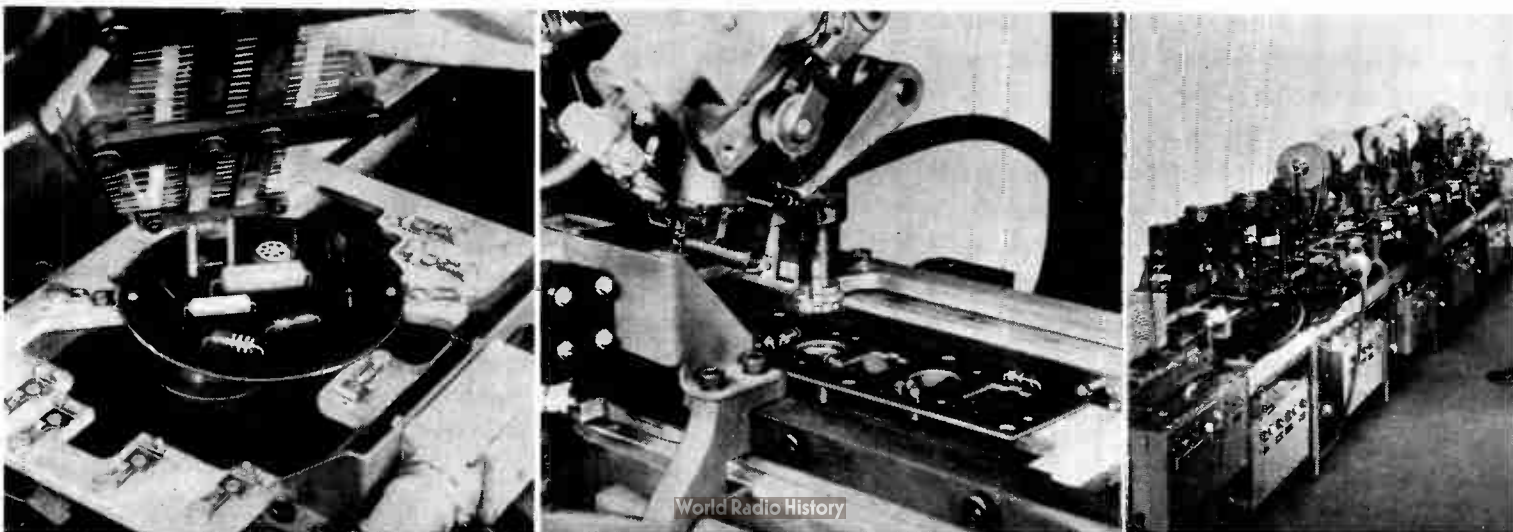

# INTRODUCING...

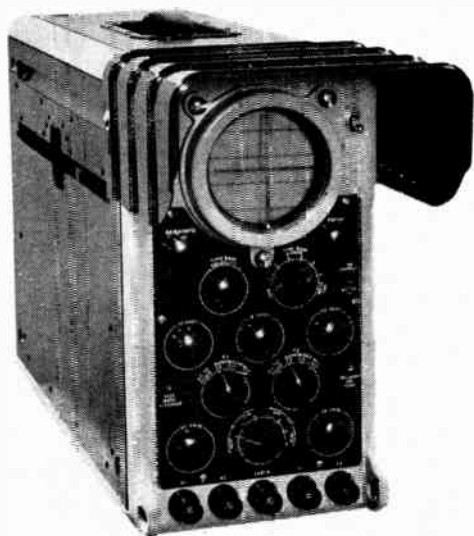

The NEW

# COSSOR

## OSCILLOSCOPES

For All  
Applications

### MODEL 1058

Single beam 4" tube  
Post deflection acceleration

Wide band D.C. Y amplifier  
Symmetrical X amplifier

Free running or triggered time  
base

Sweep expansion times 5

Automatic trigger and sync.  
control

Continuously variable trigger  
pulse attenuator.

#### Y AMPLIFIER

D.C. to 6 mc/s.

Sensitivity 25V to 125V per cm.  
Gain continuously variable.

#### X AMPLIFIER

10 c/s to 150 Kc/s.  
Sensitivity .5V to 50V per cm.  
Gain continuously variable.

Weight — 42 lbs.

### MODEL 1052

Double beam 4" tube.  
Frequency Range  
25 c/s to 3.5 mc/s  
Matched amplifiers.

Full screen deflection at all posi-  
tions of T.B.

Sweep duration — 5 microsecs to  
200 milliseconds.

Weight — 42 lbs — portable.

### MODEL 1056

Single beam post  
deflection acceleration.

#### Y AMPLIFIER

5 c/s to 40 mc/s.  
Rise time 10 millimicrosecs.  
Sensitivity — .2V to 60V per cm.  
Gain continuously variable.  
Signal delay 16 millimicrosecs.

#### TIME BASE

Triggered only  
10 millimicrosec. to 30 microsec  
per cm. Sweep amplitude two  
screen diameters.  
Timing wave 100 mc/s to 100 Kc/s

Weight — 65 lbs. approx.

### MODEL 1059

Double beam  
Post deflection acceleration.

#### Y AMPLIFIER

10 c/s to 10 mc/s.  
Sensitivity .2V to 180V per cm.  
Gain continuously variable.

Signal delay 150 millimicrosecs.

#### Y1 PREAMPLIFIER

Gain 20 times over 20 c/s to 5 Kc/s.

#### Y2 AMPLIFIER

Same as Y1.

#### X AMPLIFIER

10 c/s to 500 Kc/s.  
Sensitivity 3V to 15V per cm.  
Gain continuously variable.

#### TIME BASE

Triggered with sync.  
Free running without sync.

.1 microsec to 50 millisecc. per cm.

Expansion times 5.

Weight — 65 lbs. approx.

## COSSOR (CANADA) LIMITED

301 Windsor St.,  
HALIFAX, N. S.

758 Victoria Square  
MONTREAL, QUEBEC

648A Yonge Street  
TORONTO, ONTARIO

For further data on advertised products use page 99.

# NEW OSCILLOSCOPES

By

# EMI

COSSOR CANADA LIMITED  
are exclusive Canadian distributors

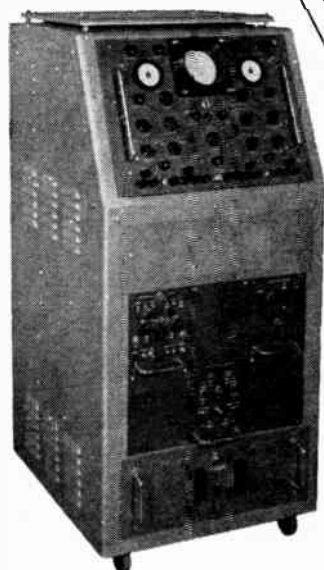

## OSCILLOSCOPE Type WM.5

A new multi-purpose precision measuring oscilloscope.  
**NEW FEATURES:** (a) The console model accommodates up to 6 plug-in sub units. This allows the basic oscilloscope to be adapted for a wide range of requirements: i.e. additional gain at high and low bandwidth, signal delay, comparison of signals, T.V. picture and line selection, high voltage inputs, monitoring high impedance sources, etc.

- (b) Continuously variable EHT—10KV.
- (c) 25 Mc/s bandwidth 'Y' Amplifiers.
- (d) D.C. or A.C. coupled 'X' and 'Y' Amplifiers.
- (e) Linear pre-sweep. A visual delaying sweep.

Time Range—10 milli-micro-seconds to 0.1 sec.

Voltage Range—10 mV to 500 V AC/DC

Photo Sweep—Single sweep for photo recording of transients, subsequent few sweeps before blackout of the tube give reference trace which can be pre-set to any D.C. voltage between 0 &  $\pm$  500V.

Measurements by instantaneous metering system. No calibration markers required.

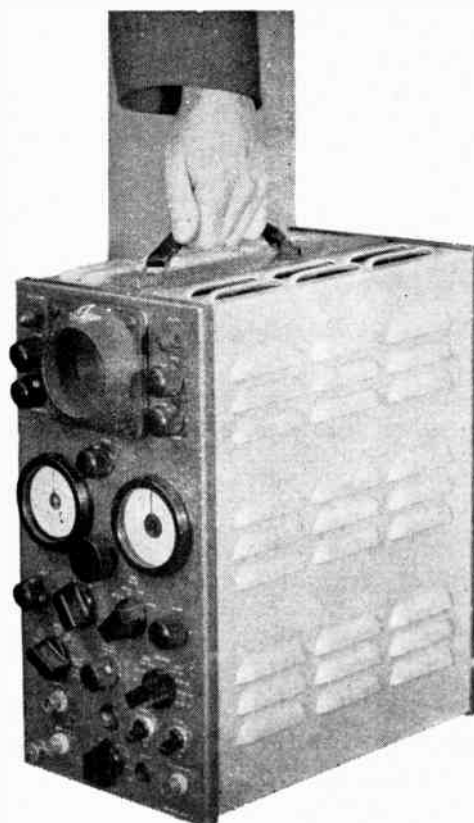

## DISTRIBUTED AMPLIFIER Type 2B

A high level wide band amplifier for use with high speed oscilloscopes, signal generators, etc.

Voltage Output—150 Vpp. Bandwidth—100 Mc/s. Gain—x12.  
Input Impedance—75 ohms. Output Impedance—200 ohms.

## OSCILLOSCOPE Type WM.3B

A compact general purpose portable oscilloscope with facilities for making rapid precision measurements of time and voltage.

EHT—0.8—1.2KV. Bandwidth—D.C.—4.5 Mc/s.  
Volts Range—10mV—500V.AC/DC.  
Time Range—0.5 micro-seconds  
—40 milli-seconds

Measurements by instantaneous metering system. No calibration markers required

Max. writing speed — 0.5 micro-second/cm

## OSCILLOSCOPE Type WM.1

An inexpensive general purpose miniature measuring oscilloscope.

EHT—800 V Bandwidth—1 Mc/s—3 Mc/s.  
Volts Range  $\pm$  0.5—500 volts. AC/DC

Measurements by instantaneous metering system. No calibration markers required.

Sweep Range—200 milli-seconds-10 micro-seconds (uncalibrated).

Sensitivity—1 cm/Volt. Max. sweep speed—2 micro-seconds/cm.

OSCILLOSCOPES For All Applications

# COSSOR

301 Windsor St.,  
HALIFAX, N. S.

758 Victoria Square  
MONTREAL, QUEBEC

648A Yonge Street  
TORONTO, ONTARIO

## Forecast For '59

# The Road Ahead For The Canadian Electronics Industry

Joseph Brouillard, Manager Sales Division, Tube Department of R.C.A. Victor Company Ltd., Montreal, in a recent address delivered to the Canadian Electronic Wholesalers Association in Calgary provided a forecast of conditions relative to the Canadian electronics industry for the next four years.

The following excerpts from Mr. Brouillard's address portray a bright future for the industry and a warning that the road ahead will not be smooth and well marked but more likely rough and uncharted. For this reason, Mr. Brouillard cautions, planning for the industry is a vital necessity. . . .

★ "All of us here are aware that the Electronic Industry has grown by leaps and bounds in the last five years. This industry has been characterized as the fastest growing, most dynamic industry in our economy. Let's interpret that growth into the number of tube sockets in use in certain types of instruments. For this purpose, we will consider car radios, home radios, and television sets . . . .

★ "In car radios, home radios and TV sets in use in the year 1949, there were over 17,000,000 tube sockets.

★ "Since 1949, the electronic wholesale business has grown so rapidly that several wholesalers and manufacturers had difficulty coping with the increasing demand for electronic equipment. . . .

★ "To sum up the number of tube sockets in use in 1954, there were 4,500,000 in car radios, 24,500,000 in home radios and 20,400,000 in TV sets, or a total of 59,400,000 tube sockets — each one of these sockets actively burning tubes! . . . .

★ "In a five-year span, there was an increase of almost 40 million tube sockets in use . . . .

★ "We know that the growth of the electronic industry in the past five years has been tremendous, however, so much is history now and your main interest lies ahead. Most of us are interested in what will happen within the next five years. Perhaps some of

us are a little apprehensive of what the future holds in store for us. Also some of us are probably a little skeptical as to whether the trend we have experienced in the last five years will continue for the next five. It is my belief, that the great increase of business that we have experienced will become even greater during the next five years. I am basing this belief on sound market forecast figures we have compiled for the period 1954 to 1959 and not in gazing into a highly polished crystal ball. There is no reason to believe that we have met any so-called saturation point and that the steep curve of business we have experienced will begin to flatten out.

### Forecast For '59

★ "So, let's take a look at the year 1959. Many new electronic devices unknown to us in 1954 will then be available . . . .

★ "I might add that in 1959, it is forecasted that television sets will only have saturated approximately 87 per cent of the Canadian market . . . .

★ "We predict that in 1959 there will be 3,360,000 TV sets in use in this country . . . .

★ "Now let's take a look into other aspects and developments of our industry, let's look at: microwave, transistors, color television, industrial television, headlight beam control, telephone, and business machines . . . .

★ "In order to properly appraise the renewal market potential of these



● JOSEPH BROUILLARD

highly important achievements in the science of electronics, let us examine them one at a time . . . .

### Microwave

★ "The term, "Silent Boom" has been used to describe the rapidly expanding microwave business . . . .

★ "In our opinion, microwave may be the largest and most comprehensive system of communication in this nation within a period of five years . . . .

★ "So, microwave, — a new electronics frontier — measured today in thousands of miles, is destined to be measured tomorrow in millions of miles and each 200 mile path is estimated to use replacement tubes at a rate of \$4,000 to \$5,000 annually . . . .

### Transistors

★ "More frequently of late, we hear the words, "transistor and germanium products". They describe a new and highly exciting electronics frontier . . . .

★ "If you think that a light-weight, compact, battery-operated portable television receiver is a pipe dream dispel the doubt because it will some day be done . . . .

★ "If we understood clearly that the transistor does not have everlasting life, if we are aware that these products' instead of obsoleting and replacing electronic tubes, are likely to greatly multiply their use, we are well on the way to understanding the magnitude of this electronics achievement in terms of expanded renewal potential . . . .

★ "The unquestionable advantages of transistors will result in a use rate of 10 to 20 million annually within a very few years . . . .

★ "It is fortunate indeed for the electronics distributors that these items take up less space than television picture tubes because their unit potential could be fifty times as great as the unit potential of television picture tubes . . . .

(Turn to page 72)



# Westinghouse 2000 Mc/s

## MICROWAVE RADIO

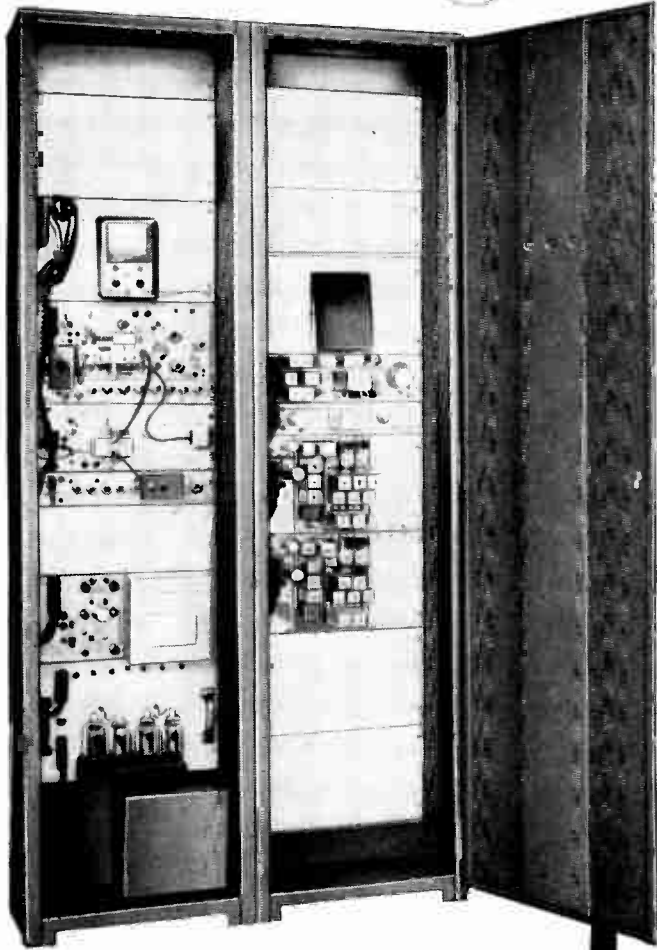

Type FR microwave radio terminal assembly with (at right) type FJ multiplexing assembly.

### design features

**best transmission reliability** and simplest circuitry provided by operation at 2000 megacycles.

**frequency stability** provided by use of crystal for reference control.

**maximum flexibility for system expansion** since terminal and repeater assemblies are readily interchangeable.

**designed for continuous operation** in  $-30^{\circ}$  to  $60^{\circ}$  C. ambient, at up to 95% relative humidity.

**voice communication channel** for maintenance purposes provided as standard equipment at each terminal or repeater station.

**easy replacement of panels** facilitated by plug connectors for all external electrical connections.

**simplified testing** by means of tip jack electrical test points on the front of all panels. A single test meter can be used for all normal maintenance.

**emergency provisions** permit normal operation on either side of a break in a system in case of repeater station failure.

### **Westinghouse 2000 Mc/s MICROWAVE RADIO is an entirely new communications system!**

This new system is especially designed for the requirements of Electric Utilities and pipeline operations. Comprised of Type FR Microwave Radio and Type FJ Multiplexing Equipment, this latest in microwave systems is exceptionally qualified to handle all of the varied communications and control functions serving power and pipeline systems.

**THE RADIO CIRCUIT** of the Type FR Microwave Radio is subdivided into functional channels by Type FJ Multiplexing Equipment — newly and expressly designed for this purpose. Up to

30 duplex voice channels are provided. Each of these, when used for telegraph alone, will handle up to 15 circuits.

**WESTINGHOUSE INSTALLS** a complete microwave communications system for you, on a turn-key basis. This includes surveys, design, construction, buildings and towers. You get the plus benefit of experience in engineering, manufacturing and application of superior end-use equipment such as supervisory control, telemetering and relaying — long a WESTINGHOUSE specialty!

Communicate with **Westinghouse**  
ELECTRONICS DIVISION

CANADIAN WESTINGHOUSE COMPANY, LIMITED — HAMILTON, CANADA

ELECTRONICS & COMMUNICATIONS, MAY - JUNE, 1955

For further data on advertised products use page 99.

# SCATTER

ANDREW Parabolic Antennas for this exciting new method of communication are available in standard sizes of 15, 30 and 60 ft. diameter.

The 30 ft. Type P-30-1 illustrated has a gain of 36 db at 800 MC and the Dual feeds have 40 db isolation. Antenna is adjustable in both elevation and azimuth. Construction is of sectionalized sheet steel, field welded. Type 16607 tower supports antenna center 50 feet above ground.

Look to ANDREW for your complete antenna system, including transmission line. Specify HELIAX<sup>®</sup>, a truly flexible air-dielectric coaxial cable.

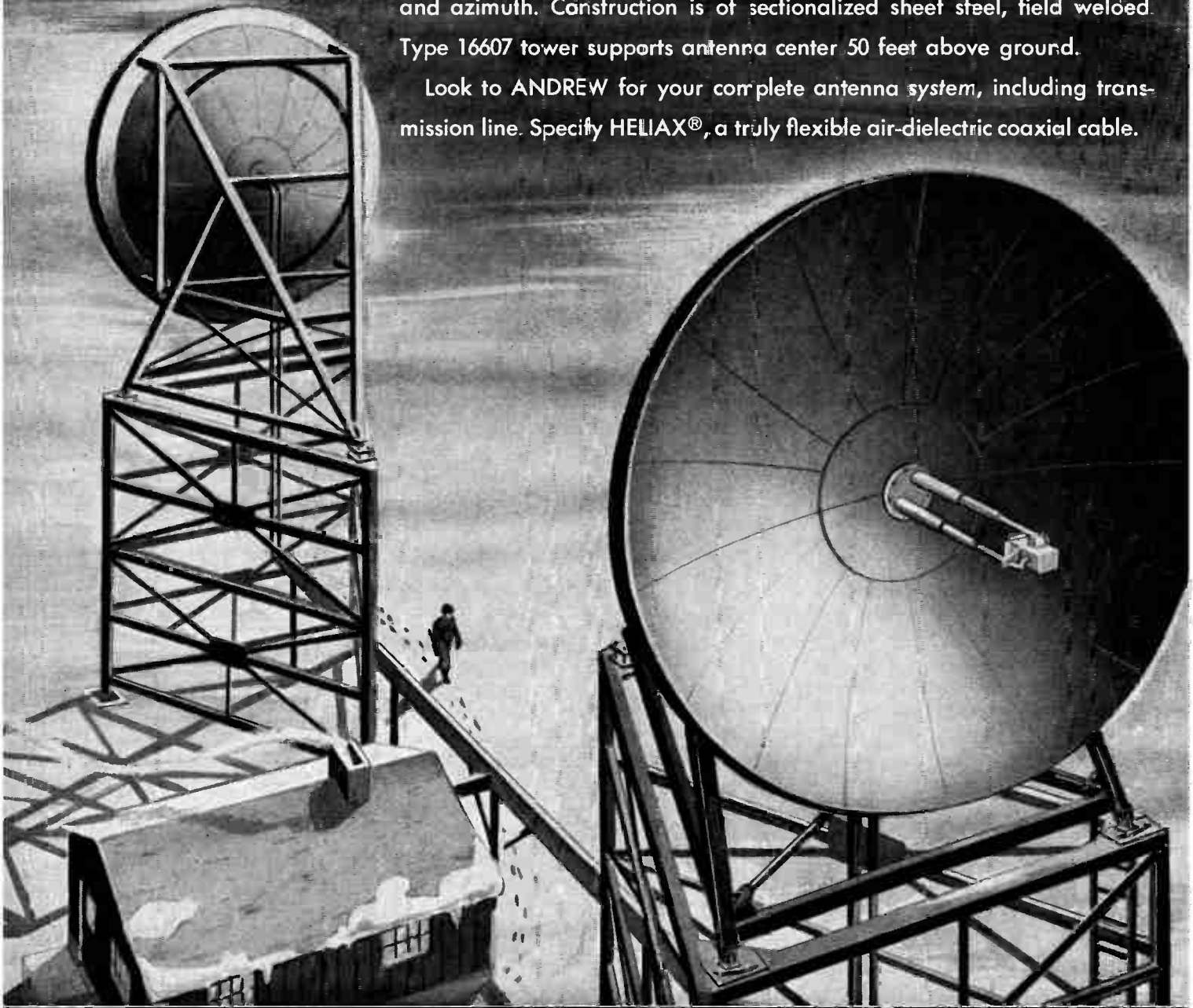

*Andrew*  
ANTENNA  
CORPORATION LTD.  
606 BEECH STREET • WHITBY, ONTARIO

TRANSMISSION LINES • ANTENNA EQUIPMENT



## Engineering

# Cadmium Sulphide Photoconductive Cells With High Dissipation Rating

By Z. SZEPESEI, Ph.D. & D. A. ANDERSON, Ph.D.  
Canadian Marconi Research Laboratories

Among the new semiconducting devices discovered since World War II the cadmium sulphide photoconductive cells are becoming more and more important. Their high sensitivity, high power handling capability, good temperature characteristic and low dark current make them valuable components in many uses where light is used to provide electrical actuation.

THE photoconductive cell makes use of the internal photoeffect in which electrons freed by light photons travel within the bulk of the material causing its conductivity to vary with the intensity of illumination. In most older varieties of photoconductive cells conductivity is limited by the mechanism producing it to about one conducting electron per incident photon. In the cadmium sulphide cell, a different mechanism operates — the incident light acting on the material as if it were opening a gate to let a flood of conducting electrons through. The number of conducting electrons may exceed the incident photons by a factor of  $10^4$  to  $10^6$ . The cadmium sulphide cell acts as a light sensing device and an amplifier combined.

the cells made from them result in expensive components whose power handling capabilities are limited. The evaporated cells which this laboratory has been experimenting with during the last three years circumvent these difficulties, giving units of large sensitive areas and uniform sensitivity, capable of carrying high currents.

### Type PCI Photoconductive Cell

The sensitive element of the PCI Photoconductive cell is a thin layer of evaporated and sensitized cadmium sulphide. The CdS used for evaporation is of the highest purity (luminescence pure). The sensitizing is obtained by the thermal diffusion of a very small amount of impurities as copper, nickel or other metals into the

TABLE 1  
SENSITIVITY DATA OF DIFFERENT PHOTOCELLS  
SENSITIVITY\*

		AT A VOLTAGE OF
Vacuum Phototube .....	20- 40 microAmps/lumen	100 volts
Gas Phototube .....	100-200 microAmps/lumen	100 volts
Photovoltaic Selenium Cell .....	160-600 microAmps/lumen	0 volts
PCI Photoconductive Cell .....	0.4- 4 Amps/lumen	100 volts
Multiplier Phototube .....	2- 40 Amps/lumen	1000 volts

\*Measured with a 2854°K. color temperature tungsten incandescent lamp.

This composite function makes it suitable for applications in many new and simplified devices.

The first CdS cells were made of artificially grown single crystals<sup>1</sup>. The regular structure of these allows easier theoretical analyses. The difficulties of growing these crystals with uniform characteristics and the small size of

layer<sup>2,3</sup>. After the sensitization, two interleaving comb type electrodes of aluminum, gold or silver are evaporated onto the top of the sensitive layer. The unit is potted in a casting resin (usually Araldite), and has pin electrode connections. The sensitive area of the cell now in production is 270 square millimeters, but cells have been

readily made with much smaller and much greater dimensions.

The high sensitivity is the most advantageous property of these CdS photoconductive cells. They are more sensitive than the vacuum phototube by a factor of several ten thousand, and they attain almost the sensitivity of the multiplier phototubes as shown in Table 1.

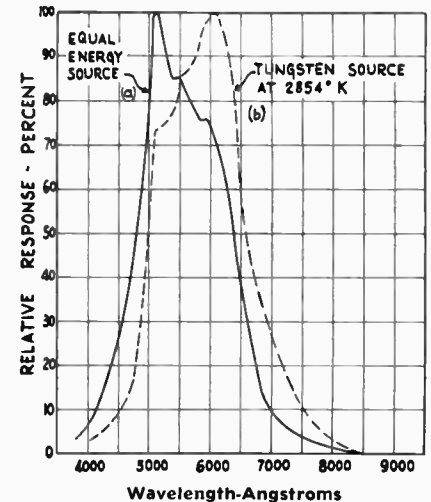

Spectral Sensitivity Characteristic of Photocell - Type PC1-05  
Fig. 1

The spectral response of the CdS cell approximates that of the human eye with its maximum of 5100 angstroms and two minor maxima at 5500 and 5900 angstroms see Fig. 1(a). Fig. 1(b) shows the response when the cell is illuminated with a tungsten lamp at a color temperature of 2854°K.

The variation of current in the cell with illumination depends upon the impurities diffused into the evaporated layer. One type of cell is linear at low illuminations and changes to a square

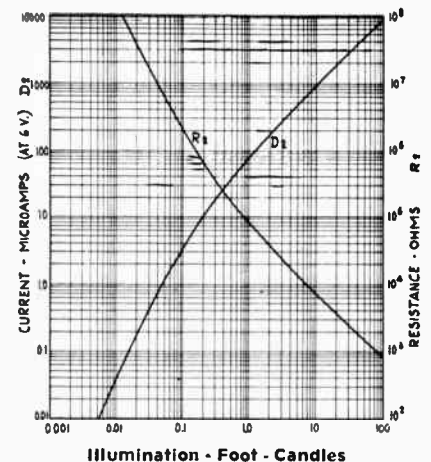

Current - Illumination Characteristics of Photocells (at 6 Volts)  
Fig. 2

root dependence at high illuminations. Another type (PC1-05) which is now in production has nearly a square law dependence for low illuminations. With increasing illumination the exponent decreases, reaching unity at about 10 ft. candles as shown in Fig. 2.

(Turn to page 60)



● Guide-O-Matic "operatorless" tractor taking a trailer load of crated goods for shipping.

Definitely the most modern means of material handling, the new electronic trucks or tractors, the product of the Barret Cravens Company, are completely automatic. Neither operator nor physical connection is required for their operation. The new tractors can take their load over a steady path to its destination at any speed desired, and under automatic control at all times.

The radio waves that control the trucks are transmitted over wires by means of signal boxes installed at desired locations throughout the plant. To call a truck it is only necessary to press a button and the truck will come immediately to the station from which the signal originated.

#### Fitted With "Sniffer"

A "sniffer" box fitted on the truck or tractor picks up waves from the overhead guide wires. Inside the "sniffer" box is an electronic brain that answers a command, instantly causing the tractor train to follow the route set by the guide wires. These routes may vary allowing many destinations to be served automatically. Guide wires are strung from the ceiling along any desired route and into work bays, stockrooms and shipping rooms. They may, if so desired, be laid in a small slot in the floor.

Motive force of the tractors is by battery and installations provide that when the truck is returned to the central parking area it can automatically couple to a charging receptacle which keeps the truck battery charged and ready for service at all times.

# Look Mom No Hands!

A FIRST glance by factory personnel at one of the new "completely electronic, automatic and operatorless" tractor trains in operation may leave them looking a little pale with astonishment but closer examination of the electronic robots as they pull their loads with unerring accuracy from point to point in a factory without apparent human guidance will dispel any doubts that the company has been taken over by netherworld influences.

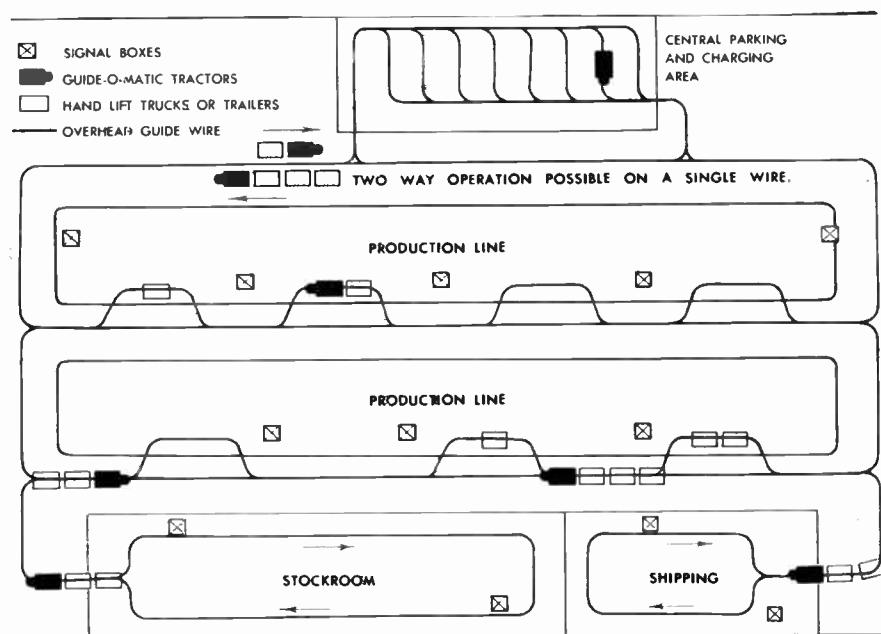

● Diagram of a typical automatic dispatch, pickup and stock moving installation. The guide wire, shown dotted, is strung from the ceiling along the desired routes and into bays where the material is to be handled.

## AUTOMATIC MACHINERY

(Continued from page 21)

Positive feed of axial or pig-tail lead components is provided by a linkage which works like a bicycle chain and sprocket. Components are linked with tape so that a chain or belt of uniformly spaced components is formed. This chain or belt is then fed into the inserting heads of the conveyor by a simple and effective sprocket type mechanism which virtually ensures positive, accurate feed.

Of comparable importance to the well nigh 100 per cent accuracy of component insertion secured from the conveyor-assembler is the pallet system of board transportation used by the machinery firm. Printed circuit wiring boards are accurately located in precision-machined metal pallets or frames. These pallets are used to carry pre-punched boards to the stations and ensure that the holes in

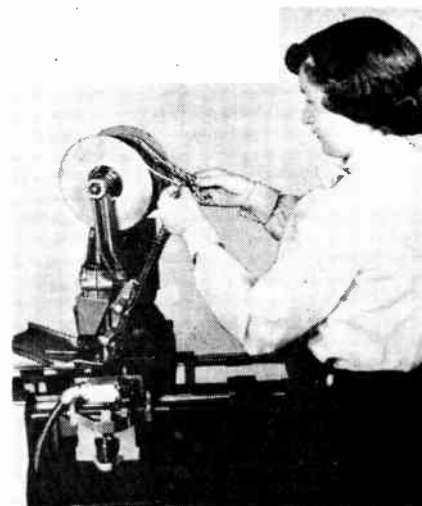

● Full reels of components are quickly spliced in place while United's conveyor assembler is running.

which the components are to be inserted are positively and accurately located under the inserting heads.

#### Pallet System Flexible

So flexible and versatile is this pallet system of PW board transportation and location that it is reported that a single conveyor is readily adaptable for use by manufacturers with diversified production and a large number of different boards. Combining maximum adaptability with minimum changeover time, the conveyor-assemblers which the firm is making extends the benefits of automation to lower volume producers of electronic equipment. Experience on production assembly lines has demonstrated that it takes only a few minutes to adjust the position of an inserting head for a new design of board. While most of the printed wiring boards now in use are rectangular, many applications require irregular shapes and some production for the Department of Defense even calls for round boards.

# Radio Engineering Laboratories uses Eimac klystrons in high power, beyond-the-horizon communication equipment

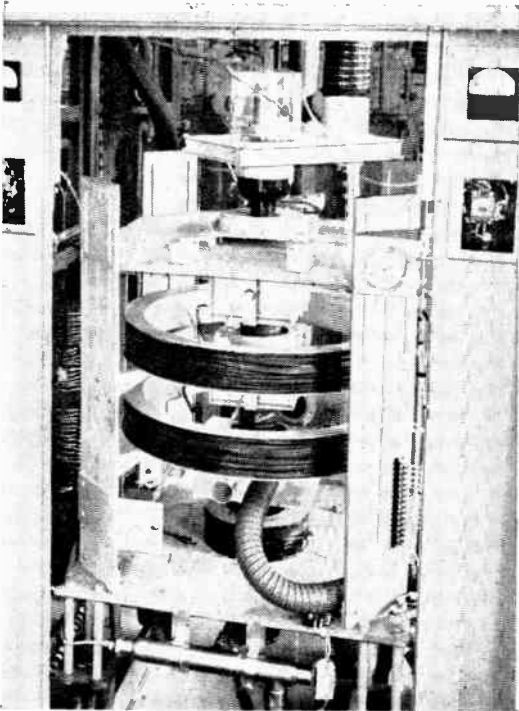

Eimac 3K50,000L klystron in klystron section of REL 10kw power amplifier.

## communication equipment

EXTENDED RANGE COVERAGE at frequencies previously limited to low power has been achieved in a new high power beyond-the-horizon UHF communication system. Radio Engineering Laboratories designed and manufactured 30 REL type 826 FM radio terminal equipments for a special system employing Eimac high power klystrons in the final amplifier stage. Eimac klystrons were selected not only because of reliability and high power, 10kw/CW power output with a minimum gain of 26 db, but also for their practical design which permits economical transmitter construction and minimizes replacement problems. Completion of this revolutionary communication system which

is now in operation confirms that 1) high power, extended range UHF and microwave coverage is practical, and 2) Eimac klystrons are the most efficient, powerful and reliable tubes for the job.

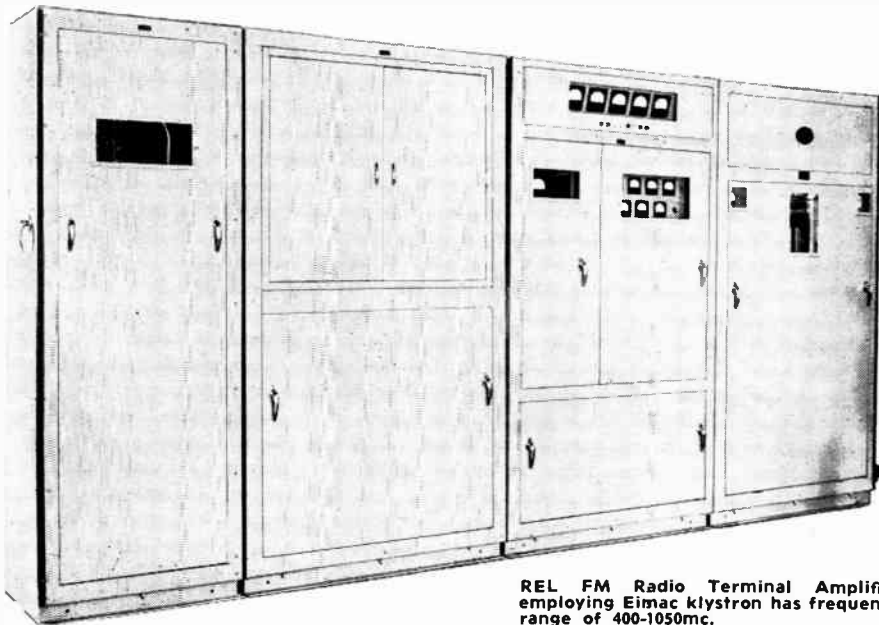

REL FM Radio Terminal Amplifier employing Eimac klystron has frequency range of 400-1050mc.

*For further information on Eimac high power amplifier klystrons, contact our Technical Services Department.*



**EITEL-McCULLOUGH, INC.**  
S A N B R U N O • C A L I F O R N I A

The phenomenal growth of the electronics industry in all industrialized countries has been evident during the post war years. The almost incredible volume of business done by United Kingdom industry has been augmented by . . . . .

# New Achievements In Electronics

By FRANK CLAWES

IT is difficult to offer a description of the British electronics industry which does not consist of a series of "tall" stories. For this there are two reasons. The first is that the industry is making rapid advances over a wide area of potential and actual applications and quite remarkable achievements are being announced almost every week — the tall stories are, in fact, true.

The second reason is the lack of any genuine alternative treatment. It is extremely difficult to state the limits of the electronics industry and no official statistics yet presume to do so. Indeed, there is still no agreed definition of electronics itself, since the fairly recent discovery of semi-conductors rendered inadequate all previous definitions. Perhaps the best way to assess the industry is to state the volume and value of the manufacture of components.

## Five Times Pre-War Rate

Components are now being produced at the rate of about 1,000,000,000 a year, which is substantially more than five times the pre-war rate. An even bigger change is that, whereas before the war 90 per cent of components were used by the domestic radio and television market, this percentage has now fallen to 45 in spite of the enormous growth in television in the United Kingdom since 1945. General radio communications and radar alone absorb about 200,000,000 components and a further 160,000,000 are directly exported; telecommunications take 50,000,000, sound reproduction 50,000,000, instrumentation take 20,000,000 and miscellaneous uses absorb 40,000,000. The value of all these components is about £50,000,000. Two things should be noted about this list; the relatively large "miscellaneous" classification hints at the great variety of uses, and there is no specific category of "military purposes".

Obviously, little is known of most of the military applications of electronic principles. Modern military aircraft carry large quantities of electronic equipment and a modern bomber will have more than 1,000 valves on board; this, however, is only a development of practices of the recent war. The most startling developments are taking place in the field of guided missiles.

Production orders have already been placed for guided missiles for fighter aircraft. Another type, under development, is an anti-aircraft missile fired from the ground. A ship-to-air missile may be tested by the Royal Navy next year. Many British guided missiles of all types have been fired in the course of development work.

## Testing Equipment

Additional to the missiles is much electronic testing equipment. For

example, Winston Electronics Ltd. has devised test gear which can check all the individual controls of a guided missile, and then, by simulating a target with a changing range and bearings in two dimensions, test the homing properties of the weapon. The same firm has made for the United States Government a sequential image converter — or electronic camera — in which the exposure time has been reduced to one-tenth of a millionth of a second with a repetition of .5 micro-seconds; six successive frames are presented on the face of cathode-ray tube and photographed simultaneously. This is believed to be the fastest working camera in the world and is to be used on rocket testing.

Such things may seem remote from radio receivers and television sets, but the enormous sums now being spent on defence convey immense commercial benefit on the electronics industry, especially in the improvement of component design. Military requirements demand that components should function with utter reliability under great stress, at high altitudes, at extremes of temperature, under heavy surge currents and yet be increasingly smaller and lighter in construction.

The second feature of the breakdown of the industry's component output is the wide range of applications suggested by the "miscellaneous" category. Perhaps nothing can better illustrate electronics' capabilities than the investigation into the causes of the explosion of a Comet aircraft on January 10, 1954.

## Helped Solve Comet Mystery

Nobody saw the disintegrating Comet enter the Mediterranean Sea, but it was important to reconstruct the pieces which had to be presumed to have spread over an area of 100 square miles. Conventional Asdic and other still secret electronic devices located underwater obstacles; when they were pin-pointed with complete accuracy a

(Turn to page 73)

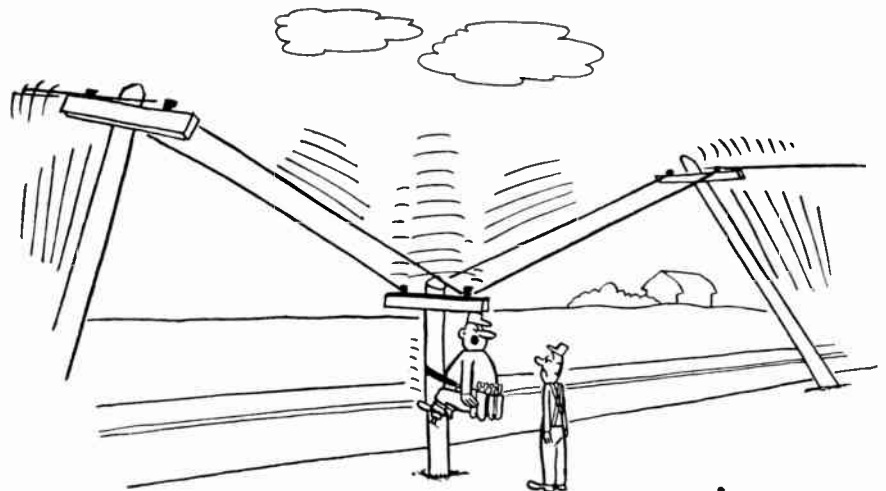

BOB KAIN

● 270 Pounds . . . . . Why?

# IMPROVE YOUR MICROWAVE RELIABILITY WITH NEW G-E QUADRIPHASE\*

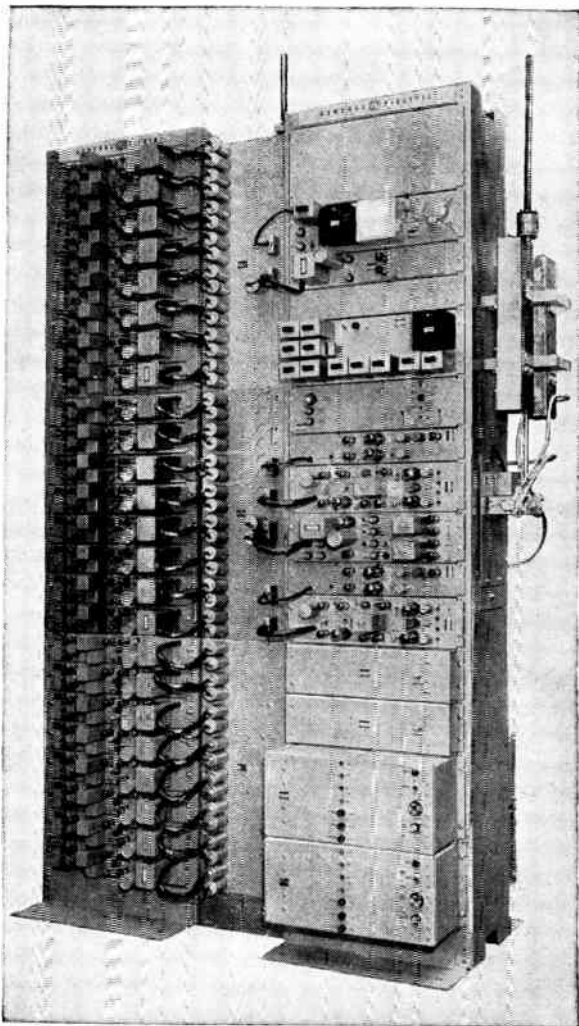

\*The new General Electric Quadriphase system utilizes four 9 KC sine waves phased in quadrature for selection of the individual channels.

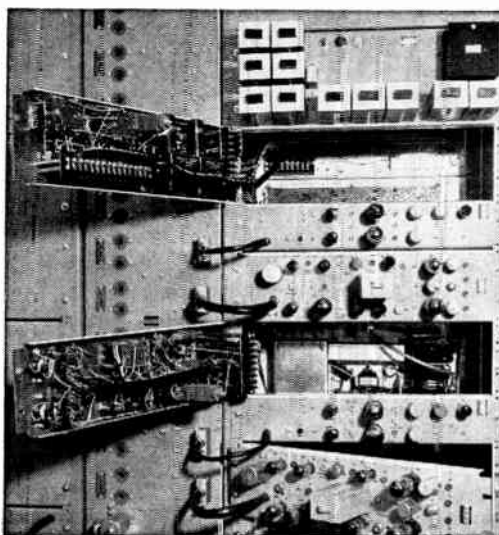

▲ New ease of servicing—units arranged to slide out or swing out for service or inspection without interrupting operation.

◀ G-E 25-channel, 2000 MC Quadriphase microwave terminal, showing all multiplex equipment. Normal and standby transmitters, receivers, power supplies and termination units are mounted on the other side of these racks.

## Highly stable channel-determining concept increases "On-The-Air" time

**N**EW General Electric Quadriphase is the only multiplexing system with channel selection determined by resistance circuits alone. There are no L-C networks . . . no tuned circuits . . . and no delay lines. As a result, you get more reliable microwave communication.

G-E engineers report numerous benefits from the new Quadriphase multiplex design—

**MAXIMUM STABILITY AND RELIABILITY**—far greater than is possible in multiplex systems requiring tuned circuits.

**FEWER CHANNEL ADJUSTMENTS**—only 2 necessary—one on the audio level in, and one out.

**FEWER TUBES** in multiplex, transmitter, and receiver. Total—less than 8 per voice channel!

**FAR LESS MAINTENANCE TIME AND EXPENSE**—You save on tube inventory and on maintenance time. Because every tube is used well below its maximum rating, G-E Quadriphase

gives you a big safety margin, and extra tube life. Simplified circuitry including new printed circuits means quick checking and servicing.

**30% LESS FLOOR SPACE FOR RACKS**—Packaging is compact—only 4 racks instead of 6 required in previous 25-channel microwave equipment.

See for yourself how to get more reliable microwave communication at less operating and maintenance expense. For complete details about the new concept of G-E Quadriphase, write today to Electronic Equipment Department, Section C-2015, Canadian General Electric Co. Ltd., 830 Lansdowne Avenue, Toronto, Ontario.



## GENERAL ELECTRIC MICROWAVE

CANADIAN GENERAL ELECTRIC COMPANY LIMITED

## Broadcasting

# Technical Background Requirements For Maximum Broadcast Studio Efficiency

By LESLIE L. HILL, Ph.D.

Contributing Editor — Electronics & Communications

**H**UMAN labor is being dispensed with by modern equipment and the progress of electronics has contributed towards reducing still further the amount of physical and mental effort by the achievement of automatic devices.

People, therefore, and especially executives of large enterprises, may become inclined to disregard the qualitative value of the individual, thinking that in the years to come the human being will be largely replaced by robots or machines which function to perfection without much care or attendance.

This, in all probability, will be true to a certain degree, but there are and always will be, a considerable number of industries where individuals will retain their definite importance. It is not always enough to buy up-to-date equipment. Highly trained people who know how to use this equipment is also necessary.

Quite often large public enterprises purchase the most modern equipment but fail to indulge in the expense of engaging competent and experienced personnel. The result of such a policy is that they will achieve much less than their competitors who have less up-to-date machinery, but a highly skilled staff.

One of the industries where the individual retains his full value is the broadcasting industry. This article does not assume to make any criticism of the broadcasting industry with its many ramifications but a review of some ways to obtain the utmost efficiency with the most suitable equipment is considered topical at this time in the growth of the broadcasting industry. To begin with it should be stressed that in order to obtain and maintain the highest technical efficiency in the interest of the listening public, it is and will remain necessary to have a highly trained and

expert staff, even if the best equipment is available.

### Location

Before entering into detail with regard to improved techniques of broadcasting, especially program routing and sequential monitoring, it might be useful to mention some fundamental rules which are often neglected and underrated. Let us assume that all the up-to-date standard equipment of broadcasting studios does not raise any particular problems and is available to any of the stations.

The most troublesome problem remaining then is to obtain the right acoustics in the studio. Microphone and

transmission channels to the loudspeaker are not equivalent to the ears of a listener to listening to a live performance. The listener uses two ears, his hearing is binaural, whereas the broadcast is brought to him from a single microphone over a single transmission channel, i.e. monaurally. As two eyes make possible stereoscopic sight, with the ability to see spatially and estimate distances, so two ears make possible stereophonic hearing with the ability to estimate direction and to concentrate, rather unconsciously, on sounds coming from one direction only. This faculty enables the listener of a live performance to concentrate on the sound coming to him directly, and to ignore the multitude of sound waves reaching him from all other directions after having been reflected one or more times from the various surfaces of a room. The microphone, however, has no such power to segregate direct and indirect (reflected) sound.

Therefore, a basic requirement of a broadcast studio is to consider some aspects of the acoustical theory of enclosed spaces. The sound waves reaching the microphone can be divided into two categories:

- (1) Those which arrive by the shortest possible path — direct sound, and
- (2) Those which arrive after one or more reflections — indirect or reverberant sound.

Desirable acoustic properties for a good broadcast studio, noticeably absent from many theatres and opera houses, are generally accepted to be in the region of a reverberation time of between  $1\frac{1}{2}$  and 2 seconds. The reverberation time is the time taken for the sound to die away into inaudibility, or, more technically, to decay 60 decibels, i.e. to one-millionth of its original intensity.

Quality and quantity of reverberant sound reaching the microphone depends upon the reflecting properties of room surfaces, like walls, ceiling, floor, type of seating and size of audience present. The more highly reflecting these surfaces are, the greater is the reverberant

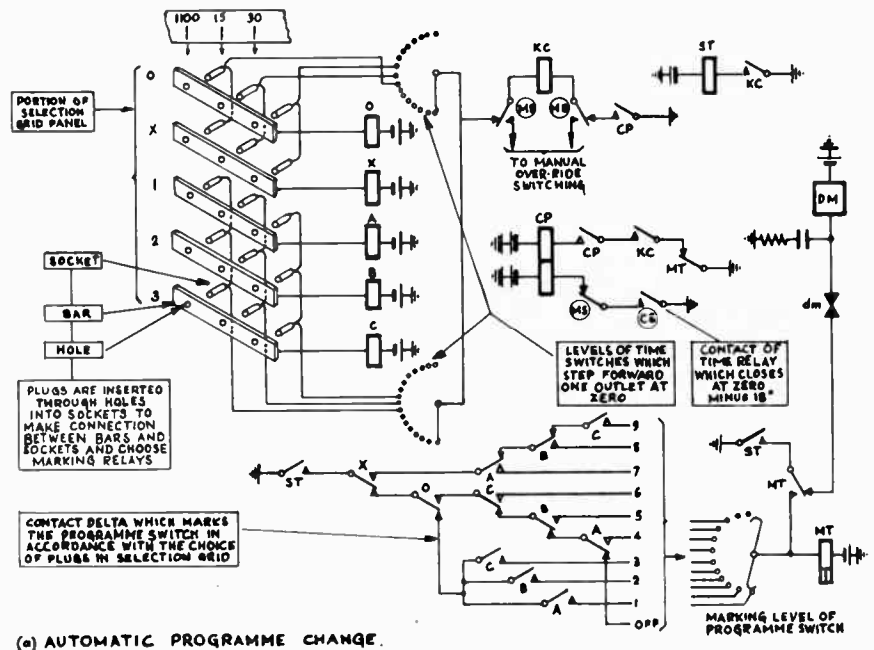

(a) AUTOMATIC PROGRAMME CHANGE.



energy in the studio; the more absorbent, the less the reverberant energy.

As the microphone is taken further and further back from the sound source, the ratio of direct sound to indirect sound becomes smaller and smaller. Direct and indirect sound have different more faithful and has all the qualities of the original. The indirect sound is partly acoustically distorted as the result of one or more reflections. It is evident, as the microphone moves back, that the reproduced sound on the loudspeaker will get more and more confused and the sound will seem a long way off.

The art of distributing microphones in relation to performers, the so-called balancing, becomes in this way the adjustment of the ratio of direct to indirect sound in order to obtain the most satisfactory reproduction on the loudspeaker. If the microphone is too close to the sound source, the ratio is large, resulting in a harsh effect; if the microphone is taken further back, the ratio becomes smaller, the reproduction is softened, and the indirect sound adds liveliness together with a feeling of space. If, however, the microphone is placed too far back beyond the balanced optimum distance, there will be lack of clarity in the performance, and confused reproduction.

Another very important factor is, however, that the indirect sound consists of one, two, or many reflections. All these reflections are not of equal importance. The first reflections from surfaces near the sound source are the most important, the overall softening of tone depends upon these first reflections, and it is advisable that there should be plenty of reflecting surfaces close to the sound source. Although the first reflections give the general effect, spaciousness is only reproduced by the overall reverberations, i.e. by the various reflections from all parts of the studio.

As already mentioned, optimum performance depends upon the reverberation time, which is in the order of 1½ to 2 seconds.

In some instances a so-called echo-room is used, where an artificial echo is created. Some of the electrical energy originating from the sound pick-up by the microphone in a fairly dead studio (acoustically dead) is passed through a loudspeaker in a small, very reverberant echo-room. The very reverberant sound resulting from the numerous reflections from the walls of the echo-room is picked up by a microphone, and the resulting output is mixed with the direct output from the microphone in the studio.

Most sources of program distortion and damaging of program depend upon selecting the right size of the studio and giving it the right furnishings. Cathode ray oscillographs are best to determine unaccounted factors to examine the way in which the sound decays after a steady tone is switched off.

**Operation**

The setting of the right volume of a program presents one of the basic problems of broadcasting. The operator must not let the volume get so weak that it is marked by noise and, on the other hand, he must not allow it to become so great that the transmitter is overloaded. The volume is usually observed on a calibrated meter. The operator must see that the program does not rise in volume over a certain number, irrespective of the loudness of the orchestra, or fall below another number, however pianissimo the soloist may be.

**Difficulties**

The control of volume, however, has its difficulties. The meter responds to program voltage, and an excess of voltage will overload the transmitter. This kind of control protects the transmitter, but is not very satisfactory to the listener. His ear in judging loudness does not pay any attention to infrequent peaks, but integrates the sound energy received over a certain period of time. A program which all the time is just below the certain number on the meter, will sound to the listener much louder

than a program which only occasionally peaked sharply to this number.

It may happen, therefore, that a listener who adjusts his receiver so that the volume is just right, finds at the start of a new program that it sounds much too loud. The listener therefore, has to run to the receiver to turn the volume down. Nevertheless, maximum and minimum electrical quantities are identical. In short, the electrical requirements have not matched the aesthetic requirements. One of the most exasperating jobs was that of a program monitor. Monitoring however is done now by an automatic electronic monitor which also replaces the checking loudspeakers.

Now, a single operator is able to monitor a program from all the incoming program lines and senders by the progress of a sequential sampling. The broadcasting transmitters are automatically grouped in a sequence with the lines from which they are currently taking program. All lines and senders not carrying program at the time are automatically excluded. The sequence is scanned continuously, approximately five seconds being spent at each point. The operator is thus able to listen to a program in five second samples, first from a line, then from the output of each sender connected to that line, etc., etc., until all lines and sender outputs in service have been sampled, when the sequence is repeated. All the incoming programs, and by comparison, all the programs as radiated are thus effectively checked.

In order to carry out automatic grouping and re-grouping in the most efficient manner, the whole schedule of program changes is usually converted to full automatic operation controlled by a station master-clock. The auto-switching also relieves the operating staff of the bulk of switching operations with the exception of a few manual duties.

The whole equipment might be divided into four parts: (1) Time control which integrates pulses from the master-clock of the station and triggers both the program changing and the monitor scanning at the correct intervals. (2) The program switching equipment which also controls the sender grouping in the sequential monitor. (3) The pre-setting arrangements for automatic selection, consisting of the selection device itself and its time marker, which conveys information to the program switches in accordance with a 24-hour schedule, simultaneously, for manual selection, overriding the scheduled change in a few exceptional cases, which do not conform to schedule, and (4) the sequential monitor itself.

The time control equipment for program changing usually consists of pulse counting groups of relays employing standard circuits, which integrate half-minute and one-second intervals pulsed from the station master-clock. The time control for the sequential monitor consists simply of an integrating group of relays, which repetitively counts five one-second intervals.

The basis of the program change circuit is a rotary switch, one of which is provided for each sender. The switch used is a step-by-step uni-selector having eight levels, each of twelve

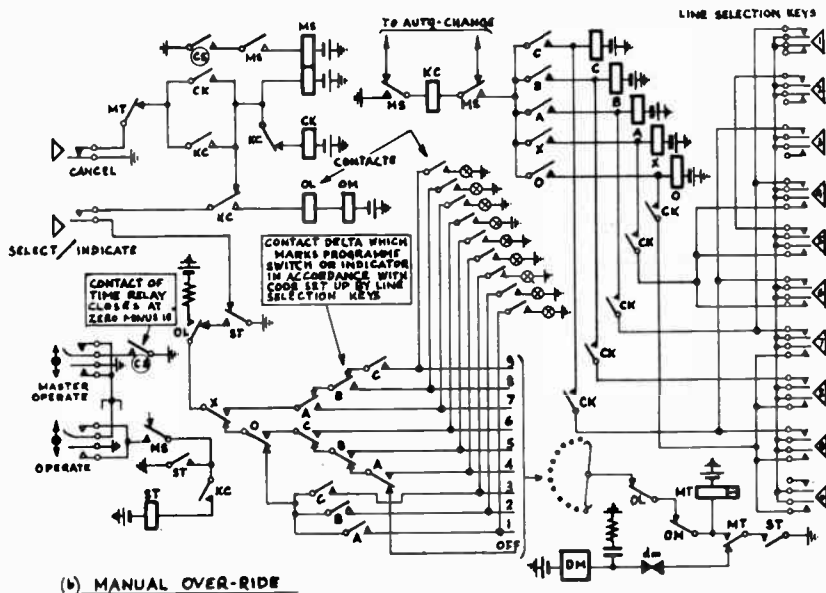

BY COURTESY OF SKELTON STATION

(Turn to page 38)

# Canada's Defense Production Deputy Tells RETMA 26th Annual Meeting That . . .



D. A. GOLDEN

## "The Best Is None Too Good"

Address by D. A. GOLDEN

**T**HE invitation to address your Association has come at a very opportune time. The past five years, since the outbreak in Korea, has been a period of rapid development in your industry. It has been, equally, a period of rapid development for the Canadian defence forces — of expansion coupled with a sweeping program of re-equipment. Industry and government have now reached a point in their parallel courses when it might be well to take stock of past relations, and give some thought to what may be expected of each in the future.

The record of development in the electronics industry is, of course, well known to all of you and needs no retelling by me. Several features of that record, however, are often obscured by the emphasis on dollar turnover. These are of particular importance in relation to our defence requirements, both past and future, and deserve some mention. One significant feature has been the steady shift from assembly operations, using imported components, to complete, or nearly complete, manufacturing. Bearing in mind the strategic aims behind the Government's policy of encouraging the growth of Canadian facilities, you will recognize that this change in the character of activities is of prime importance to the Department of Defence Production. The other feature which I would single out is the internal development in the structure of the electronics industry and, in particular, the emergence of a large number of smaller suppliers of parts and materials. These specialists, the foundation of any industry, have generally figured in our defence electronics program in the role of subcontractors rather than prime, but while our dealings with them have been correspondingly remote, we have been by no means unaware of their significance.

Both of these features are of outstanding importance to the Government, as evidence of the growing maturity of the electronics industry, the strengthening of its technology, and the broadening of its experience. We are not indifferent to size. On the contrary, we must recognize that certain of our defence needs — and this may be increasingly true in future — can only be met by large scale industry. But the point I would stress — and it is, in a sense, the crux of what I have to say this evening — is that mere bigness is not enough. There must also be the kind of development within the industry which has been taking place, and which must continue to characterize your progress.

I might add, as my own opinion, that the Canadian Government, and the Department of Defence Production in particular, can take a good deal of satisfaction from this growing-up of the industry. While defence requirements may not have been the most important factor in the growth of sales — when compared, for example, with the development of television — it is nonetheless true that defence needs can claim a major share of the credit for the advances in technology, many of whom would not have developed, or would have developed much more slowly, had it not been for the stimulus of orders for defence electronics of increasing complexity. Constant encouragement, material as well as moral, has been given to the establishment in this country of new facilities employing new skills. It might even be claimed that your success in developing and supplying the commercial demand for radio and television equipment owes something to the skill and experience developed in response to defence requirements.

The other side of the picture, of course, shows that there have been benefits to the Government as well.

I need only recall the men who have shaped and directed our defence procurement program — starting with my immediate predecessor as Deputy Minister — to remind myself of our debt to your industry. Many of you have given your services and the benefit of your experience — and are continuing to do so — to help us supply the Canadian forces with the most effective equipment possible, and, in the process, to develop a Canadian defence production base which will ensure, we hope, that this high standard can be maintained in future from our own resources.

I might sum up what I have been saying by pointing out that last year the Department was able to pass almost 90 per cent of its total orders for electronic and communication equipment with Canadian firms, whereas the best proportion reached in previous years was about 75 per cent. It is my hope — which I am sure you will share — that we can maintain this proportion, or even increase it in the future.

This hope can only be realized if, in the first place, the Canadian electronics industry continues to show at least as much interest in defence work as it has in the past. The striking growth of the market for civilian products may suggest that, as a whole, the industry is becoming less dependent for its livelihood on defence orders. From our point of view, this is a good thing. What is needed is an industry with independent sources of strength, which will not wilt the moment there is an interruption or faltering in the flow of defence orders. It must be enterprising and self-reliant, but we shall be the losers if independence is carried to the point of indifference. Even if defence production is to become relatively less important in your lives — and I am by no means

(Turn to page 43)

make sure you get the most important  
**TAPE WOUND CORE IMPROVEMENT**  
 in 6 years

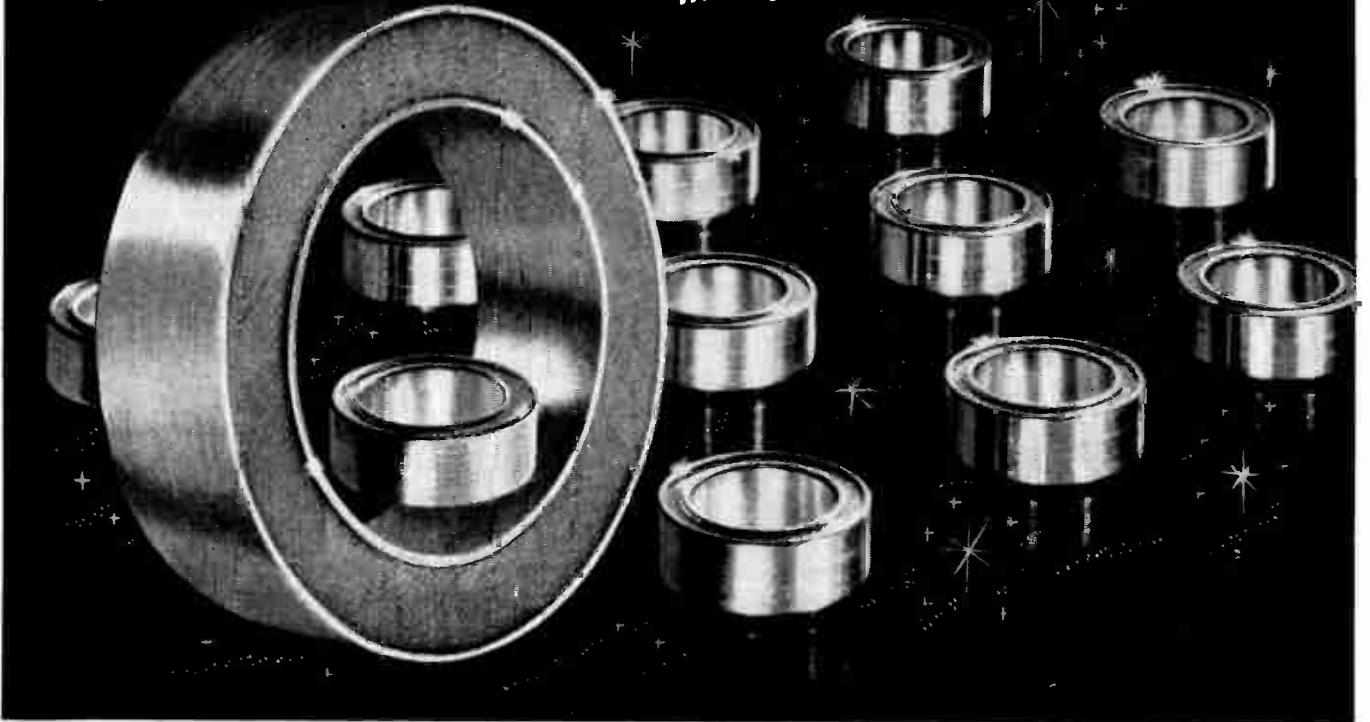

revolutionary **ALUMINUM CORE BOX<sup>†</sup>** construction

withstands **HIGH TEMPERATURE** • **VACUUM IMPREGNATION**  
**HEAVY WINDING STRESSES** • **SHOCK and VIBRATION**

This is a development which calls for immediate changes in purchasing specifications for Tape Wound Cores, because introduction of the Aluminum Core Box means designing your toroids around four important new advantages:

1. Use of an aluminum core box means the new Magnetics, Inc. tape wound cores will withstand temperatures of *at least* 450° F.
2. Because of the unusual seal provided by forming the aluminum over the silicone glass seal, true vacuum impregnation of your coils is now possible. Varnish cannot penetrate the core box and affect magnetic properties of the tape.
3. The strong aluminum construction absolutely prevents deflection of the core box when coils are wound—a distortion-free construction which means no change of magnetic properties.
4. Cushioned with an inert material, the tape winding in the core box is protected against vibration and shock. In most cases it is so completely minimized that it is no longer a problem.

Because of the many advantages of these new Magnetics, Inc. Tape Wound Cores, it will pay you many times over to specify "Aluminum Core Boxes" on your next order.

<sup>†</sup>PATENT PENDING

Immediately available in 109 standard sizes, using all commercially available magnetic materials.

ALL *Performance - Guaranteed*

For full details, write for  
 Bulletin TWC-200  
 Catalog TWC-100

**MAGNETICS inc.**

DEPT. EC-21, BUTLER, PENNSYLVANIA



Electron photo microscope's view of conventional oxide coating used by many long play tapes. (Artist's conception.)

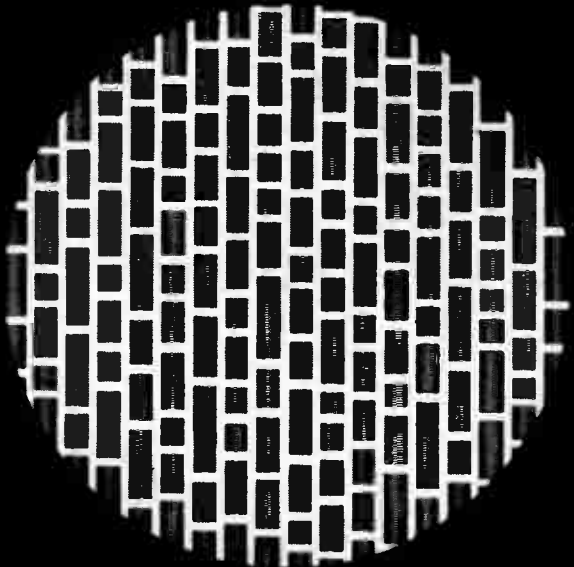

Similar enlarged view showing exclusive oxide dispersion method developed by "Scotch" Brand for new Extra Play Tape.

# SEE

## the difference ...

### then hear the difference ...



You'll notice the difference at once—the way revolutionary "Scotch" Brand Extra Play Tape outperforms ordinary long play tapes with old-fashioned, *full-depth* oxide coatings. There's a crisper tone, higher fidelity on "Scotch" Brand ... *and* a generous 3 db. boost in the high frequency range.

The secret of "Scotch" Brand's superiority? It's the completely new oxide dispersion process. By laying carefully filtered, fine-grain particles in a

neat, orderly pattern, "Scotch" Brand is able to produce a super-sensitive magnetic recording surface that contains the same amount of oxide as conventional tapes, yet is 50% thinner. That's important to remember when buying tape. Because recording experts are aware that a thinner, more potent oxide coating is essential for improved results with long play magnetic tapes.

Ask for "Scotch" Brand Extra Play Tape *today!*

**NEW!** **SCOTCH**  
REG. TRADE MARK  
BRAND

*Extra Play* Magnetic Tape 190



MINNESOTA MINING & MANUFACTURING OF CANADA LIMITED • LONDON • CANADA

Sales Offices: Halifax Montreal Toronto Winnipeg Calgary Vancouver

Resident Salesmen: Saint John • Quebec City • Ottawa • Hamilton • North Bay • Saskatoon • Regina • Edmonton

For further data on advertised products use page 99.



# Electronics & Communications At The Trade Fair

The Canadian International Trade Fair attracted a considerable cross-section of electronic products manufactured by both domestic and foreign manufacturers. Many of the products on display were shown publicly for the first time. A unique Canadian product on display was a small television camera for viewing industrial processes or any operation from a remote point over a closed circuit. The new camera is unusually compact to permit locating it in positions inaccessible to personnel.

Three new items were exhibited by the Canadian branch of an English electrical firm. One is the power rheostat that is smaller in size in relation to power dissipation than any previously made, and is also said to be mechanically much stronger. The rheostat can be used in scientific and industrial applications to replace larger sliding resistances and stud type regulators. Plastic molded fitting knobs designed especially to meet the requirements of high class electrical equipment were also shown. Molded in thermo-setting plastic of high impact strength, the knobs fit permanently tight to plain round shafts and will not slip or loosen. A new regulating transformer also shown is said to satisfy the demand for an economical, compact and reliable means of obtaining a continuously variable output voltage without the heat losses associated with resistances. Any alternating current load within its rating can be controlled from zero to full voltage without the necessity for special designs for individual applications.

● Exhibits of electronics and communications equipment displayed at the Canadian International Trade Fair are shown left of page top to bottom with personnel in attendance: Clare Fraser, Senior Liaison Engineer, P.S.C. Applied Research; E. S. Allen, M. Settelen and J. Read, Standard Telephone and Cables; N. C. Wilson and L. F. Purcer, Dominion Electrohome Instruments Ltd.; G. A. Peters, Bach Simpson; S. A. Rybb, E. C. Kent and P. Sporryng, Dawe Instruments Ltd.; Right side of page top to bottom: A. Lucis, Atlantic Films and Electronics; Eric Sullivan and H. Tribble, Pye (Canada) Ltd.; J. Callan, Cannon Electric; Bob Halfnight and Darcy Counsell, National Fibre Company of Canada Ltd.; and J. S. Turner, Redifon (Canada) Ltd.



## BROADCAST STUDIOS

(Continued from page 33)

outlets, i.e. an eight pole twelve-way switch. The pre-setting of the schedule of program changes is made on a specially designed plug and socket device, usually called a selection-grid.

The sequential monitor unit consists essentially of two motor uni-selectors which alternate in providing the listening point for the monitoring operator. As soon as the first selector is switched to provide the monitor point, the other selector searches for and locates the next point in the sequence, directed by information derived from the program switches. In this way the selectors continue to scan the sequency of lines and senders in use. Keys are provided, so that the device can be stopped at the point reached in the sequence. It can also be switched immediately to any other point in order to check a suspected fault.

There is little doubt that the efficiency of any major broadcasting station would be greatly increased by the use of the foregoing equipment. One highly trained operator can control the whole program input and monitor programs for the entire master station. The accompanying schematics show the automatic program change and manual over-ride, in short, the automatic program routing circuits as developed by the master station at Skelton, in England.

Such a concentration of control and program routing, however, requires the highest reliability of the equipment. Several operators can be relieved of the tiresome business of continual aural monitoring. The future may show ways in which the actual degree of automatic operation may still be extended, but, nevertheless, highly skilled and trained engineers will always be required to operate and maintain the equipment in working condition.

The foregoing description applies mainly to the large broadcasting corporations and master station networks like the B.B.C. and the C.B.C., of which it may be said continually strive to improve the quality and variety of broadcasts in the interests of the general public. It is considered however that this is not always the case with privately owned stations and is believed to be of the utmost importance to them, especially in view of the ever increasing competition which justifies a periodical re-assessment of their entire operation.

### Technical Considerations

Technical considerations for privately owned broadcasting stations are the following: (1) Acceptable quality of sound, unfortunately very seldom based on comprehensive system testing. (2) Lowest possible operating cost and lowest possible capital equipment cost. These factors lead often to an installation including not more than two control rooms and to the employment of non-technical announced-operators, and (3) Minimum lost air time, meaning lost revenue or lost audience. (A large proportion of the stations have spare transmitters to help reduce lost time.)

The greatest fault of such installations is inflexibility. Announcer-operators are employed, consequently using only one or two moderately competent technicians, who are primarily assigned to

transmitter duty. The result is that many studio installations tend to be rather makeshift except for the basic commercially built equipment such as consoles and turntables. The system will fulfill the daily requirements as they existed at the time of installation, but "haywire lashups" are required to perform anything out of the ordinary. Flexibility costs money, and where no immediate return is foreseen, funds are often unobtainable.

Most private stations have only one transmitter to feed (or at most, an FM satellite) and have no need for elaborate program switching and despatching systems such as are essential for network operations. If necessary, it is a simple matter to set up an arrangement whereby the extra feed is bridged off the regular transmitter line.

Many stations are now showing great interest in the use of automatic sequencing or automatic programming, but still try to maintain the system as operationally-simple and convenient as possible. These are modified and properly adapted systems whereby pre-recorded tapes and discs are started and stopped on the proper cues by means of sub-sonic or super-sonic tones recorded with the program material. Such devices offer means of reducing staff at night and other off-hours, but lead to an increase of work-load at other times owing to the

necessity of pre-recording much of the program material. How this system will work out in practice will be seen.

Most private station managers are very transmitter-conscious, which is the obvious view, because the most modern equipment will be useless if the signal cannot be heard by the greatest possible number of people.

One often-neglected aspect of broadcasting in smaller stations is in inter-communication and talk-back facilities. Many installations have grown very haphazardly and are not suitable to changes.

Tape recorders have become increasingly popular and important. Many stations are doing fewer and fewer live remote broadcasts and are replacing these with tape recordings made at the remote location and broadcast on a delayed basis. This eliminates line charges and often results in better (edited) programs.

The tape recorder has brought a real revolution in broadcasting, since it enables the delay and repetition of broadcasts with quality almost indistinguishable from the original.

Often the basic original facilities are enlarged by opening up an additional studio and control room for recording use (even simply using a tape recorder mixer as a combined studio control and recording amplifier).

(Turn to page 60)

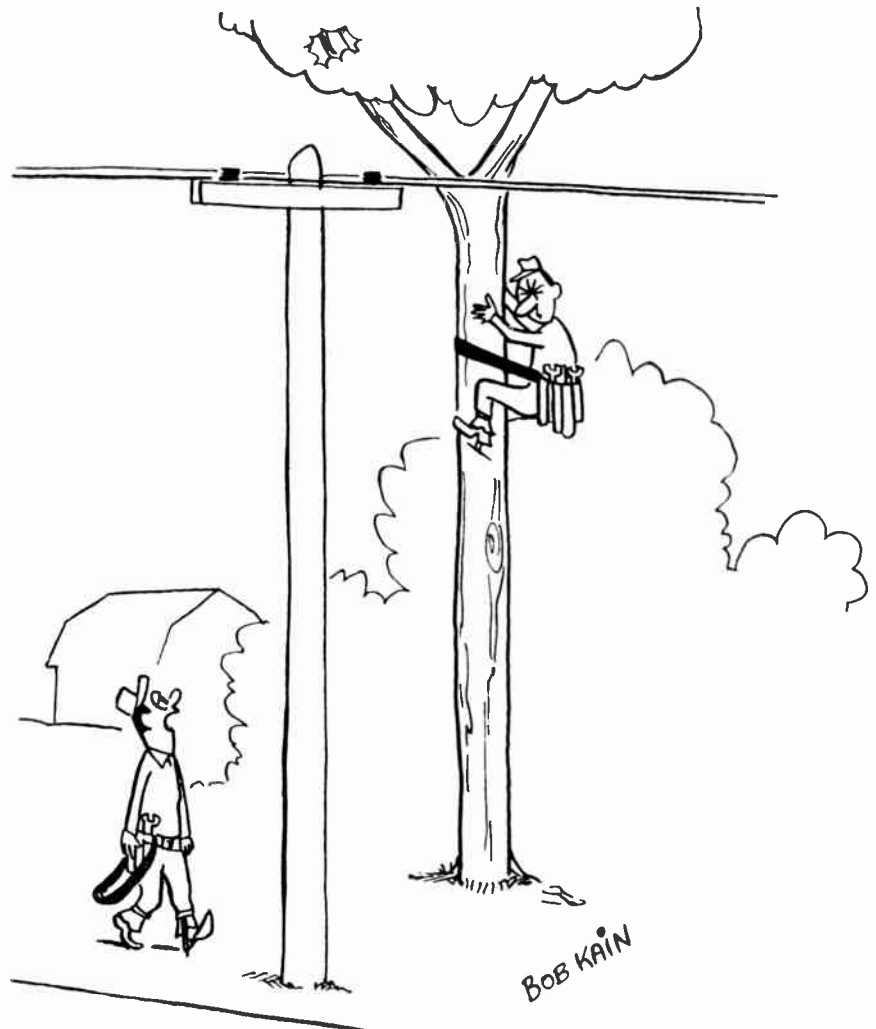

● "Lose your glasses, Ed?"



## “Get prices down! Keep quality up! **BUT HOW?**”

With the many materials now available, and new ones coming on the scene, how can a designer be sure he's got the right answer?

Here's one way. Work with a company that has an exceptionally broad line of basic engineering materials, plus the research facilities and production experience you need to support your decision.

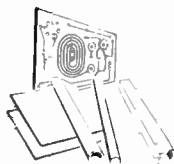

NVF materials—Vulcanized Fibre, Phenolite Laminated Plastic, Metal-Clad Phenolite and Fibre, Peerless Insulation—are surprisingly adaptable. Each is manufactured in many forms, grades, and combinations, with various degrees of hardness, resilience, flexibility, insulating ability, dielectric strength, moisture resistance, and ease of fabrication. What they can do—to reduce costs and preserve product quality—has raised many a manufacturer's eyebrows *and profits!*



NVF design assistance is complete. Our technical people can work with you while your project is in the head-scratching stage—make sure that you get exactly the right material or product for the specific job. But even more important, they stick with the project until it's completed to your satisfaction.

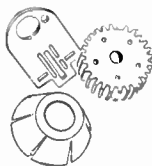

NVF maintains complete facilities for machining and forming ready-to-use parts. This saves you operating steps and gives you 100% usable parts. Working with a single integrated supplier often turns red figures into black ones.

If you have a design problem, call on National. It's the job of our engineering staff to discover ways and means of applying NVF materials to your difficult applications. Full details of our materials and services are yours without obligation.

Write for  
sixteen-page  
General Catalog,  
attention Dept. AD-5.



# **NATIONAL**

**FIBRE COMPANY OF CANADA, LTD.**

ATLANTIC & HANNA AVENUES, TORONTO  
1411 CRESCENT STREET, MONTREAL

Also Manufacturers of Peerless Insulation, Materials Handling Receptacles, Vul-Cot Wastebaskets and Textile Bobbins.

In the air — on the sea and under the sea —  
the navy depends on electronics to seek out  
and destroy its adversaries.

# Electronic Needs For The Navy

Some indication of the amount of electronic equipment purchased by the navy may be realized from the fact that the estimated cost of communications equipment to be purchased for the navy in the year 1954-55 will amount to \$15 million. This is 4.7 per cent of the gross total for the navy and presumably the figure does not include the large quantities of other shipborne electronic equipment such as radar, fire control equipment, asdic control etc.

The following account gives some idea of the part played by electronics in the Royal Canadian Navy.

**I**T is impossible to be in the present day Royal Canadian Navy without constantly being aware of electronic devices of one kind or another. They are everywhere.

Although, like the Royal Canadian Navy itself, electronics is a comparative youngster, it has become indispensable to the fighting efficiency of a modern warship.

Electronics was first introduced into

the navy in the form of communications equipment. Previously, the dispatch of orders and commands was limited to as far as the eye could see and the voice could carry. The advent of radio changed the whole concept of naval operations. Today, ships at sea, no matter where they are, can keep in touch with shore stations, aircraft and other ships.

Canada's modern destroyer escorts are today equipped with as many as five radio rooms, each fitted with transmitters and receivers, which cover a wide range of frequencies, and the refinement of radio teletype and facsimile terminal equipment enables information to be dispatched and received in typewritten form.

The Canadian electronics industry has long produced communications equipment for the Royal Canadian Navy. During the Second World War the industry's production was confined largely to the communication field, although by 1944 it was producing many types of radar equipment.

By 1950 the industry had developed its manufacturing facilities to the extent that all major or large volume items embodied in electronics were made in Canada with a varying degree of imported content.

Today, the industry is producing more highly developed equipment and



● Acting Captain Robert Waugh Murdoch, CD, RCN, Director of Naval Communications.

sub-assemblies than ever before, and the navy is drawing on the skills and resources of the industry to an ever-increasing degree.

This is nowhere more evident than in the field of radar, which is perhaps the most highly regarded electronic equipment on board ship.

### Canadian Production

Radar has reached the point of development where it can locate an enemy surface ship or aircraft in the dark or in thick fog, identifying the target as friendly or otherwise, and when within gunnery range can automatically control the ship's armament to destroy the enemy without even sighting him.

It is significant that the navy's latest and most powerful air search radar, the AN/SPS-12, is being produced in Canada. This set, the most powerful shipboard radar ever produced in Canada, has an output of several hundred thousand watts and can be modified to increase it to several million watts — the most powerful naval set in existence. The set can

(Turn to page 70)



● Radar set in ship's operations room.



● Commodore (L) William Hugh Gregory Rogers, OBE, CD, RCN, Electrical Engineer-in-Chief.





## *Years Ahead...*

The console that was *years ahead* when it was introduced in 1951.

*still ahead* when the idea of electrically and mechanically joining two consoles for almost double facilities was introduced in 1952.

*... and still years ahead* with the introduction of the R5420D single and R5421B double consoles in 1954.

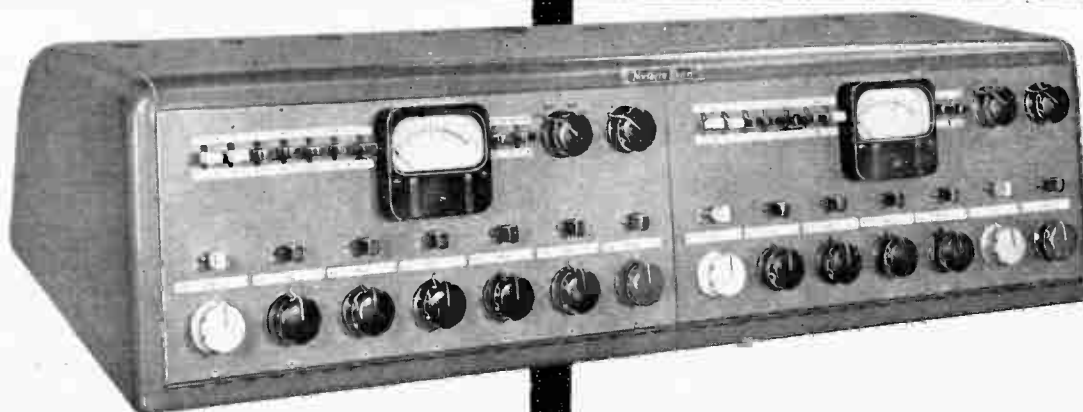

The new R5420D Console with DC on the filaments offers besides all other features a console with vastly improved noise characteristics — better than 75 db below + 18 dbm.

As a station owner or manager you cannot afford to operate with an old or obsolete console with high maintenance costs when the cost of a new Northern Electric console is so reasonable. Now is the time to contact your local Northern Electric Branch Office.

# *Northern Electric*

COMPANY LIMITED

SERVES YOU BEST

1055-4

## COMMON CHARACTERISTICS OF ALL TYPE 2131 GEARED MOTOR GENERATOR UNITS

O.D. of Case	1.000 inch	No. of Poles (Motor)	6
Case Length	3.301	*No Load Speed (Min.)	6500 rpm
Case Weight	7.5 ounces	Rotor Inertia	1.1 gram-cm <sup>2</sup>
Frequency	400 cycles		

\*Motor Speed at input to gear train.

# NEW

## integral gear head in small servo motors

### OUTSTANDING FEATURES OF TYPE 2131 GEARED MOTOR GENERATOR

- New methods of manufacture result in high efficiency
- High torque to inertia ratio to give fast response
- Available for 115 volt — 115 volt two phase or single ended tube operation
- High impedance winding for direct plate to plate operation available
- High generator output voltage with excellent signal to noise ratio
- Zero degree phase shift in generator
- All metal parts corrosion resistant
- Extremely wide operating temperature range

*Other models  
of one inch O.D. units*

TYPE NO.	DESCRIPTION
2103	Induction Motor
2101	Geared Induction Motor
2028	Motor Generator

A new line of units has been added to the Kollsman "Special Purpose Motors" family combining precision machining, advanced electrical design and the latest in new materials. An unusual feature of the new line is the integral gear head unit. Contained within a single case is the gear train and motor; or gear train, motor and generator. Gear ratios as high as 300:1 can be supplied.

This new line consists of Induction Motors and Induction Generators supplied separately or combined in a single case one-inch in diameter. The new motors have been designed to give the maximum torque per watt ratio with the minimum rotor inertia. The generators have been designed to give the maximum output voltage with the minimum residual voltage and phase shift.

One of the principal features of the Kollsman "Special Purpose Motors" is the interchangeability of parts which permits numerous electrically different combinations of motor and generator windings within the same case.

### INPUT PER PHASE ONLY 1.8 WATTS ELECTRICAL CHARACTERISTICS OF TYPICAL TYPE 2131 GEARED MOTOR GENERATORS

Latest catalog and/or complete specification drawings will be sent upon request.	TYPE NO.	Excitation		Input Per Phase	MOTOR		GENERATOR		
		Fixed	Control		Stall Torque	Theoretical Accel-eration At Stall	Excitation Fixed	Input	Output Per 1000 rpm
	2131-0411110	26	26	2.3	0.4	25600	26	1.8	.51
	2131D-0412120	26	26	4.0	0.6	38500	26	2.2	.68
	2131D-0413120	26	26	1.8	0.3	19200	26	2.2	.68
	2131-0460600	115	115	4.0	0.6	38500	115	2.6	1.00
	2131-0463600	115	55	4.0	0.6	38500	115	2.6	1.00
	2131-0470600	115	P-P	4.0	0.6	38500	115	2.6	1.00
		volts	volts	watts	Oz-in	rad/sec <sup>2</sup>	volts	watts	volts



**GYROSCOPE COMPANY OF CANADA LTD.**

CANADIAN REPRESENTATIVES FOR KOLLSMAN INSTRUMENT CORPORATION, SUBSIDIARY OF STANDARD COIL PRODUCTS CO., INC.

For further data on advertised products use page 99.

## NONE TOO GOOD

(Continued from page 34)

certain that it will — you will become not less but more important in ours. We may still be a long way from the push-button army of machines, but the number and variety of push buttons is growing constantly, working new devices to find the enemy, to frustrate his plans, and to destroy him. The one thing that can be said with absolute certainty about defence requirements of the future is that the need for a strong electronics industry will grow steadily. This does not mean that there is likely to be enough defence work to carry the industry. There should be proper balance between commercial and government work to ensure a healthy, vital and progressive industry. On the other hand, it would be a serious blow to the defence effort if preoccupation with the civilian world of radio and television were permitted to affect the proper carrying out of defence orders.

There is, I think, every reason why it is to be expected that your interest in defence will continue. You are not, I am confident, devoid of a sense of public responsibility. What is equally important, the benefits you have received from defence orders in the past, which I have already mentioned, will result no less from future programs. The jobs we will ask you to do for us will be tough ones — tougher than anything you have attempted before. They will call for all the know-how and ingenuity which you can muster. Some of them, like the research and development programs of Defence Research Board, may be small in terms of cost, and smaller still in terms of net return. But regardless of their size — and they will not all be small — their successful conclusion cannot help but improve the technological resources of your industry, and your ability to hold your own in markets in the world.

Granted a continuing interest on your part, what sort of a future may we expect? I shall confine myself to indicating, generally, what you may expect from defence production, and to suggesting what the Government shall look for from the electronics industry.

First of all, the fundamental facts of our existence are not likely to change. As a department of government, we have the responsibility to the public which must be met. Those of you who have dealt with the Department will appreciate what this means in terms of the way we do business. The money to be spent is public money, and judgment is passed both on what it is spent for and how it is spent.

For the most part, of course, the Department of National Defence must answer on the first count. The Department of Defence Production buys what

(Turn to page 92)

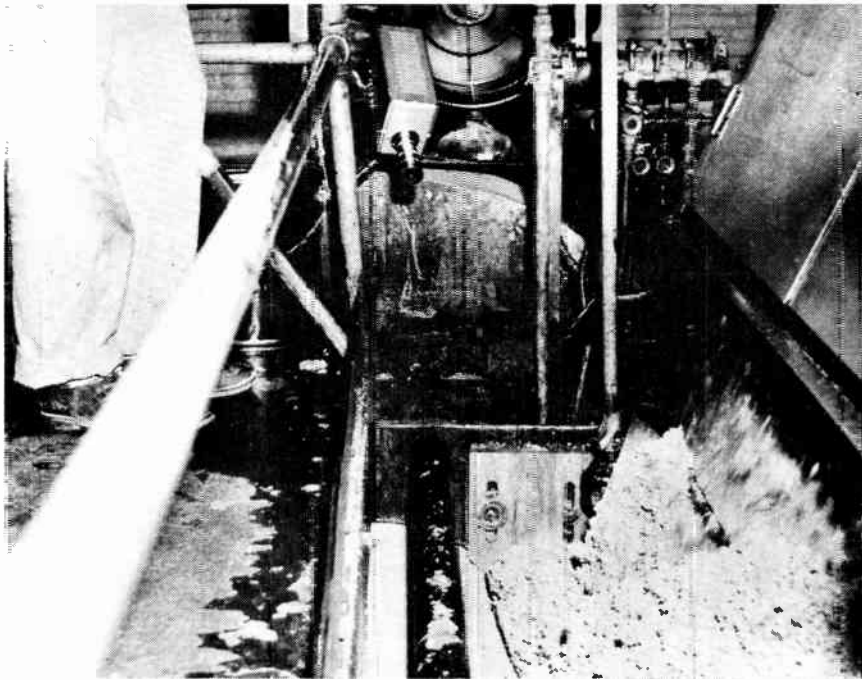

● TV camera (upper left) focuses on linoleum mix as it drops between calender rolls at the Armstrong Cork Company's Floor Plant.

# Industrial TV Coordinates Detached Plant Operations

A CLOSED circuit television system — similar to the type used to beam championship fights into theaters — is helping the Armstrong Cork Company ensure top quality production of linoleum and plastic floorings.

The TV setup bridges a three-storey

● Workman on third floor of Armstrong Cork Company's Floor Plant views linoleum mix he is shovelling enter the calender rolls two storeys below.

gap in the linoleum operations at the company's floor plant. On the third floor, a workman shovels linoleum mix into a hopper. On the way downstairs the raw ingredients undergo intensive mixing, are combined with color pigments and emerge in granule form at huge calender rolls which form the mix into sheets of flooring

The timing and regulation of interdependent plant operations, the locations of which are remote from each other is being increasingly facilitated by the use of closed circuit television hook-ups. The application of television for this use is ousting such old-fashioned and dangerous methods of intercommunication between separated plant operations such as the "long and short" whistle and bell system.

material. It's important that the mix enter the rolls uniformly.

Normally a workman at the first floor operation signals upstairs, by means of a bell system, to stop or start shovelling on the third floor. Now a TV camera focuses on the mix and the image is flashed upstairs on a receiver, which allows the workmen to keep an eye on the operation below and regulate shovelling accordingly.

Although still in the experimental stage, the system has worked out well and there is a possibility similar setups will be installed in other departments on a full-time basis.

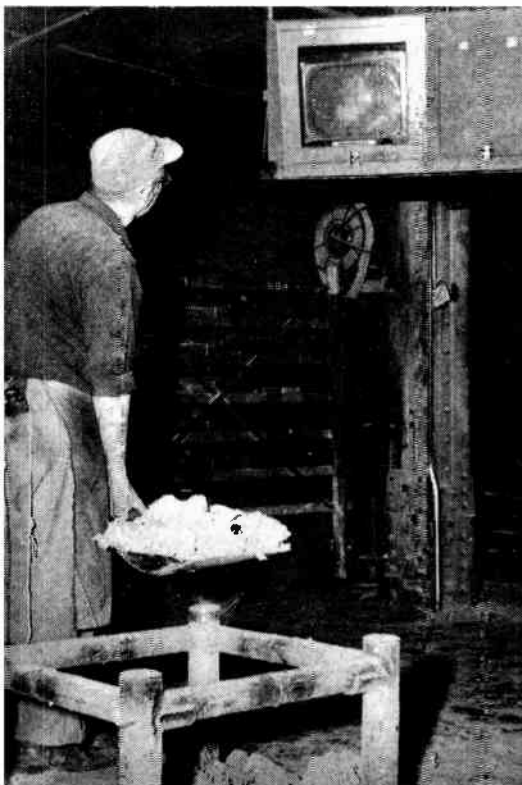

Modern Equipment For The Remote Control Of  
Radio Transmitters Permits Lower Cost And  
Higher Efficiency In . . . . .



G. W. LEE

# Broadcast Operations

**S**TANDARD Amplitude and frequency modulated broadcast transmitters in Canada have, since 1948, been completely controlled from the Radio Station studio, effecting a vast reduction in operating costs and, to the nation's benefit, better use of skilled technical manpower. This boon to the radio industry has come about due to the efforts of station owners to reduce costs, the engineering enterprise and know-how of electronic equipment manufacturers, and the co-operation of the Department of Transport, the governing body of Canadian Radio.

During the infant years of broadcasting, remote control was just a dream in the station owner's mind or a lively topic of discussion whenever radio engineers gathered. A multitude of schemes and plans were put forth, but after searching analysis rejected as being dangerously unsafe or economically impractical. It was not until 1948 that the Department of Transport, believing the industry ready for advancement, amended the regulations governing broadcasting to allow transmitter operation by remote control. This amendment specifically allowed two control systems, that of "telemetering" and "marginal alarm relays" while provisionally allowing any other acceptable means. Telemetering is simply sending by means of telephone lines various voltage levels that are read on a meter at the studio, and which indicate the state of the transmitter circuits at any time; while the marginal alarm relay system is a collection of relays situated at the studio which are actuated by sample voltages carried over telephone lines from the transmitter circuits.

## Physical Advantages

In December, 1949, the first remote control system, utilizing telemetering, was installed and put into operation

at CFAR, Flin Flon, Manitoba. The system proved an immediate success, demonstrating once and for all that unattended operation of broadcast transmitters are feasible. Since then approximately 60 stations have followed CFAR's example: 250 and 1000 watt omnidirectional antenna stations, as well as 1000 watt stations employing 2 and 3 tower directional antenna arrays. The large 5 or 10 kw. omni or DA stations offer no unsurmountable engineering problems and currently many are planning remote installations. It is only a matter of more design and installation engineering; the

Gerald W. Lee the author of this article is a Registered Professional Engineer of the Province of Ontario and has had considerable experience in the radio broadcasting field. Mr. Lee has practiced as a consulting engineer specializing in the field of radio station design and construction and is well qualified to discuss the various aspects of remote controlled transmitters with which this article deals.

fundamental principles are the same for small or large stations.

Remote control yields certain advantages to the radio station and to the community in general, over the old method of unattended operation. A few of the more obvious are as follows:

It releases the services of four or five skilled transmitter operators. On the surface this may appear a detriment to a community — five less available jobs. However, operators usually have a good working knowledge of electronics, and with the industry chronically short of skilled personnel such men can always find employment, usually for better wages. Another aspect, any operator will

readily admit, is that in attending transmitter his capabilities are not used to best advantage either to himself or to the community. He wastes away the time often hoping something will go wrong so as to test his knowledge and worth. With a modern transmitter, well serviced, this rarely occurs.

Control of the entire radio station is at one central point — the studio. As radio signals serve as effective beacons for aircraft, efficient control of such can be a matter of life or death to a community in the event of air attack. Only the studio has direct access to news flashes and central air raid warnings, and therefore the studio must be able to shut the transmitter down instantly if necessary. As a matter of fact, "Operation Conelrad", the required procedure for air defense, utilizes studio control. The standard remote control equipment can be employed as a part of "Conelrad".

In time of natural disaster, such as fire, flood or earthquake, remote control may become the only means of putting a station "on" and "off" the air. Radio coverage at such times is necessary for broadcasting warnings, messages, and so forth to isolated communities.

The transmitting equipment is under control at *all* times. In the past many small stations found it impossible to operate economically, if sufficient personnel was employed to continuously monitor the transmitter as required by law. Therefore, the law was often ignored; the transmitter turned on in the morning and perhaps checked one or twice a day. Such operation, of course, resulted in large "off-air" losses, and often serious damage to equipment. This situation is alleviated by remote control inasmuch as the studio operator *has* to be on

(Turn to page 70)

**AUTOMATIC ELECTRIC • LEADERS IN CARRIER COMMUNICATION •** *Lenkurt*

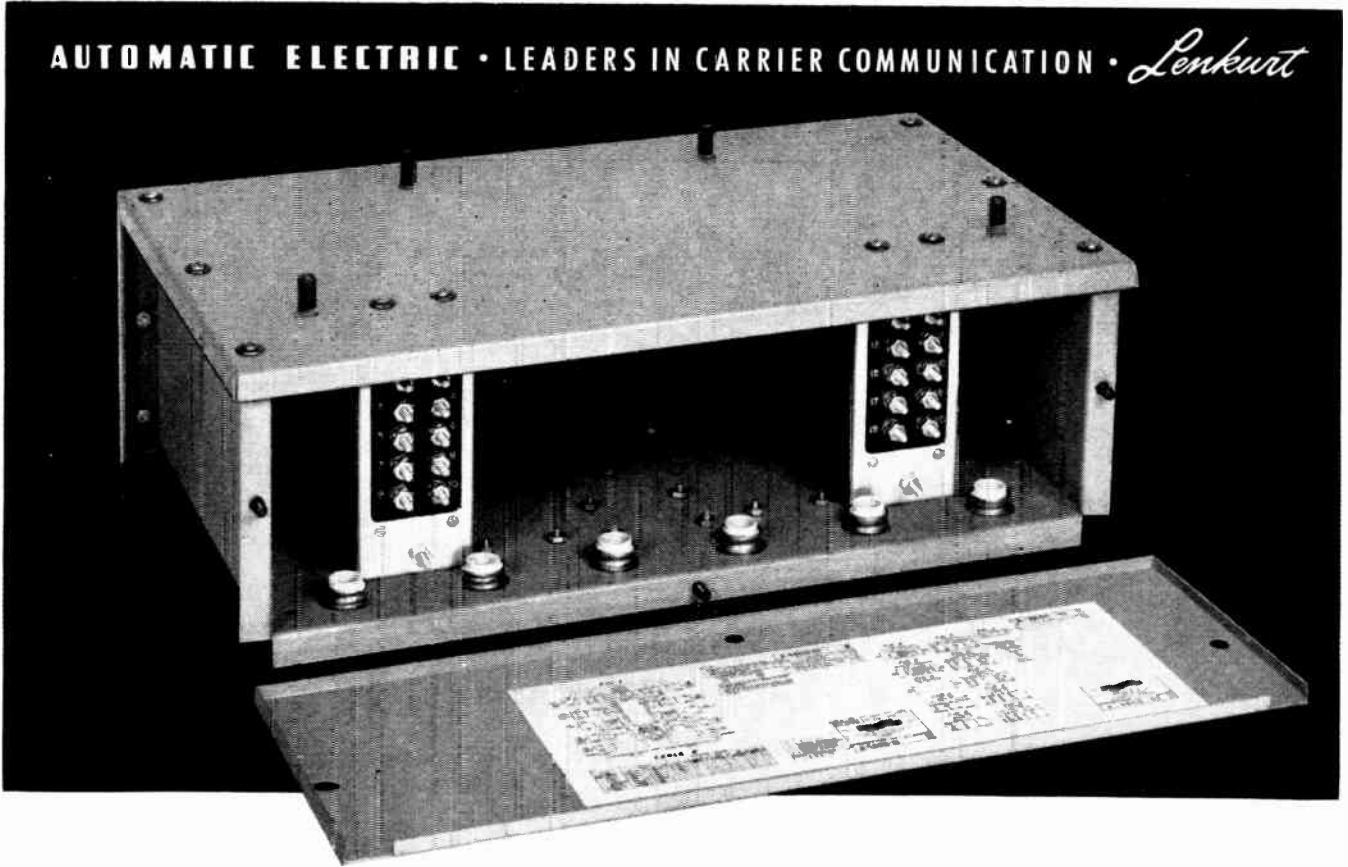

**carrier line circuit components . . .  
where you want them on the line**

*Lenkurt* **TYPE 560-A** weatherproof housing

A weatherproof steel container designed for installation on pole cross arms which provides mounting facilities for carrier line filters, transformers, balance networks, high voltage protection units and other line circuit components in various combinations as required. Equipped with terminal strips, porcelain bushings for external wiring entrance and mounting brackets adjustable for either single or double crossarms.

*Full details on request*

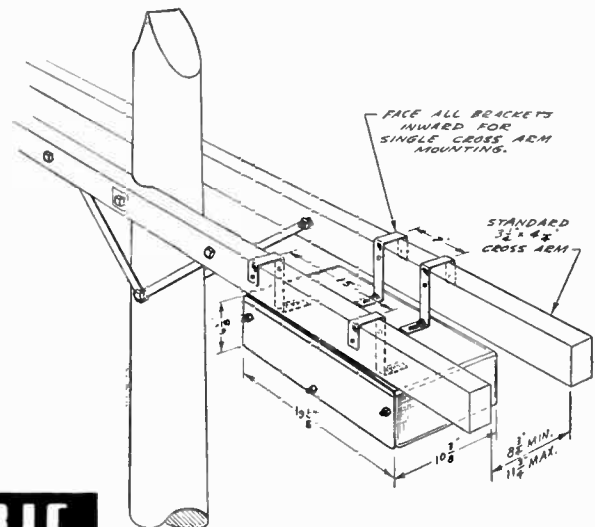
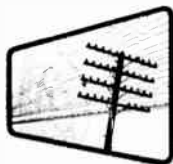

*Mounting arrangement and dimensions*

**AUTOMATIC ELECTRIC**

(CANADA) LIMITED

Distributor in Canada

**AUTOMATIC ELECTRIC SALES (CANADA) LIMITED**

Head Office: 185 Bertley Drive, Toronto 16

MONTREAL • OTTAWA • BHOCPVILLE • HAMILTON • WINNIPEG • REGINA • EDMONTON • VANCOUVER

L-5530



With Approximately 5,000,000  
File Cards In Constant Use . . .



With The Need To Transport  
Thousands Of Workers Daily  
Through A Ten-Storey Building and . . . .



With The Speed And Efficiency  
Demanded Of Present Day  
Operations . . . . .

## Business Can't Do Without Electronics!

**I**NDICATIVE of the part electronic equipment plays in the planning of large new office buildings is the magnificent new structure which will house the head offices of the Crown Life Insurance Company which is located in the business hub of Toronto. In designing such a building architects must take into consideration the large amounts of electronic equipment that is used in conducting present day business and the complexity and volume of work transacted by insurance companies have put them in the forefront as users of electronic equipment.

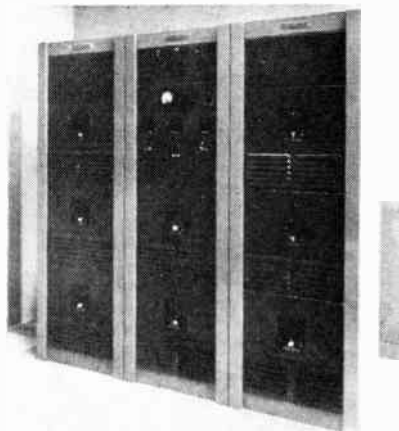

● Main amplifier bays of the sound system fitted in the Crown Life Insurance Company's new building. This system was fitted by Engineered Sound Systems Limited.

The Crown Life has a completely electronic billing and accounting department which is located on the third floor. The installation includes 8 alphabetic key punches, 5 alphabetic verifiers, 2 alphabetic collators (each capable of merging up to 480 cards per minute) 8 electronic sorters (each capable of sorting 650 cards per minute) 4 tabulators, (which will list 100 lines per minute or add 150 cards per minute), 2 model "407" tabulators which lists 150 lines per minute or adds 150 cards per minute. These machines are especially adaptable to the complex operations of the life insurance business. The department is also equipped with 4 reproducing summary punches (each capable of processing 100 cards per minute) 1 interpreter (which interprets 100 cards per minute), and 1 electronic "604" calculator. This machine does very complex calculations and punches results on individual cards at the rate of 100 cards per minute. A model "101" statistical machine (for analyzing and summarizing a file of cards at the rate of 450 per minute) and an accumulating reproducer for summarizing files at the rate of 200 cards per minute will be delivered very soon.

The Tabulating Department has files of approximately 5 million cards which are in constant use. There are 250 control panels for use in various machines to accomplish different jobs. New equipment recently added include a decollator which can be used for extracting carbon paper automatically



● Top:—The "electronic brain" behind the automatic elevator system. Bottom:—The underwriting department on the fourth floor has to consult permanent record files in the basement and to facilitate the speedy movement of these files, the company has installed a Telautograph service.

and a "Burster" for fast, clean separation of individual forms.

The company has installed subsidiary equipment which is especially designed to increase efficiency in the Tabulating room.

### Electronic Elevators

There are three passenger elevators installed, two of which run from the basement to the seventh floor and one from the sub-basement to the seventh floor. Each car has a load capacity of 3,500 lbs. and travels at the speed of 500 feet per minute. The elevators are of the new modern automatic electronic operating type. When a passenger pushes a call button, the closest

(Turn to page 71)

# NEW PHOTOCELL OPERATES RELAY DIRECT

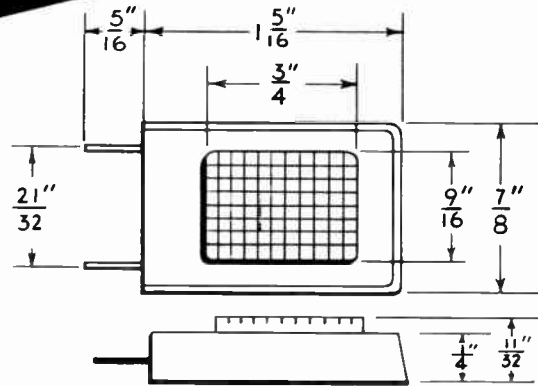
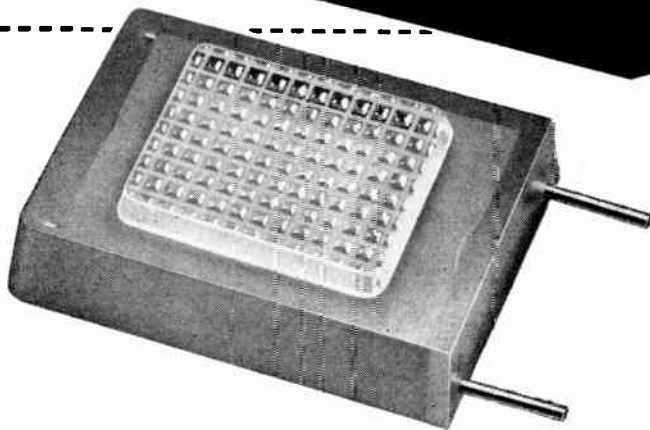

## GENERAL DESCRIPTION

Sensitive area ..... 1.45 cm x 1.85 cm  
 Electrodes ..... Interleaving combs  
 Cell casing ..... Cast Araldite  
 Socket ..... Special

## MAXIMUM RATINGS

**Dissipation** ..... **0.3 max. watt**  
**Voltage** ..... **120 max. volts (a.c. or d.c.)**  
**Current** ..... **20 max. ma**  
 Temperature range - 40°C to +75°C ambient

## PHOTOELECTRIC CHARACTERISTICS

Wavelength at maximum response.....	.5100°A		
	<u>MIN.</u>	<u>AVG.</u>	<u>MAX.</u>
Dark resistance.....	100	1000	10,000 megohms
*Resistance at 50 ft candles.....	1500	2000	3,000 ohms
*Sensitivity at 1 ft candle, 100 volts.....	0.25	0.4	0.5 amp./lumen
Capacitance.....	20	25	30 mmfd
Rise-time constant at 50 ft candles.....	.5 m.sec		
Decay-time constant at 50 ft candles.....	.10 m.sec		

\*Measured with a 2854°K colour temperature tungsten lamp.

For further information, write for the C.M.C. Photocell Handbook to

PHOTOCELL DEPARTMENT

# CANADIAN **Marconi** COMPANY

2442 TRENTON AVENUE, MONTREAL, P.Q., CANADA

World Radio History

# NEWS



## W. J. Riley Appointed Chief Engineer For Sperry

E. W. King, Managing Director of Sperry Gyroscope Company of Canada, Ltd., has announced the appointment of William J. Riley as Chief Engineer.



W. J. RILEY

W. J. Riley, M.C., P.Eng., M.E.I.C., is a graduate of McGill University and served in numerous supervisory and managerial roles in Canadian industry until his association with Sperry in 1953. Prior to this appointment Mr. Riley was Works Manager of Sperry Gyroscope Ottawa Limited.

The Sperry Gyroscope Company of Canada, Ltd., is currently engaged in the design, development and production of precision instruments and electronic controls for the air, marine and industrial fields.

## Cossor Installs PA System At Naval Air Base

A public address system engineered, manufactured and installed by Cossor (Canada) Limited is now in use at H.M.C.S. "Shearwater" Naval Air Base at Dartmouth, Nova Scotia.

This system gives complete coverage of the entire base. The entire system can be controlled from any of four main control points, one of which is usually designated central control to regulate the whole system. There are a further 20 local control points covering different sections of the base. This means that messages affecting only personnel in one section can be confined to the local area, thus avoiding the nuisance effect of continually listening to messages which have no interest to the majority of people in the base. The message can be broadcast either from the local control or from one of the main control points.

When fully loaded nearly 1,000 watts of audio power is radiated through the base with up to 24 simultaneous calls from as many control points.

Generally the system provides public address communication and paging facilities to over 60 hangars and buildings, thus providing one of the most comprehensive systems in use at airfields today in Canada and likely to provide a standard for the large modernization program presently being planned at Canadian airports and airfields.

## Electrodata Signs Computer Representative For Canada

ElectroData Corporation, digital computer manufacturers of Pasadena, has named the Ottawa firm of Data Processing Associates Ltd., as its sales and service representative in Canada, according to an announcement by President James R. Bradburn.

Data Processing Associates President is George S. Glinski, research engineer and college lecturer, who has pioneered digital and analog computation in Canada. He is past president and executive engineer of Computing Devices of Canada Ltd., and has been particularly active in the use of data processing for military and national defense purposes.

Douglas H. Peacock, business systems specialist with an extensive background in computer application, is vice-president and managing director of the Canadian firm. Engineering sales manager is Andre Barszczewski, mathematician and computer research expert.

Data Processing Associates will carry out all phases of marketing, systems study, installation and maintenance service for Datatron machines in Canada, under general direction from ElectroData headquarters in California. Canada's industrial centers of Ontario and Quebec will be serviced directly from Ottawa, and future representatives will be stationed by D.P.A. in other important areas of Canada.

## Dalic Metachemical Establish Canadian Office

The formation and opening of Dalic Metachemical Limited, a Canadian company associated with Laboratoires Dalic, Paris, France, and Metachemical Processes Limited, London, England and Birmingham, has been announced.



L. W. PIDDINGTON

Mr. L. W. Piddington, formerly with Metachemical Processes Limited, London, England, has been appointed General Manager in charge of all operations. Offices and laboratory are located at 121 Leicester Avenue, Toronto 18, Ontario, Canada. The Company has been established for the development and distribution of the Dalic Process of electro-plating and will service both Canadian and American Industries.

## Lenkurt Electric Builds New West Coast Plant

Plans for construction of a new \$200,000 factory and office building in Burnaby near Vancouver, British Columbia, have been announced by the Lenkurt Electric Co. of Canada, Ltd.

President L. G. Erickson said construction will begin in June and should be completed in time for all operations to move there early in 1956 from the present plant in Vancouver.

The new building is an integral part of an accelerated program to increase the Canadian content of Lenkurt products, according to George F. Koth, vice-president and work manager.

The building site is a 6½ acre plot approximately 8 miles east of downtown Vancouver. The new building will be of modern construction and will have a total of 15,000 square feet of floor space. Two-thirds of this will be devoted to production operations and the remainder to offices.

## New Company To Manufacture Telephone Cables

Mr. J. R. Bradfield, President of Canada Wire and Cable Company, Limited, announces the completion of arrangements with General Cable Corporation of the United States for the formation of a company for the manufacture of a complete line of telephone cables in Canada.

The new company, Telecables and Wires Limited, will be under the management of Canada Wire and Cable Company, Limited, and will also have available at all times the extensive engineering and manufacturing experience of General Cable Corporation. It is planned to locate the plant at Winnipeg.

## Automatic Electric Sales Appoints P. M. Gleason To Western Post

Automatic Electric Sales (Canada) Limited announce the appointment of P. M. Gleason as sales representative for the province of Saskatchewan. Mr. Gleason has had several years of experience with the Automatic Electric organization in Canada in the installation and engineering of communication equipment. He will be located at the firm's new sales office in the Exner Building, Regina.

(Turn to page 54)



# What's important to remember about these?

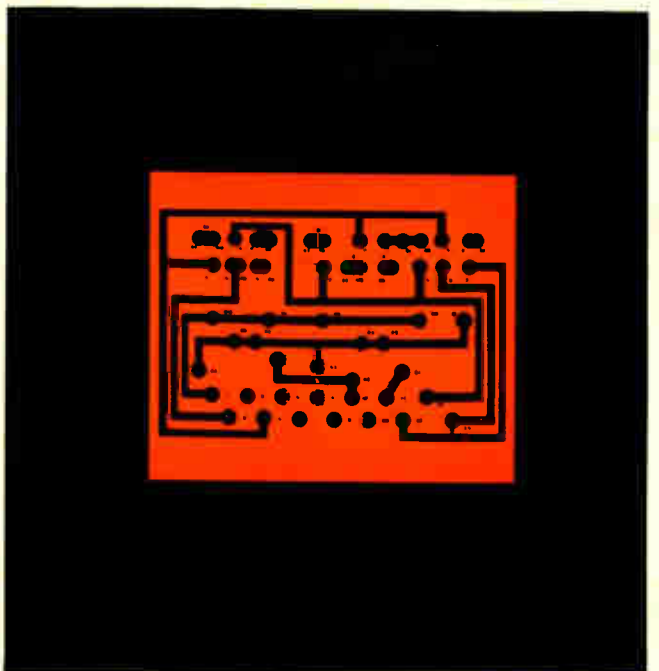
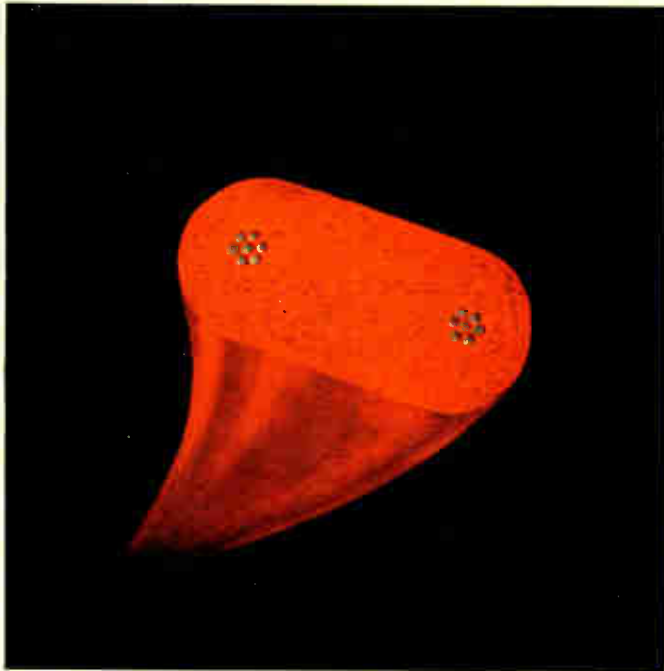
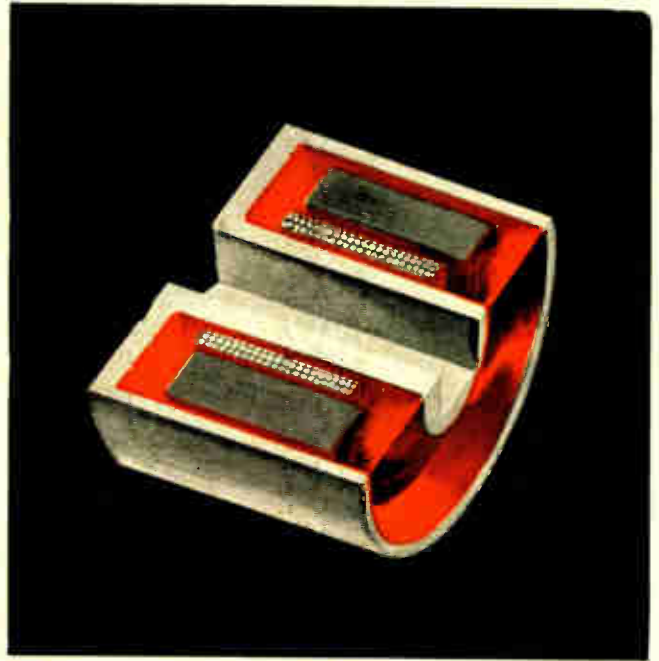

**T**hese are just three of countless mileposts marking the closely parallel growth of two great industries—electronics and plastics.

You'll recognize the epoxy resin potted coil. The cellular polyethylene TV lead-in. The phenolic laminate printed circuit. Each typifies new processes and materials that have wrought basic technological changes affecting the design, quality and cost of such things as radar, TV, and computers.

BAKELITE has long been especially identified with the steady growth of electronics. Almost historically classic are the panels, knobs and dials of early home radios made of BAKELITE Brand

Phenolic Plastic . . . the first molded plastic radio cabinets.

But as electronics became truly complex and critical, BAKELITE developed other basically new plastics *that actually became one with circuits themselves.*

Today the number and variety include not only BAKELITE Brand Phenolics, but Styrenes, Vinyls, Polyethylenes, C-11's—and the even newer and extremely versatile Epoxies, Fluorothenes, and Cellular Polyethylene.

What's important to remember? Simply that BAKELITE's leadership in plastics will continue to keep pace with the growth of the electronics industry—with still better plastics as needed.



**BAKELITE COMPANY**, Division of Union Carbide Canada Limited, **UCC** BELLEVILLE, ONTARIO  
Sales Headquarters: 40 St. Clair Ave. East, Toronto. Sales Office: 1425 Mountain St., Montreal

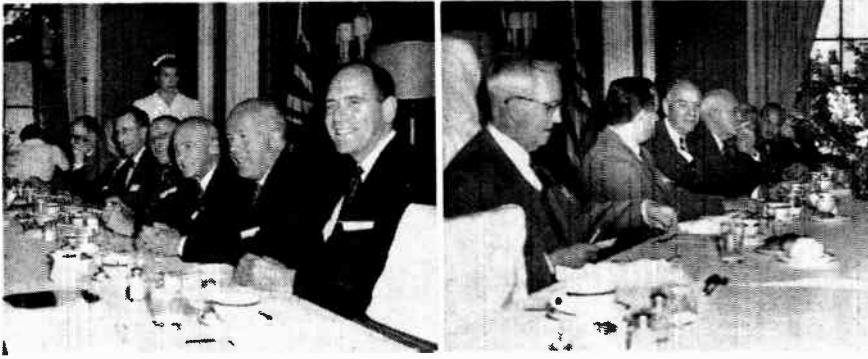

● The head table RETMA (Canada) banquet showing some of the principal speakers.

## R. E. T. M. A. 26th Annual Meet

# President C. A. Pollocks Report Indicates Growth

**T**HE three Vice-Presidents, as Chairmen of the Divisions of the Association, have presented reports of the activities of the Divisions during the past year, and it falls upon me, as President and Chairman of the Board, to review the Association year just ended and to give a brief report on the work of the Executive Committee and the Standing Committees reporting directly to the Board of Directors.

This 26th Annual General Meeting takes place at the end of the first post-war decade, and it is an appropriate occasion to recall the record of the progress of the Association and the electronics industry in general since the blip of the last enemy aircraft ran off the edge of a Canadian-made radar screen somewhere in Europe. Since that time the Association has grown both in stature and in strength. The path has not been an easy one, and many problems have been encountered and successfully surmounted by sheer hard work and perseverance by the members of the Association. The organization itself has been tested many times, but its flexibility and adaptability have enabled it to overcome each difficulty and challenge.

Our recent decision to change our name to the Radio-ELECTRONICS-

● G. C. W. Brown, retiring Director of Telecommunications, Department of Transport, Ottawa, is shown extreme right being presented with portable radio by Ralph Hackbusch (center) and Stu Brownlee (right).

Television Manufacturers Association of Canada and our other constitutional changes are indicative of our readiness to make organizational changes in accordance with the unfolding of the scientific environment in which we live and which we in our industry, help to create.

Membership in the Association continues to increase and, with the new companies we have welcomed during the past year, the total membership for the first time in the history of the Association since it was established in 1929 now exceeds one hundred. There are now 66 in the Parts & Accessory Division, 21 in the Receiver Division, and 16 in the Electronics Division, a grand total of 103 member-companies, practically the whole of the electronic manufacturing industry in Canada.

The decision to make a new member-

ship classification to admit associate members is a good one and will result in the Association expanding its contacts into related fields where common interests are concerned.

The year under review has been a very good one. In the twelve months ending April 30, 1955, the members of our Receiver Division reported sales of 678,623 television receivers having a list value of over \$224,000,000, an increase of 66 per cent over the 400,000 television receivers sold in the previous Association year. Although radio receivers sales were substantial, they decreased somewhat from the previous year. Added interest in Hi-Fi and new innovations such as transistorized portables are expected to add impetus to lagging radio sales.

The Defence orders and the sale of commercial equipment and servicing of electronic devices, when added to these figures, shows that the Canadian Electronics Industry is maintaining over a half-billion dollar a year turnover, a figure we can fully expect to increase as further scientific developments in the electronic field are made. Our industry, since the beginning of this decade, has produced nearly 1½ million television receivers, and has put Canada third among the nations of the world in the number of sets in use.

### *Bitter Disappointment*

The bitterest disappointment of the Association year was the Government's decision not to remove, or even reduce, the 15 per cent Excise Tax currently levied against radio and television receivers. On February 1st last, the Chairman of the Government Acts and Regulations Committee, Mr. W. H. Jeffery, and the General Manager of the Association, visited Ottawa and presented a Brief to the Minister of Finance, the Honorable Walter E. Harris, in which an appeal was made to repeal the discriminatory 15 per cent Excise Tax, and to assist the CBC financially from General Revenue. In view of this appeal, the disappointment when the recent Budget was brought down was felt very deeply by us all, especially when the Government granted a concession to the motor car industry by reducing the tax from 15 per cent to 10 per cent on cars.



Radio and television receivers now stand alone at being taxed at 15 per cent and the Canadian Broadcasting Corporation received over \$25 million from the Excise Tax on television and radio receivers in the past year. The tax now discriminates solely against our industry. Now that television is national in scope there appears to be no reason for not assisting the CBC financially from the country's General Revenue rather than subjecting the products of a specific industry to this discriminatory tax.

In view of the seriousness of the situation the Government Acts and Regulations Committee is planning a consistent and continuous line of action in its campaign to have this tax removed or at least, as a temporary measure, to have it reduced by a substantial amount.

The Tariff Committee, under the Chairmanship of Mr. J. R. Longstaffe, has been quite active during the year and the Board approved the Committee's recommendation that the Association engage the services of an Ottawa Customs Tariff and Tax consultant on a six-month trial basis. Mr. F. Walter Perkin has been engaged and has already supplied the Association with considerable useful information.

In April the Government issued its report on the Restrictive Trade Practices Commission inquiring into loss-leader selling. As is now well-known, the report did not recommend that any legislation should be enacted to prevent this type of merchandising which it considered not to be too serious. However, there is some concern by members regarding the administration of the Resale Price Maintenance Section of the Combines Act and we intend to continue our study of the situation in co-operation with the Canadian Manufacturers Association.

The Industrial Relations Committee, under the Chairmanship of Mr. W. E. Curry, has done excellent and useful work during the past year, its most recent effort being a highly successful panel discussion on "Labor Problems In A Small Plant" at the last meeting of the Parts and Accessory Division. The Public Relations and Publicity Committee now has a new chairman in the person of Mr. D. Olorenshaw, and we know that this Committee has made its plans to get every degree of publicity out of this Annual meeting. The Defence Production Committee, under the Chairmanship of Mr. W. D. Scholfield, held another of its excellent open meetings with representatives of the Department of Defence Production recently and any of you who attended will know the importance of those meetings as opportunities to exchange views between industry and Government. The large part that electronics plays in the National Defence is well known, and the co-ordination and goodwill existing between the Association and the

Department of Defence Production is due in no small measure to the work of this Committee.

Our Director of Engineering, Ralph A. Hackbusch, reports directly to the Board, as you know, and the past year has seen him engaged in his usual activity in the engineering field. Our appreciation of his efforts is shared by other organizations to which he devotes his time and energy unstintingly. At the 10th Annual Meeting of the Radio Technical Planning Board, of which he was President from 1949 until last December, he was presented with a citation in recognition of his enterprise and leadership in the electronics engineering field. At the end of this month he goes to England to represent our Association at the International Electrotechnical Commission meeting in London, a job we all know he will do with his usual efficiency.

#### *New RETMA Offices*

During the Association year just ended the RTMA Office acquired new and spacious headquarters at 200 St. Clair Avenue West, in Toronto. This move has provided much better facilities than those that existed at Bay Street, and a large permanent conference room is now available. More meetings of the various committees now take place in the Association Office rather than at hotels — in fact there is a meeting almost every day, and the attendance at each meeting is very good; the more accessible location of the office together with the greatly improved parking facilities have contributed to this good attendance.

As approved by the Executive at the last Annual General Meeting, an addition to the staff has taken place in the form of an assistant to look after public relations writing and publicity. The monthly news bulletin call the "RTMA NEWS" which is circulated to all members and is quoted as quite authoritative in many trade papers and magazines, is an outcome of this decision. Also, official press releases are published fairly frequently and these have enjoyed wide publicity in the press. The staff now numbers nine persons. In addition to Stuart Brownlee and his assistant Cowan Harris, Dennis Gareau handles the statistics and accounts, Basil Jackson the publicity and distribution of engineering data, and five girls efficiently handle the great volume of work involved.

● Speakers at the RETMA (Canada) banquet held on the occasion of the 26th Annual Meeting of the Association held in Niagara Falls last June 2nd, 3rd, are from top to bottom: R. M. Brophy, Chairman of the Board, Rogers Majestic Electronics; Max F. Balcom, Chairman, Board of Directors, RETMA (United States); C. A. Pollock, President of the RETMA (Canada); D. A. Golden, Deputy Minister, Department of Defense Production, Ottawa; and G. C. W. Brown, Director of Telecommunications, Department of Transport, Ottawa.



a flash of flame ...

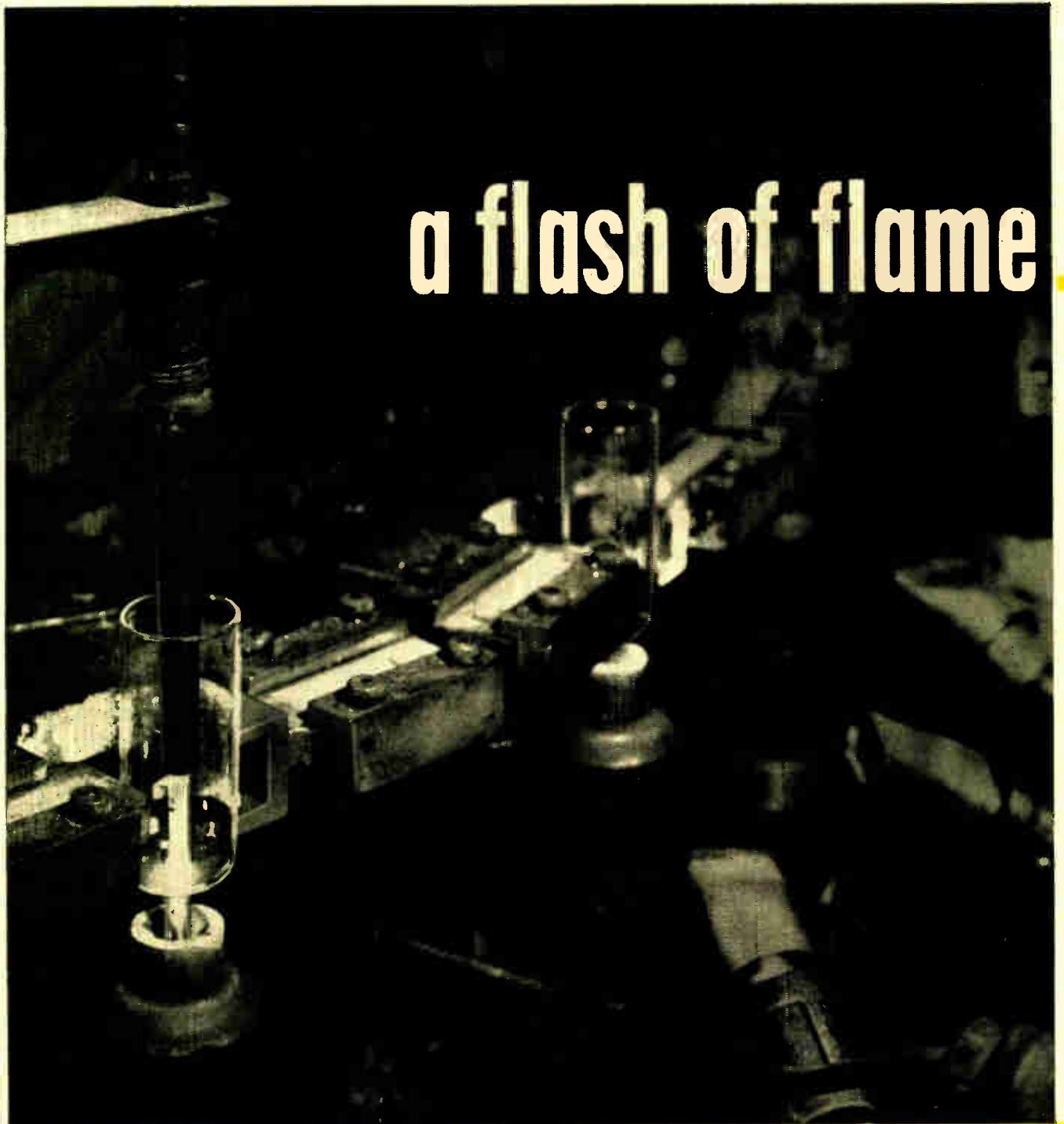

*Replace with guaranteed*

**ROGERS**  
ELECTRONIC TUBES



RECEIVING TUBES • PICTURE TUBES • TRANSMITTING TUBES • FERROXCUBE •

For further data on advertised products use page 99.

# tubulating

This dramatic photograph, taken in ROGERS glass department, shows tubulating in process. A piece of small glass tubing, about three inches long, is fused to the top of a glass envelope. Through this, air is exhausted from inside the finished miniature, resulting in a vacuum tube. The point at the top of every miniature tube shows where tubulating took place.

The photograph illustrates the instant when a flame lance pierces the glass envelope, fusing it to the tubing beneath.

High standards of engineering, rigid inspection and the thorough testing of every completed tube ensure the high quality and long-life performance of ROGERS electronic tubes.

Every tubulated bulb, as the unit is now called, is carefully inspected to ensure that a perfect joint has been made. Once air has been exhausted from the finished miniature, the tubing is removed.

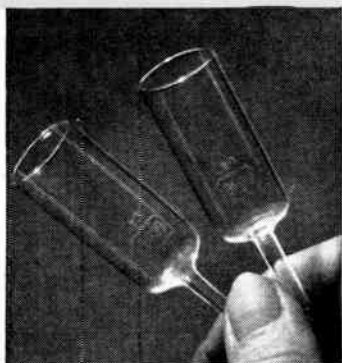

GERMANIUM DIODES • SPECIAL PURPOSE TUBES

ELECTRONICS & COMMUNICATIONS, MAY - JUNE, 1955

## Low-Mu Power Triodes for regulated power supplies. Types 6336 (Twin) and CH 1068

These low-mu, high perveance, power triodes of the heater cathode type represent a substantial advance in characteristic suitability for regulated power supply purposes.

The characteristics of each type are as follows:

	Type 6336 (Twin) Each Unit	Type CH 1068
Heater Voltage	6.3 ± 10% volts	6.3 ± 10% volts
Heater Current	4.75 amp	7.25 amp
Plate-Supply Voltage	190 volts	225 volts
Cathode-Bias Resistor	200 ohms	100 ohms
Amplification Factor	2.7	2.7
Plate Resistance	250 ohms	60 ohms
Transconductance	11,000 umhos	45,000 umhos
Plate Current	185 ma	450 ma
Overall Length	4.75"	6"
Seated Length	4.25"	5.7"
Diameter	2"	2.32"
Base	Short Jumbo Octal 8-pin	Giant 7 Pin A7-17

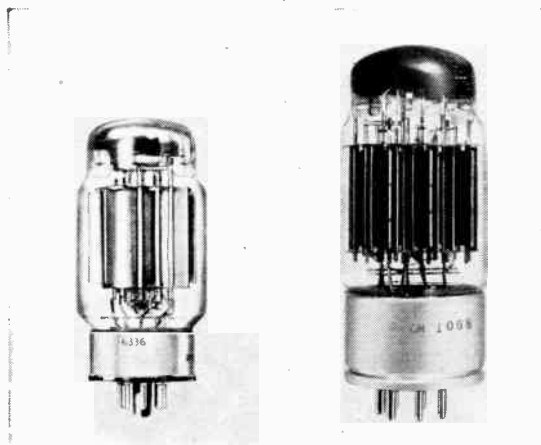

The Rogers 6336 and CH 1068 are very compact in design and special attention has been given to features which improve their strength both as to shock and vibration. Hard glass envelopes are used to withstand shock and high temperature. Button stems strengthen the mount structure and provide relatively wide inter-lead spacing. Because of this spacing between leads, susceptibility to electrolysis is reduced.

In the case of 6336 triode balance is held within ±10% at rated current. Plate current drift is absent in both types.

For further information on these tubes please write to:—

# ROGERS

ELECTRONIC TUBE & COMPONENT DIVISION  
11-19 Brentcliffe Road, Leaside, Toronto 17, Ontario  
MONTREAL • TORONTO • WINNIPEG • VANCOUVER  
A division of Canadian Radio Manufacturing Corporation Limited

For further data on advertised products use page 99.

## NEWS

(Continued from page 48)

### R.T.M.A. Transformer Sub-Committee Meet In Dundas

The Transformer Sub-Committee, Parts and Accessory Division, Engineering Committee, of the Radio Television Manufacturers Association of Canada were hosts at a meeting sponsored by El-Met-Parts Limited, Dundas, Ontario, on May 18, at which more than one hundred visitors representative of 45 electrical manufacturing firms were guests.

The program for the occasion provided a tour of the plant of El-Met-Parts Limited manufacturers of transformer laminations followed by a reception and banquet at which Mr. Carl W. Stoker, United States Steel Corporation was the guest speaker.

Head table guests at the banquet included A. L. Stopps, President of El-Met-Parts Limited; C. A. Norris, Chairman, Engineering Committee, Parts and Accessory Division R.T.M.A., L. Harris, Chairman Parts and Accessory Division, R.T.M.A., C. A. Pollock, President, R.T.M.A., H. Parkhill, G. E. Kemp, C. Branston, Assistant Manager, United States Steel Export Company; Carl W. Stoker, United States Steel Corporation and J. C. Hutchison, President, Audio Transformer Company.

### Aeromotive Engineering Named As Canadian Representative

Aeromotive Engineering Products of Montreal have announced their appointment as the Canadian representatives for Microwave Development Laboratories Inc., of Wellesley, Massachusetts.

Microwave Development Laboratories are specialists in the design and manufacture of microwave components. President of the firm is Dr. Henry Riblet, well known design engineer in the field of microwave.

### C.A.E. Instal Closed Circuit TV On C.N.R.'s Supercontinental

A probable world's first was chalked up by CAE with the installation of a closed circuit telecasting system on the crack new CNR Supercontinental for the pre-inaugural run from Montreal, Que. to Pembroke, Ont. and return, April 23rd.

The installation was carried out by the Consumer Products — Dumont Television — division as an added attraction for CNR officials and members of the press, radio and TV news services from Canada and the United States invited for the 10 hour long trip.

Camera and microphone were set up in the parlor car in the rear of the train and picture and sound transmitted to Dumont telesets placed in the club and other cars.

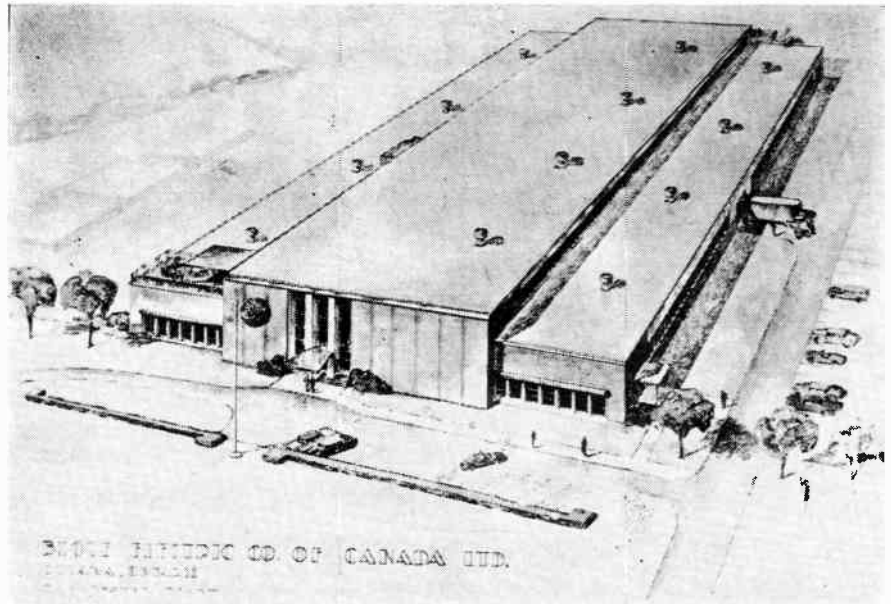

● This is the architect's conception of the new plant now under construction for Bogue Electric Company of Canada Limited, near Ottawa. To be completed this summer, the new plant will make such equipment as motor-generator sets, magnetic amplifiers, 400 cycle power equipment, bearing temperature monitors, aircraft electric ground support equipment, switchboards and panels, rectifiers, continuous power equipment for microwave and radar, servo systems, automatic process control systems, battery chargers and railway power equipment. Sales representative in Canada for Bogue is the Northern Electric Company.

### Dominion Electrohome To Extend Manufacture Of Raytheon Products

Based on the first six-months period of a manufacturers' agreement between the Roytheon Manufacturing Company and the Dominion Electrohome Industries, Ltd., of Kitchener, Canada, to manufacture Raytheon-designed TV sets in Canada, it is now planned to extend the coverage of the line to include all TV and radio products of Raytheon design as quickly as possible. This will make available both Raytheon color television and transistor-radios to the Canadian market.

The announcement was made jointly by Henry F. Argento, vice-president and general manager of the television and radio operations of Raytheon, Chicago, and J. Gordon Tufts, vice-president of Electrohome.

### Directors Appointed To Collins-Canada Posts

Appointed to executive positions in Collins Radio Company of Canada Ltd. last month were J. P. Giacoletto, Director of Engineering; W. T. Weinhardt, Director of Manufacturing; R. C. Mullaley, Contract Administrator and Secretary; and R. F. Rice, Purchasing Agent.

Collins-Canada, a wholly-owned subsidiary, was incorporated in October, 1953. Sales offices have been maintained in Ottawa, and recently factory facilities were established in Toronto

where design and manufacturing operations will be centered.

### Canadian Westinghouse To Represent Standard Electronic Corp.

Mr. William H. Zillger, vice-president and general manager of the Standard Electronics Corporation, Newark, New Jersey, has announced the appointment of Canadian Westinghouse Company, Limited, as the company's Canadian Sales Engineering Representative.

Mr. John H. Fletcher will manage the sales of Standard Electronics equipment for Canadian Westinghouse Company, Ltd., whose offices are located in Hamilton. Canadian Westinghouse maintains branch offices throughout Canada. These offices are staffed with qualified electronic engineering personnel who will assist Mr. Fletcher in selling Standard Electronics' TV equipment.

### James T. Howley Appointed To Committee Of Nucleonics

James T. Howley, P.Eng., of Chalk River, Ontario is the first Canadian to be appointed to the Committee on Nucleonics of the American Institute of Electrical Engineers.

The committee to which Mr. Howley has been appointed will take an active part with respect to speakers for the Nuclear Engineering and Science Congress which will be held in Cleveland, Ohio in December, 1955.

(Turn to page 56)

# BEFORE they affect service locate troubles quickly with AUTOMATIC ELECTRIC testing equipment

Here are only a few of the many special items of testing equipment developed by AUTOMATIC ELECTRIC for automatic telephone and other communication and electrical control equipment.



### CURRENT FLOW TEST SET

Designed for use in making mechanical adjustments of switches and relays. Compensating for variations in the voltage of the test current, it directs a measured amount of current into the coil of the relay or switch under test. Complete description in Circular 1831.

### PORTABLE DIAL SPEED TESTER

This versatile unit makes possible impulse testing at any location where 48-volt battery is available. Not only telephone-type dials, but impulse repeaters, key senders and automatic switching equipment can be tested quickly and easily. Ask for Circular 1707.



### REMOTE-CONTROLLED DIAL SPEED TESTER

Enables service men to test telephone dials at subscribers' stations by merely dialing a test number to the exchange. Operates automatically without help from the exchange personnel. Fully described in Circular 1707.

### TYPE 21 TEST TURRET

Designed specifically for testing subscribers' lines and trunks in small automatic telephone exchanges (of not more than 1000 lines ultimate capacity) and in private automatic branch exchanges P-A-B-X's) of any size. Virtually all of the tests required for small exchange maintenance can be made. Full details given in Circular 1830.

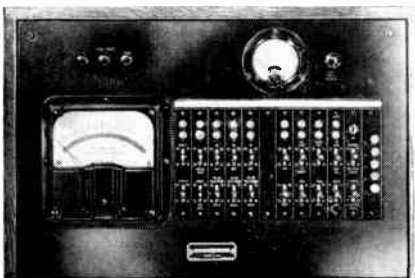
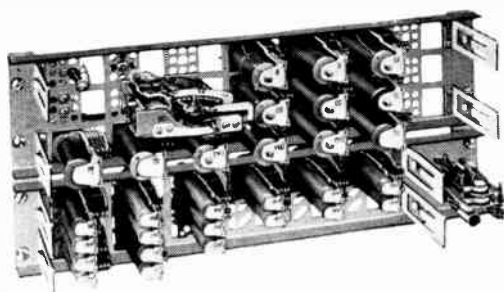

### LINEFINDER TEST SET

Designed for complete operational checks of two-motion linefinder switches on the test bench before they are returned to the equipment shelves—ready for service! Ask for Circular 1826.

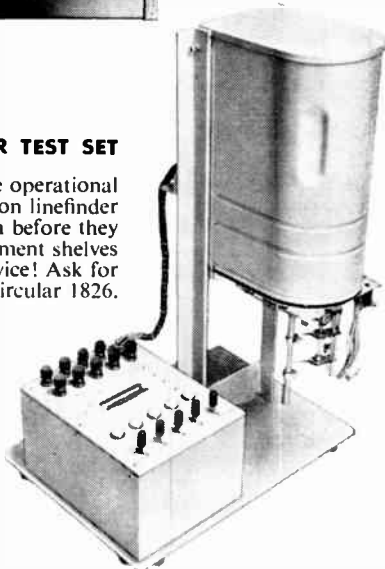

### LINE INSULATION ROUTINER

Automatically routines exchange lines for insulation faults at the rate of 30 lines per minute! Makes three tests on every line—foreign potential, loop leak to ground. It even checks itself automatically! See Circular 1811.

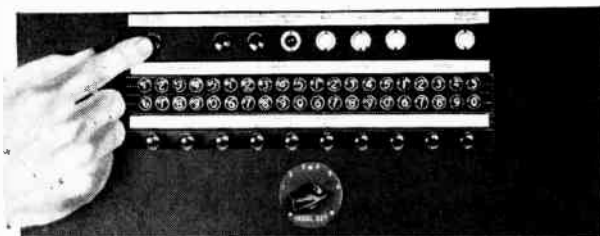

**AUTOMATIC ELECTRIC**

(CANADA) LIMITED

Distributor in Canada

**AUTOMATIC ELECTRIC SALES (CANADA) LIMITED**

Head Office: 185 Bartley Drive, Toronto 16

MONTREAL • OTTAWA • BROCKVILLE • HAMILTON • WINNIPEG • REGINA • EDMONTON • VANCOUVER

World Radio History

# AT LAST!

fast,  
exact  
replacement  
of original  
electrolytic  
TV capacitors



## with the new AEROVOX AFH and PRS CROSS REFERENCE BOOKLET

Now you can replace burnt out capacitors in television receivers in far less time than ever before. This handy pocket-size Aerovox booklet lists original electrolytic capacitors found in TV receivers and gives exact Aerovox equivalents for replacement. There's no guessing, no tedious searching—all the information you'll need is right at your fingertips.

Your free copy of The Aerovox Electrolytic Replacement Guide is available from your Aerovox jobber or by writing direct to Aerovox Canada Limited.

5508



Standardize with AEROVOX

**AEROVOX CANADA LIMITED**  
HAMILTON, CANADA

Manufacturers of fixed capacitors  
for all radio, TV and electronic equipment.

western sales CHAS. L. THOMPSON LTD.,  
VANCOUVER, B.C.  
in U.S.A. AEROVOX CORPORATION,  
NEW BEDFORD, MASS.

## NEWS

(Continued from page 54)

### F. M. Hanna Named Technical Assistant To Vice-President Of Hunting Associates Ltd.

Fred M. Hanna has been appointed Technical Assistant to D. N. Kendall, Vice-President of Hunting Associates Limited of Toronto. In this position he will be responsible for assisting Mr. Kendall in the establishment of technical policy in all companies in the



F. M. HANNA

Canadian Hunting Group and for liaison with an co-ordination of research programs with the Group's overseas associates. He will also carry out engineering and market studies of new products and processes prior to the Group's embarking on them whenever such studies are needed to assist policy decisions.

Mr. Hanna's previous appointment was as Chief Engineer of PSC Applied Research Limited, one of the Hunting Associates companies. He is closely associated with this company's development of airborne magnetometers and radiation detectors. He started work for the Group in 1948 as an electronics engineer in the Technical Division of The Photographic Survey Corporation which became PSC Applied Research in 1951. With the establishment of the new company, he became chief engineer and a director of it.

### Canadian Westinghouse Appointed Distributor For Standard Electronics Corp.

The Canadian Westinghouse Company has been appointed exclusive Canadian distributor of Standard Electronics Corporation's complete line of television transmission equipment.

The agreement, announced by John H. Fletcher, Commercial Sales Manager for the Westinghouse Electronics Division at Hamilton, means that the company will now offer to the television industry, complete packaged TV transmission stations as well as engineering services, installation and maintenance facilities anywhere in Canada.

Addition of the Standard line rounds out a complete range of broadcast equipment, according to Mr. Fletcher. Auxiliary equipment for the expansion of existing TV station facilities will now be available, in addition to complete units. This will include a range of power amplifiers, camera chain equipment, picture and wave form

monitors, video amplifiers and switching equipment.

### Ralph A. Hackbusch To Represent RTMA At London Meeting

Ralph A. Hackbusch, Director of Engineering of the Radio Television Manufacturers Association of Canada has been named by the Board of Directors of the RTMA to represent the Association at the London, England meeting of the International Electrotechnical Commission to be held during the last week of June and the first week of August.

### George Suarez Appointed Field's General Manager

George Suarez has been appointed general manager of Field Aviation Company Limited, of Oshawa, Ontario, D. N. Kendall, vice-president of Hunting Associates Limited and president of Field, announces.

Mr. Suarez, formerly manager of the Survey Flying Division of The Photographic Survey Corporation and Kenting Aviation Limited, two other Hunting companies, has been with P.S.C. since 1947. He has worked in various departments, notably accounting and estimating. In the spring of 1952 he was appointed assistant to the general manager of P.S.C., W. H. Godfrey. His work in the personnel field laid the groundwork for the company's present good employee relations. Two years later he became the manager of P.S.C.'s Survey Flying Division.

### Minnesota Mining Announces Key Appointments

Three key appointments among the sales executive of Minnesota Mining and Manufacturing of Canada Ltd., have been announced by Roy W. Keeley, Director of Sales.

A. H. DeMille moves up from Toronto District Sales Manager to become Sales Manager, Abrasives and Related Products. Mr. DeMille has been with 3M and associate companies for 10 years. Mr. DeMille will locate in London, Ontario.

E. H. Lill, who has been with the company and its associates for 13 years, has been named Manager, Western Canada. He was Vancouver District Sales Manager for eight years prior to his new appointment.

J. A. Gauthier has been named Manager, Eastern Canada. Mr. Gauthier has had 14 years' service with the company and its associates. He moves up from the position of Montreal District Sales Manager which he held for eight years prior to his new appointment.

(Turn to page 74)





Use these

Westinghouse

# ELECTRONIC TUBE SERVICE HELPS

Tube business is *big* business. More and more TV and radio being sold every day means more and more demand for tubes. And tube business is *good* business: generous mark-up, lots of repeat orders.

Are you getting *your* share? Westinghouse has plenty of ideas to help you make tubes a *bigger* and *better* profit-maker. They're in this handy tube sales manual that includes a full listing of sales aids, some of which are shown here. It's free. Why not write for your copy . . . now?



**SERVICE STICKERS**

Put a Westinghouse Easy-Stick service sticker on the back of each Radio or TV set. Make it easy for your customers to contact you next time they need expert service — Prices as shown below.



**DECALCOMANIA**

A colorful window or door transfer to attract attention to your service facilities. FREE!

**RADIO WESTINGHOUSE TUBES**



**TUBE TAPPER**

The service man's "trouble-shooter." It's a probe, a tube tester and hook to detect loose connections in small wires. Made of fibrous insulation material. FREE!

**GOODWILL BUILDERS**

Useful novelties that are designed to keep your name in front of your customers, at home and at the office. Prices are low and include your imprint. Write for free catalogue.

CANADIAN WESTINGHOUSE CO. LIMITED, TUBE DIVISION — HAMILTON, CANADA

# JUST LOOK at the watt-hour rating of

## Centralab's New, Exceptionally Small, Military-Quality Model 3 Radiohm®

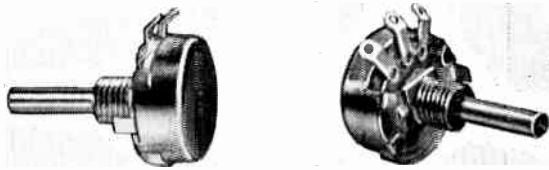

Less than 1/16" diameter



The model 3 has many other desirable characteristics:

Designed for high operating temperatures.

Closed case construction readily lends itself to sealing and potting, (even though we believe that a control should "breathe").

Available in 1/8" diameter shaft, standard or locking-type.

Order a quantity of Model 3's for pilot testing. Call in your Centralab representative or write directly to the office.

**DON'T** look further for a high-quality variable resistor that you can use at exceptional wattage for short periods of time with minimum resistance change. Centralab's new Model 3 Radiohm is your answer. Tests prove it.

Take the 10,000 Ohm value for example. It stacks up this way:

**ONLY 10% MAXIMUM CHANGE**

- when used at . . . 1 watt for 1 1/2 hours
- . . . 3/4 watt for 35 hours
- . . . 1/2 watt for 80 hours
- . . . 1/3 watt for 300 hours
- . . . 1/4 watt continuous rating

This is just one of a complete selection of values for all miniature applications, guided missiles, geophysical equipment, etc., etc.

Technical bulletin EP-63 gives you complete engineering data. Write for it.

**More proof that if it's a job for electronic components, it's a job for Centralab**

Centralab's advanced engineering continues to create the prototypes of the components industry

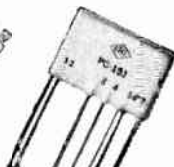

Like to win a library of high-fidelity records of your own choosing? Enter this month's

### Electroni-Kwiz†

Answer this question in 50 words more or less:  
**What qualifications do you consider most important when specifying electronic components?**  
 A leading editor will pick the winner of this month's major prize.  
 Mail your entry to us before June 30.

†Nothing to buy. Employees of Centralab and their advertising agency not eligible. Duplicate prizes awarded in case of tie.



**A DIVISION OF GLOBE-UNION INC.**

964F E. Keefe Avenue • Milwaukee 1, Wisconsin  
 In Canada: 804 Mt. Pleasant Road, Toronto, Ontario

SINCE 1922, INDUSTRY'S GREATEST SOURCE OF STANDARD AND SPECIAL ELECTRONIC COMPONENTS

For further data on advertised products use page 99.

# NEW PRODUCTS

New Product specifications published in *Electronics and Communications* have been briefed for your convenience. If you require further information on any of the items published you may readily obtain such by using our Readers' Service, Page 99. Just mark the products you are interested in on the coupon on Page 99 and the information will be in your hands within a few days.

## ● Film Type Resistor

### Item 686

The development and availability of the new Davohm Series 850-T Resistor is announced. The new film type resistors can be used at 150°C. at full rated power. They derate linearly to zero power at 190°C.

The temperature coefficient of these resistors is unique for a film type resistor. The temperature coefficient is below 400 ppm/°C., is always positive in value, and is independent of resistance value. Any ohmic value of these Series 850-T resistors will track within approximately 20 ppm/°C. of the normal temperature coefficient value over the temperature range. This allows matching resistance network values through wide temperature ranges, to accuracies previously unobtainable with film type resistors.

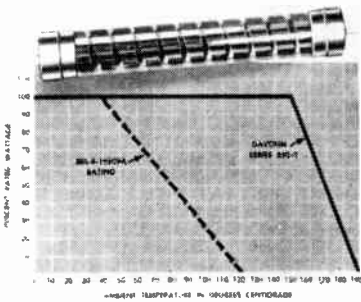

The new hermetically sealed Series 850-T resistors offer excellent moisture resistance and load life stability. On a typical MIL cycle 1000 hour load test of twelve 2 watt type 852-T, 200,000 ohm resistors, one had a maximum deviation of 0.2 per cent and the rest had maximum deviations of 0.1 per cent. Voltage coefficient, often a problem with composition and film type resistors, is negligible in these 850-T resistors. The voltage coefficient is below 0.0005 per cent per volt.

## ● Improved Compandors For General Use

### Item 687

Compandors have been available for some time, providing for the economical control of noise and crosstalk in carrier circuits. Several improvements have been made recently in this useful device and its mounting arrangements.

To facilitate the applications of compandors under many different conditions, the new models of compandors have been designed so that any one of three different dc voltages can be used for the plate supply.

In addition to the new arrangement for connecting the compandor shelf to different battery voltages, other improvements in the new model compandor and mounting shelf include an electrically balanced output circuit, a better arrangement of fuses, and more accessible filament voltage adjustment. Previous difficulties involved when the compandor was located a considerable distance from the carrier terminal have been overcome by improved output and input transformer arrangements that provide good electrical balance and eliminate the necessity for ground current loops in such cases.

The compandor permits the operation of carrier circuits over facilities that would

otherwise be unsuitable. With the several physical and electrical improvements that have been incorporated in the new model compandor unit and mounting shelf, installation and maintenance have been simplified and operation of the compandor remote from the carrier terminal has been greatly simplified.

## ● A.C. Oscilloscopes

### Item 688

Wide bandwidth — high sensitivity — low price: these are major features of two new ac oscilloscopes recently announced. Called Models 701 and 701-D (with delay line), the units cover the range of 5 cps to 10 mcs and are useful to 20 mcs.

Both the models 701 and 701-D have a conservatively rated sensitivity of 16 millivolts peak to peak per centimeter and a rise time of .035 microseconds. Large signal displays is possible through four inches of useful deflection. Easy to operate sweep circuits provide triggered or recurrent sweeps from 0.1 to 10,000 microseconds per centimeter, and a high input impedance of two megohms paralleled by 25 mmf permits more accurate measurements through low loading of the tested circuit.

An internal 1 kc square wave is available for calibration and adjustment of attenuators and probes. Cathode follower outputs for external gate and sweep connections provide synchronization for auxiliary equipment. On the Model 701-D, leading edges of pulses can be effectively displayed by delaying vertical signal through a 0.25 microsecond delay line until sweep starts.

## ● Low-Voltage, Low-Current Power Supply

### Item 689

A new dual-output, high-precision regulated power supply for laboratories is announced. The unit offers wide application as a low-voltage, low-current supply for instrumentation groups. Output is 0.50 volts at 50 ma per side. Manufacturer states that the unit—designated as D50—.05B—is priced considerably lower than units with a range up to 200 and 300 volts, and is far more compact.

Regulation from no load to full load is better than .1 of 1 per cent. Output impedance is less than 1 ohm at dc . . . output ripple: 3 mv or better. Each side can be operated independently of the other. The two

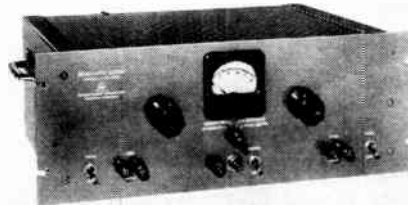

sides are contained in a chassis suitable for rack mounting or bench use. Outputs are monitored for both current and voltage on a single meter selected by a switch on the front panel. Both sides float above the chassis. Panel size: 7" high, 19" wide and 11" deep. Chassis fits a standard 19" rack.

These units are especially designed to supply low-voltage, low-current power to operate transistors, and for experimental work with such components.

## ● Stand-Off And Feed-Thru Terminals

### Item 690

Stand-Off and Feed-Thru insulator terminals incorporating Teflon, for use in high and ultra-high frequency electronics applications, are now in production in a wide range of sizes.

The toughness, high dielectric strength and heat resistance of Teflon virtually eliminates service failures of this type terminal. Resiliency of the Teflon allows permanent, 10 lb.

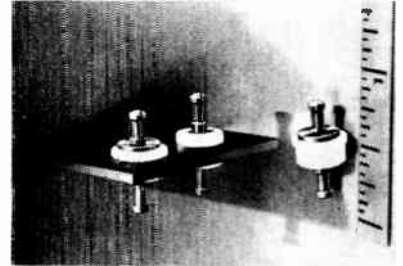

minimum pull test "press-fit" installation of these one piece insulators — reducing assembly costs and eliminating mounting hardware.

Miniaturization is easily accomplished since Teflon's dielectric constant (2.0) and loss factor (0.005) are unaffected in temperatures from 80°F. to 400°F.

## ● Low Pressure Miniature Pickup

### Item 691

A new low-pressure pickup not adversely affected by outside vibrations prevalent in such applications as aircraft flight tests, automotive engine tests, and windtunnel measurements has recently been released.

The pickup has low acceleration sensitivity as a result of the extremely low mass of the "star" sensing element which is common to

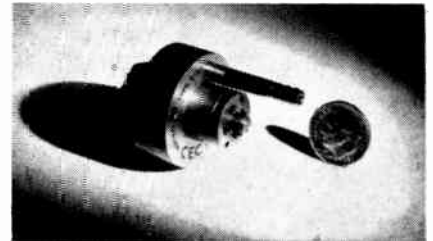

all members of the company's Type 4-300 series of miniature transducers. The type 4-315 is available in standard ranges of  $\pm 1$ ,  $\pm 2$ ,  $\pm 3$  psi differential.

It is constructed of Type 416 Stainless Steel and measures approximately 1 1/4 inches in diameter at the diaphragm and 1 1/8 inches in length. Electrical connection is made through four numbered pin connectors. Pressure connections feature an 1/8 inch NPT threaded inlet and a 5-40 NC female threaded inlet on the reference.

Specifications include: Sensitivity —  $\pm 10$  mv full-scale open-circuit output at 5-volts excitation; input and output impedances — 350 ohms; linearity — deviation less than  $\pm 1.0$  per cent of full-scale output; hysteresis — less than 1.0 per cent full-scale output; compensated zero shift — less than 0.05 per cent of full scale per degree F. over the compensated temperature range of — 65° F. to + 165° F.; pressure overload limit — 200 per cent of full scale on normal side, 150 per cent of full scale on reference side, maximum line pressure 15 psig; total weight — 60 grams.

## ● 35 KW Liquid-Cooled Germanium Power Rectifier

### Item 692

The availability of a 35 kw liquid-cooled germanium power rectifier, Type 53-0075-0 has been announced. This new product is a

(Turn to page 64)

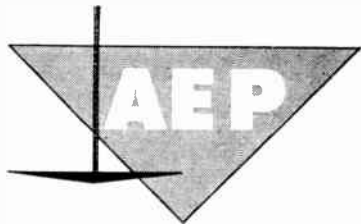

# MICRO miniature PRECISION Ball Bearings

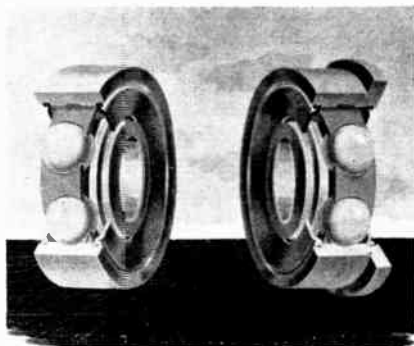

MICRO Retainer Radial Bearings now available with single or double side shields for added protection against contamination during installation and use. Can be removed for cleaning the bearing. Oil or grease lubrication as specified.

Types include straight or flanged outer rings. Sizes from  $\frac{1}{16}$ " bore  $\frac{1}{2}$ " overall diameter. Tolerances ABEC 5 or better. Stainless steel (type 440) at same prices as chrome steel (SAE 52100). Ask for print 1031 showing complete details.



## TRANSISTORS

Multiple transistor socket strips by Hydro-Aire Inc.

## POTENTIOMETERS

Ultra low torque. Extreme precision. Made by Electro-Mec.

## SWITCHES

Miniature, snap-acting for control and indicating circuits. Made by Unimax.

Waterproof and Thermal switches by Control Products Inc.

Immediate replies to all enquiries.

**AEROMOTIVE**  
Engineering Products

MONTREAL ELWOOD 9602  
5257 Queen Mary Road

TORONTO EMPIRE 4-1017  
P.O. Box 760, Brampton, Ont.

## CADMIUM (Continued from page 27)

Otherwise the cell is a simple resistor shunted by a capacitance of 20-30 mmfd., the value of the resistor being set by the incident illumination. The resistance also depends on the temperature. For a given illumination it changes less than  $\pm 10$  per cent between  $-40^{\circ}\text{C.}$  and  $+100^{\circ}\text{C.}$  Rise of temperature is accompanied by an increase of dark current in a manner very typical of semi-conductors. The latter presents a serious circuit design problem only when the cell is being used at low light levels since at illuminations higher than 0.01 foot candles it is swamped by the photo-induced current (see Fig. 3). In order to keep the dark current down to a reasonable value and to prevent other deleterious effects from setting in, the operating temperature should be kept less than  $100^{\circ}\text{C.}$  and the current to less than 20 ma for the above specified area. This imposes a power restriction of about 1 mw per square mm of surface or 300 mw for this cell.

When the cell is first put into operation there is usually a slow change of sensitivity and dark current after which the cell remains stable. If stability is important in the circuit a run-in period of a few hours at maximum power rating will improve the performance. Operation with ac voltages gives the advantage of greater stability at low light levels where the

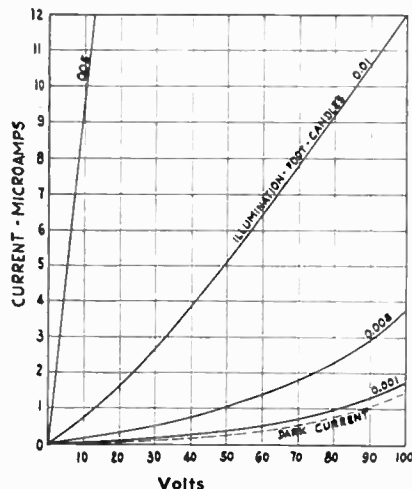

PC1-05 Voltage Current Characteristics at Low Illuminations.

Fig. 3

initial dark resistance change may be bothersome. The frequency of the ac voltage can be any value up to several mc/sec where the shunting capacitance becomes important.

In contrast to this rapidity of the response of the cell current to voltage changes, the response to illumination is much slower—of the order of milliseconds to seconds depending on the level of illumination. At low light levels — of the order of milli-foot candles — the response may be a few seconds while at an illumination of 50 foot candles the time constant is 5-10 milliseconds. At intermediate values proportional to the light intensity.

## Applications

The high sensitivity and dissipation enable the cell to operate a relay directly from the 115 volt power line without any amplification. The circuit is very simple: the cell and an ac relay in series are connected to the power line (Fig. 4).

A moderately sensitive ac relay (for example 0.3 volt-amp) can be actuated in this circuit by an illumination of a few foot candles. One can increase the sensitivity by mounting a lens before the cell, and if still more sensitivity is desired, a dc relay and a rectified voltage can be used.

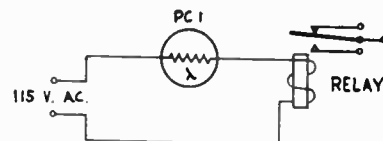

PHOTO-RELAY CIRCUIT WITH PC 1 PHOTOCELL

FIG. 4

Thus this simple photo-relay is suitable for the innumerable practical applications where phototubes with electron tube amplifiers are used, for example, automatic light switching, door openers, industrial controls etc.

Many other applications should suggest themselves to the designer of equipment because the photocell gives outstanding advantages in simpler circuitry, in ruggedness and compactness, as well as many applications where other types of photocells cannot be used.

## BIBLIOGRAPHY

1. R. Frerichs: *The Photoconductivity of Incomplete Phosphors.* Phys. Rev. 72, 504-601, 1947.
2. P. Goercke: *Activated Cadmium Sulphide Photoelectric Cells.* Ann. des Telecomm. 6, 325-31, 1951.
3. F. Gans: *Cadmium Sulphide Cells.* Bull. Sci. Assoc. Ingen. Montefiore. 66, 897-911, 1953.

## BROADCAST STUDIOS

(Continued from page 38)

Summarizing the requirements for good studio broadcasting it may be said that: (1) Good broadcast equipment is available from practically all the well-known suppliers. (2) All special or standard equipment to give a broadcast station complete versatility for its own special mode of operation is available as an "off-the-shelf" item in most cases. (3) A good percentage of the broadcast stations are taking advantage of the new up-to-date equipment to modernize their plants. However, too many of today's stations are doing nothing about it. Most of their equipment has been in operation for ten years or more and has never been replaced. (4) A large number of the broadcast stations which have excellent equipment have not the technical personnel to operate it properly and (5) Many station managers or owners are too economy-minded and are inclined to let their technical personnel struggle along with out-moded equipment, no matter how much their technicians recommend renewal of equipment to meet program or commercial competition.



# JCNAAF (JAN) APPROVED FACTORY-SEALED "BONDED STOCK" RESISTORS NOW AVAILABLE FROM DISTRIBUTORS

(All Current JAN Approved 1/2 and 1 Watt Resistors Available)

These resistors are Government Inspected and stamped at our factory prior to shipment and in effect are **FULLY APPROVED JAN RESISTORS.**

Sealed in **PLASTIC PACKS** —

**Dustproof!**

**Waterproof!**

**Convenient Handling!**

**Longer Shelf Life!**

This is the initial step in our "Bonded Stock" program. It is intended to continually add JAN resistors to our list of available items. Watch for announcement and keep in touch with your Distributors!

IRC Type	Rating	JCNAAF-R-31 Spec.	EXTENT OF APPROVAL
BTS	1/2 watt	RC-20	All specifications, tolerances and charact. BF & GF in values 82 ohms to 20 megs. inclusive.
BTA	1 watt	RC-30	All specifications, tolerances and charact. BF in values 100 ohms to 20 megs. inclusive.

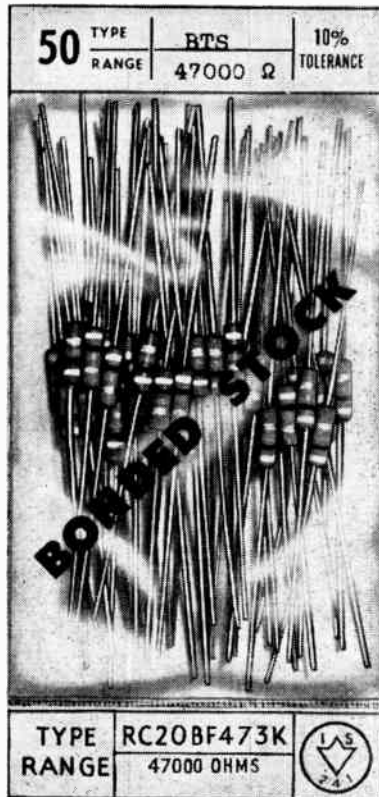

AVAILABLE IN 10's and 50's

**JAN RESISTORS FOR THOSE WHO REQUIRE THEM . . .**

**... "AROUND THE CORNER" SERVICE FROM YOUR LOCAL DISTRIBUTOR!!**

**ANOTHER IRC FIRST!!**

*Available from:*

### **PAYETTE RADIO LIMITED**

730 St. James St. W.,  
Montreal, Quebec

### **A & A RADIO CO. LTD.**

29 Adelaide St. W.,  
Toronto, Ontario.

### **TAYLOR-PEARSON CO. LTD.**

10215 103rd Street,  
Edmonton, Alberta.

These Distributors have "BONDED STOCK" on the shelf.

**TRY THEM!!**

**INTERNATIONAL RESISTANCE CO. LIMITED**  
349 CARLAW AVENUE TORONTO 8, ONT.

— SALES OFFICES —

1500 St. Catherine St. W.,  
MONTREAL, Quebec

Radiovision Sales Limited,  
325 Tenth Ave. West,  
CALGARY, Alberta

for quick  
determination of "Q"

**DAWE "Q" METERS**

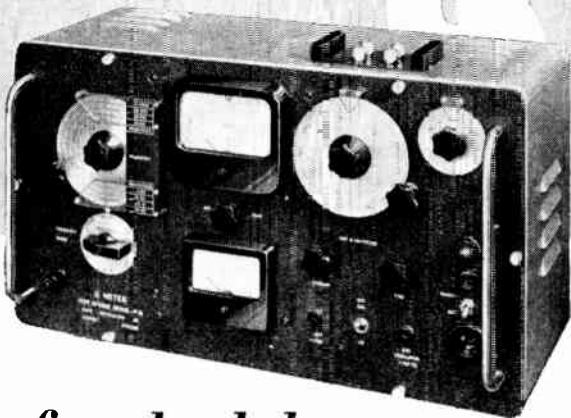

for the laboratory  
and the factory...

- Simple to Operate
- Direct Reading
- Mains Operated

The DAWE "Q" Meters are designed to add speed, efficiency and accuracy to your factory or laboratory.

Type 622 is designed for the determination of "Q" and related R.F. measurements by resonance methods in the range of 50 kc/s to 75 Mc/s. The instrument is completely self contained, totally enclosed, extremely robust, and can be plugged into any A.C. supply.

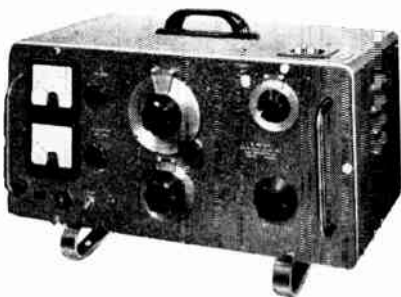

totally enclosed, extremely robust, and can be plugged into any A.C. supply.

Type 620—  
Specially Suited  
For Mass Production  
Testing.

The Type 623 supplements the Type 622 model by extending the range of the measurement to 200 Mc/s. Its wide frequency range covers television channels.

Write for further information on DAWE "Q" Meters and other DAWE Electronic Instruments.

5406

**DAWE INSTRUMENTS LIMITED**

CANADIAN DIVISION — 59 CROWN CRESCENT, OTTAWA, ONTARIO

Sole Sales and Service Agency Across Canada

MJS Electronic Sales Limited, 2028 Avenue Road, Toronto

For further data on advertised products use page 99.

## BUSINESS BRIEFS — Continued

★ According to RETMA, approximately 36,000,000 television receivers have been delivered to dealers in the United States in the last eight years.

★ An unnamed group of microwave engineers in the United States reported to be headed by one of the world's leading microwave engineers claims that they have sufficient knowledge and know-how to establish a U.S.-Europe microwave link across the Atlantic Ocean with one link.

★ The fall of 1960 will see most of the machine tool manufacturers in the United States displaying electronically controlled metal working machines. Reports indicate that machine tool builders have been busy for some months designing the new models in co-operation with manufacturers of industrial electronic equipment.

★ Orders for electronic tubes, emergency receiver equipment, radar equipment and quartz crystals placed by the Department of Defense Production in the first two weeks of March amounted to \$166,105.

★ The First Annual Report of the Ontario Telephone Authority states that 21 independent telephone systems went out of business during 1954. "Each succeeding year, for some years to come, more and more small systems will relinquish their territories to other systems because they are unable to meet the requirements of dial installations, and the demands for modern telephone service from their subscribers", the report states.

★ Those concerned with the manufacture of office equipment claim that there is an \$80 million boom for the Canadian industry. Closed circuit television systems, electronic data processing equipment and other so-called push-button office aids are considered to be a bit premature at this time as standard office equipment but manufacturers of this type of equipment are concentrating on lowering the cost of such equipment to make it more financially available to smaller business enterprises.

★ The growing need and the increasing demand by residents of some Ontario localities for telephone communications service is pointed up in the 1954 Annual Report of the Ontario Telephone Authority. Among the reasons cited by the Ontario Telephone Authority as causes for additional telephone service are increasing activity in tourist resort districts and the need for reliable communications facilities to serve new mining developments and their adjacent townships.

★ Widespread interest has been caused by the announcement from the British Information Service that Britain's ten-year plan for industrial atomic power estimates that the first commercial nuclear stations are expected to produce electricity for .7 cents per kilowatt hour or about six tenths of an English penny. The cost is based on an estimated price for plutonium produced as a power station by-product.

★ Canadian television manufacturers turned out 620,000 television receivers in 1954, an increase of 200,000 more than were produced in 1953.

★ J. A. Fuller, President of the Shawinigan Water and Power Company says that electric power from atomic energy may be produced on a commercial basis in Ontario and the Maritimes and even in Quebec within the next twenty years but only as a supplement to that derived from conventional sources.

(Turn to page 99)

## EDITOR'S SPACE

(Continued from page 13)

engineers that it would not be possible to secure adequate engineering experience in the forces to prepare them for entering industry upon their return to civilian life. The other factor noted by the Association concerned the professional recognition given to the members of medical and dental professions on entering the services, including responsibility, pay and higher rank.

It's our opinion that it will be some time (actually we hope never) before the engineering profession achieves the level of self-arrogated professional egotism characteristic of the medical fraternity which is more than likely the main reason for extending higher pay and higher rank to its members on entering the armed services. Insofar as providing engineering graduates with experience that may be helpful to them in civilian employment, it is considered neither reasonable nor logical to expect military service to provide it. One alternative to this problem however, would be for young engineers entering the armed services to do so with the intention of making it their career. Experience for civilian employment would then be unnecessary.

Apropos the Chicago Electronics Parts Show there seems to be an increasing number of exhibitors who have turned to the use of attractive and scantily attired models to attract the attention of visitors. Though electronics is part of our business — at least to the extent of recording its progress and achievements — we have no compunction in being honest about the fact that we'd rather examine a well constructed blonde, brunette or red head than the cold engineering facts of a transistor, capacitor or resistor. It's a moot question whether the products of exhibitors employing models received as much attention as the models. We know the model agencies won't like the thought but there it is!

In an address to the National Industrial Conference Board, Malcolm P. Ferguson, President of the Bendix Aviation Corporation says that there is the possibility of a collision warning device which could be fitted on an automobile. This would give an indication of cars ahead or behind you and might ultimately — although this is highly controversial — tell the automobile what to do even if the driver doesn't respond. Mr. Ferguson went on to say: "Whether or not you think these practical, you must remember that electronics operates on a very simple principle: There is a practical method today for sensing practically anything you want to sense, whether it is movement, light, temperature, pressure, humidity — practically anything but love." Come now sir. No practical method for sensing love? Looks like we've all been led down the garden path for some time past.

It's hard to believe that the space of two decades could bring about the technological advances that have marked the industrial growth of Canada in the past twenty years. Time was, not so long ago, when Canada was aptly symbolized pictorially by fields of wind-swept prairie wheat and the majestic impressiveness of British Columbia's giant firs. This was a country of agricultural importance in which it may be figuratively stated that the tractor, plow, combine and sawmill represented the required manufacturing optimum to sustain Canada's export trade. A recent peek at the engineering and scientific achievement of Canadian enterprise in the field of guided missiles at one of our largest electronic research laboratories, a field which is perhaps, with the exception of nuclear research, the acme of scientific endeavor, leaves no doubt that Canada is passing through a renaissance destined to afford it an equal prominence in science and industry it has long held as an agricultural nation.



## New communications system bridges wide gaps

C.G.E. announces  
High Power Scatter System

G-E Scatter Systems can be provided to span distances up to 200 miles in one hop, with provision for up to 36 voice channels.

The Scatter system is a new method of providing multi-channel communications, when long hops over rugged terrain are involved. It offers quality comparable to that of conventional wire or radio facilities and eliminates the need of intermediate repeater stations involving difficult installation and maintenance.

With high power Scatter added to our comprehensive equipment lines of Mobile, VHF, Microwave, TV Relay, Open Wire Line, Power Line Carrier, Teletype and Telegraph, Remote Control and Supervision, Broadcast and TV Transmission, Canadian General Electric is now uniquely qualified to meet your Canadian communications requirements. For systems advice on any communication problem, consult us.

*Progress Is Our Most Important Product*



# COMMUNICATIONS

Electronic Equipment Department

CANADIAN GENERAL ELECTRIC COMPANY LIMITED

830 Lansdowne Ave., Toronto 4, Ont.

640W-255

## NEW PRODUCTS

(Continued from page 59)

3 phase bridge unit, rated for a maximum of 450 amps. dc continuous output and can be supplied for input voltages of 26 v, 36 v, 52 v and 66 v rms maximum.

The Type 53-0075-0 has a volume of approximately 220 cubic inches as compared to 1650 cubic inches for a comparable selenium unit (fan cooled) and 14,000 cubic inches for a copper oxide unit (fan cooled). This new unit requires liquid coolant (water, oil, etc.) at a maximum inlet temperature of 25°C. and a volume of 1/2 gallon per minute minimum.

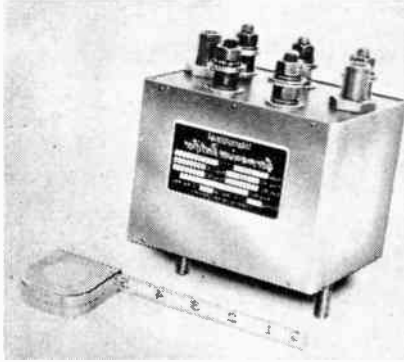

Efficiencies up to 97 per cent are attainable and the power factor is essentially 100 per cent. Aging is negligible or zero. Rectifier regulation as low as two per cent is possible from no load to full load.

The new liquid-cooled germanium power rectifier is applicable for all types of dc load requirements except those requiring heavy surge currents and those subject to heavy intermittent overloads or occasional short circuits. Sizes of this unit may vary slightly with ratings.

## ● Precision Variable Delay Line

Item 693

This delay line consists of 60 sections of LC m-derived networks and one 60 position rotary switch. The LC m-derived networks are especially designed for fast rise time, and negligible overshoot. The rotary switch is used to change the amount of time delay between the input and output by connecting the output terminal to anyone of the 60 sections of LC networks. The input impedance characteristic impedance. The output termination of the delay line is equal to the nominal should be connected to a high-impedance load, (approximately 20 times or more the characteristic impedance of the line), such as the grid circuit of the amplifier. The end of the delay line has been terminated by a resistor equal to the characteristic impedance internally.

Both the m-derived networks and the rotary switches can be removed from the cabinet and incorporated into any equipment where various time delay is needed. Since all components employed in the unit are carefully manufactured and selected, the accuracy of time delay can be as high as  $\pm 0.5$  per cent of the time delay at any point. As a result, this device is very valuable for many applications where precision variable time delay is needed. For example, it can be used for distant measurement in radar systems, phase and time delay measurement of various signals, or time delay for pulse circuits.

There are five different types available. Type 605a has a maximum time delay of 0.6 us in step of 0.01 us, 75 ohms impedance, 32 megacycles bandwidth, and 0.01 us rise time. Type 605b has a maximum time delay of 1.5 us in step of 0.35 us, 95 ohms impedance, 12.4 megacycles bandwidth, and 0.025 us rise time. There are three more types available with total time delay up to 12 us. All of them have 60 steps and impedance ranging from 75 ohms to 300 ohms.

## ● Precision Delay Line

Item 694

Model DL 0510/400/125 Delay Line is a precision, low attenuation unit, developed for correlation measurements and wave form analysis covering sub-audio and audio frequencies. Overall delay is 5,000 us.; characteristic impedance 510 ohms; taps are available every 40 us.; calibration accuracy at

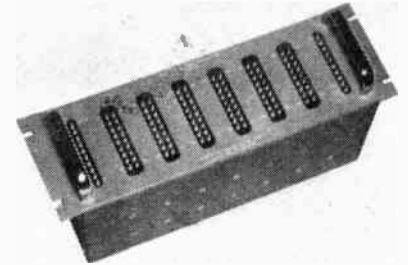

each of 125 taps is  $\pm 0.1$  us.; insertion loss is 1.7 db; cut-off frequency 9 kc; phase linearity is  $\pm 1$  per cent up to 5 kc. The unit size is 19" x 6" x 6" for relay rack mounting.

## ● High-Speed Syncro-Snap Switch

Item 695

New high speed Torq Syncro-Snap rotary switches were recently subjected to a series of tests which showed the units to provide complete and instantaneous cut-in or cut-out; a characteristic never before obtainable in a centrifugal switch. The unique design of this unit results in a non-fluttering, snap-acting device. The attached photograph shows an actual section of one test chart which traces the characteristics of a specific Syncro-Snap unit calibrated to cut-out at 7400 rpm.

(Turn to page 66)

# ARE ADJACENT POWER LINES A PROBLEM IN YOUR COMMUNICATION SERVICES?

They were at Knob Lake in the Labrador iron ore project and the problem seemed an unsurmountable one, a communications pair for voice and carrier, joint usage with a 23 K.V. single phase power line 360 miles long. Then Osborne Engineers with 30 years experience in the field of communications protection tackled the job.

The result — the successful solution of the problem, the planning and construction of a highly efficient communication system to serve this project.

If you have a similar problem, no matter how small or how large and complicated, get it off your mind, make it Osborne Electric's problem.

**OSBORNE ENGINEERS MANUFACTURE AND SUPPLY:**

● Drainage Transformers	● Grounding Relays	● Neutralizing Transformers
● Isolating Transformers	● Horn-Gap Arresters	● Telephone Ringing Generators
● Custom Built Transformers	● Gas-Filled Arresters	● Custom Wound Magnet Coils
● Custom Built Relays, Open and Hermetic Sealed.		

Write for complete data on above.

# OSBORNE ELECTRIC COMPANY LIMITED

95 WESLEY STREET

TORONTO 14, ONT.



# 5 reasons why it pays to use...



## FORMEX MAGNET WIRE

### For winding or rewinding motors and coils

Ever since C.G.E. introduced Formex Magnet Wire to the motor winding industry, it has been widely adopted by manufacturers and designers, and has proved a money saver for rewind shops. Tough, efficient Formex insulation, has served many years without an equal in the entire industry. Here are five of the many reasons why you should specify and use G-E Formex Magnet Wire:

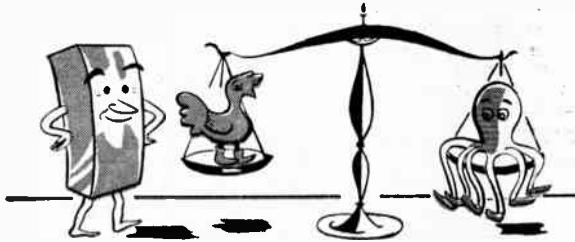

**1 More Footage Per Pound.** Thin Formex insulation gives money-saving, additional footage over rolls of fibrous and fibrous enamel wires. It also takes up less space in the Motor, allowing smaller, compact units; or more wire in a given space.



**2 Easier To Wind.** Formex insulation is a tough polyvinyl-acetal resin that withstands rougher usage, allowing faster winding without physical damage. Its smooth surface slips into place easily, permitting increased production . . . lower assembly costs.



**3 Greater Strength.** The toughness, adhesion and flexibility of Formex insulation coatings permit flexing and bending without cracking the surface of the insulation or lowering its dielectric strength. You're always sure of complete motor protection.

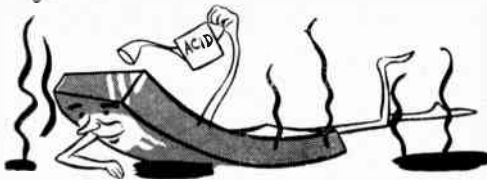

**4 Resists Heat Shock, Heat Aging and Solvents.** Formex resists the cracking effect of high heat and shock, and aging in temperatures above ambient for long periods of time. It also resists the destructive effects of practically all commonly used solvents.



**5 Moisture Resistance.** The tough insulating film of Formex presents a continuous wall of protection against moisture and moisture absorption.

For further information contact your nearest C.G.E. office or: Wire and Cable Department, Canadian General Electric Co. Ltd., 212 King St., West, Toronto, Ontario.

403W-1155

CANADIAN GENERAL ELECTRIC COMPANY LIMITED

**NEW PRODUCTS**

(Continued from page 64)

Snap-type switching action is completed within 3 rpm of the shaft to which the Syncro-Snap is attached, the manufacturer claims.

High speed Syncro-Snap switches are inherently balanced and are temperature compensated to assure precise operation at a predetermined speed over a wide temperature range. These switches are particularly suitable as a safety device on high speed aircraft, turbines, rotary converters, series wound motors, similar applications.

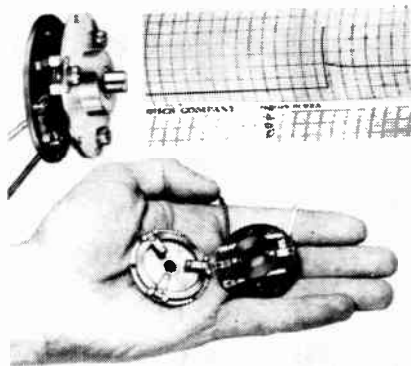

They can be used as an overspeed or underspeed limit control, or can be used in pairs to limit high as well as low speeds for a single application. SyncroSnaps detect rotational speed alone, regardless of voltage or load. They are presently furnished for any speed to 13,000 rpm. In addition, packaged Syncro-Snap speed control devices can be furnished to specifications in open, closed, or explosion-proof housings, ready for immediate coupling to power shaft.

● **Booklet On "Printed Circuitry"**  
Item 696

This booklet describes in detail the application, uses, and advantages of printed circuits in various electrical products and equipment, as well as technical information to aid in design or planning of printed circuitry.

The attractive two-color booklet explains simply and authoritatively the different types of base materials, laminate characteristics and circuit designs. Other chapters explain how to prepare master drawings, soldering techniques, and pricing variables.

With the development of printed wiring advancing rapidly, this all-inclusive booklet on the subject is particularly useful. "Printed Circuitry" is available free on request.

● **Dual Half Duplex Adapter**  
Item 697

The Northern Radio Company Type 181 Dual Half Duplex Adapter couples a 4-wire full duplex tone telegraph system to a half duplex 2-wire dc teleprinter loop. This makes possible the half duplex operation of the tone links, and in such a system a teleprinter in any dc loop becomes a two-way non-simultaneous system, with any other teleprinter in any other dc loop associated with a remote tone station. This provides for an economical two-way communication system between any number of stations which are linked by tone lines or radio links and at each station a



maximum of six teleprinters which are linked by a standard 2-wire dc loop.

In a half duplex circuit, two-way communication cannot be carried on simultaneously and the stations obviously have to take turns in the use of the circuit. Thus in the case of urgent messages, it must be possible for any teleprinter to break into the transmission of any other teleprinter and thereby show its need to take over the circuit. For this reason the Northern Radio Half Duplex Adapter is provided with an exclusive Break Circuit which immediately recognizes a break signal and automatically switches the Adapter from its transmit to its receive position. This enhances the half duplex arrangement by permitting a receiving operator to break into the circuit, bringing the system closer to full duplex operation.

● **Engineering Materials For Modern Industry**  
Item 698

"Engineering Materials For Modern Industry" is the title of a new 16-page, 2-color bulletin covering the properties, grades and uses of vulcanized fiber and Phenolite laminated plastic.

Case studies illustrated by more than 45 photographs match physical properties (impact resistance, dielectric strength, arc resistance, durability, light weight, flexibility, temperature and corrosion resistance, compressive and tensile strength) to typical uses (transformer coils, circuit breakers, rail joint insulation, gear blanks, athletic safety equipment, backing for abrasive discs, sample cases, chrome plating barrels, printed circuits) for both of these materials.

Tables list the general properties of the several grades of National vulcanized fiber (including commercial fiber, bone fiber, Peerless insulation) and the 40 grades of Phenolite laminated plastic (including such base materials as paper, cotton fabric, asbestos, fiber glass and nylon fabric).



**FOR PRECISION LABORATORY OR PRODUCTION TESTING**

**FREED**

**1110-A INCREMENTAL INDUCTANCE BRIDGE AND ACCESSORIES**

Accurate inductance measurement with or without superimposed D.C., for all types of iron core components.

- INDUCTANCE — 1 Millihenry to 1000 Henry
- FREQUENCY — 20 to 10,000 Cycles
- ACCURACY — 1% to 1000 Cycle, 2% to 10KC
- CONDUCTANCE — 1 Micromho to 1 MHO
- "Q" — 0.5 to 100
- SUPERIMPOSED D.C. — Up to 1 Ampere
- DIRECT READING — For use by unskilled operators.

ACCESSORIES AVAILABLE: 1140-A Null Detector, 1210-A Null Detector — V.T.V.M., 1170 D.C. Supply and 1180 A.C. Supply.

INSTRUMENT DIVISION

**FREED TRANSFORMER CO., INC.**

1716 Weirfield St., Brooklyn (Ridgewood) 27, N.Y.

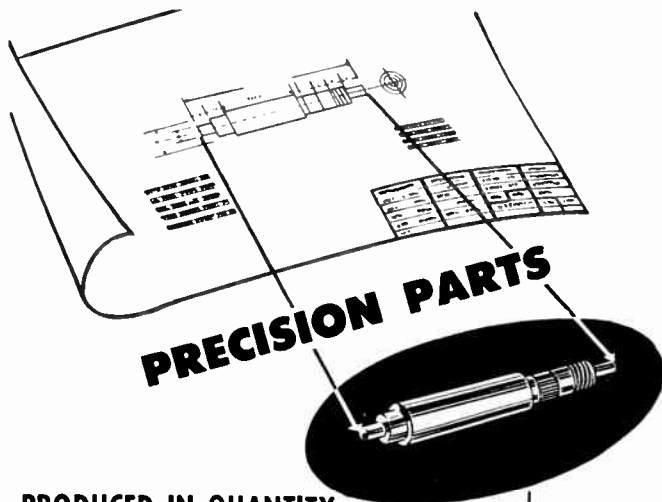

**PRODUCED IN QUANTITY... ON THE LATEST PRECISION EQUIPMENT**

We make only one thing — small parts — and we make them so well that many of Canada's leading manufacturers are using our facilities. Parts in Telfon, Styrene, Brass, Copper, Bronze and Steel are produced on the latest automatics, lathes and thread-rolling equipment.

Give us a call today!

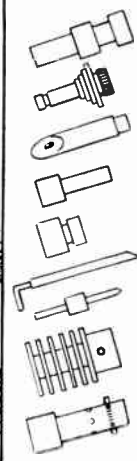

For further data on advertised products use page 99.

● **Miniature Terminals  
And Contacts For  
Printed Circuits**  
*Item 699*

Newly available miniature tubular pins and female contacts cut wiring time, speed production and save assembly costs on printed circuit applications. Said to be the first self-retaining terminals developed for this purpose, they are especially designed to promote automation in the electronic, electrical, automotive and similar fields.

The tubular pin is readily adapted to numerous wiring problems. Two beads on the lower part of the pin terminal depress and snap out again when pushed through an accommodating panel hole. The pin snaps into the panel with a positive locking action, eliminating roll-over operations and possible fracturing of panel or chipping of plating. This locking action retains the pin until additional components are added and until it is permanently soldered.

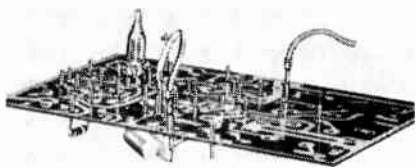

Resistor, capacitor, condenser and neon pigtails can be fed into the terminal at either the top or bottom of the panel and held in place by tapered portion of the terminal until solder dipped. External leads from other components, such as tuner, CRT socket, volume control and speaker, etc., can be wrapped around the pin terminals and spot soldered. Terminals will not vibrate loose during additional assembly or other operations prior to permanent soldering.

● **High Vacuum Rectifier**  
*Item 700*

The Eimac 2X3000F rectifier is an external anode, forced air cooled, high vacuum, high current rectifier rated at 3.0 amperes average current at 25,000 volts peak inverse. Six tubes will deliver 9.0 amperes at 23,000 volts dc in a three-phase bridge connection. The filament is rated at 7.5 volts.

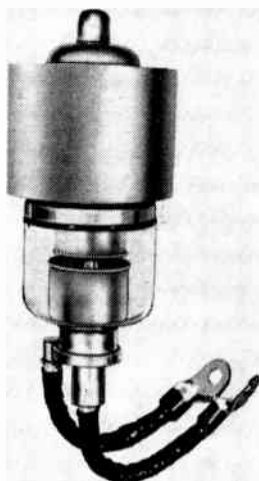

The new rectifier is ideal for use in power supply units, voltage multipliers, pulse service or special applications at high frequencies, extreme ambient temperatures and high inverse voltages. The Eimac 2X3000F, like all Eimac high vacuum rectifiers, will give reliable performance at high frequencies and high voltages without generating radio frequency transients and will operate over a high ambient temperature range.

● **Squaring Circuit**  
*Item 701*

Squaring Circuit Z-90049 has been designed to operate from 0 to 1 megacycle. It is intended to square input sine or complex waveforms. Where the original information has poor rise time, it is frequently necessary to use this EECO squaring circuit to trigger EECO 1 mc Flip-Flop Unit Z-90048. Squaring

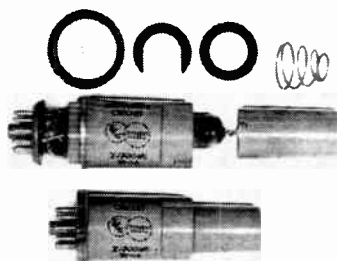

Circuit Z-90049 provides relatively fast rise and decay times. The squaring circuit may also be used as a base and peak clipper.

The Z-90049 squaring circuit is packaged as a plug-in unit with an 11 pin base. The plug-in unit has a 1 1/2" overall diameter and an overall height of 4 1/2". Squaring Circuit Z-90049 has the same physical dimensions as some 30 other companion plug-in units, which accommodate a wide variety of electronic circuits. The plug-in unit is designed to be taken apart or assembled without any tools. The unit weighs approximately 3.25 ounces and is provided with a removable tube shield. The base and tube shield are made of die-cast aluminum and finished in a baked grey enamel.

● **Differential Pressure  
Transducer**  
*Item 702*

A dual element air flow differential pressure transducer instrument specifically designed for high output to speed-altitude-time computers, telemeter systems, electric recorders, servo systems, meter display or alarms is now on the market.

The pressure response movements of each of two metal bellows is translated into motion of sliders of paired precision potentiometers. One bellows is connected to the dynamic pick-up line from Pitot or Venturi; the other bellows is exposed to pressure from the pick-up line sampling the static or ambient pressure. The electrical outputs of each of the instrument's four potentiometers are individually brought out to terminals, providing individual access to dynamic or to static data. Through an external electrical combining network, dynamic data may be automatically "normalized" or corrected with respect to static data as required by the application, limited only by the designer's ingenuity.

Typical application to speed-altitude measurement provides a range from 0 to 580 knots over an altitude range of - 1000 to 20,000 feet. Potentiometer resistance ratio vs. pressures is linear within 0.5 per cent; hysteresis within 0.5 per cent; change with temperature (- 55°C. to + 71°C.) not over 0.5 per cent; resolution increment less than 0.2 per cent of pressure range. Construction withstands 40g shock; departure from static calibration not over 0.7 per cent under 10g vibration up to 200 cycles. Size 2 7/8" x 4 3/8" x 5 7/8"; weight 1.3 lbs.

● **Radial Beam Power Tetrode**  
*Item 703*

The manufacturer of Eimac electron-power tubes, announces the 4X5000A, the first Eimac ceramic radial-beam power tetrode. The 4X5000A is constructed entirely of ceramic and metal, thereby offering greater electron-tube reliability and increased immunity to damage from thermal and physical shock. With a plate dissipation rating of 5000 watts and a power output of 16 kw in Class C telegraphy service through 30 mc. the 4X5000A fills a power gap in the tetrode field.

(Turn to page 68)

**SLIDE  
RULE  
No. 1777  
VERSALOG**

FOUR LOG SCALES

Descriptive Leaflet  
Free On Request

THE  
**HUGHES-OWENS**  
COMPANY LIMITED

HALIFAX · MONTREAL  
OTTAWA · TORONTO  
HAMILTON · WINNIPEG  
EDMONTON · VANCOUVER

— MADE IN CANADA —  
**VARIABLE  
RESISTORS**

**2 WATT  
COMPOSITION TYPE**

**High Stability!**

**Sturdy!**

**Dust-Proof!**



**APPROVED FOR  
JAN-R-94 type RV-4**

**PRECISION ELECTRONIC  
COMPONENTS LTD.**

50 WINGOLD., TORONTO, ONT.

RU. 1-6174

## NEW PRODUCTS

(Continued from page 67)



Especially suitable for Single Sideband operation, the new tetrode delivers 10 kw output in Class AB1 service and handles high inputs without going into the positive grid region. The simple coaxial structure allows low lead inductance and an integral finned anode permits improved cooling with low air pressure.

USE COUPON ON PAGE 99

## ● Continuity Analyzer

Item 704

Input, operation and continuity test characteristics of this analyzer are as follows: Input: Four adapter jacks with gold-plated contacts accommodate 50 circuits and one external ground. Circuits may be multiconductor cables, resistive networks or complex wiring installations with relays and switching circuits.

Operation: A solenoid-driven stepping switch automatically and progressively connects the circuits to the Analyzer. The stepping switch stops automatically when the test is completed or stops during the test if a fault exists. A pointer driven by the stepping switch indicates the number of the circuit being tested, and panel indicators identify the type of fault.

Open-short continuity test: (1) An open circuit stops the stepping switch and the circuit is identified by number on the indicator dial.

(2) A circuit with excessive continuity resistance is indicated as an open circuit. The permissible resistance may be adjusted from 0.5 ohms to 100 ohms by a calibrated dial. External battery jacks provide for an extended resistance range of 1000 ohms per 45 volts.

(3) A circuit shorted to any other (or to an external ground) stops the stepping switch at the circuit number(s) and turns on a red light.

(4) A circuit with less than 5 megohms insulation resistance between every other circuit (or an external ground) is indicated as a short.

## ● Molded Phenolic Jack Strips

Item 705

Molded construction (rather than machined) is the outstanding feature of an improved telephone-type phenolic jack strip recently introduced. Molded construction reduces costs and has a neater appearance. Jack strips facilitate the distribution, switch-

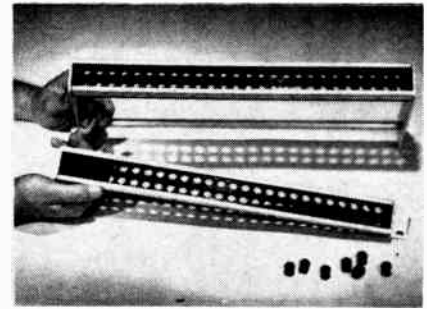

ing, and testing of communications circuits.

Each jack strip provides mounting spaces for 52 single (26 double) jacks. Horizontal and vertical hole spacings are arranged so that either single or double plugs can be used.

Two types of mounting brackets are available: flush mounting or standoff. Jack strips are also available without brackets.

In addition to the basic jack strip, four styles of telephone-type jacks are offered for assembling complete jack panels.

## ● Long Life Chopper

Item 706

A miniature 6.3 volt, 400-cps mechanical modulator rated for a life of 2,000 hours has been developed. The contacts of this single-pole double-throw chopper are rated for a maximum of 1 milli-ampere for signals from 0.1 millivolts to 100 volts. Production units on life test at low current and low voltage (the most severe operating condition) indicate that life in excess of 2,000 hours can be expected. The Type 300 chopper is constructed to operate in ambient temperatures from  $-65^{\circ}\text{C}$ . to  $+100^{\circ}\text{C}$ ., is hermetically sealed for use in humid atmospheres and at altitudes to 50,000 feet. This rigidly built chopper withstands mechanical shocks of 100 G and vibrations of 0.06 inch total travel from 10 to 55 cps.

## Quick Switches

are a

**DAVEN**

Specialty

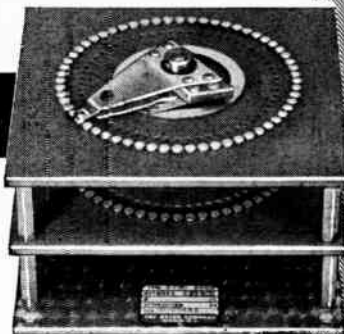

And the "specialty of the house" is double-barreled . . . first, choose from hundreds of standard units to satisfy your needs—for quick switch delivery . . . second, Daven can effect quick 'switches' or changes from standard units to special switches, by using components at hand. That, too, makes for speed, dependability, economy. Write for more detailed data.

THE **DAVEN** CO. IN CANADA: Adams Engineering Ltd. Montreal and Toronto  
193 Central Avenue, Newark 4, N. J.

Write for FREE copy of DAVEN's new, 28-page brochure on SWITCHES!

# ELMENCO

## The Accepted

# ELMENCO

## Capacitors

# ELMENCO

## in the Industry

The acceptance of ELMENCO capacitors by military and commercial users has been overwhelming . . . with good reason. ELMENCO fixed mica di-electric capacitors meet all applicable MIL-C-5A specifications . . . are known the world over for their reliability under all operating conditions. And they are available for IMMEDIATE DELIVERY. Write today for the latest ELMENCO catalogue and prices.

EXCLUSIVE WITH

**ELECTRO SONIC**  
SUPPLY CO. LTD.  
543 YONGE ST., TORONTO 5  
WA. 3-2481



For further data on advertised products use page 99.

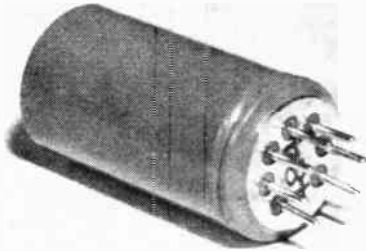

Switching phase angle is  $65 \pm 15$  degrees, dwell time on each pole is  $145 \pm 20$  degrees; balance between dwell times is  $0 \pm 15$  degrees. Required driving frequency is 400  $\pm$  20 cps; required coil voltage is  $6.3 \pm 0.6$  volts. Coil impedance is  $230 \pm 60$  ohms at 400 cps with 6.3 volts rms applied at 25°C.

### ● 75 Microsecond Pulse Transformer

#### Item 707

A new two-winding, Epoxy resin impregnated and hermetically sealed 75 microsecond pulse transformer with a rise time of only 2 microseconds is now offered to the



market. The new units, H75-11, meet MIL-T-27, grade 1, class A test specifications. Operating temperature range is from  $-70^{\circ}\text{C}$ . to  $135^{\circ}\text{C}$ . Size  $\frac{7}{8}$ " x  $\frac{7}{8}$ " x  $1\frac{1}{4}$ " exclusive of terminals and mounting flange.

### ● Wide-Band Dielectric Potentiometers

#### Item 708

A completely new and unique principle has been incorporated in the Type PD-2 Dielectric Potentiometer. This variable voltage divider is free of phase and frequency distortion over the wide range 20 cycles to 10 megacycles. The output voltage, therefore, has the identical waveform of the input voltage. Consequently this device excels as a calibrated attenuator in wide-band oscilloscopes, transmission measuring sets, amplifiers, signal generators, network analysis systems, and waveform comparison or balancing schemes.

In effect, the Dielectric Potentiometer is a three-terminal network. The effective resistance-capacitance shunt and series elements of this network result from the inherent resistivity and dielectric constant of a lossy liquid dielectric immersing the terminal electrode structures. The output electrode is mechanically mobile with respect to the input electrode. Since the resistance and capacitance components vary in exactly inverse manner with movement of the output electrode, a precisely constant re product is maintained in each of the ratio arms.

### ● Rack And Panel Connector Bulletin

A new sixty-four page Engineering Bulletin on all DP rack, panel/chassis types is available.

Format of the DP9 Bulletin is strikingly modern and provides a more complete and readable compendium of technical information on the various DP lines, plus the RTC, all rack, panel chassis designs. Many new features have been added: a new descriptive index, detailed, illustrated parts, exploded views, contact detail, data summaries, comparative shell sizes (configuration), extensive mounting area information and wire and assembly data.

Item 709

### ● 1" Sealed Panel Meters

#### Item 710

In keeping with the trend toward extreme reduction in weight and size requirements for aircraft and electronic applications, a manufacturer now offers its miniaturized Model 100 1" Panel Meter.

The Model 100 uses a miniaturized version of the highly accurate external pivot D'Arsonval movement. Scale windows and terminals are gasket sealed watertight. An "O" ring

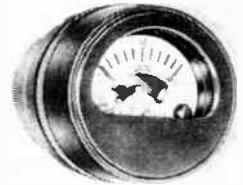

panel gasket and locknut are provided for sturdy, shock-proof mounting. Watertight qualities meet MIL M-3823 specifications.

This new sealed meter can be ordered with white, black or luminous markings on white or black scale background, and a choice of colors for the pointer. The round mounting flange measures  $1\frac{1}{4}$ ". A square Model 102 is available on special order.

(Turn to page 86)

THE ULTIMATE *in* SERVICE and  QUALITY.



Example:  
Type: SL 77H  
Capacitance: = 1 Mfd.  
Working Volts:  
= 250 V.D.C.  
Length: =  $1\frac{1}{8}$ "  
Diameter: =  $\frac{3}{8}$ "

## T.C.C. "SUPERLYTIC" CONDENSERS

T.C.C. "SUPERLYTICS" fulfil the demand for a condenser having the electrical characteristic of a paper condenser together with the small size of an electrolytic. The leakage is so low that one can properly speak of Insulation Resistance. A figure in the order of 10,000 Megohms—Mfd. is achieved at the rated working voltage.

Additional advantages are:

Exceptionally long working life.  
Operation up to  $100^{\circ}\text{C}$ .  
Small size.

If your problems involve condensers and their applications, phone or write:

**THE GLENDON COMPANY, LTD.**

44 WELLINGTON ST. EAST · TORONTO, ONT.

EMpire 6-5673

## NAVAL ELECTRONICS

(Continued from page 40)

detect aircraft at ranges of over 100 miles.

Canada is also producing an anti-submarine torpedo. It will be an important asset to the fleet. The multi-million dollar torpedo program was inaugurated in 1952 and has continued apace since that time. Numerous problems inherent in the new program were met, contended with and solved vigorously and with the co-operation of all concerned.

Other naval equipment, which is now being manufactured, or is slated for manufacture, in Canada in the near future, and is either wholly or in part electronic in construction, includes:

**Sonar**, or Asdic equipment — this is employed in the detection of submerged submarines, to determine their depth and course and to direct or control the weapons used against them.

**Sonobuoys** — operating on the sonar principle, these devices are dropped from aircraft by parachute in a suspected submarine area. The buoy can pick up the sound of the submerged submarine and broadcast it back to searching ships and aircraft. Increasingly, RCN aircraft rely on radar, radio, magnetic airborne detection equipment and sonobuoy systems to fulfill their function.

**Squid** — One of the latest types of anti-submarine mortar, this weapon is being manufactured in Canada, and the electrical apparatus necessary to make the weapon effective is considerable.

### Industry's Vital Role

The electronics industry is playing a vital role in the production of naval anti-aircraft and surface armament, notably in the manufacture of the 3 inch 50 calibre gun. Primarily intended for defense against aircraft, this gun is so equipped that it may be used

also against surface targets. It is an important part of the armament of Canada's major warships.

Radar-controlled fire systems for heavier armament are also being manufactured in this country.

Electronics plays an important part in the modern ship's internal communications organization. Among the devices fitted in modern warships are automatic telephone exchanges, public address systems and alarm systems, all of which are of Canadian manufacture. There are, in fact, very few devices on board Canadian warships



● Tuning in wireless set in Labrador's radio room are left to right: L/s Robert Frowley, Windsor, Ontario and AB Robert Smith, Bishop's Falls, Newfoundland.

that do not depend upon electronics for their operation.

The continual development of electronics in naval warfare is having its effect even on ship design. The operations room, with all its electrical and electronics gadgets, has become the nerve center of the modern fighting ship.

The Canadian electronic industry

has a challenge to meet, but in the past, it has proven not only its willingness, but its ability, to tackle successfully everything that the navy has asked of it. There is every reason to believe the industry can handle anything that may be demanded of it in the future.

## BROADCAST OPERATIONS

(Continued from page 44)

duty to control program level, and while at his post it is little added work to check transmitter readings once an hour on the remote gear. In fact, once used to it, many operators enjoy the added work because they then know for certain that the program is being radiated.

### Economic Advantages

The economic advantages over attended operation are so great as to be almost self-evident. For instance, a station operating 18 hours a day generally requires three shifts daily, taking into consideration meal hours and travelling time. Allowing for legal holidays, days off, sickness, at least four operators must be employed to operate the transmitter. Wages vary in different parts of the continent, but \$250 per month may be taken as an average. This amounts to \$1,000 per month or \$12,000 per year — a good percentage of a small station's operating budget.

For an initial investment of approximately \$3,500 remote control entirely eliminates this expense. The \$3,500 is roughly made up of \$3,000 for the equipment, \$250 for an engineering brief prepared by a qualified consultant and presented to the governing bodies, and \$250 to install and check out the equipment. After the initial cost, upkeep is negligible, costing no more for tubes and components than

For the Best in **QUARTZ CRYSTALS**

Specify **SNELGROVE**

Wide range of types and frequencies

Approved by D.N.D.

Similar units may be supplied to commercial specifications.

**C. R. SNEGROVE CO. LIMITED**

391 SAMMON AVENUE

TORONTO, ONT.

Manufacturers of Precision Lowdrift

Quartz Crystals for the Military and Industry

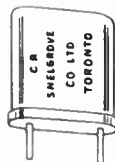

FOR EVERY APPLICATION

a good quality amplifier. Little wonder that remote control has been hailed as the greatest money saver in radio since the advent of the studio console, the instrument whereby announcing and operating the studio can be done by one man. Remote control carries progress one step further — announcing, or disk jockeying, controlling program level, plus operating the transmitter are all efficiently accomplished by one operator.

**BUSINESS ELECTRONICS**

*(Continued from page 46)*

elevator automatically stops at the floor and the door opens. A light beam is broken by the entering passenger, the door closes and the passenger selects his floor on a button control panel inside. If there are intermediate calls, the elevator will continue to pick up passengers until it is loaded. The elevator installation is one of the fastest and most direct systems of elevator transportation yet devised.

**Sound System**

Loudspeakers of the radiator type are installed throughout the building, concealed just above the acoustic ceilings. Musical programs will be carried at low level (soft background music) throughout the day. This music can be brought in by Muzak through the Bell Telephone System or from an

internal tape recorder. The sound system can be turned on or off by areas. Special paging calls and emergency calls may be sent over this system from a microphone at the telephone switchboard. When special meetings are being conducted in any part of the building the sound can be kept locally to the meeting area or sent to the rest of the building as desired.



● This electronic calculator one of the latest additions to the machine accounting department will do in a very few minutes mathematical calculations which would consume hours of working time if done manually.

**Telautograph System**

Many thousands of permanent record

files which are stored in the basement have to be continually referred to by the Underwriting Department of the company which is located on the fourth floor of the building. To facilitate the speedy movement of these files the company has installed a Telautograph service. Requests for files are written on the fourth floor and the written request is instantly recorded on a receiving unit in the file vaults of the building.

**CORRECTION**

In the March-April issue of *Electronics & Communications* Sir Robert Watson-Watt was incorrectly stated to be President of Airtron Limited, Toronto. Sir Robert is President of Adalia Limited with offices in Montreal and New York and President of Logistics Research Inc., of Redondo Beach, California.

We regret any inconvenience caused to the parties concerned.

**Up to 40 Contacts**      **in 35% Less Space!**

**DPA and DPX**  
Miniature Connectors

For "unit-plug-in" applications... rack, panel, chassis.  
Strong aluminum shell. Corner-keying prevents mismatching.  
Chamfered lead edges permit blind piloting.  
Gold-plated contacts, 5 amp. and coaxial.  
Hi-dielectric insulation. Junction shells available.  
Write for PR-DPI folder. Write TODAY!



CANNON ELECTRIC CANADA LIMITED, 160 Bartley Drive, Toronto 16, Ontario.  
Montreal Office—Trans-Atlantic Bldg., Montreal Airport, Dorval, P.Q.

**HAMMOND**  
gives you **SERVICE** on  
standard or special items

**TRANSFORMERS**

- FOR REPLACEMENT WORK
- FOR SOUND EQUIPMENT
- FOR TRANSMITTING EQUIPMENT
- FOR INDUSTRIAL APPLICATIONS
- FOR TEST AND DEVELOPMENT PURPOSES

DISTRIBUTED FROM COAST TO COAST  
BY CANADA'S LEADING PARTS JOBBERS

5502 HAMMOND MANUFACTURING COMPANY LIMITED, Guelph, Ont.

## FORECAST FOR '59

(Continued from page 24)

### Color Television

- ★ "This industry of ours is progressing at such a rapid pace that we haven't been able to really appreciate the impact of color television. However, you and I know that it is a restless giant with a great destiny . . . .
- ★ "Two to three hours of color programs are coming from the States into Canada right now — more will follow. Imported color receivers will be sold in Canada this year . . . .
- ★ "The people want color; therefore, nothing under the sun can prevent them from having it. We believe that a color signal will originate in Canada

no later than 1956 . . . .

- ★ "Relative to its effect on the renewal market, we can summarize as follows: (1) color studio broadcasting equipment is more elaborate and uses more tubes. (2) color receivers are more elaborate and use more parts and tubes than are used in black and white receivers. (3) the tri-color Kinescope is more complex and is, therefore, somewhat more costly than its black and white cousin . . . .
- ★ "More and better test equipment will be required to design, manufacture and service color television receivers. Rest assured that the crossing of this new electronics frontier will greatly expand the electronics renewal market.

### ITV

- ★ "Industrial television, a new fabulous electronics frontier, is probably the greatest forward step ever taken in increasing man's capabilities . . . .
- ★ "Today, now I T V is practical for thousands of applications. Do you realize that in this statement we are suggesting that thousands of television cameras may someday be placed in service? . . . .
- ★ "Perhaps we are all beginning to better understand those people in our business who have repeatedly declared that the electronics industry is today in its infancy . . . .
- ★ "In every field of human endeavor thus far encompassed, electronic methods have proved superior to all others . . . .
- ★ "Consequently, as the electronics industry crosses each of these new frontiers, revolutionary devices appear to make more activities dependent to a yet greater degree upon electronics . . . .

★ "The cordless telephone set is already being tried experimentally. Electronics will eventually provide coast-to-coast dialing and the personal wrist watch telephone is looked upon as something that may be available to everyone in the future.

★ "To illustrate another phase of these electronic marvels (business machines), allow me to quote a little article from the *Montreal Gazette* . . . .

"Columbia University announced the solution of a basic problem that has confronted scientists for more than sixty years and could not have been solved by any human mathematician.

The correct answer was finally found by the International Business Machines' giant electronic 'brain', known as the Selective Sequence Electronic Calculator.

The machine's 12,500 vacuum tubes performed some 20,000,000 calculations in a total working time of 150 hours, telescoping in that time interval an estimated 100 years of computations with the aid of a desk calculator, or with paper and pencil."

★ "Somewhere in our future — and perhaps not too far away, the industry will be manufacturing and selling such things as electronic air conditioning, electronic ignition systems, light amplifiers and other revolutionary electronic devices. So, as far as can be seen into the future, we in the electronic renewal business will be blessed with a strong tailwind — a tailwind that will carry the industry to heights unimaginable . . . .

★ "There is no inference here that the road will be smooth and well marked. It is more likely to be rough and uncharted . . . .

★ "Therefore, the greater the growth, and the faster the pace, the more urgent the need for shock-absorbers and a roadmap. This need — simply named, is PLANNING . . . ."

to **NEW** heights of  
**ACHIEVEMENT**

with  
**TEXAS INSTRUMENTS**  
INCORPORATED

World's foremost manufacturers of Semi-Conductor Products, Electronic Components, Instrumentation and Specialized Electronic Equipment.

Exclusive Canadian Representation for  
**SALES, SERVICE APPLICATIONS  
AND MANUFACTURING**

*Computing* **DEVICES**  
OF CANADA LIMITED  
311 Richmond Rd.—Ottawa, Canada

For further data on advertised products use page 99.



## NEW ACHIEVEMENTS

(Continued from page 30)

television camera, lowered into the sea, identified the objects and suggested the best way of grabbing the debris without further damage. Meanwhile, in Britain an "Ace" (automatic computing engine) was being used to investigate hitherto unsuspected problems of aerodynamics. It is fair to say that, without electronics, the mystery of the Comet could not have been satisfactorily solved.

Since then, the English Electric Company Ltd. has manufactured the "Deuce" (digital electronic universal computing engine), an advanced model of the Ace. The Deuce, which is claimed to be the most capable of its kind in Europe, has a capacity limited by its 12 mercury delay lines each storing 32 words, ten shorter lines, and a magnetic recording drum storing 8,192 words or more than 250,000 digits. The Deuce has already solved a set of 115 simultaneous equations with 37 right hand sides, although problems of a tenth of this magnitude could not otherwise be tackled.

On an altogether different scale (and costing 25 times as much) is "Tridac", a three-dimensional analog computer made for Britain's Royal Aircraft Establishment by Elliott Brothers (London) Ltd. It is said to do as much work in 20 seconds as 100 girls using calculating machines in an eight-hour day. Then, among others, there is "Leo" — manufactured by J. Lyons and Company Ltd., a catering firm, for its own use — which is designedly an office machine, and a digital computer made by Ferranti Ltd. In fact, a revolution in business accountancy and office routine has already begun, and the British electronics industry is at its fore.

### Eradicating Waste

Another development which British firms have pioneered is in filming with electronic cameras. This eradicates the wasteful trial and error of conventional filming and, by use of multiple cameras and a monitor, permits the film director to control his film in the making. Intended primarily to produce cheap film for television, it will, oddly enough, help the cinema industry to compete with television as a rival. In television, Britain's next step is to make permanent the cable for "Eurovision"; color television is only awaiting Government sanction; and a big export market is being built up (the Pye transmissions were the sensation of last year's Baghdad Fair and the transmitter and complete studio were bought on the spot).

More than half of all United Kingdom ships over 500 tons have been fitted with radar and upwards of 4,000 overseas ships have been supplied too. Ekco Electronics is the first firm in the world to go into regular production with search radar for civil aircraft and the equipment is being fitted in

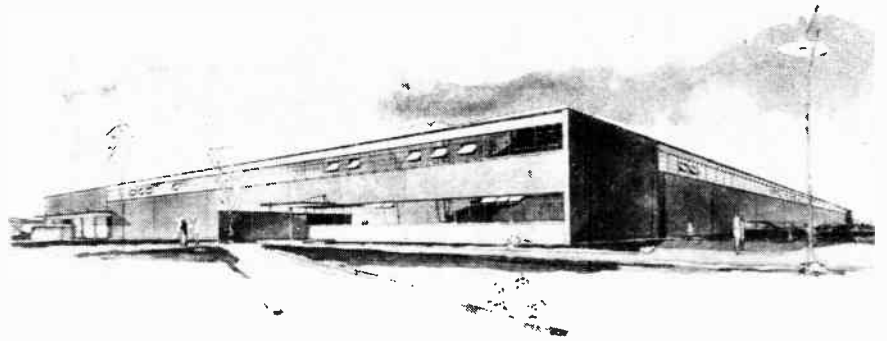

● Architect's sketch shows the 120,000 square foot plant planned for Radio Valve Company, Limited, in Etobicoke. Construction of the facility was recently announced by company president W. E. Davison. The new plant will manufacture TV picture tubes, Cathode ray tubes, oscilloscope tubes, radar indicator tubes and like products.

the new Britannia aircraft. Britain was again first in the world with electronic switch control of telephone exchanges and six such directors have been working in the Richmond exchange, near London, for over three years; they provide a silent service with substantially less mechanical wear.

Another activity in which Britain is very active is nuclear fission; the service of electronics in this respect has called for a new word, nucleonics, and reliable nucleonic instruments are now available. In medicine, electronic instruments, such as the electronic microscope, are now commonplace.

Industry provides virtually limitless

possibilities for the application of electronic technique. The automatic control of processes (right up to the control of a rolling or blooming mill), the examination for flaws of solid steel, controlled machine tools, electronic welding — these are becoming the accepted way of doing things. There remains only in the future the fully automatic factory. This is not the place to discuss how soon it will come or what its effects will be; these matters are still for speculation. But there is no doubt that Britain's electronics industry will be able to provide reliable equipment to control the factories if it is needed.

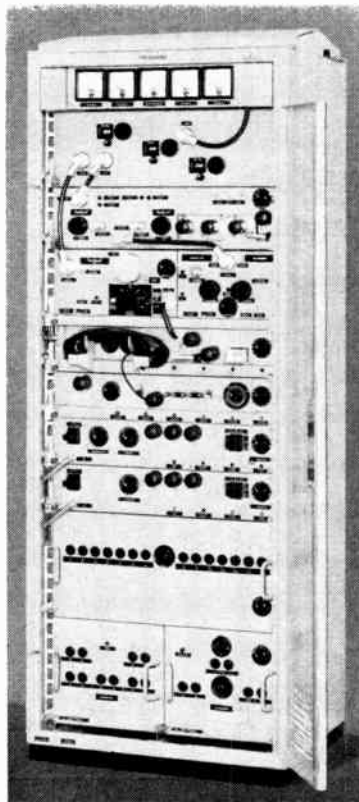

### SIXTY-CHANNEL UHF FM RADIO SYSTEM OF ADVANCED DESIGN

Type FM60/2000 Radio System transmits up to 60 voice channels in a frequency range of 1700 to 2300 mc. Transmitting power is 5 watts and a single antenna is employed for both transmitting and receiving. The maximum frequency swing is 0.5 mc, and the transmitted frequency band is 12 to 252 kc. A similar system type FM60/300 operating in the frequency band 235 to 328 mc is also available. These radio systems operate in conjunction with the type F60 carrier-telephone system, which provides up to 60 3400-cycle telephone channels in 5 12-channel groups.

◀ A complete FM60/2000 Radio Terminal requires a single cabinet.

## RADIO ENGINEERING PRODUCTS

1080 UNIVERSITY STREET, MONTREAL 3, CANADA

Telephone: UNiversity 6-6887

Cable Address: Radenpro, Montreal

MANUFACTURERS OF CARRIER-TELEGRAPH, CARRIER-TELEPHONE AND BROAD-BAND RADIO SYSTEMS

## NEWS

(Continued from page 56)

### Computing Devices Of Canada Named Exclusive Canadian Reps.

Computing Devices of Canada Ltd., 311 Richmond Road, Ottawa, announce that they have been appointed exclusive Canadian Agents for the complete line of transistors, semi-conductors and specialized components produced by Texas Instruments Incorporated of Dallas, Texas.

Texas Instruments is one of the largest manufacturers of transistors in the United States.

This new tie-up will make available to the armed forces and industry in Canada an advanced step in transistorizing, for an infinitely wide variety of applications, company officials state.

### Officers Of Data Processing Associates

Data Processing Associates, Ltd., Ottawa, announces the election of George Glinski, Pipl. Eng., P.Eng., as Director and President, and Douglas Peacock as Managing Director and Vice-President. Mr. Glinski has been associated with electronic research and development for 20 years and since 1948 has specialized in electronic computation and automation. For the last seven years he has been a director of Computing Devices of Canada, Ltd..

Ottawa, having been a co-founder of that company in which he held the offices of president and vice-president. Mr. Glinski has directed the application of most of the electronic computing equipment to defence and civilian requirements in Canada. He was the first in Canada to conduct graduate courses in digital and analog computation, which he continues to do at McGill University and Carleton College.

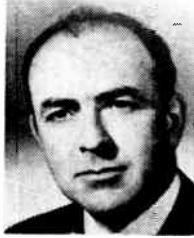

D. H. PEACOCK



G. S. GLINSKI

Mr. Peacock has been associated with Systems and Procedures Applications for 10 years and for the last three years has specialized in the sale of electronic data processing and data reduction equipment. He formerly was Sales and Contract Manager for Computing Devices of Canada and was responsible for the first high speed general purpose electronic digital computer systems placed in use in Industry and Government in Canada. He served in the R.C.A.F. in World War II, holding the rank of squadron leader.

### Aerovox Acquires Luther Manufacturing

Acquisition of the Luther Mfg. Co. of Olean, N.Y., by Aerovox Corporation is announced by James Key, general manager of Aerovox Canada Limited. Aerovox is a leading manufacturer of capacitors, resistors, steatite insulators, powder-iron cores and other electronic components as well as specialized electronic equipment.

### C.A.E. Appointed Agents For Dressen-Barnes Corp.

Canadian Aviation Electronics have been appointed by the Dressen-Barnes Corporation of Pasadena, California, as their Canadian agents for all Canadian territory excepting British Columbia. The Dressen-Barnes Corp., are manufacturers of regulated power supplies.

### Three Stations Share Memorial Award

The Colonel Keith S. Rogers Memorial Engineering Award, donated annually by Canadian General Electric, was presented this year to three Ontario broadcasting stations "in recognition of their outstanding action during Hurricane Hazel in devoting the entire resources of their stations

*Consolidated*

1156 YONGE STREET  
TORONTO - CANADA

ELECTRONIC EQUIPMENT COMPANY  
LIMITED

MANUFACTURERS AND DISTRIBUTORS *Cleeco*

## THE ELLY "SNAPPER" THERMAL TIME DELAY RELAY



can be the answer to your engineering problem.  
A product of the Electronic Division of  
Curtiss-Wright Corporation.

Write for data.

**CONSOLIDATED ELECTRONIC EQUIPMENT  
COMPANY LIMITED**

1156 YONGE STREET TORONTO, CANADA

# USECO

USECO Knobs are in stock, ready for immediate delivery. Made of aluminum, they can be anodized in your choice of 40 different colors.



Knobs are but *one* item in the big line of USECO standardized electronic hardware which includes terminal lugs, plugs, sockets, stand-offs, shaft locks, etc. Etched circuits and terminal board made to your specifications. Write for catalogs and name of representative in your area.

## U.S. ENGINEERING CO.

A Division of Litton Industries, Inc.  
521 COMMERCIAL ST., GLENDALE 3, CALIFORNIA

For further data on advertised products use page 99.

to community assistance". These stations were chosen by an independent Award Committee selected by CARTB.

The three stations so recognized for their gallant service in the event of that emergency were CFJB, Brampton; CFOR, Orillia; and CHUM, Toronto.

The presentation was made at the Thirtieth Annual Banquet of the Canadian Association of Radio and Television Broadcasters on March 21, 1955, by R. M. Robinson, Vice-President and General Manager of the Electronics Division, Canadian General Electric Company. Mr. Robinson, in making the presentation, compared the growth of electronics with the development of the broadcast industry. He referred to the late Colonel Rogers' extensive pioneering days and highlighted the part played by CFJB, CFOR and CHUM in the last year contributing to the betterment of Canadian broadcasting.

### Ian F. McRae To Head Design Team Of Canada's First Nuclear Reactor

H. M. Turner, President of Canadian General Electric Company Limited, has announced the appointment of Vice-President Ian F. McRae to head the company's engineering team assigned to design, engineer and construct Canada's first nuclear reactor for power purposes.



● IAN F. McRAE.

Announcement of the undertaking of the nuclear power project was made in the House of Commons recently by C. D. Howe, Minister of Trade and Commerce. Atomic Energy of Canada Limited is responsible for the specifications and cost of the reactor while the Hydro-Electric Power Commission of Ontario is responsible for the specifications and cost of the conventional part of the power plant. Canadian General Electric will design, engineer and construct the reactor, and install and test the conventional electrical equipment involved. C.G.E. is making a substantial contribution toward the cost of designing and developing the nuclear reactor.

Mr. McRae joined Canadian General Electric in 1925. From 1941 to 1950 he was manager of the company's largest plant at Peterborough, where a team of Canadian engineers is being drawn together to implement the company's part in the reactor program. In 1952, following six months on loan to the Government as Director, Gun Division, Department of Defence Production, Mr. McRae was appointed a vice-president. He is the present president of the Canadian Industrial Preparedness Association.

### Electronic Informer For Purchasing Agents

Dissemination of timely topics of interest to the electronic industry is the job of the "electronic informer" published bi-monthly by Canadian Electrical Supply Co., Montreal. The "Electronic Informer" is published as a service to those engaged in the purchase of industrial electronic equipment.

(Turn to page 76)

## Marconi

offers a **NEW**  
**SIGNAL GENERATOR**



#### Advanced features provide:

- greatly increased oscillator tube life
- freedom from variable r.f. contact resistance.

The Marconi TF-801B Signal Generator covers the frequency range 10 to 500 Mc/s with a source impedance of 50 ohms and output continuously variable from 0.1  $\mu$ V to 2V.

The hand calibrated main tuning dial and auxiliary vernier dial allow fast and accurate reading, precise and easy interpolation for bandwidth measurements.

To give freedom from the variable properties of r.f. contact resistance *contactless* wave band selection is employed.

A NORMAL/HIGH output switch on the front panel enables oscillator tube life to be considerably prolonged since the tube is under-run in the NORMAL position and the HIGH position is used only when maximum or near-maximum output is needed.

The above are just a few of the many features of the Marconi TF-801B Signal Generator — write or wire today for the complete specification.

## Marconi



Canada's  
Largest  
Electronic  
Specialists

CANADIAN MARCONI COMPANY  
MONTREAL 16



● Indicative of the festive atmosphere at the RETMA reception held in Niagara Falls last June 2nd and 3rd, are the above groups. *Top row*, left to right: Norman McHardy, Age Publications Ltd., Toronto; Bill Schofield, Canadian General Electric; Milton Stark, Stark Electronics, Ajax, Ontario; R. M. Brophy, Chairman of the Board, Rogers Majestic Electronics; Emil Loos; D. A. Golden, Deputy Minister, Department of Defense Production. *Bottom row*, left to right: Mrs. A. B. Hunt; Mr. Rice, Canadian Westinghouse Co., Hamilton; Miss Hunt; A. B. Hunt, Department of Defense Production, Ottawa; Mrs. Rice; C. A. Pollock, President of RETMA (Canada) and J. R. Longstaffe, of J. R. Longstaffe Co., Toronto.

### Boonton Represented In Canada By Bayly Engineering

Bayly Engineering Limited of Ajax, Ontario, have been appointed sales and service representatives in Canada for the Boonton Radio Corp., of Boonton, N. J. Complete service facilities for the repair and calibration of Boonton equipment which includes Q meters,

FM signal generators and other test equipment will be available in the Ajax plant of Bayly Engineering.

### Television Servicing Home-Study Course

The Service Committee of the Radio-Television Manufacturers Association of Canada, in co-operation with the

Radio College of Canada, has concluded arrangements for group enrollment in the home-study television servicing course operated by Radio College. By this method the cost of the course is reduced from \$125 to \$81, a saving to each student of \$44.

The group rate enrollment arrangement has been made available to assist service technicians increase their technical training to keep abreast of advances in the field. This is a follow-up to the very successful "Town Meetings" arranged by the RTMA Service Committee during the past few years. These consisted of concentrated courses of television servicing techniques held in various towns across Canada.

### G.E. Company Of England Controls Amalgamated Electric Corporation

The General Electric Co. Ltd. of England, the largest electrical manufacturing organization in the British Commonwealth, has recently completed the purchase of 99 per cent of the shares of the Amalgamated Electric Corporation Ltd. of Toronto.

Mr. A. V. Armstrong will continue to lead the team of executives of Amalgamated Electric Corporation Ltd., whose products include electrical distribution and lighting equipment, motor control apparatus, and wiring supplies.

## INDUSTRIAL ELECTRONICS H.Q.

# CESCO



BRANCHES  
MONTREAL  
OTTAWA  
TORONTO  
EDMONTON

### ONE SOURCE FOR ALL PURCHASES

Make CESCO your Headquarters for electronic component purchases and save. One source of supply for all your requirements. One purchase order to write and what is more important, the lowest industrial prices. Note these lines now carried in our stocks:

National Industrial Tubes  
Potter & Brumfield Relays  
Microswitch  
Struthers-Dunn Relays

Send in your inquiries to any of our 4 branches. You can be sure of a prompt reply to your requests for information, catalogues and quotations. If you do not have our 1955 Buying Guide write for your FREE copy today.

Wholesale Industrial Electronic Components

## CANADIAN ELECTRICAL SUPPLY CO. Ltd.

MONTREAL 275 Craig St. W. UN. 1-2411\*    OTTAWA 836 Somerset St. W. 8-5675\*    TORONTO 522 Yonge St. WA. 1-5111\*    EDMONTON 9\*23 101A Ave. 41224-41321

# SOUND

by

## "Engineered Sound"

Was selected by Crown Life Insurance Company for their new Home Office Building, Toronto. The main power amplifying bays as shown, provide high quality music distribution and paging facilities.



Call us for a survey of your sound requirements, large or small.

## ENGINEERED SOUND SYSTEMS

LIMITED

167 KIPLING AVE. S.

BE. 3-2155

TORONTO 18

## RTMA Publishes Production Source And Date Code

The Radio-Television Manufacturers Association of Canada has recently published a registration list of Production Source and Date Code symbols allotted to each of its member-companies. By this means manufacturers of radio, television, parts and accessories will be able to stamp or emboss their individual symbols on each component manufactured. The symbol also includes the month and year of production. By the use of the Production Source and Date Code it will now be possible for the manufacturer's name and date of production of any Canadian-made radio, television, or any other electronic component to be instantly identified.

## New IRE Section To Serve Bay of Quinte Area

A new section of the Institute of Radio Engineers has been formed to serve the members of the Bay of Quinte area including the cities of Trenton, Belleville and Kingston and the counties of Hastings, Northumberland, Prince Edward, Peterborough, Frontenac and Lennox and Addington.

At a meeting called by Mr. M. J. Waller, P.Eng., Member of I.R.E. held in Belleville on April 15th, the following were appointed to serve as a provisional executive committee:

Chairman: J. C. R. Punchard; Vice-Chairman: R. L. Smith; Secretary-Treasurer: M. J. Waller; Members-at-large: R. Williamson, K. V. Burkett, W. H. Holmes, W. D. Ryan.

Officers of the new section have stated that residents of the area interested in IRE activities should contact Mr. M. J. Waller, R.R. No. 1, Foxboro, Ontario.

## Hamilton Section I.R.E. Hold Annual Meeting

Dr. G. C. Laurence, Director, Reactor Research and Development Division, Atomic Energy of Canada Limited, at Chalk River was the guest speaker at the annual dinner meeting of the Hamilton Section, Institute of Radio Engineers held in the Wentworth Arms in Hamilton, April 18, last. Dr. Laurence spoke on the subject of Nuclear Electric Power Stations.

### Elect New Executive

The election of officers for the 1955-56 season for the Hamilton Section I.R.E. was held during the meeting and the following have been voted as the executive of the section for the coming year: Chairman, George Beaumont; Vice-Chairman, Armand Fromanger; Secretary-Treasurer, Norman Chapman.



● CGE vice-president R. M. Robinson (left) is shown with the recipients of the Colonel Keith S. Rogers Memorial Engineering Award. From left are: Mr. Robinson; Fenwick Job, CFJB, Brampton; Ernie Towndrow, representing CFOR, Orillia; and Allan Waters, CHUM, Toronto.

## Celebrated Inventor To Head Logistics Research, Inc.

Sir Robert Alexander Watson-Watt has been named President and Board Chairman of Logistics Research, Inc., designers and manufacturers of electronic computers, it has been announced.

In developing the potentialities of Logistics Research, Inc., Sir Robert will draw upon the scientific, engineering and management services he also heads. These are Sir Robert Watson-Watt and Partners, Ltd., London, and its two North American subsidiaries, Adalia, Ltd., Canada, and Adalia, Inc., New York.

The immediate program is to guide the development, manufacture and sale of ALWAC III, a low-priced, high-speed, general purpose digital computer that is finding wide use in business, scientific research and government.

## Watt Electronics Limited Acquire New Plant

Officials of Watt Electronic Products Limited have announced that their manufacturing facilities have been moved to a new plant at 151 Weber Street South in Waterloo, Ontario.

(Turn to page 78)

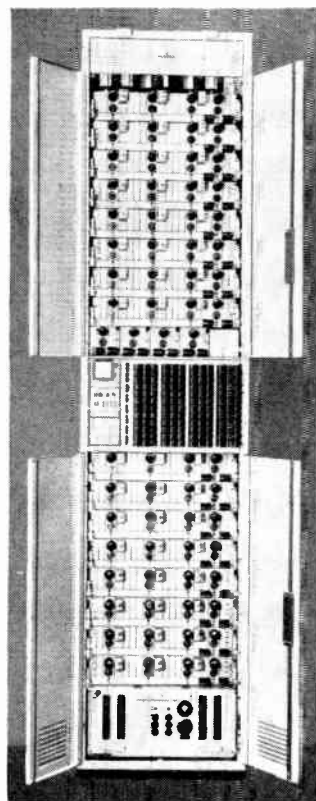

## SIXTY-CHANNEL CARRIER-TELEPHONE SYSTEM OF ADVANCED DESIGN FOR RADIO LINKS

The type F60 carrier-telephone system provides up to 60 channels, in 12-channel groups, on a four-wire basis for transmission over cable pairs or an FM radio system. Transmission is single-sideband suppressed-carrier in the frequency range 12 to 252 kc. Miniaturized plug-in equipment units are used, which also form part of universal carrier-telephone systems of from 3 to 960 channels. Channel band width is 300 to 3400 cycles. Three telephone channels in each group may be replaced by a 10-kc program channel. Built-in ringing and dialing facilities are available. The types FM 60/2000 Radio System, operating in the band 1700 to 2300 mc, FM60/300 Radio System, in the band 235 to 328 mc, and FM24/50 Radio System, in the band 41 to 68 mc, are designed for use with the F60 carrier-telephone system.

← Forty-eight channel modems mount on one boy side. Two boys mount a complete type F60 terminal.

## RADIO ENGINEERING PRODUCTS

1080 UNIVERSITY STREET, MONTREAL 3, CANADA

Telephone: UNiversity 6-6887

Cable Address: Radenpro, Montreal

MANUFACTURERS OF CARRIER-TELEGRAPH, CARRIER-TELEPHONE AND BROAD-BAND RADIO SYSTEMS

# KESTER

Absolutely non-corrosive and non-conductive, KESTER "RESIN-FIVE" CORE SOLDER contains an activated type of resin that gives you that fast, positive action on all your jobs . . . including the most difficult.

**KESTER SOLDER COMPANY OF CANADA, LTD.**  
Dept. U - Brantford, Canada

## SOLDER

## NEWS

(Continued from page 77)

### New President For Phillips Wires & Cables

Mr. A. S. Torrey, Chairman of the Board of Phillips Electrical Company (1953) Limited, has announced the election of Mr. T. A. Lindsay as the new President of Phillips. He succeeds T. W. Brackinreid, long-time President of the Company, who retired recently.

Mr. Lindsay is a graduate of the University of Manitoba, in Electrical Engineering, and is well-known in both Eastern and Western Canada.



T. A. LINDSAY

where he has served during his 21 years of association with the Company. He was appointed a Vice-President in 1951, and became Executive Vice-President of Phillips last November.

### D. D. McLean Named Westinghouse Electronics Sales Manager

Donald D. McLean has been named manager, sales department, in the Canadian Westinghouse Company's Electronics Division at Hamilton.

During the past four years of expansion for the company's Electronics

Division, Mr. McLean has served as supervisor of the government contracts section and manager of telecommunications equipment sales. He was appointed manager of the defence contracts department in



D. D. McLEAN

1953. Mr. McLean is a member of the Engineering Institute of Canada and the Institute of Radio Engineers.

(Turn to page 84)

This ONE instrument checks RF, IF, and AF performance of receivers.

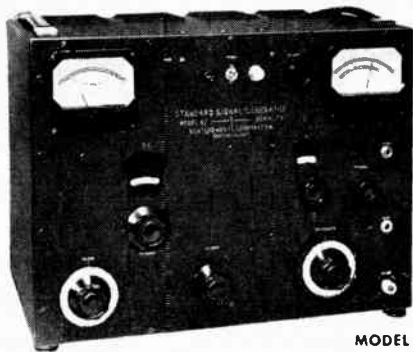

MODEL 82

#### SPECIFICATIONS:

**FREQUENCY RANGE:** 20 cycles to 200 Kc. in four ranges. 80 Kc. to 50 Mc. in seven ranges.

**OUTPUT VOLTAGE:** 0 to 50 volts across 7500 ohms from 20 cycles to 200 Kc. 0.1 microvolt to 1 volt across 50 ohms over most of range from 80 Kc. to 50 Mc.

**MODULATION:** Continuously variable 0 to 50% from 20 cycles to 20 Kc.

**POWER SUPPLY:** 117 volts, 50/60 cycles. 75 watts.

**DIMENSIONS:** 15" x 19" x 12". Weight, 50 lbs.

## Standard Signal Generator

20 cycles - 50 mc.

#### FEATURES:

- Continuous frequency coverage from 20 cycles to 50 mc.
- Direct-reading individually calibrated dials.
- Low harmonic content.
- Accurate, metered output.
- Mutual inductance type attenuator for high frequency oscillator.
- Stray field and leakage negligible.
- Completely self-contained.

**MEASUREMENTS CORPORATION**

BOONTON · NEW JERSEY

IN CANADA —

H. Roy Gray, Ltd. 46 Danforth Road, Toronto, Canada.



For further data on advertised products use page 99.



# Heathkit PRINTED CIRCUIT 5" COLOR TV Oscilloscope Kit

MODEL  
0-10  
**\$69<sup>50</sup>**  
Shpg. Wt. 27 lbs.

The technical specifications for this fine instrument speak for themselves. Vertical channel sensitivity is 0.025 volts RMS/inch at 1 Kc. Vertical frequency response is essentially flat to 5 Mc, and down only 1.5 db at 3.58 Mc. Ideal for Color TV work!

Extended sweep generator range is from 20 cps to 500 Kc in five steps, far beyond the range normally encountered at this price level.

Other features are: plastic-molded capacitors for coupling and by-pass—preformed and cabled wiring harness—Z axis input for intensity modulation—peak-to-peak voltage calibrating source built-in—retrace blanking amplifier—regulated power supply—high insulation printed circuit boards—step attenuated and frequency compensated vertical input circuit—push-pull horizontal and vertical amplifiers—excellent sync. characteristics—sharp, hairline focusing—uses 5U1P CRT—extremely attractive physical appearance.

An essential instrument for professional Laboratory or for servicing mono-chrome or color TV.

## Heathkit PRINTED CIRCUIT 3" OSCILLOSCOPE KIT

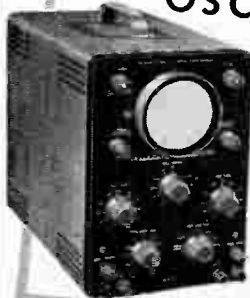

This light, portable 3" oscilloscope is just the ticket for the ham, for service calls, or as an "extra" scope in the shop, or lab. Measures only 9 1/2" H x 6 3/4" W x 11 3/4" D, and weighs only 11 lbs.  
Employs printed circuit board for improved circuit performance. Vertical amplifiers flat within +3 db from 2 cps to 200 Kc. Vertical sensitivity 0.25 volts RMS/inch peak-to-peak, and sweep generator operates from 20 cps to 100,000 cps. R.F. connection to deflection plates.

**MODEL OL-1**  
**\$29<sup>50</sup>**  
Shpg. Wt. 14 lbs.

## Heathkit PRINTED CIRCUIT 5" OSCILLOSCOPE KIT



This full-size 5" Oscilloscope incorporates many outstanding features. Vertical channel flat within +3 db, 2 cps to 200 Kc, with 0.09 volts RMS/inch peak-to-peak sensitivity at 1 Kc. Sweep operation from 20 cps to 100,000 cps. Built-in peak-to-peak voltage calibration—3 step frequency compensated input attenuator—phasing control—push-pull deflection amplifiers. Printed circuits for reliable performance and reduced construction time.

**MODEL OM-1**  
**\$49<sup>50</sup>**  
Shpg. Wt. 26 lbs.

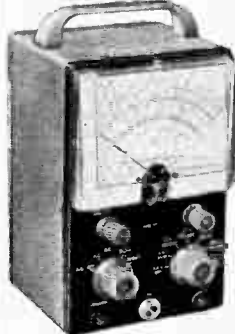

### Heathkit PRINTED CIRCUIT VACUUM TUBE VOLTMETER KIT

**MODEL V-7**  
**\$24<sup>50</sup>**  
Shpg. Wt. 7 lbs.

This VTVM has set a new standard for accuracy and reliability in kit-form electronic instruments. Features modern, time-saving printed circuits, and functional arrangement of controls and scales. Includes new peak-to-peak scale for FM and TV work.

Measures AC (RMS) and DC voltage at 0-1.5, 15, 50, 150, 500, and 1500; peak-to-peak AC voltage at 0-4, 14, 40, 140, 400, 1400, and 4000; center-scale resistance readings of 10, 100, 1000, 10,000, 100 K, 1 meg., and 10 meg. DB scale provided also. Zero-center operation within range of front panel controls. Polarity reversal switch—200  $\mu$ a 4 1/2 meter-transformer power supply—11 megohm input impedance—1% precision resistors—high quality components used throughout.

### Heathkit VOLTAGE CALIBRATOR KIT

Once calibrated, this instrument provides a known peak-to-peak voltage standard for comparison with unknown voltage values on an oscilloscope. Panel calibrated directly—no involved calculations required. Operates within a voltage range of .01 to 100 volts peak-to-peak.



**MODEL VC-2**  
**\$11<sup>50</sup>**  
Shpg. Wt. 4 lbs



### Heathkit 20,000 ohms/volt MULTIMETER KIT

**MODEL MM-1**  
**\$29<sup>50</sup>**  
Shpg. Wt. 6 lbs.

Features comprehensive range coverage. 20,000  $\Omega$ /V D.C. and 5000  $\Omega$ /V A.C. Ranges: 0-1.5, 5, 50, 150, 500, 1500, and 5000 V. direct current from 0 to 150  $\mu$ a., 15 a. in 5 steps. Center-scale resistance of 15, 1500 and 150,000 ohms, and db from -10 to +65.

Uses 1% precision resistors—50  $\mu$ a. meter—molded bakelite case.

### Heathkit DIRECT-READING CAPACITY METER KIT



Extremely valuable where speed and convenience are essential. Quality control work, production line checking, etc. Reads capacity directly on meter scale, from 0-100 mmfd, 1000 mmfd, .01 mfd, and .1 mfd. Residual capacity less than 1 mmfd. Not susceptible to hand capacity.

**MODEL CM-1**  
**\$29<sup>50</sup>**  
Shpg. Wt. 7 lbs.



### Heathkit A.C. VACUUM TUBE VOLTMETER KIT

**MODEL AV-2**  
**\$29<sup>50</sup>**  
Shpg. Wt. 5 lbs.

Measures AC voltage only, from 10 cps to 50 Kc. Covers the range from 1 millivolt to 300 volts in 10 steps at high impedance input. Incorporates full 10 ranges of db scale from -52 db to +52 db. Essential in the audio laboratory or for audio enthusiasts and experimenters. Provides sensitivity essential for low level audio measurements.

### Heathkit ELECTRONIC SWITCH KIT



This device will electronically switch between 2 input signals to produce both signals alternately at the output. Used in conjunction with an oscilloscope, it will permit the observation of 2 signals simultaneously. Provides switching rates from 10 cps to 200 cps.

**MODEL S-2**  
**\$23<sup>50</sup>**  
Shpg. Wt. 11 lbs.

# HEATH Company

A SUBSIDIARY OF DAYSTROM INC.

BENTON HARBOR 3, MICHIGAN

# Heathkit TUBE CHECKER KIT

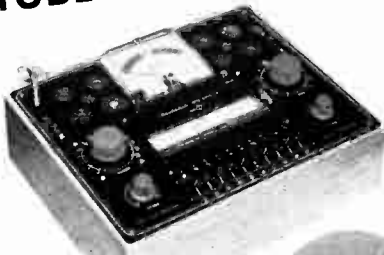

**MODEL TC-2**  
**\$29.50**  
Shpg. Wt. 12 lbs.

Because of its low price this fine tube tester is available, not only to the service shop and laboratory, but to part-time servicemen, experimenters, and radio amateurs, as well. Will test all tubes commonly encountered in radio and TV service work. Simple "GOOD-BAD" scale on the 4 1/4" meter. Tests for open, short, and quality on the basis of total emission. Includes illuminated roll chart. Fourteen different filament voltage values available. Separate lever switch for each tube element.

Model TC-2P is the same electrically as TC-2, except that it is housed in a beautiful two-toned portable carrying case. Only \$34.50. Shpg. Wt. 15 lbs.

Portable carrying case available separately for Model TC-2, or older model TC-1. Cab. No. 91-8, \$7.50. Shpg. Wt. 7 lbs.

CRT Test Adapter, Model 355 for use with the TC-2, \$4.50. Shpg. Wt. 1 lb.

# SELECT YOUR NEXT HEATHKIT FROM

## Heathkit TV ALIGNMENT GENERATOR KIT

Here is the complete R.F. signal source for FM and TV alignment, (both monochrome and color). Provides output on fundamentals from 3.6 Mc to 220 Mc in four bands, with harmonic output usable up through the UHF channels. Electronic sweep circuit eliminates mechanical gadgets and accompanying noise, hum, and vibration. Continuously variable sweep up to 0-42 Mc, depending on base frequency.

Variable marker (19-60 Mc on fundamentals) and crystal marker (4.5 Mc and multiples thereof) generators built-in. Crystal included with kit. Provision for external marker if desired.

Packed with outstanding features. 50 ohm output impedance—exceptionally good linearity—effective AGC action—plenty of R.F. output. An essential instrument for the up-to-date service shop.



**\$49.50**

**MODEL TS-4**  
Shpg. Wt. 16 lbs.



**MODEL SG-8**  
**\$19.50**  
Shpg. Wt. 8 lbs.

## Heathkit SIGNAL GENERATOR KIT

This is one of our most popular kits, and is "serviceman engineered" to fulfill the signal source requirements of the radio serviceman and experimenter.

Covers 160 Kc to 110 Mc (in fundamentals (5 bands), with output in excess of 100,000 microvolts. Calibrated harmonics extend usefulness up to 220 Mc. Choice of unmodulated R.F. output, 400 cps modulated R.F. output, or 400 cps audio output. Step-type and continuously variable output attenuation controls.

Coils are prewound, and construction manual is complete. Calibration unnecessary for service applications.

### Model RS-1 Heathkit RESISTANCE SUBSTITUTION BOX KIT



Provides switch selection of 36 RTMA 1 watt standard 10% resistors, ranging from 15 ohms to 10 megohms. Numerous applications in radio and TV work.

**\$5.50**  
Shpg. Wt. 2 lbs.

### Heathkit CONDENSER SUBSTITUTION BOX KIT

Very popular companion to Heathkit RS-1. Individual selection of 18 RTMA standard condenser values from .0001 mfd to .22 mfd. Aluminum panel, bakelite case, and includes 18" flexible leads with alligator clips.

**Model CS-1**  
**\$5.50**  
Shpg. Wt. 2 lbs.



### Model DR-1 Heathkit DECADE RESISTANCE KIT



Twenty 1% precision resistors provide resistance from 1-99,999 ohms in 1 ohm steps. Indispensable around service shop, laboratory, ham shack, or home workshop.

**\$19.50**  
Shpg. Wt. 4 lbs.

### Heathkit DECADE CONDENSER KIT

Provides capacity values from 100 mmf to 0.111 mfd in steps of 100 mmfs. +1% precision silver-mica condensers used. High quality ceramic wafer switches for reduced leakage.



**Model DC-1**  
Shpg. Wt. 3 lbs.  
**\$16.50**

### Heathkit CONDENSER CHECKER KIT



Measures capacity in four ranges from .00001 to 1000 mfd. Power factor control is provided for indication of electrolytic condenser efficiency. Tests capacitors under actual load conditions. Checks resistance from 100 ohms to 5 megohms. Direct reading scales for all tests. No calculation necessary.

**Model C-3**  
**\$19.50**  
Shpg. Wt. 7 lbs.

### Heathkit LABORATORY GENERATOR KIT

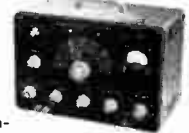

Here is a signal generator for use where high accuracy and metered performance are essential. Covers 150 Kc to 30 Mc on fundamentals in 5 bands. 400 cps modulation variable from 0 to 50%. R.F. output at 50 ohms from 100,000 to 1uv. Meter reads R.F. output in uv or modulation percentage. Fixed-step and variable output.

**\$39.50**  
Shpg. Wt. 16 lbs.

### Model T-3 Heathkit VISUAL-AURAL SIGNAL TRACER KIT



**\$23.50**  
Shpg. Wt. 9 lbs.

This signal tracer features a high-gain R.F. channel and probe to permit signal tracing from the receiver antenna input through the R.F. and I.F. stages. Separate low gain channel for audio circuits. Both visual and aural indication by means of speaker and electron beam "eye" tube.

Also noise locate circuit, wattmeter, and terminals for "patching" output transformer or speaker into external circuit.

### Model M-1 Heathkit HANDITESTER KIT



**\$14.50**  
Shpg. Wt. 3 lbs.

The M-1 is literally pocket size to fit in your coat pocket, tool-box, glove compartment, or desk drawer. Measures A.C. or D.C. v. in 5 steps from a full scale minimum of 0-10 v. to a maximum of 0-5000 v. Measures direct current at 0-10 Ma and 0-100 Ma, and provides ohmmeter ranges of 0-3000 and 0-300,000 ohms. Sensitivity of 1,000 ohms/v. 1% precision divider resistors employed.

# HEATH Company

A SUBSIDIARY OF DAYSTROM INC.  
BENTON HARBOR 3, MICHIGAN



# THESE HIGH QUALITY INSTRUMENTS

## Heathkit HARMONIC DISTORTION METER KIT



MODEL HD-1  
**\$49.50**  
 Shpg. Wt. 13 lbs.

Performs the functions of more elaborate and much more expensive audio distortion testing devices and yet is simple to operate and inexpensive to own. Used with a sine wave generator, it will check the harmonic distortion output of audio amplifiers under a variety of conditions. Essential in audio design work.

The HD-1 reads harmonic distortion directly on the meter as a percentage of the original signal input. It operates from 20 to 20,000 cps in 3 ranges, and incorporates a VTVM circuit for initial reference settings and final harmonic distortion readings. VTVM ranges are 0-1, 3, 10, and 30 volts full scale. 1% precision voltage divider resistors used. Distortion meter scales are 0-1, 3, 10, 30 and 100% full scale. Having a high input impedance the HD-1 requires only .3 volt input for distortion tests.

## Heathkit AUDIO GENERATOR KIT

This basic audio reference generator deserves a place in your Laboratory. Complete frequency coverage is afforded from 20 cps to 1 Mc in 5 ranges, and output is constant within  $\pm 1$  db from 20 cps to 400 Kc, down only 3 db at 600 Kc., and 8 db at 1 Mc. An extremely good sine wave is produced, with a distortion percentage below 0.4% from 100 cps through the audible range.

Plenty of audio output for all applications; up to 10 v. under no load conditions. Output controllable with a continuously variable or step-type attenuator with settings of 1  $\mu$ v, 100  $\mu$ v, 1 v, and 10 v. Cathode follower output.



MODEL AG-8  
**\$29.50**  
 Shpg. Wt. 11 lbs.

## Heathkit AUDIO ANALYZER KIT



MODEL AA-1  
**\$59.50**  
 Shpg. Wt. 13 lbs.

The AA-1 consists of an audio wattmeter, an AC VTVM, and a complete IM analyzer, all in one compact unit. It offers a tremendous saving over the price of these instruments purchased separately.

Use the VTVM to measure noise, frequency response, output gain, power supply ripple, etc. Use the wattmeter for measurement of power output. Internal loads provided for 4, 8, 16, or 600 ohms. VTVM also calibrated for DBM units so db gain or loss can be noted quickly.

High or low impedance IM measurements can be made. High (6 Kc) and low (60 cps) frequency generators built-in. Only 4 meter scales are employed, and one of these is in color so that results are easily read on the scale. Full scale VTVM ranges are .01 to 300 volts in 10 steps, full scale wattmeter ranges are .15 mw to 150 w in 7 steps. IM analyzer scales are 1%, 3%, 10%, 30% and 100%.



## Heathkit VARIABLE VOLTAGE POWER SUPPLY KIT

Model PS-3  
**\$35.50**  
 Shpg. Wt. 17 lbs.

Provides regulated DC output for B+, and 6.3 v. AC at 4 amps, for filaments. Output variable from 0 to 500 v. DC at no load, linear from 0 to 10 ma at 450 v. ac and 0-130 ma at 200 vdc! Essential for circuit design and development. Voltage or current read on  $4\frac{1}{2}$ " meter.



## Heathkit "Q" METER KIT

Model QM-1  
**\$44.50**  
 Shpg. Wt. 14 lbs.

Will measure Q of condensers, RF resistance and distributed capacity of coils, etc. Uses  $4\frac{1}{2}$ " 50  $\mu$ a meter for direct indication. Will test at 150 Kc to 18 Mc in 4 ranges. Measures capacity from 40 mmf to 450 mmf within  $\pm 3$  mmf. Useful for checking wave traps, chokes, peaking coils. Indispensable for coil winding and determining unknown condenser values.

## Heathkit AUDIO OSCILLATOR KIT



MODEL AO-1  
**\$24.50**  
 Shpg. Wt. 10 lbs.

(SINE WAVE - SQUARE WAVE)

Features sine or square wave coverage from 20 to 20,000 cps in 3 ranges. An instrument specifically designed to completely fulfill the needs of the serviceman and high fidelity enthusiast. Offers high-level output across the entire frequency range, low distortion and low impedance output. Uses a thermistor in the second amplifier stage to maintain essentially flat output through the entire frequency range. Produces good, clean square waves with a rise time of only 2 microseconds.

## Heathkit IMPEDANCE BRIDGE KIT



Measures resistance, capacitance, inductance, dissipation factors of condensers, and the storage factor of inductance. Employs 2-section CRL dial. D, Q and DQ functions are combined in one control.  $\frac{1}{4}$ % resistors and capacitors used in critical circuits. 100-0-100 microammeter for null indications. 1000 cycle oscillator, 4 tube detector-amplifier, and power supply built-in.

Model IB-2  
**\$59.50**  
 Shpg. Wt. 12 lbs.

## Heathkit 6-12 VOLT BATTERY ELIMINATOR KIT



Furnishes 6 or 12 volt output for the new 12 v. car radios in addition to 6 v. models. Two continuously variable output voltage ranges; 0-8 v. DC at 10 A. continuously or 15 A. intermittent, 0-16 v. DC at 5 A. continuously or 7.5 A. intermittent. Output voltage is clean and well filtered by two 10,000 mfd condensers. Panel meters read voltage and current output.

Model BE-4  
**\$31.50**  
 Shpg. Wt. 17 lbs.



MODEL BR-2  
**\$17.50**  
 (Less Cabinet)  
 Shpg. Wt. 10 lbs.

## Heathkit BROADCAST BAND RECEIVER KIT

Build your own receiver with confidence. Complete instruction book anticipates your every question.

Features transformer-type power supply, high-gain miniature tubes, built-in antenna, planetary tuning from 550 Kc to 1600 Kc,  $5\frac{1}{2}$ " speaker. Also adaptable for use as AM tuner or phono amplifier. CABINET: Fabric covered plywood cabinet available, complete with aluminum panel and re-inforced speaker grille. Part No. 91-9, Shpg. Wt. 5 lbs., \$4.50

**HEATH Company**  
 A SUBSIDIARY OF DAYSTROM INC.  
 BENTON HARBOR 3, MICHIGAN

**New**

# Heathkit DX-100 PHONE AND CW TRANSMITTER KIT



MODEL DX-100

**\$189<sup>50</sup>**

Shpg. Wt. 120 lbs.

Shipped motor freight unless otherwise requested. \$50.00 deposit required for C.G.D. orders.

This one compact package contains complete transmitter, with built-in VFO, modulator, and power supplies. Provides phone or CW operation—VFO or crystal excitation—and hand-switching from 160 meters through 10 meters. R.F. power output 100—125 watts phone, 120—140 CW. Parallel 6146's modulated by push-pull 1625's. Pi network interstage and output coupling for reduced harmonic output. Will match non-reactive antennas between 50 ohms and 600 ohms. TVI suppressed with extensive shielding and filtering. Rugged metal cabinet has inter-locking seams.

The high-quality transmitter is packed with desirable features not expected at this price level. Copper plated chassis—potted trans-

formers—wide spaced tuning capacitors—ceramic insulation—illuminated VFO dial and meter face—remote control socket—preformed wiring harness—concentric control shafts—high quality, well rated components used throughout. Overall dimensions 20 $\frac{1}{2}$ " wide x 13 $\frac{3}{4}$ " high x 16" deep.

Supplied complete with all components, tubes, cabinet and detailed construction Manual. (Less crystals.) Don't be deceived by the low price! This is a top-quality transmitter designed to give you years of reliable service and dependable performance.



MODEL AT-1

**\$29<sup>50</sup>**

Shpg. Wt. 15 lbs.

## Heathkit AMATEUR TRANSMITTER KIT

Enjoy the trouble-free operation of commercially designed equipment while still benefiting from the economies and personal satisfaction of "building it yourself."

This CW Transmitter is complete with its own power supply, and covers 80, 40, 20, 15, 11 and 10 meters. Single knob handswitching eliminates coil changing. Panel meter indicates grid or plate current for the final. Crystal operation, or can be excited by external VFO. Crystal not included in kit. Incorporates features one would not expect in this price range, such as: key-click filter, line-quality components throughout, prewound coils, 52 ohm coaxial output, and high quality components throughout. Instruction Book simplifies assembly. Uses 6AG7 oscillator, 6L6 final and 5U4G rectifier. Up to 35 watts plate power input.



Model GD-1B

**\$19<sup>50</sup>**

Shpg. Wt. 4 lbs.

### Heathkit GRID DIP METER KIT

This is an extremely valuable tool for Hams, Engineers or Servicemen. Covering from 2 Mc to 250 Mc, it uses 500  $\mu$ a meter for indication. Kit includes prewound coils and rack. Will accomplish literally hundreds of jobs on all types of equipment.

### Heathkit ANTENNA IMPEDANCE METER KIT

Use in conjunction with a signal source for measuring antenna impedance, line matching purposes, etc. Will double, also, as a phone monitor or relative field strength indicator.

100  $\mu$ a meter employed. Covers the range from 0 to 600 ohms. An instrument of many uses for the amateur.



Model AM-1

**\$14<sup>50</sup>**

Shpg. Wt. 2 lbs.

### Heathkit VFO KIT

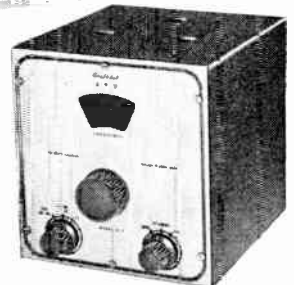

MODEL VF-1

**\$19<sup>50</sup>**

Shpg. Wt. 7 lbs.

Weigh the cost of this kit against the cost of crystals—and consider the convenience and flexibility of VFO operation. This is one of the most outstanding kits we have ever offered for the radio amateur.

Covers 160—80—40—20—15—11 and 10 meters with three basic oscillator frequencies. Illuminated and precalibrated dial scale clearly indicates frequency on all bands and provides more than two feet of dial calibration. Reflects quality design in the use of ceramic coil forms and tuning capacitor insulation, and copper plated chassis. Simply plugs into crystal socket of any modern transmitter to provide coverage of the bands from 160 meters through 10 meters. Uses 6AU6 Clapp oscillator, and OA2 voltage regulator for stability. May be powered from plug on Heathkit Model AT-1 Transmitter, or supplied with power from most transmitters.



Model AC-1

**\$14<sup>50</sup>**

Shpg. Wt. 4 lbs.

### Heathkit ANTENNA COUPLER KIT

Poor matching allows valuable communications energy to be lost. The Model AC-1 will match your low power transmitter to an end-fed long wire antenna. Also attenuates signals above 36 Mc, reducing TVI. 52 ohm coaxial input—power up to 75 watts—10 through 80 meters.

### Heathkit COMMUNICATIONS RECEIVER KIT

Covers 550 Kc to 35 Mc in 4 bands. Features electrical bandspread—separate R.F. and A.F. gain controls—noise limiter—AGC—BFO—phone jack—5 $\frac{1}{4}$ " PM speaker.

CABINET: Fabric covered plywood cabinet. Part No. 91-10. Shpg. Wt. 5 lbs. \$4.50



Model AR-2

**\$25<sup>50</sup>**

Shpg. Wt. 12 lbs. (Less Cabinet)

# HEATH Company

A SUBSIDIARY OF DAYSTROM INC.  
BENTON HARBOR 3, MICHIGAN

For further data on advertised products use page 99.

THESE HIGH QUALITY INSTRUMENTS

Heathkit HARMONIC DISTORTION METER KIT



MODEL HD-1  
**\$49.50**  
Shpg. Wt. 13 lbs.

Performs the functions of more elaborate and much more expensive audio distortion testing devices and yet is simple to operate and inexpensive to own. Used with a sine wave generator, it will check the harmonic distortion output of audio amplifiers under a variety of conditions. Essential in audio design work.

The HD-1 reads harmonic distortion directly on the meter as a percentage of the original signal input. It operates from 20 to 20,000 cps in 3 ranges, and incorporates a VTVM circuit for initial reference settings and final harmonic distortion readings. VTVM ranges are 0-1, 3, 10, and 30 volts full scale. 1% precision voltage divider resistors used. Distortion meter scales are 0-1, 3, 10, 30 and 100% full scale. Having a high input impedance the HD-1 requires only .3 volt input for distortion tests.

Heathkit AUDIO GENERATOR KIT

This basic audio reference generator deserves a place in your Laboratory. Complete frequency coverage is afforded from 20 cps to 1 Mc in 5 ranges, and output is constant within  $\pm 1$  db from 20 cps to 400 Kc, down only 3 db at 600 Kc., and 8 db at 1 Mc. An extremely good sine wave is produced, with a distortion percentage below 0.4% from 100 cps through the audible range.

Plenty of audio output for all applications; up to 10 v. under no load conditions. Output controllable with a continuously variable or step-type attenuator with settings of 1  $\mu$ v, 100  $\mu$ v, 1 v, and 10 v. Cathode follower output.



MODEL AG-8  
**\$29.50**  
Shpg. Wt. 11 lbs.

Heathkit AUDIO ANALYZER KIT



MODEL AA-1  
**\$59.50**  
Shpg. Wt. 13 lbs.

The AA-1 consists of an audio wattmeter, an AC VTVM, and a complete IM analyzer, all in one compact unit. It offers a tremendous saving over the price of these instruments purchased separately.

Use the VTVM to measure noise, frequency response, output gain, power supply ripple, etc. Use the wattmeter for measurement of power output. Internal loads provided for 4, 8, 16, or 600 ohms. VTVM also calibrated for DBM units so db gain or loss can be noted quickly.

High or low impedance IM measurements can be made. High (6 Kc) and low (60 cps) frequency generators built-in. Only 4 meter scales are employed, and one of these is in color so that results are easily read on the scale. Full scale VTVM ranges are .01 to 300 volts in 10 steps, full scale wattmeter ranges are .15 mw to 150 w in 7 steps. IM analyzer scales are 1%, 3%, 10%, 30% and 100%.



Model PS-3  
**\$35.50**  
Shpg. Wt. 17 lbs.

Heathkit VARIABLE VOLTAGE POWER SUPPLY KIT

Provides regulated DC output for B+, and 6.3 v. AC at 4 amps, for filaments. Output variable from 0 to 500 v. DC at no load, linear from 0 to 10 ma at 450 vdc and 0-130 ma at 200 vdc! Essential for circuit design and development. Voltage or current read on  $4\frac{1}{2}$ " meter.



Model QM-1  
**\$44.50**  
Shpg. Wt. 14 lbs.

Heathkit "Q" METER KIT

Will measure Q of condensers, RF resistance and distributed capacity of coils, etc. Uses  $4\frac{1}{2}$ " 50  $\mu$ a meter for direct indication. Will test at 150 Kc to 18 Mc in 4 ranges. Measures capacity from 40 mmf to 450 mmf within  $\pm 3$  mmf. Useful for checking wave traps, chokes, peaking coils. Indispensable for coil winding and determining unknown condenser values.

Heathkit AUDIO OSCILLATOR KIT



MODEL AO-1  
**\$24.50**  
Shpg. Wt. 10 lbs.

(SINE WAVE - SQUARE WAVE)

Features sine or square wave coverage from 20 to 20,000 cps in 3 ranges. An instrument specifically designed to completely fulfill the needs of the serviceman and high fidelity enthusiast. Offers high-level output across the entire frequency range, low distortion and low impedance output. Uses a thermistor in the second amplifier stage to maintain essentially flat output through the entire frequency range. Produces good, clean square waves with a rise time of only 2 microseconds.

Heathkit IMPEDANCE BRIDGE KIT

Measures resistance, capacitance, inductance, dissipation factors of condensers, and the storage factor of inductance. Employs 2-section CFL dial. D, Q and DQ functions are combined in one control.  $\frac{1}{2}$ % resistors and capacitors used in critical circuits. 100-0-100 microammeter for null indications. 1000 cycle oscillator, 4 tube detector-amplifier, and power supply built-in.



Model IB-2  
**\$59.50**  
Shpg. Wt. 12 lbs.

Heathkit 6-12 VOLT BATTERY ELIMINATOR KIT

Furnishes 6 or 12 volt output for the new 12 v. car radios in addition to 6 v. models. Two continuously variable output voltage ranges; 0-8 v. DC at 10 A. continuously or 15 A. intermittent, 0-16 v. DC at 5 A. continuously or 7.5 A. intermittent. Output voltage is clean and well filtered by two 10,000 mfd condensers. Panel meters read voltage and current output.



Model BE-4  
**\$31.50**  
Shpg. Wt. 17 lbs.

Heathkit BROADCAST BAND RECEIVER KIT



MODEL BR-2  
**\$17.50**  
(Less Cabinet!)  
Shpg. Wt. 10 lbs.

Build your own receiver with confidence. Complete instruction book anticipates your every question.

Features transformer-type power supply, high-gain miniature tubes, built-in antenna, planetary tuning from 550 Kc to 1600 Kc,  $5\frac{1}{2}$ " speaker. Also adaptable for use as AM tuner or phono amplifier.

CABINET: Fabric covered plywood cabinet available, complete with aluminum panel and re-inforced speaker grille. Part No. 91-9, Shpg. Wt. 5 lbs., \$4.50

HEATH Company

A SUBSIDIARY OF DAYSTROM INC.  
BENTON HARBOR 3, MICHIGAN

**New**

# Heathkit DX-100 PHONE AND CW TRANSMITTER KIT



MODEL DX-100

**\$189.50**

Shipped motor freight unless otherwise requested. \$50.00 deposit required for C.O.D. orders.

Shpg. Wt. 120 lbs.

This one compact package contains complete transmitter, with built-in VFO, modulator, and power supplies. Provides phone or CW operation—VFO or crystal excitation—and band-switching from 160 meters through 10 meters. R.F. power output 100—125 watts phone, 120—140 CW. Parallel 6L46's modulated by push-pull 1625's. Pi network interstage and output coupling for reduced harmonic output. Will match non-reactive antennas between 50 ohms and 600 ohms. TVI suppressed with extensive shielding and filtering. Rugged metal cabinet has inter-locking seams.

The high-quality transmitter is packed with desirable features not expected at this price level. Copper plated chassis—potted trans-

formers—wide spaced tuning capacitors—ceramic insulation—illuminated VFO dial and meter face—remote control socket—preformed wiring harness—concentric control shafts—high quality, well rated components used throughout. Overall dimensions 20 $\frac{3}{4}$ " wide x 13 $\frac{3}{4}$ " high x 16" deep.

Supplied complete with all components, tubes, cabinet and detailed construction Manual. (Less crystals.) Don't be deceived by the low price! This is a top-quality transmitter designed to give you years of reliable service and dependable performance.



MODEL AT-1

**\$29.50**

Shpg. Wt. 15 lbs.

## Heathkit AMATEUR TRANSMITTER KIT

Enjoy the trouble-free operation of commercially designed equipment while still benefiting from the economies and personal satisfaction of "building it yourself."

This CW Transmitter is complete with its own power supply, and covers 80, 40, 20, 15, 11 and 10 meters. Single knob bandswitching eliminates coil changing. Panel meter indicates grid or plate current for the final. Crystal operation or can be excited by external VFO. Crystal not included in kit. Incorporated features one would not expect in this price range, such as key-click filter, line-quality components throughout. Instruction Book simplifies assembly. Uses 6AG7 oscillator, 6L6 final and 5U4G rectifier. Up to 35 watts plate power input.



Model GD-1B

**\$19.50**

Shpg. Wt. 4 lbs.

### Heathkit GRID DIP METER KIT

This is an extremely valuable tool for Hams, Engineers or Servicemen. Covering from 2 Mc to 250 Mc, it uses 500  $\mu$ a meter for indication. Kit includes prewound coils and rack. Will accomplish literally hundreds of jobs on all types of equipment.

### Heathkit ANTENNA IMPEDANCE METER KIT

Use in conjunction with a signal source for measuring antenna impedance, line matching purposes, etc. Will double, also, as a phone monitor or relative field strength indicator.

100  $\mu$ a meter employed. Covers the range from 0 to 600 ohms. An instrument of many uses for the amateur.



Model AM-1

**\$14.50**

Shpg. Wt. 2 lbs.

### Heathkit VFO KIT



MODEL VF-1

**\$19.50**

Shpg. Wt. 7 lbs.

Weigh the cost of this kit against the cost of crystals—and consider the convenience and flexibility of VFO operation. This is one of the most outstanding kits we have ever offered for the radio amateur.

Covers 160—80—40—20—15—11 and 10 meters with three basic oscillator frequencies. Illuminated and precalibrated dial scale clearly indicates frequency on all bands and provides more than two feet of dial calibration. Reflects quality design in the use of ceramic coil forms and tuning capacitor insulation, and copper plated chassis. Simply plugs into crystal socket of any modern transmitter to provide coverage of the bands from 160 meters through 10 meters. Uses 6AU6 Clapp oscillator, and OA2 voltage regulator for stability. May be powered from plug on Heathkit Model AT-1 Transmitter, or supplied with power from most transmitters.



Model AC-1

**\$14.50**

Shpg. Wt. 4 lbs.

### Heathkit ANTENNA COUPLER KIT

Poor matching allows valuable communications energy to be lost. The Model AC-1 will match your low power transmitter to an end-fed long wire antenna. Also attenuates signals above 36 Mc, reducing TVI. 52 ohm coaxial input—power up to 75 watts—10 through 80 meters.

### Heathkit COMMUNICATIONS RECEIVER KIT

Covers 550 Kc to 35 Mc in 4 bands. Features electrical bandspread—separate R.F. and A.F. gain controls—noise limiter—AGC—BFO—phone jack—5 $\frac{1}{2}$ " PM speaker.

CABINET: Fabric covered plywood cabinet, Part No. 91-10. Shpg. Wt. 5 lbs. \$4.50



Model AR-2

**\$25.50**

Shpg. Wt. 12 lbs. (Less Cabinet)

# HEATH Company

A SUBSIDIARY OF DAYSTROM INC.  
BENTON HARBOR 3, MICHIGAN



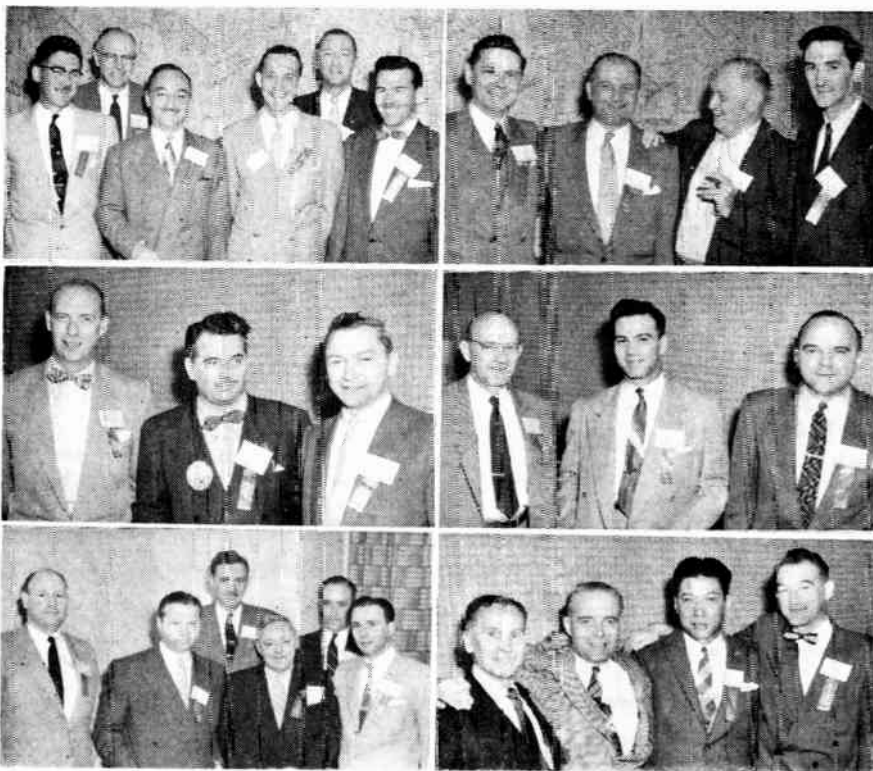

## Canadian Electronics Sales Reps Meet In Chicago

Guest speaker at the 12th annual luncheon of the Canadian Electronic Sales Representatives meeting held in the Conrad Hilton Hotel, Chicago, May 18th last, was Frederick H. Palmer, M.C., Canadian Consul-General in Chicago.

The theme of Mr. Palmer's talk to the more than 140 members of the CESR who attended the luncheon concerned the development of a better understanding between Canadians and Americans. In the course of his address Mr. Palmer pointed out some of the reasons why Canadians and Americans misunderstand each other but said that with the increasing volume of American investment in Canada, Americans were rapidly learning more about this country and the Canadian people. In order to increase this growing understanding, Mr. Palmer said, Canadians also should do their utmost to understand their American neighbors.

The CESR Annual Meeting held concurrently with the Electronic Parts Distributors Show in Chicago returned the existing executive to office for another year. Members of the executive are: Fred Harris, Chairman; C. G. Pointon, Vice-Chairman; A. T. R. Armstrong, Treasurer; Chas. L. Thompson, Vice-Chairman and John T. Rochford, Secretary.

● Some of the members of the CESR who attended the Electronics Parts Show in Chicago are shown above *top row*, left to right: Jim Key, Aerovox; Chas. L. Thompson, Chas. L. Thompson Ltd.; H. M. Best, Antiference; B. F. Lord, J. R. Longstaffe, Ltd.; W. H. Furneaux, Aerovox; Al McNabb, Aerovox; L. Claude Simmonds, A. C. Simmonds and Sons Ltd.; Gene Dahmer, Electrohome; Chas. W. Pointon, Chas. W. Pointon Ltd.; and John MacDiarmid, Chas. W. Pointon Ltd. *Center row*, left to right: Roy Gray, F. Fucille; Leo J. Doucette; J. R. Tilton, J. R. Tilton Co.; Wilf Farrow, Alex L. Clark Ltd. and C. M. Westcott, Delhi Metal Products. *Bottom row*, left to right: J. F. Hogan, Rogers Majestic Electronics; Ben Mannis, Stark Electronics; Ted Hill, Antiference; John Rochford, Secretary, CESR; R. S. Williams, Rogers Majestic Electronics; Sol Budd, Stark Electronics; Len Davidge, Hackbusch Electronics; Bill Choate, Canadian Westinghouse Co. Ltd.; George Seto, Canadian Astatic and Frank W. Morgan, Canadian Astatic.

# COMPLETE SERVICE

insures your  
complete satisfaction

Through long and intimate association with all phases of the communications field,

## AUTOMATIC ELECTRIC

can offer you the advantages of complete advisory and engineering services in addition to a source of supply for all communication wires and cables.

### PHILLIPS PAPER INSULATED LEAD COVERED TELEPHONE CABLES

Available in all types and sizes for aerial and underground use, and with various protective coverings for buried and submarine installations. Designed and manufactured for reliable service and long life.

Distributor in Canada

# AUTOMATIC ELECTRIC

SALES (CANADA) LIMITED

Head Office: 185 Bartley Drive, Toronto 16

MONTREAL • OTTAWA • BROOKVILLE • GAMILTON • WINNIPEG • REGINA • EDMONTON • VANCOUVER

5528

For further data on advertised products use page 99.

World Radio History



● Representatives of the Government service attending the Electronics Part Show in Chicago are shown above left to right: H. Robinson, Canadian Military Electronics Standards Agency; H. Reiche, also of the Electronics Standards Agency; John Murphy, Cannon Electric; S. J. Taylor of the Electronics Standards Agency and E. J. Parnell-Smith, Defense Research Telecommunications Establishment.

### Computing Devices Of Canada Named Exclusive Reps For U.K. And U.S. Firms

Computing Devices of Canada, Ottawa have recently been appointed as the exclusive Canadian distributors for Solartron Laboratory Instruments Limited of Thames Ditton, England and Allison Laboratories of Puente, California.

Solartron Laboratory Instruments are manufacturers of oscilloscopes and electronic laboratory test equipment. Allison Laboratories are producers of continuously variable passive network

audio frequency filters, clinical auditory test equipment and sound level meters and analyzers.

### Westinghouse Increases Component Production

Additional jobs will soon be created in the TV-radio division when two new departments begin operations at the Brantford TV plant of Canadian Westinghouse. The new departments will make printed wiring plates and horizontal output transformers for TV sets. Because of the plant's increased production it is now economical to

make these parts, plant officials have announced.

To take full advantage of this development, the TV-radio division has set up special equipment for the manufacture of printed wiring. Special equipment is also being installed, the first of its kind in Canada, for the manufacture of horizontal output transformers.

### J. M. Gibson Named Winnipeg Rep For Canadian Marconi

Jack M. Gibson has been named Western Canadian Representative for Broadcast and Television Station Equipment Sales, it is announced by C. P. McNamara, Manager of the Canadian Marconi Company Commercial Products Division.



J. M. GIBSON

Mr. Gibson will make his headquarters in Winnipeg from where he will serve the Broadcast and Television field in Western Canada.

Until this present appointment, Mr. Gibson was stationed in mid-west in General commercial products sales.

(Turn to page 93)

# CABLE SPINNING EQUIPMENT

FOR COMMUNICATION,  
SIGNAL, CONTROL AND  
POWER AERIAL CABLE  
INSTALLATIONS

Distributor in Canada

## AUTOMATIC ELECTRIC

SALES (CANADA) LIMITED

Head Office: 185 Bartley Drive, Toronto 16

MONTREAL • OTTAWA • BROCKVILLE • HAMILTON • WINNIPEG • REGINA • EDMONTON • VANCOUVER

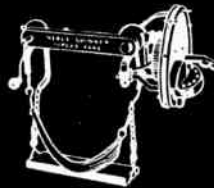

#### NEALE MODEL B ONE-MAN SPINNER

Designed expressly for one-man operation and ideally suited for spinning existing cable.



#### NEALE MODEL D PULL TYPE SPINNER

Adaptable for spinning all sizes of cable up to a maximum diameter of 2 1/4 inches.

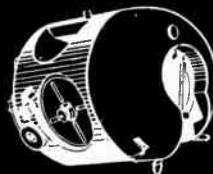

#### NEALE MODEL K PULL TYPE SPINNER

Designed to spin single or multiple cables, from a single cable of 5/8 inch diameter up to three cables each of 2 inches diameter, with one or two spinning wires.

#### SPINNING WIRE, TOOLS AND ACCESSORIES

Everything required for any cable spinning job. Complete information and prices available upon request.

5529

**STARK**

**ELECTRICAL AND  
ELECTRONIC INSTRUMENTS**

**METERS  
SWITCHBOARD TYPES**

Flush and Surface Mounting.  
Available in all commercial ranges.



**PANEL TYPES**

Round and Rectangular from 2" to 9". AC and DC.  
Ammeters-Milliammeters-Microammeters-Voltmeters,  
etc.

**TEST INSTRUMENTS**

For Electrical, Radio and Television applications.  
Analyzers-Signal Generators-Tube Testers  
Vacuum Tube Voltmeters, etc.

**STARK ELECTRONIC INSTRUMENTS LIMITED**

General Offices and Factory: AJAX, Ontario  
Export Division: 276 West 43rd St., New York 36, N.Y., U.S.A.  
Cables: STARKEK, New York

**NEW PRODUCTS**  
(Continued from page 69)

● **FM Radio Phone**  
Item 711

This FM radio phone which provides light dependable portable communication is the nearest thing yet to taking your office telephone with you. It is the most practical answer yet to a light weight portable radio communication unit that can be used by personnel in remote areas. The needs of forestry men, survey crews, contractors, engineers have all dictated the requirements



that had to be met by this new development in portable communication.

The complete communication unit consists of: 1 FM receiver; 1 or 2 single frequency transmitters (FM); 1 handset; 1 antenna, demountable whip; 1 battery pack and 1 carrying strap.

● **Reflectometer System**  
Item 712

A fast accurate reflectometer system capable of wide range microwave impedance measurements has been developed.

The system includes a new ratio meter, a 7 to 10 KMC swept-frequency oscillator, a power supply, and related crystal detectors and directional couplers. All have been developed specifically for use in the reflectometer system, although individually, components have many additional uses.

Besides permitting instantaneous measurement of reflection coefficient or SWR over a wide frequency range, the system makes possible direct and continuous swept-frequency oscilloscope presentation. It eliminates time-consuming point-by-point checking, and the system is unaffected by amplitude variation. It is said to be particularly applicable to fast production checking of reflection coefficient or SWR, as well as useful in waveguide system alignment, checking of waveguide components, determining antenna and rotary joint performance and similar laboratory or production measurements. Reflection coefficient readings are direct, and the entire system is so simple to operate it can readily be used by non-technical personnel. Single frequency measurements can be made with accuracies greater than possible with slotted lines. At present available for X-band operation only, the system will soon include components for operation at other microwave frequencies.

For Product Information  
Use Coupon Page

● **Rotary Feed Hopper**  
Item 713

A new rotary hopper, designed to provide accurate, high-speed parts delivery to machine tools, has recently been announced. The hopper feeds parts to presses, grinders, special machines and machine tools, and can also be used for sorting, counting and inspection operations.

According to company statements, the new "160" rotary hopper automatically feeds parts three to five times faster than hand-feeding methods, thereby increasing production and efficiency, and reducing labor costs substantially.

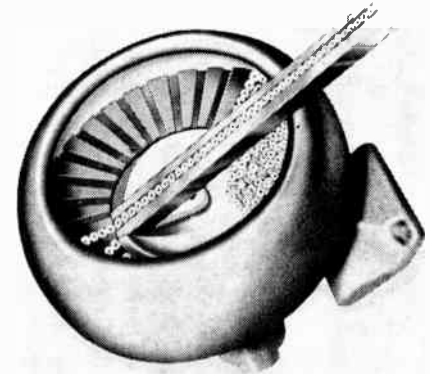

The unit operates by means of a fully enclosed, continuous-duty motor, and has a slip clutch for overloads, which is easily accessible for adjustment. 12-pitch gears, mounted on ball-bearing shafts, are used throughout for continuous, heavy-duty performance. All gears and bearings operate in an oil bath. The rotary hopper incorporates a 3-point mounting in the base, for easy installation on rough or uneven surfaces. The unit itself is fully adjustable to assure best feeding angle. The hopper can be supplied with as many as four separate feeding tracks.

(Turn to page 90)

I'm  
**DALOHM...**  
miniature  
but mighty!



You can depend on

**DALOHM**  
 $\Omega$

**TYPE RS  
MINIATURE POWER  
RESISTORS**

For all applications where the equipment must survive the most severe environmental, shock, and vibration conditions.

Completely welded from terminal to terminal. Silicone sealed, offering high dielectric strength, maximum heat dissipation, and maximum resistance to abrasion. Impervious to moisture, salt ions, vapor and gases.

**Three wattage ranges: RS-2, 2 watts;  
RS-5, 5 watts; RS-10, 10 watts.**

- Temperature coefficient 0.0002/Deg. C
- Ranges from 0.1 ohm to 55,000 ohms depending on type
- Tolerances 0.05%, 0.1%, 0.25%, 0.5%, 1%, 3%, 5%

Conform to Applicable JAN and MIL Specifications

WRITE FOR BULLETIN No. R-23



**DALE PRODUCTS, Inc.**  
1322 28th AVE., PHONE 2139, COLUMBUS, NEB.

Export Dept.—Pan-Mar Corp.,  
1270 Broadway, New York 1, N.Y.

For further data on advertised products use page 99.



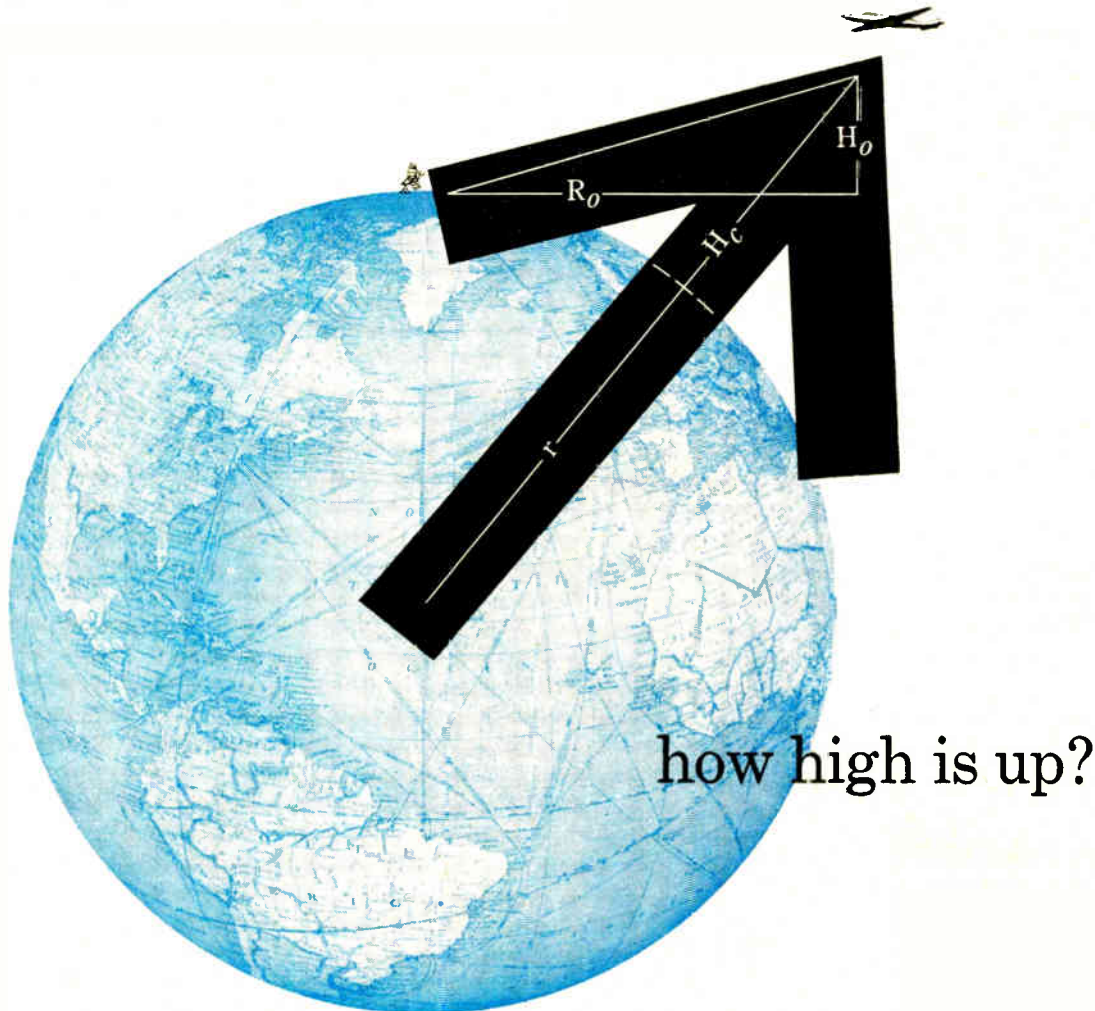

how high is up?

A child's conundrum becomes a matter of life and death...when radar tells a lie. When our radar tracks attacking aircraft...or an incoming missile...the lives of all of us on target balance on the pinpoint of a mathematical riddle.

How high is up? It depends on the point-of-viewing.

Because of earth's curvature, radar sees an interloper... 100 miles away... 6600 feet lower than it really is. Readings must be corrected instantaneously before being fed to our interceptors... otherwise, attacker and defender play true or false at twice the speed of sound.

Electronic Engineering Company of California has designed an analog computer that makes this vital correction... converting radar observation into true altitude above sea level. The computer continuously solves the equation

$$H_c = H_o + (R_o^2 / 2r)$$

The mathematics are complex. The mechanism, with a two-gang HELIPOT\* series A precision potentiometer at its heart, is beautifully simple. Both are fully described in a new application data sheet... write for Data File 604.

*Helipot makes precision potentiometers... linear and non-linear... in the widest choice of sizes, mounting styles and resistances. Many models are stocked for immediate shipment... our engineers will gladly adapt standard models to your requirements... or design entirely new HELIPOT precision potentiometers for you.*



# Helipot

*first in precision potentiometers*

Helipot Corporation, a division of BECKMAN INSTRUMENTS, INC.

Factory: No. 3 Six Points Road, Toronto 18, Ont.

Representative: R-O-R Associates, Ltd., 290 Lawrence Ave. W., Toronto 12, Ont.



390 \*Reg. U.S. Pat. Off.

## CONTINENTAL DEFENSE

(Continued from page 17)

the Distant Early Warning Line, is the largest project ever to be undertaken in the Canadian Far North and extends into the northern portion of Alaska. The problems of transportation and supply in this area add immeasurably to the difficulties involved in the construction of this line.

As mentioned earlier, the line is being constructed and financed by the United States. Responsibility for the project rests with the United States Air Force, who have appointed Western Electric Company of New York as management contractor. Under this arrangement, the procurement of all requirements (other than those furnished by the U.S.A.F.) and the letting of contracts is handled by the Company. In order to carry out the conditions of the agreement between Canada and the United States, there is close co-operation between the Company and representatives of the United States Air Force and the Canadian Government, operating through the DEW Project Office which was set up

in New York.

By working through this office, arrangements have been made to enable Canadian manufacturers to bid on construction and major items of equipment when tenders have been called. All arrangements for inviting and assessing tenders and for placing contracts are the responsibility of the management contractor.

### The DEW Line

A number of factors have governed the extent of Canadian participation in contracts for the DEW line. In the first place, delivery times have been extremely short in order to arrange for shipment of as much as possible this year. In view of the very limited shipping season in the North, this has meant that deliveries have had to be made in a matter of weeks. In many cases, only companies with a large portion of the equipment in stock or with designs at a very advanced stage have been able to tender successfully. The early planning for this line was carried out by the United States and this, together with the fact that U.S. funds are financing the project, has

had a bearing on the awarding of contracts, particularly in the electronics field.

The two construction contracts covering the portion of the DEW line located on Canadian territory have been awarded to Canadian companies. As is the practice under such contracts, these two companies are responsible for the procurement of all construction material and equipment required to build the project. So far, some 75 per cent of these contracts have been placed with Canadian firms. The construction companies are also responsible for the transportation of goods to the site. In this connection, Canadian commercial aircraft companies have received contracts to carry substantial quantities of freight. A Canadian company has also received a contract for installation of communication equipment during the construction period.

For all these lines, the initial construction is only part of the whole picture. Maintenance and operational requirements, together with the re-supply of spares for maintenance depots, continue as long as the System is in operation. Many of these orders for the line already in operation have been placed with Canadian firms. As the other two lines are put into operation, orders of this kind will undoubtedly become of increasing importance to Canadian industry.

### Guided Missiles Next

The possible uses of electronics for defense show no sign of tapering off. The push button devices on planes and ships and guns have now become an integral part of these equipments and there is every indication that they will be of even greater significance. The importance of the network of early warning lines now being constructed in Canada has already been discussed and the technological advances that have been made and are being made in these systems have contributed a great deal to the growth of the electronics industry. The next major field of endeavor is undoubtedly the manufacture of guided missiles. What the future holds is, of course, uncertain, but there can be little doubt that electronics will continue to fill a substantial role in the defense picture.

What this will mean to the Canadian electronic industry cannot be measured at this stage. One thing, however, is clear. The magnitude will not be sufficiently great to support and sustain the industry at its present level. Nor will it be possible for Canadian industry to produce the highly complex and intricate equipment needed unless development and production on the commercial side is continuing at the same time. Only by a proper combination of the two, can the electronics industry in Canada make its maximum contribution to the future economic progress of this country.

## WHERE THERE'S A WILL THERE'S OFTEN A WAY

Industrial Development Bank engineers, accountants and specialists in law and insurance examine industrial proposals before the Bank undertakes to provide financing. This can be an advantage whether or not an I.D.B. loan is arranged. It can make for a more efficient operation if the loan is granted or it may uncover factors which make regular commercial financing feasible.

If you have an industrial project that meets practical requirements for success and have not been able to discover ways to finance it efficiently, you may find it worthwhile to know more about I.D.B. and its wide experience with unusual problems.

We suggest that you enquire of your bank or auditor, or write for information to:

### INDUSTRIAL DEVELOPMENT BANK

MONTREAL • TORONTO • WINNIPEG • VANCOUVER  
901 Victoria Sq. 85 Richmond St. W. 195 Portage Ave. E. 475 Howe St.

new, revolutionary development  
in the handling and dispensing of **FEDERAL** magnet wire

## **PAYOFFPAK**

a boon to users of **FEDERAL**  
magnet wire



*Fabricators simply open this amazing new container and thread the machine. The wire pays off like a fisherman's line from a spinning reel. There are no backlash, over-run or inertia problems and—most important—no stops.*

**Saves Time—Saves Work—Saves Money.**

**One Payoffpak container holds 600 lbs. of magnet wire—replaces 8 reels.**

**Two standard-size Payoffpaks eliminate down time and need for a wide range of reel sizes.**

**Set up time on the winding machines is cut to the very minimum.**

**Interlocking tops and bottoms allow storage in a minimum amount of space.**

**Made of tough, reinforced fibre—standard-size container weighs only 22 lbs.**

*Speed up your production with Payoffpak—improve your product with Federal Magnet Wire!*

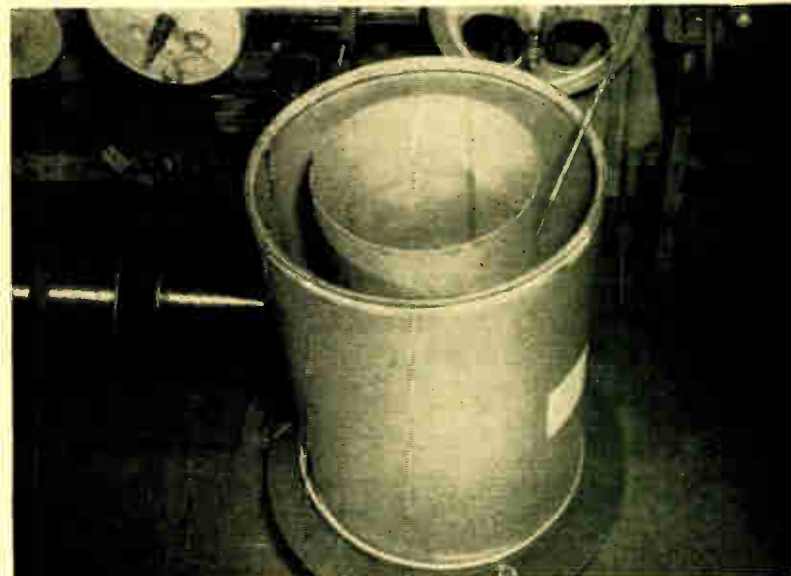

**FEDERAL Wire and Cable Company Limited**  
GUELPH, ONTARIO

## NEW PRODUCTS

(Continued from page 86)

### ● Featherweight Instant Solder Gun

Item 714

A new instant solder gun which is solder-hot in a few seconds, without the use of heavy transformer or fragile thermostats and weighs but 8 oz. compared to 40 oz. for equivalent transformer types, is now available.

Special alloy lifetime tip cannot wear, corrode or bend — thus eliminating tip maintenance, is claim of the manufacturers.

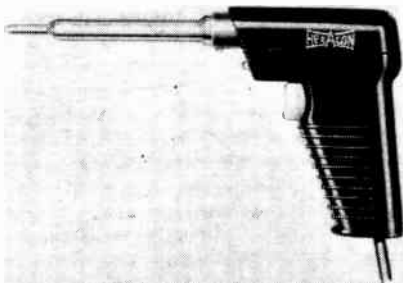

Trigger control gives any degree of heat required without danger of overheating. Has more heat capacity than size indicates and tiny 1/4" tip for finest soldering, but will do heavier work because heating element is right in the tip. Has long, thin reach for getting in tight places and an effective spotlight.

USE COUPON ON PAGE 99

### ● New Photo-Conductive Cell

Item 715

A new photo-conductive cell handling power up to 0.3 watts has been announced. It eliminates the electronic amplifier, the vacuum photocell and the dc power supply.

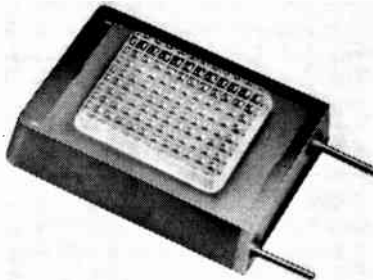

This cell, another outcome of semiconductor technology, is designed to operate relays and other devices on voltages from 110 volts to 1.5 volts ac or dc with incident light values from daylight (1000 ft. candles) to moonlight (.020 ft. candles). The sensitivity is 0.40 amperes per lumen.

### ● Six Station Intercommunication System

Item 716

Presented as the first completely selective wireless intercom system, the Talk-A-Phone LCM-8806 offers many features of the Talk-A-Phone conventional line, including a six-channel selector, which enables each unit in the system to transmit to any of the six separate channels and receive calls on any channel it selects to use.

As many as three separate conversations can be carried on simultaneously over the six-station system. Wireless selective communication, enabling any master to select and carry on a conversation with any other master separately, is another of the exclusive features of the new unit.

### ● Tuning Slug Retrievers

Item 717

A handy pair of highly useful servicemen's tools has just been introduced. These "Tuning Slug Retrievers" (12" and 15" sizes) are stated to work on all Standard Coil tuners where they are used to recover tuning slugs on the oscillator coils of channel strips. They are also said to fit easily the new wide slotted slug and deep seated tuning units.

Each of these new tools has a precision made alloy blade and Tenite handle, and is claimed to be very easy to use. In addition to slug retrieving, the tools can be used to reclaim screws and also to start set screws in previously inaccessible spots.

### ● New Precision Resolver

Item 718

A new size 15 boosterless resolver, Type 3D-2348, is now available. No associated amplifiers and compensators are necessary because of the small variation in transformer ratio and phase shift with varying input voltage. Axis misalignment is  $\pm 7$  minutes and maximum angular error is .12 per cent.

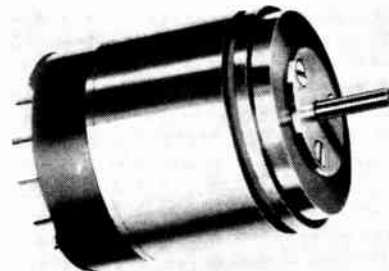

Input voltage ranges from 0-16 v 400 cps. Input impedance is 740/79°. The unit is available with terminal connectors and is designed for phase shifting and interchanging rectangular and polar co-ordinates in computer applications.

(Turn to page 98)

## THE NEW ALL CANADIAN

## MICRO TR-16

## TRANSCRIPTION TURNTABLE

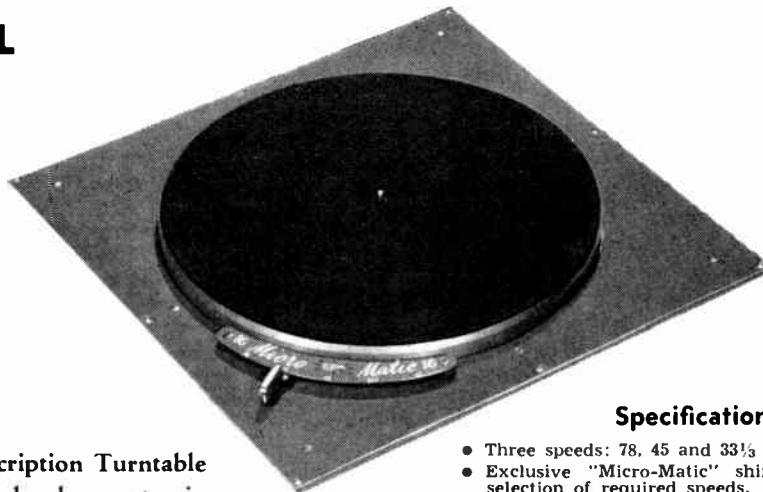

The "Micro-Matic" Transcription Turntable incorporates the latest developments in Broadcasting, Television, Recording Studios and high fidelity engineering. Designed around an entirely new type of three speed change mechanism. The "Micro-Matic" embodies a drive system, which is completely decoupled acoustically and mechanically from the Turntable Disc. The motors are built to rigid Micro specifications by the foremost motor specialists. The "Micro-Matic" easily meets the requirements of the most particular Broadcaster and Music Connoisseur.

### Specifications

- Three speeds: 78, 45 and 33 1/3 R.P.M.
- Exclusive "Micro-Matic" shift enables instant selection of required speeds.
- Two "off" positions, disengages drive and switches off motor.
- Cast aluminum, precision machined turntable, with hardened and ground shaft insures wow free operation.
- Neoprene rubber idler wheels of proper shore hardness, provides positive drive, without rumble or wow.
- Wow and flutter content well within NARTB broadcast standards.
- Ribbed rubber mat insures good record drive with ease of removing recordings.
- "Micro-Matic" available in two models. TR-16 with 16" diameter turntable. TR-12H with 12" diameter turntable.
- Equipped with hysteresis synchronous motor.
- Write for bulletins.

**MICROLAB DEVICES LTD. 1195 Lawrence Ave. West, Toronto, Canada**

For further data on advertised products use page 99.

## COMPUTING DEVICES OF CANADA ANNOUNCE APPOINTMENTS

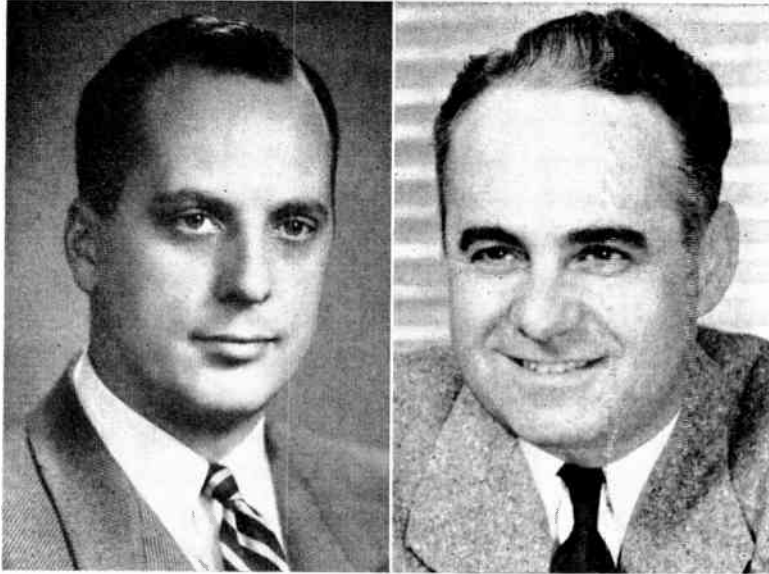

W. H. HOLROYD

D. J. MASER

● Charles F. Hambley, President of Computing Devices of Canada Limited, announces the appointment of William H. Holroyd as Sales Manager, and David J. Maser as Contracts Administrator and Public Relations Manager. William H. Holroyd was formerly Sales Manager of the Electronic Equipment Department of Canadian General Electric Co. Ltd. and is well known in the fields of aviation, telecommunications and broadcasting. David J. Maser comes to C.D.C. from the Department of Defence Production, where he was Contracts Officer in the Electronics Branch.

### New Cesco Montreal Salesman

Mr. M. I. Rosenthal, president of Canadian Electrical Supply Co. Ltd. has announced the addition of David L. Stern as salesman for the company's Montreal Branch. Mr. Stern has been associated with the radio parts and record player business for the past 12 years. He was previously with Snidor Radio and Music and Desoronto Electronics, where he was Sales Manager of both companies. Mr. Stern is well known in the trade having travelled from coast-to-coast. He will be calling on dealers in the west-end of Montreal and being familiar with their problems will be able to offer them improved service.

### Chas. W. Pointon Announces Staff Appointments

Charles W. Pointon Limited announce the appointment of two new additions to their staff, R. P. (Bob) Mitchell and E. W. (Ernie) Spence.

Bob Mitchell was formerly on the Engineering staff of Stark Electronic Instruments Ltd. and with the Communications Sales and Service Division of Pye Canada Ltd.

Ernie Spence was for several years with Philco Corp. of Canada Limited in the Processing and Material Control Division.

### Toronto Section I.R.E. Plan For New Season

An executive meeting of the Toronto Section I.R.E. was held June 7 last to prepare tentative plans for the new season which will commence in September. Chairmen of the standing committees were appointed at the meeting and are as follows: Meetings and Papers, H. F. Shoemaker; Membership, Ron Bullock; Publicity, R. J. A. Turner; Educational, Dr. George Sinclair and Representative for Canadian Section Publications, George Armitage.

### D. C. Marrs Appointed Comptroller For Westinghouse

The election of D. C. Marrs to the post of Assistant Comptroller at the Canadian Westinghouse Company has been announced.

Mr. Marrs joined Westinghouse in 1936 and with the exception of wartime service with the R.C.A.F., occupied various Accounting and Treasury Department positions until 1952 when he undertook a special assignment with the Canadian Westinghouse Supply Company.

Mr. Marrs was named General Auditor for that firm in 1953 and last year was appointed Operations Manager.



## Red Label Irons for the production line



No. 38,  
100 watt



No. 58,  
200 watt

ESICO extra heavy-duty elements are constructed to stand up to 24-hour-a-day continuous operation on production lines and to deliver ample heat to the tip for the fastest work. Rugged construction guarantees unlimited service. Low handle temperatures assure comfortable handling. Six ratings — 100 to 550 watts. ESICO Red Label Production Soldering Irons are designed so that elements and tips can be replaced in a matter of minutes, saving the time and expense of sending to the supplier for repairs. Replacement parts readily available.

DESIGNED TO REACH  
HARD-TO-GET-AT PLACES



No. 38H

The ESICO right-angle iron promotes even greater efficiency through reducing the effort and fatigue of working in confined areas. Will take 100, 130 or 150 watt element. Please specify when ordering

Order from your jobber  
or write to:

Electronic Tube & Components Division  
**CANADIAN Marconi COMPANY**  
830 BAYVIEW AVENUE • TORONTO • ONTARIO

Branches: Vancouver • Winnipeg • Montreal  
Halifax • St. John's, Nfld.

## NONE TOO GOOD

(Continued from page 43)

it is asked to buy, but is responsible for the way in which the purchase is made. I don't mean to suggest by this that the Department of National Defence can budget its appropriations as it chooses, or that other Government Departments are not vitally concerned.

I have pointed out that the Department of Defence Production's greatest concern is with the methods rather than the objects of expenditures for defence supplies. Working from precedent to precedent and building on the accumulated experience of World War II and the Korean emergency, a procurement system has been developed which is primarily intended to safeguard the interests of the public. It is neither a foolproof nor a frictionless system. I do not claim it is perfect — but I would be most reluctant to abandon established procedures without very convincing evidence that something better is available.

In a sense, the basic assumption on which our present system rests is that the best guarantee of fair value for the public's money lies in an open competitive market. The Department has, therefore, wherever possible, based contracts on competitive tenders, and shall continue to do so. We are conscious of the fact that this system will only work as long as there is a

competitive market, and as long as steps are taken to guard against the abuses to which a tendering system is susceptible. In the first place, the tendering system should not be used indiscriminately. In the second place, I am satisfied that the internal safeguards of our procurement system will ensure the fair treatment which is of importance to you both as taxpayers and as potential tenderers.

Where the tender system is inappropriate — for example, in the case of requirement for which there is a sole supplier or for which a source of supply must be developed — the Department will continue to resort to negotiation, and to employ the various forms of cost reimbursement. These, as you know, range all the way from the cost-plus contract — which we like least for obvious reasons — to target price, fixed fee and incentive bonus arrangement with the possibility of a reward for efficiency. In all cases, however, the ultimate aim of negotiation will be a fair price, both to the Government and the contractor, determined on the basis of a full knowledge of the costs.

In short, we are no less determined to get the best we can in quality and price than is any private business concern — and we try to be at least as conscientious in the pursuit of this aim as any self-respecting firm would be. But, in return, we shall offer fair dealing with an assurance of a

reasonable profit.

I have already indicated the other prediction I can make about the future procurement program, as it affects the electronics industry. In a future of continental defence systems, of guided missiles and, for that matter, of possible automation throughout a substantial part of the defence effort, you will be faced with increasingly demanding requirements. We are well beyond the screwdriver and soldering iron stage — and moving farther. Moreover, it is no comfort to an army in the field to know that the manufacturers stand behind its equipment with a replacement guarantee and a large service organization. Our aim must be complete reliability in the equipment which is produced.

These requirements mean that many of the policies which work — and may work well — in the civilian radio and television world, must be put aside when you approach defence electronics. No other sector of industry faces this problem in the same degree as does yours. It means, in effect, that you must lead a double life if you are to meet defence requirements, with two sets of attitudes and a double standard of acceptability.

What I am asking is that you remember the means by which the electronics industry grew. The products which you are now pouring out by the thousands into Canadian homes

(Turn to page 96)

## RURAL COMMUNICATIONS

a vital link

TMC MAGNETO  
TELEPHONE AND  
SWITCHBOARD  
EQUIPMENT  
GIVES TWO-WAY  
SATISFACTION

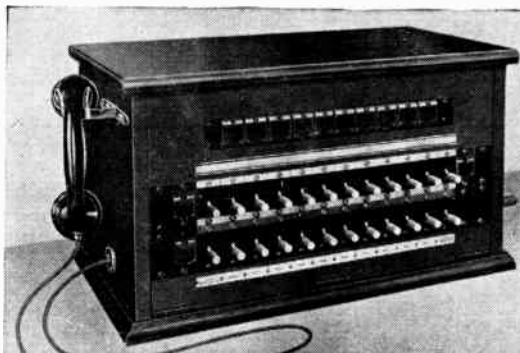

Cordless Switchboards, both C. B. and Magneto

Our Magneto Telephone Equipment is designed and built to operate at high efficiency in all climatic conditions for long periods without attention.

Maintenance is simple because all parts are easily accessible. Smart as well as rugged, the telephones have polished black moulded bakelite cases and combination handsets, with anti-side-tone circuits.

Magneto Switchboards, strongly constructed of seasoned hardwoods, having attractive modern designed cabinets are also available.

A full range of equipment is kept at our showrooms. We invite you to call or write for full details and technical data.

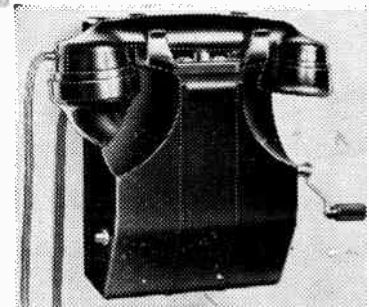

Magneto Wall Telephone



For further data on advertised products use page 99.

NEWS

(Continued from page 85)



● Frederick H. Palmer, M.C. Canadian Consul General in Chicago, guest speaker at the Canadian Luncheon held during the Chicago Electronics Parts Show told the more than 200 Canadians who attended how Canadians and their American neighbors could better understand each other.

Canadian Electrical Supply Announce Staff Changes

M. I. Rosenthal, President of Canadian Electrical Supply Co. Ltd., has announced the following addition to the company's Toronto staff.

Hilton J. MacNeill has been appointed as Sales Manager to the company's Toronto branch. He was formerly General Manager of Wholesale Radio and Electronics Ltd. In his new position, Mr. MacNeill will service dealer and industrial accounts.

Miss "Mat" Volny has been appointed to take charge of the Industrial Order Department. Miss Volny has had several years' experience in the electronics parts business and is one of the few women in electronic component sales work. In her new capacity she will service the firm's industrial accounts.



MISS 'MAT' VOLNY

Mr. Brian M. Duffield who has recently joined the company in the capacity of Audio Sales Engineer, is a graduate of Birmingham College in Industrial Product Design. During the past four years he has been involved with all phases of High-Fidelity from building systems to designing installations. He will be primarily concerned with promotion and sales of High-Fidelity and Sound Equipment in the Toronto area.



H. J. MacNEILL

concerned with promotion and sales of High-Fidelity and Sound Equipment in the Toronto area.

# TEFLON\*

PARTS OR MATERIALS FOR UHF APPLICATION?

FOR MINIATURE AND SUB-MINIATURE COMPONENTS?

## YOU CAN GET JUST WHAT YOU WANT

from

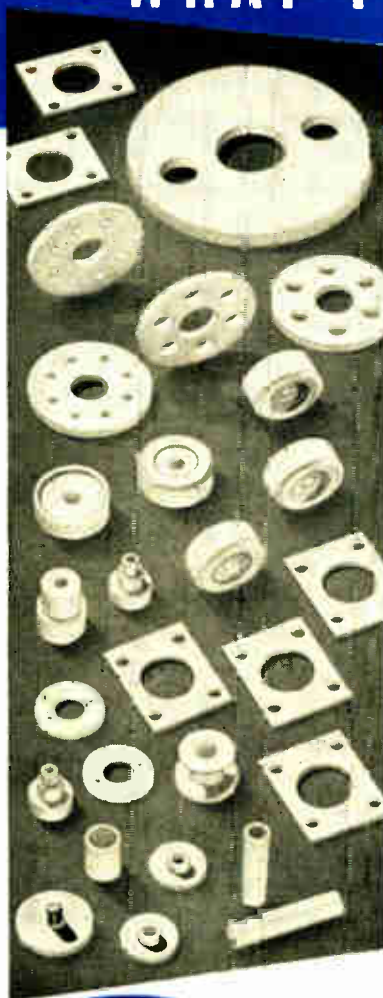

**FOR:** insulators of all types, sleeves or inserts, capacitor seals, feed through insulators, bushings, slot liners, coaxial spacers, layer insulation or any other parts or forms subject to high charge, extended frequency range, mechanical and thermal shock, extreme temperatures and climatic conditions.

You can order in any quantity and be sure of true Teflon performance, because "John Crane" gives you these *plus* factors: complete uniformity throughout, high density control, freedom from flaws and rigid adherence to your specifications.

"John Crane's" complete fabrication facilities assure you prompt delivery on *exactly* what you want. If you have an entirely new requirement, no standard design or procedure—"John Crane's" laboratory facilities, know how, research and engineering experience go to work on *your particular* need.

Now is a good time to put "John Crane" to test. Contact Crane Packing Company today.

# TEFLON

DuPont trademark

- Dielectric Strength: 480 v/mil.
- Dielectric Constant (60 to 10<sup>3</sup> cycles): 2.0
- Power Factor (60 to 10<sup>8</sup> cycles): < 0.0005
- Volume Resistivity: 10<sup>15</sup> ohm-cm
- Surface Resistivity: 3.6x10<sup>6</sup> megohms
- Surface Arc-Resistance: does not track
- Temperature Range: -450° to +500°F.
- Chemical Resistance: completely inert
- Moisture Absorption: zero

Crane Packing Co. Ltd., 627 Parkdale Ave. North, Hamilton, Ontario.



**CRANE PACKING COMPANY**



BRIDGE ON THE PRINCIPAL ST. ST.

**800**  
**Motorola\***  
**MICROWAVE TERMINALS**  
*now in and operating*

The trouble free performance during almost a decade of operation of thousands of channel miles has won widespread industry acceptance for Motorola microwave systems. Motorola Microwave equipment has met the exacting standards of the telephone industry with regard to reliability and transmission characteristics. There are more than 800 terminals of Motorola microwave equipment being successfully operated at the present time.

This equipment is now manufactured in Canada and installed by Rogers Majestic Electronics Limited.

**COMPLETE ENGINEERING AND DESIGN SERVICE**

Rogers Majestic Electronics Limited will assume complete responsibility for all phases of your communications system from the initial planning to the completed installation and final acceptance testing.

\*Motorola is a registered trade mark, owned by Motorola, Inc., in the United States, and by Motorola Canada, Ltd., in Canada.

DISTRIBUTED BY

*Equipment Division*  
**ROGERS MAJESTIC ELECTRONICS**  
 LIMITED  
 HALIFAX • MONTREAL • TORONTO • WINNIPEG • VANCOUVER

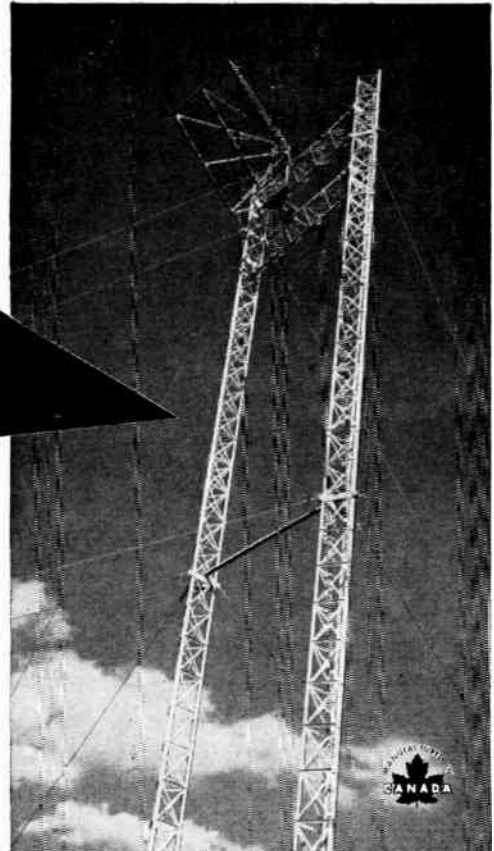

*Motorola microwave equipment, supplied by Rogers Majestic Electronics Limited, on Hamilton (Ont.) Mountain, links studio to transmitter of Hamilton's new television station CHCH.*



*General Manager Ken S. Soble seated at CHCH's master control board. Ch. Engr. Wm. Jeynes looks on.*

*this booklet can save you money*

Gentlemen:

Please send R.M.E.L.'s new 16-page systems planning booklet describing the major types of radio communication and control systems and their applications.



NAME.....

COMPANY.....

ADDRESS.....

**R.M.E.L. COMMUNICATION SERVICES:**

- MICROWAVE SYSTEMS • MOBILE 2-WAY RADIO SYSTEMS • POINT-TO-POINT 2-WAY RADIO SYSTEMS • SUPERVISORY CONTROL SYSTEMS • POWER LINE CARRIER SYSTEMS • TELEMETERING SYSTEMS • SELECTIVE SWITCHING SYSTEMS • COMMUNICATIONS CONSULTING SERVICE



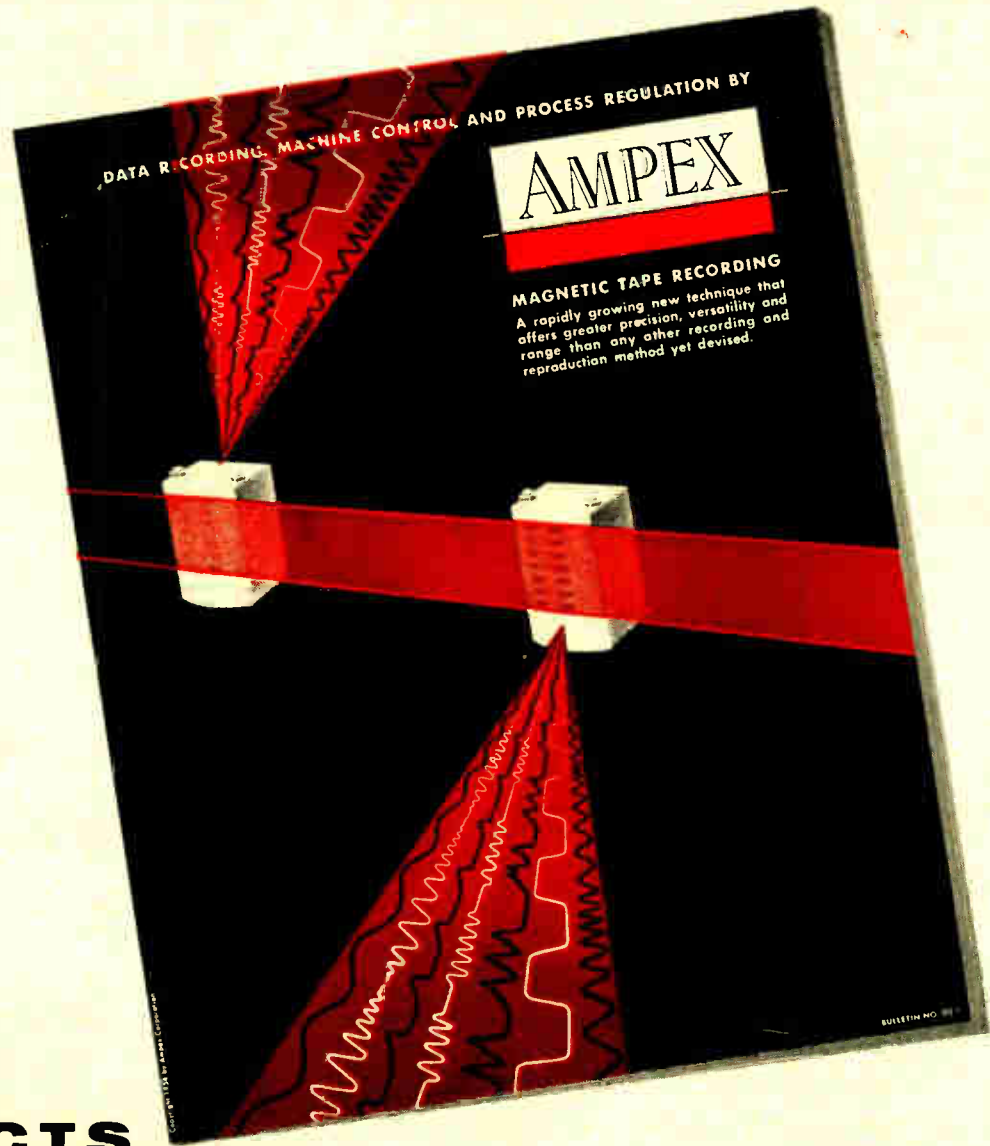

**FACTS  
ON MAGNETIC RECORDING**  
the flexible "MEMORY" for science and industry

- In industry today magnetic recorders can "remember" and re-create the motions of skilled machinists, the forces encountered by a truck driving down a test road, the reflections from underground shock waves, the complex control of chemical processes.
- Magnetic recorders have long been at work recording complex data and reproducing it in its original electrical form — ready for automatic reduction and analysis.
- With greater accuracy and less cost than any other method, magnetic tape can "remember" situations encountered in your business — laboratory data, motions, processes and hundreds of kinds of information.

Get the facts in this important new bulletin from the company that has been building magnetic recorders for scientific purposes longer than any other firm. Written in clear, non-technical language, it tells what magnetic recording can do for you.



Distributed in Canada by  
Electronic Equipment Department  
**CANADIAN GENERAL ELECTRIC**  
Company Limited

Canadian General Electric Co. Ltd.  
Section BA20  
830 Lansdowne Ave.  
Toronto, Ont.

Please send me a copy of Ampex Bulletin No. D2-1.

Name .....

Address .....

**NONE TOO GOOD**

*(Continued from page 92)*

and Canadian business are the product of years of painstaking effort and the slow accumulation of hard-won discoveries, many of which at the time may have seemed unrewarding. Only the same kind of effort can meet defence requirements — and, incidentally, keep your industry progressive, I would ask you to remember, too, that in actively encouraging the development of an electronics industry in Canada for strategic reasons, the government has acted on the assumption that such an industry will be capable of meeting defence needs efficiently. If that expectation is disappointed, the effort fails.

You may even have to forget to compete at times. As I said earlier, some of the defence electronics needs will require large scale industry — and in some cases, the scale required will be beyond that of any single Canadian firm. Under such circumstances, we shall be able to use Canadian facilities only if they are willing to pool their skill, experience and physical resources. Failing this, we shall have to look elsewhere.

I realize that I have been saying a great deal about what is wanted or expected from the electronics industry. I have in fact done so with no hesitation, feeling that the long and close

association which the Department has enjoyed with you carries with it the right to be candid. The kind of cooperation I have been inviting from you includes a reciprocity of candor about our respective wants and expectations. If at any time you take exception to the Department's purposes or methods, tell us so. If your production experience suggests that the Department or the design authorities are going off the rails, let us have the story. In other words, cooperation embraces criticism, as long as it is constructive.

Needless to say, in inviting your cooperation I am not trying to shift any of our own responsibility. We in the Department of Defence Production cannot dodge this and have no wish to do so. Nor, by the same token, can we relinquish the powers to which our responsibility is attached. We can not, for example, simply go to your industry with our program and invite you to share it out among yourselves on the basis of your own estimate of competence. We must account for the way in which the job is done; we must therefore be the judge of fitness for the job.

This, then, is the prospect as I see it. It is my hope that the electronics industry will wish to continue the successful association we have enjoyed in the past. In doing this, both parties to the association must bear in mind,

in pursuing our respective interests as procurement agency and contractor, that there is a third party in all our dealings whose wants and expectations are infinitely more important than our own — the Canadian serviceman whose success in battle, and whose very life, will depend on the quality of the equipment which we, through our joint efforts, shall provide. As long as this paramount consideration is kept clearly in sight, any differences which may arise between us from day to day can, I am confident, be readily resolved, and we shall have the added satisfaction of knowing that our Services will have the benefit of the very best which this country can provide. And the best is none too good.

●  
**Say You Saw It**  
**Advertised In**  
**Electronics**  
**and**  
**Communications**  
 ●

**DAMP? HEAT?**  
**COLD? FUMES?**  
**VIBRATION & SHOCK?**



Hermetically sealed potentiometers have been JAN approved for use in Arctic and Tropical conditions.

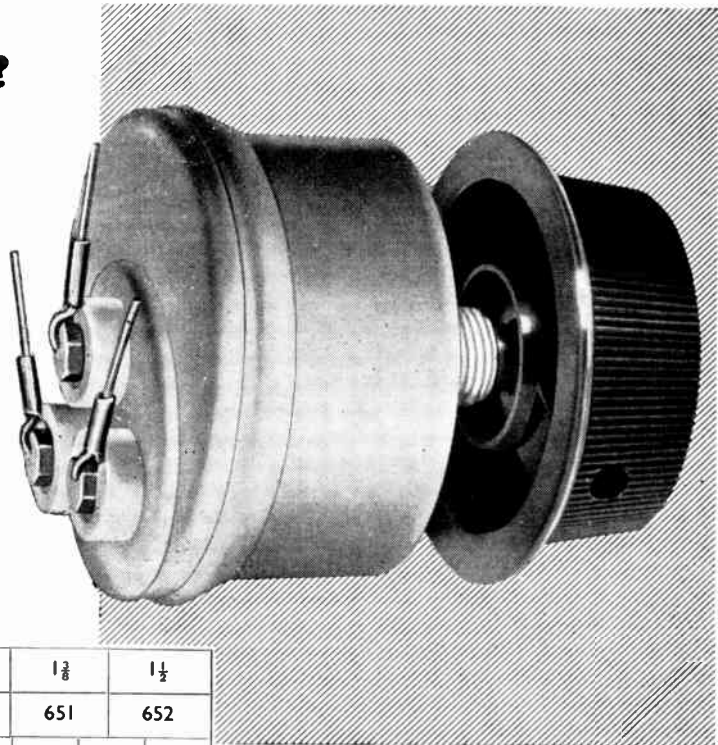

Shaft Length (inches) ...	$\frac{7}{8}$		1		$1\frac{1}{8}$		$1\frac{1}{4}$		$1\frac{3}{8}$		$1\frac{1}{2}$		
Part No. ...	647		648		649		650		651		652		
Ohmic value ...	5	10	25	50	100	250	500	1,000	2,500	5,000	10,000	25,000	50,000
Current (amps.)	1	.7	.45	.32	.22	.14	.1	.07	.045	.032	.022	.014	.01

**CANADIAN ELECTRIC RESISTORS LIMITED**  
 Curity Avenue · Toronto 16 · Ontario · Telephone: Plymouth 5-1891  
**Manufacturers and Sole Licensees for Berco Products in Canada**



BR 1241-AH

For further data on advertised products use page 99.

## BUSINESS BRIEFS — Continued

★ The Canadian television and radio industry exported an estimated 17,500 receivers during 1954 compared to 22,000 in 1953.

★ The Radio News Bureau of Washington has taken a peek into the future and predicts the following: Advertisers will spend \$3.5 billion on television in 1965 and 65,000,000 sets — most of them resembling pictures hung on the wall — will be in American homes. Sixty per cent of the sets will be in color. Battery-powered, portable color sets, weighing five to ten pounds, will be as easy to carry as a brief case. Circuits will be printed and tubeless. Sets will be repaired as easily as changing a light bulb. One thousand stations will be linked by three "live" TV networks and "tape" networks will be as common as today's radio transcriptions.

★ A further prediction of the Radio News Bureau in Washington forecasts that TV's top station rates, also presumably in 1965, will be between \$10,000 and \$20,000 per hour; that international TV on tape, will be commonplace, and that movie going will be an "event" of the nature of "going to a Broadway play, the opera, championship fight, Kentucky Derby, etc.". If Fee-TV clicks, the bureau says, neighborhood movie theatres will be wiped out.

★ According to W. Benton Harrison, of Sylvania Electric Products Inc., the American electronic industry is today virtually a \$9,000,000,000 industry from a standpoint of sales and revenues. From 1958 to 1960 total sales will approach \$14,000,000,000 a year. In 1964 we will be justified in calling electronics an industry with sales and revenues totalling over \$20,000,000,000 a year.

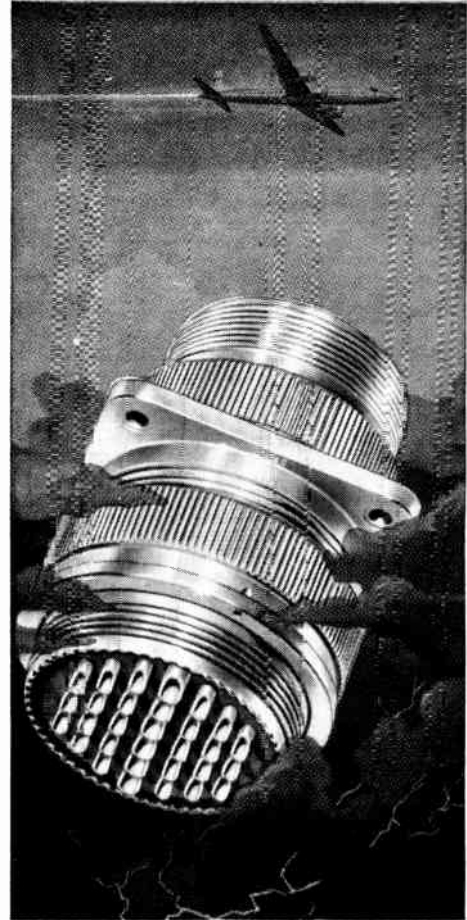

## BUDELMAN FREQUENCY METER TYPE 17A



- For checking frequency swing of FM transmitters due to modulation.
- For comparing unmodulated carrier frequency against internal crystal standard.
- Highly accurate signal source for aligning receivers.
- Field strength meter for comparative transmitter output checks.
- Battery operated.
- Direct-reading meter calibrated in kilocycles.
- Supplied for one or two specified frequencies in 25-50, 152-174 or 450-470 mc/s bands.

### PYE CANADA LIMITED

60 Front St. West

Toronto, Ont.

## For QUALITY ELECTRONIC COMPONENTS Consult Us

Representing among other time tested lines:

Sigma Instruments Inc.  
Speer Resistor Division,  
Speer Carbon Company.  
Superior Flux and Manufacturing Co. Inc.  
Tyni-Switch Division, The Sessions Clock Co.

### SAMUEL C. HOOKER (Canada) LTD.

8025 Decarie Blvd.  
MONTREAL 9  
REgent 1-2157

21 King St. East  
TORONTO 1  
EMpire 4-2578

## Pioneers in Development of Vibration-Resistant Electrical Connector

The unsatisfied demand for a rugged, dependable connector capable of meeting the exacting requirements of modern aircraft led the Scintilla Division of Bendix\* to develop the first vibration-resistant electrical connector. These connectors using the revolutionary new insert material known as Scinflex were first used on Scintilla Division's ignition equipment for piston engines.

So outstanding was the performance of this new and better connector that its acceptance and use have now become world-wide. Today the Scintilla Division is a major contributor to the electrical connector industry.

This pioneering has never stopped. Bendix was first in the field with cadmium plated connectors, which were later made a requirement of military specifications. Our latest contribution is the best engineered closed entry socket contact available anywhere—one which cannot be mechanically overstressed.

\*TRADE-MARK



Export Sales:  
Bendix International Division • 203 East 42nd St., New York 17, N. Y.

#### FACTORY BRANCH OFFICES:

117 E. Providencia Ave., Burbank, Calif. • Stephenson Bldg., 6560 Cass Ave., Detroit 2, Mich. • 512 West Ave., Jenkintown, Pa. • Brouwer Bldg., 176 W. Wisconsin Ave., Milwaukee, Wisc. • American Bldg., 4 South Main St., Dayton 2, Ohio • 8401 Cedar Springs Rd., Dallas 19, Texas • Boeing Field, Seattle 8, Washington • 1701 "K" Street, N.W., Washington 4, D.C.

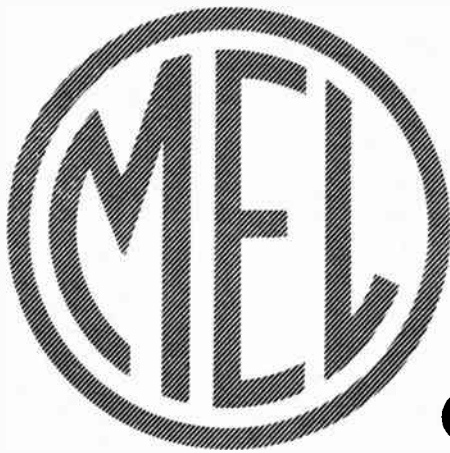

- ① IDEAS
- ② SKILL
- ③ KNOW-HOW
- ④ FACILITIES
- ⑤ EXPERIENCE

## MEASUREMENT ENGINEERING LIMITED

*Has All Five*

Here at Measurement Engineering you will always find an "It can be done attitude". You will find the skill and manufacturing facilities to take care of your needs, large or small, plus special experience in filling the distinctive needs of the Canadian market.

INVITE US TO HELP YOU WITH YOUR PROBLEMS  
OR REQUIREMENTS ON

MAGNETIC AMPLIFIERS - TOROIDS - FILTERS

RADIOTELEPHONES - AMPLIFIERS

FACTORY INSTRUMENTATION

*Ask for our new PRODUCT INDEX . . .*

*A complete listing of products we can supply*

We are also specialists in Aluminum, Brass and Steel Fabrication.

## MEASUREMENT ENGINEERING LIMITED

Field research engineers and equipment specialists  
in every phase of Electronics and Communications.

ARNPRIOR, ONTARIO

### NEW PRODUCTS

(Continued from page 90)

#### ● Multiple Pressure Readout Systems Catalog Item 719

Multiple pressure readout systems to speed up data handling for process industries, wind tunnels, engine test facilities, and marine model basins are illustrated in color in this new 12-page catalog 58-15. These unique packaged systems utilize a single high-accuracy sensing device and pressure comparators to sample up to 200 pressures simultaneously with accuracy of 1 part in 2000.

Operation, applications, and performance characteristics are illustrated with photos, dimension drawings and schematic diagrams. Catalog 58-15 is available on request.

#### ● Radial-Beam Power Tetrode Item 720

For operation as an amplifier, oscillator or frequency multiplier into UHF, the 4W300B is a water and air cooled version of the famous Eimac 4X150A. Rated at 300 watts plate dissipation, this powerful little tube delivers 140 watts of useful power output at 500 mc in a coaxial-cavity amplifier circuit.



The Eimac 4W300B is especially suitable for applications requiring higher plate dissipation capabilities than the air cooled Eimac 4X150A. The Eimac 4X150A/4001 ir-system socket is recommended for use with the new tetrode.

#### ● Preset Counter Item 721

Designated as the DS-8600 Series, this reliable and rugged preset counter will control with absolute accuracy any counting operation after a pre-selected total has been reached. Any electrical, mechanical or optical event which can be converted into electrical impulses can be counted and controlled. Transducers to effect electrical impulse conversion may be photocells, magnetic coils or switches. Some of the many applications include: batching and packaging of pills, bottles, bottle caps, canned goods, pen points, machine parts, electronic components, etc., in exact preselected quantities; controlling the exact length of stock in cutting operations and electronic control of high speed machinery.

For Further Information  
On New Products  
Use Coupon Page

# READERS' SERVICE PAGE

We realize that our readers are busy people and may not always have time to write letters of enquiry to manufacturers regarding advertised products that are of interest to them. Therefore, to save you the time of writing a letter, we offer you the use of this Readers' Service Page. It is designed for your convenience in obtaining free and without obligation detailed information on any advertiser's product or New

Product appearing in this issue of *Electronics and Communications*.

Check as many New Products or Advertisements as you like on the attached coupons and send to *Electronics and Communications*, 31 Willcocks Street, Toronto 5, Ontario. We will see that detailed information concerning your enquiries is in your hands within a few days.

## Check Advertiser's Name For Information

Advertiser	Page	Advertiser	Page
<input type="checkbox"/> Aeromotive Engineering micro miniature ball bearings	60	<input type="checkbox"/> Dalohm miniature power resistors	88
<input type="checkbox"/> Aerovox electrolytic T.V. capacitors	56	<input type="checkbox"/> Daven switches	68
<input type="checkbox"/> Ampex magnetic recording equipment	95	<input type="checkbox"/> Dawe meters	62
<input type="checkbox"/> Andrew parabolic antenna	26	<input type="checkbox"/> Elmec klystrons	29
<input type="checkbox"/> Automatic Electric cable spinning equipment	85	<input type="checkbox"/> Elmeco capacitors	68
<input type="checkbox"/> Automatic Electric carrier line circuit components	45	<input type="checkbox"/> Engineered Sound Systems power amplifying bays	76
<input type="checkbox"/> Automatic Electric testing equipment	55	<input type="checkbox"/> Federal Wire & Cable magnetic wire	89
<input type="checkbox"/> Aviation Electric metal mounts	103	<input type="checkbox"/> Freed Transformer incremental inductance bridge	66
<input type="checkbox"/> Bach Simpson tube tester	100	<input type="checkbox"/> Hammond transformers	71
<input type="checkbox"/> Bakelite phenolite plastic	4	<input type="checkbox"/> Heath electronic equipment kits	79-83
<input type="checkbox"/> Bank of Canada Industrial banking services	49	<input type="checkbox"/> Hellpot potentiometers	87
<input type="checkbox"/> Bendix Aviation Scintilla electrical connectors	88	<input type="checkbox"/> Hewlett-Packard voltmeter	102
<input type="checkbox"/> Berco potentiometers	96	<input type="checkbox"/> Hooker electronic components	97
<input type="checkbox"/> Bohne springs	13	<input type="checkbox"/> Hughes Owens slide rule	67
<input type="checkbox"/> Bomac Laboratories silicon diodes	7	<input type="checkbox"/> International Resistance "bonded stock" resistors	61
<input type="checkbox"/> Bristol dynamaster continuous balancing electronic recorder	14	<input type="checkbox"/> Kaiser-Willys jeep	6
<input type="checkbox"/> Budelman FM-UHF microwave and radio systems	10	<input type="checkbox"/> Kester solder	78
<input type="checkbox"/> Budelman frequency meter	97	<input type="checkbox"/> Magnetics Inc. tape wound cores	35
<input type="checkbox"/> Canadian Aviation Electronics electronic equipment	12	<input type="checkbox"/> Measurements Corp. signal generator	78
<input type="checkbox"/> Canadian Electrical Supply Co. electronic components	76	<input type="checkbox"/> Measurement Engineering electronic components	98
<input type="checkbox"/> Canadian General Electric quadraphase	31	<input type="checkbox"/> Micro transcription turntables	90
<input type="checkbox"/> Canadian General Electric Formex magnet wire	65	<input type="checkbox"/> Motorola microwave terminals	94
<input type="checkbox"/> Canadian General Electric communication systems	63	<input type="checkbox"/> National Fibre phenolite laminated plastic	39
<input type="checkbox"/> Canadian Marconi photocell	47	<input type="checkbox"/> Northern Electric console	9
<input type="checkbox"/> Canadian Marconi radiotrons	3	<input type="checkbox"/> Osborne Electric communications protection equipment	41
<input type="checkbox"/> Canadian Marconi signal generator	75	<input type="checkbox"/> P.S.C. Applied Research navigation computer	64
<input type="checkbox"/> Canadian Marconi soldering irons	91	<input type="checkbox"/> Phillips paper insulated lead covered telephone cables	2
<input type="checkbox"/> Canadian Stackpole cores	104	<input type="checkbox"/> Precision Electronic Components variable resistors	84
<input type="checkbox"/> Canadian Westinghouse 2000 Mc/S microwave radio	25	<input type="checkbox"/> Radio Engineering Products 60-channel UHF FM radio system	67
<input type="checkbox"/> Canadian Westinghouse electronic tube service helps	57	<input type="checkbox"/> Radio Engineering Products 60-channel UHF FM radio system	73
<input type="checkbox"/> Cannon plugs	71	<input type="checkbox"/> Radio Engineering Products 60-channel carrier telephone system	77
<input type="checkbox"/> Centralab electronic components	58	<input type="checkbox"/> Rogers Majestic electronic tubes	52-53
<input type="checkbox"/> Clarostat wire wound controls	20	<input type="checkbox"/> Sanborn 8 and 6 channel oscillograph recording system	101
<input type="checkbox"/> Collins electronic components	19	<input type="checkbox"/> Scotch Brand magnetic tape	36
<input type="checkbox"/> Computing Devices position and homing indicator	8	<input type="checkbox"/> Snelgrove quartz crystals	70
<input type="checkbox"/> Consolidated Electronic Equipment Ely "Snapper" thermal time delay relay	74	<input type="checkbox"/> Sperry integral gear head	42
<input type="checkbox"/> Cossor oscilloscopes	22-23	<input type="checkbox"/> Stark meters	86
<input type="checkbox"/> Crane Packing parts and materials	93	<input type="checkbox"/> T.C.C. superlytic condensers	69
		<input type="checkbox"/> T.M.C. telephone equipment components	92
		<input type="checkbox"/> U.S. Engineering knobs	74
		<input type="checkbox"/> Y.W. Small Parts precision parts	66

## Check New Product Item For Further Information

<input type="checkbox"/> 686	<input type="checkbox"/> 691	<input type="checkbox"/> 696	<input type="checkbox"/> 701	<input type="checkbox"/> 705	<input type="checkbox"/> 710	<input type="checkbox"/> 714	<input type="checkbox"/> 718
<input type="checkbox"/> 687	<input type="checkbox"/> 692	<input type="checkbox"/> 697	<input type="checkbox"/> 702	<input type="checkbox"/> 707	<input type="checkbox"/> 711	<input type="checkbox"/> 715	<input type="checkbox"/> 719
<input type="checkbox"/> 688	<input type="checkbox"/> 693	<input type="checkbox"/> 698	<input type="checkbox"/> 703	<input type="checkbox"/> 708	<input type="checkbox"/> 712	<input type="checkbox"/> 716	<input type="checkbox"/> 720
<input type="checkbox"/> 689	<input type="checkbox"/> 694	<input type="checkbox"/> 699	<input type="checkbox"/> 704	<input type="checkbox"/> 709	<input type="checkbox"/> 713	<input type="checkbox"/> 717	<input type="checkbox"/> 721
<input type="checkbox"/> 690	<input type="checkbox"/> 695	<input type="checkbox"/> 700	<input type="checkbox"/> 705				

Company Name

Your Name

Your Position

Address

## Check Advertiser's Name For Information

Advertiser	Page	Advertiser	Page
<input type="checkbox"/> Aeromotive Engineering micro miniature ball bearings	60	<input type="checkbox"/> Dalohm miniature power resistors	88
<input type="checkbox"/> Aerovox electrolytic T.V. capacitors	56	<input type="checkbox"/> Daven switches	68
<input type="checkbox"/> Ampex magnetic recording equipment	95	<input type="checkbox"/> Dawe meters	62
<input type="checkbox"/> Andrew parabolic antenna	26	<input type="checkbox"/> Elmec klystrons	29
<input type="checkbox"/> Automatic Electric cable spinning equipment	85	<input type="checkbox"/> Elmeco capacitors	68
<input type="checkbox"/> Automatic Electric carrier line circuit components	45	<input type="checkbox"/> Engineered Sound Systems power amplifying bays	76
<input type="checkbox"/> Automatic Electric testing equipment	55	<input type="checkbox"/> Federal Wire & Cable magnetic wire	89
<input type="checkbox"/> Aviation Electric metal mounts	103	<input type="checkbox"/> Freed Transformer incremental inductance bridge	66
<input type="checkbox"/> Bach Simpson tube tester	100	<input type="checkbox"/> Hammond transformers	71
<input type="checkbox"/> Bakelite phenolite plastic	4	<input type="checkbox"/> Heath electronic equipment kits	79-83
<input type="checkbox"/> Bank of Canada Industrial banking services	49	<input type="checkbox"/> Hellpot potentiometers	87
<input type="checkbox"/> Bendix Aviation Scintilla electrical connectors	88	<input type="checkbox"/> Hewlett-Packard voltmeter	102
<input type="checkbox"/> Berco potentiometers	96	<input type="checkbox"/> Hooker electronic components	97
<input type="checkbox"/> Bohne springs	13	<input type="checkbox"/> Hughes Owens slide rule	67
<input type="checkbox"/> Bomac Laboratories silicon diodes	7	<input type="checkbox"/> International Resistance "bonded stock" resistors	61
<input type="checkbox"/> Bristol dynamaster continuous balancing electronic recorder	14	<input type="checkbox"/> Kaiser-Willys jeep	6
<input type="checkbox"/> Budelman FM-UHF microwave and radio systems	10	<input type="checkbox"/> Kester solder	78
<input type="checkbox"/> Budelman frequency meter	97	<input type="checkbox"/> Magnetics Inc. tape wound cores	35
<input type="checkbox"/> Canadian Aviation Electronics electronic equipment	12	<input type="checkbox"/> Measurements Corp. signal generator	78
<input type="checkbox"/> Canadian Electrical Supply Co. electronic components	76	<input type="checkbox"/> Measurement Engineering electronic components	98
<input type="checkbox"/> Canadian General Electric quadraphase	31	<input type="checkbox"/> Micro transcription turntables	90
<input type="checkbox"/> Canadian General Electric Formex magnet wire	65	<input type="checkbox"/> Motorola microwave terminals	94
<input type="checkbox"/> Canadian General Electric communication systems	63	<input type="checkbox"/> National Fibre phenolite laminated plastic	39
<input type="checkbox"/> Canadian Marconi photocell	47	<input type="checkbox"/> Northern Electric console	9
<input type="checkbox"/> Canadian Marconi radiotrons	3	<input type="checkbox"/> Osborne Electric communications protection equipment	41
<input type="checkbox"/> Canadian Marconi signal generator	75	<input type="checkbox"/> P.S.C. Applied Research navigation computer	64
<input type="checkbox"/> Canadian Marconi soldering irons	91	<input type="checkbox"/> Phillips paper insulated lead covered telephone cables	2
<input type="checkbox"/> Canadian Stackpole cores	104	<input type="checkbox"/> Precision Electronic Components variable resistors	84
<input type="checkbox"/> Canadian Westinghouse 2000 Mc/S microwave radio	25	<input type="checkbox"/> Radio Engineering Products 60-channel UHF FM radio system	67
<input type="checkbox"/> Canadian Westinghouse electronic tube service helps	57	<input type="checkbox"/> Radio Engineering Products 60-channel UHF FM radio system	73
<input type="checkbox"/> Cannon plugs	71	<input type="checkbox"/> Radio Engineering Products 60-channel carrier telephone system	77
<input type="checkbox"/> Centralab electronic components	58	<input type="checkbox"/> Rogers Majestic electronic tubes	52-53
<input type="checkbox"/> Clarostat wire wound controls	20	<input type="checkbox"/> Sanborn 8 and 6 channel oscillograph recording system	101
<input type="checkbox"/> Collins electronic components	19	<input type="checkbox"/> Scotch Brand magnetic tape	36
<input type="checkbox"/> Computing Devices position and homing indicator	8	<input type="checkbox"/> Snelgrove quartz crystals	70
<input type="checkbox"/> Consolidated Electronic Equipment Ely "Snapper" thermal time delay relay	74	<input type="checkbox"/> Sperry integral gear head	42
<input type="checkbox"/> Cossor oscilloscopes	22-23	<input type="checkbox"/> Stark meters	86
<input type="checkbox"/> Crane Packing parts and materials	93	<input type="checkbox"/> T.C.C. superlytic condensers	69
		<input type="checkbox"/> T.M.C. telephone equipment components	92
		<input type="checkbox"/> U.S. Engineering knobs	74
		<input type="checkbox"/> Y.W. Small Parts precision parts	66

## Check New Product Item For Further Information

<input type="checkbox"/> 686	<input type="checkbox"/> 691	<input type="checkbox"/> 696	<input type="checkbox"/> 701	<input type="checkbox"/> 706	<input type="checkbox"/> 710	<input type="checkbox"/> 714	<input type="checkbox"/> 718
<input type="checkbox"/> 687	<input type="checkbox"/> 692	<input type="checkbox"/> 697	<input type="checkbox"/> 702	<input type="checkbox"/> 707	<input type="checkbox"/> 711	<input type="checkbox"/> 715	<input type="checkbox"/> 719
<input type="checkbox"/> 688	<input type="checkbox"/> 693	<input type="checkbox"/> 698	<input type="checkbox"/> 703	<input type="checkbox"/> 708	<input type="checkbox"/> 712	<input type="checkbox"/> 716	<input type="checkbox"/> 720
<input type="checkbox"/> 689	<input type="checkbox"/> 694	<input type="checkbox"/> 699	<input type="checkbox"/> 704	<input type="checkbox"/> 709	<input type="checkbox"/> 713	<input type="checkbox"/> 717	<input type="checkbox"/> 721
<input type="checkbox"/> 690	<input type="checkbox"/> 695	<input type="checkbox"/> 700	<input type="checkbox"/> 705				

Company Name

Your Name

Your Position

Address

# NEW!



**a Volt-Ohmmeter  
you can carry in  
your shirt pocket!**



**Simpson  
MIDGETESTER**  
MODEL 355

**SELF  
SHIELDED!**

The world's first practical shirt-pocket volt-ohmmeter. Rugged and accurate. Not affected by any outside magnetic influences. 10,000 Ohms per volt AC and DC! Fourteen ranges: 5 for AC voltages, 5 for DC voltages, and 4 for DC resistances.

**See your Parts Distributor**

**\$37<sup>95</sup>**  
including  
probe leads

**Bach-Simpson  
LIMITED**

1255 BRYDGES ST.

LONDON, CANADA

IN USA: Simpson Electric Company  
5200 W. Kinzie St.  
Chicago 44, Ill.



## Book Review



**Basic Electronics** by Van Valkenburgh, Nooger and Neville Inc., Volume 1 to Volume 5, contains the texts of the entire Basic Electricity and Basic Electronics courses, as currently taught at Navy specialty schools, have now been released by the Navy for civilian use. This educational program has been an unqualified success. Since April, 1953, when it was first installed, over 25,000 Navy trainees have benefited by this instruction and the results have been outstanding.

The unique simplification of an ordinarily complex subject, the exceptional clarity of illustrations and text, and the plan of presenting one basic concept at a time, without involving complicated mathematics, all combine in making this course a better and quicker way to teach and learn basic electricity and electronics.

In releasing this material to the general public, the Navy hopes to provide the means for creating a nation-wide pool of pre-trained technicians, upon whom the Armed Forces could call in time of national emergency, without the need for precious weeks and months of schooling.

**Basic Electronics** is published by John F. Rider, Publisher Inc., 480 Canal Street, New York 13, N.Y. The volumes are soft cover bound, cost \$2.00 per volume.

**Servomechanisms and Regulating System Design, Vol. II** by Harold Chestnut and Robert W. Mayer, is distinguished by the following important features.

It . . . states the problems met in the design of regulators and feedback control systems and develops methods for their solution. Although an analytical approach is employed, the emphasis has been placed on practical design. Volume II builds on fundamentals stated in Volume I.

. . . provides an early chapter on the measurements of quantities.

. . . treats thoroughly the means for establishing design specifications.

. . . develops techniques for handling the effects of extraneous signal inputs.

. . . discusses the factors influencing the selection of elements for power and stabilizing sections.

. . . presents amplifier design factors to minimize gain changes, drift, and changes in tubes and other components.

. . . describes all-a.c. servomechanism design. . . stresses linearization techniques and non-linear operation for large input signals and deliberate parameter changes.

. . . includes many illustrative problems, all adopted from actual design projects.

**Servomechanisms and Regulating System Design** is published by John Wiley and Sons Inc., 440 Fourth Ave., New York 16, N.Y., contains 384 pages, hard cover bound, cost \$8.50.

**Radio and Television Engineer's Reference Book**, General Editor, E. Molloy, Advisory Editor, W. E. Pannett, A.M.I.E.E. brings together, within one convenient volume, comprehensive technical data and information on the latest developments in the transmission and reception of radio and television signals, and allied subjects.

The Reference Book is arranged in forty-five main sections, each dealing with a specific branch of the subject, and written by specialists in the particular fields concerned. All sections have been written bearing in mind the practical requirements of engineers, technicians and amateur enthusiasts engaged in designing, maintaining, operating, servicing or selling modern radio and television equipment for broadcasting or communication.

The instructor and student also will find much information that is invaluable in preparing for a career in this rapidly expanding industry.

For example, the first section **FORMULAE and CALCULATIONS** provides, in concise form, an invaluable guide to fundamental

radio engineering calculations, with many worked examples typical of everyday problems encountered by field installation and maintenance engineers, designers and draughtsmen, instructors and operators. Included in this section are **MATHEMATICAL TABLES** and advice on the use of the slide rule and other aids to calculation. The following section, **OPTICS and ELECTRON OPTICS**, will be of special interest to all television engineers. **MATERIALS** provide useful data on the electrical and physical properties of the materials used in modern practice.

Limited space does not permit a complete review of the wide range of subjects covered in this volume but it may be said that the whole field of radio and television is more than fully dealt with by the 36 specialist contributors to the book which contains over 1,600 pages, and over 1,860 tables and diagrams.

**Radio and Television Engineer's Reference Book** is published by George Newnes Ltd., Tower House, Southampton Street, Strand, WC 2, London, England, and is available in Canada through the British Book Service (Canada) Ltd., 1068 Broadview Avenue, Toronto 6, Ontario.

**Rider's Specialized Tape Recorder Manual I, 1954-55.**

The Magnetic Tape Recorder is rapidly assuming a prominent roll in the life of the human being. The convenience of being able to instantly record the human voice or any other sounds; to repeat them as often as desired, and then to reuse the recording medium for new recordings, has resulted in great popularity for this medium.

This volume has been specially planned to contain the service information on the popular varieties of magnetic tape recorders manufactured over a five year period — from 1950 through 1954, including 1955 models. Every effort has been made to make the information complete. The data are accurate and authentic, having been procured directly from the manufacturers of the devices. The expert knowledge they have gained during the design and production of their units is contained with these covers, and it is the aim of the publisher to convey to the reader and the user of this publication, the best there is in servicing data and techniques concerning these devices.

The products of tape recorder manufacturers not contained in this volume will be found in other volumes in this series.

**Rider's Specialized Tape Recorder Manual I, 1954-55** is published by John F. Rider, 480 Canal Street, New York 13, N.Y., contains 286 pages, soft cover bound, price \$4.50.

**Transistors, Theory and Applications** by Abraham Coblenz and Harry L. Owens. A practical treatment of transistors, showing the principles of their operation, how they are made, and how they are applied in electronic circuits. Everything is presented in simple language and with a thoroughness that will make the book understandable and useful to technicians, engineers, and advanced workers alike.

The book takes you step by step from basic concepts to advanced topics, offering help in manufacturing techniques, precautions, and practices, and in testing, evaluating, and using transistors in circuits. It discusses both silicon and germanium transistors. Theory is stressed only in its relation to practical needs.

You will find in this book helpful information on such topics as cascading of transistors . . . silicon preparation and silicon transistors . . . the intermetallic compounds and criteria for their selection as transistor materials . . . power transistors . . . high frequency transistors . . . and a host of other related subjects.

**Transistors, Theory and Applications** is published by McGraw-Hill Book Company Inc., New York, Toronto and London; contains 313 pages, hard cover bound.

# now SANBORN



## and 6 CHANNEL "150" SERIES OSCILLOGRAPHIC RECORDING SYSTEMS

in  
addition to



and



Channel  
Models

These new additions to the "150 family" follow the original "150" design concept which permits rapid change-over from one set of recording requirements to another by means of interchangeable, plug-in type preamplifiers.

The Model 158-5460 eight-channel system (upper left photo) consists of an eight channel recorder assembly and eight Driver Amplifier-Power Supply units. To this basic assembly the user adds any combination of Sanborn "150" plug-in preamplifiers to meet his requirements. Each channel provides a 4 cm deflection.

The six-channel system (156-5460) has the same basic assembly, except for *two less* galvanometers and *one less* Driver Amplifier-Power Supply unit in each cabinet. Each channel provides a 5 cm deflection.

Both systems offer: *nine* chart speeds (0.25 to 100 mm/sec.); *extended* frequency response; *improved* regulated power supplies; *individual* stylus temperature control for each channel; *improved* control of input signals by 1, 2, 5, 10, 20, etc. attenuator ratios; controls for timing, manual and remote coding.

### Also 8 and 6 Channel Systems for recording analog computer outputs,

or other applications where 1 volt/cm sensitivity is usable. complete eight-channel system shown comprises four Model 150-2000 Dual Channel DC Amplifiers and an eight-channel Recorder Assembly. Each Dual-Channel Amplifier is complete with common power supply. (The six-channel version is identical, except for two less galvanometers and one less Dual-Channel Amplifier.) Also four channel models.

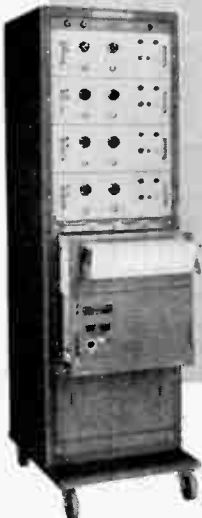

Canadian Representative  
R-O-R ASSOCIATES  
290 Lawrence Ave. West  
Toronto 12, Ontario, Canada

**SANBORN**  **COMPANY**  
CAMBRIDGE 39, MASS.

**Fast, accurate**

# VOLTAGE MEASUREMENTS

**10 cps to 700 MC**

Hewlett-Packard, leader in electronic test instruments, offers 3 precision vacuum tube voltmeters that provide coverage for almost all voltage measuring needs. Together these three instruments cover frequencies 10 cps to 700 MC, and measure voltages from 0.1 millivolts to 300 volts. Each has high sensitivity, wide range, simple operation and broadest usefulness in research or production testing. Construction is sturdy and of highest quality. Accessories extend voltage range to 30 kilovolts and make possible measurements from 1 microampere to 3 amperes.



### NEW! -hp- 400AB Vacuum Tube Voltmeter

Here is a new precision instrument for general ac measurements that can be the most useful equipment on your bench. -hp- 400AB covers frequencies from 10 cps to 600 KC, and measures voltages from 0.3 mv to 300 v. Accuracy is  $\pm 2\%$  from 20 cps to 100 KC. A high input impedance of 10 megohms with 25  $\mu\text{f}$  shunt insures that circuits under test are not disturbed. Readings are direct in volts or dbm. \$200.00



### -hp- 400D Vacuum Tube Voltmeter

This instrument's frequency coverage is 10 cps to 4 MC, voltage range 0.1 mv to 300 v. New amplifier circuit provides 56 db of feedback (mid-range) for highest stability. Input impedance is 10 megohms to prevent disturbance to circuits under test. Readings are direct in dbm. Condensers are sealed or long-life electrolytic. \$225.00



### -hp- 410B Vacuum Tube Voltmeter

Industry's standard for vhf-uhf voltage measurements. Wide frequency range of 20 cps to 700 MC; response flat within 1 db full range. Diode probe places 1.5  $\mu\text{f}$  capacity across circuit under test. This plus 10 megohms input impedance assures circuits are not disturbed. Combines ac with dc voltmeter (100 megohms impedance) and ohmmeter measuring 0.2 ohms to 500 megohms. \$245.00

Canadian Rep.: Atlas Radio Corp. Ltd., 50 Wingold Ave., Toronto

**GET COMPLETE INFORMATION TODAY**

#### HEWLETT-PACKARD COMPANY

3338G PAGE MILL RD., PALO ALTO, CALIF.

PLEASE SEND INFORMATION ON  400AB  400D  410B

Name \_\_\_\_\_

Company \_\_\_\_\_

Street \_\_\_\_\_

City \_\_\_\_\_ Zone \_\_\_\_\_ State \_\_\_\_\_



ELECTRONIC TEST  
INSTRUMENTS

### ADVERTISERS' INDEX

Aeromotive Engineering Products	60
Aerovox (Canada) Ltd.	56
Ampex Corp.	95
Andrew Corp.	26
Automatic Electric Sales (Canada) Ltd.	45; 55; 84; 85
Aviation Electric Ltd.	103
Bach Simpson Ltd.	4; 100
Bakelite Co.	49
Bank of Canada	88
Bendix Aviation Corp.	97
Bohne Industries Ltd.	13
Bomac Laboratories Inc.	7
Bristol Co. of Can. Ltd., The	14
Canadian Aviation Electronics Ltd.	12
Canadian Electric Resistors Ltd.	96
Canadian Electrical Supply Co. Ltd.	76
Canadian General Electric Co. Ltd.	31; 63; 65
Canadian Marconi Co.	3; 20; 47; 75; 91
Canadian Stackpole Ltd.	104
Canadian Westinghouse Co. Ltd.	25; 57
Cannon Electric (Can.) Ltd.	71
Centralab (Div. Globe Union Inc.)	58
Collins Radio Co.	19
Computing Devices of Canada Ltd.	8; 72
Consolidated Electronic Equipment Co.	74
Cossor (Canada) Ltd.	22-23
Crane Packing Co. Ltd.	93
Dale Products Inc.	86
Daven Co., The	68
Dawe Instruments Ltd.	62
Eitel-McCullough Inc.	29
Electro Sonic Supply Co. Ltd.	68
Engineered Sound-Systems Ltd.	76
Federal Wire & Cable Co. Ltd.	89
Freed Transformer Co. Inc.	66
Glendon Co. Ltd., The	69
Hammond Mfg. Co. Ltd.	71
Heath Co.	79-83
Helipot Corp.	87
Hewlett-Packard Co.	102
Hooker (Can.) Ltd., Sam. C.	97
Hughes Owens Co. Ltd.	67
International Resistance Co. Ltd.	61
Kaiser-Willys of Canada Ltd.	6
Kester Solder Co.	78
Magnetics Inc.	35
Measurements Corp.	78
Measurement Engineering Ltd.	98
Microlab Devices Ltd.	90
Minnesota Mining & Mfg. of Canada Ltd.	36
National Fibre Co. of Canada Ltd.	39
Nichols Ltd., R. H.	9
Northern Electric Co. Ltd.	41
Osborne Electric Co. Ltd.	64
P.S.C. Applied Research Ltd.	2
Precision Electronic Components Ltd.	67
Pye (Canada) Ltd.	10; 97
Radio Engineering Products Ltd.	73; 77
Rogers Majestic Electronics Ltd.	52-53; 94
Sanborn Co.	101
Snelgrove Co. Ltd., C. R.	70
Sperry Gyroscope Co.	42
Stark Electronic Inst's. Ltd.	86
Telephone Mfg. Co. Ltd.	92
U.S. Engineering Co.	74
Y.W. Small Parts Ltd.	66

For further data on advertised products use page 99.



# ROBINSON **MET-L-FLEX** all-metal mounts for vibration isolation and shock protection

FOR AIRBORNE ELECTRONIC EQUIPMENTS, INSTRUMENTS AND CONTROLS

## SERIES 878 TWIN UNIT MOUNT ASSEMBLY

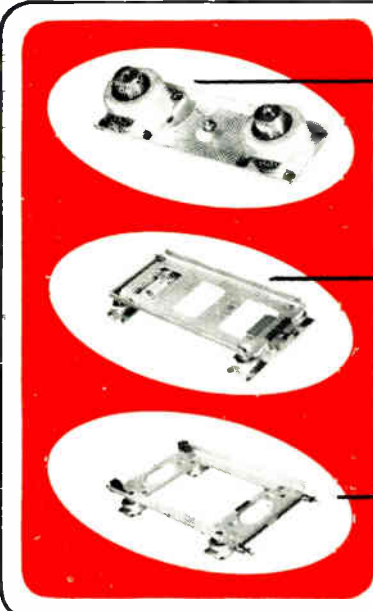

The assembly consists of two Series 7001 MET-L-FLEX Unit Mounts on a flanged tie-plate for attachment to your own tray or mounting base. S-1 and S-2 standard bases incorporate this assembly. Special widths and load ratings available. See Dwg. 878 B for details.

Robinson Model Number	Load Rating Lbs. Each End
878 1	1/2 to 1
878 2	3/4 to 1 3/4
878 3	1 1/2 to 3
878 4	2 1/2 to 5 1/2
878 5	5 to 10

## SERIES 892 UNIT MOUNTING BASE

Designed and manufactured in conformance with JAN-C-172A and included specifications. "Proof Tested" Construction. Uses two Series 878 MET-L-FLEX Twin Unit Mounts and Bonding Jumpers. See Dwg. 892 B for details.

Robinson Model No.	Standard Designation	Load Range in Pounds	Weight in Lbs.
892 1	MT S 1	6 12	1 25
892 2	MT S 2	10 22	1 35

## SERIES 831 UNIT MOUNTING BASE

Designed and manufactured in conformance with JAN-C-172A and included specifications. "Proof Tested" Construction. Employs four Series 7002 MET-L-FLEX Unit Mounts and Bonding Jumpers. See Dwg. 831 B for details.

Robinson Model No.	Standard Designation	Load Range in Pounds	Wgt. in Pounds
831 1	MT A 1 B	10 24	2 40
831 2	MT A 1 C	10 24	2 45
831 3		10 24	
831 4	MT A 1 D	18 40	2 50
831 5		10 24	
831 6	MT B 1 B	18 40	2 60
831 7		10 24	
831 8	MT B 1 2 C	18 40	2 65
831 9	MT B 1 2 D 1	22 50	2 70
831 13	MT B 1 2 D 2	40 80	2 70
831 14	MT C 1 2 C	40 80	2 80
831 15	MT C 1 2 D	40 80	2 85

**Robinson MET-L-FLEX** Engineered Mounting Systems, Mounting Bases, and Unit Mounts . . . by Robinson Aviation Inc. . . are compact, rugged and effective at *all altitudes*. The basic unit mount is an all-metal resilient element made of stainless steel which has . . .

- High damping stability at all altitudes.
- Non-linear deflection characteristics — maximum vibration absorption.
- Sea level performance at any altitude — unaffected by oils, hydraulic fluids, temperature, vibration or moisture.
- Extremely long life.
- Negligible drift rate and wide temperature range — 90 to +175C.

Mounting Bases to meet your exact dimensional and load requirements are available on special order.

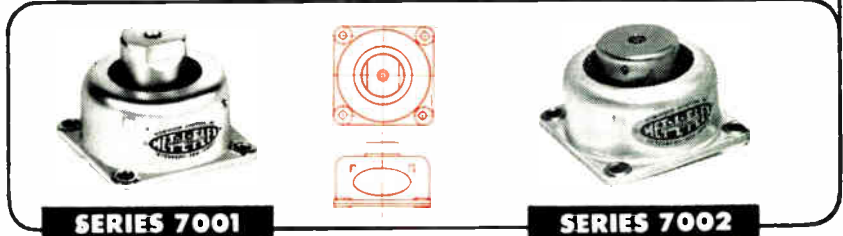

Robinson mounts are designed and built for the operating life of the aircraft. They lack the inherent weaknesses of mountings incorporating organic or plastic materials. Anti-vibration mounts are available in a wide range of sizes, permitting replacement of existing mounts in most cases.

Write for bulletin on vibration isolation mounts to: 200 Laurier Blvd., Montreal

Model Number	Application Range in Lbs.
7001-H	1/2 to 1
7001-J	3/4 to 1 1/4
7001-K	1 1/2 to 3
7001-L	2 1/2 to 5 1/2
7001-M	5 to 10

Model Number	Application Range in Lbs.
7002-G	1 1/2 to 2 3/4
7002-H	2 1/2 to 6
7002-J	4 1/2 to 10
7002-K	5 1/2 to 12 1/2
7002-L	10 to 20
7002-U	15 to 30
7002-M	18 to 40
7002-P	35 to 50
7002-R	45 to 75

MET-L-FLEX is the copyrighted designation for the all-metal resilient cushions developed and pioneered by Robinson.

Canadian Distributor

# AVIATION ELECTRIC

MONTREAL LIMITED VANCOUVER

For further data on advertised products use page 99.

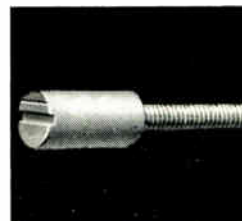
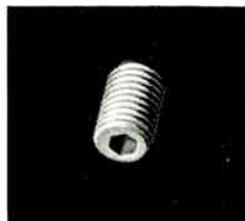
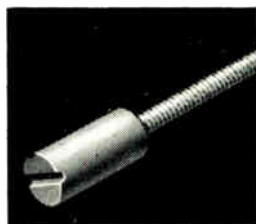

# CUT IRON CORE COSTS

## with Stackpole "PREFERRED TYPES"

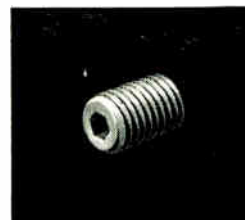

**"EE" SERIES . . .  
FOR  
ENGINEERED ECONOMY**



Made to well-known Stackpole quality standards, these new "EE" Cores are available only in commonly needed grades and sizes. They're ready for delivery from stock . . . at low prices . . . and without the usual set-up charge for custom-engineered cores.

Mechanical specifications conform to the latest MPA recommendations. Electrical standards fully meet 8 out of 10 requirements of radio, TV, and communications equipment. Write, wire, or 'phone for details.



CANADIAN STACKPOLE LIMITED

550 Evans Ave., Etobicoke, Toronto 14, Ont.

# STACKPOLE

For further data on advertised products use page 99.

World Radio History