

Electronics Today

\$1.75

MM70924

INTERNATIONAL FEBRUARY 1981

Electronics in Photography

- Ultrasonic Burglar Alarm
- Fuzz/Sustain Project
- Audio Filter Design
- Process Timer

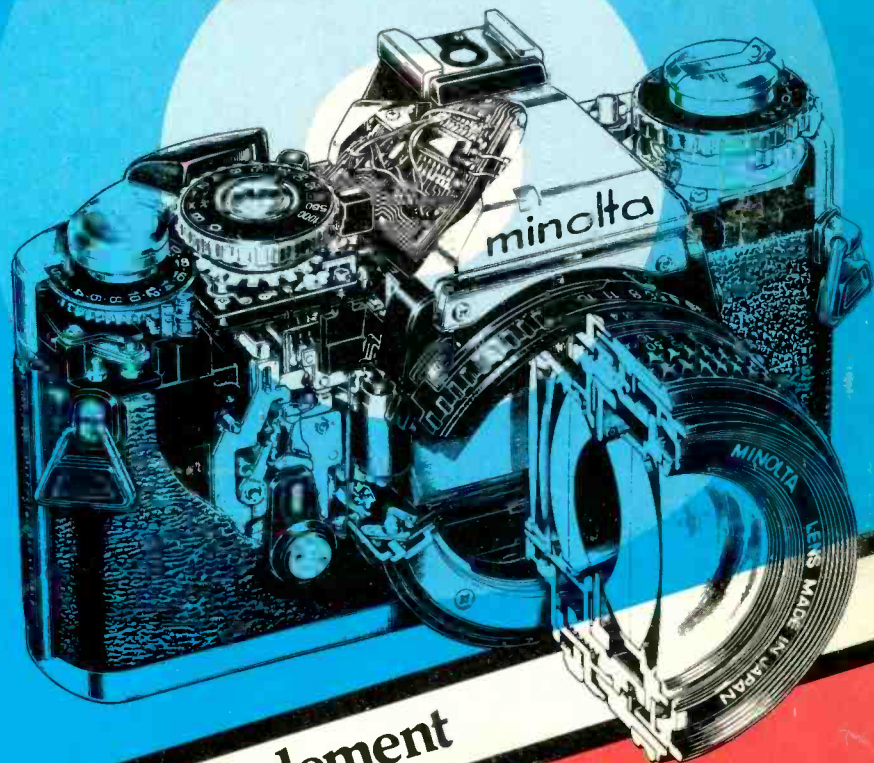

EXTRA: 24 Page Computer Supplement

ZX80 Computer Reviewed

- Computers-an overview
- Selecting a Business System
- Choosing a Floppy System



NO. 272 048 03
FARADAY ST
KJY 3MF
TAMA ON

Catalo



TRANSISTORS

BC148	.35	2N3994	1.30
BC204	.35	2N4013	.40
BC207	.35	2N4032	.15
BC259	.30	2N4036	.45
BC327	.35	2N4037	.95
BC337	.35	2N4061	.15
BC548	.35	2N4062	.15
BC557	.35	2N4106	.45
BC558	.35	2N4123	.15
PM1486	.05	2N4124	.10
SJE5544	.35	2N4126	.15
SPS5210	.35	2N4208	.35
SPS5457	.25	2N4222	1.35
SPS5458	.30	2N4250	.25
2N1536	1.50	2N4400	.15
2N1893	.50	2N4401	.15
2N2102A	.50	2N4402	.15
2N2219A	.40	2N4403	.15
2N2222	.25	2N4416A	2.95
2N2369A	.25	2N4871	.80
2N2484	.35	2N4891	2.25
2N2646	.95	2N4898	.95
2N2647	.50	2N4916	.40
2N2904	.35	2N4920	2.95
2N2905A	.35	2N4923	2.70
2N2906A	.25	2N4970	.15
2N2907A	.30	2N5023	.45
2N3019	.60	2N5038	8.30
2N3053	.45	2N5064	.25
2N3055	.75	2N5087	.25
2N3114	.40	2N5088	.15
2N3117	.75	2N5089	.30
2N3250	.40	2N5129	.35
2N3301	.25	2N5131	.15
2N3390	.15	2N5143	.70
2N3391A	.15	2N5172	.70
2N3394	.20	2N5210	.25
2N3415	.15	2N5224	.15
2N3416	.15	2N5225	.15
2N3440	1.10	2N5232A	1.25
2N3442	2.30	2N5245	.80
2N3565	.50	2N5306	.90
2N3566	.30	2N5369	.90
2N3568	.30	2N5400	.30
2N3569	.30	2N5401	.35
2N3585	.90	2N5415	1.50
2N3638A	.30	2N5447	.30
2N3639	.20	2N5449	.50
2N3643	.30	2N5457	.25
2N3644	.30	2N5458	.70
2N3704	.15	2N5459	.60
2N3705	.15	2N5497	.60
2N3707	.15	2N5525	.50
2N3708	.15	2N5550	.30
2N3710	.15	2N5630	8.95
2N3711	.30	2N5769	.30
2N3715	1.50	2N5770	.15
2N3725	.40	2N5771	.15
2N3773	1.95	2N5772	.15
2N3819	.45	2N5877	1.15
2N3820	.55	2N5879	.70
2N3904	.15	2N5961	.15
2N3905	.15	2N5962	.25
2N3906	.15	2N6027	.35
2N3976	.15	2N6028	.35
		2N6058	1.95
		2N6059	4.25
		2N6076	.15

2N6079	1.05	MPSA05	.15
2N6111	.60	MPSA06	.20
2N6121	1.00	MPSA09	.20
2N6122	.61	MPSA10	.20
2N6124	.55	MPSA13	.20
2N6129	.60	MPSA14	.35
2N6340	18.95	MPSA18	.25
2N6657	9.95	MPSA18	.25
2N6658	10.95	MPSA42	.30
		MPSA43	.30
		MPSA55	.15
		MPSA56	.20
		MPSA65	.20
		MPSA70	.25
		MPSA92	.25
		MPSH05	.30
		MPSL01	.30
		MPSL07	.30
		MPSU01	1.00
		MPSU01A	1.25
		MPSU05	1.00
		MPSU06	1.25
		MPSU10	1.50
		MPSU51	.60
		MPS3394	.15
		MPS3395	.15
		MPS3638	.10
		MPS3704	.10
		MPS3705	.10
		MPS3706	.10
		MPS3709	.10
		MPS3710	.10
		MPS3904	.15
		MPS5457	.25
		MPS5458	.25
		MPS5793	.20
		MPS6514	.30
		MPS6515	.25
		MPS6516	.35
		MPS6546	.25
		MPS6565	.10
		MJ3701	.50
		MJ4000	2.50
		MP6061-2	1.25
		MP6061-3	1.25
		MPF102	.45
		MPF103	.45
		MPF105	.50
		MSS1000	1.00
		MJE170	1.00
		MJE340	1.90
		MJE350	2.50
		MJE2370	.75
		MJE2955	1.75
		MJE3055	1.50
		TI511	1.50
		TI3027	1.25
		TIL32	.25
		TIL228-2	.35
		TIL232-2	.30
		TIL261	.15
		TIS43	.70
		TIS62	.25
		TIS98	.25
		TIS101	.20
		TIP29B	.70
		TIP29C	.75
		TIP30	.75
		TIP31A	.70

TIP31B	.75
TIP31C	.90
TIP32B	.60
TIP32C	.75
TIP33C	1.50
TIP34C	1.95
TIP35C	2.95
TIP36C	3.10
TIP41B	1.10
TIP41C	1.20
TIP42C	1.20
TIP48	1.25
TIP50	1.25
TIP53	3.95
TIP102	1.80
TIP110	1.00
TIP111	1.75
TIP115	1.40
TIP120	1.50
TIP121	1.40
TIP122	1.70
TIP125	1.25
TIP127	1.95
TIP140	2.75
TIP141	3.15
TIP142	3.10
TIP146	3.25
TIP1598	.05
TIP2955	1.25
TIP3055	1.10

DIODES

IN4001	.07
IN4002	.10
IN4003	.12
IN4004	.15
IN4005	.15
IN4006	.18
IN4007	.20
IN638	.25
IN709	.25
IN914	.05
IN966B	.25
IN2071	.25
IN4009	.02
IN4143	.10
IN4148	.05
IN4150	.10
IN4151	.10
IN4152	.10
IN4153	.10
IN4154	.10
IN4444	.10
IN4448	.10
IN4631A	.10
IN4822	.25
IN5061	.25
IN5820	.55
BA102	.10
B110	.25
IS352	.10
GI033	.10

SCR'S, TRIAC'S

TIC106D	.75
TIC116B	1.70
TIC116D	1.75
TIC126B	2.15
TIC126D	1.75
TIC206B	1.60
TIC206D	1.75
TIC216B	1.75
TIC216D	1.95
TIC226D	1.60
TIC236D	2.35
TIC253D	4.50
TIC263D	4.50

BRIDGE RECTIFIERS

W005M...50V...1.5amp...	.70
W02M...200V...1.5amp...	.75
W04M...400V...1.5amp...	.85
W06M...600V...1.5amp...	.90
W08M...800V...1.5amp...	1.20
KBPC08...800V...8A...	2.25
KBPC10-06...600V...10A...	2.25
PB20...200V...25amp...	3.25
PI...600V...25amp...	3.50
KBPC6-02...200V...6amp...	1.70
KBPC6-06...600V...6amp...	1.90
KBF02...200V...2.5amp...	1.10
KBF06...600V...2.5amp...	1.20
KBPC-02...200V...3amp...	1.20
KBPC-06...600V...3amp...	1.35

ZENER'S

1 WATT 30c	IN5345
	IN4729
	IN4730
	IN4732
	IN4733
	IN4734
	IN4735
	IN4736
1/2 WATT 25c	IN4738
	IN4740
	IN4741
	IN4743
	IN4744
	IN4745
	IN4746
	IN4747
	IN4748
	IN4749
	IN4753
	IN4754
	IN4755
	IN4758
	IN4760
	IN4763
	IN4764
5 WATT 40c	IN5253
	IN5254
	IN5341
	IN5344
	IN5259

Send certified cheque, money order, ChargeX, Master Charge...Include expiry date, card number and signature. We process only prepaid orders. Minimum order \$10.00 Add 5% (minimum \$2.00) for shipping and handling; Ontario residents add 7% sales tax. All prices subject to change. Dealer inquiries welcome.

409 Queen Street West, Toronto, Ontario, M5V 2A5. 868-1315

Exceltronix

Components & Computing Inc.

OUR COMPETITIVE POLICY:
IF YOU KNOW OF ANY PRICES BETTER THAN OURS,
JUST TELL US AND WE'LL TRY TO BEAT THEM.
ALSO, WE ARE OFFERING VERY ATTRACTIVE DEALS
TO QUANTITY BUYERS.

319 COLLEGE STREET, TORONTO, ONTARIO, CANADA. M5T 1S2 (416) 921-5295

Superb! MULTIFLEX Z80A COMPUTER

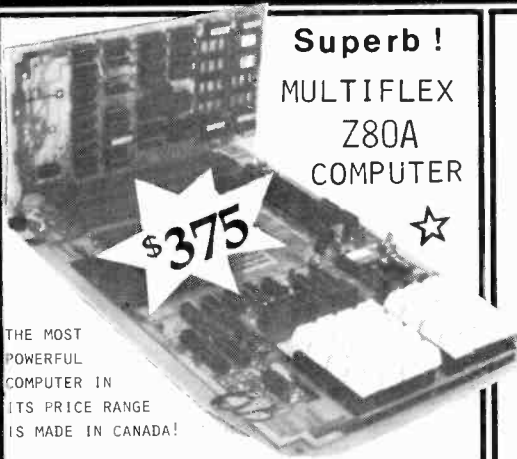

THE MOST
POWERFUL
COMPUTER IN
ITS PRICE RANGE
IS MADE IN CANADA!

You've heard a lot about the Multiflex computer.
Why not come in and SEE one in action, or write
for full information.



MEMORY SPECIALS



- 4116 (200 nS, ceramic, 16Kx1 dynamic)..... \$4.95*
- 4116 (300 nS, ceramic, 16Kx1 dynamic)..... \$3.80*
- 2102LFPC (300 nS, 1Kx1 static)..... \$1.40*
- 2114L (200 nS, 1Kx4 static)..... \$5.50*
- 2114 (450 nS, 1Kx4 static)..... \$4.35*
- 2708 (1Kx8 EPROM)..... \$6.40**
- 2716 (2Kx8 EPROM)..... \$9.95**
- 2532 (4Kx8 EPROM)..... \$29.50**

*10% off quantities over 15, negotiable over 31 pcs.
**10% off quantities over 4, negotiable over 9 pcs.

REMEMBER, QUANTITIES = DISCOUNTS

THIS COLUMN: ALL PRICES

10% OFF ▽ ▽ ▽ ▽ ▽

EXCELTRONIX KITS

Here's a sampling of our 26 kits:

- 1: Bicycle Turning Signal..... \$16.95
- 2: Decision Maker..... \$ 4.95
- 3: Code Practice Oscillator..... \$ 3.95
- 5: 3-Channel Colour Organ..... \$12.50
- 7: British Siren..... \$ 3.95
- 8: American Siren..... \$ 3.95
- 14: Windshield Wiper Controller..... \$ 4.50
- 15: Programmable LED Chaser..... \$19.95
- 16: Programmable Chaser Expander..... \$16.95
- 17: Opto-Isolated Triac board..... \$23.95
- 18: "Lightning Bolt"..... \$59.95
- 19: Dot/Bar LED Watchmeter..... \$22.95
- 23: Automatic Morse Code Generator..... \$69.95
- 25: Car Headlight Shutoff Delay..... \$ 7.50

Come in or check our catalogue for full details

TTL most types in stock

74LS00	.29	74LS90	.57	74LS240	1.53
74LS04	.37	74LS93	.49	74LS241	1.48
74LS08	.43	74LS123	1.09	74LS244	1.76
74LS10	.29	74LS124	1.29	74LS245	3.58
74LS20	.35	74LS136	.85	74LS251	1.89
74LS30	.24	74LS138	.90	74LS253	.77
74LS32	.55	74LS161	1.16	74LS257	1.22
74LS47	.90	74LS163	1.27	74LS374	1.89
74LS48	.90	74LS174	.64	74LS375	1.29
74LS74	.73	74LS175	.68	74LS377	1.87
74LS75	.64	74LS193	1.16	74LS640	3.40
74LS86	.96	74LS221	1.14		

CMOS

CD4001	.38	CD4024	.62	CD4508	2.33
CD4007	.51	CD4027	.57	CD4511	.90
CD4009	.64	CD4049	.57	CD4512	1.00
CD4010	.64	CD4050	.51	CD4514	2.54
CD4011	.38	CD4051	1.00	CD4518	1.76
CD4013	.51	CD4052	1.42	CD4522	1.16
CD4016	.51	CD4056	1.00	CD4529	1.09
CD4017	.85	CD4075	.38	CD4532	1.42
CD4018	.74	CD4081	.34	CD4543	2.24
CD4021	.90	CD4082	.29	CD4584	.62
				CD4702	11.56

MICROS, ETC.

Z80-CPU	12.80	8216	3.75	6802	14.95
Z80A-CPU	14.40	8224	4.45	6810	4.85
Z80-PIO	7.95	8226	3.80	6820	4.25
Z80A-PIO	10.25	8228	6.45	6821	4.85
3080A	6.95	8251	8.50	6850	4.99
8085	14.95	8255	8.50	6502	12.85
8212	3.55	6800	8.40	6522	14.25

MULTIFLEX \$475.



LOW COST
LOGIC STATE ANALYZER

The Multiflex Logic State Analyzer is simply the
most powerful digital design and debugging tool
available to the hobbyist. Watch the pages of
ETI for an article describing this new Canadian
product, or write to Exceltronix for information

Come in for a demonstration

sample prices on POWER SUPPLIES

- +5V, 1.5A..... \$38.95
- +5V, 5A..... \$59.95
- ±12V, 1A..... \$68.95
- ±15V, 1A..... \$68.95
- 5 to 30V, 1.5A... \$47.95

(GOOD NEWS: Now you can program your own 2708,
2716 or 2516 EPROM's right here in our store
for FREE if the EPROM's are bought from us,
or for \$2.00 per PROM if bought elsewhere.)

Note: The PROM Burner you will be using is
one of the many features of MULTIFLEX's Z-80A
Computer KIT. Please write for more info.

MAIL ORDER...

Send a certified cheque or money order (not cash).
Minimum order is \$5 plus \$1 handling charge.
Ontario residents must add 7% P.S.T. Master Charge
and ChargeX accepted: Send account no., signature
and card expiry date.

FLOPPY DISC DRIVES

CDC

CDC 4096 8" floppy drive
Single or Double sided
Single or Double density
IBM 3740 compatible
Soft Sected

SHUGART

Shugart SA800 8" drive
Single sided
Double density
IBM 3740 compatible
Hard Sected

ASCII KEYBOARDS



\$89.00

\$100 BACKPLANES

\$55.00 FRAME \$10 EXTRA

\$100 CONNECTORS \$5.00

IC SOCKETS: 1¢ PER PIN

WHILE THEY LAST!

OHIO SCIENTIFIC

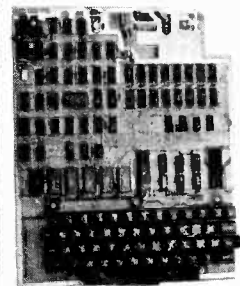

only

\$389.

ALL OSI
PRODUCTS
AVAILABLE
WRITE OR
PHONE FOR
DETAILS

SUPERBOARD II MICROCOMPUTER

The first single-board complete microcomputer

- built-in video interface with many special graphics characters
- 8K Microsoft BASIC-in-ROW, 4K RAM on board expandable to 8K
- Built-in audio cassette interface
- Upper/lower case, 53-key keyboard
- Fully assembled and tested
- Requires +5V at 3 Amps and a video monitor or TV set with RF modulator

ALL PRICES ARE IN CANADIAN FUNDS, 9% FEDERAL SALES TAX INCLUDED

Electronics Today International
 Editorial and Advertising Offices
 Unit 6, 25 Overlea Boulevard,
 Toronto, Ontario, M4H 1B1
 Telephone (416) 423-3262

Publisher and Editor
 HALVOR W. MOORSHEAD
 Assistant Editor
 JOHN VAN LIERDE

Advertising Manager
 MARK CZERWINSKI
 Marketing Representative
 SENG HARRISON
 Advertising Representative
 JIM O'BRIEN
 Advertising Services
 CAROLYN WYATT

Subscription Department
 BEBE LALL
 Accounts Department
 NANCY ALLEN

Production
 SARAH-JANE NEWMAN
 CINDY BAKER

Contributing Editors
 WALLACE PARSONS
 STEVE RIMMER
 DICK CARTWRIGHT
 DAVID VAN IHINGER

INTERNATIONAL EDITIONS
Electronics Today International,
 145 Charing Cross Road,
 London WC2H 0EE, UK
Electronics Today International,
 Ryrie House, 15 Boundary St.,
 Rushcutters Bay, Sydney, Australia
Elrad
 Kommanditgesellschaft, Bissendorfer
 Strasse 8, 3000 Hannover 61, Germany
Electronica Top Internationala
 Postbus 93 Bithoven, Holland

ETI Magazine is published by:
 Electronics Today International (Canada) Ltd
 Printed by:
 RBW Inc., Owen Sound, Ontario.
 Newsstand Distribution:
 Master Media, Oakville, Ontario.

SUBSCRIPTIONS
 \$16.95 (one year), \$29.95 (two years). For
 US add \$3/yr., other countries \$5/yr. Please
 specify if subscription is new or renewal.

BACK ISSUES AND PHOTOCOPIES
 Previous issues of ETI-Canada are available
 direct from our offices for \$3 each; please
 specify by month, not by feature you
 require. 1977 issues available: Feb, May
 July, Nov. 1978 issues NOT available: Jan,
 Feb, Mar, and Apr. We can supply photo-
 copies of any article published in ETI-
 Canada for which the charge is \$2 per
 article, regardless of length. Please specify
 both issue and article.

POSTAL INFORMATION:
 Second Class Mail Registration No. 3955.

Mailing address for subscription orders,
 undeliverable copies and change of address
 notices is:
 Electronics Today International,
 Unit 6, 25 Overlea Blvd., Toronto, Ontario,
 M4H 1B1.

Electronics Today

INTERNATIONAL

FEBRUARY 1981 Vol.5 No.2

Features

Electronics in Photography 13
 Cameras are changing fast and becoming very sophisticated all thanks to electronics. Phil Gerring focuses in on what's happening.

Audio Filter Design 26
 Tim Orr describes various circuits which separate out audio frequencies one from the other.

Piezo Electricity 38
 Applying physical pressure or a voltage to certain crystals produces some unusual results which have many applications in electronics. Ian Sinclair explains.

Into Electronics Part 5 41
 This month we look at what makes transistors work and what bias is. Author Ian Sinclair also explains the importance of matching the impedances of the various stages.

Studio Techniques Part 2 52
 Steve Rimmer continues his feature by describing some of the more unusual effects produced by and for musicians in the recording studio.

Projects

Ultrasonic Burglar Alarm 22
 Protect your house without the inconvenience of having to run miles of wiring by using our ultrasonic alarm system.

Fuzz Sustain Unit 31
 Use this project to produce a really raunchy sound. The foot switches enable you to select straight through operation, regular fuzz or sustained fuzz.

Process Timer 49
 Working over a range from 0.1 seconds to 20 minutes, this circuit has masses of applications in electronics and photography.

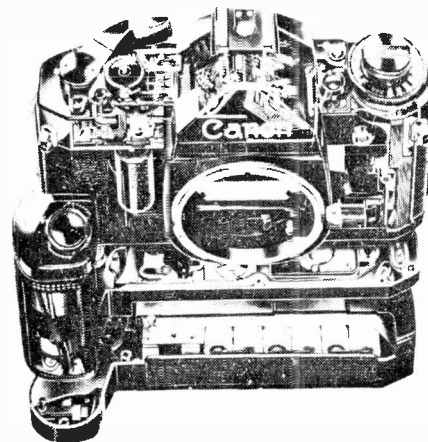

Electronics in Photography, p.13

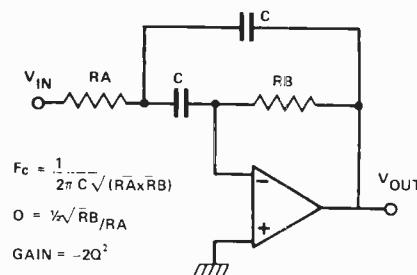

Audio Filter Design, p.26

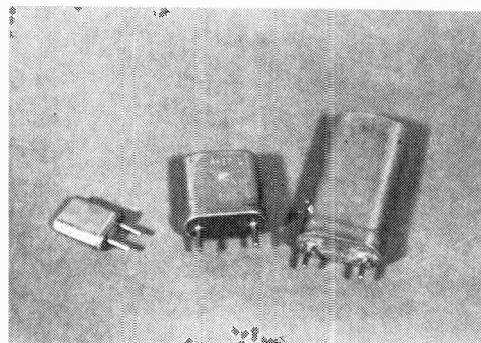

Piezo Electricity, p.38

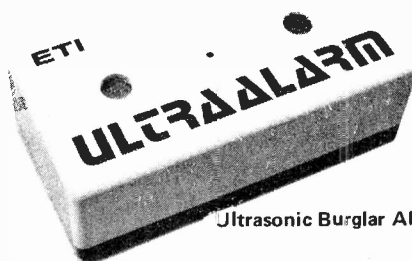

Ultrasonic Burglar Alarm, p.22

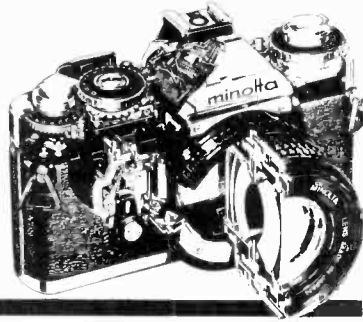

Cover: If your camera is over five years old, you may not realise what has been happening to the latest models. See Electronics in Photography on page 13. Our thanks to Minolta Canada in Mississauga for the cover picture.

ISSN 0703-8984

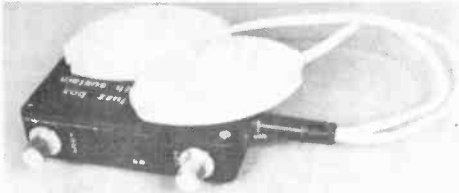

Fuzz Sustain Unit, p.31

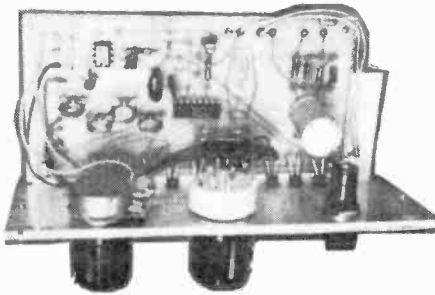

Process Timer, p.49

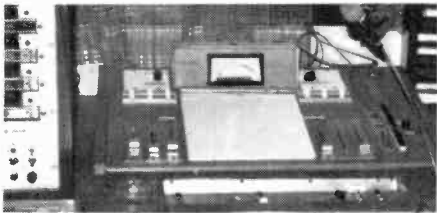

What's New, p.45

Computer

Computing News S-3

So You Want a Computer, Eh? . . S-6
A quick guide for the businessman.

ZX80 Computer Reviewed . . . S-10
John Van Lierde has been trying it out.

Modern Modem. S-14
How to get computers to talk to each other.

ETI/Heathkit Contest. S-15
Win a computer learning course worth nearly \$500.

Choosing a Printer. S-17
A brief guide of what to look for.

Columns

Designer Circuits 35,59
 What's New 45
 Steve Rimmer
 Fun of Electronics 56
 Paul Gieger
 Audio Today 60
 Wally Parsons
 Tech Tips. 64

News/Info

Project Book No.2. 6
 News. 7
 ETI Binders 19
 Babani Books 20
 Back Issues. 25
 Next Month in ETI 30
 ETI Special Publications . . 6,36,58
 ETI Book Service 37
 Subscriptions 57,58
 Reader Order Form 57
 Reader Service Card. 68

Supplement

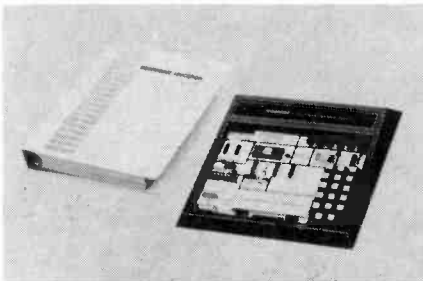

Win a Heathkit Microcomputer Trainer
Page S-15

Computers, An Overview S-18
 What are they? Where did they originate?
 Selecting A Floppy Disk S-22
 How to make a rational choice.

A-1 Electronics S 16
 Active Component Sales Corp 72
 Alberta Audio. 11
 Arkon Electronics 2, 67, S 2
 Audiovision 67
 Avalon Audio 65
 BCS Electronics 11
 Bryan Electronics 63
 Ceres. 63
 Cesco Electronics
 Catalogue. Centre Section
 Challenge Software S 4
 Dominion Radio and Electronics . . . 8
 Electronic Packaging Systems 11
 Electronics 2001 S 4
 E.S.S.N.A. Limited S 24
 Exceltronix 3
 Gladstone Electronics. S 21
 Hammond Manufacturing 10
 Heath Company S 21
 Public Service Canada 55
 Len Finkler Limited. 71
 McGraw-Hill. 12
 Metermaster 69
 Omnitronix 65
 Omnitronix/Winegard. 48
 Orion Electronic Supplies S 9
 RCA S 4
 Rocelco. 62
 H. Rogers Electronic Instruments . . 66
 Sheppard Agencies. 67
 Teletek Devices. S 1
 Tuner Service Co. of Calgary 67
 Videland 65

COPYRIGHT
 All material is subject to worldwide copyright protection. All PCB patterns are copyright and no company can sell boards to our design without our permission.

LIABILITY
 Whilst every effort has been made to ensure that all constructional projects referred to in this magazine will operate as indicated efficiently and properly and that all necessary components to manufacture the same are available, no responsibility whatsoever is accepted in respect of the failure for any reason at all of the project to operate efficiently or at all whether due to any fault in design or otherwise and no responsibility is accepted for the failure to obtain component parts in respect of any such project. Further no responsibility is accepted in respect of any injury or damage caused by any fault in the design of any such project as aforesaid.

EDITORIAL QUERIES
 Written queries can only be answered when accompanied by a self-addressed, stamped envelope. These must relate to recent articles and not involve the staff in any research. Mark such letters ETI-Query. We cannot answer telephone queries.

BINDERS
 For ETI are available for \$6.75 including postage and handling. Ontario residents add 7% PST.

SELL ETI
 ETI is available for resale by component stores. We can offer a good discount and quite a big bonus, the chances are customers buying the magazine will come back to you to buy their components. Readers having trouble in buying ETI could ask their component store manager to stock the magazine.

COMPONENT NOTATION AND UNITS
 We normally specify components using an international standard. Many readers will be unfamiliar with this but it's simple, less likely to lead to error and will be widely used everywhere sooner or later. ETI has opted for sooner!
 Firstly decimal points are dropped and substituted with the multiplier, thus 4.7uF is written 4u7. Capacitors also use the multiplier nano (one nanofarad is 1000pF). Thus 0.1uF is 100n, 5600pF is 5n6. Other examples are 5.6pF=5p6, 0.5pF=0p5.
 Resistors are treated similarly: 1.8M ohms is 1M8, 56k ohms is the same, 4.7k ohms is 4k7, 100 ohms is 100R and 5.6 ohms is 5R6.

PCB SUPPLIERS
 This magazine does not supply PCBs or kits but we do issue manufacturing permits for companies to manufacture boards and kits to our designs. Contact the following companies directly when ordering boards. NOTE, we do not keep track of what's available from who, so please don't write to us for information on kits or boards. Similarly, do not ask our PCB suppliers for project help.

K.S.K. Associates, P.O. Box 54, Morrison, Ontario N0B 2C6.
 B.R. Electronics, P.O. Box 6326F, Hamilton, Ontario, L9C 6L9
 Spectrum Electronics, Box 4166, Stn 'D', Hamilton, Ontario, L8V 4L5
 Wentworth Electronics, R.R. No.1, Waterdown, Ontario L0R 2H0
 Danocinths Inc. P.O. Box 261, Westland, MI 48185, USA.
 Exceltronix Inc., 319 College St., Toronto, Ontario, M5T 1S2
 Arkon Electronics Ltd., 409 Queen St. W., Toronto, Ontario, M5V 2A5.
 A-1 Electronics, 5062 Dundas St. West, Islington, Ontario M9A 1B9. (416) 231-4331.

NEW

Electronics Today Projects Book No.2

Our last two specials, published in the Summer of 1980 were so successful, we just had to follow up.

Now we bring you ETI Projects Book No.2. This contains 25 of the very best projects from ETI magazines from the last three years. This special has 100 pages.

\$3.95

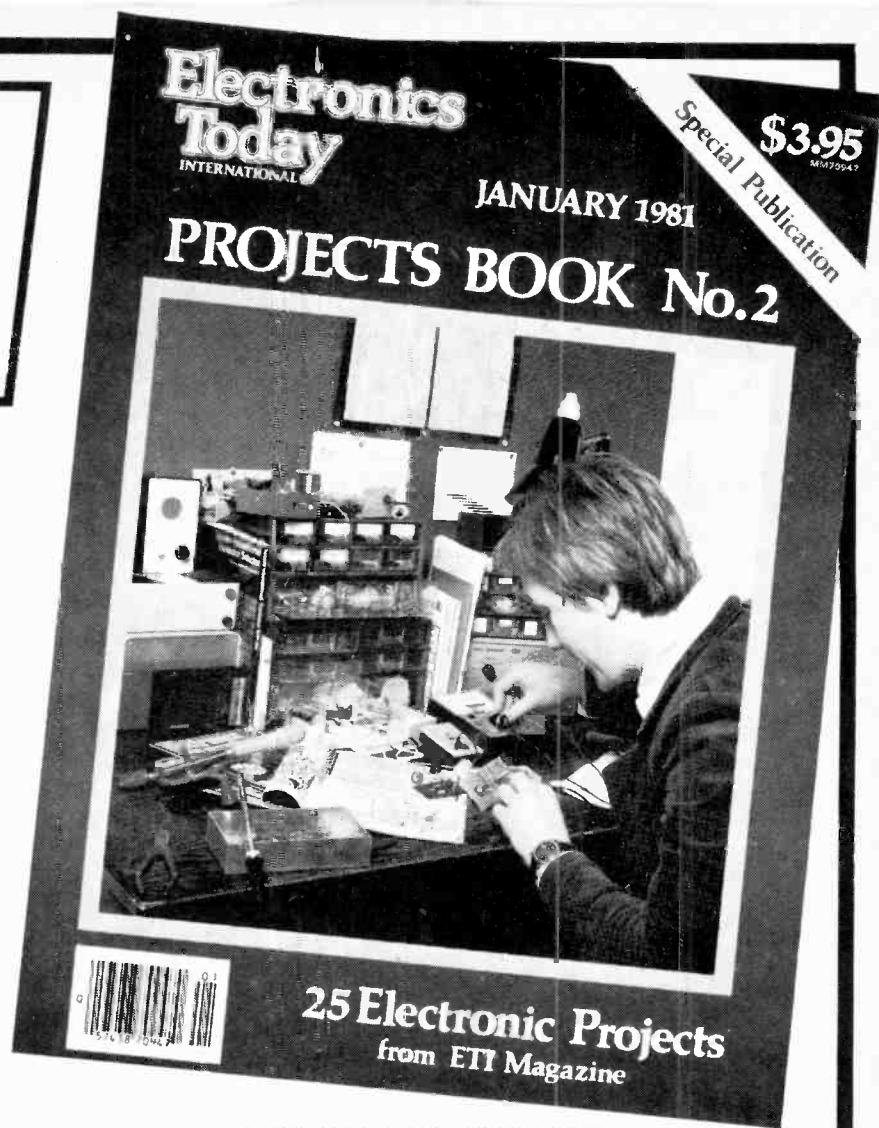

Electronics Today		Projects Book No.2	
January 1981			
High Performance Stereo Pre-amplifier 7	Logic Probe 38	Flash Detector 59	Two Octave Organ 78
Moving Coil Phono 13	A useful piece of test gear for digital novices.	A neat little, inexpensive, monophonic organ.	
Two projects to take care of the front end of our Series 4000 system.			
Power Supply 18	Battery Condition Indicator 44	Digital Tachometer 61	Light Chaser 79
Suitable for the Series 4000 stereo system.	Test the state of your batteries with this handy checker.	Gives you an accurate indication of your engine speed.	Make your own light flashing unit.
50W Amplifier Module 21	Cable Tester 46	Varisweep 64	Test Bench Amplifier 83
Really excellent specifications and the output stage for the Series 4000.	Of considerable interest to those who are continually using mobile equipment.	Corrects your single speed wipers to intermittent operation.	A well designed and useful addition to your test gear.
Series 4000 Amplifier 27	Frequency Generator 43	Parach Light 87	Shutter Speed Timer 88
How the individual projects mate together to give you an excellent hi-fi system.	Several different waveforms can be produced over a wide range of frequencies.	Automatically switches on your porch light when the sun sets.	Accurately test the shutter speed settings on your camera.
Remable Filter 34	Room Alarm 54	Spirit Level 70	Hi-Cat Charger 92
How to eliminate unwanted low frequencies from your hi-fi system.	Produces an audible warning as soon as it begins to rain.	An electronic version of the old 'hot cooker' party game.	A constant current charger for use with hi-cat cells.
Dynamic Noise Filter 36	Egg Timer 56	Perry Grenade 76	ETI Wet 95
Provides significant improvement in the perceived signal-to-noise ratio of your tape deck.	Hard or soft - this kitchen gadget will save your breakfast.	An electronic version of the old 'hot cooker' party game.	Our automatic mister to keep your plants in peak condition.

Available now from your local electronics store, newsstand or direct from ETI.
Send \$3.95 to:
Projects Book No.2, ETI Magazine,
Unit 6, 25 Overlea Blvd., Toronto, Ontario, M4H 1B1

NEWS

Let's Not Talk About The Weather...

On October 20, Larry Grossman, Minister of Industry and Tourism of Ontario, announced the first step in what may be a major shot-in-the-arm for our high technology industries and associated professional people.

While government and industry are fully aware of the importance of microelectronics, neither is certain as to the specific ways and means to strengthen the industry. There is much to be done. We do not know which areas of the market we should concentrate our attention. Indeed, we don't know which sectors we can really excel in. The number of qualified personnel coming out of our schools will be inadequate to meet the demands of industry.

In order to answer these questions, Mr. Grossman announced the Task Force on Microelectronics. Its purpose is to look into Canada's future and identify areas for development and discussion. The specific mandate is:

To identify opportunities for research and development in microelectronics technology; to define problems and opportunities in both the software and hardware sectors of the microelectronics industry; to examine current and future applications of microelectronics; and to assess the probable impact on society - both beneficial and detrimental.

Furthermore, in view of the urgency of the situation, the Task force has been asked to submit its recommendations within a year.

In the past ten years, the Ottawa Carleton area has become known as a sort of Canadian 'Silicon Valley' growth rates for high technology industries were in the range of 50-75% in 1979. It is felt that the success of these will profoundly affect the economy of Ontario. Not just immediately in terms of tax revenues and high skilled jobs, but also in long term benefits from possessing advanced technology and industry.

Where Do We Fit In?

It's all very well for one to watch and/or criticize government and the private sector as they struggle to revitalize our industries, but where do we, as students and potential members of the work force, fit in?

The Technical Service Council has recently completed a 10 year forecast that, among other things, says there will be shortage of bachelor level engineers until 1984. There is a steady demand for electrical engineers, electrical draftsmen as well as many other types of professionals. Several were cited to account for this, among them the immense energy related projects currently under planning.

The need for professionals is so acute that some Alberta firms are considering postponing projects because of their inability to recruit staff. In fact close to 50% of job openings in Alberta took six months to fill.

The need is so acute that companies have been forced to look overseas to recruit personnel. The process is lengthy and can cost \$10,000 to \$20,000 to hire each person, who may not be able to start work for six months (maybe companies would put that

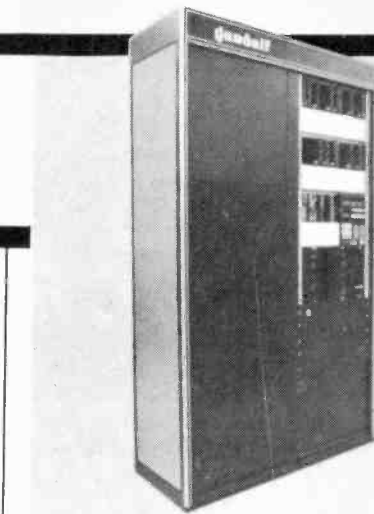

Saving Future Generations

A microwave meter is available from Allen Simpson Marketing Ltd. It is claimed as providing a quick check on possible microwave leakage at oven door seals. Independent test results indicate a high degree of accuracy. A "Safety / Danger" display is indicated by a pulsating needle in either state.

The meter does not use batteries or external power source and is intended for domestic use. Full instructions are provided and a retail of around \$20.00 is suggested. Send enquiries to Allen Simpson Marketing & Design Ltd., 1 Albert Street, Eden Mills, Ontario, NOB 1P0. Telephone (519) 856-4626.

money into our Universities which are in desparate need of funds for undergraduate programs).

The forecast takes into account projected graduating class sizes and industry growth. It says that in 1984 there will be a surplus of engineers but also goes on to say that the forecast should be updated in five years because of 'uncertainty about future government policy and technological developments make it difficult to project the number and magnitude of projects beyond 1985.' In view of government and industry desire to increase our technological base, might we not expect an even greater demand for engineers and professional people?

The technical Service Council was formed in 1927 to prevent the drain of trained professionals to the United States. Aside from initiating studies on the job situation in Canada it also operates a coast to coast placement service for all types of professional people.

The TSC is financed by over 690 firms. If you want to know more, write to the Technical Service Council, 1 St. Clair Ave. E., No. 901, Toronto, Ontario M4T 2V7.

Gandalf Wizardry

Gandalf Data Communications Ltd., has introduced the PACX IV Private Automatic Computer Exchange System. PACX IV, which is a microprocessor controlled terminal switching system, is designed to automatically connect up to 256 computer terminals having various service requirements to a number of computer ports capable of supporting these requirements. Since the first PACX system was introduced in 1972, more than 600 systems have been installed world-wide. PACX IV deliveries are scheduled to commence in November.

PACX IV represents state-of-the-art switching technology which will (hopefully) substantially increase PACX installations in both domestic and international markets. In its basic configuration PACX IV has been designed to optimize system growth as required, with supposedly more data switching system features and cost efficiencies than competitive systems.

A U.S. affiliate, Gandalf Data Inc., is located in Wheeling, Illinois. A U.K. affiliate, Gandalf Digital Communications Ltd., is situated in Warrington, Cheshire. Incidentally, Gandalf celebrated its 10th anniversary in 1980.

A Caution

It's all very well to talk of boosting our high technology, but it isn't the cure-all for Canada's economic woes. More important, Canada should take steps to expand its manufacturing capability. Granted, it is vital that we develop better microelectronic devices and equipment but we also have the choice of manufacturing here or having it made overseas under license. In the latter case the company involved earns royalties, nothing more. In the former case, however, Canadian goods are sold on international markets, domestic support industries (catering, real estate, small parts manufacturing etc.) are fostered, Canadian jobs are directly and indirectly created, and much, much more.

This problem already exists in the United States. In the next few years California will lose a major portion of the personal computer market to Japan. Take a close look at you HP or TI calculator, at a 4001 or 741 ICs. Chances are they were manufactured and/or assembled in Singapore, Malaysia, Mexico, Japan, or Korea or anywhere but North America. Why can't Canada manufacture 741 ICs? Why can't Canada manufacture say 50% of the consumer goods it uses?

Lack of inexpensive manufacturing is the problem, or rather it is the symptom. High labour cost, low productivity, outdated facilities, lack of automation, lack of initiative (or incentive, it's probably the same thing) and others are the real culprits. The economic and social climate in North America just does not support any useful amount of manufacturing. If this trend continues, our society may ultimately consist of highly trained \$50,000 a year professionals selling their works to the Middle and Far East, and a lot of unskilled, possibly semi-literate, people waiting for their pogy to come in.

If what government and industry says is true, a very healthy advanced technology 'tree' is growing in Canada. In a few years it will start producing great quantities of 'fruit'. The question is, who will pick it?

John Van Lierde

CHARGE



CHEQUE OR MONEY ORDER

DOMINION RADIO ELECTRONICS

Address:
535 Yonge St.
Toronto, Ont.
M4Y 1Y5
Phone: (416) 922-1818
No collect calls please.

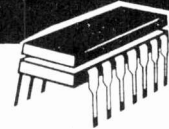

KITS

LIGHTING EFFECTS	AUDIO KITS
*3 channel 500 watt Colour Organ \$21.95	* 1 watt Audio Amp 17.95
*3 Channel 1500 watt Colour Organ \$32.95	* 5 watt Audio Amp \$19.95
*16 Channel Light Chaser ... (up-down-pulse) \$22.95	POWER SUPPLY KITS
16 Channel 8-mode Programmable Light Chaser ... \$32.95	* 0-24 volts 1 amp \$39.95
	* ±5 volt and +12v @ 1 amp .. \$14.95
	* ± 12 volts and +5v @ 1 amp. \$14.95
	* Kits come with etched, drilled and plated P.C. boards.

RESISTORS

Values from 1 ohm to 10 meg. 1/4 or 1/2 watt. Still Only 3½¢ each.

CAPACITORS NISSEI POLYESTER FILM

	Price	uF		Price	uF		Price
.0010	.20	.012	.20	.0027	.20	.027	.25
.0012	.20	.015	.20	.0033	.20	.033	.25
.0015	.20	.047	.30	.0039	.20	.039	.25
.0018	.20	.056	.30	.0047	.20	.12	.35
.0022	.20	.068	.30	.0056	.20	.15	.40
.0068	.20	.082	.30	.018	.25	.18	.45
.0082	.20	.10	.30	.022	.25	.22	.50
.010	.20						

CAPACITORS

**ELNA
ELECTROLYTIC AND
TANTALUM CAPACITORS**

AXIAL LEAD

uF	WV(SV) 16 (20)	WV(SV) 25 (32)	WV(SV) 50 (63)
1			.25
2.2			.25
3.3			.25
4.7			.25
10	.25	.25	.30
22	.30	.30	.35
33	.30	.35	.35
47	.35	.35	.35
100	.35	.40	.50
220	.35	.40	.55
330	.40	.50	.65
470	.45	.55	.75
1000	.60	.70	1.00
2200	.75	1.05	
3300	1.05	1.35	
4700	1.65	1.95	

DIPPED SOLID TANTALUM Capacitance Tolerance +/-20%

uF	WV(SV) 16 (20)	WV(SV) 25 (32)	WV(SV) 35 (46)
0.22			.35
0.33			.35
0.47			.35
0.68			.35
1.0			.35
1.5			.35
2.2			.35
3.3			.35
4.7	.35		.35
6.8	.35		.35
10	.45	.50	.55
15	.50	.55	.85
22	.55	.65	1.35
33	.65	1.20	2.25
47	1.95	2.75	
68	2.75		
100	3.50		

RADIAL LEAD

uF	WV(SV) 16 (20)	WV(SV) 25 (32)	WV(SV) 50 (63)
1			.25
2.2			.25
3.3			.25
4.7		.25	.25
10	.25	.25	.25
22	.25	.25	.25
33	.25	.25	.30
47	.25	.30	.35
100	.30	.30	.35
220	.30	.35	.45
330	.35	.40	.60
470	.40	.50	.85
1000	.60		
2200	1.00		

POWER SUPPLY

1400	16	.65	6800 Com	25	6.95
1600	16	.65	15000 RPE	10	4.50
2200	16	.75	12000 COM	40	6.95
2500	10	.65	14000 COM	40	7.50
1000 Can	16	1.50	15000 RPE	10	5.50
4700 El.ec	40	1.75	15000 Can	16	4.90
4700 COM	100	8.95	15000 CAN	25	5.50
6800 RPE	25	6.95	15000 Com	50	11.95
			44000 Com	35	14.95
			80000 Com	20	14.95

TTL (DIGITAL) IC's

7400	.45	7423	.55	7472	.55	74123	1.10
7401	.45	7425	.65	7473	.70	74125	.98
7402	.45	7426	.65	7474	.70	74141	1.15
7403	.40	7427	.55	7475	.98	74150	2.50
7405	.75	7430	.45	7476	.70	74151	.98
7406	.85	7440	.45	7475	1.40	74154	2.50
7407	.95	7441	1.35	7486	1.50	74160	1.75
7408	.75	7442	1.35	7490	1.15	74164	1.25
7409	.45	7446	1.45	7491	1.15	74177	1.45
7410	.39	7447	1.65	7492	.85	74190	1.65
7411	.55	7448	1.75	7493	.85	74191	1.60
7412	.55	7454	.65	74121	.65	74192	1.55
7413	.85	7460	.40	74122	.90	74193	2.95
7420	.45						

4000 SERIES CMOS IC's

4000	.50	4015	1.50	4026	2.35	4044	1.05
4001	.45	4016	.50	4027	.85	4045	1.78
4002	.45	4017	1.50	4028	1.50	4047	1.09
4006	1.25	4018	.75	4029	1.25	4049	.45
4007	.20	4019	1.65	4030	.40	4090	1.50
4008	1.15	4020	1.25	4033	1.95	4069	.45
4010	.75	4021	1.95	4040	1.29	4510	1.95
4011	.65	4024	1.25	4041	2.05	4511	1.95
4013	.65	4025	.40	4043	1.30	4516	1.35
4014	.90						

Micro-Processor IC

LS SERIES	PRICE						
74LS00	.85	74LS32	.80	74LS109	.80	8080	8.95
74LS04	.60	74LS33	.60	74LS125	1.00	8212	3.00
74LS08	.65	74LS38	.80	74LS132	1.40	8216	3.50
74LS10	1.50	74LS74	.70	74LS151	1.60	8224	6.95
74LS11	.75	74LS75	1.10	74LS155	1.10	8228	6.25
74LS20	.70	74LS86	.70	74LS247	1.18	8255	8.95
74LS30	.65	74LS90	.95	Z80	14.95	4116	7.95

1 Watt zener diodes

TYPE #	VOLTAGE	WATTAGE			
BZX61-C75	3.3V	1W	IN758A	10	1W
IN4623	4.3	1W	IN759A	12V	1W
IN751A	5.1	1W	IN964B	13	.5
IN4733A	5.1	1W	3E216D5	14	1W
IN4734	5.6	1W	IN966	16	1W
14-515-04	6.2	1W	BZX61-C18	18	1W
114574	6.2	.5	H220C	20	1W
IN753A	6.2	1W	BZX61-C20	20	1W
IN754A	6.8	1W	GE5028	20	1W
IN752A	5.6	1W	14-515-31	22	.5
17-515-35	6.8	1W	IN4751A	30	1W
HZ7B	7	1W	BZX61-C30	30	1W
IN755A	7.5	1W	BZX79C36	36	½W
IN74738A	7.5	1W	BZX61-C56	56	1W
IN757A	9.1	½W	IN5045	56	5W
IN4739A	9.1	.5	BZX61-C68	68	1W
BZX61-C9V1	9.1	1W	IN4764A	100	1W
IN757A	9.1	1W	IN5593B	183	1W

49C EA



Transistor replacement list

PART No:	REPLACE	JLR. PRICE					
2N2906	- ECG - 159	1.79	2SC1025-	ECG - 175	2.95	2SC940 - ECG - 283	11.95
BF-245	- ECG - 133	1.99	2SC1304-	ECG - 124	2.59	2SC939 - ECG - 163A	12.95
2N3391	- ECG - 199	1.15	2SC1104-	ECG - 124	2.59	BF245A - ECG - 133	2.25
BF-199	- ECG - 161	1.59	2SD24Y	- ECG - 124	2.59	2SC945 - ECG - 199	.89
TIS 92	- ECG - 128	2.40	AD162	- ECG - 131	3.99	2SC544 - ECG - 289	1.59
BD136	- ECG - 185	2.99	AD139	- ECG - 104	1.89	2SC839 - ECG - 123A	1.59
BD135	- ECG - 184	2.79	2SC1160-	ECG - 175	3.50	2N6558 - ECG - 191	4.25
2SC1505-	ECG - 198	2.95	2N3614 -	ECG - 121	3.95	2SC458 - ECG - 289	1.49
2SC1520-	ECG - 198	3.00	2SC1106-	ECG - 162	9.95	2SB77 - ECG - 102A	1.99
2SC1507-	ECG - 198	2.95	BD182	- ECG - 130	4.79	2N1613 - ECG - 128	1.99
2SC1446-	ECG - 198	2.95	BU205	- ECG - 165	9.95	AC-187 - ECG - 103A	2.30
MJE2370-	ECG - 242	3.59	BU108	- ECG - 165	9.95		

- * All Semiconductors prime stock
- * Use DRE quality components for optimum results
- * First grade components at surplus pricing
- * This is only a partial listing of our semiconductor line
- * Catalogue available upon request
- * Minimum order \$10.00

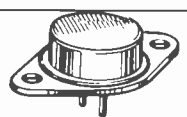

PRICES SUBJECT TO CHANGE WITHOUT NOTICE

Circle No. 17 on Reader Service Card.

Lab Power Supplies

A series of Canadian designed and manufactured laboratory power supplies have been introduced by Allan Crawford Associates Ltd.

Anatek's 3000 series features extremely high power density in a small lightweight package, the result of advanced switchmode design. Both voltage and current outputs are fully metered and fully adjustable with switchable remote sense capability.

Four models are available with maximum ratings of 7.5V at 40A; 15V at 20A; 30V at 10A; and 60V at 5A. All units are housed in small 15.1 X 20.4 X 26.7 cm packages with the heaviest model weighing 5.5 kg (12 lbs).

For more information contact Allan Crawford Associates Ltd, 6503 Northam Drive, Mississauga, Ontario L4V 1J2, (416) 678-1500.



Amprobe Technical Digest

Amprobe Instrument has introduced its 'Amprobe Industrial Digest'.

The Amprobe Industrial Digest is a collection of technical articles on the use of electrical instruments. Single copies are available free of charge from selected Amprobe distributors or by writing to Altas Electronics Limited, Marketing Services Dept., 50 Wingold Avenue, Toronto, Ontario M6B 1P7.

Etco Cat

Etco Catalogue No. K is now available. The catalogue consists of 96 pages of every kind of surplus part and equipment available. The catalogue is available free from Etco Electronics, North Country Shopping Center, Rt. 9 North, Plattsburgh, N.Y. 12901.

Precision 200 MHz Counter

The TF200 is a laboratory quality bench/portable Frequency Meter covering the range 10 Hz to 200 MHz and featuring an 8 digit LCD readout. An external pre-scaler unit is available, taking the upper frequency capability to 600 MHz.

The TF200 has exceptional input sensitivity, better than 30mV RMS. High resolution at low frequencies is achieved by a Time Averaged Period facility. The internal time base is set to an accuracy of $\pm 0.3\%$ ppm, but full external time base facilities are also provided.

The instrument can be operated either from internal batteries or an external AC adaptor. Typical battery life is over 200 hours which, coupled with the unit's small size (225 X 150 X 50 mm), low weight (1200 gms) and rugged construction, gives a precision instrument equally at home on the laboratory bench and in the field.

The price of the TF200 is \$620.00. Contact Audi Electronics, 1736 Ave Road, Suite B, Toronto, Ontario M5M 3Y7.

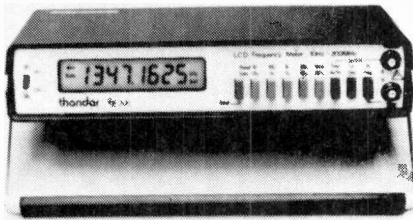

Looking Back

RIAA Preamp, December 1980

C5 is listed in the Parts List as a 22n tantalum. It should be a 22u unit.

Foolproof Power Supply, October 1980

ICI was incorrectly listed as a uA78GKC. It should be uA78HGKC. This is the 5 amp unit, the 1 amp unit was correctly listed.

Another point to note is that users may notice ICI shutting down during high current, low voltage usage. This can be corrected by reducing the input voltage to the rectifier bridge, possibly by switching from full transformer output to its center tap.

The Last Word

We couldn't help having a little fun with this Bruel and Kjaer news photo. The picture was originally intended to emphasize the compactness of their new B & K type 2225 sound Level Meters. Considering the quality of some of the older units we've seen, such theatrics are unnecessary.

If you want to know more about the type 2225, write to Bruel & Kjaer Canada Limited, 90 Leacock Road, Pointe Claire, Quebec, H9R 1H1.



Shure Mikes

A new decorative dimension has been introduced to the audio scene in the form of two new starmaker microphones with ebony or tan finishes.

Designated the SM77 and SM78, both are professional quality dynamic microphones, designed for hand-held or stand-mounted vocal or instrumental use. Their appearance and comfortable handling qualities are features entertainers will find especially well suited to a wide variety of live and televised performance situations.

Both units are lightweight and extremely rugged. Their "Suede-Coat" finish is durable and easy to clean. Even consistent in-out use in a microphone stand will not mar the finish.

The cardioid pickup patterns of both microphones effectively reject feedback and make them suitable for sound reinforcement applications where room acoustics or ambient noise is a problem. When used for closeup vocals, wind and pop protection are provided in the SM78 by a built-in filter. An accessory windscreen is available for the SM77.

For more information contact A. C. Simmonds & Sons Limited, 975 Dillingham Road, Pickering, Ontario, L1W 3B2, or phone (416) 839-8041.

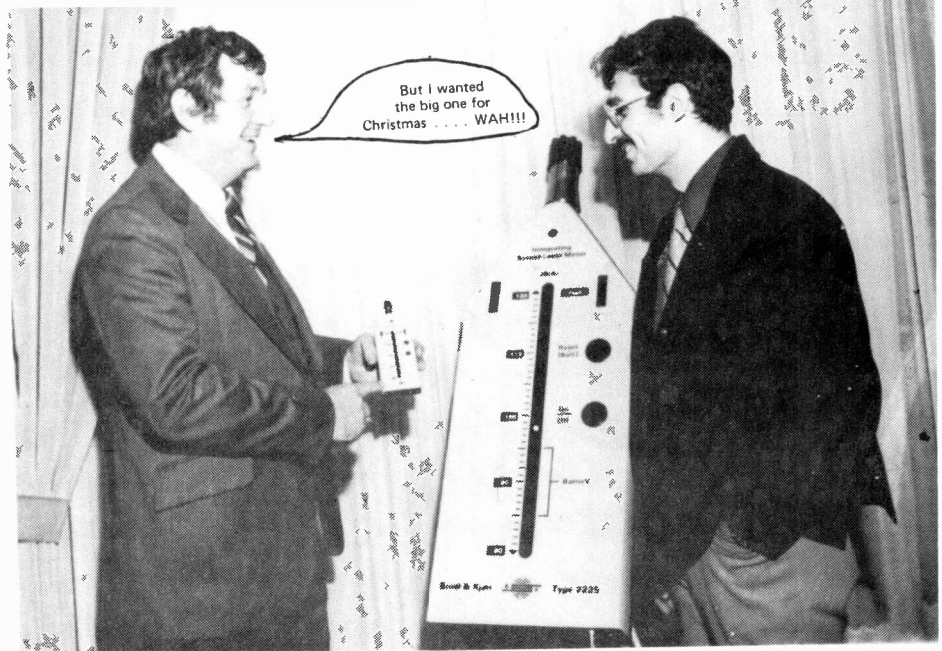

WANT to know more about Microcomputing?

6502, Z80, KIM, Z8000 . . . What do they mean? Sybex Books tell you what you need to know about architecture, instruction sets and programming microprocessors and microcomputers. Whether you're a student, engineer, or just plain interested, you'll find Sybex Books indispensable. Prices shown include postage and handling. Use the handy order form provided elsewhere in this issue or send cheque or money order (no C.O.D.) to Electronics Today International, Unit 6, 25 Overlea Blvd., Toronto, Ontario M4H 1B1.



An Introduction to Personal & Business Computing
SYBEX C200 \$10.75

This is a basic introductory text on microcomputers. Its main goal is to answer the question: "What do I need for . . . ?" in specific detail. No previous technical background is assumed. The author addresses progressively all the essential topics of interest to the microcomputer user (as opposed to the designer). How a system works. Which modules are required for which function. How much memory is needed. Which peripheral should be used. The cost. The software. Differences between existing microcomputers. Is a mini-BASIC sufficient? The real cost of a business system. Its limitations. Can you really manage a mailing list on a floppy disk? Packages and other programs. The traps for the hobbyist. Application techniques. New systems and facilities.

The book is designed to educate the reader in all the aspects of a system, from the selection of the microcomputer to the required peripherals. No computer background is required.

Programming the 6502
SYBEX C202 \$18.75

An educational text designed to teach you programming from the ground up. Already one of the most successful programming books ever published, it has been revised and expanded at both the low end and high end of the spectrum. The range of programming concepts and techniques presented is such that it addresses the needs of virtually every programmer interested in using the 6502 microprocessor, from beginner to expert.

6502 Applications Book
SYBEX D302 \$17.75

This book presents practical applications techniques for the 6502. You will build a complete home alarm system, including fire detection, as well as an electronic piano, a motor speed-regulator, a time-of-day clock, a simulated traffic control system, and a Morse code generator. You will also design an industrial control loop for temperature control, including analog-to-digital conversion, and your own simple peripherals from paper-tape reader to microprinter.

Truly the "input-output" book for the 6502, it includes more than 50 exercises designed for testing yourself at every step.

6502 Games Book
SYBEX G402 \$18.75

This book is designed as an educational text on advanced programming techniques. It presents a comprehensive set of algorithms and programming techniques for common computer games. All the programs are developed for the 6502 at the assembly language level.

Because programs must reside within less than 1K of memory in order to reside on a single-board microcomputer (such as the SYM used in this book), the book covers virtually all aspects of advanced programming, effective algorithm design, data structures design and effective coding techniques related to storage economy.

The reader will learn how to devise strategies suitable for the solution of complex problems, typical of those encountered in games. He/she can also use all the resources of the 6502, and sharpen his/her skills at advanced programming techniques. All the games presented in this book can be played on a real board (the SYM), and require a very small amount of additional components.

Programming the Z80
SYBEX C280 \$20.75

This book has been designed both as an educational text and as a self-contained reference book. As such, it can be used as a complete introductory book on programming, ranging from the basic concepts to advanced data structures manipulations.

It also contains a comprehensive description of all the Z80 instructions as well as its internal operation, and should provide a comprehensive reference for the reader who is already familiar with the principles of programming, but wishes to learn the Z80. All concepts are explained in simple yet precise terms, building progressively towards more complex techniques.

Programming the Z8000
SYBEX C281 \$22.75

This book was designed as both an educational text and a self-contained reference manual. This book presents a thorough introduction to machine language programming from basic concepts to advanced programming techniques. Detailed illustrative examples and numerous programs show the reader how to write clear, well-organized programs in the language of the Z8000.

The book also contains a comprehensive description of the Z8000 architecture as well as programming instructions. The author has arranged the instructions logically, rather than simply alphabetically by mnemonic name. This feature enables the reader to gain insight into the overall capabilities of the machine.

With over 113 illustrations, a thorough index, and 5 appendices, Programming the Z8000 is an indispensable text for engineers, students, PDP-11 users and anyone interested in learning machine language programming skills.

The alternative to custom enclosures

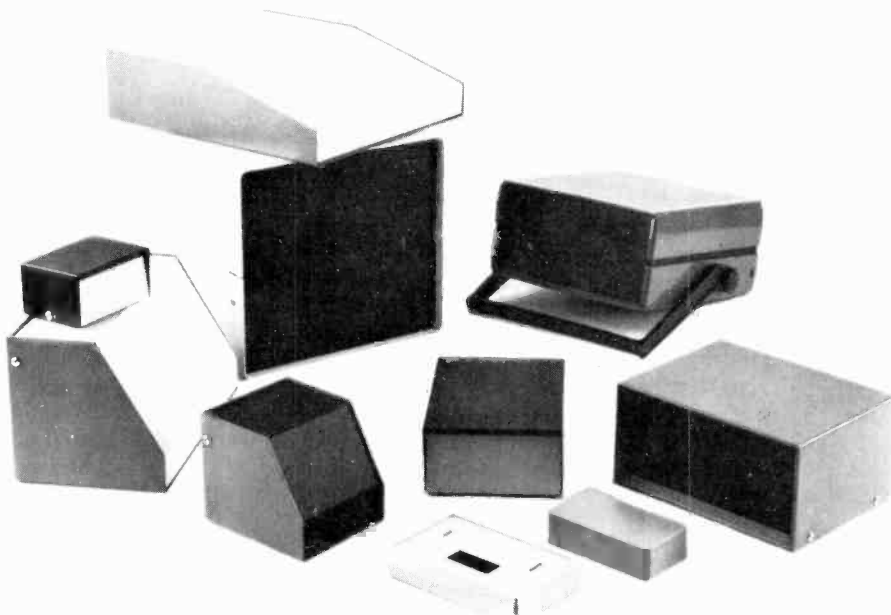

The problem with custom fabricated enclosures is the cost of tooling and the cost of making changes.

We offer you an alternative; one of the largest selections of small enclosure designs, shapes, sizes and colours available in Canada today. We have IN STOCK, miniature enclosures, small enclosures, meter housings, desktop component and keyboard consoles; in steel, aluminum and plastic. In all, over 750 models available in many different colours. No stocking, tooling or manufacturing problems for you.

Investigate the alternative, call your local Hammond distributor and have a hard look at cost, availability and design freedom. We think you will like what you find.

Circle our reader card number, and we will send you our catalogues, prices and a list of Hammond distributors in your area.

M HAMMOND
MANUFACTURING TM

W HAMMOND MANUFACTURING CO. LTD.
394 Edinburgh Rd. Guelph Ontario N1H 1E5 (519) 822-2960 or (416) 456-3770

Circle No. 3 on Reader Service Card.

**YOU CANNOT SKI
DOWN
OUR
SLOPES**



vero

But VERO SLOPING FRONT CASES do make attractive housings for many projects.

They are available in two sizes, made from high quality, two tone plastic, with anodised aluminium front panels. Both cases have integral circuit board fixing points in the base.

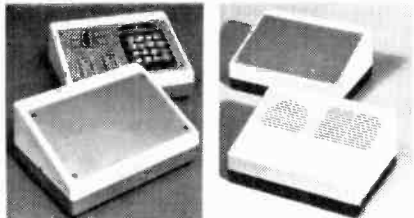

65-2523E and 75-1798K make ideal housings for test equipment, audio gear (faders, mixers, rhythm generators etc.) and control boxes.

See them at your local electronics shop and judge for yourself.

For your Free Catalogue circle No. 49 on Reader Service Card, Dealers reply on letterhead.



ELECTRONIC PACKAGING SYSTEMS LTD.
Retail Department,
P.O. Box 481, Kingston, Ontario
K7L 4W5 Telephone (613) 384-1142

JENSEN

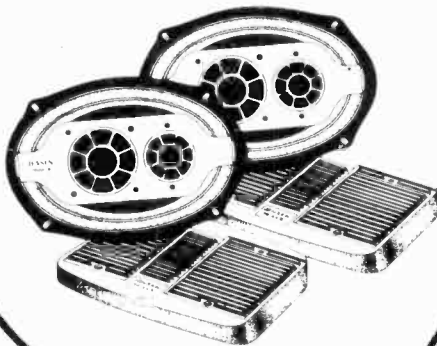

-- best prices --
-- speakers - decks --

PAY NO SALES TAX.

Alberta Audio

1107 73rd. Ave. S.W., Calgary, Alberta T2V 0R9
(403) 252-1038

Circle No. 20 on Reader Service Card.

HAMEG Oscilloscopes

Top Performance
In Every Range



HM 307

HM 307

Y: Bandwidth DC-10MHz (-3dB) • Sensitivity 5mV-20V/cm ($\pm 5\%$)
X: Timebase 0.2s-0.2 μ s/cm ($\pm 5\%$) • Triggering 2Hz-30MHz (3mm)
Built-in component tester • Calibrator • Screen 6x6cm • 1kV

HM 312

Y: Bandwidth DC-20MHz (-3dB) • Sensitivity 5mV-20V/cm ($\pm 3\%$)
X: Timebase 0.2s-40ns/cm incl. x5 Magn. • Trig. 3Hz-30MHz (4mm)
Dual trace • X-Y Operation • Calibrator • Screen 8x10cm • 2kV

HM 412

Y: Bandwidth DC-20MHz (-3dB) • Sensitivity 2mV-20V/cm ($\pm 3\%$)
X: Timebase 0.2s-40ns/cm incl. x5 Magn. • Trig. DC-40MHz (5mm)
Dual trace • Algebr. addition • X-Y Operation • Screen 8x10cm
Sweep delay • Overscan, Trigger, Delay indications • Trigger filter
Z-Modulation • Calibrator • Graticule illumination • 2kV

HM 512

Y: Bandwidth DC-50MHz (-3dB) • Sensitivity 5mV-50V/cm ($\pm 3\%$)
X: Timebase 5s-20ns/cm incl. x5 Magn. • Trig. DC-70MHz (5mm)
Dual trace • Algebr. addition • X-Y Operation • Screen 8x10cm
Delay line • Sweep delay • After delay triggering • Trigger filter
Single shot + Reset • Overscan, Trigger, Ready, Delay indications
var. Hold-off • Z-Modulation • Graticule illumination • 12kV

HM 812

Y: Bandwidth DC-50MHz (-3dB) • Sensitivity 5mV-50V/div. ($\pm 3\%$)
X: Timebase 5s-20ns/div. incl. x5 Magn. • Trig. DC-70MHz (0.5div.)
Dual trace analog storage with var. Persistence and Auto-Storage
Algebr. addition • X-Y Operation • Screen 8x10div. (7.2x9cm)
Delay line • Sweep delay • After delay triggering • Trigger filter
Single shot • Overscan, Trigger, Ready, Delay, AS indications
var. Hold-off • Z-Modulation • X-Guard circuit • Calibrator • 8.5kV



HM 812
storage

BCS

ELECTRONICS LIMITED
Instruments For Industry and Service

980 Alness Street
Unit 35
Downsview, Ontario
M3J 2S2
(416) 661-5585

Circle No. 42 on Reader Service Card.

New from NRI! **25"** color TV that DIAGONAL tunes by computer, programs an entire evening's entertainment.

Just part of NRI's training in servicing TV, stereo systems, video tape and disc players, car and portable radios.

Only NRI home training prepares you so thoroughly for the next great leap forward in TV and audio...digital systems. Already, top-of-the-line TV's feature digital tuning, computer programming is appearing, and new digital audio recording equipment is about to go on the market.

NRI is the only home study school to give you the actual "hands-on" training you need to handle servicing problems on tomorrow's electronic equipment. Because only NRI includes this designed-for-learning, 25" diagonal color TV with electronic tuning, built-in digital clock, and computer programmer as part of your training. With this advanced feature, you can pre-program an entire evening's entertainment...even key lock it in to control children's viewing.

Exclusive Designed-for-learning Concept

The color TV you build as part of NRI's Master Course looks, operates, and performs like the very finest commercial sets. But behind that pretty picture is a unique designed-for-learning chassis. As you assemble it, you perform meaningful experiments. You even introduce defects, troubleshoot and correct them as you would in actual practice. And you end up with a magnificent, big-picture TV with advanced features.

Also Build Stereo, Test Instruments

That's just a start. You demonstrate basic principles on the unique NRI Discovery Lab,[®] then apply them as you assemble a fine AM/FM stereo, complete with speakers. You also learn as you build your own test instruments, including a 5" triggered sweep oscilloscope, CMOS digital frequency counter, color bar generator, and transistorized volt-ohm meter. Use them for learning, use them for earning as a full- or part-time TV, audio, and video systems technician.

Complete, Effective Training Includes Video Systems

You need no previous experience of any kind. Starting with the basics, exclusive "bite-size" lessons cover subjects thoroughly, clearly, and concisely. "Hands-on" experiments reinforce theory for better comprehension and retention. And your personal NRI instructor is always available for advice and help. You'll be prepared to work with stereo systems, car radios, record and tape players, transistor



radios, short-wave receivers, PA systems, musical instrument amplifiers, electronic TV games, even video tape recorders and tape or disc video playbacks.

Send for Free Detailed Catalog

Mail the postage-paid card today for our free 100-page catalog with color photos of all kits and equipment, complete lesson plans, convenient time payment plans, and information on other electronics courses. You'll also find out about NRI's new Computer Technology Course that includes your personal microcomputer. Or Complete Communications with 2-meter transceiver. If card has been removed, write to:



NRI Schools
McGraw-Hill Continuing
Education Center
330 Progress Avenue
Scarborough, Ontario M1P 2Z5
or telephone 416-293-1911

ELECTRONICS IN PHOTOGRAPHY

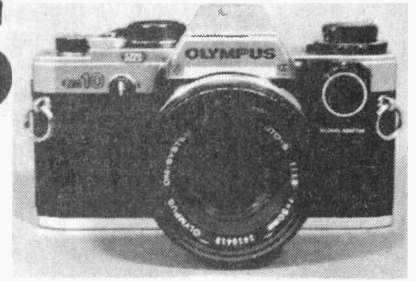

Latest developments exposed by Phil Gerring.

SINCE JOSEPH NIEPCE produced the first photographic image in 1826 the science of photography has advanced beyond all recognition. Indeed Niepce, confronted with a modern SLR compact, would be at a loss to know what it is — let alone how to use it. Niepce's first photograph took eight hours to expose; today the same scene can be captured in 1/1000 of a second (at a far better quality).

The camera manufacturers are continually bringing out new models incorporating the latest technology. This article follows and explains the development of electronics as applied to photography, and looks into the future.

Exposure Meter

As far back as 1873 a guy by the name of Willerby Smith noticed that the conductivity of a piece of selenium varied with the amount of light falling on it. Despite this early instance of photo-conductivity, it wasn't until the 1930s that the first commercial electric light meter was developed. Since then there have been many advances and developments. In the late 40s germanium and silicon were applied to photo-voltaic and photo-conductive uses. In the 50s light meters became a permanent fixture on cameras and in the 60s 'Through the Lens' metering was instituted on both semi-automatic and fully automatic cameras.

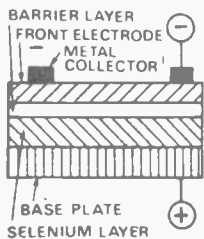

Fig. 1. Structure of the selenium cell. This was used in the first commercial exposure meter and is still popular today.

There are four different types of photocell used in exposure meters. The first of these are selenium cells or barrier layer cells (Fig. 1). They generate their own electricity (photovoltaic) and use a sensitive galva-

nometer attached to a mechanical claculating dial. Their sensitivity is limited and dependent on the area of cell exposed to the light. The light meter uses a baffle to limit the acceptance angle to that of the camera lens employed. Its advantages are that it requires no power supply and is relatively inexpensive. It is, however, too large to be incorporated inside the camera and does not perform very well in low light levels.

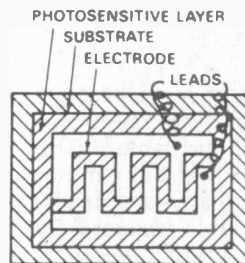

Fig. 2. The cadmium sulphide cell, with leads for the external power supply. Its sensitivity allows its use in TTL metering.

The cadmium sulphide cell (CdS) is a photosensitive cell and an increase in light reduces its resistance to a flow of electricity, thus increasing the flow of current from a battery across the cell (Fig. 2). A sensitive galvanometer is used to calculate the exposure setting (see Fig. 4). It is usually employed as a 'Through The Lens' light meter (TTL) as it is very compact. It is more sensitive than the selenium cell and responds well in low light levels. Its disadvantages are that it tends to retain or memorize a light level (it is slow to respond to a new one) and it is also very sensitive to red light which results in under-exposure of red subjects.

Silicon cells (Si) are solid state photodiodes (Fig. 3) that generate a minute current (photovoltaic). This is then amplified to obtain a useful output and an op-amp is used as a current-to-voltage converter with a suitable

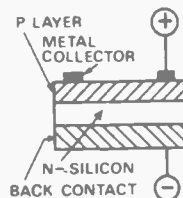

Fig. 3. Silicon cells are extremely fast reacting and very small.

feedback resistor to give high output voltage in proportion to the incident light on the cell. This then gives a significant response even at low light levels and also a linear response over a wide range with an almost instantaneous response to changing levels. As these cells are small and reliable, they are used in common camera bodies. Being very sensitive to red light, they are often fitted with blue filters and called Silicon Blue Cells (SBC) which give a better acceptance of the spectrum. However, the cell becomes unreliable in temperature extremes.

The fourth type is the gallium arsenide phosphide cell (GaAsP). This is a fast-reacting compact photocell and provides reliable readings in blue and red light. It also responds well in low light levels and is not over sensitive to temperature extremes. It is similar to the Silicon cell in that it responds about 1000 times faster than the CdS cell. It is, however, a fairly recent innovation and is not at the moment in common use.

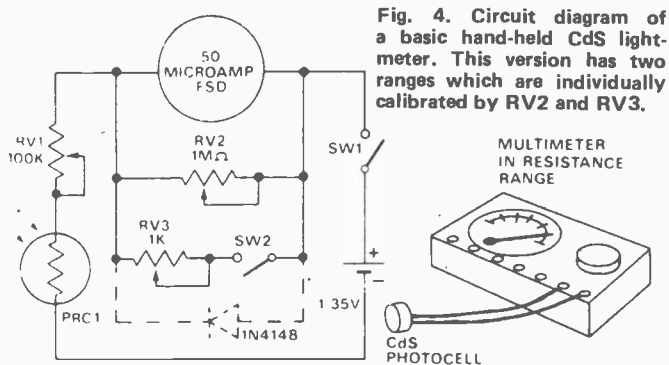

Fig. 4. Circuit diagram of a basic hand-held CdS light-meter. This version has two ranges which are individually calibrated by RV2 and RV3.

Semi Automatic Cameras

A practical semi-automatic system first became possible with the development of a compact photosensitive resistor which could be installed in or on the camera. The next development was to directly link the light meter circuitry to the shutter, aperture and film speed controls. This was achieved using a series of variable resistors. By the mid-70s the cameras used a moving coil meter with a needle as an indicator.

There are two basic metering systems. One uses a two needle system. A "match" needle is linked to the ASA film speed which is directly linked to the metering coil. The aperture and shutter are linked to the other needle, which may have a ring attachment at its end. The photographer adjusts the ring until it is aligned with the needle by altering the shutter speed and aperture controls.

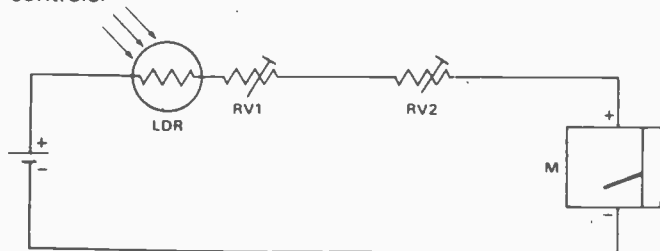
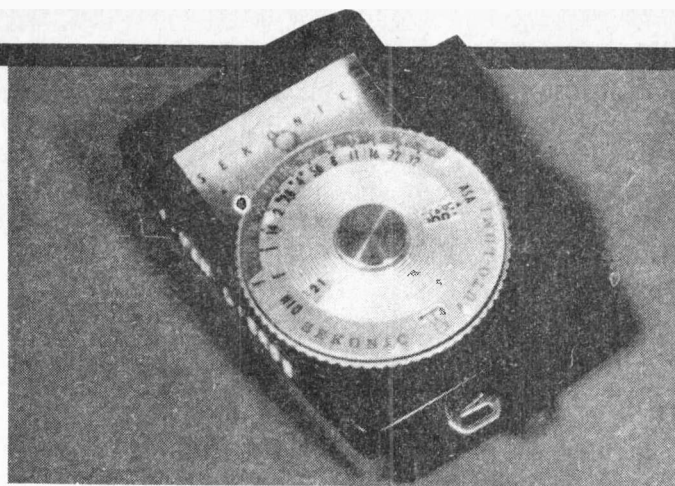

Fig. 5. An early design for an in-camera exposure meter. RV1 and RV2 are connected to the shutter speed and film speed respectively.

The other major system uses the needle centre method (Fig. 5). All the exposure controls as well as the light-dependent resistor are connected to a single needle



A typical handheld light meter. This particular unit costs approx \$20.00 and is self powered.

which is situated at the side of the viewfinder and is free to swing between two markings. If the needle swings towards the +ve end of the scale this indicates that the picture will be over-exposed and conversely, if it swings the other way it will be under-exposed. The photographer can then adjust his aperture and/or shutter speed accordingly.

The drive circuits for the integral systems, as described above, in modern 35mm cameras can be very basic arrangements. For example, the single-ended circuit operates a meter by measuring the amount of light falling on the LDR through the lens of the camera. As the ASA of the film and the shutter speed are preset, the meter can be centred by adjusting the aperture ring. (Note: The aperture is not connected to the circuit.)

This circuit arrangement has disadvantages and can be unreliable because it is dependent on a constant voltage supply from the battery. So if the battery voltage fluctuates above or below its normal it is going to result in a faulty meter reading and consequently affect the exposure.

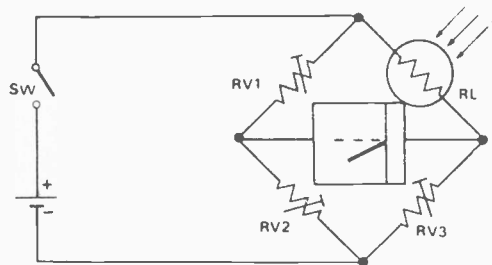
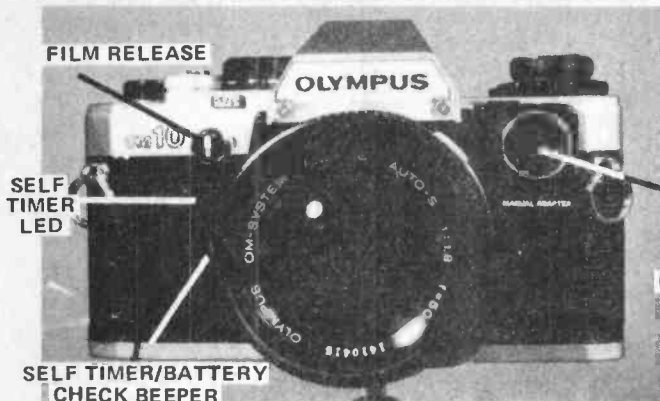
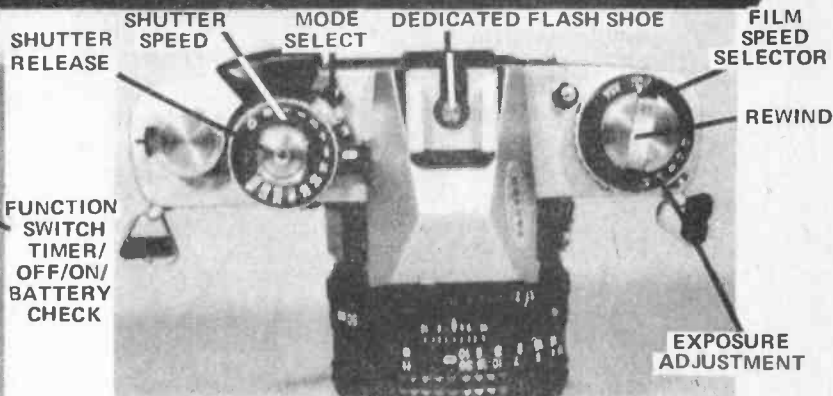
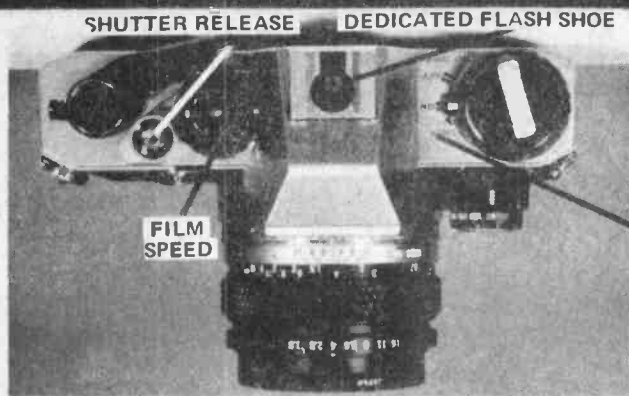

Fig. 6. Wheatstone bridge arrangement.

A more reliable circuit is achieved by using a Wheatstone bridge arrangement (Fig. 6), which operates independently of any fluctuations in the battery voltage.

The sensitivity of the microammeter in the metering system of semi-automatic cameras is so crucial that should it get damaged the whole metering system would have to be replaced and this can be very expensive. So when LEDs first appeared on the market, camera manufacturers were quick to see the obvious advantages of these solid state devices, and they began developing them for application in photography. Linked to a drive 'chip', these devices have many advantages over the old moving coil metering system. The most common display arrangement used is a vertical column of three LEDs. The top and bottom LEDs glow red to indicate either over- or under-exposure. When the exposure is correct the middle LED glows green.



The Olympus OM10 is an aperture – priority automatic camera. Features include a electronic self timer with flashing light and beeper, audible battery check and touch on light meter. The shutter speed selector is removeable.

Automatic Cameras

In the 50s crude forms of automatic exposure meters were being built into cameras but these were mainly mechanical systems designed for the amateur market.

They were not always reliable and had a fixed shutter speed. The aperture was adjusted electro-mechanically. A photo-voltaic cell would measure the incident light and power a servo motor which then adjusted the aperture using a series of geared wheels.

Another popular system in early 'automatic' cameras used the needle trap method. A meter is used to read the output from a photocell and then the meter needle is clamped into position (which doesn't do a microammeter much good). Then on depressing the shutter button a lever travels to the position at which the needle was trapped and adjusts the aperture as it moves. This system is accurate but easily damaged. It can, however, incorporate a range of resistors which allows for a variety of shutter speeds.

By the early 60s microcircuitry was beginning to come into its own and in 1968 Konica brought out the first fully-automatic electronic 35mm SLR. All the other major manufacturers soon followed with their own versions.

Most of these early auto cameras have an 'aperture priority' control whereby the photographer sets the film speed on the dial which is in turn linked to the exposure calculator circuitry. Then, by moving the aperture control only, the camera works out the correct shutter speed to go with the chosen aperture. This is done using a comparator chip which can accept the output from the photoelectric cell and the variable resistances from the aperture and film speed settings.

Most of the recent auto-exposure cameras use electro-magnetic aperture control with a direct electronic link made to the timing circuitry giving faster and more

The Minolta XD11 allows shutter priority, aperture priority and manual exposure operation. Exposure compensation of up to 2 f-stops either way is possible.

accurate exposures. The early versions had automatic aperture controlled by levers and servos.

Micro-electronic developments, such as more 'intelligent' and compact chips as well as flexible circuit boards and greatly increased reliability, have made it possible for cameras to have more than one auto-exposure mode. As well as manual operation they are capable of aperture priority or, with the flick of a switch, shutter speed priority. This dual mode feature coupled with an increased reliability is particularly attractive to professional photographers.

Some modern cameras are pre-programmed by the manufacturer so that if there is either too much or too little light for the exposure even after the shutter or aperture has gone to its limits, the camera will take over the setting. These alterations are usually displayed in the viewfinder so that a check can be made in case the settings are not close enough to get the desired effect.

Some cameras make use of stepped programmes. These are mainly incorporated in compact 35mm cameras in the higher price range. The exposure rating is staggered between the aperture and exposure settings, thus giving the photographer a balanced setting between depth of field (aperture) and fast exposure (shutter speed).

Using electronic shutters and apertures enables cameras to operate with continuous exposure values to give more accurate and more consistent exposures. There are some recent fully automatic cameras where the light reading is taken partly off the actual surface of the film emulsion. So with fast-reacting electronics a shutter speed or aperture can be corrected in mid-exposure. In compact cameras a stepless exposure works only above 1/100th of a second so that camera shake problems are minimised.

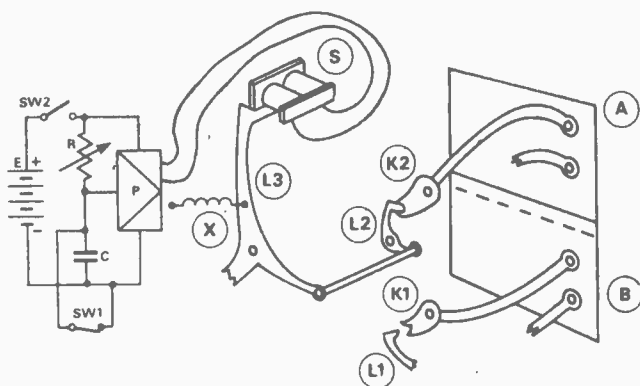

Fig. 7. Many electronic shutters still require complex lever arrangements to function.

gate voltage which then triggers the SCR (to a closed circuit). This puts a voltage across the solenoid which in turn attracts the lever releasing the second blade of the shutter.

Autofocus

Cameras have developed rapidly in recent years with the aid of high technology electronics. Cameras can decide and set their own shutter speed, aperture and even film speed controls to give you fully automatic operation. The next stage was the development of autofocus, so that a camera could calculate the distance of the subject from the lens to bring it into focus.

The first autofocus camera was developed by Canon in 1963 but autofocus cameras did not actually come onto the market until 1978 with an autofocus camera designed by Konica. There are now three systems used. The first, and at the moment most predominant, system is based on the Honeywell Visitronic Autofocus Module. This uses a system of comparing the contrast of light on a subject as viewed by two banks of light sensitive cells.

The second is a system used by Polaroid. This sends out an ultrasonic wave (sonar type) at the subject for automatic focusing. The third and newest system is one used by Canon which bounces an infra red light beam off the subject.

In the Honeywell system light from the subject passes through two windows on the front of the camera and is reflected by a series of mirrors into the autofocusing module. Here the two light sensitive panels (silicon photocells) compare the lighting contrast from the two views of the subject. The contrast is a maximum at the point of exact focus and falls away on each side of it.

The sonar system employed in Polaroid cameras works on the same principle as that used by submarines. A transducer sends out and later receives the sound waves and converts them into electrical energy. The transducer sends out a chirp lasting about 1/100 sec towards the subject. The chirp contains four ultrasonic frequencies between 50 and 60 kHz. A crystal oscillator clock times how long it takes for the chirp to rebound onto the camera and a chip calculates the focal setting from this information, a servo motor adjusting the lens accordingly.

The Canon autofocus system uses an infra red light beam to assess the correct focus. It works using an IRLED (infra red light emitting diode) which sends out a beam of invisible light of about 900 nm (nanometres) wavelength. The camera has two rangefinder-style windows. The infra red leaves one window and scans the

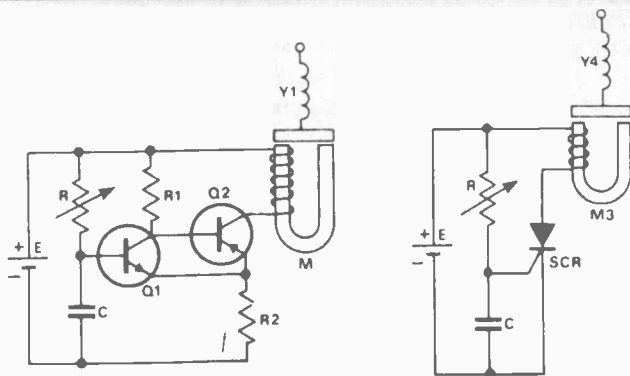

Fig. 8.9. The Schmitt trigger and SCR timers.

subject scene from left to right through an angle of about 10°. When the receiving sensor is receiving the maximum signal, the IC electronics informs the lens of the correct setting, and all this takes about 120 milliseconds.

Each system has its advantages and disadvantages. The Honeywell is compact and for the first time afforded quick, easy, sure, sharp automatic focusing for all photographers. It does, however, have a slight 'memory' whereby it retains previous focal settings and does not function very dependably in dim light or low contrasting light (and is therefore inadequate for flash). It can also have trouble focusing on small repetitive patterns.

The advantage of the ultrasonic or sonar system is that it does not depend on bright lighting of the subject and so can focus in absolute darkness. The only drawback is if a solid object such as a window lies between the subject and the camera, as the sonar cannot then judge the distance to the subject.

The infra red system works in almost any situation in which the Honeywell system does not and it can focus even in total darkness. It can also focus through glass. The only drawback to the system is that it may not work well on subjects with low reflectance characteristics. It is the infra red system which will probably predominate autofocusing systems in cameras during the 80s.

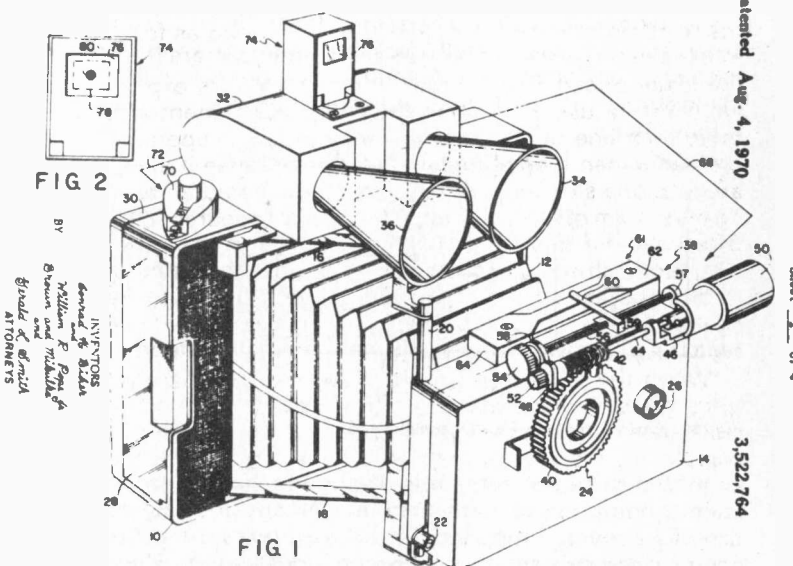

This first sonar-focusing camera was — as an experimental model — completed in 1967. Following the introduction of SX-70 photography, a sonar-focusing SX-70 camera was ready by 1976 and refined for introduction in 1978. This particular model never got past the prototype stage.

Electronic Flash

1851 saw the first electronic flash when Fox-Talbot, an early photographic pioneer, borrowed equipment from Faraday and demonstrated the use of an electric spark as an artificial light. But it wasn't until the 20th century that electronic flash became available as a convenient light source. Flash guns require a DC power supply, capacitors, flash tube, triggering circuit and a reflector. Modern flash guns have flash tubes filled with xenon surrounded by a toughened glass envelope. This is connected to a capacitor which has been specifically designed for flash guns and similar instruments, and these are called either energy storage or auto flash types.

There are three types of flash guns which make use of varying sizes of capacitor depending on the application. Low power amateur flash guns make use of capacitors charged from 180-500 volts. Portable studio guns use 500-1500 volts and industrial giants can use 1500-15000 volts. As thousands of volts are discharging through the flash circuit, there will be several hundred amps moving along the flash tube for 1/250th to 1/1000th of a second. Therefore the power produced can be as high as a 100kW at the peak of the flash.

In modern portable flashguns the capacitor requires a power pack running from a few 1.5 pencil batteries. The small 1.5 volt cells can charge the capacitor up to sufficiently high voltage by using a transistor 'inverter' circuit (Fig. 10). This circuit oscillates at an audio frequency (this accounts for the whining noise heard as the flashgun charges up). The oscillator produces an AC voltage which is stepped up by a transformer and the high-voltage AC is then converted back to DC by a rectifying diode, and goes to charge the storage capacitor via a current limiting resistor. The flash gun then has to be fired to release the stored charge.

It is critical that the flash synchronizes precisely with the shutter. A synchronizing switch is built into the camera. This switch cannot directly handle the flash current, so it is used to trigger a thyristor in the flash unit.

Charge control circuits are built into flashguns to ensure constantly bright flashes regardless of the state of the batteries. This circuit fully charges the capacitor before switching off to conserve the battery power. But if the voltage drops below a certain % level the circuit will automatically switch itself back on again to keep the flash at a consistent level. A small neon light is included in the circuit and lights up to indicate when the flash gun is fully charged.

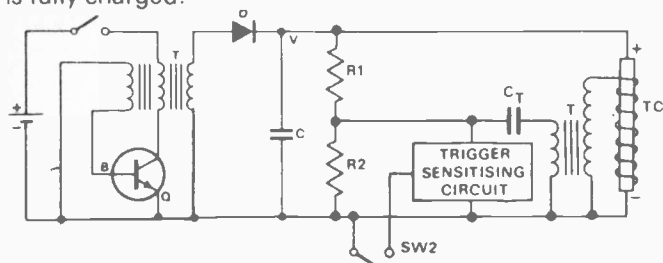
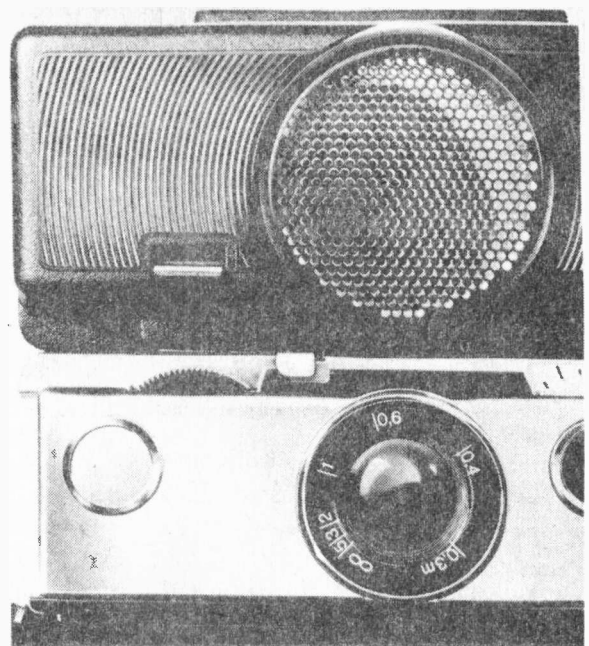

Fig. 10. Basic diagram of a manual flashgun.

In recent years automatic flashguns have become keenly competitive with ordinary flashguns (as described above). The automatic flashguns use a fast acting photocell such as a silicon photodiode. These cells operate so quickly that they are able to calculate the correct exposure setting while taking the light reading off the subject. In the flashgun the cell is used to



The transducer on Polaroid's sonar auto-focus cameras acts as both loudspeaker and microphone — transmitting and receiving millisecond-long ultrasonic waves to travel to the subject and echo back to the camera, advanced electronics set the camera lens at the precise focus position. The transducer, 3.5cm in diameter, is composed of a concentrically-grooved backplate (the capacitor) over which a 3-mil foil of gold-coated Kapton is stretched. The foil is the moving element transforming electrical energy to sound waves and the returning echo into electrical energy.

read the amount of light reflected from the object and transfer the information to an integrated circuit which works out when enough light has been reflected to register on the film. It then shuts off the flash by cutting the power supply.

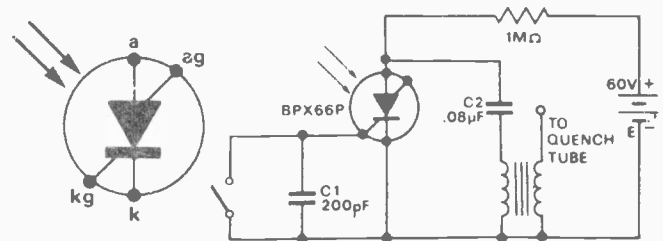
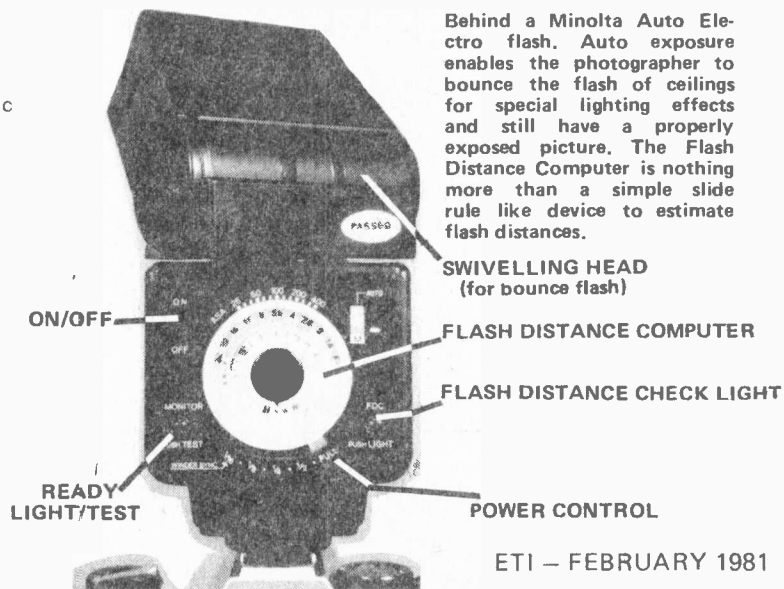
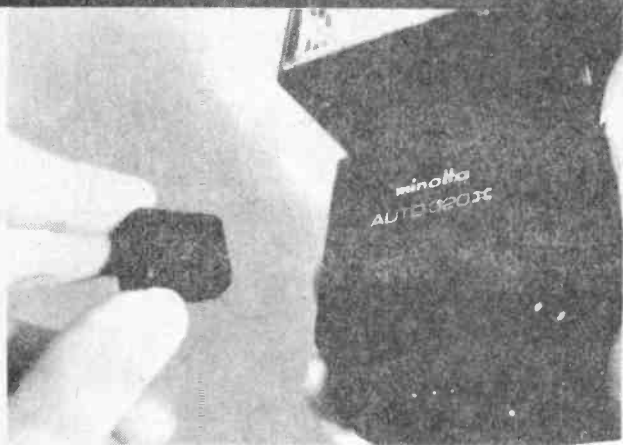

Fig. 11. The extra circuitry required for an automatic flashgun.

Behind a Minolta Auto Electro flash. Auto exposure enables the photographer to bounce the flash of ceilings for special lighting effects and still have a properly exposed picture. The Flash Distance Computer is nothing more than a simple slide rule like device to estimate flash distances.





The 'eye' of an automatic flash. A phototransistor measures incoming light and shuts the flash down when the right amount of light comes back. Removeable sensors allow remote operation of the flash.

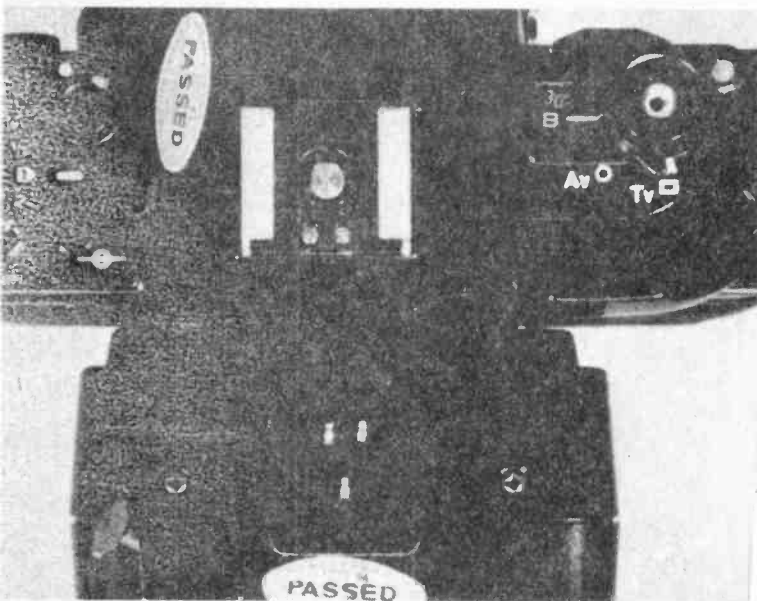

The auto flashes of the 60s used a system called 'Dump Quenching' which meant that when the integrated circuit decided that there had been enough light emitted it would cut out the flash by shorting the remainder of the power in the capacitor to the negative rail. The system worked well but wasted a lot of power, so in the early 70s a 'Blocking Quench' system was introduced (Fig. 11). This used a silicon sensor and integrated circuit as before but instead of shorting the circuit it used a faster thyristor which cut the power from the capacitor to the flash gun thus leaving the capacitor still partially charged.

On some recent auto exposure cameras there is a special connection for flash guns made by the same manufacturer (for the really dedicated) whereby the exposure calculation circuitry controls the flash power directly and also has an LED readout in the viewfinder informing the photographer of the state of readiness of the flash gun and also whether there was enough light to illuminate the subject correctly.

Recent innovations in portable flash photography include double flash heads on one body — one a low power flash and the other high power, for bounce diffused lighting. Rollei have recently introduced their latest flash which has an illumination range of 80 feet for

an average speed film. The development in their flash is that it has an LED readout — and when the ASA film speed and aperture used are fed in it works out the distance the flash can cover.

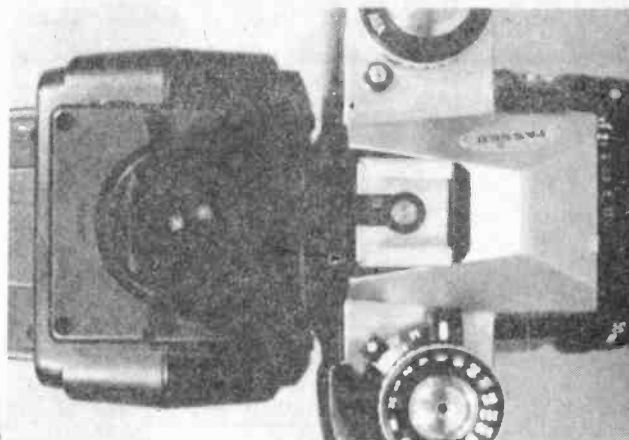

Hot shoe contacts of two dedicated flashes. On the right, the Minolta Auto Flash has an extra contact that automatically puts the camera in flash synchronization whenever the flash is ready. The Canon shoe (on the left) has two contacts, one for setting shutter speed, the other for setting the aperture.

This gives some idea of the way in which electronic flash photography is rapidly developing. The flashguns these days can even switch the cameras electronic shutters to the speeds required to take flash pictures. ●

All the figures illustrating this article are reproduced from "Electronics And The Photographer" by T.D.Towers, and appear by permission of the publishers, Focal Press. We recommend this book to anyone wanting to read further on this subject. You'll have to send for it though, write to Focal Press, 31 Fitzroy Square, London W1, U.K.

In addition, special thanks to Black's Cameras (and their Thornecliffe Park Branch in particular) for the loan of the Minolta XD11, Canon A1 and flash used in the pictures in this articles.



Deputy Editor For ETI

We're looking for someone to join us in a senior editorial capacity. This is a new position and reflects the rapid growth being experienced by the magazine.

Candidates must have three qualities:

1. Interest in and knowledge of electronics.
2. Knowledge of and preferably experience in publishing.
3. A desire to communicate.

Although a degree in electronics is an advantage, it is not essential. Candidates must be literate.

The Deputy Editor must have qualities which would enable them to take on the day-to-day running of the editorial side of the magazine after a period of familiarisation.

ETI Magazine is an independent company, 100% owned, published and printed in Canada. The company has experienced rapid growth and it is anticipated that this will continue. The salary will depend initially upon experience but will ultimately depend upon the individual's contribution to the company.

Applications should be made in writing (these will be treated as confidential). Send to:

H. W. Moorshead, Publisher
ETI Magazine
Unit 6, 25 Overlea Blvd.,
Toronto, ONT M4H 1B1.

Babani Books from

BP1: First Book of Transistor Equivalents & Substitutes \$2.80

More than 25,000 transistors with alternatives and equivalents make up this most complete guide. Covers transistors made in Great Britain, USA, Japan, Germany, France, Europe, Hong Kong, and includes types produced by more than 120 different manufacturers.



BP14: Second Book of Transistor Equivalents & Substitutes \$4.80

This handbook contains entirely new material, written in the same style as the "First Book of Transistor Equivalents & Substitutes". The two complement each other and make available some of the most complete and extensive information in this field.

BP24: Projects Using IC741 \$4.25

The popularity of this inexpensive integrated circuit has made this book highly successful. Translated from the original German with copious notes, data and circuitry, a "must" for everyone, whatever their interest in electronics.



BP33: Electronic Calculator Users Handbook \$4.25

An invaluable book for all calculator users whatever their age or occupation, or whether they have the simplest or most sophisticated of calculators. Presents formulae, data, methods of calculation, conversion factors, etc., with the calculator user especially in mind, often illustrated with simple examples.

BP35: Handbook of IC Audio Pre-amplifier & Power Amplifier Construction \$5.50

This book is divided into three parts: Part I, Understanding Audio ICs; Part II, Pre-amplifiers, Mixers and Tone Controls; Part III, Power Amplifiers and Supplies. Includes practical constructional details of pure IC and Hybrid IC and Transistor designs from about 250mW to 100W output. An ideal book for both beginner and advanced enthusiasts alike.

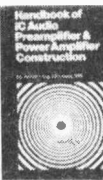

NO.205: First Book of HI-FI Loudspeaker Enclosures \$3.55

The only book giving all data for building every type of loudspeaker enclosure. Includes corner reflex, bass reflex, exponential horn, folded horn, tuned port, lipshorn labyrinth, tuned column, loaded port and multi-speaker panoramic. Many clear diagrams are provided showing all dimensions necessary.

BP37: 50 Projects Using Relays, SCR's & Triacs \$5.50

Relays, silicon controlled rectifiers (SCR's) and bi-directional triodes (TRIACs) have a wide range of application in electronics today. These may extend over the whole field of motor control, dimming and heating control; delayed, timing and light sensitive circuits and include warning devices, various novelties, light modulators, priority indicators, excess voltage breakers, etc.

The enthusiast should be able to construct the tried and practical working circuits in this book with a minimum of difficulty. There is a wide latitude in component values and types, allowing easy modification of circuits or ready adaptation of them to individual needs.



BP39: 50 (FET) Field Effect Transistor Projects \$5.50

The projects described in this book include radio frequency amplifiers and converters, test equipment and receiver aids, tuners, receivers, mixers and tone controls, as well as various miscellaneous devices which are useful in the home. This book contains something of particular interest for every class of enthusiast - short wave listener, radio amateur, experimenter or audio devotee.

BP42: 50 Simple L.E.D. Circuits \$3.55

50 interesting and useful circuits and applications, covering many different branches of electronics, using one of the most expensive and freely available components - the Light Emitting Diode (L.E.D.). Also includes circuits for the 707 Common Anode Display. A useful book for the library of both beginner and more advanced enthusiast alike.



BP44: IC 555 Projects \$7.55

Every so often a device appears that is so useful that one wonders how life went on before without it. The 555 timer is such a device. It is manufactured by almost every semiconductor manufacturer and is inexpensive and very easily obtainable.

Included in this book are Basic and General Circuits, Motor Car and Model Railway Circuits, Alarms and Noise Makers as well as a section on the 556, 558 and 559 timers.



BP46: Radio Circuits Using IC's \$5.90

This book describes integrated circuits and how they can be employed in receivers for the reception of either amplitude or frequency modulated signals. Chapters on amplitude modulated (a.m.) receivers and frequency modulation (f.m.) receivers. Discussion on the subjects of stereo decoder circuits, the devices available at present for quadrophonic circuits and the convenience and versatility of voltage regulator devices. An extremely valuable addition to the library of all electronics enthusiasts.

BP47: Mobile Discotheque Handbook \$5.90

The aim of this book is to give you enough information to enable you to have a better understanding of many aspects of "disco gear". The approach adopted is to assume the reader has no knowledge and starts with the fundamentals. The explanations given are simplified enough for almost anyone to understand.

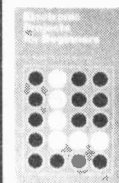

BP48: Electronic Projects For Beginners \$5.90

The newcomer to electronics, will find a wide range of easily made projects and a considerable number of actual component and wiring layouts. Many projects are constructed so as to eliminate the need for soldering. The book is divided into four sections: "No Soldering" Projects, Miscellaneous Devices, Radio and Audio Frequency Projects and Power Supplies.

BP49: Popular Electronic Projects \$6.25

A collection of the most popular types of circuits and projects which will provide a number of designs to interest the electronics constructor. The projects selected cover a very wide range. The four basic types covered are: Radio Projects, Audio Projects, Household Projects and Test Equipment.

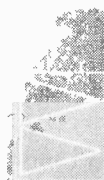

BP50: IC LM3900 Projects \$5.90

The purpose of this book is to introduce the LM3900, one of the most versatile, freely obtainable and inexpensive devices available to the Technician, Experimenter and the Hobbyist. It provides the groundwork for both simple and more advanced uses.

Simple basic working circuits are used to introduce this IC. The reader should set up each of these for himself. Familiarity with these simple circuits is essential in order to understand many more complicated circuits and advanced uses.

BP51: Electronic Music and Creative Tape Recording \$5.50

This book sets out to show how electronic music can be made at home with the simplest and most inexpensive of equipment. It then describes how the sounds are generated and how these may be recorded to build up the final composition. For the constructor, several ideas are given to enable him to build up a small studio including a mixer and various sound effects units. All the circuits shown in full have been built by the author. Most of the projects can be built by the beginner.



BP62: BOOK 1. The Simple Electronic Circuit & Components \$8.95
BP63: BOOK 2. Alternating Current Theory \$8.95
BP64: BOOK 3. Semiconductor Technology \$8.95
BP77: BOOK 4. Microprocessing Systems & Circuits \$12.30

Simply stated the aim of these books is to provide an inexpensive introduction to modern electronics. The reader will start on the right road by thoroughly understanding the fundamental principles involved.

Although written especially for readers with no more than ordinary mathematical skills, the use of mathematics is not avoided, and all the mathematics required is taught as the reader progresses.

The course concentrates on the understanding of the important concepts central to electronics. Each book is a complete treatise of a particular branch of the subject and, therefore, can be used on its own. However, latter books assume a working knowledge of the subjects covered in earlier books.

BOOK 1: This book contains fundamental theory necessary to a develop a full understanding of the simple electronic circuit and its main components.

BOOK 2: This book continues with alternating current theory.

BOOK 3: Follows on semiconductor technology, leading up to transistors and integrated circuits.

BOOK 4: A complete description of the internal workings of microprocessors.

BP65: Single IC Projects \$6.55

All the projects contained in this book are simple to construct and are based on a single IC. A strip board layout is provided for each project, together with any special constructional points and setting up information, making this book suitable for beginners as well as more advanced constructors.



These books are specially imported from England by us.
 All prices include handling and postage.
 To order, use the order form in this publication or
 write to:
 ETI Magazine, Unit 6, 25 Overlea Boulevard,
 Toronto, Ontario, M4H 1B1.

BP66: Beginners Guide To Microprocessors & Computing \$7.55

This book is intended as an introduction to the basic theory and concepts of binary arithmetic, microprocessor operation and machine language programming. The only prior knowledge which has been assumed is very basic arithmetic and an understanding of indices. A helpful Glossary is included. A most useful book for students of electronics, technicians, engineers and hobbyists.

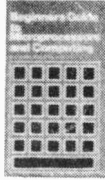

BP67: Counter Driver & Numeral Display Projects \$7.55

The author discusses and features many applications and projects using various types of numeral displays, popular counter and driver IC's, etc.

BP68: Choosing & Using Your Hi-Fi \$7.25

The reader is provided with the fundamental information necessary to enable him to make a satisfactory choice from the extensive range of stereo equipment currently on the market. This should aid him in understanding the technical specifications of the equipment he is interested in buying. Full of helpful advice on how to use your stereo system properly so as to realise its potential to the fullest and also on buying your equipment. A Glossary of terms is included.



BP69: Electronic Games \$7.55

The author has designed and developed a number of interesting electronic game projects using modern integrated circuits. The book is divided into two sections, one dealing with simple games and the latter dealing with more complex circuits. Ideal for both beginner and enthusiast.

BP70: Transistor Radio Fault-Finding Chart \$2.40

Author Mr. Chas. Miller has drawn on extensive experience in repairing transistor radios to design this book. The reader should be able to trace most of the common faults quickly using the concise chart.



BP71: Electronic Household Projects \$7.70

Some of the most useful and popular electronic construction projects are those that can be used in or around the home. These circuits range from such things as '2 Tone Door Buzzer' and Intercom through Smoke or Gas Detectors to Baby and Freezer Alarms.

BP72: A Microprocessor Primer \$7.70

A newcomer tends to be overwhelmed when first confronted with articles or books on microprocessors. In an attempt to give a painless approach to computing, this small book will start by designing a simple computer that is easy to learn and understand. Such ideas as Relative Addressing, Index Registers, etc. will be developed and will be seen as logical progressions rather than arbitrary things to be accepted but not understood.

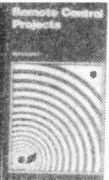

BP73: Remote Control Projects \$8.58

This book is aimed primarily at the electronics enthusiast who wishes to experiment with remote control and many of the designs are suitable for adaptation to the control of other circuits published elsewhere. Full explanations have been given so that the reader can fully understand how the circuits work and see how to modify them. Not only are Radio control systems considered but also Infra-red, Visible light and Ultrasonic systems as are the use of Logic ICs and Pulse position modulation etc.

BP74: Electronic Music Projects \$7.70

Although one of the more recent branches or amateur electronics, electronic music has now become extremely popular and there are many projects which fall into this category, ranging in complexity from a simple guitar effects unit to a sophisticated organ or synthesiser.

The purpose of this book is to provide the constructor with a number of practical circuits for the less complex items of electronic music equipment, including such things as Fuzz Box, Waa-Waa Pedal, Sustain Unit, Reverbation and Phaser-Units, Tremolo Generator etc.



BP75: Electronic Test Equipment Construction \$7.30

This book covers in detail the construction of a wide range of test equipment for both the hobbyist and radio amateurs. Included are projects ranging from a FET Amplified Voltmeter and Resistance Bridge to a Field Strength Meter and Heterodyne Frequency Meter.

Not only can the home constructor enjoy building the equipment but the finished project can also be usefully utilised in the furtherance of his hobby. An ideal book for both beginner and advanced enthusiast alike.

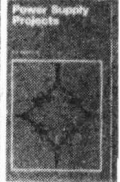

BP76: Power Supply Projects \$7.30

Power supplies are an essential part of any electronic project. The purpose of this book is to give a number of power supply designs, including simple unregulated types, fixed voltage regulated types, and variable voltage stabilised types, the latter being primarily intended for use as bench supplies for the electronic workshop. The designs are all low voltage types for use with semiconductor circuits.

There are other types of power supplies and a number are dealt with in the final chapter, including a cassette supply, Nicad battery charger, voltage step up circuit and a simple inverter.

BP78: PRACTICAL COMPUTER EXPERIMENTS \$7.30

This book aims to fill in the background to microprocessors by describing typical computer circuits in discrete logic and it is hoped that this will form a useful introduction to devices such as adders, memories, etc. as well as a general source book of logic circuits.

An essential addition to the library of any computer and electronic enthusiast.



BP79: Radio Control For Beginners \$7.30

The aim of this book is to act as an introduction to Radio Control for beginners to the hobby. The book will commence by dealing with the conditions that are allowable for such things as frequency and power of transmission. This is followed by a "block" explanation of how control-devices and transmitter operate and receiver and actuator(s) produce motion in a model.

Details are then given of actual solid state transmitting equipment that the reader can build. Plain and loaded aeriels are then discussed and so is the field-strength meter to help with proper setting up.

The radio receiving equipment is then dealt with, this includes a simple receiver and a crystal controlled superhet. The book ends with electro-mechanical means of obtaining movement of the controls of the model.

BP80: POPULAR ELECTRONIC CIRCUITS-BOOK 1 \$8.25

Another book by the very popular author, R.A. Penfold, who has designed and developed a large number of circuits which are accompanied by a short text giving a brief introduction, circuit description and any special notes on construction and setting up that may be necessary.

The circuits are grouped under the following headings; Audio Circuits, Radio Circuits, Test Gear Circuits, Music Project Circuits, Household Circuits, and Miscellaneous Circuits.

An extremely useful book for all electronic hobbyists, offering remarkable value for the number of designs it contains.

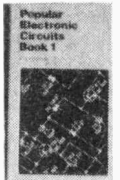

NO.213: Electronic Circuits For Model Railways \$4.50

The reader is given constructional details of how to build a simple model train controller; controller with simulated inertia and a high power controller. A signal system and lighting for model trains is discussed as is the suppression of RF interference from model railways. The construction of an electronic steam whistle and a model train chuffer is also covered.



NO.215: Shortwave Circuits & Gear For Experimenters & Radio Hams \$3.70

Covers constructional details of a number of projects for the shortwave enthusiast and radio "Ham". Included are: an add-in crystal filter, adding an "S" meter in your receiver; crystal locked H.F. Receiver; AM tuner using phase locked loop; converter for 2MHz to 8MHz; 40 to 800MHz RF amplifier. Aerials for the 52, 144MHz bands, Solid State Crystal Frequency Calibrator, etc.

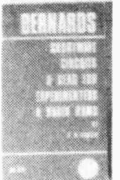

NO. 223: 50 Projects Using IC CA3130 \$5.50

In this book, the author has designed and developed a number of interesting and useful projects using the CA3130, one of the more advanced operational amplifiers that is available to the home constructor. Five general categories are covered: Audio Projects, R.F. Projects, Test Equipment, Household Projects and Miscellaneous Projects.

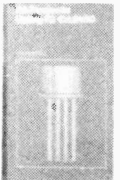

NO.224: 50 CMOS IC Projects \$4.25

CMOS IC's are suitable for an extraordinary wide range of applications and are now also some of the most inexpensive and easily available types of IC's. The author has designed and developed a number of interesting and useful projects. The four general categories discussed in the book are: Multivibrators, Amplifiers and Oscillators, Trigger Devices and Special Devices.

ULTRA SONIC BURGLAR ALARM

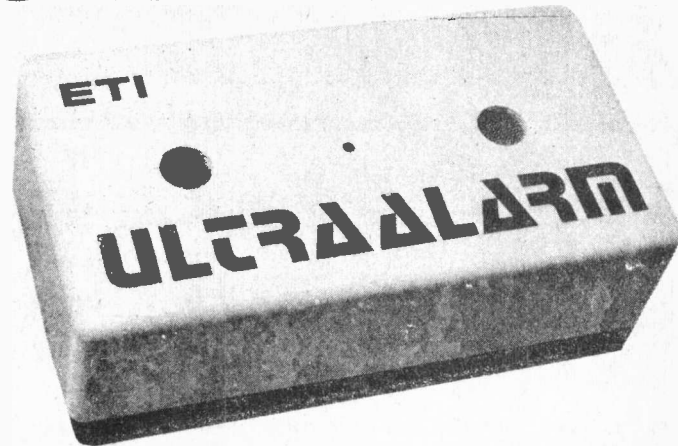

IF YOU HAVE even a passing interest in electronics, you'll know that there have been more than a few burglar alarm designs published — alarms set off when a switch opens or closes or when an invisible beam is broken or activated by a pressure mat. The permutations are endless. This project offers a novel movement detector based on the Doppler shift principle.

Super Shift

The unit consists of an ultrasonic transmitter radiating at about 40 kHz. Energy reflected from a moving target is shifted in frequency slightly. When mixed with the original signal, a heterodyne or 'beat' note is generated. This is detected by demodulating the ultrasonic carrier. The frequency of the heterodyne depends on the speed of the moving target and its direction. Consequently the unit is most sensitive to objects moving directly towards or away from the sensors. A person walking directly towards the unit will normally produce heterodynes in the 0

to 30 Hz range. Higher frequencies are generated by the faster moving limbs, swinging arms and legs, for example.

A drawback with systems of this type is that they are sensitive to any movement, including swinging doors, fluttering curtains and even convection air currents from heating or air conditioning systems. However, by careful positioning of the unit, these problems can be largely overcome.

Construction

Although any method of construction can be used, our PCB provides a convenient and practical solution. Use

of a PCB helps to prevent possible problems with instability as the ultrasonic amplifier has considerable gain. Only one wire link is needed and this should be soldered into place first, followed by the IC sockets (use them! It doesn't cost much and it can save lots of time afterwards), resistors, capacitors and semi-conductors. Watch out for the polarity of the capacitors and semiconductors.

Current consumption of the unit is low; most of the current used will be that required by the load and a suitable transformer rating can be calculated from this. Flying leads connect the

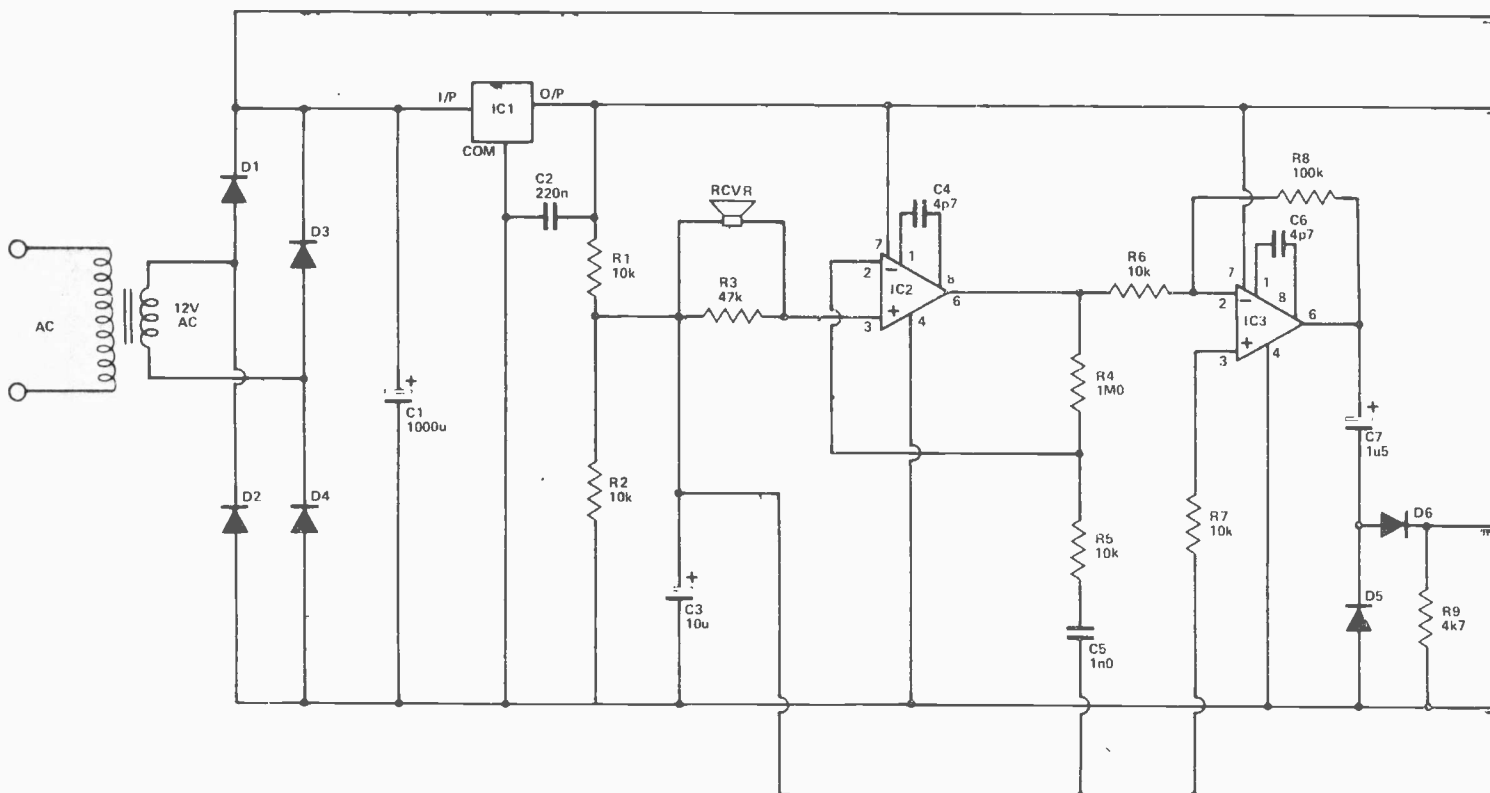

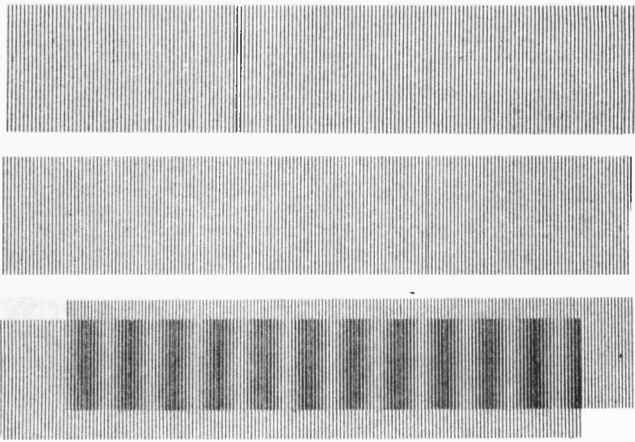
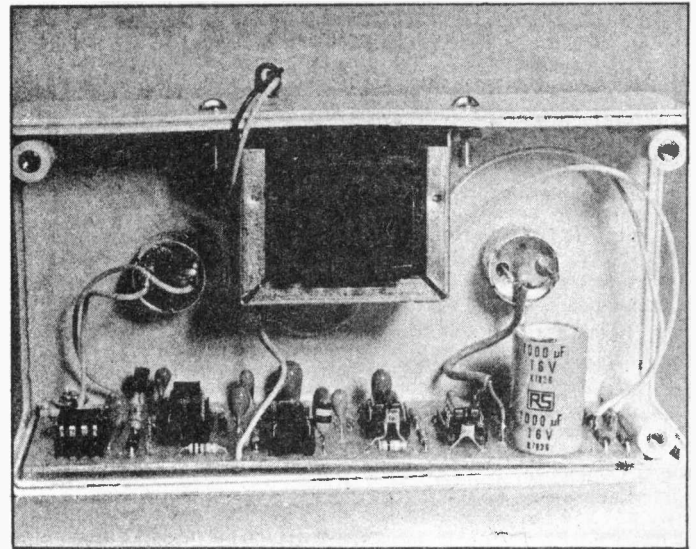

Fig. 1. (above) When the received signal is mixed with the original signal, the slight difference in frequency produces a heterodyne or beat note.



A behind-the-scenes view of the ETI Ultrasonic Burglar Alarm. The two transducers to the can be held in place by a couple of spots of contact cement. Note the use of the screened cable to connect the receiver transducer to the PCB. The single board contains power making the unit self-contained no-add-on-supplies or peripheral 'black boxes'. Note the use of IC sockets on the PCB. It's worth the expense. The board, transformer and transducers all fit neatly into a standard verocase.

transducers to the board. Use shielded cable for the receiver connection; it doesn't matter for the transmitter. Note that a wire lead is required to return the load to the unregulated supply. The specified driver transistor will sink in excess of 100 mA.

When connecting the transducers, take care not to over-heat them. A quick soldered joint should not cause any problems. Although the transducers are sensitive to mechanical vibration, no special mounting precautions will normally be needed. We fixed ours to the case with a few dabs of contact cement and that worked fine.

Setting Up

If you have an oscilloscope, then setting up will be very easy. Even without one, it will not be too difficult; in fact a small screwdriver is all you need. With power applied, adjust RV2 for maximum indication of signal from pin 6, IC3. If you don't have a 'scope then connect a voltmeter across C9 and adjust for a maximum here. You will probably find two positions for RV2 which produce a high reading. Use either. This operation tunes the transmitter to about 40 kHz; the operating frequency of the transducers. The required sensitivity may now be set by adjustment of RV1. Too much

sensitivity will lead to the unit being triggered by fluctuating air currents, low flying bats, etc and LED 1 has been included to indicate large signals at output. You will soon find the

Fig. 2. (below) Circuit diagram.

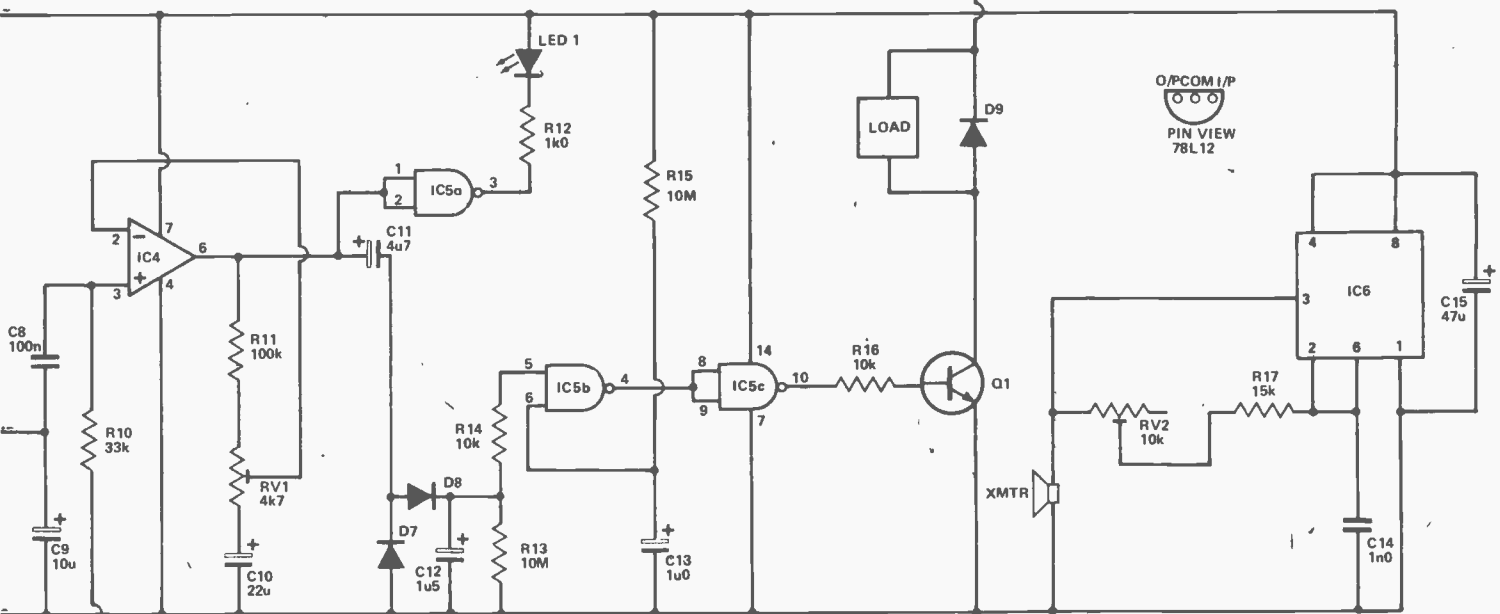

- NOTES:
 IC1 Is 7812
 IC2,3 are LM301
 IC4 Is 741
 IC5 Is 555
 D1,2,3,4,9 are 1N4001
 D5,6,7,8 are 1N4148
 Q1 Is 2N4401
 LED 1 Is any LED
 XMTR and RCVR are 40kHz Transducer pair

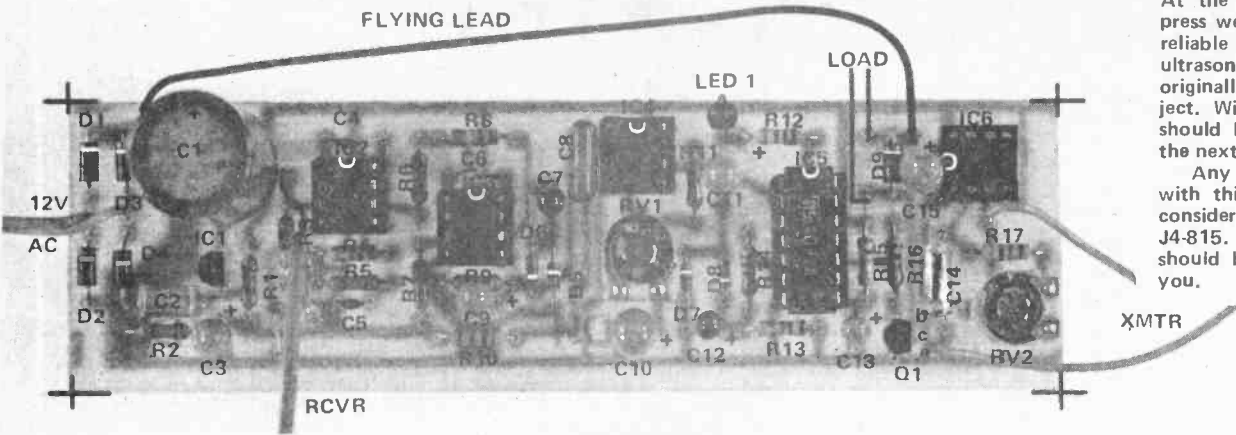

Fig. 3. Component overlay.

At the time this issue went to press we were unable to locate a reliable source of the 40kHz ultrasonic transducers that we had originally specified for this project. With any sort of luck we should have this information by the next issue.

Any transducer should work with this circuit. A good one to consider is GC Electronics No. J4-815. Your local GC dealer should be able to order this for you.

HOW IT WORKS

An ultrasonic drive signal is generated by IC6, a 555 configured as an astable oscillator. The circuit differs from the conventional design, as it has the timing resistor returned to the output and the internal discharge transistor (pin 7) is unused. This arrangement was chosen as it enables a 50% duty cycle to be obtained providing a better drive signal to the transmitter transducer. If close tolerance components are used then RV2 should tune the circuit between approximately 30 and 50 kHz, enabling the transmitter to be set up for most efficient operation. The power supply to IC6 is decoupled by C15 directly at the chip.

The reflected ultrasonic waves are picked up by the receiver transducer. Signals from this are coupled directly to the non-inverting input of op-amp IC2. The 'Q' of the transducer is lowered by the shunt resistance of R3, facilitating 'setting-up' the unit. IC2 is a non-inverting amplifier with a gain of 100 at 40 kHz. Gain versus frequency is tailored for best response by C4 and C5. IC3, directly coupled via R6, operates as an inverting amplifier with a gain of 10. Compensation is provided by C6. The low frequency signals resulting from Doppler shifts are demodulated

from the 40 kHz signal by the network around C9. They are then amplified by IC4. The gain of this stage is made variable by adjustment of RV1, enabling overall sensitivity of the unit to be controlled.

The AC output from IC4 is integrated by C12 and the associated network. When the voltage across C12 exceeds the upper threshold of the IC5 input, transistor Q1 will be driven on and the load energised. One section of IC5 is connected directly to IC4's output and drives the LED which indicates the major excursions of IC4's output. This is of considerable use when 'setting-up' the unit. Components R15 and C13 provide a delay following switch-on before the alarm becomes active.

The values of C12, R13 and C13, R15 may be changed to suit your particular requirements. For some applications, IC5 and its associated components may not be required. In such a case, they may be omitted and an output taken directly from IC4.

The power supply, for the unit is utterly conventional and needs no description here. Current consumption will depend on the load employed. The circuit draws only about 10 mA when unloaded.

best operating position for your unit. Avoid placing the unit near fires, radiators, etc and keep the area near the sensors clear as this could otherwise severely restrict sensitivity. Over-all range will depend on the target and the working environment. Hard, reflective surfaces are best.

PARTS LIST

Resistors

1/4W 5% unless specified

- R1, 2, 5, 6, 7, 14, 16 10k
- R3 47k
- R4 1M0
- R8, 11 100k
- R9 4k7
- R10 33k
- R12 1k0
- R13, 15 10M
- R17 15k

Potentiometers

- RV1 4k7 miniature horizontal preset
- RV2 10k miniature horizontal preset

Capacitors

- C1 1000u electrolytic
- C2 220n polycarbonate
- C3, 9 10u tantalum
- C4, 6 4p7 ceramic
- C5 1n0 ceramic

- C7, 12 1u5 tantalum
- C8 100n polyester
- C10 22u tantalum
- C11 4u7 tantalum
- C13 1u0 tantalum
- C14 1n0 polystyrene
- C15 47u tantalum

Semiconductors

- IC1 78L12
- IC2, 3 LM301
- IC4 741
- IC5 4093B
- IC6 555
- D1, 2, 3, 4, 9 1N4001
- D5, 6, 7, 8 1N4148
- Q1 2N4401
- LED 1 any LED

Miscellaneous

- Ultrasonic transducers, see text.
- 12V transformer, case.

ETI alarm

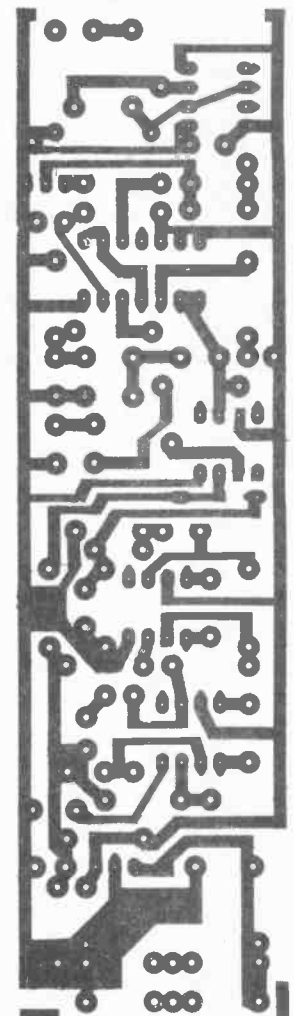

Back Issues From ETI



February 1977

Features: CN Tower, Biorythm Calculator, VCT, 555 Timer Applications, Yamaha B1 Review, Scope Test Your Car.

Projects: 5W Stereo Amp, Philips Speaker System, Reaction Tester, Patch Detector, Heads or Tail, SCR Tester.



August 1978

Features: Getting into Shortwave, Using a 'Scope, Semiconductor Guide, Intro To Amateur Radio 2.

Projects: Sound Level Meter, 2 Chip Siren, Induction Balance Metal Locator, Porch Light.

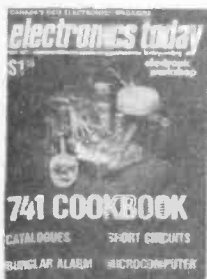

May 1977

Features: Projection TV, 741 Cookbook, Easier Way to Make PCBs, Choosing a Microcomputer.

Projects: Burglar Alarm, Ceramic Pre-amp, Ni-Cad Battery Charger, Power Supply, Fuzz Box, Stereo Rumble Filter.



October 1978

Features: Personal Computing Commentary, CMOS Quickies, SSB by Phasing, History of Electronics in Medicine.

Projects: UFO Detector, CCD Phaser, Strobe.



July 1977

Features: A Generation Away, I²L Explained, CB Supplement, Intro to Computers.

Projects: Mastermind, DVM, Overled, Turn Indicator Cancellor.



June 1979

Features: Op Amps, Inside Info From Ultrasound, Computer Catalogue.

Projects: Colour Organ, LCD Thermometer, Colour Sequencer, VHF Antenna, Bip Beacon.

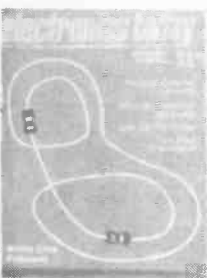

May 1978

Features: Tools Catalogue, Data Sheet Special on Memory Chips, Microbiography.

Projects: White Line Follower, Add-on FM Tuner, Audio Feedback Eliminator.

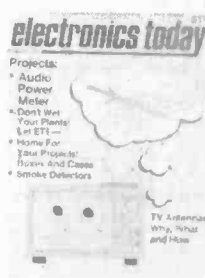

August 1979

Features: Casing Survey, Smoke Detectors, TV Antennas, Reed Switches, Magnetic Field Audio Amp, Industrial Electronics.

Projects: Audio Power Meter, Shoot-out, ETI-Wet Plant Waterer.



July 1978

Features: Digital Multimeter Survey, Pinball Machines, Intro to Amateur Radio, TI Programmer.

Projects: Real-Time Analyser, Electronic Race Track, Proximity Switch, Accenuated-Beat Metronome.



December 1979

Features: LM10 Circuits, Police Radar Speed Meters, Practical Guide to Triacs, Fluorescent Displays.

Projects: High Performance Stereo Preamp, Photographic Development Timer, Logic Trigger.

The back issues shown and described above are available direct from us. Please order by Issue, not by feature. They are \$3.00 each or 5 for \$10.00. Use handy order form, which lists other back issues available, or just send to:

BACK ISSUES
ETI Magazine
 Unit 6,
 25 Overlea Boulevard
 Toronto, Ontario
 M4H 1B1

FILTER DESIGN

Tim Orr tackles the subject of Active Filters.

THE FREQUENCY RESPONSE plot of a first order low pass filter (Fig. 1) reveals several important features. The break frequency F_c , is defined as the point at which the output signal is attenuated by 3dB. The curve then approximates to a -6dB/octave roll off slope. By using a straight line approximation it is easy to calculate attenuations caused by the filter. For example, an 8kHz sinewave filtered by a 1kHz first order lowpass filter will be attenuated 18dB, a reduction in level of almost one-tenth. The calculation is simple; 8kHz is 3 octaves above 1kHz. The filter attenuates at 6dB per octave, therefore the final attenuation is

$$3 \times 6 = 18\text{dB.}$$

To increase the roll of slope, the filter order must be increased, figure 2. When constructing high order filters, it is necessary to assemble them out of smaller filter sections each having different Q factors. A high order filter constructed from sections all having the same Q factor will have a very 'unabrupt' frequency response curve, which is generally not what is required.

A simple first order filter (Fig. 3) merely requires a resistor, a capacitor and a voltage follower. A second order filter (Fig. 4) requires two RC networks. This circuit has a 'flattest amplitude' response (when it has a Q of 0.7) and is often referred to as a Butterworth response. The response may be modified by altering the Q factor, but in all the following examples a Butterworth response has been chosen. This design is known as a 'unity gain Sallen and Key' filter. The Q factor is determined by the ratio of the two timing capacitors. This often leads to a circuit design which employs non-preferred capacitor values as can be seen in the three filters by a process known as scaling. For instance, if the required break frequency is 5kHz, then the resistors, or the capacitors in the filter should be reduced by a factor of five. If say the filter in figure 5a had to be redesigned to operate

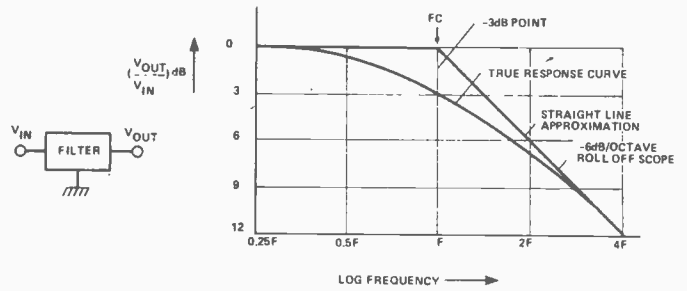

Fig. 1. Frequency response of a first order low pass filter.

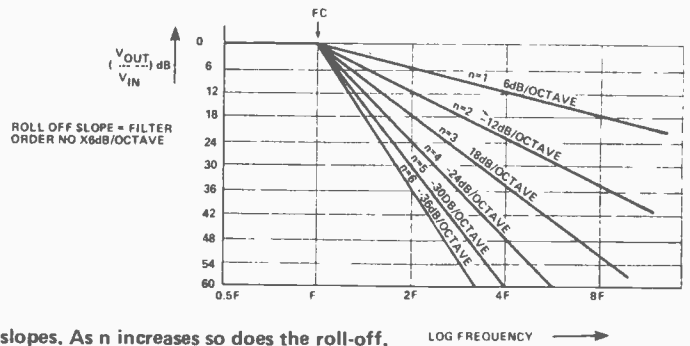

Fig. 2. Filter roll-off slopes. As n increases so does the roll-off.

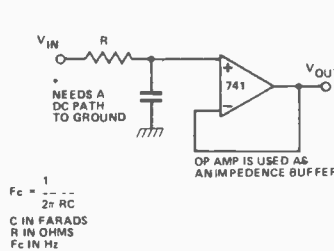

Fig. 3. Simple first order low pass filter.

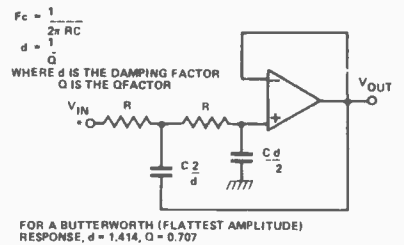

Fig. 4. Second order unity gain Sallen and Key low pass filter.

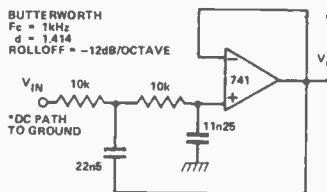

Fig. 5a. Second order low pass filter 1kHz.

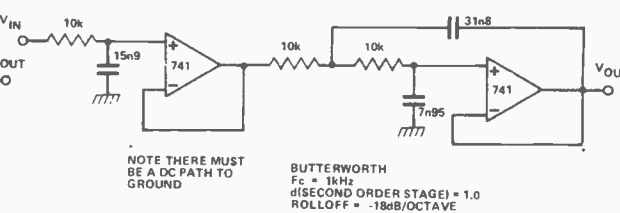

Fig. 5b. Third order low pass filter, 1kHz.

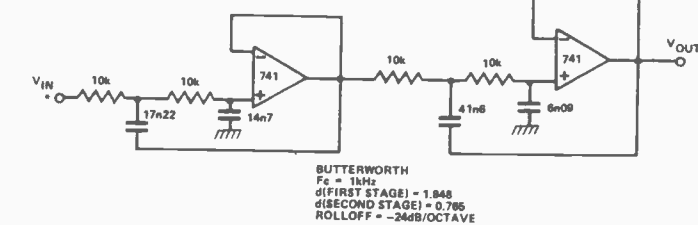

Fig. 5c. Fourth order low pass filter, 1kHz.

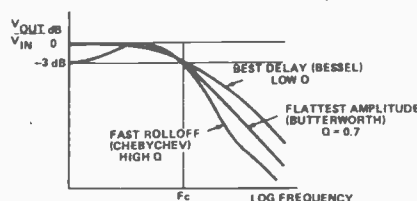

Fig. 6. Frequency response versus Q factor.

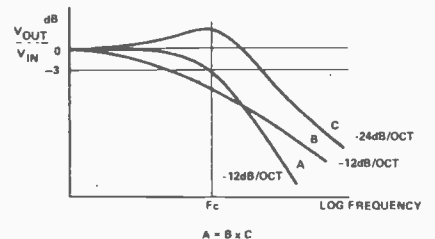

Fig. 7. Combining high and low Q factors.

at 250Hz, then the required component changes would be to change the 10k resistors to 40k. Active filters generally employ op amps and so care should be taken so as not to operate them near to their bandwidth limit, which would cause the filter response to be degraded. A 741, for instance, should not be used for frequencies above 50kHz.

Figure 6 shows the effect of varying Q in a low pass filter. Generally, the response that is wanted is the 'flattest amplitude' curve. A fourth order filter (Fig. 5c) is constructed from a low Q and high Q filter. The overall response of this filter is seen in figure 7. Note that the flattest amplitude curve (A) is made up out of the product of curves B and C. The peak in the high Q curve (C) is flattened out by the droop of the low Q curve (B).

The problem of having different and unpreferred capacitor values is greatly reduced by using an 'equal component' design, figure 8a, b, c. The Q factors are controlled by the gain of the op amp and so the capacitor values are all the same. Note that these filters provide a voltage gain which is in fact the product of the DC gains of each amplifier. Frequency scaling can be performed by modifying the R and/or the C components. Capacitors generally are available in E6 or E12 values, whereas resistors can be obtained in the E24 series, and so it is usually much easier to scale the R components, keeping them within the range 1k to 100k. Low pass filters find many uses in audio processing and are often used in data acquisition systems (fig. 9). The high pass filter (fig. 10) is exactly complementary in operation to the low pass device. The unity gain Sallen and Key structure is seen in figure 11 with calculated values for second, third and fourth order filters in figure 12a, b, c. Also there are calculated values for 'equal component' realizations in figure 13a, b, c.

The band pass response is defined in figure 14. This can be realized with a single op amp circuit, the multiple feedback band pass filter, figure 15. Calculated values are seen in the chart of figure 16. The maximum Q should be kept below a value of 20 at 1kHz, otherwise the filter may become unstable and oscillate. Frequency scaling may be

performed by multiplying the R or the C components with a constant. High Q, high frequency operation is not possible with this design because the op amp runs out of bandwidth.

The state variable filter (fig. 17) overcomes this problem by using the bandwidth of three op amps. Q factors of several hundred at 1kHz are ob-

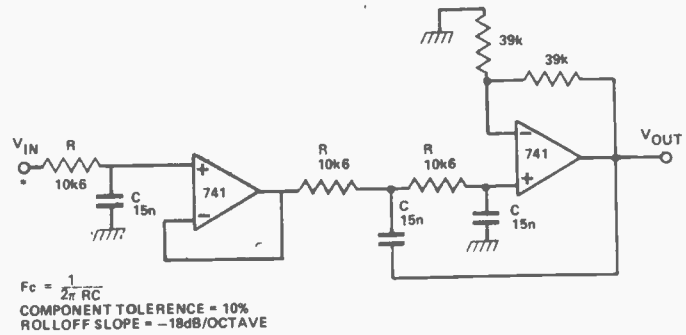

Fig. 8b. Third order low pass filter, 1kHz.

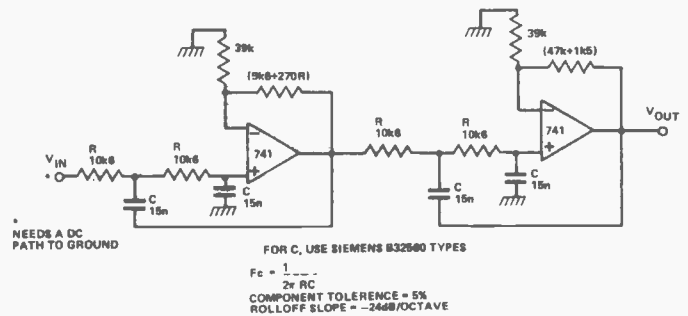

Fig. 8c. Fourth order low pass filter, 1kHz.

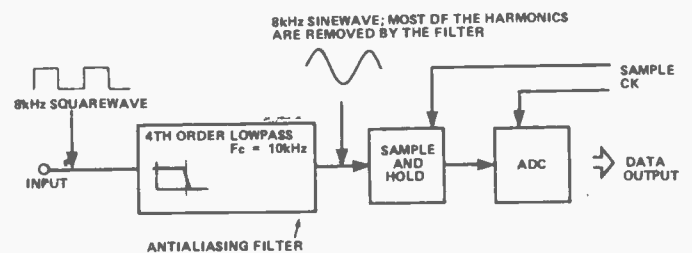

Fig. 9. Use of a low pass filter in an ADC system.

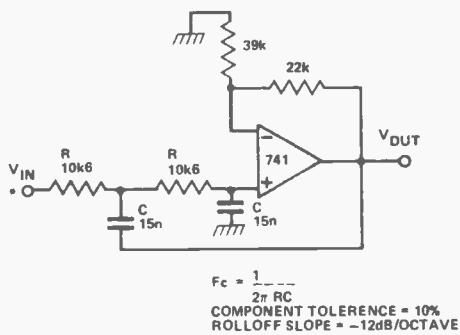

Fig. 8a. Second order low pass filter, 1kHz.

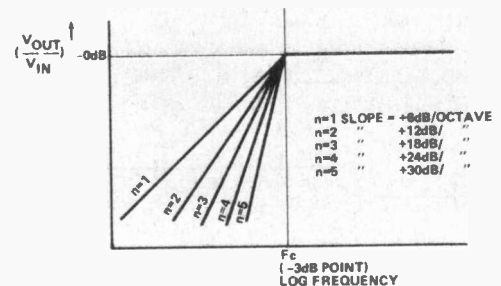

Fig. 10. Frequency response of different orders of high pass filter

tainable with this circuit. It also produces four outputs; high, low, band pass and notch, making it a very versatile design. The frequency may be scaled by altering the R or the C components and also the Q factor is separately programmable and is invariant with frequency. The all pass filter (fig. 18) has a flat frequency response, which in itself is of

no use at all. However, it does suffer a 180° phase shift as a function of frequency. By cascading two stages (fig. 19) it is possible to obtain a 180° phase shift at the frequency Fc. This phase shifted signal when mixed with the original will give a notch response due to the cancellation of the two signals.

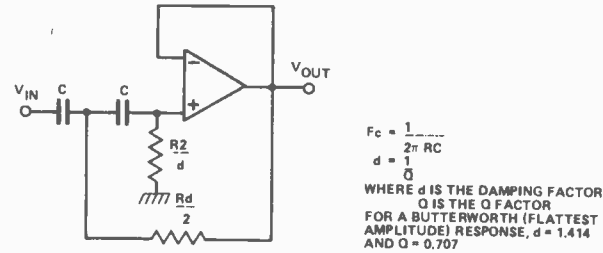

Fig. 11. Unity gain Sallen and Key high pass filter.

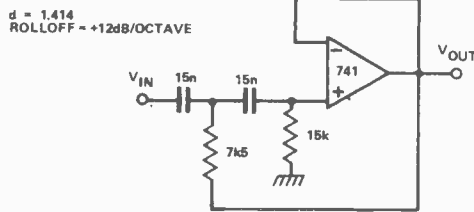

Fig. 12a. Second order Butterworth 1kHz high pass filter.

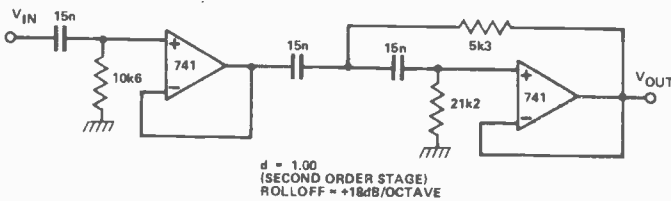

Fig. 12b. Third order Butterworth 1kHz high pass filter.

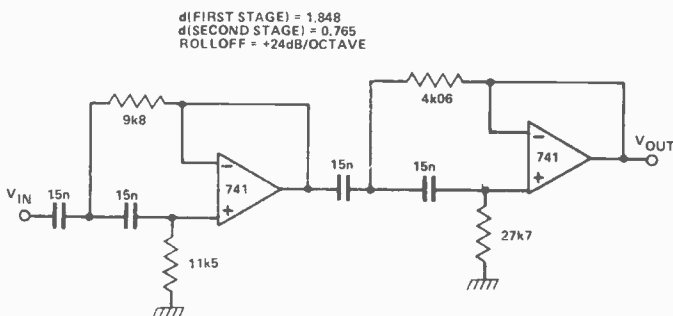
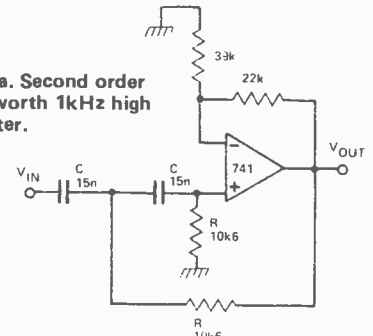

Fig. 12c. Fourth order Butterworth 1kHz high pass filter.

EQUAL COMPONENT HIGHPASS
 COMPONENT TOLERANCE = 10%
 ROLLOFF = +12dB/OCTAVE

Fig. 13a. Second order Butterworth 1kHz high pass filter.



EQUAL COMPONENT HIGHPASS

Fig. 13b. Third order Butterworth 1kHz high pass filter.

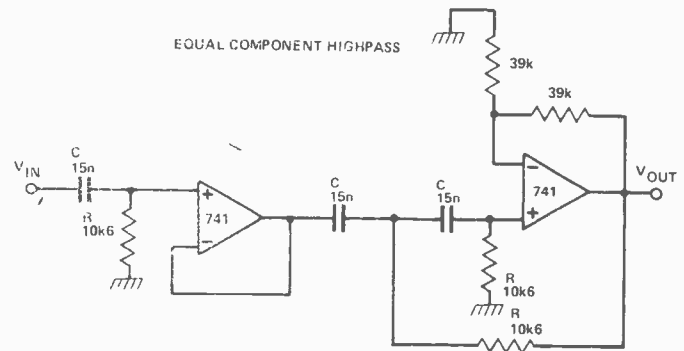

$F_c = \frac{1}{2\pi CR}$
 COMPONENT TOLERANCE = 5%
 ROLLOFF = +24dB/OCTAVE

Fig. 13c. Fourth order Butterworth 1 kHz high pass filter

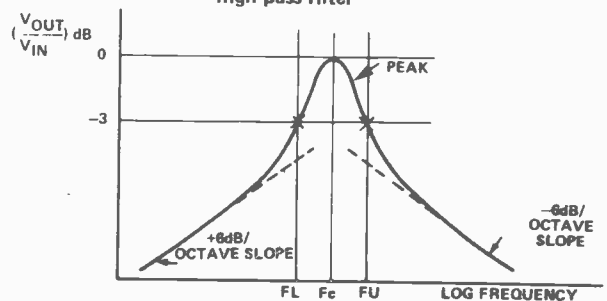
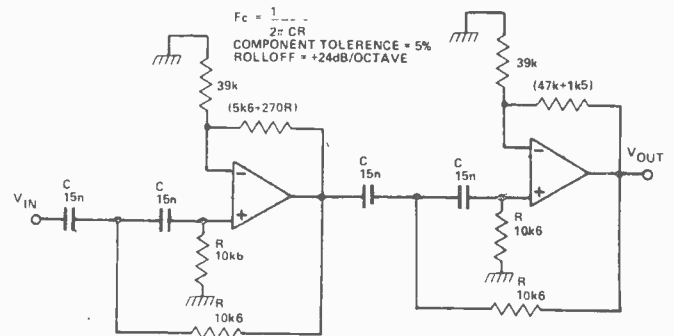

Fig. 14. Band pass response (single pole).

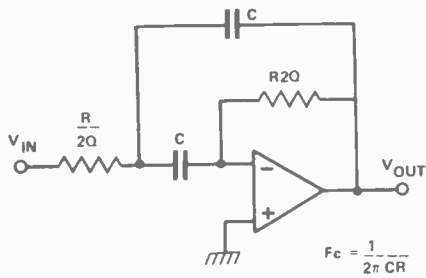

Fig. 15. Single pole multiple feedback bank pass filter.

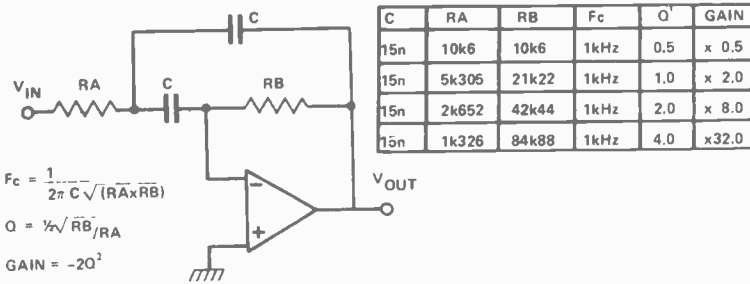

Fig. 16. Multiple feedback filter selection chart.

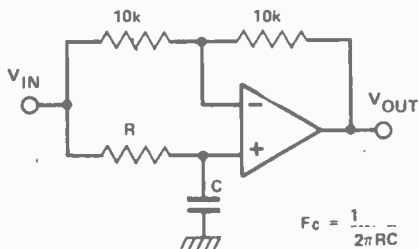
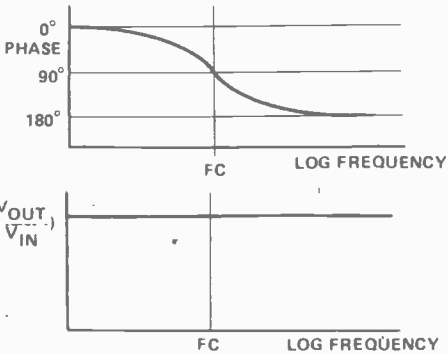
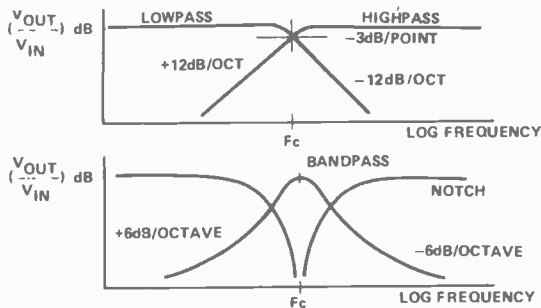

Fig. 18. All pass filter.

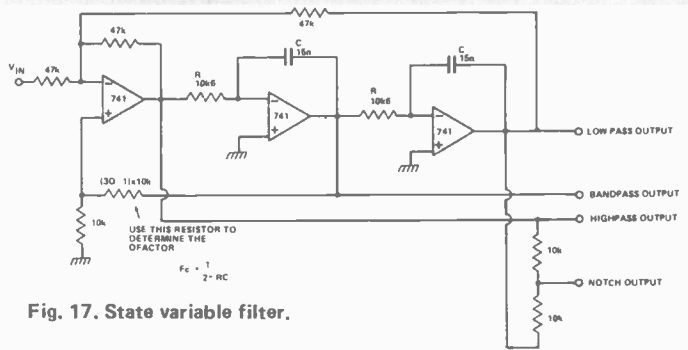

Fig. 17. State variable filter.

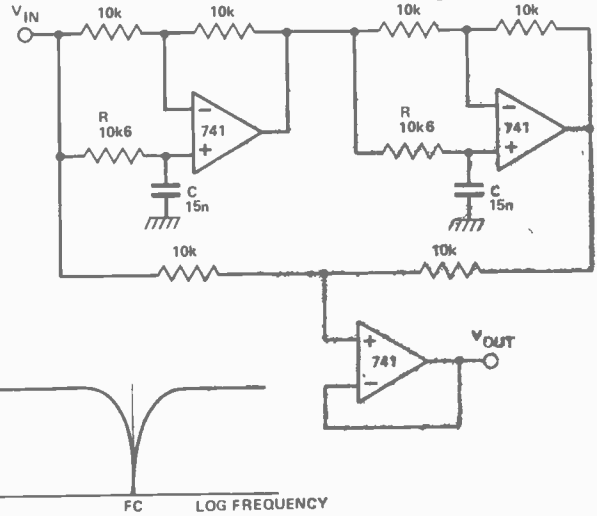

Fig. 19. Notch filter using all pass sections.

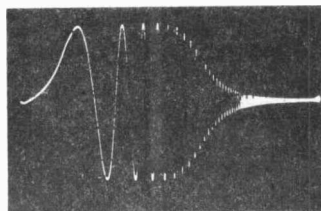
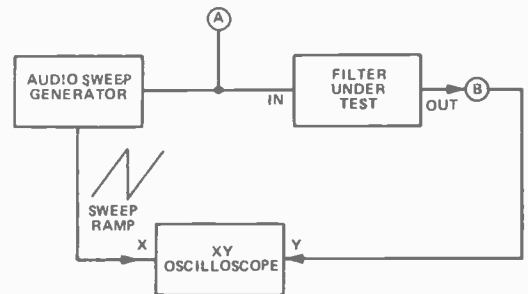
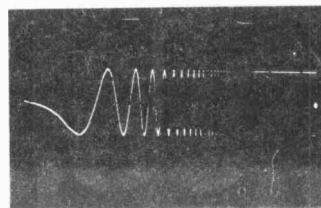

Fig. 20. Testing filter design with an oscilloscope. 'Scope traces' from points A and B are shown left (A above, B below).



Testing active filters is very easy if you have a swept sine wave generator and an XY oscilloscope (fig. 20). The frequency response appears as a linear amplitude versus log frequency display. It is generally possible to sweep five times a second, which gives an almost continuous display and allows you to see immediately the effect of any changes that you make to the filter.

Electronics Today

INTERNATIONAL

At the time of going to press, the articles mentioned are in an advanced stage of preparation. However, circumstances may result in changes to the final contents of the magazine.

NEXT MONTH

MARCH

CATALOGUE SURVEY



If you saw our survey of retail stores in the January issue, you'll notice how many companies produce catalogues. In the March issue we'll take a look at what's on offer so you can decide what is worth sending for.

THE UBIQUITOUS OSCILLOSCOPE

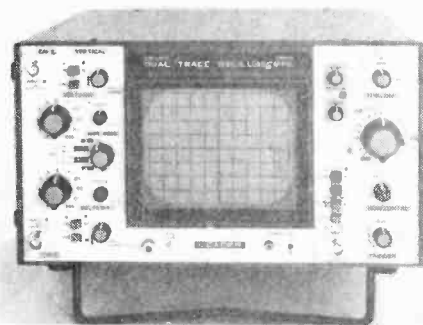

There's no substitute for 'looking' inside a circuit when you really want to know what's going on; this is what the 'scope will do and it's the most versatile electronic piece of electronic equipment ever devised. Les Bell and Roger Harrison take you on a guided tour.

SERVICING SUPPLEMENT

This issue carries the first of a series of special supplements that we've planned. The next issue contains the second and will be dealing with aspects of servicing. Articles planned at the moment include a look at CICA, Zenith's warranty policy, a look at the Huntron Tracker and Exceltonix's Logic State Analyser plus the return of Richard Cartwright our popular columnist.

MICROBE RADIO CONTROL

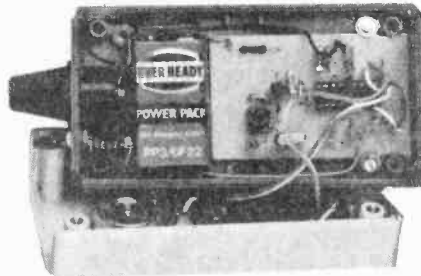

We present what must be the last word in simplicity as far as well designed and inexpensive to make proportional radio control systems are concerned. Using the latest chip technology you get an excellent system for a fraction of the cost of a few years ago.

MOTOROLA PIA'S

More than one computer enthusiast has been stumped by the task of I/O and peripheral interfacing. Next month we'll try to explain a useful device called a PIA: Peripheral Interface Adaptor.

PHOTOCELLS

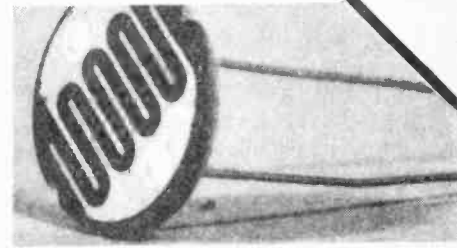

These are the devices we use to detect light by making use of the energy that is carried by light to generate an electrical signal. A wide variety of substances are affected by light leading to a large range of photocells. K.T. Wilson explains.

VFETS

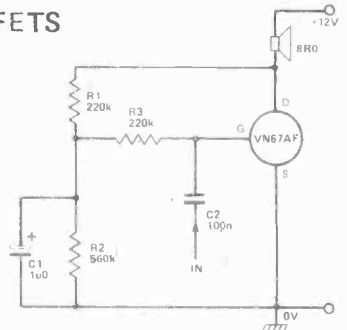

Is the VMOS power FET a really important device or a mere flash in the pan? Ray Marston takes a look at these semiconductors and presents several practical circuits for you try.

HUM FILTER

There are few things more annoying than trying to track down the source and remove hum from an audio system. If you're only partially successful, this project should remove the last trace of 60Hz from your system.

Save up to 28% on the Newsstand price by subscribing to ETI see page 57

FUZZ SUSTAIN UNIT

For that raunchy sound beloved of electric guitarists the world over, this simple little project is just the thing.

THE INVENTOR of the fuzz-tone is lost in history (rugged country, that), along with the discoverer of the wheel, the first chef, and the architect of square corners. However, his legacy is with us still, to the joy of those who like their music *loud*, and the despair of those who can't stand it that way!

Like the first bar-b-que, the first fuzz-tone was probably an accident — a blown speaker, perhaps, or a badly overdriven amplifier. However, the essential nature of the phenomenon did not long remain hidden, and keen guitarists soon had the fuzz by the short and curlies.

Fuzz-tone is to guitar what salt is to meat — it adds flavour and body. The ETI Fuzz Unit, based on the 'clever fuzz-box' circuit which appeared in ETI, February '80, page 39, has an added bonus in an in-built sustain circuit, adding a bit of extra spice to the idea.

The device offers three distinctive sounds, in addition to the 'straight through' option: sustain, fuzz with sustain or fuzz without sustain.

How We Did It

To explain how these sounds are realised, we have to consider the circuit diagram.

The input amplifier, IC1, is required to give the system some overall gain, to boost the treble response, and to present the correct load impedance to the instrument. The mid-range gain is set to 5, allowing 1V peak-to-peak input signals before distortion, and producing the largest possible dynamic range. The frequency response is flat from 20Hz to about 2kHz, after which an 8dB step provides a gentle treble boost up to 20kHz, where the response is rolled-off.

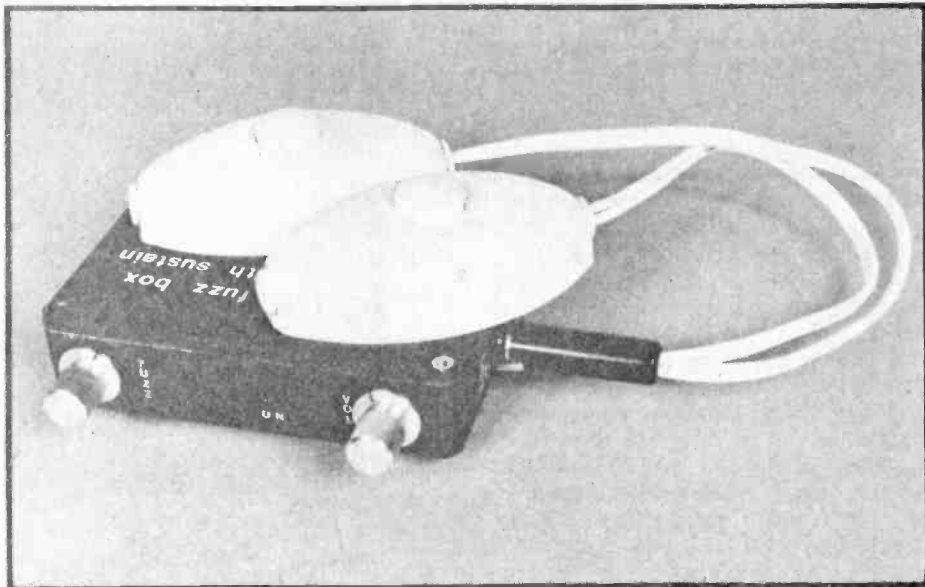

Following the input stage is IC2/1, one-half of an NE 571 compander IC configured as a conventional compressor with a fixed compression ratio of 2:1. This compression effectively halves the dynamic range of the incoming signal by attenuating high level signals and boosting low level ones; thus the signal hangs on — "sustains" — for much longer than it otherwise would. The compression also provides a constant level drive to the clipping stage, making the fuzz sound independent of the instrument input level.

For a more precise description of the NE 571 Componder, refer to the 'How It Works' section.

The fuzz stage, Q1, is a high gain amplifier stage. Because of the high, constant drive from the compressor it is always driven into hard clipping, resulting in an output which is substantially a squarewave. The output of the fuzz stage is fed through a tone control which varies the quality of the sound by rolling-off the high frequencies — one of the reasons for the treble boost at the input stage was to ensure that there would be some high frequencies to roll-off at this point!

The by now well-and-truly-fuzzed signal is fed to the signal input of IC2/2,

the second half of the NE 571 Componder. This time the device is set-up as an envelope follower with a signal input and a control input; the output of IC2/2 is whatever frequencies are applied to the signal input but with the amplitude envelope of the signal fed to the control input (for details see 'How It Works'). It is this envelope follower, plus some simple switching, which makes The Fuzz Unit so versatile — of which more shortly!

A deliberate modification to the envelope follower ensures that IC2/2 shuts-off completely when the signal on the control input falls below a certain level. This is a simple 'noise gate' function which prevents the amplification of low-level signals and noise, eliminating the hisses and buzzes of unwanted sounds and the squeals and howls of unexpected feedback! This function operates only when Fuzz function is selected.

As we mentioned earlier, The Fuzz Unit is capable of producing either sustain, fuzz with sustain, or fuzz without sustain. These variations are achieved by selecting the appropriate output and the appropriate drive to the control input of the envelope follower.

The switching system is entirely electronic, so the guitar signal never leaves

the box even if the footswitches themselves are a dozen yards away. The signal is not required to travel long lengths of cable, and so is not attenuated or subject to interference. Also, single-pole non-audio type switches may be used, allowing a larger choice of switch types (audio quality footswitches are hard to find at the moment!)

Two switch lines are used to control our electronic switches operating as two sets of change-over switches. One line controls SW A and SW B (sustain on/off), the other controls SW C and SW D (fuzz on/off).

If neither fuzz nor sustain is selected SW A and SW C are closed while SW B and SW D are open; the output of the unit is derived from the input preamplifier (so it will be a little louder and a little brighter than the guitar itself) via A and C.

If sustain is selected SWs A and B change over and the output is from IC2/1.

Selecting fuzz closes SW D and opens SW C. Whether it is fuzz with sustain or fuzz without sustain now depends on the position of the sustain select switch. If sustain is selected the drive to the control input of the envelope follower is the compressed signal from IC2/1; compression followed by expansion restores the amplitude envelope of the signal, so the output will have the dynamic characteristics of the original

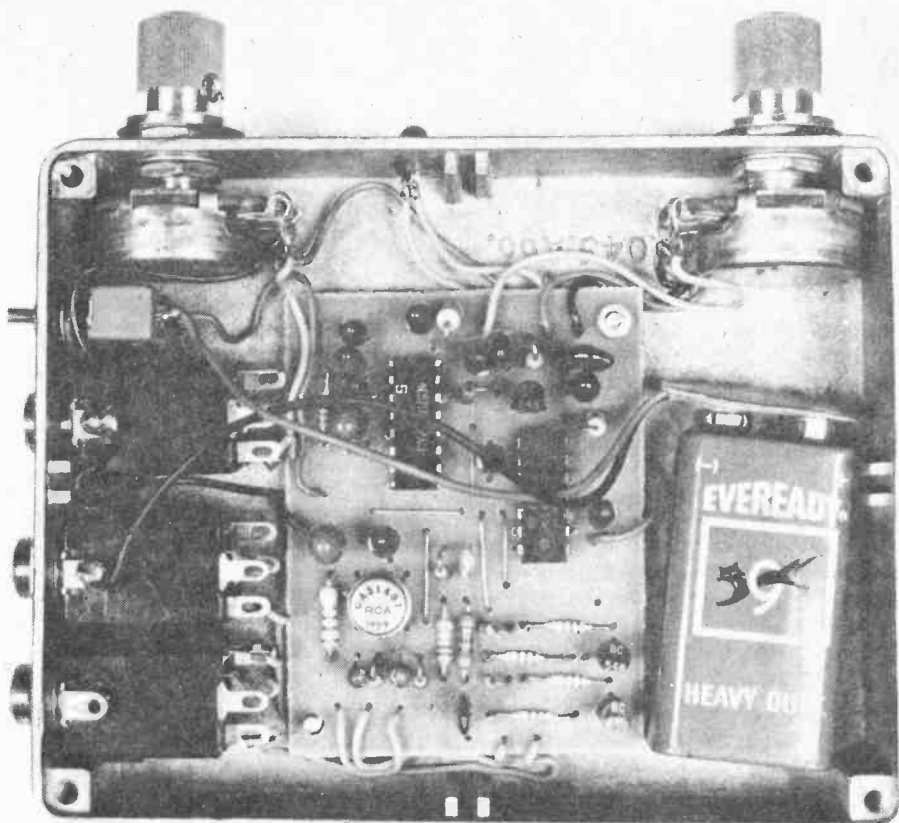

We housed the fuzz unit in a diecast aluminum box. It's not as much of a squeeze as it looks. A piece of sponge rubber will secure the battery.

HOW IT WORKS

The input amplifier is a CA 3140, chosen for its low noise. The input impedance of the device is quite high, so the effective value is determined by the parallel combination of R1, R2; the values used give an impedance of 90k. R1 and R2 can be as low as 10k or as high as 1M, as long as they are the same and within this range.

The bias for the CA 3140 is filtered and regulated by R3, C2 and LED1; the LED also acts as a 'power on' indicator! The LED must be RED as other colours have a different forward voltage. The stage gain of 5 is set by the ratio of R4 and R5, while C4, C5 and R6 tailor the frequency response as described in the text.

IC2 is a dual gain control IC, NE 571, which may be set-up to implement a number of signal processing functions. Each half of the IC consists of a full wave rectifier acting on the control input, a variable gain cell (signal input), an operational amplifier and bias system. The blocks may be set-up as, for example, a compressor, an expander, a limiter or an envelope follower. The compression/expansion ratio is internally set at 2:1 while the attack and release times are determined by an external timing capacitor and an internal resistor, the attack-to-decay time ratio is internally set at 1:5.

It is possible to vary both the compression ratio and the attack/decay ratio by the use of complex external circuitry, however the internally set values are adequate for the purpose of this gadget.

IC2/1 is configured as a compressor. The control signal is rectified and fed to an internal summing node. The rectified current is averaged by the external capacitor C7, and the average rectified current controls the gain of the variable gain cell ΔG . The gain cell is connected as an expander in the feedback loop of the op-amp; a 3dB increase in the gain of the ΔG cell, producing a 6dB increase in feedback current to the summing node at the op-amp input, if the input rises 6dB, the output can rise only 3dB.

The speed with which the gain changes to follow the input signal is determined by the rectifier filter capacitor C7. A small value will follow rapidly but will not fully filter low frequency signals on the control input. Any ripple on the gain control signal will modulate the signal passing through the ΔG cell, producing third harmonic distortion, so there is a trade-off between fast attack/decay times and distortion. C7 should not be reduced below about 470n.

The ΔG cell has a built-in compensation scheme for temperature variations and for cancelling odd harmonic distortion. A THD trim terminal is provided, but not used here, for cancelling even harmonic distortion caused by internal offset voltages. The operational amplifier is also internally compensated.

The non-inverting input is tied to an internal reference voltage and the summing node at the inverting input is tied internally to the ΔG cell output as well, the invert input is brought out of the package directly

and via an internal resistor. This allows the gain of the stage to be controlled by internal components only or, as we have done, by an external network (R7, R8, C2). The output stage is capable of $\pm 20\text{mA}$ output current.

For maximum dynamic range, the control (rectifier) input current should not exceed 30uA (3V using only the internal resistor). Maximum ΔG cell input current is 140uA (2.8V with internal components only).

Q1 is a high gain amplifier which is always driven into hard clipping, as described in the text. R11, RV1, C12 and C13 form a tone control network which varies the fuzz-tone by rolling-off the top end. The clipping amplifier feeds the second half of IC2 which is connected as an envelope follower.

In the usual expander configuration the control and signal inputs are tied together, so that a 3dB rise or fall at the input produces a 3dB variation in the gain of ΔG , giving a 6dB rise or fall at the output.

The attack/decay times of the follower are set by C16; it is best not reduced below about 100n.

The switching system used a CA 4016 quad analog switch with Q2 and Q3 as drivers. With both control lines floating SWs A and C are closed, B and D open. When the fuzz control line is grounded Q3 cuts-off, opening C and closing D; similarly when the sustain line is grounded, A opens and B closes.

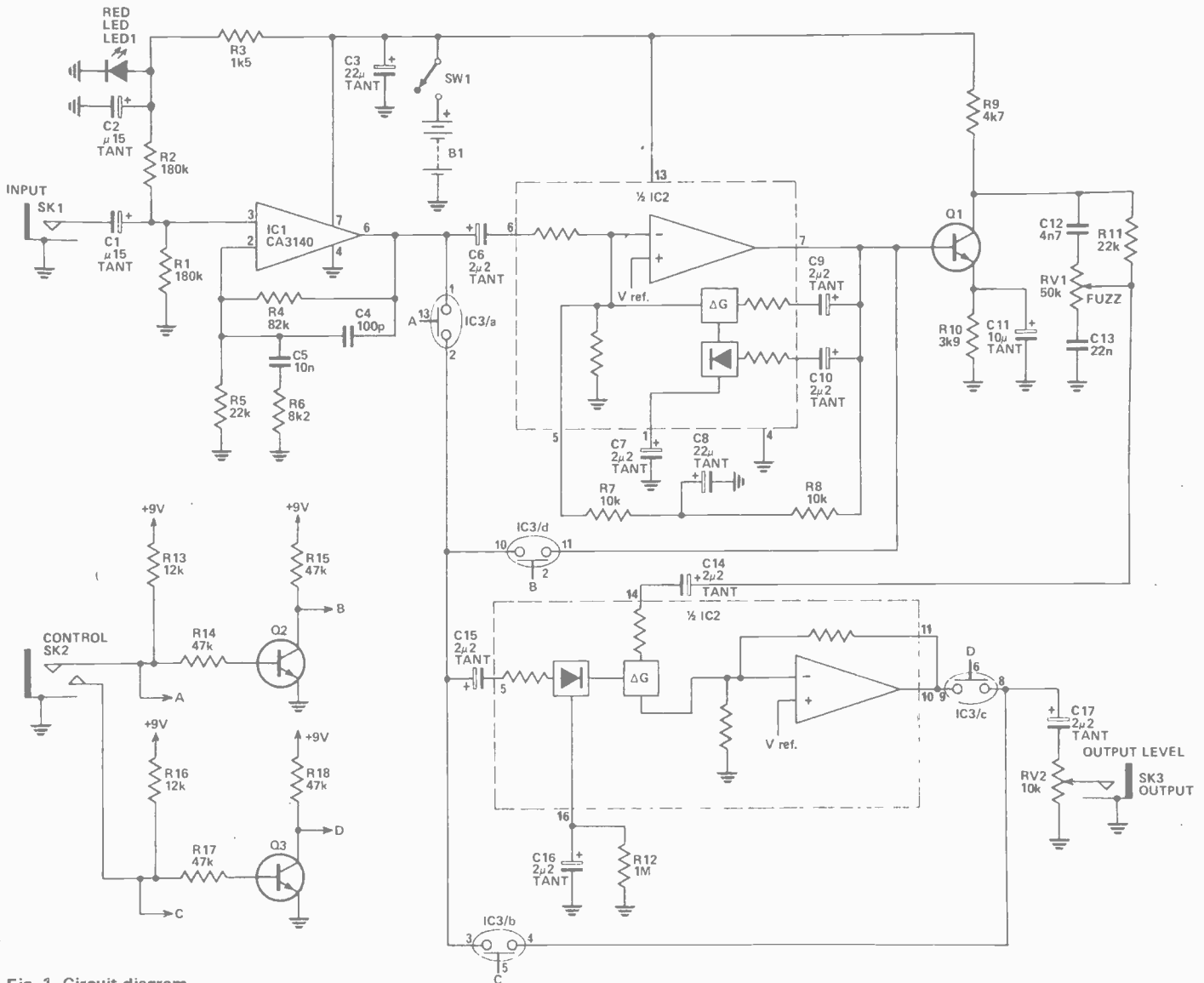

Fig. 1. Circuit diagram

PARTS LIST

Resistors	all ½W, 5%	C6, C7	2u2 tantalum
R1, R2	180k	C8	22u tantalum
R3	1k5	C9, C10	2u2 tantalum
R4	82k	C11	10u tantalum
R5	22k	C12	4n7 plastic film
R6	8k2	C13	22n plastic film
R7, R8	10k	C14 - C17	2u2 tantalum
R9	4k7		
R10	3k9	Semiconductors	
R11	22k	Q1 - Q3	2N3904
R12	1M	LED1	TIL 220R or similar
R13	12k	IC1	CA3140
R14, R15	47k	IC2	NE571
R16	12k	IC3	CD4016
R17, R18	47k		
RV1	50k lin. pot	Miscellaneous	
RV2	10k log. pot		
Capacitors			
C1, C2	15u tantalum		
C3	22u tantalum		
C4	100p disc ceramic		
C5	10n plastic film		

quitar sound, but will sustain for longer than usual. If sustain is not selected, the envelope follower control input is from the pre-amp, therefore the output of IC2/2 is the original signal expanded. Because of the value chosen for C7 and C16, the Fuzz Unit will produce a rather long 'delayed attack' effect when in this mode. If a shorter attack is wanted, C7 and C16 should be reduced; this will give a faster attack in "fuzz without sustain", and enhanced attack in 'fuzz with sustain'.

Construction

The major problem in constructing this project is the non-availability of certain components. We were unable to find a reliable supply of audio-quality foot-switches, and for this reason opted for external switching using a pair of door-

Note: Capacitors C7 and C16 may be varied from the 2u2 value recommended. For a faster 'attack', reduce to a value of 0u47 (470n); for a slower attack, increase the value to 4u7.

bell switches. These are definitely not your usual stage gear, but they are fairly rugged and work very well indeed. Also, they are cheap!

For a touch more class use a commercial dual footswitch. With a bit of juggling you may be able to mount the project in these boxes. We used a diecast aluminum box. If you are lucky enough to find a pair of audio footswitches and wish to mount them in the top you will need a deeper box.

The usual method of switching the battery in effects boxes is to use a 6.5 mm socket with a separate pair of switching contacts — power is applied whenever a guitar is plugged in. We were unable to locate any of these sockets, so we have used an on/off switch.

Once the box has been drilled, the pc board should be assembled according to the circuit and layout diagram. Be sure that polarised components are correctly installed. The ICs should be put in last, as they are electrically fragile.

All solder joints should be clean and neat, with no stray connections across tracks on the pc board. Finally, interconnect the various major components as shown in the wiring diagram, using the shortest possible lengths of wire; use care when soldering the LED, as they are very heat sensitive and easily cooked.

Use insulated wire, and make sure that nothing is shorting to the box; the battery is best restrained by using a piece of double-sided tape.

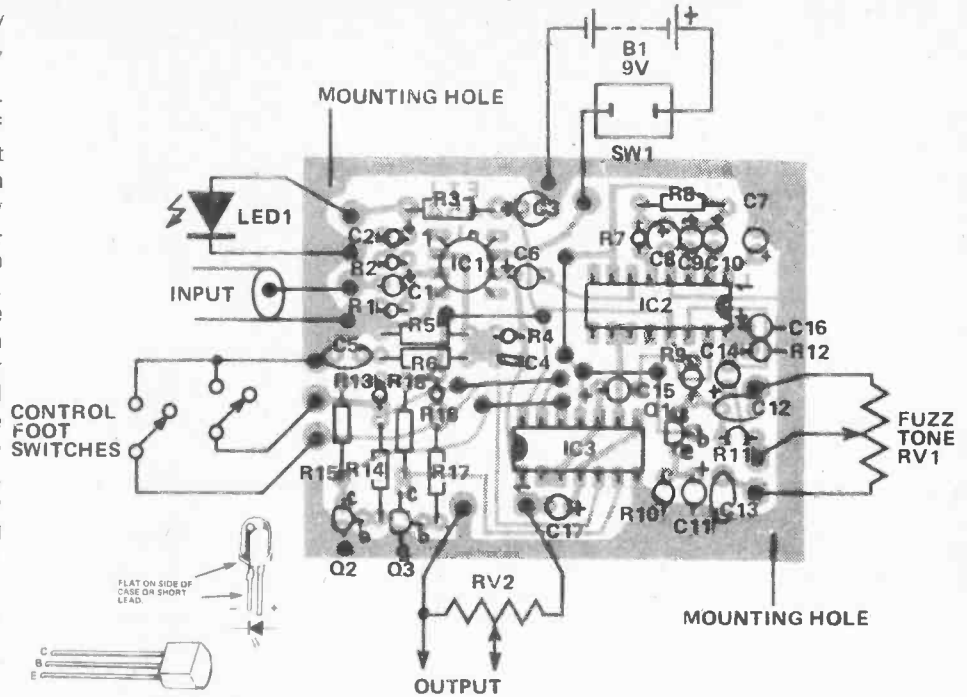

After carefully checking that all connections are as they should be, apply power and you've got 'The Fuzz'.

Best results are obtained with the guitar output as high as it will go without causing distortion on loud notes when The Fuzz is switched to sustain only.

PROBLEMS? NEED PCBs? Before you write to us, please refer to 'Component Notations' and 'PCB Suppliers' in the Table Of Contents. If you still have problems, please address your letters to 'ETI Query', care of this magazine. A stamped, self addressed envelope will ensure fastest reply. Sorry, we cannot answer queries by telephone.

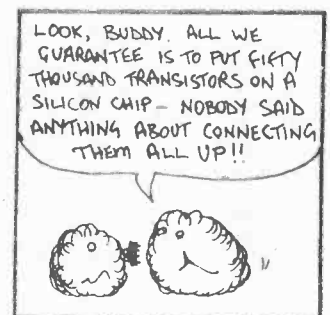
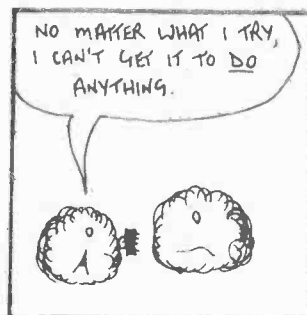
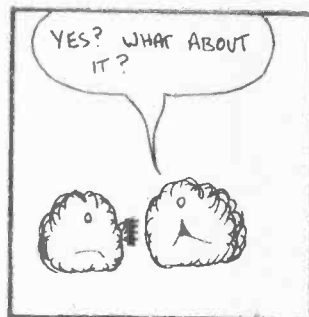
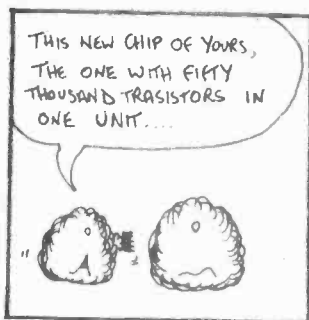
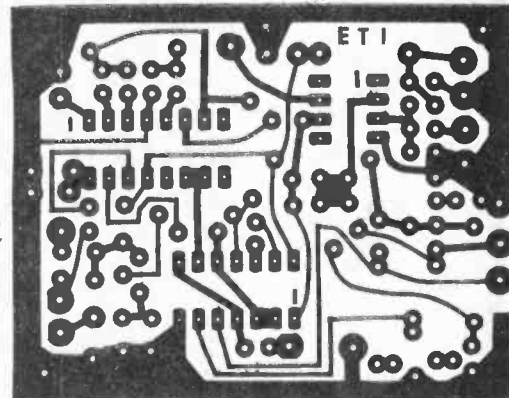

Designer Circuits

NOISE GATE

Noise gates are primarily used in communications equipment, but they could, no doubt, be used in public address equipment and other applications where there is the problem of a high background noise level. The purpose of a noise gate is simply to reduce the gain of the equipment when there is only a low signal level. Thus, during brief pauses that occur during normal speech the background noise is attenuated, but while the speech signal is present the gain of the equipment is returned to its normal level. The true signal to noise ratio is not actually improved at all, but the monotony of the continuous high noise level is removed, making the signal easier to listen to and aiding intelligibility.

Q1 is an N channel JFET which is used here as a voltage controlled resistance. Under quiescent conditions Q1 gate is biased to the negative supply rail by R3, and this switches the device hard on so that it exhibits a low resistance of only about 100 ohms. The input signal is applied to an attenuator which has R1 as the series element, and R2 plus the drain to source resistance of Q1 as its shunt element.

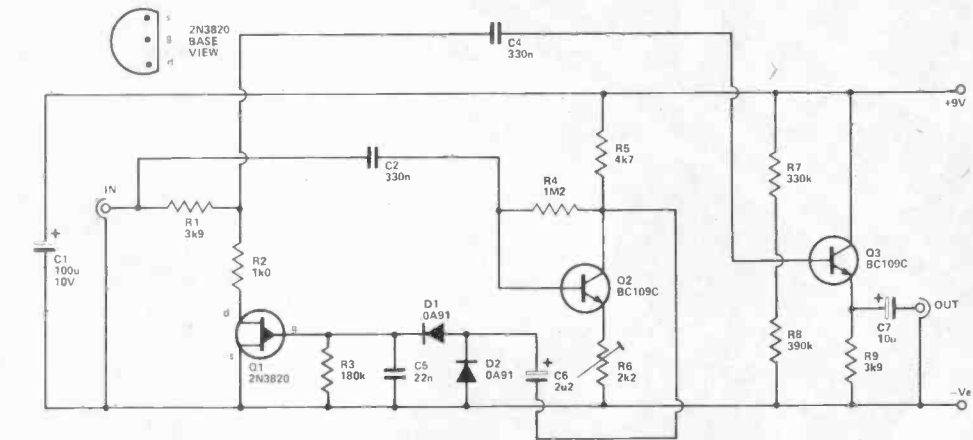

With Q1 switched on there is a loss of about 11dB through the attenuator.

Some of the input signal is amplified by a common emitter amplifier based on Q2, and then fed to a rectifying and smoothing circuit which is comprised of D1, D2, and C5. If the input signal is of sufficient strength this produces a strong enough positive bias to switch off Q1, causing its drain to

source resistance to increase to many megohms. There is then very little attenuation of the signal. Thus, low signal levels (noise only) are reduced while high signal levels (noise and wanted signal) are allowed to pass virtually unaffected. The attenuator must feed into a fairly high impedance or the action of the circuit will be impeded. An emitter follower buffer

stage based on Q3 is therefore interposed between the attenuator and the output. The time constant of the circuit has been made quite short so that there is a quick response to changes in signal level.

The circuit will operate with an input level of between about 50 mV and 2 V. RMS. R6 is adjusted for virtually the lowest resistance that does not cause the background noise to activate the unit.

POWER SUPPLY WITH IC REGULATOR

A regulated power supply used to require a fairly complex circuit but the introduction of special ICs has made matters much simpler.

The chart shows the various voltage requirements for four types of voltage regulator. The last two numbers of this range of IC indicate the voltage so the 7812 will give 12V. Care has been taken that the voltage ratings of the regulator are not exceeded as this can blow up the IC.

The secondary voltage from the transformer (it must be an isolating transformer but most are) is full-wave rectified by the diodes and then smoothed by capacitor C1. The voltage here is unregulated and has AC ripple superimposed upon it. The IC removes this and gives an almost ripple free, stable DC voltage. C2 and C3 must be sited close to the regulator to prevent any loss of performance due to high frequency instability. Note that the capacitor and common lead from the IC should be wired to the same point, this helps to reduce instability and current hum problems that can occur due to poor layout.

The 78XX series of regulators which come in a TO220 package generally can supply 500 mA of

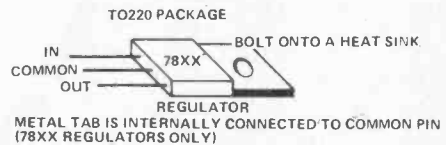
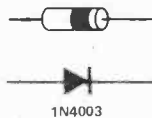
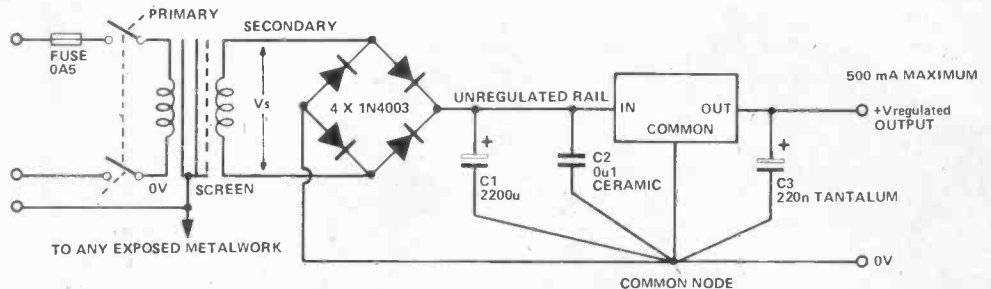

REQUIRED OUTPUT VOLTAGE	REGULATOR 78XX	TRANSFORMER SECONDARY V _s	CAPACITOR VOLTAGE C1	TYPICAL MAXIMUM INPUT VOLTAGE TO REGULATOR
5V	7805	8 TO 9 V RMS	16 TO 25 V	25V
12V	7812	12 TO 15 V RMS	25 TO 35 V	30V
15V	7815	15 TO 16 V RMS	35 TO 63 V	30V
24V	7824	20 V RMS	35 TO 63 V	38V

current. Therefore the maximum power dissipated in them is probably going to be 500 mA times the voltage difference between the input and output terminals. This

might mean that the regulator has to dissipate 5 W of heat. Therefore an adequate heatsink must be used. The 78XX series is current limited which means that if the

maximum current is exceeded, the output voltage drops towards 0V. The regulator is thus short-circuit protected as long as proper heat sinking is provided.

ETI SPECIALS



Electronic Circuit Design
92 pages
 A collection of major articles on various aspects of circuit design including CMOS, Audio Amplifiers, Power Supplies, SCR's, Op-Amps, Using the 3080 and Temperature Control. A large number of useful circuits are given but the emphasis is on guidance and how to tackle the design for yourself.

\$3.95



Hobby Projects
100 pages
 First published Summer 1980. Contains 25 straight-forward projects most of which have never appeared in the magazine including: Stereo Amp, Audio Mixer, Scratch and Rumble Filter, Constant Volume Amp, Graphic Equaliser, Envelope Generator, White Noise Unit, Linear Scale Ohmmeter, Intercom, Drill Speed Controller, LED Tacho, Parking Meter, Timer, Electronic Organ, Touch Switch, Electronic Dice, Siren, Simple Receivers.

\$3.95



Canadian Projects Book No. 1
100 pages
 25 of our most popular projects from our earlier issues including: Audio Limiter, 5W Stereo, Bass Enhancer, Modular Disco, Touch Organ, Electronic Mastermind, Double Dice, Reaction Tester, Sound Operated Flash, Burglar Alarm, Injector-Tracer, Digital Voltmeter.

\$3.00

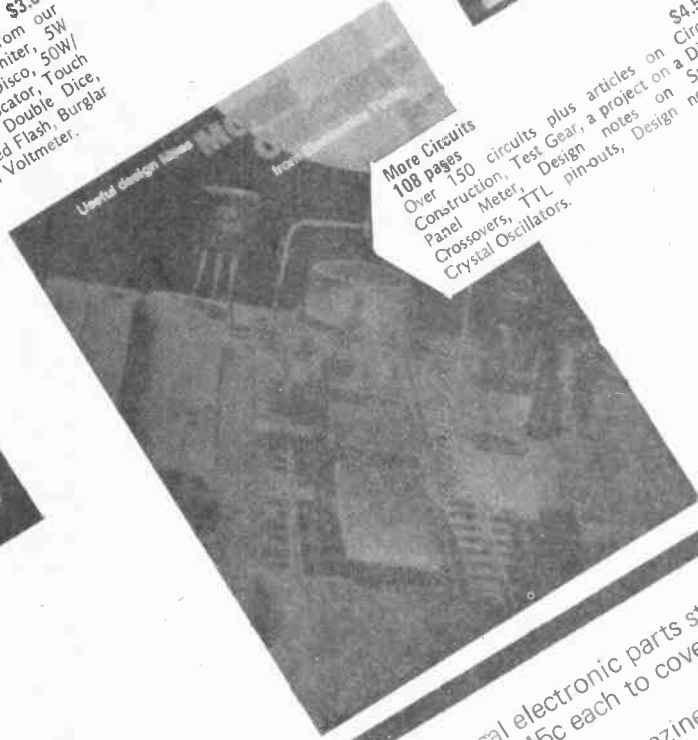

More Circuits
108 pages
 Over 150 circuits plus articles on Circuit Construction, Test Gear, a project on a Digital Panel Meter, Design notes on a Speaker Crossovers, TTL pin-outs, Design notes on Crystal Oscillators.

\$4.50

Available from your local electronic parts store or direct from ETI (please add 45c each to cover postage).
 Send money to:
 Electronics Today Magazine,
 Unit 6, 25 Overlea Blvd.,
 Toronto, Ont.,
 M4H 1B1

COMPUTING SUPPLEMENT

TELETEK

Computation and
Instrumentation
(Canada) Inc.
Introduces the New

μ P Modem

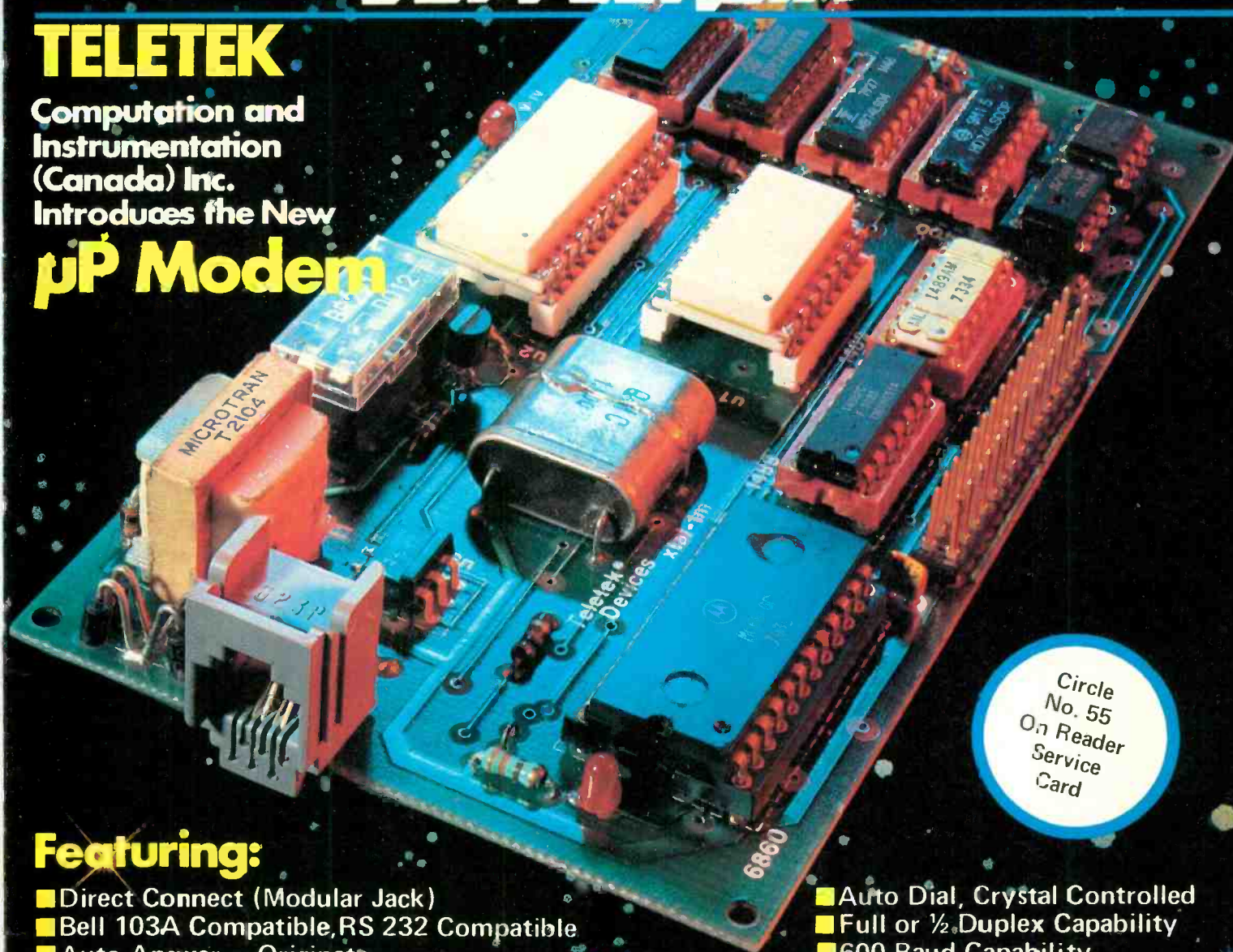

Circle
No. 55
On Reader
Service
Card

Featuring:

- Direct Connect (Modular Jack)
- Bell 103A Compatible, RS 232 Compatible
- Auto Answer - Originate
- Built In Ring Detect
- Complete M.S.I. Construction
- Auto Dial, Crystal Controlled
- Full or 1/2 Duplex Capability
- 600 Baud Capability
- All Handshaking Provided Through Scotchflex Connector

Distributed By INTERPLANETARY SYSTEMS & DESIGN

950 Dennison St., Unit 17, Markham, Ontario, L3R 3K5 Tel: (416) 495-2424. Dealer Inquiries Welcome.

- ZX80 Computer Reviewed
- Selecting a Business System
- Computers - an overview

- Choosing a Floppy Disk System
- Selecting a Printer
- A Modern Modem

ARKON electronics Ltd

INSTANT SOFTWARE

PET

0005P	PERSONAL WEIGHT CONTROL/BIORHYTHMS	\$9.95
0006P	MORTGAGE WITH PREPAYMENT OPTION	9.95
0014P	CASINO 1	9.95
0015P	CASINO 2	9.95
0022P	CHECKERS AND BACCARAT	9.95
0026P	DOW JONES	9.95
0029P	TANGLE SUPER TRAP	9.95
0032P	TREK-X	9.95
0035P	PET DEMO 1	9.95
0038P	QUBIC-4/GOMOKU	9.95
0039P	MIMIC	9.95
0044P	PENNY ARCADE	9.95
0045P	ARCADE 2	9.95
0048P	ACCOUNTING ASSISTANT	9.95
0054P	HAM PACKAGE 1	9.95
0062P	BASEBALL MANAGER	18.95
0064P	DUNGEON OF DEATH	9.95
0074P	ARCADE 1	9.95
0083P	DIGITAL CLOCK	9.95
0085P	ELECTRONIC ENGINEER'S ASSISTANT	12.95
0091P	HOOPTEODOOLE	12.95
0097P	TURF AND TARGET	9.95
0104P	DECORATOR'S ASSISTANT	9.95
0105P	UTILITY 1	12.95
0175P	SANTA PARAVIA	12.95
0110P	CHIMERA	12.95
0112P	CODE NAME: CIPHER	9.95

TRS-80 LEVEL 2

0001R	BASIC AND INT. LUNAR LANDER	9.95
0002R	SPACE TREK 2 (L 1 & 2)	9.95
0003R	KNIGHT QUEST/RBT CHS/HORSE RACE (L 1)	9.95
0004R	BEG. BACKGAMMON AND KENO (L 1 & 2)	9.95
0007R	HAM PACKAGE 1 (L 1 & 2)	9.95
0008R	ELECTRONICS 1 (L 1 & 2)	9.95
0009R	GOLF CROSS-OUT (L 1 & 2)	9.95
0010R	CAVE EXP/YACHT MEM (L 1 & 2)	9.95
0011R	CAR RACE/RAT TRAP/AIRCRAFT (L 1)	9.95
0012R	STATUS OF HOMES/AUTO EXP. (L 1)	9.95
0013R	BUSINESS PAK 1 (L 1)	36.95
0017R	AIR FLIGHT SIMULATION	9.95
0019R	BUSINESS PAK 4	9.95
0020R	DEMO 1 (L 1)	9.95
0021R	DESTROY SUBS/BOMBER/GUNBOAT (L 1)	9.95
0023R	OIL TYCOON (L 1 & 2)	9.95
0024R	MODEL ROCKET ANALYZER	9.95
0027R	PERSONAL FINANCE (L 1)	9.95
0028R	RAMROM PATROL/TIE FIGHTER/KLINGON CAP.	9.95
0030R	DOODLES AND DISPLAYS (L 1)	9.95
0031R	SPACE TREK 3 (L 1)	9.95
0033R	BOWLING (L 1 & 2)	9.95
0034R	SPACE TREK 4	9.95
0037R	FUN PK 1 (L 1)	9.95
0041R	HEX PAWN/SHUTTLE CRAFT/++ (L 1)	9.95
0042R	DOODLES AND DISPLAYS 2	9.95
0043R	SANTA PARAVIA (L 1 & 2)	9.95
0046R	OTHELLO	12.95
0047R	WHO DONE IT	9.95
0049R	DEMO 2	9.95

0050R	GRADE BOOK	12.95
0051R	BALL TURRET GUNNER	12.95
0055R	DEMO 3	9.95
0056R	BOWLING LEAGUE STATS SYSTEM	32.95
0057R	CHESSMATE 80 (L 1 & 2)	25.95
0058R	PROGRAMMER'S CONVERTER	12.95
0061R	BUSINESS PKG. 3 (L 1)	9.95
0063R	CARDS	9.95
0065R	TEACHER	12.95
0066R	MIMIC	9.95
0068R	YOUR CRIBBAGE AND CHECKERS PARTNER	12.95
0069R	HOUSEHOLD ACCOUNTANT	9.95
0070R	SKIRMISH 80	12.95
0072R	FINANCIAL ASSISTANT	9.95
0076R	UTILITY 2	9.95
0077R	ENHANCED BASIC	32.95
0081R	UTILITY 1	12.95
0082R	DAREDEVIL	12.95
0084R	MUSIC MASTER	9.95
0089R	ENERGY AUDIT	64.95
0092R	ARCHIMEDES' APPRENTICE	12.95
0100R	VIDEO SPEED READING TRAINER	12.95
0102R	CLIMATE-COMP	25.95
0103R	PERSONAL BILL PAYING	9.95
0106R	AIR MAIL PILOT	12.95
0109R	BODY BUDDY	12.95
0111R	WORD WATCH	9.95
0117R	NIGHT FLIGHT	12.95
0118R	MIND WARP	12.95
0124R	WINNER'S DELIGHT	12.95
0125R	INVESTOR'S PARADISE	12.95
0126R	THE COMMUNICATOR	12.95
0127R	SURVEYOR'S APPRENTICE	12.95
0130R	TERMINAL-80	32.95
0131R	SALES ANALYSIS	32.95
0132R	ENERGY CONSUMPTION	12.95
0135R	EXECUTIVE EXPENSE REPORT GENERATOR	12.95
0136R	BEGINNER'S RUSSIAN	12.95
0137R	EVERY DAY RUSSIAN	12.95
0140R	ORACLE-80	97.95
0141R	BATTLEGROUND	12.95
0156R	MONEY MADNESS	12.95
0157R	IQ TEST	12.95
0159R	JET FIGHT PILOT	19.95
0171R	FLIGHT PATH	12.95
0203R	BASIC PROGRAMMING ASSISTANT	19.95
0223R	COSMIC PATROL	19.95
0230R	TLDIS	19.95
0232R	THE DISASSEMBLER	12.95
0250R	IRV	32.95
5002R	BASIC MATH, BY EMSI	103.95

TRS-80 DISK

0052D	ENERGY AUDIT DISK	97.95
0075RD	ACC. REC./ACC. PAY.	259.95
0095RD	BOWLING LEAGUE SECRETARY	64.95
0123RD	THE ONE-D MAILING LIST	32.95
0129R	WORD SLINGER	38.95
0139RD	DISK-SCOPE	25.95
0147RD	CHEQUE MANAGEMENT SYSTEM	51.95
0152RD	ORACLE-80	129.95
0180RD	DISK EDITOR	51.95
0212RD	THE RUSSIAN DISK	32.95
0231RD	TLDIS	25.95
5000RD	MAIL/LIST (MODEL 1)	129.95
5001RD	MAIL/LIST (MODEL 2)	259.95

PERSONAL SOFTWARE

VISICALC	189.50
CCA DATA MANAGEMENT SYSTEM	125.50
DESK TOP PLANNER	125.50

CALIFORNIA PACIFIC COMPUTER CO.

CP-1	BILL BUDGE'S TRILOGY OF GAMES: NIGHT DRIVER, PINBALL, SPACEWAR	39.95
CP-2	BILL BUDGE'S SPACE ALBUM: DEATH STAR, SOLAR SHOOT, TAIL GUNNER, ASTEROID	52.95
CP-3	HEAD ON	32.95
CP-4	BILL BUDGE'S 3-D GRAPHICS SYSTEM	52.95
CP-5	AKALABETH — BEYOND ADVENTURE	45.95

N.B. These Disk Programs run on all Apple Computers.

SIRIUS SOFTWARE

SIR-1	BOTH BARRELS	32.95
SIR-2	STAR CRUISER	32.95
SIR-3	E-Z DRAW (WITH VIDEO MARQUEE)	45.95

N.B. These Disk Programs run on all Apple Computers.

STRATEGIC SIMULATIONS INC.

SS-1	COMPUTER AMBUSH	89.95
SS-2	COMPUTER BISMARCK	89.95
SS-3	COMPUTER NAPOLEONICS — WATERLOO	89.95
SS-4	COMPUTER QUARTERBACK	52.95

N.B. These Disk Programs run on all Apple Computers.

MICROSOFT SOFTWARE

TRS-80

M1101	LEVEL III BASIC	66.95
M1102	TYPING TUTOR	19.95
M1104	EDITOR/ASSEMBLER	39.95
M1203	ADVENTURER	39.95
M1205	FORTRAN	134.95
M1206	ASSEMBLY LANGUAGE	134.95
M1207	BASIC COMPILER	260.00
M1208	MUMATH	99.95

TRENDCOM

PRODUCT

Trendcom 100 Printer (includes manual and one roll of paper)	\$525.00
Trendcom 200 Printer (includes manual and one roll of paper)	795.00
T-80A Interface (requires Radio Shack Expansion Interface)	65.00
T-80B Interface (connects directly to TRS-80*)	109.00
A-I Interface for Apple II*	109.00
A-IIG Interface (with expanded ROM for simplified graphics printing)	145.00
P-2 Interface for Commodore PET*	109.00
SR-1 Interface for Exidy Sorcerer*	65.00
8305 Trendcom 100 Black Thermal Paper, 6 roll carton	60.00
8306 Trendcom 200 Black Thermal Paper, 10 roll carton	60.00

SPECIAL

MEMORY CHIPS

4116-300NS	8 FOR	\$47.00
4116-200NS	8 FOR	55.00

CP-10-1

An S-100 system card, wired and tested that will outperform the mass market systems in versatility, price and speed. It has all the CPU (8080) disc control (1771) and IO (8255) needed for a disc based CPM system. Interfaces, to all common 8" and 5 1/4" drives. (Shugart, Memorex, BASF, Siemens, Wang). Also features EIA RS-232 port (110 to 9600 baud), fully vectored interrupts (TMS5501), on board digital data separator, 2 K bytes EPROM, 24 fully handshaked IO lines, dual mapped IO, cassette interface on board, fully buffered. \$495.00

NEW!

EPSON MX-80. 80 column dot matrix printer. Interfaces available upon request...\$995.00

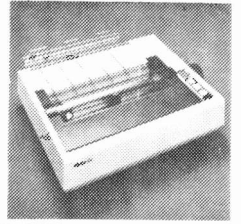

MULLEN EXTENDER BOARD TB-4

The best extender board made, complete with a digital probe for in circuit checkout and tracing for S-100 bus...\$69.00

SUPERBOARD 11

Complete computer on a board 4K RAM expandable to 8K, 8K Basic in ROM, video display I/Face & integral keyboard, expandable to dual mini-floppies — requires 5V power supply, needs case and video monitor...\$415.00

SUPER S-100 XFORMER

8V at 18A for +5V supply
28Vct at 4.5A for ±5V supply
22V at 4.5A for disc drives...\$49.95

ASCII KEYBOARD KIT

60 key complete ASCII character set. Highest commercial quality key switches. Uses a KR 2376 ST encoder IC. Output compatible with TTL. Caps lock for upper case alpha characters. Repeat key. Parity and/or data invertable. Positive and negative keypressed and strobe signals. Requires +5V to +30V at 100mA.
Complete kit all parts...\$99.95
Power supply kit (+5V)...7.95

RE6416 VIDEO TERMINAL

The RE6416 video terminal card with excellent technological refinements! It's completely crystal controlled and displays 5x7 dot matrix characters in a format of 16 lines with 64 characters per line. Easily interfaces to most computers via serial data lines at speeds ranging from 110 to 9600 baud employing either RS232, 20mA current loop or TTL level interfaces. Also accepts parallel keyboard input with positive or negative-going key-pressed strobe. Composite video output is standard TV peak to peak. Horizontal and vertical sync pulses also available separately. Requires +5V at 1A, ±12V at 1A (for 20mA loop or RS232).
Kit of all parts...\$169.95
Board and manual...69.95
Lower case option...16.95
5V power supply option...16.95

S-100 MOTHER BOARD

Exclusively ARKON'S... the A6S100 6 slot mother board, designed for the system builder using modern boards where few slots are required. Provision for semi-active termination.
A6S100...\$24.95
S-100 edge connector...\$5. ea./6 for \$25.

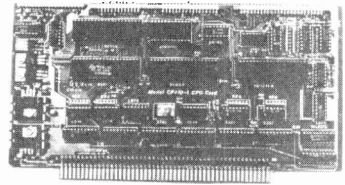

Software available through mail order only.

Send certified cheque, money order, Charge, Master Charge ... Include expiry date, card number and signature. We process C.O.D.'s for Canpar or Post Office. Minimum order \$10.00. Add 5% (minimum \$2.00) for shipping and handling. Any excess refunded. Ontario residents add 7% sales tax. All prices subject to change.

ARKON electronics Ltd

409 Queen Street West, Toronto, Ontario, M5V 2A5. 868-1315

NEWS

Low Cost Business System

The Land Of The Rising Sun (and Fallen Daughter?!) is starting to make great inroads in to the small computer field. One market that is under attack is small businesses.

One example is the YX-3200 business computer from Sharp Electronics of Canada, a new expandable small business computer, featuring a unique step-by-step programming aid, to be test-marketed this Fall and available across Canada next Spring. The complete system includes CPU, high resolution CRT display with easy-to-read green characters, dual-drive floppy disk and an impact printer.

The YX-3200, priced from \$8000.00 (or less), is aimed at the small businessperson who is looking for ways to make his operations more efficient through advanced technology. The desk-top system is designed with an expandable 32K ROM 64K RAM and features an automatic program generator which poses questions to the user that, when answered by a simple yes or no in most cases, actually designs the desired program. Once entered into the unit's memory, the program can be stored indefinitely or used at the operator's convenience. The YX-3200

Apple Talk

FORTRAN and COBOL, two of the most widely used data processing languages ever, are now being offered for the Apple II computer by Microsoft Consumer Products.

Both languages, which run under the CP/M operating system, are designed to be used with Microsoft's SoftCard peripheral for the Apple II which was introduced earlier this year.

Microsoft's FORTRAN-80 is an extremely fast and compact compiler. It can compile several hundred statements per minute in a single pass and needs less than 25K bytes of memory to compile most programs.

The FORTRAN compiler creates true Z-80 machine code which allows programs to execute typically 2-3 times faster than programs compiled using Apple FORTRAN. FORTRAN-80 also supports double precision, integer X 4 and integer X 1 data types. It is supplied with an extensive library of floating point, math and I/O routines.

Microsoft's COBOL-80 is the first implementation of the powerful COBOL language to be made available to Apple owners.

COBOL-80 is ANSI standard 1974 with many enhancements including four kinds of data files—sequential, line sequential, relative and indexed sequential—designed to optimize simplicity and speed in data retrieval. Extremely sophisticated screen definition facilities permit full-screen I/O and editing with a single command. Program chaining with parameter passing allows total system control from within COBOL applications.

COBOL-80 requires an Apple II with softCard, 48K an two disk drives. Suggested retail price is \$750.00. FORTRAN-80 runs on an Apple II with SoftCard, 48K and one disk drive. Suggested retail price is \$195.00.

FORTRAN-80 and COBOL-80 for the Apple II are available from Microsoft Consumer Products retail dealers. For the name of the nearest dealer, consumers can contact Microsoft Consumer Products, 400 108th Ave. NE, Suite 200, Bellevue, WA 98004. Telephone 206-454-1315.

Circle No. 33 on Reader Service Card.

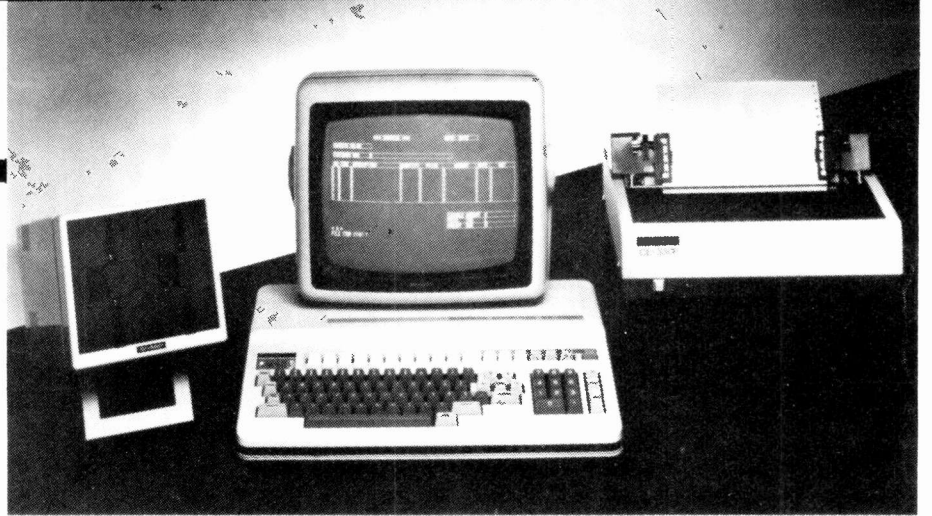

features an easy-to-understand extended BASIC language.

Easily expandable, the YX-3200 can accommodate up to 72K ROM and 138 RAM. The 5¼" floppy disk drives (dual-sided, double density) can store up to 284 bytes per diskette. The YX-3200 can accommodate a maximum of eight disk drives.

The high-resolution 12-in. CRT display offers upper and lower case green characters on an 80 column/24 line screen for a total of

1,920 characters. Another feature of the east-to-read display is its capability to increase character size for group viewing or dramatic graphic purposes. When this feature is utilized, the CRT can contain up to 40 characters per column on a 15-line display for a total of 600 characters.

Interested persons should contact Sharp Electronics of Canada Ltd., 116 Galaxy Blvd., Rexdale, Ontario, M9W 4Y6.

Circle No. 31 on Reader Service Card.

A Better Scratchpad

VisiCalc plus, software that combines the award-winning VisiCalc program with new enhancements, has been introduced for Hewlett-Packard's HP-85 personal computer.

With VisiCalc data easily can be arranged and manipulated in tables. The program has proved to be a boon to users doing forecasting, budgeting and other business and technical applications.

The PLUS in VisiCalc PLUS stands for enhancements that are not available with VisiCalc on other microcomputers. The most important of the HP-85's extra powers are the graphics programs that let users turn VisiCalc tables into four-color graphics.

While VisiCalc assembles data into useful tables, VisiCalc PLUS turns those tables into four-color, even more illuminating graphics. Line charts, bar charts, pie charts, and curve-fitting graphs are available along with versatile graphics features, such as six different styles of lines and hatchings.

VisiCalc PLUS also features more than 20 functions not available on other VisiCalcs. These financial, statistical and math functions

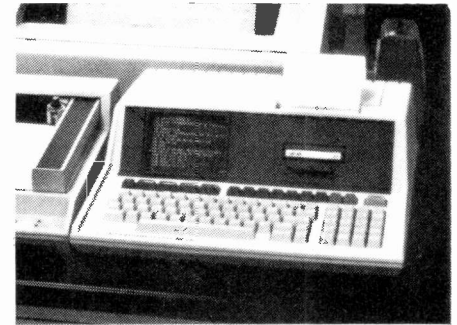

include internal rate of return, standard deviation and variance. A "HELP" facility, which displays information about a key work typed by the user, also is part of VisiCalc PLUS.

VisiCalc PLUS will be sold in tape cartridge and disc form for \$310.30 by computer stores and office equipment dealers who sell the HP-85. (A 16-kilobyte memory module must be plugged into the HP-85 to run VisiCalc PLUS. To run the graphics programs, an external plotter (HP 7225A or 9872A) and other enhancements are needed.)

If you wish to know more about VisiCalc, write to Inquiries Manager, Hewlett Packard (Canada) Ltd. 6877 Goreway Drive, Mississauga, Ontario, L4V 1M8.

Circle No. 30 on Reader Service Card.

Super TRS-80 Graphics

Programma's hi-resolution graphics board for the TRS-80 Computer, called 80-GRAPHIX, is now available in Canada from Arkon Electronics Ltd. The P.C. board lays on top of the computer's mother-board and connects with four DIP jumpers (note that this voids the Radio Shack warranty). Features include inverse video, lower case characters and effective screen resolution greater than other computers' highest resolution.

Also supplied is a character generator program for up to sixty-four programmable characters as well as other demonstration programs. Programma's 80 GRAPHIX board is available exclusively in Canada from Arkon Electronics Ltd., 409 Queen St. W., Toronto, Ontario, M5V 2A5, (416 868-1315. The price in Canada is \$225.00.

Circle No. 32 on Reader Service Card.

Expose Yourself

News Digest is a regular feature of ETI Magazine. Manufacturers, dealers and clubs are invited to submit news releases to News Digest, c/o ETI Magazine. Sorry, submissions cannot be returned.

What can you honestly expect from an interactive data terminal that costs only \$369?*



Well, to begin with, color graphics.

RCA's VP-3301 has unique color-locking circuitry that gives you sharp, jitter-free color graphics and rainbow-free characters.

Plus much more: Microprocessor control. Resident and programmable character set. Reverse video. State-of-the-art γ -SI video control. 20 and 40 character formats. RS232C and 20 mA current loop. Six baud rates. Eight data formats. ASCII encoding. Light-touch flexible-membrane key switches for reliability and long life. CMOS circuitry and a spill-proof, dust-proof keyboard for hostile environments.

The VP-3301 can be used with a 525-line color or monochrome monitor or a standard TV set through an RF modulator. It serves a wide variety of industrial, educational, business and individual applications including communication with time sharing and data base networks such as those provided by Dow Jones News/Retrieval Service, CompuServe and Source.

All this—for the low price of \$369. And it's made by RCA. So get the whole story about the surprising VP-3301 today. Write RCA Solid State, 1 Vulcan Street, Rexdale, Ontario M9W1L3, or phone (416) 247-5491.

RCA

Circle No. 26 on Reader Service Card.

COMMODORE COMPUTERS

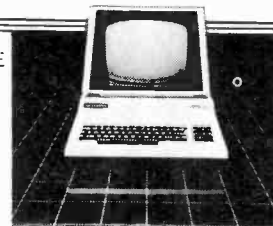

Full keyboard, separate numeric keypad, 25 lines of 40 characters. (8032 has 80 characters by 25 lines).

2001-8k	\$1195.00
2001-16k	\$1495.00
2001-32k	\$1795.00
8032	\$2495.00
Cassette Deck	99.00

Memorex 5 $\frac{1}{4}$ " Diskettes . 10 for \$49.95
Memorex C10 Cassettes . . . \$1.00 ea.

BOOKS

PET Personal Computer Guide .	\$19.95
Library of PET Subroutines . . .	\$24.95
The PET Revealed	\$24.95
Hands on BASIC with a PET . . .	\$17.50
PET and the IEEE	\$19.95

We carry a large selection of software for Commodore, Apple and TRS80 computers — write or call for a catalogue or come in and see us.

Send Money Order, Charge, Master-Charge. Include expiry date, card number bank name and signature. Add 5% for shipping (excess refunded). Ontario residents add 7% sales tax. All prices subject to change.

ELECTRONICS **FOOL**

5529 Yonge St. (just south of Finch)
Willowdale, Ontario M2N 5S3
(416) 223-8400

Circle No. 23 on Reader Service Card.

SOFTWARE FOR CHALLENGER AND SUPERBOARD SYSTEMS

Copy-mate

Foolproof copier of diskettes with only one drive \$13.50

Disk-vu

Direct disk-to-video display of data. Doesn't disturb memory. \$14.50

Tape-vu

As Disk-vu except for taped program. \$13.50D \$9.95T

Ont. and Fla. residents add sales tax. No credit cards or COD's please. Allow 4-6 weeks for delivery. Catalog available on request. Dealer inquiries welcome.

CHALLENGE SOFTWARE
1912 AVENUE ROAD
TORONTO, ONT. M5M 4A1

Circle No. 25 on Reader Service Card.

*Suggested user price. Monitor and modem not included.

A Business PET

A new sophisticated microcomputer system offering virtually unlimited access to any office file and high quality visual presentation of data has been launched by Commodore Business Machines Limited.

The system, made up of Commodore's 8000 series business computers and our 8050 Dual Drive Floppy Disk, is suited to a wide variety of applications for small and medium-sized businesses. Its Dual Drive Floppy Disk's increased capacity of almost one megabyte allows customers to have on-line reach to nearly all information in an office, as well as eliminating the need to change disks. It can copy all files from one diskette to another without reproducing unused space.

The 8000 series computers have a wide screen display with a capacity of up to 80 character lines of information, enabling the units to be used effectively as word processors. Entire pages can be displayed on the screen, so that customers can capture text exactly as it is printed.

The complete microsystem retails for between \$5,000 and \$10,000. Write to Commodore Business Machines Ltd., 3370

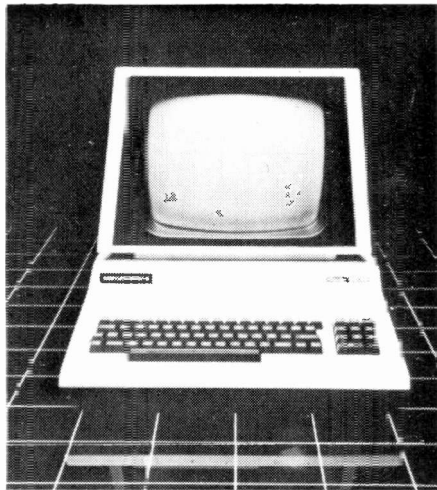

Pharmacy Avenue, Agincourt, Ontario, M1W 2K4.

Circle No. 34 on Reader Service Card.

An Attentive Terminal

The ADM3AH enables a user to accurately input data or commands to your computer or auxiliary peripherals without using a keyboard or maintaining visual contact with the display screen. The terminal is manufactured by Lear Siegler, Inc. of Anaheim, CA.

Once the terminal has been trained you can, by simply talking into the noise cancelling microphone, execute any functions that previously could only be done through the keyboard. The ADM3AH can be trained with words or phrases up to 3 seconds in length to a maximum vocabulary of 128 words or phrases. The ADM3AH is RS232C00 current loop compatible plus all the standard features of the ADM3A Dumb Terminal (for the customer that already has a ADM3A, an upgrade kit is available).

For more information contact Zentronics, 1355 Meyerside Dr., Mississauga, Ontario, L5T 1C9.

Circle No. 35 on Reader Service Card.



Light Modem

Light Bits an RS-232C compatible short-haul has been developed by Belden Corp.'s Fiber Optics Group as part of a stand-alone optoelectronic data transmission system.

The Model 222001 optical Bit-Driver modem provides asynchronous simplex and duplex data transmission at speeds to 56K bps. Depending upon the type of standard Belden fiber optic cable selected, transmission ranges up to 1800 m (more than a mile) can be achieved.

The Bit-Driver system, which includes RS-232C molded cable assemblies, is designed for inhouse and in-plant data communications between computers and peripheral units and for experimental use. The short-haul modems, used in pairs, replace conventional telephone company equipment, eliminating equipment leasing and line charges. Because optical cables do not emit electromagnetic interference, are not affected by it, and do not cause sparking, optical Bit-Driver systems are recommended for high-interference and explosive environments.

The rear panel of Model 222001 Bit-Driver incorporates an RS-232C interface using a 25-pin Type D connector. Also located on the rear panel are two AMP

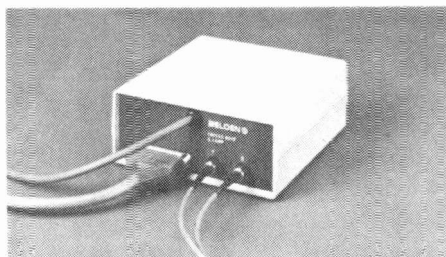

fiber optic transmission line receptacles. A three-unit LED array on the front panel indicates system status and aids diagnosis.

For additional information, write to White Radio Ltd, 4445 Harvester Rd., Burlington, L7L 4X1.

Circle No. 36 on Reader Service Card.

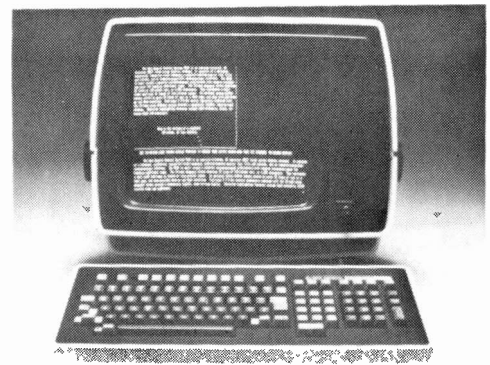

A Really Big Show

A new 132-column large screen display that provides 79 per cent more active screen area than standard 80 column displays has been announced by Data General (Canada) Limited.

The Model 5210 is designed for data processing and text editing applications. It can also be used for communications applications. The 15-inch diagonal screen displays 33 lines of 132-column text or 4,356 characters. This represents a full-width, half-page in length of line printer output. An optional screen buffer memory stores an extra 33 lines of text or a full page, and also provides both up and down scrolling. Full-size 5 X 8 dot matrix characters are used.

The 5210 has 96 upper and lower case ASCII characters plus 32 special graphics characters. Standard functions include horizontal and vertical forms ruling, and symbols for "paragraph" "trademark" and "copyright." International or custom-designed character sets and keyboards are available as options.

The display's communications interface has eight switch-selectable speeds, from 300 to 38,400 bits per second. Interface to a host computer is done either with an RS-232-C port that can be interfaced to a slave printer. When the host processor uses the display as an output channel, the screen data is not affected during the pass-through function. List price is \$6,080 CDN. Write to Data General (Canada) Ltd, 2155 Leanne Blvd., Mississauga, Ontario, Canada, L5K 2K8.

Circle No. 37 on Reader Service Card.

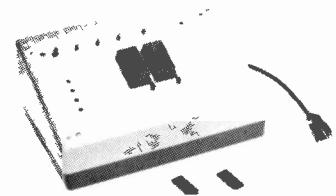

Duped EPROMS

Manufacturers of small run equipment will be interested in this EPROM duplicator. The RCE EPROM Programmer works with 2716 and 2758 devices and is designed to copy from a master into erased chip. The unit takes a maximum of 102 seconds to do its stuff and also has the capability to verify data and check for empty bits. In addition, a switch allows partial programming of 2716s.

The price \$399.00. Write to Roberts Control Equipment, 3640 Weston Rd., Unit 3, Weston, Ontario M9L 1W2. Telephone (416) 749-5062.

Circle No. 38 on Reader Service Card.

SO YOU WANT A COMPUTER, EH?

If you're budgeting for a system costing over \$25,000, this article will be of no interest. If you're going to try to computerise on a shoestring we may have some advice for you. . .

OFFERING ADVICE ON computers is a dangerous business; the choice is phenomenal. Nevertheless, we're going to try to give some basic advice which we hope will start pointing you in the right direction.

We'll have to make some basic assumptions about your knowledge: that you know the difference between software and hardware and that you've scanned advertisements for small business systems. We also assume that you have spent at least some time day-dreaming about shunting some of the office routine work onto a computer.

Background

IBM have a marvellous TV commercial. "Would you like a Rolls Royce for \$57? A super night out for two for a nickel? That's how much these things would cost if they'd fallen in price as much as the cost computers," it's all true. You see advertisements for home computers at about \$500 and you read articles about how these are being applied in the home and in business.

The falling price of the electronic components has brought about a mass market for computers which has in turn brought down the cost of the

mechanical components necessary to build a complete system.

The large growth area in computers is going to be at the small business end of the market, large companies are already massively computerised. Just a few years ago there were large systems (usually called main-frame computers) and there were a few companies producing computers for the home enthusiast. What has happened is that the big boys are moving down, the small boys are moving up, both to fill the gap: both groups recognise the potential for someone wanting a system but unable to afford (or justify) something costing six or seven figures.

One of the Altos Sun Series ACS8000 computers.



What can a small system do?

We've imposed on ourselves a \$25,000 maximum. What can a system costing less than this do for you? An awful lot but by no means everything.

Lets work our way upwards from the least expensive system and describe what they can do.

Up to \$3000

There are a number of systems costing less than this and which are genuine computers.

For this sum you'll get a computer with 16K of program memory, a cassette recorder to hold the software and an inexpensive dot matrix printer.

A system of this type can perform a few useful functions where it can be regarded as an extremely powerful programmable calculator. The author has used a PET with a printer for financial budgetting, for calculating and printing out complex tables and for other jobs.

Where a system like this can do a lot of work is in financial costings. There are tens of thousands of people in Canada who are employed to work out prices; the inputs will usually be material cost, labour time, overhead

Computer Glossary

We have made no attempt here to explain all terms. The explanations given here are for words, abbreviations and expressions taken from sales literature.

ASCII:	American Standard Code for Information Interchange. Common binary code to represent the letters of the alphabet, numbers and other characters.
BASIC	By far the most popular programming language used in small systems. The instructions to the computer are very easily learnt as they are essentially English words (e.g. PRINT, LET, END, IF, THEN, etc).
Baud:	Used to express the speed of transmission (e.g. 300 baud is 30 characters per second).
Bit:	A single binary digit (a one or a zero)
Bus System:	The interconnections that carry the data and/or power between various parts of the computer. Hardware, whoever makes it, using the same bus system, can be used together.
Character Generator:	The IC inside the computer which translates the computer's output to the form necessary to display characters on a TV screen (VDU).
CP/M:	A popular operating system for microcomputers developed by Digital Research.
CPU:	Central Processor unit. The heart of the computer which actually performs the work.
CRT:	Cathode Ray Tube—just the TV tube itself.
Daisy Wheel Printer:	A printer which has much in common with a typewriter. The letters are made by having a raised letter on a circular printing element hit a ribbon onto the paper.
Dot Matrix Printer:	Uses an arrangement of pins (usually seven closely vertically stocked) to form a letter one column at a time (usually five columns in all).
Firmware:	Software (usually in an IC) which is an integral part of the computer. It cannot be readily changed by the operator.
Hardware:	The physical parts of the computer or its peripherals.
Interface:	A circuit which goes between different sections of hardware. It enables devices such as disks to communicate with the CPU, the CPU to communicate with a printer, etc.

Kilobyte (K):	1024 bytes. The usual way to describe the memory capacity of a system.
Language:	The means by which people communicate with a computer.
Main Frame Computer:	A big one!
Micro-computer:	A computer using a microprocessor as it's heart. Typically deals with only one user at a time.
Minicomputer:	A small computer, less than a Main Frame, more than a Microcomputer. The distinction between Mini and Micro is very blurred. Minis are more powerful (computationally) than micros and can typically deal with more than one user at a time.
Micro-processor:	A CPU on a single chip.
MPU:	A Microprocessor.
Operating System:	A system used to allocate computer resources to different users at different times.
Peripheral:	A peripheral is a device which communicates with a person, (e.g. printer, floppy disk, VDU, but not memory or the CPU).
Program:	A set of instructions which direct the computer to perform a desired action (e.g. sort 500 numbers in ascending orders).
RAM:	Random Access Memory. Memory which can be reused. You can read from it or write into it. The computer's notepad.
ROM:	Read Only Memory. Memory holding something permanent (e.g. the BASIC language).
Software.	Stored programs. These may be in the RAM, on cassette or on disk.
Thermal Printer:	The least expensive type of printer which produces the character from a series of dots which are formed by heating up the special paper necessary.
S-100:	The most popular bus system (one of the first for microcomputers).

A more extensive explanation of these and thousands of other microcomputer terms can be found in the "Illustrated Dictionary of Microcomputer Terminology". It's Tab Book No. 1088, available through the ETI Book Service for \$11.85. See the order form elsewhere in this issue.

Left: The TRS-80 Model I is essentially a personal computer but even a system as basic as the one shown here, using a cassette recorder for holding programs and a simple printer for permanent copy, can be extremely useful for some business purposes.

The TRS-80 Model II on the right is a real business computer. Not only do Radio Shack have a very respectable range of software but the popularity of this computer has led to many other companies competing for this business making it very good value.



contribution, production run and profit. A simple computer of this type will handle quite complex jobs and print out a copy for records. It will also reduce the likelihood of error and will automatically perform complex calculations which are often estimated crudely using manual methods.

A major disadvantage is that there's very little software available off-the-shelf. You're going to have to write the programs yourself or be prepared for a very high charge for someone to do it. Writing your own programs is not difficult, some people find it addictive but it *does* take time.

With a system like this you're not going to be able to store data or work with it unless you key it in (there are ways of controlling a cassette from the computer but they're very slow and not really practical for most purposes).

Up to \$8000

It's a big leap from \$3000 but is necessary because it takes us up two steps that are essentially interrelated: the addition of floppy disks and more program memory: probably 64K.

At this stage we're really talking business. A floppy disk will store plenty of data which can be drawn on by the computer and the computer can record it's results. The floppy disk also holds your programs which can now be entered into memory in seconds rather than minutes.

With 64K and an 8" floppy disk there's a lot of business software available: Accounts Receivable, Accounts Payable, General Ledger and Payroll are available from several sources; You'll also be able to have a mailing list with up to 2000 names; Your machine also becomes an effective word processor. Check some of the US magazines such as Byte or Microcomputing—there's a lot of software offered for a system of this type.

Up to \$15,000

A single disk drive will do a lot—a second drive will enable you to produce copies of your first disk (protecting your records) as well as doubling your data capacity. Third and even fourth disk drives can be added.

In this price bracket you'll be able to have a daisy wheel printer. Although dot matrix printers produce legible quality copy and does it fast, it's only really for intercompany use—a letter will look very impersonal if its produced on one of these. Daisy wheel printers produce documents which look exactly as though they're done on a regular typewriter: they



The Heath/Zenith Data Systems WH - 11A/32 featuring 64K byte memory.

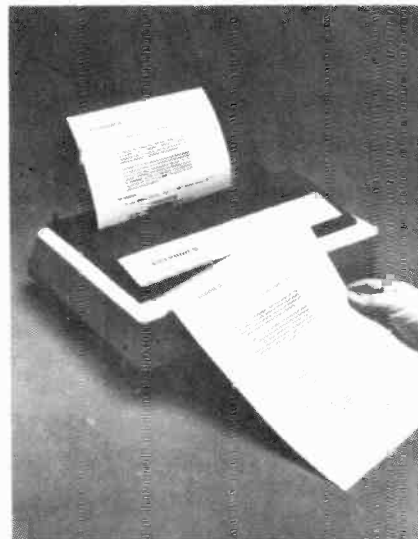

A very small dot matrix printer from Centronics.



Another typical arrangement for a small business, the Centurion Series 100. This system employs three 8" floppy disk units.

cost slightly more than dot matrix but are much slower. While a dot matrix printer will do anywhere from 100 to 180 characters a second, daisy wheel types operate at about 50 characters a second—although this is about six times faster than a good typist, it's slow by computer terms: it is, however, ideal if you're going to do word processing for letters or legal documents.

Some systems will support additional terminals even at this price, though we're at the top of our price unit. Terminals themselves aren't particularly expensive — typically



The Apple II business system for offices. Note the two floppy disks under the VDU.

\$1000 — \$2000 — but you'll need an operating system as well.

Up to \$25,000

In this price range you'll be able to add a hard disk system. Instead of the 500K bytes which an 8" disk can hold, you'll have access to maybe twenty times that storage. And your programmes and the company information can be kept on the one disk. There are a lot of prepackaged systems in this price category. They

vary in their hardware, not all have a hard disk but may include two or three terminals. Others produce a package including a lot of common software.

Software

You'll hear a lot of comments about the reliability, either good or bad, about the different hardware units of makers. We've not heard consistently bad reports about any company and most equipment is probably pretty reliable.

Software, however is very important—there's good and there's bad and the price range is enormous. There are a few systems that are so popular that dozens of people are competing to supply the software: Radio Shack's TRS-80 Model II is the outstanding example but there's a lot available for PET's and Apple's as well. One approach to buying a small business system is to start with the software and buy the hardware to run it. However, make certain that the hardware can be expanded to meet your needs.

Final Points

Don't ignore the human side when shopping for a computer. In a business setting the person who buys the system isn't usually the person who has to use it. It's true to say that most people are deeply suspicious about computers and maybe a bit frightened: they're not going to admit this as they're also afraid of being regarded as reactionary. Being aware of this is half the battle, the other half is letting them play with the hardware and software. If you handle it properly they'll become as enthusiastic as you are.



Just \$595. INTERACT COMPUTER 16K LEVEL II

Write for our flyer on Interact Computer

A powerful microcomputer with a full standard 53 key typewriter style keyboard and built-in cassette recorder for use in entering and storing programs. Utilizing the versatile Intel 8080A microprocessor, the Interact computer has 16K of RAM and 2K of ROM at its disposal. Output is in color on your own TV screen. Sound is also generated through your TV set and can consist of exhilarating computer beeps or two full octaves of music. This is truly a powerful computer capable of developing and handling a variety of programs, and with available software provides true educational stimulus (examples: Star Track, Chess, Concentration, etc.). The Interact computer offers the ideal opportunity to learn BASIC, the most popular computer language for small business and hobbyists, and with the use of the 84 page manual, you learn at your own pace.

INSTALLATION: Attach to antenna terminals of your color TV set and plug into 120 VAC wall outlet. Computer includes built-in RF modulator, FCC approved and UL and CSA listed.

PROGRAMMING: Most Micro-computers start you off with an abbreviated 4K BASIC, and then later you have to relearn the more powerful language. Since this computer has 16K of RAM, we start you with Level II Microsoft 4.7 BASIC. BASIC is the most popular Micro-computer language using commands that are words we are ordinarily used to: such as, PRINT, NEW, GOTO (For go to), END, COLOR, JOY, INPUT, etc. To help you learn programming we have included an 84 page instruction manual, plus a 20 page book of program examples.

Educational and Entertaining

ORION Electronic Supplies Inc.

ELECTRONIC DISTRIBUTOR
INDUSTRIAL — EDUCATIONAL — COMMERCIAL — HOBBYIST



START WITH ORION FOR A NEW ERA IN THE WORLD OF ELECTRONICS

We have the most complete selection of electronic components.

Full line of TTL, CMOS, Linear, ICs, Computer Interface, Support Chips and CPUs.

- ASCII Keyboard Fully encoded, 128-character ASCII alphanumeric keyboard, 58 light touch keys (2 user defined) Selectable Upper-Case-Only **VP-601** \$99.75
- ASCII/Numeric Keyboard ASCII Keyboard identical to VP-601 plus 16 key numeric entry keyboard for easier entry of numbers **VP-611** \$129.95
- Cable: ASCII Keyboards to **VP-711** Flat ribbon cable, 24 in. length, for connecting VP-601 or VP-611 and VP-711. Includes matching connector on both ends **VP-620** \$27.50
- Cable: ASCII Keyboards Flat ribbon cable, 36 in. length with mating connector for VP-601 or VP-611 Keyboards. Other end is unterminated. **VP-623** \$27.50

AP Products

The all-new line of ACE All-Circuit Evaluators WITH POWER

POWERACE 103	POWERACE 101	POWERACE 102
<i>Triple-output power supply for prototyping model for prototyping lab with both linear and digital circuits.</i>	<i>The general purpose prototyping lab with all types of circuits. FREE logic probe built in!</i>	<i>The complete digital supply for prototyping model for prototyping lab with both linear and digital circuits.</i>
\$159.00	\$107.93	\$159.00

Orion Electronic Supplies Inc.
40 Lancaster Street West
Kitchener, Ontario N2H 4S9
(519) 576-9902

Master Charge & Visa COD, Cheque, Money Orders accepted. CODs, shipping & insurance extra. Write for our FREE catalogue!

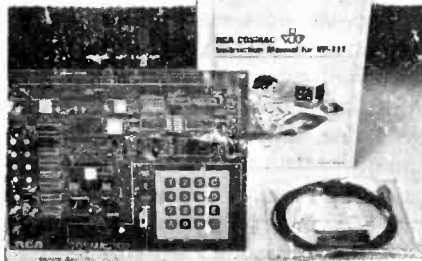

New! VP 111 \$129.50
Microcomputer

- Features
- RCA 1802 Microprocessor
- 1K Bytes static RAM
- Expandable on-board to 4K
- Expandable to 32K Bytes total
- 512 Byte ROM operating system
- CHIP-8 interpretive language or machine language, programmable
- Hexadecimal keypad
- Audio tone generator
- Single 5-volt operation.

Assembled* and tested.

- Video output to monitor or modulator
- Cassette interface—100 Bytes/sec
- Instruction Manual with 5 video game listings, schematics, CHIP-8, much more
- Ideal for low-cost control applications
- Expandable to build full VIP capability with VP-114 Kit.

*User need only connect cables (included), a 5-volt power supply, and speaker.

ZX80 REVIEW

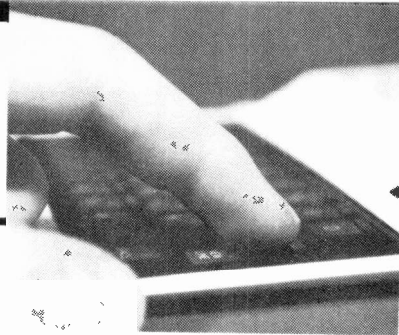

A complete, ready-to-run computer for under \$350 would make anyone sit up and take notice. John Van Lierde takes a look.

IN THE SIX or so years that home computers have been around, the market has seen a wide variety of models ranging from simple evaluation kits costing a few hundred dollars to full blown systems that are ready to go on power-up and cost as much as two years tuition to the university of your choice. In many ways there is no middle ground. A Superboard will set you back about \$400 and it doesn't even have a case. Evaluation boards are cheaper (well . . . they used to be), but who wants to spend their time hand assembling machine language programs only to have them write all over themselves on execution?

Well folks, the middle ground is here, in the form of the Sinclair ZX80 from Science of Cambridge.

First Impressions

My initial comment on seeing the ZX80 was, "So where's the computer?! . . ." The machine in no way seems related to the PETs, TRS 80s, IBM 370s that we've all come to know and love. It's essentially the same shape and arrangement as any desktop computer you'd care to name, but *it is tiny*. Dimensions are a mere 180mm wide, 216 mm deep and a tad under 38mm at its highest point. It weighs only 340gm. The case feels like it is made out of the same plastic as egg cartons. At first glance there doesn't appear to be a keyboard, but rather just a picture of a QWERTY type layout.

This is a complete, ready to run Z80 computer?

You bet . . .

A Tiny Revolution

The ZX80 is a totally new approach to bringing the microcomputer to the masses at an affordable price. The design features of the machine are not so much attempts at cutting corners as a calculated effort to trim the hardware fat off a 'regular' computer.

The basic machine comes with 1K RAM and a 4K ROMed BASIC. The user has to share his RAM with not only the BASIC's various internal variables but also the video display's memory. When fully loaded the display can hog

some 800 bytes of your precious 1024.

This isn't as bad as it sounds. The screen takes up only as much memory as it needs. Also, your BASIC program doesn't take up much space because all commands (PRINT, NEXT, THEN, etc.) are reduced to single characters. This brings us to the ROM.

The ZX80 comes with 4K integer BASIC. Unimpressed? Well those 4096 bytes support virtually all the BASIC commands you'd want to use, a powerful editing facility and the video character generator software. The latter is necessary because the ZX80 has no video display controller, what you see on the screen is all done in software. An enhanced Z80 MPU, the Z80A, handles the task of computation and video control.

The keyboard (fig. 1) is of the bubble 'lite touch' variety with three levels of characters. The first level is more or less similar to the basic QWERTY set up we all know. The next level is shift selected and carries graphics characters, cursor control, etc. The third level is enabled by the machine and generates all the one key BASIC statements.

The case is made from two pieces of vacuum formed plastic held together by push rivets. Using a light plastic case

keeps the weight down, which I think is an advantage from a portability point of view. (Incidentally, the case is adequate. I succeeded in dropping our review model from a height of 4-5ft. A corner broke off but aside from that, there was no damage to the unit and it functioned properly. Embarrassing though, at the time it was the only ZX80 (that we knew of) in Canada.)

Using It

The ZX80 is a snap to set up (fig. 2). Power is derived from a 9V, 600mA plug-in transformer. Two sockets provide input and output for the cassette interface (being short of cables, cassette recorder and time, I didn't test this feature. I understand it works quite well though). An additional socket connects to the antenna terminal of the TV monitor.

I had trouble with trying to get a stable video display. My first attempt was with a five year old 10 inch tube type portable. The resulting display rolled, skipped and did everything but sit still. It seems that some old sets just can't sync with British standard video signals. I got better results with a 4 inch portable but the text was a bit unstable and therefore unsuitable for picture taking. Eventually I managed to get

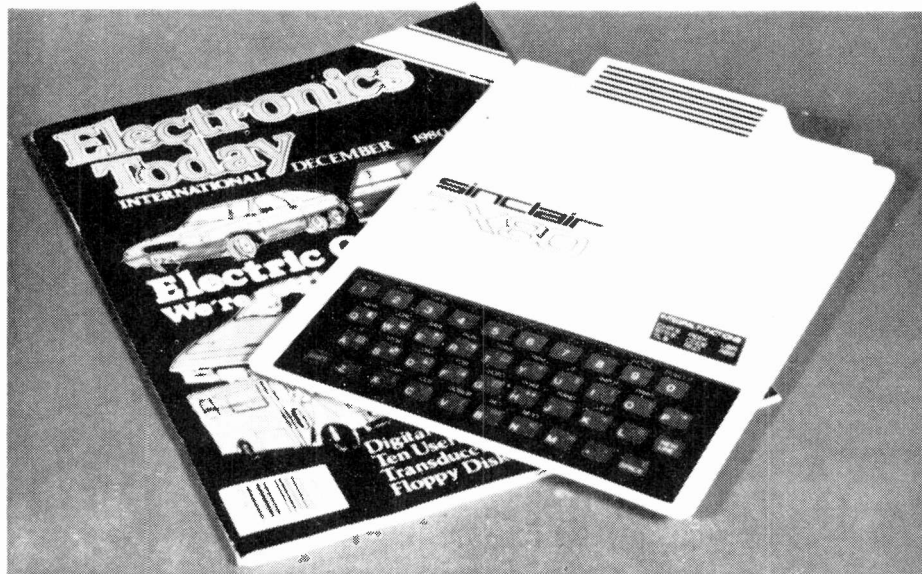

We tried dozens of ways to bring across the tinyess of the ZX80. Here's one.

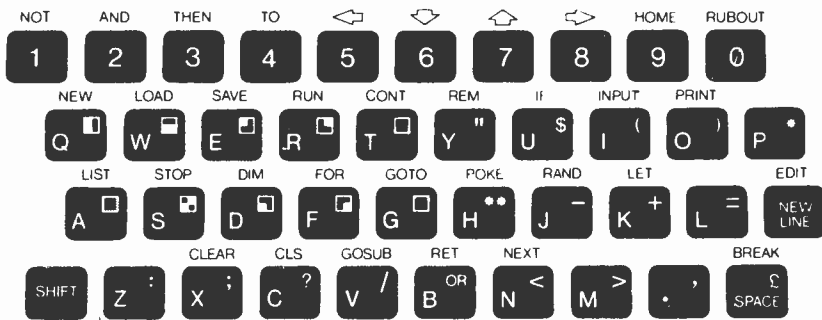

Fig.1 Keyboard layout of the ZX80. Note the third level BASIC commands.

hold of a 12 inch unit that worked fine.

Getting an adequate display requires radical readjustment of the sets vertical and horizontal hold. Also, the characters are black reversed out of a white field, which required that the set's brightness and contrast controls be at their maximum settings. Even then I wasn't terribly satisfied with the clarity. Another point to remember is that setting up a TV for the ZX80 renders it unfit for regular viewing, which can be a drag if your using the family tube.

For a person accustomed to normal keyboards, the ZX80's is something of a surprise. Not only do you not get any tactile feedback (in the form of a click), but you can't even find your way around the keyboard by touch (fig.3). Keying in data requires that you look at the keyboard to find the right spot to put your finger (touch typing is out), hit or touch the spot, then check the display to see if you did it right. As keyboards go, however, it is pretty reliable. Even after several weeks of daily use as a store demo model, the keyboard legend showed no sign of fading or wearing off. Also, there wasn't even the tiniest hint of switch bounce.

Fig.2 Connections to the ZX80 are simple (all cables are supplied). With the exception of adjusting the monitor, this is probably the easiest machine to get going.

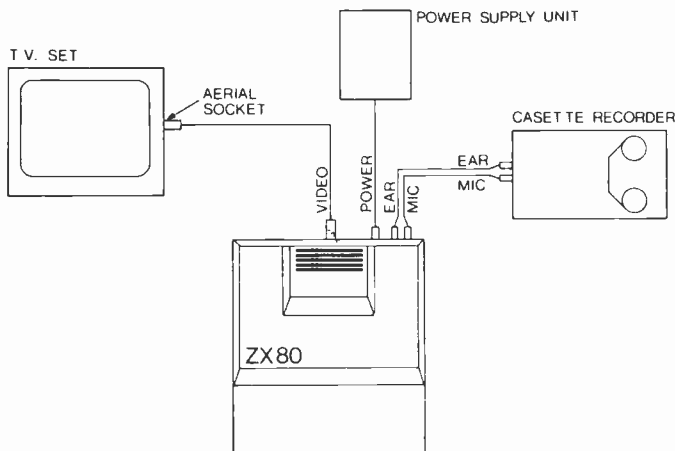

Because the CPU spends all of its off hours generating the display, entering data or program execution causes the display to flip out for the duration of the interruption. The hiccups on entry can be very annoying, but one gets used to it. On the other hand, a novice probably wouldn't even notice.

4K BASIC: An Editor's Delite

The ZX80 sports a simple to use but highly effective editor. Aside from letting you insert and delete characters (*sans* retyping the whole line), it will absolutely refuse to accept a statement with any sort of syntax errors.

Fig.4 shows a BASIC listing in the process of being edited. Note that there are three cursors (the white on black things) on screen. The first, the arrow embedded in line 90 can be moved up and down by depressing the appropriate cursor control keys. The line can be brought down for modification by depressing the EDIT key. Line 90 also appears at the bottom and contains two cursor characters. The 'L' points to where the machine will insert/delete characters if made to do so. This can be moved by the left and right cursor control keys. In this example a bracket

Fig.4 Program editing on the ZX80 is exceptionally easy. Note the three cursors.

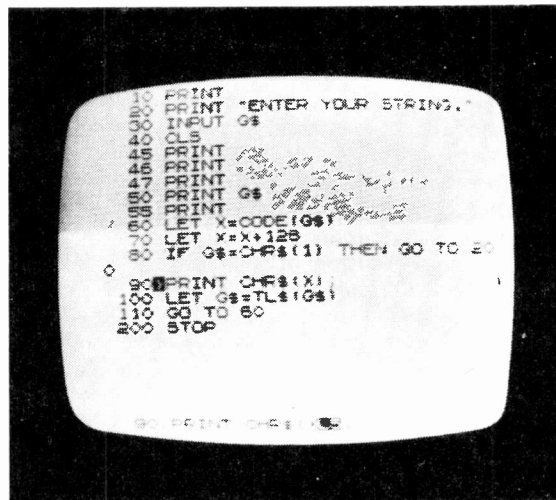

was deleted for some obscure reason. The reversed 'S' indicates that there's syntax error. In this case CHR\$(argument is incomplete.

No matter how often you hit NEW-LINE, no matter how much you curse, spit and swear, the machine will not accept a statement with a syntax error. This can be quite infuriating. If you make an error in keying a statement and don't catch it on the CRT, the next statement you enter will be tacked onto the first (and the ZX80 still won't take it).

A unique feature of the ZX80 is its use of single keystroke BASIC statements. The principle is similar to a programmable calculator. It works like this: starting with a blank line, a reversed 'K' appears in the bottom left hand corner of the screen. At this stage the machine knows it will get either a line number or a command from the keyboard. If you key in 100 (or any number), 100 will be displayed. If you hit the letter 'O', you get a 'PRINT' statement. After this the keyboard switches to regular characters and an 'L' replaces the 'K'. You can't spell PRINT directly, you have to use 'O' (also known as a 'token'). Similarly, you can't type NOT, AND, THEN and TO directly either, they are also available through the keyboard as tokens.

It is clear that this feature can speed up program entry and execution, but to the experienced user it takes some getting used to.

For instance, trying to type a GOTO directly would result in a statement like this:

```
100 GOTO OTO 100
```

Needless to say, the machine won't accept this. Ultimately, however, one learns to accept this feature.

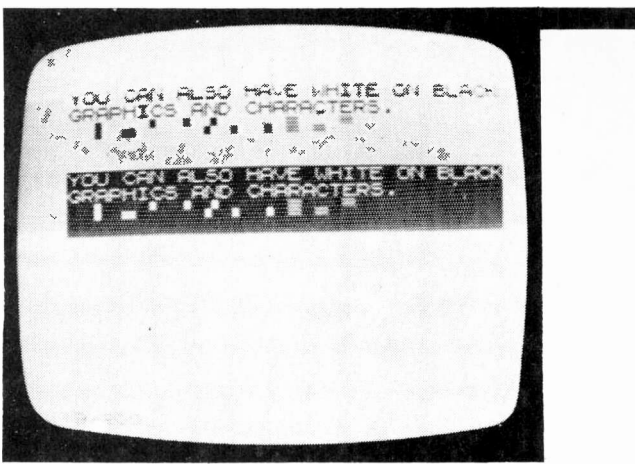

Reversed characters and graphic symbols are also available, though not directly accessible from the keyboard.

Like all integer BASICs, the ZX80's is noticeably limited in its mathematical abilities. Floating point operations such as SIN, COS and so on just aren't possible on this machine. It is possible to work with fixed point arithmetic, but somehow I just can't get excited about the idea. Variables are stored in two eight bit words which limits the user to numbers between -32767 to +32767. In spite of this, it appears to be an extremely fast interpreter, most likely because the reduction of commands to single characters makes statement parsing much faster.

The BASIC supports a fairly complete instruction set. There are some limitations such as the fact that you can't string together several statements on a single line. You can have up to 26 character strings and up to 26 single dimension arrays, both with no limit on length other than the confines of available memory. Normal numeric variables can be named in the same fashion as on other machines.

The ZX80 also has the capability to run machine language programs and subroutines using a statement called USR. There is no monitor provided but you can easily write one using PEEK and POKE. Indeed you could write an entire operating system in BASIC expressly for writing and running machine language programs. (Not being familiar with the Z80 vernacular, I gave this idea a miss.)

A characteristic of the BASIC's output is that it will not scroll the video display. If you happen to overfill the screen, program execution is halted. There's a very good reason for this. You can't see what's being displayed until the CPU finishes its job. Displaying more than 24 lines requires that you stop execution after 24 lines have been outputted, look at the result and restart execution with the first instruction clearing the screen.

You can, however, scroll through the program listing for editing purposes.

The manual provided with the

SYMBOL	CODE	SYMBOL	CODE	SYMBOL	CODE	SYMBOL	CODE
	2		7		130		135
	3		8		131		136
	4		9		132		137
	5		10		133		138
	6		11		134		139

Fig.5 Grafix anyone? The ZX80 comes equipped with a complete set of simple graphic symbols.

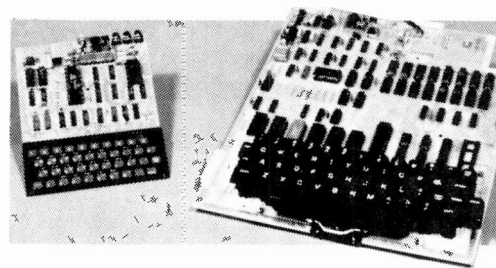

A tale of two computers. On the left the ZX80, on the right, an OSI Superboard.

machine teaches how to use BASIC commands in an easy conversational style. A few complaints here though. First, the Table Of Contents lists the various chapters but doesn't give any page numbers. Really makes it a great system reference. Also some of its dealings with programming techniques and character manipulations are rather sketchy. A supplemental text on programming technique might be useful to the beginner.

Grafix

The ZX80 was my first encounter with a non-memory mapped display. Most micros have a block of memory dedicated to storing characters in the same order as they are viewed on the CRT. This memory is accessed by the video display controller except when the CPU interrupts and sticks new data in.

To save on memory space and time the ZX80 doesn't use this arrangement. The video memory is stored as a series of variable length strings. The more stuff you want to put on-screen, the longer the strings. As I said before, this can take up to 800 bytes of available RAM.

The string handling facilities of the machine are meager, but should be adequate for most purposes. A set of graphics characters are provided (fig.5) which increases the overall resolution to 48x66 pixels (3168 cells in all).

Unfortunately, I just couldn't get

any sort pictures I could be proud of. Rather naively I decided to display the letters 'ETI' in 7x5 block letters. Unfortunately the three letters took up so much space that I succeeded in overwriting the display memory (I think). The ZX80 freaked out and eventually steadied on two vertically rolling black bars. I had to pull the plug to get the stupid machine's attention.

As it stands, a bare bones ZX80 just does not have enough memory to support any serious graphics work. Another point that should be mentioned is that animated graphics are impossible on this system. The reasons are twofold. First, video display and calculations cannot occur simultaneously. If the CPU has work to do, the display flips out. Secondly, for some reason I don't understand, it takes the machine close to 8 seconds to fill the display with characters.

After some thought it occurred to me that a pseudo memory mapped display is feasible. The ambitious owner may want to fill the screen with blanks and then POKE the appropriate graphics in the right places. Careful though, putting a half square on a NEWLINE character will cause the whole show to crash and you'll have to pull the plug. Still, playing with the machine's display files seems to be a potentially intriguing pastime.

A further note on characters. The ZX80 does not use ASCII which means you can't use it with printers or other peripherals without some sort of lookup table. Again, for most potential ZX80 users this shouldn't be a problem. The character set itself is kind of interesting. Of the 256 possible characters, some 174 are used. A lot of them are regular and reversed letters, some 90 will output as '?'s and the rest are the characters that make up the compacted program statements in memory. The statement, 'PRINT CHR\$(X)' where X=243 would display 'NEXT', X=231

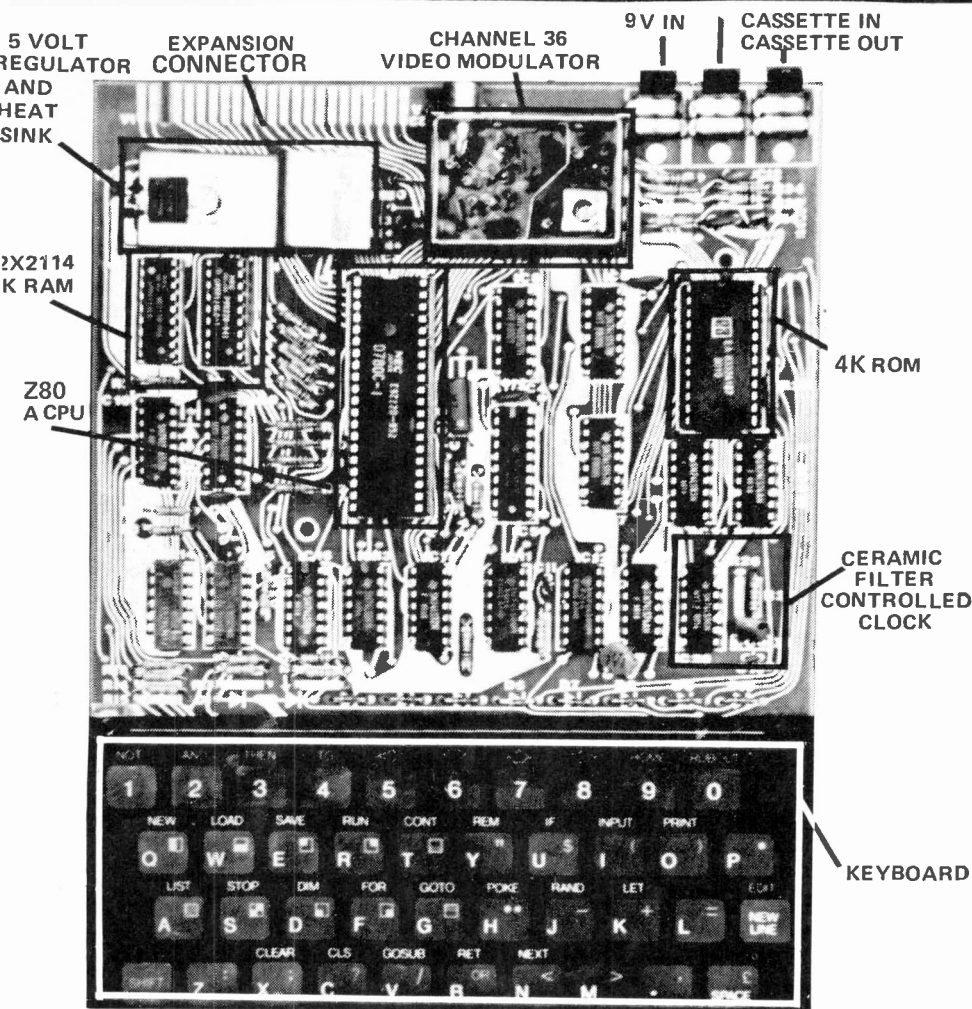

Fig.6 Inside the ZX80. Everything lives on one PC board.

generates a 'RETURN', 213 gets you a 'THEN' and so on.

Inside

Fig.6 shows the PC board of the ZX80. This unit is also sold as a kit in the UK (only in Britain . . . ?) and this is reflected in the open PCB layout.

At the top left hand corner is a printed circuit edge connector intended for expansion via future accessories. This is accessible through a hole at the case's rear. At the top right hand corner are three miniature phone jacks for power and cassette I/O.

The system runs off a ceramic filter controlled clock. The tallest component on the board, the RF modulator, is supposed to produce an output at UHF channel 36. Actually it turned out to be channel 35 on our set, but I won't quibble. (apparently the next batch of ZX80s to come over will output on VHF channel 2).

As I said before the ZX80 displays a very disciplined approach to personal computer design. In the majority of the machines available the CPU runs idle most of the time or is under-utilized (ie. scanning the keyboard). The folks at Science of Cambridge decided their CPU should earn its keep. The result? You

save on some \$50 or so of video display controller and memory chips.

The keyboard is another example of controlled design. Why use \$70-80 worth of crosspoint switches when a membrane keypad is adequate. Also why encase the beast in a 14ga. steel case that you could drive a Mack truck over when you know darn well that no-one in their right mind would do such a thing?

So Who Needs It?

Overall I was quite impressed by the machine and its features. Here is a computer truly aimed at the newcomer to computing.

That doesn't mean I would buy one for myself. If you have had any experience on larger systems, I would not recommend buying this system unless you know *exactly* what you want. I found the integer BASIC to be very restricting. The keyboard is downright strange (even after 16 hours of use) and the less than 1K memory can be inadequate in some applications (notably the interesting ones).

A lot of these problems will disappear with the introduction of some add-ons promised for the future. One is a 16K dynamic memory costing

approximately \$135 in the UK. Also soon to be available is an 8K floating point BASIC for \$55 (again UK price). Apparently this will be software incompatible with the current integer BASIC which would require that programs would have to be rewritten to run on the upgraded machine. (PLEASE NOTE. This information was culled from UK computing magazines some months olds. Among other things it doesn't include duty, FST, PST or Britain's phenomenal rate of inflation. Prices and specs will most likely be radically different, so don't ask for these goodies until they're available here.)

On the other hand, if you don't have any experience with computers, the ZX80 is an excellent way to learn. The manual's conversational style should make learning fairly easy. Also, using other BASIC manuals should be no trouble with this machine. I also think that, with the floating point BASIC, the ZX80 would make an excellent low cost number cruncher. Schools too, might be interested in the ZX80 as an inexpensive way to introduce students to the essential principles of computing. The editing features of this machine would free the student from the problems of syntax errors and allow him to get down to actually developing programming skills.

Overall the ZX80 is an unusual machine at an unusual price. In a highly competitive market it stands a good chance of carving a niche of its own, if Japan doesn't get there first. ●

Gladstone Electronics is importing the ZX80 in Canada. Among other things, they tell us the RAM should be available this month and the 8K ROM should be here sometime in May (apparently it's being held up for modification). The computer will be sold with an antenna switch which attenuates the video output and makes it easier for some TVs to handle it. If you want to build the ZX80 from a kit, you're out of luck, apparently there is no cost advantage and therefore they will not be available here.

Despite the integer BASIC, there is a fair amount of software available for the ZX80. Gladstone will be publishing 'ZX80 Canada', a newsletter for ZX80 owners. They'll also be able to tell you about various software sources.

The ZX80 will retail for \$329.00 and should be available in a number of stores when sufficient quantities are imported. For more information write to Gladstone Electronics, 1736 Avenue Rd., Toronto, Ontario M5M 3Y7.

Special thanks to Gladstone for lending us the review model and my sincerest apologies to Howard Gladstone for my damaging his review model.

MODEM

Nicholas Cosentino of Teletek, a Markham, Ontario company describes a new Canadian

modem that doesn't need an acoustic coupler.

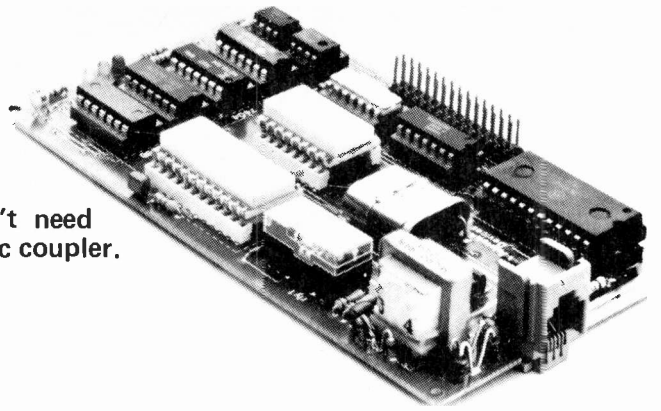

THE USE OF a computer as a serious hobby has been experiencing a tremendous growth rate and the future bears exponential tendencies. One of the continuing problems for computer hobbyists is communications. The need to establish a means of communicating amongst themselves in order to expand, develop and utilize their software libraries to their greatest potential. In addition, as more and more data based systems come on line, the serious hobbyist will desire to have access to these information sources.

The 300 baud modem offers a very inexpensive solution to many communications related problems. A modem, when properly configured, will allow hobbyists to communicate and exchange programs utilizing normal telephone circuits. Also, the use of the 300 baud frequency "shift keying" technique is advantageous because the majority of computer installations presently have a 300 baud port allocated for telephone line type communications. This type of modem, as there are many, utilize a pair of frequencies. These are commonly referred to as "originate pair" and "answer pair", which are the "talking" and "listening" pairs, respectively.

The term "modem" is the acronym combining the words "modulator" and "demodulator" and is descriptive of the techniques utilized by such a device. "Frequency Shift Keying" or "FSK" for short, is the shifting from one frequency to another in response to a data input. When the modem receives a "mark", as data, it will output a 1270 Hz and will output 1070 Hz when receiving a space, in the originate mode. When in the answer mode, the modulator will output 2225 Hz for a mark and a 2025 Hz signal for a space.

The term "originate" refers to the modem or terminal that initiates the communications about to take place and not the direction of data. The "answer" modem is the responding or "called" station or terminal.

These modems can be further broken down into "acoustically coupled" and "direct connect" the latter being the state of the art.

The acoustically coupled modem requires that the hobbyist originates a line, by dialing a number and upon receiving a tone from the answer modem,

The Teletek MuP modem enables a user to connect his computer directly to the telephone lines.

the user inserts the hand set into the two cups located on the top of the modem, hence we derive acoustic coupled. This method is far inefficient and inferior, since the coupler relies on a mechanical transfer of data. It is at this point where unwanted distortion and interference is introduced, bearing in mind that the telephone lines are infested with cross talk, voltage transients, phase shift delays and other undesirable signals which degrade the quality of the data being transferred. In a very long transmission, one wrong data list can render the complete transmission useless, let alone trusting the so described modem to handle financial transactions.

In contrast, the direct connect modem is electrically connected to your telephone lines and computer so that extraneous sounds and mechanical distortion are eliminated. Thus, the user has a very reliable communicating device. One such modem which is very versatile and reliable is the Teletek Computation & Instrumentation MuP Modem.

The MuP Modem has a very long list of features such as: 1. Direct connect; 2. Originate; 3. Auto Answer; and 4. Computer auto dial, and the list goes on and on. It is small enough that one could be implemented in an existing video terminal or printer. It contains the necessary electronics to dial out a call under computer control. Thus eliminating the telephone handset.

The card requires three readily available voltages; +5, +12 and -12, which can be obtained from your terminal. It comes with a modern universal wall-type plug which plugs into a subscriber line and the board. This is your "direct connect". There are many wire-wrap posts, which can also be used as a mass termination connector, which have all input-output handshaking lines and many user available options. Since this card has many more options, far too numerous to mention, it is beyond the scope of this article to go into great detail.

For further information, consult the manufacturers, which, incidently are Canadian.



A typical acoustic-coupled modem. There are several disadvantages inherent in these devices, not the least of which is that they take up desk space.

ETI/Heathkit CONTEST!

WIN!

Win a microcomputer training course worth \$459.95

In keeping with this month's computer theme, Heath Company and ETI have joined forces to produce this month's contest.

This time some lucky person wins two prizes. First, the Heathkit ET-3401 Microprocessor Self-Instruction Program. What do you get? A binder containing 10 learning units covering all aspects of MPU systems. Starting at number systems and codes, the course goes through microcomputer basics, computer arithmetic, programming, a study of the 6800 microprocessor, interfacing, and then finishes off with programming and interfacing experiments. Components are provided to perform the experiments.

In addition to the above, Heath Company will provide the winner with an ET-3400 Digital Microprocessor Trainer to give complete hands-on experience. The ET3401 features 1K ROM, 256 bytes of RAM (expandable to 512 with the parts from the ET-3401), 6 digit display, 17-key keyboard and a prototyping area for experiments.

Total value of this package is \$459.95, you can have it for free (if you win). How do you enter? Read the rules below, complete the crossword, mail in the entry form and watch News Digest in future issues for contest results.



- ET-3400 Features**
- 6800 MPU
 - 256 byte RAM
 - 1K ROM monitor
 - 6 digit hex display
 - 17-key keyboard
 - Buffered address, data, and control lines
 - Prototyping area
 - Built in power supply

- ET-3401 (not shown)**
- UNIT 1 - Number systems and codes
 - UNIT 2 - Microcomputer Basics
 - UNIT 3 - Computer arithmetic
 - UNIT 4 - Introduction to programming
 - UNIT 5 - The 6800 microprocessor Part 1
 - Unit 6 - The 6800 microprocessor Part 2
 - UNIT 7 - Interfacing—Part 1
 - UNIT 8 - Interfacing—Part 2
 - UNIT 9 - Programming experiments
 - UNIT 10 - Interfacing experiments
- AS WELL AS:**
- two 2112 4x256 byte RAMs
 - 6820 PIA
 - 1406 D-A converter
 - 741 and 301 op amps
 - and more

RULES

When you have determined your answers to the crossword, enter them, along with your address and phone number in the appropriate spaces on the form provided. Mail the entry form to:

Heath Computer Contest
c/o Electronics Today
Unit 6, 25 Overlea Blvd.
Toronto, Ontario M4H 1B1

The first correct answer drawn wins.

Readers not wishing to cut up their magazines may submit their entries on a handdrawn facsimile of this form. Only one entry per person, multiple entries will be disqualified.

This contest is open to residents of North America with the exception of ETI staff members, their families, their printers and distributors and employees of Heath Company.

All entries become the property of Heath Company.

Contest closes March 13, 1981.
Editor's decision is final.

ENTER NOW!

NAME.....
(PLEASE PRINT)

ADDRESS.....
.....
.....

PHONE.....
Are you a subscriber to ETI? Yes No.

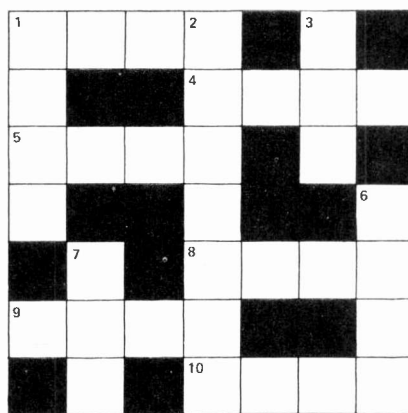

ACROSS

1. Traffic sign in a program.
4. Basic word from the three R's.
5. Basic jump.
8. Slow rate affects this time.
9. This bus carries intelligence.
10. Halloween accessory used in making IC's.

DOWN

1. Direction of a number.
2. Software TV show but leave me off.
3. Although this bat is mixed up, it organizes spaces well.
6. A quick look into your memory.
7. The ewe's favourite memory.

THE CHALLENGER LINE.

The C1P Series 2:

- Self contained personal computer with full computer style keyboard, video display interface with graphics, cassette interface,



BASIC-in-ROM and large system expansion capability.

- 18k total RAM/ROM with 8k of program workspace, expandable to 32k program workspace.
- High level BASIC-in-ROM equivalent to high priced optional BASICs on other personal computers.
- Standard computer style 53-key keyboard with upper and lower case and user programmability. Video display has upper and lower case, graphics and gaming character elements with an effective resolution of up to 256 X 256 points.
- NEW program selectable 24X24 character display or 12x48 character display (up to 32x32 or 16x64 character displays with specially modified closed circuit monitors).
- NEW sound, music and voice output via a digital to analog converter.
- 1MHz 6502 high speed operation.
- Machine code directly accessible through included machine code monitor, resident assembler/editor available.
- High reliability audio cassette interface, new switch selectable audio cassette, 300 baud modem and printer interface included.
- NEW durable high impact shell over a solid aluminum RF shielded chassis.
- Easy expansion to dual floppy disk drives. New easy expansion to color display, joysticks, AC remote control and much more.
- Over 120 cassette titles for education, entertainment, personal and small business available today with more coming.

The C1P's durable keyboard, standard closed-circuit television hook up capability, wide range of screen formats and powerful resident BASIC make it an excellent computer for educational applications. The machine's graphics capability coupled with its large software library provide entertainment as well as personal use and business utility. The computer's modem interface makes it usable as an economical remote terminal in conjunction with timeshare services and/or for use with the new personal computer information services. BASIC's advanced floating point math capability and "immediate mode" operation make the computer useful as an advanced scientific calculator. The standard machine's 8k workspace provides sufficient memory for virtually any cassette based program.

Suggested Retail. \$640.
With combination TV/Monitor. . . \$849.

The C1P MF Series 2

The C1P MF provides the convenience and utility of fast access program files and data files via its mini-floppy disk drive as well as all the features of the C1P. The C1P MF comes complete with two disk operating systems — PICO DOS which allows the operation of ROM BASIC and cassette originated programs on diskettes and OS-65D a powerful business and development oriented system with a 9-digit BASIC by Microsoft and interactive assembler/text editor, and random access and sequential data files.

- All the features of the C1P.
- Real time clock which can provide timing and time of day information in conjunction with programs.
- 30K total RAM/ROM, 20K RAM, 8K program workspace under 65D expandable to 32K RAM.
- Complete with single 90k byte fast access mini-floppy.
- Directly expandable to a second mini-floppy, easily expandable to color display, joysticks, AC remote control, security and much more.

The C1P MF mini-floppy disk allows the user to select programs in a fraction of a second. Each of Ohio Scientific's mini-floppy diskette packages instantly comes up with a "menu" for user selection. With two keystrokes the user can instantly select one of several programs on each diskette. The computer's data file capability allows the convenient permanent storage of pertinent information such as business accounting records or personal information such as phone numbers, recipes, etc.

Ohio Scientific offers a wide range of educational, personal, entertainment and small business programs on diskette. Ohio Scientific also offers "OS-MDMS", a small data base management system for use on the C1P MF. This data base management system allows the user to store collections of information on diskette for instant recall and for computer analysis, all without requiring any programming knowledge. The C1P MF with its instant loading floppy disk, and its high level of built-in intelligence is by far the most convenient and easy to use small computer system on the market today.

Suggested Retail \$1840.
With combination TV/Monitor \$2040.

ORDERING INFORMATION:

Clearly print out order. Ontario residents add 7% PST. Pay by certified cheque, Chargex, Mastercharge (include signature, expiry date, card number and bank name). All prices subject to change without notice. Shipping is prepaid. Come by and see us. We're near the new Kipling subway station. We stock ETI project boards.

Superboard Series II (same features as C1P Series 2, but less power supply & case). \$399

A-I ELECTRONICS Hours: 9:30 — 6 pm: Mon, Tues, Wed & Sat. 9:30 — 9 pm: Thurs & Fri
5062 Dundas St. West, Islington, Ontario, M9A 1B9. (416) 231-4331

CHOOSING A PRINTER

Once you've established your basic system the first upgrade is likely to be a printer. M. J. LaPalme, President of E.S.S.N.A. Ltd. describes some of the points to consider when choosing.

Choosing a Printer

ONCE BITTEN by the computing bug, the shortcomings of the video screen output rapidly became evident to the serious user. It was at that time that the search for a suitable, reliable, hard copy output device started. There is a curious aspect of printed output in that it is really the only permanently visible evidence of what a computer system can do. Sure, you can make lights blink on and off and display very interesting patterns on the monitor screens but these are all temporary; once the power is turned off everything is gone. However, a document produced on a printer is retained for further analysis and used to maintain records of your efforts. Even if this listing is only a program listing, you can always get back to it at a later date.

For the personal computer user the problem is how to achieve this within a limited budget. This is usually summarized under the term "Price/Performance Ratio", which simply means "how much bang do you get out of your buck".

Very low cost hard copy devices are available with their own unique features, such as short line length and specially treated paper, etc. The original problem is really not solved, merely postponed, because for the serious user the goal of high quality output document is still paramount.

Once you start shopping around it can become discouraging to find that the cost of a printer can exceed the cost of the computer. The reason for this is that the semiconductor technology which made possible the low cost microcomputer does not really apply since a printer is an electro mechanical device. However, some recent product enhancement has greatly been improved this situation.

With the goal of a presentable document in mind, some of the points to consider when shopping around are listed below:

Print Quality

Full face printers are quite expensive and can really only be justified for high quality word processing applications. The dot matrix method of character generation is cheaper which accounts for its popularity. Recently introduced printers incorporating true descenders (the tails on g's and y's for example) and lower case characters, coupled with such features as emphasized print can produce output which is very acceptable for many word processing applications. In addition, some of these printers have the graphics capabilities together with compressed and expanded print.

Line Length:

132 and 80 column characters are becoming fairly standard. However, newer printers have line lengths that are either hardware or software selectable (i.e. 40 - 66).

Control Features:

The ASCII code contains many control characters and some of the most recent low cost printers have the use of these codes. For instance, horizontal tab, vertical tab, top of form, cancel, bell, etc. Using escape (ESC) sequences, additional control functions can be performed, such as specifying forms length, expanded print, emphasized print, etc. Other features such as character sets, auto line feed are normally hardware selectable.

Print Motion:

A very selected group of low cost printers have the bidirectional and logic seeking head motion. Bidirectional means printing in both motions and logic seeking means maximizing data throughput by minimizing head travel/time to print the next line.

Interfacing:

The Centronics/parallel type interface

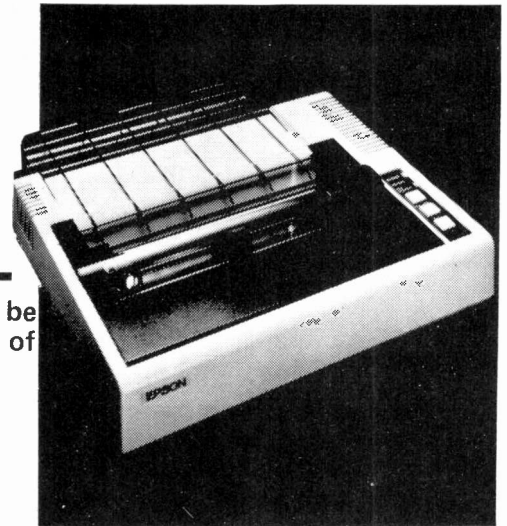

An Epson dot matrix printer (distributed by E.S.S.N.A. Ltd.)

is fairly standard, however, the capability to use other protocols such as RS232-C, current loop, IEEE 488 plus the ability to connect to most popular microcomputers (Apple, Pet, TRS-80, etc.) is an extremely valuable feature on a printer. This concept assures the user of a much better resale value for his printer if there's any chance of wanting to change. In addition, should a user decide to change computers he can simply change the interface on his existing printer.

Support:

This is an area which is often overlooked by most purchasers. After sales support programs which offer convenient service at a reasonable cost should be considered and factored in at time of purchase. For diagnostic purpose the self test feature capability is almost mandatory. In addition, the cost of a replacement Print Head should be considered at time of purchase. ●

February
is heart
month

Give...
THE
HEART
FUND



COMPUTERS, AN OVERVIEW

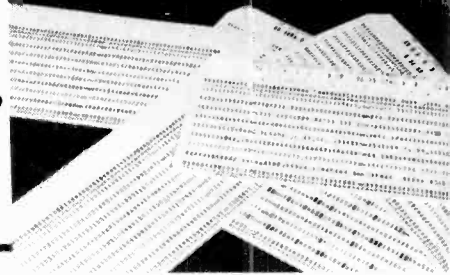

What are they? Where did they start? Henry Budgett brings a little perspective on the computing situation

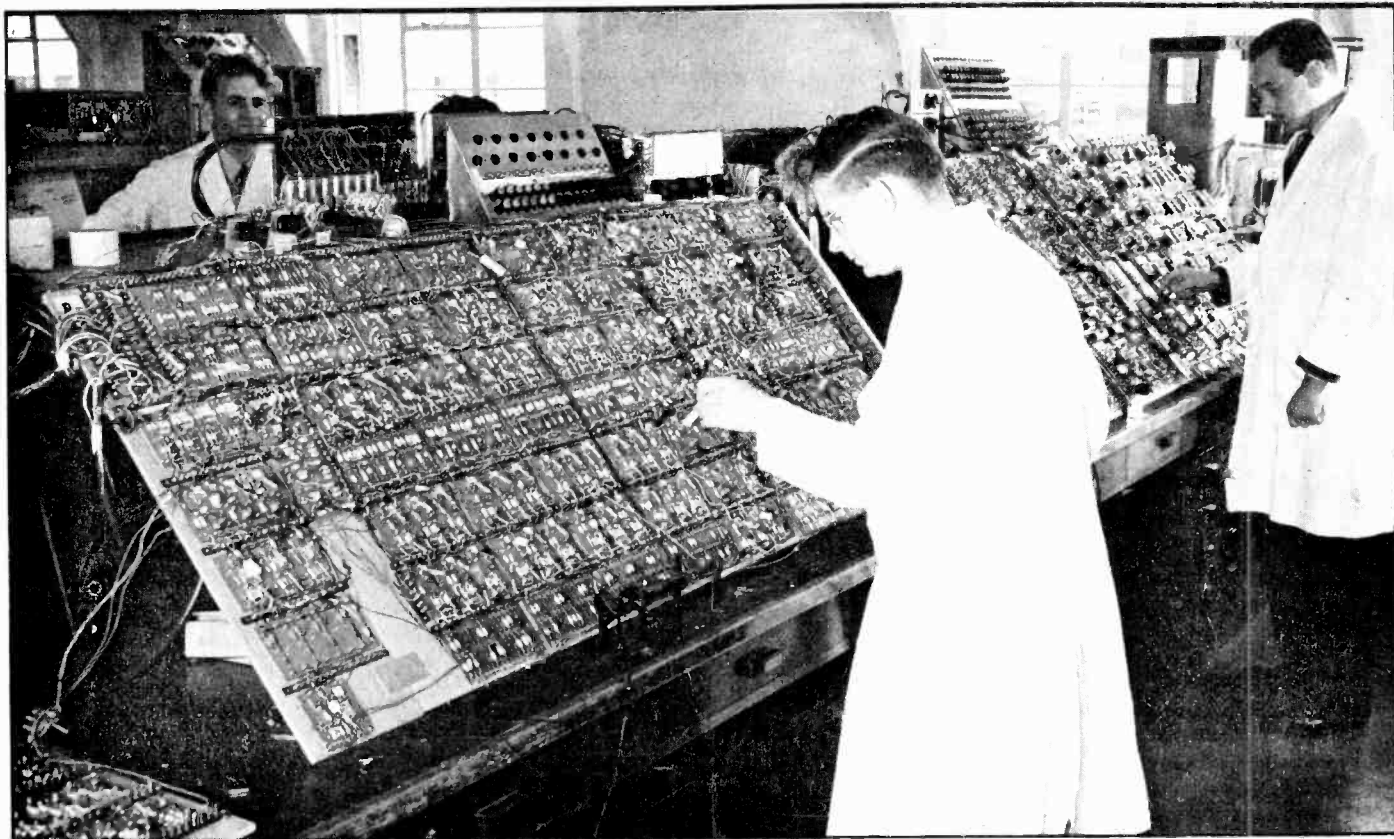

ALMOST WITHOUT FAIL we read in some publication or other that the age of computers is upon (or with) us. Whilst this statement is unquestionably true it is well worth looking back at the developments that have resulted in this proliferation of computers and computer-based systems. There is a popular temptation to attempt to baffle readers with science and technical terms in articles like this and this has led to an almost 'cult' image being foisted upon the industry, whereas, in reality, we should be trying to do exactly the opposite. It is to this end that I will attempt to define and explain each piece of terminology as it is reached.

Three Wise Men

In taking a look over our shoulders at the names associated with the very early computers we find that three stand out S-18

as veritable beacons. Taking them in chronological order, for no better reason than simplicity, we first meet Blaise Pascal. Born in the seventeenth century in France; he made a considerable impact on the field of mathematics at that time. His father was a tax collector and the sight of him spending many hours adding figures stimulated Blaise to produce a mechanical engine that would remove the drudgery. The basic design worked, no mean feat in itself, and enjoyed a limited commercial success. Its main drawbacks were that it could only add or subtract (and only one of those at a time). The Pascaline, as it was called, is still in use today recording the mileage travelled in your car and its improved successor which was capable of multiplication survived until the first electronic calculator sent it to the scrap heap. If you are fortunate enough to

have one lying in a corner it is worth the trouble to take its lid off and reveal the guts. Remember as you look that this was invented when the Industrial Revolution was still in the future and there were no facilities for making accurate mechanical parts, a problem that was to cause our next innovator to fail.

Inventor With A Difference

Charles Babbage began in a similar manner to Pascal. He was also a child prodigy in the field of mathematics and soon began to find fault with the tables of logarithms being published. It was to the end of producing a machine for calculating these tables that Babbage began his life's work. It was fortunate that he was a wealthy man because despite a Government grant of some \$17,000 and eleven years work he finally abandoned his Difference Engine. Despite this failure his thoughts on automated

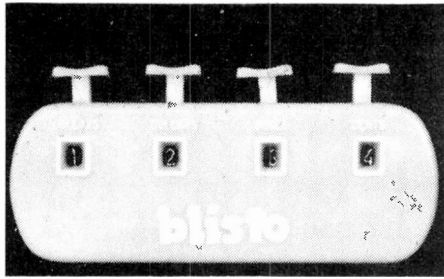

A direct descendant of the Pascaline. Adding machines such as this were used by shoppers until the pocket calculator came along.

mathematical machines were still active and he conceived the Analytical Engine that was to eventually ruin him. This idea was to incorporate all the essentials of the Difference Engine but with the magic ingredient of being 'programmable'. The original specification of the machine was that it could perform mathematical operations to order on data provided.

At this instant the concept of computers as we know them today was born. The 'Engine' even incorporated most of the elements found in modern electronic machines. However the theory was not matched by the practice. The inability to make precision parts once again spelled doom and Babbage died aged 80 with not much left to his name except a pile of cogs and wheels. His son did manage to put together a working model, which can today be seen in the Science Museum in London England.

Herman the Wise

Less than twenty years later our third individual, Herman Hollerith, forged the final link in the chain of events with his Tabulator. Designed as an entry in a competition to find a system that could analyse the results of the 1890 American census it harnessed the newly developed power source, electricity. Hollerith's machine completed the census in record time and made its inventor a very rich man. Indeed, the company he founded, IBM, is probably the largest mainframe computer producer in the world.

This combination of electricity and advanced mechanics was by no means an ideal solution. In the case of the 'Tabulator' it was designed for one specific job and could not be easily changed. This was not the programmable tool conceived by Babbage. It is interesting to note that, just as Babbage had looked toward the punched cards used by weavers to control their looms, so Hollerith used similar cards to record the census information on. These cards are still in use today in many computer rooms (some things never change!)

The Electronic Age

Just as the application of electrical energy brought Hollerith's 'Tabulator'

the success it did, so it spurred on the development of the wide variety of electronic circuits based around the thermionic tube. By the time of the second World War there were many potential challengers for the title of the first computer but they all shared one common characteristic. The development of electronic switching had resulted in the universal adoption of the binary number system. The reason is simple, you can easily turn something on or off and hence create a binary code, but it is obviously much harder to turn something off or on in nine discrete steps. If Pascal or Babbage had designed their systems around binary mathematics instead of the conventional decimal they would have simplified their problems ninefold and the world may even have been introduced to the steam powered computer. Having taken the step to binary, computers never looked back and giants such as Colossus, ENIAC and ACE were born. Each of these were the descendent of the 'Analytical Engine' in that it could be programmed to do any logical task, within reason, and consisted of a number of basic elements, as in today's computers.

In much the same way as the transition from mechanical to electrical occurred, these early computers were replaced by pure electronic devices based on the newly invented transistor. The thermionic tube was an unreliable object, slow in operation and costly in terms of power consumption and space. Indeed, the processing capabilities of most of today's microprocessors greatly exceed the facilities offered even thirty years ago. The advent of the transistor produced the 'second generation' of computers. A 'generation' in computer terms is generally defined as a tenfold decrease in size with a tenfold increase in processing throughput at a tenth of the original cost. As the transistor became the descendent of the tube, so the chip or integrated circuit became the descendent of the transistor. In those days, some ten to twelve years ago, the first integrated devices consisted of perhaps a half dozen transistors on a single chip of silicon. Rapid advances

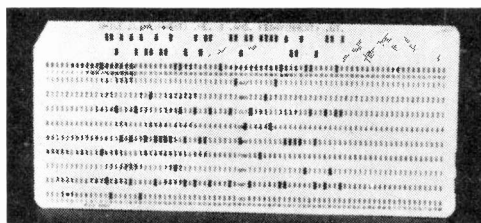

A Hollerith encoded punch card. Although the design is over 80yrs old, they're still a major form of input and program storage.

were made and soon a new kind of computer was born.

The Minis

Just as the Mini car revolutionised the way the world looked motoring so the minicomputer changed the face of computers. Up till the advent of the integrated circuit there had been only 'computers', now there were 'mainframes' and 'minis'. These two were rigidly divided into sectors of operation, the mainframes were used for serious purposes, the minis were 'toys' used in research. Among the names of companies who were to make their fortunes producing minis was DEC, probably still the world leader. Soon the mini was to be found everywhere from research labs to classrooms and their spread was due simply to the fact that they were small, cheap and relatively easy to use. They were even built into pieces of equipment like machine tools. Indeed it is fair to say that the mini paved the way for the micro, although the actual distinctions between them have been rapidly eroded.

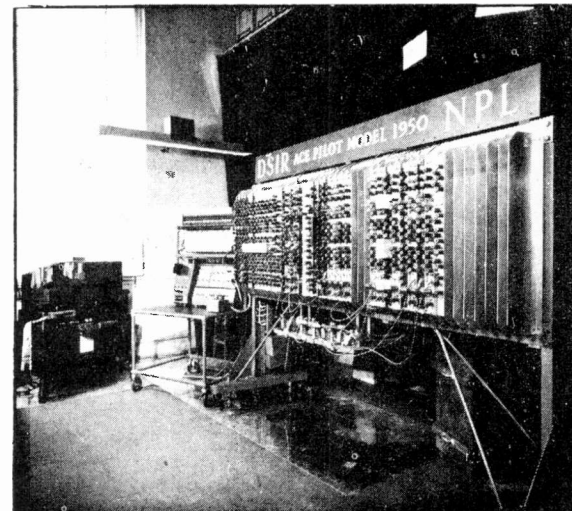

The pilot model of ACE, one of the first real computers.

Firms involved in the business of integrated circuit production tend to follow a natural progression in the devices that they make. First off the production line come the standard logic elements, the AND/OR type gates, and once the production of these is running at a profitable level they attempt to squeeze a little more onto the slab of silicon. As soon as this stage is proved they take another leap forward and so on. In the terminology this is a progression from SSI (Small Scale Integration) with about 10-20 actual devices on the 'chip' through MSI (Medium Scale Integration) which has a dozen or so gates (rather than discrete elements) up to LSI (Large Scale Integration) which is taken as being greater than 100 gates on the chip. At this stage of the game we are still talking about complex TTL

type packages, the next jump is to VLSI which, believe it or not, stands for Very Large Scale Integration. We are now in the realm of memory devices and microprocessors.

Common Concept

If we take a look at Fig.1 we can see a generalised block diagram of a computer. What kind of computer is not important; they all have the same functional blocks within them, be they micro or mainframe. The common misconception is that the "mighty chip" is a computer, far from it. Your average microprocessor still needs all the memory circuits, control circuits, mass storage devices and other components that even the old tube machines needed; they are merely smaller. The very first microprocessor came about 1971 simply because it was realised that it would be possible to make a device of that complexity on a single chip. The device was called the 4004 and the company that made it was Intel.

Eye On

The five fundamental elements of any digital computer are:— the ALU or Arithmetic Logic Unit, the control unit,

the store or memory and the input and output devices. Taking these in the reverse order we have the input and output devices, often abbreviated to the I/O. Obviously the machine must be able to communicate with the outside world and vice versa, so the most common form of I/O is the Video Display Unit or VDU. This has, to a very large degree, replaced the old-fashioned Teletype, a special electric typewriter often called a TTY, and is totally silent in operation, which is a welcome change from the racket the earlier device made. Other forms of I/O device are printers, for producing typed copy, plotters for producing graphical output or in the most esoteric cases digitisers and speech synthesisers.

The function of the I/O was simply to enable the user of the computer to load information for processing into the computer and to be able to get the answers back. Quite apart from this information there is the requirement of the computer programmer who wishes to put in information that will instruct the computer to perform certain operations. This, the program, is stored in the memory and of this vital component there are two types; general purpose memory and off-line or backing memory. The general purpose memory is made up of a large number of bistable elements manufactured in either magnetic or semiconductor materials. In the context of the micro we often refer to these as the user memory. The backing memory is generally of a mass storage type like magnetic tape in one of several forms or

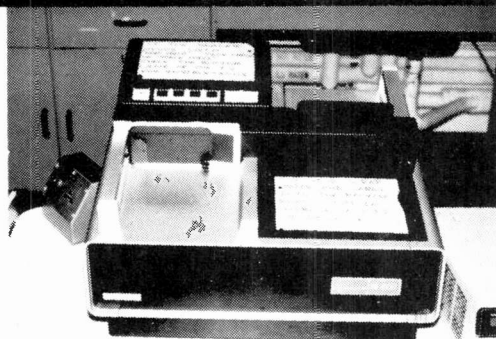

A punch card reader. Cards are stacked in the corner in the top right hand hopper, and are removed from the bottom left.

magnetic discs or drums. Whilst the computer may have immediate access to some few thousand storage elements in the user memory, it can often store a few million elements in the backing stores.

The control unit performs the task of making sure that all the various bits of the computer are working in the correct order. It would not be a very efficient machine that had to pause for information because it gave priority to looking after a printer and left the user waiting. The basis of all the control signals is a clock, in fact a very accurate



An IBM 029 keypunch. Thousands are in use in universities.



Panel view of a DEC PDP11. Virtually a standard fixture in research and universities it has become a standard.



... and this computer will even make your breakfast for you, if you're willing to spend an extra \$75 for a cereal interface.

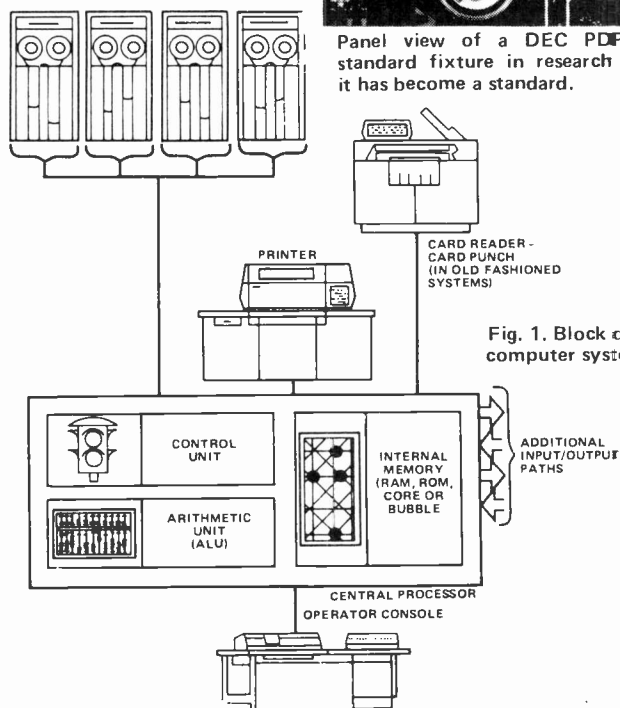

Fig. 1. Block diagram of a computer system.



Another way to talk to a computer. A Diablo terminal and modem to communicate via phone lines.

oscillator circuit running at several million cycles per second. This is the heart of the machine and almost without exception all the functions within the computer are locked or synchronised to it.

The one remaining piece of the jigsaw is the ALU. This exists solely to perform arithmetic operations on the elements that are fed to it. Some of these elements are recognised as being instructions, others are simply information which is to be processed according to

the previously received instructions. All this takes place at the level of binary signals, that is, each separate piece of information is represented by a pattern of logical ones or logical zeros and this is commonly called 'machine code'. Indeed, at this level of operation the computer is only aware of two groups of patterns — those which correspond to the defined set inside the machine, its "instruction set" in computer parlance, and those patterns which do not match this set which must be data. ●

The SINCLAIR ZX80

A complete personal computer —
Only \$329.00

COMPLETE: For just \$329.00 you get this powerful full-function computer! Proven by test to be faster than previous personal computers.

BASIC: The ZX80 cuts away computer jargon and mystique. Go straight into BASIC — the most common and easiest language to use.

QUICK: Simply take it out of the box, connect to your TV, turn it on and with the manual supplied you will be running programs in 1 hour.

SINCLAIR ADVANCED DESIGN FEATURES

- * 4K Integer Basic.
- * 1 stroke entry for key words.
- * Automatic error detection.
- * Text editing capability.
- * Machine code programming too.
- * 26 string variables, any length.
- * Random function, built-in.
- * 1K RAM matches others 4K.

Price includes TV and cassette connectors, AC Adapter, and 128 page manual.

30 Day money back guarantee.
90 Day limited warranty.



Qty. limited.
Orders shipped in sequence.

Phone (416) 787-1448

TO: GLADSTONE ELECTRONICS
1736 Avenue Rd., Toronto M5M 3Y7
Please send me ZX80 personal computer(s) @ \$329.00* each
I enclose a cheque/money-order/credit card number.

Visa-M/C:
Expiry Date:
Amount: \$
Signature:
NAME:
ADDRESS:
CITY PROV.
POSTAL CODE AGE
Occupation
Intended Use
Ever used a computer? Y () N ()

*Ontario residents please add 7% P.S.T.

WHAT'S NEW IN HOME COMPUTERS?



Find out in the latest Heathkit Catalogue. It's filled with exciting kits in every price range, all easy to assemble, all at build-it-yourself savings.

Discover the fun you and your family can have building your own home computer, stereo system, color TV. Discover the pride of

saying, "I built it myself." It's easier than you think.

Send today for your FREE Heathkit Catalogue.

Heathkit®

If coupon is missing, write
Heath Company, 1480 Dundas Highway East
Mississauga, Ontario L4X 2R7

Send For FREE Catalogue Today!

Send to: Heath Company, EV 0281
1480 Dundas Highway East
Mississauga, Ontario L4X 2R7

Send my free Heathkit Catalogue now. I am not currently receiving your catalogue.

Name _____

Address _____

City _____ Prov. _____

Postal Code _____

SELECTING A FLOPPY DISK

One of the first additions you'll want to make to your system is a floppy disk. Bruce Evans gives us advice on how to choose.

THE MOST USEFUL peripheral and the one that best turns a microcomputer into a "real" system is a minifloppy disk. Recently, I have been considering which one to buy for my SOL-20. It was a much more complicated decision than I had expected and I decided to share my method with you to save you some time and help you to make a more informed selection.

When you are shopping for a disk system, you must go about it the same way that you would research any other large purchase. Too often, computer users will buy a disk system on completely irrational grounds. It is a tribute to the manufacturers that most of these unthought-out purchases work so well but it is a shame to buy a peripheral that may surpass the price of your computer and then find that you are getting only 75% of your system's capability.

First you should ask the obvious question "Why do you want a disk system?". This can vary from wanting the best system on the block to the nuts-and-bolts answer that you need it for your business. The answer to this question will tell you where you stand in the inevitable cost-performance trade-off. The business man needs reliability at any cost while the hobbyist can horse trade. Once your priorities are established, you can go on.

Start by looking at your own system. If you have a computer that supports only peripherals made by one company, your search is over whether you like it or not. If you do have a choice, you should assess your memory first. A disk system will require 24K of reliable RAM as a minimum. Reliability of the memory is essential in the disk environment due to the speed of data transfer. A number of manufacturers of inexpensive memory boards warn in the documentation that they are not compatible with a disk system. Heed this warning. Ideally, the memory should have an access time of less than 400 nanoseconds. This is the time of the board, not just of the memory chips since the speed of memory is determined by all the

hardware on the board. Be especially wary of inexpensive dynamic boards since they generally don't have the hardware to generate a wait state if the memory requires one. Some disk systems can't respond to a wait state anyway. If you must use dynamic memory, it is best to buy a system that does not use Direct Memory Access (DMA) since this is where most memory problems will occur. You should check with the manufacturer to see if DMA is used since I found that the dealer usually doesn't know but won't admit it. The second thing to look at is your bus structure. As the controller board usually plugs into a backplane slot, it must be compatible. You can interface non-standard busses but don't try it unless you have a lot of experience and even more patience.

Next it is necessary to assess your software. If you have a monitor program in read-only memory, it is usually more efficient to get a system that interacts with the monitor than to get one that duplicates the monitor functions. You should also look at any conflicts that may occur between your present programs and the new software. There is no uniformity in the computer industry as to where programs reside. If your Disk Operating System (DOS) starts at 0100 Hex and your favourite programs load at 0000, they had better be short! If such a conflict exists (and it probably does) you have three choices. You can relocate the programs (often difficult but possible), you can replace the software (try haggling with your dealer) or you can discard your software and start over. None of these are satisfactory, so try to avoid them.

Once you know why you are looking for a disk and what you have to start with, it is time to look at the systems you are considering. First look at the system hardware which consists of a controller board that plugs into your machine and a disk drive that is connected to it. You can arrive at this combination by homebrewing it, building it from a kit or buying it assembled. If you are a homebrewer, read no more, this article isn't for you. If you want a kit

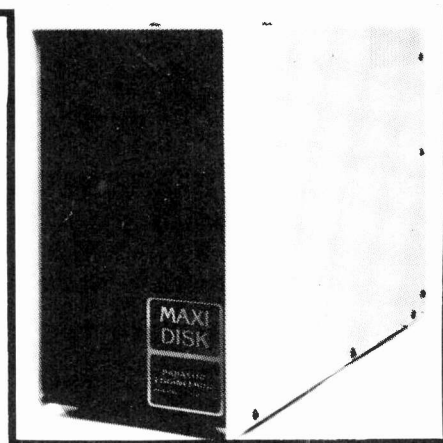

A typical 8 inch Floppy disk drive. You'll need more than this, however, before it'll run on your system.

you are limited to North Star which really isn't too bad a limitation. However, I think most of you will be buying the system assembled. Except for making sure that the controller board is compatible and that it has the capability to handle enough drives, there isn't much to this part of the system. When it comes to the disk drive, it is best to stick with well known names such as Shugart and Percom. They have been around for a long time and have proven their reliability. There is no sense in buying brand X unless there is a very marked difference in price and you know that your local dealer can service it. The number of drives depends upon your demands and pocketbook. Two are very useful for a hobbyist but one is really quite sufficient.

The main part of the software is the Disk Operating System. You can write your own; you can purchase one written specifically for your system or you can buy CP/M. If you want to write your own, read no farther, you can join the homebrewers. The one specific for your system is usually supplied with the disk system. It is specific for the hardware and other software provided but it has to be customized for your computer. This process can be very easy, such as in the Micropolis system where you merely enter the code number for your system into the initialization portion, or it can require writing a machine language subroutine. In the latter case the documentation usually includes a sample program to guide you. If this is beyond your capabilities, the dealer can do it for you, probably at no cost. The limitation of this choice of DOS is that it is impossible to swap software on disks from different

systems. If you write all your own software, this is no problem but if you write software to sell, it is crucial that you have a system that has a large number of users or you will have a severely limited market. So too, if you usually buy your software ready written, it is important that your DOS is one that is supported by many software dealers. This is certainly the case with CP/M and North Star systems and to a lesser degree with the Micropolis system.

DEC's disk operating system, CP/M, has the advantage of being compatible with many different 8080-based micro's. Any software written on any computer using this monitor program can be read and run by any other machine using it. For further information on CP/M, I would suggest reading Dr. John Stewart's article in the April 1978 issue of kilobaud as a complete discussion of this is beyond the scope of my article. I would like to add that CP/M does require 10 K for its storage whereas most system-specific disk operating systems require less than half of this. Also, most reviewers dwell on the compatibility of CP/M but few are completely happy with all its features. Personally, I can't stand its editing function!

You should also decide whether you want single or double density formatting of your disks. This is probably academic since all the manufacturers seem to be switching to double density to increase the storage on the diskette. They all claim fabulous reliability but I have talked to several fellows who repair computer equipment and they were all rather negative on the dependability of the double density format.

Next you should consider what other software comes with the system or is available. Most packages include a form of extended disk BASIC. If this is your main programming language, give it a lot of study.

If you do much string handling, it would be worthwhile reading Richard Roth's article in the May 1978 edition of Kilobaud which deals with the string handling capabilities of the two main versions of BASIC. Unfortunately, there is no perfect version of BASIC and you will have to make compromises here; so be sure that you know the pro's and con's of the BASIC provided. Remember that

the speed of the BASIC is provided. Remember that the speed of the BASIC is probably its least important feature. If you are planning to program in FORTRAN, Pascal or assembly language see if these are available and try them in the store before you decide. Very often an assembler is included in the package but make sure that you feel at ease with it. There is little in common between various assemblers other than the mnemonics! The same is true of text editors.

You are probably wondering where you can get all the necessary information. The best place is from friends or members of a local computer club who have disk systems. They have used them and can give you an unbiased opinion of the good and bad points (unless they are trying to unload a lemon system on you themselves!). Also any of these will be more than pleased to show you his system in action and let you try it. Hands-on experience is invaluable. Your computer-users group will also be helpful. Computer magazines are a goldmine of information and I have earlier mentioned two useful articles. However, remember that happy users

Many manufacturers supply disk systems to run directly on their machines. It's better to have two drives from the standpoint of data safety. You can have two sets of data, one for back up.

tend to write articles and unhappy ones tend to write letters-to-the-editor. Check both places. Naturally, your local dealer should give you a lot of information but as more and more dealers are starting to carry only one brand, their advice is not without bias. Be prepared to challenge any of their statements and don't accept fuzzy answers. Finally, all the major manufacturers of disk systems will very quickly and courteously answer your questions by mail. I find them very helpful and knowledgeable. They usually can answer direct questions better than any other source.

In conclusion, you must take the time and effort to be able to make the best decision on which disk system to buy. However, it will be well repaid when you upgrade to disk. One final piece of advice is to be sure you have the dealer put in writing that if the system does not work in your system, you can return or at least exchange it.



THE WORLD'S PRINTER LEADER

EPSON

Member of Seiko Group.

NOW IN CANADA

THROUGH

E.S.S.N.A. LTD.

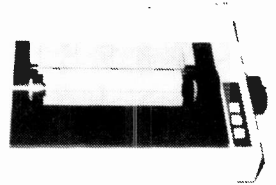

MODEL MX-80

The EPSON MX-80 Dot Matrix Printer is a highly versatile, general-purpose and computer-grade printer featuring 80 CPS bi-directional printing with logical seeking capability and 9x9 dot-matrix character formation. The

MX-80 accepts the ASCII 96 codes and codes for special characters/symbols (e.g., Å Ç £). It also accepts codes for 64 graphic patterns.

Characters can be printed in any desired size — enlarged, condensed, emphasized, normal, etc.

The one-chip microprocessor is engaged in performing all functions of the Printer and the two built-in stepper motors of the MX-80 control the carriage and paper feeding

functions respectively. Therefore, versatile software controls, such as horizontal and

vertical tabs, and form feed are at your disposal.

In addition, various interface options are available to permit handshaking with most personal computers.

MODEL 3110

The model 3110 Dot Matrix printer Mechanism is 80 columns, 150 characters per second, with a 5 x 7 dot Matrix. This model is excellent for intergration as a part of system where reliability and speed are important. It will operate in the horizontal as well as the vertical position.

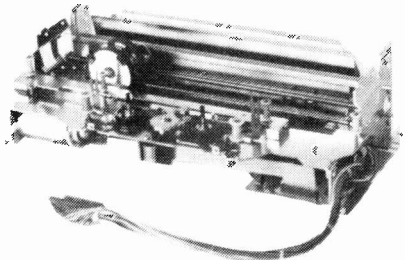

MODEL 512

The model 512 Dot Matrix printer mechanism is bi-directional, 40 columns, 3.0 Lines Per Second with a print Head Life expectancy of 100 x 10⁶ characters. It is ideal for OEM use as a general purpose page printer.

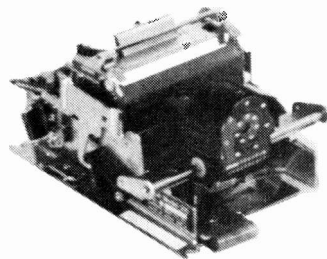
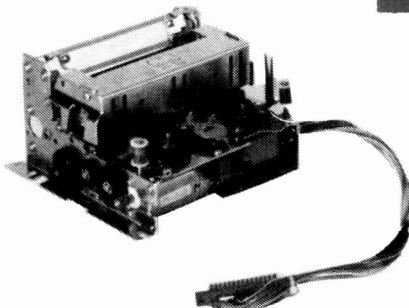

MODEL 210/210-S

The model 210 Dot Matrix Printer Mechanism is ideally suited where speed, compactness, and reliability are mandatory. The 210 will print from 26 to 35 columns at 2.4 Lines Per Second on paper three inches wide in two colours. the 210 is also available with sprocket paper feed.

E.S.S.N.A. LTD.

425 Steelcase Road East
Markham, Ontario L3R 1G3
(416) 495-9392
Telex 06-966623

The Tx-80-B Printer is a low cost (\$750*) high performance Dot Matrix Printer. It will interface to P.E.T., TRS-80, Apple 11, Centronics type interface as well as RS232-C serial. This concept assures low printer upgrade cost and high resale value. *Qty. One F.O.B. Cdn. Funds. *Acoustic covers available for Model Tx-80-A & B friction feed and tract feed.

TECHNICAL/PRODUCT SUPPORT FOR ABOVE PRODUCTS

1. SPARE PARTS SOLD FOR ALL PRODUCTS
2. RIBBONS AND ACCOUSTIC COVERS
3. ELECTRONICS FOR ALL MECHANISMS
4. CUSTOMIZED INTERFACES FOR ALL PRINTERS
5. LOCAL AND CENTRALIZED REPAIRS

MODEL MX100

The MX 100 is a high speed Bi-directional with logical seeking Dot Matrix Printer. It will print up to 136 column on 15 inch wide paper. It can produce one original and four copies. Interfaces with most smaller business computers.

THUNDER BAY AUDIO
CENTRE
Tel.: 807-345-7334

LEVEL TWO COMPUTERS
Tel.: 416-579-5613

CANADIAN MICRO
DISTRIBUTORS LTD.
Tel.: 416-878-7277

COMPUTERLAND OF WINNIPEG
Tel.: 204-772-9519

ARISIA MICROSYSTEMS
Tel.: 416-274-6033

ARKON ELECTRONICS LTD.
Tel.: 416-868-1315

COMPUTER INOVATIONS
Tel.: 613-233-8413

CUSTOM COMPUTING SYSTEMS
Tel.: 306-242-7808

IRISCO DU QUEBEC INC.
Tel.: 418-647-4422

Distributed in Canada by:

COMPUCENTRE
Tel.: 514-354-3810

FUTUR BYTE
Tel.: 514-861-3120

SEMAD ELECTRONICS
Tel.: 416-663-5650

B.W.W. TELECOMPUTING
SYSTEMS LTD.
Tel.: 403-265-4039

CONTI ELECTRONICS LTD.
Tel.: 604-324-0707

THE COMPUTER SHOP
Tel.: 403-243-0301

LYONS LOGIC LTD.
Tel.: 519-672-8220

COMPUTER CIRCUIT
Tel.: 519-672-9370

MEGABYTE BUSINESS
SYSTEMS LTD.
Tel.: 416-684-5155

Dealer Inquiries Invited O.E.M. Discount Available.

For further information on printer mechanisms, circle No. 40 on Reader Service Card. For information on complete printers, circle No. 41.



To get yours, fill in the form in this issue or write to ETI Magazine, Unit 6, 25 Overlea Blvd., Toronto, Ontario M4H 1B1. Please allow six weeks for delivery. Due to sometimes uncertain supplies, some books may not be in stock, please indicate whether you wish your order held or if you wish your money refunded.

Master Handbook Of 1001 Practical Circuits
TAB No. 800 \$18.30
Master Handbook Of 1001 More Practical Circuits
TAB No. 804 \$18.35

Here are IC and transistor circuits for practically anything and everything — with ALL the data needed to put them to work. The ideal schematic source-book for all active technicians, engineers, experimenters, amateurs — for anyone who must occasionally or regularly construct or adapt electronic circuits for any purpose whatsoever. You'll find any circuit you're ever likely to need in the pages of this rich volume. The schematics are classified according to general application, and the Sections themselves appear in alphabetical order.

99 Test Equipment Projects You Can Build
TAB No. 805 \$11.75

Here's the A to Z guide you need to build all sorts of electronic test equipment — from a simple signal tracer to a sophisticated multi-frequency 50 MHz counter — and virtually everything in between! Here are voltmeters and ammeters, capacitance meters, resistance and impedance meters, testers for solid-state components, digital voltmeters, calibrators and frequency standards, signal generators, frequency counters, oscilloscopes, and a variety of RF test equipment. The variety is incredible and almost endless — virtually every test instrument you could possibly want to build for yourself, it's perfect for the hobbyist — and indispensable for the professional because you can incorporate each one — or a combination of several — into your work bench setup or other gear.

The Power Supply Handbook
TAB No. 806 \$11.75

A complete one stop reference for the hobbyist and engineer. Contains high and low voltage supplies, as well as mobile and fixed units. Everything you need to keep your project perking with the right volts and amps.

Build Your Own Working Robot
TAB No. 841 \$8.55

Here are complete instructions — plans, schematics, logic circuits, and wiring diagrams — for building Buster. Not a project for novices! Buster is a sophisticated experiment in cybernetics. You build him in phases and watch his personality develop as you add progressively more advanced circuitry to his mainframe. The first of this three-phase robot, Buster I, is "leash-led" and dependent on his master for decision-making; you create the "animal" and give him wheels, steering capability, and the capacity to "understand" your basic commands. Phase II makes Buster more independent. Now he has a basic brain he can use to decide when he's in need of a battery charge, or trapped into a physically binding situation he can't get out of.

57 Practical Programs & Games In Basic
TAB No. 1000 \$11.55

From arithmetic progression to statistical permutations to one-arm bandits, here are 57 practical, useful and fun programs designed to help you really put your minicomputer to work!

Game programs include blackjack, one-arm bandit, craps, and two space wars. Math and accounting programs include compounding, straight-line depreciation, statistical permutations, instant derivatives, and solutions for integrals — even a whole section of geometric solutions for modern-day Euclid. For history buffs, there is a Day-of-the-Week program for any date back through 1753.

Each program begins with an introductory paragraph describing its capabilities, and continues with a typical program sequence and flowchart. All programs will run on any floating point BASIC.

Tower's International Transistor Selector
TAB No. 1010 \$9.85

Here are transistor substitutions, outline diagrams, terminal identifications, manufacturers' codes and specs for more than 13,000 devices made in the U.S., Japan, Europe, and England. This ultra-complete reference-guidebook is an absolute MUST for anyone who deals with transistors or the equipment in which they're used — makes it as easy to locate transistor substitutes for Japanese and European imports as for mass-market U.S. consumer electronic products. Contains info on device ratings, characteristics, case and terminal identification, applications, manufacturers and addresses, and voltage ratings — collector-to-base, collector-to-emitter, and emitter-to-base.

A Beginner's Guide To Computers & Microprocessors — with projects
TAB No. 1015 \$9.70

Here's a plain-English introduction to the fascinating world of the microcomputer — its capabilities, parts, functions, and programming — and how you can have one in your own home. Numerous projects, using actual computer parts, demonstrate the operation of a computer and lead to the assembly of a working minicomputer capable of performing many useful functions around the home and office.

A typical family-sized computer, with video screen, printer, and keyboard, is fully described.

How To Design, Build & Test Complete Speaker Systems
TAB No. 1064 \$11.85

If you've always wanted to build your own speaker system, here's a book crammed with everything you need to know to do it right — the first time! It contains a variety of ready-to-build speaker system projects, from simple speaker-in-a-box setups to complex multi-drive systems, plus all the information even a beginner needs to design and build his or her own.

This clear guide shows you exactly how a speaker works, how its power and resonance are attained, and how speakers may differ from one another. It's as thorough a book as you'll find on the complete subject of speakers, speaker systems, and enclosures.

Digital Interfacing With An Analog World
TAB No. 1070 \$12.35

Are you looking for ways to really put your microcomputer to work? This book tells you how to go about it — how to convert energy produced by pressure, force, position, temperature, etc. into an electrical voltage or current that your microcomputer can deal with. It's for the user who views the microcomputer as a bit of hardware to be applied, and who views software as either a simple set of instructions to make the machine go or, more importantly, as a valid substitute for hardware. It presents information, in handbook style, for users of microcomputers who want to design a device or system with a microcomputer at its heart.

Very simply, this book is for the microprocessor/computer user who wants to use the machine to measure certain conditions, or to control external devices.

The Complete Handbook Of Robotics
TAB No. 1071 \$10.90

Create your own robot? All the information you need to build a walking, talking friend and companion or a helpful servant appears in this book!

Your robot can take on many forms and operate in any way you choose. Every possible option is covered in minute detail — including light, sound, heat, and proximity sensors, minicomputer "brains" and more.

Whether you want a robot for a experimenting, for a security application or to perform some task suitable for a "smart" machine, all the ideas you need are packed into this book.

Artificial Intelligence
TAB No. 1076 \$11.55

Artificial intelligence is the branch of computer science devoted to programming computers to carry out tasks that, if carried out by human beings, would require intelligence. Here is a book that deals with the entire subject of artificial intelligence. It describes what we consider intelligence where computers are concerned, and presents an interesting summary of the step-by-step advancement of computer complexity toward the rudiments of human-type intelligence.

Illustrated Dictionary Of Microcomputer Terminology
TAB No. 1088 \$11.85

This reference book, contains clear and detailed explanations for nearly 4000 terms currently used in the exploding field of microcomputers.

Anyone having trouble understanding the "buzz" words, the jargon, the technical language to the computer crowd — and the domain of the personal computer in particular — will find this authoritative reference book of terminology absolutely indispensable.

OSCAR: The Ham Radio Satellites
TAB No. 1120 \$7.75

If you want to get in on one of the hottest new frontiers in amateur radio, this book is for you! It's your thorough guide to communications via the Orbital Satellite Carrying Amateur Radio (OSCAR) satellites. If you think amateur radio is fun now, wait till you see what can be done by using satellite communications. This easy-to-read manual will tune you in on one of the latest trends in ham radio, and at the same time show you all the details you need to start your own amateur earth station.

The Active Filter Handbook
TAB No. 1133 \$9.75

A designer's and users' guide to the theory and applications of active filter circuits.

For anyone interested in electronics, this handy one-stop guide to modern filter technology will prove invaluable. It introduces filters and their purposes, compares different filters, and covers LC passive filter operation, op amps, Butterworth filters, Chebyshev filters, low pass filters, high-pass filters, etc. This all-inclusive manual offers coverage of electronic math and basic electronic theory also. Cannot be beat for a complete and practical discussion and examination of filter techniques.

Antenna Data Reference Manual
TAB No. 1152 \$11.75

Since the antenna system has a large influence on what you get out of a ham or CB station or get into a shorewave or an AM/FM receiver, best results are obviously achieved with the best possible antenna. This book will show you how to make and install hundreds of antennas, among them half-wave dipoles, inverted vees, verticals, yagis, quads, deltas, FM broadcast, and CB antenna and transmission line, plus limited space and hidden antennas. Included are precise specifications for a huge variety of different designs, tuned to work on most amateur, marine, international broadcast, AM/FM broadcast and CB bands.

The Giant Handbook Of Computer Projects
TAB No. 1169 \$13.75

If microcomputers have caught your interest, or if you've been through the ready-made hardware routine, you're ready for this book. It's a huge collection of ready-to-use information designed for the enterprising hobbyist who wants more flexibility — and practicality — than that offered by systems assembled for the mass market.

Model Radio Control — 3rd Edition
TAB No. 1174 \$9.75

This all new and complete revision will thoroughly acquaint you with everything you need to know about model radio control — how it works, how to design a system, how to install it, and how to operate model airplanes, cars, boats, toys or virtually anything by radio control. Starting out with fundamental RC concepts, the author takes you through all the latest and most modern equipment. Including coding and coders, relays, superregenerative receivers, decoders and power control circuits, servo motors, tone-operated and proportional control systems and much more!

If you want to keep up with the changes in radio-controlled modeling, or if you want to get in on the ground floor of the hobby, this lucid guide should be part of your library.

21 Custom Speaker Enclosure Projects You Can Build
TAB No. 1234 \$11.75

If you really want to get some truly great sounds out of your audio system, this unique new book shows you 21 good ways to do it. From simple closed-box systems to complex omnidirectional speakers, you get complete descriptions, design and construction details for 21 build-it-yourself projects — virtually every kind of audio speaker you could want. You can pick and choose your own project — from the simplest to the most advanced... for home or car, stereo or quad... even for a van or RV.

How To Build Your Own Self-Programming Robot
TAB No. 1241 \$11.75

This is a straightforward how-to book about machine intelligence — a practical guide that shows you how to build a robot capable of learning how to adapt to changing circumstances in its environment. The unique little creature described in this book, named Rodney, can pick up signals and stimuli from his environment and develop perceptions just like humans and higher animals do. Yet Rodney is fully trainable, and his "personality" can be altered and molded by human intervention. All in all, Rodney is in a class by himself, and is a most remarkable and fascinating machine — he can program himself to deal with the problems of the moment and devise theories for dealing with similar problems in the future. Yes, Rodney is self-programming, and as a result no two Rodneys behave exactly the same way. In fact, if you wipe out his self-generated memory, he'll develop another one that's somehow different from the first.

An Introduction to Personal & Business Computing
SYBEX C200 \$10.75

This is a basic introductory text on microcomputers. Its main goal is to answer the question: "What do I need for...?" in specific detail. No previous technical background is assumed. The author addresses progressively all the essential topics of interest to the microcomputer user (as opposed to the designer). How a system works, which modules are required for which function, how much memory is needed, which peripheral should be used, the cost. The software. Differences between existing microcomputers. Is a mini-BASIC sufficient? The real cost of a business system, its limitations. Can you really manage a mailing list on a floppy disk? Packages and other programs. The traps for the hobbyist. Application techniques. New systems and facilities.

The book is designed to educate the reader in all the aspects of a system, from the selection of the microcomputer to the required peripherals. No computer background is required.

Programming the 6502
SYBEX C202 \$18.75

An educational text designed to teach you programming from the ground up. Already one of the most successful programming books ever published, it has been revised and expanded at both the low end and high end of the spectrum. The range of programming concepts and techniques presented is such that it addresses the needs of virtually every programmer interested in using the 6502 microprocessor, from beginner to expert.

Programming the Z80
SYBEX C280 \$20.75

This book has been designed both as an educational text and as a self-contained reference book. As such, it can be used as a complete introductory book on programming, ranging from the basic concepts to advanced data structures manipulations.

It also contains a comprehensive description of all the Z80 instructions as well as its internal operation, and should provide a comprehensive reference for the reader who is already familiar with the principles of programming, but wishes to learn the Z80. All concepts are explained in simple yet precise terms, building progressively towards more complex techniques.

Programming the Z8000
SYBEX C281 \$22.75

This book was designed as both an educational text and a self-contained reference manual. This book presents a thorough introduction to machine language programming from basic concepts to advanced programming techniques. Detailed illustrative examples and numerous programs show the reader how to write clear, well-organized programs in the language of the Z8000.

With over 113 illustrations, a thorough index, and 5 appendices, Programming the Z8000 is an indispensable text for engineers, students, PDP-11 users and anyone interested in learning machine language programming skills.

6502 Applications Book
SYBEX D302 \$18.75

This book presents practical applications techniques for the 6502. You will build a complete home alarm system, including fire detection, as well as an electronic piano, a motor speed regulator, a time-of-day clock, a simulated traffic control system, and a Morse code generator. You will also design an industrial control loop for temperature control, including analog-to-digital conversion, and your own simple peripherals from paper-tape reader to microprinter.

Truly the "input-output" book for the 6502, it includes more than 50 exercises designed for testing yourself at every step.

6502 Games Book
SYBEX G402 \$18.75

This book is designed as an educational text on advanced programming techniques. It presents a comprehensive set of algorithms and programming techniques for common computer games. All the programs are developed for the 6502 at the assembly language level.

The reader will learn how to devise strategies suitable for the solution of complex problems, typical of those encountered in games. He/she can also use all the resources of the 6502, and sharpen his/her skills at advanced programming techniques. All the games presented in this book can be played on a real board (the SYM), and require a very small amount of additional components.

PIEZO ELECTRICITY

It sparks when you hit it. Well, that's not an altogether bad description of the Piezo Electric effect, but these crystals can do a whole lot more as Ian Sinclair explains.

PIEZO ELECTRICITY HAS been with us for some time, and yet we seem to keep meeting new applications of this remarkable effect. How is it that we can use the crystals to generate sparks, to convert vibration into electrical waveforms, to stabilise the frequency of oscillation, or to make precise electrical wave-filters? Here's how — just switch off that soldering iron for a minute or two.

By this time, you should be getting used to the idea that most materials form crystals. Crystals are regular arrangements of atoms, probably the most perfect structures we know, but that doesn't mean that the structures are exactly alike in each direction. The key word here is isotropic. An isotropic crystal has the same properties in any direction (Fig. 1). Properties in this case means measurable quantities like electrical conductivity, heat conductivity, expansion coefficient, elasticity and all the other measurable quantities which fundamentally depend on how atoms are arranged.

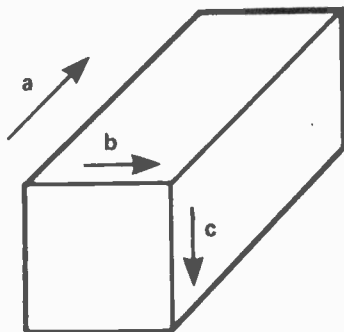

Fig. 1. An isotropic crystal gives the same readings for quantities like expansivity, resistivity, etc., in any direction along the crystal, a, b, or c.

Crystal Clear

An isotropic material is mercifully easy to make measurements on, because you don't have to choose any special direction in the material. The materials we call anisotropic (meaning not isotropic) aren't like this, though, how they behave depends on which direction we choose to work on. Wood is a simple example, everyone who has ever worked on a piece of wood knows how differently wood cuts across the grain as compared to along the grain.

Many crystals are anisotropic, because the spacings between atoms are quite different in different directions along the crystal. The result is that each quantity that we can measure will have different values, depending on the direction that we choose in the crystal.

Now when a crystal is anisotropic, it usually behaves

in a peculiar way in a strong electric field. Any material will be affected by a strong electric field; usually what happens is that the material has some electrons separated off, starts to conduct, then sparks across. Some very anisotropic crystals behave differently, their atomic spacings re-arrange themselves a bit. When this happens there is no way the crystal can be the same size as it was before, because the size of the crystal is decided by the size of the atoms and the way they are arranged. Usually what happens is that the atoms move slightly closer to each other *in one direction* so that the crystal becomes slightly shorter in that direction. The dimensions of the rest of the crystal may remain unchanged. These changes of length are very small, but they're certainly not undetectable.

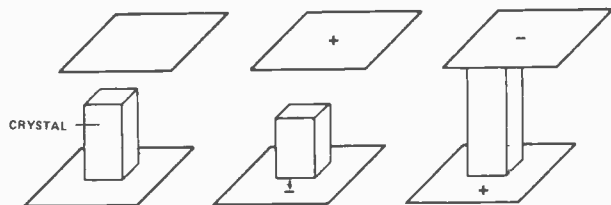

Fig. 2. The drawing's an exaggeration, of course, but it shows the idea. Piezo-electric crystals become shorter in one direction of electric field and longer when the field is reversed.

What makes the process more interesting is that if an alternating electric field is applied to the crystal, it will become longer and shorter alternately, in phase with the field. How do we apply an alternating field? Simple enough, we simply sandwich the crystal between metal plates and connect an alternating voltage between the plates. Since we usually want the distance between the plates to be very small, the usual way of achieving this is to deposit a metal, usually silver, on opposite faces of the crystal, making sure that we have chosen the right direction in the crystal.

With a crystal treated in this way, an alternating voltage across the metal conducting will cause vibration, with the crystal length becoming longer and shorter at the frequency of the AC. This is a piezoelectric transducer, which will vibrate at the frequency of the AC signal and pass on the mechanical vibration to anything in contact with the crystal. Cementing one face of the crystal to a diaphragm creates a piezoelectric tweeter, a loudspeaker unit which will give out a sound wave from the large surface of the diaphragm which is being vibrated by the crystal.

Fast Movers

There's no reason to stick to frequencies in the audio range of 30 Hz—20 kHz though. The crystals them-

selves can vibrate quite happily at much higher frequencies, even up to several MHz. In this way we can have ultrasonic tweeters, giving out invisible beams of air vibration like sound but at frequencies too high to hear. The favourite frequency range is around 35--65 kHz, because the vibration of the crystal can be transferred to air reasonably easily in that frequency range.

Any material that is in contact with the crystal will be vibrated along with it, though, so that this ultrasonic vibration has many applications. One is non-destructive testing. A piezoelectric crystal vibrates a sample, perhaps a metal casting, and the path of the beam of vibration through the material is traced, using another piezoelectric crystal as a detector. An invisible flaw inside the material causes the beam path to be unaccountably shifted, so that the material can be rejected. This principle is used widely, along with X-ray methods, for detecting holes and faults in metal casting, particularly if the casting is valuable or if its failure could cause likes to be in danger. They don't bother too much with things like the kick-start cranks of motor bikes, though!

Fig. 3. An ultrasonic cleaner. The metal beaker has a piezo-electric crystal soldered to the base. Leads to the beaker and to the contact on the face of the crystal are fed with high frequency signals from the generator. The vibrations of the crystal cause the liquid in the beaker to vibrate.

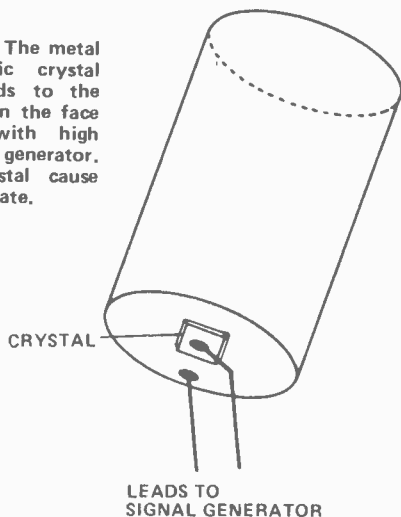

Clean Sound

Ultrasonic cleaning is another widespread use of ultrasonics. A piezoelectric crystal is mounted on the base of a metal beaker, so that it will vibrate any liquid in the beaker — the liquid can be water or any grease solvent like benzene, and anything placed in the vibrating liquid will be thoroughly cleaned with no need for scrubbing. Of course, you've all got cheap digital watches and probably don't remember the old fashioned tick-tock type, but ultrasonic cleaning was the standard method for cleaning these things. Using an ultrasonic cleaner meant that the watch didn't have to be taken apart, so saving an immense amount of time and skilled work.

A piezoelectric crystal with quite a different type of application is the quartz crystal. Quartz crystals are prepared in just the same way as the barium titanate crystals of ultrasonic cleaners, but the aim is not to harness the mechanical vibration but to make use of the electrical behaviour of the crystal. Any insulator with a couple of metal contacts on opposite faces is a capacitor, but the materials we usually make into capacitors are not piezoelectric, so that the capacitor behaves, well, just like a capacitor.

A capacitor made from a piezoelectric material is rather special, though, because electrical energy is converted into mechanical energy of vibration when the

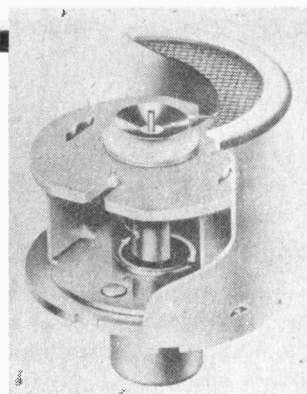

An ultrasonic transducer utilizing the piezo electric effects.

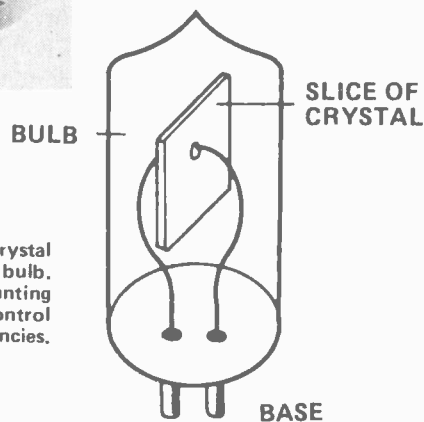

Fig. 4. A quartz crystal inside an evacuated bulb. This is a type of mounting used for crystals that control radio transmitter frequencies.

crystal is driven by an alternating voltage. This, in turn, alters the electrical behaviour. A good comparison is a loudspeaker speech coil which may measure 6 ohms on a meter, but whose apparent resistance, equal to AC volts divided by AC amps, can change considerably from one frequency to another because of the transfer of energy from the coil to the core.

The crystal and the loudspeaker also show the effects of resonance. At one particular frequency, the energy converting process is very much more efficient than it is at other frequencies, so that a very large amount of vibration can be caused by a very small amount of electrical energy. Now this resonance is the same sort of effect as we get when an inductor and a capacitor are connected together either in series or in parallel, but with one important difference. Mechanical resonances are usually very sharply tuned, with a very small bandwidth, a quantity which is measured by the 'Q' factor of a tuned circuit. Q factors of 100 to 250 are considered pretty good by the standards of electrical tuned circuits, but mechanical resonances can achieve Q values of 30,000 or more.

Crystal gazing

All of that prepares us for the fact that the quartz crystal behaves electrically like an incredibly efficient tuned circuit. At a frequency well below the frequency of mechanical resonance, the whole thing behaves like a capacitor, with a value of reactance which decreases as the frequency is increased, and a 90° phase shift, current leading voltage. This behaviour keeps up until near the frequency of resonance, when the crystal starts

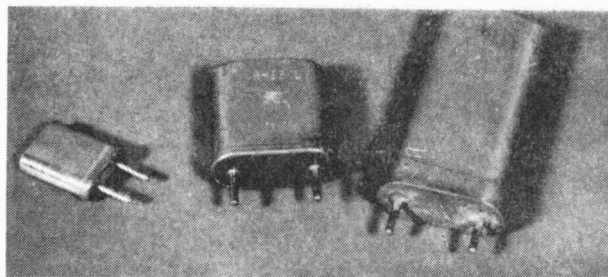

Various types of crystals used in radio equipment. The one on the right is a 100kHz unit used for frequency marker generators.

PIEZO

A crystal filter centering on 9MHz.

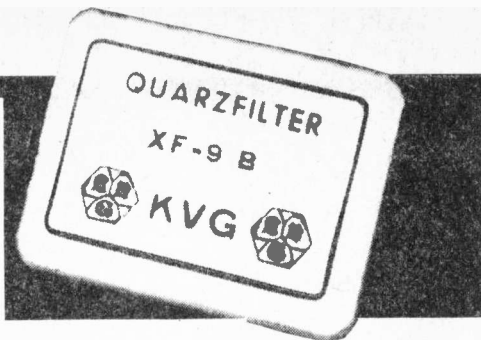

to behave as if it had a resistor connected in parallel with the capacitor, allowing more current to flow, and reducing the phase shift. At the first peak of resonance, the crystal behaves for AC like a small value resistor, with no phase shift. This peak is called the series resonant peak. As the frequency of the signal across the crystal terminals is raised, the resistance rises, the phase shifts violently again and at a frequency a few kHz higher than the series resonant frequency another resonance occurs. This time the crystal behaves like a parallel resonant circuit, and at the peak of resonance the resistance appears now to be very high, once again with no phase shift. At higher frequencies still, the crystal behaves like a capacitor again, with a 90° phase shift, current leading voltage.

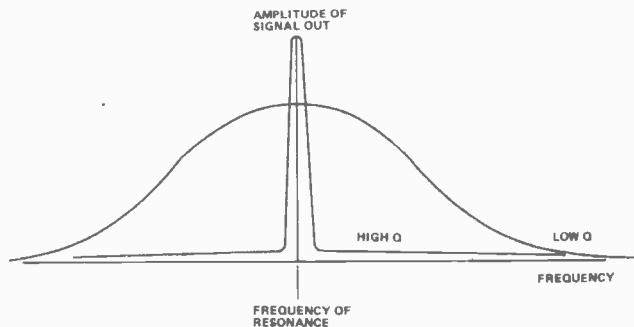
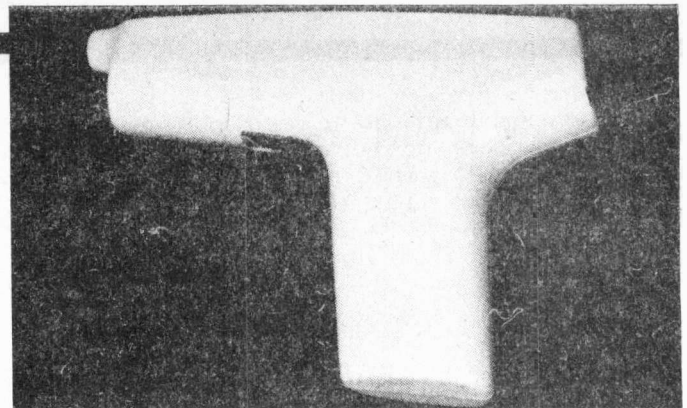

Fig. 5. Q-factor of a tuned circuit. A high-Q tuned circuit tunes sharply to one frequency, so that there is very little output at other frequencies.

All of this leads to crystals being used in oscillator circuits which can maintain a very precise frequency—used for applications as diverse as digital watches and radio transmitters. In addition, crystal filters can be designed which will pass only a very small bandwidth around a selected frequency.

Quartz crystals intended for oscillators are never driven very hard—too much vibration could split the crystal—but the vibration can be used. The piezoelectric effect can work both ways however, particularly in ceramic crystals and if we put a second set of electrode plates onto a ceramic crystal then a mechanical vibration of the crystal will cause an alternating voltage to appear across these additional plates. This arrangement can be used as a very efficient filter, passing only a narrow band of frequencies around the resonant frequency of the crystal. This can permit the use of untuned (IC) amplifiers, with just a couple of these ceramic filters providing the tuning. In addition, the removal of unwanted frequencies is much easier than when coil-capacitor tuned circuits are used.

The fact that the effect works the other way around—with mechanical vibration causing an electrical output—has, of course been the basis of ceramic gramophone pickups for many years. Less well known is the application of the same transducers to measure speed and acceleration of aircraft and missiles. The transducers give a voltage proportional to acceleration, and analogue computers transform this into readings of



An anti-static gun using piezo electricity to generate a high voltage.

Fig. 6. Equivalent circuit of a crystal—this circuit would behave electrically just like a crystal if we could ever get suitable components for L, C and R.

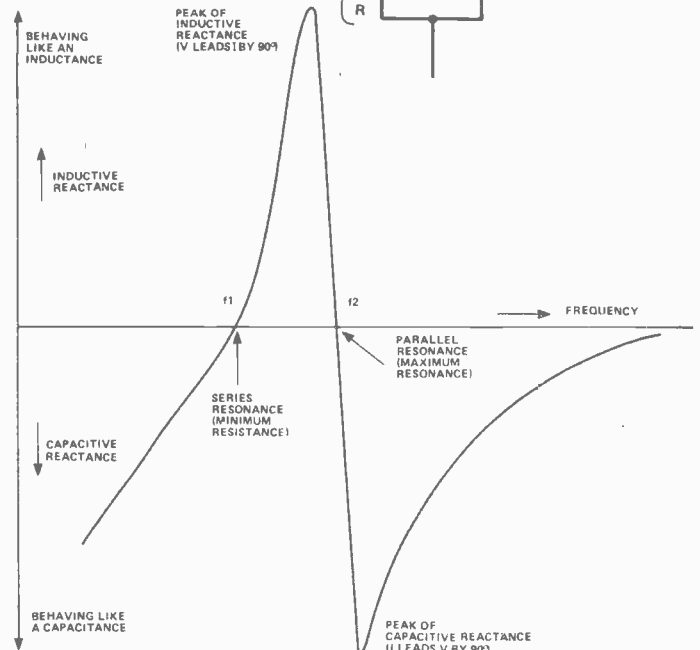
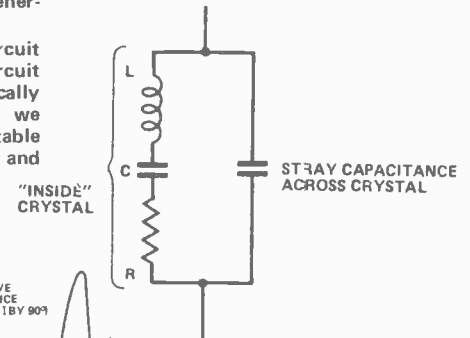

Fig. 7. Electrical behaviour of a crystal. At low frequencies, the crystal behaves like capacitance, with its reactance decreasing until it reaches zero at f_1 , the frequency of series resonance. Just about this frequency, the crystal behaves like an inductor, reaching a peak of reactance which then reduces to zero again at f_2 , the frequency of parallel resonance. The crystal then behaves like a capacitor again, with a peak of reactance occurring before the normal capacitor reactance curve is resumed.

speed and distance. In addition, the transducers which are used as ultrasonic sources can also be used as receivers for the same frequency, so that ultrasonic burglar alarms are possible.

The familiar piezoelectric gas lighter is yet another example of these crystals in use. A barium zirconate crystal can give an enormous voltage, 20kV or more, when it is hit hard enough. These gas lighters pull a hammerhead back against a spring and then suddenly release the lot on the unsuspecting crystal. Result is a sudden pulse of voltage, enough to produce a spark across a gap. Sparks, squeaks and squeezes; they're all part of the piezoelectric story!

INTO ELECTRONICS (Part 5)

In our last part we discussed what is necessary to make a transistor work. This month Ian Sinclair tells how to turn them into amplifiers.

IN THE PREVIOUS CHAPTER we ended up with transistor amplifiers and their voltage gain, which is

$$\frac{\text{signal voltage out}}{\text{signal voltage in}}$$

Table 1 summarises the methods of calculating just how much voltage gain you can get from a single-transistor amplifier; the current gain is, of course, the figure h_{fe} which can be measured for any transistor. A simple circuit for measuring h_{fe} is shown in Fig. 1; it is useable only for silicon NPN transistors, but that's the type we mostly use now anyhow. Assuming that the transistor starts to conduct for about 0.5 V between the base and the emitter, the resistor R1 makes the current into the base about 5 μ A. Now if the h_{fe} value for the transistor happens to be 200, the collector current caused by this base current will be $200 \times 5 \mu$ A, which is

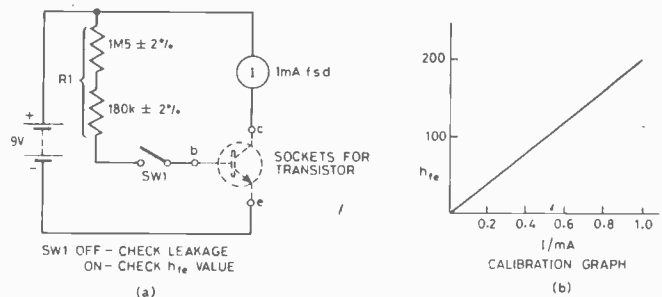

Fig. 1. Simple transistor tester circuit (a), with calibration graph (b). If any reading appears on the meter before SW1 is pressed, the transistor is leaky and should be rejected.

resistance, for example, which is equal to the ratio $\sqrt{V_b}/I_b$. The squiggles above the letters indicate that these measurements of base voltage and current are of AC signal voltages and current, not DC. This quantity, written as R_{ie} is not a constant resistance, its value depends on the amount of steady bias current that is passing through the transistor. A close approximation for modern transistors is $R_{ie} = h_{fe}/g_m$ with R_{ie} in kilohms. For example, a transistor with the usual g_m

TABLE 1
CALCULATING VOLTAGE GAIN

	$(1) G = \frac{h_{fe} R_L}{r_{ie}}$	<p>where h_{fe} is current gain, R_L is value of load resistor, and r_{ie} is input resistance.</p>
	<p>or</p> $(2) G = g_m R_L$	<p>where g_m is mutual conductance and R_L is load resistance. The value of g_m is 40 mA/V for each 1 mA of steady collector current (bias current)</p>
	<p>or</p> $(3) G = 40 \times (\text{d.c. voltage across } R_L)$	

1,000 μ A, or 1 mA and the 1 mA meter which is connected in the collector circuit will read full-scale. The meter reading is in fact, proportional to the h_{fe} value, as the calibration graph shows. Simple enough, isn't it?

Transistors give a goodly amount of voltage gain. As the simple rule-of-thumb in Table 1 shows, with 5 V DC dropped across the collector load resistor, for example, we can expect a voltage gain of $5 \times 40 = 200$ times. Do we ever get this much gain? Yes, but *only* if there is nothing in the circuit to act as a potential divider for signals, and that's rather rare.

Fig. 2 for a moment. This is what's called an equivalent circuit, which uses a combination of conventional components to give us some idea of what a transistor does in a circuit. There's always an input

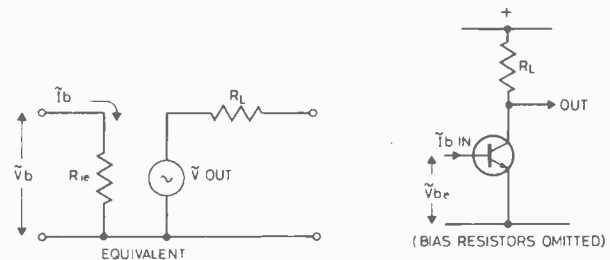

Fig. 2. Equivalent circuit of transistor with a load resistor.

value of 40 (with 1 mA collector current) and an h_{fe} value of 100 will have an R_{ie} value of $100/40$ k, which is 2.5k.

The output resistance of a transistor can be measured as the ratio V_c/I_c , with the base current fixed, but this quantity is not particularly useful to us. For one thing, it represents a resistance connected in parallel, and we want to find an equivalent series resistance. Fortunately, the value of this resistance is so high (around 40 k) that we can ignore it in comparison to the low values of

collector load resistors that we use. When we connect a load resistance to a transistor to make it a voltage amplifier, the output resistance for the amplifier becomes just the value of the load resistance.

The equivalent circuit shows both quantities, input resistance and output resistance as if they were resistors wired into the circuit, with the actual voltage amplifier completely separate. What's the point? Well, take a look at Fig. 3 which shows a voltage amplifier transistor connected between two others, each with the same values of input and output resistances. Drawing each

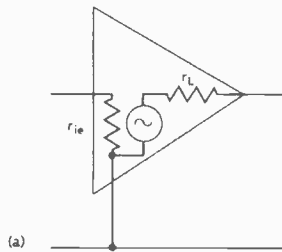
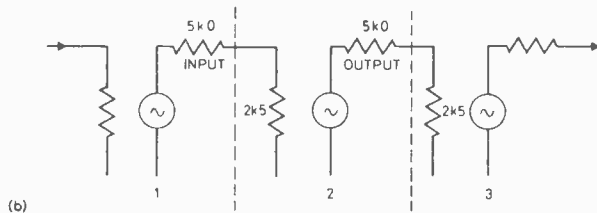

Fig. 3. Signal losses. (a) One method of showing input and output resistances of an amplifier. (b) Equivalent circuit of three identical transistor amplifier stages; Stage 2 is affected by the output resistance of stage 1, and by the input resistance of stage 3.



amplifier stage like this shows that the output and input resistances act as potential differences for signals that we are trying to amplify. Incidentally, because we are talking only of signals, we do not need to draw in capacitors, we assume that they pass signal currents perfectly.

At the input, the signal comes through a resistance of 5k (the output resistance of that stage) and is passed into an input resistance of 2.5k, so that the division ratio is

$$\frac{R_{in}}{R_{out} + R_{in}} = 2.5 / 7.5, \text{ or } 0.33$$

At the output, exactly the same happens, so that our voltage gain of 200 becomes now $200 \times 0.33 \times 0.33 = 22.2$, which is not exactly quite so impressive. With gains like this, who needs losses?

This potential divider action isn't confined to transistors, of course. Every transducer that we use has its internal resistance which can be represented by a resistance in the equivalent circuit. An example will show why a single-transistor amplifier is not enough for our purposes, even with a voltage gain of 200 times. Suppose we have a pick-up cartridge with an internal resistance of 5k (often called source resistance) and an output of 5 mV, which is rather on the high side for such gadgets. We might think that an amplification of 200, which could give a signal of 5×200 mV which is 1V might be enough to drive a loudspeaker with a resistance of 3 ohms. After all, if the voltages are RMS, then the power output should be V^2/R , which will be 0.33 watt, about the amount we get from a small pocket radio.

The equivalent circuit shows why it won't work. At the input, the signal is divided by the ratio $2.5 / 7.5 = 0.33$, just as before, and at the output the division is enormous, with the 5 k output resistance of the amplifier

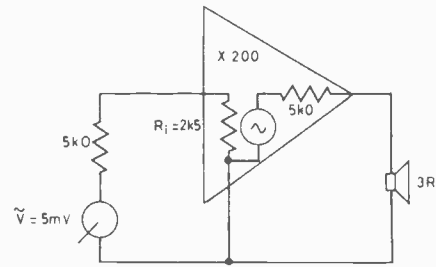

Fig. 4. Single-transistor amplifier, input from a pick-up cartridge, output to a loudspeaker.

feeding a 3 ohm loudspeaker, division ratio $3 / 5003$. The signal voltage that we actually get across the speaker is therefore:

$$5 \times 0.33 \times 200 \times \frac{3mV}{5003}, \text{ which is } 0.199 \text{ mV.}$$

The words 'dead loss' spring to mind To succeed at this sort of thing we need a higher input resistance and a much lower output resistance, and these desirables, rather than just voltage gain, are why we make use of amplifiers with more than one transistor.

How To Reduce Gain Painlessly

No, we're not joking. One of the most useful circuit tricks we know is one that reduces voltage gain; it's called **negative feedback**. After what we've just been through, this may look mad, but voltage gain isn't everything. If we take a bit of care over input and output resistances we can get a lot of voltage gain from a few transistors.

For example, even if we get a voltage gain of only 20 times from a transistor which is connected to two others, then the three of them should give a voltage gain of $20 \times 20 \times 20$, which is 8,000 times, a pretty healthy gain, and more than we usually need. Now this here negative feedback isn't like income tax; *your sacrifice of gain is never in vain*. When we reduce the gain of an amplifier, using negative feedback, we can obtain the following advantages:

1. Changes in the input and output resistance values. For example, we can obtain higher input resistance and lower output resistance.
2. Reduction in distortion. The transistor behaves as if the graph of output current / input voltage were rather more like a straight line.
3. Reduced noise. The noise signals caused by electrons bouncing around in the transistors and the resistors are reduced.
4. Greater bandwidth. The gain of the amplifier, though less, will stay constant over a greater range of frequencies.
5. Better tolerance of change. The replacement of a transistor in the circuit or changes that take place in resistor values as the components grow old, have less effect on the gain of the amplifier.

Quite an impressive list of advantages for the sacrifice of a bit of gain, you'll agree. So how do we go about it?

We apply negative feedback to an amplifier by taking some of the output signal and subtracting it (that's the

negative bit) from the signal at the input. It sounds complicated, but it isn't really, if you remember that subtracting signals is the same as adding signals that are inverse (or out of phase).

Figure 5 shows the idea; adding the voltages of signals that are in phase (coinciding) gives a larger wave, but adding the voltages of waves that are in antiphase (one wave the inverse of the other) gives a smaller wave, the result of subtraction. Negative feedback therefore means making a connection between an amplifier input and an output that has an out-of-phase signal. No signal will be lost at the output by doing this, apart from the "potential divider" losses we always get.

Figure 6 is a pretty obvious example of negative feedback. The signal at the collector of a common-emitter amplifier is inverted with respect to the input signal. This is because a rise in the steady voltage at the

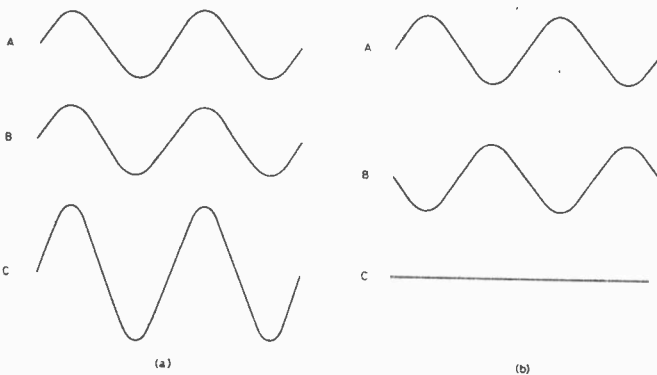

Fig. 5. Adding wave voltages. (a) in phase, (b) in antiphase. The sum or resultant wave can be large or small depending on the phase of the waves being added.

base would cause more base current, so more collector current, therefore more voltage drop across the load resistor, and so a drop in the steady voltage at the collector. The same action must be true for signal voltages, which are just variations in the steady voltages, so that any signal path connected between output and input in this amplifier will cause negative feedback; we have used this as a bias method, feeding back DC rather than just signal. This kind of feedback is called **shunt feedback**, and one of the effects that shunt feedback has is that it lowers the effective input resistance of the amplifier.

Curiously enough, this is not necessarily a disadvantage. If the signal is fed into the amplifier through a source resistance R_s , which might be the resistance of a

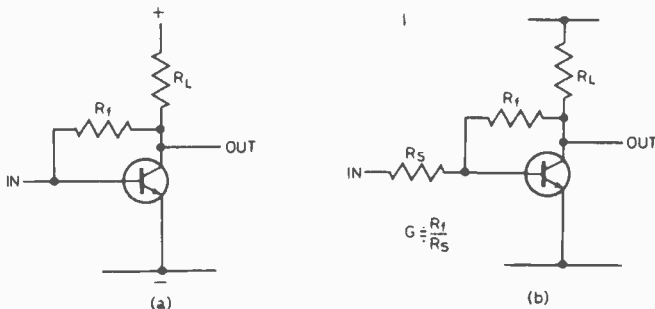

Fig. 6. Shunt negative feedback (a) simple circuit, ignoring bias. (b) Rule-of-thumb formula for finding gain. R_s is the "source" resistance, either wired in circuit or part of the previous stage resistance.

TABLE 2

COMPUTED VOLTAGE GAIN — SHUNT FEEDBACK

R_f value (k)	Gain	R_f/R_s
10	0.99	1.0
20	1.97	2.0
30	2.94	3.0
40	3.9	4.0
50	4.8	5.0
60	5.8	6.0
70	6.7	7.0
80	7.6	8.0
90	8.5	9.0
100	9.5	10.0
200	18.0	20.0
300	25.9	30.0
400	33.0	40.0
500	39.8	50.0
1000 (1M)	66.4	100.0
2000 (2M)	99.7	200.0

Assuming voltage gain before feedback of 200 times.

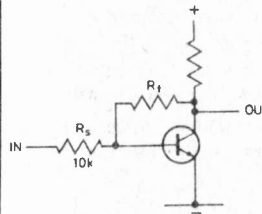

transducer or the output resistance of another transistor, then the voltage gain of the amplifier with its feedback in action is R_f/R_s . If we make $R_f = R_s$, then the voltage gain is unity, (one). This rule of thumb assumes that the voltage gain of the amplifier without the feedback is much greater than the voltage gain with the feedback. Try it for yourself; assemble the circuit of Fig. 6 and check the effect on voltage gain (measured with a 1 kHz signal) of various resistors, R_f . A set of computer-generated figures is shown in Table 2 for comparison. The values that are obtained by the simple formula R_f/R_s hold reasonably well up to a gain of about 10, assuming that the gain with no feedback is 200 times.

That's one type of negative feedback circuit, but there is another type which also can be used on a single transistor. Fig. 7 shows the circuit, and this time it's not so easy to see why there is negative feedback, where it comes from and where it goes to. The answer is that

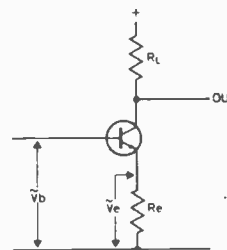

Fig. 7. Series negative feedback using the emitter resistance R_e .

the feedback in Fig. 7 is caused by the emitter resistor R_e , and the feedback signals come from the emitter current and affects the base-emitter voltage. The action is something like this.

Imagine a signal at the input causing a signal current between the collector and the emitter. Now think of a portion of that signal input, the rising-voltage portion of a sine-wave for example, which increases the voltage between the base of the transistor and the negative line. This causes the collector current to increase, so the emitter current will also increase. The emitter current, flowing through the emitter resistor R_e will then cause an increase of voltage at the emitter. That's what causes the negative feedback. Why?

The signal at the input of the transistor that causes the change of collector current is the signal voltage between the base and the emitter. If the base voltage and the

emitter voltage were to rise by, for example, 1V each, then there would be no change in the voltage between base and emitter, which means no change in the input to the transistor.

The actual signal into the transistor is $\tilde{V}_b - \tilde{V}_e$, where the squiggles, as usual, remind us that we are now talking about AC signal voltages. V_b is the signal voltage between the base terminal and ground, V_e is the signal voltage between the emitter terminal and ground.

This is a type of negative feedback that we call **series feedback** and it has some quite different effects. For one thing, it raises the input resistance of the amplifier quite noticeably. The extra input resistance is approximately $h_{ie} \times R_e$, so that for a transistor with $h_{ie} = 100$, and $R_e = 330\Omega$, the input resistance is raised by $100 \times 0.33k = 33k$, quite an improvement. Series feedback also raises the output resistance of the transistor, but since the output resistance of the amplifier depends more on the resistance of the load resistor, this has little noticeable effect.

This type of feedback is not so easy to test practically, because any change in the emitter resistance will affect the bias of a transistor. Fig. 8 shows a method, though. The emitter resistor is a 1k potentiometer with a capacitor C2 connected between the wiper arm of the

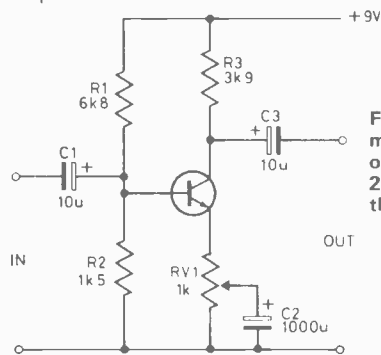

Fig. 8. A practical arrangement for testing the effect of series feedback. Use a 2N3904 if you want to try this circuit.

potentiometer and the ground line. There is always a 1k resistance between the emitter and ground, so that the bias is unchanged by varying the potentiometer setting, but the capacitor will by-pass part of the 1k as far as AC signals are concerned. When the potentiometer is set so that the whole of the 1k is bypassed for AC, the gain of the amplifier will be at its maximum value (remember the effect of the coupling resistances). Typical computed figures of gain are shown in Table 3, assuming that h_{ie} is about 100 and that the bias current is about 1 mA. Try it for yourself.

This series feedback circuit can be troublesome, though, because it can lead to low gain when we don't want low gain. If we use the bias circuit of Fig. 9 (and who doesn't?) then the effect of the emitter resistor which does such a good job of stabilising the bias, because of negative feedback of DC, is to make the gain of the amplifier rather low, about equal to R_L/R_e . We can get round this by remembering that it's only the resistance to signal currents that causes the negative feedback. If we connect a large-value capacitor, C_e between the emitter of the transistor and the ground line, then R_e is a short circuit as far as signal currents are concerned, provided that C_e is a large enough value. This capacitor is called the **emitter bypass capacitor**.

The Emitter-Follower

In Part 3 we had a quick squint at a common collector or

Assuming $h_{ie} = 100$		
R_e (ohms)	G	R_L/R_e
100	31.2	39
200	17.3	19.5
300	12	13
400	9.2	9.75
500	7.4	7.8
600	6.2	6.5
700	5.3	5.6
800	4.7	4.9
900	4.2	4.3
1000	3.8	3.9
2000	1.9	1.9

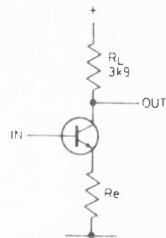

emitter-follower circuit. It's just a logical development of the common-emitter amplifier, but with 100% feedback through the emitter resistor. The input is taken between the base terminal and the ground line, and the output is taken between the emitter terminal and the ground line, so that the whole of the output signal is fed back. The voltage gain is less than unity, but the input resistance is high, and the output resistance is very low. This combination makes the emitter-follower ideal to use as a **buffer stage**, a stage which can be used as a link

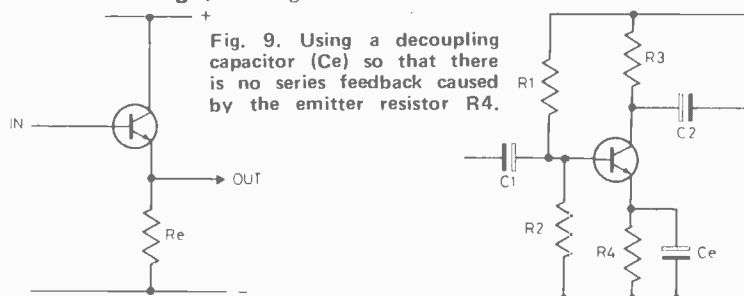

Fig. 9. Using a decoupling capacitor (C_e) so that there is no series feedback caused by the emitter resistor R_4 .

Fig. 10. The emitter-follower (bias arrangements omitted.)

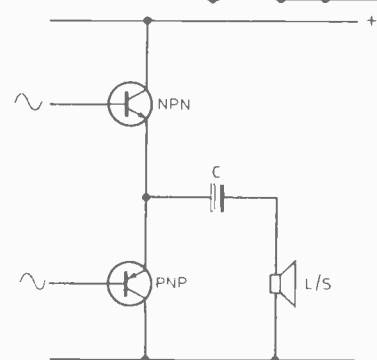

Fig. 11. The 'totem-pole' circuit, with two emitter followers, which is used as an output stage to drive loudspeakers. One transistor is NPN, the other PNP.

between a high-resistance output and a low-resistance input with negligible loss of signal. The name? Well it's because the signal at the emitter follows the signal at the base, it's in phase and almost the same amplitude.

Because of the large amount of negative feedback, distortion is very low, and the circuit is generally very well-behaved. Emitter followers are often found as input stages, when their high input resistance is an advantage, and also as output stages when a low output resistance is an advantage. The most popular type of circuit which is used as the output to a loudspeaker has two transistors both connected as emitter followers (Fig. 11). Because one transistor is NPN and the other is PNP, both can be fed with the same input signal. No load resistors are needed because the loudspeaker acts as the emitter load resistor for AC signals and each transistor acts as the emitter load resistor of the other for DC current.



WHAT'S NEW

By Steve Rimmer

Do you want to be a D.J.?

Before you sign up for night school, listen to what Steve Rimmer has to say . . .

" . . . AND THAT was the Unpleasant Smell, with their bit big hit: *I Want To Bayonet Your Cocker Spaniel Tonight*, really sweet song, something for all you punkers out there; kind of a cross between Olivia Newton John and a five car pile up. Right, well, we're here on the all hit countdown, comin' to you from the number one radio in the big, big city, radio one-oh-five. Let's hear from Gary Numan, and his all time big single, *Brain Damage*.

"Geez, well, let me tell you, that is one really fine song. But, Jack, over there in the control room looks like he's tryin' ta fix our old turn-table One, so let's just leave it for later, and get right into our next big hit on the all hit countdown, here's The New Wave Boppers, with *I'd Wrap My Trans-Am Around A Pole For You, Baby . . .*"

"Well, heck, Jack, why didn't you tell us all that turn-table Two was on the fritz as well? Hey, you're listening to the all hit countdown. Next hour we're going to be hearing from the Drug-tones, the Five Slimes, and the latest thing from good ol' Billy Joel, a song in which he actually cuts off his right leg with a chain saw in the break. . .but first, we're gonna go to a commerci. . .for gosh sakes, Jack, commercial player's buns up too. . . want me to get my harmonica and entertain the folks? How long before we're rolling again, there, Jack old boy . . .hang on, hang on, he's holding up a sign. . .just a second, it says. . . N-E-V-E-R. . . O-N. . . S-T-R-I-K-E. . .hey, Jack, that's what I like to see, humour in the trenches, always use a good laugh from the control room, hey, Jack, where you headin' for?"

This month, we're going to look at the mysterious workings inside the on air booth at a radio station.

Getting Board

Yes, I suppose somebody really ought to be shot for that title.

The "board", or console, is the nexus of the on-air booth in a radio station. Now, even at this early stage, boards get sliced up into two distinct types, depending upon what sort of music is to be played through them. For instance, boards that are going to have a lot of disco booging through their transistors are properly given a frontal lobotomy prior to leaving the factory.

Pop stations usually define the on-air booth as either AM or FM. . . this isn't really a technical distinction, so much as one of format.

Getting AM to clip along at the speed it does isn't really a fair task for just one man. Aside from spinning discs, keeping track of spots, and mouthing off on schedule, there's an awful lot of behind the mike paper

pushing, and form filling required to passivate the CRTC. The huge volume of material to be pumped out each hour can leave all but the fleetest of fingers buried in a huge, quivering mound of triplicate copies. Thus, the AM "jock" is, in fact, usually composed of the jock proper, and a nearby second banana, called an "op", or operator.

An FM studio, on the other hand, because it doesn't try to come down at the speed of light, is easily opped by the announcer. Thus, it is usually only a single room. Unlike the AM guys, the disc jockey handling the FM mike does usually get to play genuine records on a genuine turntable.

The board is, at heart, a line mixer, although it is frequently busy being so many other things that you might not catch this immediately. It has three basic functions: to mix the input lines into a single, hopefully unified



The heart of any DJ's booth, the control board.

program, to switch the signals on the input lines between the two internal busses, and to provide remote control for the other studio fixtures which want frequent stopping and starting. It also has to look complicated enough to impress the stockholders.

The board is fed with every audio signal in the booth. Generally, this amounts to the outputs of two turntables, a microphone (either in the booth or in a separate announcer's booth), a phone patch, and one or more cart (tape) machines. In addition to this, depending upon the phase of the moon at the time of construction, there might also be lines in from other studios. All these have to be made available for mixing into the program material, or, in the dialect, "potting up", whenever the jock gets it into his or her head or other quasi-conscious organ to go ahead and do so. For this reason, everything gets fed into its own separate channel on the board. . . often referred to as a "pot", or a fader control.

There are, prior to the pots, several phila of pre-amps. The mike, for example, will need a mike pre-amp. However, because the on-air mike is frequently a condenser mike, the pre-amp must also be capable of supplying the forty-eight or so volts. . . with no ripple. . . required by this type of microphone, for polarizing and general metaphysical setting up.

The turntable pre-amps are usually located at the turntables, and as such, the board sees line level signals coming at it. The same is true of the various tape devices involved. The only nasty of the lot is the telephone which, as one might expect, requires a bit of coddling and tickling beneath the chin if it isn't going to throw a fit. The phone line signal is actually modulated DC, which will upset almost anything it comes in contact with. It won't feed the 600 ohm inputs of a board and be too happy about it, and it contains all sorts of transistor popping, meter pinning pulses and transients generated by picking up the phone, putting down the phone, staring at the phone, or just dialing. In addition, the signal level is anything but reliably constant, so a level follower is called for. On top of this, when one permits a third party, other than the RCMP or a Russian spy, to listen in on a 'phone conversation, it is blessed under the law to inject a beep every twenty seconds to warn the poor devil at the other end of the wire that his rude story about

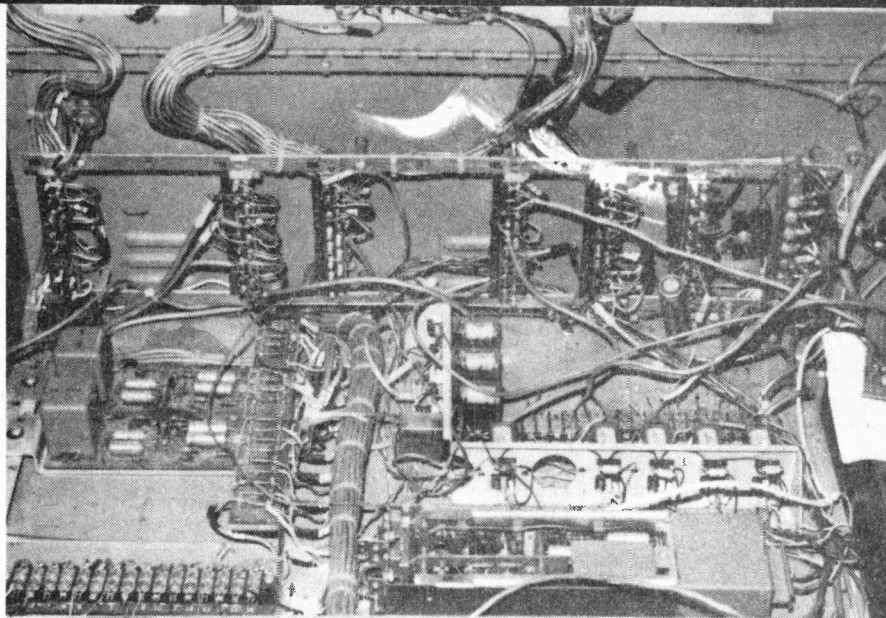

The control board has a lot of work to do which requires lots of switching. This is what the inside looks like.

Margaret and a troupe of boy scouts is being heard by twelve thousand listeners.

The pots mix down to a single signal, called the program signal. . . this being found jolly on the program bus. However, those signals don't always go through the pots. There are several other interesting places to send them, and this requires that their eventual destinations be selectable. This gets into the second function of the board, this being switching.

It is also handy to be able to send some little sounds to internal places, like a cueing speaker. This is a separate bus, monitor amp and bin set up for use exclusively inside the booth. In order to have things happen with any degree of tightness at all, it is essential to be able to set up records and tapes such that one knows exactly when they are going to start. This requires a modicum of precision in excess of that achieved by just dropping the needle in the blank space between cuts on a disc. A platter is cued up by spinning it until the first sound is heard, and then, utilizing the infinite dexterity of the right manual appendage, or, technically, hand, winding it backwards until silence is reached. Since it is necessary to do this with every disc aired, a fairly rapid sort of switching arrangement is desirable.

The inputs from the turntables are switched such that when the turntable motor is running but the pot is not sending signal to air, the output of the turntable is sent to the cue buss. There is a relay control to restart the motor once the album has been cued,

which, as well, flops the line off the cue bus and through the pot onto the program bus.

Boards designed for use with a separate announcer and op usually incorporate a third bus, for intercom. This, like the cue bus, is internal only, but, it, too, does some complicated switching. When the jock's mike is not going to air, it is associated with the intercom line, as is the op's mike. Some kind of push to talk, or, more frequently, vox circuitry is entrenched in there, somewhere, to keep both mikes from being on simultaneously, and, thus, causing manifest highly perturbing acoustic feedback. The outputs from the turntables and other line inputs can be switched to the intercom bus so the announcer can hear what the next cut is going to open like. The phone can be patched in as well, but will also require a relay to flop it onto the programme bus, for those rare moments when the master wishes to communicate with a representative of the filthy hoards.

The busses are also equipped with muting relays. For instance, if the board is to be opped by the announcer, a relay will mute the program and cue busses going to their respective monitor speakers when the on air mike is on, to keep from producing the aforementioned unkind feedback, or from attracting heavily bad vibes from extraneous sounds coming over the speakers. On a board with a separate announcer and op, the intercom bus gets muted whenever the mike is on.

Lastly, there is the switching on and off of the peripheral devices. One

cannot have the jock having to lean back and switch on a record while he's talking, so everything is relay operated, and remote controlled from right there at the board. Usually, this entails a start and stop button for every device, or separate bit of every device, in the booth. These remote controls also have to be interfaced with the audio bus switching in the board, so that, for example when a turntable is switched on and commences to spin, its signal is flopped over from the cue bus to the program bus, and it commences to sing.

To The Mardi Gras

Another title worthy of a garrotting.

There are two or possibly three kinds of tape used in radio, these being the usual reel-to-reel number, the occasional cassette, and the cart machine.

The tape machine shown is typical of the sort of beast found in the average on-air booth. This particular one is an Ampex 400. It is quite unlike consumer type tape recorders for several reasons. . .the most important of which is that a Sony of my own-y would last about a month in this sort of environment. Broadcast tape decks are designed to stand up to fairly heavy weather for long periods of time without going belly up. This one, for example, has been running since 1952.

AM stations, being wholly monaural, use a type of tape format unlike that found in any other medium; the one track. Unlike single



Generally, program sources are kept together. In this case, two turntables and, in the background, a five spot cart machine.

track mono, as found on super econo mini recorders, this arrangement utilizes no tracks at all. The gap on the head spans the full width of the tape. This, although having no stereo separation to speak of, does succeed in scraping every last db of signal to noise ratio out of the tape.

The other kind of tape machines are the almost mythical cart machines. Carts are another one of those things almost wholly unknown outside the fourth dimensional reality of the disembodied voice.

A cart, or cartridge, is properly known as a Fidelipack, the name of the company which first conjured the

things out of the pot. They look exactly like eight track cassettes, and function in the same way. The only difference is that eight tracks have built in pinch rollers, while carts have openings into which a cart player can project a roller. The cart contains an endless loop of tape running anywhere from thirty seconds to eight minutes. There are also larger sized carts, which can roll for a half hour.

The usual cart format is two track tape, although stereo carts require three tracks. This is because one of the tracks is not used for sound exactly. Instead, it is left blank, except for a beep, which is inserted at the beginning of the spot or song recorded on the cart. The beep comes out of one channel of the head, and has the sole function of activating the stopping relay in the cart player.

The wonderful thing about carts is that, providing the last guy who played the one in question didn't stop it prematurely, they are always cued up exactly, and ready to be played. They are never in need of threading, back spinning or cleaning; one simply snatches one from where it is reposing in the cart rack, and jams it into the appropriate slot in the cart machine.

The initial use for carts was in playing commercials, although these days, especially in the Top 40 AM trip, they have entirely supplanted records. AM radio doesn't actually play that many different tunes, they just run the current hits over and over. . .so a few hundred carts, with the out of date ones being constantly withdrawn and re-recorded, are quite sufficient. Aside from being easier to get along with, carts (at least until they get old and jam up), are not prone to any sort of mechanical degradation. Records, on the other hand, pop, click, develop scratches or, at stations having a high punk content, sometimes even toothmarks. Carts are also a lot more resistant to coffee.

Cart machines have become fairly complex of late, so there'll always be something new to put in the sales brochure. You can have, for instance five spot, i.e., has five separate cart players in it. There's also a floor to ceiling model around here, somewhere, that holds 55 of them. While most of the machines found in on air booths are still largely manually operated, such that the DJ has to start each cart at the appropriate moment, there are several automatic systems on the market which will play a series of spots sequentially, using the stopping pulse of one to start the next. Large

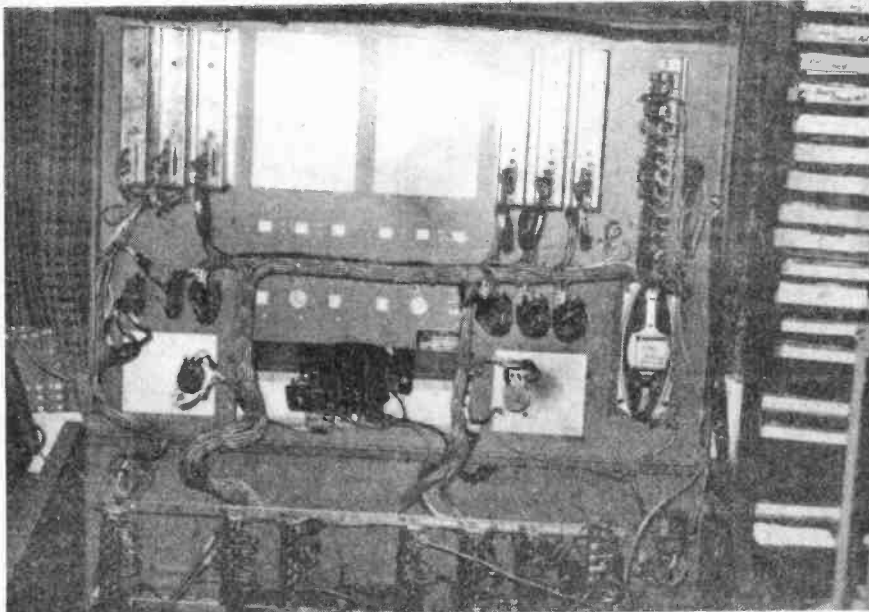



Needless to say, program material is absolutely necessary.

capacity machines are also found in some stations with remote controls attached; the announcer never actually has to handle the carts himself, or even look at them.

Automation

Harry Chapin had a song on the box quite some time ago, which had a line that went "I am the morning DJ, at WOLD. . .". It was a kind of catchy little tune, for which the real WOLD tried to sue him. What was most curious about this was that WOLD didn't have a morning DJ at all. It was a robot. It played tapes from California.

Robot radio, or automation, isn't new by any means. It arrived slowly, evolving out of multi-spot cart machines and complex process timer controls. The first application was in replacing the dusk to dawn jock, a shift no one really wanted anyway. One could take a tape machine or two, loaded up with ten inch reels, attach a large capacity cart player, and get through a six hour shift with room to spare. The tape is set up with the same sort of beep cueing system as the carts; after a few songs, a beep on the tape stops the recorder and starts the cart player which, after doing its number, and laying the pleasures of capitalism on the planet, shuts itself down and restarts the tape, or starts a second tape.

This, of course, can be easily expanded such that the station could run 24 hours a day like this. However a better way, one which provides a much larger degree of flexibility, is to attach the whole mess to a computer.

With a beep at the beginning of each cut on the tape, the machine can be interfaced with multiple transports to be able to locate and cue up anything it wants to. The machine knows the location of each set and air break on the tapes, so it can select the

music in any order it likes, and then match it to the appropriate announcements. Commercials can be added in much the same way, either from carts in a multi deck machine or, more usually, from a long running tape, just like the voice and music. With a room full of decks, and a machine of even moderate capacity, the whole system can run unattended for as long as a week.

Most stations utilize some degree of automation. There is one firm which offers a semiautomated system which interfaced 16 cassette decks with a PET computer to handle music and commercials, so all the announcer has to do is to babble when the light flashes.

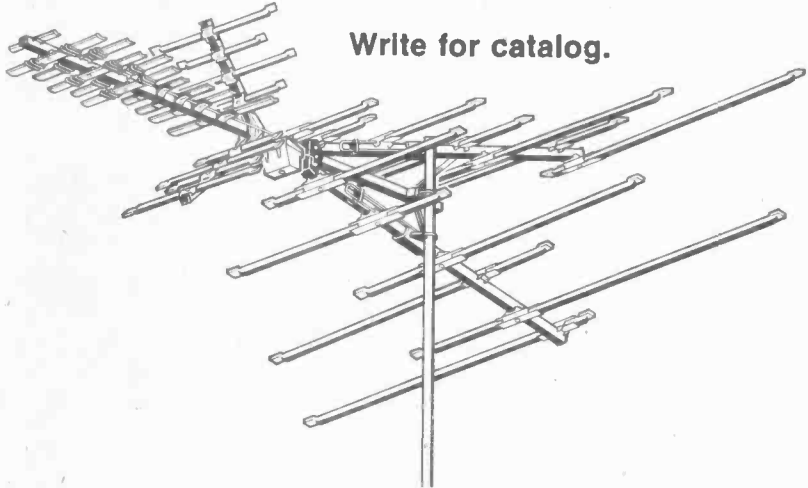

Write for catalog.

High performance, high quality

WINEGARD[®] ANTENNAS
TELEVISION SYSTEMS

AND PREAMPLIFIERS

Stocked in Canada by

OMNITRONIX LTD./WINEGARD

2056 S. Service Road Dorval, P.Q. H9P 2N4

Circle No. 10 on Reader Service Card.

UNIVERSAL PROCESS TIMER

This controller has myriad applications in electronic and photographic work. It features an LED display which 'counts down' and is easily visible in darkroom or daylight.

VARIOUS PROCESSES in fabricating electronic projects require timing a chemical reaction or process — developing photoresist in making printed circuit boards being a prime example.

The Technique

The easiest way of producing a time delay is by using a 555 timer IC, but a glance at the data sheets shows that it should not be used for periods in excess of 100 seconds. By using the 555 as an oscillator and feeding its output into a 4017 counter/decoder IC the maximum timing period can be increased ten fold. The unused decoded outputs can then be connected to a column of LEDs which will give an indication of elapsed time.

Each pulse from a 555 clocks the 4017, moving a high level along its ten decoder outputs, lighting each of the LEDs in turn. When the high level reaches the last output it is used to operate the relay and thus the time delay has been multiplied by ten.

A permanently-lit LED has been included at the bottom of the row to show when the unit is on. This also gives a better indication of elapsed time in a darkroom, as the LEDs can be seen to step towards a reference light.

Four time ranges have been provided with a trim pot on each one for easy adjustment. The table gives the values for each trim pot and C1, for a variety of times. The minimum time is limited by the time taken for the relay to operate, maximum time by the limitation of the 555. In practice, times from 100 mS to twenty minutes

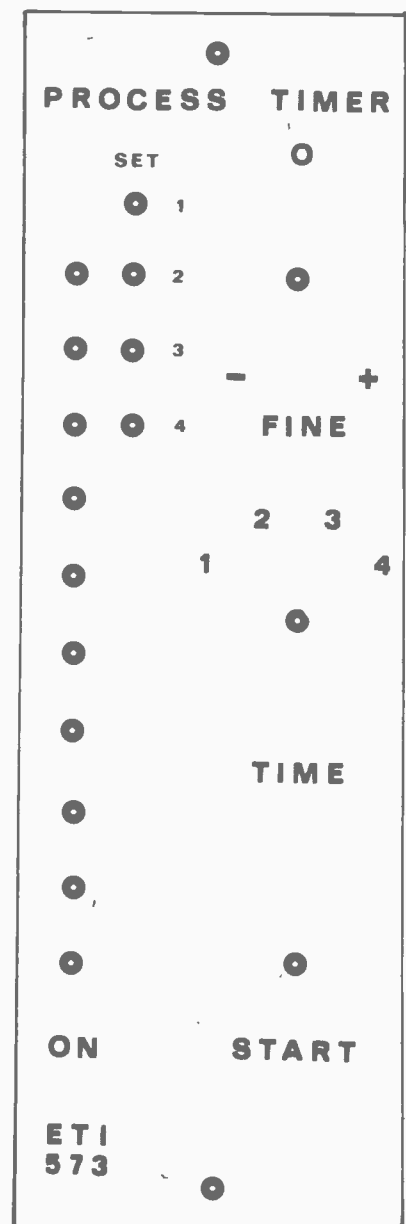
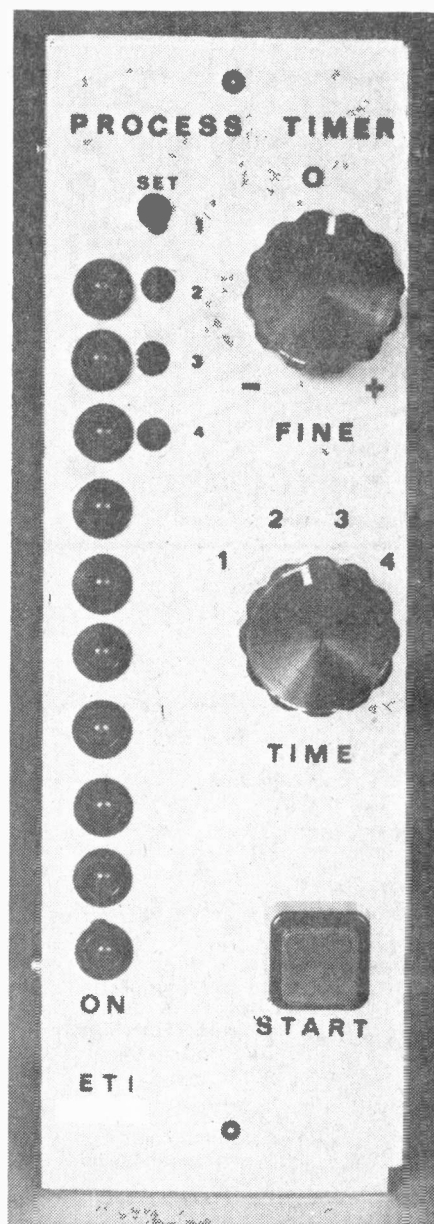

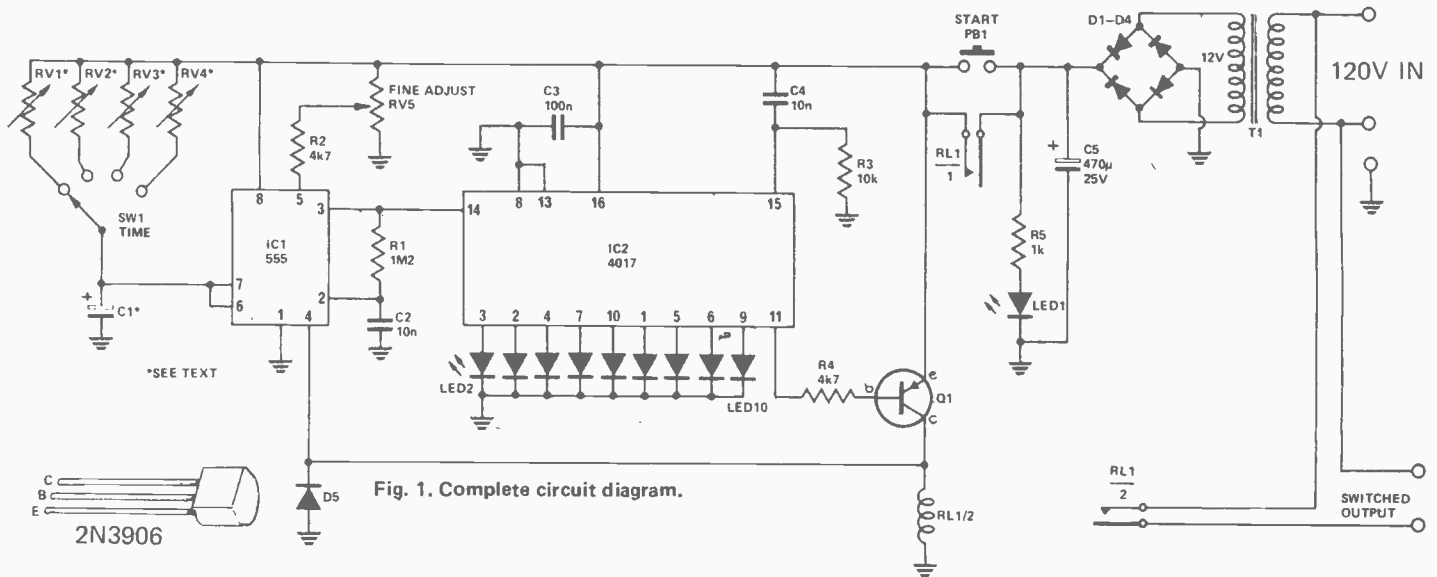
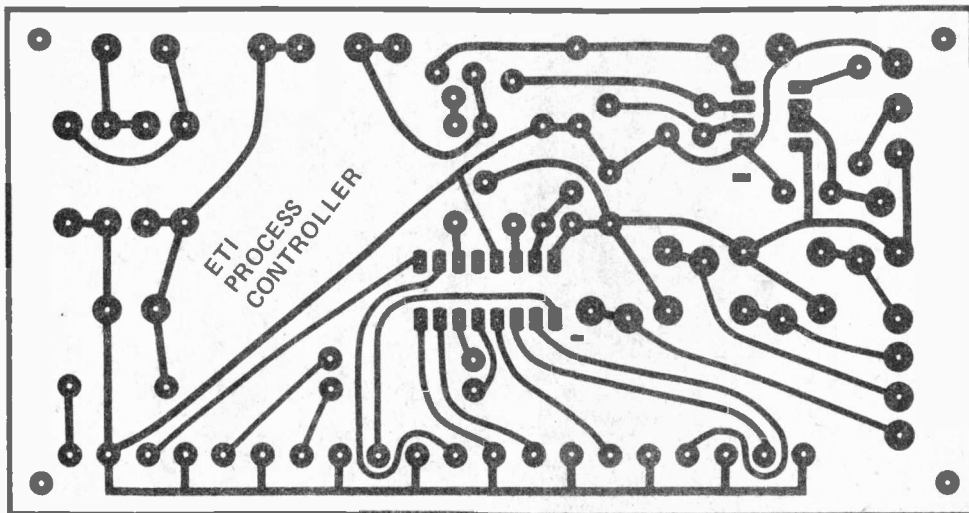

Fig. 1. Complete circuit diagram.



The PCB pattern shown full size.

can be achieved. For very short times the time elapsed indication will not be much use and the LEDs can be left off the board.

Fine adjustment of the timing is achieved by adjusting the threshold voltage on pin 5 of the 555. When the voltage on pin 5 reaches a set value, the output (pin 3) of the 555 goes 'low' (i.e. the 555 triggers). This voltage is normally set at two-thirds the value of the supply rail, fixing the time during the charging cycle of C1 when the 555 triggers.

If the threshold voltage is increased, the time taken for C1 to charge to the required value increases, and the frequency of oscillation decreases. Thus, the total timing period is increased.

What device you want to control with the timer will determine the type of relay you use. This unit is capable of driving quite large relays, however, we used a commonly available type having contacts rated at 10A.

Construction

First, you will have to determine from the table the correct values of RV1-RV4 and C1 to provide the times you want for your application.

Next, mount all the components taking care to correctly orientate the semiconductors. The LEDs are best mounted by inserting them into their holes and bending them over flush with the edge of the PCB. The photo shows the way we mounted the LEDs.

The completed unit can be mounted in a variety of ways to suit individual applications. Either in a box, together with its relay and a mains female output socket for the switched output, or on a panel with a

PARTS LIST

Resistors

- all 1/2W, 5%
- R1 1M2
- R2 4k7
- R3 10k
- R4 4k7
- R5 1k

Potentiometers

- RV1-RV4 . . . See text
- RV5 10k lin pot

Capacitors

- C1 See text
- C2 10n polyester
- C3 100n polyester
- C4 10n polyester
- C5 470µ 25V electrolytic

Semiconductors

- D1-D4 IN4004 or sim Power Diode

- D5 IN914 or sim

- Q1 2N3906

- IC1 555
- IC2 4017

- LED1-
- LED10 TIL220R or sim LED

Miscellaneous

- SW1 One pole, four pbs. switch
- PB1 Momentary Push Button
- T1 12V, one amp transformer
- RL1 12V relay with two changeover contacts, PCB, knobs, suitable box or bracket.

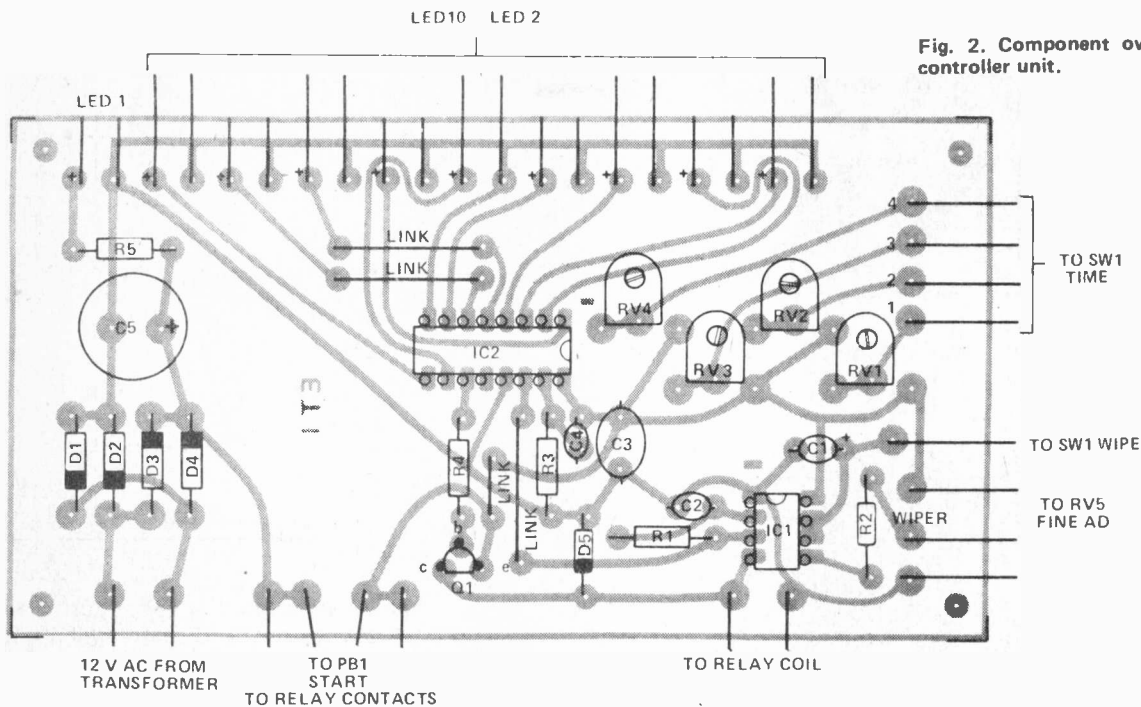

Fig. 2. Component overlay for the process controller unit.

Maximum time delay	1 sec	10 sec	100 sec	1000 sec
value of C1	1 μ F	1 μ F	10 μ F	100 μ F
value of RV (1 - 4)	200 k	2 M	2 M	2 M

Table of values for C1 and RV1 - RV4 required for differing time delays

PROBLEMS? NEED PCBs? Before you write to us, please refer to 'Component Notations' and 'PCB Suppliers' in the Table Of Contents. If you still have problems, please address your letters to 'ETI Query', care of this magazine. A stamped, self addressed envelope will ensure fastest reply. Sorry, we cannot answer queries by telephone.

HOW IT WORKS

The timer consists of a 555 timer IC used as an oscillator driving a 4017 counter/decoder IC, the decoded outputs being used to drive a row of LEDs and switch a relay.

The timing period is set by the frequency of oscillation of IC1. This is dependent on the time constant of RV1-RV4 and C1. As either of these components are increased in value the time constant will increase and the frequency of oscillation decrease. Fine frequency adjustment is provided by RV5 which adjusts the threshold voltage on pin 5 of the 555. This voltage is normally set at two thirds of the supply voltage, but here it is adjusted varying the required voltage across C1 to the 555.

Output from the 555 is fed to the clock input of the 4017. After each pulse a different decoded output of the 4017 goes high, lighting each LED in turn. After the tenth clock pulse the output on pin 11 of the 4017 goes high. We shall come to what that does shortly.

When power is first applied, the relay contacts RL1/1 are open and the bottom LED (LED 1) is lit. When the 'start' button is pressed the 4017 is reset to zero by a positive pulse applied to pin 15. This pulse is provided from R3 and C4. Pin 11 goes low, turning on the PNP transistor Q1, and the relay operates. The now closed relay contacts (RL1/1) short out the start button and sustain the power after the start button has been released. The transistor also drives the reset line of the 555 (pin 4) which commences to oscillate. This ensures accurate timing of the first cycle.

On the tenth pulse from the 55 pin 11 of the 4017 goes high, turning off Q1, stopping the oscillator, and the relay is de-energised. The contacts RL1/1 open removing the supply to the timer returning it to its original condition, ready for the next sequence.

During the timing period, the second set of contacts RL1/2 close and can be used to switch up to 5A using the relay specified.

remote transformer and relay.

To mount the unit against a front panel, drill a row of ten holes for the LEDs and four holes to line up with the trim pots for screwdriver adjustment of the timing. The start button, timing switch and fine adjustment pot can be mounted anywhere convenient. The board should be mounted against the panel so the LEDs protrude through the holes.

Setting Up

Having assembled the unit, all that remains is to calibrate the ranges. This is easily done with the aid of the second hand of a watch. For shorter times, say under five seconds an oscilloscope is best.

Monitor the positive supply after the relay contacts RL1/1 and measure the time the contacts operate. For other purposes it may be best to set the ranges by trial and error, such as when the it is being used for a PCB development timer. In either case, the fine adjustment control should be set in its mid position when calibrating. ●

STUDIO TECHNIQUES

In the second part of his article, Steve Rimmer describes some basic sound effect techniques.

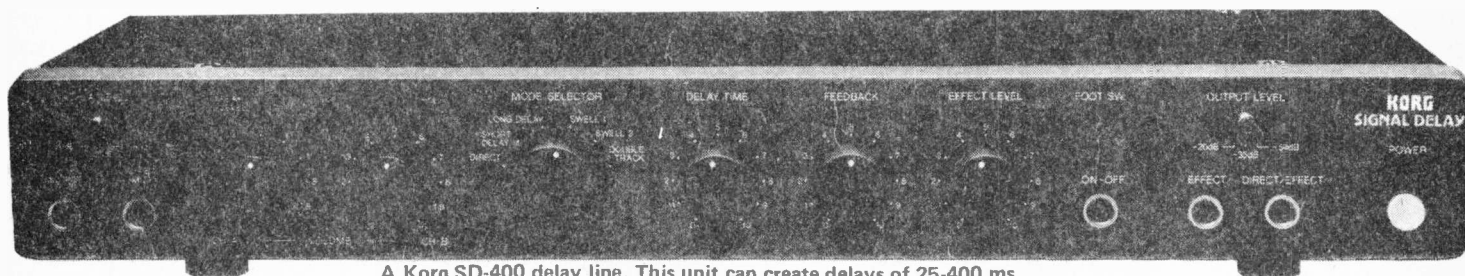

A Korg SD-400 delay line. This unit can create delays of 25-400 ms.

Effects

EFFECTS, signal processing and modification, are probably the most interesting and potentially ingenious bit of the studio. These can be subdivided into commercial effects, and homemade ones. The latter are, by far, the most useful because every commercial effect ever invented has been used by every musician on the planet at least once, while stuff you create yourself has at least some hope of being original. Homemade effects are not electronic in the spit and soldering iron sense of the word.

Commercial effects are usually found in the form of pedals, set up so that they can be switched on and off by means of foot dexterity, the crunch of an Earth Shoe upon the button, while both hands are occupied in playing. There are countless variations on the themes, but the following constitute most of what's kicking about at the moment.

Volume changers do their number, as one might expect, on the magnitude of the noise being fed through them. These include simple volume pedals, in which the angle of the foot in relation to the absoluteness of the floor determines the gain of an amp, and various sorts of envelope shapers. Sustainers keep turning up the gain of themselves as the note being fed through them dies off, creating the illusion of its hanging on much longer than it really does. There are also envelope shifters, to lengthen the attack of a note, and make it come up gradually.

The mighty fuzz box is just an amp which is designed to do heavy distortion at the very slightest provocation, availing even the meekest guitar of supreme raun-

chiness. All the heavy metal bands have them. Fuzzes are very overworked alone, but, because the distortion involves the generation of lots of nifty odd harmonics, they provide a nice source for further processing.

The mighty fuzz is certainly in the same league as the equally mighty wah-wah, which is a low pass filter that can be swept back and forth across the signal by means of a foot pedal. All the reggae bands have them. Straight wah is another well-worn effect, and generally well ignored.

Delay boxes come as a myriad of configurations, and constitute the most popular of the current crop of effects. They're sort of the marijuana of the electronic druggie scene. There are flangers, a swept comb filter, producing the all too familiar whooshing jet plane sound, echoes, which, yes, do echo, chorusing, which lays automatic flowing harmonies on a single track, and automatic double tracking, which does a short delay and feedback number to make a single voice sound like two.

Commercial pedals are really severely limited in what they can do, because they are designed to work in real time. Because of the temporal bending possible in the studio, these restrictions are not heavy upon us if we don't want them to be, and, thus, one need not succumb to the lure of the flanger. There are much wierder possibilities.

Tape manipulations offer all manner of really trippy effects. The easiest is just to flip the tape over, and run it through the machine the other way around. This will, of course, invert the

order of the tracks. Now, everything will come out sounding backwards. The characteristics of most musical acoustic sounds are that they have a short attack, and long delay, which, of course, will all be reversed. The "thump" will become "whoosh". Similarly, anything recorded when the tape is rolling like this will come out reversed when it's put back the right way. This can be a very startling effect, because the backwards sound is almost never heard naturally. It sounds like some reversed drum sounds are being used on "Let My Love Open The Door" on Townsend's "Empty Glass" disc, if you'd like a "fer instance".

Especially if you're using pancakes, flipping the tape can be a bit tricky, and will frequently result in a brown avalanche all over the floor. Therefore, I shall now impart to you a very rare and hitherto carefully guarded secret, once vouchsafed to me by a very old and venerated lama on the side of a mountain in Tibet, concerning how to make the tape go backwards without turning it over. Like, don't spread this around, so only you and thirty thousand other will know. We won't count the lama, since all he has is one of those Elcassette recorders, and he can't even get tape for the nasty thing anymore.

On a studio three motor transport, when the real motors have been properly adjusted, if the tape is slipped out of the headblock and capstan, and just stretched between the two reels with the thing in "Play", the tape will not move; the two opposing reel tensions should be perfectly balanced. Therefore, it is only the direction of the capstan that actually rolls the

tape. Now, if we could reverse the capstan direction we'd be all set, but few recorders have provision for this. However, the same effect can be achieved if the tape comes at the capstan in the opposite direction. Thus, thread the tape normally, and then remove it from between the capstan and the pinch roller. Bring it around the other side of the pinch roller, and across the capstan in the opposite direction. It should describe an "S" shape. When the machine is put in play, the tape will go in the opposite direction.

Now, this technique leads to one curious problem, that is, that the heads are now the wrong way around. The tape passes over the erase last, thereby wiping out what has just been recorded. It is therefore necessary to cover the erase with a bit of cardboard when doing this trip.

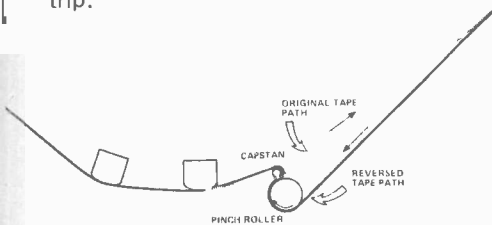

Play something backwards? You can turn it around or get unusual effects by doing this with your tape deck to reverse tape movement.

Random music backgrounds are another useful tape manipulation. It's frequently handy to be able to get a drone effect that sounds like a particular type of music, but not like an specific piece. You might want to have a string quartet going, for instance. The way to do this is to get several two track recordings of string quartets, and cut the tapes into small sections about three or four inches in length. Put the bits in a bag and shake vigorously, as if you were making synthetic fried chicken. Then splice the tape back together. Some of the bits will come out backwards, some out of place, and so on. After the initial re-assembly, it is usually necessary to reshuffle a few segments to get the whole thing fairly homogenous. A bit of reverb will smooth over the transitions. This can thereupon be dubbed onto the four track.

This probably sounds a bit nouveau to actually be good for anything, but, in fact, it is very frequently employed, even in pop piece. You'll find it done on "The Benefit of Mister Kite", on "Sergeant Pepper's Lonely Hearts Club Band" to name but one . . . (the only one that comes to mind at the moment, actually).

Vari-pitching the tape is something nobody does very much, but it does have quite a lot of potential, especially if you have limited resources, in terms of instru-

ments. It requires a low frequency sine wave oscillator, and an amplifier beefy enough to drive the tape machine's capstan motor through a step up transformer. Most studio transports have a plug for introducing an external sixty cycle power source for the capstan. The exception here is the crystal controlled capstan transports, such as the Studer Revoxes, in which the motors run at different frequencies. In this type of arrangement, the capstan speed is varied by padding the master oscillator.

If the tape speed is continuously variable, so are the pitches of the signals on it. Therefore for instance, you could record a guitar track, and then lay down a cello track using a violin, by increasing the speed of the tape. You can also obtain very realistic low sax sounds this way using a flute fed through a fuzz box. By making more delicate adjustments to the speed of the tape, it's possible to tune the music already recorded to a non-tunable instrument, like a recorder.

When varying pitch in this manner, the envelopes of sounds are also shifted accordingly. This can do supremely magical numbers on percussive noisemakers, like tongue drums or a clavichord. If the tape is rolled very fast on recording, the envelopes of the sounds recorded will be stretched considerably, producing a great deal more "tone" than would be experienced naturally.

Frequently repeated sounds are good sometimes, especially if you're doing a largely percussive bit. These can be obtained by using tape loops. Tape loops are really an art unto themselves.

To make a tape loop, record a sound of some sort. (the sixteen eyed, hound of halitosis snorting talcum powder, for example) on a two track. Cut out the bit of tape actually containing the sound, and splice the two ends together. Put it back on the tape recorder. If the sound is fairly long, and the loop extends more than a few feet, it will have to be supported, or it will transform itself into a plate of shiny brown Kraft dinner and get munched in the whirring machinery. If the tape recorder is vertical, this can be arrived at by letting the tape dangle down, and dropping a small empty plastic reel into the crook of the loop. When the tape is running, it will just sit there, spinning around as the tape goes by, and keeping the tension up. It's kind of interesting to watch, if you're a bit wrecked. If the transport is horizontal, the tape is brought out beyond the front of the machine, and looped around a mike stand, the back of a chair, or a python hanging from the ceiling. Boa constrictors are also suitable. Obviously, much longer tape loops can be accommodated with horizontal mac-

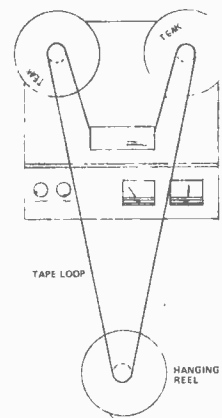

An inexpensive way to make a tape loop for repeated passages. The hanging reel shouldn't be too heavy or the tape will be stretched.

hines, unless your vertical one is sitting at the brink of an elevator shaft.

Really interesting textures can be arrived at by getting two tape loops going simultaneously and letting the sound interact. There was a piece a number of years ago, called "Come Out", by Steve Wright, in which the words "Come Out" were dubbed onto two identical bits of tape, and the two loops run through two machines, one vari-pitched down the very tiniest bit, so that they gradually went out of phase, producing a very strange flowing drone after a half hour or so.

Flanging

Curiously, almost nobody really knows what flanging is, anymore. Most guitarists think it comes out of a little box with three knobs and a pedal button. Actually, it's called flanging because it's a tape effect, or, at least, it once was . . . the flanges are the platters of tape reels. It was come upon over twenty years ago by Phil Spector, for a song called "The Big Hurt". How ignominious!

Tape flanging is much more interesting than CCD flanging, and isn't terribly difficult, either. To get the flanged effect, you'll need two identical dubs of the piece to be flanged, played back on two separate recorders. One can be dubbed onto a track of the four track, to eliminate the need for actually owning a pair of two track machines. The two dubs are played back simultaneously, and the phase relationship adjusted by placing a thumb, toe, or other available extremity (nose, perhaps?) on the flange of one of the feed reels to slow it down very slightly. This will result in the familiar waahing effect of the two signals interfering with each other. The rate of the waah is, of course, determined by the phase difference between the two tapes . . . a fair bit of thumb dexterity is required to gain sufficient control over the kingdom of flanges to make the techni-



The Korg SE-300 is an echo unit intended for stage use. The smaller photo shows how the tape is arranged in the unit.

que practical.

Echo

The last effect we'll look at is echo, or reverberation, of which there are four types, not counting the electronically synthesized versions.

Since we've been doing tape effects, we'll cover tape echo first. This can be further chopped up into short delay and long delay. Short delay is easily accomplished using any three headed transport and a mixer. Some recorders, like the Revoxes, have the effect built in. To do it externally, a signal is fed into the machine in the normal manner, and immediately monitored off the playback head. Because the two heads are a finite distance apart, there will be an interval of time between the instant the sound is recorded and that at which the tape it'd been recorded on arrives and the playback head, whereupon it is heard. The monitored sound is mixed back into the signal going into the machine at a much lower level . . . the exact level determining the length of the resulting reverberation.

The process can be meddled with by vari-pitching the recorder, and changing the capstan speed while the echo is happening. The results are . . . well, very bizarre, and not easily described.

To lengthen the reverb time past the fraction of a second available with the inter head spacing, long delay echoes can be set up. The principle is the same; the distance between heads is increased by using a tape loop . . . or just a reel of tape . . . strung between two recorders, in which one does the recording, and the second one the playing back.

The second type of echo is room echo, which is frequently employed by large studios that have nice, quiet rooms to use for it. Whereas tape echo is very hard, and choppy, the echo's being each a sharply defined distance apart, room reverb can contain many reflections, which gives it a feeling of spaciousness, but without any fixed delay time. It is ac-

complished by placing a monitor speaker at one end of a large room, and hanging mikes here and there. The sound to be reverberated is played into the bin, and mixed back into the original as heard by the mikes, which pick it up after it's bounced around a while. Obviously, a good, live room is needed, one with hard walls, floor and ceiling, in order that the sound is not muffled and absorbed. The room must also be large enough to provide an audible delay.

Pipe echo is very seldom used, but has the advantage of being quite cheap. In its simplest incarnation, it consists of a garden hose with a funnel at one end. A speaker is glomped over the funnel, and a mike is affixed to the opposite end of the hose. Sound played into the speaker must travel down the hose to reach the mike, thus contributing a delay. Really long delays can be obtained by using several hoses. The possibilities of building a combination delay unit and plumbing sculpture are staggering.

Unfortunately, pipe echo has two drawbacks, aside from sounding a bit peculiar. It's most susceptible to external sound, and it's very noisy, because the mike usually wants quite a bit of gain to get a decent level off the signal meandering down the hose. This isn't bad for short delays, but gets quite noticeable if a couple of those super economy family size ultra hoses are married.

Lastly, there is a spring reverb, with which most of us have probably had some contact. The delay system is a long, suspended spring, with a transducer at either end. There are actually reverbs of this type that are as big as the average human, and look like the slime dervish that devoured Greenwich Village, but most are tiny little things a foot and a half long.

Spring reverbs sound very twangy, and contribute quite a bit of noise. However, the sound they make is rather well loved, so they remain rather on top of the heap. One really neat thing to do with a spring reverb is to kick whatever

it is mounted in, at which point it will begin to generate some interesting, and possibly even useful, percussive effects.

Once you get everything down on the four track the way you want it, it must be dubbed onto a two track master. The usual speed for this is 15 ips . . . just in case you're planning to approach a label with your creation. The four signals from the four track are run back into the board, positioned on the stereo stage, EQ'd if necessary, and the whole mess dubbed into stereo.

The only wrinkle in mastering is something which has crept up of late, namely, half speed backwards dubbing. It's just what it sounds like; you can make your dubs at half the regular speed, and, to further, complicate matters, you can do them in reverse. There are, oddly enough, actual reasons for doing this.

As far as the half speed part goes, tape is happier with low frequencies. The higher a pitch gets, the less the system is able to deal with it. Up in the treble end, things are really bad, which is why there are Dolbys, and whatnot, to compensate for this sort of negativity. However, one can simply cheat the equipment by dubbing at seven and a half, instead of fifteen, thus moving all the notes down one octave. If the highest note was twelve kilohertz at fifteen, it will only be six now, where it won't cause anywhere near the problems it once did. Of course, the tape recorder's EQ will go to pot doing this. I get around this by using Telex multiple EQ dubbing electronics, but these are really awfully expensive. The other approach is to compensate for the miscalculation with an outboard graphic equalizer.

The playing backwards part is a bit more like alchemy. It seems that tape responds better to sharp trailing edges than it does to sharp leading edges. Most acoustic sounds, as we've discussed, have sharp leading edges, which can be reversed if the tape is.

And, in conclusion . . .

I hope that all seems like an improvement over crooning into a dictating machine. With the present state of the musicians art, in pop especially, producing is as much an aspect of a work as is playing . . . for many new wave bands, in which guitar lessons are a future aspiration, perhaps it is even more so. Thus, it isn't too surprising that, as the performer has begun to become a bit eclipsed by the producer, many players have been snatching control back for themselves by betting into small studios. There are quite

a number of bands, Boston, for instance, who have done complete, and highly successful, albums under these conditions. Many others use a four track to get all the bugs out before hitting the two-inch tape.

Even if your just interested in polishing up your rendition of "Blowin' In The Wind", a studio is a fascinating toy.

Oh, there's another wonderful studio accessory . . . I almost forgot to mention it. Having a four track, and a board also entitles you to a bright crimson lamp to hang outside the studio door that says "RECORDING. SHUT-UP."



Open to both
men and women

TRANSLATORS

Salary: TR-01 \$12,830 – \$24,740
TR-02 \$23,198 – \$30,038

SECRETARY OF STATE
TRANSLATION BUREAU
OTTAWA-HULL, MONTREAL, DOWNSVIEW,
QUEBEC

Competition No.:

81-SEC-CS-480-SF / Technical Translators
English to French
81-SEC-CS-481-SF / Scientific Translators
English to French

Duties

Under the supervision of a reviser, translates texts from English to French or from French to English in accordance with Translation Bureau standards; carries out terminological research and assists in the preparation of the section glossary.

Qualifications

Technical Translators: Aptitude for translation and experience in one of the fields listed below:

- Mechanics
- Aeronautics
 - Aircraft mechanics
 - Operation (aircraft and helicopter)
 - Air traffic control
- Electronics
- Construction
- Computer Science

Scientific Translators: Aptitude for translation and experience in one of the fields listed below:

- geophysics
- mining engineering
- health sciences

For all positions: Experience in translation or in a field related to the duties of the position is essential. Good knowledge of the source text language and thorough knowledge of the target text language.

N.B.: A written examination in the chosen speciality will be administered to all candidates in order to verify their qualifications and level of competency in translation.

Additional job information is available by writing to the address below:

Toute information relative à ce concours est disponible en français et peut être obtenue en écrivant à l'adresse suivante:

How to Apply

Send your application form and/or résumé to:

Françoise Plourde
Staffing Officer
Examination Centre
Staffing Division
Personnel Administration Branch
Secretary of State
Ottawa, Ontario K1A 0M5
Closing date: February 27, 1981

N.B.: Please quote the appropriate competition number on all correspondence, desired work location, preferred area(s) of work.

Canada

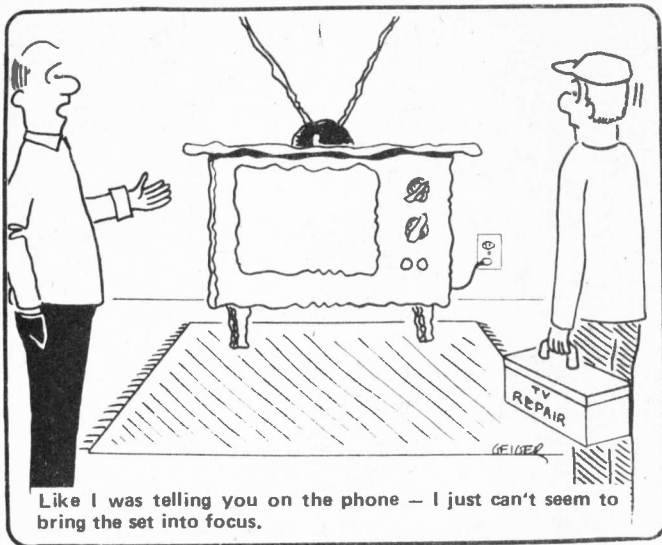

Like I was telling you on the phone -- I just can't seem to bring the set into focus.

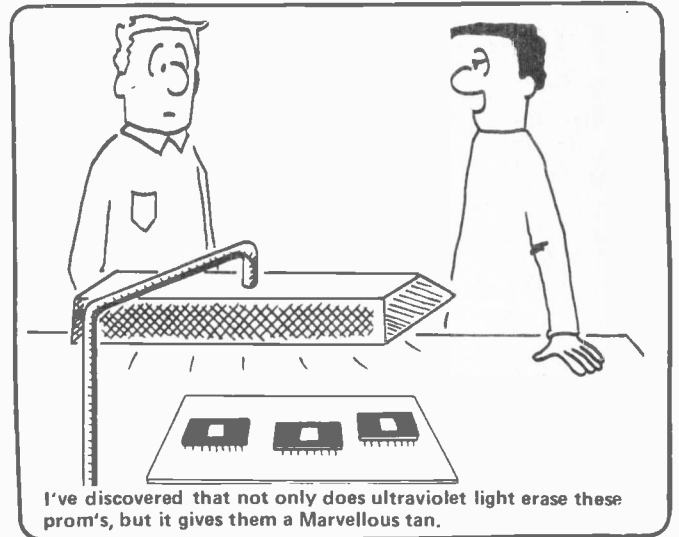

I've discovered that not only does ultraviolet light erase these prom's, but it gives them a Marvellous tan.

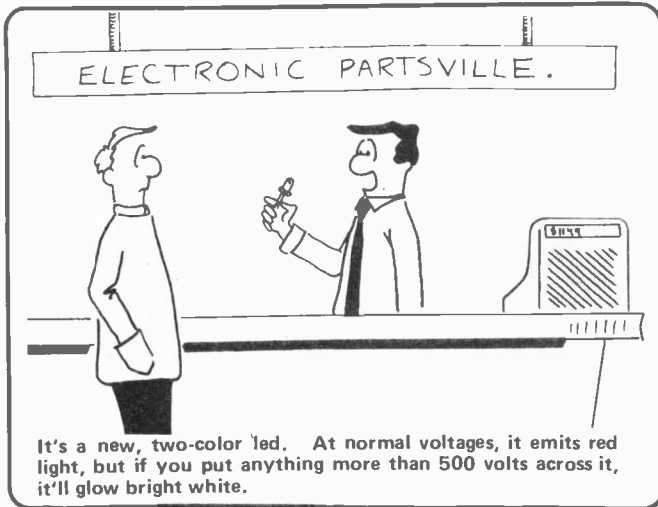

It's a new, two-color led. At normal voltages, it emits red light, but if you put anything more than 500 volts across it, it'll glow bright white.

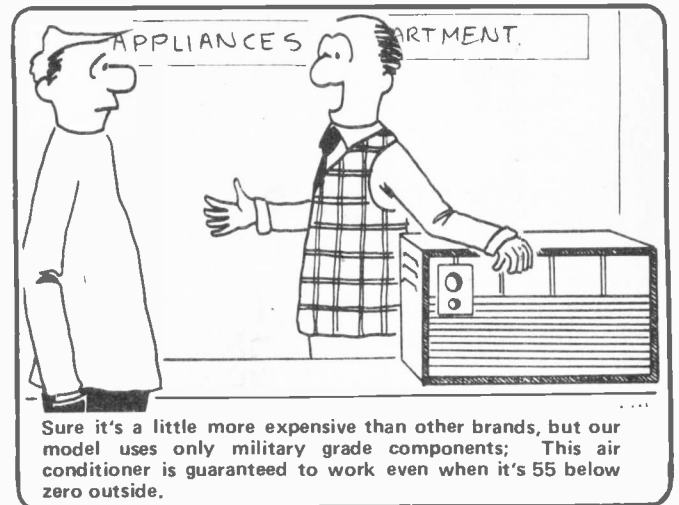

Sure it's a little more expensive than other brands, but our model uses only military grade components; This air conditioner is guaranteed to work even when it's 55 below zero outside.

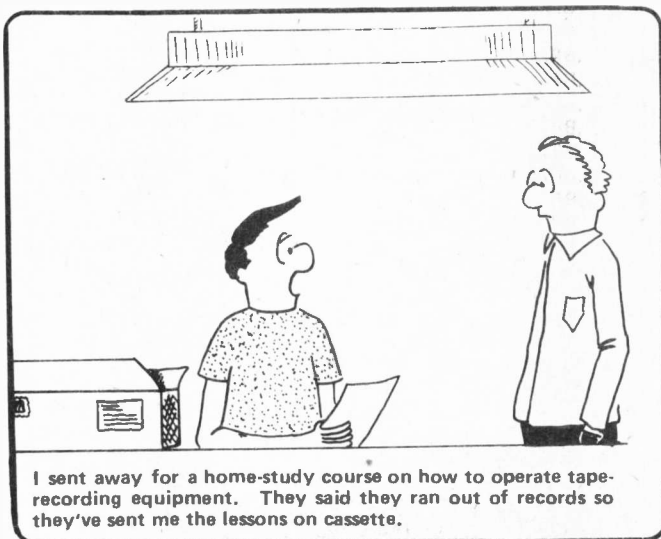

I sent away for a home-study course on how to operate tape-recording equipment. They said they ran out of records so they've sent me the lessons on cassette.

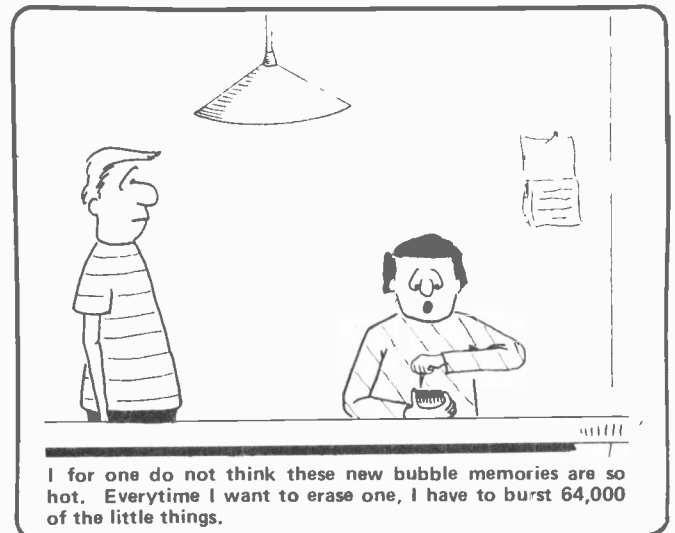

I for one do not think these new bubble memories are so hot. Everytime I want to erase one, I have to burst 64,000 of the little things.

Save up to 28% on the Newsstand price!

One Year Subscription to ETI Magazine: \$16.95
(a 23.8% saving over the newsstand price)

Two Year Subscription to ETI Magazine : \$29.95
(a 28.6% saving over the newsstand price)

Fill out the coupon on the reverse of the order form or send your cheque (or Visa or Mastercharge Card number and expiry date) to:

Subscription Department,
ETI Magazine,
Unit 6, 25 Overlea Boulevard,
Toronto, Ont., M4H 1B1

ETI ORDER FORM

BACK ISSUES: Please circle issues desired.

1977	February	May	July	November			
1978	May	June	July	August	September		
	October	November	December				
1979	January	February	March	April	May	June	July
	August	September	October	November	December		
1980	January	February	March	April	May	June	July
	August	October	November				
1981	January	February					

QTY.	ITEM	AMOUNT
.....	.Back issues @ \$3 (mark choice above)	\$
.....	.Canadian Projects Book No. 1 @\$3.45	\$
.....	.ETI Circuits Book @ \$5.45	\$
.....	. 'More Circuits' Book @ \$4.95	\$
.....	.ETI T-shirts @ \$5.50	\$
	Small () Medium () Large ()	
.....	.ETI Binders @ \$6.75	\$
	Ontario residents add 7% PST on last three only.	\$
.....	.Subscriptions @ \$16.95/\$29.95	\$
.....	.Hobby Projects @ \$3.95	\$
.....	.Electronic Circuit Design @ \$3.95	\$
.....	.Projects Book No.2 @ \$3.95	\$

BABANI		BABANI	
QTY.			
..BP1	\$2.80	..No.223	\$5.50
..BP14	\$4.80	..No.224	\$4.25
..BP24	\$4.25		
..BP33	\$4.25		
..BP35	\$5.50		
..BP37	\$5.50		
..BP39	\$5.50		
..BP42	\$3.55		
..BP44	\$7.55		
..BP46	\$5.90		
..BP47	\$5.90		
..BP48	\$5.90		
..BP49	\$6.25		
..BP50	\$5.90		
..BP51	\$5.50		
..BP62	\$8.95		
..BP63	\$8.95		
..BP64	\$8.95		
..BP65	\$6.55		
..BP66	\$7.55		
..BP67	\$7.55		
..BP68	\$7.25		
..BP69	\$7.55		
..BP70	\$2.40		
..BP71	\$7.70		
..BP72	\$7.70		
..BP73	\$8.58		
..BP74	\$7.70		
..BP75	\$7.30		
..BP76	\$7.30		
..BP77	\$12.30		
..BP78	\$7.30		
..BP79	\$7.30		
..BP80	\$8.25		
..No.205	\$3.55		
..No.213	\$4.50		
..No.215	\$3.70		
..No.221	\$5.50		
BABANI SUBTOTAL	\$		

TAB	
QTY.	
..No.800	\$18.30
..No.804	\$18.35
..No.805	\$11.75
..No.806	\$11.75
..No.841	\$8.55
..No.1000	\$11.55
..No.1010	\$9.85
..No.1015	\$9.70
..No.1064	\$11.85
..No.1070	\$12.35
..No.1071	\$10.90
..No.1076	\$11.55
..No.1088	\$11.85
..No.1120	\$7.75
..No.1133	\$9.75
..No.1152	\$11.75
..No.1169	\$13.75
..No.1174	\$9.75
..No.1234	\$11.75
..No.1241	\$11.75

SYBEX	
QTY.	
..C200	\$10.75
..C202	\$18.75
..C280	\$20.75
..C281	\$22.75
..D302	\$18.75
..G402	\$18.75

* BABANI SUBTOTAL	_____
TOTAL ENCLOSED	_____
BABANI SUBTOTAL	\$

If we cannot complete your order, do you wish the balance refunded? YES NO

PLEASE PUT YOUR NAME AND ADDRESS ON REVERSE SIDE OF THIS FORM.

SUBSCRIBE NOW!



BOOKS, BACK ISSUES BINDERS - SEE OVER

Electronics Today Magazine, Unit 6, 25 Overlea Blvd., Toronto, Ontario M4H 1B1.

SUBSCRIPTIONS: NEW SUBSCRIPTION? OR RENEWAL? Please check one.
 One year subscription (12 issues) \$16.95 Two year subscription (24 issues) \$29.95
 Postage and handling to Canada is included, for U.S. please add \$3, other countries add \$5/yr.

NAME _____
 ADDRESS _____
 TOWN/CITY _____ PROVINCE/STATE _____
 CODE _____ DATE _____

Cheque enclosed. DO NOT send cash
 Bill Mastercard. A/C No. _____
 Bill Visa A/C No. _____

Signature _____ Expiry Date _____

PLEASE ALLOW 6-8 WEEKS FOR YOUR FIRST MAGAZINE TO ARRIVE

FOR OFFICE USE

Code

0281

Number One ETI CIRCUITS

The ultimate ideas book for the experimenter. Get yours now!

ALARMS

- Basic Alarm
- Photo Intruder Alarm
- Intruder Alarm
- Photo Electric Relay
- Low Temperature/Lights out
- Temperature Sensor
- Coolant level
- Water Level
- Electronic Lock
- Car Battery Watchdog
- Simple Car Alarm
- Simple Lock

AMPLIFIERS & PREAMPLIFIERS

- High Input Impedance
- High Impedance Buffer
- Low Output Impedance
- High Input Impedance
- Low Frequency Extender
- Virtual Earth Preamp
- IC Tape Head Preamp
- Simple Stereo Tape Player
- 2.5 Watt
- 20 Watt Slave
- 10 Watt
- Loudspeaker Microphone
- Voltage Controller Amp
- Wide Band Amplifier
- Video Power Amp
- Broadband Amp

SIGNAL PROCESSORS

- Fuzz Box
- Guitar Fuzz
- Fuzz Box
- Waa Waa
- Disco Autotune
- Simple Autotune
- Information Transfer
- Optical Pulse Conditioner
- TV Sound Pickoff
- Crackles/Pops Potentiometer
- Voltage to Frequency
- Sine to Square Wave
- Precision AC to DC
- Voltage Processor
- Universal Meter
- Double Precision
- Fast Half Wave
- Simple Chopper
- Noise Rejecting SCR Trigger
- Phase Shifter

SIGNAL GENERATORS

- Simple
- Variable Duty cycle
- Fast Edge
- FET
- Improved Multivibrator
- Variable Duty cycle
- Stable RC
- Cheap (CMOS)
- Simple TTL XTAL
- Uncritical XTAL
- Pulse
- Zero Crossing
- Simple Pulse
- Needle Pulse
- Stable Linear Sawtooth
- Zener
- Noise
- Pink
- Simple Relaxation
- Triangle with independent slope
- Exponential
- Wide-range Multivibrator
- Multiple Waveform
- Linear Sweep
- Step Frequency
- Beeper
- 7400 Siren
- Simple Siren
- Ship Siren
- Two Tone
- Tor Siren
- Kojak Startrek Z Cars
- Sound Effects
- Sound Effects

FILTERS

- Bandpass
- Low & High Pass
- Rejection Notch
- Bandpass
- Cartridge EQ & Rumble
- Hum Stopper
- Tape Hiss Reduction
- Simple Crossover

DIGITAL

- Thermometer
- Heads or Tails
- Binary Calculator
- Voltmeter
- Seven Segment to Decimal
- D
- Random Binary
- CMOS Die
- Multiplexer Hints
- Learning Memory
- CMOS Clock

Simple Transistor/SCR

- SCR Tester
- Crystal Checker
- Good Bad Battery Tester
- Battery Tester
- Op-Amp Tester
- Op-Amp Checker
- Cheap Logic Probe
- Audible TTL Probe
- Audible Slow Pulses
- Logic Probe
- Logic Analyser
- Land O Display Probe
- Simple High Impedance
- Voltmeter
- Audio/RF Tracer
- Thermocouple Thermometer
- Measuring Stabilised supplies
- Simple Frequency Meter

TIMERS & DELAYS

- Low Standby Drain
- 741 Timer
- Sell Triggering Timer
- Pulse Timer
- Pulse Delay
- Voltage Controlled Monostable
- Sequential Relays
- Door Chime Delay

SWITCHING

- Touch Triggered Bistable
- Touch Sensitive Switch
- Electronic Switch
- Sound Operated 2 Way
- FSST Switch Flip Flop
- Two Signals on one Wire

INDICATORS

- Line-o-Light
- 3 Step Level
- Light Level
- Bargraph Display
- Fuse Failure
- Blown Fuse
- Back Up Lamp
- DC Lamp Failure
- FM Tuner Station
- Current Flow
- Disco Cue

AUTOMOBILE

- Brake Lamp Failure
- Courtesy Light Delay
- Simple Hazard Light
- Light Extender & Reminder
- Four Way Flasher
- Headlamp Dipper
- Wiper Delay
- Suppressed Zero Voltmeter
- Rev Counter/Tachometer
- Auxiliary Battery

POWER SUPPLIES

- Constant
- Temperature Stable
- Constant
- Voltage Controlled
- Precision Voltage Divider
- Dual Polarity
- Simple Balanced
- Voltage Divider
- Low Regulated
- Short Circuit Protected
- Simple TTL Supply
- N414 Supply
- Stable Reference
- Transformerless Inverter
- DC to DC AC
- Voltage Multiplier
- Automobile Converter
- Shaver Adaptor
- DC/DC
- High Voltage From Battery
- Variable +ve or -ve output
- Simple
- 12V from Battery Charger
- Bucket Regulator
- Adjusting Zener Voltage
- Variable Zener
- Zener Boosting of Regulators
- High Power
- Electronic Fuse
- Better Fuse
- Regulator & Fuse
- Fast Acting
- SCR Crowbar
- Voltage Polarity
- NI CAD Discharge
- Current Limiting

TEST

- Diode Checker
- GO NO GO Diode Tester
- Zener Check
- GO NO GO Transistor Tester
- Quick JFET Test
- Current Gain Tester
- Basic Transistor Tester

FLASHERS

- Dancing Lights
- Low Frequency Strobe
- Flasher
- Ultra Simple

POWER CONTROL

- LDR Mains Control
- Floodlamp Control
- Zero Crossing Sync
- Train Controller
- Low Differential Thermostat
- Simple Temperature Control
- Full Wave SCR Control

DETECTORS & COMPARATORS

- Peak Detect & Hold
- Window Detector
- Peak Program
- Positive Peak
- Reaction Comparator

RADIO FREQUENCY

- Crystal Marker
- 100 kHz Marker
- RF Voltmeter
- RF Detector
- LED RF Indicator
- RF Amplifier Protection
- FET Radio
- Op-Amp Radio

MISCELLANEA

- Phase Locked Loop
- Touch Doorbell
- Phase Lock Control
- Audio Mixer
- Virtual Earth Mixer
- Pop Eliminator
- Loudspeaker Protection
- Digital Capacitance Probe
- Digital Tape Recorder Adaptor
- Breakdown Diode Substitution
- Dual Function Charger
- Dual Mode Amp
- Capacitor Substitution
- Electronic Capacitor
- Speeding Up Darlington
- Shutter Saver
- Thyristor Sensitivity
- Sound Operated Flash
- Strength Tester
- Logic Noise Immunity

TIPS

- Identifying 74 Series
- Supply Pins
- Soldering IC's
- Tinning With Solder Wick
- PCB Stencils
- Front Panel Finish
- DIL Drilling
- Fluorescent Starting
- Avoiding Insulated Heat Sinks
- TTL Mains Interface
- Boost Your Mains
- High Resistance on Low Meters
- High Voltage Electrolytics
- Transistor Identification
- Template & Heat Sink for
- Power Transistors
- Transistor Socket
- Solder Flow Problems
- Odd Resistor Values
- Resistors in parallel
- CMOS DIL Handling
- Identifying Surplus IC's
- Extending Battery Life
- Battery Snaps
- Power Supply or Battery
- Battery Checking
- Muck Remover
- Transformer: in reverse
- Loudspeakers Checking
- Improving UJT Linearity
- Signal Tracer
- Crystal Earpieces
- Cheap Varicaps
- Zener Lifts Capacitor Rating

DATA

- 741 Op-Amp Data
- BC 107-109 Data
- BC 177-179 Data
- CMOS & TTL Data
- 2N3055 Data
- MJ2955 Data
- Bipolar Data Tables
- Bipolar FETs/Rectifiers
- Diodes Pinouts Zener Misc

SEND \$500 TODAY
 To: ETI Circuits, ETI Magazine
 Unit 6, 25 Overlea Boulevard
 Toronto, Ont. M4H 1B1
 Add 45¢ for postage and handling.

Designer Circuits

AUTOMATIC FADER

This unit can be used at discos, slide shows, film shows, etc. At the flick of a switch it can be used to automatically fade a signal in or out without introducing any clicks or other background sounds. Normally a unit of this type is used to control background music (providing a simple method of fading it out during a commentary and returning it again afterwards), or some similar application.

In this circuit P channel JFET transistor Q1 is used as a voltage controlled resistance. Its drain to source resistance actually forms a voltage controlled attenuator in conjunction with R1. The input signal is applied to this by way of DC blocking capacitor C2. When power is initially applied to the circuit, C4 will be uncharged and the gate to source voltage of Q1 is therefore zero. This gives Q1 a low drain to source resistance of only about 100 ohms, causing high losses through the relatively high resistance of R1. As the ratio of these two resistances is about 10,000 to 1, the output from the attenuator is only about one 10,000th of the input level (-80dB) and the signal is thus effectively cut off. As C4 begins to charge via R2, Q1 becomes increasingly reverse biased, causing its drain to source resistance to increase. As this

resistance increases, the losses through R1 decrease, causing the signal to "fade" in. Eventually the drain to source resistance of Q1 reaches its maximum value of about 1,000 megohms, which gives no significant losses through R1.

Switching SW1 to the "down" position gradually discharges C4 through R3, returning the bias on Q1 to its original state and fading out the

signal once again. Switching SW1 back to the "up" position returns the reverse bias to Q1, bringing the signal back up to full level once again. IC1 is simply used as a high impedance buffer stage that ensures little loading is placed on the attenuator so that it is permitted to function correctly.

The fade up and fade down times are controlled by the settings of R2

and R3 respectively, and can be adjusted from a fraction of a second to as much as about 8 seconds or so. If the full fade out level of about -80dB is not required, a 1M preset can be inserted between Q1 drain and the junction of R1-C3. The fade out level can then be adjusted from about 6dB to the full 80dB using this component. The current consumption of the unit is only about 2 mA.

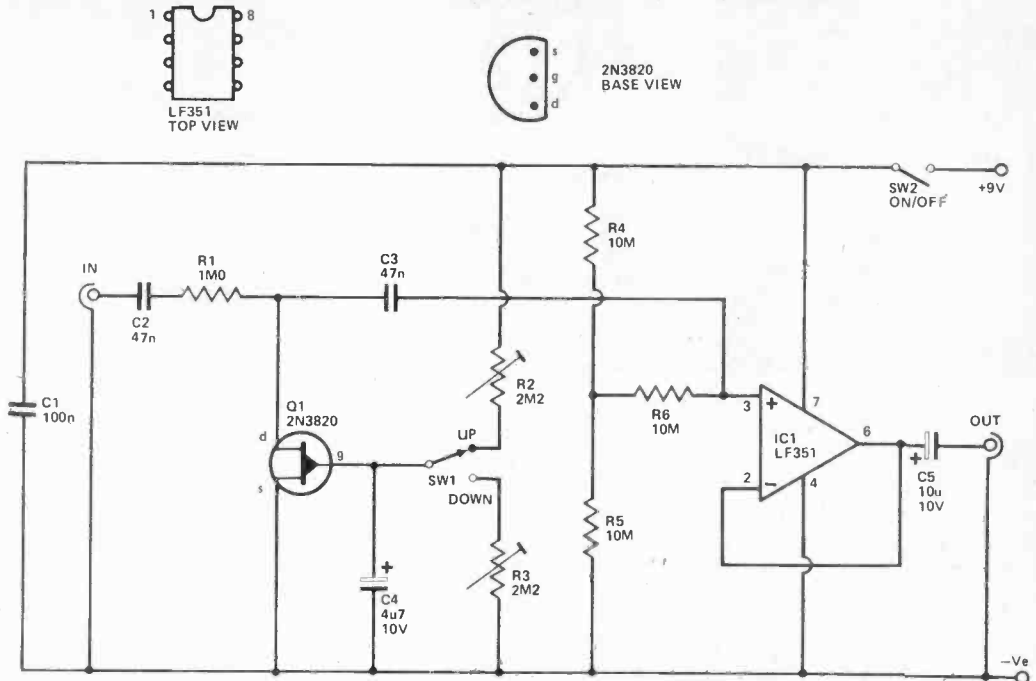

TREMOLO UNIT

This is one of the most popular types of special effect unit for use with guitars, the operation is to amplitude modulate the input signal with a low frequency signal. Thus a constant input as in (a) would emerge from the tremolo unit varying in amplitude at a low frequency as in (b).

In this circuit the input signal is taken to the input of an electronic attenuator (based on IC2) via a common emitter amplifier using Q1. R6 sets the gain of the attenuator (with zero modulating voltage) at about unity, but the amplification provided by Q1 gives an output level of a few hundred millivolts. This can either feed a high level input of the amplifier, or R7 can be adjusted to attenuate the output to a level which is suitable to drive the ordinary guitar input. It is necessary to have the stage of amplification ahead of the IC2 so that this part of the circuit is handling a fairly high signal level, and gives a good signal to noise ratio.

The gain of IC2 can be varied by applying a control voltage to pin 2. This control signal is generated by a conventional CMOS astable circuit which uses two of the gates

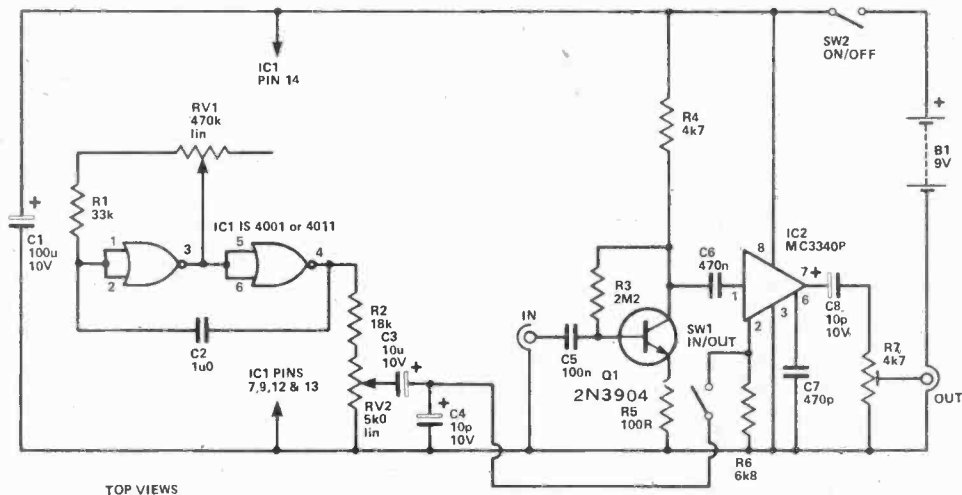

contained in IC1. The operating frequency of the astable can be varied from about 1 to 10 Hz by means of frequency control RV1. A squarewave signal is produced by the astable, and this must be filt-

ered to remove the high frequency components in order to give a smooth and pleasant tremolo effect. This filtering is given by R2 and C4. RV2 controls the amplitude of the modulating signal and acts as the tremolo depth control. SW1 can be used to disconnect the modulation when the tremolo effect is not required.

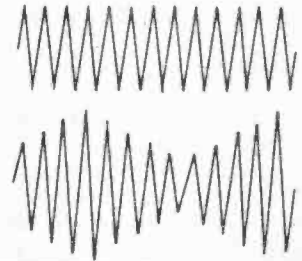

TOP VIEWS

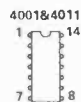



Audio Today

THE SLEWING CAPABILITY of an amplifier has been stated in the advertising of many manufacturers as if this were the only characteristic which need be known in order to determine the quality of the equipment.

This compares with the equally simplistic practice of running banner headlines over each minute fraction of a percent reduction in total harmonic distortion without regard to the manner in which it is achieved and the side effects thereof, or even whether or not the difference is even audible.

In last month's discussion of the subject, slew rate was described essentially as an amplifier's ability to follow, at its output, the wavefront of a step input which, by definition, has an infinitely short rise time, and by extension defines the fastest rate of change in instantaneous input level which can be faithfully reproduced.

We ended with a practical example which would leave the reader with the impression that a slew rate of 1.6V/us would be more than adequate for any high quality amplifier.

In fact, there are many highly respected engineers who would consider even this figure to be an example of over-engineering, while many highly regarded amplifiers boast slew rates of 50 V/us and higher.

What we are really dealing with is an example of two conflicting schools of thought, and the controversy has often resulted in the dispensation of as much vitriol as a debate in the House of Commons, or the United Nations, although, happily, not on such an infantile level.

Signal Slope

Last month it was stated that an amplifier which will pass a frequency at least ten times the fundamental of a square wave could be said to pass the square wave unaltered. Although this is a rather arbitrary statement, it has been accepted with enough universality to make it valid for our purposes, and will be used

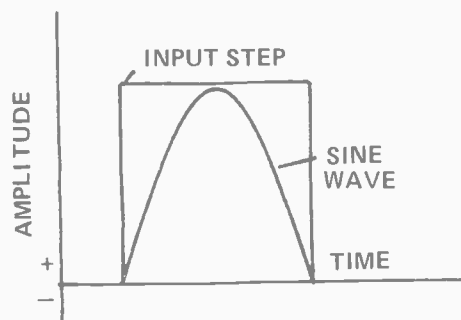

Fig. 1. Comparing sine wave slope with step signal.

throughout this discussion.

Fig. 1 shows a square wave on which has been superimposed its fundamental sine wave of equal rms value. In our initial discussion we were concerned with the ability of the amplifier to slew at a rate equal to or greater than that required to handle one quarter of the sine wave.

The only problem with this approach is that it assumes, incorrectly, that the quarter wave interval adequately defines the speed at which amplifier output must change if it is to follow the input signal. However, as figure 1 shows, the actual slope of the signal is steepest at the zero crossing point, approaching that of a square wave. Thus, even though a quarter cycle of a 1 kHz sine wave takes 250 us to reach its peak the rate of change at the zero crossing point is considerably greater, while near the peak the rate of change is minimal.

Fig. 2 now superimposes an amplifier response to a step input, along with a sine wave. In this example the slew rate capability is slightly greater than needed to handle the sine wave, based on one-quarter cycle criterion. But it is clearly inadequate to handle the slope near the zero crossing point, and since the output change rate cannot exceed the slewing limitations of the amplifier, the resulting output looks like figure 2b., and is clearly distorted.

The First Complication

The characteristic shown in fig. 2 has a slew rate which is constant from zero to maximum. In fact, the design of an amplifier may result in a characteristic like fig. 3. Such an amplifier is clearly able to track a very steep slope up to a point at which slew rate limiting sets in, and will not exhibit any of the slewing induced distortion of fig. 2 except at higher frequencies or peak outputs.

Unfortunately this distinction is never made in slew rate specifications except in graphic form in integrated circuit manuals.

But this is all academic anyway, because feedback will take care of the distortion, won't it.

Oh?

Poor old overworked feedback. The Department of Labour ought to enact legislation to prevent undue exploitation of such a willing worker. So many people seem to think that all you have to do is wrap a feedback loop around an amplifier and you can get away with anything.

Feedback in a circuit is never constant, not even throughout the waveform. If it were, you wouldn't need it.

This month we are not dealing with feedback theory, so I have no intention of digressing by delving deeply into it, but I should point out that feedback does only one thing: it alters the amount of gain change which may occur within the loop. In the case of negative feedback, it holds the gain more nearly constant than would be the case without it. This is true no matter what the cause of the change.

When a fraction of the output is returned to input, it reduces the input level by some specified amount. If the gain of the amplifier changes, then for a given input level, the output level will change, and so will the level fed back. As a result, there will be a change in the amount by which the signal level at the input is reduced.

For example, if gain is reduced at some frequency, the output level will reduce, causing a reduction in feedback level, and less reduction due to feedback of the input. Thus the input level increases causing an increase in the output level.

Non-linearity in the transfer characteristic of a transistor results in the gain changing at different instantaneous levels of the waveform. Feedback minimizes these non-linearities, reducing distortion.

The feedback loop has no way of knowing whether a difference between input and output waveforms is due to non-linearity or the phases of the moon; it will do the same job regardless.

Inside the Loop

There has been no evidence brought

forth to show conclusively that the human ear can detect the kind of time delays involved here. But, like the Shadow, the Amplifier knows.

We will not go into the reason for using compensation within the amplifier's forward loop, but with conventional design one of the effects is a phase shift ranging from 0° to a maximum of 90° over a frequency range of two decades, and equalling 45° at the corner frequency. Since phase shift is also another way of describing time delay, there is also a constant time delay throughout this range. A decade above the corner frequency the phase shift becomes constant at 90° .



Fig. 2a



Fig. 2b

Fig. 2. Effects of slew limit on wave form.

As a result of the time delay, the output signal does not appear via the feedback loop at the input exactly out of phase. Nor does it get applied at the same instant as the input signal. Since the input signal is reduced by feedback, it is not uncommon for the early stages to be designed to handle only the maximum input-plus-feedback signal for which the entire amplifier was designed. But if a signal with a steep slope is applied, for a fraction of a second *only* the input signal will appear, a signal which may be a *hundred times as great* (or more) as the input-plus-feedback signal.

If the time delay involved is only equivalent to a few degrees of phase there is no serious problem, but at 90° an entire quarter wave will have been applied before feedback is available to reduce it.

The result is, inevitably, distortion in the input stage. Provided compensation occurs only after the first stage. But if it is provided later in the circuit, say, in the driver section, then *every* stage prior to compensation will be overloaded, and feedback used up in trying to correct the resulting distortion.

It should be emphasized that this problem is most severe under conditions of maximum phase shift.

Maximum phase shift also corresponds to maximum attenuation. As a matter of fact, 90° phase shift occurs at the point where gain has been reduced by 20dB or more.

In other words, feedback has been reduced at those very frequencies where



Fig. 3. Another kind of step response.

it's needed most. And we can't make up for this by increasing overall feedback further, because this will result in the need for even greater input signal and greater compensation, both of which exacerbate the problem.

Avoiding the Problem

The problem described is often called Transient Intermodulation Distortion, a term which can best be described with an unprintable word, but any way you look at it, it comes out as semantic garbage.

It's also easy to avoid. The techniques are varied, but include designing for maximum stage by stage linearity and bandwidth, with or without feedback around individual stages, feed-forward compensation, which introduces a

leading phase angle, and all of the above making possible minimum overall feedback.

In using the amplifier the problem can be avoided by ensuring that it is never presented with a signal slope greater than its slew rate limit. How? By introducing a filter which rolls off response above the lowest frequency which will produce this condition.

It follows too, that if any amplifier in a chain has a power bandwidth greater than the preceding stage, it *cannot* be driven beyond its slewing capability by any signal within its linear operating level.

The problem was quite well understood even in the fifties, and many of the solutions go back that far.

Like the re-invention of the wheel, people seem determined to re-discover old problems, and re-invent old solutions under new names.

Gives them something to do. ●

AUDIO TODAY LETTERS

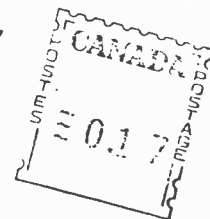

A Moving Problem

I have a late model General Motors vehicle with a Delco AM-FM cassette radio, a Fosgate amplifier, a pair of Philips tweeters and a pair of Jensen triaxial speakers.

Although my car has the standard factory-equipped suppression devices (capacitors and resistor spark plugs and wire) and even a special capacitor-choke suppression kit made up by a local auto stereo dealer, my radio still suffers from ignition spark plug hash.

1. What is there left that I can do to alleviate the problem?
2. Would wrapping all power and speaker wires with lead foil help?

How about writing an article on audio noise suppression methods in a future ETI issue as there are probably a lot of people out there who'd like to get the hash out of their radios and some music in their ears.

D.T., St Catharines, Ont.

I've tried for years to get hash out of radio but the programme dir-

rectors just won't listen.

I can only accept as given that the noise is ignition noise, and that it occurs on AM only. If such is the case, and your ignition is in good order, check your antenna system. Many GM vehicles are equipped with an antenna built into the windshield. While the idea may help to sell cars, it doesn't do much for reception. If signal strength is weak, the AGC in the receiver brings sensitivity up to the point where ignition noise is audible. Remember, ignition resistance *only reduces* noise, it doesn't eliminate it. To do that would require so much resistance that spark duration would be insufficient. If this is the case, a good remedy is to install a good whip antenna outside, preferably a power unit so that its height can be adjusted for maximum sensitivity, and preferably mounted on the left rear fender. That gets it away from the ignition system, and it's safer from vandals than on the curb side.

No amount of filtering will remove true ignition hash, but you may find it necessary to get

a more sensitive receiver.

Often hash is confused with other interference. For example, I had trouble with radiation from the CD ignition module, mounted close to the power antenna on the left front fender. The solution was self-evident.

The alternator has a suppression capacitor built into it to remove hash from the lines. Sometimes this goes, in which case you'll likely get some noise on all inputs including tape and FM.

Should this be the case, repair is indicated. If suppression is inadequate, check all grounds for good contact, especially the battery ground on the engine block. You may even have to run all grounds to this one point, and connect a separate (fused) power line from the sound system directly to the battery, with or without a filter at the battery.

About all you'll accomplish with the lead foil will be to make the car heavier.

Let me know how it all worked out.

The Rational Audio Nut

The following stands in relation to your 471 group. Thinking in terms of bi-amp, two 100W modules, separately supplied, two 60W modules commonly supplied, assuming matched slew rates, would provide clean power in a more applicable manner. They should be designed for 2 ohm stability parallelling Hafler and N.A.D. Then acquire some clear documentation by sending a representative sample out for independent test.

I have been assured by my local electronics engineer that the body of your pre-amp section is good but the subsonic cut is a joke. It should be at least an 18dB slope. The loudness compensation can be ignored and the tone control slopes are as standard as a half inch bolt. No one with good speakers needs bass boost above 60Hz, but that's what we get. In addition, a lot of very good speakers dive over the cliff at 50Hz, indicating a valid need for auxiliary boost at or about 30Hz.

As an individual I would rather have equipment designed out by the same man as impedances, slew rates and gain would come out even. There is more than one way to collect a dose of T.I.M.

A.M.B., Edmonton, Alberta

This is precisely the kind of twaddle one gets from neophyte stereo sales men and people who wear tweed jackets to audio club meetings. Pick up a smidgen of half-truths and spout it out.

Point for point, now, why would you supply the 100 Watt modules separately, and the 60 Watt modules commonly? Why do you insist on matching the slew rates? And why would you design for a 2 ohm load when it's intended for 8 ohms? There is such a thing as optimum matching, as your local electronics engineer would tell you if he knows anything about amplifiers. Or do you really think that speaker impedances should vary all over the lot?

I'm glad you like the body of our pre-amp, even if it is a standard circuit. As for the subsonic cut, if you'd go to the trouble of matching your pickup and arm properly you wouldn't need such a circuit at all. And if you had looked more carefully you would have noticed that the equalization curve follows the new IEC characteristic, which corresponds to the old RIAA, except that it's spec'd to 20Hz and incorporates a rolloff below 20Hz, thus reducing the need for rumble filters.

The loudness control should do. Feel free to ignore it.

Of course the tone controls follow a standard slope. What else should it do? Or do you think the standard slopes came into existence by accident?

I've said it many times, if you want speaker response below 50Hz you get a speaker which goes below 50Hz, you don't get one that's deficient and then boost it. Tone controls are used to correct deficiencies in *programme material*, not equipment. The equalizers to which you refer are intended for use with specific groups of Thiele alignments, and, incidentally, make pretty heavy demands on power amplifiers.

I'm not really angry that you don't like our preamp. But if you shoot from the lip, be ready for the consequences. After all, your P.S. did warn me that this was my last chance to ignore you.

Anyway, I retained your Buzzword at the end. Even if it doesn't mean anything.

Have you ever tried prophylactics?

FREE
Celestion

**PROFESSIONAL
LOUDSPEAKERS
VENTED CABINET
CONSTRUCTION
PLANS**

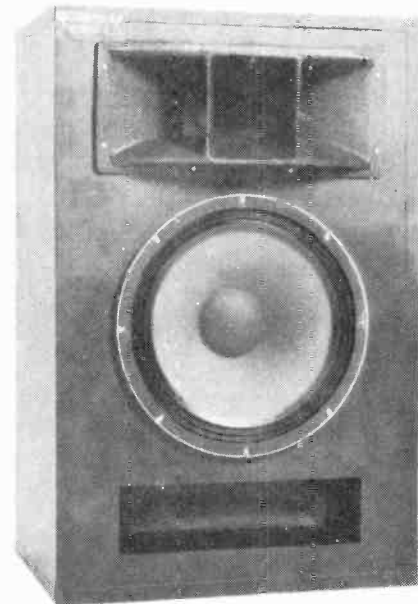

Here at last! Seven Thiele-alignment vented systems. All expertly designed for concert-hall efficiency and smooth, extended bass response. And all using professional affordable Celestion Power Loudspeakers.

Also new at your Celestion dealer; your choice of pre-cut front baffle board only, or complete knockdown cabinet kits for above systems. Plus three new heavy-duty crossovers.

Write to Rocelco for complete "VENTED PLANS" yours FREE on request.

**PROFESSIONAL AND
AFFORDABLE
SYSTEMS START with**

Celestion



**POWER RANGE
LOUDSPEAKERS**

EXCLUSIVE CANADIAN DISTRIBUTORS:

ROCELCO INC.

Dept. ETI

1669 FLINT RD. DOWNSVIEW, ONT.
TEL: (416) 663-5302 M3J 2J7

Circle No. 5 on Reader Service Card.

IT'S A BREAKTHROUGH!

CERESIST

Direct etch PCB transfers
MAKING EASY TO DO EASY WAY

CERESIST 94/1



THE DRY TRANSFER MADE SPECIFICALLY FOR PCBs

FAST EASY ROUTE
TO
PROFESSIONAL LOOKING

P.C. BOARDS!

69 different patterns

100% GUARANTEED

As thousands have discovered, CERESIST is not a gimmick, but a revolutionary medium for PCBs. You rob down the transfers to make up the desired foil pattern directly on board, then you etch! It's that simple, and CERESIST premium quality is backed by our 100% money-back guarantee. IT WORKS! (It's also great for layouts on film, paper etc.)

Just 3 patterns (see box on right) will get most people going, and probably be enough for several PCBs.

If you want to know more about PCB making, our new booklet PRINTED CIRCUITS WITHOUT HASSLES, by John Cox, is now ready. This is packed with basic info, tips and ideas, some of which you won't find anywhere else. Covers Photoresist and other methods in detail. Send 50¢ now for booklet (which also contains 50¢ coupon applicable to CERES product).

These I will get you going...

61/1

TR. PADS

41

LINES FINE

94/1

I.C. DIPS

EACH SHEET APPROX 90 SQ CM TRANSFER AREA \$1.99 PER SHEET

CERES

866 Bloor Street West,
Toronto, Ontario,
M6G 1M5

For Parts o BRYAN ELECTRONICS o For Everything

BARGAIN BASEMENT PRICES!!
—POTENTIOMETERS—
LINEAR, 5K, 10K, 50K, 100K,
AUDIO, 5K, 10K
\$.89 ea. 10 assorted \$7.95

CMOS

4000 \$.60
4001 \$.50
4002 \$.50

REED SWITCHES
standard \$.49 ea. 10/\$3.99
heavy duty \$.59 ea. 10/\$4.99

SUPER DEAL!
AC LINE CORDS
2-WIRE \$.39 ea. 10/\$3.99
3-WIRE \$1.19 ea. 10/\$10.95

4006	\$1.50	4034	\$4.25	4081	\$.50
4007	\$.20	4040	\$2.15	4082	\$.50
4008	\$.60	4042	\$1.70	4085	\$1.25
4009	\$.50	4044	\$2.50	4086	\$1.95
4010	\$.50	4046	\$1.75	4089	\$3.50
4011	\$.50	4048	\$.50	4093	\$1.00
4012	\$.60	4050	\$1.30	4094	\$2.50
4013	\$.75	4052	\$1.80	4501	\$3.25
4014	\$.80	4053	\$1.50	4502	\$2.10
4015	\$1.65	4059	\$2.50	4508	\$3.50
4016	\$.60	4060	\$2.00	4510	\$2.00
4017	\$2.00	4062	\$1.50	4511	\$2.00
4018	\$1.80	4063	\$.60	4512	\$1.60
4019	\$1.80	4069	\$.50	4515	\$5.90
4020	\$1.50	4070	\$.50	4516	\$1.45
4021	\$1.50	4071	\$.50	4518	\$2.00
4022	\$1.80	4072	\$.50	4519	\$1.00
4023	\$.50	4073	\$.50	4520	\$2.00
4024	\$1.50	4075	\$.50	4522	\$2.15
4025	\$.50	4076	\$.80	4526	\$2.50
4026	\$1.90	4077	\$.50	4528	\$1.65
4027	\$.95	4078	\$.60	4531	\$1.90
4028	\$1.75				
4029	\$1.60				
4030	\$.50				
4033	\$2.15				

BARGAINS

FINISHED PRODUCTS
Watch for this space in our upcoming ads in ETI.
We are going to save you money!
Shipping is extra on these items
75 day return privilege
CASSETTE TAPES—
MAXELL UDXLII
C 90 \$4.95 ea.
TDK SA C-90 \$4.95 ea.
Scotch Ferro-Chrome Master III
C 90 \$4.95 ea.
Our Own Studio Quality Cassette
C 90 \$2.95 ea.
Jensen Triax II
6" x 8" \$139.95 pr.
Lear Jet 10 band 70
WRMS Total \$119.95
Equalizer/Amp \$119.95
Write for more details on these items.

YOU CAN'T AFFORD TO PASS ON THIS ONE!!!
Miniature push button switch
—S.P.S.T.
—1A 125VAC
—momentary
\$.49 ea. BUY 10,
GET 5 FREE!!!
BUY 20, GET 15 FREE!!!

L.E.D.'s
MIL31-RED \$.28 ea. 10/\$1.99
MIL31-GREEN \$.40 ea. 10/\$2.99
MIL31-YELLOW \$.40 ea. 10/\$2.99
HARDWARE-MIL31 \$.12 ea.
MIL51-RED \$.28 ea. 10/\$1.99
MIL51-GREEN \$.40 ea. 10/\$2.99
MIL51-YELLOW \$.40 ea. 10/\$2.99
HARDWARE-MIL51 \$.12 ea.

LED IN CHROME BEZEL
RED \$.99 ea. GREEN \$1.20 ea.

BONUS GIFT \$.82 each
FREE WITH EVERY ORDER!! 10/\$.72 each
CB "SOUND BOOMER"
for your CB - \$3.50 value 25/\$.62 each

—Add \$2.00 for shipping and handling.
—C.O.D. orders \$2.00 additional.
—Ontario residents add 7% sales tax.
—Mastercharge, Visa, Money Orders.
—Do not send cash.
—Be sure to sign your order.

Dress up your projects!
Neon (120VAC) Panel Indicators. Built in resistor, 1/4" panel hole.
Your choice: red, green, amber



LIMITED OFFER

Complete the following sentence:
"I like BRYAN ELECTRONICS because..."
and we will give you 25% off on your kit purchase — this month only!!

MICRO KIT'S	
Stereo ohmo pre-amp	\$.95
1 watt amplifier	\$16.95
3 watt amplifier	\$19.95
15 watt amplifier	\$24.95
Crystal radio	\$.85
Stereo mixer	\$49.95
CCD photo	\$79.95
Frequency shifter	\$79.95
16 ch. multi-mode chaser	\$29.95
Strobe light	\$19.95
1 channel colour organ	\$.95
3 channel 300W colour organ	\$19.95
3 channel 1500W colour organ	\$29.95
Music code oscillator	\$.95
0-24V power supply	\$29.95
16 channel LED chaser	\$14.95

BRYAN ELECTRONICS
90 Kennedy Road South
Brampton, Ontario
L6W 3E7
Phone: (416) 457-9269

STOP! READ ME AND SAVE!

Circle No. 16 on Reader Service Card.

BINDERS FROM ETI

You've been getting ETI for a few months and already they're getting tattered and dog eared. Protect your investment with ETI binders. They're made of quality durable plastic and will hold twelve issues. Cost? Just \$6.75 post-paid (Ontario residents add 7% provincial sales tax).

To get yours, use the handy order form in this issue or send cheque or money order to:

Binders Offer
ETI Magazine
Unit 6
25 Overlea Blvd.
Toronto, Ontario M4H 1B1

Subscriptions Hot Line

You can now take out your subscription to ETI by phone during discount rates. Our answering machine will accept your order between 6.00 pm and 8.00 am EST.

If you wish to use this service, please have the following information ready before making the call and be prepared to tell us:

1. If you want a 1 year or 2 year subscription.
2. If you want to a) be billed.
b) Charge it.
3. If you wish to charge your subscription, please give your Visa or Mastercard number and the expiry date.
4. Give us your name and address with the postal code.
5. Give us your day-time phone number (in case of queries).

Please spell out any part of your name and address that could cause us problems, please remember telephone circuits are not high quality links. We will acknowledge your order by post.

This is an experimental service and only subscriptions orders can be taken at the present on this number.

(416) 423-3265

TECH TIPS

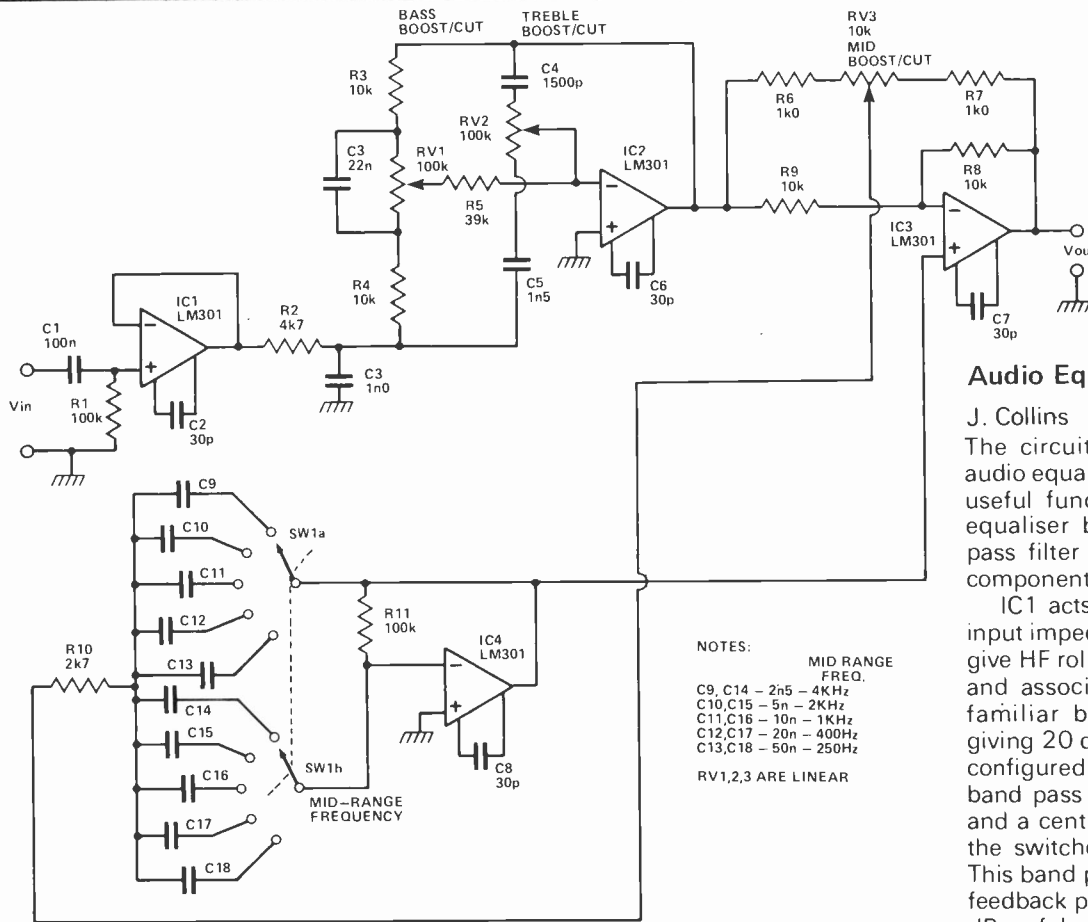

Audio Equalizer

J. Collins

The circuit is a versatile line level audio equaliser providing many of the useful functions of a multi-channel equaliser but using only one band pass filter and, therefore, far fewer components.

IC1 acts as a buffer, providing an input impedance of 100 k. R2 and C3 give HF roll-off at around 30 kHz. IC2 and associated components form a familiar bass/treble tone control giving 20 dBs of boost and cut. IC4 is configured as a multi-feedback type band pass filter with a Q factor of 3 and a centre frequency selectable by the switched capacitors C9 to C18. This band pass filter is connected in a feedback path of IC3, giving up to 20 dBs of boost or cut at the centre frequency by varying RV3.

All three potentiometers give no boost or cut at their centre (midway) positions and give a smooth increase in boost or cut on rotation to the right or left respectively.

LED 'Logicator'

M. Kyrannis

This circuit can be used as a logic monitoring device to plug into an IC socket. A 'high' level on each of the pins will light its corresponding LED. One good idea might be to build the indicator onto the pins of an IC test clip. The indicator could then be simply clipped over the top of an operating IC. Be careful though that the circuitry can drive the LEDs.

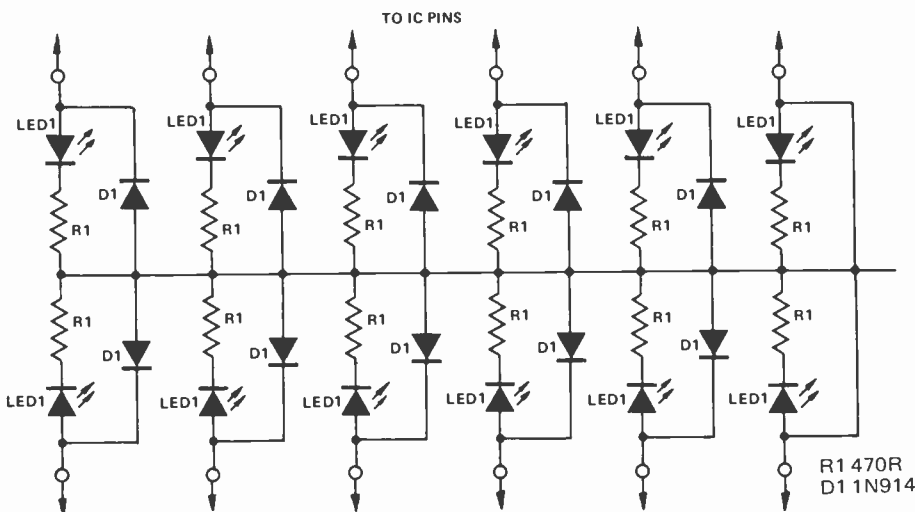

ROLL OVER BEETHOVEN BACH, OR BRAHMS . . .



NAGAOKA



Like a captive liquid, our special dry polymer surface flows into the record grooves and lifts out even the finest micro-dust particles. Most important: that dust does not build up on the cleaner as it does on all other devices. As often as you wish, you can clean the surface of the stroller completely under the tap! Clean a record with your present cleaner system and look closely at the record surface under strong light. See that haze of micro-dust left in the grooves? We can remove it! Come in for a demonstration at your **NAGAOKA** dealer. For his name, phone Avalon 861-1031

Circle No. 14 on Reader Service Card for the name of your nearest dealer. Or call Avalon at (416) 861-1031.

VIDEO at DISCOUNT

6 hr VHS VCR (1981 Model, Solenoid controlled) . . . \$999
 6 hr VHS tapes . . . \$19.99 min of 6 . . . \$20.99 for 1
 TDK and FUJI L500's . . \$18.99 T120's . . \$24.95
 \$1 off each if you buy 10 or more.
 SANYO Beta video recorder . . . \$888
 6 hr portable with tuner . . . \$1299

Video accessories available:
 -Dust covers (specify model) . . . \$22.95
 -Cleaning kits . . . \$9.99
 -Others available. Write for catalogue.
 Movies from . . . \$49 + up
 Satellite Earth Stations . . . \$4995 and up
 Shipping Extra

Write for a free catalogue or circle the Reader Service Number (below) on the Reader Service Card.

VIDEOLAND

LOWEST PRICES.
WE SHIP ANYWHERE.

TORONTO

Head Office &
 Mail Order Address:
 780 Wilson Ave.
 (W. of Dufferin)
 Downsview, Ont.
 M3K 1E2
 (416) 638-2974

582 Yonge St.
 (N. of Wellesley)
 Toronto, Ont.
 921-0264

1375 Danforth Rd.
 (N. of Eglinton)
 Scarborough, Ont.
 265-3525

1158 Queensway
 (W. of Islington)
 Etobicoke, Ont.
 255-7543

OTTAWA

1154 Bank St.
 (at Glenn)
 236-0475

SARNIA

773 Confederation
 Sarnia, Ont.
 336-8433

NORTH BAY

1138 Cassells St.
 North Bay, Ont.
 476-0007

Other locations opening soon in Montreal, Calgary and Vancouver. Call telephone operator for phone number. Retail (non-mail order) customers must present this ad (or a photocopy) to get these prices.

(DEALERSHIPS AVAILABLE)

Circle No. 6 on Reader Service Card.

INJECTORALL

REG. U.S. PAT. OFF.

If you need:

- printed circuit boards and connectors
- drafting aids
- breadboards
- PCB chemicals
- Electronic chemicals

send for our complete catalogue today!

P.C. PRODUCTS

CATALOG NO. 80

INDEX

INJECTORALL
 ELECTRONICS
 CORPORATION
 P.C. CONNECTIONS
 PRINTED CIRCUIT KITS
 ALIGNMENT TOOLS
 ELECTRONIC CHEMICALS

25c

INDUSTRIAL

MASS MERCHANDISER

SERVICE DEALER

1980

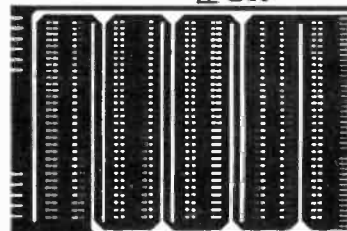

INJECTORALL ELECTRONICS CORP.

88-110 Glen St., Glen Cove, N.Y. 11545 U.S.A.
 Tel: 516-751-1011

Please send me a copy of your Injectorall Catalogue and Price List.

Name _____
 Address _____
 City _____
 Prov. _____ Postal Code _____

omnitronix ltd.

2056 TRANS CANADA HWY. UNIT 7, 6295 SHAWSON DRIVE
 DORVAL, QUE. H9P 2N4 MISSISSAUGA, ONT. L5T 1H4
 Tel: (514) 683-6993 Tel: (416) 678-7170
 Telex: 05-822692 Telex: 06-958653

Circle No. 9 on Reader Service Card.

Zener Tester

M Ibions

This circuit is to provide a cheap and reliable method of testing zener diodes.

RV1 can be calibrated in volts, so that when LED 1 just lights, the voltage on pins 2 & 3 are nearly equal. Hence the zener voltage can be read directly from the setting of RV1.

The supply need only be as high a value as the zener itself. For a more accurate measurement, a precision pot could be added and calibrated.

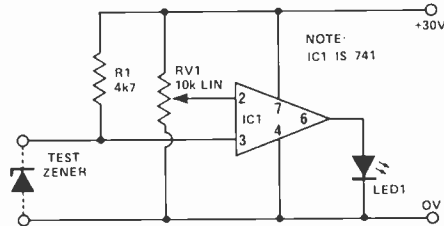

Train Controller With Inertial Brake

M. Bright

D2-5 full wave rectifies the AC and C1 smooths the output. RV1 acts as a regulator controlling train speed. Switch S1 switches in the inertia simulator (comprising D1, RV1, R2 and C2). S2 switches in the brake, the action of which is altered by RV3. RV2 controls the amount of inertia, so that the train can take as long as ten seconds before even moving. Q1,2 act as a Darlington pair, supplying current to the output. Q3 monitors the output and provides short-circuit protection. When a short occurs, D2 lights up and the current into Q1 is reduced. Hence, the output is reduced. Two 1W resistors are used for R3,4 rather than a wirewound 1/2W resistor, which would cost more. S3 simply reverses the polarity and hence the train.

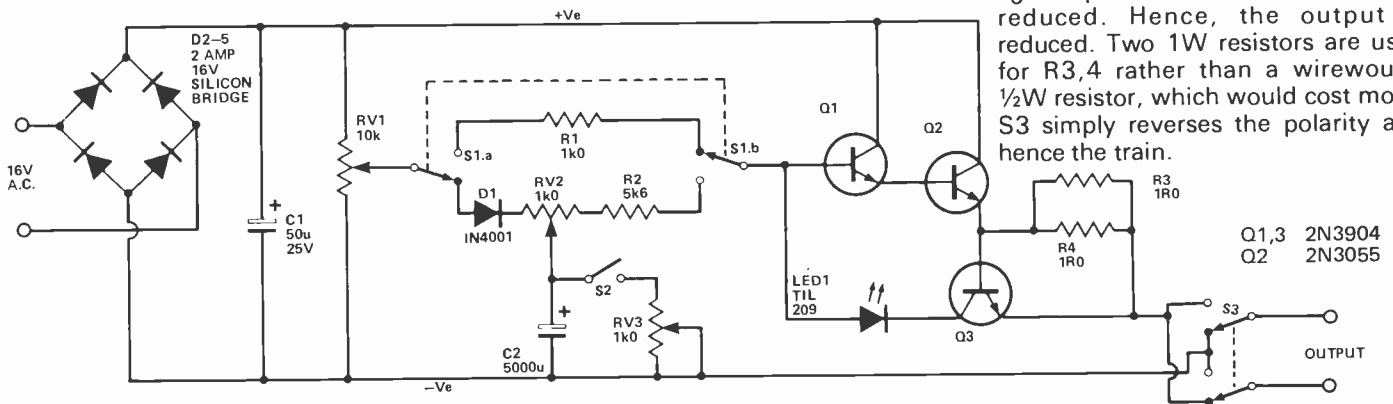

HICKOK MX SERIES DMM's

World's Fastest Troubleshooters

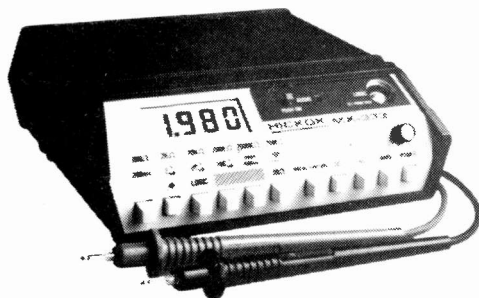

MX333 \$295.00

MX331 \$249.00

- 0.1% Basic Accuracy
- LCD Display in Unique Wide View Case
- Uses Single 9V Battery
- Compact Size. Rugged Construction
- Superior Overload Protection
- Exclusive VARI-PITCH Audible Output (MX333)
- Fast LOGI-TRAK Logic Function (MX333)
- 20Ω Range (MX333)

LOGI-TRAK function on MX333 combines the features of a high performance logic probe and voltmeter in one convenient function. Use any 10:1 high frequency scope probe to measure all logic signals and DC voltages from 10mV to 20V. Audible tone output identifies logic Hi's, Lo's, pulses as narrow as 5 nsec as well as marginal and faulty logic states and pulse trains.

Compact size, unique shape and easy-to-read-from-almost-any-angle sloped display facilitates use as a hand held, bench top or belt mounted instrument.

VARI-PITCH, audible signal on MX333 provides instant indication of the resistance, voltage or current measured for quick and easy troubleshooting. The audible response is instantaneous and proportional to the reading.

Duty and FST included. ChargeX (Visa) accepted. Ont. res. add 7% sales tax. Shipping Extra.

ROGERS electronic instruments Ltd.

P O Box 310, 595 Mackenzie Avenue Units 1 & 2
Ajax, Ontario L1S 3C5 Tel (416) 683-4211

CONDENSED SPECIFICATIONS: MX331 and MX333
DC VOLTS (5 RANGES): 200mV to 1000V full scale
RESOLUTION: 0.1mV, **ACCURACY:** ±0.1% + 1 digit
INPUT IMPEDANCE: 10MΩ, **OVERLOAD PROTECTION** 1000V DC or peak AC + up to 6kV transients all ranges.
AC VOLTS (5 RANGES): 200mV to 1000V full scale,
RESOLUTION: 0.1mV, **ACCURACY:** ±1% + 2 digits, 45 Hz to 1kHz, ±5% + 5 digits to 5 kHz, **INPUT IMPEDANCE:** 10mΩ, **OVERLOAD PROTECTION:** 1000V DC/1750 RMS.
RESISTANCE (7 RANGES): 20Ω to 20MΩ full scale except no 20Ω range on MX331, **RESOLUTION:** 0.01Ω on MX333, 0.1Ω on MX331, **ACCURACY:** 0.1% + 1 digit except 0.2% on 200Ω, 1% on 20MΩ, and 3% on 20Ω ranges. **OVERLOAD PROTECTION:** 500V DC on RMS all ranges plus 2A fuse on 20Ω range. **TEST VOLTAGE:** Low power, 0.25V max of full scale.
DIODE TEST (1 RANGE): Measures forward voltage drop across diode and transistor junctions at 2mA nominal current.
AC/DC CURRENT (5 RANGES): 2mA to 10A full scale, **RESOLUTION:** 1μA, **ACCURACY:** ±1.2% + 1 digit DC, ±2.5% + 1 digit AC, **OVERLOAD PROTECTION:** 250V @ 2A all ranges except 10A, max 15A on 10A range.
VARI-PITCH (MX333 ONLY): Variable pitch proportionate to reading, off at open circuit. Increasing frequency as resistance approaches "0" on ohms function. Increasing frequency as input increases on volts and current functions. **RESPONSE:** Instantaneous (less than 100 msec.)
LOGI-TRAK (MX333 ONLY): 0-20V range using Hickok SP-7 (not incl.) or other 10:1 scope probe. **HI/LO INDICATION:** High or low audible tone, **PULSE INDICATION:** Audible "chirp" plus lighted colon on display. **MIN PULSE WIDTH:** 5 nsec typical, **MAX FREQUENCY:** 80 MHz, **ACCURACY:** ±0.25% + 1 digit + probe accuracy. **INPUT IMPEDANCE:** 10MΩ, **INPUT PROTECTION:** 300V DC or RMS.
GENERAL: Dimensions: 2.2x6.7x6 in. (5.6x17x15.2 cm), Weight: 22 oz. (7.7kg); Power: 9V battery (incl.) or Hickok AC adapter; Battery Life: 200 Hrs. typical, Temperature: 0-50°C operating, -35 to +60°C storage. **INCLUDES:** Deluxe safety test leads, battery, manual and belt clip.

ACCESSORIES

- SP-7 10:1 Divider Probe for Logi-Trak Input ... \$50.75
- TP-20 (C or F) Temperature Probe ... \$72.50
- VP-14 RF Probe (0.25V to 40V rms) ... \$50.75
- VP-40 40KV DC Probe (0 to 40KVDC) ... \$56.00
- CC-4 Deluxe Vinyl Carrying Case ... \$23.00
- RC-3 AC Adapter ... \$12.50

Circle No. 8 on Reader Service Card.

TSC

Serving The
Technician
Since 1971

— Tuners are
our only
business.

Tuners are cleaned ultrasonically, checked on new Wavetek sweep equipment for gain, bandwidth, oscillator tracking and AFC divergence. Shaft repairs a specialty. Affiliated with Tuner Service Corporation, Bloomington, Indiana. Only new parts are used, meeting manufacturer's specifications.

\$16.95 VHF UHF Varactor

Same day service.

One year warranty on workmanship and materials on tuner repairs.

Please do not send mounting brackets.

TUNER SERVICE Co. of CALGARY

P.O. Box 5823
Station "A"

Calgary, Alberta T2H 1Y3
(403) 243-0971

Circle No. 7 on Reader Service Card.

NEW! **THE LATEST!**

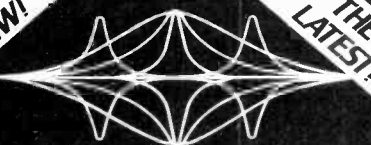

Build your own
Stereo Parametric Equalizer
and up grade your system

- Now you can tailor the sound of your audio system to your precise requirements.
- Centre frequency and bandwidth independently adjustable.
- The latest circuit design, using BI-FET ICs.
- Cuts or boosts any frequencies from 30Hz to 20Khz up to ± 16 db.
- Ultra low distortion.
- Output up to 10V RMS.
- Kit Includes all electronic parts and high quality precision made cabinet.
- 10 day money back guarantee and 90 day free repair service.

No. 2300
Kit: \$199.50 Assembled: \$259.50
Send cheque or money order plus 5% for postage and handling.
Ontario residents add 7% P.S.T. Master charge and Visa accepted.

PHONE ORDER (MASTERCHARGE OR VISA ONLY):
(416) 499-0401

AUDIOVISION SERVICE
P.O. Box 955, Station B,
Willowdale, Ontario. M2K 2T6

Circle No. 2 on Reader Service Card.

ETI - FEBRUARY 1981

ARKON'S AUDIO GUARANTEE: WE WILL NOT BE UNDERSOLD!

WOOFERS

PHILIPS

AD4060/W8 .8ohm .20W.rms...18.75
AD5060/W8 .8ohm .20W.rms...17.30
AD70620/W8 .8ohm .20W.rms...19.95
AD70650/W8 .8ohm .40W.rms...26.15
AD80100/W8 .8ohm .40W.rms...34.50
AD80671/W8 .8ohm .60W.rms...33.25
AD10100/W8 .8ohm .40W.rms...69.95
AD10200/W8 .8ohm .80W.rms.....

Coming Soon

AD10240/W8 .8ohm .80W.rms...51.00
AD12200/W8 .8ohms .80W.rms...72.50
AD12250/W8 .8ohm 100W.rms...81.10
AD12240/W8 .8ohm .80W.rms...57.70

LASER

LA1032AS .8ohm .50W.rms...29.95
LA1254AS .8ohm .150W.rms...64.95
LA1254BR .8ohm .150W.rms...64.95
LA1554AS .8ohm .150W.rms...74.95
LA1554BR .8ohm .150W.rms...74.95

R.S.C.

15878 .8ohm .200W.rms...105.00

OAKTRON

FE18Y2W .8ohm .175W.rms...175.00

TWEETERS

PHILIPS

AD0140/T8 .8ohm .20W.rms...11.95
AD0141/T8 .8ohm .20W.rms...11.95
AD0162/T8/44 or .8ohm40W.rms13.60
AD0163/T8/44 or .8ohm40W.rms13.95
AD01633/T8 .8ohm .50W.rms...16.05

MOTOROLLA

KSN1039A .8ohm * .100W.rms...10.25
KSN1041A .8ohm * .100W.rms...11.95
KSN1005A .8ohm * .100W.rms...12.95
KSN1016A .8ohm * .100W.rms...13.95
KSN1025A .8ohm * .100W.rms...22.50

*CROSSED OVER
ABOVE 6KHZ!

PEERLESS

K010DT .8ohm .70W.rms...19.95

MIDRANGE

PHILIPS

AD5060/SQ4 or 8 ohm40W.rms20.60
AD0211/SQ.4 or .8ohm.40W.rms.31.40
AD02161/SQ4 or .8ohm60W.rms39.95

R.S.C.

5" MID .4 or .8ohm .40W.rms .9.95

OAKTRON

BF6HMR .8ohm .18W.rms...24.55
8HMR .8ohm .18W.rms...26.45
BF8KMR .8ohm .25W.rms...38.60

COMPLETE CABINETS

SYSTEM I

40W.rms 2 Way Speaker System 10"
Woofer 2" Tweeter Walnut Veneer
Cabinet

\$79.95PR

SYSTEM II

80W.rms 3 Way Speaker System 12"
Woofer 5" Midrange 1" Dome Tweeter
Rosewood Veneer Cabinets

\$199.95PR

CAMBRIDGE

70W.rms Air Suspension 12" Woofer
2" Voice Coil, 25Hz Resonance.
2 for \$65.00

MARSLAND TRI-LINEAR

6" x 9" Bi-ampable 100W.rms Eac.
40oz. magnet. 1 1/4" Voice Coil.
2 for \$99.95

Send certified cheque, money order, Charge, Master Charge...include expiry date, card number and signature. We process only prepaid orders. Minimum order \$10.00 Add 5% (minimum \$2.00) for shipping and handling. Ontario residents add 7% sales tax. All prices subject to change. Dealer inquiries welcome.

arkon
electronics ltd

409 Queen Street West, Toronto, Ontario Canada M5V 2A5 (416) 868-1315

Avantek

Lower cost
120° K TVRO LNA.
Model AWC - 4215.



The Model AWC-4215 is specified for lower cost manufacture, yet offers the same top performance as the thousands operating in cable systems worldwide.

Miniature transistor amplifier modules.

The GPD-200, -400, -1000 Series are in T0-12 packages, ready to operate in a microstrip circuit upon application of DC voltage. Bandwidths are 5 to 200 MHz., 5 to 400 MHz. and 5 to 1000 MHz.

Varactor Tuned Oscillators.

The VT0-8000 Series covers 400 MHz. to 9600 MHz. in ten models. Thin film construction in T0-8 package.

Avantek is a leader in wide-band low-noise solid state amplifiers covering the frequency range from a few hertz to 18 GHz.



Sheppard Agencies Limited

P.O. Box 8, Georgetown, Ontario L7G 4T1
Telephone: (416) 877-9846 Telex: 06-97500

Circle No. 1 on Reader Service Card.

NEED MORE INFORMATION?

Center Tuning Indicator Gervais de Courval

The circuit proposed here, built around 741, is designed as a simple ultra low cost alternative.

The opamp acts as a zero volt detector and will blink the LEDs within a few millivolts of either side of the virtual ground. When both LEDs appear to glow equally, the tuner cannot be nearer to optimal center tuning.

A reed relay has been included in series with the stereo pilot light to

switch on the center tuning indicator only when a stereo program is detected: The result is an eye catching indication of what side of the channel you are on.

There are no critical values. Simply chose a reed relay to suit the voltage of the stereo pilot light circuit. Although you may have to change the value of the resistor (R2). This limits the current through the stereo pilot LED. If this is the case, play it safe and keep the current drain as small as possible for proper operation.

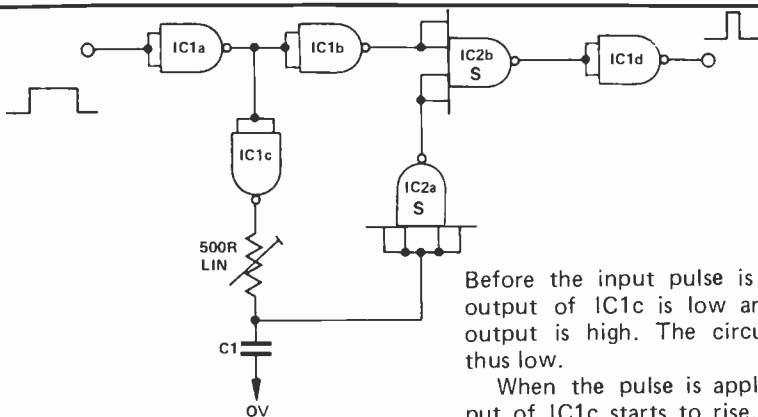
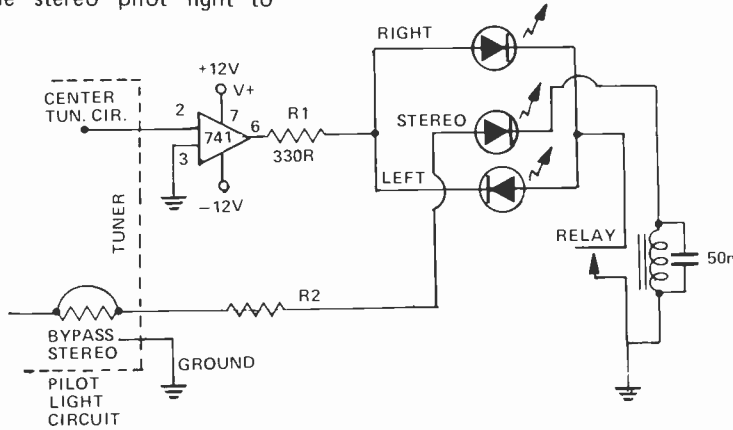

Pulse Compressor

This circuit will prove useful in any application where it is required to reduce the width of a digital pulse by a pre-set amount.

Using only two ICs, it can achieve pulse width reductions up to about 10 milliseconds. The following table gives some examples of the width reduction achieved by using different capacitor values:

Width reduction	C1
3 ms	8 u
5 ms	4 u
9 ms	1 u
9.5 ms	470 n
9.9 ms	100 n

Before the input pulse is applied, the output of IC1c is low and so IC2b's output is high. The circuit output is thus low.

When the pulse is applied, the output of IC1c starts to rise, but the output of the circuit remains low because of the high on the output of IC2a. When C1 charges the threshold voltage of IC2a, the output of IC2a will go low and the output of IC2b will go low while the input to the circuit is still high. Thus the start of the pulse is delayed by the amount of time taken for C1 to charge.

Tech-Tips is an ideas forum and is not aimed at the beginner; we regret that we cannot answer queries on these items. We do not build up these circuits prior to publication.

ETI is happy to consider circuits or ideas submitted by readers; all items used will be paid for. Drawings should be as clear as possible and the text should be preferably typed. Anything submitted should not be subject to copyright. Items for consideration should be sent to the Editor.

If you would like more information on the products or services mentioned in the advertisements:

1. Fill in the attached card with your name, address, etc
2. Circle the appropriate Reader Service number for further information about advertised products.
3. Mail the card and the advertiser will send you literature free of charge. If the card has been removed, or if you want the information in a hurry, phone or write direct to the advertiser and refer to the ETI issue and page number.

Your Company Classification (if applicable):

- A. Manufacturer
- B. Retailer
- C. Government
- D. R&D
- E. Servicer/Installer
- F. Distributor/Representative
- G. Educational Institution

In the field of:

1. Computer and Related Equipment
2. Communications Equipment & Systems
3. Navigation, Guidance or Control Systems
4. Test & Measurement Equipment
5. Consumer Products
6. Industrial Controls & Equipment
7. Components & Subassemblies
8. Other (Please specify on the card)

Your major job function (if applicable):

- A. Buying
- B. Technologist
- C. Educator
- D. Not employed in an electronics-related field
- E. Engineering
- F. Technician
- G. Management
- H. Sales
- I. Other (Please specify on the card)

What interests you most about ETI? (your favourite five or less):

- A. Audio
- B. Video
- C. Ham Radio
- D. Shortwave Listening
- E. Servicing
- F. Components & Technology
- G. Reports on the Electronic Industry
- H. Microcomputers
- J. Projects
- K. News Digest
- L. Other (Please specify on the card)
- M. Tech Tips

The Best Scope Buys Available!

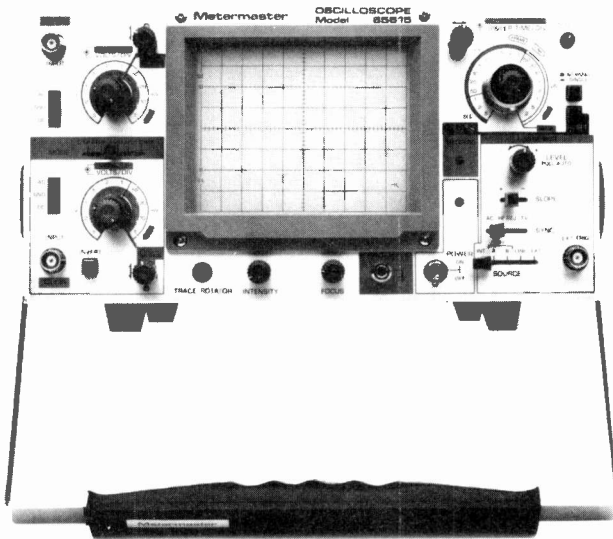

Introducing...

Metermaster's NEW
40MHz Dual Trace
Oscilloscope.

Model 65615

Featuring an Extremely
Bright CRT Display
(15KV acceleration voltage).

only **\$1395.**
F.S.T. INCLUDED

FEATURES INCLUDE:

- Internal Graticuled 5" CRT.
- Full 40MHz Bandwidth at -3dB.
- 5mV Vertical Sensitivity for the full bandwidth, expandable to 1mV/div. utilizing the X5 Gain Multiplier below 10MHz.
- Trace Rotator.

PLUS:

- 50 nsec delay for viewing pre-trigger data.
- X5 Sweep Magnification.
- Supplied with AC Line Cord and an Operations and Maintenance Manual.

Accessories: Probes (extra).

Look...

At the features
of these 15MHz
Oscilloscopes

\$695. each
F.S.T. INCLUDED

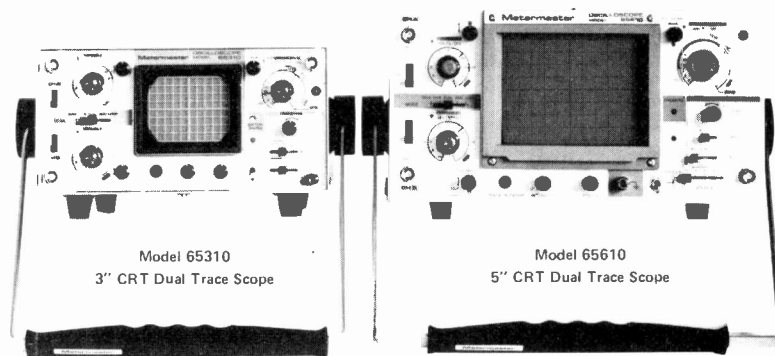

- Model 65310:**
- Operates from 3 Power Sources
 1. Rechargeable Ni Cad Batteries.
 2. 120 VAC Line (also charges batteries).
 3. 11 - 30 VDC.
 - Fully Automatic Triggering.
 - Bandwidth DC - 15MHz (-3dB).
 - Trace Rotator.
 - 2mV Vertical Sensitivity.

Accessories: Vinyl carrying case, probes (extra).

- Model 65610:**
- Operates from 2 Power Sources
 1. 120 VAC Line.
 2. 11.5 - 30 VDC.
 - Fully Automatic Triggering.
 - Bandwidth DC - 15MHz (-3dB).
 - Trace Rotator.
 - HF Rejection.
 - 5mV Vertical Sensitivity.

Accessories: Probes (extra).



Metermaster
R.H. NICHOLS

Head Office: 214 Dolomite Drive, Downsview, Ontario M3J 2P8

TORONTO (416)661-3190 • MONTREAL (514)337-0425 • EDMONTON (403)432-7746 • OTTAWA (613)238-7007

All prices F.O.B.
Downsview, Ontario
subject to change with-
out notice. P.S.T. extra
where applicable.

Circle No. 4 on Reader Service Card.

CLASSIFIED ADVERTISING

United Way
of Canada



ETI's classified advertising section allows you to reach 30,000 Canadian readers nation-wide. For as little as \$15 (there's a 20 word min.) you can promote your business from coast to coast.

WHAT DO YOU DO?

Send us your typewritten or clearly printed words, your permanent address and telephone number, and your money (no cash please). Make your cheque or money order payable to 'ETI Magazine'. We're

at Unit 6, 25 Overlea Blvd., Toronto, Ontario. M4H 1B1

WHAT DO WE DO?

We typeset your words (and put the first word and your company name in BOLD capital letters). If we get your message by the 14th of the month, it will appear in ETI 1½ months later. For example if we receive it by October 14th you (and thousands more) will see it in the December issue.

CHALLENGER SOFTWARE. Quality software now available for Superboard/Challenger systems. Send \$1.00 for listing (refundable with first order). Dealer enquiries welcome, write on letterhead or phone (416) 789-4458 for information. **CHALLENGE SOFTWARE**, 1912A Avenue Rd., Toronto, Ontario M5M 4A1 or **CHALLENGE SOFTWARE**, P.O. Box 6984, Orlando, FL 32803.

VIDEO EQUIPMENT— Used. Colour or B&W cameras, recorders, monitors, special effects, etc. Think of the possibilities! Use the encoder from a surplus colour TV camera and colourize your CRT display. Descriptive catalogue published monthly. Phone or write for sample copy. **MAGNATRON LIMITED**, 889 Kipling Avenue, Toronto, Ontario, M8Z 5H2, (416) 236-1868.

ENGINEER Hammond Manufacturing Company Limited requires an **ELECTRONIC TRANSFORMER DESIGN ENGINEER** who is experienced in the design of 50Hz to 20KHz power transformers, inductors and pulse transformers to MIL-T-27 standards and/or higher quality industrial requirements. This totally Canadian owned Company offers potential for advancement for a qualified individual in a modern plant in Southern Ontario with pleasant working conditions and excellent fringe benefits. Please state background, education and expected salary to: Jane Williams, Personnel Manager, **HAMMOND MANUFACTURING COMPANY LIMITED**, 394 Edinburg Road North, Guelph, Ontario N1H 1E5

J&J ELECTRONICS LTD., P.O. Box 1437E, Winnipeg, Manitoba R3C 2Z4. Surplus Semiconductor Specialists. Do you get our bargain flyer? Send \$1.00 to receive the current literature and specials and to be placed on the mailing list for future publications.

NEW STORE! Hobbyist. Parts. Speakers. Kits. Equipment. **GENERAL ELECTRONICS**, 5511 Yonge St., Willowdale, Ont. M2N 5S3, 221-6174. Please write for free catalogue. Monday, Friday, Saturday: 10:00 AM - 6:00 PM. Tuesday, Wednesday, Thursday: 10:00 AM - 8:00 PM

COMPLETE Electronic Hobby Services. Custom kits, circuits, technical writing, special parts, original designs. Free information. **TEKNIKIT ASSOCIATES** 301 Flora Street, Carleton Place, Ontario K7C 3M8.

SEMIS & KITS. 1. 168W Leach power amplifier kit \$214. /2. 80W Playmaster amplifier kit \$169. /3. MJ15003, 15004 \$9.00 per pair. /4. MJ802, 4502 \$8.00 per pair. Send \$1.00 for our catalogue add 5% for shipping. **KITSTRONIC INTERNATIONAL** Box 577 Station J, Toronto M4J 4Z2

PRINTED CIRCUIT Boards available for all E.T.I. projects. Process Controller - \$4.95; Burglar Alarm - \$2.79; Fuzz Unit - \$1.79. Inquire about our selection of parts. Write to: **WENTWORTH ELECTRONICS**, R. R. No. 1, Waterdown, Ontario, L0R 2H0.

DYNAMIC bias Super Class A amplifiers* Colour LED VU and Power meters* Versatile bench power supplies* F.M wireless Mic.* Electronic switches and many other quality Kits. Write for your free catalog: **CLASS-A ENTERPRISES, INC.** No.104 - 206 E. 6th Ave. Vancouver, B.C. V5T 1J8.

LOW-PRICED, high quality ETI project Boards. Glass epoxy, drilled, tinned, guaranteed. Inquire about our low-cost TRS-80 (TM) printer interface. For latest flyer send stamp to: **K.S.K. ASSOCIATES**, P.O. Box 54, Morriston, Ontario, N0B 2C0.

EPROM PROGRAMMER. Programs 2716, 2732, 2516, 2532 and 48016. PCB, source listing and complete assembly instructions for \$47.00. Requires +5/30VDC plus parallel interface. **TUK MICROSYSTEMS**, 3 - 3624 Stanley Rd. S.E., Calgary T2G 3Y7.

WSI RADIO - SWL Radios - Ham radios 18 Sheldon Avenue North, Kitchener, Ontario N2H 3M2. Tel. (519) 579-0536. Write for giant catalogue, free of course!! (VE3EHC).

SPECIAL! 1000 pieces for \$10.00. Choke - capacitor - diode - hardware insulator - rectifier - relay - resistor - transistor - speaker - switch - transformer - zener - etc. Money back guarantee. Free flyer & sample on request. **SURPLUS ELECTRO-QUEBEC**, 2264 Montee Gagnon, Blainville, P.Q., J7E 4H5.

Oxfam

Working with people
who are helping themselves

Send Your Tax-Deductible Contribution To:

OXFAM-CANADA

BOX 18,000
TORONTO
OTTAWA
HALIFAX
ST. JOHN'S

BOX 12,000
WINNIPEG
REGINA
CALGARY
VANCOUVER



The Finkler File

An established and reliable source for electronic and electrical equipment.

Components, instruments, hand tools, production devices, printed circuit board holders, hardware, communication antennas, soldering and desoldering irons, digital equipment, breadboarding elements, etc. etc.

Eighteen different companies' product lines are represented across Canada by Len Finkler Limited. Their catalogues list thousands of products used daily by all

segments of the Canadian Electronic & Electrical Industry.

The Finkler File designed to fit into a standard filing system, is a complete set of product data and catalogues represented by Len Finkler Limited. Each company has its own file folder, which is tabbed with detailed product information and local distributors' addresses and telephone numbers.

The Finkler File is part of the commitment to the pursuit of service excellence initiated 25 years ago.

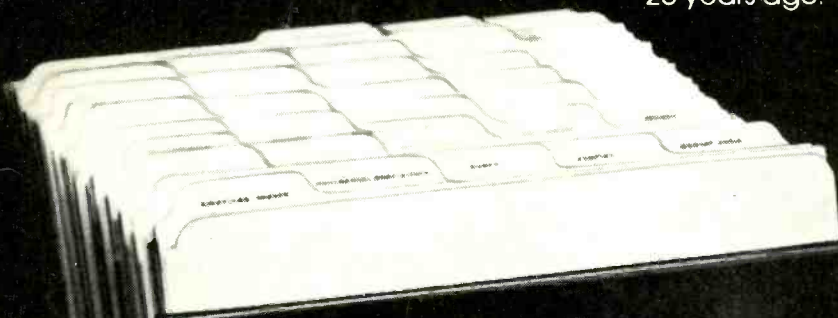

len finkler limited

25 Toro Road
Downsview, Ontario M3J 2A6

Telex: 065-24010 • Phone: (416) 630-9113



For your own Finkler File, please mail this coupon to:

len finkler limited

25 Toro Road
Downsview, Ontario M3J 2A6

Please send my Finkler File to:

NAME _____

POSITION _____

DEPT. _____

COMPANY _____

ADDRESS _____

POSTAL CODE _____

(Type or print clearly please)

B *Circle No. 13 on Reader Service Card.*

AMERICAN BEAUTY • HUNTER TOOLS • LENLINE
• K. MILLER TOOLS • MOODY TOOLS
• PANA-VISE • TRIPLETT



STOP! SHOP! PRIME HIGH QUALITY SUPER COMPETITIVE PRICING

Zilog NEW LOW PRICES

Z80-CPU	2.5 MHz	10.99	Z80-SIO/0	2.5 MHz	29.19
Z80A-CPU	4.0 MHz	12.29	Z80A-SIO/0	4.0 MHz	37.13
Z80-PIO	2.5 MHz	7.78	Z80A-SIO/1	2.5 MHz	29.19
Z80A-PIO	4.0 MHz	9.95	Z80A-SIO/2	4.0 MHz	37.13
Z80-CTC	2.5 MHz	7.78	Z80-SIO/9	2.5 MHz	21.91
Z80A-CTC	4.0 MHz	9.95	Z80A-SIO/9	4.0 MHz	28.00
Z80-DMA	2.5 MHz	24.25	Z80-DART	2.5 MHz	18.79
Z80A-DMA	4.0 MHz	29.84	Z80A-DART	4.0 MHz	22.88

METAL CAN SMALL SIGNAL POWER TRANSISTORS

METAL CAN	SMALL SIGNAL	POWER	TRANSISTORS	TO-92 SMALL SIGNAL									
2N404A	1.56	2N2222A	.25	2N3055	.73	2N3702	.13	2N4123	.10	2N4403	.11	MPSA05	.16
2N697	.38	2N2369A	.31	2N3440	.73	2N3704	.13	2N4154	.10	2N5401	.20	MPSA06	.16
2N706	.31	2N2484	.31	2N3771	1.68	2N3706	.13	2N4125	.10	2N5550	.14	MPSA13	.16
2N1613	.38	2N2905A	.47	2N3772	1.68	2N3710	.17	2N4126	.10	PN2222A	.12	MPSA56	.16
2N1711	.38	2N2907A	.25	2N3773	2.46	2N3904	.09	2N4401	.11	PN2907A	.12	MPSA42	.18
2N1893	.38	2N3053	.38	2N6133	.73	2N3906	.09	2N4402	.11	PN5138	.13	MPSA92	.18

MICROPROCESSOR CHIP SETS

Part No.	Price	Part No.	Price	Part No.	Price	Part No.	Price
8080A CPU	6.44	8228	6.47	6800 CPU	7.09	6502 CPU	10.21
8085 CPU	11.67	8251	7.74	6802 CPU	14.24	6504 CPU	10.99
8212	2.93	8253	12.55	6810	3.89	6505 CPU	10.99
8214	4.75	8255	7.35	6821	3.89	6520	7.44
8216	2.57	8257	14.24	6850	3.89	6522	12.29
8224	4.49	8259	14.24	6852	3.89	6532	16.33
8226	2.93			6852	6.551	6551	16.12

Part No.	Price	Part No.	Price
74S298	4.49	256 bit, 16 PIN	
74S188	4.49	256 bit, 16 PIN	
93427/MB7052	4.75	1K, 16 PIN	
93417/MB7057	4.75	1K, 16 PIN	
93446/MB7053	6.44	2K, 16 PIN	
93436/MB7058	6.44	2K, 16 PIN	
93453/MB7122	11.51	4K, 18 PIN	
82S185/7128	36.34	8K, 18 PIN	
74S478/7132	25.79	8K, 24 PIN	
82S191/7138	101.40	16K, 24 PIN	

MOS MEMORIES

MOS Static RAM's

Part No.	Price
2101-35 1K (256 x 4) 350NS 22 PIN	5.14
2102-25 1K (1K x 1) 250NS 16 PIN	1.42
P2111-45 1K (256 x 4) 450NS 18 PIN	4.49
P2112-35 1K (256 x 4) 350NS 18 PIN	3.25
2114L Low Power 4K (1024 x 4) 300NS	3.87
2147 4K (4K x 1) 55NS	12.94
2147 4K (4K x 1) 70NS	11.64

UART's

AY5-1013A 40 KHz Single 5V Supply	Special 5.14
-----------------------------------	---------------------

1K CMOS RAM

5101 1K (256 x 4) 450NS 22 PIN Low Power	5.14
--	------

4K CMOS RAM

P6504 4K (4K x 1) 550NS 18 PIN 110MW	10.34
P6514 4K (1K x 4) 450NS 18 PIN 110MW	9.04

SHIFT REGISTERS

3341APC FIFO 1MHz	6.47
3347PC 80 bit	5.14

COMPUTER SUPPORT CENTER

EPROM'S

C2708 1K x 8 450 ns	6.44
TMS2532 (T.I. Pin Out) 32K (4096 x 8) 450 ns	27.30
C2732 (Intel version) 32K (4096 x 8) 450NS	27.30
C2716/TMS2516 (Intel version) 16K 450NS Single 5V Supply	9.69
TMS2564 64K (8K x 8) 450 ns	253.50

16K MOS DYNAMIC RAM'S (16 PIN)

4116-20 (200NS)	4.75
4116-30 (300NS)	3.84
4K MOS DYNAMIC RAM'S	
TMS4060-30	Special 3.25
4K (4K x 1) 300NS 22 PIN	
TMS4060-20	4.55
4K (4K x 1) 200NS 22 PIN	
16K CMOS STATIC RAM	
6116 16K (2K x 8) 150NS 16 PIN	67.60
64K MOS DYNAMIC RAM	
4164 64K (64K x 1) 200NS 16 PIN	90.94

TTL — LOW POWER SCHOTTKY

WE ARE THE SOURCE WITH ALL NEW MAJOR MANUFACTURERS AND GUARANTEED DELIVERY

74LS00N .22	74LS20N .25	74LS55N .31	74LS95N .62	74LS139N .77	74LS163N .94	74LS194N 3.20	74LS249N 1.29	74LS290N 1.01	74LS365N 1.09	74LS447N .48
74LS01N .22	74LS21N .25	74LS73N .42	74LS96N .77	74LS145N 1.55	74LS164N .77	74LS195N .70	74LS251N 1.89	74LS293N .49	74LS366N 1.09	74LS490N 2.54
74LS02N .31	74LS28N .64	74LS107N .49	74LS107N .49	74LS147N 3.24	74LS147N 3.24	74LS198N 1.42	74LS253N .77	74LS298N 1.29	74LS367N 1.27	74LS630N 110.50
74LS03N .31	74LS27N .44	74LS175N .47	74LS109N .49	74LS148N 1.81	74LS166N 2.80	74LS197N 1.16	74LS257N .98	74LS299N 3.45	74LS368N 1.27	74LS631N 110.50
74LS04N .31	74LS30N .25	74LS176N .70	74LS112N .49	74LS151N .57	74LS170N 2.54	74LS221N 1.10	74LS258N .59	74LS320N 3.84	74LS373N 1.81	74LS669N 1.63
74LS05N .31	74LS32N .51	74LS178N .38	74LS122N .62	74LS153N .47	74LS173N .83	74LS240N 1.29	74LS259N 3.84	74LS321N 5.14	74LS374N 1.81	74LS670N 3.75
74LS08N .25	74LS37N .42	74LS183N 1.00	74LS123N .90	74LS155N .96	74LS174N .51	74LS241N 1.29	74LS260N 1.29	74LS322N 6.44	74LS375N 2.54	
74LS09N .31	74LS38N .42	74LS186N 1.27	74LS125N 1.27	74LS156N 1.89	74LS175N .57	74LS242N 1.29	74LS266N .57	74LS323N 6.44	74LS377N 1.87	
74LS10N .25	74LS42N .59	74LS188N .67	74LS126N .70	74LS157N .75	74LS181N 2.85	74LS243N 1.42	74LS273N 1.55	74LS324N 3.25	74LS378N 1.55	
74LS11N .31	74LS47N .90	74LS190N .51	74LS132N .68	74LS158N .68	74LS189N 1.16	74LS244N 1.29	74LS275N 6.44	74LS348N 3.84	74LS379N 1.76	
74LS12N .31	74LS48N 1.29	74LS191N 1.16	74LS133N 3.71	74LS160N .94	74LS191N 1.16	74LS245N 2.54	74LS279N .75	74LS352N 1.76	74LS390N 1.87	
74LS13N .33	74LS51N .29	74LS192N .64	74LS136N .57	74LS161N .94	74LS192N .88	74LS247N .99	74LS280N 2.57	74LS353N 2.54	74LS393N 1.68	
74LS14N .55	74LS54N .27	74LS193N .55	74LS138N .77	74LS162N 2.15	74LS193N 1.61	74LS248N 1.63	74LS283N 1.16	74LS362N 15.54	74LS395N 1.76	

74S SCHOTTKY

74S00N .57	74S37N 2.43	74S134N 6.05	74S168N 6.05	74S241N 4.88	74S373N 4.49
74S02N .63	74S38N 2.18	74S135N 1.93	74S169N 7.07	74S244N 5.14	74S374N 4.49
74S03N .63	74S40N .57	74S136N 1.50	74S174N 1.41	74S251N 2.47	74S381N 10.34
74S04N 1.03	74S41N 1.01	74S139N 1.63	74S175N 1.41	74S253N 9.69	74S412N 3.87
74S05N 1.03	74S44N .90	74S140N 1.89	74S181N 5.81	74S257N 1.81	74S471N 12.94
74S08N .63	74S51N 3.11	74S151N 1.55	74S182N 3.84	74S258N 1.94	74S472N 21.91
74S09N 1.27	74S56N 1.87	74S153N 1.55	74S189N 9.44	74S266N 2.38	74S474N 23.21
74S10N .90	74S112N 2.07	74S157N 1.55	74S194N 3.84	74S274N 38.35	74S476N 11.64
74S11N 1.14	74S114N 1.95	74S158N 1.88	74S195N 2.46	74S275N 35.10	74S478N 22.04
74S20N .88	74S124N 3.60	74S161N 3.71	74S201N 19.44	74S280N 3.77	
74S30N .82	74S132N 1.61	74S162N 4.81	74S225N 11.64	74S283N 5.06	
74S32N 1.27	74S133N 1.27	74S163N 4.87	74S240N 5.17	74S299N 9.07	

SCR's and TRIAC's

C106D .44	SCR 5 amp 400V TO-220
TIC116B 1.26	SCR 8 amp 200V TO-220
TIC126B 1.42	SCR 12 amp 200V TO-220
TIC216B 1.29	Triac 8 amp 200V TO-220
TIC228D 1.24	Triac 8 amp 400V TO-220
TC236D 1.89	Triac 12 amp 400V TO-220
TC246D 1.89	Triac 16 amp 400V TO-220

Bi-Fet OP AMPS

TL064CN 3.58	Quad low power
TL071CP .77	Low noise
TL072CP 1.55	Dual low noise
TL074CN 3.06	Quad low noise
TL101CP .64	J-FET input
TL082CP 1.29	Dual J-FET input
TL084CN 2.54	Quad J-FET input

1980 IC MASTER

Final sale \$32.43

Subject to prior sale

NEW 1981 EDITION

2 volumes — 3200 pages

now available

regular price: \$134.85

Introductory Offer: \$99.99

New section on custom IC's and microprocessor development systems

CMOS

CD4001BE .25	CD4026BE 2.20	CD4068BE .31	CD4516BE 1.16
CD4002BE .25	CD4027BE .57	CD4069BE .25	CD4519BE .70
CD4006BE .98	CD4028BE .73	CD4070BE .31	CD4520BE .90
CD4007BE .42	CD4029BE .98	CD4071BE .31	CD4522BE 1.09
CD4008BE .90	CD4030BE .57	CD4072BE .31	CD4526BE 1.63
CD4009BE .59	CD4033BE 2.28	CD4073BE .38	CD4527BE 2.07
CD4010BE .59	CD4034BE 3.33	CD4075BE .38	CD4528BE 1.09
CD4011BE .25	CD4035BE 1.09	CD4076BE .87	CD4531BE 1.09
CD4012BE .25	CD4040BE 1.01	CD4078BE .38	CD4532BE 1.46
CD4013BE .44	CD4041BE 2.03	CD4079BE .31	CD4539BE .83
CD4014BE .77	CD4042BE .83	CD4082BE .31	CD4543BE 2.57
CD4015BE .77	CD4043BE 1.25	CD4085BE .62	CD4553BE 3.76
CD4016BE .44	CD4044BE .90	CD4086BE .62	CD4555BE .75
CD4017BE .85	CD4046BE 1.01	CD4093BE .87	CD4556BE .75
CD4018BE .70	CD4047BE 1.01	CD4099BE 2.57	CD4581BE 2.58
CD4019BE .77	CD4049BE .55	CD4104BE 2.59	CD4582BE 1.25
CD4020BE 1.03	CD4050BE .55	CD4508BE 2.99	CD4584BE .57
CD4021BE .77	CD4051BE 1.03	CD4510BE .96	CD4585BE 1.09
CD4022BE 1.27	CD4052BE 1.03	CD4511BE .83	CD4702BE 10.99
CD4023BE .31	CD4053BE 1.03	CD4512BE 1.09	40097PC 1.29
CD4024BE .82	CD4060BE 2.03	CD4514BE 2.18	40098PC 1.29
CD4025BE .38	CD4066BE .62	CD4515BE 2.18	40161PC 1.63
			40174PC 1.63
			40175PC 1.29

OPTO SALE

L.E.D. LAMPS	Price
LED209 T-1 2 mm Red	.12
LED211 T-1 3 mm Green	.25
LED212 T-1 3 mm Yellow	.18
LED220 T-1 3/4 5 mm Red	.14
LED222 T-1 3/4 5 mm Green	.31
LED224 T-1 3/4 5 mm Yellow	.21
DISPLAYS	Price
FND357 375' Common Cathode	1.29
FND500 500' Common Cathode	1.29
FND507 500' Common Anode	1.29
DL1416 16 segment alphanumeric display 1/8" ht	38.94
4 digit, 1/8 segment alphanumeric display 1/8" ht	
ISOLATORS	Price</