

Electronics & Technology Today

\$3.50
MM70924
JAN/89

Canada's Magazine for High-Tech Discovery

Digital Audio!

FM Sound Synthesis
Denon Digital Preamp
Wavesound Generator

PLUS

Infrared Object Counter
The Techie's Guide to C
Interfacing Your PC

Leader Portable Scope

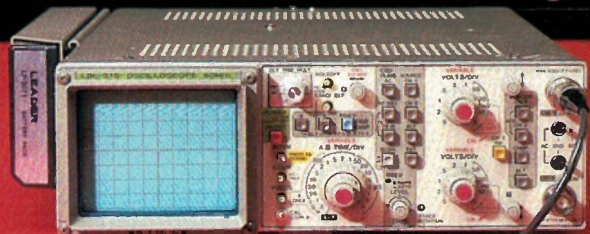

TAKE YOUR FIRST STEP TOWARD A CAREER IN THE MUSIC BUSINESS.



- Highly selective, two-year training program
- Campuses throughout North America
- Current theory mixed with practical hands-on training
- Modern state-of-the-art 24-track recording studios and digital audio labs
- All classes taught by qualified, working professionals
- Job placement assistance
- Financial assistance available
- Fully accredited by ACCET

 **TREBAS**
INSTITUTE OF RECORDING ARTS

6602 Sunset Blvd., **Hollywood, CA**,
U.S.A. 90028 (213) 467-6800

112 East 3rd Ave., Suite 305, **Vancouver, B.C.**,
Canada V5T 1C8 (604) 872-2666

410 Dundas St. East, **Toronto, Ontario**,
Canada M5A 2A8 (416) 966-3066

290 Nepean Street, **Ottawa, Ontario**,
Canada K1R 5G3 (613) 232-7104

1435 Bleury, Suite 301, **Montreal, Quebec**,
Canada H3A 2H7 (514) 845-4141

Circle No. 1 on Reader Service Card

Electronics & Technology Today

Canada's Magazine for High-tech Discovery

Volume 13, Number 1

January 1989



Our Cover

Our articles on digital sound are illustrated by AutoCAD plus some darkroom magic, and the Leader scope struts its stuff in a review; graphics and photos by Bill Markwick.

FEATURES

- An Introduction to FM Synthesis** 6
Making music without loads of oscillators.
- The Techie's Guide to C Programming** 16
Steve Rimmer's series on powerful software for circuits.
- An Approach to Active Filters** 28
One man's solution to sharp filtering.
- Op Amp Circuit Design with BASIC** 32
Designs and prints amplifiers in seconds
- A Guide to PC Interfacing** 44
Beginning Steve Rimmer's series on ports.

TECHNOLOGY

- How Temperature Controllers Work** 21
Explaining the smart thermostat.
- Weather Satellite Photos** 40
Watch the weather by radio and computer.

PRODUCT REVIEW

- Leader LBO-315 Portable Scope** 9
- VoiceCAD Voice Recognition** 15
- Denon DAP-5500 Digital Preamp** 50

PROJECTS

- Wavesound Synthesizer** 10
- Infrared Object Counter** 24
- Shift Register Demonstrator** 54

INFORMATION

- For Your Information** 4
- Classified Ads** 23
- Books** 30
- Win a Toshiba Computer** 32
- Marketplace** 39
- Next Month** 47
- Subscriptions** 47
- Order Form** 48
- Software** 57
- Advertiser's Index** 60

Electronics & Technology Today

Electronics & Technology Today is published 12 times a year by: Moorshead Publications Ltd.
1300 Don Mills Road, North York, Ontario
M3B 3M8 (416)445-5600 FAX: (416)445-8149

Editor: William Markwick
Director of Production: Papu Leynes
Art Direction: Kevan Buss
Circulation Manager: Sharon Cernecca
Advertising Representative: Garth Birt
President: H.W. Moorshead
Publisher & V.K. Marskell
Executive Vice-President:
Vice-President—Sales: A. Wheeler
Vice-President—Finance: B. Shankman
Production Assistants: C. Dalziel
N. Sunderji
B. Zurek
Office Manager: P. Dunphy
Reader Services: R. Cree
J. Cardoni
Advertising Services: M. Millett
H. Brooks

Newsstand Distribution:
Master Media, Oakville, Ontario

Subscriptions:
\$22.95 (one year), \$37.95 (two years).
Please specify if subscription is new or a renewal.

Outside Canada (US Dollars). U.S.A. add \$3.00 per year. Other countries add \$5.00 per year.

Postal Information:
Second Class Mail Registration No. 3955.
Mailing address for subscription orders, undeliverable copies and change of address notice is:
Electronics & Technology Today
1300 Don Mills Road, North York, Ontario
M3B 3M8.

Printed by:
Heritage Press Ltd., Mississauga, Ontario
ISSN 07038984

Moorshead Publications also publishes PETS Magazine, Computing Now!, Computers in Education, Business Computer News and Government Purchasing Guide.

Circulation independently audited by MURPHY & MURPHY Chartered Accountants.

Electronics & Technology Today is indexed in the Canadian Magazine Index by Micromedia Ltd.
Back copies are available in microfilm form from Micromedia Ltd. 158 Pearl Street, Toronto, Ontario M5H 1L3 (416)593-5211.

FOR YOUR INFORMATION

Smart Fluids

Can you say "electrorheological fluids"? Sure you can. The new smart fluids promise a revolution in hydraulics. ER fluids are suspensions of fine particles, mostly polymers, in non-conducting oils or other liquids. When a current is passed through them, they instantly turn into a gel-like solid. When the current is removed, they revert to a liquid. The change in state occurs in 0.1 to 1 millisecond. The solid-state valve becomes a reality, as do solid-state clutches, motors and self-adjusting suspensions. Most major auto companies are doing research, and it shouldn't be long until we see working hardware.

Soundolier Source

Atlas Electronics is the Canadian source for Soundolier professional sound equipment, including speakers, modular racks, microphone stands, noise masking systems, horns and drivers, etc. Their head office is at 50 Wingold Avenue, Toronto, Ontario M6B 1P7, (416) 7789-7761. There are branch outlets in St. Laurent Que., Burnaby BC, Duffield Alberta and Winnipeg Man.

Satellites for Air Safety

A Canadian first in satellite technology will bring space-age communications to small aircraft. Teleglobe Canada will furnish a satellite communication system for non-commercial aviators. The Aerosat service will ensure aviators a constant link from the remotest areas, transmitting voice or data or both, even from areas where conventional radio is difficult or impossible.

Aerosat is already in service on an experimental basis; prototypes have completed more than five months of air ambulance tests in Northern Ontario. Full service is slated to begin in 1990, with the radio network using the satellites of the Inmarsat consortium.

Spaceborn GRID

NASA's shuttle astronauts will be using two laptop computers manufactured by GRiD Systems. They'll be used to assist the crew in monitoring the orbiter's position over the earth, and impending flight conditions. The eight-inch amber display screen will mirror the large-screen projection at Mission Control at Houston, which monitor's the shuttle's course and position. Since the fluctuating course and altitude of the shuttle combined with the earth's curvature frequently moves the earth out of the crew's field of vision, the computer will let the crew know where the shuttle is. It also notifies the astronauts of the timing of sunlight-darkness or equatorial crossings.

New Solar Cell Research

The 3M company and Iowa State University have joined in a cooperative venture, the Center for Amorphous Semiconductors. The focus is on developing silicon-based photovoltaic cells on a plastic base. The new technology has the potential to power anything from portable radios to space vehicles. The amorphous silicon material is deposited by means of a discharge process, producing material about the thickness of a human hair that acts like a whole bank of conventional cells. The material is far stronger than the usual crystal silicon covered by a glass plate. 3M may market rolls of the photovoltaic material for any application that requires portable power.

And now for...

...something a little bit different. To keep costs down, E&TT will be using more uncoated pages, but there'll be more of them, with more construction and electronic theory articles.

Continued on page 60
E&TT January 1989

Now, training includes XT-compatible computer plus NRI's remarkable Robotic Discovery Kits!

Get training for industry's hottest new jobs as you build and program complete robotic control systems

Now you can get the skills in demand for the new jobs in industry today. With NRI's new at-home training in Robotics Technology, you actually build a fully IBM XT-compatible computer, then use it to program and control working robotic systems . . . each one engineered to recreate the exact operations performed by the robotic equipment found in today's industrial workplace.

It's no secret. Industry is being transformed by technology—with everything from precision electronic instruments to giant locomotives now being produced with the help of advanced robotic systems. And with automation have come jobs . . . thousands of jobs building, programming, and servicing the robotic systems in use today.

Now, unlike any other school, NRI offers you training that prepares you to take advantage of these new opportunities . . . training that gives you the practical know-how and the hands-on skills to advance on

Robotics comes to life as you see real-world industrial control principles in action

Your NRI Robotic Discovery Kits come complete with everything you need to create working, moving robotic systems. You get structural members, motors, gear drives, sensors, scanners, potentiometers, plus a special Robotics Interface that links the robots you build to your computer.

Together, your computer and the robotic devices you construct become fully integrated

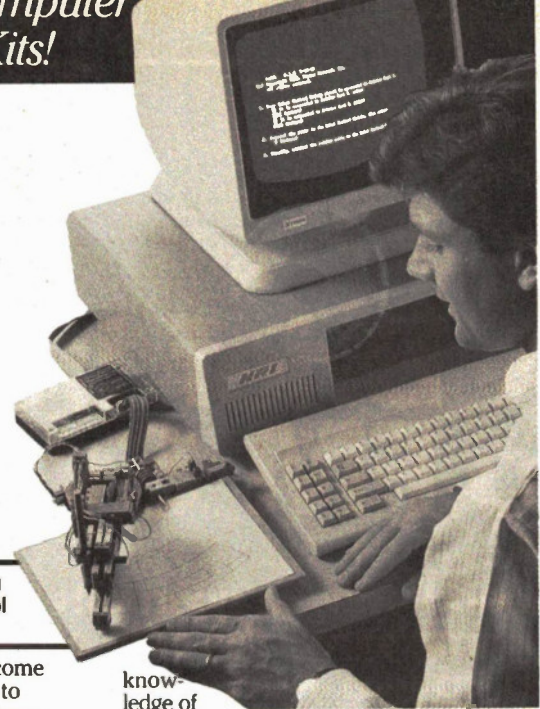

know-ledge of electronic circuits and components as you experiment with your NRI Discovery Lab® and professional digital multimeter.

Rapidly, theory becomes understanding as you move on to digital logic, computer fundamentals, right up to writing practical programs to control specific robotic operations using NRI's Robotic Programming Language software included in your course.

Your success is assured by your personal NRI instructor, whose expertise and personal guidance are always available to you whenever you need a helping hand along the way.

Get training you can build a career on—send for your FREE catalog today!

See for yourself how NRI's breakthrough training can put you at the heart of the robotics revolution. Send today for NRI's big, 100-page, full-color catalog that gives you all the details about NRI's exciting new training in Robotics Technology, plus training in computer electronics, TV/video/audio servicing, electronic music technology, security electronics, and other growing high-tech career fields.

If the coupon is missing, write to: NRI School of Electronics, McGraw-Hill Continuing Education Center, 330 Progress Avenue, Scarborough, ON M1P 2Z5.

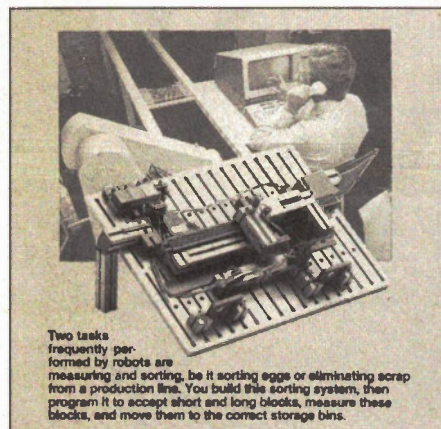

Two tasks frequently performed by robots are measuring and sorting, be it sorting eggs or eliminating scrap from a production line. You build this sorting system, then program it to accept short and long blocks, measure these blocks, and move them to the correct storage bins.



This "teachable" robotic arm is the most complex robot model you construct. Once you manually put the robot through a sequence of operations, it will "remember" these steps and perform them whenever asked.

the job or start a new career as a robotics and industrial control technician.

The powerful XT-compatible computer you build becomes central control for the robotic systems you construct

As an integral part of your NRI hands-on training, you build a fully IBM XT-compatible computer from the keyboard up. You assemble the power supply, install the 5¼" floppy disk drive, and attach the high-resolution monitor. Most important of all, by performing meaningful tests and demonstrations at each stage of assembly, you come to a full understanding and appreciation of the microprocessor technology that makes today's robotics applications possible. But that's just the beginning.

You go on to use your computer to program and control a diverse array of robotic systems you create with NRI's remarkable Robotic Discovery Kits.

automation systems, programmed by you to do the types of operations and tasks performed in today's industrial environments. Tasks such as plotting polar coordinates to create graphic displays of numeric data . . . sorting different size objects and routing these objects to separate containers . . . even performing a preprogrammed sequence of operations again and again just as robots now do on manufacturing lines.

Nothing is left out, nothing is left to chance. You get everything you need—the skills, the confidence, and the equipment—to feel completely at home with today's robotics technology.

Step by step, you get the training you need to move into robotics fast

You need no previous experience to succeed with NRI training, because NRI takes you from electronics basics all the way up to the state of the art in robotics technology. You train from the ground up . . . first gaining a working

NRI

McGraw-Hill Continuing Education Center
330 Progress Avenue,
Scarborough, ON M1P 2Z5

For career courses approved under GI Bill
 check for details

Check one catalog only

<input type="checkbox"/> Robotics Technology	<input type="checkbox"/> TV/Video/Audio Servicing
<input type="checkbox"/> Computers and Microprocessors	<input type="checkbox"/> Communications Electronics
<input type="checkbox"/> Security Electronics	<input type="checkbox"/> Telephone Servicing
<input type="checkbox"/> Electronic Music	<input type="checkbox"/> Data Communications
<input type="checkbox"/> Digital Electronics Servicing	<input type="checkbox"/> Basic Electronics

Name _____

Street _____

City/Prov/Code _____

11-019

A Brief Introduction to FM Synthesis

Second only to quantum mud wrestling in complexity, the FM synthesis theory tied up in a Yamaha keyboard is really heady stuff. Here's a digital aspirin

STEVE RIMMER

Synthesizers come and synthesizers go. Quite a few have come and gone from my space over the years. Being synthetic, the sounds which electronic instruments dream up seem to go stale more quickly than do real acoustic noises. They have a finite complexity, and the ear grows bored with them after it has heard them a few times.

Bored ears are worse than a Big Mac with too much special sauce.

One of the few synthesis systems which I've actually hung onto has been the FM synthesizers in the Yamaha "X" instruments. I have a number of these going at the moment, including an FB-01, a TX-81Z and, of course, a trusty old DX-7 keyboard. These boxes all use a rather peculiar strategy for making noise — it's extremely hard to understand, but it gets really interesting once you do.

FM synthesis is a pretty hairy subject for a single article — you won't come away from this one knowing everything there is to know about it. However, you should have a reasonable leg up onto it if you plough through to the end of this feature. If you're still curious about it when the dust settles, you might want to check out a book called *FM Theory & Applications* by John Chowning and David Bristow, available from most Yamaha dealers.

Dial 0

The Yamaha "X" instruments all use a pretty consistent *theory* of sound generation — even if none of their voice files are in the least bit compatible with one another. We'll talk about the DX-7 here, although what we get into will apply to any FM instrument you want to check out.

The simplest form of synthesis is basic subtractive analog noise making. It was really big stuff back in the sixties. In its most rudimentary sense, an analog synthesizer takes a complex wave form which contains all the harmonics of the sound we're after and uses filters to snuff the ones we don't like the look of. The result is an approximation of something we might want to listen to.

Analog synthesis of this sort is actually rather boring to listen to, because even complex patches don't really approximate the natural processes which make sound happen. They can't reproduce the complex interplay of energy that exists in natural sounds. If we set up a conventional analog synthesizer with enough filters and oscillators to start to approach the complexity of real noise, we begin running into problems like finding a dedicated

hydroelectric project to power it and a team of roadies to plug in all the cords.

The reality of all this being as it may, however, we can still find some useful theory in classical analog synthesis. If you check out Fig. 1, for example, you'll find a pretty easily understood diagram of how square waves come to be. A square wave is the addition of a fundamental pitch and a spectrum of odd numbered harmonics. With enough oscillators going at the correct pitches and amplitudes, the resulting wave would, indeed, look square on an oscilloscope.

In fact, consider that our ears kind of peter out about sixteen kilohertz or so. If the fundamental note is 440Hz, the first odd numbered harmonic is 1320Hz (three times the fundamental), the next is 2200Hz (five times), the next is 3080Hz — it doesn't take long for the harmonics to be too high to be audible. As such, we can see that it's not actually necessary to include very many actual tonal components in a waveform to make it *sound* like a square wave.

Now, up until this point we've been speaking of analog oscillators. There are no analog oscillators in an "X" instrument, such as a DX-7. There are digital things which can be made to behave like analog oscillators, and we'll treat them as such because it's a lot easier to deal with sounds as sounds than as data. However, it's important to note that these instruments really are digital, with all their sounds produced by digital to analog converters. All the stuff we're going to look at in a moment regarding operators and algorithms and such involves the process by which the computer which runs FM synthesis goes about creating its data.

A DX-7 is essentially a dedicated computer with a touch sensitive organ keyboard for input — plus the odd membrane switch and a MIDI port — and a sixty kilohertz digital to analog converter for output. Theoretically, the computer can come up with any sort of data and, as such, can emit any sound imaginable with essentially perfect fidelity. In practice, this is not so, because aside from having the hardware to make the noises we want, we need the software process to generate the data that will produce the sounds.

An "X" instrument isn't quite so versatile as to be able to generate absolutely any sound. However, the vast range of sounds it can get together are a result of a program which implements classical FM synthesis on its internal microcomputer.

Under FM synthesis, a sound source has one or more program segments that generate sine waves — or, more correctly,

that generate data which, if sent to the digital to analog converter of the synthesizer would result in sine waves spewing out from the audio jack at the back. These program segments are called "operators". The computer is able to control the frequency of the output of each operator, the amplitude of the resultant sine wave and, to a somewhat less flexible extent, how the output of multiple operators will be combined. That's about it — this is all there is to FM synthesis, at least at the organizational level.

The DX-7 has six operators, that is, essentially six digital oscillators. The output of these six operators is data which will sound like sine waves when it's eventually converted to audio. However, before this happens the six data streams can be mathematically manipulated. For example, two digital sine waves can be "mixed" by simply adding each of the values of their respective samples to get a third data stream that's a combination of the first two. This is essentially what happens naturally when we mix to analog wave forms, but in this case we must have the computer do the actual math, rather than using handy physical laws which are already in place for analog stuff.

The specific details of combining the outputs of the six operators in a DX-7 are called "algorithms". There are thirty two predetermined algorithms in the DX-7. This may seem like a small subset of all the possible permutations of six entities — it is, in a way, but for practical purposes it turns out that the thirty two algorithms represent all the good bits. Most of the others either just don't sound very nice, or are effectively duplicated in the thirty two algorithms that *are* available.

The output of an operator can go to one of two places — either directly into the resulting sound, or into another operator to control some aspect of it. Typically, in the latter case, this would mean that one operator controls the pitch or amplitude of another. Figure two is a typical algorithm on a DX-7 — this happens to be algorithm number one. In this case, the outputs of operators one and three are directly producing sound. Some aspect of operator one is being controlled or modified by operator two, and the same can be said of operator three by operator four. However, operator four is in turn being modified by operator five which is in turn being modified by operator six — which appears to be modifying itself as well.

Obviously, this algorithm does not itself define a specific sound, but, rather, one of

A Brief Introduction to FM Synthesis

thirty two basic strategies for generating sound. We still have lots of things which are variable in this basic structure. We get to define whether the parameters being controlled on the operators are amplitude or frequency. We also get to decide on the pitches of the controlling operators, and the amplitudes of their outputs as they affect the controlled operators.

As you can see, there's a good potential here for a really complex final waveform. Once again, it's important to remind ourselves that all of the actual mixing of sounds and modification of the parameters of the operators — the sound sources — is handled in software, and that all the things which we like to think of as being sonic are actually mathematical constructs until they finally hit the digital to analog converter.

No Static at All

We can now begin to understand how FM synthesis gets around to its uniquely complex sound. Consider a two operator algorithm — we don't actually have one, but we can arrive at the result of one by simply turning the amplitude right down on operators three through six on algorithm one. What's left is one operator producing sound and a second one modifying some parameter of the first. We'll set it up so that the parameter being modified in the first operator is the frequency of the resulting sound.

If the first operator is producing a note of four hundred and forty hertz and the second operator a waveform of, say, ten hertz, the result will be a note with vibrato — something which is pretty common even in many acoustic instruments. The amplitude of operator two determines the "depth" of the vibrato, that is, how much the frequency of the note generated by operator one moves around.

In a purely technical sense, the frequency of operator one is being modulated by the frequency of operator two — frequency modulation, which would seem to have something to do with the name for the synthesis technique used in "X" instruments.

If you increase the frequency of operator two — a lot — the rate of the vibrato of operator one will appear to increase. After a while, it will increase to the point where there's no longer any real perception of a single note swinging slightly in pitch. Instead, we experience a single, extremely complex sound with a lot of harmonics which are obviously related to the fundamental, but not in any immediately obvious way. A very interesting sound indeed

results from operator two having the same frequency as operator one.

Think about that one for a sec —

A whole range of potentially interesting and useful sounds can be arrived at by making the pitch of operator two numerically related to that of operator one. Having them removed from each other by one or more octaves is a fairly obvious arrangement, but we can also experiment with fixed

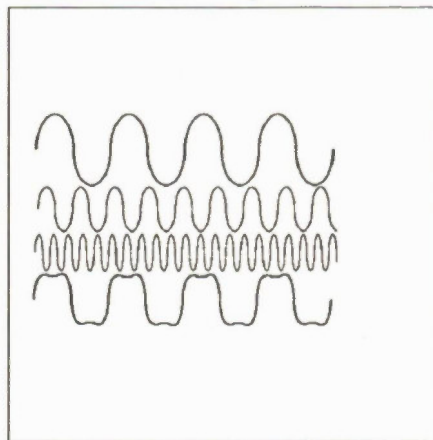

Fig. 1. If enough sine waves of the right pitch, phase and amplitude are combined, the result is a square wave.

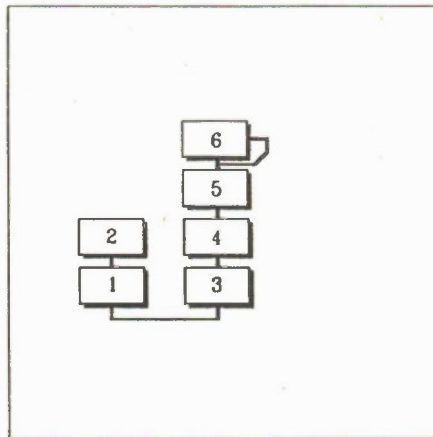

Fig. 2. An algorithm which guides the interaction among the operators in a synthesis device.

musical intervals, such as fifths and sevenths. In each case, a different set of complex harmonics will be generated, and different — potentially interesting — sounds will stream their way out of the digital to analog converter of the synthesizer.

Using the traditional process of backwards justification — finding a good reason for doing something after it has proven successful — we can see that the physical processes of producing acoustic noises usually do so though a mechanical analog to FM synthesis. A saxophone, for example, has a fundamental vibrating frequency gen-

erator — a reed — with all sorts of other mechanical "operators" acting upon it, including the cavity it vibrates in, the shape and dimensions of the horn it blows into and the velocity of the air blowing over it.

As such, FM synthesis produces a better synthesis of many acoustic sounds than one might expect because it turns out to use much the same process — if not the same tools — as the analog machines which originally generated the sounds. Having said this, I should note that a saxophone is one of the few instruments I've never been able to work up a satisfactory DX-7 voice for.

Obviously, if we combine all six operators of the DX-7 in this way, we'll have a very, very complex waveform indeed at our disposal. Allowing that we can actually make some sense of it — which turns out to be a lot easier to do in practice than it is on paper — we can approximate a lot of really decent sounding instruments quite closely.

We Did Say "Brief"

As you'll note if you look down this column a bit, this is where we're going to let go of FM synthesis for today. In fact, the theory of this rather complex subject really only begins here. It gets pretty mathematical from this point on, though. More to the point, the reading grows a bit thick.

It will be fairly obvious, however, that the rather simplistic looking algorithms of an "X" instrument are the basis for an almost infinite number of sounds. Predicting what the result of using these operators will sound like is, of course, the real trick of the exercise. Because of the complexity of FM synthesis, this isn't anything like easy. In fact, it's really only through experience that one can begin to predict what an FM voice will sound like prior to its actual completion.

While there are more techniques for digital synthesis than most people not living near a nuclear power plant have fingers and toes, the FM synthesis technique used in Yamaha's "X" instruments has the dual advantages of being almost infinitely flexible and very nearly incomprehensible for a long time after you get started with it. The latter has the effect of keeping the plebes away from your synthesizer — worth it for that alone.

Finally, when it's all over with and you just don't want to look at another operator until hell or Ottawa freezes over, you can take the sensible approach that I use. Nip out, buy yourself a couple of disks full of canned commercial voices and get back to just playing music. ■

Leader LBO-315 Portable Scope

Bring battery-powered convenience
to troubleshooting

BILL MARKWICK

Despite the fact that you can now get DMMs hardly bigger than a credit card, and pocket-sized meters that include such things as frequency counters, technicians often haul around the standard bench scope when doing fieldwork. You have to look for a place to balance it, and an outlet to power it, not to mention the weight as you haul it in and out of the car.

The Leader LBO-315 brings battery-powered portability to field work, with a size approximately 9" wide by 3" deep by 13" long and a weight of about 10 pounds with the rechargeable NiCad battery. This dual-channel scope has a bandwidth of 60MHz and a vertical amp sensitivity of 5mV/division, expandable to 1mV/div with the x5 function.

A scope that doesn't lock solidly onto the signal is like no scope at all, and the LBO-315 provides a comprehensive triggering section, with all the usual options, such as AC/DC, TV sync, slope, etc. There is also a holdoff control, which lets you slide the triggering point along the waveform to find the optimum. The delay control is a ten-turn knob, with each complete turn counted out in a tiny window, and with the knob marked 0-100, this gives you 1,000 repeatable settings.

Power

The LBO-315 is powered by a NiCad battery pack that fastens to the left side of the scope. This outboard approach may seem odd at first, but it's particularly handy if you need to change battery packs. The pack, incidentally, is a Sony Betacam type, widely available if you need one in a hurry. Battery life is about one hour, with the low battery

condition announced by a flashing pilot light. This pilot light LED, which is labelled "low batt", stays a continuous red during charging whether the scope is on or off; maybe it should just be labelled "batt". The scope can also be operated and recharged from the AC line by plugging in a line cord (no external power pack required). One thing about this I didn't particularly like was the manual switch on the back to stop the recharge after the recommended eight hours. I'm notorious for forgetting to do this and overcharging NiCads, something that shortens their life (my battery-powered drill now has a hardware-store 24-hr timer on it to keep it from getting the overcharge red-hots). May Leader see fit to install automatic charge control.

Coping With Tiny

Making things small is no problem — operating them with human-sized fingers is something else. Leader has solved this problem cleverly, with tiny control shafts that extend when you press them and retract when you press them again; these are for the functions that you use less often — the main controls are standard size. The pushbuttons are spaced far enough apart that you can get at them, and the rotary switches present no problem. The screen, which measures about 3 1/2" diagonally and has an 8 by 10 graticule, is surprisingly easy to see; it even has a little removable plastic hood to reduce glare.

The Back End

The scope is made even more versatile by adding connectors on the back panel. These include Channel 1 output for driving such things as recorders (at 50mV/div into 50 ohms), an AC input that automatically ad-

justs to any frequency or voltage, a DC input for 10-20VDC (about 2A max.) so you can run it from a car battery or other DC source, external triggering, an intensity-control input (Z input) and the aforementioned pesky charging off/on switch.

Other Features

The scope can be protected in transit with a hardshell carrying case, and when you get there, a plastic stand unlocks from the bottom of the scope and snaps into a bail for tilting the front of the unit upwards. There are also feet on the rear panel so you can stand the scope up vertically (this feature is defeated if you fit the AC cord, which protrudes beyond the feet).

The included leads have 1:10 switches on them, allowing maximum input voltages of 5 or 50 V/div.

The manual is excellent, and provides all the operating instructions you need for basic operation, including a good section on the trigger amp and Leader's horizontal-display mode, which allows independent adjustment of the A and B sweep starts.

The sweep was sharp, clear and stable, locking onto all sorts of signals with no problem. Everything seemed very precise and stable, with the possible exception of the trace rotation adjustment, which needed a bit of warmup time to stabilize.

At a price of \$2815 (federal and provincial taxes not included), the Leader LBO-315 is a delight for fieldwork and for the bench when you get back again. It's distributed in Canada by Omnitrone, 2410 Dunwin Drive, Unit 4, Mississauga, Ontario L5L 1J9, (416) 828-6221, or 8100F Trans-Canada Highway, St. Laurent (Montreal), Quebec H4S 1M5, (514) 337-9500. ■

Wavesound Synthesizer

An exercise in the digital synthesizing of sound.

ANDY FLIND

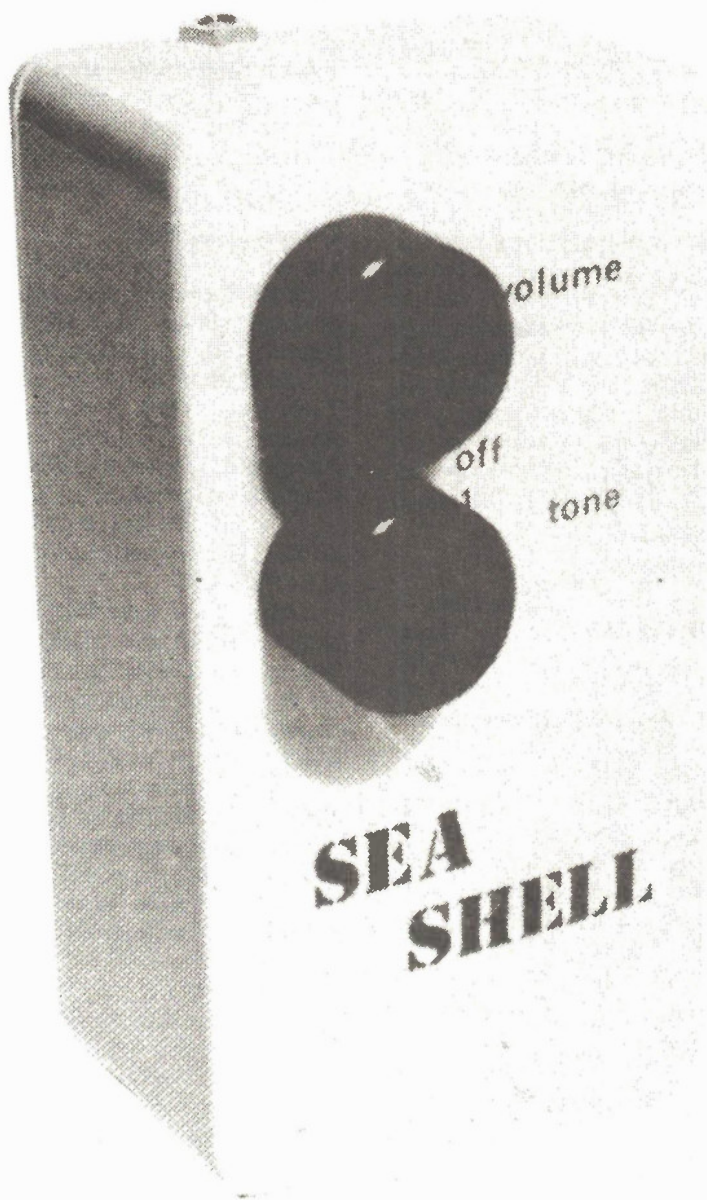

This project will recreate the sound of the surf, either through headphones (try the effect during a stressful day at the office) or through a hifi, where judicious use of tone controls will simulate anything from actual presence on the beach to the muffled roar as heard from a distance. The realism is quite incredible; after a few minutes one tends to forget it's a simulation, the sound is unconsciously accepted as the real thing.

Design Objectives

The design objectives for this project were simple. The sound should be as realistic as possible, in stereo, with appropriate tone and volume changes plus apparently random variations.

There would be absolutely no compromise in sound quality. Also, if possible it was to be pocket-sized, portable and capable of driving Walkman-type headphones.

In practice this meant low-current operation for prolonged use from a single 9V battery. Unfortunately the first objective led to a fairly complex unit, which raised difficulties with the second, but eventually a successful design was arrived at.

Although the circuit is rather complex, all the components are fairly cheap so it is inexpensive to build. The complexity stems mainly from there being two of almost everything; if only one channel were needed it would be much simpler. However, the stereo sound produced is incredibly realistic; constructors will probably agree that the final result is well justified.

White Noise

The first problem was generation of suitable "white noise". Considering the effort sometimes needed to minimize electronic noise, it's amazing how difficult it is to find some when it's wanted.

Most recognized sources are not, in fact, very noisy; they only cause problems where high gain levels are used. The usual "noise generators" found in projects are Zeners and reverse-biased diode or transistor junctions.

Most Zeners and diodes produce less than a millivolt and, of transistors tried, fewer than one in five proved suitable. The quality of sound also varied widely between devices.

A prototype of this project used special "noise diodes" which were very effective, but subsequently these were withdrawn by the manufacturers and no suitable substitute could be found. Eventually, the circuit was redesigned with a digital noise source, based

on IC4, IC5 and IC6 (see Fig. 2). The principle is shown in simplified form in Fig. 1, where a shift register has its output exclusive-OR'd with the output from a tap at stage n and returned to the input.

If the shift register is clocked at a suitable frequency, the output will be a pseudo-random series of 1's and 0's which will take a considerable time to repeat. Just how long depends on the number of stages and the tap position; choice of tap for the longest possible sequence requires involved calculation and is best left to the experts, but the arrangement used in this design has a 33-stage register with a tap at stage 14 and when clocked at 1MHz takes over two hours to repeat.

Circuit Description

In the full circuit diagram for the Seashell shown in Fig. 2, the clock consists of IC4a and IC4b, running at approximately 1MHz and driving a 33-stage register made up from IC5 and IC6. The register output, from IC6 pin 9, is EX-OR'd with the output from the tap, IC6 pin 13, by IC4c for return to the input, IC5 pin 1.

It is possible for the circuit to get into a state where all the circulating bits are "0's". This would result in an input of 1, so the output would appear to be continuously low. This condition is avoided by the inclusion of capacitor C12 and resistor R27, which will rapidly inject a 1 to break the sequence should it occur.

Two apparently independent noise sources are required by this project. If a stereo amplifier is switched to mono and turned up until the background hiss is audible, the effect of switching to stereo will immediately be apparent. From being a mere irritant, the noise will acquire depth, suggestive of wind and wide open spaces, and this is the type of sound needed for processing into waves.

Instead of building two separate sources (with six chips) the register input is EX-OR'd with another tapping point by the remaining gate IC4d to become a second output. A pair of two-stage low-pass filters convert signals, and attenuation by resistors R32 and R33 reduce them to a suitable level, about 35mV RMS, for the following stages. The two sources look sufficiently unrelated for the intended purpose on a scope, and they certainly sound right.

Volume and tone are controlled by diodes. Taking the channel following

capacitor C17, the signal passes through diodes D5 and D7 to appear across resistor R40. The diodes act rather like variable resistors whose resistance falls as the DC current flowing through them is increased. The current needed is just a few microamps, supplied mainly from resistor R36. From here the signal passes through C21 and R44, which with capacitor C23 provides "top cut" tone control varying with the current, from resistor R42, passing through diode D9.

The full control network includes diode D3, resistors R8, R11, R38, and capacitors C19, and C25, and with the values given produces a realistic crashing-

and R5, taking about four seconds to reach half supply voltage where IC2c and IC2d each go high for about two seconds.

These positive (high) pulses are fed to the wave generators by D3, R11 and D4, R12. When the outputs go low again they provide the discharge paths for slow sound decay through resistors R8 and R9.

If the waves simply crashed regularly and in unison they would sound boring and unrealistic (though less control circuitry would be required.), so IC3 introduces a little randomizing. The two amplifiers in this chip are configured as very slow running astable oscillators, with slightly different rates set by resistors R19 and R20.

The signals found on capacitors C7 and C8 are very slow triangle waves (approximately), of which small proportions are fed to capacitors C3 and C4 by resistors R13 and R14 respectively. This alters the times taken by these capacitors to charge to half-supply, slightly varying the switching

times of the following gates.

The apparent effect is that the waves occasionally crash initially a little to one side. A little crosstalk introduced by resistor R10 improves the realism. Two further signals taken from IC3 are fed directly into the amplitude controlling stages by resistors R34 and R35. The high value of these resistors keeps the effect small, but it results in the backwash effect after each wave varying in volume and apparently swinging around. Again a little crosstalk, this time through resistor R25, improves the effect.

Construction

All components except the Volume control VR1, Tone (or Presence) switch S1 and the Headphone socket JK1 are accommodated on the printed circuit board. The component layout (assuming the board has not been cut) and copper foil master pattern is shown in Fig. 3.

There can be few projects where constructors are advised to begin by sawing the circuit board in half. This isn't necessary, of course, if it is to be housed in a case that will accept it in one piece. However, if pocket-size is required this is the first step.

The cutting line is marked by a dotted track, along the centre of the copper side of the board which should be carefully sawn

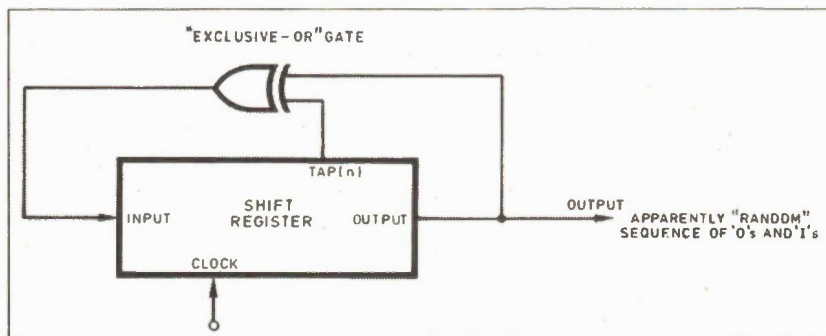

Fig. 1. A simplified digital noise generator using a shift register.

wave sound when supplied with a positive pulse lasting about two seconds. The tone change lags slightly behind the volume, so the wave crashes initially at high pitch, shifts rapidly to a deep roar, then as it dies away the pitch gradually rises again for a realistic backwash effect.

Volume control VR1a lets the user adjust the level before amplifier IC7a, which can produce an output of about 200mV RMS maximum. IC7 is a 1458, the dual version of the trusty old 741. Tests proved this to be capable of directly driving Walkman-type headphones for portable use.

Switch S1b offers two levels of overall tone control if required. The tone positions could well, in fact, be labelled "near", "far" and "furthest". The second channel, following capacitor C18, works in exactly the same way.

Sound Waves

The rest of the circuit is concerned with providing suitable pulses to control the sounds. IC1a and IC1b for a simple clock, cycling about once every ten seconds. The output is differentiated by capacitor C2 and resistor R3, so the coupled outputs of IC1c and IC1d are normally high, but go low for about one second with each clock cycle.

Each output pulse discharges capacitors C3 and C4 through resistors R4

Wavesound Synthesizer

Fig.2. The schematic diagram of the Wavesound Synthesizer.

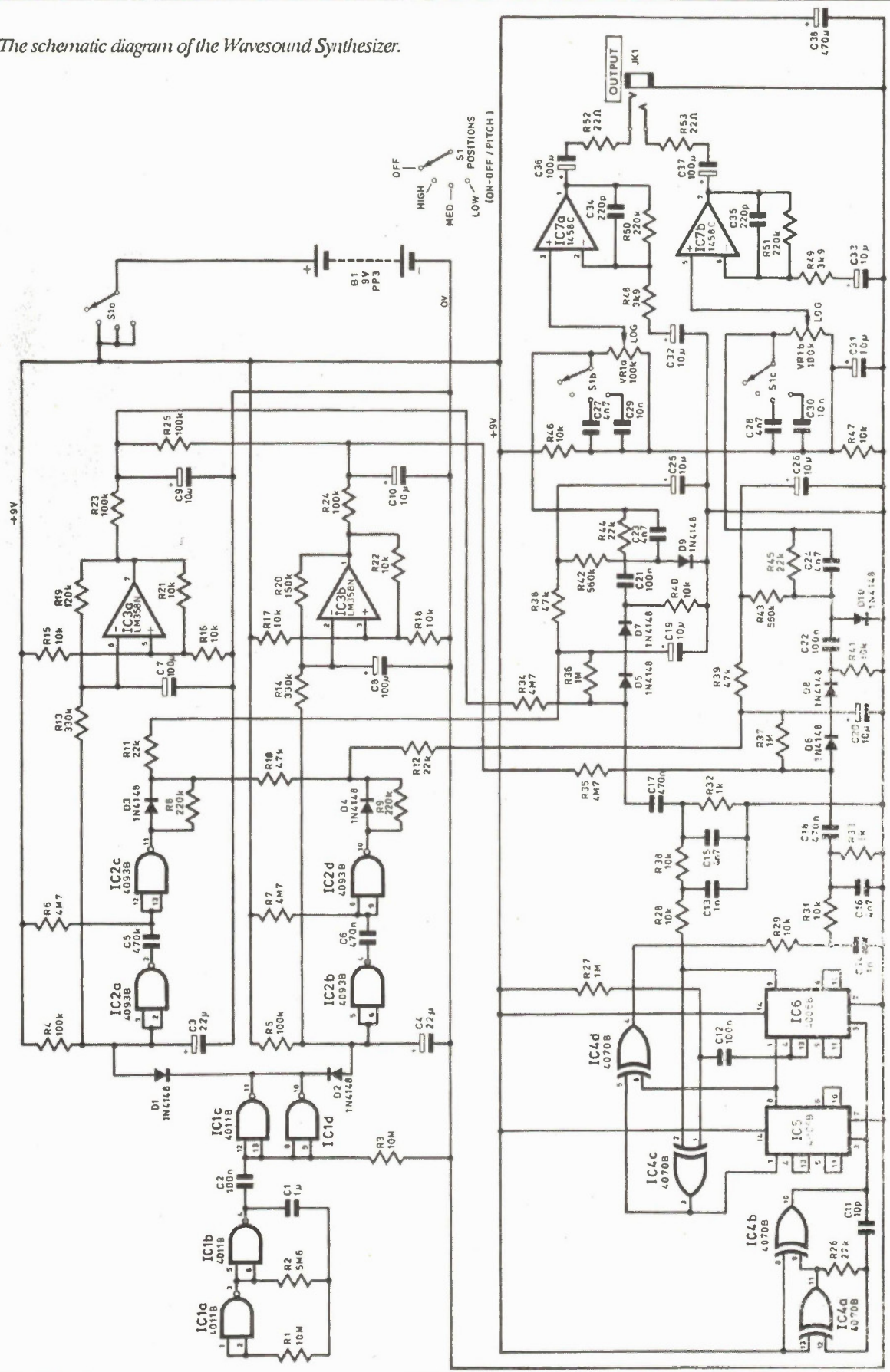

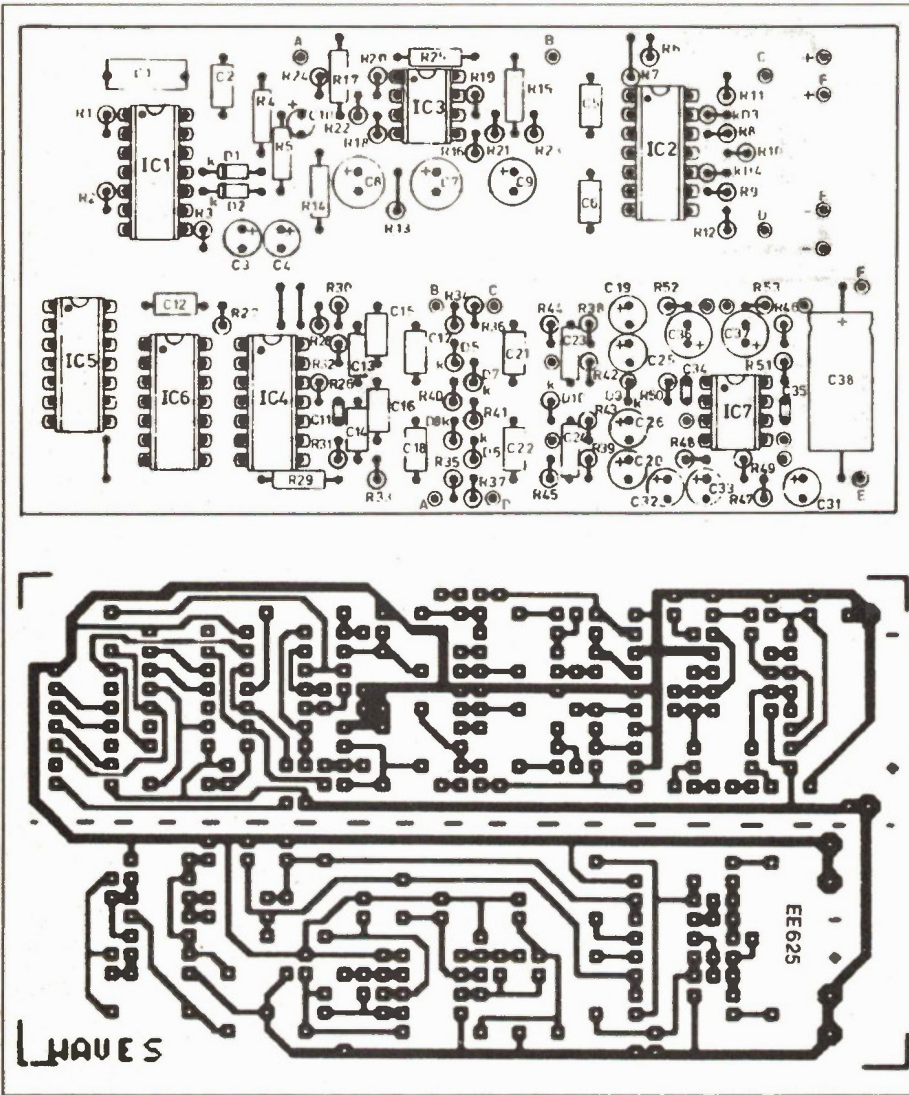

Fig. 3. The PCB and component layout. This board is cut in half if using the case specified.

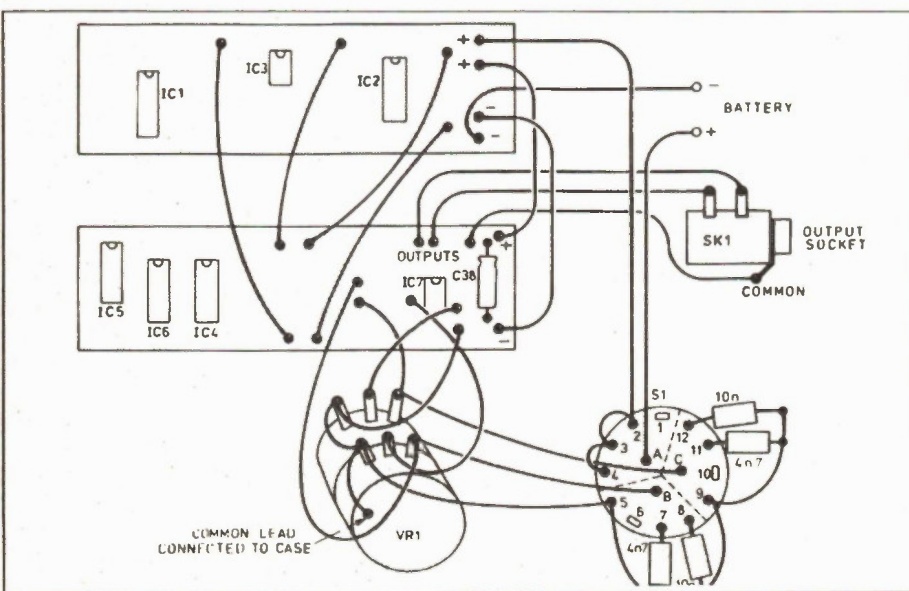

Fig. 5. Interwiring to the boards, VR1, JK1 and S1.

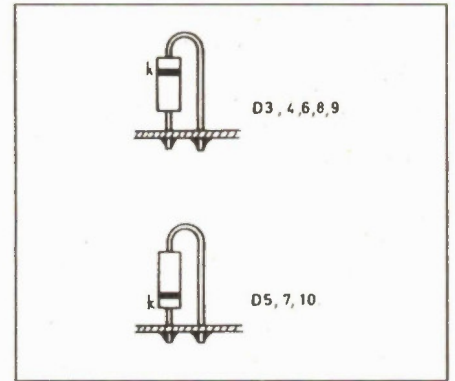

Fig. 4. Polarity guide for mounting the diodes on the PCB.

with a fine-toothed hacksaw. The two halves should then fit lengthwise into the moulded slots of the recommended case and the lid should fit; they can be trimmed with a file if necessary. Their edges can be smoothed with emery paper when cutting is complete.

As the components are quite densely packed together a fine-tipped iron is essential for construction. The components should be of the correct type, otherwise they may not fit. In particular, all the non-electrolytic capacitors, save C39 and C40, are miniature polyester layer types, not the larger polyester film variety.

All the electrolytics save capacitor C11 are the single-ended PCB mounting type. Their dimensions are 11mm (high) X 5mm (dia.) for 10uF and 22uF and 11mm X 6.3mm for 100uF. The height is important as space between the boards is limited.

The layout of all components is shown in the overlay drawing, Fig. 3. Care should be taken over the polarity of the diodes; Fig. 4 provides additional guidance for their installation. If they are bent and placed as shown their polarities will be correct.

The electrolytic capacitors normally have their negative leads identified with a broad stripe and all except capacitors C36 and C37 are fitted with positive sides uppermost. They must be fitted close against the board to minimize overall height. DIP sockets should be used for all the ICS, which should not be plugged in at this stage.

It is always preferable where possible to test a new project in stages, to minimize chances of catastrophic damage and simplify the location of any faults which may be present. Before starting to test this project, all connections between the boards and controls should be completed, temporarily if preferred, except those to the rotary switch S1 which should be added afterwards.

The use of coloured ribbon cable, though not essential, makes for a neater

job and reduces risk of error. The inter-wiring connections are shown in Fig. 5. Note the lead between the "common" point on VR1 and its case, to reduce hum pickup. If the board is not cut, the power rails will be unnecessary. None of the ICs should be plugged in yet.

Testing

If a 9V supply is connected to the project with a milliammeter in series, the drain, following a brief initial surge, should be around 1.3mA to 1.4mA. Any obvious deviations from this figure should be investigated before progressing further.

If all seems well, IC7 can be fitted and power reapplied. This will raise the consumption to about 3.5mA. The voltage on pins 1 and 7 of this IC should be half the supply, or about 4.5V.

If the headphones are plugged in, a fair amount of hum will probably be heard, especially if the volume control VR1 is turned up. Touching the top ends of the volume control sections should produce loud hums on the corresponding headphone. Following this test, the volume should be turned right down.

The next stage is to fit IC4, IC5 and IC6. This will raise the drain to about 7mA. IC4 pin 4 and IC6 pin 9 should, if tested for DC voltage, show about half the supply. These are the outputs and if they are operating correctly this will be their average level. If there appears to be a problem, a check on IC4 pin 10 should show about half the supply voltage, indicating that the clock oscillator is running.

Fitting IC3 will increase the current to 7.7mA. IC3 pins 1 and 7 should be switching from 0.5V to 7.5V and back very slowly, about every 20 to 30 seconds. These provide a small amount of drive to the diode attenuator circuits, so if the volume is turned up a little the output sounds should be heard while they are positive.

If IC1 is now plugged in the current taken will start to vary slightly with the oscillator action. Pin 4 of IC1 should be clocking up and down at about 10 seconds per cycle, while pin 10 and pin 11 will be normally high, pulsing low about once every 10 seconds and pin 4 goes high.

IC1 on its own will not affect the audio output. Fitting IC2 should, however, result in the full "wave" sounds appearing.

If testing is needed here, pin 3 and pin 4 of IC2 should be normally low but go high for about three to five seconds in every 10 seconds, while pins 10 and 11 should also be normally low, going high for about two seconds in every 10 and trigger-

ing waves as they do so.

The total drain of the complete circuit depends on the output volume, point on the clock cycles, etc, but should be around 8mA to 12mA. With an operating current of around 10mA this circuit will operate for long periods from a single 9V battery.

Final Wiring

Following satisfactory results of these tests the tone switch S1 can now be wired up. The capacitors C27 to C30 are mounted directly onto the tags of this switch as shown in Fig. 5, with a piece of heavy gauge wire attached to tags 5 and 9 forming their common connection. Three wires connect S1 to VR1.

The drilling details for mounting the volume control, function switch and output stereo jack socket in the case are shown in Fig. 6. The project can now be assembled into the case. The output jack socket should be fitted after the volume control, which in turn will have to be connected before installation.

In the prototype the battery is held by a plastic clip cut from a 35mm photographic slide box and glued into place, with a piece of foam plastic to prevent rattling. The small clearance between parts of this project means there is some risk of parts touching, so check carefully and use small bits of plastic to insu-

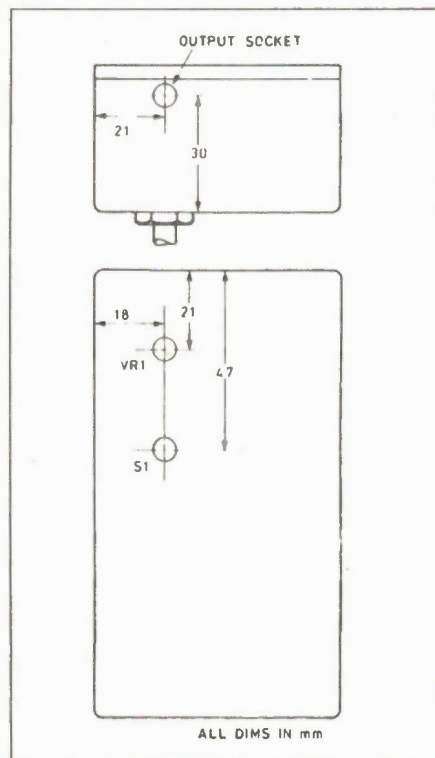

Fig. 6. Case drilling details.

late adjacent items if necessary. On the prototype the presence of the wiring between the boards keeps them apart satisfactorily. ■

PARTS LIST

Resistors

All 5W, 1%

R1,3	10M
R2	5M6
R4,5,23,24,25	100k
R6,7,34,35	4M7
R8,9,50,51	220k
R10,38,39	47k
R11,12,44,45	22k
R13,14	330k
R15,16,17,18,21,22,28	
29,30,31,40,41,46,47	10k
R19	120k
R20	150k
R26	27k
R27,36,37	1M
R32,33	1K
R42,43	560K
R48,49	3k9
R52,53	22

Potentiometer

VR1 100k dual log

Capacitors

C1	1u polyester
C2,12,21,22	100n
C3,4	22u 16V
C5,6,17,18	470n
C7,8,36,37	100u 10V
C9,10,19,20,25,26	
31,32,33	10u 50V
C11	10p
C13,14	1n
C15,16,23,24,27,28	4n7
C29,30	10n
C34,35	220p
C38	470u 10V

Semiconductors

D1-10	1N4148 sil. signal
IC1	4011B quad NAND
IC2	4093B quad Schmitt
IC3	LM358 dual op amp
IC4	4070B quad X-OR
IC5,6	4006B shift reg.
IC7	1458 dual op amp

Miscellaneous

S1 3-pole 4-way rotary switch, JK1 stereo jack, 2 knobs, 2 8-pin DIP sockets, 5 14-pin DIP sockets, 9V battery and connector.

VoiceCAD

A voice recognition system for hands-free commands in AutoCAD.

BILL MARKWICK

VoiceCAD is a voice recognition system that allows you to produce AutoCAD drawings without entering commands from the keyboard or selecting them from the screen menu. It consists of a headset-mounted microphone, a card for the expansion slot of the IBM PC/XT/AT/386 or compatibles, and software. It uses the command structure of AutoCAD Release Nine (which requires a math coprocessor), and since about 70K worth of the software remains resident in memory, 640K of RAM is necessary (and versions for VersaCAD and CADkey are available).

The VoiceCAD system is based on the IntroVoice voice recognition card, which allows you to input commands to word processors, desktop publishing, etc. It's also available with two-way communication; a small speaker lets the voice synthesizer give you various information and prompts (IntroVoice is available separately for voice-recognition applications other than AutoCAD for \$695 without voice synthesis, or \$895 with the two-way feature).

After installing the hardware and software, it's necessary to train the program to accept the 500 spoken AutoCAD commands. The software prints all the commands on the screen one at a time, and the user repeats them into the microphone. Each of the training sessions takes about 20 to 25 minutes; one repetition of each command is not enough for accurate operation — it likes to average several repetitions, with three passes recommended for simple commands and six for the complete vocabulary. If you cough or bump the microphone on the first runthrough, that becomes the sound for that particular command. As you make more passes through the vocabulary, the cough or microphone noise will be dis-

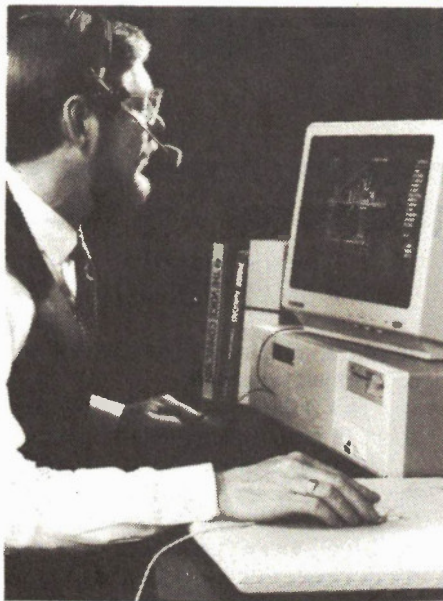

carded as the program learns the proper word. Individual words can be edited after the vocabulary is completed.

Once this is done, you can start a new file by voice command, since it accepts numbers and letters (though letters require the alpha-bravo-charley phonetics for best clarity). You then say, for example, "Line" — and the AutoCAD command LINE appears onscreen. Move the mouse to the locations you want, and then try putting in a circle, some hatching, a block, etc. If the vocabulary has been trained enough times, the system works reliably and quickly. The voice recognition feature can be disabled with the Num Lock key. The resident software didn't cause any memory problems, though this might not be true if you ran memory-intensive applications such as large AutoLISP programs (in this case, memory allocation can be adjusted to suit AutoCAD's needs via DOS's SET command).

The voice recognition is done by divid-

ing the audio spectrum into bands, much like a spectrum analyzer, and converting the various outputs into digital code. It then does a best-match with the voice commands that you've previously entered into the vocabulary. The output of the bandpass filters can be displayed as a bargraph on the screen; this came in handy when I was using a handheld mike that kept triggering the system oddly. The bandpass filters showed that it had far too much output with sibilant words, and the cure was to use the headset type included with VoiceCAD.

The system really did meet its claim of giving you hands-free AutoCAD operation, and it also eliminates having to move your eyes from the drawing to a menu and back. In this sense, people who do a great deal of work with AutoCAD will find it well worth its Canadian price of \$1395.00, which includes the two-way IntroVoice, speaker, headset/microphone, VoiceCAD software and manuals.

One drawback is the length of time needed to repeatedly retrain the vocabularies, especially since an interruption means that you have to start again from the beginning. Another is getting buried in AutoCAD's menu structure, a structure so complex that VoiceCAD gives you a poster of the routing (they also have a new version coming out that allows jumping across submenus, which should save a good deal of back-and-forth). Another is the need to make a vocabulary file for each person using VoiceCAD.

If you don't mind the training time and you don't feel self-conscious about sitting in your office talking to your computer, VoiceCAD is a worthy tool to increase your production. It's represented in Canada by Tech Speak Systems, 23 Fin-tona Avenue, Scarborough, Ontario M1E 1V4, (416) 284-9055. ■

The Techie's Guide to C Programming

Looking for something hotter than BASIC for those technical programs? Try the power of C.

STEVE RIMMER

Programming is a lot like hardware design, really — except that you can't burn your fingers on the soldering iron. Much of the process of getting a program together is similar — at least in concept — to designing circuitry. Of course, programming offers you considerably more choices to cloud the issue with at the onset.

One of the obvious choices is that of the language you're going to program in. If you're predominately interested in hardware, and have only gotten into programming so much as it has supported your hardware efforts, you've probably developed what code you've needed in BASIC. While good for the odd ten line test routine, BASIC has more limitations than most wombats have fleas.

Wombats have a lot of fleas.

There are better development tools than BASIC — in fact, come to think of it, there are few worse ones that spring readily to mind. As you might have gathered, I consider that one of the best ones going is the C language. As we'll get into, it's a powerful platform on which to develop hardware related code — and just about anything else.

In addition to this, it looks cryptic and scares people who don't know what it's about. For example, if I park Horatio, the

office cat, in front of a monitor full of C code, he just runs away.

This is the first of a series of features about C programming for technicians — don't sweat it, we're not going to blast through the entire ordeal in this magazine. It's based on Borland's Turbo C running on a PC compatible, which is a really handy development system and extremely cheap. However, one of the principal attributes of C is its lack of dependence on any one compiler or, to a large degree, on any specific sort of computer. As such, what we discuss here will be largely applicable to whatever computer and compiler you happen to have on hand.

I Don't Like Mondays

There are several strata of languages, and, as with most things, each stratum entails some trade offs. BASIC might be regarded as the highest stratum in a sense. It offers you complete protection from the nastiness of the system — you can't, in theory, crash your computer from BASIC. It's very easy to use. However, it arrives at this state by being tediously slow and by denying you access to about ninety percent of what your computer is capable of.

A pox on BASIC.

The other end of the spectrum is occupied by assembly language, which involves programming in the computer's native

tongue. Assembly language programming allows you to make the computer do absolutely everything it can possibly get up to, but you have total responsibility for handling the machine. Assembly language programs under development crash a lot, and when assembly language programmers get together for a brew and a few laughs after a long day down in the pits, they often talk about how colourfully they can blow up a program. Weird souls, these.

In addition to all this, assembly language code takes ages to develop, because you have to write stuff for absolutely every tedious little function you want to include in your program.

The middle ground is occupied by a plethora of languages, of which C is probably the most popular. These languages represent a trade off. They give you much of the speed of assembly language, some of the protection of BASIC and what are called "libraries". A library is a collection of low level routines which you can include in programs you write to keep you from having to re-invent the wheel every time you start a new project.

Pascal is another of these languages, by the way. We could just as easily be talking about Pascal here, except that nobody really likes it and it involves a lot more typing than C. It has been said that real men don't program in Pascal. Far be it for

```
File Edit Run Compile Project Optic
Edit
Line 262 Col 1 Insert Indent Tab D:SCOOP.C
unsigned int paint_lines=0;
#endif

main(argc,argv)
int argc;
char *argv[];
{
static char b[81];
int c,call_view();

textattr(0x07);
card = which_card();

if(card == COLOURCARD) {
hello_left = 208;
hello_top = 32;
}
}
Message
F1-Help F5-Zoom F6-Message F9-Make F10-Main menu
```

The illustrations in this article show the development of a program in the C language.

me to argue with such obvious wisdom.

Unlike BASIC, C is a compiler language. This may take a bit of explaining. When you run a BASIC program under BASICA or GWBASIC or whatever happened to come with your DOS disk, the BASIC language walks through your program *interpreting* everything line. If it finds a line that says

```
PRINT "ZEBRA LUST"
```

it trucks off somewhere in the interpreter, finds the routine that prints, tells it where the string to be printed is and does the deed. Then it finds the next line to interpret.

This process is very slow.

Under a compiler, you write the program as a text file using a word processor or, in the case of something like Turbo C, with the text editor built into the language system. You then run the compiler program, which translates each action in your program into corresponding machine code. When the compiler is done, you have an authentic EXE file, all ready to run from MS-DOS.

This makes the code a lot faster than it would have been under an interpreter. However, the process of getting into the text editor, editing your program, getting out of the text editor again, running the compiler, running the EXE program and then repeating the process is a bit deadly. While I learned to program in C this way, you won't have to because integrated environments

like Turbo C mash the whole ugly process together. We'll get into this in greater detail in a future installment of this series.

In addition to this, because the result of a compilation is effectively machine language, we can write what are called "hybrid" programs, that is, ones which are comprised of both C language and assembly language routines. This allows you to have the ease of development of C and the speed of assembly language in those few cases that you really need it. We'll get into this in a future article as well.

The most important feature of C, however, is a bit intangible. C is structured. BASIC can be structured, and some of the newer BASIC environments, such as QuickBASIC, have lifted quite a lot of structure from C in an effort to overcome the tendency of BASIC programmers to write spaghetti code. However, C is inherently structured, and by simply letting its normal structure flow out through your fingers and into your computer, you'll write tight, easy understandable programs and dance past about three quarters of the bugs that BASIC programs are heir to.

Trust me.

No Deposit, No Return

A C program consists entirely of functions. Under BASIC, a function is, by definition, a pretty simple thing. Under C, it's the essential building block of any program.

Under C, a function is a routine which takes in zero or more arguments, does something and optionally returns a result. Functions can call other functions, which in turn can call still other functions. When a C program runs, it starts off by calling a function named *main*, which in turn calls all the other functions of the program.

This is a very simple C program.

```
#include "stdio.h"

main()
{
/* print a string, Billy */
printf("Hello, planet");
}
```

```
File Edit Run Compile Project Optic
Edit
Line 273 Col 31 Insert Indent Tab D:SCOOP.C
unsigned int paint_lines=0;
#endif

main(argc,argv)
int argc;
char *argv
{
static cha
int c,call

textattr(0
card = whi

if(card ==
he
he
}
}

Compiling
Main file: SCOOP.C
Compiling: INCLUDE\STRING.H

Total File
Lines compiled: 800 800
Warnings: 0 0
Errors: 0 0

Available Memory: 232K
Ctrl-Break to quit

Alt-F1-Last help Alt-F3-Pick Alt-F5-Saved screen Alt-F9
```

The Techie's Guide to C Programming

and when *print* finishes doing its stuff, they'll disappear. If *print* is called a second time, they'll come back. Another function could also have two *ints* called *i* and *l*, but they'd be different variables, and the two functions would not interact. This eliminates an additional hive of bugs that plague BASIC programs, wherein all variables are global.

The C language allows for global variables as well — ones which can be accessed by all functions — but we'll check them out another time.

Under C, we pass small objects to functions directly. For instance, an *int* is a small object. A string is a big object, and, while I suppose we could pass it in its entirety, this would make our programs slow and ugly. As such, we pass pointers to strings in most cases.

Pointers are one of the things under C which crawl into the inner ears of beginning C programmers and sing off key into their brains until they go mad. No foolin'. They're a bit hard to get your head around at first, and you'll have to use a bit of faith in this case to understand what this one is up to.

Under C, the notation **s*, as it's used in the second line of the *print* function, tells C that what is going to be passed to *print* should be regarded as a pointer to a string, or, more properly, to an array of *chars*. Thereafter, the variable *s* will stand in for the string that was passed to *print*. In this case, *print* has to trust that it was actually passed a string.

A pointer is simply an object which says where something is, rather than being the something itself. As a simple example, you probably know that the memory for the first character on the screen of a PC usually lives at location zero in segment B800H — you might have experimented with POKEing data to this location to see the screen contents change. If we create a pointer to this location under C, we can alter the screen contents by altering what the pointer points to. This is actually a very useful way to directly access the screen under C.

The first actual line in *print* that does anything is the one which assigns *l* the value of *strlen(s)*. The *strlen* call is a library function which returns an *int* value containing the length of the string passed to it. Under C — by convention — a string consists of any number of characters terminated by a zero byte, or "null". As such, what *strlen* actually does is to start with the first location pointed to by *s* and keep counting 'til it finds a zero byte.

The next line is a *for* loop, the

equivalent of a FOR NEXT loop under BASIC. As is typical of C, it's a bit cryptic at first. It translates as follows. First, set the value of *i* to zero. Repeat the loop while *i* is less than *l*. With each iteration of the loop, increase the value of *i* by one.

That last one might not be quite as easy to understand as were the first two. In programming, incrementing and decrementing values by one is a common occurrence, so C gives a short hand way of expressing it. The notation *++i* means to increment *i*, and *--i* means to decrement it. Wait'll we get into how you increment *i* by two.

The *for* loop executes whatever's in the set of curly brackets associated with it for each iteration of the loop. In this case, we call another library routine called *putchar*, which prints a single character to the screen. We pass it, in turn, each element of the array of characters that comprises our string. If *s* points to a string, *s[0]* is the first element, *s[1]* is the second, and so on. Everything starts with zero in C — there seems to be little point in wasting perfectly good numbers by starting with one.

Unlike as with BASIC, we don't have to tell a C function to return when it's done with. After the last statement inside the outer set of curly brackets of the *print* function has been completed, it will automatically return to whatever called it.

Extra Texture

The *print* function we've looked at

was — hopefully — fairly easy to understand. It was, however, very clunky and awkward by C standards. Not only was it inelegant, but it would execute much more slowly than needs be. Here's a quick look at how C really parties before we split.

```
This is the print function, version two.  
print(s)  
char *s;  
{  
while(putchar(*s++));  
}
```

There's nothing up my sleeve — that's all of it. Let's see how it works.

In order to know what this is up to, you'll have to know a few more things about how C gets its act together. One of the concepts which C is very fond of is that of truth and falsehood, which is very philosophical, of course. Under C, zero is false and everything else is true. In the case of a string, then, all of the characters in the string represent true conditions, except for the zero byte at the end. Very useful, this.

This version of *print* uses a new C construct, the *while* loop. This is of the form

```
while(whatever is true) <do this >
```

The notation **s++*, designating what gets passed to *putchar*, is splendidly cryptic. It tells C to extract the number which *s* is pointing to, pass it to *putchar* and then to increment *s* to point to the next location in memory, that is, the next character in the string. Under C, if we say

```
File Edit Run Compile Project Optic
Line 289 Col 27 Insert Indent Tab D:SCOOP.C
hello_left = 208;
hello_top = 40;
jump_right = 260;
}
if(card == EGAMONO) {
hello_left = 208;
hello_top = 40
paint_deep = 374;
jump_right = 260;
}
SetSysFont(&systemFONT); /* tell MAP2TUBE wh
Text();
Graphics(); /* establish graphi
show_hello(); /* show the startu
Message
Compiling D:\TC\SCOOP.C:
Error D:\TC\SCOOP.C 289: Statement missing ; in function m
F1-Help F5-Zoom F6-Edit F7/F8-Prev/Next error F9-Make
```

```

File Edit Run Compile Project Op
Edit
Line 273 Col 31 Insert Indent Tab D:SCOOP.C
unsigned int paint_lines=0;
#endif

main(argc,argv)
  int argc;
  char *argv
{
  static cha
  int c,call

  textattr(0
  card = whi

  if(card ==
  he
  he

```

Compiling

Main file: SCOOP.C
 Compiling: EDITOR → SCOOP.C

	Total	File
Lines compiled:	3008	3008
Warnings:	0	0
Errors:	1	1

Available Memory: 270K
 Errors : Press any key

```

Alt-F1-Last help Alt-F3-Pick Alt-F5-Saved screen Alt-

```

This program defines a function called *main*, which, as we said, will automatically be called by the computer when the program is run. A function under C is always written with parentheses after it. These contain any arguments passed to the function. In this case, you might think that *main* will always have an empty argument list. It does in this case, but it needn't always. C allows for command line arguments to be passed to *main* — but more on this another time.

The working bits of a function under C are always contained in curly brackets. As we'll get into, a function can have smaller bits of itself enclosed in still more curly brackets — indenting and nesting pairs of curly brackets is an art form under C, and makes even fairly sloppy code look very elegant.

This *main* function calls one other function, called *printf*. The *printf* function is a standard C function, and is provided with the library of the compiler. It's amazingly powerful, as we'll get to anon. In this case, though, we've used it in a very simple sense. It prints a string to the screen. Strings in C are contained in double quotes, just like under BASIC.

Every line in a C function is ended by a semicolon, and leaving the semicolon off is one of the most common mistakes for beginning C programmers. Except in special cases, a C compiler ignores line returns when it's scanning a program. This function could be written as

```
main() { printf("Hello, planet"); }
```

as far as the compiler is concerned. The former version is a lot easier to read, though.

The very first line of the program is a compiler directive. It tells C to read in and compile a file called *STDIO.H* before it does anything else. This is called a "header" file. This one is also provided with the compiler, and includes some basic definitions to tell the compiler things like how to find the screen. It's included with every program you write, and you'll probably find that lots of other headers want including too, as you get into more complex programs.

Finally, just above the *printf* call there's a comment. Under C, anything which is enclosed in */** and **/* is a comment, and will be ignored by the compiler. This is useful to add comments to your code — C is a little terse, and very hard to read all by itself without a few prompts from the real world. It's also handy for temporarily "commenting out" blocks of code in a program under development.

One of the justifications for *not* putting comments in your code in C is that anything which is difficult to write should also be difficult to read. You can take this any way you feel like.

One last note before we move on — don't mix up slashes and backslashes under C — they mean different things. In fact, it's worth observing that C uses every

one of the normal printable ASCII characters for something. Further, C is case sensitive. The compiler regards *printf*, *PRINTF* and *Printf* as being three different things. C programs are traditionally written in lower case.

This next program is a bit more complicated. Note that I've left off the *include* directive at the beginning — we won't bother with these in future, as they can be assumed to be there.

```
main()
{
  printf("There once was a Hermit
  named Dave");
}
```

```
print(s)
char *s;
{
  int i;
```

```
l = strlen(s);
for(i=0; i < l; ++i) {
  putchar(s[i]);
}
```

In this program, we use both library functions and one of our own. The function *print* is defined here as being something which prints a string to the screen — essentially what *printf* was up to in the last example. This one, however, lets us see how the whole thing works.

There's a lot going on here.

Under C, data is stored in different sorts of variables, called *types*. Simple numbers are stored as integers, or *ints*. An *int* is a signed sixteen bit number on a PC. Strings, such as the one we're going to print, are stored as arrays of characters. A single character is of the type *char*. As such, a string is contained in a buffer of sequential *chars*.

Under C — unlike BASIC — every variable you use must be explicitly declared before you use it. You must tell the compiler it exists, and you must say what it will be used for. In *print*, we have declared two *ints* called *i* and *l*. Because we must declare what type of variables these are, C will not allow use to casually put the wrong sort of data in them, a common failing under BASIC. This is called "strong type checking". We can over-ride this when we need to, but it catches a whole seething hive of potential bugs in the normal development of a program.

The two *ints* in *print* are "local" variables. They exist only within this function,



++s we're telling C to increment s and then do something. If we say s++, we are telling C to do something and then increment s — which, in this case, means something slightly different, as you can see.

The asterisk may also be confusing, as it appears to mean different things in different contexts. There's a reason for this, actually — it does. If s is a pointer to a string, *s is the first byte of the string. But wait, you cry — I thought that s[0] was the first byte of the string. It is — the two notations are equivalent in this case. We can use either, although in this version of *print* the one with the asterisk allows us to do less typing and write tighter code.

The library function *putchar* prints its argument to the screen and, for the sake of code like this, also returns it. As such, testing the truth of *putchar*, in this case, is just as good as testing the truth of each byte of the string. This means that *putchar* will print the zero byte when it gets there, of course, but since zero bytes aren't printable, nothing will happen.

What this function is actually saying, then is this. While *putchar* has not printed a zero byte, get the next byte of the string, increment the string pointer for the successive iteration and print that byte. We can write this in less compact C notation as

```
while(*s){
    putchar(*s);
    ++s;
}
```

This is easier to read, and, in fact, results in no less acceptable code than our really compressed version above.

No Cigarettes, No Matches

The weird, compact notation of C takes some getting used to, and you shouldn't worry too much about not being able to write fluently in it at first. If you're used to BASIC, learning C will be a bit of a brain trauma to begin with. Stick with it — you'll find that it gets a lot easier as you go. In time, you'll wonder how you could ever have gotten anything to work in a language as funky and unnatural as BASIC.

In the next installment of this series, we'll look briefly at a few of the compiler packages available to let you do some real experimenting in C, talk about some of the better reference books about and look at a bit more of the esoteric little world of C code.

Same time, same station. ■

Value Priced Oscilloscopes

20 MHz DUAL TRACE OUR MOST POPULAR SCOPE!

Features built-in component tester ideal for troubleshooting solid state circuits and components with no circuit power; 80 x 100 mm high luminance CRT; TV sync measurement; for vertical and horizontal circuitry. Sensitivity 1mV/div. Dimensions: 6.4"x11.5"x14".
MODEL NO. 33330 **\$595.**

15 MHz PORTABLE

Dual trace, rechargeable battery or AC operation, 3.5" CRT, TV video sync filter, sensitivity 2mV/div., carry handle.
MODEL NO. OS615S **\$829.**

35 MHz DUAL TRACE

Features fast sweep time, high brightness 80 x 100 mm CRT display, stable display of Ch.A and Ch.B waveforms, single trace viewing, sensitivity 1mV/div.
MODEL NO' OS635 **\$849.**

Set of 1:1/10:1 switchable probes \$59.

50 MHz also available. Please add \$15 for shipping and handling.
Order by phone or mail. Credit card, money order, cert. cheque or C.O.D.
Ontario residents add 7% P.S.T.

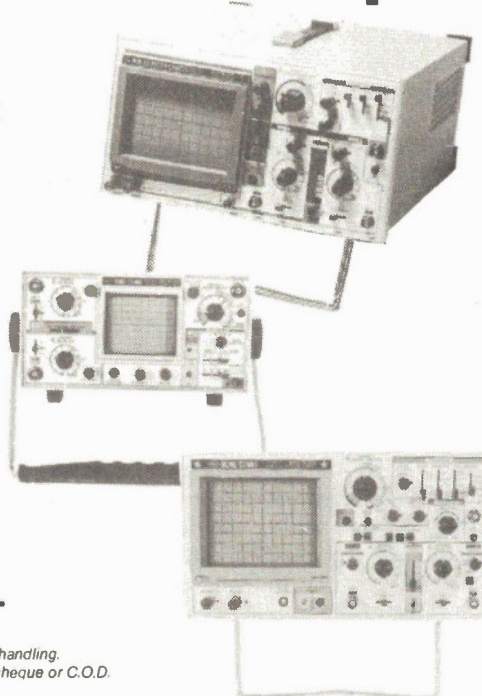

KB ELECTRONICS

355 Iroquois Shore Road, Oakville, Ontario L6H 1M3
Tel: (416) 842-6888 • Telex: 06-982396 KBELOKVL

ASK FOR
OUR FREE
CATALOGUE
TEST BENCH
EQUIPMENT



How Temperature Controllers Work

There's more to thermostat switching
than meets the eye.

DR. H. VIRANI

Controlling the temperature is one of the basis industrial process tasks. In its essence, a temperature control system involves sensing the temperature of the plant, and depending on whether the plant temperature is higher or lower than the set point, increasing or decreasing, the heating or cooling accordingly. Of course things are not that straightforward. Some plants are easier to control than others, and some processes require more accurate control than others. Therefore, there is a range of controllers to satisfy these needs, each with their own advantages and disadvantages.

On/Off Controllers

The on/off controller (also known as the bang-bang controller) in its simplest form turns the heat off if temperature increases beyond the set point, and turns heat on if temperature drops beyond the set point. The trouble with this scheme is that if the temperature is hanging around the set point (which is what you want it to do) the controller will be turning on and off very quickly and often, especially if there is a bit of noise in the temperature measurement. The "chatter" very quickly shortens the life of the controller output, and if it is driving large solenoids or actuators of some sort they could easily be destroyed. For this reason nearly all on-off controllers need hysteresis built into the control characteristic (see figure 1).

When a little hysteresis is introduced, the plant is forced to cycle between the two temperatures either side of the set point. Typically the hysteresis is about 0.5°C to 2°C. If you can live with your plant being cycled over a couple of degrees or more, than an on/off controller will solve your problem. However, there's a trap. If the plant is slow to respond, then the cycling can be much larger than the hysteresis. The typical control system has a number of elements that will introduce small time delays (see figure 2).

The cumulative effect is that it might be many seconds or minutes before the controller sees the result of turning the heater on or off. Figure 3 compares the respond of a fast and slow plant with the same on-off controller. Usually if the plant is slow the cycling will be unacceptable and you must look at a more sophisticated controller.

Proportional Controllers

The proportional controller adjusts the heating or cooling in proportion to the temperature error it sees. A typical control characteristic is shown in figure 4, and figure 5 demonstrates most of the proper-

How Temperature Controllers Work

ties of the proportional controller. While operating inside the proportional band, the controller applies heat according to the temperature error.

Heat applied = (some constant) X (temperature error) = $K(T_0 - T)$ Watts
 Where K is the controller gain [units: Watts/°C]. Generally the heat lost from the plant is proportional to the temperature of the plant — *ie* the hotter the plant, the more heat is lost.

Heat lost = (constant) X (plant temperature - room temperature) =

$$(T - T_a)/R$$

Where T_a is the ambient temperature (room temperature) and R is the thermal resistance to ambient (units: °C/Watt). When the plant temperature is steady the heat applied equals the heat lost. If the loop gain of the system, RK , is very large, then the temperature error will be very small. Typical values for RK are 0.5 to 5 or more for an industrial plant, to greater than 200 for "well behaved" plant, *eg* a calibration bath. Notice too that the larger RK is, the less sensitive the plant is to external influences.

Suppose that the ambient temperature changes by 10°C; the plant temperature will change by:

$$\text{change in } T = 10/(1 + RK)$$

So high values of RK are desirable.

However, there's another trap here. In any system R and K are not constants. For example, the controller usually has filters to remove high frequency interference, noise, etc. Similarly, the plant takes time to respond to heater power changes—it won't see the power changing in the heater at 120 cycles per second (assuming a 60Hz mains). So both R and K fall to very low values at high frequency and usually become negative. In fact it is inevitable that if you keep increasing the frequency gain then eventually there will be one frequency where $RK = -1$. Then we are in trouble because the terms with RK in the denominator become very large and the plant/control system will burst into oscillation at the frequency where $RK = -1$. This frequency can be anything from a few cycles per minute to many minutes or hours depending on how slow the plant is. The result is that there is a practical limit to the low frequency loop gain RK . This means there will always be a temperature error.

This an obvious fact, really, because

to be putting heat into the plant at all, the controller must see that the plant is not at the set point temperature. This temperature error is known as offset. On most commercial controllers there is an adjustment usually called reset or manual reset, which adds or subtracts a couple of degrees to the set point and makes the controller look perfect. It also means that the operator doesn't have to add or subtract a few degrees from the set point every time he or she changes it. The other adjustment on proportional controllers is the controller gain. It is usually expressed

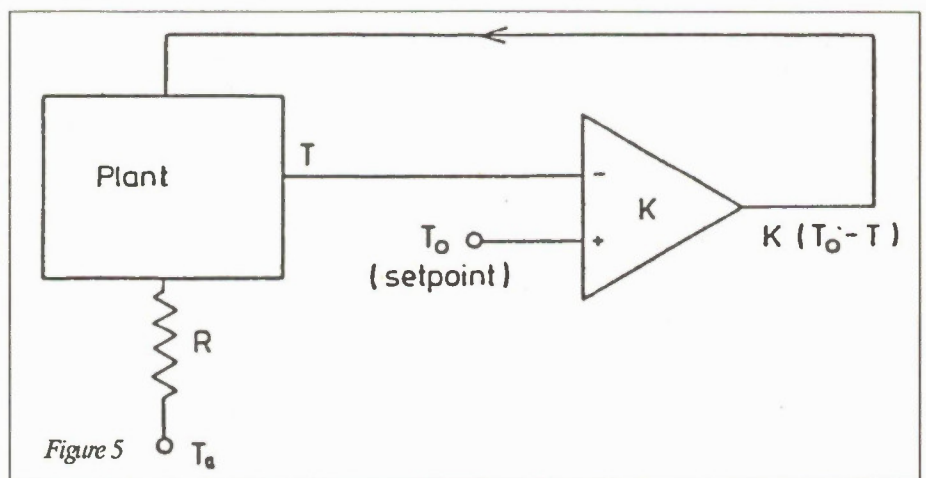
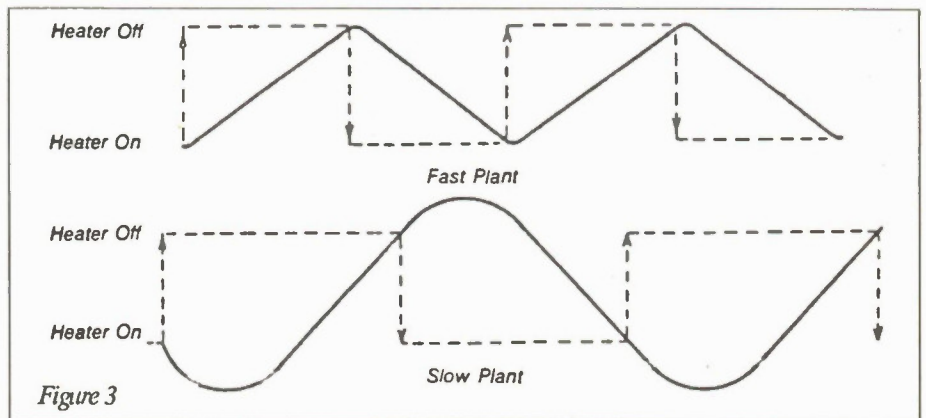
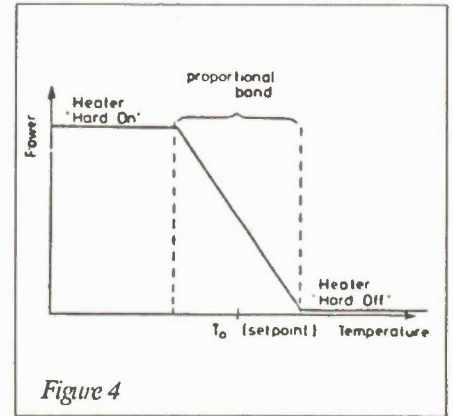
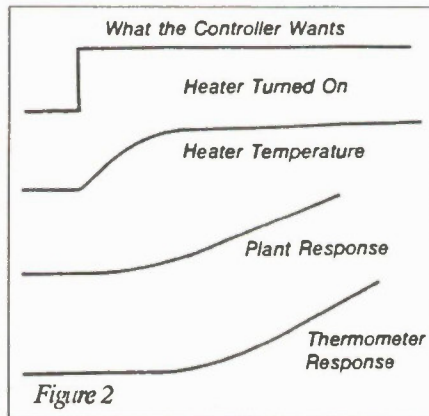
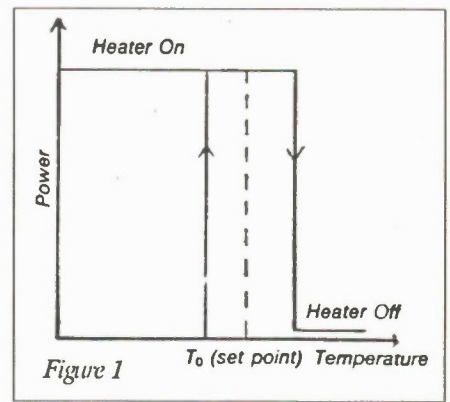

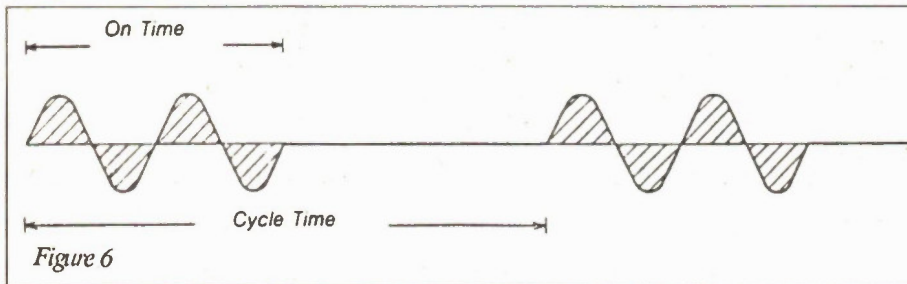

Figure 6

as a percentage of full scale. For a controller with a range of 0 to 1000°C a 5% proportional band is $0.05 \times 1000 = 50^\circ\text{C}$. A 1% proportional band is 10°C . The smaller the proportional band the higher the controller gain.

Having said all that, it should be pointed out that most proportional controllers actually control the power by switching the heater hard on and hard off for short periods, as in figure 6. By varying the duty cycle (the ratio of on-time to total cycle time), the amount of heat can be controlled proportionally. If the cycle time is fast enough, then the plant won't know the difference. Typically the total cycle time will vary between a second for laboratory controllers to minutes for industrial controllers. If your plant is particularly responsive (fast) and the cycle of your controller is long, the cycling will be apparent in the plant response. If the temperature variation proves to be unacceptable a controller with a short cycle time should be sought. Some controllers have an adjustable cycle time.

P.I.D. Controllers

If your plant is particularly slow and difficult to control, it is almost impossible to get the loop gain enough to ensure good immunity to ambient temperature variations. For example, the day and night temperature may differ by 15°C or more. If the loop gain is less than five then the plant temperature will vary at least 3°C each day, and this may be unacceptable. To alleviate this problem some controllers include an integral component (the I in P.I.D.) as well as the usual proportional component (the P in P.I.D.). The integrator constantly adds up the temperature off set (T-To) and applies a correctional signal. Only when the integrator has driven the plant to the set point will the integrator sum stop increasing or decreasing. In this way the integrator component will slowly but surely remove the offset. So long as the offset does not change too fast for the integrator, it will constantly adjust to long term (hours or longer) changes in the ambient temperature. The feature is often called automatic reset. The integrator component then will ensure

long term stability and solve the offset problem, but will not help solve the short term stability problem. Ultimately, the only solution is to increase the loop gain somehow. Derivative action (the D in P.I.D. makes this possible). Essentially the derivative component looks at the rate of change of the plant temperature. If it is moving too fast then it says "slow down". This action helps damp out oscillations that may occur when the loop is again very high and the system is marginally stable. It is then possible to operate at slightly higher loop gains.

In some industrial plants where the loop gain might otherwise be as low as 0.5 the derivative component is essential. The big disadvantages of P.I.D. controllers is that they are difficult to tune, particularly if the set point often changes and the plant must settle quickly. On a plant that is inherently slow, tuning could easily take weeks under the eye of an expert. Each of the P, I, and D gains must be adjusted and they all interact with each other. In very difficult plants more sophisticated controllers are required.

Self Tuning controllers

To overcome the P.I.D. tuning problem, a lot of theoretical effort on the part of control theorists has resulted in intelligent "black boxes" called self tuning regulators. They are often P.I.D. controllers with a microprocessor that constantly adjusts the gains to optimize the performance. Others are even more sophisticated. These controllers generally work by constantly twiddling with the gains (in a well defined manner) and assessing the results. Even while twiddling they perform better than any fixed gain P.I.D. controller.

There can be drawbacks with some designs, since when they first start learning to control a particular plant, the twiddling can be excessive and cause major plant disturbances. Nevertheless, they represent the highest performance available with off the shelf controllers. They can only be bettered by special custom designed controllers based on intensive studies of the plant to be controlled. Many of the controller manufacturers now offer such a service. ■

AMAZING SCIENTIFIC & ELECTRONIC PRODUCTS

PLANS — Build Yourself - All Parts Available in Stock

- IC7—BURNING CUTTING CO2 LASER \$20.00
- RUBA—PORTABLE LASER RAY PISTOL \$20.00
- TCC1—3 SEPARATE TESLA COIL PLANS TO 1.5 MEV \$25.00
- ICG1—ION RAY GUN \$10.00
- GRA1—GRAVITY GENERATOR \$10.00
- EML1—ELECTRO MAGNET COIL GUN/LAUNCHER \$8.00

KITS With All Necessary Plans

- MFT3K—FM VOICE TRANSMITTER 3 MI RANGE \$49.50
- VWP7K—TELEPHONE TRANSMITTER 3 MI RANGE \$39.50
- BTC3K—250,000 VOLT 10-14" SPARK TESLA COIL \$249.50
- LHC2K—SIMULATED MULTICOLOR LASER \$44.50
- BLS1K—100,000 WATT BLASTER DEFENCE DEVICE \$69.50
- ITM1K—100,000 VOLT 20' EFFECTIVE RANGE INTIMIDATOR \$69.50
- PSP4K—TIME VARIANT SHOCK WAVE PISTOL \$59.50
- STA1K—ALL NEW SPACE AGE ACTIVE PLASMA SABER \$50.00
- MVP1K—SEE IN DARK KIT \$199.50
- PTG1K—SPECTACULAR PLASMA TORNAO GENERATOR \$149.50

ASSEMBLED With All Necessary Instructions

- BTC10—50,000 VOLT—WORLD'S SMALLEST TESLA COIL \$54.50
- LGU40—1MW HeNe VISIBLE RED LASER GUN \$249.50
- TAT30—AUTO TELEPHONE RECORDING DEVICE \$24.50
- GVP10—SEE IN TOTAL DARKNESS IR VIEWER \$349.50
- LIST10—SNOOPER PHONE INFINITY TRANSMITTER \$169.50
- IPG70—INVISIBLE PAIN FIELD GENERATOR—MULTI-MODE \$74.50

• CATALOG CONTAINING DESCRIPTIONS OF ABOVE PLUS HUNDREDS MORE AVAILABLE FOR \$1.00 OR INCLUDED FREE WITH ALL ABOVE ORDERS.

PLEASE INCLUDE \$3.00 PH ON ALL KITS AND PRODUCTS. PLANS ARE POSTAGE PAID. SEND CHECK, MO, VISA, MC IN US FUNDS.

INFORMATION UNLIMITED

P.O. BOX 716, DEPT. ET AMHERST, NH 03031

Circle No. 3 on Reader Service Card

CLASSIFIEDS

Where Buyers Find Sellers

Electronic Design/Computer programming. Call Bob (416) 665-4288.

PC/AT 640KB 6-slot 101-KB 1.2MB FOD S/P Ports, clock, monitor Dox/Basic 1-Yr warranty — \$1450 + \$20 S&H, C.O.D., H.E.S., P.O. Box 2752, Station B, Kitchener, ON N2H 6N3.

ORIGINALTRI-MODE parts \$89.95, SB3 Parts \$69.95, Notch Filters \$39.95, Catalogues \$1.00, GENIE, Box 522, Montreal, PQ, H3S 2V3

CABLE TV DESCRAMBLING TECHNIQUES. 56 pages. \$13.95. Channel 3 notch filter \$39.95. Amazing see-in-the-dark infra-red night view kit \$295.00. SCA background music kit \$49.95. Catalogues \$1.00 Octe(J), P.O. Box 173, Montreal, PQ., H3X 3T4. (514) 739-9328.

For Advertising Information Call:
(416) 445-5600 Or Fax:
416-445-8149

Infrared Object Counter

Count objects with up to 255 pulses per count.

ROGER PARSELL

Most object counters around today implement a mechanical method of counting and those that don't use some very sophisticated and expensive methods of determining the presence of an object. These may take the form of magnetic induction or single ended optical detection, both of which have some major drawbacks. I required an object counter that could count objects of different size, shape, composition and orientation as they pass the sensor.

I decided that an optical method was best suited to the task. For this reason I used an infrared transmitter and receiver; this was superior to the mechanical method because there is no physical contact made between the object and the sensor. I also had the problem that the object might break the beam more than once during the pass, eg, a car has two sets of

wheels as seen from the side, giving two counts for one object, so a programmable divider was included to count once when the beam was broken a desired number of times. The number of objects that have passed the sensor is displayed on a seven segment display.

How It Works

As can be seen in the block diagram (Fig. 1) an oscillator generates pulses of infrared light at a predetermined frequency, in this case 5kHz. This light is then detected by the receiver and amplified. The amplified signal is then fed through a filter that only allows a signal of 5kHz to pass, followed by a pulse shaping circuit which outputs one pulse every time the beam is broken. This is sent to the programmable divider or directly to the counters, whichever is required.

The counters are decade counters and directly drive the displays from their

decoded outputs, thus eliminating the need for counters, decoders and drivers.

Circuit

The transmitter is based on the NE555 timer IC configured in the astable multivibrator mode (Fig. 2). The advantage of

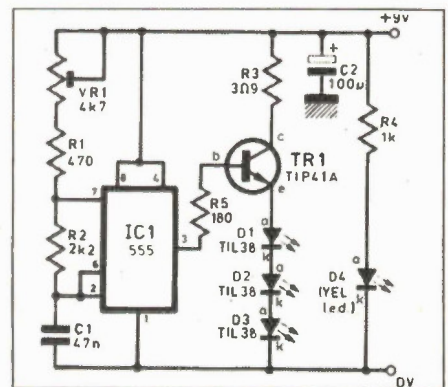

Fig. 2. Transmitter circuit diagram.

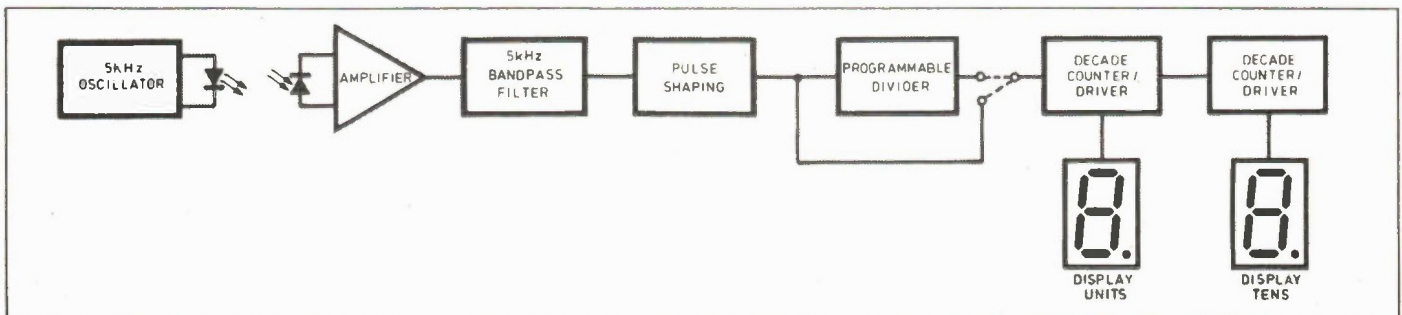

Fig. 1. Block diagram of the IR Object Counter.

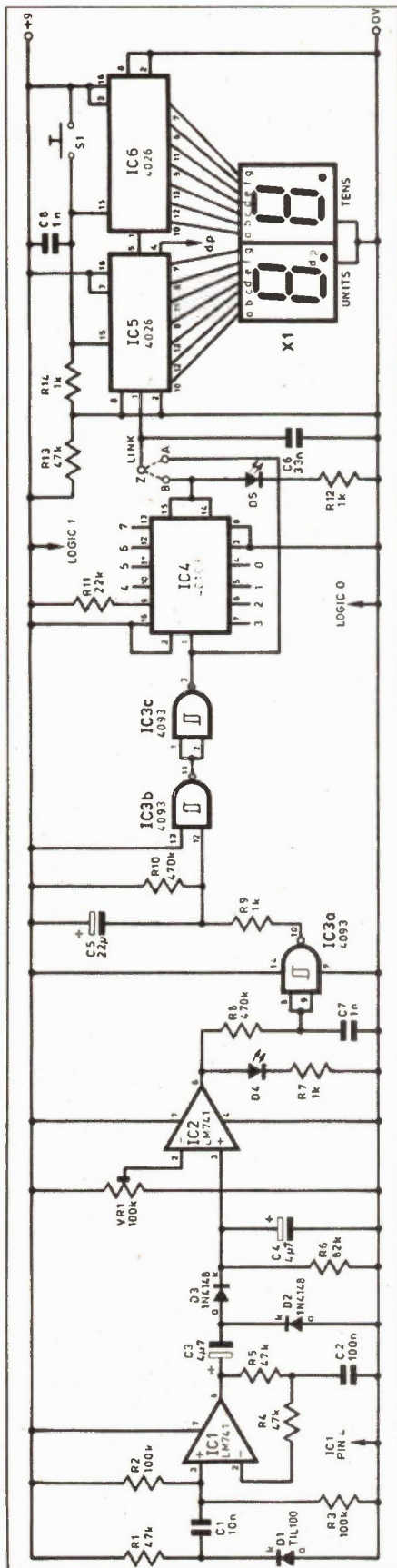

Fig. 3. Receiver and counter circuit.

using a pulsed beam in preference to a continuous beam is that the beam can be encoded in a way that the receiver can differentiate from any other light source. This allows the system to be used in optically noisy environments, such as those that are prone to lights being turned on and off or even the transition from day to night. These environmental changes can cause the receiver to trigger a false count.

There is also a power saving when using the encoded system because the output diodes are flashed on and off many times a second; the output is only on for half the time, so only half the power is used.

The timing components VR1, R1, R2 and C1 are selected to produce 5kHz at the output. VR1 is incorporated so that the transmitter can be fine tuned to the optimum for the environment. The output of the NE555 can only sink loads up to 200mA, so transistor TR1 is used to drive the output diodes as these take 100mA each.

Resistor R3 should not be replaced by a lower value than 3.9 ohms or this might damage the transistor TR1. R4 and D4 are only incorporated to indicate the connection of power to the transmitter as the output diodes do not emit any visible light.

Receiver And Filter

The device used to receive the infrared signal is the TIL100 photo diode (Fig. 3). This diode works best when light in the infrared spectrum falls upon it. When the light falls upon the sensor the current flowing through it increases. If this diode is connected in reverse bias across the supply through a pullup resistor, we can get a change in potential at the point where they meet; this is proportional to the light falling on the sensor. This potential is also oscillating at the same frequency as the transmitter, so we can AC couple the signal to the amplifier via C1.

The amplifier is designed so that only a signal of 5kHz can pass easily due to the feedback arrangement of R4, R5 and C2. At low frequencies, the gain of the amplifier is approximately 1:1, but at 5kHz the impedance of C2 decreases so that the gain of the amplifier increases to several thousand. The 5kHz frequency at the output of the amplifier is then sent through a voltage doubler circuit D2, D3, and smoothed by R6 and C4. It then reaches the pulse shaping stage.

Pulse Shaping

Pulse shaping is required to shape the smoothed signal into a pulse with fast attack and fast decay, eliminating the risk of

PARTS LIST

TRANSMITTER

Resistors

All 1/4W, 5%

R1	470
R2	2k2
R3	3R9
R4	1k
R5	180

Potentiometer

VR1	4k7 hor. trim
-----	-------	---------------

Capacitors

C1	47n
C2	100u 16V

Semiconductors

IC1	555 timer
TR1	TIP41A NPN
D1-3	TIL38 infrared diode
D4	LED

RECEIVER

Resistors

All 1/4W, 5%

R1,4,5,13	47k
R2,3	100k
R6	82k
R7,9,12,14	1k
R11	22k

Potentiometer

VR1	100k hor. trim
-----	-------	----------------

Capacitors

C1	10n
C2	100n
C3,4	4u7 16V
C5 22u	16V
C6	33n
C7,8	1n

Semiconductors

IC1,2	741 op amp
IC3	4093 quad NAND Schmitt
IC4	40103 divider
IC5,6	4026 counter driver
D1	TIL100 photo diode
D2,3	1N4148
D4,5	LED

X1 double 7-seg. common cathode display

Miscellaneous

Short length of 16-way ribbon cable, wire, solder, etc.

Infrared Object Counter

a false reading by unwanted noise spikes. Noise spikes can occur by the switching on and off of light switches, etc., in the close proximity of the receiver.

The first stage of the pulse shaping is to compare the input pulses with a known potential; this is done by a comparator circuit. A 741 operational amplifier (IC2) is used to compare the potential set at pin two by the potentiometer VR1 — this is known as the reference potential. The input signal is connected to pin three and is then compared with the reference potential. If the signal is greater than the reference, then the output goes high. If the signal potential does not reach the reference potential, then the output will remain low. By using a comparator all the noise spikes less than the reference potential are eliminated. The out-

put of the comparator then feeds R7 and D4. This diode emits light when the beam remains unbroken and stops emitting when the beam is broken.

The next stage is formed by IC3 which consists of four 2-input NAND gates, which can be used as Schmitt triggers, simplifying the task of pulse shaping. (As the Schmitt trigger is a dedicated pulse shaping device, it is an obvious choice.) The input pulse is fed into the first two gates for shaping and the third is incorporated as an inverter to invert the output of IC3b ready to be fed through the dividing circuit.

Pulse Dividing

As described previously, the pulse divider was incorporated to enable the use of the system in applications where the beam

might be broken more than once by the object. By calculating how many times the beam will be broken by the object, this number can then be programmed into the divider so the output will only pulse once for every predetermined number of times the beam is broken, or once every time the object passes.

The programmable divider is virtually self-contained as IC4. The input is fed to pin one of IC4 and divided by the value set by the program inputs, which are pins 4, 5, 6, 7, 10, 11, 12, and 13. As can be seen, there are 8 inputs and these must be programmed in binary, with a binary 1 equal to +ve and binary 0 equal to 0V; this combination of 1's and 0's is connected to the programming inputs of IC4 to give the number to be divided by.

Resistor R12 and D5 indicate the output pulses from IC4. IC4 can divide the input pulses from 2 to 256; if a 1:1 count is required then the link should be made to bypass the counter — otherwise connect a link from divider to counters. The link should never go from the output of the divider to the bypass as the Schmitt triggers cannot drive the LED and IC3 would be destroyed.

Counter Driving

Again in the counter driver section most of the circuits are self-contained in the chips and very few external connections are necessary. IC5 and IC6 are both decade counter drivers that count from 0 to 9 and reset to 0; also contained on the chips are seven segment decoders and drivers, allowing seven segment displays to be driven directly from the decoded outputs.

The few components that are associated with these ICs consist of capacitor C8 and switch S1. These are both connected to the reset pin 15. When this pin is connected to the +ve supply via S1 the counters will reset. The capacitor C8 holds pin 15 high at switch on for a short while in order to reset the counters to zero each time the unit is turned on.

Construction

The circuits are constructed on the PCBs as shown in Figs. 4, 5 and 6. It is advisable to use the PCB method of construction rather than Veroboard, as this would not be easy even for the experienced constructor. It would also be possible to severely damage or totally destroy one of the chips with an incorrect connection.

On the receiver driver board (Fig. 4) the wire links on the top of the board should be connected first using insulated

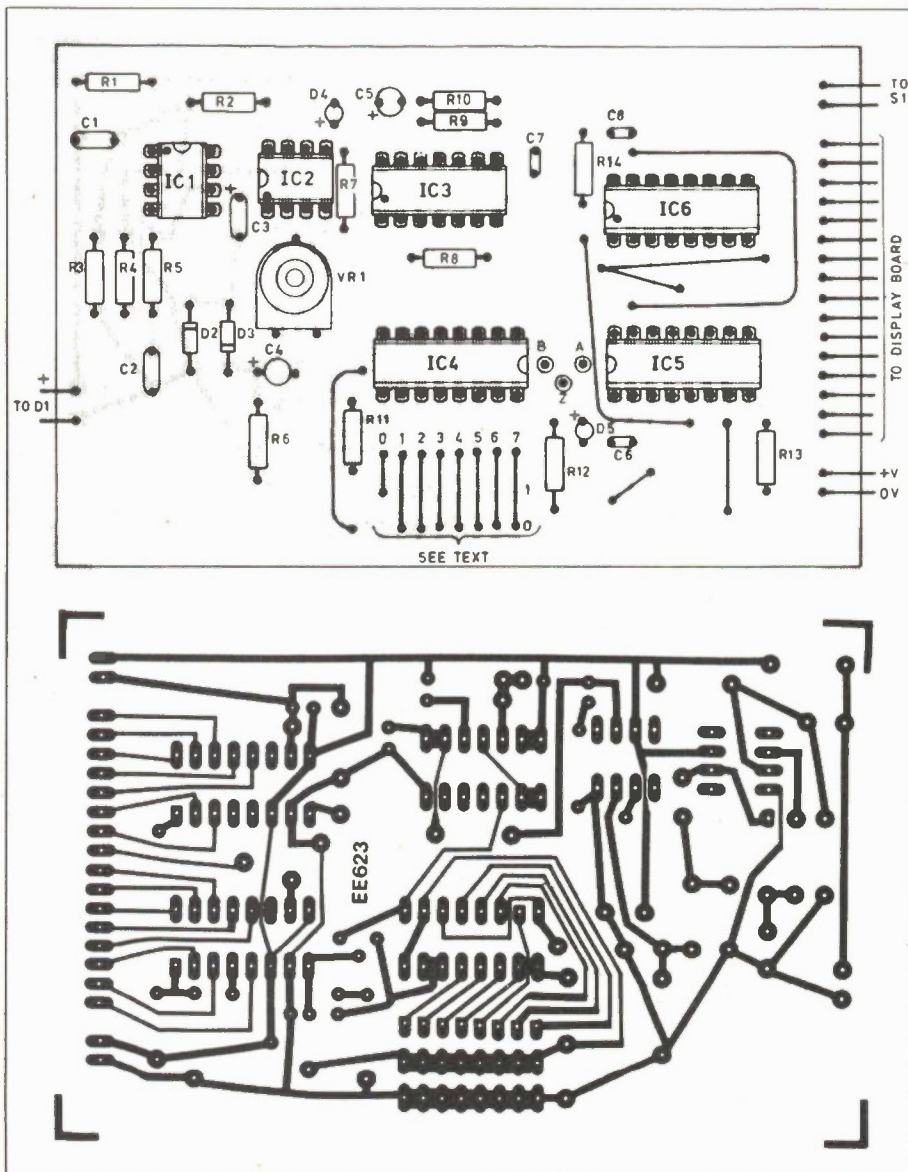

Fig. 4. The component overlay (top) and the PCB for the Object Counter.

connecting wire (these replace the double-sided PCB used in the prototype). Then all resistors should be connected. The resistors should then be followed by inserting the signal diodes D2 and D3, ensuring the correct orientation. Then connect the remaining capacitors and LEDs, also ensuring the correct orientation.

The ICs should be connected using IC sockets since it's very difficult to remove them once they have been soldered in place. Components IC3, IC4, IC5 and IC6 are all CMOS devices and should be handled with all static handling precautions. D1 could be connected to the PCB or connected remotely via two connecting wires, but pay particular attention to the orientation of this device. The long lead should be connected to the positive and the short lead connected to the 0V line.

The transmitter board (Fig. 6) is assembled in much the same way, with the resistors and capacitors connected in place first. This should then be followed by D1, D2, D3 and D4 connected in forward bias with the long lead to the positive. Finally IC1 and TR1 should be connected in. The display board should cause no problem in construction but make sure that the display is the correct way around.

Setting Up

Before testing the board the programmable divider should be set up using solder links. All eight programming presets or IC4 must be connected to either positive for logic 1 or the 0V rail for logic 0. Any count can be made between 1 and 255 and this is set in binary using solder links to the supply rails as shown in the connection diagram. Having worked out the number of times the object will break the beam, the number can be set up as an eight-bit binary code.

Each preset input of IC4 corresponds to a single bit of an eight-bit binary number as follows:

0	1	2	3	4	5	6	7
1	2	4	8	16	32	64	128

Thus any number can be programmed up to 255 by connecting the appropriate input to either positive input or ground. For example, if you require one count for every 122 times the beam was broken:

$$122 = 0 \times 128 + (1 \times 64) + (1 \times 32) + (1 \times 16) + (1 \times 8) + (1 \times 2) + (0 \times 1)$$

This is 01111010 in binary, set by connecting the programming inputs in the following way:

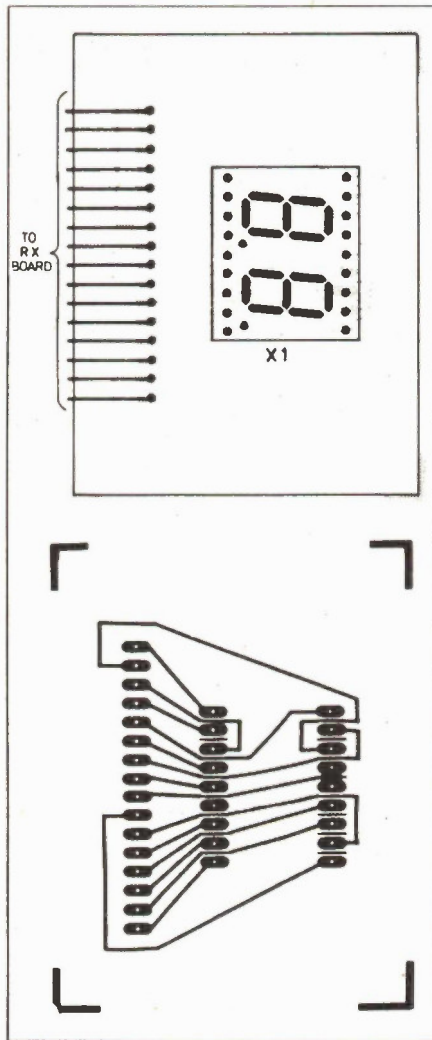

Fig. 5. The component overlay (top) and the PCB for the display.

- Preset 7 goes to 0V
- Preset 6 goes to +ve
- Preset 5 goes to +ve
- Preset 4 goes to +ve
- Preset 3 goes to +ve
- Preset 2 goes to 0V
- Preset 1 goes to +ve
- Preset 0 goes to 0V

A word of caution: the preset inputs 0-7 do not correspond to the IC pin numbers (see Fig. 3), so check before you start.

Testing

The transmitter may be powered by any voltage source of eight or nine volts. When powered up you will not be able to see anything being emitted, as infrared is invisible to the human eye. However, checking pin three of the NE555 with either a high impedance earphone or an oscilloscope should confirm the presence of high frequency oscillation.

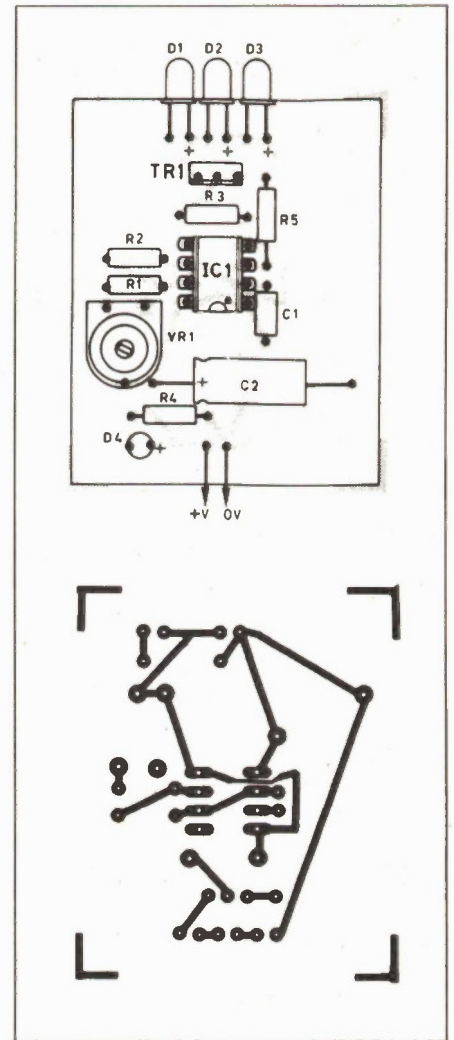

Fig. 6. The component overlay (top) and the PCB for the transmitter.

The receiver is best checked by powering up and then bringing the transmitter close to D1 of the receiver, at which point the LED D4 should light. If it doesn't, try rotating VR1, a result should be obtained when it is set to a central position. If the diode still stays unlit, check that photo diode D1 is connected the right way around, and also check that C3, D2, D3, are the right way around.

In use, the receiving diode should be covered by a light guide, thus making it more directional and less sensitive to stray pickup. A small piece of rubber sleeving is ideal for this.

An operational range of up to 3.5m is possible. The only adjustment required is to alter VR1 on the transmitter and VR1 on the receiver for optimum operation. It is also necessary to set the programming of the divider and the link to count pulses or count the output of the divider, as described earlier. ■

A Practical Approach to Active Filters

Noodling out an active filter with available hardware.

GEORGE HYLTON

Active filters are all the rage now days. For the experimenter, however, there's a bit of a problem. The texts about them seem to come in two varieties, neither of which is very helpful.

One is full of complex maths and short on component values. The other gives component values, but for filters which never seem to be quite what you need.

Practical Case

It so happened that I needed a decent low-pass audio filter recently. I'd been working on a simple short-wave receiver. The RF front end part of the design was finished and I now needed an audio section.

Short-wave broadcast stations are packed like sardines, often only 5kHz apart. Reception is often noisy. Simple receivers of the direct conversion or synchrodyne kinds (mine is both) convert adjacent-channel signals into noise, mostly high pitched.

A good low-pass audio filter is needed to reduce this "side band splash". Ideally the filter should have a variable cutoff frequency so that it can be adjusted to suit the reception conditions of the moment. None of my books and magazines had a ready-made answer. I was stuck.

An Unusual Component

Browsing through a component store, I found an unusual component: a quad (four-gang) 50 kilohm potentiometer. Dual (two-gang) pots for stereo are common enough. Quad pots, presumably for quadraphonics, are rare.

I figured that with a quad pot I could make a four-section variable cut-off low pass -RC filter (Fig. 1). With -R variable I should get at least a ten-to-one range of cut-off frequency, more than enough for speech and music and maybe of some use for CW.

So I bought some "quad pots". They turned out to be neat little Japanese jobs. Ohmmeter tests showed that they were log law, and actually about 45k max.

Would they do the job? I assembled the filter on a plug-in breadboard, using 4n7 capacitors for C. Why 4n7? Well, I happened to have plenty of that value, but I did make a quick check with a nomogram which showed me that 4n7 has a reactance of 45k at about 760Hz.

The -3dB cutoff frequency of a single RC section falls at the point where the reactance of C equals R. With four sections it would be lower in frequency, but at least I was in the right area. With the pot set near minimum resistance the cutoff would be at least ten times higher, at 7.6kHz, which was about as much as I needed.

The next job was to hitch my audio generator to the filter input and set R to give a practical cutoff frequency. I chose 3kHz, which is the sort of cutoff you need when interference is bad.

The response turned out to be as shown in curve A. Not bad, but a bit droopy. Could it be made flatter in the pass-band and steeper beyond it?

Phase Shift Oscillator

I've always found oscillator circuits interesting, and I knew of one which can use exactly this sort of RC lowpass network for turning. The circuit block diagram is shown in Fig. 2. Note that the amplifier is inverting, as indicated by the minus sign in front of the gain symbol, A.

At frequencies well below cutoff the feedback through the RC network is negative. At DC, all the amplifier output is fed back negatively to the input and the gain is effectively one.

As the frequency is raised, the effect of

C becomes significant. From Fig. 1, curve A, it's clear that C produces attenuation. But it also produces phase shift. This means that the feedback isn't quite so negative, so the gain isn't reduced as much as expected.

At one frequency, the phase shift is -180°. That is, the phase is inverted by the network. So there are now two phase inversions (one in the amplifier, one in the network), which means that the overall feedback becomes positive. If the gain (-A) is high enough, the circuit oscillates.

Using a double-beam oscilloscope to compare input and output signals it was easy to adjust the frequency of my audio generator to get a shift of 180° from my RC lowpass. I found that the output signal was then about one sixteenth of the input.

This meant that in Fig. 2 if the amplifier gains exceeds 16, the circuit will oscillate. For gains a bit short of 16 it won't, but,

a peak will appear in the response. Clearly, the peak will get sharper as the gain is raised towards the oscillation point and less sharp as it's reduced.

There seemed to be a fair chance of finding a gain at which the response is reasonably level, up to a frequency somewhere near the 180° one. Beyond it the gain must drop sharply, for two reasons. First, the attenuation of the network increases faster than the amplifier can compensate. Secondly, beyond the 180° frequency the feedback becomes less positive.

At very high frequencies each section must have a phase shift of nearly 90°, giving a total network phase shift of 360°. The feedback is then negative.

Bench Test

Theorizing is all very well, but does it work? Next step: try it and see.

The "circuit" in Fig. 2 is just an aid to

understanding. It has no provision for applying input signals.

After a good deal of doodling I arrived at the practical test circuit of Fig. 3. Here, transistor TR1 is just an emitter-follower input buffer. The voltage gain comes from transistor TR2 and is about 8. TR3 is an output buffer.

Adding the input signal to the feedback is arranged for by resistors R1 and R2. At very low frequencies the gain is mainly defined by these resistances, which form a negative feedback network.

If transistor TR2 had infinite gain then the effective very-low frequency gain would be $R2/R1 = 1.5$. But since the actual gain of TR2 is low the real IF gain is less than 1.5. In fact, resistor R2 was selected by trial and error to set the gain as close to one as possible using E12 resistances. (It's a little over one, in fact.)

At higher frequencies, where the RC phase shift makes the feedback more positive the gain of TR2 has much more influence. To adjust it I used various values for resistor R4 until I found one (82k) that gave the flattest response, plotted in Fig. 1 as curve B. to make this comparable with A, the network resistances R were adjusted to give the same -3dB point, 3kHz. The improvement is obvious.

Having produced a useful-looking 3kHz lowpass filter, the next step was to vary R and confirm that the response keeps the same general shape but with different cutoff frequencies. The lowest obtainable cutoff (-3dB) proved to be 560Hz. The highest I checked was 10kHz: beyond that was of no interest to me.

In all cases the response was like curve B: fairly level in the pass band and fairly steep in the stop band. Very satisfactory, considering that I'd done no maths and,

used no unusual or close tolerance component values (the 4n7 capacitors were 10 per cent).

Also, the filter has equal values of C and equal values of R. My research through the literature turned up designs where if the Rs were equal the Cs were not, and vice versa.

I was beginning to get quite smug about it when I ran a test which showed that one of my tacit assumptions was quite wrong: the response at the 180° frequency was well down. I'd assumed that the 180° frequency would lie in the passband, not outside it.

Fixed Filters

If you want to use fixed values of R and C and don't want to resort to cut-and-try you need more information. How much? The essentials seem to be C, R and -3dB frequency for one filter. From these it should be possible to estimate the values for other filters.

I set up my circuit using fixed close tolerance components: $R = 10k$, $C = 10n$. These gave a -3dB response at exactly 1kHz.

Very convenient. If either C or R is increased the cutoff frequency is decreased. The response, then, is inversely proportional to C times R.

My 1kHz filter has $CR = 100$, if C is in nF and R in kilohms. This suggests a simple design formula: $CR = 100/f_c$, where f_c is the -3dB frequency in kHz, C is in nF and R is in kilohms.

Thus for a 4kHz filter CR would be 25. If you happen to have plenty of one nanofarad capacitors then R needs to be 25 kilohms. If you use 22k the bandwidth will be a bit more than 4kHz; with 27k it will be a bit less.

This is all you need to design your own "active" lowpass filter. Well, not quite. You have to make sure that the filter impedance is compatible with the circuit in which you connect it.

The network should be driven from a source whose impedance is much less than R. It should be terminated by an impedance much greater than R.

My circuit should work for most practical values, provided that it is driven from a source impedance small compared with resistor R1 (if not, reduce R1 to keep it, plus the actual source impedance equal to 100k approx.) Also, the load connected to the output (capacitor C2 and ground) should be at least 10k.

Any high gain audio transistors will do. ■

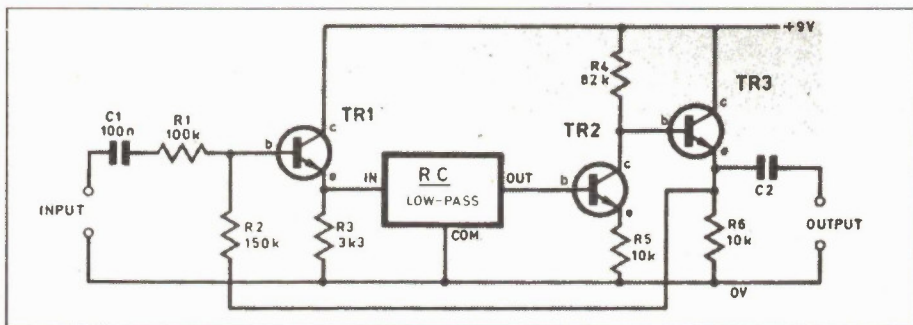

Fig.3. Circuit diagram for a practical lowpass active filter embodying a four-section RC network with equal C and equal R.

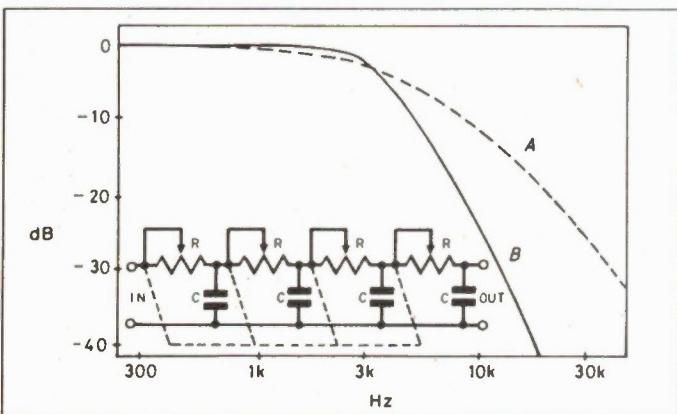

Fig. 1. Four-section RC low-pass network. Curve A shows the response of the network alone for values of R and C which produce a -3dB point at 3kHz. Curve B is for an active filter with a similar net-

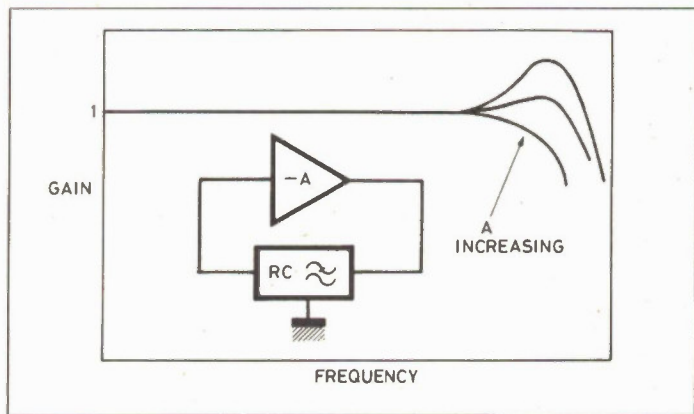

Fig. 2. When an RC lowpass with three or more section is connected as a feedback path in an inverting amplifier the frequency response becomes very dependent on the gain when the phase shift of the network is close to 180°.

BABANI BOOKS

248: MUSICAL APPLICATIONS OF THE ATARI STs \$15.00

A wide selection of topics is covered, including the internal sound chip, MIDI, applications programs such as sequencing and score writing etc. Simple but useful add-on projects and MIDI programming.

BP240: REMOTE CONTROL HANDBOOK \$12.00

Includes remote control systems, transmission links, digital electronics, methods of control, coders, decoders, etc.

BP111: AUDIO \$14.00

This one is ideal for readers who want to really get into sound. A wide range of material is covered from analysis of the sound wave, mechanism of hearing, acoustics, microphones and loudspeakers, amplifiers, and magnetic disc recording.

BP239: GETTING THE MOST FROM YOUR MULTIMETER \$9.00

This book is aimed at beginners and those of limited experience of electronics. Using the simple component and circuit testing techniques in this book the reader should be able to confidently tackle servicing of most electronic projects.

BP53: PRACTICAL ELECTRONIC CALCULATIONS AND FORMULAE \$11.75

A book that bridges the gap between complicated technical theory and the "cut and try" method. A good reference book.

BP174: MORE ADVANCED ELECTRONIC MUSIC PROJECTS \$12.00

Complementing Book PB74, "Electronic Music Projects", BP174 provides more advanced projects, such as a flanger, a phaser, mini-chorus and ring modulators, percussion synths, etc. Each project has an Introduction circuit diagram and constructional notes.

BP113: 30 SOLDERLESS BREADBOARD PROJECTS - BOOK 2 \$9.00

R.A. Penfold
A companion to BP107. Describes a variety of projects that can be built on plug-in breadboards using CMOS logic IC's. Each project contains a schematics, parts list and operational notes.

BP92: ELECTRONICS SIMPLIFIED - CRYSTAL SET CONSTRUCTION \$5.25

This is a book written especially for those who wish to participate in the intricacies of electronics.

BP192: MORE ADVANCED POWER SUPPLY PROJECTS \$8.00

Robert Penfold.
A companion to BP76, this book covers switched mode supplies, precision regulators, tracking regulators, computer-controlled supplies, etc.

BP222: SOLID STATE SHORT WAVE RECEIVER FOR BEGINNERS \$7.80

R.A. Penfold
In this book, R.A. Penfold has designed and developed several modern solid state short wave receiver circuits that will give a fairly high level of performance, despite the fact that they use only relatively few and inexpensive components.

BP197: INTRODUCTION TO THE AMSTRAD PCs \$20.00

The Amstrad PC is an MS-DOS computer for general and business use. This book explains all you need to know to start computing.

BP150: AN INTRO TO PROGRAMMING THE SINCLAIR QL \$7.80

Helps the reader make the best use of the Sinclair QL's almost unlimited range of features. Complements the manufacturer's handbook.

BP48: ELECTRONIC PROJECTS FOR BEGINNERS \$7.80

F.G. Rayer, T. Eng. (CEI), Assoc. IERE
Another book written by the very experienced author - Mr. F.G. Rayer - an in it the newcomer to electronics will find a wide range of easily made projects. Also, there are a considerable number of actual components and wiring layouts, to aid the beginner.

BP135: SECRETS OF THE COMMODORE 64 \$5.85

This book is intended as a beginner's guide to the Commodore 64.

BP155: INTERNATIONAL RADIO STATIONS GUIDE \$9.00

An invaluable aid in helping all those who have a radio receiver to obtain the maximum entertainment value and enjoyment from their sets.

BP130: MICRO INTERFACING CIRCUITS — BOOK 1 \$9.00

Aimed at those who have some previous knowledge of electronics, but not necessarily an extensive one, the basis of the book is to help the individual understand the principles of interfacing circuits to microprocessor equipment.

BP131: MICRO INTERFACING CIRCUITS — BOOK 2 \$9.00

Intended to carry on from Book 1, this book deals with practical applications beyond the parallel and serial interface. "Real world" interfacing such as sound and speech generators, temperature, optical sensors, and motor controls are discussed using practical circuit descriptions.

BP51: ELECTRONIC MUSIC AND CREATIVE TAPE RECORDING \$5.85

This book sets out to show how Electronic Music can be made at home with the simplest and most inexpensive equipment.

BP74: ELECTRONIC MUSIC PROJECTS \$10.00

R.A. Penfold
Although one of the more recent branches of amateur electronics, electronic music has now become extremely popular and there are many projects which fall into this category. The purpose of this book is to provide the constructor with a number of practical circuits for the less complex items of electronic music equipment, including such things as a Flux Box, Waa-Waa Pedal, Sustain Unit, Reverberation and Phaser Units, Tremolo Generator, etc.

BP110: HOW TO GET YOUR ELECTRONIC PROJECTS WORKING \$7.80

R.A. Penfold
We have all built circuits from magazines and books only to find that they did not work correctly, or at all, when first switched on. The aim of this book is to help the reader overcome these problems by indicating how and where to start looking for many of the common faults that can occur when building up projects.

BP86: AN INTRODUCTION TO BASIC PROGRAMMING TECHNIQUES \$5.85

This book is based on the author's own experience in learning BASIC and also in helping others, mostly beginners to programming, to understand the language.

BP234: TRANSISTOR SELECTOR GUIDE \$15.00

Listings of British, European and eastern transistor characteristics make it easy to find replacements by part number or by specifications. Devices are also grouped by voltage, current, power, etc., includes surface-mount conversions.

BP233: ELECTRONIC HOBBYIST HANDBOOK \$15.00

A single source of easily located information: colour codes, pinouts, basic circuits, symbols, etc.

BP101: HOW TO IDENTIFY UNMARKED IC's \$19.95

An unusual and fascinating chart that is highly recommended to all those interested in electronics and which will hopefully pay for itself many times over, by enabling the reader to use IC's that might otherwise have been scrapped.

BP121: HOW TO DESIGN AND MAKE YOUR OWN PCBs \$5.85

The purpose of this book is to familiarize the reader with both simple and more sophisticated methods of producing printed circuit boards. The book emphasizes the practical aspects of printed circuit board designs and construction.

BP125: 25 SIMPLE AMATEUR BAND AERIALS \$5.85

This book describes how to build 25 amateur band aerials. The designs start with the simple dipole and proceed to beam, triangle and even a mini-rhombic.

BP180: ELECTRONIC CIRCUITS FOR THE COMPUTER CONTROL OF MODEL RAILWAYS \$9.00

Shows how home computers can easily be applied to the control of model railroads and other quite sophisticated control. A variety of projects are discussed as well as circuits for train position sensing, signal and electric points control, etc.

BP78: PRACTICAL COMPUTER EXPERIMENTS \$5.25

The aim of this book is to enable the reader to simply and inexpensively construct and examine the operation of a number of basic computer circuit elements and it is hoped gain a fuller understanding of how the mysterious computer "chip" works.

BP185: ELECTRONIC SYNTHESIZER CONSTRUCTION \$9.00

With this book a relative beginner should be able to build, with a minimum of difficulty and at a reasonably low cost, a worthwhile monophonic synthesizer and also learn a great deal about electronic music synthesis in the process.

BP115: THE PRE-COMPUTER BOOK \$5.85

Aimed at the absolute beginner with no knowledge of computing, this entirely non-technical discussion of computer bits and pieces and programming is written mainly for those who do not possess a microcomputer but either intend to one day own one or simply wish to know something about them.

BP72: A MICROPROCESSOR PRIMER \$5.25

In an attempt to give painless approach to computing, this inexpensive book will start by designing a simple computer and then the short-comings of this simple machine will be discussed and the reader is shown how these can be overcome. Includes a glossary of microprocessor terms.

BP42: 50 SIMPLE L.E.D. CIRCUITS \$5.85

Contains 50 interesting and useful circuits and applications, covering many different branches of electronics, using one of the most inexpensive and freely available components.

BP85: INTERNATIONAL TRANSISTOR EQUIVALENTS GUIDE \$9.00

This book is designed to help the user find possible substitutes for a popular user-oriented selection of modern transistors and includes devices produced by over 100 manufacturers.

BP140: DIGITAL IC EQUIVALENTS AND PIN CONNECTIONS \$15.00
Shows equivalents and pin connections of a popular user-oriented selection of Digital Integrated Circuits. Includes European, American and Japanese devices.

BP100: AN INTRODUCTION TO VIDEO \$5.85
This book is for the person who has just, or is about to buy or rent video equipment but isn't sure what it's all about.

BP136: SIMPLE INDOOR AND WINDOW AERIALS \$10.00
Detailed instructions on plotting the indoor aerial.

BP156: AN INTRODUCTION TO QL MACHINE CODE \$10.00
The powerful Sinclair QL microcomputer has some outstanding capabilities in terms of its internal structure. With a 32-bit architecture, the QL has a large address range, advanced instructions which include multiplication and division. These features give the budding machine code programmer a good start at advanced programming methods. This book assumes no previous knowledge of either the 68008 or machine code programming.

BP93: ELECTRONIC TIMER PROJECTS \$7.80
Windscreen wiper delay, darkroom timer and metronome projects are included. Some of the more complex circuits are made up from simpler sub-circuits which are dealt with individually.

BP141: LINEAR IC EQUIVALENTS AND PIN CONNECTIONS \$23.80
Adrian Michaels
Find equivalents and cross-references for both popular and unusual integrated circuits. Shows details of functions, manufacturer, country of origin, pinouts, etc... includes National, Motorola, Fairchild, Harris, Intersil, Philips, ADC, AMD, SGS, Teledyne, and many other European, American and Japanese brands.

BP7: RADIO AND ELECTRONICS COLOUR CODE AND DATA CHART \$3.00
Opens out to Wall Chart approximately 584 X 457mm. Includes many Radio & Electronics Colour Codes in use in UK, USA, Europe and Japan. Covers Resistors, Capacitors, Transformers, Field Coils, Fuses, Battery Leads, etc.

BP144: FURTHER PRACTICAL ELECTRONICS CALCULATIONS AND FORMULAE \$15.00
This book covers many aspects of electronics where a knowledge and familiarity of the appropriate formulae is essential for a fuller understanding of the subject. An essential addition to the library of all those interested in electronics be they amateur, professional or student.

BP225: A PRACTICAL INTRODUCTION TO DIGITAL ICs \$7.00
This book deals mainly with TTL type chips such as the 7400 series. Simple projects and a complete practical construction of a Logic Test Circuit Set are included as well as details for a more complicated Digital Counter Timer project.

BP47: MOBILE DISCOTHEQUE HANDBOOK \$7.80
Divided into six parts, this book covers such areas of mobile "disco" as: Basic Electricity, Audio, Ancillary Equipment, Cables and Plugs, Loudspeakers, and Lighting. All the information has been subdivided for quick and easy reference.

BP147: AN INTRODUCTION TO 6502 MACHINE CODE \$10.00
The popular 6502 microprocessor is used in many home computers; this is a guide to beginning assembly language.

BP59: SECOND BOOK OF CMOS IC PROJECTS \$7.80
This book carries on from its predecessor and provides a further selection of useful circuits, mainly of a simple nature. The book is well within the capabilities of the beginner and more advanced constructor.

BP88: HOW TO USE OP-AMPS \$11.80
E.A. Parr
A designer's guide covering several op-amps, serving as a source book of circuits and a reference book for design calculations. The approach has been made a non-mathematical as possible.

ELEMENTS OF ELECTRONICS - AN ON-GOING SERIES \$11.80 EACH
F.A. Wilson, C.G.I.A., C.Eng.
OR ALL 5 BOOKS FOR \$44.00

Although written especially for readers with no more than ordinary arithmetical skills, the use of mathematics is not avoided, and all the mathematics required is taught as the reader progresses.

Each book is a complete treatise of a particular branch of the subject and therefore, can be used on its own with one proviso, that the later books do not duplicate material from their predecessors, thus a working knowledge of the subjects covered by the earlier books is assumed.

BP62: BOOK 1. This book contains all the fundamental theory necessary to lead to a full understanding of the simple electronic circuit and its main components.

BP63: BOOK 2. This book continues with alternating current theory without which there can be no comprehension of speech, music, radio, television or even the electricity utilities.

BP64: BOOK 3. Follows on semiconductor technology, leading up to transistors and integrated circuits.

BP77: BOOK 4. A complete description of the internal workings of microprocessor.

BP89: BOOK 5. A book covering the whole communication scene.

BP194: MODERN OPTO DEVICE PROJECTS \$9.00
This book provides a selection of optical devices including such things as fibre optics, ultra-bright LEDs and passive IR detectors.

BP37: 50 PROJECTS USING RELAYS, SCR's & TRIACS \$7.80
F.G. Rayer, T. Eng., (CEI), Assoc. IERE.
Relays, bi-directional triodes (TRIACs), and silicon controlled rectifiers (SCRs), have a wide range of applications in electronics today. This book gives tried and practical working circuits which should present the minimum of difficulty for the enthusiast to construct. In most of the circuits there is a wide latitude in component values and types, allowing easy modification and ready adaptation of them to individual needs.

BP95: MODEL RAILWAY PROJECTS \$7.80
Electronic projects for model railways are fairly recent and have made possible an amazing degree of realism. The projects covered included controllers, signals and sound effects: stripboard layouts are provided for each project.

BP84: DIGITAL IC PROJECTS \$7.80
F.G. Rayer, T. Eng. (CEI), Assoc. IERE.
This book contains both simple and more advanced projects and it is hoped that these will be found of help to the reader developing a knowledge of the workings of digital circuits. To help the newcomer to the hobby the author has included a number of board layouts and wiring diagrams. Also the more ambitious projects can be built and tested section by section and this should help avoid or correct faults that could otherwise be troublesome.

BP44: IC 555 PROJECTS \$10.00
E.A. Parr, B.Sc., C. Eng., M.I.E.E.
Every so often a device appears that is so useful that one wonders how life went on before it. The 555 timer is such a device included in this book are Basic and General Circuits, Motor Car and Model Railway Circuits, Alarms and Noise Makers as well as a section on the 556, 558 and 559 timers.

BP94: ELECTRONIC PROJECTS FOR CARS AND BOATS \$7.80
R.A. Penfold
Projects, fifteen in all, which use a 12V supply are the basis of this book. Included are projects on Windscreen Wiper Control, Courtesy Light Delay, Battery Monitor, Cassette Power Supply, Lights Timer, Vehicle Immobiliser, Gas and Smoke Alarm, and more.

BP49: POPULAR ELECTRONIC PROJECTS \$10.00
R.A. Penfold
Includes a collection of the most popular types of circuits and projects which, we feel sure, will provide a number of designs to interest most electronics constructors. The projects selected cover a very wide range and are divided into four basic types. Radio Projects, Audio Projects, Household Projects and Test Equipment.

BP99: MINI-MATRIX BOARD PROJECTS \$7.60
R.A. Penfold
Twenty useful projects which can all be built on a 24 X 10 hole matrix board with copper strips. Includes Door-buzzer, Low-voltage Alarm, AM Radio, signal Generator, Projector Timer, Guitar Head-phone Amp. and more.

BP103: MULTI-CIRCUIT BOARD PROJECTS \$7.80
R.A. Penfold
This book allows the reader to build 21 fairly simple electronic projects, all of which may be constructed on the same printed circuit board. Wherever possible, the same components have been used in each design so that with a relatively small number of components and hence low cost, it is possible to make any one of the projects or by re-using the components and P.C.B. all of the projects.

BP98: POPULAR ELECTRONIC PROJECTS \$7.80
R.A. Penfold
This book contains 21 simple electronic projects, all of which may be constructed on the same printed circuit board. Wherever possible, the same components have been used in each design so that with a relatively small number of components and hence low cost, it is possible to make any one of the projects or by re-using the components and P.C.B. all of the projects.

BP195: AN INTRODUCTION TO SATELLITE TELEVISION \$15.00
For the absolute beginner or anyone thinking about purchasing a satellite TV system, the story is told as simply as such a complex one can be.

BP106: MODERN OP-AMP PROJECTS \$7.80
R.A. Penfold
features a wide range of constructional projects which make use of op-amps including low-noise, low distortion, ultra-high input impedance, high slew-rate and high output current types.

BP107: 30 SOLDERLESS BREADBOARD PROJECTS - BOOK 1 \$9.00
R.A. Penfold
A "Solderless Breadboard" is simply a special board on which electronic circuits can be built and tested. The components used are just plugged in and unplugged as desired. The 30 projects featured in this book have been specially designed to be built on a "Verobloc" breadboard. Wherever possible the components used are common to several projects, hence with only a modest number of reasonably inexpensive components it is possible to build, in turn, every project shown.

BP127: HOW TO DESIGN ELECTRONIC PROJECTS \$9.00
Although information on stand circuits blocks is available, there is less information on combining these circuit parts together. This title does just that. Practical examples are used and each is analysed to show what each does and how to apply this to other designs.

BP122: AUDIO AMPLIFIER CONSTRUCTION \$6.75
A wide circuits is given, from low noise microphone and tape head preamps to a 100W MOSFET type. There is also the circuit for 12V bridge amp giving 18W. Circuit board or stripboard layout are included. Most of the circuits are well within the capabilities of even those with limited experience.

BP179: ELECTRONIC CIRCUITS FOR THE COMPUTER CONTROL OF ROBOTS \$12.00
The main stumbling block for most would-be robot builders is the electronics to interface the computer to the motors, and the sensors which provide feedback from the robot to the computer. The purpose of this book is to explain and provide some relatively simple electronic circuits which bridge the gap.

BP108: INTERNATIONALDIODE EQUIVALENTS GUIDE \$7.00
Cross-references European, American and Japanese diode part numbers. Besides rectifier diodes, it includes Zeners, LEDs, Diacs, Triacs, SCRs, OCIs, photodiodes, and display diodes.

BP118: PRACTICAL ELECTRONIC BUILDING BLOCKS - BOOK 2 \$7.60
R.A. Penfold
This sequel to BP117 is written to help the reader create and experiment with his own circuits by combining standard type circuit building blocks. Circuits concerned with generating signals were covered in Book 1, this one deals with processing signals. Amplifiers and filters account for most of the book but comparators, Schmitt triggers and other circuits are covered.

BABANI BOOKS EXCLUSIVELY AVAILABLE IN CANADA FROM MOORSHEAD PUBLICATIONS. ORDER YOUR SELECTIONS BY TELEPHONE: (416) 445-5600 OR FAX: 416-445-8149 OR WRITE TO US AT 1300 DON MILLS ROAD, NORTH YORK, ONTARIO M3B 3M8

THIRD ANNUAL

MOORSHEAD PUBLICATIONS

Subscribe Now

over \$10,000 in the latest computer products and save up to 58% off

YOUR CHANCE TO WIN THE LATEST IN COMPUTER TECHNOLOGY FROM TOSHIBA. AND ALL YOU HAVE TO DO IS ENTER!

Celebrate MOORSHEAD PUBLICATIONS Anniversary as Canada's No. 1 publisher of computer and electronics magazine by entering our THIRD ANNUAL SWEEPSTAKES! You could become the lucky winner of the Toshiba products shown here worth over \$10,000... no purchase necessary... ALL YOU HAVE TO DO IS ENTER!

HOW THE SWEEPSTAKES WORK

There are two ways of entering: take out a new subscription, or renew one, to any of the participating magazine, before April 15th, 1989 and your name will be entered for the draw if you use an official entry form OR if you write (boldly and clearly) the word "SWEEPSTAKES" on other cards or forms. If you wish to enter without subscribing you may use the Official Entry Form on this page. Only one entry per envelope is acceptable. On April 30th, 1989, a random draw will be made from qualifying entrants. The first entrant drawn to answer a time limited skill testing question correctly will be declared the winner.*



THESE GREAT PRODUCTS FROM TOSHIBA COULD BE YOURS!

If you're the lucky winner of our THIRD ANNUAL SWEEPSTAKES, we'll arrange for you to receive at your home or office the products shown; a total value of over \$10,000! Simply by subscribing to (these publications) you have the chance to win the very latest in computer technology with the quality and reliability you've come to expect from Toshiba. You'll be able to conduct professional business transactions and computerize your business or home as never before!

TOSHIBA
WE MEAN BUSINESS
INFORMATION SYSTEMS DIVISION

TIONS SWEEPSTAKES

ow and Win!

puter technology from Toshiba on your subscription!

GAS PLASMA LEGEND FROM TOSHIBA

The new T3100e offers true AT performance in a package small enough to take anywhere. Based on the extremely successful and award winning T3100/20 portable PC, this outstanding updated machine takes advantage of the latest advances in portable computer technology and packs more speed, memory and power than ever before into an even smaller and lighter package. The T3100e features an 80286 microprocessor running at 12MHz, a fast 20Mb internal hard disk drive plus a 1.44Mb 3.5 inch floppy disk drive, and 1Mb of RAM standard expandable to 5Mb. Boasting a brilliant gas plasma display, the new T3100e provides outstanding resolution. At 640 x 400 pixels, it's perfectly suited for all text and graphics applications. With all standard ports including parallel, two serial, RGB, and external 5.25 inch floppy, this amazing machine also has an 8-bit expansion slot for all industry standard and Toshiba proprietary communications cards or for an expansion chassis. The Toshiba T3100e, at less than thirteen pounds, is the portable computer that truly combines the convenience of a portable with superior desktop AT performance.

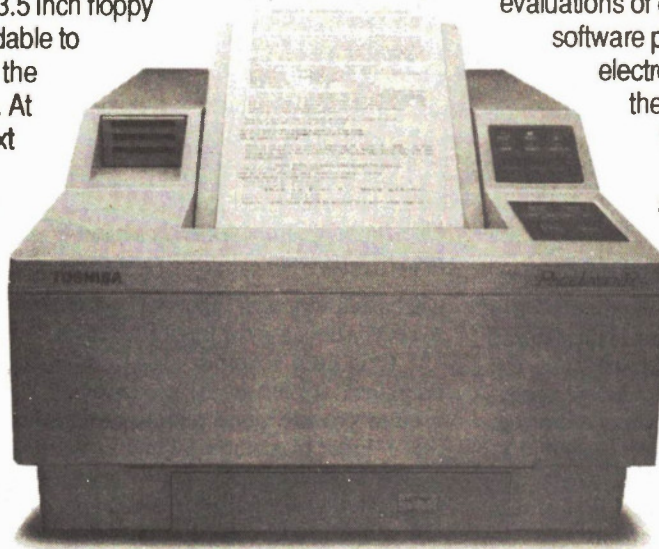

MAKE THE MOST OUT OF YOUR TOSHIBA SYSTEM WITH THE MAGAZINES OF THE MOORSHEAD GROUP... COMPUTING NOW!, ELECTRONICS & TECHNOLOGY TODAY, COMPUTERS IN EDUCATION.

Enter your subscription(s) and receive in-depth evaluations of computers, peripherals, and software plus the latest happenings in electronics & technology. Expand the use of your microcomputer with probing articles on programming break-throughs and important news that will increase your "computer consciousness"! You will find applications and innovations you can use directly on any computer and keep abreast of the newest developments in microcomputing! Closing dates for entries April, 15th 1989.

THE NEW PAGELASER 12

Laser printer quality with a whole lot more. Outstanding full-page print quality and graphics, with its resolution of 300 dots/inch. And at 12 pages/minute it's incredibly fast. Long product life at 600,000. It holds up to 750 sheets, more paper than anyone else. Up to 2MB of memory and a 16-digit English-Language panel display. A high duty cycle of 10,000 pages/month. It comes standard with many features including Serial and Parallel RS232 Interfaces.

*IBM PC-AT is a registered trademark of International Business Machines Corporation.

*Employees and their families of Moorshead Publication and Toshiba Canada are not eligible to enter.

THIRD ANNUAL

OFFICIAL ENTRY FORM MOORSHEAD PUBLICATIONS SWEEPSTAKES

- Yes, enter my name in the SWEEPSTAKES for \$10,000 in TOSHIBA products
 Start my subscription to Computing Now! Electronics & Technology Today Computers in Education for the term checked below as a saving of up to 58% on the newsstand rates.
 One Year for \$19.97 Two Years for \$36.97
 NO, I don't wish to subscribe now, but tell me if I've won.

Name _____ Company _____

Address _____

City _____ Province _____ Postal Code _____

Check one: Payment enclosed Charge my: American Express Visa MasterCard.

Card No. _____ Expiry Date _____

Special subscription rates are for SWEEPSTAKES only,
(Savings are up to 21% off regular subscription rates)

MOORSHEAD PUBLICATIONS

1300 Don Mills Road, North York (Toronto) Ontario M3B 3M8 Tel: (416) 445-5600 Fax: 416-445-8149

Designing With Op Amps

Designing your own circuits with BASIC.

DERRICK RENAUD

Operational Amplifiers have two inputs and one output (in their most common form). With just a few connections they can perform many different functions, such as Amplifiers, Integrators, Differentiators, Filters, etc. This article will be limited to using them as amplifiers only. For anyone wanting to go in depth, I would suggest reading the *Master Op Amp Applications Handbook*, written by Harry W. Fox and published by TAB Books.

The Inverting Amplifier

The Inverting Amp is shown in Figure 1. Its function is to produce an inverted copy of the input at the output with a specified amount of gain. The gain is determined by the ratio of R2 to R1 and can be determined by the formula: (Voltage) GAIN = $-R2/R1$.

R2 is a feedback resistor used for reducing the op amp's maximum gain which also reduces distortion. Higher values of R2 produce more Offset voltage at the output. So R2 should be kept as low as possible (offset voltage is the output's variance from ground, when the input is grounded.)

R1 is the Input resistance of the circuit. It should be determined first, if it is critical to your circuit application.

R3 is used to reduce the offset voltage. It's optional, if you are not worried about offset; just replace it with a short (0 ohms) to ground if it is not needed.

C is used to block DC which would otherwise be amplified. If a DC amp is required then it can be replaced with a short.

The Non-Inverting Amplifier

The Non-Inverting Amp is shown in Figure 2. Its function is to produce an output of the same polarity as the input, with a specified amount of gain. The gain is determined by the ratio of R2 to R1 and can be determined by the formula: (Voltage) GAIN = $R2/R1 + 1$. R2's function is the same as in the Inverting Amplifier.

R3 is used to reduce the Offset voltage. Since a non-inverting amp without R3

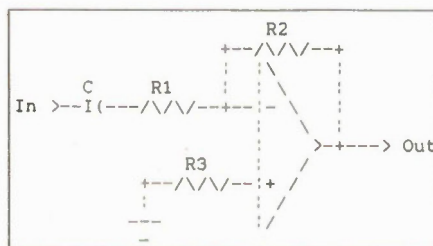

Inverting Amplifier as drawn by the BASIC program.

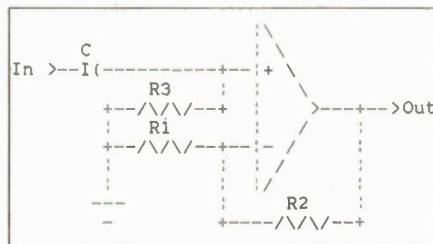

Non-Inverting Amplifier as drawn by the BASIC program.

will have a very high input resistance, then R3 in this circuit is the input resistance.

C is used to block DC from being amplified. R3 has to be used when C is used to provide a bias path to ground for the + input bias current. (The - input is biased by R2 in both the inverting and non-inverting Amplifiers.) In the case of a DC amplifier, C can be replaced with a short. R3 can be removed because the DC source will provide the bias path.

Other Parameters

Once the gain has been determined, you can begin to worry about Slew Rate, Band Width Gain and Frequency compensation.

Slew rate (SR) determines how fast a voltage can rise or fall. It is determined by the maximum frequency and the peak to peak output voltage, using the formula: $SR = 6.28 \times F_{max} \times V_{pp} \times 10^{-6}$. A value greater than this should be used to give the amplifier extra headroom.

Band Width Gain (BWG) determines the maximum amount of gain a certain frequency bandwidth can have. It can be determined by the formula: $BWG = (\text{Voltage}) \text{Gain} \times F_{max}$. In practice a value

at least 10 times this is used to make certain there will be enough BWG.

Slew Rate and Band Width Gain, once calculated, are used to find the proper op amp for the job; just check them against values in different data books.

Frequency compensation is required to reduce oscillations caused by internal phase shifts in the op amp. The simplest way to do this is called Single Pole Compensation, for which the manufacturer supplies pin connections. All that is required is a single capacitor determined by the formula: $C_{comp} = (C_s \times R1) / (R1 + R2)$; where C_s is usually 30 pF. C_{comp} is in pF.

Numbers, Numbers, Numbers

If all this seems like a lot of paperwork to get the values needed, think again. All the values are calculated by given mathematical formulas.

Give a computer the formulas and presto. One such program is shown in Listing 1.

About the Program

The program was written in Microsoft Basic using an APPLE IIe running CP/M. When it is run, it will ask you to input five parameters. The only parameter that has to be entered is the gain. If the input resistance is not given then a suitable value will be determined. The other parameters are only needed to calculate the DC blocking capacitor, slew rate and band width gain.

The program displays a schematic diagram of the chosen amp along with all values. It will choose common resistor and capacitor values for you. It's very easy to use — just type it in, save it, and start punching in values.

Subroutine 2570 — is used to clear the screen and can be replaced by whatever your computer Clear Screen command is.

A Final Note

Amp stages can be cascaded for higher gains.

$$\text{Voltage Gain} = VG1 \times VG2 \times \dots$$
$$\text{Gain (dB)} = G1 + G2 + \dots$$

E&TT January 1989

```

1000 DIM Z(168), Y(33)
1010 GOSUB 2580
1020 PRINT:PRINT:PRINT "CALCULATING RESISTOR TABLE... Please wait"
1030 REM *** LOAD RESISTOR TABLE ***
1040 FOR A=1 TO 24
1050 READ B
1060 FOR C=0 TO 6 : Z(A+24*C)=B*10^C : NEXT C
1070 NEXT A
1080 REM *** LOAD CAPACITOR TABLE ***
1090 PRINT : PRINT "CALCULATING CAPACITOR TABLE... Please wait"
1100 FOR A=1 TO 11
1110 READ B
1120 FOR C=0 TO 2: Y(A+11*C)=B*10^C : NEXT C
1130 NEXT A
1140 GOSUB 2580
1150 PRINT "          *****"
1160 PRINT "          #   AMPLIFIER   DESIGN   #"
1170 PRINT "          #           (c) 1988           #"
1180 PRINT "          #   BY Derrick Renaud   #"
1190 PRINT "          *****"
1200 PRINT : PRINT : PRINT
1210 PRINT " Do you need: 1. Inverting Amplifier"
1220 PRINT "                2. Non-Inverting Amplifier"
1230 PRINT
1240 INPUT " TYPE 1 or 2 ";T : IF T<>1 AND T<>2 THEN 1240
1250 REM *** CLEAR PARAMETER VALUES ***
1260 F1=0: F2=0: VM=0: G=0: RI=0
1270 REM *** INPUT DATA ***
1280 GOSUB 2580 : PRINT : PRINT : PRINT SPC(20);
1290 IF T=2 THEN PRINT "Non-";
1300 PRINT "Inverting Amplifier Parameter Input"
1310 PRINT : PRINT
1320 PRINT "NOTE: IF Fmin = 0 THEN C WILL NOT BE CALCULATED."
1330 PRINT "      IF Fmax = 0 THEN SR AND BWG WILL NOT BE CALCULATED."
1340 PRINT "      IF V0max = 0 THEN SR WILL NOT BE CALCULATED."
1350 PRINT "      IF Ri = 0 THEN IT IS ASSUMED THAT IT IS NOT CRITICAL AND A REASONABLE"
1360 PRINT "                VALUE WILL BE DETERMINED."
1370 PRINT "      PRESSING 'RETURN' WILL DEFAULT A VALUE OF 0."
1380 PRINT : PRINT
1390 INPUT "LOW FREQUENCY LIMIT IN Hz (Fmin) ";F1 : IF F1<0 THEN 1390
1400 INPUT "HIGH FREQUENCY LIMIT IN Hz (Fmax) ";F2 : IF F2=0 THEN 1430
1410 IF F2<F1 THEN 1400

```

```
1420 INPUT "MAXIMUM RMS OUTPUT VOLTAGE (VOmax) ";VM : VM=ABS(VM)
1430 INPUT "GAIN IN dB ";G : IF G=0 AND T=2 THEN 1430
1440 INPUT "INPUT IMPEDANCE IN OHMS (Ri) ";RI : IF RI<0 THEN 1440
1450 PRINT : PRINT : PRINT "IS ALL DATA CORRECT? ";
1460 A$=INKEY$ : IF A$="N" THEN 1280
1470 IF A$>"Y" THEN 1460
1480 V=10^(G/20)
1490 REM *** CHECK INPUT IMPEDANCE ***
1500 RX=RI : IF RI<>0 THEN 1610
1510 R2=10000
1520 IF G>15 THEN R2=47000!
1530 IF G>30 THEN R2=100000!
1540 IF G>45 THEN R2=470000!
1550 IF T=1 THEN R1=R2/V ELSE R1=R2/(V-1)
1560 RT=R1 : GOSUB 2290 : R1=RT
1570 R3=R1*R2/(R1+R2)
1580 RT=R3 : GOSUB 2290 : R3=RT
1590 IF T=1 THEN RI=R1 ELSE RI=R3
1600 GOTO 1730
1610 RT=RI : GOSUB 2290 : RI=RT
1620 IF T=2 THEN 1680
1630 R1=RI : R2=V*R1
1640 RT=R2 : GOSUB 2290 : R2=RT
1650 R3=R1*R2/(R1+R2)
1660 RT=R3 : GOSUB 2290 : R3=RT
1670 GOTO 1730
1680 R3=RI
1690 R2=R3*V
1700 RT=R2 : GOSUB 2290 : R2=RT
1710 R1=R2/(V-1)
1720 RT=R1 : GOSUB 2290 : R1=RT
1730 REM *** CALCULATE CAPACITANCE (C) ***
1740 C1=0
1750 IF F1>0 THEN C1=1/(6.4*F1*R1) * 1E+12
1760 REM *** CALCULATE SLEW RATE, BAND WIDTH GAIN, COMPENSATION CAP ***
1770 SR=6.28*1.414*VM*F2*.000001
1780 BW=10*V*F2
1790 CP=(R1*30)/(R1+R2)
1800 REM *** CALCULATE ACTUAL VOLTAGE GAIN ***
1810 IF T=1 THEN VA=-(R2/R1) ELSE VA=R2/R1+1
1820 REM *** OUPUT RESULTS ***
1830 GOSUB 2580
```

```

1840 PRINT SPC(17); G; "dB ";
1850 IF T=2 THEN PRINT "Non-";
1860 PRINT "Inverting Amplifier"
1870 PRINT
1880 IF C1=0 THEN 1900
1890 CT=C1: GOSUB 2400: C1=CT: C1$=CT$
1900 CP=CP: GOSUB 2400: CP=CT: CP$=CT$
1910 IF T=2 THEN 2060
1920 PRINT "                R2"
1930 PRINT "                +---/\//---+"; SPC(15); "R1="; R1; "OHMS"
1940 PRINT "                : \      !"; SPC(15); "R2="; R2; "OHMS"
1950 PRINT "                C      R1  ! | \      !"; SPC(15); "R3="; R3; "OHMS"
1960 PRINT " In >--I(---/\//---+---!- \      !"; SPC(15); " C=";
1970 IF C1=0 THEN PRINT " SHORT" ELSE PRINT C1; C1$
1980 PRINT "                : \      !"
1990 PRINT "                :      >+----> Out"
2000 PRINT "                R3  ! /"; SPC(18); "Ccomp="; CP; CP$
2010 PRINT "                +---/\//---!+ /"; SPC(19); "Ri="; RI; "OHMS"
2020 PRINT "                :      ! /"; SPC(20); "GAIN (Actual)= x"; VA
2030 PRINT "                ---      !/"
2040 PRINT "                -"
2050 GOTO 2180
2060 PRINT "                ;\"; SPC(20); "R1="; R1; "OHMS"
2070 PRINT "                C      ; \"; SPC(19); "R2="; R2; "OHMS"
2080 PRINT " In >--I(-----+---!+ \"; SPC(18); "R3="; R3; "OHMS"
2090 PRINT "                R3  ! | \"; SPC(18); "C=";
2100 IF C1=0 THEN PRINT " SHORT" ELSE PRINT C1; C1$
2110 PRINT "                +---/\//---+ ;      >+----> Out"
2120 PRINT "                : R1      ! /      !"; SPC(12); "Ccomp="; CP; CP$
2130 PRINT "                +---/\//---+---!- /      !"; SPC(12); "Ri="; RI; "OHMS"
2140 PRINT "                :      ! | /      !"; SPC(12); "GAIN (actual)= x"; VA
2150 PRINT "                :      ! | /      !"
2160 PRINT "                ---      !      R2      !"
2170 PRINT "                -      +-----\//---+"
2180 PRINT : PRINT
2190 IF VM<>0 THEN PRINT "Vomax="; VM; "Vrms"
2200 IF F1<>0 THEN PRINT "Fmin="; F1; "Hz"
2210 IF F2<>0 THEN PRINT "Fmax="; F2; "Hz"
2220 IF F2<>0 AND VM<>0 THEN PRINT "Slew Rate (SR)="; SR; "V/uS"
2230 IF F2<>0 THEN PRINT "BAND WIDTH GAIN (BWG)="; BW
2240 IF R2>910001 THEN PRINT "**** WARNING *** R2 values over 1M ohms lead to instability."
2250 PRINT : PRINT "ANOTHER DESIGN (Y/N)?";
2260 A$=INKEY$: IF A$="Y" THEN 1140

```

Designing With Op Amps

```
2270 IF A$<>"N" THEN 2260
2280 STOP
2290 REM *** FIND RESISTOR VALUE ***
2300 REM *** ON ENTRY 'RT' HAS VALUE LOOKING FOR COMMON RESISTANCE ***
2310 REM *** ON EXIT 'RT' HAS COMMON VALUE RESISTANCE ***
2320 A=1 : B=168
2330 C=INT((A+B)/2)
2340 IF C=A THEN 2370
2350 IF Z(C)>RT THEN B=C ELSE A=C
2360 GOTO 2330
2370 IF ABS(Z(C)-RT) > ABS(Z(C+1)-RT) THEN C=C+1
2380 RT=Z(C)
2390 RETURN
2400 REM *** FIND CAPACITOR VALUE ***
2410 REM *** ON ENTRY 'CT' HAS VALUE IN pF LOOKING FOR COMMON CAPACITANCE ***
2420 REM *** ON EXIT 'CT' HAS CAPACITOR VALUE ***
2430 REM *** 'CT$' HAS UNIT ***
2440 CT=INT(CT*10+.5)/10
2450 IF CT<-820 THEN CT$="pF" : GOTO 2490
2460 CT=INT(CT/100+.5)/10
2470 IF CT<-820 THEN CT$="nF" : GOTO 2490
2480 CT=INT(CT/100+.5)/10 : CT$="uF"
2490 A=1 : B=33
2500 C=INT((A+B)/2)
2510 IF C=A THEN 2540
2520 IF Y(C)>CT THEN B=C ELSE A=C
2530 GOTO 2500
2540 IF CT>Y(C) THEN C=C+1
2550 CT=Y(C)
2560 RETURN
2570 REM *** CLEAR SCREEN ***
2575 REM *** PRINT 25 LINES DOWN ***
2580 FOR A=1 TO 25 : PRINT : NEXT A
2585 REM *** PRINT 25 LINES UP ***
2590 FOR A=1 TO 25 : PRINT CHR$(11); : NEXT A
2600 RETURN
2610 REM *** STANDARD RESISTOR TABLE ***
2620 DATA 1, 1.1, 1.2, 1.3, 1.5, 1.6
2630 DATA 1.8, 2, 2.2, 2.4, 2.7, 3
2640 DATA 3.3, 3.6, 3.9, 4.3, 4.7, 5.1
2650 DATA 5.6, 6.2, 6.8, 7.5, 8.2, 9.1
2660 REM *** STANDARD CAPACITOR TABLE ***
2670 DATA 1, 1.5, 1.8, 2.2, 2.7, 3.3, 3.9, 4.7, 5.6, 6.8, 8.2
```

MARKET PLACE

We have a variety of products for Mechatronic applications using computer.

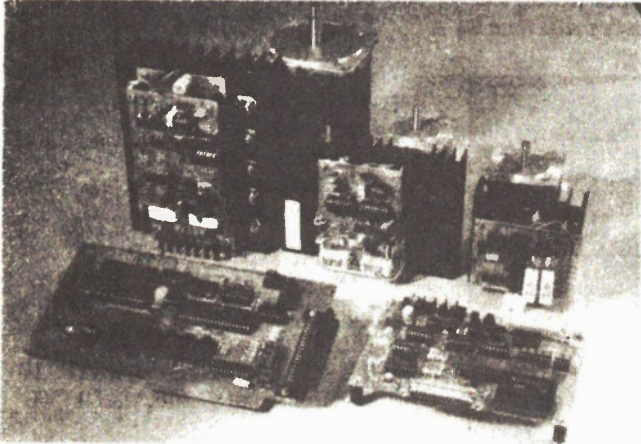

- 1) Several types PWM method stepping motor drivers
KEM-802 series
- KEM-802-12 Max. 1.2A \$125.00
 - KEM-802-24 Max. 2.4A \$145.00
 - KEM-802-50 Max. 5.0A (with cooling fan) \$285.00

And we prepare many kinds of stepping motors for your robotics applications.

- 2) Intelligent Stepping motor controller via RS-232C for any computer \$315.00
- 3) Intelligent 2-axis stepping motor controller for IBM I/O slot .. \$435.00
- 4) Multi I/O port with timer counter card for IBM I/O slot \$185.00
- 5) 8CH-solid state relay (max. 250V 1A/ch) I/F card to control AC motor, lamps, solenoid and magnet clutch etc. \$115.00
- 6) 16CH 12 bit A/D and 1CH 12 bit D/A card for IBM \$198.00
- 7) 2CH Rotary encoder I/F card for IBM \$345.00
- Rotary encoder 60p/r to 500p/r. Price range \$145 to \$189.

New Version for IBM AT/XT/Turbo

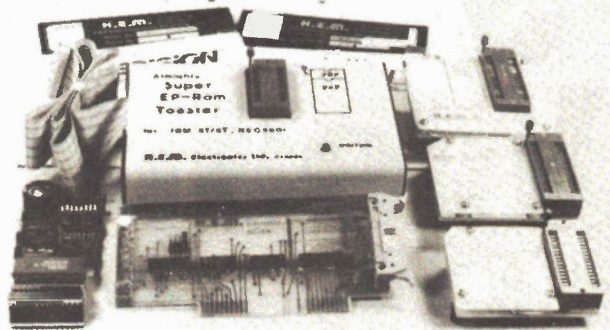

Only K.E.M. original almighty SUPER EP-ROM TOASTER can support 1 Mega bits EP-Rom programmer, 1-chip CPU programmer & EP-Rom emulator adapter units.

Features:

- Program 2716 to 27512 including CMOS and A versions In super high speed.
- Can Program 32 pin type/One Megabit EP-Rom with optional adapter unit KEM-904.
- Can Program 1-chip CPU with optional adapter units KEM-903A (8741/48/49) or KEM-903B, (8751, 87C51).
- Also with an optional EP-Rom unit KEM-902 this programmer becomes a powerful development tool.

- Super KEM-901SP (New version) \$215.00
- KEM-902 (New version) \$145.00
- KEM-903A \$145.00
- KEM-903B (New version) \$195.00
- KEM-904 \$145.00

Intel HEX, Motorola, S format - Binary conversion software \$50.00

Shipping and handling — \$6.00 for Prepaid, \$10.00 for C.O.D. Plus PST for B.C. residents. Ask information with 4 pcs of 37¢ stamps.

Sorry we have no facility for credit cards and do not accept Invoice orders.

K.E.M. Electronics Ltd.

Mail to Box 69126 Station(K), Vancouver, B.C. V5K 4W4
 Office 879E. Hastings Vancouver (604) 251-1514

Get the best of professional desktop publishing services

- Brochures • Catalogues • Forms • Instructions
- Parts Lists • Price Lists • Sales Flyers
- Product Information • Technical Documentation
- Training Manuals • Directories • Corporate Identity
- Annual Reports • Menus • Magazines...and much more

Call

MP
 COMMUNICATIONS

Kenneth Marskell
 (416)445-5600

A Division of Moorshead Publications
 1300 Don Mills Road, North York, Ontario M3B 3M8 FAX: 416-445-8149



SOLDERING IRONS

Over 40 Years of Complete Design and Manufacturing Innovation

- TCSU-1: 70-435°C Adjustable Station, Built-in iron holder
- TCSU-D2: LED readout to 450°C, holder, sponge tray, 50W iron
- PSU: 24VAC Supply Unit with sponge tray, 3 sizes of holder, for use with Antex and other makes using 24VAC under 50W
- TCS: 50W iron with its own circuit in the handle to adjust temp. 200°-450°C available for 115V or 24V for use with PSU
- C, G, CS & XS pencil irons from 15-25W versions; 12, 24 and 115V models
- Large assortment of bits including BITS TO REMOVE 16 PIN DIPS
- All parts available as spares

SEND FOR COMPLETE BROCHURE DEALERS INVITED

COBRA SALES

Ste. 119, 4373 Steeles Avenue W., Downsview, Ontario M3N 1V7
 Telephone: (416) 740-3738 Fax: 674-8114

Receiving Satellite Weather Photos

Weather pictures of Canada by radio.

HANK BRANDLI

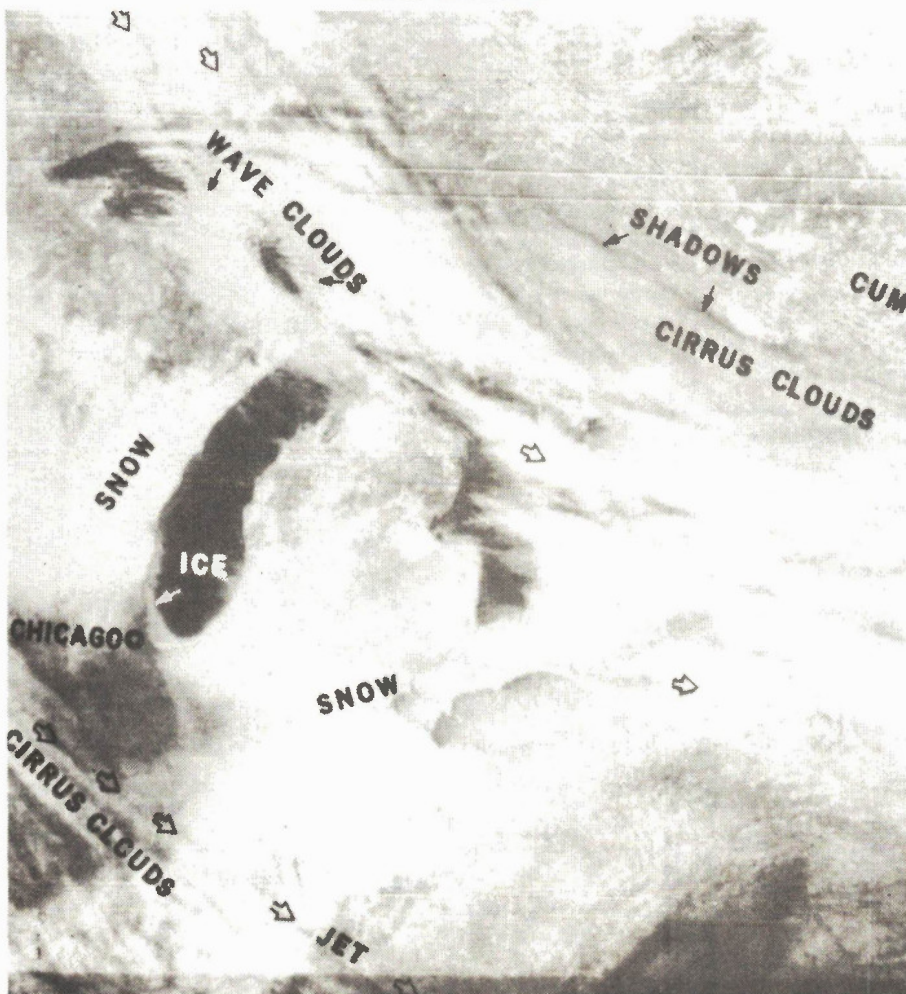

I've always been a believer in the old adage that "a picture is worth a thousand words," but I was never more convinced of it as when I first saw a weather satellite photo.

If you've seen such photos on television weather reports, you probably think it takes a small fortune or sophisticated equipment to receive and reproduce their 22,000 mile-high geostationary weather photos. You would be correct — at least for the TV stations. But the reality is that this need not be the case if you want to personally receive such photos from lower-orbiting 500 mile-high meteorological satellites. The polar orbiting images have better resolution at latitudes Canadians are familiar with than do the geostationary satellites that all weather services subscribe to. The infrared or thermal resolution of polar orbiting satellites are three times better than the GOES infrared pictures. Cost can be moderate, may be only a few hundred dollars if you're already equipped with a computer system.

The Birds

Day and night, polar-orbiting meteorological satellites launched by the U.S., China and U.S.S.R. take visual and/or infrared images of every area on Earth from satellite platforms out in space. These satellites circle the globe at altitudes ranging from 400 to 600 miles up, passing over the Earth every 100 minutes or so, ceaselessly taking pictures and transmitting them back to ground stations. Three U.S. NOAA (National Oceanic and Atmospheric Administration) weather satellites in polar sun-synchronous orbits take, record and transmit to Earth photos of the same location at approximately 9:00 a.m. and 9:00 p.m., 1:00 a.m., and 1:00 p.m. and 3:00 a.m. and 3:00 p.m. Simultaneous visual and infrared (thermal) imagery 1,600 miles wide are processed during the day, while nighttime pictures, in the absence of visible light, are infrared only.

China's "Feng Yun I" is similar to NOAA and takes images at 5:00 a.m. and 5:00 p.m.

Russia's Meteor 2 & 3 spacecraft transmit mostly visual-only pictures that are 1,200 miles wide. The near-polar paths of these two satellites systems permit photo-taking at increasing or the opposite times during the day. Whereas the 1,600 mile-wide NOAA images can spot areas of cloud as small as 2 miles on a side, constant across the image scan, the meteor "shots" record locales as small as 1 mile square. Previous U.S. and

U.S.S.R. meteorological spacecraft had poorer resolutions and distorted images on the edges.

Transmission frequencies of the U.S. birds and 137.50 and 137.62 MHz, China's transmit at 137.78, while those for the Soviet birds are 137.30 MHz, 137.40 and 137.85 MHz.

About The Author

Since my retirement, I have been working as a consultant for several companies, along with a lot of writing and some lecturing. My love has always been weather satellite photo analysis. Harris Corporation, in Melbourne, Florida, loaned me a sophisticated laser photocopying machine and a special telephone line to receive the 22,000 mile high geostationary weather photos day and night from Washington, D.C., via Miami, Florida. Most readers are familiar with these images which forecasters in the media use.

After my stint in Vietnam as a weather satellite specialist, (having the dastardly duty of forecasting for bombing mission), I always wanted to get true current photos from low-level 500 mile high polar orbiting American and Russian satellite spacecraft.

At about this time in my lifework, I was diagnosed as having Multiple Sclerosis. I was retired from active duty in Air Force and thusly continued my work from my home in a wheelchair. This required my needing assistance to put together the equipment to process weather satellite pictures from these satellites in my home. I asked a technician to build me an inexpensive antenna to place on the roof. He designed one out of PVC pipe and four welding rods. This technician, Holly Johnson, of Cape Kennedy Air Force Station, Florida, bought the PVC pipe at a Scotty's Hardware for approximately \$3.00. He purchased the welding rods from a place called "Black Bart's Welding Shop", for .50 each. The welding rods are about 43" long. He put this together, connected the welding rods, as directed in the schematic. I thought — "This is a joke — it looks like a bird roost!" Holly replied: "Believe in it!"

A Ham radio operator had told me of a small company in New York (Vanguard Labs) that could send me a receiver for less than \$200.00. This was the size of a small book. They shipped it to me along with the necessary five crystals that were required to get signals for the 500 mile high polar orbiting Meteor vehicle of the Soviet Union and NOAA "Birds" of the United States. A preamp was also included in the order.

After the "magic antenna" was assembled along with the necessary cable,

garage ceiling and into the Laserfax inside the house.

We had the computer ephemeris and knew what time a satellite would be passing over. Sure enough, we started to get a beep-beep-beep signal. Not a strong one, but definitely a signal. Adjustments were made to the antenna to optimize it and we could see that by orienting the welding rod dipole configuration in various ways, the signal improved. Just for the fun of it, I turned the machine on. We received a very, very small, somewhat noisy picture.

It was not obvious that the rooftop antenna needed to be secured. This is when Holly had the ingenious idea of taking the legs off an old pair of jeans and filling them with sand, tying the ends to form sandbags. He ran cable from the roof antenna down through the garage windows and hooked it up to the receiver.

We waited for another pass. Active "beeps" started coming from the speaker over the Laserfax. The signal was stronger, but the picture was still noisy and very small.

"Back to the drawing board"... another call to Vanguard Labs, finding out we needed a newer type preamp with a special filter. A week later when the new preamp was hooked to the power supply and attached to the receiver.

We again waited patiently for a 3:00 p.m. NOAA-9 bird. After a few minor adjustments, the signal was strong. Eight minutes later, a beautiful photo pair displaying Southern Canada all the way to South America!

The infrared photo showed temperatures of water, land and cloud tops. Then we heard a "thump-thump"... followed by large 10" photo from the Russian Meteor satellite. These exciting images from space made all our efforts worthwhile. Here I was, in the comfort of my own home, receiving these beautiful satellite photos that showed all the way up into Canada!

To get back to the equipment needed. A surplus facsimile machine can be purchased from surplus for a few hundred dollars up to a couple thousand. Or, you can display these images on a personal computer.

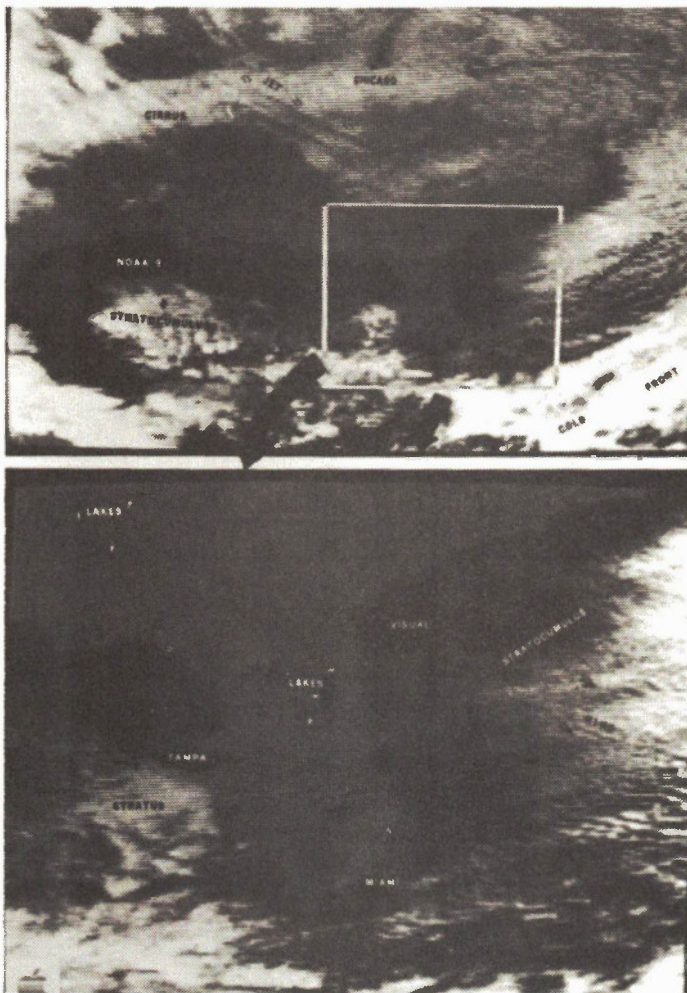

the technician then purchased "hardware cloth" for about a dollar; this was just ordinary chicken fencing, to be used as 4' x 4' ground plane for the antenna.

For the first test, it was all just placed on the lawn with coax cable running through the garage into the receiver. We had a 12-volt power supply that came from government surplus, a very crude looking device. This was connected with hookup wires into the receiver and then plugged into an outlet in the garage. 30 feet of speaker wire was run along the

Receiving Satellite Weather Photos

The audio output from the receiver needs to be converted to digital samples for a computer. Interface cards and some software is available. Apple and IBM computers and their clones need little modification. High quality prints for hard copy can be achieved at a fraction of the cost of what used to be. And, with the same computer you can program the satellite acquisition times and locations exact, creating your own ephemeris.

You may want to leave your receiver on and just wait for the beeping beacon signal. But, to determine exactly when a satellite is to pass over, get the daily message APT prediction message transmitted over worldwide communications circuits under the heading TBUS-2, for south to north swings. They tell the exact location and times of successive passes each day. The APT Coordinator, Direct Readout Services, U.S. Department of Commerce, NOAA/NESS, Washington, D.C., 20233, is a good source for any satellite status, or Electronic Bulletin Board Information.

Photos

Visual satellite photos are very easy to understand since clouds or snow are white and land masses are usually seen and can be outlined by either computers or by hand. Canadians can map snow and even snow depth (with a little practice). Ice formation or breaking-up stand out on visual images.

Infrared photos, however, are somewhat harder to comprehend without an explanation. Infrared film records thermal properties or temperatures. Hot temperatures appear black and cold temps appear

white. Since high clouds, for example are colder than low ones, the former appear much whiter. Infrared cameras are used exclusively at nighttime to detect clouds and thermal properties. Land and water temperatures can be distinguished with no clouds.

The ability to differentiate between clouds is important since cold fronts are very easy to detect on photos and can be tracked to determine speed of movement. In this way, an exact time for arrival of a front with its inevitable rain, snow and wind, can be ascertained.

Further developments in infrared photography, can be used on home computers to devise a technique whereby nighttime black and white thermal pictures can be converted to color. Each color in a photo corresponds to a different temperature.

In addition, hurricanes can also be spotted by both day and night weather satellites. When monitored every 3 hours, satellite photos indicate quite accurately the path and severity of these tropical storms. Tracing storm movement is like the game "follow the dots."

I tracked "Gilbert" (from my home), the most powerful hurricane in history from his birth to demise in Southern Canada.

Infrared photos can determine water temperatures for fishing.

Even pollution (air and water) can be ascertained.

Thus, it is within the realm of possibility to utilize satellite weather photos for close monitoring of agricultural and winter conditions, as well as fire control, arctic storms or hurricane warnings.

Now, anyone can watch the weather on space photos rather inexpensively.

Today I get as many as a dozen photos or photo pairs, day and night, visual or infrared. Strange as it may seem, twenty years ago in Saigon, I got less reception for more than ten times the cost. I've come a long way and have made a lot of personal and technological progress.

So, how about it? With a small financial outlay, a little electronic knowledge and a tad of initiative, you can be the first in your area to receive satellite images of impending weather patterns. It's a field that touches everyone. We all need to know what the weather is going to do. ■

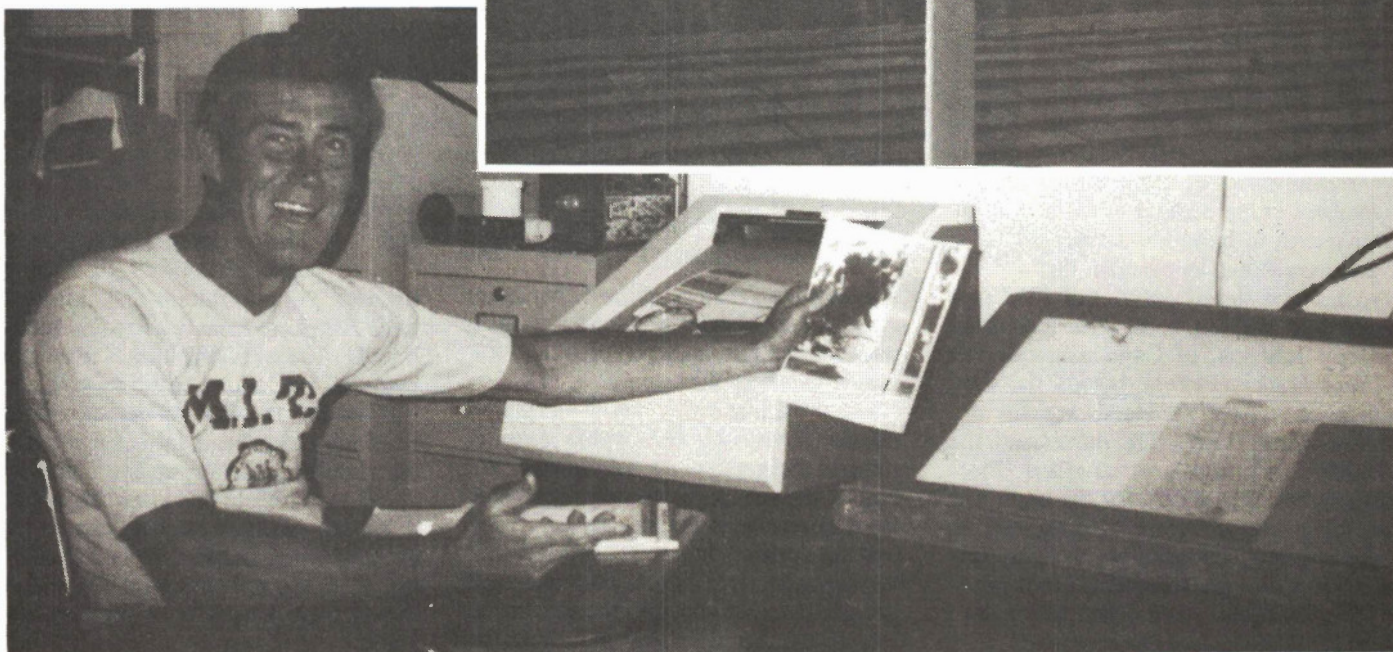

NEW PRODUCTS



Commodore 288

Commodore's PC40-III is an AT compatible using the 80286 CPU with 6, 8 and 10MHz clock speeds. It has a small footprint and it doesn't take up much space, either. Built-in features include parallel and serial ports, 101-key keyboard with the CTRL key in the wrong place as usual, a clock/calendar and a mouse port. The hard disk is a 40MB with the controller on the motherboard.

Circle No. 5 on Reader Service Card



Full-function DMM

Kyoritsu's Model 1007 DMM is a 3 1/2 digit unit which measures DC/AC volts and current, plus ohms from 200 ohms to 20M, continuity test, diode test, a low power ohms range for in-circuit tests, and data and range hold. Input jacks can withstand an overload of up to 3kV. From Omnitronix.

Circle No. 6 on Reader Service Card



IEEE-488 Catalog

National Instruments presents their free Fall Product Catalog of IEEE (GPIB) control, data acquisition, analysis and presentation products, including LabVIEW, three data acquisition cards for the IBM PS2, 488/RS232 bus controllers, interface boards for the PC/AT and VXIbus and much more. From Allan Crawford Assoc.

Circle No. 7 on Reader Service Card

PC Hardware Interfacing

Exploring the mysteries of designing PC interface cards.

STEVE RIMMER

The mysteries of computer hardware are like no mysteries you'll ever check out on Masterpiece Theater. These are nasty ones. A good bit of hardware microcomputer design will make you long for boat building.

This being the case, of course, designing microcomputer circuitry is one of the most rewarding things you can turn your soldering iron to. It's tricky and demanding, but when you finally do get the thing going it's a hell of a rush.

Designing interface cards for the IBM PC is a slightly tamer subset of microcomputer hardware design. Notice that I said "slightly". It has the advantage that you don't actually have to design a whole computer, and the disadvantage that you have to work with an architecture which was originally perpetrated by a three foot two inch tall green skinned troll from Mars who had it in for everything bigger than he was... this, of course, being the creature which IBM actually employed to design the original PC. Betcha didn't know that.

It's not horribly difficult to design boards to plug into a PC, although you do need to know a few things first. Successful hardware design for the system involves both knowing where to put the chips and, subsequently, knowing how to talk to them from within the computer.

Over the next few months we're going to see how to do both. You might also want to check out the C language series that's starting this month. The two will kind of fuse together later on, inasmuch as you'll need a programming language to communicate with the cards you'll build.

In this first installment, we're going to look at the evil secrets of I/O decoding. Some people have described I/O decoding on a PC as being more fun than sex — not very many, though.

Any Old Port in a Storm

In order to understand how to talk to a PC at the hardware level, you have to begin by getting your head around how it talks to itself. You can start by putting your ear up to the ventilation grill and listening,

but this usually just gets you a drafty ear.

The "bus" of the 8088 microprocessor that drives a PC is actually several buses... sort of a transit company. Looking at things from the point of view of the I/O bus connections — essentially the processor's bus brought out to slots so we can associate peripherals with it — we have a power bus, a data bus, an address bus and a miscellaneous signal bus. An AT has still more buses, and an 80386 based system looks like downtown at rush hour — we won't get into them just now.

When the 8088 says that it feels like writing a byte of data to a specific location in memory, here's what actually happens. The processor puts the number it wants to load into the memory onto its data bus. The data bus has eight lines, so the number can be anywhere from zero to two hundred and fifty five. Next, it puts the number of the location in memory where it wants the data to go on its address bus. The address bus has twenty lines, so this number can be anything from zero to a megabyte. Finally, the processor pulls the

MEM W line of the miscellaneous signals bus, which is a signal to write data to memory.

We think of the memory in a PC as being part of the computer, but the processor sees it as being a peripheral. It's a black box which stores things in a way that's useful to the processor. As such, we can envision the memory system of the PC as a machine which stores numbers when the MEM W line is pulled and spits them back out when the MEM R, the memory read line, is pulled.

In theory, the memory doesn't have to be actual silicon memory. We might imagine a tape transport with a long tape capable of holding a million items of data. When the MEM W line is pulled, the tape transport moves the tape so that the item whose number is contained in the address bus is over the tape head and writes the number on the data bus to it. In theory, the 8088 could drive such a memory device just as it drives normal IC memory. In practice, of course, such a contraption would be too slow to possibly be good for anything, but it illustrates how the 8088 actually regards its memory.

I bring this up because it points out that memory doesn't have to be memory, and, in some machines, frequently is not. Suppose we built a circuit which would watch the address bus for a particular number and light up an LED every time that number appeared on the bus. This is pretty easy to envision; it would just be a series of gates and inverters. If the number it was looking for was one hundred, every time the processor tried to read or write to location one hundred, the LED would light up for an instant.

Now, suppose we expanded this circuit so that the number on the data bus was shown on a display whenever the processor accessed location one hundred and it pulled the MEM W line, that is, whenever it actually wrote data to this location. Ah hah... we've invented an output port.

We could make this into an input port by having the circuitry read an external condition in eight bits and jam it onto the data bus whenever the processor accessed location one hundred and pulled the MEM R line.

This is a very simple sort of I/O called "memory mapping". It's used on Apple][+ computers, for example, because it's the only sort of I/O that computer's microprocessor knows how to do. Memory mapped I/O has the advantage that it's fast and easy to do, but it ties up

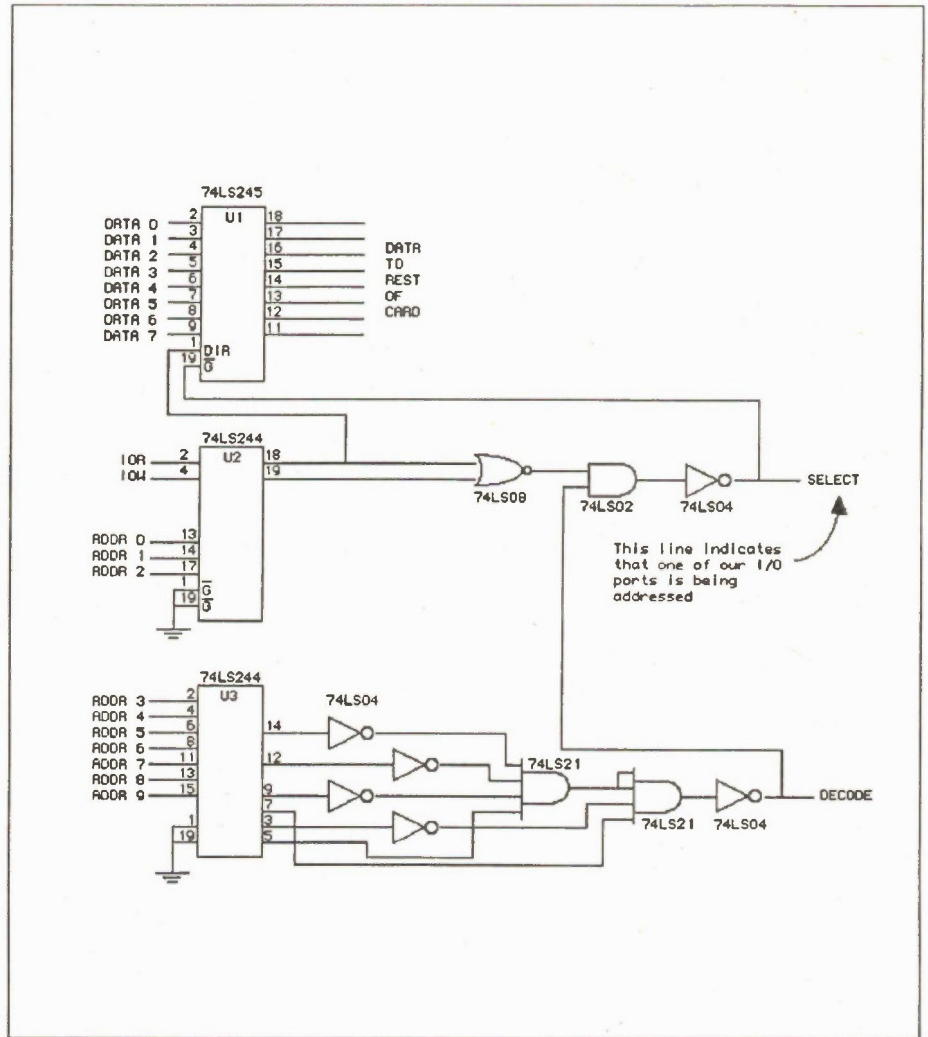

Fig. 1. A simple IO decoder derived from the IBM PC. It selects the port range from 300H to 31FH.

memory space for what is actually a non-memory function. As you might have noticed, PC users invariably want all the memory they can get, and would be loath to give any of it up if they could avoid it.

The PC does use some memory mapped I/O. The video board of a PC is just a big chunk of circuitry which makes a range of memory appear as data on a picture tube. If the processor writes to this area of RAM, the screen contents change. Of course, there is actually memory here, although it lives on the video board and is essentially part of the display circuitry.

Memory mapped I/O is faster than the other kind of I/O, which we'll get to in just a sec, because in effect, the processor gets to talk directly to the screen. In the case of the PC's screen, which we'd like to have operate as quickly as possible, the design of the computer allows that it's worth giving up some memory space to come up with speedy communications.

For most of its basic I/O, however, the PC uses I/O ports. A port is a funny sort of phenomenon. In some ways it behaves like memory, but it lives off the memory bus and, as such, the processor can access a full house of memory and still have lots of ports going.

The PC's use of ports is a bit erratic, as we'll see.

One way of looking at I/O ports is that they're just memory locations that the memory system ignores. When the 8088 wants to write to memory location one hundred, it puts one hundred on the address bus, data on the data bus and pulls the MEM W line, as we've seen. When it wants to write to I/O port one hundred, it puts one hundred on the address bus, the data on the data bus and it pulls the IOW line. Because the MEM W line does change, the data doesn't affect the contents of memory. The hardware which is associated with the port, assuming there is

any actually there, will watch the two buses and this line and do something with the data when its port is written to.

The whole process seems a bit artificial, and, in a sense, it is. It's a protocol by which the 8088 uses the same address and data buses to communicate with both memory and I/O devices.

In software, by the way, the machine language to do these two analogous functions is also similar. This

```
MOV DX,100
MOV [DX],AL
```

would write to memory location one hundred, while this

```
MOV DX,100
OUT DX,AL
```

would write to port one hundred. As memory access is considerably more common in a PC than is port access, there are considerably more ways to handle variations on the first case.

By using the address bus in this way, the PC allows for multiple devices to sit on the I/O bus at once. Each device has... presumably... a unique I/O address, so that the computer knows, for example, that talking to port 03F8H will involve chatting with the COM1 serial port while port 03D8H is one of the registers of the video card controller. The actual slots what the devices sit in are all identical, and peripheral cards, as a rule, don't care which slot they're plugged into. They know they're being spoken to when they see their port numbers appear on the address bus and the IOW or IOR — the I/O read line — pulled.

Kibbles and Bits

In practice, most peripheral cards have more than one port, and we usually talk about associating a range of ports with a given I/O function. If we consider a simple parallel printer interface, for example, at the very least we would need one port to actually send data to the printer and a second one to control the beast... to tell it when the data on the first port is valid and ready to print, to tell the printing software when the printer is ready to accept data, whether it's out of paper and so on.

A basic subject of board design for the PC, then, is the decoding of I/O addresses. Before we can do anything clever, we need a circuit which will look at the buses of the computer, decide when our card is being communicated with and ex-

tract the appropriate data from the data bus. As we get into this, we'll find that there are other considerations to contend with... for example, it's desirable in many cases to make the base of the range of addresses which our card uses somewhat variable, so that it can accommodate other cards which might be in the system using fixed ranged of port addresses.

Fig. 1 is a simple I/O decoder, derived from the now antediluvian original IBM PC prototype card; it selects the port range from 300H to 31FH, which is a bit huge. This means that the line I've marked SELECT will go high if one of these addresses is placed on the address bus and one of the I/O lines is pulled, and it will stay low for the rest of the time.

Let's see what the beast is up to. We'll start by looking at how to decode for the address 300H

We can represent the hexadecimal number 300H in binary as

```
1100000000
```

If you imagine an LED connected to each line of the address bus, when the number 300H was on the bus, the pattern of on and off LEDs for the first ten lines would correspond to the ones and zeros of our binary representation of the data.

If we designed a circuit to look for the following pattern in the upper two bits

```
11
```

we'd have a way of knowing whether the address ranged from 0300H to 03FFH... this involves simply watching for the number three in the upper two lines of the pertinent part of the bus. You can envision such a circuit pretty easily: it's just a two input AND gate. Watch these two lines and the IOW and IOR lines as well and you've got an I/O port decoder for this admittedly too large range of addresses.

If we watch a slightly larger number of lines.

```
110
```

and only raise our SELECT line when that extra bit is zero, we'll have narrowed the range down to 0300H through 037FH. If we watch this range

```
1100
```

we can narrow it down to 0300H through 033FH. Finally, watching

```
11000
```

gets it down to 0300H to 031FH, which is what we're after. If this pattern of bits exists on the address bus in these positions... and either the IOW or IOR line has been pulled... the processor wants to talk to a port in the range of 0300H through 031FH, the ports our card is interested in.

The lower five lines are immaterial to the task of deciding whether our port address range is being talked to, as these represent the numbers from zero through 1FH, and our range of ports encompasses all of them.

We'll need to deal with the lower five bits later on, when we want to know which particular port in our range of ports is being dealt with, but that's another story.

The arrangement of gates at the bottom of the circuit diagram in figure one is a fixed address decoder. If you care to trace through it, you'll find that it watches address lines five through nine for the pattern 11000, raising the DECODE line if it spots them.

The NOR gate up in the centre of the drawing watches the IOW and IOR lines. It tells us when either of the lines is pulled, as this indicates that some sort of port I/O is happening. The status of the IOR line is used to set the direction of U1, which buffers the data. We only want data to go out... that is, to be jammed onto the 8088's data bus... when the IOR line is high.

The 74LS02 AND gate after the NOR gate gets the whole party together. It tells us when the address has been decoded *and* an I/O line is high. As such, its output can be used to say when we actually should be ready to do some work. Notice that it also enables data transmission through U1; most of the time this is in its tri-state mode, and does nothing.

The Load Out

At this point, we know how to make the card decide whether it's being addressed in a general way. The next step is to see how to make it recognize individual port addresses when it's spoken to, and then what to do with these addresses. We'll have a peek at some of this next month.

In the mean time, you might want to dream up some actual applications for cards you build yourself. Once you know how to make your circuitry actually communicate with the PC — pretty simple stuff in the end — the rest is just solder and blinding inspiration. We'll check out some of that in the months to come too. ■

NEXT MONTH IN *Electronics & Technology Today*

Join
the
Celebration

Out 12th Anniversary Issue!

Since our start in February 1977, we've tried to cover all the aspects of electronics, technology and build-it-yourself projects.

Next month, we celebrate with:

Lots of Projects!

A bumper crop of projects, large and small.

Circuits

Pages of schematics on a wide variety of topics for the experienced constructor.

Then and Now!

We look at a few favourite projects from the past ten years or so, and compare them with today's technique.

Surround Sound Receiver!

We look at Pioneer's surround-sound receiver and see if you really do want those two extra speakers.

Plus, of course, the usual projects, articles and news!

Subscribe today!

For advertising or subscriptions, please call (416) 445-5600, FAX 445-8149.

SUBSCRIBE TODAY!

Be sure of your
issue
each month

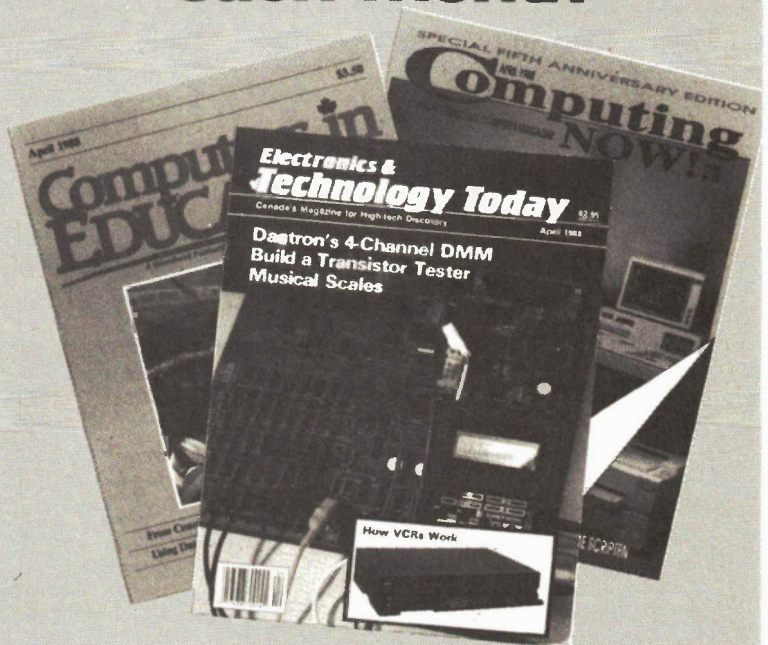

Moorshead Publications

1300 Don Mills Road, Toronto, Ontario M3B 3M8

SUBSCRIPTIONS: NEW SUBSCRIPTION RENEWAL

Electronics & Technology Today

One year (12 issues) \$22.95 Two years (24 issues) \$37.95

Computing Now!

One year (12 issues) \$22.95 Two years (24 issues) \$37.95

Computers in Education

One year (10 issues) \$25.00 Two years (20 issues) \$45.00

Outside Canada (US Dollars)

For U.S. please add \$3.00 per year Other countries add \$5.00 per year

NAME _____

ADDRESS _____

TOWN/CITY _____ PROVINCE/STATE _____

CODE _____ DATE _____

POSTAL CODE _____

Cheque enclosed DO NOT send cash

MasterCard Account No. _____

Visa Account No. _____

American Express Account No. _____

Expiry Date _____

Signature _____

To order Books, Back Issues, Binders, Software and Special Publications, see over.

ORDER FORM

Software

_____	\$	_____
_____	\$	_____
_____	\$	_____
Sub Total	\$	_____
Tax (Ontario Residents) 8%	\$	_____
Postage	\$	_____
Total Enclosed	\$	_____

Bookshelf

CODE (e.g. BP12)	TITLE (Short form acceptable)	PRICE
_____	_____	\$ _____
_____	_____	\$ _____
_____	_____	\$ _____
_____	_____	\$ _____
_____	_____	\$ _____

Special Publications

ITEM	QUANTITY	AMOUNT
_____	_____	\$ _____
_____	_____	\$ _____

Binders

ITEM	QUANTITY	AMOUNT
Moorshead Publications \$9.75 each (Ontario Residents add 8% P.S.T.)	_____	\$ _____

Back Issues

\$4.00 each. Ontario residents add 8% P.S.T. Some issues may be out of stock. Please call the Reader Service Department at (416)445-5600 or enclose a self-addressed, stamped envelope for a complete list of available issues.

Orders from the Bookshelf are tax exempt.
Please add \$1.00 for postage.
Ontario residents add 8% P.S.T.
for Specials and Software.

Get the best of professional creative services

- Complete Desktop Publishing
- Expert Editorial Management
- Creative Marketing & Art Direction
 - Professional Photography
 - Extensive Direct Mail Services
- Moorshead Publications Reprints
and much more...

Call
MP
COMMUNICATIONS
Kenneth Marskell
(416)445-5600

A New Division of Moorshead Publications
1300 Don Mills Road, North York, Ontario M3B 3M8 FAX: 416-445-8149

IF YOU WANT TO LEARN PC SERVICING, YOU MUST GET INTO A MICROCOMPUTER!

"ALSO INCLUDES DOT MATRIX PRINTER!"

Learn PC Servicing By Building Your Own (PC-XT Turbo) Desk-Top Computer!

NTS "Home-Study" training gets you right down into the heart of computer circuitry. Learn how microprocessors function, how they operate and are used to solve problems. Your programme includes a wide variety of tests and projects you perform as you build your own PC-XT-Turbo, circuit board by circuit board unit by unit.

Hands-On Training With Your (100% IBM Compatible) PC-XT Turbo Puts You At The Leading Edge of Technology!

This remarkable desk-top Micro-computer is the most powerful and versatile ever offered in any home study course and it's yours to keep.

- IBM is a Registered Trademark of IBM Corporation.
- All Diploma Programmes 100% tax deductible.
- Monthly payment Plan available.

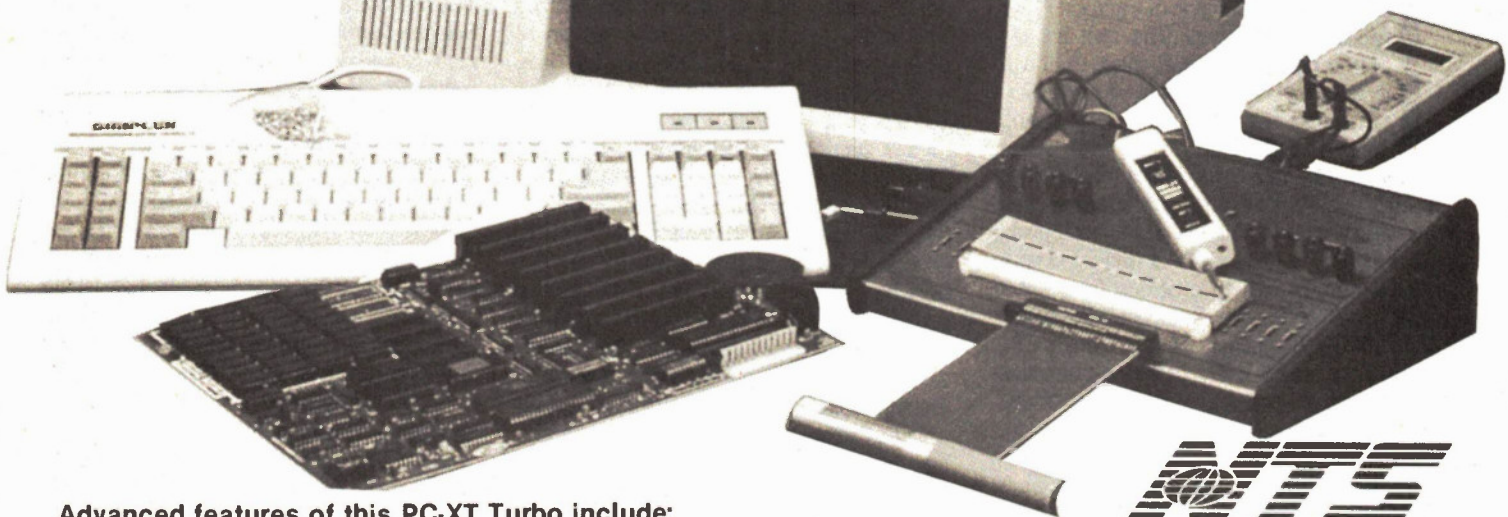

PHONE FOR FREE COLOUR CATALOGUE
842-8383

Advanced features of this PC-XT Turbo include:

- 16 Bit 8088 microprocessor for IBM compatibility • 640K Ram for high speed performance • 8 expansion slots • 135 watt power supply
- Dual 360K double density floppy disk drives • Colour graphics/printer adapter card
- Operating system included: MS-DOS with GW Basic • 4.77 MHz - 8MHz "Turbo".

NTS
TRAINING THE WORLD FOR THE 21ST CENTURY

National Technical Schools
517 Bohemia Cres, Oakville, Ontario
L6J 2K7 (416) 842-8383

School Head Office: 456 W. Martin Luther King Jr. Blvd., Los Angeles, CA 90037

REVIEW

Denon

DAP-5500

A digital preamplifier that's a harbinger of things to come.

TIMOTHY PALMER-BENSON

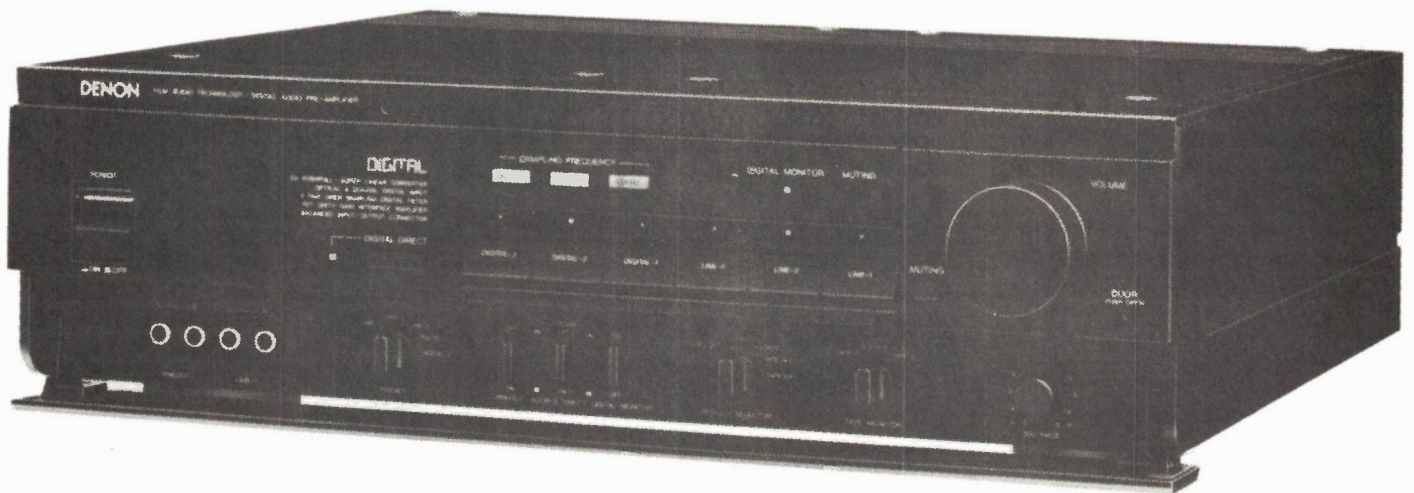

The Denon DAP-5500 is a digital preamplifier in the truest sense and a forerunner of the type of equipment we will see more often. The unit has no phono preamp. Instead, more than half its circuitry is devoted to processing digital signals from different sources and converting them to analog form when required. The idea behind this unit is to have a high quality control preamplifier that can be relied upon to provide consistently good sound from a CD or DAT machine with digital outputs and to provide the cleanest path possible for any analog audio signal. The DAP-5500 does this in style from line in, to line out, and it looks classy with its black anodized front panel, gold lettering and softly lit LED indicators above each input selection button.

The 5500 is one of the heaviest preamplifiers I have ever handled. It harks back to the days when Japanese manufacturers were less concerned about shipping costs. It weighs 13.7kg and measures 434(W) x 133(H) x 380(D)mm. There are

four large isolator feet to support the thick steel and aluminum chassis with two additional smaller feet positioned amidships. The digital and analog sections are completely separate. Each half has its own well-regulated power supply and each is housed in a separate inner chassis. The digital section has additional shielding. Twin bottom plates (for the two separate sections of the preamp) are made out of two sheets of steel with a sheet of vibration absorbing polymer material sandwiched in between them. There are two circuit boards in each section of the preamp which can be easily removed. The boards are positioned one on top of the other and are separated by aluminium plates. The unit has seven inputs, of which three are line and four are digital. Of the digital inputs one is optical and three are coaxial with one of these being assigned for digital tape (DAT). There's a digital monitor output to complete the DAT monitoring loop. A digital direct switch on the front panel makes it possible to disconnect the

digital circuitry or to select the direct output of the digital to analog converters (D/A) without passing the signal through a volume control or additional amplification (see block diagram fig.1). Other outputs pass through a 16.5dB gain amp, a volume and balance control and an FET unity gain buffer amp. There are inputs and outputs with monitoring for two analog tape recorders and in addition to the DAC outputs for left and right channels there are two other line outputs both of which are controlled by the volume control. As is the case with one of the line inputs, one of these pairs of outputs uses female XLRs and provides balanced 600 ohm output.

The DAP-5500 automatically senses sampling frequencies of 32kHz, 44kHz and 48kHz and displays them with a green light on the front panel. A lid folds down along the bottom of the front panel to reveal additional controls. These include a digital monitor switch for a DAT machine, a source direct switch that bypasses the built-in 16.5dB gain amp and a preamp

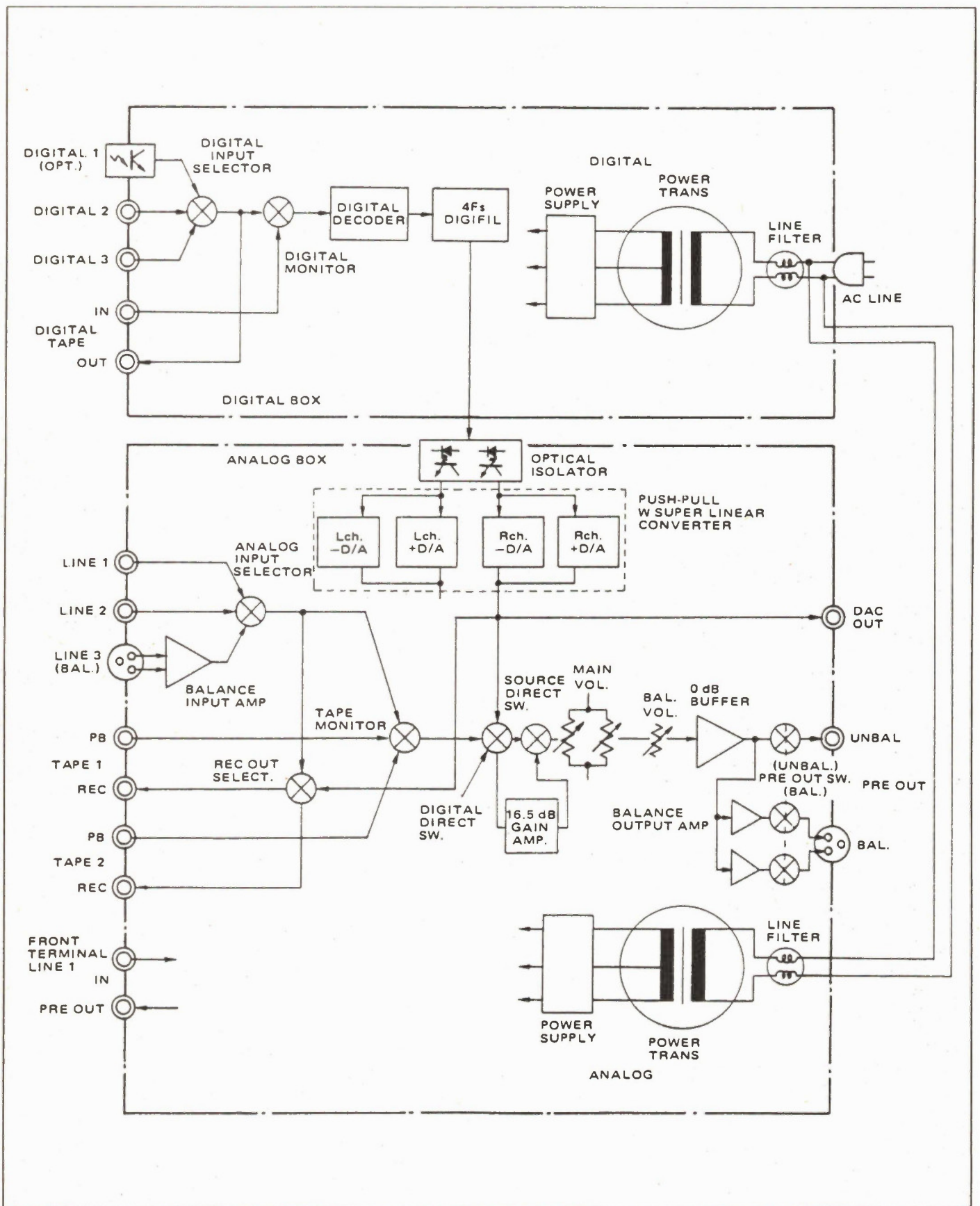

Fig. 1. The block diagram of the Denon DAP-5500 digital preamp.

line output switch. This control affects both the unbalanced and balanced outputs. There the usual switches for tape monitoring and recording, a balance control and analog line outputs and inputs which are connected in parallel with those on the rear panel. There is no headphone jack.

The DAP-5500 uses four times oversampling and four super linear 16-bit converters. Two converters - Burr Brown's tightest tolerance types, the PCM56K, are used for each channel in a push-pull configuration. Their outputs are passed to pair of op amps and then to a pair of gentle analog filters that clean up any out-of-band spurious, but without causing major phase abnormalities (see fig 2). There are four 100k trim pots to adjust the converters for lowest distortion and best monotonicity.

It has been suggested that Japanese manufacturers are adjusting their players for lowest distortion with a 0dB 1kHz non-dithered test tone. Stan Lipshitz, a researcher at the University of Waterloo and an authority of digital audio, says that this method can lead to errors below -70dB and that they can be heard. Professor Lipshitz, who has recently been appointed president of the Audio Engineering Society (AES), says a system with perfect D/A's is capable of delivering zero distortion with a -70dB dithered 1kHz sine wave (a distortionless signal). This not the case with any of the players I have tested. They all exhibit small amounts of distortion at this level - typically between three and four per cent. The DAP-5500, despite its tight tolerance DACs, is no exception, as can be seen in the following graphs.

Figs. 3a and 3b show monotonicity for both channels as played back from the CBS CD-1 test disc, through a Technics SL- P990 CD player that was connected via an optical cable to the DAP-5500's digital input. The monotonicity trace has been captured on an HP3561A spectrum analyzer. The cone shaped trace is produced by 1,102.5Hz square waves, starting at digital zero and rising in ten progressively higher steps. The trace has been subjected to a 1.5kHz low pass filter to remove ringing on the tops of the square waves and show the steps more clearly.

The traces show that the signal on both channels has been inverted and that there is a slight error (1 LSB) in converting the first levels. The error shows up in a spectrum analysis of THD for both channels in Figs. 4a and 4b. These plots show

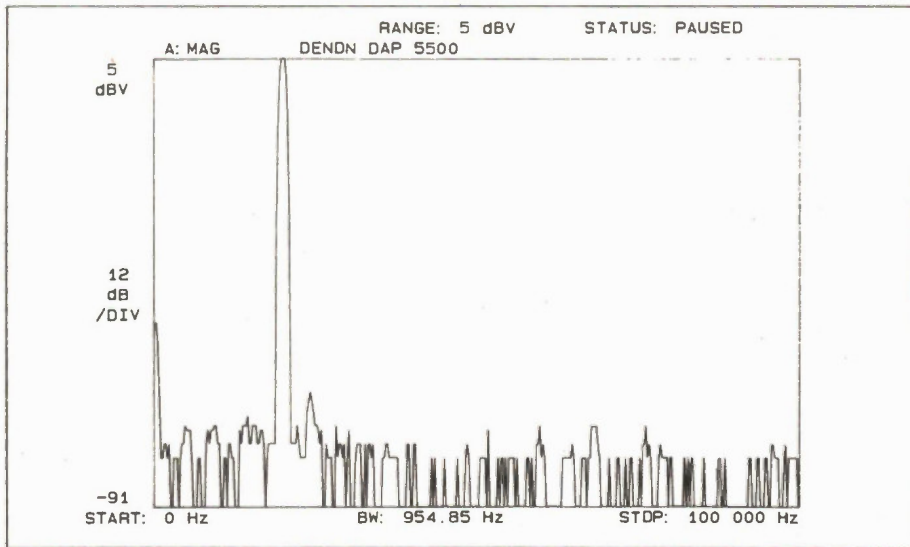

Fig. 2. A spectrum analysis of the Denon digital preamp's left channel output.

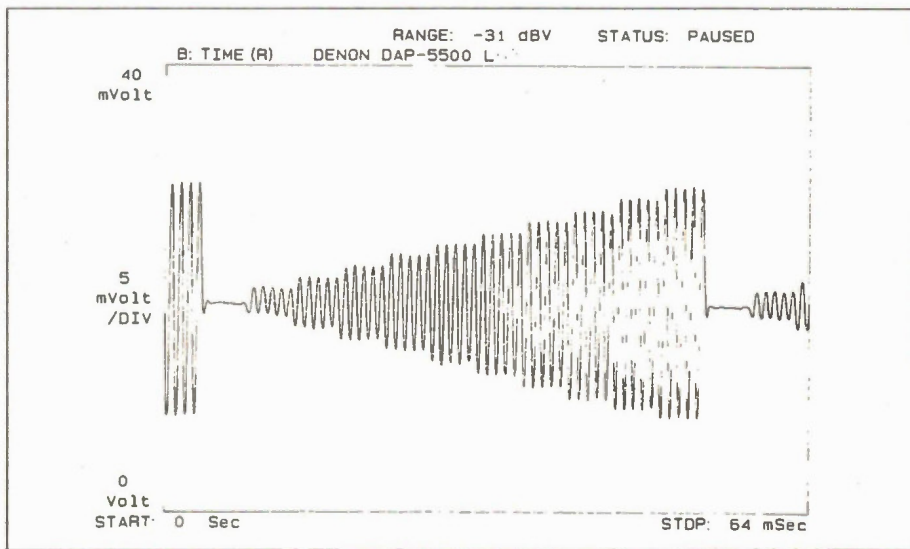

Fig. 3(a). A monotonicity test for the left channel.

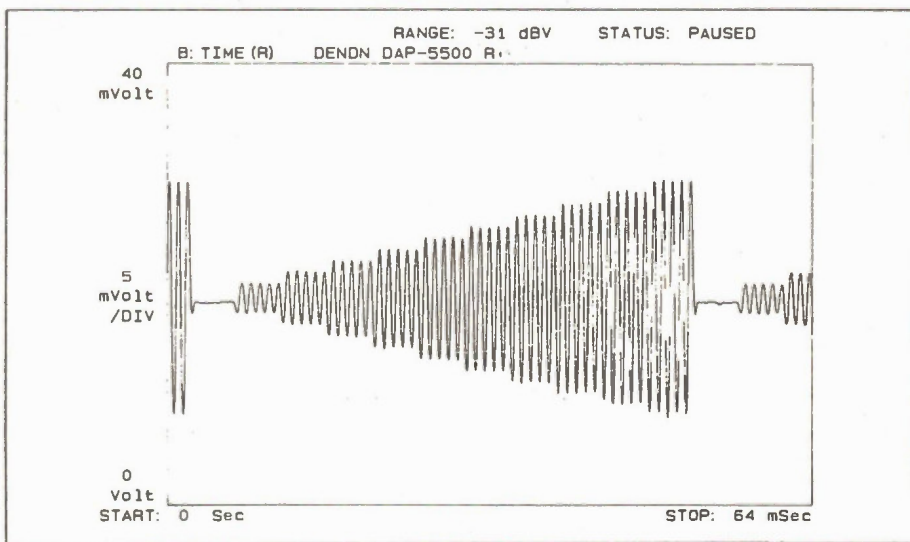

Fig. 3(b). A monotonicity test for the right channel.

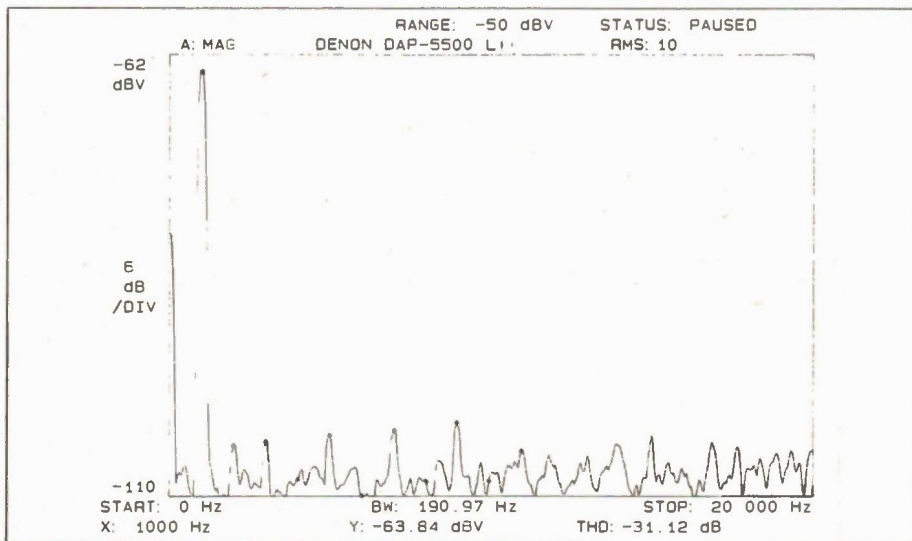

Fig. 4(a). Distortion products for the left channel.

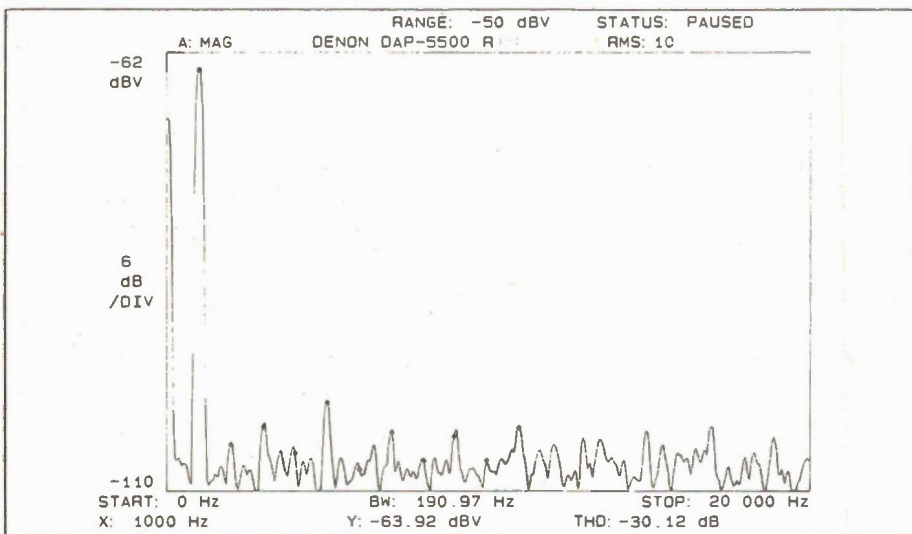

Fig. 4(b). Distortion products for the right channel.

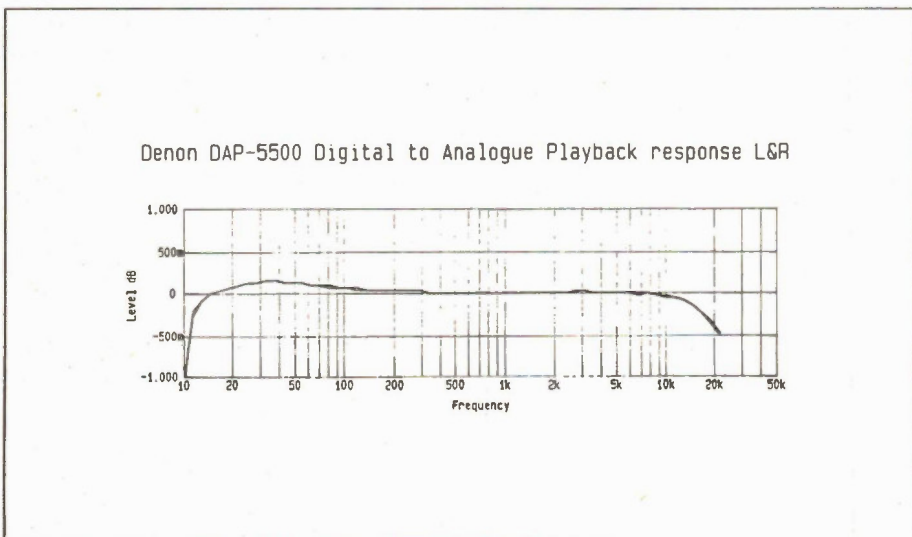

Fig. 5. Playback response of the Denon, left and right.

what the DAP-5500 does with a -70dB dithered 1kHz test tone. THD on the left channel is -31dB or 2.78% while on the right channel it is at -31.12 or 3.12% on the left. It should be noted that the distortion is very nearly buried in the noise and is at a considerably lower level than the fundamental. Readers of my review of the Sony CDP-ESD707 CD player in the October issue of *E&TT* may like to note that the Denon's distortion readings are somewhat lower than the Sony which uses even more trim pots for its converters.

Playback response for both channels was exactly the same at 1kHz. A 0dB signal produces 1.94 volts from the DAC outputs (direct D/A output) on both channels. Maximum output for the same 0dB signal routed through the 16.5dB amplifier measured 12.74 volts on the left channel and 12.67 volts for the right. A frequency response plot (fig.5) shows that both channels are exactly the same. They both show a slight roll off in the high frequencies but only by a half dB - possibly caused by the analog filters. This may account for some listeners describing this unit as having a somewhat warm sound. No differences in frequency response were noted when the same measurement was made via the unit's 16.5dB gain amplifiers but there were slight differences when it came to separation and noise measurements. Left to right separation as measured at the DAC outputs was 97.27 dB at 1kHz while right to left separation measured 97.8dB. This changed to 90.80dB for the left and 90.2dB for the right when measured through the amplifiers. The same slight loss in separation occurred at the extreme high frequencies. At 16kHz, for example, left to right separation was 74.39dB directly via the DACs but 71.05dB via the amplified outputs. Signal-to-noise ratios for both the DAC and regular line outputs were in excess of 100dB on both channels. Also the analog section of the DAP-5500 has lots of headroom. An input will take in excess of 16.5 volts at 1kHz before showing any significant distortion.

In conclusion one has to say that the DAP-5500 digital audio preamplifier is a top quality audio product, even though it has its flaws. Its sound reproduction quality ranks among the best. If you are in the market for a line amp with impeccable analog specs and one that contaminates the signal path the least, this unit will be for you. It is also preamp for those who feel comfortable with digital audio and who have put their turntable away. ■

Shift Register Demonstrator

One of the basic building blocks of digital circuitry explained.

OWEN BISHOP

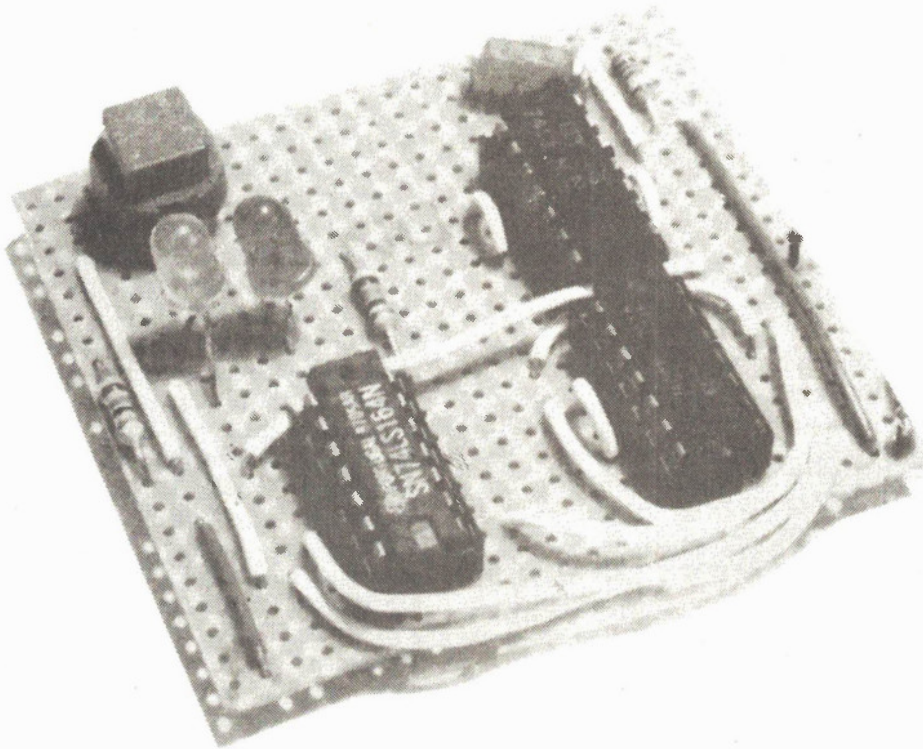

Shift registers, as their name implies, are used for shifting data. They have various designs, of which the one shown in Fig. 28 is a simple example. Here we have a register of four "flip-flops". Each flip-flop can be in the set or reset state, so the register as a whole can hold any of the 4-bit binary values 0000 to 1111.

The flip-flops are connected to each other in a chain and, when the clock input changes from low to high, the data is shifted one step along the chain. Let us see what happens.

A circuit for testing a shift register is shown in Fig. 2, and Fig. 3 shows how to set this up on a breadboard. The shift register used has eight flip-flops, A to H, but we use only the first four to begin with. The clock pulses that make shifting occur are provided by a 555 time IC wired as an astable.

With the resistors and capacitor indicated, the astable runs at 0.48Hz. It delivers an upward-going "clocking edge" to the register every two seconds approximately. This register (IC2) has two inputs, useful for other applications, but here we input *A* 'high' and use input *B*. Fig. 3 shows the input wire unconnected. Before connecting the power to the circuit, push the free end of the input *B* wire into a +V socket in the top row of the breadboard. This gives a high input to *B*.

The four LEDs (D1-D4) show the state of each of the flip-flops *A* to *D*, reading from left to right. When you first switch on, these LEDs all come on, though perhaps not all at once. After a few seconds they are all on, since a high input is being fed into the chain of flip-flops.

Now put the flying lead into one of the sockets in the bottom row of the board (0V). Keep it there until diode D1 goes out, then return it to the top row. Watch the LEDs. Can you see the "low" input being shifted along the chain? Repeat this a few times, until you understand just what is happening.

Try putting the flying lead into the 0V socket for differing lengths of time. Watch the pattern of highs and lows being shifted along.

When you have finished, leave the circuit connected, as we shall be adding to it later.

Applications

The register used above had *serial input*; the data is fed into it one bit at a time. It has *parallel output*; each flip-flop has its own output terminal. Thus, this is a *serial-*

in/parallel-out register, or SIPO for short.

If you want *serial* output (perhaps to feed to another 8-bit register) this can be taken from the output of register *H*. So this is also a SISO (serial-in/serial-out) register. Other types of register are available with parallel input and serial output (PISO) or with parallel input and parallel output (PIPO).

Each type has its uses, especially in computers where data often needs to be shifted. For example, you may have a byte of data that has to be sent along a pair of wires to a printer. The data is put into an 8-bit PISO register, eight bits at once. Then it is shifted out a bit at a time and fed down the wire to the printer.

Shifting is used for calculations in the microprocessor itself. For example, the decimal value 116 is represented in binary by:

1110100

If this is shifted one place to the right, it becomes:

0111010

This has a decimal value 58. Shifting the binary digits one place to the right is equivalent to dividing by two. Conversely, shifting one place to the left is equivalent to multiplying by two.

Shift registers shift either right (like the one we used above) or to the left, and some can be controlled so as to shift either way. With these we can rapidly multiply or divide by two or its multiples. We would normally use a PIPO register for such calculations.

Random - Or As Good As

An extension of the demo shift register circuit to create "random" sequence is shown in Fig. 4. Fig. 5 shows how to modify the breadboard component layout. The output from the two last stages of the register are fed to a network of NAND gates and the output from this network is fed back to the input, pin 2, of the register.

The gates are connected to make up an EX-OR (exclusive-OR) gate. We could have used a ready-made gate in a 7486. The logic of EX-OR is "A or B but not both". Its truth table is:

INPUT OUTPUT

A	B	
0	0	0

0	1	1
1	0	1
1	1	0

A shift register with two of its outputs EX-ORed together and fed back to the input has interesting properties. Connect the battery and watch what happens.

If by chance none of the LEDs comes on, disconnect the battery and try again. Obviously, if all flip-flops hold "0" (low), both outputs will be "0", the output of the EX-OR gate will be "1", and a series of zeros will be fed back, indefinitely.

If at least one of the flip-flops holds

"1" (high) to begin with, try to write down the stages as they occur. How many different combinations of "0"s and "1"s can you record?

Do they occur in a regular sequence? Does the sequence repeat? If so, how often? The answers are at the end. Incidentally, if you find things shifting too fast, slow the clock down by substituting a 22u or 47u capacitor for C1.

You could try using other pairs of outputs from the register and find out what sequences you obtain. When you have finished, keep this circuit wired up as we shall be coming back to it later.

PARTS LIST

SHIFT REGISTER

Resistors
All .25W, 5%

R1,2..... 100k
R3-7..... 180

Capacitors
C110u (see text)
C2 100u elec.

Semiconductors
D1-5 LED
IC1555 timer
IC2 74164 TTL 8-bit shift reg.
IC3 ..7400 quad 2-in NAND

Miscellaneous
Breadboard, B1 ^ V battery and connector, wire, etc.

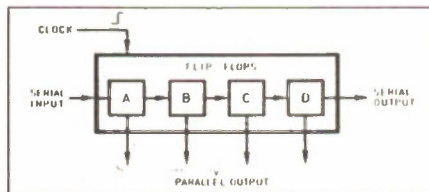

Fig. 1. A SISO/SIPO shift register.

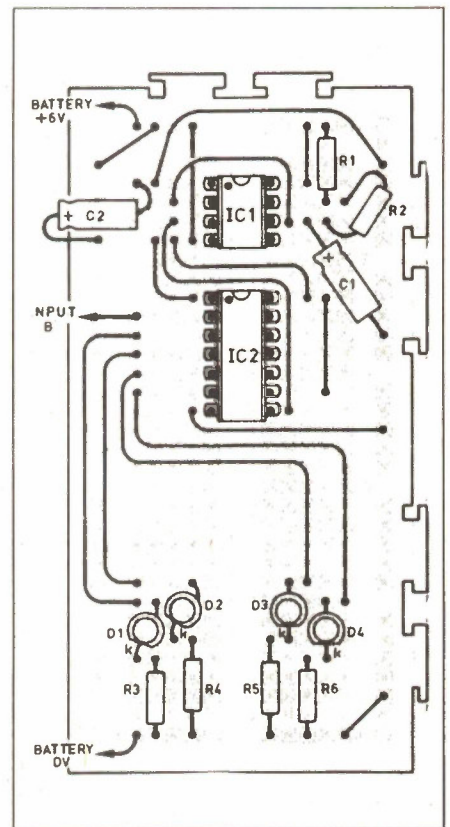

Fig. 3. Shift register demonstration board component layout.

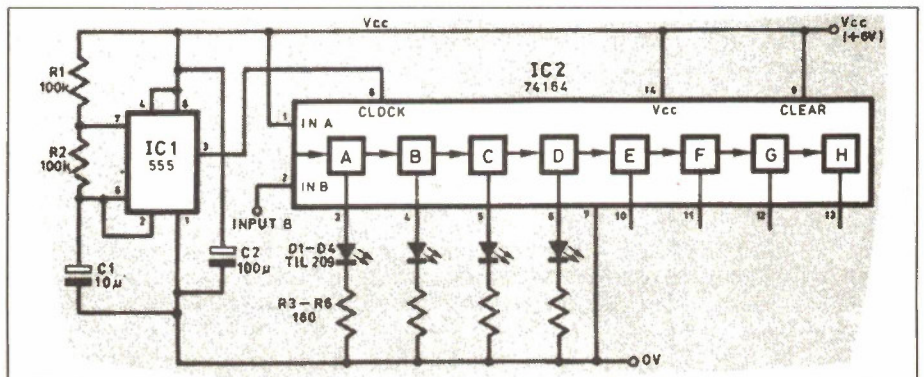

Fig. 2. Circuit diagram for investigating a shift register.

Pseudo-Random Sequences

Given any one combination of "1"s and "0"s in the register it is not difficult to work out what the next combination will be. For example, if we have "0110", the last two digits are unlike, so their EX-OR is "1" (see truth table). Shifting the existing digits gives "011", and the result of EX-ORing is put in on the left, giving "1011".

Working in this way, you can confirm that the sequence repeats itself after 15 steps, as listed opposite. However, though it is easy to do this in the simple case of 4-bits, it becomes tedious when there are many flip-flops in the register.

With seven flip-flops, there are 127 steps. With 33 flip-flops there are so many steps that it takes about two hours to run through the sequence *once* — even with

the clock running at 1MHz (one million shifts per second). With 100 flip-flops and a clock rate of 10MHz, the time taken to run through the sequence is longer than the age of the universe!

Even with a shift register of reasonable length (say, a dozen or so flip-flops) the sequence is so long that it is virtually impossible to memorize it. Although, strictly speaking, it is predictable, it is not practicable for anyone to know what the next combination of digits will be. It *appears* to be unpredictable. In other words, the sequence is *pseudo-random*.

The situation is similar to that in which a numerical algorithm is used to generate a series of pseudo-random numbers. Although the sequence repeats itself after many numbers have been generated,

and although it is possible to calculate what the next number will be, it is just not practicable to do so and the series can be used as if it were truly random.

Pseudo-Random Noise

Replace C1 with a 100nF capacitor, to speed the clock up to 480Hz. Connect the battery and watch the LEDs. They should now flicker in an *apparently* random way, like the flickering of a candle flame in a draught.

Connect a crystal earphone to the circuit, see Fig. 6. You should hear an *apparently* random series of crackles. This "random" noise is called "white noise". It is something that we often want to get rid of as it produces unwanted hissing and rushing sounds that spoil our hi-fidelity audio. But sometimes, we wish to generate white noise for sound effects and we normally do this by using a shift register.

Sound effects chips contain a long register (about 17 flip-flops) used for this purpose. By clocking at different rates, and taking the output from different stages we are able to produce different kinds of white noise under controlled conditions.

When you listen to the white noise from a 4-bit register, you can hear that the sequence repeats fairly often. Try using seven flip-flops, taking the outputs from F and G (pins 11 and 12) instead of C and D.

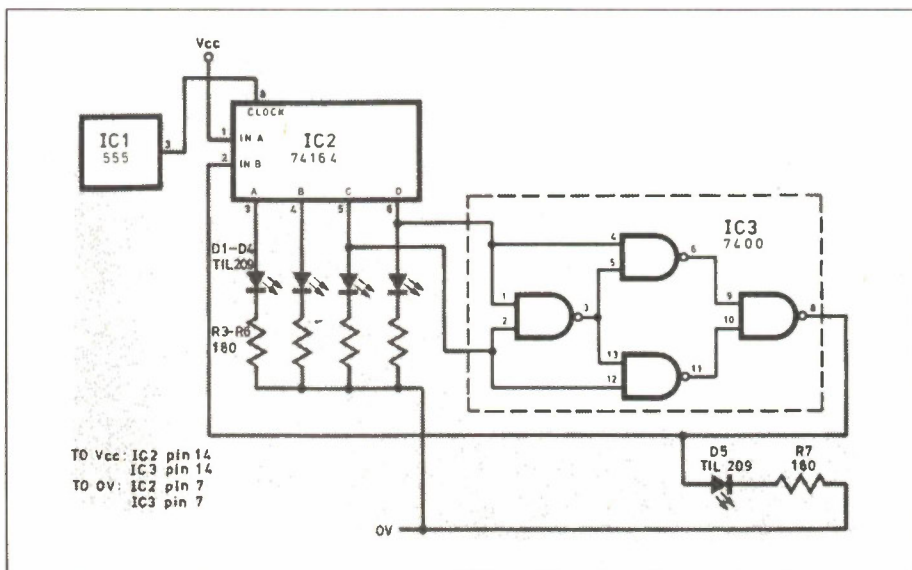

Fig. 4. Circuit diagram for a Pseudo-Random Sequence Generator.

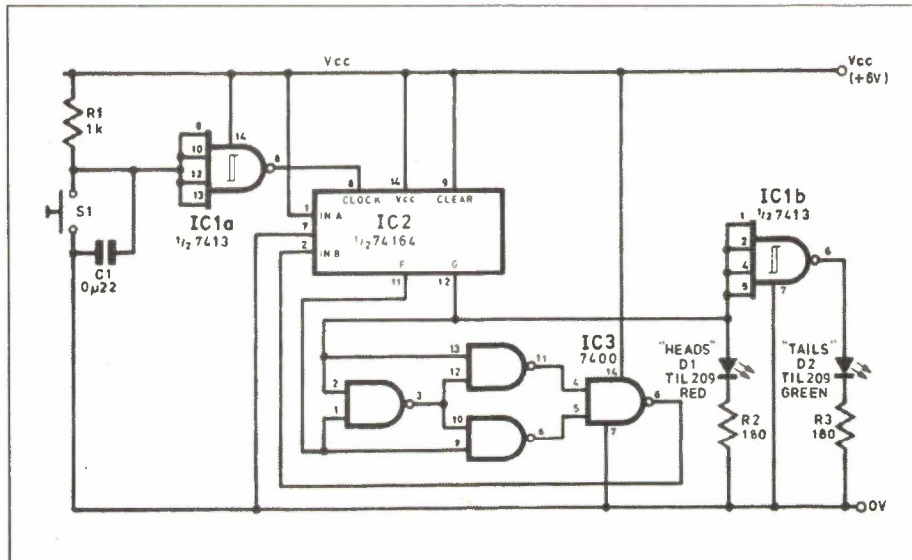

Fig. 7. The circuit diagram for creating a Pseudo-Random Heads or Tails.

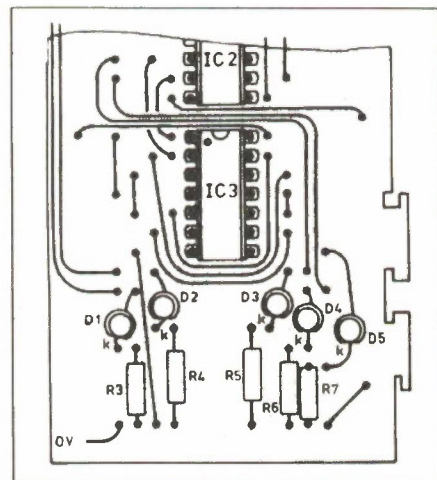

Fig. 5. Layout of components for random sequence.

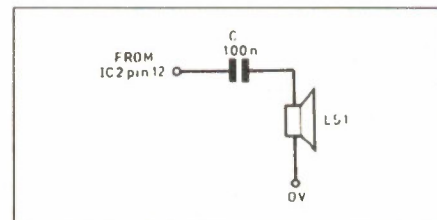

Fig. 6. Using a crystal earphone to listen to the random output.

CLIPART

FOR PC AND MACINTOSH

If you have begun using the popular Ventura desktop publishing software package, you'll know how much graphics can dress up your documents. However, unless you have a scanner and a ready source of hard copy clip art at your disposal... or a paint box program and a great deal of time... it's very nearly impossible to find spot illustrations in picture files. At least, it used to

be. Almost Free Ventura ClipArt picture collections are disks full of image files. They will work with Ventura 1.1, and we include a utility to make them suitable for use with the original 1.1 release or the patched one. Each disk has a variety of pictures, both for spot illustrations and full pages. They're suitable for reproduction on any output device. Only \$19.95 each.

VOLUME 1

- BABY
- BELVEDERE
- BLUES BROTHERS
- BLUENUN
- BUGS
- CHEETAH
- CLIPART
- FISHES
- GIRLWING
- KNOT
- KOALA
- LETTER A
- HEARTS
- WOMAN
- RELATIVITY
- SCAN
- ESCHER WATERFALL

VOLUME 2

- AIRCRAFT
- BUTTERFLY
- CAR LOGOS
- COLLECTORS CARS
- MORE CLIP ART
- CUBE
- DANCERS
- DRAGON
- GLASSES
- GREYHOUND
- HANDS
- MORE KNOTS
- LEATHER GODDESS
- MINOTAUR
- SKELETON
- TIGER
- ANOTHER WORLD
- ZEBRA GIRL

VOLUME 3

- BADNEWS
- DRAGONS
- DREAM
- KIDS1
- MEN1
- WOMEN1
- MONALISA
- CAT
- RHINO
- TRIANGLE
- OLDMAN
- SHELL
- BEACH
- FLOWER
- PAISLEY

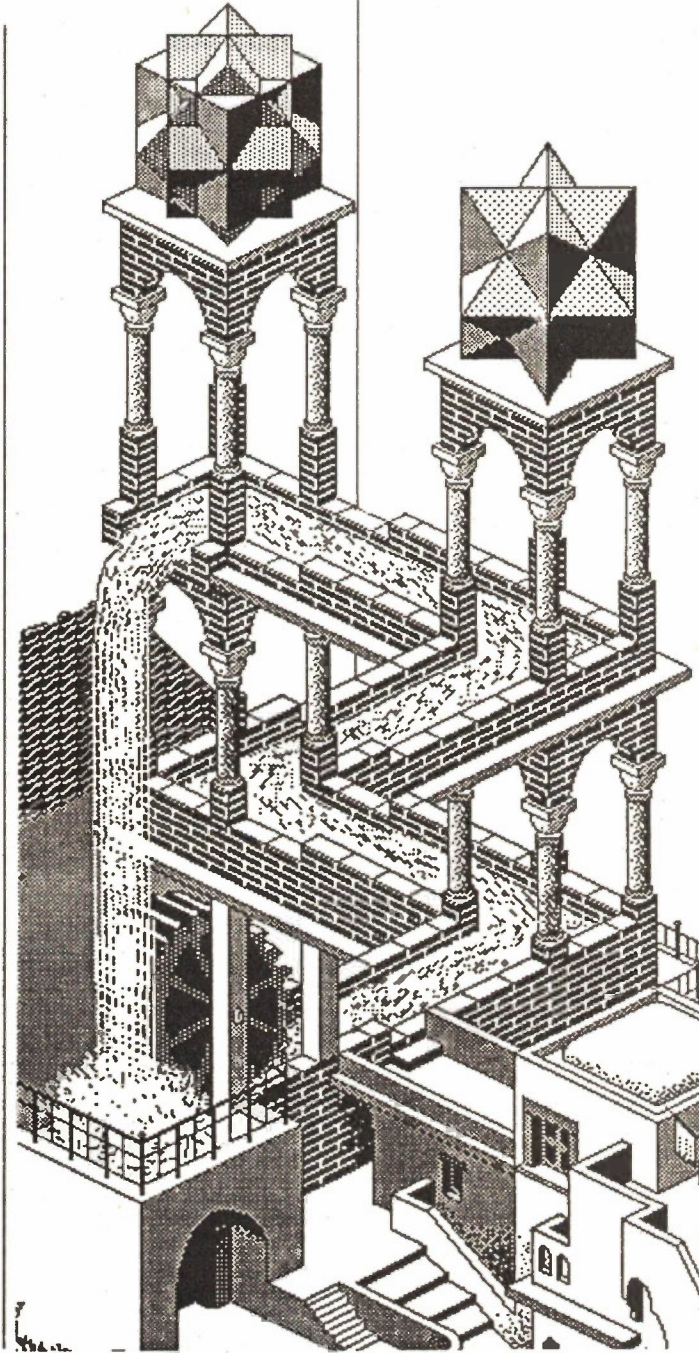

VOLUME 4

- BUDBRAIN
- DRAGON2
- SKULLS
- KIDS2
- MEN2
- WOMEN2
- PERSUIT
- SUNDIAL
- PORCHE
- EASTWOOD
- VANGOGH
- IBM WARS
- STELLA
- QUADRANT
- YAWN

VOLUME 5

- BIRD
- BOOP
- BORDER
- CLIPART1
- CLIPART2
- CONAN6
- COUPLES4
- DRAGONX
- ELEGANT
- HUNTED
- KIDS3
- KRAZYCAT
- MEN3
- SCRAPS
- SCROOGE
- SPLINTR
- WOMEN3

VOLUME 6

- AUSTRAL
- CLIPART3
- CLIPART4
- CONAN1
- CORNCOCK
- DONATELL
- IBMGIRL
- KIDS4
- MEN4
- NEWMACS
- PANEL
- PINUP
- POOH
- SPORTS
- WOMEN4

ORDER THESE DISKS FOR \$19.95 EACH, PLUS 8% O.S.T., FROM MOORSHEAD PUBLICATIONS
 1300 DON MILLS ROAD, NORTH YORK, ONTARIO M3B 3M8 (416)445-5600 FAX:416-445-8149

THE PC VERSIONS OF THESE IMAGE COLLECTIONS INCLUDE A UTILITY TO CONVERT THE MACPAINT IMAGE FILES TO IMG FILES FOR EASY INTEGRATION INTO VENTURA DOCUMENTS, AS WELL AS THE MCSCOOP PAINT FILE VIEWER. THE MACINTOSH VERSIONS INCLUDE MCSCOOP AND ARE SUITABLE FOR USE WITH PAGEMAKER, READY,SET,GO, QUARK, WORD AND ALL MACINTOSH APPLICATIONS USING MACPAINT FORMAT IMAGE FILES.

This gives 127 stages in the sequence. Try increasing the clock rate by further reducing the value of capacitor C1.

We cannot easily use all eight flip-flops because an 8-bit register needs three outputs to be EX-ORed to get a long sequence. With only two outputs the sequence is short — as you can work out for yourself, on paper.

Heads Or Tails

We conclude with a simple project to demonstrate the shift register IC as a heads-or-tails generator. Heads or tails devices usually consist of a fast-running clock that you can stop by pressing a button.

Depending on whether the clock is “high” or “low” when it is stopped, the result is “heads” or “tails”. The randomness of this result depends on *you*, not the electronics.

Moreover, unless the clock’s output is high for *exactly* as long as it is low (i.e. it has a mark-space ratio of exactly 1), then the result is biased. An exact mark-space ratio is difficult to achieve and to maintain.

The Pseudo-random Heads or Tails circuit (Fig. 7), based on a 7-bit shift register, takes the output from register G. A high output turns on the red “heads” LED. A low output turns on the green “tails” LED.

It is slightly biased, since the 0000 state is not allowed, and in continuous series of 127 “throws” there will be 64 heads and 63 tails. Betting on “heads” gives you a marginal chance of profit!

Remember that the sequence is only pseudo-random, not truly random. In theory, you could memorize it and be able to “predict” the next result. But it is highly unlikely that any normal person could succeed in such a feat of memory and recognise how far along they were in the sequence. So, *in practice*, this is as random as spinning a coin.

The “throw” is made by pressing switch S1. This is debounced by the Schmitt trigger gate IC1a, to give a single clean transition from low to high when S1 is pressed. It clocks the shift register IC2 one step. The EX-OR gate IC3 is made from four NAND gates, as before.

The output from flip-flop G is fed directly to the red LED (D1). It also goes to the other Schmitt gate IC1b, used simply as an inverter, to turn the green LED (D2) on when G is low.

Construction

The stripboard component layout for the Heads or Tails circuit is shown in Fig. 8.

Commence construction by making all the breaks in the copper strips as indicated in the underside view. These should be checked carefully before tackling the top-side components.

The IC holders, terminal pins and link wires should now be carefully soldered in position. It is a good idea to double-check these connections before finally soldering.

Next the resistors, capacitors, LEDs and push switch S1 should be soldered in place. This should be followed by the supply leads and the completed board given a final checkover prior to connecting the battery B1.

Answers

The sequence is as follows — 1111, 0111, 0011, 0001, 1000, 0100, 0010, 1001, 1100, 0110, 1011, 0101, 1010, 1101, 1110, and then repeats.

There are 15 stages, representing all the 4-bit binary values, 0001 to 1111 (but not 0000, for reasons explained earlier). ■

PARTS LIST

HEADS OR TAILS Resistors

All .25W, 5%

- R1 1k
- R2,3 100

Capacitors

- C1 0.22u

Semiconductors

- D1 red LED
- D2 green LED
- IC1 ... 7413 dual 4-in Schmitt
- IC2 74164 8-bit shift reg.
- IC3 .. 7400 quad 2-in NAND

Miscellaneous

Stripboard, 3 14-pin DIP sockets, S1 press-to-make pushbutton, B1 6V battery and connector, wire, etc.

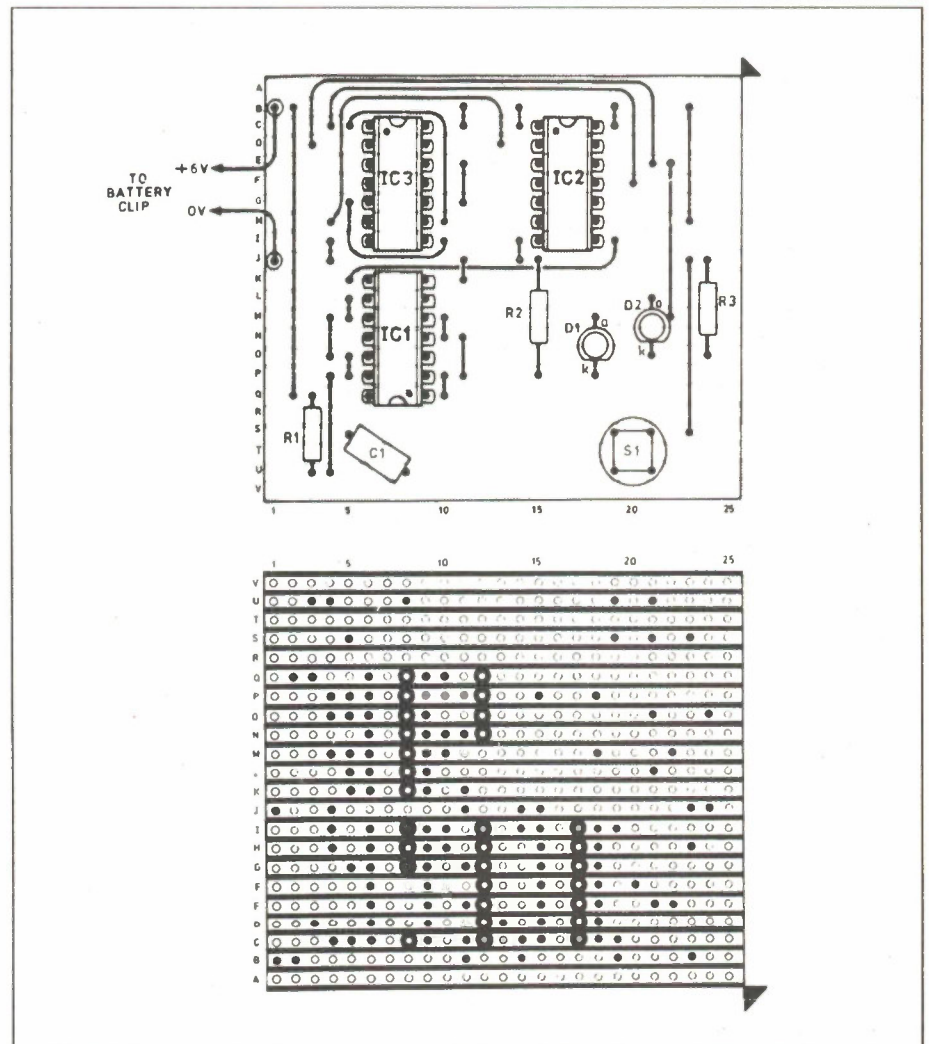

Fig. 8. Stripboard component layout for the Heads or Tails circuit.

ORION SYSTEM 88

4.77/10 MHZ MOTHER BOARD. 256K MEMORY
360K DISK DRIVE AND ADAPTER. MONOCHROME OR COLOUR VIDEO ADAPTER.
SERIAL. PARALLEL. GAME. CLOCK PORT.
150W POWER SUPPLY. AT KEYBOARD.

\$599



ORION SYSTEM 286

610/12.5 MHZ MB. 512K MEMORY
1.2MB DISK DRIVE. 16 BIT DISK CONTROLL
MONOCHROME OR COLOUR VIDEO ADAPTER.
SERIAL. PARALLEL. GAME. CLOCK PORT.
200W POWER SUPPLY. AT KEYBOARD.

\$1295

ORION SYSTEM 386

1MB MEMORY. 16/20 MHZ MOTHER BOARD.
1.2MB DISK DRIVE. 16 BIT DISK CONTROLL
MONOCHROME OR COLOUR VIDEO ADAPTER
SERIAL. PARALLEL. GAME. CLOCK PORT.
200W POWER SUPPLY. AT KEYBOARD.

\$2495

ORION PORTABLE SYSTEMS

9" AMBER DUAL CRT 1295.00 1895.00 2995.00
LCD 600x400 SCRN 1645.00 2245.00 3345.00
PLASMA 600x400 S 2395.00 2995.00 4095.00

CALL FOR THE LOWEST CUSTOM QUOTES

HARDWARE, SOFTWARE & PERIPHERALS AT DISCOUNT PRICES

SEAGATE HARD DISK SYSTEM

20MB (DRIVE CONTROLLER/CABLE) 399.95
30MB (DRIVE CONTROLLER/CABLE) 429.95

WE CARRY THE MOST EXTENSIVE LINE OF
REG. OR HIGH DENSITY DRIVES & CONTROLLERS.
(CALL FOR A COMPLETE PRICE LIST!)

FLOPPY DISK DRIVES

PANASONIC OR EPSON (YOUR CHOICE)
5 1/4" 360K DSDD 119.95
5 1/4" 1.2M HIGH DENSITY 139.95
3 1/2" 720K DSDD 128.95
3 1/2" 1.44M HIGH DENSITY 146.95

HARDWARE & MOUNTING BRACKET -
FROM 3" - 5" 9.95

HARD & FLOPPY DISK CONTROLLER

XT FLOPPY CONTROLLER 39.95
XT HIGH DENSITY CONTROLLER 74.95
XT HARD DRIVE CONTROLLER 65.95
XT RHL HARD DISK CONTROLLER 99.95
AT HARD DISK/FLOPPY CONTROLLER 109.95
AT RHL HARD DISK CONTROLLER 299.95
AT HARD DISK CONTROLLER 199.95

80M TAPE BACKUP SYSTEM FROM

..... 895.00

MODEMS / FAX

1200 HAYES COMP. INTERNAL 99.95
1200 HAYES COMP. EXTERNAL 129.95
2400 HAYES COMP. INTERNAL 189.95
2400 HAYES COMP. EXTERNAL 199.95
FAX CARD 4800 WITH SOFTWARE 99.95
FAX CARD 9600 WITH SOFTWARE 99.95
PANAFAX UF-150 WITH PHONE 1895.00
PANAFAX UF-250 WITH PHONE 2585.00

SCANNERS

HANDY SCANNER 2.5" 299.95
HANDY SCANNER 4" 375.95
LOGITECH SCANNER 4" 399.95
CAT IMAGE SCANNER (FOR PRINTER) 299.95
CHINON DESK SCANNER 896.95
SHAPE DESK TOP 1295.00

MICE

LOGITECH SERIAL 99.95
LOGITECH BUS 119.95
LOGITECH HIRES 149.95
LOGITECH 2 BUTTON 89.95
MOUSE PAD FROM 7.95
IBM COMPATIBLES JOY STICKS FROM 29.95
JAVIS CANADIAN MADE 54.95

DIGITIZERS

KEWAM CT 1170 1000 LINE/INCH 495.00
TITAN KT2000 400 LINE/INCH 580.00
TITAN KT3000 1000 LINE/INCH 595.00

POWER SUPPLIES

1500 ULCSA 99.95
2000 ULCSA 139.95
2000 ULCSA FOR TOWER CASE 189.95
AT STYLE CASE FULLY FIT FROM 189.95
-XT OR BABY AT MOTHER BOARD 89.95
AT FULL SIZE CASE WITH HARDWARE 109.95
AT TOWER CASE 229.95

PORTABLE FOR AT OR XT WITH POWER SUPPLY

- 9" DUAL AMBER MONITOR, KEYBOARD 695.00
LCD PORTABLE WITH POWER SUPPLY KEYBOARD 1190.00
SAME AS ABOVE BUT PLASMA DISPLAY 1795.00

KEYBOARDS

XT/AT 5080 STANDARD 84 KEY KEYBOARD 89.95
XT/AT ENHANCED 101 KEY KEYBOARD 89.95

IBM COMPATIBLE BOARD

MOTHER BOARD
4.77/10 MHZ XT OK 395.00
6.8/12 MEG AT 286 OK 475.00
10/12 MEG. AT 286 4MEG EMS OK 475.00
16/20 286 "NEAT" 595.00
16/20 386 4MEG EMS OK 1290.00

VIDEO ADAPTER

MGA HERCULES COMP. W/ PRINTER PORT 69.95
CGA COLOR GRAPHIC VIDEO ADAPTER 69.95
EGA 840x350 256K 199.95
SUPER MGA 840x480 256K 299.00
EGA 800x600 395.00
ATI GRAPHIC SOLUTIDN 199.00
ATI WONDER CARD 359.00
GT MGA/CGA AUTO SWITCH 149.00
SXT/VIP MGA/CGA/EGA/VGA 459.00

VO CARDS
XT PARALLEL PRINTER PORT 59.95
XT RS232 SERIAL PORT 29.95
AT NAME PORT (TWO PORT) 39.95
XT MULTI I/O (S/P/C/I/G/DISK CONTR) 89.95
XT GAME PORT (TWO PORT) 29.95
AT NAME PORT (TWO PORT) 39.95
TIME CARD WITH BATTERY BACK UP 49.95
SXT/VIP MGA/CGA/EGA/VGA 459.00
AT I/O SERIAL/PARALLEL 99.95
AT I/O SERIAL/PARALLEL/GAME 79.95

MEMORY CARDS

XT 576 RAM CARD OK 54.95
XT 2 MEG EMS 31 3.2 4 OK 129.00
AT 2 MEG EMS. OK 149.00
2.5 MEG EXPANSION CARD 109.00

APPLE COMPATIBLE COMPUTER

BOARDS
III LASER 128EX II + II-III COMP. 649.00
LASER DISK DRIVE "C" COMPATIBLE 199.95
LASER DISK DRIVE II + COMPATIBLE 199.95
90 COLUMN CARD AUTO SWITCH 99.95
220 CARD FOR CPM 69.95
SERIAL PRINTER CARD MODEM/ PRINTER 99.95
NICE PARALLEL PRINTER CARD 99.95
16K RAM (LANGUAGE CARD) 69.95
SPEECH CARD 75.00
COLOR MODULATOR KIT 19.95
POWER SUPPLY 119.95
DISK CONTROLLER CARD 69.95

SPECIALTY INDUSTRIAL BOARDS FOR IBM COMPUTERS

SA-1208D ANALOG INPUT 495.00
SD-1203 ANALOG OUTPUT BOARD 535.00
SC-1832 A/D DAQ CARD 495.00
SI-3232 INDUSTRIAL CONTROL MODULE 549.95
SI-7210C IEEE 488 CARD (GPIB) 349.95
SI-8255 8255 I/O CARD 149.95
SI-8255 RS422 CARD ZACTIVE PORT 119.95
SI-5124 FROM WRITER FOR 4EPRPM 299.95

WE CARRY A LARGE SELECTION OF EMPROM WRITER, UNIVERSAL PROGRAMMER, IC TESTER PAL, PROGRAM WRITER (CALL FOR INFO).

AB SWITCH BOXES SERIAL/PARALLEL, AUTO - OR MANUAL, WITH/ WITHOUT BUFFERFROM 39.95
GENDER CHANGER DB9/15 F/5/ F/ M/ M/ CONVERTERS, BOOSTERS, MINTESTERS.

LOCAL AREA NETWORK SYSTEM

UPS 110/210 ARCNET LANCARD 229.00
UPS 1000 ETHERNET LANCARD 349.00
UPS 400 4PORT ACTIVE HUB CARD 229.00
UPS 400 4PORT PASSIVE HUB CARD 59.95
UPS 808 8PORT ACTIVE HUB CARD 496.00

CALL FOR FULL INFORMATION.

HIRES MONITORS

OLDSTAR
4215 RGB 399.95
4395 EGA 499.95
4330 VGA 509.95
2115 12" AMBER SWIVEL BASE 139.95
2025 12" AMBER COMPOSITE 129.95
PACKARD BELL AMBER SWIVEL BASE 129.95

TTX MONITORS
1201A 12" COMP. AMBER MONOCHR. 129.00
1402FA 14" 179.00
1452FW 14" VGA AN WHT FL. SCREEN 199.95
2410 14" RGB 43mm PDL. TLT/TSW 399.00
2410AG 14" RGB 43mm A.G.L. TLT/TSW 445.00
2411 14" RGB 39mm PDL. TLT/TSW 475.00
2411AG 14" RGB 39mm A.G.L. TLT/TSW 499.00
2412 14" EGA 39mm A.G.L. TLT/TSW 475.00
2422 14" EGA 31mm A.G.L. TLT/TSW 599.00
1435 14" MULTI SYNC 850.00
1310 12" ELECTROHOME M. SYNC 1099.00
1810 12" ELECTROHOME M. SYNC 3250.00

DATATRIN MONITORS, COLOUR

DC2005 14" 41mm DOT P. RGB T/S 449.95
DC2055 12" AMBER COMPOSITE 349.95
DC3535 14" 31mm D.P. EGA/CGA/T/S 549.95
DC355 DOT PITCH 41mm EGA/CGA 479.95
CC505 DOT PITCH 41mm VGA 499.00
CC900 M. RES. VGA/DIG. D.P. 31mm 979.95

DATATRIN MONITORS, MONOCHROME

V240A 12" AMBER COMPOSITE 139.95
V242 12" TLT AMBER OR GREEN 139.95
V252 12" M. RES. MONO AMBER/GN 149.95
V262A 12" FLAT SCREEN TLT AMBER 159.95
V272 14" DUAL FREQ. AMBER/WHT 189.95
V282 14" D. FREQ. FLT. SCRN. AMBER 199.95
V502 12" AN.G. VG.A/M.C/S MONO WH 199.95

PRINTERS

ROLAND PRINTERS
PR1012 144CPS DOT MATRIX 249.95
PR1112 192CPS DOT MATRIX 299.95
PR1212A 219CPS DOT MATRIX 475.95
PR1250 288CPS DOT MATRIX 549.95
PR1215 218CPS WIDE CARRIAGE 699.95
PR1550 288CPS WIDE CARRIAGE 799.95
PR2450 288CPS WIDE CARRIAGE 999.00
PR2017 17CPS DAISY WHEEL 449.95

EPSON 9 PIN DOT MATRIX PRINTERS

LX-800 180/150CPS DRAFT/3025 NLO 275.00
LX-800/4 180/150CPS DRAFT/3025 NLO 449.00
EX-1000 250/45CPS DRAFT/NLO SL. TP 899.00
EX-800 250/45CPS DRAFT/NLO SL. TP 899.00
FX-1050 264/54CPS D/NLO 132CL.SPK 899.00
FX-256 200/40CPS D/NLO 132CL.SPK 799.00
FX-850 265/54CPS D/NLO SMART/PAK 659.00
FX-96E 200/40CPS D/NLO 80 CLMM 849.00
24 PIN LETTER QUALITY DOT MATRIX PRINTERS
LQ-1050 264/220/80/73CPS 1066.00
LQ-1050 270/90CPS DRAFT/NLO 1499.00
LQ-500 180/80CPS DRAFT/NLO ESCIP 575.00
LQ-550 284/220/73CPS 895.00
DX-10 EPSON 10CPS DAISY WHEEL 349.00
SQ-2500 54/180CPS DRAFT/NLO 299.00
24 NOZZLE INK JET 132 CDL 1495.00

STAR PRINTERS

NX-1000 144CPS 299.00
NX-1000C 144CPS 299.00
NX-1000 144CPS COLOUR 399.00
NX-1000 144CPS COLOUR 399.00
NX-15 120CPS 549.00
NR-10 240CPS 599.00
NR-15 240CPS 799.00
NX-2400 170CPS 549.00
NB24-10 218CPS 775.00
NB24-15 218CPS 995.00
LASER PRINTER

ORION DISKETTES

100% ERROR FREE & LIFETIME WARRANTY

ORION BRAND 5 1/4" DISKETTES

DD2D 360K DS/DD 8.95
DD2H 1.2M DS/HD 17.50
FOR COLOUR ADD 3.00

ORION BRAND 3 1/2" DISKETTES

OF2D 1M DS/DD 18.95
DF2H 2M DS/HD 49.95
FOR COLOUR ADD 4.00

NO NAME DISKETTES

5 1/4" DS/DD 360K 4.99
FOR COLOUR ADD 3.00
3 1/2" 1M 14.99
FOR COLOUR ADD 4.00

FOR QUANTITY DISCOUNTS CALL

KAO

KAO is for keeps

KAO MD2D 5 1/4" 360K DS/DD 8.95
KAO MD2H 5 1/4" 1.2M DS/HD 18.95
KAO COLOUR DISKETTES ADD 3.00
KAO MF2DD 3 1/2" 1M DS/DD 22.50
KAO MF2H 3 1/2" 2M DS/HD 49.95
KAO COLOUR DISKETTES ADD 4.00
KAO DISCARO 3 1/2" 1M POUCH 29.95

ROLAND PLOTTERS

DXY-980A B-SIZE 8 PEN 1398.00
DXY-885 B-SIZE AUTO PEN 1995.00
DXY-908A B-SIZE ELECTROSTATIC 1069.00
DX1000 B-SIZE ELECTROSTATIC 2198.00
DXP-2200 C-SIZE FLATBED 5750.00
DXP-3300 D-SIZE FLATBED 5995.00
DXY-1100 A/B SIZE 8 PEN 1348.00
DXY-1200 A/B SIZE ELECTROSTATIC 1749.00
DXY-1300 A/B SIZE 1M BUFF. STD 2206.00
GRX-300 D-SIZE ROLLERBED 5995.00
GRX-400 E-SIZE ROLLERBED 7998.00

ROLAND PLOTTER PENS

WATER BASE 417.50
OIL BASE 419.50
CERAMIC BASE 434.95
IMAGE-TEC PLOTTER PENS FIBERTIP 417.50
ROLLERBALL 499.95
PLOTTER PAPER ALL SIZES
UNINTERRUPTIBLE POWER SUPPLIES
UPS-250 SENDON 499.00
UPS-400 SENDON 599.00
UPS-800 SENDON 1209.00
POWER BAR WITH SURGE PROTECTOR 17.50
OD-100L HOLDS 100pc 5 1/4" WITH LOCK 8.99
OD-120L HOLDS 120pc 5 1/4" WITH LOCK 12.50
OD-80L HOLDS 80pc 3 1/2" WITH LOCK 12.50

WE CARRY ONE OF THE LARGEST SELECTION OF RIBBONS FOR ALL TYPES OF PRINTERS, SOFTWARE FOR IBM, APPLE, COMMODORE, ATARI ETC. BOOKS FROM MOST PUBLISHERS CALL FOR A FREE FLYER & PRICING COMPUTER CABLES FOR PRINTERS, MODEM, DISK DRIVES, CUSTOM MADE CABLES, CONNECTORS, DB SERIES, HEADERS, EDGE CARD, SEMICONDUCTORS, RAM, ROM, EPROM, TTL CMOS, TUBES, CAPACITORS, RESISTORS, FUSES, CRYSTALS, TRANSISTORS, LAMPS, SWITCHES ETC TEST INSTRUMENT, SCOPE, MULTI TESTERS, LOGIC PROBES ETC. ELECTRONIC KITS, EDUCATION / HOBBYIST MOVING SIGN ANY SIZE

CALL US FOR YOUR ELECTRONIC NEEDS!

MOST ORDERS SHIPPED WITHIN 24 HOURS. SERVING YOU FOR OVER 15 YEARS If you find a better price call us before you buy.

TERMS

VISA/MC/COD/CHECK
ALL ITEMS SHIPPED BY CANPAR OR UPS. ADD \$4.00 FOR ALL COD ORDERS. ALLOW 10 BUSINESS DAYS FOR SHIPPING WHEN PAYING BY PERSONAL CHECK
ALL ITEMS SUBJECT TO PRIOR SALE DELIVERY & HANDLING CHARGE 5%. MIN \$50.00. ALL RETURNED MERCHANDISE MUST HAVE RMA NUMBER
RESTOCKING CHARGE 20%. PRICE SUBJECT TO CHANGE WITHOUT ANY NOTICE.

WHY WAIT? CALL ORION ELECTRONICS NOW!

ORDER TOLL FREE!
1-800-265-2658

40 LANCASTER ST., W., KITCHENER, ONT. N2H 4S9
PH: (519) 576-9902 FAX: (519) 576-9028

DEALER INQUIRIES INVITED



Order desk & technical support open:
9:00 a.m. to 6:00 p.m. Monday - Friday
9:00 a.m. to 5:00 p.m. Saturday

**For Service
CALL
1-519-576-9026**

Immediate shipment on purchase orders from qualified institutions (schools and universities included).

Oh Thirty

Hewlett-Packard (Canada) Ltd. has begun volume shipments of its HP 9000 Model 370 workstation, which uses the Motorola 33MHz 68030 processor. The 32-bit CPU and HP design produce what is claimed to be the industry's fastest workstation. Sony Microsystems has also introduced workstations, the NEWS 1700, 1800 and 1900 using the 25MHz 68030 and 68882 floating-point coprocessor. They join other vendors such as Apple, NeXT and Fujitsu who have systems based on the top-of-the-line Motorola processor.

More R&D Needed

Peter Janson, president of Asea Brown Boveri, delivered a message to the Science Council of Canada that's familiar to Canadian industry: Canadian corporations must fine tune and upgrade the level of effort they are giving to R&D if we are to survive in the world of mega-corporations. He suggested that researchers be included in major executive decision-making and that the general atmosphere of corpora-

tions be made more conducive to technological innovation. He also urged that communications networks be set up so that advances made in universities or government research can be made readily available.

You would naturally assume that these sensible things would already be in place...

Super-efficient LED

Dialight's new 555 series red LEDs produce 0.6mcd at 1mA of current, about the same amount of light the average LED produces at a current of 10mA. The chip is gallium aluminum arsenide with an internal resistor, eliminating the need for the usual external resistor. At Dialight dealers.

1 Gigabyte Cartridge

3M's Magnetic Media Division, which originated the 1/2" data cartridge, has presented a detailed proposal for a 1/4" cartridge that would serve as the basis for a new generation of gigabyte-plus tape products. The 3M plan calls for a cartridge

tape system recording data on 40 tracks at a density of 45,000 bits per inch. The tape would be 600 feet of high coercivity magnetic media.

But is it gigabyte or jigabyte? The experts are divided.

Portable Spectrum Analyzer

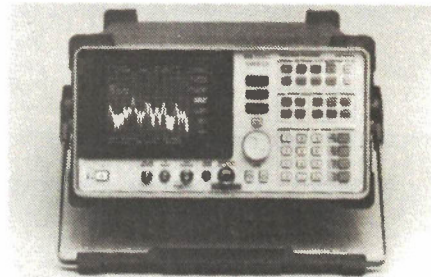

The HP 8561A spectrum analyzer provides continuous sweep capability from 1kHz to 6.5GHz. It meets MIL specs for ruggedizing, and includes markers, a frequency counter, AM/FM demodulation and a speaker. Hewlett-Packard (Canada) Ltd.

Circle No. 13 on Reader Service Card

Advertiser's Index

Cobra Sales	39
Duncan Instruments of Canada Ltd.	62
EMJ Data Systems.....	64
Fluke Electronics Canada.....	card
Future Interface Inc.	60
Information Unlimited	23
Joseph E Seagram & Sons, Limited	61
Kaientai Electronics Ltd.....	39
KB Electronics Ltd.	20
McGraw Hill.....	5
National Technical Schools	49
Orion Electronics.....	59
Trebas Institute of Recording Arts.....	2
Toshiba of Canada Ltd.....	63

**For Advertising Information
Call (416) 445-5600
Fax: 416-445-8149**

**FUTURE INTERFACE INC.
YOUR HARD DRIVE
REPAIR SPECIALISTS**

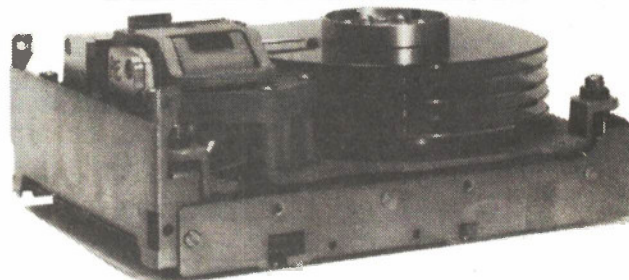

CMI FUJI SEAGATE TANDON MAXTOR
QUANTUM SHUGART MINISCRIBE C.D.C.
I.M.I. NEC RODIME PRIAM OLIVETTI
MICROSCIENCE

• Class 100 Clean Room • Servo and Wedge Writing Capabilities • 5 to 10 Day Turnaround • Full 24 Hour Burn-in on all Repaired Drives • 180 Day Warranty on all Work • Competitive Pricing • In-House Servo-Writing on Seagate 4000 Series • Free Estimates Available

416-470-6280

FUTURE INTERFACE INC.
401 ALDEN RD., UNIT 8, MARKHAM,
ONTARIO L3R 4N4

Circle No. 8 on Reader Service Card



trust me

"Maybe you're right. Maybe none of us should bother with a car after all."

"Good. Now tell me, what time do you expect to be home?"

"Aw, Mom."

"Famous last words."

"Come on, Mom, you know I'm a good driver."

"I know. But it's a big occasion and you'll be out with your friends. If you wind up having a few drinks you mightn't be so terrific driving home."

"I won't drink. I promise."

"That's easy enough to say now."

"Well, I can always get a lift back with one of the others."

"I have a better idea. Why don't you all share a cab instead? It won't be that expensive and you might be doing yourselves a favor."

Seagram

For a free chart on responsible drinking limits, write to us.
P.O. Box 847, Station H, Montreal, Quebec. H3G 2M8

Circle No. 12 on Reader Service Card



THE QUALITY LINE

DUAL TRACE OSCILLOSCOPES — GOS SERIES

For performance and reliability.

- Select from five models.
- Dual or single trace.
- Band width: 40, 20 MHz.
- Triggered/Delayed sweep operation.
- Sensitivity to 1 mV.

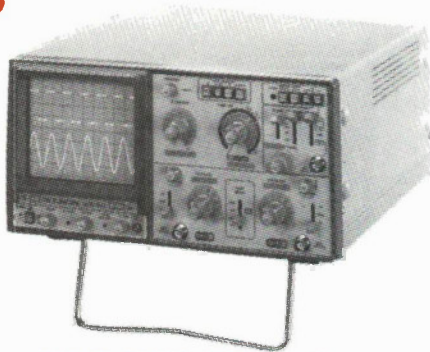

COUNTERS — GFC/GUC SERIES

Full featured, dependable and value priced.

- Choose from four models:

Universal
5 Hz-100 MHz
GUC2010

Intelligent
DC-1.3 GHz
GFC8130

Frequency
1 Hz-550 MHz
GFC8055

Frequency
1 Hz-120 MHz
GFC8010

- Easy to read LED display.



DIGITAL MULTIMETERS — GDM SERIES

Rugged and reliable—for the lab, field or production line.

- Select from four models:

3 1/2 or 4 1/2
Digit Display.
LED or LCD
Digital Display

- Standard Functions (AC/DC Volts/Amps & Resistance) plus:
Diode check
Continuity Test
Capacitance
1.99 nF to
19.99 uF GDM8034

- Accuracy: to 0.03% (TRMS) GDM8045; to 0.1% DCV GDM8035.



DC POWER SUPPLIES — GP SERIES

Over twenty quality power supplies for the lab, classroom or production line.

- Single, Dual or Quad output
- Dual-tracking Volts/Amps. (GPD/GPQ) 0-60V./0-10A
- Analogue metering or Digital display
- Regulation 0.01% typical



WAVEFORM GENERATORS GFG/GPG SERIES

An exceptional combination of Functions and Features.

- Select from these models:

2 MHz
Function
GFG8015/
8016/8020-

2 MHz
Sweep/
Function
GFG8017/8019

13 MHz Function GFG813

5 MHz Pulse GPG8018

- Waveform Output: Sine, Square, Triangle, TTL Pulse & Ramp



DIGITAL IC TESTERS — GTC/GUT SERIES

- Test up to 1800 popular ICs.

- Choose between two models:

GUT6000
(1800 types)
GTC3000
(1700 types)

- Test:

54/74 Series TTL
55/75 Series TTL
High Speed CMOS

- Repetitive Test Cycle for Production Usage.
- Auto-Search identifies unknown ICs.



CSA Approved where applicable — One Year Warranty. Available through your local electronic distributor.



DUNCAN INSTRUMENTS CANADA LTD.

ELECTRONIC INSTRUMENT SPECIALISTS

121 MILVAN DRIVE, WESTON (TORONTO), ONTARIO M9L 1Z8

TELEPHONE: (416) 742-4448 FAX: (416) 749-5053

We can count the number of portables we make on one hand.



It's just that we need several extra fingers to do it. Because our "first family" of portable computers is almost three times larger than anyone else's.

Which means that we offer you the portable computer which fits *your* needs like a glove. Whatever your needs. From the complete battery powered laptops to incredibly powerful desktops, intelligent terminals and LAN nodes and servers. All in truly portable packages.

It's our impressive and

comprehensive quality family, coupled with state-of-the-art technology and a commitment to stay number one, which has made Toshiba the best selling portable computers in Canada. Thanks to you, over 50% of Canada's portables proudly bear the name Toshiba.

The best do keep getting better. To get your hands on the best portable for you, call your nearest Toshiba reseller. Or call Toshiba direct at 1-800-387-5645.



TOSHIBA

WE MEAN BUSINESS

INFORMATION SYSTEMS DIVISION

Circle No. 10 on Reader Service Card

Tecmar Set the Standard for Excellence in Tape Backup.

Now We've Topped It.

Introducing QT-125™

Nobody has to tell you that Tecmar is the leader in tape backup systems. After all, *more than 70,000 users* have chosen Tecmar's popular QIC-60™ 60MByte products to protect their data.

The New Standard. And now, Tecmar has set the new tape backup standard for massive data storage applications—with a 125MByte tape system for IBM PC/XT/AT, Compaq 286, 386 and compatibles. It's called the QT-125, the first in Tecmar's new QualityTape™ family of products.

The Performance Leader. The QT-125 internal and external drives incorporate industry-standard SYTOS™ tape drive software, are QIC-120 hardware compatible, and employ the high-reliability Wangtek drive. Performance features include:

- Network compatibility with Novell, 3COM and IBM Token Ring.
- Automatic and unattended backup.
- IBM 6157 streaming cartridge tape compatibility.



EMJ Data Systems Ltd.

HEAD OFFICE
GUELPH
(519) 837-2444 FAX (519) 836-1914



Circle No. 11 on Reader Service Card

- On-line backup speed of 5MBytes per minute.
- File-by-file or mirror-image backup and restore.
- And much more.

Two-Year Warranty Plus. Best of all, with the QT-125 you get Tecmar quality backed by the industry's only two-year warranty including the new QuickTurn™ Quality Service program. If you have any trouble with your Tecmar QT-125 in the first six months of operation, we'll send you a replacement within 48 hours.



Stay with the Leader. So, when you need tape backup, go for the top in quality, reliability and performance. It's Tecmar—again.

QIC-60 is a trademark of Colorado Memory Systems; SYTOS is a trademark of Sytron Corp.; IBM PC/XT/AT are registered trademarks of International Business Machines Corp.; ComputerLand is a registered trademark of ComputerLand Corporation; BusinessLand is a registered trademark of BusinessLand Corporation.

Circle Number 06 on Reader Service Card

TECMAR

a subsidiary of Rexon, Inc.

The Power Behind Your PC

BRANCHES

Vancouver (604) 875-9344 FAX (604) 875-6393	Calgary (403) 229-1535 FAX (403) 244-4469	Winnipeg (204) 452-4411 FAX (204) 452-8594
Toronto (416) 454-2940	Montreal (514) 849-4171 FAX (514) 288-6062	Halifax (902) 423-6152 FAX (902) 423-3628

(B.C., Alta.): 1-800-663-9048

*TOLL FREE

(Man., Ont., Que., N.B., N.S., P.E.I.): 1-800-265-7212