

Electronics Today

\$3.75
MM70924

December 1986

Canada's Magazine for Electronics & Computing Enthusiasts

Cambridge Technolog

Inside: Satellite TV Special!

24 pages of TVRO

Moving Magnet Preamp
Basic and Deluxe

Radio Pirates
Stealing the air

Cambridge L/C Meter
Measuring reactance

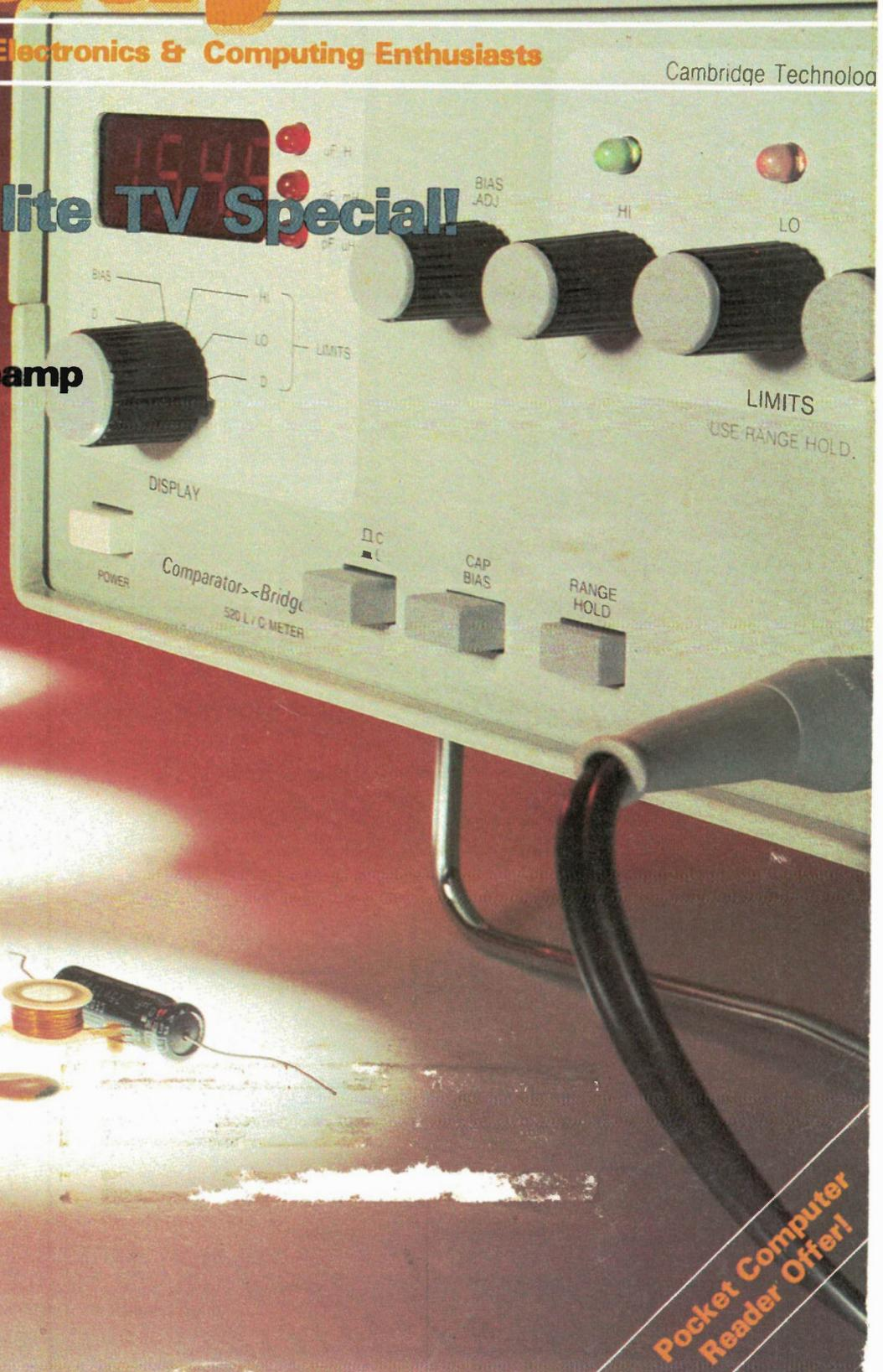

**Pocket Computer
Reader Offer!**

BEST Computers

FREE:
\$395 ATI Graphics Solution Card
 with **ALL BEST Computers**
 Dual Function Video: Hi-Res Monochrome and Colour.
 (Substitutes regular boards). See our new catalogue
 for full specs. Time Limited Offer.

Specifications
 in our 1987
 Catalogue
 call for a free
 copy

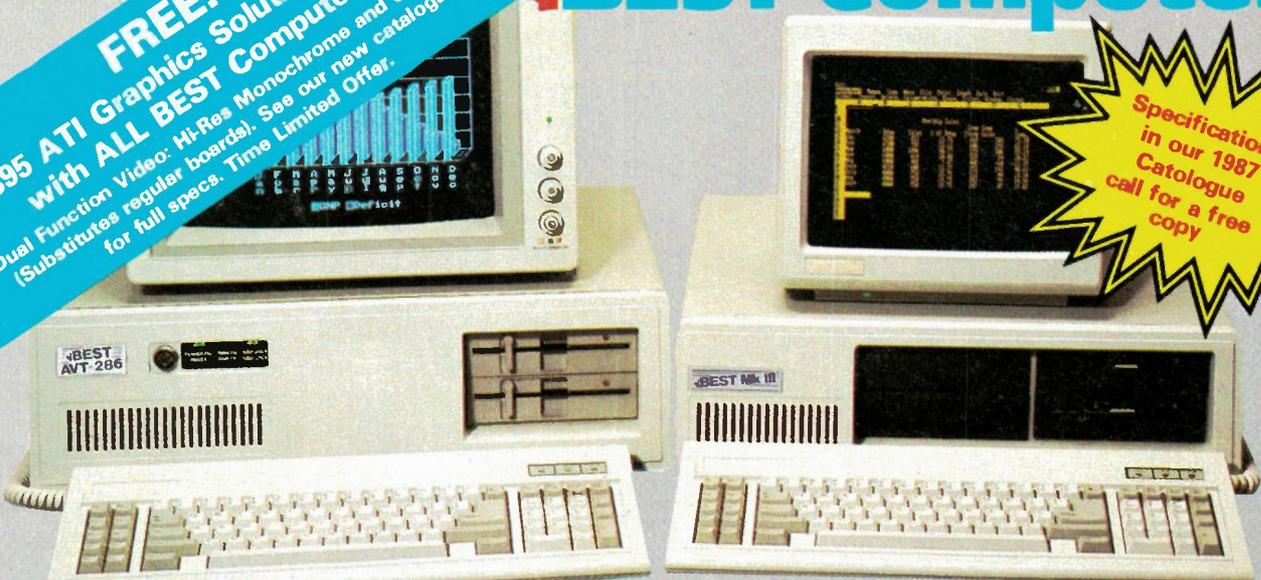

Made in Canada, IBM PC, XT & AT Compatible

Monitor not included. IBM, IBM PC, IBM XT and IBM AT are registered trademarks of IBM Canada Ltd.

Features common to BEST MK II, MK III & MK IV

- Superb IBM PC & XT Compatibility
- Canadian Made
- 256K RAM Standard minimum (uses 41256K RAM chips)
- Expandable on board to 640K RAM
- Parallel Port (for printer)
- Serial Port (for communications)
- Real Time Clock/Calendar (with Battery Backup)
- Presocketed for optional co-processor — such as 8087 Math Processor
- IBM Compatible Keyboard
- Reset Switch
- Phoenix BIOS as used in many major brand IBM compatible systems.
- 150 Watt Power Supply which will handle a Hard Drive without upgrade.
- 7 Slots
- Flip top case
- 2 Slimline DS,DD 5 1/4", 360K Disk Drives
- Colour Video (RGB & Composite) Board or Hi-Res Monochrome Card (customer choice)
- Disk Controller Board
- CSA Approved

Warranty

We have such confidence in the reliability of the BEST that we offer a full One Year Warranty. This far exceeds the 90 day industry standard. On-site service plan is available across Canada at extra cost through 3M of Canada Ltd.

BEST MK II.

Two 350K DS,DD disk drives, Serial and Parallel Ports, Real Time Clock, Phoenix BIOS, uses 8088 processor — full specifications given above.

\$1695⁰⁰

ONE YEAR WARRANTY

Other Configurations:

With 640K RAM \$1795
 With 20 Meg Hard Drive/1 Floppy/256K ... \$2495
 With 20 Meg Hard Drive/1 Floppy/640K ... \$2595

4.77/8MHz
 DUAL
 SPEED

The FAST BEST MK III

As BEST MK II plus speed selectable: 4.77 and 8MHz (most software will run on the higher speed), uses 8088-2 processor.

\$1895⁰⁰

ONE YEAR WARRANTY

Other Configurations:

With 640K RAM \$1995
 With 20 Meg Hard Drive/1 Floppy/256K ... \$2695
 With 20 Meg Hard Drive/1 Floppy/640K ... \$2795
 With 80 Meg Hard Drive/1 Floppy/640K ... \$4495

ULTRA
 FAST

SUPER-FAST BEST MK IV

As BEST MK III plus TRUE 16-Bit machine, 8086-2 processor, IBM compatible 8-Bit I/O channel bus, even faster than MK III due to 16-Bit architecture. With 640K standard.

\$2195⁰⁰

ONE YEAR WARRANTY

Other Configurations:

With 20 Meg Hard Drive/1 Floppy/640K ... \$2995
 The BEST MK IV Main board processes data approx. 2.1 times faster than the IBM PC/XT or BEST Mk II.

IBM
 AT
 Compatible

AVT-286

Superb IBM AT compatibility, 640K RAM, Two 5.25 in disk drives (one high density 1.2 Megabyte, one standard 360K), serial and parallel ports high quality-keyboard, keyboard lock and status monitor. 16 MHz clock (8MHz CPU)

\$3495⁰⁰

ONE YEAR WARRANTY

A Basic Configuration with fast stepping

Hard Drives:
 20 Meg Hard Drives \$4795
 30 Meg Hard Drive \$4995
 40 Meg Hard Drive \$5495
 80 Meg Hard Drive \$5995
 Built-In Tape Backup Systems from \$ 799
 BEST 1200/300 Plug-in-Modem \$ 249

Lightening Fast
 New, IBM AT compatible.

- 10 MHz CPU
- 2Meg RAM
- Up to 4 Meg RAM on Board

AVT10-286

- Superb IBM AT compatibility plus more
- Standard 2Meg RAM and optionally up to 4 megabytes of RAM on main board
- 8 MHz, 6 MHz, and 10 MHz selectable system speed
- (2) 5 1/4" disk drives (1 high density 1.2 meg, one standard 360K)
- Serial and parallel ports, high quality keyboard, keyboard lock and status monitor.

With 2Meg RAM and 10 MHz CPU

\$4995⁰⁰

ONE YEAR WARRANTY

As Basic Configuration with fast stepping

Hard Drives:
 20 Meg Hard Drive \$6295
 30 Meg Hard Drive \$6495
 40 Meg Hard Drive \$6995
 80 Meg Hard Drive \$7495
 Additional 2 Megabytes RAM (to bring system to full 4 Megabytes) \$ 995
 Built-In Tape Backup Systems from \$ 799

Exceltronix

Toronto Store: 319 College Street, Toronto (416) 921-8941
 Ottawa Store: 217 Bank Street, Ottawa (613) 230-9000
 Mississauga Showroom, Pickup Counter and Mail Orders:
 6315 Kestrel Road, Mississauga, Ont., L5T 1S4
 Long Distance Orders: 1-800-387-8995, Local Orders: (416) 673-5111

Fresh opportunities for

UNLIMITED INCOME

Selling MICRO COMPUTERS to small and medium size businesses can turn your skills and local knowledge into **LARGE GAINS.**

EXCELTRONIX, one of Canada's leading PC/XT/AT compatible makers invites those who qualify to share in the **UNLIMITED REWARDS** of successful selling by becoming part of its network of Independent Agents.

A total investment of \$7,500 secured by inventory opens an **OUTSTANDING OPPORTUNITY** for self starters.

Our Independent Agents have **NO CEILINGS ON INCOME; HAVE GUARANTEED TERRITORIES AND ENJOY EXCELLENT SUPPORT** directly from the people who designed and manufactured the product line - no offshore clones here.

Choice territories for Independent Agents are still available in all urban centres in Canada.

INTERESTED PERSONS can receive more information in confidence from:

Director of Special Projects Exceltronix Components & Computing Inc.

6315 Kestrel Road, Mississauga, Ontario L5T 1S4 (416) 673-5111

Applies to most BEST and Multiflex products.

NEW: Mini-88

What you've been waiting and asking for is now here! New Compact Portable 8088-2 Dual Speed PC/XT Compatible From **\$499**



- 8088-2 Motherboard
- 8MHz and 4.77MHz operation
- Compact case and power supply
- 256K RAM on board expandable to 640K
- 90 Day Warranty

Basic Unit as listed \$499.00

Basic Unit with Video Board (Colour or Hercules Compatible), Floppy Controller, Keyboard \$699.00

Basic Unit with Video Board (Colour or Hercules Compatible), Floppy Controller, Keyboard and Built-in 3.5" 750K Disk Drive \$849.00

Second 3.5" 750K Disk Drive (Built-in) \$159.00 extra

Basic Unit with Video Board (Colour or Hercules Compatible), Floppy Controller, Keyboard and External plug-in 360K Disk Drive \$849.00

Basic Unit with Video Board (Colour or Hercules Compatible), Floppy Controller, Keyboard and external plug-in Dual 360K Disk Drive package \$995.00

External 20 Meg Hard Drive package with controller and power supply available.

NEW: Mini-286

At Last! A 80286 AT Compatible From Only **\$1495!**



- 16MHz clock (8MHz CPU)
- 80286 Motherboard
- 512K RAM On-Board Expandable to 640K
- Case and 150W Power Supply
- AT Compatible Keyboard
- 7 Expansion Slots
- 90 Day Warranty

Basic Configuration as listed \$1495.00

As Basic unit plus Video Board, Floppy Controller, and one 5.25" 360K drive \$1995.00

As Basic unit plus Video Board, Floppy Controller, and one 5.25" 360K drive and 20 Meg Hard Drive \$2995.00

Optional 1.2 Megabyte Drive for any configuration ... \$ 199.00

Exceltronix

Toronto Store: 319 College Street, Toronto (416) 921-8941
Ottawa Store: 217 Bank Street, Ottawa (613) 230-9000
Mississauga Showroom, Pickup Counter and Mail Orders:
6315 Kestrel Road, Mississauga, Ont., L5T 1S4
Long Distance Orders: 1-800-387-6995, Local Orders: (416) 673-5111

Computing Centre Inc.

Come and visit our new expanded premises, nearly 2,000 square feet of computer and electronics hobbyists paradise and discover our great bargains.

IBM Compatible Peripheral Boards

- Colour Graphics, RGB and composite . . . \$ 99.95
- Monochrome Boards (Hercules compatible) . . . \$129.00
- Floppy Disk Controller (up to 4 drives) . . . \$ 44.95
- Floppy Controller w. Real time clock, serial port and parallel port . . . \$159.00
- Parallel Printer Card . . . \$ 35.00
- Clock Card . . . \$ 36.95
- Game Card . . . \$ 34.95
- I/O Card, 2 x serial ports, parallel printer port, game port, real time clock/calendar . . . \$149.00
- 512K Memory Card, socketed for 512K with 64K RAM on board . . . \$139.00
- 256K Multifunction Board w. serial port, parallel port, game port, with real time clock calendar with 256K RAM . . . \$199.00

IBM XT Compatible 8-slot Motherboard

4.77 MHz, Japanese made boards, burnt-in with 256K RAM, expandable on board to 640K with Phoenix BIOS . . . \$199.00

IBM XT Compatible Turbo 8-slot Motherboard

4.77/8 MHz, Japanese made boards, burnt-in with 256K RAM, expandable on board to 640K with Phoenix BIOS . . . \$269.00

Keyboards



- 5150 Style . . . \$ 95.00
- 5151 Style . . . \$119.00
- Maxiswitch Keyboard - switch selectable between XT and AT compatibility . . . \$139.00

Switching Power Supplies

- 150W IBM compatible for our motherboards. 5V 15A, 12V 5.5A, -5V and -12V at 0.5A CSA Approved . . . \$134.95
- 200W. CSA Approved . . . \$159.95

Complete Systems

- 4.77 MHz, 8088 based (8087 optional) Phoenix Bios, reset switch, 8 IBM compatible I/O slots, 256K RAM (expandable to 640K), colour card, 135W CSA Approved power supply, 5150 style keyboard, flip top case, one Panasonic disk drive . . . \$799.00
- As above but Turbo version - 8MHz . . . \$899.00

Cables

- IBM type parallel printer cable, 6ft . . . \$13.95
- 8ft . . . \$15.95
- 10ft . . . \$17.50
- IBM type serial cable RS232C 6 ft . . . \$13.95
- 8ft . . . \$15.95
- 10ft . . . \$17.50

DB Connectors

- DB25 Solder Tail Male . . . \$1.35
- DB25 Solder Tail Female . . . \$1.35
- DB25 Right Angle PCB Mount Male . . . \$2.19
- DB25 Right Angle PCB Mount Female . . . \$2.19
- DB25 Flat Ribbon Cable IDC crimp type Male . . . \$3.29
- DB25 Flat Ribbon Cable IDC crimp type Female . . . \$3.29
- DB15 Solder Tail Male . . . \$1.15
- DB15 Solder Tail Female . . . \$1.15
- DB15 Right Angle PCB Mount Male . . . \$1.65
- DB15 Right Angle PCB Mount Female . . . \$1.65
- DB15 Flat Ribbon Cable IDC crimp type Male . . . \$2.79
- DB15 Flat Ribbon Cable IDC crimp type Female . . . \$2.79
- DB9 Solder Tail Male . . . \$1.75
- DB9 Solder Tail Female . . . \$1.75
- DB9 Right Angle PCB Mount Male . . . \$2.29
- DB9 Right Angle PCB Mount Female . . . \$2.29
- DB9 Flat Ribbon Cable IDC crimp type Male . . . \$3.29
- DB9 Flat Ribbon Cable IDC crimp type Female . . . \$3.29

Memory Special

- 4164 150nS . . . \$ 1.99
- 41256, 150nS . . . \$ 4.99
- 8087, 4.77MHz . . . \$159.00
- 8087, 8 MHz . . . \$245.00
- Set of 8088, 8255A-5, 8237A-5, 8288, 8284, 8253A-5, 8259A . . . \$ 39.95

IBM Style Flip Top Cases . . . 69.95

Disk Drives

- Panasonic JU455 Disk Drives, 5.25in DS-DD . . . \$147.00
- 20 Meg Seagate Hard Drive, Half Height with controller and cable . . . \$699.00

Huge Selection of Apple Compatible Boards, Power Supplies and other parts. Come and Browse.

Please Call for quantity pricing
We will NOT be Undersold!

Mail orders add 5% (\$5 minimum) for shipping and handling. Ontario residents add 7% PST. We welcome Visa, Mastercard and American Express, Money Orders and cheques (allow 14 days for uncertified cheques). Do not send cash. Returns subject to 20% restocking charge and shipping fees. All prices and specs subject to change without notice.

8088 Board with Built-in Modem: \$49.95!

This could be the biggest bargain of all times.

Buy TWO
Get ONE FREE

SUPER SPECIAL: Buy 2, get 1 FREE!



The main board shown can be used in many different ways. Made recently by one of the Canada's leading electronics companies, this board utilizes some of the most current technology and parts.

Use your imagination, software and hardware to make this board into many interesting projects. The board is capable of colour graphics and was originally designed as a terminal for home-ordering system and has many of the facilities similar to the Telidon terminals in use in shopping malls, hotels etc.

This magnificent board features an 8088 CPU, 6545 CRT Controller, 150/1200 Baud auto-dial, direct-connect modem, serial ports, RF Modulator (Ch.3) for 40 characters, EPROMs, 64K Video RAM, 16K RAM and 64K of EPROM for the processor.

All you need is power supply with 5V at 2A, plus/minus 12V at 0.05A. The current value of the parts alone on this board is in excess of \$300!

- A. The Board itself with the original software, schematics, memory map and block diagram: . . . \$49.95
- B. Membrane Keyboard Kit . . . \$19.95
- C. Plastic Case to house the main board . . . \$ 9.95
- Items A, B and C as a package . . . \$74.95

Block Diagram of the Board

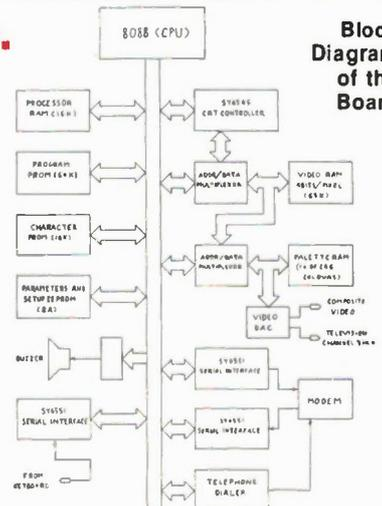

Copyright

All material is subject to worldwide copyright protection. All PCB patterns are copyright and no company can sell boards to our design without our permission.

Liability

While every effort has been made to ensure that all constructional projects referred to in this magazine will operate as indicated efficiently and properly and that all necessary components are available, no responsibility whatsoever is accepted in respect of the failure for any reason at all of the project to operate efficiently or at all whether due to any fault in the design or otherwise and no responsibility is accepted for the failure to obtain component parts in respect of any such project. Further no responsibility is accepted in respect of any injury or damage caused by any fault in design of any such project as aforesaid.

Editorial Queries

Written queries can only be answered when accompanied by a self-addressed, stamped envelope. These must relate to recent articles and not involve the staff in any research. Mark such letter Electronics TodayQuery. We cannot answer telephone queries.

Binders

Binders made especially for Electronics Today (ETI) are available for \$9.75 including postage and handling. Ontario residents please add provincial sales tax.

Back Issues and Photocopies

Previous issues of Electronics Today Canada are available direct from our office for \$4.00 each; please specify by month, not by feature you require. See order card for issue available.

We can supply photocopies of any article published in Electronics Today Canada; the charge is \$2.00 per article, regardless of length. Please specify both issue and article.

Component Notation and Units

We normally specify components using an international standard. Many readers will be unfamiliar with this but it's simple, less likely to lead to error and will be widely used everywhere sooner or later. Electronics Today has opted for sooner!

Firstly decimal points are dropped and substituted with the multiplier: thus 4.7uF is written 4u7. Capacitors also use the multiplier nano (one nanofarad is 1000pF). Thus 0.1 uF is 100nF, 5600pF is 5n6. Other examples are 5.6pF = 5p6 and 0.5pF = 0p5.

Resistors are treated similarly: 1.8Mohms is 1M8, 56kohms is the same, 4.7kohms is 4k7, 100ohms is 100R and 5.6ohms is 5R6.

PCB Suppliers

ETI magazine does NOT supply PCBs or kits but we do issue manufacturing permits for companies to manufacture boards and kits to our designs. Contact the following companies when ordering boards.

Please note we do not keep track of what is available from who so please don't contact us for information PCBs and kits. Similarly do not ask PCB suppliers for help with projects.

K.S.K. Associates, P.O. Box 266, Milton, Ont. L9T 4N9.

B-C-D Electronics, P.O. Box 6326, Str. F., Hamilton, Ont. L9C 6L9.

Wentworth Electronics, R.R. No. 1 Waterdown, Ont. L0R 2H0.

Dancoinths Inc., P.O. Box 261, Westland MI 48185 USA.

Arkon Electronics Ltd., 409 Queen Street W., Toronto, Ont., M5V 2A5.

Spectrum Electronics, 14 Knightswood Crescent, Brantford, Ontario N3R 7E6.

For Your Information

The Editor's Corner

In the August issue of *Byte*, a book reviewer quoted an author as saying that artificial intelligence researchers will never synthesize an artificial brain for a number of reasons. One of these is our ability

memory cache. There's certainly no doubt that an enormous amount of yes-no logical computing goes on when we're trying to retrieve a half-remembered face. "I can't do two things at once!"

to the framework, the basic chord changes and fundamental rhythm. That's why Bach sounds to non-fans like someone sawing up and down on the same four cello notes for hours, or why all bluegrass fid-



to recognize familiar faces without any apparent computing time. The process appears to be some sort of instant comparison of the incoming "video" with a model in memory, and how it works is poorly understood. The book reviewer didn't entirely buy the argument.

Now there's an interesting subject for some late-night speculation: how the mind processes complex information easily and rapidly, leaving us the impression that the end result is obtained instantaneously, magically derived, like recognizing that familiar face in a crowd.

But consider the recognition process when it's someone we barely know, or knew years ago. Now the mind's gears begin to grind: where do I know them from? Do I know them, or is it just a similarity? Maybe it's that woman I met in the laundromat when I had athlete's foot...

If the brain can somehow scan and compare two visual images instantly, it must take a fair amount of whatever we use for RAM, and therefore the most often used images must be kept up front in a

overworked parents and teachers used to say. But of course, you can. We all do it all the time. It's interesting, though, to see if you can somehow watch the process going on in your head and try to figure it out. It's a real strain sometimes and demands tremendous concentration, but it's fascinating. I can't resist trying it with music, listening to Bach's contrapuntal music via headphones, which eliminate distractions. Can I really hear two or three melodies going on at once? Well, yes, and so can any music fan, but isn't there a multiplexing going on? Isn't the mind accepting only one note at a time, switching furiously from melody to counter-melody? And, amazingly, while three melodies provide three widely different melodic and rhythmic textures, another part of the mind integrates simultaneous notes vertically, producing Bach's unique and glorious harmonies.

Of course, if you don't like Bach (and this applies to any other kind of music), the mind refuses to multiplex and reintegrate. It just sullenly sits there and listens only

die tunes sound alike ("we went to a folk club and had a great time listening to the same tune all night"). The brain has to be coddled past its dislike of the unfamiliar and forced to do a bit of picking apart. Then it will grudgingly admit that the stuff isn't half bad, if only in places.

Sometimes I can just catch the hang of this multiplexing business, and there's a tiny revelation as to how it works. This pleases me no end and makes me feel as if I'm beginning to comprehend an astoundingly complex phenomenon.

Until, of course, reality sets in and I then wonder: if it's taking me, a mere mortal, such an incredible amount of brainteasing just to get the drift of it, how in the world could Bach have cranked this wonderful stuff out, day after day, year in and year out? What kind of RAM, ROM, and I/O did his brain luck onto?

Come to think of it, that author I mentioned at the beginning may have been onto something, if only intuitively. I think the AI people have a tough row to hoe before they unveil their Artificial Human, Mark I.

Motorola has a new GaAs FET, featuring low noise and a low price. The MRF966 has 1uA gate leakage, 17dB gain at 1GHz and a 1.2dB noise figure at 1GHz. It is aimed primarily at receivers in the 500 to 1000MHz region. Cost is \$1.95US in 100 quantities. For further information contact Motorola dealers, or Motorola Semiconductor Products, Inc., PO Box 20912, Phoenix, Arizona 85036, (602) 244-3818.

Electro Rent Corporation has released their fall catalog of used test equipment and a flyer featuring the latest specials. Analyzers, scopes, telecom, microprocessors, and lots more. All equipment is covered by a 120-day warranty which can be extended to one year. Electro Rent has outlets in Montreal, Ottawa and Vancouver, or contact their head office at 1110 Kamato Road, Unit 1-2, Mississauga, Ontario L4W 2P3, (416) 624-6132.

EG&G Wakefield Engineering announces a new Thermal Compound, the 126 series. It's said to eliminate the creeping and migration that plagues silicone compounds. It does not contaminate solder baths and will not dry out, harden or melt; heat transfer is said to be superior to many silicone-based compounds. For more information, contact International Rectifier Canada, 101 Bentley St., Markham, Ontario L3R 3L1, (416) 475-1897.

Fabric EMI Screen

by David P. Dempster

A new nickel-coated metallized fabric that provides excellent screening against electromagnetic interference (EMI) has been introduced by Mobay Chemical Corporation, Pittsburgh, Pennsylvania.

quencies, with attenuation of at least 40dB in the microwave range. Reflectance of incident microwaves is typically more than 98 percent. This extremely low reflection loss is an indication of low penetration of electromagnetic waves through the metallized fabric, and thus of high attenuation.

In addition, there is no electrostatic charging of the metallized fabrics. Depending upon the pure metal used, the surface resistance is generally well below 10 ohm/square metre, and may be as low as 0.02 ohm.

The materials are said to have excellent resistance to corrosion and abrasion. This is enhanced by impregnating the cloth with a specialized weatherproofing coating called Impranil C, another material also from Mobay.



Tradenamed Baymetex T, the textile is ideal for making protective covers for outdoor broadcast television cameras where the picture quality may be impaired by interference from local radio transmissions and high-powered radar installations.

Other principal end-uses are expected to include EMI-shielding covers for portable video cameras, recorders, computers and other electrical/electronic applications.

Television camera covers made from the material are currently in use by British Broadcasting Company's Outside Broadcast Department. Mobay's parent company in West Germany manufactures the metallized fabric for the application.

The screening covers, which also provide a high degree of weather protection, are tailored to fit the cameras, permitting access to service panels and normal circulation of ventilating air. Their low weight, textile character and metal properties make the covers easy to handle, simple to install and highly effective.

In the metallizing process, the basic polyamide fabrics are coated with a thin, even layer of metallic nickel. Although the individual fibres are uniformly coated, there is no adhesion of the woven monofilaments.

The homogeneous metal film on the fabric has good electrical conductivity at thicknesses from 0.05 to 1.0 mm, depending upon the weave of the textiles.

The EMI-shielding properties of the fabrics are effective at all fre-

The Electrical and Electronic Manufacturers Association of Canada has lauded the October Throne Speech which puts emphasis on the development of technology and stresses the importance of the relationship between technology development and education. Dr. Doug Barber, Director of Research and Development for EEMAC, praised the creation of a National Advisory Board for Industrial Technology, headed by the Prime Minister. He had some reservations as to the government's definition of technological development: Revenue Canada has made most scientific and experimental research ineligible for tax concessions.

MAIL ORDERS: Minimum order \$50.00. Send Money Order, Certified Cheque or Cheque (allow 2 weeks for clearance), Visa/Master Card plus 5% (min. \$5.00) for shipping and handling. Ontario residents add 7% P.S.T. Sorry no C.O.D. (Prices and availability are subject to change without notice. All returned non-defective merchandise are subject to 20% restocking charges.)

COMPUTERS	CARDS	DISKETTES
The Affordable XT/AT compatible	Tecmar EGA master \$499	Dysan, DSDD \$26.95
• 8088 XT \$1,150	Everex EGA 479	Nashua, DSDD 14.95
640K, 2 drives, colour graphic card, clock serial, parallel and game ports.	ATI Graphics Solution 295	SSDD 9.95
• 8088 XT portable \$1,600		Bonus, DSDD 13.95
640K, 2 drives, TTL monitor, clock, serial, parallel and game ports.		
• 80286 AT \$2,200		
640K, 1.2M drive, HD/FD controller card.		
MONITORS/CARDS	PRINTERS	RIBBONS
COMPOSITE	Epson, FX85 \$599	Epson, FX80 \$ 6.50
Zenith, green/amber \$135	LQ1000 1200	Toshiba 1350 9.50
TTL	Roland, 1011 349	Star, OKI 2.50
Zenith amber \$219	1111A 429	Roland 1011, 1111A 14.50
YJE, green/amber 219	1215 729	Olympia R.O 9.50
NEC, green \$229	Seikosha, SP1000 359	
	Canon, Laser 3,895	
	Ink Jet 895	
	HARD DRIVE SYSTEMS	ACCESSORIES
	Seagate, 20M, XT \$649	14" Monitor Base \$18.95
	30M, XT 995	12" Monitor Base 17.95
	20M AT 995	Power Center 29.95
	30M, AT 1,195	Joystick 32.95
	40M, AT 1,395	Universal Printer Stand 21.95
	Tape Backup, 60M 1,395	Switch Box 69.00
	20M 1,050	
	MODEMS AND MOUSE	
	Smarteam, 1200 \$299	
	2400 699	
	Modem Card, 1200 279	
	Logitech Mouse 145	

*XT/AT are registered Trademarks of International Business Machine Corporation.

SUNIX INC.

578 Marlee Ave.,
(at Glencairn subway)
Toronto, Ont. M6B 3J5
(416) 781-3263
Telex: 06-217736 Sunix Tor.
Mon.-Sat. 10-6
Thursday 'til 8:30 p.m.

4800 Sheppard Ave.,
Unit 114,
(East of McCowan Ave.)
Scarborough, Ont. M1S 4N5
(416) 292-0588
Mon.-Sat. 10-6
Thur. & Fri. 'til 9.00 p.m.

Importer, retailer, mail order since 1978.

ET-286 Plus

HyperSpeed SuperComputer

As artificial intelligence and expert systems become more the rule than the exception in personal computer software, and as office automation takes on larger and larger tasks, superior machines will emerge with attributes that support **faster speed, massive memory and more extensive storage.** Naturally, the drive to communicate will also stimulate a variety of **networking applications.**

In the OEM Marketplace, just such a superior machine already exists: The **ET-286 plus.** The ET-286 plus pushes back the envelope in personal computer performance without sacrificing compatibility with more conservative products.

The ET-286 plus is an IBM AT compatible singleboard computer from SOLTECH SYSTEMS INC., designed for the most demanding applications in networking, office automation, CAD/CAM and high performance workstations. The ET-286 plus conforms to both the software and hardware compatibility requirements of the AT. It has the same form/fit characteristics, 6 full expansion slots, 2 PC/XT expansion slots, matching keyboard and power supply connectors **plus** high speed and high performance characteristics that set it apart from IBM and all the rest.

It isn't enough to be merely compatible... be the best

- 6/8/10/12 MHz 1 Wait State
- 6MHz 0 Wait State
- 12.5MHz Architecture
- 4 Meg On-Board Memory
- 6 Full AT Expansion Slots
- 2 PC/XT Expansion Slots
- 3 Serial Ports (Switchable)
 - RS-232
 - RS-422
- 2 Centronics Parallel Ports
- Built-In Clock/Calendar
- IBM AT Compatible BIOS

Also available: the standard for IBM PC/XT Compatibility, The ACS-1000 Super Computer.

- 1 Megabyte On-Board Memory
- Built-in Disk Controller
 - up to 4 Floppies
- 54 KB User Definable ROM
- Switchable: 4.77 or 8 MHZ
- Built-in Multifunction Board
 - Parallel Printer Port
 - 2 Serial Ports
 - Time-of-day Clock

**Seize Control of Your Hardware
Destiny**

If you are using board level microcomputers you can have greater power, versatility and reliability by using ET-286 plus or the ACS-1000 Singleboard Supercomputers. These products have been designed for the serious OEM.

To order or for more details call
or write

Soltech Systems Inc.
3083 Grandview Highway
Vancouver BC
V5M 2E3
(604) 439-1289

Circle No. 7 on Reader Service Card

For Your Information

Mini-Review: Psion Organiser II

THE Psion Organiser from the UK, introduced in late 1984, has been expanded considerably in the new release. It features either 8K or 16K of internal memory, depending on the model, and accepts up to two datapaks of up to 64K in size. Remember a few short years

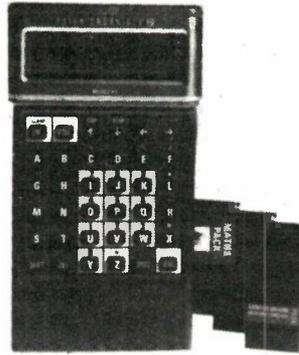

ago when 64K took up a whole desktop? Now you can hold 128K in the palm of your hand like a calculator. Of course, next year you'll probably be laughing at this paragraph as you slip a 20 meg hard drive the size of a dime into your watch. Who knows?

The first noticeable change from the older model is, bless 'em, a new keyboard. It has larger keys that are much easier to work with, although the shape of the Psion discourages a QWERTY layout. There's a tiny click from the internal audio generator when you make contact.

The display is a 16 x 2 LCD which changes state without the usual sluggishness associated with liquid crystals. The first thing to appear is the main menu with 12 headings, and here is where you'll see just how many features they've packed into the new software (which is held in a 32K ROM on the Model XP). There's a database with a remarkably fast search function which can look for any or all of any record, a diary that includes an alarm function for noti-

fying you of upcoming events, a calculator with 10 memories and full editing, the OPL programming language (similar to BASIC), eight alarm settings, time/date display and all the file-handling functions you'll need.

The datapaks are tiny, non-volatile cartridges that plug into the two available slots on the back. The internal memory is called A on the display and the two drives are labelled B and C; memory is kept up by the battery even when the unit is turned off, and the information in the datapaks is safe even if you remove them from the Psion. In fact, you can't erase files even if you want to; they can be dropped from the directory, but the only way to clear the datapak for real is with an EPROM eraser.

The optional paks and peripherals really turn the Psion into a comprehensive system. There's a math pack worthy of any scientific calculator, a financial pack, and even a spelling checker with over 25,000 words. You can plug an optional RS232 cable into the port on top of the Psion, allowing it to run a printer or modem or exchange files with a computer. There's a barcode reader and a magnetic card reader. In fact, the Psion is so comprehensive that we played with it for days and were still finding all kinds of submenus and features tucked here and there.

Psion has done a very good job of structuring the Organiser so that everything flows without too much confusion. It's difficult enough with the tiny keyboard and display; you certainly don't need awkward software. The manual isn't clear on some points; with so many options available, you need a bit more hand-holding than the manual gives you, at least at the beginning.

The original Organiser was aimed at everybody; selling point was the fact that it was a really neat gadget to have. The Organiser II is obviously aimed at the business user, with the emphasis on its practicalities in and out of the office. The price has been upgraded, too, to \$399 for the model XP with 32K ROM and 16K internal RAM.

The Psion Organiser II is available from Electronics Today as a reader offer (see ad in this issue) or from Gladstone Electronics, 1736 Avenue Road, Toronto, Ontario M5M 3Y7, (416) 787-1448.

Solid Tantalum Chip Capacitors

The Type 239D Domino miniature molded-case solid-electrolyte capacitors have recently been introduced by Sprague Electric. These new capacitors are designed specifically for surface mount applications and conform to EIA industry specifications for standard capacitance range devices.

Available in four package sizes, the capacitors come in voltage ranges from 4 to 50 WVDC, and capacitance values from 0.10 to

100uF. The operating temperature range is -55 deg C to +85 deg C, and to +125 deg C with derating.

For complete technical data, write for data sheet 3549 to: Sprague Electric Co., Marketing Communications Dept., 41 Hampden Rd., P.O. Box 9102, Mansfield, MA 02048-9102.

Circle No. 8 on Reader Service Card

Continued on page 54

Introducing the PSION ORGANISER II Pocket Computer

An amazing portable computer for professionals, engineers, students — anyone who needs facts and figures at their fingertips! We were so impressed with its performance that we made special arrangements to supply the Psion to readers, complete with a free datapak.

Order the Psion Organiser II before December 31, 1986 and receive a 16K datapak totally free — a \$59.95 value!

The PSION Organiser II takes over where your memory leaves off. It's a powerful hand-held computer that thinks with you. It replaces notebooks and diaries. It's an appointment calendar and a multi-alarm clock. It's a massive memory computer with powerful programming facilities. It's a computer you can use to communicate with office systems. Yet it's hand-held, and slips into your pocket or briefcase to go anywhere.

Clock, calendar, and diary

The Psion Organiser II shows the weekday, date, month, year, hour, minutes, seconds on a two-line display. You record appointments against the relevant date and time, not just for the current year but for future years too. Like any other diary you can browse through the entries or go straight to a specific date. The diary can buzz up to an hour before any appointment and show you who, where, and when on the screen. You can also set up to eight alarms to ring on a regular weekly or daily schedule.

Portable records storage and filing system

The database stores vital personal and business information such as names, addresses, telephone numbers, customer data, stock records and reference information. Just type in any small detail as a clue and the powerful built-in cross-referencing system will recall the item you require in less than one second and automatically scroll it across the screen. Each record can contain up to 255 characters and 16 lines of information.

Powerful calculator

Entries are displayed on the screen as they are performed, so they can be checked or changed for "what if" calculations. There are 50 built-in mathematical and scientific functions, 10 memories, up to 12 decimal places, and limitless brackets.

Plug in extra programs

The Psion Organiser is built to run plug-in application programs. The Finance Pak allows the quick and efficient calculation of complex financial matters (compound interest, discounted cash flows, investment portfolio evaluation, etc), as well as allowing you to record, monitor and analyze your expenses. Additional program packs available include the Math Pak and the Concise Oxford Spelling Checker.

A computer designed for a thousand applications

The Organiser II has the features of a desk-top PC in a handheld device...up to 304K on-board memory...ready to use software built-in...powerful programming facilities for your own specific needs...extra plug-in program packs... "solid state drives" to store information and load programs...plug-in peripherals and links to office systems...all for a mere fraction of the price of a desk computer.

Expanding the Organiser II's internal memory is as easy as plugging Datapaks into the two thumb-sized slots in the back of the machine. These packs perform a similar role to floppy disks on a desk top computer, provide mass storage with exceptional data security. Up to 128K is available with datapaks. The data is safe, even if you remove the pack from the computer.

Telephone Orders: We accept telephone orders for Visa, Mastercard or American Express. Please have your card number and expiry date ready, and call: **Moorshead Publications, (416) 445-5600.**



Easily programmed and powerful

The high-level, structured programming language built into the ROM of the Organiser is drawn from BASIC but developed further using modern structured programming concepts. It includes integer handling, real arithmetic, variables and string and numeric arrays. The language includes full database facilities which allows the creation of files, the definition of fields and records, searching and locating of records and so on.

Communicates with office systems

Psion Organiser II has a standard peripheral port at the top of the machine. It is expanded into a complete system by plugging in the optional RS232 LINK communications cable and connecting it to printers, computers, and modems. Records and files can be transferred in either direction. Organiser II can be connected directly to a modem.

Mall Orders: Send to Moorshead Publications, 1300 Don Mills Road, Toronto, Ontario M3B 3M8.

Order now! This offer expires December 31, 1986.



Yes! Please send me _____ Psion Organiser II Model XP at \$399.95 each with FREE Bonus 16K Datapak (\$59.95 Retail Value). TOTAL _____

Datapak, Programs Paks, Accessories

_____ 8K Datapak(s)	\$ 44.95 each	TOTAL _____
_____ 16K Datapak(s)	\$ 59.95 each	TOTAL _____
_____ 32K Datapak(s)	\$109.95 each	TOTAL _____
_____ 64K Datapak(s)	\$239.95 each	TOTAL _____
_____ Finance Program Pak(s)	\$ 99.95 each	TOTAL _____
_____ Math Program Pak(s)	\$ 99.95 each	TOTAL _____
_____ Concise Oxford Spell Checker(s)	\$ 99.95 each	TOTAL _____
_____ RS232 Link(s) (includes software and interface)	\$189.95 each	TOTAL _____

Ontario residents add 7% sales tax
First-class postage and handling

TOTAL \$5.00

Ship to: NAME _____

ADDRESS _____

CITY _____ PROV _____ CODE _____

Payment Enclosed: Cheque _____ Money Order _____ or charge to Visa _____

Mastercard _____ American Express _____ Card No. _____ Expiry Date _____

Percussion Synthesizer

*An inexpensive percussion synthesizer
activated either externally
or by touch.*

By Mark Stuart

THIS SINGLE channel synthesizer is capable of producing a wide range of percussion sounds. It can be set up to mimic real percussion instruments or to produce synthetic 'electronic' percussion sounds.

The sound may be triggered by positive pulses from a sequencer or by tapping a piezo electric pick-up device. In the latter mode the circuit is touch sensitive, the sound level varying according to how hard the pick-up is hit.

The circuit has seven controls altogether as follows:

Sensitivity Sets the gain of the trigger input circuits to suit the sequencer or pick-up output.

Pitch The frequency of the master VCO which produces the basic triangular output waveform.

Sweep This control varies the frequency of the master VCO during the beat. The effect of this control is very important and adds greatly to the quality of the synthesizer output. Sweep can be set to increase or decrease the pitch of the VCO. At its centre setting it has no effect.

Level Sets the level of the VCO signal in the output mix.

Noise Level Sets the level of the noise generator signal in the output mix.

Noise Filter A six position switch controlling a high 'Q' factor tuned circuit which enables different frequencies to be emphasized from the noise generator.

Decay Sets the time constant of the output waveform envelope. The range of the control covers from 10 milliseconds to 1 second.

Power is provided by two 9V batteries which should last for a considerable time. The output signal is fed to a standard jack socket and is suitable for any amplifier with an input impedance of around 50 kilohms and standard 'line level' sensitivity.

Circuit Description

The complete circuit diagram of the Percussion Synthesizer is shown in Fig. 1. As with all complex circuits it is best understood if it is explained one section at a time. The two batteries B1 and B2, connected in series, provide +9V and -9V supplies with a common centre 0V or 'ground' line. A double-pole switch S2a and S2b on the sensitivity control switches these two supplies on and off.

Capacitors C16 and C17 provide supply decoupling for the majority of the circuit. A separate -9V supply is provided from the standard supply via diode D2 decoupled by C10. This extra decoupling ensures that the output signal is pure and free from low voltage shifts.

White Noise

A small signal silicon transistor junction (TR1) operating in reverse breakdown at very low current is used to produce the white noise signal. A high input impedance non-inverting amplifier IC1a amplifies this signal and provides a suitably low output impedance to drive the output filter circuit. The AC gain of IC1a is set to 100 by R2 and R3.

Transistor TR2 is connected as a common emitter amplifier. Its gain is determined by the components connected in its emitter circuit.

Normally in such circuits a large electrolytic 'bypass' capacitor connected in parallel with the emitter resistor provides a low impedance path for signal currents. This ensures a high gain over a wide frequency range.

However, in this circuit the emitter resistor R4 is bypassed instead by a series tuned circuit consisting of L1 and one of the capacitors C3 to C7, according to the setting of S1. The series tuned circuit has a high impedance except near to its resonant

frequency where its impedance falls to a low value. Signal currents at or near to the resonant frequency therefore pass easily and the circuit has a high gain. Above and below resonance the circuit gain falls to much lower levels.

The effect that this filtering has on the noise level is quite dramatic. Different settings of S1 enable different bands of frequencies to be emphasized as required.

The resistor R5 broadens the frequency peak on the last setting of S1 to provide a more standard type of 'white noise' output. The signal from TR2 appears across VR3, the Noise Level control. From the slider of VR3 the signal passes via C2 and R30 to be mixed with the VCO signal at the input to IC4.

Voltage Controlled Oscillator

Integrated circuits IC2 and IC3 form a voltage controlled oscillator (VCO) producing a triangular wave output. Capacitor C13 is alternately charged and discharged by the output of IC2. Switching over from charging to discharging is done by IC3 which senses the voltage level on capacitor C13.

When the voltage on C13 reaches the negative trigger threshold of IC3 the output of IC3 switches from -9 volts to 0 volts. The output of IC3 is connected to the input of IC2 via resistor R18 so that when the output voltage of IC3 changes the output current from IC2 changes also.

The voltage on C13 now begins to move towards the positive input threshold of IC3 at which point the output of IC3 switches, IC2 reverses and C13 begins to charge once more towards the negative input thresholds of IC3. In this way the circuit oscillates continuously.

The frequency of oscillation is set by the value of C13 and the amount of current used to charge and discharge it. The current is provided from the output of IC2 which is a CA3080 variable transconductance amplifier. This means that the amplifier output current depends on the input signal voltage and upon the transconductance or 'gain' of the amplifier.

The input voltage to IC2 is constant. It is set by potential divider resistors R18 and R19 from the constant output voltage swing of IC3. The transconductance of IC3 can be varied over a wide range by altering the current fed into the 'bias' terminal, pin 5.

A 'high' current on pin 5 produces a high gain and so C13 is charged and discharged rapidly giving a high frequency output. Similarly a low current produces a low frequency output.

The bias current to IC2 is derived from the output of IC1c via resistor R20 and the Pitch control VR6. When the sweep control is set to neutral (centre position)

the output of IC1c remains fixed at 0V. In this condition the bias current to IC2 is set solely by VR6 which provides a frequency adjustment range of 22 to 1.

Voltage Controlled Amplifier

The output from the VCO is amplified by IC1d and fed to the Tone level control VR7. The signal from the slider of VR7 passes via R24 and C12 to be mixed with the noise signal at the input to IC4. The mixture of input signals at IC4 is exactly as it will appear at the output of the synthesizer.

The percussive nature of the sound is dependent not on the waveform of the output signals but upon their "dynamics". That is the rise and fall (attack and decay) of the signal level. The dynamics are imparted to the signal by varying the bias and therefore the gain of IC4 in the same way as the gain of IC2 was varied in the VCO circuit.

The envelope control current is provided by transistor TR4 which produces a current output proportional to the voltage on capacitor C9 which is connected to its base. C9 is charged rapidly via R11 and D1 whenever TR3 is turned on. Transistor

TR3 is turned on either by positive trigger pulses applied to the trigger input from a sequencer or during positive half cycles of the signal from a piezo electric transducer XI. IC1b inverts and amplifies the trigger signal. VR1 sets the gain of the trigger amplifier stage to accommodate different transducers and trigger signal levels.

After the trigger pulse TR3 turns off and C9 discharges via R10 and the Decay control VR2. Setting VR2 to a low value produces a very rapid decay, a high value produces a slow decay.

The current from TR4 follows this voltage and controls the gain of IC4. Thus when the current is triggered the gain of IC4 rises rapidly and then falls gently at a rate set by the Decay control VR2.

In the absence of trigger pulses the gain of IC4 falls to zero so that the circuit is silent. Depending upon the setting of sensitivity control VR1, a soft tap on the input transducer may only partially charge C9 so that a quieter output signal is produced.

Sweep Generator

The voltage across C9 is also used by the sweep amplifier IC1c. The Sweep control

VR4 allows the gain of this stage to be varied from +1 through 0 to -1. The output voltage of IC1c is used to provide the bias current which controls the frequency of the VCO. Varying this voltage causes the frequency of the VCO to vary.

As the Sweep control VR4 is moved from the centre (neutral) position a proportion of the envelope control voltage also modulates the frequency of the VCO. This means that the pitch and level of the output signal vary together. The amount of pitch change can be varied to introduce extreme 'swooping' effects or very subtle effects which add realism when synthesizing natural percussive sounds. The control can be set to introduce a pitch rise or a pitch fall by turning the control clockwise or anticlockwise.

Construction

The entire circuit is built on a single printed circuit board and the PCB pattern is shown in Fig. 2. The board component layout is given in Fig. 3.

Before inserting any components use the bare board as a template to mark out the front panel of the case. Note that the track side of the board is the side that will

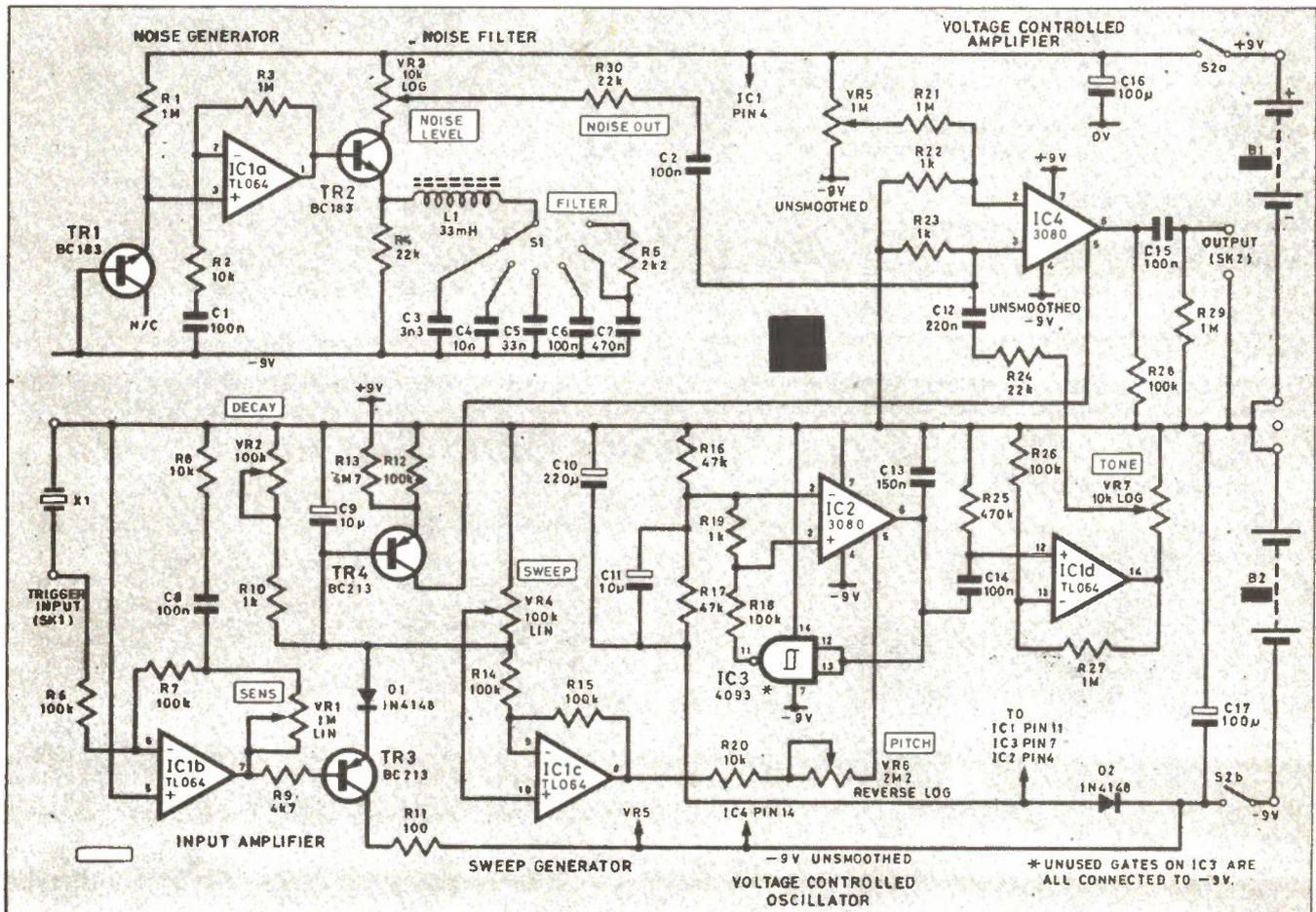

Fig. 1 The complete circuit of the Percussion Synthesizer. The input and output sockets are standard 1/4 in. mono jack sockets.

Continued on page 58

MARKET PLACE

ROBOTS ON THE BEACH

YEAR ROUND COURSES SINCE 1983
BUILD YOUR OWN ROBOT
 AS SEEN ON CBC'S WonderStruck

Children focus on understanding electronics and robot design by building their own robot to take home.

4 CHILDREN PER CLASS

Each child has their own program designed just for them.

Instruction by international artist/educator Stephen W. Long whose **CREATING WITH COMPUTERS** software is approved by the Ministry of Education and is distributed to Ontario Schools by TV Ontario. Authorized agents for the GEMINI educational robot.

CREATING WITH TECHNOLOGY
 (416) 694-8842

HIGHEST QUALITY XT/AT COMPATIBLES

COMPLETE XT* SYSTEM - only \$699.00	NEW!!! Packard Bell AT* System \$2499.99	DISK DRIVES
640K RAM	80286 CPU - 6Mhz	Panasonic 360kb \$149.00
Disk drive	640K RAM on board - expandable to 1MB	Seagate ST-225 \$829.00
Color graphic card	1 1/2 Mb floppy drive	wctrl \$999.00
At style keyboard	30 Mb hard disk ST-4038 40MS	Seagate ST-4026 \$1199.00
150 watt power supply	Floppy/hard disk controller	Seagate ST-4038 \$1199.00
Turbo 8mhz, version of above (+)	210-watt power supply	Western Digital ctrl \$175.00
\$150.00	MS DOS 3.1	
ACCESSORIES	ROLAND PRINTERS	MONITORS
XT Motherboard 640K at OK \$199.00	(2 year warranty from XEROX)	V232G \$159.00
Turbo XT (8mhz) Motherboard OK \$249.00	PR-1011 \$349.00	V232A \$169.00
Color graphic card \$ 89.00	PR-1111A \$429.00	V242G \$179.00
Monographic card \$129.00	PR-121A \$589.00	V242A \$189.00
ATI Graphic Solution card \$299.00	PR-1215 \$789.00	V300G \$229.00
384K multi-function card at OK \$149.00	PR-1550 \$999.00	V300A \$239.00
I/O Plus card \$125.00	PR-2017 \$529.00	V310A \$249.00
I/O Plus II card \$176.00	PR-2022 \$639.00	
Floppy disk controller \$ 79.00		
Parallel card \$ 49.00		
Serial (RS-232) card \$ 69.00		

DISKETTES
 DS/DD bulk diskettes 10pack \$ 9.95

DRAMS
 4164 - 150 ns (Japanese) \$ 1.95
 41256 - 150 ns (Japanese) \$ 4.95

1 year warranty on systems, monitors & disk drives. 90 days warranty on accessories. Most orders processed within 24 hours.

We accept: VISA, M.C. C.C. Min. shipping charge \$5.00 or 5%, whichever is larger. 20% restocking charge on all returned items (EXCEPT DEFECTIVE). Ontario residents add 7% P.S.T.

*XT/AT are registered trademark of IBM CANADA LTD. Complete product/price list available. - To order, please call TOLL FREE 1-800-387-5335



Super Micro Computer System's Inc.

3261 Kennedy Road, Unit #1 Scarborough, Ontario,
 M1V 2J9 Tel. (416) 292-9977

Business Hours:
 Monday-Friday
 9:00 am - 9:00 pm
 Saturday & Sunday
 10:00 am - 6:00 pm

PC COMPATIBLE SYSTEM

Includes:

- Keyboard & 150W power supply
- Fully loaded 640K
- 2 DS/DD Disk drive & controller
- Serial parallel and game port, clock and calendar monochrome graphics board.
- 6 Months warranty
- Includes Monitor

SALES PRICE **\$1250.00**

BONUS

If you buy this system we will offer you a high resolution TTL Monitor.

EUTHA Enterprises (613) 345-3524
 26 Kincaid Street,
 Brockville,
 Ontario K6V 4Z9

Shipping: Add \$20.00 for System and \$15.00 for Monitor. Certified cheque, personal cheque (allow time for clearance). Ontario residents add 7% P.S.T.

ELECTRONICS TODAY BACK ISSUES
50% OFF!

Regular price \$4.00 each. With this coupon \$2.00 each. Check availability from order form/advertisement in this issue.

Ontario residents, please add 7% P.S.T.

K.E.M. Stepping Motor Controller and Driver

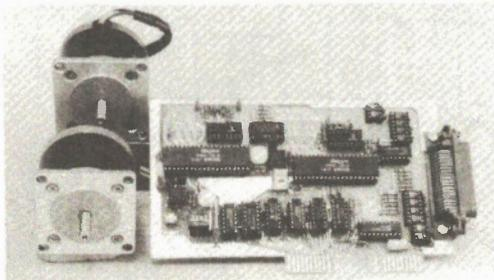

(Two motors are optional)

For IBM XT.

- Programmable Intelligent Stepping motor controller
 New model KEM-806 \$398.00 with demo-software
 2-CH intelligent motor controller Interface I/F card for IBM XT.
 2 custom MPU built-in to control 2 stepping motors (max. 16 motors) simultaneously by using BASIC or other high level languages. Photo Isolator for input and output signals. 5000pps (10000pps option)
- High Performance PWM type stepping motor driver
 New model KEM-802 \$98.00/ch
 \$205.00/2ch with heatsink
 High speed, high torque stepping motor driver. PWM constant current power driver IC and phase controller IC are used, current limiter and power down circuit built-in. Photo isolator signal input.
 output power 2.25V to 18V 1.5A max.
 pulse rate 20000pps
 mini size 55mm, 75mm, 30mm w/without heatsink
- Rotary Encoder OSS Series
 Pulse rate 100P/R to 500P/R. Price range \$98.00 to \$198.00

K.E.M. Electronics Ltd.

Mail: Box 69126 Station (K), Vancouver, B.C. V5K 4W4
 Office: 879E. Hastings St., Vancouver, B.C. Tel: (604) 251-1514

MARKET PLACE

LET US HELP YOU BUILD YOUR OWN COMPUTER WITH PRICES SUCH AS THESE...

XT KIT — \$949.00

- 1 Motherboard/640K RAM
- 1 360K Floppy Drive
- 1 Colour Graphic Card
- 1 Floppy Disk Controller
- 1 Keyboard 5150 Style
- 1 150 Watt Power Supply
- 1 Flip Top Case

ACCESSORIES

- Seagate 20mb Hard Disk & Controller Card \$620.00
- MCK-860 Keyboard \$ 99.00
- 150 Watt Power Supply \$125.00

TERMS: Money Orders and Certified Cheques acceptable. 90 Day warranty on all parts. Quebec residents add 9% Sales Tax.

TYFU Computers, 1304 Greene Ave., Westmount PQ. H3Z 2B1 (514) 932-4674

SEND IN THIS COUPON TO GET YOUR FREE TYFU CATALOGUE



INSTRUMENT RENTALS CANADA

Sale of Used Equipment at up to 90% off list
Sold "as is" (R indicates needs repairs). \$50 minimum order.
Quantities limited. Other equipment may be available.

	MFR/MODEL	SSALE	MFR/MODEL	SSALE	MFR/MODEL	SSALE
6815 Rexwood Rd., Unit 6, Mississauga, Ontario. L4V 1R2.	AJ/1234	\$112.10	B&K/4425	\$152.50	BIRD/10	\$ 9.10
	BIRD/100	8.50	BIRD/25	15.40	BIRD/5	8.50
	BIZ/1031-03	41.90	BRU/13-4615-30	137.10	DATUM/9100-210	190.00 R
	DATUM/9300	995.00	DEC/LA34	150.00	DEC/LA34-KL	90.00
	EIA/RS232-10MM	6.20	ELG/2 UNIT CAB	11.60	ELG/400B	11.60
	HON/122-RACK	50.00	HON/1858	1,000.00	HON/1881HGD	167.10
	HON/1883MPD	63.10	HON/1885SCG	157.90	HON/1887TCD	160.90
	HP/00085-1500X	50.00	HP/13222N	12.20	HP/13296A	113.20
	HP/1640A	890.00	HP/2622A-202	275.00	HP/2623A/050	700.00
	HP/2624A/050	450.00	HP/2631B	470.60	HP/2647A	900.00 R
4026 Rue Steinberg, St.-Laurent, Quebec. H4R 2G7	HP/6113A	192.50	HP/8007B	608.30	HP/8011A	700.00
	HP/85F	595.40 R	HP/9845T	500.00 R	HP/9885M	250.00
	HP/9895A	500.00	HUGHES/1177HO2	1,259.00	IBM/ASYNCH CAR	\$15.40
	IBM/DOS 2.0	\$9.20	IBM/DOS 2.1	10.00	IBM/DOS 3.0	10.00
	LSI/ADM-31	238.70	LSI/ADM-31-1	385.00	LSI/ADM-42A	200.20
	RIX/LDM710	99.00	RIX/T209A	615.20	TCM/3001	22.90
	TEK/140R	4,162.00	TEK/8002/38	167.90	TEK/P6063B	100.00
	TEK/P6462	400.00	TEK/8002/49	238.70	TEK/832	307.20
	TI/820-613-PKG	300.00	TKN/822	272.30	TKN/951	230.20
	TV1/924	400.00	VENTEL/MD212	92.60	VENTEL/502-1	18.50
TO ORDER: Ontario/Quebec 1-800-387-3411	BEEHIVE/ATL-004	475.00	CENTRONICS/H80	395.00	WAVETEK/171	900.00
	WAVETEK/2001	2,500.00	WAVETEK/3006	4,900.00		
Rest of Canada 1-800-268-4928						

NEXT MONTH IN

Electronics Today

Graphics For Electronics!

Are you still doing schematics with instant lettering? Still doing line drawings with a technical pen?

Our January issue looks at some of the amazing computer-aided-drafting software that's available, software that can save you hours of time. And besides: it's fun to use.

The Differential Amplifier!

"Never use them. Strictly IC opamps for me." Well, the differential amplifier forms the front

end for just about every opamp going. Find out how they work and how to optimize discrete versions for your circuit.

Direct Input and How They Work!

The DI, also called Direct Insertion or Direct Injection, connects musical instruments directly into an audio console. It's a worthwhile method of solving microphone problems.

For subscriptions call (416) 445-5600

Moving Magnet Preamplifier

A preamplifier suitable for moving magnet stereo pickups.

By Graham Nalty

A PREAMP for magnetic record cartridges has two basic functions. First, it changes the frequency response to cancel the RIAA equalization put on every record as a means of reducing noise, and second, it raises the level of the signal until it equals that obtained from radios and tape recorders.

Equalization

The preamplifier requires a gain which varies with frequency as shown in Fig. 1. Typically we need a gain of about 50 at 1kHz rising to 500 at 20Hz and falling to 5 at 20kHz. The most common method of obtaining RIAA equalization is by feedback, in which equalization is carried out in the negative feedback loop of the active circuitry. A typical example is shown in Fig. 2.

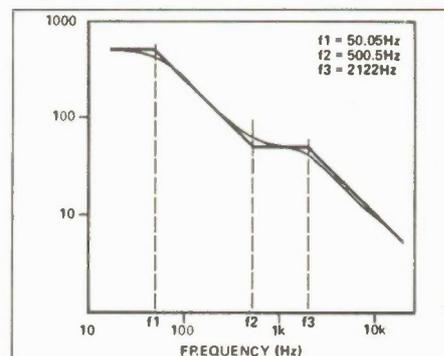

Fig. 1. The desired frequency response of an RIAA preamp.

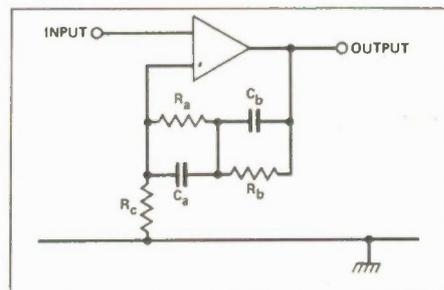

Fig. 2. A typical shunt feedback equalization.

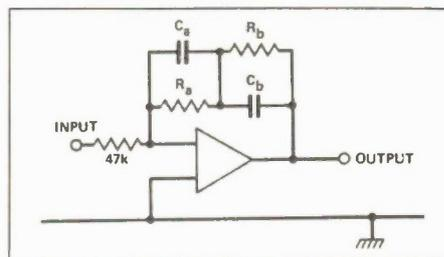

Fig. 3. A series-feedback equalization arrangement.

This circuit uses a minimum of components, especially if built around an integrated circuit, but is becoming less popular among designers of higher-

**AN OLD RESPECTED NAME.
A BOLD NEW LOOK.**

Computer Mail Order is one of the oldest computer mail order companies in the country. We've succeeded where others have failed, because year after year, we've delivered to you the most product performance for your dollar and given you the attentive service you desire and deserve. This month we launch a new look. We hope you'll find it as easy on your eyes as Computer Mail Order has been on your pocketbook. We also hope you'll do us the honor of calling us C-M-O.



FINE PRODUCTS.

When you call CMO toll-free, you order from a selection of the finest computer hardware, software and peripherals available. More than 5000 items from the best sources in the business (including PC-TOO,TM the tailor-made clone, direct from CMO!).

FINE PRICES.

Call us. Compare us. Talk to us. We won't hang up. We like talking price as much as we like talking computers.

FINE SERVICE.

We know computers. And we back that product knowledge with our best warranty package ever. And we deliver with next-day shipping on our entire inventory. At CMO, we're committed to keeping you up, running and satisfied.

NO FINE PRINT.

We're CMO. No hot air. No come-ons. No hang-ups. And no fine print. Turn the page. Explore CMO.



HOME COMPUTERS		MODEMS	
ATARI		Managing Your Money/Meca 194.00	Anchor
1040ST Colour Sys. Call		WordStar 2000 + /Micro Pro 512.00	Volks Modem 1200 Bd \$213.00
1040ST Mono Sys. Call		Wordstar Pro w/GL Demo 270.00	Signalman Express 1200 Bd 329.00
520ST Colour Sys. Call		R:Base 5000 435.00	Express! 1/2 Card 1200 Bd 246.00
520ST Mono Sys. Call		Micro Soft Word 463.00	6480 C64/128 1200 Bd 197.00
520ST Basic CPU Call		Micro Soft Mouse/Serial 222.00	VM520/520/1040ST Atari 213.00
65XE 64K CPU \$149.00		Micro Soft Mouse/Bus. 207.00	Omega 80 Amiga 213.00
130XE 128K CPU 213.00		Crosstalk XVI 156.00	Everex
800XL 64K CPU 116.00		Multimate 3.3 359.00	Evercom 920 1200 Bd \$229.95
1010 Disk Drive 79.99		Multimate Advantage 457.00	Hayes
1050 Disk Drive 206.00		Norton Utilities 75.00	Smartmodem 300 \$229.95
1020 Printers 47.75		First Choice/PFS 145.00	Smartmodem 1200 641.99
XM301 Modem 66.00		Professional Write/PFS 190.00	Smartmodem 1200B 593.00
835 Modem 50.00		Professional File 236.00	Smartmodem 2400 956.00
850 Interface 197.00		Word Perfect 4.1/Satellite 364.00	Smartmodem 2400B 890.00
ICD Printer Connection 99.00		Enable/Software Group 588.00	Smartmodem IIe 246.00
Ape face Modem 66.00		Wordstar 2000 380.95	Peripherals
COMMODORE		Wordstar 2000 + 460.00	Practical Modem 1200SA \$296.00
C64 Package \$ 824.00		R:Base 5000 476.00	Quadram
C128 Package 1286.00		Clout 2.0 222.00	Quadmodem II \$494.00
64C Keyboard 329.00		R:Base System V 555.00	SVPPA
64C Geos 79.99		Advantage 428.00	MPP 1064 AD/AA C64 \$116.00
128 Keyboard 444.00		Enable 555.00	1200AT Atari 8 Bit 246.00
1571 Disk Drive 395.95		Decision Resources	1200ST Atari 520ST 246.00
1541 Disk Drive 316.95		Chart Master 365.00	
1902 Monitor Colour 494.00		Sign Master 253.00	
Amiga 1020 5 1/4" Ext. 316.95		Diagram Master 333.00	
Amiga 1010 3 1/2" Ext. 365.00		Map Master 412.00	
Amiga 1080 RGB Monitor 477.00		MONITORS	
1660 Modem 99.00		Amdtek	
1670 Modem 229.95		Amdek 310A TTL \$263.00	
1530 Datasette 64.00		Amdek 410 TTL Call	
C128 Univ. Mon. Cable 23.50		Amdek 600 RGB 659.00	
C128 512K Expansion 328.95		Amdek 722 RGB 824.00	
PP Printer Interface 58.00		Amdek 730 RGB 1154.00	
XETEC S/Graphics 8K 116.00		Magnavox/NAP	
XETEC 83.00		8CM515 RGB Monitor 80 \$477.00	
Candco Super G 87.99		7BM623 PC Monitor 80 164.00	
Micro R & D M.W.350 83.00		NEC	
SOFTWARE		JB1285 TTL Amber \$213.00	
Paradox/ANSA \$855.00		JB1280 TTL Green 230.00	
DBASE III plus Ashton Tate 650.00		JC-1401-P3A Multi-Sync 989.00	
Framework II/Ashton Tate 660.00		Princeton Graphics	
Reflex/Borland 145.00		MAX12 Amber \$279.00	
Lightening/Word Wizard/Borland 145.00		HX12 16 Colour 708.00	
Copy II PC/Central Point 42.00		HX12E 64 Colour 823.95	
Fastback/5th Generation 142.00		SR12 823.95	
Mouse W/Dr. Halo/IMSI 179.00		SR12E Super Hi-Res 972.00	
General Ledger/IUS 520.00		SR12E RGB Analog 1071.00	
Super Calc III/IV 487.00		Taxon	
Super Project Plus 474.00		220 Colour Composite \$279.00	
Volkswriter III/Lifetree 232.00		620 640 x 200 659.00	
Lotus 1-2-3/Lotus 449.00		630 640 x 200 725.00	
Symphony/Lotus 629.00		640 720 x 400 741.00	
		640 + RGB Hi-Res. 890.00	
		Zenith	
		ZVM1220/1230 Mono \$165.00	
		ZVM1240 IBM Amber 246.00	
		ZVM1330 1-3" RGB 758.00	
		DRIVES	
		Allied Technologies	
		Apple Half height \$174.00	
		CMS	
		Drive Plus 20M Card \$635.00	
		T-120 20MB Tape Backup 746.00	
		T-160 60MB Tape Backup 1112.00	
		Everex	
		60MB Internal Backup \$1271.00	
		20MB Streamer Tape 1112.00	
		I Omega	
		A210H 10 + 10 Bernoulli Box \$3020.00	
		A220H 20 + 20 Bernoulli Box 3974.00	
		Indus	
		Atari GT \$316.95	
		Commodore GT 316.95	
		Mountain	
		Drive Card-20 \$1096.00	
		Drive Card-30 1509.00	
		Priam	
		ID-60AT Innerspace \$2145.00	
		Racore	
		1501 Exp Chassis/DMA \$508.00	
		2103 512K Memory Card 206.00	
		Seagate	
		ST-4026 20MB Hard Drive \$1096.00	
		ST-4038 30 MB Hard Drive 1175.95	

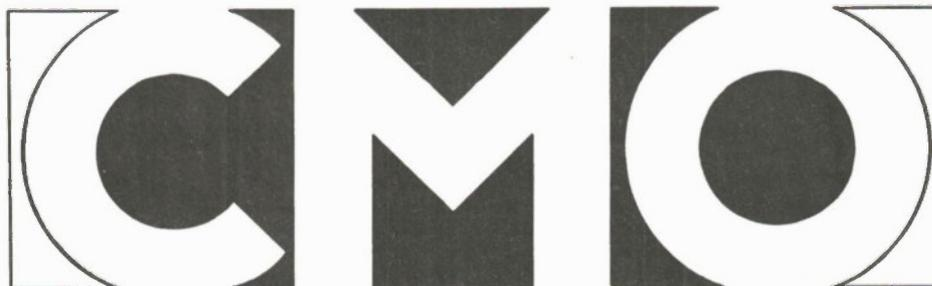

business, person to person.

PRINTERS					
Canon		Amansy		1200-2400 Baud Int. Modem	Call
LBP-8A1 Lazer	\$2846.00	Disk TUB 50 5 1/4"	\$16.99	I/O Board P/S/C	Call
Citizen		Disk TUB 30 3 1/2"	16.99	XT-512K Expansion	Call
MSP-20 Dot Matrix	\$555.00	Innovative Concepts		EGA	Call
MSP-10 (80 CI) Dot Matrix	476.00	Flip & File 10	\$ 4.50	Serial	Call
Premier 35 LQ Daisywheel	714.00	Flip & File 50	19.99	2 Serial	Call
C-Itch				Parallel	Call
8510-SEP Dot Matrix	Call	MS DOS		Paradise	
Starwriter A10-30	444.00	AT & T	\$2799.00	Modular Graphics Card	\$444.00
Cor Data		Compaq	2499.00	Colour/Mono Card	229.95
The Desktop Printshop	\$3497.00	Corona	1699.00	Multidisplay	263.00
Diablo		IBM-PC	1999.00	Auto Switch EGA	593.00
635 Daisywheel	\$1748.00	IBM-XT	2999.00	Polaroid Palette	
Epson		IBM-AT	4699.00	Computer Image Recorder	\$2309.00
FX-85 Dot Matrix	Call	Leading Edge	2199.00	Quadram	
FX-286 Dot Matrix	Call	Sperry	3199.00	Quad EGA Plus-Graphics	
LQ-800 24 Pin	Call	Zenith	1699.00	Adapter	609.00
LQ-1000 24 Pin	Call	MULTIFUNCTION CARDS		Expanded Quadboard	229.95
Hewlett Packard		AST:		Silver Quadboard	395.00
2686A Laser	Call	Six Pak Plus PC/XT	\$279.00	Quadport XT	213.00
7475S Plotter	Call	Six Pak Premium PC/XT	609.00	Microfazer II	444.00
7550S 8 Pen Plotter	Call	Advantage IBM/AT	559.95	STB	
Juki		Rampage PC/XT	460.95	EGA Plus/Dr. Halo	\$527.00
6000 LQ. Dalsywheel	Call	Rampage IBM/AT	791.00	SPECIALS	
6100 LQ Daisywheel	Call	DCA		5th Generation fastback	\$141.95
6300 LQ Daisywheel	Call	IRMA PC-3278 I/O	\$1400.95	Amdek 310A Amber	
5510C Colour Matrlix	Call	IRMA 3270 Emulations	1319.00	Monitor	229.95
NEC		Everex		Paradise Auto Switch	
P560-660-760	Call	Edge Card	\$395.00	EGA Card	593.00
3550 Spinwriter	\$1239.00	EGA Video	461.00	Hayes-Smartmodem	
8850 Spinwriter	1748.00	EV640 Edge Card	428.00	1200 bd Ext	625.50
DISKETTES		Hercules		CMS 20MB Kit w/west.	
Maxell		Graphics Card	\$329.00	Dig. Cont.	635.00
MD1-SS/DD (10) 5 1/4"	\$19.50	Graphics Card Plus	362.00	Toshiba 1100 + Laptop	
MD2-DS/DD (10) 5 1/4"	20.95	Colour Card	279.00	Comp.	2781.00
MD2-HD AT (10) 5 1/4"	40.00	IDEA Associates		Canon LBP8-Laser Printer	2845.00
MD2E-DS/DD (10) 5 1/4"	Call	IDE 5251 Emulation Board	\$873.00	PCT00 256 EXP 640 -	
Sony		Intel		360K Floppy	824.00
MD1-SS/SD (10) 5 1/4"	\$15.95	AC Above Board 2MB/64K	\$395.00	Curtis SP-1 Diamond	
MD2-DS/DD (10) 5 1/4"	19.95	AT Above Board 2MB/128K	626.00	Surge Protector	48.00
MD2HD AT (10) 5 1/4"	40.00	8087, 80872, 80287, 802878	Call	Magnavox NAP 12" Comp.	
MFD1-SS/DD (10) 3 1/2"	31.00	Video-7		Monitor GR./Amb.	126.00
MFD2 DS/DD (5) 3 1/2"	13.99	EGA Graphics Card	\$543.00	Epson Homewriter 10.	
Verbatim		Vega Video Adapter EGA	560.00	with Pic	158.00
VE-1 SS/DD (10) 5 1/4"	\$15.99	Zuckerboard		Practical Peripherals	
Generic		Colour Card w/Parallel	\$149.00	Promodem 1200	279.00
NT02 DS/DD (10) 5 1/4"	\$ 9.99	Monochrome Card	165.00	Quadram Quadjet 7 colour	
Elephant		576 Memory Card	99.99	printer	296.00
EL2 DS/SD (10) 5 1/4"	\$13.99	Lava		Commodore Amiga 1000	
EL5 DS/D (10) 5 1/4"	16.25	Multifunction C,S,P, 512K OK	Call	Colour System	2127.00
EL6 Head Cleaning Kit 5 1/4"	9.75	Intelligence PC/XT 2 MB EHS	Call		
		Intelligence AT	Call		
		AT-128K Expansion	Call		

When you want to talk computers.

When you want to talk price.

Call toll-free: 1 800-268-4559 Canada, 1-800-268-3974 Ont/Que.

Toronto Area Call: 828-0866 Telex: # 06-218960

Computer Mail Order Canada 2505 Dunwin Drive, Unit 3 • Mississauga, Ontario L5L 1T1

GET A TAILOR-MADE 20 MEG, XT-COMPATIBLE FOR AS LITTLE AS \$1499

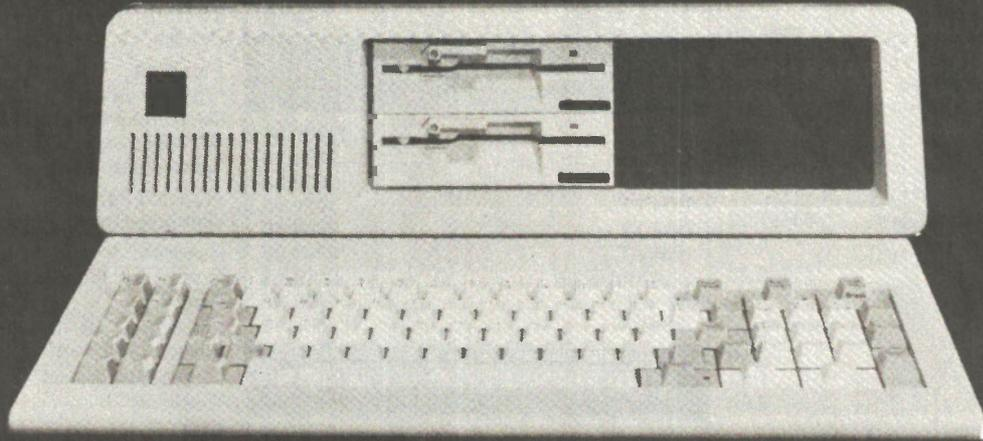

Presenting PC TOO™. Only from CMO.

When you think of tailor-made, you think expensive, right? Think again.

Now CMO can offer you a 20 Mb PC-compatible-one we assemble in our Pennsylvania lab just for you. To your specifications. With the attention to quality and performance you've come to expect from CMO. All for just \$1499.

Every tailor-made clone we make is backed with a full 90-day warranty on labor and parts, a 30 day money back guarantee and easy access to CMO technical support after the sale-the kind that keeps you up, running and satisfied.

For \$1499, you get: A 20 Mb, PC-XT compatible that runs thousands of programs, including Lotus 1-2-3™ ● A 4.77 Mh chip speed. An XT chassis with 256K (expandable to 640K) ● A 20 Mb hard drive ● A 360K floppy drive ● A floppy disk and hard drive controller.

A 150 watt power supply (not just 130) ● Open architecture with 8 expansion slots (not just 7) ● And an 84-key, XT-style keyboard.

Need more power and more flexibility? Call us. Let's talk about your tailor-made PC TOO.

Your options are unlimited.

CMO. Policies and particulars.

Next day shipping on all in-stock items ● Free technical support from our own factory-trained staff. ● Toll-free order inquiry. ● No surcharge on VISA or MasterCard orders. ● Credit cards will not be charged until the order is shipped. ● No limit and no deposit on COD orders. ● No sales tax on orders shipped outside Ont. ● No waiting period for cashier's cheques.

SHIPPING. Add 3% (minimum \$10.00) shipping and handling on all orders. ● Larger shipments may require additional charges. ● Returned items may be subject to a restocking fee. ● All items subject to availability and price changes.



When you want to talk computers.

When you want to talk price.

Call toll-free: 1 800-268-4559 Canada, 1-800-268-3974 Ont/Que.

Toronto Area Call: 828-0866 Telex: # 06-218960

Computer Mail Order Canada 2505 Dunwin Drive, Unit 3 ● Mississauga, Ontario L5L 1T1

Circle No. 19 on Reader Service Card

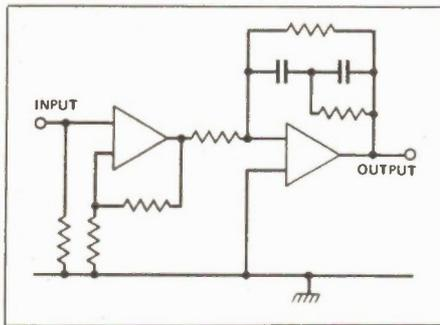

Fig. 4. Combined shunt and series feedback arrangement.

quality amplifiers because the amount of negative feedback varies with frequency. At low frequencies, where less negative feedback is applied, a very high open loop gain is needed to maintain an accurate frequency response. At high frequencies a high level of feedback makes slew-rate limiting and transient intermodulation distortion more likely.

The shunt feedback circuit of Fig. 2 has an additional problem, as the high frequency response does not roll off to zero but to a gain of 1. The effect of this error is to emphasize extreme high frequencies, including sibilance and record scratches.

This problem can be solved by the series feedback circuit of Fig. 3, but only at the expense of increased input circuit noise. In this circuit, the impedance seen from the input is the resistor (47k) in series with the cartridge (about 1kΩ plus inductance). In the shunt feedback amplifier the impedance is the cartridge in parallel with the 47k resistor and is much lower. Hence the noise level is much lower, but neither of these circuits can be considered ideal.

A solution to this problem is shown in Fig. 4. Two stages of amplification are used. The first is a shunt feedback circuit (low noise) with a gain of 5 at all frequencies. This is followed by a series equalization amplifier in which the virtual ground-resistor is much lower than the 47k required for a single-stage series equalization circuit. The phase of the output is inverted, but where this causes problems an extra unity-gain series-feedback buffer amplifier can be added.

An alternative way to achieve correct response at extreme high frequencies is shown in Fig. 5. This again is a two stage circuit. The first stage has a constant gain at all frequencies and is followed by a passive high frequency roll-off network, turning over at 2122 Hz. The 50Hz and 500Hz turnover frequencies are equalized by the shunt feedback network in the second stage of amplification. This configuration has been used by a number of manufacturers of amplifiers at the more expensive end of the market.

Electronics Today December 1986

Frequency	Input	Output of first amplifier	Input to second amplifier	Output of second amplifier	Input to third amplifier	Output
20Hz	20mV	159mV	158mV	1.26 V	1.26 V	10 V
1kHz	158mV	1.26 V	1.26 V	10 V	1 V	17.9 V
20kHz	1.26 V	10 V	1 V	7.9 V	795mV	16.3 V

Table 1: Maximum peak signal levels in the circuit of fig. 6.

Frequency	Input	Output of first amplifier	Input to second amplifier	Output
20Hz	20m	447mV	447mV	10V
1kHz	200mV	4.47 V	447mV	10V
20kHz	447mV	10V	100mV	2.24V

Table 2: Maximum peak signal levels in the circuit of fig. 7.

Frequency	Single passive network	Split Passive network	Feedback equalisation
20Hz	20mV	20mV	20mV
1kHz	200mV	158mV	200mV
20kHz	447mV	1.26V	2 V

Table 3: Comparison of the maximum input levels permissible with various equalisation arrangements.

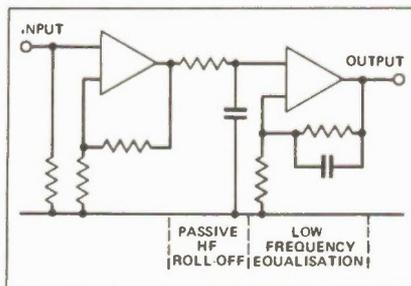

Fig. 5. An alternative two-stage equalization circuit.

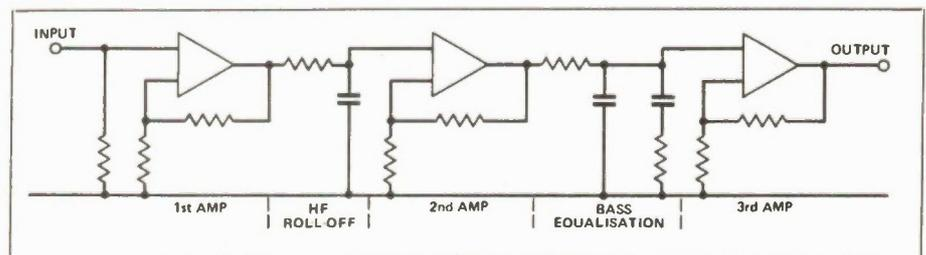

Fig. 6. Using three stages simplifies the component value calculations.

The passive equalization arrangement of Fig. 6 is one which I have used in a number of different amplifiers over the years. The signal is amplified by about 7 or 8 times in each stage and the 2122 Hz turnover (HF roll-off) is carried out by a resistor and capacitor after the first stage. The signal is then amplified a second time and the bass equalization (50Hz and 500Hz turnovers) is carried out by a second passive network. Noise and overload margins are optimized when the gains of the stages are approximately equal. This has all the important factors: correct phase, accurate frequency response and uniform feedback at all audio frequen-

cies. It has the advantage that the component values can be easily and quickly calculated.

This method can be applied to circuits which do not have any feedback in their active stages. The only disadvantage is that three separate stages of amplification are used. The intention in this design is to upgrade the preamplifier by providing separate power supplies for each stage of amplification, and with three stages this would quickly become very complicated.

We can cut things down by using the single-stage passive equalization arrange-

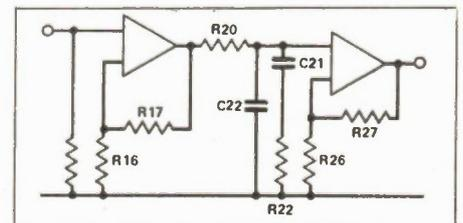

Fig. 7. The two-stage equalizer which forms the basis of this design.

ment of Fig. 7 which requires only two stages of amplification. The required gain

of each stage is now increased to 23. The disadvantage, shared with any other RIAA single network, is that component values are very difficult to calculate accurately.

Overload

An important part of the design of an RIAA preamp is to obtain an adequate overload margin. This is to make certain that the loudest signals from the cartridge are amplified accurately and reproduced without clipping or slew-rate timing. Problems start when you realize that different cartridges give a different output for a given recorded level in the disc and that the maximum signal in the groove can vary from record to record. There is thus no defined maximum cartridge output level on which to base our designs.

In practice, most RIAA preamps are designed with an overload capability well above the maximum typical output of a cartridge. This can be a real benefit to the person who owns a higher-than-average output moving coil cartridge and a high gain head amp. In the past quite a bit of nonsense has been talked about overload margins by people who assume that a preamp with a larger overload margin will

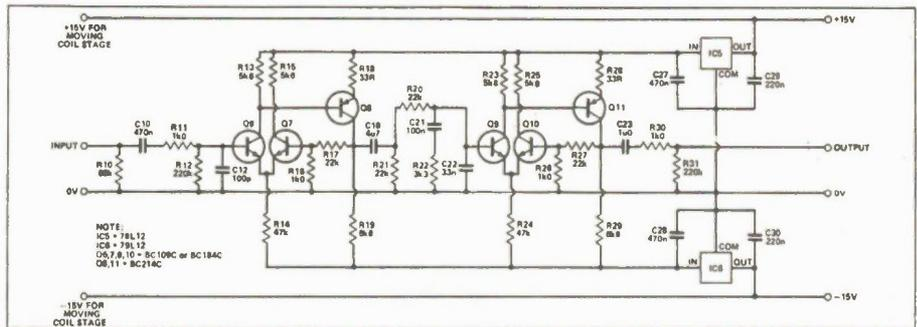

Fig. 8. Circuit diagram of the moving magnet stage in its standard version (one channel only).

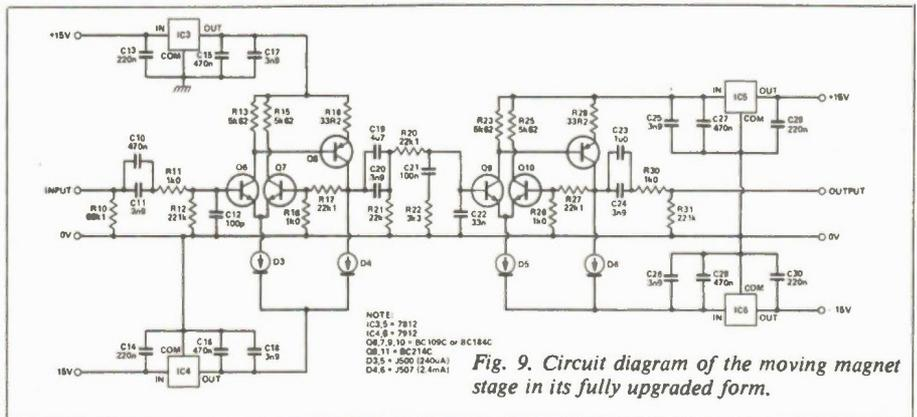

Fig. 9. Circuit diagram of the moving magnet stage in its fully upgraded form.

ALL SALES SUBJECT TO THE TERMS OF OUR 90 DAY LIMITED WARRANTY. FREE COPY UPON REQUEST.

THE NEW 65/9028 VT ANSI VIDEO TERMINAL BOARD!

★ FROM LINGER ENTERPRISES ★

A second generation, low cost, high performance, mini sized, single board for making your own RS232 Video Terminal. Use as a computer console or with a MODEM for hook up to any of the telephone-line computer services.

FEATURES:

- ★ Uses the new SMC 9028 Video Controller Chip coupled with a 6502A CPU.
- ★ RS-232 at 16 Baud Rates from 50 to 19,200
- ★ On board printer port!
- ★ 24 X 80 format (50/60 Hz).
- ★ For 15,750 Hz (Horiz.) monitors.
- ★ 3 Terminal Modes: H-19, ADM3A, and ANSI X 3.64-1979
- ★ Wide and thin-line graphics.
- ★ White characters on black background or reversed.
- ★ Character Attributes: De-Inten, Inverse, Underline and Blank.
- ★ Low Power: 5VDC @ .7A, ± 12VDC @ 20MA.
- ★ Mini size: 6.5 X 5 inches.
- ★ Composite or split video.
- ★ 5 X 8 Dot Matrix characters (U/L case) with descenders.
- ★ Answer back capability.
- ★ Battery backed up status memory.
- ★ For ASCII parallel keyboard.

MICRO SIZE!

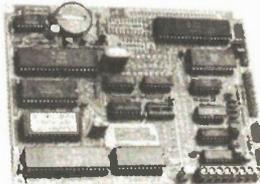

\$99⁹⁵
(Full Kit)

ADD \$40 FOR A&T

OPTIONAL EPROM FOR PC/XT STYLE SERIAL KEYBOARD: \$15

SOURCE DISKETTE: PC/XT FORMAT 5 1/4 IN. \$15

Digital Research Computers

(OF TEXAS)

P.O. BOX 381450 • DUNCANVILLE TX 75138 • (214) 225-2309

Call or write for a free catalog on Z-80 or 6809 Single Board Computers, SS-50 Boards, and other S-100 products.

TERMS: Add \$3.00 postage. We pay balance. Orders under \$15 add 75c handling. No C.O.D. We accept Visa and MasterCard. Texas Res. add 5-1/8% Tax. Foreign orders (except Canada) add 20% P & H. Orders over \$50 add 85c for insurance.

ECS-8088 Computer Special \$795.00

- 8088 processor
- optional Intel 8087
- numeric coprocessor
- 256K memory expandable to 640K
- double sided double density disk drive
- detachable keyboard
- 150 watt power supply
- Colour R Mono video card
- support PC software
- One Year warranty
- 8 slot Mother board

Optional:

- TURBO 8MHz motherboard \$50.00

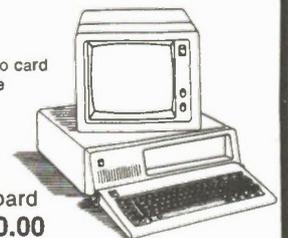

TTL Flat Screen Monitor \$179.00



Mouse — \$99.00



AT* Compatible

- 512K memory \$1995.00
 - 1 1.2M drive
 - Colour card
 - Keyboard
 - 200 watt power supply
- *IBM is a registered trademark of International Business Machines.

XT/PC MAIN PERIPHERAL

Enhance Graphic Card	\$395.00
Mother Board 8 Slot	\$195.00
Color Graphic Card	\$ 90.00
Multifunction Card	\$119.00
Monochrome Card	\$ 90.00
Monochrome Graphic	\$129.00
Game Port	\$ 30.00
RS232 Card	\$ 59.00
Parallel Interface	\$ 59.00
Disc Controller Card	\$ 89.00
Case	\$ 59.00
Keyboard (Cherry)	\$ 99.00
Power Supply 150 Watts	\$139.00
Printer Cable	\$ 25.00
RS232 Cable	\$ 25.00
Disk Drive Cable	\$ 15.00
Moving Message Board	\$495.00
TTL and CMOF test Card	\$ 99.00
150 Watt Power Supply	\$149.00
Modem 1200 B	\$299.00
Network Card	\$495.00

ELECTRONIC CONTR'L SYSTEMS

1590 Matheson Boulevard, Suite 1 & 2, Mississauga, Ontario L4W 1J1
(416) 625-8036 Hours — Mon. to Fri. 10-6. Sat. 10-2

sound better. On other occasions reviewers have criticized a preamp because they have measured a lower overload margin. But unless a reviewer can actually feed a genuine signal from a cartridge into the preamp and show a clipped waveform, there can be no justification for criticizing the overload margin.

To illustrate this point, I have calculated the maximum possible signal at each stage in a passive equalization circuit at 20Hz, 1kHz and 20kHz assuming a) an overall gain of 500 equally divided between each stage of amplification and b) a maximum peak voltage of 10V in either direction (Tables 1 and 2). Notice how the overload point (underlined) varies with frequency. Table 3 compares the maximum possible input voltage of these passive circuits with a feedback equalization circuit. The overload margin could be increased by lower gain in the earlier stages of amplification but this may increase the noise of the circuit.

The MM preamplifier to be described here uses two separate stages of amplification. RIAA equalization is carried out by a passive network consisting of R20, R21, C21 and C22 located between the amplification stages. The signal reaching the RIAA stage is filtered by R11 and C12 to remove radio frequency interference. It is then amplified by the first stage amplifier formed from Q6, Q7 and Q8. The gain is determined by resistors R16 and R17 and is calculated at $R16 + R17/R16 = 23$.

The output from the first stage is then equalized by the RIAA network and applied to the second active stage. This is based on Q9, Q10, and Q11 and also has a stage gain of 23, defined by R26 and R27. A buffer resistor R30 protects the amplifier from low impedance or large capacitance loads. Onboard regulators provide regulated supplies of plus 12V and minus 12V to the active circuitry and these each require input voltages of 15V or greater.

The circuit of the standard economy version is shown in Fig. 8 with single 78L12 and 79L12 regulators powering both stages of amplification. Two percent tolerance is adequate for resistors, but I have specified 1 percent wherever the resistor affects the equalization or gain. Capacitors are radial polyester and axial polystyrene types. Capacitor tolerance is important for the RIAA equalization components so I have specified 5 percent types.

The circuit of the fully-upgraded MM stage is shown in Fig. 9. The improvements are:

- the use of separate regulators for each stage of amplification
- the use of metal-tab T0220 regulators to reduce temperature generated distortion

Electronics Today December 1986

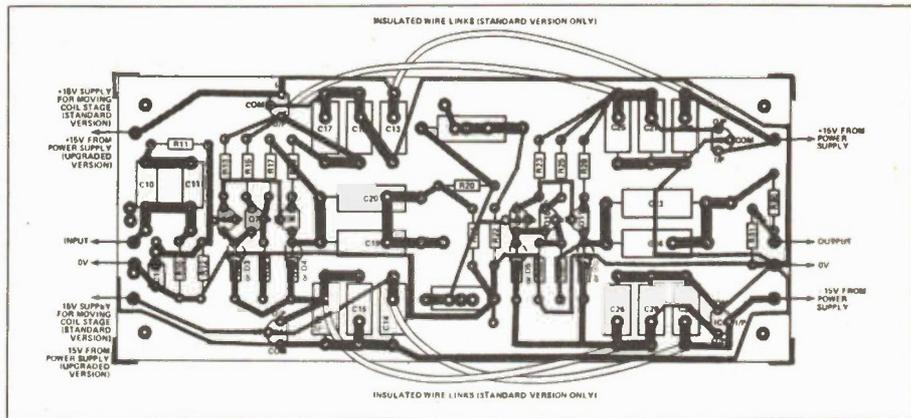
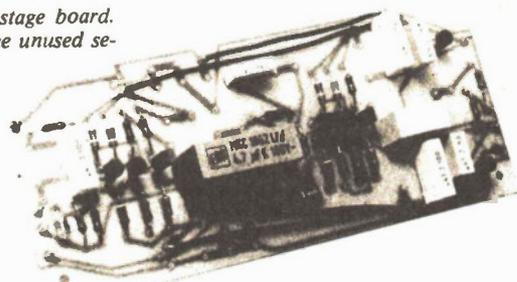

Fig. 10. Component overlay for the moving magnet PCB. Note that the supply rail connections at the left end perform different functions in the two versions.

A standard version of the MM stage board. Note the wire links running to the unused second regulator positions.



PARTS LIST

Resistors

	Standard Version (2% unless stated)	Upgraded Version
R10	68k	68k1
R11, 30	1k0	1k00
R12, 31	220k	221k
R13, 15	5k6	5k62
R14	47k	see D3
R16, 26	1k0 1%	1k00
R17, 27	22k 1%	22k1
R18, 28	33R	33R2
R19	6k8	see D4
R20	22k	22k1
R21	22k 1%	39k2
R22	3k3 1%	5k62
R23	5k6	5k62
R24	47k	see D5
R29	6k8	see D6

Capacitors

C10, 15, 16	47n polyester	47n polycarbonate
C11, 17, 18, 20, 24, 25, 26	—	3n9 polystyrene or silver mica
C12	100p polystyrene	100p polystyrene or silver mica
C13, 14	—	22n polycarbonate
C19	4u7 polyester	4u7 polycarbonate
C21	100n 5% polyester	56n 1.5% polystyrene
C22	33n 5% polyester	19n 1.5% polystyrene or silver mica
C23	1u0 polyester	2u2 polycarbonate

Semiconductors

IC3	—	7812
IC4	—	79212
IC5	78L12	7812
IC6	79L12	7912
Q6, 7, 9, 10	BC549C or 2N5818	BC549C or 2N5818
Q8, 11	BC559	BC577
D3, 5	—	J500 (240uA)
D4, 6	—	J507 (2.4mA)

Miscellaneous

PCB; double-sided PCB pins, 10 off, T092 transistor pads, 6 off (on upgraded version only); PCB pillars; case, power supply, sockets, wiring etc, according to choice and application.

All of the components listed above are for one channel only (with the exception of the case, power supply, etc). Two of each will be required for stereo.

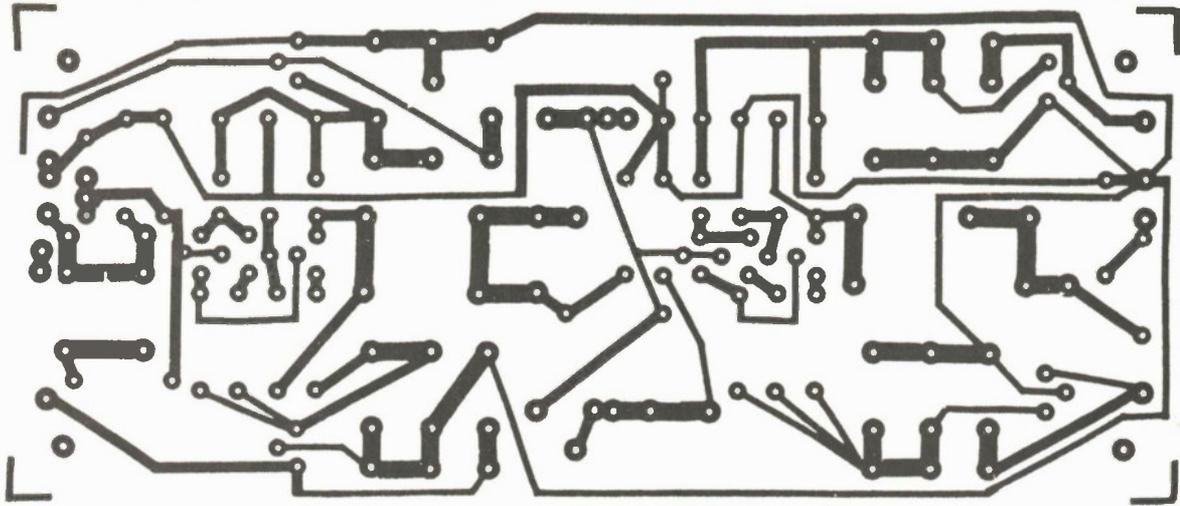

PCB artwork for the Moving Magnet Preamp.

- c) the replacement of all standard resistors with metal film resistors.
- d) the use of polycarbonate capacitors instead of polyester capacitors
- e) the bypassing of higher value capacitors with 3n9 to 10n polystyrene capacitors
- f) the replacement of R14, R19, R24, R29 with constant current regulator diodes (D3-D6) for better supply ripple rejection
- g) the use of close tolerance extended foil

polystyrene capacitors for RIAA equalization

Construction

The moving magnet stage is assembled on a single-sided circuit board which carries one complete stage. The board is therefore mono and two will be required for stereo. Holes are provided on the board for the various upgrading options and also to allow several smaller polystyrene

capacitors to be used instead of some of the less-readily obtainable ones. Make sure you know in advance which holes you need to use for the version of the preamp you are building.

The use of PCB pins is recommended for the external connections to the board. The pins should be installed before any of the other components and tapped lightly through the board before being soldered. The rest of the components can then be soldered into place, starting with the resistors and then the semiconductors and the capacitors. Finally, if you are building the standard version, insulated wire links will be needed to carry the power lines across the board to where the second set of regulators would be on the upgraded version. The position of these links is indicated on the overlay.

When the board is complete, connect it to a power supply giving between plus and minus 15V and 25V. Using Table 4 as a guide, check that the voltages around the circuit are correct. If all seems well, connect up a record deck and cartridge to the input and feed the output into the tape, tuner or auxiliary input of a preamplifier. With luck, you should be able to hear music! The moving magnet stage is so designed that two of them can be positioned side by side and the power connections can then be jumped across on short links.

The MM boards can be used with any other preamplifier which has a dual-rail supply of between 15 and 25V available. The boards could also be installed in a small case with their own power supply and used as a stand-alone, plug-in disk stage. This would make a useful accessory for PA amplifiers and audio mixers which do not have a low-level, RIAA equalized input. If preferred, the regulators can be omitted and a battery used instead. For a 9V battery supply use two 33k resistors in parallel for R14 and for R24 and replace R19 and R29 with 3k9 resistors. ■

Electronics Today December 1986

DOES YOUR DIGITAL CAPACITANCE METER DO THIS?

FULL 4 DIGIT 0.5 INCH LCD DISPLAY COMPLETELY AUTORANGING WITH 10 RANGE MANUAL CAPABILITY

AND THIS
RANGE OF 0.0 pF to 1 FARAD (999.9 mF)
0.5% BASIC ACCURACY UP TO 100 uF

AND THIS
READS DIELECTRIC ABSORPTION

AND THIS
EXTENDED PSEUDO 5 DIGIT
RESOLUTION ON SOME RANGES ONLY

AND THIS
ABILITY TO ZERO LARGE CAPACITANCE
VALUES UP TO 99.99 uF

AND THIS
CALCULATES TRUE CAPACITANCE
IF CAPACITOR IS LEAKY

AND THIS
DIODE CLAMP AND FUSED
PROTECTED INPUT.
DISCHARGE RESISTOR IN OFF
POSITION AT TERMINAL INPUTS.
POWERED BY 9V BATTERY

AND THIS
IDENTIFIES TRANSISTORS (NPN, PNP)
AND THEIR LEADS (E, B, C, ETC.)

AND THIS
TESTS ZENER DIODES AND RECTIFIERS.
UP TO 20V ZENER WITH AC ADAPTOR,
ZENER VOLTAGE WITH 9V BATTERY
DEPENDS ON ITS CONDITION

AND THIS
AUTOMATICALLY CALCULATES LENGTHS
OF CABLES IN FEET, METRES, MILES,
KILOMETRES (THEORETICAL RANGE
OF 9,999 MILES)

AND THIS
ABILITY TO SORT CAPACITORS IN
MANY DIFFERENT MODES

AND THIS
ABILITY TO READ LEAKY CAPACITANCE
(INSULATION RESISTANCE OR CURRENT)

AND THIS
CALCULATES TIME CONSTANTS WITH
USER DEFINED RESISTANCE VALUES

AND THIS
HOLD FUNCTION FREEZES DISPLAY

MADE IN CANADA

MODEL MC300

Approx. Size 7" x 4" x 1 1/4"

DAETRON
A DIVISION OF BERGERON
TECHNOLOGIES INC.
7865 KIMBEL STREET
UNIT 5
MISSISSAUGA, ONT.
L5S 1E9
(416) 676-1600
DEALER ENQUIRIES INVITED

ONE YEAR PARTS & LABOUR WARRANTY FOR ONLY THIS

\$169.95

PLEASE SEND ME _____

____ (QUANTITY) MC300(s) @ \$169.95 \$ _____

CARRYING CASE \$19.95 \$ _____

AC ADAPTOR \$11.00 \$ _____

ONTARIO RESIDENTS ADD 7% PST \$ _____

SHIPPING AND HANDLING @ 5.00 per instrument \$ _____

I ENCLOSE CHEQUE MONEY ORDER VISA MASTERCARD

CARD NO. _____

EXPIRY DATE _____ SIGNATURE _____

NAME _____

ADDRESS _____

CITY _____ PROV. _____ POSTAL CODE _____

Pirate Commercial Radio

*Pirate commercial radio is still alive and well,
working around broadcasting regulations.*

by David Kingsley

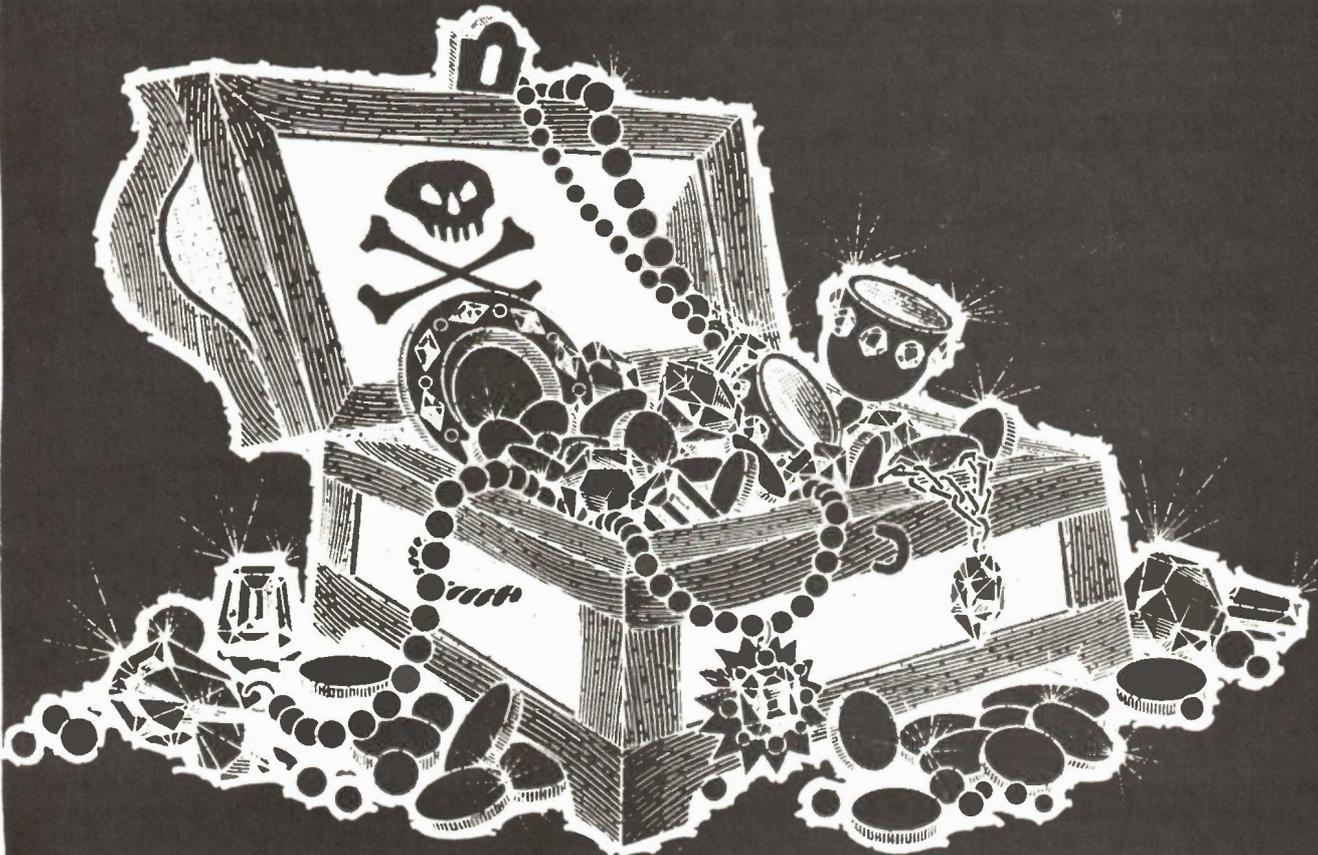

"...and you're tuned to Big Bee Radio, the station that gives you music with a sting. We're on the air now and then to bring you the hits that never were, like this one by the Bedbugs..."

THAT little off-the-air excerpt is fictitious, but it is typical just the same, of the many, many unlicensed pirate broadcasters which have operated in North America over the past several years. They come and they go in a never ending parade, carrying names that are often unusual, to put it mildly.

Electronics Today December 1986

This pirate radio phenomenon is hardly anything new. In fact, it has been around virtually since radio began.

Europe

The "modern" pirate era began in Europe in the 1960s. Pirate broadcasters there sprang up in response to the government controlled broadcast media which had been largely ignoring the younger audience, an audience that was ready for a little life in its radio. American commercial broadcasters had already spotted this need and created the fast paced, high

voltage top 40 format with its contest, jingles and quick-tongued disc jockeys. European youth, particularly in Britain, wanted something like it and so set about to do it themselves.

Once the first pirates had gone on the air in Britain and elsewhere, the response to this kind of radio was nothing short of astounding. It didn't take very long before commercial interests spotted the potential and it wasn't long after that the first pirates for profit went on the air. Most of them operated from locations just outside the reach of communications

law, on ships or abandoned oil rigs or other structures just outside national borders. Names like Radio Northsea International, Radio Veronica and Radio Caroline filled the air with a European version of the American Top 40 stations and became instant hits.

Tougher laws hit the stations where it hurt most - in the pocketbook. It became illegal to advertise on or provide supplies to offshore broadcasters. That and the competitive infighting which caused the well known stories of pirate warfare on the high seas, murders and intrigues, led to the eventual demise of most of the commercial pirates. Pirate activity does continue in Britain, albeit on a more personal and limited basis.

The British pirates did achieve one thing. They were instrumental in pushing along the concept of community radio, radio to which citizens had greater access. And they forced the adoption of new formats which had a greater appeal to the younger audience. Indeed, the BBC local stations have actually hired some former pirate radio disc jockeys.

Ireland has had a number of pirate stations on the air almost continuously since the current fad began. Unlike the British, the Irish government hasn't been able to get a solid anti-pirate law on the books. Ireland, in fact, is host to the only European pirate which can be heard fairly often in North America, Radio Dublin International on 6.910 MHz.

In Italy pirates have become quasi-legal operations and in France, where most pirates operated on the FM band, they've led to changes in the law which now allows a class of low powered community stations to operate on FM.

Like the Beatles, North America caught the pirate craze after it appeared in Europe.

North America

But in Canada and the United States the idea of a commercially viable pirate broadcaster was laughable. Most potential listeners to any such station in North America already had a huge choice of broadcast signals, many already appealing to the kind of audience European pirates were seeking. And no one in full control of his faculties would have placed a commercial pirate transmitter on the AM or FM bands where it would be certain to be spotted and closed down, virtually overnight. That left only shortwave and an equally illegal shortwave operation there would have offered up an even more limited audience.

Furthermore, the European commercial pirates operated full time. The private pirates at least developed the custom of operating within a particular range of



Fig. 1 TNFM is one of the few currently active Canadian pirates.

shortwave frequencies (6.200 - 6.300) and during the same general time period, early Sunday mornings. Thus potential listeners knew when and where to tune for their favourite pirate or where and when to search for a new favourite.

North American pirates have at least established a pirate "band" (7.300 - 7.500) where most operate, but without anything close to an exact schedule. Most are on, if they are on, during the weekends. But there are a lot of hours in a weekend and few listeners, even if they are trying to do so, are likely to hear a particular broadcast if it is not announced in advance, which is seldom the case. So pirates here cannot even count on an audience. One North American says it has been operating on shortwave every weekend for several years and has never had any indication it has been heard by anyone!

The need to operate in this fly-by-night fashion is, of course, in order to maximize the chance of escaping the notice of the communications authorities and a necessary step if a pirate is to enjoy any kind of longevity. It is a Catch 22 situation: operate regularly and develop a following with the near certain result of being closed down or operate irregularly with a purely accidental and much smaller audience.

While the programming on a few of the pirates is actually rather good, on most it is amateurish at best. Rock and roll reigns, although there is often folk music, hits from the 50s, old comedy records, self-produced skits, satires on commercials and the occasional clever take-off on various subjects such as Bible-pounding radio preachers or other shortwave stations. The technical quality of the broadcasts is usually mediocre at best although,

again, some stations do a good job. Often the equipment used is home brew or an ancient ham rig converted for operation outside the amateur bands.

The 7.300 to 7.500MHz shortwave area, while the most popular of the pirate preserves, isn't used exclusively. There are occasional operations in the area around 6.250 to 6.350, below 9.500 and just above 15.000MHz, among others. The high end of the medium wave band around 1,610 to 1,630 is also used, although with more limited signal coverage. A few purely local pirates also show up on FM now and then.

As noted earlier most pirate activity occurs during the weekends and around holidays, usually anytime from the late afternoons on into the evening hours and occasionally even past midnight. Broadcasts generally last for an hour or less.

For the DX-inclined, many pirates do respond to reception reports. Most operate through mail drops in which a third party forwards the letter on to the pirate. Three of the most frequently used maildrop addresses are: Box 982, Battle Creek, MI 49016 or Box 5074, Hilo, HI 96720 or Box 245, Moorhead, MN 56560. For Canadian listeners reporting to a US pirate the equivalent in International Reply Coupons of 3 units of first class postage should be included or US stamps if available.

Those interested in keeping up with pirate activity, particularly in North America might join ACE - The Association of Clandestine Enthusiasts (P.O. Box 46199, Baton Rouge, LA 70895-46199). ACE publishes a monthly bulletin covering pirate, clandestine and numbers station activity. Memberships are US\$12.00 per year.

In Europe, the Free Radio Listener's
Continued on page 56

NEW

Only NRI gives you a 27" high-resolution stereo color TV you build to prepare you for today's video servicing careers.

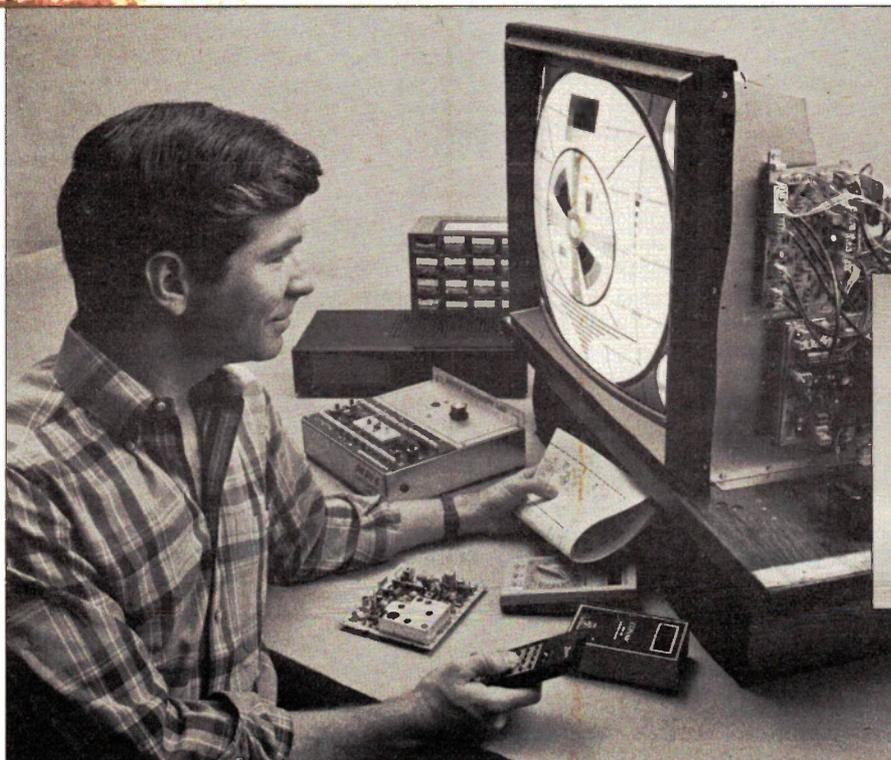

You Build a 27" Stereo TV

During the assembly process of your state-of-the-art Heath/Zenith 27" TV, you learn to identify and work with components and circuits as they actually appear in commercial circuitry. Then through tests, adjustments, and experiments you quickly master professional troubleshooting and bench techniques.



Inside Your TV

The Heath/Zenith 27" TV has all the features that allow you to set up *today* your complete home video center of the future. Flat screen, square corners, and a black matrix to produce dark, rich colors . . . even a powerful remote control center that gives you total command of video and audio operating modes.

NRI has purposely designed your training around equipment that has the same high-tech circuitry you'll encounter in commercial equipment. That means your training is real-world training.

Your NRI Training

Has Another Special Element

Also built into your NRI training is the enormous experience of our development specialists and instructors. Their long-proven training skills and personal guidance come to you on a one-to-one basis. Always available for consultation and help, these instructors ensure your success both during your training and after graduation.

Step Into the Future Today

The richest reward gained from your NRI Video/Audio training is a firm grip on the future. Now is the time to act. Send the post-paid card to us today. You will receive our 100-page catalog free. It's a fascinating explanation of our training methods and materials. (If someone has used the card, write to us at the address below.)

NRI School of Electronics

McGraw-Hill Continuing

Education Center

330 Progress Avenue

Scarborough, ON M1P 2Z5

Canada



Become one of America's most sought-after technicians . . . put your talents and spare time to work for you in the "explosive-growth" world of home entertainment electronics.

Train in state-of-the-art video/audio servicing and become a fully qualified service professional the uniquely successful NRI way. It's hands-on training, at home . . . designed around the latest electronic equipment you build and keep as part of your training.

The High-Tech Revolution in the Home Is Just Starting

Sweeping changes are taking place in our homes, changes brought about by the phenomenal growth of home entertainment electronics. Already available are high resolution TV, TVs with stereo sound, simultaneous multi-channel viewing, projection TV, Camcorders, 8 mm video cassettes, and compact disc players.

And the revolution has spread to the business sector as tens of thousands of companies are purchasing expensive high-tech video equipment used for employee training, data storage, even video conferencing.

Join the Future or Be Left Behind

Today the consumer electronics industry represents a whopping \$26 billion opportunity for the new breed of consumer electronics technician.

Today's consumer electronics revolution is creating huge servicing and repair mar-

kets that are just starting to boom.

Here is your chance to become a fully qualified professional the way tens of thousands have trained with NRI.

Totally Integrated Hands-On Training

Since NRI training is built around "learn by doing," right from the start you conduct important experiments and tests with your professional digital multimeter. You assemble the remarkable NRI Discovery Lab and perform a complete range of demonstrations and experiments in the process.

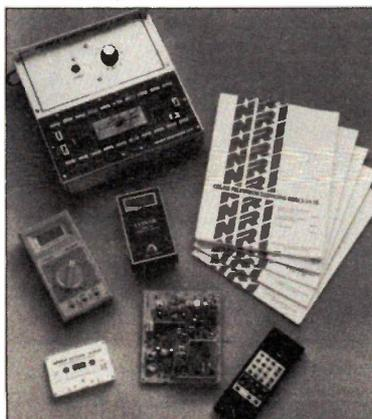

NRI's commitment to you goes beyond providing you with equipment appropriate to the latest technology. Best of all, we ensure that in the learning process you acquire the very skills that will make you a professional service technician on the job.

Headphone Isolator

Use an opto-isolator to isolate audio feeds from a live chassis.

By Andrew Armstrong

THE most obvious means of connecting headphones to a television is to use a loudspeaker transformer. I considered this and rejected it for two reasons. First of all I could not find a suitable transformer in any of my catalogues, and second I wanted to modify the frequency response to improve the intelligibility of speech even at the expense of some musical quality. A boost to the middle frequency range, relative to the bass and treble, can provide higher intelligibility for a given volume. This, I hoped, would reduce the likelihood of hearing fatigue being induced by wearing headphones for long periods.

The scheme I settled on was to transfer the signal from television to headphones via an opto-isolator and some associated electronics.

I have tried using an opto-isolator for this type of task before, with little success. Using a simple system of linear signal transfer, with the base of the phototransistor unconnected, there was nothing I could do to prevent it from picking up a loud buzzing, presumably related to the switched mode power supply, the rectifiers, or the timebase. A pulse width modulation system seemed much more promising, and now seems to work well.

Such a system is more complicated than a straightforward linear system, but the results appear to justify it. The scheme for generating a pulse width modulated signal is shown in Fig. 1. This leads neatly to the next design decision, the choice of switching frequency.

It also gives rise to another consideration. The average opto-isolator, when used in its normal manner, cannot switch cleanly at this speed. It gives out a rather limp-looking triangle wave. In order to make it operate faster, the collector/base junction of the phototransistor has to be connected as a photodiode. This, of course, gives virtually no signal output, as can easily be determined from the Law of Conservation of Misery.

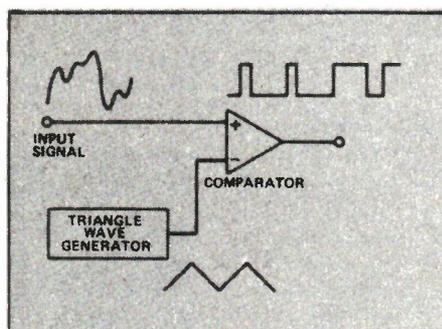

Fig. 1. The scheme for generating a pulse width modulated signal.

The signal from the opto-isolator therefore has to be squared up by a comparator before it is of any use, after which the high frequency component of the waveform is filtered out, leaving the averaged audio signal. This can be amplified by a conventional amplifier circuit and fed to a pair of headphones. The

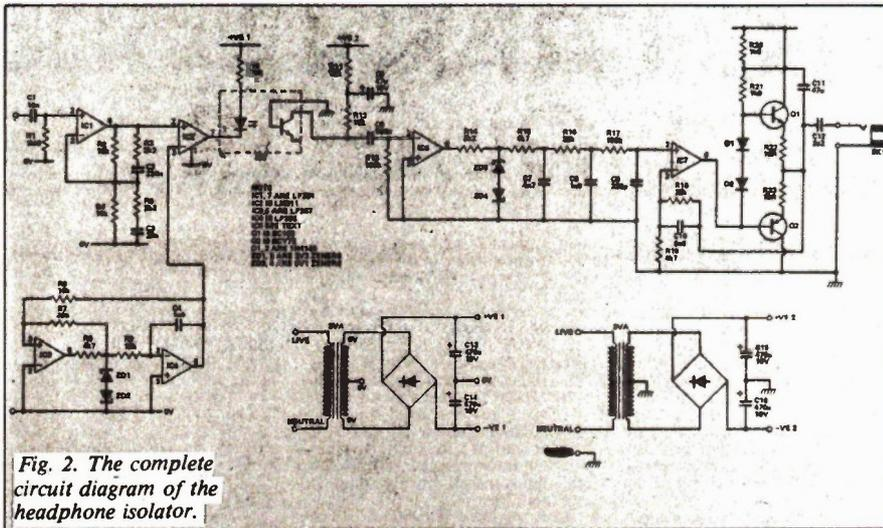

Fig. 2. The complete circuit diagram of the headphone isolator.

amplifier circuit shown here uses an opamp and transistors, simply because these components were to hand at the time of building. A small amplifier IC would be equally suitable.

Circuit Details

Some of the details of the circuitry comprising the blocks described deserve mention. First of all, the frequency shaping network is designed to produce a voltage gain of two at the extremes of the frequency range, but to provide a gain of almost five in the middle of its frequency range. The corner frequencies are nominally 234 Hz and 3386 Hz.

The triangle wave generator produces a waveform of approximately 1V peak to peak, at a frequency of approximately 45kHz. A fast opamp which is not unity-gain stable is used as a comparator, and a unity-gain stable version of the same thing is used as the integrator. In order to prevent the power supply from influencing the waveform, the square wave signal fed to the integrator is clipped symmetrically by a pair of back-to-back zener diodes, so it cannot run into the supply rails.

The triangle waveform is compared with the audio signal to generate the switching waveform. The choice of the LM311 comparator for this job was largely because it has an output stage which can sink substantial currents to 0V, even though it is powered from plus and minus supplies.

The opto-isolator can be almost any ordinary transistor type, but Darlington types are not suitable. There are also a few transistor types which are not fast enough. I used a 4N27 from the junk box.

On the "safe" side of the circuit, the supply to the collector of the opto-isolator is decoupled by a 47u capacitor, because the power supply does not use voltage regulators, and thus will cause hum on the sound given half a chance. The output

from this is fed to another LF357 used as a comparator, and once again its output is clipped by back-to-back zener diodes to prevent the power supply ripple from interfering with the sound. After this the signal is fed to a cascaded RC filter which reduces the 45kHz components of the signal to negligible levels, while leaving the audio. A bit of extra rolloff is provided in the amplifier, by C10, to attenuate any high frequency hiss and interference which may be present.

The output of the amplifier is coupled to the headphones via 2u2 capacitor, which is an unusual value to use. This was chosen because the original circuit picked up a background hum of 60Hz, which could not be eliminated by any other simple means. The 2u2 capacitor, in conjunction with the impedance of the headphones, attenuates such low frequencies.

The Headphones

Suitable headphones for this job are ones which are comfortable to wear for a long time, without costing an arm and a leg. There do exist monophonic headphones specially designed for TV and video listening, a fact which I did not discover until I went shopping for a suitable set. These headphones are wired for mono, and are provided with a volume control near the headphone end of the lead. The lead itself is about three times as long as on most phones, to enable the viewer to sit at a comfortable distance from the set. Other types of headphone will do as well: I was looking for a pair which were light, had large foam earpads and a bit of padding in the headpiece. The large "earmuff" type phones tend to be heavy for an elderly person, and personal stereo headphones are often hideously uncomfortable after prolonged wearing. But everyone has their own preference.

There was one small modification to make (isn't there always?). The left and

right earpieces were wired in parallel, which gave a very harsh audio taper on the volume control. Connecting them in series improved the responsiveness greatly. The earpieces each have an impedance of 30 ohms, and the volume control is a 500 ohm pot.

Installation

The circuit is provided with a high impedance input, so that it is able to pick up a signal from the volume control of the television set. In the event I discovered that the set in question used a voltage controlled sound IC, so there is no signal on the volume control. The loudspeaker terminals provided a very acceptable signal instead, and the loudspeaker was muted with a switch.

Whatever signal takeoff you use, the procedure is to adjust the signal into the isolator box so that it is just below the clipping level. After this initial adjustment is made, the volume may always be adjusted on the headphones' volume control. For most signal takeoff points this initial adjustment may be made with the volume control on the set, but if that is not practical a trimpot can easily be added to the isolator board. ■

Finally, A New Reliable Source For...

Complete Precision Custom Metal Cabinets Consoles etc.

Specializing in:

- Small/Medium Production Runs
- R&D/Prototype, Development
- Complete Paint Finishing
- Quality Screen Printing
- Contract Sub-Assembly to virtually any level of completion.
- Hot Stamp Printing: Bezels, Key Caps, Cable Ties, etc.

In-depth experience and state-of-the-art equipment assure repeatable accuracy of fabricated parts. Integrated in-house capabilities provide shorter lead times and much lower costs to the Electronic Industry. Work to military, DIN, VDE, VDI, CSA & NEMA SPEC.

CANADIAN COMPUTER DESIGNERS MFG.
 (416) 673-7773
 7150 Torbram Road, Unit # 10,
 Mississauga, Ontario, Canada L4T 4B5

Product Review: Cambridge 520 L/C Meter



A fast and accurate L/C tester for testbench or production line.

By Bill Markwick

SELECTING capacitors and inductors can be a cumbersome task. If you're looking for a capacitor or inductor that will make an oscillator run at a specific frequency, you can always plug them into a working circuit one at a time from a large pile, saving the ones that work properly. This is awkward and doesn't give you direct information about component parameters, aside from being useless if you sort incoming shipments. It's also difficult to measure LC values of suspect components when you're doing repairs or debugging. What you need is a fast, precise meter that will let you march through a pile of parts in minimum time.

Just such a meter is the Cambridge 520 L/C Meter, made by Cambridge Technology of Massachusetts and represented in Canada by Duncan Instruments. It's compact (4.5 by 9 inch front panel, 7.5 pounds) and the operating time constants are worked out to let you zip right along without waiting for the display to settle and so on.

Basics

The meter front panel basically consists of a 3 1/2 digit LED display, a pushbutton for L or C measurements, and a comparator section for specifying and displaying the upper and lower measurement limits.

Begin by putting any capacitor into the sturdy clips. The unit has autoranging; one of three LEDs beside the display will light to indicate the range: pF, nF or uF (or uH, mH or H). The display will lock to a stable setting within about one second or so. If you'd prefer it even faster, you can lock the range with the Range Hold button; this speeds settling time to less than 1/2 second.

The range is 10pF/uH to 2000uF/H. The smallest values may require trimming of a front panel trimpot to null out lead and test jig capacitance; even so, the minimum display with the leads open will likely be in the neighborhood of 0.5. The specified accuracy is 0.25 percent plus 1 count plus 0.5pF or 1uH. There is also a

factor affecting accuracy based on the effects of the component's loss (D). The overall accuracy will then depend on what you're measuring, but it should be well within 1 percent.

If you'd like to know how circuit DC is going to affect capacitance, you can switch the display to Bias and apply 0 to 10VDC to the output terminals with a ten-turn pot and the Bias on/off button; the manual shows a simple hookup for applying up to 50V from an external supply. It's interesting to see just how much the capacitance drifts as voltage is applied. Film capacitors don't seem to care, but ceramics and electrolytics may change by quite a few percent. In particular, high-value, low voltage ceramics were dramatically affected: a 0.33uF, 12V ceramic went from 0.31 unbiased to 0.16 with a 10V bias.

The next thing you can measure is the dissipation factor, or D. When a capacitor or inductor is driven with a sinewave, as it should be to minimize harmonic com-

Continued on page 53

Winter

1986

Canadian Satellite Downlink

A SPECIAL SUPPLEMENT TO
ELECTRONICS TODAY

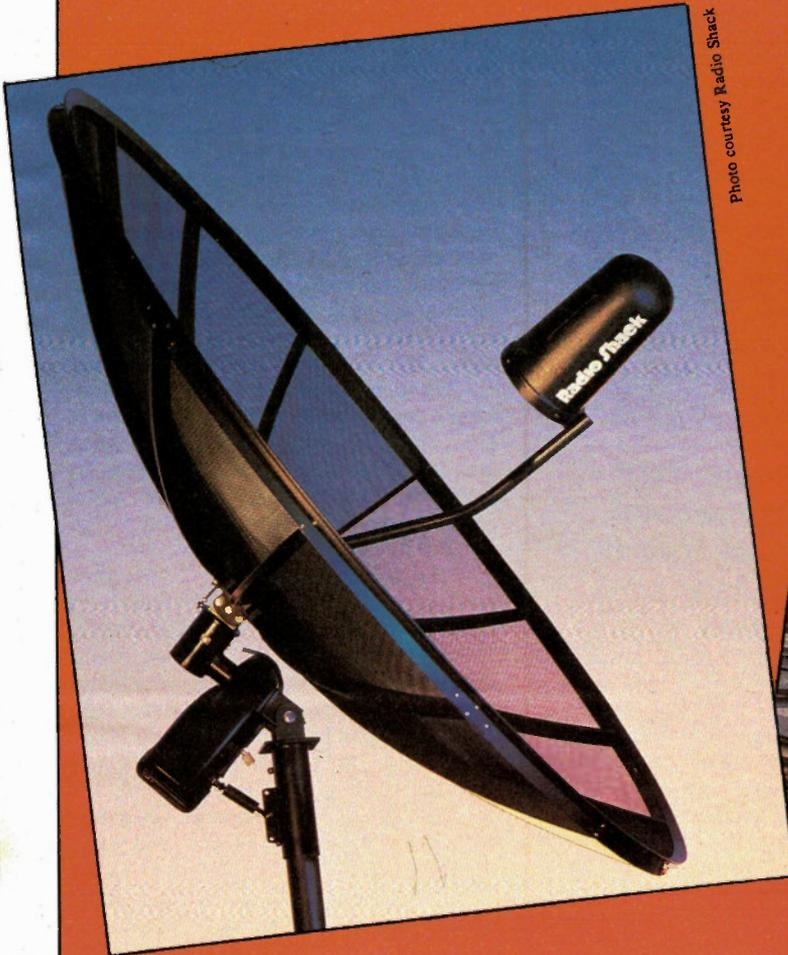
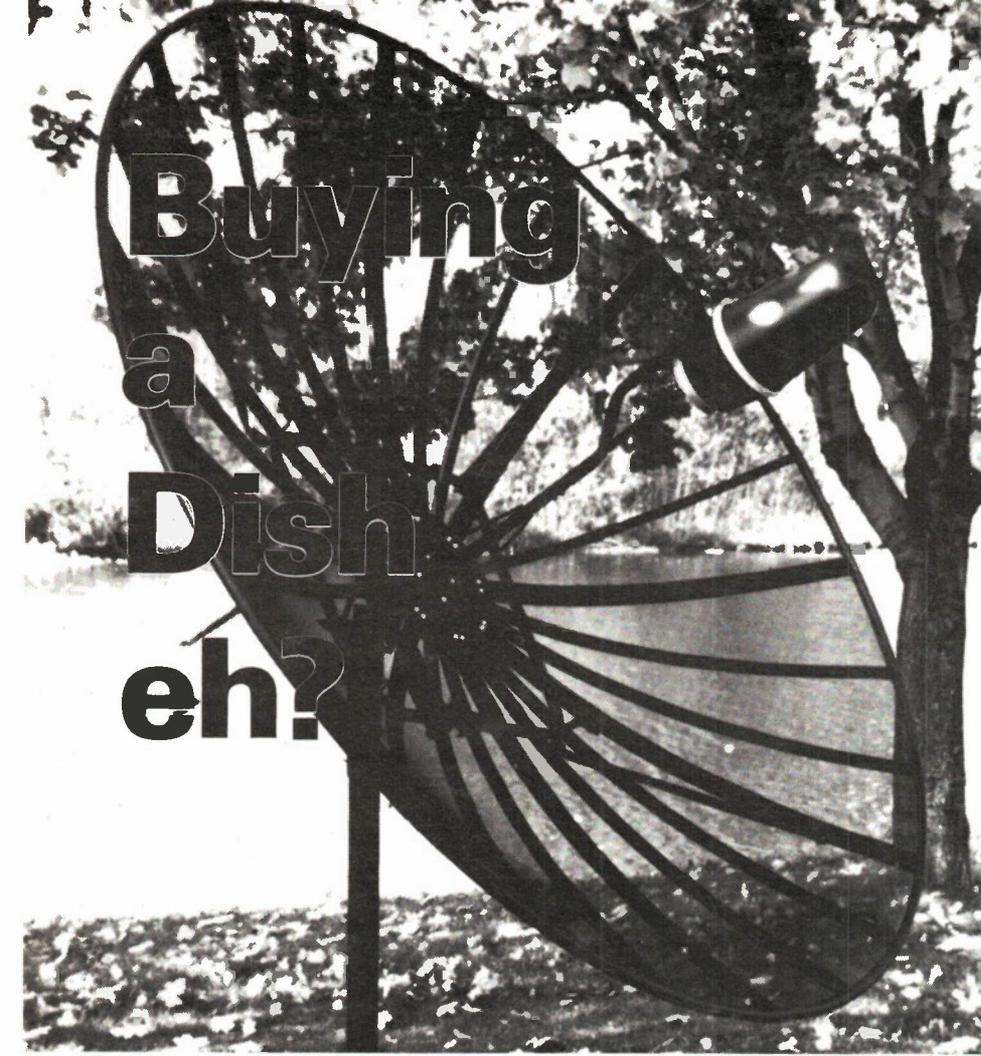

Photo courtesy Radio Shack



- Introduction to Satellite Television
- Downlink Installation
- The Truth About Scrambling
- Alternate Feeds
- Much More

A MOORSHEAD PUBLICATION



Buying a Dish eh?

A satellite system is a moderately gargantuan investment, one not to be taken lightly unless you have a need for a large, functionless round thing on your lawn. Here are some things to consider before you spring for a dish.

by Steve Rimmer

SPENDING a few thousand dollars for anything can be a bit harrowing... whipping out your Visa card for something as potentially complex as a satellite downlink is positively frightening. There's nothing less pleasing than the thought that you may be spending a month's wages on an immovable, extremely ugly lawn ornament.

There are a lot of satellite systems around, varying greatly in what they can do and what they're worth. This article isn't going to get into a comparison of them all... there's the basis for a whole magazine in that subject alone. However, if you read through this short feature you should have a better idea of what exists in dishes and what you should be looking out for.

Watcher Of The Skies

There are a lot of decisions to be made in choosing a downlink system. The most

visible ones concern the toys you'll be planting on your lawn. The dish, while essentially a fairly simple piece of work, is usually the subject of great controversy.

I confess, I'm not about to offer you a comfortable, tight answer to the dish question here.

There are three principal sorts of dishes available for home use, these being fiberglass dishes, spun aluminum dishes and mesh dishes. These come in three common sizes, to wit, six, eight and ten feet across. These sizes are approximate... my ten foot dish is actually ten and a half, for example.

The size of one's dish is usually the easiest thing to decide on. Six foot dishes for use on C band are really down at the low end of the scale. If you plan to only watch the very strong satellites... Anik, perhaps... or if you don't mind really awful pictures, a six foot reflector might do it for you. Most of the dishes one sees

are eight foot ones, which are pretty reasonable for most applications in the middle of Canada where the satellite signals are reasonably strong. Popping up the extra two feet for a ten foot dish is usually worth the effort if you're either on the far edge of the footprints of the satellites you want to see or if you just like gloriously sharp pictures.

A six foot dish, on the other hand, will usually be just fine for Ku band. Now, there isn't all that much up on Ku band just yet, so this may be a bit of a moot point.

There are other considerations. A larger dish will present bigger wind load problems... if you're planning to put the thing on an exposed roof, for example, something really huge may lay some structural nasties on you when it gets covered with ice and caught in a storm.

The material that a dish is made of is usually the cause of most of the arguments among downlink manufacturers. The arguments are very complicated. The fiberglass dish guys say that mesh dishes that are assembled in sections are never perfectly parabolic, and, as such, their efficiency is impaired. They say that mesh dishes lose their shape after a number of years, too. The mesh dish guys say that the fiberglass dishes get damaged by prolonged cold over time, and begin to crack. They also maintain that the metal screens that get imbedded in the fiberglass to form the actual reflectors are never perfectly parabolic either, and impair the dish's efficiency.

We have an eight foot fiberglass Vexus dish at our offices, and I have a ten foot Radio Shack mesh one at home. They're both excellent dishes, with glorious pictures. Now, we haven't had either of them long enough to know what the effects of a lot of weather will be on them, so you'll have to decide who you want to believe on this score.

I've never heard anyone complain about the structural integrity of spun aluminum dishes.

The mount that a dish sits on is easily as important as the dish itself. The mount has to move the thing accurately over the whole range of the satellites that one wants to have a peer at. It also has to stand up to the unpleasanties of a Canadian winter... not an easy thing for most mechanical devices.

The most common sort of mount is a pivoted dish with a long, thin actuator. This is actually a motor with a big screw attached to it. The screw can wind in and out, moving the dish on its pivot. This is the sort of system we have on our Vexus dish.

A more recent innovation, "horizon to horizon" mounts move the dish in a

Canadian Satellite Downlink 1986.

larger arc across the sky. The one on my Radio Shack dish consists of a giant half gear with a worm gear driving it.

The important things about the mount and actuator that you do buy are that it should be very, very stable and rugged enough to stay that way even when conditions get inhospitable. This is one good reason to deal with one of the more experienced satellite companies... they'll be able to advise you as to the mount that will best survive your application.

A good dish mount is a very heavy, serious looking piece of metal.

The feed of a dish... the thing that actually picks up the microwaves and sends them down the cable... is also extremely important. It consists of a feed horn, a low noise amplifier and a low noise block down converter in most cases, this latter bit being a thing to beat the microwaves down to a frequency that will make it across a coaxial cable to your house. This is another place not to try to save bucks.

A passable LNA will have a noise value of less than a hundred degrees Kelvin. Really good ones are available with as little as sixty-five degrees. The one on my Radio Shack system is an eighty degree LNA, and produces no noticeable snow or picture interference. If you have a smaller dish you'll need a better LNA to get good pictures.

There are feeds available which will allow you to receive both C band and Ku band satellite signals, called "dual feeds". In fact, these things are usually set up so that the Ku band feed is slightly off the focal point of the dish in order to accommodate the C band feed. The huge size of a C band dish, as far as a Ku band feed is concerned, makes up for this misalignment. If you install a Ku band feed, however, bear in mind that you'll need a Ku band compatible receiver.

As we'll get to in a minute, all of this hardware will be driven by a very complicated package of electronics. There is nothing like a single standard for LNBS, dish actuators and so on. One must choose a combination of all the bits in a satellite system which can work together. This is another situation in which dealing with a decent satellite dealer or manufacturer can save you a lot of sweat.

Lights And Buttons

The receiver is the other aspect of a satellite system. These things come in all degrees of sophistication. Your choice of a receiver will determine whether your system is there simply to be watched and enjoyed, or whether you'll have to take an active part in its operation... cursing and swearing and fiddling with knobs every time you want to change channels.

The latest generation receivers are Canadian Satellite Downlink 1986.

almost unbelievably sophisticated. They're also pretty cheap, which is probably still more surprising considering what they do. The Gensat 4/12 that we use with our Vexus system and the receiver that's part of my Radio Shack downlink are good examples of this sort of box.

Sitting down at either the Vexus or the Radio Shack system, one encounters a remote control to run the receiver. One can choose any of the twenty-four channels on the satellite the dish is currently pointing to, or move the dish to point at something else. The receiver knows where all the satellites are... to go look at Spacenet one, for example, one would hit "S" and "1" on the remote control and the receiver would position the dish. As one changed channels, it would move the polar rotor appropriately.

With a good receiver running the works, one need not know which channels are horizontally polarized, where on the arc any particular satellite lives, which of the several standards of audio a particular channel is using and so on. These receivers are actually sophisticated dedicated computers... you program them up once when you get your system... or the installer does it... and then forget all about the grotty details.

The memory that stores all these numbers is battery backed up on both of these receivers... it will keep its data even if the receiver is unplugged.

Being microprocessor controlled, these things tend to have a lot of extra features dripping from them. Among these are things like "parental lockout"... the option of making some feeds unavailable to one's ankle biters... and "favourite channel" selection. Under this latter trip, one can instruct the receiver to ignore all the feeds on all the satellites except those that you've said you wanted to see. With this, you can program all the unused or scrambled feeds out of existence, for example.

Most of the newer receivers are compatible with current descramblers. Some of the older ones are not, or require some modifications to make them work. This is something to check out if you're thinking of getting a VideoCypher.

These two receiver systems are about as sophisticated as any I've encountered. When you're thinking about what system to buy you should check at least one of 'em out, if only to get something to compare the rest of creation against.

What To Go For

The range of prices for satellite systems is deceptive. Depending on what you really want, they probably aren't as cheap as they seem.

I had a peek at one system that cost well under a thousand dollars. This was effectively a working system for about the cost of a good television set. It consisted of a six foot dish, a fixed mount made out of pieces of angle iron, a hundred degree LNA and a low cost receiver. Its optional extras included a can of spray paint to keep the angle iron from rusting.

The dish wasn't steerable... that is, the receiver couldn't position it because it lacked any sort of actuator. One changed satellites by taking one's receiver and monitor out to the dish, setting it up, and physically moving the dish around, while adjusting its elevation, until one received the satellite one wanted.

This might be the sort of system to look at if you just want to fool around with a downlink, as opposed to acquiring a lot of really watchable television. It might be a good system to stash at one's cottage, for example, as you can pick up the dish and stash it in the garage when you aren't around to keep an eye on it. It's also a good way to receive non-video feeds, which don't require anything like the signal quality that video does.

There are a number of systems in the fifteen hundred to twenty-five hundred dollar range. These encompass the usual assortment of treasures and monsters, and one has to be a bit careful when checking out a mid-priced system. Some of the designs one encounters are pretty ancient... the receivers are all right, but they lack the really clever dish positioning toys that the newer boxes have.

I have a great deal of regard for the three thousand dollar and up systems that I've seen but, then, it isn't hard to get something worth while if you're prepared to pry open your wallet.

Visa Limit

The most important component in a satellite system is very often not something you buy, but rather who you buy it from. Sadly, there are a number of turkeys in the industry, dealers and manufacturers who are selling bad hardware or providing nonexistent support for it. Popping a bit extra for equipment that you've heard of, from a source that has a reputation for being straight up, is well worth what it costs.

Buying a cheap system from a dealer who isn't going to assist you with its little peculiarities will get you no closer to the sky, and extremely frustrated. Even a good system without support will prove a bit touchy for someone who's never used one before if there's no one to ask questions of. Most reputable dealers will tell you who they've sold systems to... go and have a word with a few souls who have their equipment before you add your name to the list. ■

ONSAT® "Canada's Guide to Home Satellite TV"™

You Can Become A

\$10 Bounty Mountie

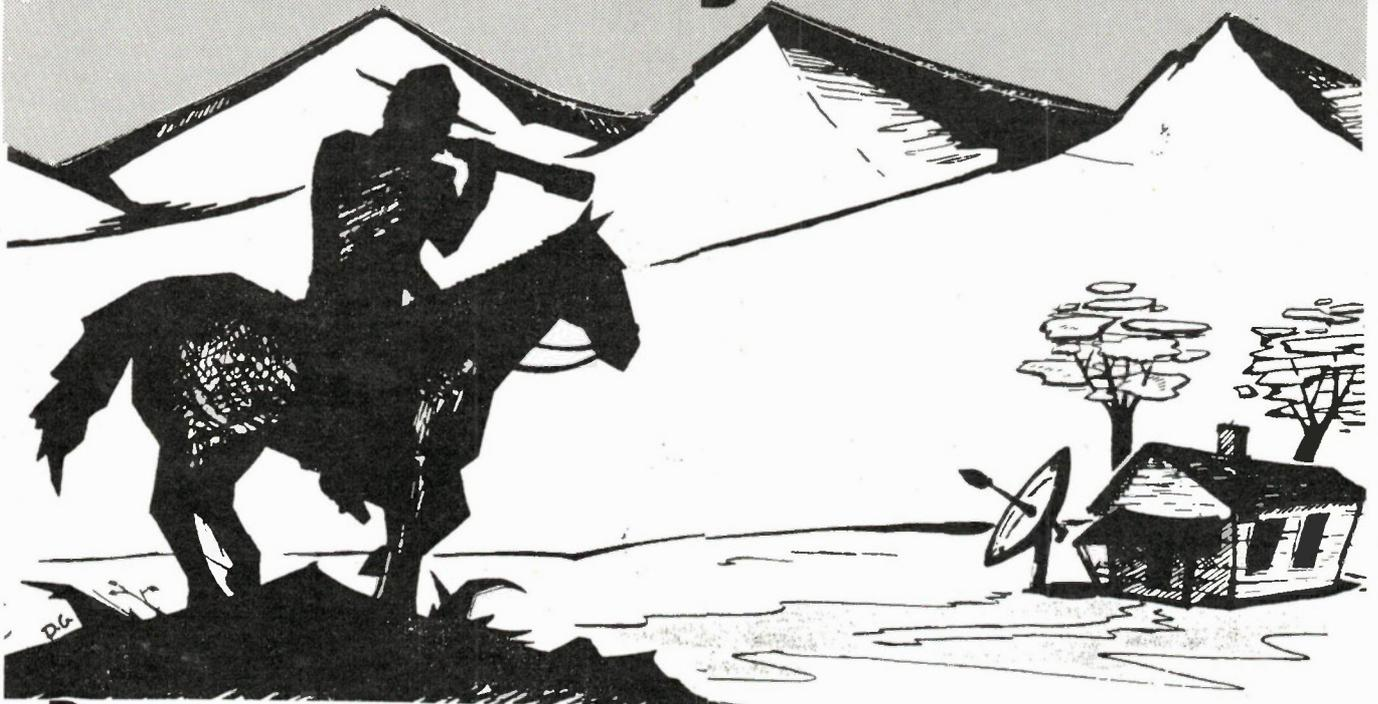

Do you know someone that has a satellite dish and does not subscribe to OnSat? For every subscriber you convert from another satellite programming guide, Triple D Publishing will pay you \$10⁰⁰! This offer is valid for satellite dealers also.

It's easy! Simply submit the name and address of the prospective subscriber along with the name of their current guide. We'll do the rest! We'll send them a sample issue along with a subscription form. If they subscribe, you will receive a check for \$10⁰⁰ at the end of the month.

Prospect 1

Name _____
Address _____
City _____ Prov. _____ P.C. _____

Prospect 2

Name _____
Address _____
City _____ Prov. _____ P.C. _____

Prospect 3

Name _____
Address _____
City _____ Prov. _____

Prospect 4

Name _____
Address _____
City _____ Prov. _____ P.C. _____

Your Name _____

Phone # _____

Address _____

City _____

Prov. _____

P.C. _____

MAIL TO: OnSat Bounty Mountie • 2857 Derry Rd. E., Suite #130 • Mississauga, Ontario, Canada L4T1A6

Canadian Satellite Downlink 1986.

Installation for Rich People



Installing your own TVRO system may not be your cup of tea, so, here's a close look at what you get when you pay the shot.

by Edward Zapletal

FOR SOME, setting up the home TVRO system may not be a big deal. If you can handle a shovel, concrete, angles of inclination and declination, and connecting up a myriad of wires, there should be no problem. Oh yes, and of course you'll need time, lots of time. But what if all this installation stuff has you biting your fingernails and losing precious sleep? Not to worry. As with everything else, there is someone who will be willing to set up the whole kit and caboodle for a price - usually in the \$500 to \$700 range. What do you get for those installation dollars, you ask? Hopefully a quick, quality, professional installation, sparing you from losing your fingernails and shuteye.

Sight Selection

We should point out here that before any system installation begins, a complete sight evaluation is necessary to determine the best location for the dish. For the system to operate at its best, it needs a virtually unobstructed view of the horizon, but this is not always possible. Some systems I've seen are completely surrounded by tall stands of spruce except for a narrow southwestern swath cut to accommodate the line of sight for the dish. Not much in the way of satellite selection there.

To find out exactly what's involved in a getting a system installed, we went along on a fairly run-of-the-mill, two-day, installation with David Gibbons of Davia Satellite Systems of Toronto. The system installed was a Vexus 2.4m dish with a top-of-the-line microprocessor controlled receiver. The location was rural with lots Canadian Satellite Downlink 1986.

of open space for the dish to point into; there were no major obstructions hindering the operation except for a tree branch which quickly succumbed to the saw.

Securing the Mount

Depending on the terrain, the dish mount takes one of two forms: slab or excavated concrete-filled. There are others, but these are the most common.

Unless you have access to a healthy supply of TNT, the Canadian Shield is the perfect example of a good location for a slab mount. If the installation location can't yield a hole with a minimum depth of 4 1/2 feet, a slab may very well be the route to go. Why 4 1/2 feet? Any depth less than this and the evil frost will heave the dish completely out of alignment. Once this happens, the dish will probably have to be disassembled, a new hole dug, and the dish will have to be realigned. Fig. 1 shows the hole being dug for the rural installation; a post-hole auger and spade are sufficient to get the job done in most cases.

With the 11 foot mount placed into the hole, concrete is poured in around it to secure it (Fig. 2). With the mount levelled up in the concrete, the installation team can prepare other things such as the cable burial to the house and the lightning ground.

If you're worried about miles of unsightly cable strung to and fro from tree branches; not to worry. Everything is kept underground as much as possible except for where the cable actually enters the dwelling. With the single-encased multi-conductor wiring now available, just one

small hole is all that is required through the faceboard just above the foundation or through the actual foundation itself.

The lightning ground (Fig. 3) consists of a 10 foot metal rod driven in within a couple feet of the mount, and a connector for the grounding cable. Although it won't protect the system against a direct hit, it does afford some security against nearby lightning strikes which can still cause enormous surges. Fig. 4 shows the completed mount, painted, and ready for the dish.

Day Two

With the concrete being sufficiently set, the dish is hoisted up to its rightful resting place atop the mount (Fig. 5). The securing bolts are left loose until the actuator is installed and the alignment begins.

The next step involves readying the actuator and feed assemblies before their installation to the dish (Figs. 6 & 7. The rubber boot placed over the "business end" of the actuator is simply additional protection against weather.

Once the actuator is bolted in place (Fig. 8), setting the angle of the dish is accomplished with an inclinometer, a device which is similar to a level but is graduated in degrees of elevation (Fig. 9). It is imperative that the dish be aligned very accurately, usually to within a fraction of degree for a really sharp picture.

The Feed Assembly

One of the more crucial components of the satellite earth station is the feed assembly which resides at the focal point of the dish. Usually mounted on a tripod

Installation for Rich People

or a "buttonhook" assembly, the feed apparatus takes the focused signals from the dish surface, amplifies them, down-converts the block of frequencies and sends them off to the receiver.

Fig. 10 shows the tripod feed support used on the Vexus system, being assembled on the ground. Once this is complete, the tripod is mounted onto the dish and the feed assembly is bolted in place. In Fig. 11, David Gibbons makes the necessary alignment adjustments to the feed assembly to ensure its correct position at the focal point of the dish.

Calibration

If there's one good reason for getting a professional to install your system, it's because of calibration. That's not to say that it's impossible to do yourself, but, with the right equipment, set-up is completed within an hour or so.

With a portable monitor, receiver, and antenna controller, the installer can align the dish without going indoors at all. Imagine having to run between the house and the dish each time an adjustment is made, to see if your picture is clear. Fig. 12 shows David Gibbons connecting his own equipment to the actuator assembly. (Temporary connections are also made to the feed assembly.) By being able to control the dish movement and monitoring the picture at the same time, Gibbons needs to make far fewer adjustments.

The calibration process involves moving the dish continually from one end of the arc to the other, making fine adjustments with the inclinometer along the way Fig. 13. Once this is complete, the installer's calibration equipment is disconnected and the consumer's receiver and antenna controller are connected to the previously laid cable.

Finishing Touches

Depending on the type of receiver purchased, there may or may not be a whole lot left to do for the installation. A microprocessor-controlled receiver, such as the Gensat CDR 4/12, will have to be programmed for all the various satellites available on a given band. Less sophisticated types need only to be plugged in, and tuning is accomplished with various switches and dials.

After a thorough run-through of the consumer's system is complete, David Gibbons drills a hole for a bolt (Fig. 17) which will serve two purposes: as a secure connection for the ground cable, and as a locking mechanism to prevent the dish from being accidentally (or purposely) moved on the mount.

As a final touch, plastic wire-ties are used to keep the cables neat and tidy, and a special sealing putty is applied around the RF connection at the feedhorn.

Fig. 1. The hole for the mount must be a minimum of 4.5 feet deep to avoid frost-heave.



Fig. 2. Concrete is poured around the mount to the level of ground and the mount is levelled.



Fig. 3. A bar is driven into the ground in close proximity to the mount for use as a lightning rod. It won't protect against a direct hit, but does afford some security against nearby strikes.



Fig. 4. The completed mount is now ready for the dish.

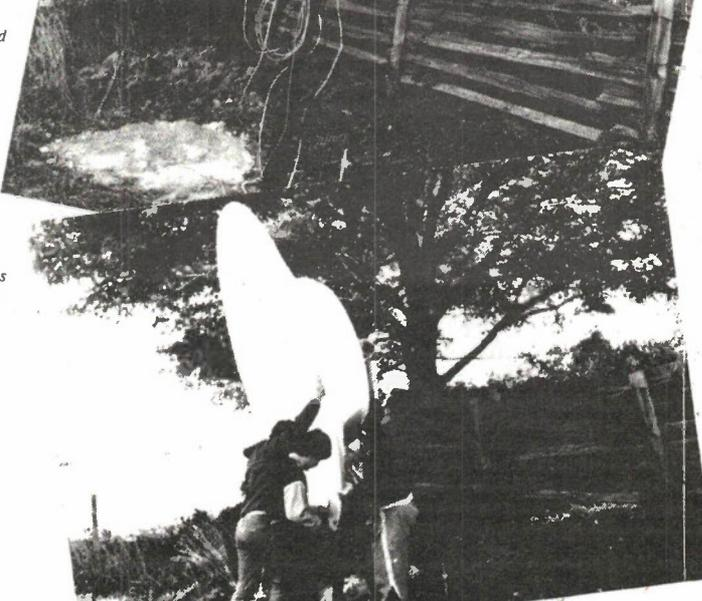

Fig. 5. The dish is hoisted onto the mount; securing bolts are left loose for the time being.

Fig. 6. Preparatory work being done on the actuator to ready it for installation.

Fig. 11. The feed is positioned on its support assembly precisely at the focal point of the dish; a critical part of the operation.

Fig. 7. Getting the various pieces of the feed assembly ready to go.

Fig. 12. The installer will connect his own receiver and antenna positioner for doing the set-up. Otherwise, several trips would be necessary between the dish and the house.

Fig. 8. The actuator bolted in position on the mount.

Fig. 13. Fine adjustments are made to the dish angles for optimum reception. Once again, the inclinometer is used.

Fig. 9. Using an inclinometer to adjust the angle of the dish. Several minor adjustments to the various axes will be necessary before a clear picture is possible.

Fig. 14. A securing bolt is inserted through the mount to prevent it from going out of alignment (accidentally or otherwise).

Fig. 15. The completed system neatly finished off with all cables tied and the receiver connected. Happy viewing!

Fig. 10 the feed support assembly is put together on the ground rather than wrestling with several pieces at once on the dish.

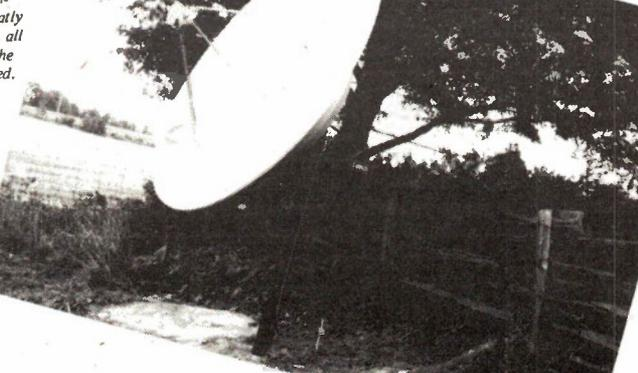
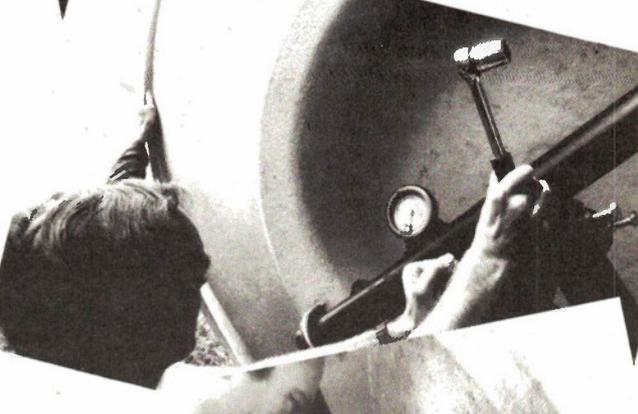
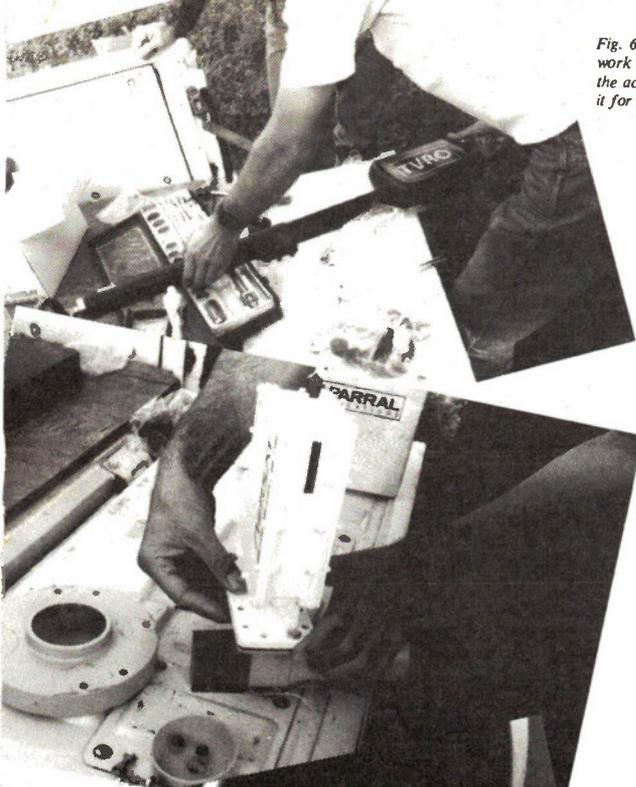



Dish Installation for Poor People

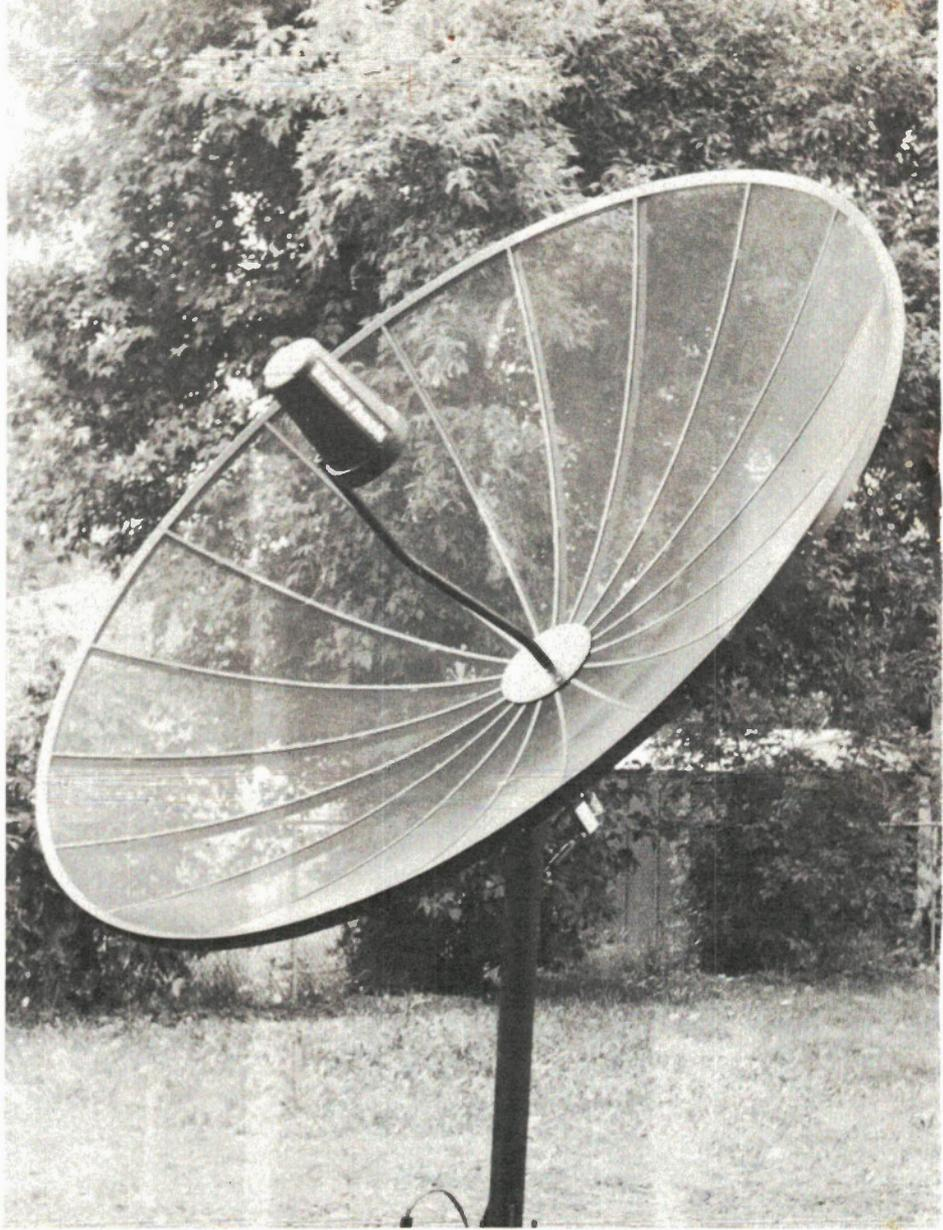

The prospect of building a dish may seem a bit intimidating. The Radio Shack ten foot system is so well documented, however, and such a generally glorious piece of work that one can undertake the ordeal with confidence.

by Steve Rimmer

I LOOKED forward to the thought of assembling a satellite dish with the enthusiasm I usually reserve for rebuilding engines and bathing the dog. The Radio Shack ten and a half foot downlink system came in a lot of heavy boxes, looked to have zillions of parts and was so complicated that they had to give you a video tape to show you how to get it together. Engine rebuilding was looking better and better.

There are two aspects to the cost of a downlink. The first is the large wallet grab

for the system itself... the other is an almost never mentioned installation cost. This latter bit can be a heavy slice, running to over five bills for a typical stash in an accessible back yard to several thousand dollars for something customized and tricky.

The attraction in what is, in effect, a giant dish kit, is that you can install it yourself and scoop all... or, at least most... of the installation cost. There are those quavering, pathetic souls who would not want to take on a task as seem-

ingly awesome as building up a dish. A pox on these mere mortals. The assembly, as it turned out, isn't as tricky as it seems, although it's a lot more work. The system, which one might expect to be a little funky... being home built... is up there with the best.

Up The Down Link

A satellite dish is a complicated, very demanding bit of technology, and some of the systems that require one to assemble stuff assume that one is a very experienced

Canadian Satellite Downlink 1986.

microwave engineer. These are really great things to stay away from.

The forethought and preparation that went into making the Radio Shack system installable by regular ground dwellers is superb. You may not notice it as you work your way through the dish... its worth is in the problems you avoid

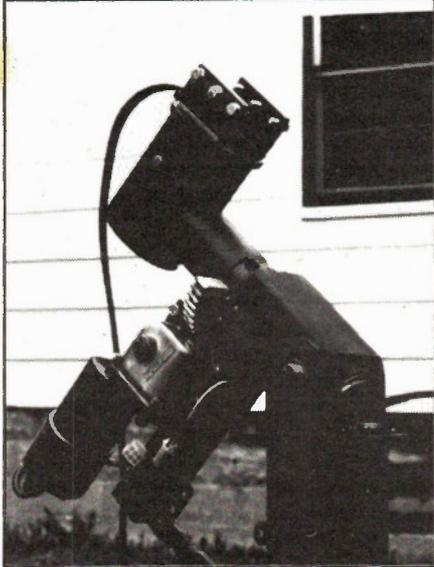

The assembled motor drive and hub mount. Most of the pictures I took before this point just looked like a pole in the ground. The big gear is the drive for the horizon to horizon mount.

and, as such, never get to find out about.

The dish comes in five large boxes. It has a really lucid manual and a VHS tape that shows a man in Texas assembling the thing. The tape is good, although it's actually for the eight foot system. It's also a bit artificial... a real system doesn't go together anything like as peacefully as the one on the tape does. However, you get to see what things look like, an invaluable option. If you lack a VCR it's worth renting one to check out the tape.

The first thing one should do... even before one mortgages the cat and buys a system... is to do a site survey. You can buy a site survey package separately from a Radio Shack while you're still busy talking the rest of the family into the enterprise. This consists of a compass, a cardboard thing to show you where the satellites are and a printout which relates your location to where everything will appear in the sky.

A site survey takes about ten minutes. It, too, is not quite as easy to use as the tape shows it to be... if you've never done this sort of thing before, the cardboard satellite finder can be a little ambiguous... but it will tell you roughly whether you have a suitable site for a dish. The microwaves from satellites don't go **Canadian Satellite Downlink 1986.**

though any of the usual obstacles. The merest hint of foliage kills 'em. Even a minimal amount of physical hardware in the path of one's dish will usually zap the satellite signals.

In my case, I have about three quarters of the arc clear in the summer and the whole thing after the leaves fall off the trees. Fortunately, the obstructed bit has nothing all that interesting on it, and there are better things to do in the summer than watch the tube.

Next summer, for example, I have an engine to rebuild.

A good rule in considering a site is that if you think that a signal might just miss the tops of your trees, it won't. Microwaves are extremely contrary about such things.

Having found a place to plant your dish, you have to dig a hole and fill it with cement to hold the dish post up. I loathe working with cement. As such, I called a Radio Shack in the next town over, which put me onto a man who came and dug the hole, did all the cement and set up the dish post. This is, to be sure, cheating. However, he cost about the same as it would have to have rented a cement mixer and

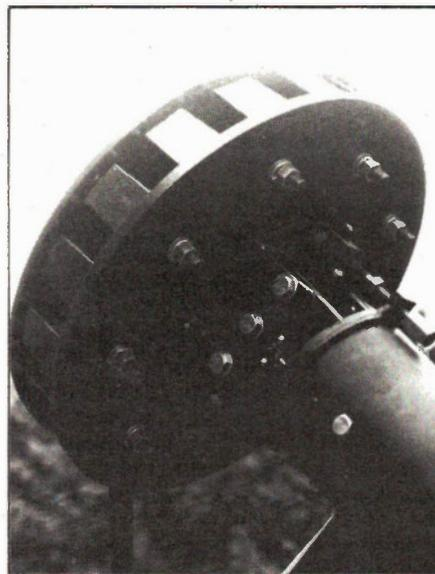

The hub assembly, showing the easily tightened hub bolts. The difficult ones are difficult for the same reason that they're invisible here.

bought the cement, about a hundred bucks.

If you do decide to set the post yourself, there is an anomaly in the manual that you might want to bear in mind. It says that you need thirty bags of cement... which most of us would take to mean thirty standard eighty-eight pound bags. The book was written in the States, however, where a standard bag of cement apparently weighs twelve pounds. The

man who planted my dish used six Canadian bags.

Unlike as in the case of most systems, the Radio Shack dish post is not set in concrete, but, rather, is mounted on three killer huge "L" shaped bolts that are. As such, the post can be removed after things have dried to get parts onto it and it can be leveled by fiddling the nuts that hold it down. To this end, there's a bubble level on the post head.

As one discovers later on, the post being vertical is essential to the proper tracking of the finished dish. Systems which rely on one setting the post vertically in concrete, with no subsequent facilities for adjusting it, are asking a lot of two by fours and prayer.

The first part of actually installing the dish is to assemble the motor drive. To do this, one unbolts the post and lays it on the ground. The post is heavy, the post head is heavy and the motor drive is unspeakably heavy. When they're all assembled, the resulting association of steel is very substantial. I got it back into the bolts by myself, but my arms haven't been the same since. It's worth getting a hand with this.

The manual mentions this and one other aspect of the thing as being the only two situations which might not be manageable by one person. This is probably true, if the one person is a weight lifter who's been moonlighting as a dish installer. Otherwise, plan on having at least one assistant. With three people going at it, it took me most of a Sunday to get the system assembled and working.

The motor drive holds the hub, a rather peculiar die cast metal affair which will ultimately hold the ribs. The hub, in turn, accepts the feed boom, which supports the feed horn. The feed horn and all the head end microwave stuff is made by Chaparral in the States, and is really well done. You have to bolt together a couple of waveguides, but the whole effort is pretty painless.

The feed horn comes with something called a "golden ring", which the manual doesn't mention. You can leave this off the assembly if you happen to forget about it while you're assembling the feed without any serious ill effects. If you install it, however, you'll get a slightly better signal to noise ratio out of the system.

The manual suggests installing the feed horn and boom fairly late on. This is probably all right for the eight foot dish... with the ten foot one, trying to get at the feed horn with the completed dish in the way is a bit of a balancing act. As such, it's worth finishing up the feed horn before you start assembling the ribs.

Putting the actual dish together is the trickiest part of the project. The ribs fit

into the hub, held in place by pins cast into the hub assembly. The surface of the dish consists of pre-cut mesh panels which are supposed to slide in between the ribs and live in little grooves.

This should work well in theory... in practice, it takes some doing to make the panels stay put while you bolt on the edge trim that keeps the whole affair together. The trim is held on by long self-tapping screws which wind into extruded channels in the ribs. My hands still ache a bit from getting them all reefed down. A power screw driver would have been an extremely good idea.

When the world becomes properly civilized, they'll have Canadian Tires that are open on Sundays.

The real party comes when it's time to put in the last panel and connect the final two pieces of trim. One usually puts the panels in by having one person push them and one person stand in the clear space beside the panel to guide them. When you get down to the last panel, there's no place to stand beside it, there being screen in every direction. I eventually got it in and wound up using gaffer's tape to keep it there while I dealt with the trim.

When all the panels are in place, the trim will have a gap in it. You're supposed to pull the periphery of the dish together



Feed horn in the grass... a pretty easy thing to assemble, the intricate microwave electronics are all locked away inside the feed horn assembly as it comes out of the box, and never rear their ugly heads.

and bolt the two ends of the trim together to form a hoop. I imagine that various things in the assembly of the dish determine just how much force one has to exert on the monster to get it into place... my dish required an awesome herculean effort to get the two trim pieces to butt. In the end, two of us held it while a third stuck a bolt in one of the holes.

Four of the bolts which tighten up the hub, with the ribs in place, are all but inaccessible with regular tools when the thing is assembled. Now, these things aren't all that important. You can eventually tickle them into place with a pair of long nosed pliers... several people who've put these systems together maintain that this is good enough, as there are plenty of other hub bolts that can be properly tightened. Prepare for a couple of skinned fingers when you tackle these.

There are a few final things to do the dish. The motor drive is covered with a plastic shield. This a bit ginchy, and takes some bending and cursing to get into place. However, when it's all sealed up it covers the works pretty well. The dish itself should be grounded... a grounding rod is one of the few things that they don't give you in the kit, presumably because different areas require different approaches to grounding the system. I bought a four buck copper grounding rod from the local Radio Shack and wired it to one of the mounting bolts.

Kill The Cable

The cables for the dish consist of a single bundle of coax that runs for a hundred and twenty-five feet. It has all the connectors on it, and you should never have to cut it. You can get extensions for it if it's too short. The cable handles getting power and control signals out to the dish and bringing back the LNB signal. There's a spare coax line in there to take care of a Ku band feed if you get one. That last bit bespeaks a high degree of planning.

The cable is a serious looking thing, well suited to the rigors of being buried. It comes with two chunks of plastic pipe to feed it through where it enters and leaves the ground. The pipe protects it from weed eaters. You're supposed to bury the cable about eight inches into the ground.

It's worth while calling the phone company and the other parties who also bury things to make sure you aren't going to zap their cables in planting your own. Whether or not you include the cable television company on your list of people to phone is up to you... once you get the dish going you probably won't care whether your cable television comes in or not.

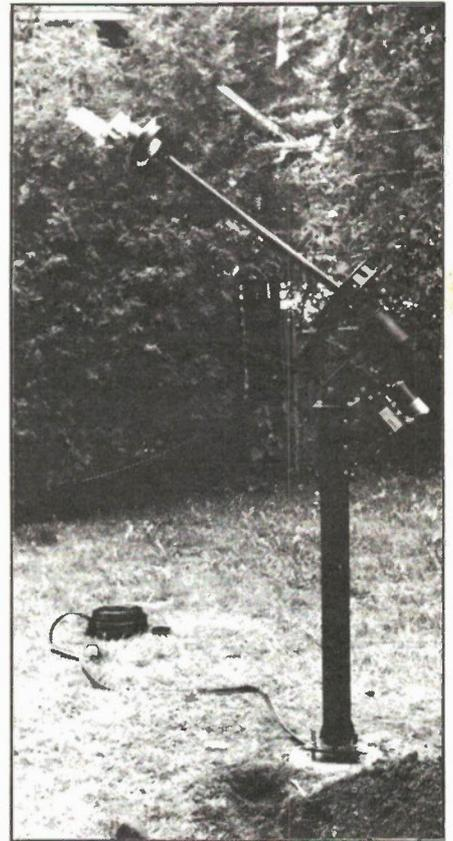

The first rib in place and the feed boom installed. The end of the cable trench can be seen in the foreground, with the cable rolled up behind the dish. The hedge in the background subsequently required some pruning. Microwaves give no quarter.

If you look around a bit you can very often find ways to run the cable into your house without cutting a hole in your foundation. If your dish is fairly close to your house you'll probably have enough cable left over to wander around a bit. I found that I could slip it in beside the pipe for an outdoor faucet.

The cable connects to the receiver through an F connector for the LNB feed and seven bare, colour coded wires that connect to seven colour coded wire block connectors. The wires are all pre-tinned, the connectors are spring loaded affairs and the whole effort happens without the merest recourse to a screwdriver.

With the system working, the dish has to be aligned so as to point at the satellites. Now, I got a lovely clear picture on it with about five minutes of fiddling, but I'd played with downlinks a bit before, so I might have gotten lucky. If you follow the manual, though, you should be able to get a recognizable picture without too much difficulty. Once you have one satellite tuned in, finding the rest of them is dead easy.

It will probably take you about an hour to fully set up the receiver, but once

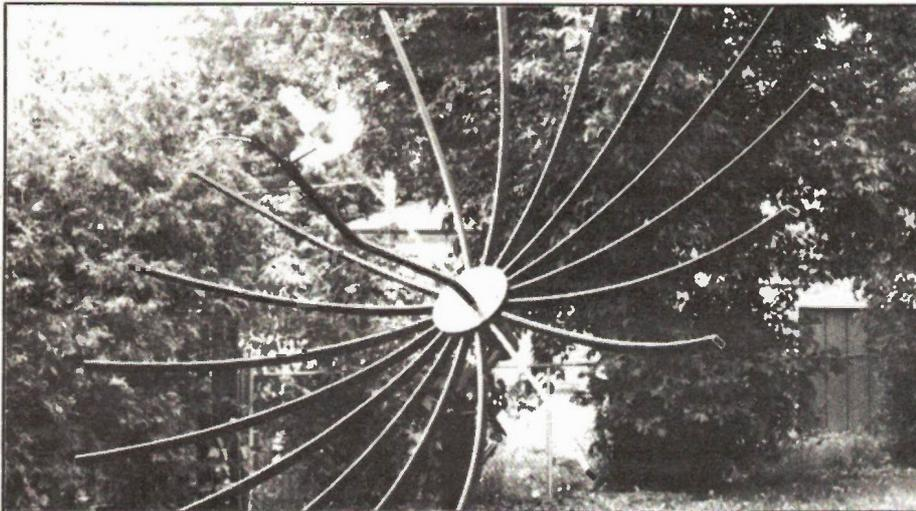

All the ribs in place, the dish awaits its mesh panels. It looks pretty innocent here.

it's done it will stay done unless you have an earthquake or somebody makes off with your dish.

There are a few things that are worth noting about setting up the receiver. To begin with, when you initially get a picture on the thing, you probably won't know which satellite you're looking at. You should buy a copy of one of the satellite television listing magazines before hand... it will be invaluable later on.

The thing that did me in for a few minutes was the polar rotor adjustment on the receiver. I'd aim the dish, switch in a channel that obviously had a picture on it and for a split second the image would be perfect. Then it would vanish into snow. What this turned out to be was the polar rotor moving past the proper orientation for the signal. There are two switches which allow one to tweak up the polar rotor setting. When you think you have a picture, play with these a bit until it clears up.

Blessings From Above

When the dust settles, the Radio Shack ten and a half foot system is easily one of the best downlink packages I've encountered. Its receiver is a magnificent bit of engineering. I'll speak about it in greater detail in another article. It has all the features that make the state of the art so impressive... it's sophisticated enough to do virtually everything a satellite system can manage, and, yet, easy enough to manage so that anyone even partially conscious can operate it.

One of the clever facets of the receiver is that all its complicated controls live behind a hinged plastic panel. When you close the panel, all the intimidating parts go away, and people who don't get along with technology very well won't feel like they're being asked to land a 747 every time they want to watch the tube.

Canadian Satellite Downlink 1986.

The receiver is usually run though an infrared remote control. This, like the rest of the system, is splendidly well thought out and very nice to use. It allows one to control the volume, fiddle the dish position and select satellites directly by their mnemonics. For example, to go look at Telstar 303, one would hit the "T" and the "3" keys on the remote control. Corresponding letters show up on a gargantuan fluorescent display on the receiver. Hit the "run" button and the dish will automatically position itself.

This is a hand and a foot above the funky mechanical controllers, fiddly adjustments and general technical unpleasantness that lesser satellite systems encumber one with.

Assembling the dish is a day's work. It's more of an effort than sitting around guarding a chair, but it's arguably worth it, as it saves you enough bucks to buy a new television to connect to the thing when it's built. If you're really lazy, of course, you can have the dish professionally installed.

The important thing about installing it yourself is that planting the Radio Shack dish is not a task for gods. It can be handled successfully with no experience and only a few simple hand tools. You have to really extend yourself to screw it up, and the instructions are second to none.

The final system, whether you build it yourself or have it done for you, is easily one of the best systems you can have for any price. As soon as you turn it on, your entire family will stop complaining about the dish on the lawn, all the cardboard boxes in the living room and the extra wires around the television set. You'll forget all about your aching muscles and whatever financial cattle rustling you had to undertake to pay for it. It's the most worthwhile one day project imaginable.

As a final note, the good thing about buying anything from a Radio Shack is that there are Radio Shacks everywhere to help you out with 'em later on. As with anything more complicated than a pair of Reeboks, you should figure out what you're going to be able to get done about your satellite system if it croaks in a year. At the very least, you can be sure that the Shacks won't all close down and split to the Caribbean between now and then. ■

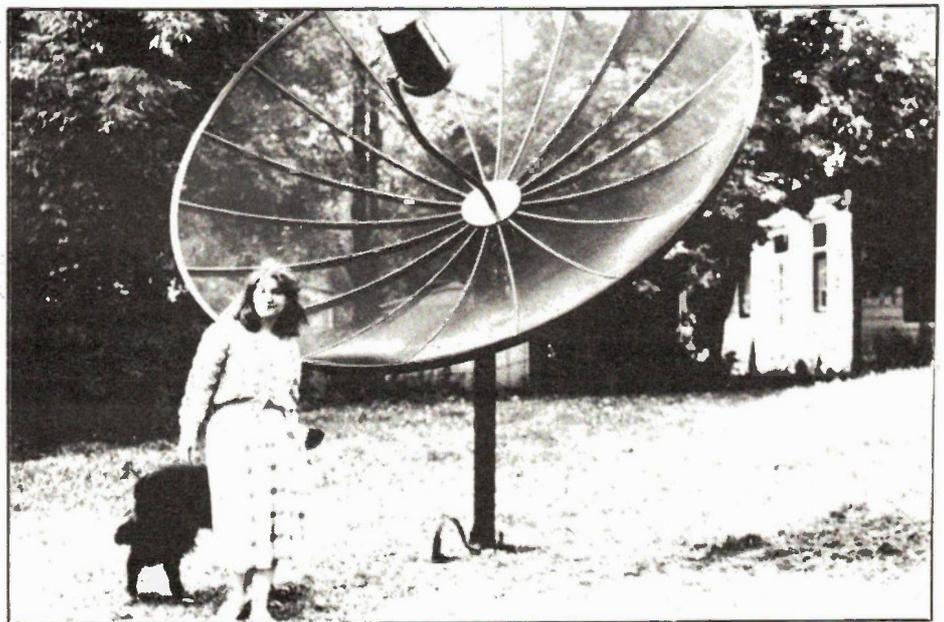

Wife, Dog and dish... several hours later. Megan didn't think she wanted a dish in the yard while it was still just a pile of boxes in the living room. Now she's fairly sure. The dog subsequently tried to chase a cat up the post and decided that it didn't want a dish in the yard either. It looks a lot better than this now that the grass has grown back over the trench.



The Truth About Scrambling

Perhaps the most uncertain aspect of satellite television is the awesome possibility that everything is going to be scrambled. Here's a bit of fact to sort out the fantasy.

by Steve Rimmer

IT was all looking pretty good for a while there... all you had to do was to buy a downlink, clear out some space in the yard and you could have all sorts of American pay channels by just aiming your dish. It was one of those situations that must have had some sort of law of nature against its continued existence.

As of this writing, most of the really hot satellite program suppliers have already scrambled their signals, and many of the rest have plans to. The very fact of this put a really heavy hurt on the companies that build downlink hardware in the early part of this year. Some of the less responsible aspects of the press did a number of features that reported the total demise of life as we know it for satellite television.

In fact, this is only partially true. The scrambling situation has changed the way satellite television can be used, but it has only killed it for people who got panicked by the early tales of darkening skies and turned their dishes into fish ponds.

In this feature we're going to have a look at the reality of scrambling... and find out that it isn't one tenth as nasty as it seems.

Sky Hooks

Perhaps the most upsetting aspect of scrambling is that, for the most part, it was never even aimed at us. It's designed to scramble signals seen by American viewers. Most of the programmers involved aren't bothered about us poor freezing lumberjacks north of the border one way or the other.

There are Canadian services which are scrambled... for the most part ones which are uplinked by Cancom so they can sell 'em to remote parts of the country... but these aren't really very interesting, being local stations from a number of parts of Canada and the northern United States. They're also cheap enough that if one wanted them, one could just rent the appropriate decoder from Cancom.

The American movie programmers... HBO, The Movie Channel, SelectTV and so on... plus an increasing number of specialty channels are scrambling with something called a VideoCypher II system. This is rather more of a problem. These feeds are interesting, and, for many potential satellite viewers, are what makes owning a dish worth while. More to the

point, they are... at least theoretically... unavailable in Canada at any price.

The key to all this is the VideoCypher II, a five or six hundred dollar box which takes the scrambled signal from one's dish and makes it into watchable video and listenable audio. It's a very sophisticated bit of hardware. The video portion of the signal is actually only lightly scrambled. As we'll get into in a moment, anyone with a bit of time to kill can crack it and make it perfectly watchable. The audio is a killer. It's encrypted digital sound, decoded by a custom microprocessor inside the VideoCypher. This is very tricky.

One can buy a VideoCypher II over the counter... at least, one can in the States. However, simply owning the box doesn't get you the feeds. Each box is individually addressable. If you buy a VideoCypher and hook it up, you have to call down into the States to arrange to be billed for the services you want to receive. The programmers in question will then uplink a turn on code unique to your VideoCypher over the satellite buried in the retrace of the video signal. It takes about twelve minutes. When your VideoCypher sees its specific code it will start

Canadian Satellite Downlink 1986.

descrambling.

The programmers will send periodic turn off codes for VideoCyphers which are owned by people who have cancelled their services or just not paid their bills. You would have to be watching the service in question when the turn off code came down for it to deactivate your system, of course, but sooner or later you'd get one if it was meant for you.

The individual addressing system means, for example, that just 'cause you have a VideoCypher descrambling HBO doesn't mean you'll get the Movie Channel too... unless you pay for it.

I said that you can buy VideoCyphers

toward the movie channels from the sky will get one better tube to watch. At present... if you can arrange it... you can get an American movie channel for about the cost of First Choice. This is very unpatriotic, I know, but then a lot of the home grown stuff on First Choice is bad enough to want to make one disavow one's citizenship.

The Tricky Bits

All of this disappears into never never land if you can't get a descrambler. There are a number of things to note in this.

The first question which most of us will ask, of course, is about the availability of black boxes, pirate descramblers

few months, as, having cracked the thing once it will be quite a lot easier to undo future versions of it.

Buying an unscrambled descrambler may get you free pay television for a few months... or forever.

There are a number of lesser video "de-cyphers" around... ostensible black boxes... but they *only* descramble the video. I bought one, a do-it-yourself effort from Valley Microwave in Nova Scotia, and put it together. It works really well... if you habitually watch the tube with the sound off.

The more reputable ones of these... such as the one I got... tell you that they only do the video. Watch out for the ones that say they do both.

If you want to know the state of the research into descrambling, you can call (305) 771-0575, which will get you a prerecorded tape of the latest descrambling gossip.

I've talked to a number of satellite companies up here which are offering VideoCypher packages. If you buy a downlink from 'em they'll arrange to get you a VideoCypher... that's a legitimate one... and have it billed for you though an American address. Some of these guys are really competitive... one of them offered us HBO at four bucks American. Once again, the legality of this is ambiguous.

You can get a VideoCypher package going if you want one, and the rates from the pay channels through it are extremely reasonable, certainly more so than the cost of cable... which just went up again a few months ago for most of us.

Dishing It Out

The best thing about satellite television is not the free movies... it's the quality and variety of programs that you can get out of the sky. The signal quality of cable is appalling in most areas... cable television distribution equipment is only capable of mediocre pictures under the most favourable conditions. Cable is expensive, has a very limited number of channels available to it... and it likes rate increases. Because cable companies usually have monopolies in the areas they serve they can usually get away with 'em, too.

Satellite television, even if you have to pay for some of the services, is a lot more fun than cable. It's nicer to look at, and there's never "nothing on". One has a whole continent of programs to choose from. On those rare occasions when you've seen all the flicks you can usually kill a few hours just jumping around the feeds trolling for weirdness.

Finally, of course, you do get to call your present cable company and tell them to come and cut their wires. It's a pleasure you'll only get to experience once, but it's sweet enough to last a lifetime.

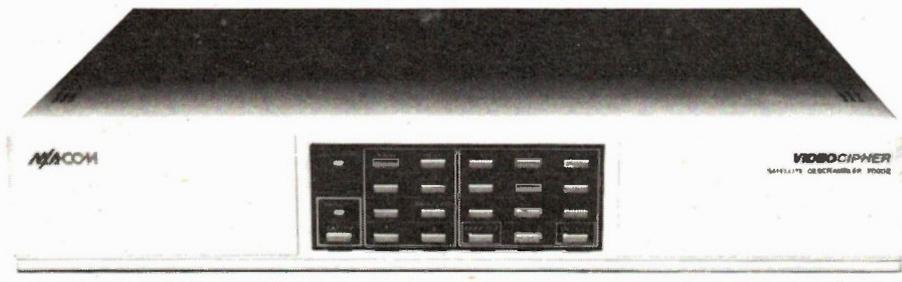

Photo courtesy of M/Acom

in the States. You can't legally get them in Canada at the moment. The American programmers only buy the rights to show their flicks in the States. As such, it's illegal for them to arrange to have them shown up here.

To this end, they won't bill a VideoCypher account to a Canadian address. The crux of the biscuit, then, is that in order to use a VideoCypher up here one must go down to the States and pick it up and then have an American address to handle the billing. At one point, MA/Comm, the company that makes the VideoCypher, was telling its dealers that it was treasonous to sell VideoCyphers to Canadians, as the scrambling algorithm that it uses is the property of the American military. No foolin'...

The actual cost of the pay television channels... if one ignores the cost of the dish and the VideoCypher... is pretty reasonable compared with cable television. Initially, it was costing about eighteen dollars American to subscribe to HBO with a VideoCypher, but most of this was being scooped by the people handling the subscriptions. The actual fee to HBO for a subscription is four dollars. There has been a bit of a price war going... the cost is now down at around twelve bucks American for HBO. Select-TV, a comparable movie channel, is charging about eight. This trend looks to continue.

In real terms, for the average human, disconnecting one's cable pay television and putting about the same amount Canadian Satellite Downlink 1986.

which will scoop the VideoCypher signals without paying for them. This may not even be illegal in Canada, as one can't buy these services if one wants to. Opinions vary over this one, and it's a bit of a moot point just now.

A few weeks before this magazine went to press, a number of groups managed to crack the very sophisticated scrambling of the VideoCypher. It's now possible to buy a chip which replaces the microprocessor in the box and makes the VideoCypher a "permanently on" descrambler for all the scrambled channels. They cost about two hundred and fifty dollars, but, as one might suspect, their sources are a bit misty and surreal. At the time of this writing I haven't actually seen one, although I'm pretty sure they do exist.

As with all mildly pirated things, there are a lot of creeps sculking in the hot chip trade just now... you send them money or a VideoCypher for conversion and you might get a chip. You also might get dead air.

The flip side of this is the position of the people who scramble things. One might think that having been cracked, the program providers will be getting into newer and nastier scrambling techniques. This might well be... but there are some good reasons why they may not, too. There are a lot of VideoCyphers out there, and the cost of retrofitting them all, even if it just means changing a single chip, is prohibitively expensive. At best this would probably keep the dogs at bay for a

What's New In Satellite Hardware

by Edward Zapletal



Uniden Antenna Controller

The UST730 antenna controller is equipped with an 81satellite memory and direct selection of satellite type and number.

The unit also includes: east/west manual control, antenna position fine tune, emergency stop, 3day memory backup, and an infrared remote control. The power supply and actuator are also included.

Circle No. 36 on Reader Service Card.

Luxor 9900 Receiver

From Europe's leading manufacturer of satellite TV products, the Luxor 9900 is a top-of-the-line, fully remote controlled receiver with a built-in antenna controller.

The unit is factory programmed for all current satellites and transponders and additional programming is possible when new satellites come online; up to 840 separate channels selections are possible.

Five audio modes are preprogrammed

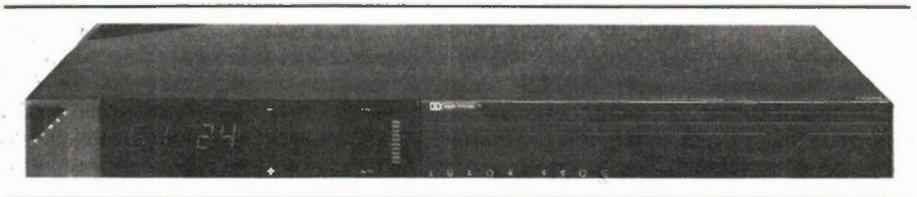

for each individual satellite channel; 2 mono, 2 matrix stereo, and discrete stereo. Multiplex selection is automatic

and Dolby is also included.

Circle No. 37 on Reader Service Card.

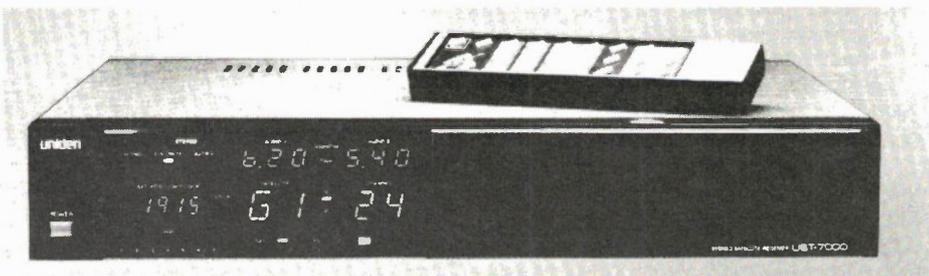

Uniden UST-7000 Receiver

This sophisticated, sleek, state-of-the-art

block downconversion receiver from Uniden includes a hand-held wireless

remote control, and a built-in programmable antenna controller.

The UST-7000 is pre-programmed for automatic selection of SATCOM and WESTAR polarities, has full stereo sound capabilities, as well as Dynamic Noise Reduction (DNR).

Fully compatible with Uniden's complete line of block downconversion components, the UST-7000 is an ideal main unit where multiple receivers are installed in one home.

Circle No. 38 on Reader Service Card.

Spectrum T-1 Stereo Receiver

The Spectrum T-1 receiver is a fully microprocessor-controlled receiver whose operating system eliminates the need for retuning and reprogramming every time you turn it on.

Features include full stereo capability, block downconversion, infrared remote control, parental lock-out, and it's VIDEOCIPHER II and KU-band compatible.

Circle No. 39 on Reader Service Card.

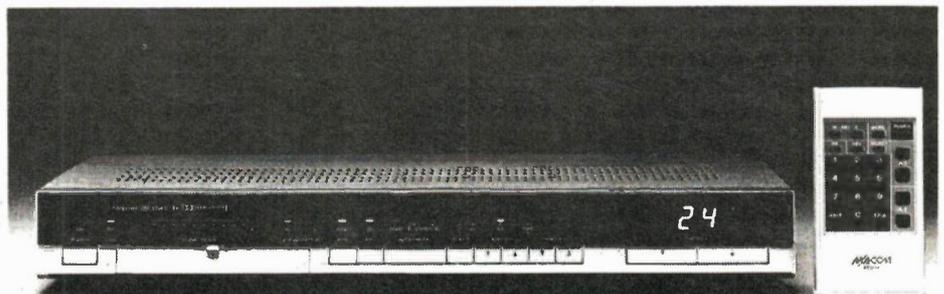

Norsat Package

The NRF 300PR package from Norsat consists of the 300PR receiver and the NCM 301 antenna positioner.

The 300PR features automatic 24 channel quartz synthesized tuning, automatic polarization, stereo audio, and video fine tuning.

The NCM 301 positioner automatically moves the antenna and adjusts for satellite format and skew. Other features include 24 pre-set satellite positions, antenna lock for parental supervision, and

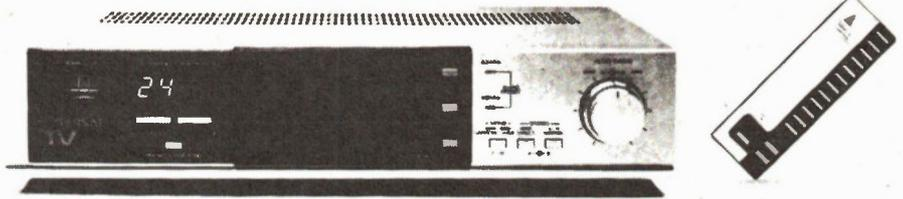

overload/overtravel protection.

A wireless infrared remote control is

also included in the package

Circle No. 40 on Reader Service Card.



Spectrum T-2 Receiver

The T-2 is a receiver that gives exceptional

picture quality with many of the features that make home satellite television easy

and enjoyable.

It has infrared remote control, parental lock-out, block downconversion, KU-band compatibility and it's VIDEOCIPHER II compatible. The T-2 makes an economical first system or it's an ideal second receiver to complement your home entertainment system.

Circle No. 41 on Reader Service Card.

Koro Receiver

The KR-300 from Koro Communications of Montreal is a state-of-the-art microprocessor based, remote controlled receiver offering channel scan, polarity control, skew, audio tuning, audio mute in a slim-line design. The KR-300 is also suitable for multiple receiver installations in a single home.

Circle No. 80 on Reader Service Card.

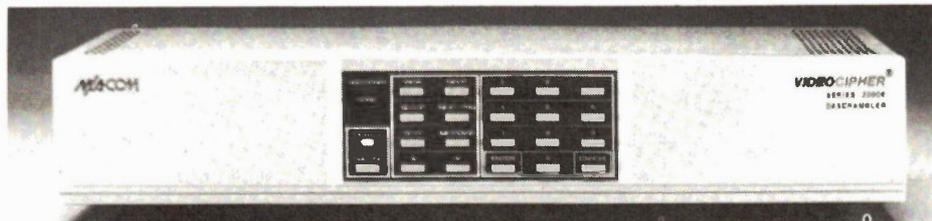

VIDEOCIPHER II Descrambler

A single VIDEOCIPHER II Series 2000

can process up to 240 channels that are coded with the VIDEOCIPHER II

scrambling system. The descrambler senses the presence of a scrambled signal and automatically decodes all subscribed channels.

There are two models designed to work with most receivers currently in use: the Series 2000E for 70 MHz or composite baseband systems, and the Series 2000E/B for composite baseband systems only.

Circle No. 42 on Reader Service Card.

Kenwood Receiver

The KSR-1000 satellite receiver from Kenwood is a fully computerized unit offering two-step tuning, full stereo with Dolby noise reduction, transponder scan, and multiple receiver capability.

The KSR-1000's memory is capable of storing all the pertinent information for the various satellites, including stereo audio information for particular transponders. Additional memory is included for up to 12 new future audio services.

Other features of the unit include: full Canadian Satellite Downlink 1986.



function remote control, parental channel lock-out, and an auto antenna positioner

(KSP-1000).

Circle No. 43 on Reader Service Card.

The Eliminator

Commander Satellite Systems of Milton, Ontario offers the Eliminator deep design dish for TVRO applications.

The all-new modified parabolic design is coupled with an extremely deep (.25 F/D) curve and a "shaped" subreflector that is claimed to be up to 20% more efficient than the best parabolas.

The all-steel tooled, ripple-free spun aluminum reflector comes with these features: excellent microwave interference suppression, one-piece assembly eliminating lengthy assembly time, extreme deep curve giving strength and warp resistance, and a strong, simple polar mount with bearings and infinite elevation and offset adjustment.

Circle No. 44 on Reader Service Card.

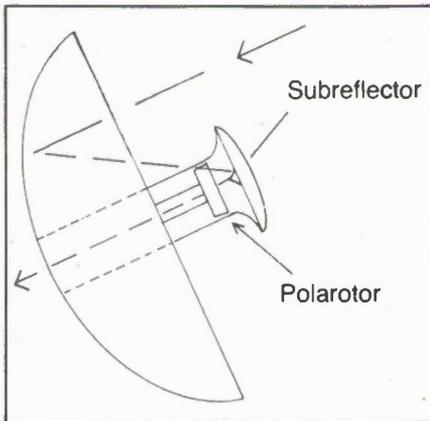

Tee-Comm TVRO Products

Tee-Comm Electronics of Montreal offers a complete line of TVRO equipment including receivers such as the TCR6520R with built-in positioner, and dishes ranging in size from 6 1/2' to 11 1/4'.

Tee-Comm also manufactures a complete line of LNAs, actuator jacks, feedhorns, and LNAs. For complete information on the Tee-Comm line:

Circle No. 45 on Reader Service Card.



Vexus 1.8m Dish

The Vexus 1800D is an ideal antenna for a home or confined installation site, and its small size, light weight and custom color options make it easy to fit into your landscaping plans.

With the use of laser topography, surface tolerance of the 1800D is sub-7 RMS resulting in superb reception of C-Band through Ku-Band frequencies.

Installation is easy with the 1800D's low-profile design and simple polar mount. Also because of its light weight, the dish is ideal as a roof mounted unit.

Circle No. 46 on Reader Service Card.



Still More Dishes

Canadian Satellite Antenna Systems of Peterborough, Ontario offer a wide selection of fiberglass and mesh antennas.

Their Galaxy line of mesh reflectors come in 10'-6", 9', and 7' sizes. The Galaxy fiberglass line is available in 10', 8'-5", and 6' sizes; there is also available, 1.2m and .75m sizes with 12 GHz offsets.

All CSAS prime focus antennas are 4 and 12 GHz compatible and come supplied with heavy duty bearing supported polar mounts. Feed supports are quad pod types which include a shroud cover.

Circle No. 47 on Reader Service Card.



Improved Ku-Band Antennas

The Winegard Company of Burlington, Iowa, has introduced a new line of perforated satellite reflectors with greatly improved efficiency on the Ku-Band.

The major change in these second generation C/Ku-antennas is a dramatic reduction in perforation size from 5/32" to 5/64", which is smaller than the generally accepted Ku-band maximum hole size of 1/10".

The new Pinnacle line of reflectors is available in 6', 8' and 10' diameters. All models are finished with a durable corrosion-resistant powder coat finish in smoked-chrome color.

Circle No. 48 on Reader Service Card.

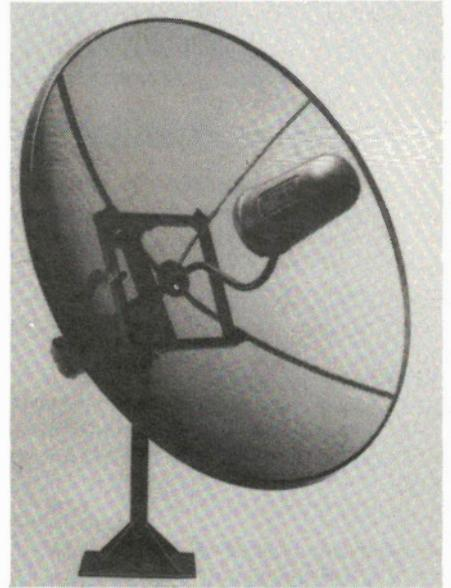

Radio Shack System

Radio Shack has a complete TVRO system available to do-it-yourself types.

The system comes complete with a 10 1/2 foot dish, microprocessor-controlled receiver, and all the other bits required to do your own installation. No special tools are required and the system comes with complete set-up instructions as well as an instructional video tape.

Cost of the system as we go to press is \$3595 and it's available from Radio Shack stores everywhere.

Circle No. 49 on Reader Service Card.



RX-1 Receiver

The RX-1 satellite receiver from Radyx Satellite Systems Ltd. offers complete remote control, built-in programmable antenna controller, full descrambler compatibility, and synthesized quartz locked tuning.

Also featured are parental lockout, built-in surge protection, automatic polarity switching and synthesized audio tuning with presets.

Circle No. 50 on Reader Service Card.



Antennas and Mounts

Command Performance Antenna Inc. of Scarborough offer a wide variety of antennas and mounts for TVRO applications.

Specifically, the model 10PA perforated 10 foot dish has a 3 dB beamwidth of 1.8 degrees, a gain of 40.5 dB, and a surface efficiency of 72%. The unit is Ku-Band compatible and comes with a quad pole feed support, touch-up paint, and LNA cover. A five year warranty is also included.

To supplement their dishes, Command Performance also offers two mounts: the U180 horizon to horizon and U90 polar models. The U180 is a 36VDC model which has a current draw of 1.8A with a 200lb load and a stopping accuracy of 0.17 (1200 pulses H-H). Limits are adjustable mechanical types, gears are steel milled, and the declination range is 2 to 10 degrees.

The U90 polar mount is ball bearing supported with a declination range of 2 to 10 degrees. Arc range is 100 degrees with an 18" jack.

Circle No. 51 on Reader Service Card.



Canadian Satellite Downlink 1986.



B.E.L-Tronics LNBS

Old hands at microwave technology, B.E.L has introduced a full line of low noise block downconverters (LNBS) for the TVRO industry.

Available in three models, the LNB-1200, LNB-1205, and LNB1210 offer a wide range of noise temperature ratings; the 1200 is rated at 100 degrees K, the 1205 at 85 degrees K, and the 1210 at 65 degrees K.

The units feature 50 dB gain minimum with a variation of ± 2.7 dB maximum over -50°C to $+ 60^{\circ}\text{C}$.

Circle No. 52 on Reader Service Card.

T.I. Filter

If your satellite TV reception is plagued with terrestrial interference (T.I.) you should check out the VBF-10 T.I. Band-pass Filter from NYSA satellite systems.

The unit offers continuously adjustable bandwidth, center frequency and gain on three independent controls. Typical applications include light to heavy T.I., small dish, long cables, local TV interference, weak transponders, partial signal blockage, half transponder and Ku Band reception.

Circle No. 53 on Reader Service Card.



B.E.L Satellite Receiver

The Micro Eye receiver from B.E.L-Tronics Ltd. provides a sharp clear picture, brilliant color, full stereo sound, and wireless infrared remote operation.

The features of the Micro Eye include: block downconversion, digital PLL tuning, matrix and discrete stereo or mono,

wide and narrow bandwidth, R.F. modulator built-in, and digital readout of signal strength when fine tuning or skew tuning.

Also included are built-in LNA power and digital readout of audio subcarrier frequency.

Circle No. 54 on Reader Service Card.

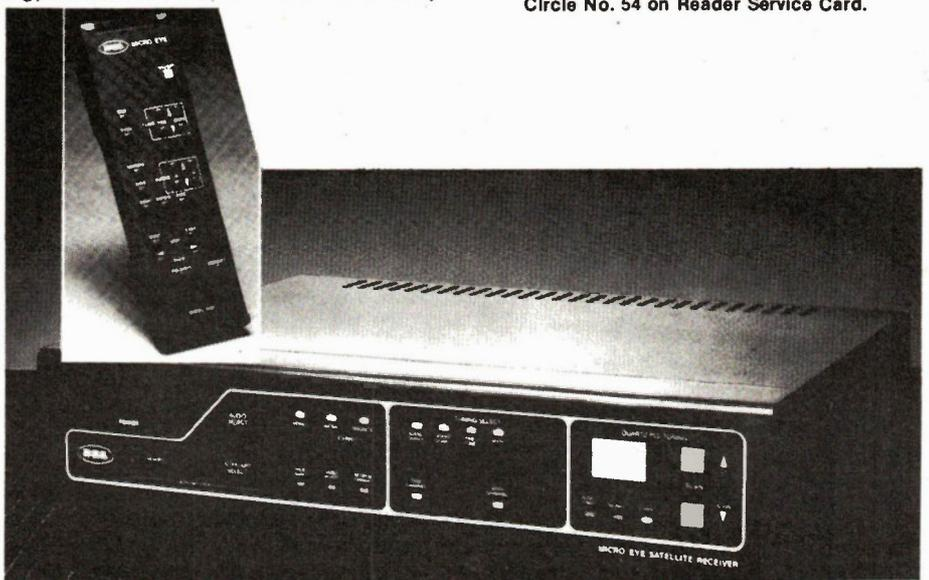



Alternate Feeds

There's a lot more to satellite television than just television. If you're a bit adventurous, you'll find a host of interesting signals buried in the transponder services.

by Steve Rimmer

WHEN all the dust was finally settled around our dish, I realized that I wasn't watching any more tube than I had been before the great planting. I'm watching different stuff now, and the pictures are infinitely cleaner. I can always find something worth watching during those times when I want to veg in front of the box... but I still have a fairly short attention span for the whole universe of television.

There is, however, a world of other things that one can do with a downlink... still in keeping with its function as a microwave receiver, and not having to get into modifying the antenna for use as a solar cooker. In fact, if you really like playing with technical toys you might well find that the television aspect of the whole dog and pony show is the least exciting part.

In this feature we're going to have a brief look at the sorts of things you can find on the satellites with the television set off.

Radio Lives On

The most obvious... and least complicated... other thing to look for on satellites is radio. Some of the standard video transponders have radio station audio buried in them along with the usual video and sound channels. These are called "subcarriers"... they're modulated into unused bits of the spectrum of some of the downlinks. Depending on the nature of the signals, a video downlink can have quite a number of sound channels hidden in it.

For the most part, these signals are commercial radio stations, although one finds a few elevator music channels and other similar things in there, too. For the most part they're in stereo, and the sound quality on the best ones rivals that of compact disk. The interesting aspect of them,

of course, is that you can listen to radio from all over North America. Actually, there are one or two European ones in there as well.

Most decent receivers allow you to tune the audio subcarrier frequency. My Radio Shack system goes a bit beyond this, and will automatically scan the spectrum of possible subcarriers and hunt down hidden signals for me. Anything that will tune the spectrum will do, however. All one needs do is to prowl around the likely transponders until sound turns up.

Not all satellites have audio signals buried in them. My favourite one is Telstar three... T3 if you have a microprocessor controlled receiver. As we'll get into, this one is ideal for all sorts of alternate feeds. Channel eighteen usually shows a constant test card, but it has a number of radio stations buried in it. A quick scan through the dial found light boring music at 5.76, rock at 5.96 and 6.26, elevator music at 6.46 and 7.16 and middle of the road stuff at 8.10.

This is an atypically full transponder, to be sure, but there's still a fair bit of radio stuff happening on many of the satellites.

One important point about these music feeds is that there is something of a lack of standardization in the way that the stereo is encoded, with some of the signals using matrix encoding and some discrete stereo channels. The latest receivers make it pretty painless to switch between the various audio parameters... it's worth getting a receiver that will do this for you.

Shorter Waves

The really interesting part of signal meddling on satellites lives in those secret transponders which appear to have nothing on them at all. Once more, Telstar three is a prime source of these,

although most of the satellites have at least one or two. The Radio Shack receiver actually has a signal meter on it, and, as one tunes across the apparently unoccupied channels one often finds ones that have no picture or sound, but still pin the meter. There is, clearly, something sneaky going on here.

The signal that comes out of the base-band video jack of one's satellite receiver typically covers a spectrum of about six or eight megahertz... possibly a bit less if your receiver insists on doing some high end filtering before it emits its video. The Radio Shack system has great wandering herds of jacks out back, one of which does unclamped video information.

We usually regard this as being a single video signal, but, on some transponders, it's just a six megahertz wide radio spectrum, no different than the one in the sky, except that it's usually modulated onto a microwave feed, and has to be demodulated by a satellite receiver before we can do anything with it.

These mysterious feeds aren't just receiver malfunctions, of course. They're instances in which people have used the spectrum of a transponder for something other than video.

What comes out of the video jack of a receiver with the system picking up one of these feeds can best be thought of as being a sort of private short wave radio spectrum. If we take the signal and send it into a short wave receiver we can tune across this spectrum and see what's buried in the hidden feeds.

This may take a bit of getting used to and, yes, it does involve sending the output of one receiver into the input of another one, but it works. It can be really interesting and, in at least one case, profoundly disturbing.

For the most part, the information in these secret feeds is sent narrow band

Canadian Satellite Downlink 1986.

single sideband... essentially audio, although not all of it is intended for human ears, as we'll get to. In order to demodulate it you need a very good short wave receiver. The one shown here abouts, the Kenwood R-2000, is such a radio. Now, without wishing to get dogmatic about the toys involved, low budget radios just won't cut it for this project. After I got this thing going with the Kenwood I tried it with another box which I'd always regarded as being pretty tight. It didn't drift much, but it was enough to trash just about everything I tried.

A good short wave receiver can make this stuff pretty interesting. A cheap one will just frustrate you. Unfortunately, good receivers are fairly few... and a tad expensive... as I found out when I started researching this article. If you get really turned on to this stuff you might want to have a serious look at the Kenwood... its Canadian distributor is listed herein. I'm pretty sure it's the best short wave radio on the planet for less than the cost of a medium sized country.

Yes, I know... I still haven't explained what the receiver is going to receive.

If you get all this set up, and tune from a hundred kilohertz or so on up, with the receiver set to either sideband, you'll eventually encounter some sounds. Most likely they'll be voices and, if you fiddle the tuning of the receiver you'll discover that they can be clarified and heard quite audibly. They aren't radio stations, though. They're phone conversations.

Ahem... all the telephone traffic that moves around on satellites... which is pretty well all the long distance calls... goes through these mystery transponders. What's more, they're all unscrambled, and available for anyone who wants to listen to 'em. Normally you only get one side of a conversation at a time on one audio channel, although it's frequently the case that the lower sideband will have one side and the upper sideband the other.

I wasn't wholly pleased to discover these things, actually. I don't really have any interest in listening to other peoples' calls, but I'm not sure I like the idea of their being able to check out mine.

There are a number of more enlightened uses for this discovery. The one that I really liked was uncovering something which sounded like modem noises. Upon further investigation... and firing up the computer... it turned out to be a wire service. With a stable receiver like the Kenwood one can have all the news, sports, stock quotations and so on that one cares to watch spewing across one's screen.

There's a feature coming in the December edition of Computing Now! Canadian Satellite Downlink 1986.

which deals with the grotty details of receiving computer data over satellites.

I also found quite a few signals that sounded a lot like FAX transmissions... digitized pictures. I suspect that they'd be wire photos and satellite weather maps, but I haven't gotten around to trying to display them as yet.

One of the weirdest things I found was on transponder sixteen of Telstar three. It had morse code popping across it. I can't actually read morse code, so I never did figure out what it was all about. It was somewhat mysterious, though.

A single satellite transponder... six megahertz worth for the sake of this argument... will hold about three thousand four kilohertz audio channels, bearing in mind that each channel has two sidebands. I haven't encountered any that are quite this full, but they are pretty dense in places. This should, first off, point up the need for a good receiver. It will also give you an idea of just how much stuff there is to check out.

Between The Lines

The most technically sophisticated of the secret signals is what is called "vertical blanking interval" data. If you roll the picture of your television set up a bit so you can see the blank line between the frames, you might notice that there are some sparkling dots in there. They don't exist on all stations. Usually, these things indicate the presence of digital information that's being tacked onto the video signal in places where it can't ordinarily interfere with the picture.

Suffice it to say that you can't dig

this stuff out with a short wave radio. Much of it is some variation of teletex... there are about as many standards and protocols for it as there are transponders in the heavens. Included in these services are news wires, commodity and stock quotations, closed caption data feeds, charts, graphs, program listings and all manner of specialized computer stuff.

Many of the VBI services are available pretty much on a contract only basis. They require sophisticated custom receivers which can only be bought or rented from the companies which provide the data. In any case, teletex equipment is expensive and, from what little I've seen of these feeds, is hardly worth it for their amusement value. They're great if you have a need for the data and don't mind paying for it.

I didn't spend a whole lot of time checking these things out as they're prohibitively costly for most of us.

Hard Copy

I've really only just gotten into this fascinating area of satellite use here... as is usually these case in a short article. You might want to check out the satellite feature in the December Computing Now! if you're interested in it. Alternatively, score a radio and start tuning.

While satellite television looks like a wholly passive activity once you get the dish installed, it has turned out to have a lot of meddling potential if you care to look behind the curtains. This sort of thing is just one aspect of its power... although it's one that can keep you interested for ages.



The Kenwood R-2000

The key to a lot of the secret satellite feeds is a sophisticated short wave receiver. Inexpensive radios won't even pretend to cut it. While there are a number of suitable receivers available, one which I know works... 'cause I'm using it... is the rather superb Kenwood R-2000. It's available in

Canada from Glenwood Trading Company Limited, 278 East First Street, North Vancouver, British Columbia, V7L 1B3. They're also very knowledgeable about satellite television, as it turns out... if you live on the west coast and want a dish you might want to check 'em out.



VEXUS®

VEXUS AUTHORIZED DEALERS AND AGENTS

CAVAN	ST. CATHARINES
ANOTHER WORLD SATELLITES R.R. 1, 814 Morton Line LOA 1C0 (705) 944-5685 Mr. Jack Lyons	BLANKHORN & SAWLE 100 Grantham Avenue L2R 7B9 (416) 684-4351 or (800) 263-7242 Mr. Phil Beddow

BURLINGTON	BURLINGTON	TORONTO	COLDWATER
COLOUR BOX 1155 Guelph Line Burlington Hts. Plaza L7P 2S7 (416) 336-4070	COLOUR BOX 3350 Fairview Street L7N 3L5 (416) 632-1203 Mr. Bob Dawson	DAVIA SATELLITE SYSTEMS LTD. 155 Eastbourne Avenue M5P 2G5 (416) 483-9694 Mr. David Gibbins	EADY ANTENNA SYSTEMS R.R. #4, Moonstone Road LOK 1E0 (705) 835-2077 Mr. Brian Swan

BURLINGTON	HAMILTON	LISLE	NEWMARKET
FAIRVIEW HI-FI 3350 Fairview Street L7N 3L5 (416) 681-1872 Mr. Larry Crosty	GLOBE AUDIO 552-1/2 Upper James L9C 2Y4 (416) 385-3055 385-5280 Mr. Mark Levine Mr. Paul Caldwell	GRAF ENTERPRISES R.R. 2 L0M 1M0 (705) 466-2758 Mr. Charles Graf	NATIONAL VIDEO Gates of York Plaza 130 Yonge Street S. L3Y 7C2 (416) 898-5242 Mr. Ron Burrell

MISSISSAUGA	BURLINGTON	BRAMPTON	LIMOGES
PEEL SATELLITE SYSTEMS 2562 Mainroyal Street L5L 1C9 (416) 820-7620 Mr. George Bursa	PROTECH SATELLITE SYSTEMS P.O. Box 1004 3317-C Mainway L7P 3S9 (416) 335-0770 Mssrs. Lawrence & David Kirby	RELIABLE ELECTRONICS R.R. #4 L6T 3S1 (416) 846-4168 Mr. Deryck Dodwell	R & R SATELLITE ANTENNAS 15 Beaver Lane, Box 16 K0A 2M0 (613) 746-5422 (613) 443-3196 Mr. Robert Lavigne

BURLINGTON	OWEN SOUND	FERGUS	OTTAWA
SATELLITE CONCEPTS 509 Fenwick Place L7N 2W9 (416) 681-1436 Mr. Kenneth J. Kalk	SCHLENKER INDUSTRIES LTD. Box 908 N4K 2M5 (519) 376-0580 Mr. Al Roberts	STATION EARTH Rt. 4 N1M 2W5 (519) THE-DISH Mr. Beatty McLean	THE SATELLITE SHOP, INC. 1439 Youville Drive P.O. Box 483 K1C 1S8 (613) 830-1121 Mr. Richard Srepol

CAMBRIDGE	TORONTO	WASAGA BEACH	WOODBRIIDGE
TV 2000 SATELLITE SYSTEMS 39 Water Street South N1R 3C7 (519) 740-2000 Mr. Jim Drew	VIDEOFLICKS LTD. 1654 Avenue Road M5M 3Y1 (416) 789-0508 Mr. John Bailey	VIDEOFLICKS LTD. 833 Mosley Street L0L 2P0 (705) 429-3232 Mr. Brian Brethauer	VIDEO STATION 116 Woodbridge Avenue L4L 2S7 (416) 851-6646 Mr. Malcolm Marcus



Lifestyle.

A Vexus Satellite Television System is television like never before. The picture is sharper, the colour superb and the programs from which to choose are simply outstanding.

A Vexus Satellite Television System is state-of-the-art Canadian technology, incorporating the highest standards of quality control, engineering and optimum performance. In short, we pledge our total commitment to excellence.

A Vexus Satellite Television System means better service. Your Vexus Dealer is a professional, certified in system design, communications technology, system installation and field service.

But most of all ...

A Vexus Satellite Television System will improve and complement your lifestyle.

Call us today.

Vexus Telecommunications Corporation, 2240 Argentia Road, Mississauga, Ontario L5N 2X6 (416) 821-8900

Circle No. 33 on Reader Service Card.



Q — I have a lot of opposition on this one. Terry, but please tell all those out there that the rumor that satellite receivers are quickly becoming obsolete just isn't true. It's just the pay-TV stations that are saying this and dishes are still a good alternative for those who can't get cable TV. I'm counting on you to answer this one for me.
Dean Pisani,
Welland

A — Sorry, Dean, but you'll have to count me out. As I'm sure you're aware, the Americans had a Great Scramble Day a few months ago that scrambled the signals of most of their cable channels. This meant that many Americans who had invested in satellite dishes were left out in the cold, capable of receiving only ABC, CBS, NBC and PBS. Of course, immediately afterwards, somebody started working on a device to descramble the knocked-out channels. But just as fast as these gizmos can be invented, the cable people will keep one jump ahead by scrambling their signals differently. Meanwhile, dish people have to keep spending more and more money for the descramblers. I haven't heard that Canadian cable channels are planning to scramble their signals although, of course, pay TV already does. But I certainly subscribe to the principle of paying for cable service rather than going to extreme lengths to grab it out of the air for free.

Moorshead Publications

Publishers of Electronics Today, Computing Now!, Computers in Education, and Pets Magazine

Terry Poulton,
Starweek,
1 Yonge Street,
Toronto, Ontario,
M5E 1E6

October 7th, 1986

Terry:

As a journalist turned publisher, I have admired you; you are both good and prolific but, boy oh boy!, did you blow your answer in TV Talkback about satellites!!!

As journalists we make loads of mistakes, not deliberately but because we can't be super experts on everything; most of the mistakes are trivial. Your answer about satellites was as close to 100% wrong than anything I have ever seen. Where on earth did you get your information?

I don't make, sell or hold any brief for anyone who's making money out of these things but the harm you will cause to an industry already reeling from continuous blows from an uninformed press is massive.

To tackle the inaccuracies:

1. There was no Great Scramble Day - in the last 9 months some 18 stations have scrambled but well spaced out.
2. "Only receive the US Networks"? Counting numbers of stations on satellite is more a matter of definition than figures. I have done my own classification; I have little personal interest in sports and none in pulpit thumping religious stations. Excluding these and such junk as shopping channels and other miscellany, there are still 34 stations that I personally find interesting. About 5 of these will probably scramble in the next year.
3. "Canadian Pay TV scrambles". They are the only ones who don't! First Choice is on a different band that few satellite receivers can receive but Much Music and The Sports Network are not scrambled!
Like many satellite owners, I don't use satellite as a way of pirating - I am on cable and pay for my \$19.95 a month.
4. "Pirate Descramblers"? No one has yet succeeded in descrambling the major systems on satellite and maybe they never will. If they did, the suppliers would not go to a new system lightly, their investment in the present technology is staggering - they would not have gone to it unless they felt it was secure for some considerable time.

Many satellite owners take that route because of the staggeringly better picture quality available from satellites than on cable. Having come from the UK where picture quality is cared about by the stations, I remain appalled by the willingness of Canadians to put up with the atrocious picture quality on cable - especially noise. People accept it because they think that is the way it has to be.

Terry, it is clear you have never had a proper chance to see satellite TV. Why not come along to my company and take that opportunity; I have a good system at our offices in the staff lounge. I put it there because the Rogers Cable wanted \$2-3,000 to hook us up to cable! I mean it, give me a call if you want to find out - remember I am not selling anything.

I suspect that you are one of the most read journalists in the Toronto area - it is such a pity that you have written rubbish on this occasion and done extraordinary harm.

Yours sincerely,

Halvor Moorshead

Moorshead Publications, 1300 Don Mills Road, Don Mills, Toronto, Ontario M3B 3M8 (416) 445-5600

Canadian Satellite Down

Tee-Comm

The leader in TVRO Technology

The Sky is the limit
for home entertainment



SATELLITE RECEPTION AT ITS BEST



- Superb Quality
- Outstanding Performance
- Backyard Beauty
- Down to earth pricing

Canadian Research & Development

Manufacturing Excellence from ...

BANVIL - **CALE** divisions of



Tee-Comm Electronics, Inc.

Complete Reader Service Card for listing of
BANVIL - **CALE** Professional TVRO dealers in your area.

Circle No. 35 on Reader Service Card

**Satellite
Communications
Association
of Canada.**

SCAC

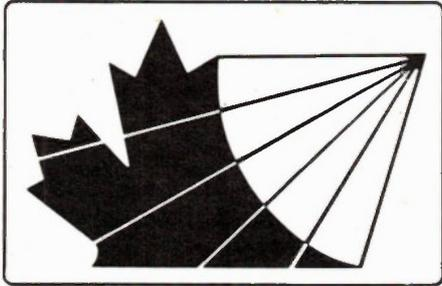

By Brian C. Dinsdale

DURING the STTI Convention in Las Vegas on April 1st, 1985, a steering committee was formed for the purpose of investigating the formation of a Canadian trade association to represent the interests of all persons dealing with satellite communication. At the Canadian Satellite and Cellular Show, held in Montreal, the Satellite Communications Association of Canada (SCAC) was formally incorporated on May 22, 1985.

SCAC represents the interests of manufacturers, dealers and distributors of satellite equipment, as well as consumers, in the TVRO industry of Canada. At that time it was apparent that signal scrambling in the United States was becoming a reality, therefore, it was urgent that all segments of the Canadian satellite industry be represented by means of a national trade organization in order that viewing rights be secured from premium programmers and that a means of compensating payments be organized.

It is important to note here that the premise of paying for premium programming is, of course, accepted. The TVRO industry is not one of pirates, crooks, and thieves. Access to programming at fair market subscription rates must be established.

The satellite TVRO industry is very young, but has developed at a tremendous growth rate since the first backyard experiments in 1978 conducted in Canada by Mr. Rod Wheeler. Let me add that when you talk about satellite technology, understand that Canadian technology and expertise is recognized worldwide as the best. Canada was the first country in the Canadian Satellite Downlink 1986.

world to have a domestic satellite system in place since the early 1970s. And yet even today, satellite direct broadcast is not a recognized sector of the broadcast community nor is it understood that no other sector of the broadcast community can better serve the 1.2 million underserved households in Canada.

From the innovative resourcefulness of a cottage industry in 1979, the Canadian TVRO industry today boasts of over 250,000 systems sold; 30-40,000 systems sold per year, representing a 100 million dollar retail marketplace, employing over 4,000 Canadians.

All this is in spite of fighting for legality, legitimacy and more recently access to programming. SCAC is determined to work tirelessly with the government, the government regulatory body (CRTC), the cable industry association (CCTA), the broadcast industry association (CAB), CANCOM, TELESAT, CBC and programmers towards the development of a broadcast policy of the future that provides Canadians everywhere with what they want.

The Task Force on Broadcasting commissioned by Marcel Masse did not do the job. The recently published Caplan-Sauvageau report has not recognized the impact of satellite broad-

cast on the communications industry in Canada. In fact, after sixteen months of exhaustive study, compiling a report of 731 pages at a cost to you and me of three million dollars, when asked why the report doesn't discuss TVRO and SMATV, Mr. Caplan responded, "We didn't think it was significant enough in Canada".

This statement is totally irresponsible. In a country that is eighty percent cabled, if you live outside cable today you will never have the opportunity for better service and choice of programming that the Caplan-Sauvageau report highly lauds, except by a satellite TVRO system.

The ignorance of our industry constantly displayed in media reporting is our greatest enemy. Should you wish more information regarding SCAC and its efforts to develop satellite "future casting" as a legitimate recognized sector of the Canadian broadcast community, please write: SCAC, 21 Erindale Crescent., Brampton, Ontario L6W 1B6, Telephone (705) 639-2188. If you have a TVRO system, tune into our "SCAC Shack" satellite radio broadcast every Monday evening, 6:30-8:30 p.m. Eastern time on Telstar 303, Transponder 18, 6:48 MHz audio.

You can be part of the future of satellite broadcasting in Canada. ■

SAVE \$ \$

Buy Direct!

LOWEST PRICES!

- SAVE UP TO 50%
- PRICE GUARANTEE

We will give up to 10% OFF a media published price of a recognized retailer when the price is on the same product in inventory. Management discretion at time of purchase.

- NO SALES TAX ADDED (except Que.)

MOST BRANDS! FULL WARRANTIES!

CHAPARRAL
MACOM
Panasonic

DRAKE
DX
OROSAT
uniden

... And Most Other Major Brands ...

COMPLETE SYSTEMS FROM \$ 899. G.M.

COMPONENTS & ACCESSORIES

Shipping Depots Across Canada for Better Service

HALIFAX ● TORONTO ● MONTREAL ● EDMONTON ● VANCOUVER

**SATELLITE
EXPERT Inc.**

NEW YORK . MONTREAL

ORDER LINE:

1 - 514 - 676-3778

Mon. - Fri.: 9 AM. - 5 PM. EST

Head Office:

7005 Taschereau Boulevard
Brossard, Québec, Canada
J4Z 1A7

Circle No. 34 on Reader Service Card.

Exceltronix

Computers and Components
Parts and Peripherals Supplement

Toronto Store:
319 College Street
Toronto
(416) 921-8941

Industrial, Mail and
Phone Orders
6315 Kestrel Road
Mississauga, Ont. L5T 1S4

Ottawa Store:
217 Bank Street
Ottawa
(613) 230-9000

(Limited stock in Ottawa store but available on request).

Long Distance Ordering
1-800-387-6995

(Operators on 800 number cannot handle enquiries other than orders)

Local Orders (416) 673-5111

300 Baud Modem
Plugs right in to your IBM or compatible. Brand new, 200 available.
\$79.00

Apple Compatible Cards
Plug-in Modem, 300-Baud, complete with software \$19.95
Z80 Card - bare board \$3.99

Chips

6502	\$1.99
68A45	\$3.99
Z80A45 CPU	\$2.99
Z80A SIO	\$2.99
555	\$0.29
4000 CMOS	\$0.99
2114	\$0.99
TMS99532 Modem Chip	\$5.99

Large quantities available

Gemini Printers
from \$99
see inside

IBM Compatible Keyboards
Open frame, new
\$29.00

Shipping: Minimum \$5.00 which includes handling and insurance. Items are shipped UPS or other suitable carrier. Shipping cost is dependant on weight and destination. If you are unsure contact our mail order department.

Make sure you have a copy of our new 1987 Catalogue. Call or write for your free copy if you did not receive this in the November issues of Electronics Today or Computing Now!

Overstock Specials - Time Limited Offer

Compare to regular prices in main listings below

Super Specials

6502	\$1.99	74LS169	0.99	74148	1.19	4034	1.50
68A45	3.99	74LS190	0.79	74180	1.89	4042	0.45
Z80A CPU	2.99	74LS196	0.99	74157	0.65	4099	0.69
Z80B CPU	4.50	74LS241	0.59	74175	0.69	4508	0.99
Z80A SIO	\$2.99	74LS248	0.99	74197	0.99	4539	0.99
555	0.29	74LS249	0.99	74198	1.79	40138	0.49
4000 CMOS	0.09	74LS253	0.59	74259	0.99		
2114	0.99	74LS283	0.49	74365	0.49	74H00	\$0.10
TMS99532 Modem Chip	5.99	74LS298	0.89			74C245	0.75
8263	0.29	74LS323	2.75	74S Series		74F258	0.75
8156 RAM I/O Timer	0.99	74LS367	0.49	74S02	\$0.49	74F280	0.75
		74LS368	0.49	74S03	0.59	74HCT259	0.69
		74LS646	4.99	74S05	0.59	54192	0.93

Large quantities available

74LS Series

74LS33	\$0.39
74LS37	0.45
74LS85	0.60
74LS112	0.39
74LS132	0.49
74LS145	0.99
74LS151	0.49
74LS153	0.59
74LS160	0.79
74LS163	0.79
74LS165	0.95

7400 Series

7400	\$0.35
7416	0.45
7451	0.35
7473	0.29
7474	0.59
7475	0.59
7476	0.55
7485	0.89
7486	0.45
74123	0.49
74125	0.75
74126	0.75
74132	0.69

74S Series

74S02	\$0.49
74S03	0.59
74S05	0.59
74S38	0.69
74S40	0.69
74S138	0.75
74S140	0.89
74S151	1.29
74S153	0.75
74S174	0.69
74S182	2.95
74S240	0.75

CMOS

4000	\$0.09
4006	0.59
4015	0.49
4018	0.59

LINEAR

337	\$0.99
358	0.39
555	0.29
558	0.75
709	0.49
723	0.49
733	0.99
741	0.29
1372	2.95
1455	0.49
1558	0.99
3900	0.45

MICROPROCESSOR CHIPS

8500 Series	
8502	8-bit CPU (1 MHz) 4.95
8502A	8-bit CPU (2 MHz) 6.95
8522	VIA Versatile Interface Adaptor 8.95
8522A	VIA Versatile Interface Adaptor 8.95
8532	RIOT (128x8 RAM, I/O, Timer) 7.45
8545	CRT Controller 12.95
8551	ACIA Async. Comm. Interface Adaptor 8.75

8800 Series	
8800	8-bit CPU (1 MHz) 4.30
8802	On Chip 128x8 1MHz CPU 5.99
8809	8-bit CPU (2 MHz) 7.39
8809	8-bit CPU (1 MHz) 9.95
88109	8-bit CPU (2 MHz) 23.00
8810	128x8 static RAM 4.15
8821	PIA Peripheral Interface Adaptor 3.59
8840	Programmable Timer 8.10
8844	DMA Controller 14.00
8845	CRT Controller 8.95
8845	CRT Controller 9.95
8847	Video Display Generator 9.95
8850	ACIA 3.45
8852	Synchronous Serial Data Adapter 5.80
8860	0-600 Baud Modem 11.95

88000 Series	
88000L8	16-bit CPU (8 MHz) 50.00
88000L10	16-bit CPU (10 MHz) 59.00
88008	16-bit CPU (8 bit data path) 52.00
88230	Parallel Interface Adapter 25.95
88450	8MHz 16-bit DMA Controller 110.00
88451	Memory Management Controller 189.00
88681	MPCC (88000 Compatible) 95.00
88681	Duart 19.50

8080 Series	
8080	8-bit CPU 9.80
8085	8-bit CPU 9.45
8087	Main Processor (Intel) 219.00
8087-2	Main Processor (Fast 8 MHz Intel) 279.00
8088	16-bit CPU (8 bit Databus Intel) 10.99
8088	16-bit CPU (8 bit Databus Intel) 10.99
8088-2	16-bit CPU (8 bit Databus 8 MHz Intel) 14.95
8212	3-bit I/O Port 4.99
8214	Priority Interrupt Controller 13.99
8218	4-bit Bidirectional Bus Driver 4.99
8224	Clock generator for 8080/8085 12.99
8226	Inverting Bus Driver 5.36
8228	System controller for 8080/8085 9.75
8237A-5	High Speed DMA Controller (AMD) 8.90
8237A-5	High Speed DMA Controller (Intel) 12.99
8250	Serial Port 12.95
8251A	Programmable Communications Interface 8.32
8253A-5	Programmable Interval Timer (AMD) 5.95
8253A-5	Programmable Interval Timer (Intel) 8.95
8254A-5	Latest Programmable Interval Timer (Improved version of 8253A-5) 7.95
8255	Programmable Interface Adapter 4.89
8255A-5	Programmable Interface Adapter 4.89
8257-5	Programmable DMA Controller 9.95
8259A	Programmable Interrupt Controller 4.95
8275	Programmable CRT Controller 24.00
8279-5PC	Programmable Keyboard Display Interface 7.50
8282PC	Octal latch, non-inverting 8.55
8283PC	Octal latch, inverting 20.95
8284A	Clock gen and driver 5.95
8286	8-bit Bus trans. Non-inverting 8.50
8287PC	8-bit Bus trans. Inverting 10.50
8288	Bus Controller 8.95
8289	Bus Arbiter 40.95
8272	Floppy Disk Controller (Equiv. to NEC 765) 8.95
8741ADC	Unlv. Programmable Interface 34.95

8748DC	CPU, 4K EPROM, I/O 28.00
8749DC	CPU, EPROM, RAM, I/O 35.00
8755ADC	2048 x 8 EPROM, I/O 37.95

8086 Series	
8086	16-bit CPU 13.50

80286 Series	
80286	8 MHz 139.00
80286	8 MHz 148.00
80286	10MHz 190.00
82288	23.99
82284	18.95

Z80 Series	
Z80A-CPU	8-bit CPU (4 MHz) 4.50
Z80B-CPU	8-bit CPU (8 MHz) 14.95
Z80A-PIC	Parallel I/O 5.95
Z80A-CTC	Counter Timer 7.79
Z80A-DART	Dual Asynchronous Receiver Transmitter 13.95
Z80A-DMA	Direct Memory Access 16.50
Z80A-SIO-0	Serial I/O ver. 0 18.95

Communications & Timers

AY3-1015	UART (Single 5V Supply) 7.95
AY5-1013	UART 5.90
S1602	UART 4.49
TMS9918	Sprite Graphics Generator 18.95
TMS9932	FSK Modem 13.95
COM5016	Dual Baud Rate Generator 18.10
COM8116	Dual Baud Rate Generator (5V supply only) 18.75
KY93600	Keyboard Encoder 10.95
KR3600	Keyboard Encoder 8.95
MS15832	Real-time Clock 18.10
MSM58321	Real-time Clock 18.10
SN05037	CRT Video Timer Controller 32.25

Floppy Controllers

WD2143	4-phase Clock Generator for Floppy 14.50
FDC1271	Single Density Disk Controller 19.00
FDC1793	Double Density Disk Controller 47.00
FDC1795	Double Density/Single Disk Controller 69.00
FDC2793	Dbl. Density Disk Controller 45.00
FDC2795	DDDS Disk Controller 45.00
FDC9216	Floppy Disk Data Separator 50.95
NEC765 (8272)	Floppy Disk cont. 8.95

74LS00 SERIES

74LS00	Quad 2 input NAND gate 29
74LS01	Quad 2 input NAND gate O/C 45
74LS02	Quad 2 input NOR gate 29
74LS03	Quad 2 input NOR gate O/C 45
74LS04	Hex inverter O/C 32
74LS05	Hex inverter O/C 45
74LS06	Quad 2 input AND gate 29
74LS09	Quad 2 input AND gate O/C 45
74LS10	Triple 3 input NAND gate 40
74LS11	Triple 3 input AND gate O/C 45
74LS12	NAND gate inverter 50
74LS13	Dual Schmidt trigger 50
74LS14	Hex Schmidt trigger inverter 59
74LS15	Triple 3 input AND gate 75
74LS20	Quad 4 input NAND gate 45
74LS21	Quad 4 input NAND gate 45
74LS22	Quad 2 input NAND gate 45
74LS24	Quad 2 input NAND Schmidt trigger 75
74LS26	Quad 2 input positive NAND gate 45
74LS27	Triple 3 input NOR gate 45
74LS28	Quad 2 input NOR buffer 45
74LS30	8 input NAND gate 45
74LS32	Quad 2 input NOR gate 45
74LS33	Quad 2 input NOR gate O/C 45

74LS37	Quad 2 input NAND gate 55
74LS38	Quad 2 input NAND gate O/C 55
74LS42	BCD to decimal decoder 90
74LS47	BCD to 7 segment decoder/driver 50
74LS48	BCD to 7 segment decoder/driver 99
74LS49	BCD to 7 segment decoder/driver 79
74LS51	And/or invert gate 45
74LS54	4 wide and/or invert gate 45
74LS55	2 wide 4 input and/or invert gate 45
74LS53	Hex current sensing switch 1.70
74LS73	Dual JK flip flop with clear 55
74LS74	Dual D flip flop 49
74LS75	4 bit bistable latch 60
74LS78	Dual JK master/slave flip flop 99
74LS77	4 bit bistable latch 1.00
74LS78	Dual JK flip flop preset, common clear 55
74LS83	4 bit magnitude comparator 94
74LS85	Quad input XOR gate 55
74LS90	Decade counter 65
74LS91	8 bit shift register 76
74LS92	Divide by 12 counter 86
74LS93	4 bit binary counter 95
74LS95	4 bit right/left shift register 80
74LS96	5 bit shift register async. preset 80
74LS107	Dual JK flip flop with clear 55
74LS109	Dual JK pos. edge triggered flip flop 60
74LS112	Quad JK edge triggered flip flop 60
74LS113	Dual JK edge triggered flip flop 55
74LS114	Quad JK edge triggered flip flop 55
74LS122	Retrievable monostable multivibrator 90
74LS123	Dual retrig. monostable multivibrator 50
74LS125	Tri state quad bus buffer 60
74LS126	Quad 3 state buffer 60
74LS132	Quad dup. 2 input NAND gate 89
74LS133	13 input NAND gate 70
74LS136	Quad XOR gate 55
74LS137	3 to 8 decoder/multiplexer 95
74LS138	1 to 8 decoder/multiplexer 68
74LS139	Dual 1 of 4 decoder/multiplexer 68
74LS145	BCD to decimal decoder/driver 1.25
74LS147	104 priority encoder 2.00
74LS148	8 to 3 line priority encoder 2.15
74LS151	8 channel digital multiplexer 75
74LS153	Dual 4 bit multiplexer 75
74LS154	4 to 16 decoder/multiplexer 1.05
74LS155	Decoder/demultiplexer 95
74LS156	Decoder/demultiplexer 85
74LS157	Quad selector/multiplexer 70
74LS158	Quad 2 input multiplexer (inverting) 75
74LS160	Decade counter with async. clear 99
74LS161	Sync. 4 bit counter 95
74LS162	Sync. 4 bit counter 95
74LS164	8 bit serial shift register 89
74LS165	Par. shift reg 8 bit shift register 1.08
74LS166	8 bit PISO shift register 1.95
74LS167	Down/enable binary counter 4.25
74LS169	4 bit sync. binary counter 1.38
74LS170	4 x 4 register file 1.95
74LS173	4 bit tri state register 78
74LS174	Hex D flip flop with clear 80
74LS175	4 bit D flip flop with clear 80
74LS181	4 bit ALU 2.75
74LS182	Look ahead carry 2.75
74LS190	Sync. up/down counter BCD 93
74LS191	Sync. up/down counter binary 80
74LS192	Binary up/down counter 93
74LS193	Binary up/down counter 93
74LS194	4 bit bi-directional shift register 83
74LS195	4 bit shift register 75
74LS196	Decade counter 1.50
74LS197	Down/enable binary counter 1.05
74LS221	Dual monostable multivibrator 1.25
74LS240	Octal inverting bus driver 1.25
74LS241	Octal bus driver 1.25

74LS242	Quad inverting transceiver 1.20
74LS243	Quad transceiver 1.17
74LS244	Tri state octal driver 1.20
74LS245	Octal bus transceiver 1.39
74LS247	BCD to 7 segment decoder/driver 1.05
74LS248	BCD to 7 segment decoder/driver 1.35
74LS249	BCD to 7 segment decoder/driver 1.35
74LS251	Tristate data selector multiplexer 78
74LS253	Dual 4 bit multiplexer 75
74LS257	Quad 2 input multiplexer 80
74LS258	Quad 2-1 multiplexer 80
74LS259	8 bit addressable latch 1.30
74LS260	Dual 5 input NOR gate 79
74LS268	Quad 2 input AND/OR O/C 50
74LS269	Octal D flip flop 1.18
74LS275	7 bit slice Wallace tree 5.55
74LS279	Quad S-P latches 59
74LS280	9 bit odd/even parity checker/generator 3.25
74LS283	4 bit binary full adder 79
74LS289	8 bit RAM 6.25
74LS290	Decade counter 90
74LS293	4 bit binary counter 95
74LS295	4 bit shift register 1.12
74LS298	Quad 2 input multiplexer (inverted output) 1.50
74LS299	8 bit storage register 2.75
74LS320	Crystal oscillator 4.75
74LS321	Crystal oscillator 4.75
74LS322A	8 bit shift register 5.40
74LS323	8 bit bidirectional universal shift 4.25
74LS348	8 to 3 priority encoder 2.75
74LS352	Dual 4 bit multiplexer 1.05
74LS353	Dual 4 bit multiplexer 1.05
74LS354	Data selector/multiplexer 4.75
74LS355	Data selector/multiplexer 4.75
74LS356	Data selector/multiplexer 4.75
74LS357	Data selector/multiplexer 4.99
74LS365	Hex bus driver tri state 6.02
74LS366	Hex bus driver (inverted output) 62
74LS367	Hex bus driver (inverted output) 62
74LS373	Octal transparent latch 1.20
74LS374	Octal data flip flop 1.20
74LS375	4 bit bistable latch 1.65
74LS377	Octal D register 1.23
74LS378	Hex D register 1.85
74LS379	4 bit register 1.85
74LS380	Multi function octal generator 9.00
74LS384	8 bit multiplier 7.95
74LS386	Quad 2 input XOR gate 50
74LS390	Dual decade counter 1.28
74LS393	Dual 4 bit binary counter 1.12
74LS395	Tri state shift register 1.89
74LS396	Octal storage register 2.75
74LS398	Quad D flip flop 2.75
74LS399	Quad 2 input multiplexer with storage 1.45
74LS629	Voltage controlled oscillator 3.30
74LS612	28.00
74LS640	Octal bus transceiver 2.20
74LS641	Octal bus transceiver 3.20
74LS648NT	Octal bus transceivers AND registers 10.95
74LS647NT	Octal bus transceivers AND registers 10.95
74LS648NT	Octal bus transceivers AND registers 10.95
74LS652NT	Octal bus transceivers AND registers 10.95
74LS670	4 x 4 register file 3 state 1.85
74LS673	16 bit SISO shift reg 18.95
74LS682	8 bit magnitude comparator 3.99
74LS683	8 bit magnitude comparator open collector 3.99
74LS684	8 bit magnitude comparator, 3-state 3.99
74LS688	8 bit magnitude comparator, 3-state 3.99
74LS689	8 bit magnitude comparator open collector 5.35
74LS795	Octal buffer (81LS95), 3-State 1.29
74LS796	Octal buffer (81LS96), 3-State 1.29
74LS797	Octal buffer (81LS97), 3-State 1.29
74LS798	Octal buffer (81LS98), 3-State 1.29
74LS799	Octal buffer (81LS99), 3-State 1.29
74LS797	Octal buffer (81LS98), 3-State 1.29

SOCKETS

High quality AMP IC Soldertail Sockets (Double Wipe Action)

8 Pin	10e	20 Pin	25e
14 Pin	18e	24 Pin	32e
18 Pin	24e	28 Pin	37e
18 Pin	24e	40 Pin	52e

Quantity Discounts Available

Note: we also carry a cheaper brand of solder tail sockets at only 1 cent per pin.

Wire Wrap Sockets (RN)

8 Pin	\$.85
14 Pin	\$.89
16 Pin	\$.11
18 Pin	\$.17
20 Pin	\$.14
24 Pin	\$.175
28 Pin	\$.189
40 Pin	\$.295

AMP ZIF Lock Sockets

High Quality AMP	
18 Pin	\$.12.95
24 Pin	\$.14.95
28 Pin	\$.18.95
40 Pin	\$.21.00

IBM Style Case

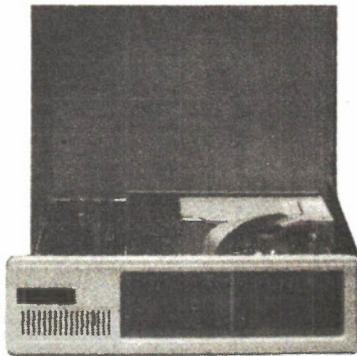

Flip-Top, 8 Slot \$ 75.00
With 150W Power Supply \$219.00

IBM Compatible Keyboards

Maxiswitch \$135.00
Keytronics 5150 \$135.00
Keytronics 5151 (Enhanced) \$249.00

IBM Compatible Power Supplies CSA Approved

130W \$129.00
150W \$139.00
200W \$199.00

MISCELLANEOUS SPECIALS

12 pos. Dip Switch \$0.69
Apple Video Jacks 0.10
6502 Power conn. male 0.45

Transistors

2N4856 \$0.35
2N6387 0.35
MPSV57 0.40

Regulators

78L05 \$0.25
79M05 0.35

MISCELLANEOUS PARTS

DB Connector Series

DB25 Solder Tail Male	\$.09
DB25 Right Angle PCB Mount Female	\$.09
DB25 Right Angle PCB Mount Male	\$.29
DB25 Flat Ribbon Cable IDC crimp type Male	\$.29
DB25 Flat Ribbon Cable IDC crimp type Female	\$.29
DB Metalized Shell	\$.09
DB15 Solder Tail Male	\$.11
DB15 Solder Tail Female	\$.11
DB15 Right Angle PCB Mount Female	\$.16
DB15 Right Angle PCB Mount Male	\$.16
DB15 Flat Ribbon Cable IDC crimp type Male	\$.16
DB15 Flat Ribbon Cable IDC crimp type Female	\$.16
DB15 Metalized Shell	\$.09
DB9 Solder Tail Male	\$.09
DB9 Solder Tail Female	\$.09
DB9 Right Angle PCB Mount Male	\$.29
DB9 Right Angle PCB Mount Female	\$.29
DB9 Flat Ribbon Cable IDC crimp type Male	\$.29
DB9 Flat Ribbon Cable IDC crimp type Female	\$.29
DB Metalized Shell	\$.09

Delta Ribbon Connectors

Quantity Discounts Available

(Centronics Parallel Printer Connector)		
36 Contacts Plug (IDC) Flat Ribbon Crimp Type Male	\$.85	Flat Cable Card Edge Connectors (Disk Drive Connectors)
36 Contacts Socket (IDC) Flat Ribbon Crimp Type Female	\$.85	50 Pin Edge Connector (8" Drive) \$5.95
36 Contacts Chassis Mount female	\$.85	40 Pin Edge Connector \$4.95
36 Contacts Solder Cable Male	\$.85	34 Pin Edge Connector (5 1/4") \$5.85
36 Metal Shell (for solder male)	\$.295	20 Pin Edge Connector (Hard Drive) \$4.79

Capacitors

.1uF 50V Bypass Monolithic 10c
100 of the above \$8.95

TANTALUM CAPACITORS			
0.1uF 35V	\$.26	6.8uF 25V	\$.45
0.15uF 35V	\$.26	6.8uF 35V	\$.58
0.22uF 35V	\$.26	10uF 25V	\$.58
0.33uF 35V	\$.26	10uF 35V	\$.61
0.47uF 35V	\$.26	15uF 25V	\$.95
0.68uF 35V	\$.26	15uF 35V	\$.79
1.0uF 35V	\$.27	22uF 25V	\$.130
1.5uF 35V	\$.27	22uF 35V	\$.225
2.2uF 25V	\$.25	33uF 25V	\$.195
2.2uF 35V	\$.30	33uF 35V	\$.249
3.3uF 25V	\$.35	47uF 10V	\$.125
3.3uF 35V	\$.40	47uF 25V	\$.270
4.7uF 25V	\$.40	47uF 35V	\$.339
4.7uF 35V	\$.50	68uF 10V	\$.190
6.8uF 16V	\$.40	68uF 25V	\$.279

Other Values Available on Request.

Ceramic

Ceramic Disc. Large Selection of Values All 10 Cents each.

Note, when ordering these, specify what voltage you require. Most are available in 50V and 100V.

Good In-Store Stock of Electrolytic Capacitors

Special Quantity Discounts Available.

Card Edge PC Mount Connectors

50 Pin Connector (used on Apple Comps)	\$.245
62 Pin Connector (used on IBM Comps)	\$.245
62 Pin High Quality Economy	\$.185
S-100 Connector (S-100, Z-80 Systems)	\$.495

DIP Switches

4-position	\$1.30
6-position	\$1.55
8-position	\$1.75
10-position	\$1.85

Two Row Right Angle Header Strips (Male)

40 Pin 20x2	\$3.40
34 Pin 17x2	\$2.80
28 Pin 13x2	\$2.49
20 Pin 10x2	\$1.95
16 Pin 8x2	\$1.40
10 Pin 5x2	\$0.95

Two Row Straight Header Strips (Male)

50 Pin 25x2	\$3.90
40 Pin 20 Pin 10x2	\$1.95
16 Pin 8x2	\$1.40
10 Pin 5x2	\$0.95

Female Header Strips

(Flat Ribbon Crimp Type Socket Connector)

50 Pin Female Header 25x2	\$4.99
40 Pin Female Header 20x2	\$4.35
34 Pin Female Header 17x2	\$3.99
28 Pin Female Header 13x2	\$3.25
20 Pin Female Header 10x2	\$1.89
16 Pin Female Header 8x2	\$1.95

Two Position Female Jumpers (Shunts) 20 cents each

DEVICE		TRANSISTORS	
2N697	\$.50	2N3391A	\$.45
2N2219A	\$.80	2N3394	\$.90
2N2222A	\$.50	2N3440	\$.10
2N2270	\$.50	2N3442	\$.25
2N2369A	\$.50	2N3566	\$.78
2N2846	\$.42	2N3568	\$.78
2N2906	\$.48	2N3638A	\$.78
2N2907A	\$.52	2N3642	\$.78
2N3053	\$.70	2N3643	\$.78
2N3055	\$.18	2N3645	\$.78
2N3117	\$.15	2N3703	\$.28
2N3227	\$.48	2N3704	\$.31
2N3250	\$.70	2N3705	\$.29
2N3819	\$.85	2N3820	\$.85
2N3904	\$.19	2N3904	\$.25
2N3905	\$.25	2N3905	\$.25
2N4062	\$.86	2N4062	\$.86
2N4112	\$.28	2N4112	\$.28
2N4123	\$.20	2N4123	\$.20
2N4124	\$.50	2N4124	\$.50
2N4208	\$.87	2N4208	\$.87
2N4222	\$.19	2N4222	\$.19
2N4248	\$.85	2N4248	\$.85
2N4250	\$.78	2N4250	\$.78
2N5771	\$.75	MPSA20	\$.30
2N5772	\$.37	MPSA55	\$.48
2N6028	\$.45	MPSU51	\$.78
MJ802	\$.45	MPSU56	\$.99
MJ255	\$.63	PN2222A	\$.39
MJ4502	\$.50	TIP29C	\$.70
MJE340	\$.25	TIP30C	\$.70
MJE802	\$.495	TIP31C	\$.70
MPP102	\$.65	TIP32C	\$.10
MPS6515	\$.42	TIP33C	\$.10
MPSA05	\$.35	TIP34C	\$.65
MPSA13	\$.35	TIP35C	\$.30
MPSA14	\$.35	TIP41C	\$.15
MPSA16	\$.36	TIP42C	\$.10

Heat Sinks

TO220	\$0.39
TO3	\$2.99

LEDs

Large LEDs	
T-1 3/4 (Normal Size)	
Red (General purpose)	\$.025
Green (General purpose)	\$.039
Yellow (General Purpose)	\$.039
Red (Extra Bright)	\$.059
Green (Extra Bright)	\$.065
Yellow (Extra Bright)	\$.065

Small LEDs (T-3/4)

Red	\$.030
Green	\$.035
Yellow	\$.036

Rectangular LEDs 75 cents each

Bar Graph Display

8-Segment, (Red, Green or Yellow)	\$.495
3S LED Matrix 2' or 3'	\$.995

Rectifier Diodes

1N4001 50V 1A	\$.07
1N4004 400V 1A	\$.09
1N4007 1000V 1A	\$.11
1N5403 300V 3A	\$.40
1N5404 400V 3A	\$.40
1N5406 600V 3A	\$.60

Switching and Signal Diodes

Green	\$.19
1N914	\$.5
1N4148	\$.5
1N4448	\$.5

Zener Diodes

1 Watt. All Values 25 cents each.	
3.9, 4.3, 4.7, 5.1, 5.6, 6.2, 7.5, 8.2, 9.1, 10, 12, 13, 15, 16, 18, 20, 22, 24, 27, 30, 33, 36	

Switches

Momentary push-button switches	\$.89
Momentary push-button switches SPDT	\$.85
On-Off Switch, SPDT	\$.85

Parts for your Modem

Small Speakers	\$.84
600 ohm to 900 ohm (1.1) isolation transformers	\$.995
Relay for your modem (HE721A0500) 5V	\$.499
DAA 1812 for Modem (Contains Built-in Transformer, relay and surge protector)	\$.39.00

SCR's

2N5064	\$.75	MCT2	\$.125
2N8337	\$.55	MCT6	\$.199
TIC106D	\$.125	4N25	\$.110
TIC116D	\$.199	4N35	\$.120
TIC126D	\$.199	4N30	\$.139
4N33	\$.88	MOC3011	\$.175
MOC3011	\$.175	MOC3031	\$.225
MOC3002	\$.299	FND500	\$.299
FND507	\$.299	TIL313	\$.195
TIL312	\$.195	TIL312	\$.195
RBG-1000	\$.599		

TRIACS

TIC208D	\$.155
TIC218D	\$.199
TIC228D	\$.187
TIC283D	\$.425

Voltage Regulators

78GASC Adjust 5A	1.47
78S40 Switching Regulator	3.84
NEGATIVE:	
7805 -5V 1A	\$.99
7806 -6V 1A	\$.75
7805 +5V 5A	\$.44
7805 +5V 10A	\$.497
7808 +8V 1A	\$.99
7808 +8V 1A	\$.75
7812 +12V 1A	\$.99
7812 +12V 1A	\$.75
7812 +12V 5A	\$.1096
7815 +15V 1A	\$.99
7824 +24V 1A	\$.99
78GUC Adjust 1A	1.80
78GASC Adjust 5A	1.99

CRYSTALS

32.768KHZ	\$.115	10.24MHZ	\$.299
1.00MHZ	\$.695	12.00MHZ	\$.099
1.8432MHZ	\$.399	14.00MHZ	\$.299
2.00MHZ	\$.250	14.318MHZ	\$.219
2.457MHZ	\$.375	18.00MHZ	\$.199
3.57MHZ	\$.75	18.00MHZ	\$.229
4.00MHZ	\$.199	18.432MHZ	\$.199
5.00MHZ	\$.195	20.00MHZ	\$.215
5.017MHZ	\$.350	17.43MHZ	\$.099
5.088MHZ	\$.195	22.118MHZ	\$.299
8.00MHZ	\$.195	48.00MHZ	\$.399
10.00MHZ	\$.195		

Wire Wrap Wire. All Colours (30 gauge)

25 ft	\$.80
50 ft	\$.85
100 ft	\$.85
Wire Wrap Unwrap Tool/Strip Tool	\$.18.25
Wire Wrap Gun and Bit	\$.83.00

IC Extractor	\$.39
IC Insertion Tool	\$.18.95
High Quality 24-40 Pin Extractor	\$.23.50

SIP Resistor Networks

Part #	Pins	Common Pin #	Value
6-1-XXX	6	1	0.39
8-1-XXX	8	1	0.44
10-1-XXX	10	1	0.59

Trim Pots

P.C. MOUNT MULTITURN TRIMPOTS		TRIMPOTS	
RESISTANCE	10K	RESISTANCE	10K
10	10K	100	100K
20	20K	250	250K
50	50K	500	500K
100	100K	1M	1M
200		2.5M	2.5M
		5M	5M
		10M	10M
		OPEN CASE	35c
		ENCLOSED CASE	85c

\$1.65 ea.

Multiflex Products

Multiflex Economy Video Display Terminal

Now available from MULTIFLEX is an economy video display terminal. Originally designed as a low cost access unit for our mail-ordering and bulletin board system, this terminal is a semi-intelligent system which is controlled by a Z80A microprocessor and a 6845 CRT controller chip. The keyboard is fully ASCII encoded and the character generator contains the full 128-character set as well as a 128-character alternate set both of which are in the 5x7 dot matrix format. The screen display is 80 characters by 24 lines if the unit is hooked to an external monitor. (Monitor not included). There are 3 software selectable attributes (dim, reverse video, and alternate character set) which can be chosen one at a time for the whole screen. The attribute can then be switched on and off for each individual character. A 2K buffer is provided for normal operation. However when the optional 6K memory upgrade is purchased, 4 screen pages can be loaded from the host machine, edited, locally, and then downloaded back to the host again saving on connect time and phone line bills. Also included are 2 RS232 ports: one for a modem and one so that a printer can be attached to the terminal. The baud rates on these ports are software programmable and can range from 110 to 9600 baud. With all these features, you would expect to pay a lot for this system, but all this is available to you, complete with an attractive case, for an extremely low price.

A&T board with keyboard (as picture top right) with one RS232 and 2K buffer \$139.00

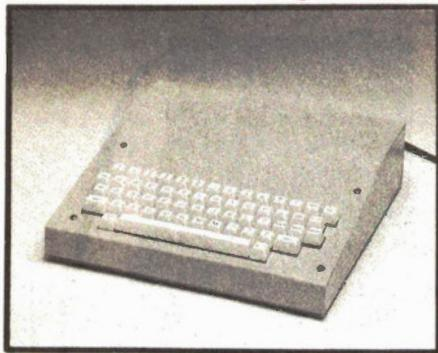

Terminal Complete: Tested and 90 days warranty with 2 RS232 ports, 2K buffer case and power supply (Hydro approved)

\$199.00

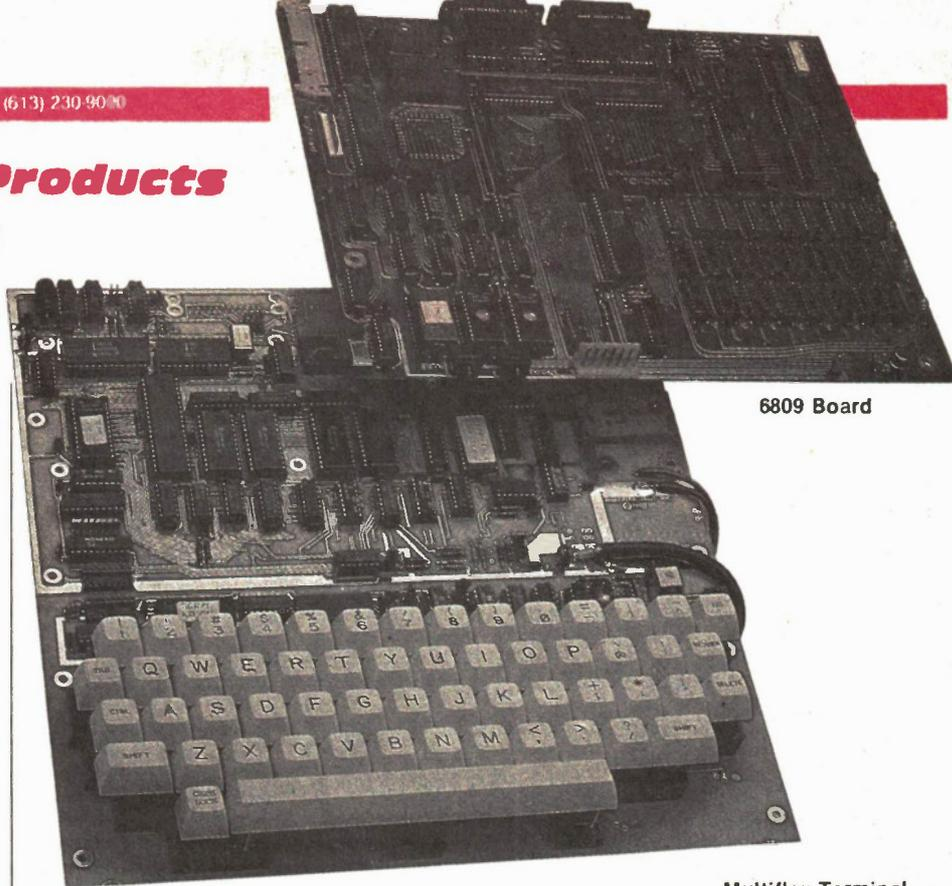

6809 Board

U of T 6809 Single Board Computer

The 6809 Single Board Computer, designed at the University of Toronto and distributed exclusively by EXCELTRONIX, is a compact hardware unit which was designed originally as a lab board for teaching students about microprocessor systems. Its many features, however, make it an ideal unit for stand-alone control applications or software development systems as well.

The system is designed around the Motorola MC6809 microprocessor. This is an 8-bit processor with full 16-bit internal architecture, 2 index registers, 2 stack pointers, 2 8-bit or 1 16-bit accumulators, a direct page register and a wide range of addressing modes, including a program-counter-relative mode. This mode allows the user to write completely position independent software, important in systems software development.

There is provision for up to 48K bytes of dynamic RAM on-board. The refreshing of this RAM is controlled by an 8202 Dynamic RAM Controller. This chip allows for completely transparent refreshing of the RAM (ie. no wait states to slow the system down). There is also provision for up to 12K of EPROM using 2532 chips.

There are 4 complete I/O circuits built onto the board. 2 of them are serial (RS232); one is used for a terminal (which is required for use of the board with the supplied monitor software), and the other one is user definable, but it is set up to

Multiflex Terminal

communicate with either a modem or a printer. Also on-board are 2 6522 VIA chips. These provide 2 parallel ports per chip along with 2 16-bit timer/counters. One of the parallel ports and one of the timers are used by the monitor software to provide a cassette interface (which operates at 300 baud). The second parallel port on that chip is wired into a connector which is ideal for interfacing a parallel printer or keyboard. The 2nd VIA is not used at all and is completely free for the user. For further expansion of the system, a fully buffered version of the CPU signals (data, address, control lines and a signal indicating whether or not the current address is located on the board) is available at a cable connector.

The software provided with the system is in a 2532 EPROM and allows the user to: test the memory; dump blocks of memory; examine and modify single memory locations; read or write from the cassette port; set and examine break-points; single step and/or execute machine language programs and set and examine the processor registers. All this is accomplished through a 9600-baud terminal interface (one of the serial ports). Included is a full screen editor/assembler which allows the user to work in 6809 assembly language rather than machine language. All this makes this board an ideal trainer, control unit or software development unit for just about anyone.

Includes U of T course documentation

A&T with 48K \$199.00

Limited quantities.

8088 Board with Built-in Modem: \$49.95!

This could be the biggest bargain of all times.

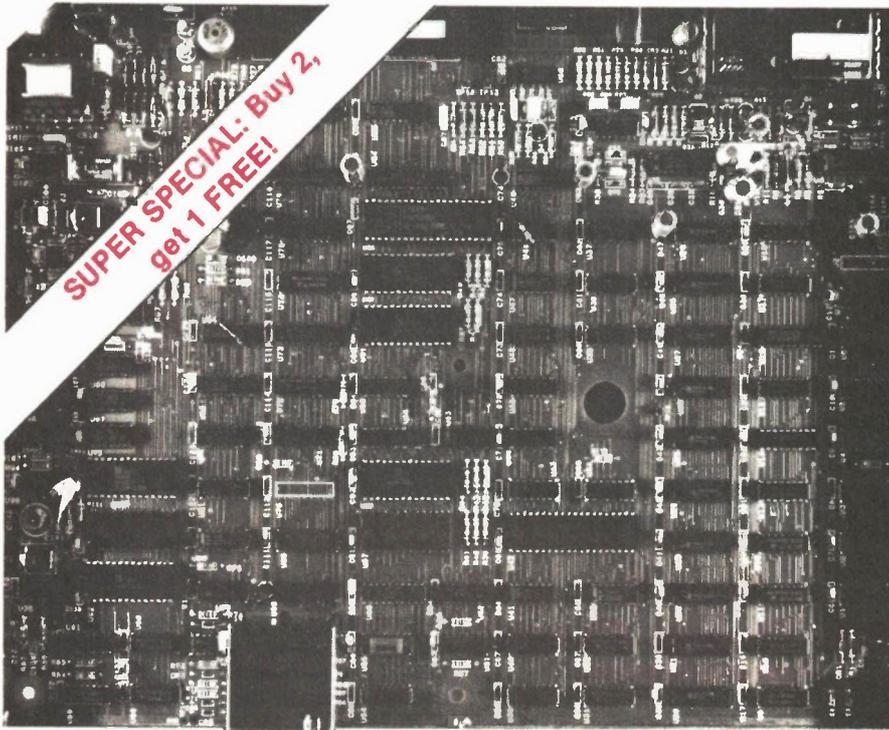

Buy TWO Get ONE FREE

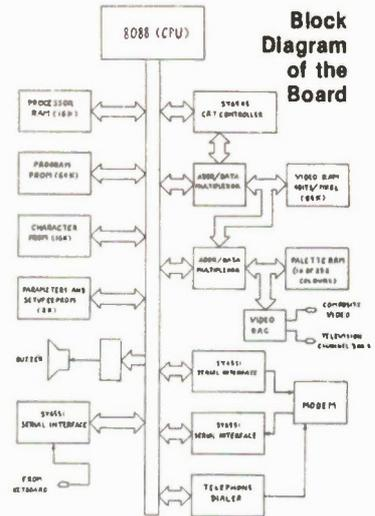

The main board shown can be used in many different ways. Made recently by one of the Canada's leading electronics companies, this board utilizes some of the most current technology and parts.

Use your imagination, software and hardware to make this board into many interesting projects. The board is capable of colour graphics and was originally designed as a terminal for home-ordering system and has many of the facilities similar to the Teldon terminals in use in shopping malls, hotels etc.

This magnificent board features an 8088 CPU, 6545 CRT Controller, 150/1200 Baud auto-dial, direct-connect modem, serial ports, RF Modulator (Ch.3) for 40 characters, EPROMs, 64K Video RAM, 16K RAM and 64K of EPROM for the processor.

All you need is power supply with 5V at 2A, plus/minus 12V at 0.05A. The current value of the parts alone on this board is in excess of \$300!

- A. The Board itself with the original software, schematics, memory map and block diagram: \$49.95
 - B. Membrane Keyboard Kit \$19.95
 - C. Plastic Case to house the main board \$ 9.95
- Items A, B and C as a package \$74.95

Wall Plug Adaptors



\$9.95

with board which provides you with +5V at 1.2A and +12V at 350mA and .5A (low current) fully regulated, Brand new.

Panasonic Printer Mechanism Thermal type, open frame brand new

\$9.95

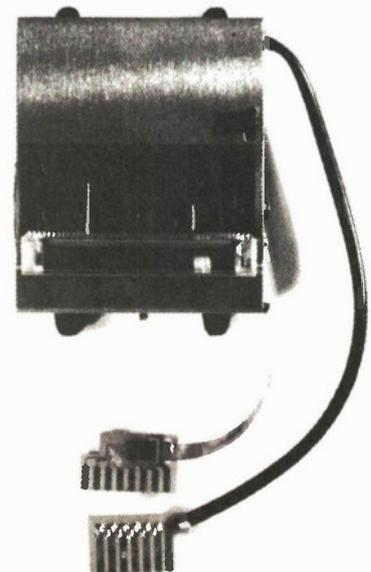

IBM Compatible Keyboard Open Frames \$29.95

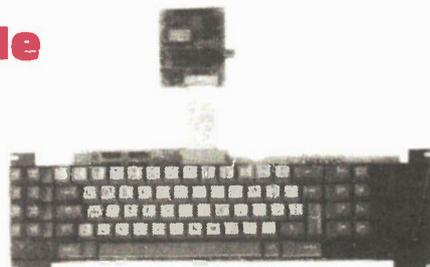

IBM Compatible Boards

300 Baud Modem. Complete	\$79.00
PCB only	\$ 9.95
Floppy Controller for 2 floppies	\$49.00
PCB only	\$ 9.95
512K RAM Card with 512K RAM	\$199.00
with 128K RAM	\$149.00
socketed only	\$29.00
PCB only	\$15.00

Quanta Board.

Includes one parallel and two serial ports and games port . . . \$99.99
PCB only . . . \$ 9.95

Penta RAM Cards

Socketed but no chips, holds up to 512K, Serial and Parallel
Ports, Real Time Clock/Calendar, Games Port . . . \$39.00
PCB only . . . \$19.00

All Cards supplied with schematics

Apple Compatible Boards

	Populated (no EPROMs where appli- cable)	Socketed (all but ICs)	Bare PC Board
Z80/64K Card Uses Z80B CPU, requires Saturn soft- ware	\$75.00	\$29.00	—
80 Column Card	\$49.00	\$29.00	\$19.00
Intelligent Printer Card (IPI)	\$19.00	\$14.00	—
Serial Card	\$19.00	\$14.00	—
Apple Compatible Modem. 300 Baud	\$69.00	\$39.00	\$19.00
Economy Modem	\$19.95	—	—
Z80 Card	\$29.00	\$19.00	\$ 3.99
16K RAM Card	\$29.00	—	—
128K RAM Card	\$79.00	—	—
Multiflex EPROM Programmer	\$89.00	—	—
Cable to use Apple II+ or IIe disk drives with IIc . . \$3.99			

Printers From \$99!

Demos and used printers in work-
ing condition. No warranty.

Gemini 10X . . .	\$99.00 to \$149.00
Gemini SG10 . . .	\$199.00
Gemini Power Type (Daisy Wheel) . . .	\$399.00
Gemini Radix . . .	\$499.00
Plus other models	

Gemini Printer Parts

Ribbons	\$ 4.50
Platten Knob	\$ 5.00
Line Feed Motor	\$35.00
Tractor Motor	\$35.00
Plastic cover	\$15.00
Tractor Unit	\$49.00
Paper Separator	\$ 5.00

Z80 - \$100 CPM Items

S100 CPU with 64K RAM . . .	\$75.00
S100 Floppy Controller . . .	\$75.00
S100 Video Board	\$75.00
S100 Backplane	\$ 9.00
S100 Proto Boards	\$12.00

Cables

IBM type parallel printer cable, 6 ft.
..... \$ 9.95
IBM type serial cable RS232C, 6ft. \$13.95
Other lengths available - please call.

Even better prices may
apply for large quantities
on all items. Please call.

MEMORY AND PARTS

Untouchable Prices!

Guaranteed Prime Stock

Call for large quantity prices.

Dynamic RAMs

4116 1x16k (150ns)	\$ 0.75
4164 1x64k (150ns)	\$ 2.49
4164's (150ns). Set of 9	\$21.95
41256 1x256k (150ns)	\$ 4.99
41256 (150ns). Set of 9	\$44.75

Static RAM

6514 4x1k CMOS 450ns	\$ 0.75
6116 8x2k 150ns	\$ 3.99
2016 8x2k 150ns	\$ 3.75
6264 8x8k 150ns	\$ 6.95

EPROMS

2716 450ns 8x2k	\$ 5.50
2716 300ns 8x2k	\$ 6.50
2732 450ns 8x4k	\$ 4.99
2732 250ns 8x4k	\$ 4.99
2764 300ns 8x8k	\$ 5.95
27128 350ns 8x16k	\$ 6.95

Commonly used parts for your
IBM-compatible (8088) systems
and peripherals.

Only prime quality parts sold.

Quantity Discounts Available.

8088 CPU	\$10.99
8087 Math Processor	\$219.00
8237A-5 Prog. DMA Cntrl.	\$8.90
8250 Serial Port	\$ 9.95
8253A-5 Prog. Interval timer	\$5.98
8255A-5 P.I.A.	\$4.89
8259A Prog. Interrupt Cntrl.	\$4.95
8284A ADC clock gen & driver	\$4.75
8288 Bus Controller	\$4.95
8272 Floppy Disk Controller	\$6.95

NEC 765 Floppy Disk Controller (equivalent to 8272)	\$8.95
8086 CPU	\$13.50
Set of 8088, 8255A-5, 8237A-5, 8288, 8284, 8253A-5 and 8259A	\$43.95

100ns delay line	\$4.95
7ns delay line	\$12.45
62 pin edge con (high quality)	\$1.79
5 pin Din conn	\$.99
Power conn	\$1.25
Dip switch 8 pos	\$1.75
4.7k x 6 sip	\$.39
4.7k x 8 pin sip	\$.44
8.2k or 10k 16 pin Resistor or network	\$.99
33ohm x 8 network	\$.99
Small speaker	\$1.99
.1 uf 50V high quality bypass capacitors	\$ 0.09
Trimcap	\$.99
34 pin card edge con.	\$5.85
for your floppy controller	

74LS322A	\$3.99
74LS629	\$3.30
74LS670	\$1.45
74S280	\$2.89
74LS125	\$ 0.49
74S157	\$1.25
74LS244	\$0.89
74LS245	\$0.99
74LS273	\$0.99
75477	\$1.19

Parts for Apple Compatibles

6502 CPU	\$ 2.99
6845 CRT controller	\$ 4.99
68A45 CRT controller	\$ 4.99
Z80A CPU (4 MHz)	\$ 3.95

We now carry a wide selection of 80286
parts at most competitive prices.

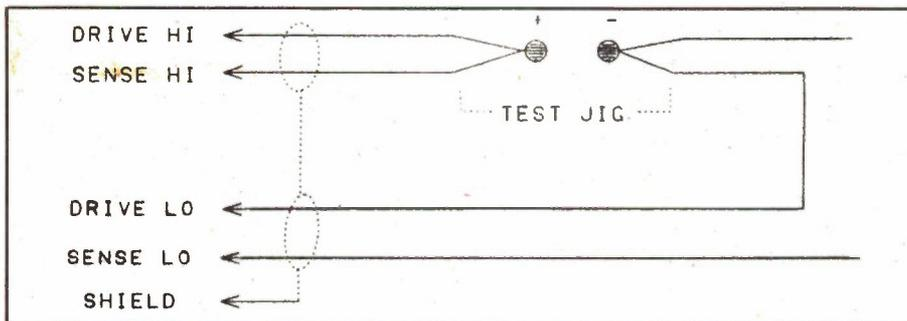

Fig. 1. The 4-wire hookup minimizes the effect of the test leads on the measurement.

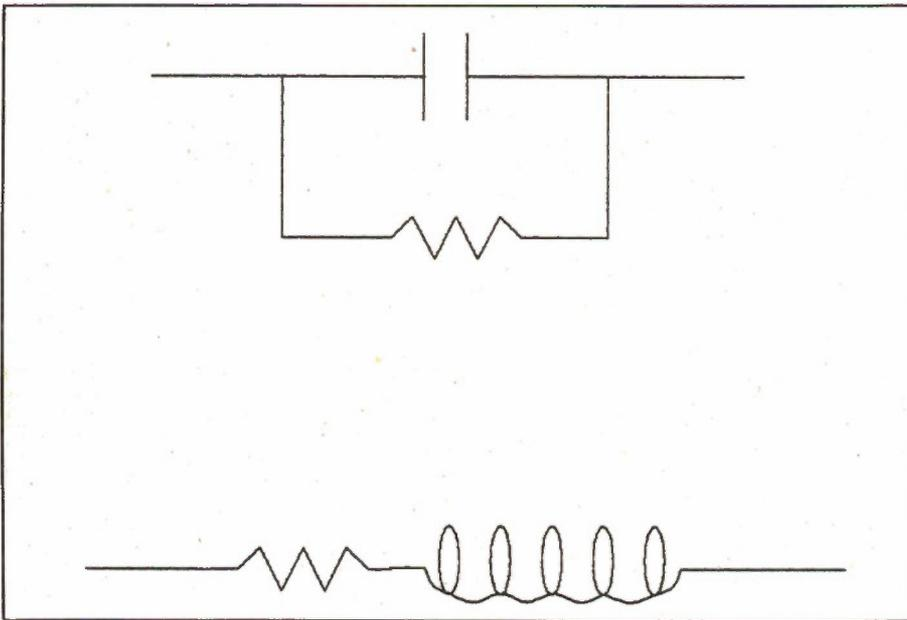

Fig. 2. The impedance models used by the meter: a capacitor (top) and an inductor (bottom).

ponents that contribute to error, the response will consist of two parts. One is the in-phase part, proportional to the real or resistive portion of the impedance. The other is 90 degrees out of phase with the drive and consists of the reactive or true value of the component under test. A pure capacitor or pure inductor would obviously appear as a pure reactance, but these components exist only in textbooks. Real hardware suffers resistive losses, if only very small ones, and the ratio of resistive ohms to reactive ohms gives the D figure of merit: the lower the better. Film capacitors approach the ideal, with D values at or approaching zero; electrolytics are typically 0.05. I tried various small inductors, from 100uH RF chokes to 1H ferrite core types, and found the D values within the range of 2 to 4. The meter will measure D up to 20.

The Comparators

If you're selecting capacitors for a particular function, or if you test and sort incoming batches, the comparator section is ideal. The comparators are activated with the Range Hold button, which also speeds

up response, and the upper limit, lower limit and D limit are dialed in using the display and the ten-turn pots. Three green LEDs let you know that the component tested is within the specified limits; they turn bright red if the limit is missed by plus or minus one count. It was really remarkable to see just how precise the Cambridge comparator circuit really is: I set the limits to 1555 and 1557uF and measured a capacitor that I had previously determined at 1556. Both LEDs glowed green, but even the heat from my hand made the upper LED flicker to red as the capacitor value drifted. Now that's tight.

Incidentally, you might point out that the hum fields and capacitance of my hand could also affect the reading, and so they could. However, the 520 uses a four-wire shielded test lead, with sensing leads brought right out to the lead tips. There's no noticeable flickering of the display from external interference, though I suppose body capacitance might affect the reading of very low value capacitors.

One caution, echoing the one in the manual: it's possible to set the meter in the inductance mode and then measure

capacitance and still get stable, apparently believable, but wrong readings. The user has to check the L/C pushbutton before testing.

How It Works

The basic idea is simple enough. The known level from a sine wave oscillator is applied to the component under test and the output read on a meter calibrated to display in the desired units. The first catch is that a single frequency used to measure over an eight decade range will be microscopic at one end and enormous at the other. The Cambridge solves this problem by using two frequencies, 120Hz and 1kHz. The oscillator, which is a Wien bridge with FET stabilization, is automatically stepped to the appropriate frequency by the autoranging circuitry.

When the L mode is selected, the output is converted to a sinusoidal current source (80mA to 0.6uA depending on range) and the voltage response of the component is measured. With capacitors, the output amp is run as a voltage source (800mV to 60mV depending on range) and the component current is measured.

As mentioned above, the impedance of a device under test consists of two parts, the real and the reactive, 90 degrees out of phase. The model for a capacitor is taken as a parallel RC circuit, and for inductors a series RL circuit is used.

The drive signal and the device output are applied to the inputs of a quadrature (90-degree) detector. If the signals are not exactly 90 degrees out of phase, indicating a non-zero loss factor (D), an electronic attenuator adds some of the inverted drive signal to the device signal. This has the effect of cancelling out the real part of the impedance, leaving only the value of the reactance. The attenuator control signal is proportional to D and is sent to the DVM for display.

Lastly...

While the 520 doesn't measure resistance, and doesn't have outputs or interfaces, its features compare favorably to many instruments costing much more. Its accuracy and fast operation make it close to the ideal for testbench and production line work, and the manual is first-rate, containing as it does an operating guide, drawings, schematics and circuit descriptions. It is presently available in Canada for \$1925 from Duncan Instruments, 121 Milvan Drive, Toronto, Ontario M9L 1Z8, (416) 742-4448. ■



ORION ELECTRONICS SUPPLIES INC.

40 LANCASTER ST. W. KITCHENER ONTARIO N2H 4S9 TELEPHONE (519) 576 9907
ELECTRONIC DISTRIBUTOR INDUSTRIAL - COMMERCIAL - EDUCATIONAL

20MB HARD DISK SYSTEM ONLY \$ 649.

SEAGATE ST-225 20 MB HARD DISK SYSTEM
INCLUDES HARD DISK CONTROLLER, CABLES AND INSTRUCTIONS. ALL OUR HARDWARE IS TESTED AND COMES WITH A ONE YEAR WARRANTY.

\$ 649.

5 Meg. Hard Disk **\$499**
with National Controller

SMITH CORONA \$169



Speed: 80 characters per second
Friction feed standard — optional tractor feed
Feature: bidirectional print, 80 character print line at 10 CPI.
Full line buffer.

Centronics compatible parallel interface
Graphics capability
Fanfold or single sheets, (not optional)
Six pinches
National service network
Toll-free telephone support
Prints: Apple • IBM • Commodore • Atari etc.

The Place To Buy Your Epson Printers

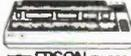

EPSON FX-200 \$ 899.00

EPSON FX-200 \$ 899.00
EPSON FX-200 \$ 899.00
EPSON FX-200 \$ 899.00
EPSON FX-200 \$ 899.00
EPSON FX-200 \$ 899.00
EPSON FX-200 \$ 899.00

SAVE PRINTERS

PR1011 100cps Roland **\$349.95**



PRINTERS

ROLAND PR1011 100cps \$349.95
ROLAND PR1011 100cps \$349.95
ROLAND PR1011 100cps \$349.95
ROLAND PR1011 100cps \$349.95
ROLAND PR1011 100cps \$349.95
ROLAND PR1011 100cps \$349.95

PANASONIC KX-P1080 PRINTER **\$375**

TTX 1014

RELIABLE DAISY WHEEL DO PRINTER



1014 FEATURES:
• 100 cps
• 12 pin printer
• 12 pin printer
• 12 pin printer
• 12 pin printer
• 12 pin printer
• 12 pin printer

ORION DISKETTES

100% ERROR FREE & LIFETIME WARRANTY

SPECIAL 12.99 SSDD
14.99 DSDD

CRT MONITORS FOR ALL APPLICATIONS High Resolution

ORION 1210 6" MONITOR	\$ 149.00	ORION 1210 6" MONITOR	\$ 149.00
ORION 1220 6" MONITOR	\$ 149.00	ORION 1220 6" MONITOR	\$ 149.00
ORION 1230 6" MONITOR	\$ 149.00	ORION 1230 6" MONITOR	\$ 149.00
ORION 1240 6" MONITOR	\$ 149.00	ORION 1240 6" MONITOR	\$ 149.00
ORION 1250 6" MONITOR	\$ 149.00	ORION 1250 6" MONITOR	\$ 149.00
ORION 1260 6" MONITOR	\$ 149.00	ORION 1260 6" MONITOR	\$ 149.00
ORION 1270 6" MONITOR	\$ 149.00	ORION 1270 6" MONITOR	\$ 149.00
ORION 1280 6" MONITOR	\$ 149.00	ORION 1280 6" MONITOR	\$ 149.00
ORION 1290 6" MONITOR	\$ 149.00	ORION 1290 6" MONITOR	\$ 149.00
ORION 1300 6" MONITOR	\$ 149.00	ORION 1300 6" MONITOR	\$ 149.00

SALE PRICES

KIMTRON RGB MONITORS

ORION 1210 6" MONITOR	\$ 149.00	ORION 1210 6" MONITOR	\$ 149.00
ORION 1220 6" MONITOR	\$ 149.00	ORION 1220 6" MONITOR	\$ 149.00
ORION 1230 6" MONITOR	\$ 149.00	ORION 1230 6" MONITOR	\$ 149.00
ORION 1240 6" MONITOR	\$ 149.00	ORION 1240 6" MONITOR	\$ 149.00
ORION 1250 6" MONITOR	\$ 149.00	ORION 1250 6" MONITOR	\$ 149.00
ORION 1260 6" MONITOR	\$ 149.00	ORION 1260 6" MONITOR	\$ 149.00
ORION 1270 6" MONITOR	\$ 149.00	ORION 1270 6" MONITOR	\$ 149.00
ORION 1280 6" MONITOR	\$ 149.00	ORION 1280 6" MONITOR	\$ 149.00
ORION 1290 6" MONITOR	\$ 149.00	ORION 1290 6" MONITOR	\$ 149.00
ORION 1300 6" MONITOR	\$ 149.00	ORION 1300 6" MONITOR	\$ 149.00

PRICE BREAKTHROUGH! ORION 5AT ORION 5XT

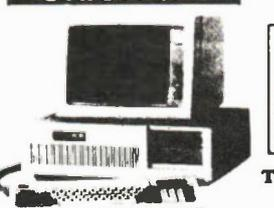

ORION 5XT \$799
100% IBM™ Compatible with 640K mother board
Includes:
• 256K Memory • 8 Expansion Slots • One 380K DS/SD Disk Drive • 150W Power Supply • Disc Controller Card • Choice of Colour or Monochrome Card • Will run 1-2-3 Flight Simulator Base II TM Super Calc, Vis Calc and others.

Turbo PC/XT PORTABLE

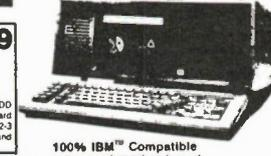

100% IBM™ Compatible with 640K mother board
System includes:
• 256K memory with turbo
• 1 380K DS/SD Drive with controller
• Colour, Graphical Monochrome Display Card
• Case, Keyboard, 120 Power Supply
• 120 Day Warranty

IBM Compatible Boards

ORION 5AT \$1995.00	with 1 meg dual clock mother board.
Includes:	• 256K memory • 200 meg power supply • 1.8 meg floppy drive • 150W power supply • AT keyboard • 120 Power Supply
Options:	2nd Drive \$140. Hiree Monitor \$149.
COMPLETE AT SYSTEM:	Dual Board (optional), 80286 CPU (80287 optional), 18-bit 8.25 or 10 MB Disk Drive, Expansion to 1MB, Clock Programmable, VGA, 1.2 MB Disk Drive, Hard Disk Controller, Printer & Serial Ports, 150-watt Power Supply, 120 Keyboard, Case, Assembly, Tested. \$2550.00
AT COMPONENTS:	AT Mother Boards: 80286 CPU (80287 optional), 18-bit 8.25 or 10 MB Disk Drive, Expansion to 1MB, Clock Programmable, VGA, 1.2 MB Disk Drive, Hard Disk Controller, Printer & Serial Ports, 150-watt Power Supply, 120 Keyboard, Case, Assembly, Tested. \$1899.00
20MB HARD DISK CONTROLLER:	Hard AT Compatible, 20MB 2.5" Floppy & Hard Disk. \$599.00
2.5MB MULTI-FUNCTION CARD:	2.5MB RAM Expansion, Printer, 2 Serial Ports, OK. \$339.00
PARALLEL & SERIAL PORTS CARDS:	\$139.00
KEYBOARD:	1.80 meg AT Keyboard. \$119.00
POWER SUPPLY:	150-watt Side Switch. \$119.00
CASE:	IBM AT Style Bezel Case. \$119.00
DRIVES:	1.2MB 10 High Floppy Disk Drive. \$299.00

THE BEST SYSTEM FOR THE BEST PRICE

IBM Compatible Boards

• IF02 348 K Multifunction (S/PP/C)/OK	\$ 179.
• IF03 284K RAM Ver II OK	\$ 75.
• IF03 512K RAM Ver II OK	\$ 75.
• IF05 Color Graphic	\$ 119.
• IF05 Monochrome	\$ 119.
• IF07 Mono-Graphic with printer port	\$ 189.
• IF09 I/O + II + (S/PP/C)	\$ 119.
• IF11 Parallel Printer (Cable extra)	\$ 35.
• IF12 Serial - RS232C	\$ 49.
• IF13 Game	\$ 29.
• IF14 Floppy Drive Controller + Cable	\$ 79.
• IF15 Clock Card	\$ 59.
• IF16 Serial + Clock Card	\$ 79.
• IF17 E-rom Burner	\$ 149.
• 380K DS/SD Disk Drive	\$ 149.
• XT Compatible Mother Board OK	\$225.

ONLY \$1295. 6502 Boards

ASC 180 Control Card	\$19.00
ASC 180B Control Card	\$19.00
ASC 180C Control Card	\$19.00
ASC 180D Control Card	\$19.00
ASC 180E Control Card	\$19.00
ASC 180F Control Card	\$19.00
ASC 180G Control Card	\$19.00
ASC 180H Control Card	\$19.00
ASC 180I Control Card	\$19.00
ASC 180J Control Card	\$19.00
ASC 180K Control Card	\$19.00
ASC 180L Control Card	\$19.00
ASC 180M Control Card	\$19.00
ASC 180N Control Card	\$19.00
ASC 180O Control Card	\$19.00
ASC 180P Control Card	\$19.00
ASC 180Q Control Card	\$19.00
ASC 180R Control Card	\$19.00
ASC 180S Control Card	\$19.00
ASC 180T Control Card	\$19.00
ASC 180U Control Card	\$19.00
ASC 180V Control Card	\$19.00
ASC 180W Control Card	\$19.00
ASC 180X Control Card	\$19.00
ASC 180Y Control Card	\$19.00
ASC 180Z Control Card	\$19.00

LASER 128 PERSONAL COMPUTER



ONE FULL YEAR WARRANTY
LOOKS LIKE A //e
RUNS LIKE A //e
APPLE COMPATIBLE INTRODUCTORY PRICE
ONLY \$749

ASSEMBLED \$38.00
16 K MEMORY \$28.00
TIME PRINTER \$78.00
ALL SOFTWARE \$38.00 to \$8.78 ea.

HOT NEW item for 86

Built In Features:
• 5 1/4" Disk Drive & Controller
• 2.80 Co-Processor RUNS GEM
• Mouse & Joystick Port Interface
• Serial Printer Port Interface
• Parallel Printer (S-232 Interface)
• Modem Port Interface
• 128K on board RAM — 32K ROM
• Expansion Slot (Apple @ Cards)
• Volume Control & Ear Jack
• Numeric Key Pad & 10 Function Keys
• Switchable to Divorac Keyboard
• LCD Display & Battery (Optional)
• RGB Runs Double Hi-Res. 16 Color Background, Backdrop & Text Graphics Resolution 560h x 384V

Optional Accessories:
• External Drive \$207.00
• 256K Expand Ram Call
• Mouse \$113.95
• Serial Cable \$ 29.95
• Parallel Cable \$ 32.95
• Modem \$152.00
• RGB Cable \$ 29.95
• Joystick \$' 21.95
• LCD Display Call
• Battery Pack Call

Computers are only a part of our business, we are still electronic experts. We stock, for immediate shipment, a full range of instruction books. Complete line of integrated circuits, tubes, switches, audio equipment, speakers in fact almost any part, piece or tool you require to finish a project or to get the job done. One Stop Shop ping at DRON.

For Your Information

Continued from page 8

Thumbwheel Switch

The next time you're looking for a thumbwheel switch consider the new EECO 16-position series 6000 thumbwheel switch.

The 6000 series switches offer a completely sealed contact area that is impervious to the entry of foreign material from dirty industrial environments and to water condensation from high humidity environments.

Available in hexadecimal true and complement codes, the switches come in a variety of configurations such as printed circuit board, wire loop or cable terminations. Eight, ten and 12 position binary codes are also available.

For more information about the 6000 series of thumbwheel switches contact: EECO Inc., Sales Administration Department, P.O. Box 659, Santa Ana, CA 92702-0659.

Circle No. 13 on Reader Service Card

Continued on page 60

Advertisers' Index

Banvil	Satellite Section
BCS Electronics Ltd.	79
Canadian Computer	
Designers Manufacturing	27
Compukits	74
Computer Mail Order	15, 16, 17, 18
Computer Parts Galore	55
Creating with Technology	12
Daetron	22
Digital Research Computers	20
Electronic Control Systems	20
Eutha Enterprises	12
Exceltronix	2, 3
Hobbitt	56
Instrument Rentals Canada	13
Inverter Technology	56
Kaientai Electronic Merchants Ltd.	12, 73
KB Electronics	73
McGraw Hill	25
Orion Electronics	54
RCC Electronics	80
Satellite Magazine	Satellite Section
Satellite Expert Corp.	Satellite Section
Seagrams	78
Silicone Valley Components	75
Solen Inc.	75
Soltech Systems Inc.	8
Sunex Inc.	7
Super-Micro Computers	12
Toronto Computing Centre	4
Tyfu Computers	13
Vexus Telecommunications Corp.	
	Satellite Section

For Advertising Information
Call 445-5600

MAIL ORDERS: We accept VISA, MC, AMEX; credit cards. Money orders, cheques (2 week wait) are also OK. Minimum packing and handling fee \$5.00 or 5%, whichever is larger. The only COD we use is via CANPAR (Add \$4.00 COD fee) or motor freight. We do not use postal COD at all. All Ont. res. add 7%. All prices are subject to change without notice. Returns are subject to a 20% restocking charge.

COMPATIBLE KEYBOARDS

- (A) 5150 Style, 83 keys, std IBM layout, uses long lasting CHERRY keyswitches, 100% IBM compatible.....\$90.00
- (B) 5151 Style, 105 keys with numeric and cursor control pad, CHERRY KSW, 100% IBM compatible..... \$99.00
- (C) 5160 Style, XT/AT Autoswitch, 83 keys, LED status array, CHERRY KSW, 100% XT/AT compatible.....\$149.95
- (D) 5161 Style, XT/AT Autoswitch, 105 keys with numeric and cursor pad, LED status array, 100% XT/AT compatible.....\$179.95
- (E) AES DATA, A surplus ASCII keyboard with serial and parallel output, open frame, with all data and hook-up plans, APPLE OK.....\$24.95
- (F) APPLE II+, Basic macro keyboard, for all real and clone APPLES, specify with/without the numeric keypad.....\$69.95
- (G) APPLE II+ Detached keyboard, in stand-alone case for custom uses.....\$149.95
- (H) APPLE IIe(FOX 2001) KB.....\$69.95
- (I) APPLE IIe(FOX2001) Detached KB.....\$99.95

MIDI STUFF

- STANDARD 6850 APPLE I/F BARE PCB AND DATA.....\$16.00
- WIRED AND TESTED.....\$69.00
- ADVANCED MIDI INTERFACE FOR APPLE WITH DRUM, TAPE SYNCHRONIZATION
- BARE PCB & DATA.....\$19.95
- WIRED AND TESTED.....\$89.95
- DIGITAL SOUND SAMPLE AND PLAY CARD FOR THE APPLE
- BARE PCB & DATA.....\$16.00
- MANUAL & SOFTWARE \$19.95
- WIRED AND TESTED WITH MANUAL, SOFTWARE.....\$120.00
- 6850 IBM MIDI INTERFACE
- BARE PCB & DATA\$18.95
- QUAD BOARD..... \$9.95
- WIRED WITH QUAD.....\$120.00
- 6850 MIDI SOURCE BOOK SPECIFY IBM OR APPLE
- BOOK & DISKETTE.....\$19.95

ATTAK-286 MODEL I

MODEL 1, FOR 8,10,12 MHZ OPERATION
The great new ATTAK-286 board using the CHIPS and TECHNOLOGY 5 chip AT LSI chipset. All the complex TTL functions have been placed on 5 LSI chips. This eliminates all the timing errors that plague the ones still using discrete TTL. This board was worth waiting for, and it is now in stock ready to ship. The board is the same size as the real AT, and has 4 layers for noise free operation. It has all the features of the AT, and some more of it's own, like 1MB on board, 8,10,12 Mhz operation, PHOENIX BIOS, and it runs like a deer.

- (A) Fully wired and tested, zero RAM, with all IC's, less the 80287.....\$349.95
- (B) Socketed board, pretested, but no IC's at all.....\$269.95
- (C) Bare pretested PCB with parts list.....\$169.95
- (D) Detailed technical manual with full CHIPS & TECHNOLOGY data and full schematics, with users hints.....\$39.95
- (E) PHOENIX BIOS, for B,C above only, very fast BIOS.....\$99.95
- (F) Keyboard BIOS, in EPROM/CPU chip.....\$39.95
- (G) Power supply, 200 Watt, FCC/UL OK.....\$229.95
- (H) HINGED TOP AT CASE, Easy access with this flip top box.....\$189.95
- (I) AT Keyboard, see AT/XT keyboards elsewhere on this page.
- (J) CHIPS & TECH 5 Chip set.....\$169.95
- (K) OTHER PARTS ARE AVAILABLE, ASK FOR LIST

XT SYSTEMS

What a deal, the best price for fully burned in and working Xt compatible systems in 4 configurations. All have a legal BIOS and are fully wired and tested for 24 hours of auto-test in our burn in room followed by a hands-on step by step functional test before shipping in our fully cushioned carton. All turbo boards are hard switchable from low to high speed and back without data loss.

- XT 4.77 MHZ STD.....\$795.00
- XT 8.00 MHZ TURBO.....\$895.00
- XT 8.00 MHZ 4 LAYER TURBO.....\$1049.95
- XT 10.00 MHZ TURBO.....\$1049.95
- * 640K MOTHERBOARD, FULLY TESTED
- * 1 DSDD HALF HEIGHT DRIVE
- * DISC CONTROLLER, 1-4 DRIVES
- * KEYBOARD
- * GRAPHICS CARD, COLOR OR MONO
- * FREE SOFTWARE
- * 256K RAM ON BOARD
- * 8 XT SLOTS
- * FLIP TOP CASE
- * 150W POWER SUPPLY
- OPTIONS
- * CLOCK/CAL/SER/PAR/GAME.....\$125.00
- * PRINTER CARD.....\$29.00
- * SERIAL CARD.....\$35.00
- * EXTRA DRIVE.....\$150.00
- * GAME CARD.....\$29.00
- * KRAM CARD, OK.....\$179.95
- * RAM BANK II, OK.....\$189.95

AT SYSTEMS

What a deal, now you can get AT systems based on the US made ATTAK-286 board. This is a robot assembled board, fully tested on a bed of nails, of 4 layer construction etc. etc.

BASIC SYSTEM

Entry level system with 2 drives, one each 360K, 1.2MB, both are high speed PANASONIC drives, 512K high speed RAM, disc controller for above drives, and video card (choice of monochrome or color graphics), with 200Watt power supply and the 5160 Autoswitch AT/XT keyboard.

BASIC AT\$2149.00

- PLEASE SELECT FROM THESE OPTIONS, ADD \$\$
- (A) 2 1.2M drives only.....\$89.95
 - (B) 1M BYTE high speed RAM.....\$139.95
 - (C) 20 M HS hard drive with controller.....\$1449.00
 - (D) Multifunction 2MB RAM, OK.....\$349.95
 - (E) 2.5MB Lotus/Intel AT RAM board, OK.....\$299.00
 - (F) 30-70Mb Hard Drives, ask.....
- We have just started with the AT compatibles and will have a lot more products next month.

TTL AMBER MONITOR

The nicest TTL monitor you can buy, from GOLD-STAR, 12", AMBER, HI-RES.....\$149.95

RGB HI-RES COLOUR

Another great deal from PARTS GALORE, made by HITACHI with 600x240 screen on 12" format at a really good price.....\$549.95

CASES

- (A) The std flip-top for the XT type boards \$79.95
- (B) AT look, XT size factor, flip top.....\$89.95
- (C) AT look, full AT size with flip-top.....\$179.95
- (D) ABS case for II+, e, clones, specify.....\$49.95

DRIVES

- PANASONIC JU-455-5, DS-DD XT drive, the industry standard at a great price.....\$149.9
- PANASONIC SA475, DS-HD, the AT drive that everyone likes, at a very good price.....\$229.00
- QUME 142, DS-DD std IBM type.....\$129.95

HARD DRIVES

- SEAGATE SA-225, w/controller.....\$699.00
- SA-225, alone.....\$540.00
- Controller, alone.....\$169.00
- Cable set.....\$29.95
- TANDON, 10M full height.....\$299.00
- AT hard drives.....CALL

SWITCHING POWER SUPPLIES

- (A) 150 Watt XT power supply for all the needs of a fully stuffed XT system. Has +5-15A, +12-5.5A and 1/2A on -5,-12 lines. Pls tell us back or side switch style for your case. \$134.95
- (B) 150Watt CSA approved type, same specs but made to tighter specs than the above unit, costs more too, only in side switch style.. \$159.95
- (C) 200 Watt AT power supply, made for a full AT loaded system it has +5-20A, +12-7.4A and 1/2A on the -5,-12 lines. comes in two styles, one is Hydro approved at \$179.95 and CSA approved at \$229.95
- (D) APPLE IIe power supply, has the std App voltages of +5-4A, +12-2.5A and 1/2A at -5-12V now at a new low price of \$69.95
- (E) OPEN frame NCR power supply, with +5-7A and +12-3A and 1/2A at -5,-12 V. This will run a full XT system with 2 drives, lots of cards, but no hard drives. A good deal \$59.95
- (F) OPEN frame Northern Telecom power supply this unit has all the IBM voltages but not a lot of guts. Has +5-4A, +12-1A, -5-1A, -12-1A. It will run an XT system with 2 drives but very few cards, the drive and color cards is all \$19.95
- (G) POWER CORDS for the above open frame power supplies, 3 wire, for general use with 3 prong connector on it \$4.95

FEEWARE

A collection of IBM compatible free software that we have compiled from many sources for the purpose of saving you both the long distance charges from Ma Bell and the time it takes to do the calls, and the time to screen the dumps to keep out the dreaded viruses that are very common on public domain software. Each group consists of 4 disks of software in the area of interest, along with disc based PR files so you can dump em and read em to find out how to use each package very easily. This is a real plus as many public domain programs are very badly documented. Each pack of 4 comes in a nice plastic diskette box that is good for keeping them in, mailing them, etc.

- (A) COMMUNICATIONS PACKAGE.....\$19.95
This package has many many files, among the most useful are: DOS manual, DOS utilities, Communications package com utilities, word processor, games, keyboard macro, pop up desk organizers
- (B) D BASE PACKAGE.....\$19.95
A very good diskette set, has a 'C' compiler, spreadsheet, database manager, DOS manual, new DOS utilities games and many small useful files.
- (C) TURBO + HARD DRIVE PACKAGE.. \$19.95
over 80 files, hard disk organizer, assembler, pascal and turbo utilities, DOS assist program, outline processor TURBO utilities, and many many more.
- (D) GREAT DEAL, ALL THE THREE ABOVE PACKAGES IN A NICE PLASTIC DISK BOX FOR THE GREAT PRICE OF.....\$49.95

UPS-250W 250W INT 150W CONT UNINTERRUPTIBLE POWER SUPPLY \$489.95

- 1. High efficiency 85%
- 2. Snoww/avoid square wave) Snowwave
- 3. Internal no-spill battery Yes
- 4. External battery terminals Yes
- 5. Audible power loss warning Yes
- 6. Fast transfer time, under 5 Ms Yes
- 7. Multiple output sockets 2
- 8. % of line transients filtered 100%

640K MOTHERBOARDS FULLY TESTED

- SME-XT WIRE, 8K, 3 HR BURN-IN.....\$199.00
- SME-XT WIRE, 8K, NO IC'S.....\$99.00
- SME-XT, BARE PCB AND ASSY DATA.....\$34.95
- TURBO 8 MHZ 2 LAYER
- SME-XTB WIRE, 3 HR BURN IN.....\$249.00
- SME-XTB WIRE, NO IC'S.....\$129.00
- SME-XTB, BARE PCB AND ASSY DATA.....\$39.95
- TURBO 8 MHZ 4 LAYER
- SME-XT4L WIRE, 3 HR BURN IN.....\$299.00
- SME-XT4L WIRE, NO IC'S.....\$149.00
- SME-XT4L, BARE PCB AND ASSY DATA.....\$79.00
- TURBO 10 MHZ 2 LAYER
- SME-XT10M WIRE, 3 HR BURN IN.....\$299.00
- SME-XT10M WIRE, NO IC'S.....\$149.00
- SME-XT10M BARE PCB AND DATA.....\$69.00

WIRED IBM CARDS

- (A) 384K RAM WITH OK, BARE PCB & DATA \$79.95
- (B) 576K RAM WITH OK, BARE PCB & DATA \$149.95
- (C) 576K RAM WITH OK, BARE PCB & DATA \$149.95
- (D) RAM BANK II, LOTUS/INTEL 2 MBYTE RAM CARD WITH OK \$189.95
- (E) RAM BANK II, LOTUS/INTEL 2 MBYTE RAM CARD WITH OK \$189.95
- (F) COLOR GRAPHICS VARD, NEW STYLE WITH A BUILT IN GRAY SCALE ADAPTOR \$99.00
- (G) MONO/HERCULES GRAPHICS CARD, THE DEFINITIVE PRINTER/GRAPHICS CARD AT A LOW/LOW PRICE OF \$129.00
- (H) 384K MULTIFUNCTION CARD, A COPY OF THE AST SMD \$24.95
- (I) 384K MULTIFUNCTION CARD, A COPY OF THE AST SMD \$24.95
- (J) DISC CONTROLLER CARD \$44.00
- (K) DISC CONTROLLER CARD \$44.00
- (L) DISC CONTROLLER CARD \$44.00
- (M) DISC CONTROLLER CARD \$44.00
- (N) DISC CONTROLLER CARD \$44.00
- (O) EXTENDER CARD, XT 8" \$119.95
- (P) EXTENDER CARD, XT 8" \$119.95
- (Q) EXTENDER CARD, XT 8" \$119.95
- (R) EXTENDER CARD, XT 8" \$119.95
- (S) EXTENDER CARD, XT 8" \$119.95
- (T) EXTENDER CARD, XT 8" \$119.95
- (U) EXTENDER CARD, XT 8" \$119.95
- (V) EXTENDER CARD, XT 8" \$119.95
- (W) EXTENDER CARD, XT 8" \$119.95
- (X) EXTENDER CARD, XT 8" \$119.95
- (Y) EXTENDER CARD, XT 8" \$119.95
- (Z) EXTENDER CARD, XT 8" \$119.95

Pirate Commercial Radio

Club at P.O. Box 99, Northampton, England, has a monthly publication and many extras available. Membership in that organization is 8 pounds per year.

There is a great deal more pirate activity in the US than in Canada, even though the US Federal Communications Commission has "busted" and levied fines on scores of pirates over the years. During 1986 the FCC raided several pirate stations and issued at least two news releases naming a number of cities where suspected pirates were under investigation. That seemed to scare off a lot of the broadcasters, so that last summer's pirate activity was the lightest in recent memory. However, by fall, with no further raids having been announced by the FCC, the stations seemed to be returning in increasing numbers.

Pirate List

Here, in no particular order, is a summary of recent pirate activity in North America, or at least those which have been fairly active during 1985.

TNFM is a shortwave simulcast of an FM pirate (KQRO). Despite the call letters it is located in Canada, broadcasting from the vicinity of Ganges, BC. Shortwave operates in the 7.437 area.

WHOT in the New York City area operates around 1,620, plays oldies rock and claims to be the largest underground broadcaster on the east coast.

Voice of Democracy/Voice of Communism satires Radio Moscow, Marx, communism and so on and is also unusual in that it plays Classical music. Shortwave operation is between 7.300 to 7.500.

UA Express plays mid-1970 rock and is apparently operated by a former member of the US military. 7MHz "pirate band" but seems to be on the air very seldom.

Voice of Laryngitis operates around 7.400. Satires, rock and a barking seal sound effect used at sign off.

WBRI, possibly located in the Maryland area, operated until late 1985 but later advised it would return with 7.5kW in the 19 and 39 meter bands.

Free Radio New England claims an east coast location and plays little known rock music. Operates around 1,620kHz.

KCB-643, 1,620, rock and background music. Claims to have a license.

KFAT usually features two announcers: "G.G." and "Deadly Earnest" who play a lot of country/western with satirical commercials. 7.435 variable.

KROK with "The Fox" and "Capt.



Fig. 2 A more or less typical pirate radio installation.

ELECTRONIC LOVERS WANTED

IF you're a Student and you Love our Discounts

IF you're a Small Business and you Love our Services

IF you Love our Choice of Parts

IF you Love our Prices and you Love Electronics

Then

HOBBILT is the Place You'll Love

HOBBILT

NEW STORE

3117A Hochelaga St. Montreal PQ H1W 1G3

Mail Orders & catalogue contact:

(514) 259-5581

7454 Langelier St. Leonard, Quebec H1S 3B7

Your Name, Address and \$1.50 Gets You Our Current Catalogue

WANT TO MAKE PROFESSIONAL P.C. BOARDS?

Send \$2.00 (Incl. postage & handling) for this extensive Handbook (Instruction Book) & Catalogue. Includes P.C.B. material and kits.

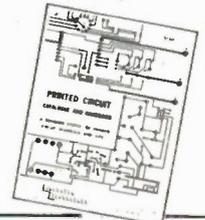

— THESE KITS AND MANY MORE! —

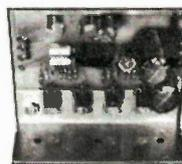

15 W. — 15 W.
(30 WATTS STEREO)
POWER AMPLIFIER
KA-S15

This fantastic little stereo amplifier is an ideal "beginner's" kit. Two amplifiers are assembled on a single fibreglass circuit board for stereo operation. Unless you are using acoustic suspension speakers in a very large room, this kit has more than enough clean power to satisfy anyone. Frequency response is from 15 Hz. to 20 kHz.

PRICE \$32⁰⁰



AUDIO FREQUENCY
SPECTRUM DISPLAY
AND ANALYSER
KA-SA

This kit offers the serious audiophile the most incredible graphic display of the entire audio spectrum that the user is likely to ever see. The audio from your sound system is input to this unit and split into 10 bands of 10 input levels (100 discrete points) and displayed graphically by 100 L.E.D.s as the music is playing. The display can be selected to show either a "dot" or "bar" format. An optional kit (KA-SAO) gives the user a condenser microphone (and amplifier) and pink noise source to add, which will allow the user to input the audio that is actually being developed in the room. You will be able to see the effect that the room has on your sound system. (Enclosure is optional - order part number KA-SAC)

PRICE \$161⁰⁰

 KITS CANADIAN MADE

ADD 10% POSTAGE & HANDLING FOR KITS.

INVERTOR TECHNOLOGY

DISTRIBUTOR ENQUIRIES WELCOME

P.O. Box 3874, Stn. 'B'
Calgary, Alberta T2M 4M5
(403) 932-5626



Willie" plays a lot of oldies when it is on, usually around 7.440.

Radio Clandestine - one of the more professional sounding stations. Claims to operate from a ship off the coast and airs slightly risque comedy. 7.360 variable.

Radio Deadman - 7.435 area. Fake commercials and a variety of music.

Secret Mountain Laboratory - 7.425 area, fake advertisements, satires on preachers, music that runs the gamut from Cajun to jazz and rhythm and blues. Comedy skits.

WPBR (Pig Boy Radio) with "The Messenger" and "The Soldier" has interviews, fake ads, satires on various subjects.

WYMN (women) features all female announcers and female country vocalists. 7.435 area.

Canadian Club Radio - has rock oldies and announces an address in Toronto. 7.440 variable.

KBFA - Free Broadcasters of America. Infrequent operation, 8.000 area.

Radio Mouser Worldwide - exact name and spelling are uncertain and it uses several versions of that name. Disc jockey calls himself "Tex X." and plays country, bluegrass and blues. Operates around 7.480.

Voice of Toobuy - another station with a name that's uncertain. Rock, with echo chamber announcements in the 7.440 area.

Radio North Coast International

Fig. 3. Radio Caroline has been a popular European pirate - in various guises - for many years.

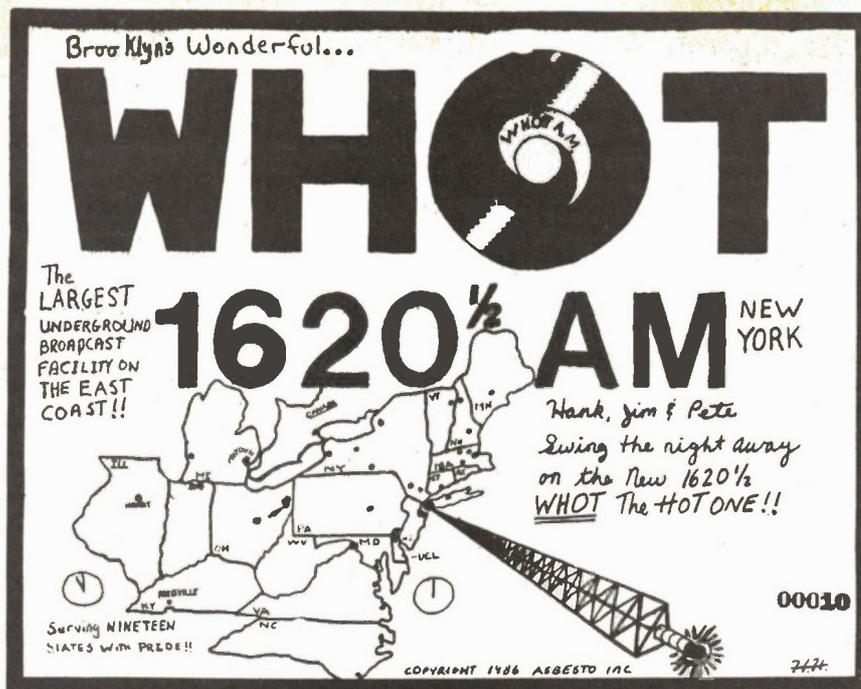
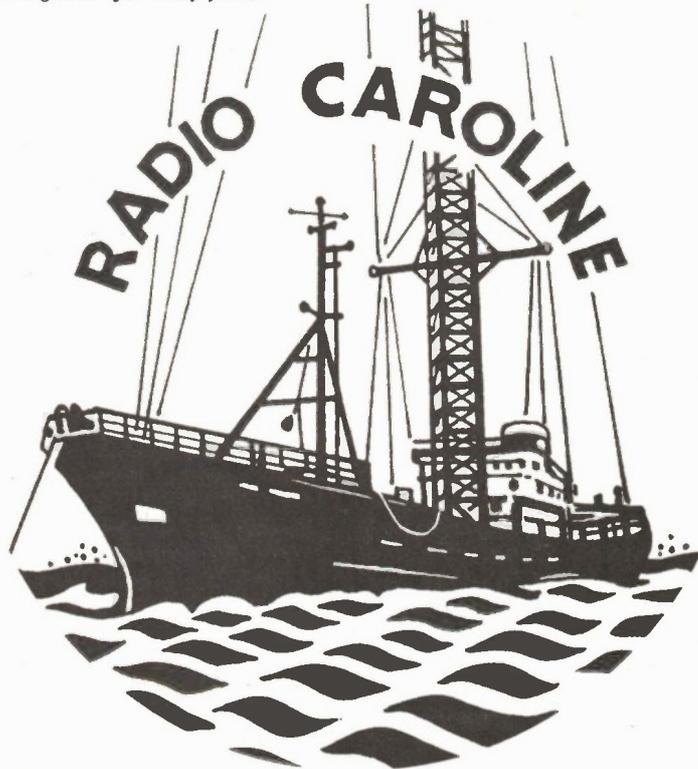

Fig. 4. New York based WHOT sends a huge QSL card.

-sometimes signs on and off with "O Canada" but believed to be in the US. Rock, ragtime, big bands. "Broadcasting from the USS Sphincter" 7.450 area.

Radio Porn - Stripper music introduces this one on around 7.435, with rock music and things like heavy breathing exercise sessions.

Zepplin Radio Worldwide - with "de Count" and fake ads, fake promotional announcements, comedy skits on about

7.425.

WPRN (Pirate Radio Network), 1,620 area with 60's and 70's music. Possibly located on Long Island.

Voice of Tomorrow - 7.400 area, is the only pirate in recent years to take a decidedly political stand. It supports white supremacy and has not met with a very favorable reception. Uses a wolf sound effect.

These stations have been recently and/or relatively active over the past year or so. In years previous pirate listeners have heard many others, including such stations as Radio Free Insanity, Voice of the Nighthawk, the Crystal Ship, Radio Soundwave, WMTV and many more.

Despite the inability of any pirate to guarantee even an audience of one, despite programming and technical quality often of limited expertise and despite the everpresent pressures in always half expecting that knock on the door signifying that the DOC or FCC has arrived, pirate broadcasters continue to operate. Something within seems to demand it. The lure of getting on the air, even if to broadcast to no one, is apparently overpowering. Given that, and the long history of pirate activity, it is safe to say that pirate activity will continue, even though old stations may disappear new ones will take their places.

Illegal or not, quality aside, stumbling across an unexpected pirate broadcast can be a "kick" even for the most jaded listener or even for those most opposed to the very idea of pirate broadcasting. They are out there, and a little weekend tuning coupled with a little luck should bring one or more of these do it yourself broadcasters into your radio's speaker. ■

be nearest to the panel. The front panel should be drilled with 1 in diameter holes to take the mounting bushes of the controls as these are used to fix the assembled board to the case.

Circuit Board

When the case front panel is complete the board can be assembled. Refer to the components list and to Fig. 3, the PCB component layout diagram.

First fit seven single-sided soldering pins to the board in the positions that will be used for making connections to the battery and signal wires. The pins should be pressed right into the board from the track side so that they are almost flush and then soldered. Next fit the wire links, preset, resistors, diodes, IC sockets, capacitors, and inductor L1.

The potentiometers should now be mounted on the board. Carefully bend their tags forward at 90 degrees so that they fit into the appropriate holes. Washers should not be used as the most must be made of the available length of mounting bush to pass through the front panel. Fit one nut to each potentiometer to fasten them to the board and then solder the tags.

The rotary switch S1 should be fitted with the markings as shown in Fig. 3 and wired to the board using insulated wire leads. When all components are fitted refer to the interwiring diagram Fig. 4 and connect the battery clips, jack sockets and piezo electric pick-up. Note that the sockets must be connected exactly as

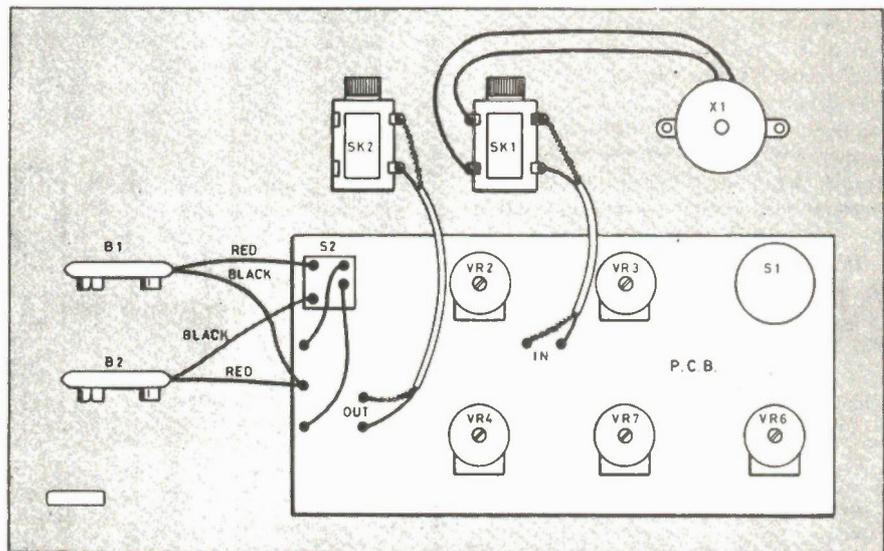

Fig. 4 Details of the interwiring of the jack sockets, battery connectors, and piezo pick-up.

shown as they are switched types. If the specified case is used allow about 20 cm of screened wire for each socket.

The pick-up can be mounted anywhere in the case using a piece of double-sided adhesive tape, alternatively it can be mounted separately in a 'practice pad' and connected to the socket via a standard jack plug and lead. It is also possible to use an internal pick-up and have a second plug-in one. The socket is wired so that the internal pick-up is disconnected whenever a plug is inserted.

Testing

Testing should be carried out after the sockets and connectors have been fitted but before the board is fitted to the front panel.

Set VR4 and preset VR5 to mid position and all other controls fully anti-clockwise. Connect the batteries, switch on and advance VR1 to mid position.

Connect the output socket to a suitable amplifier with the volume turned to a low setting. Tap the pick-up to trigger the synthesizer and listen. There will pro-

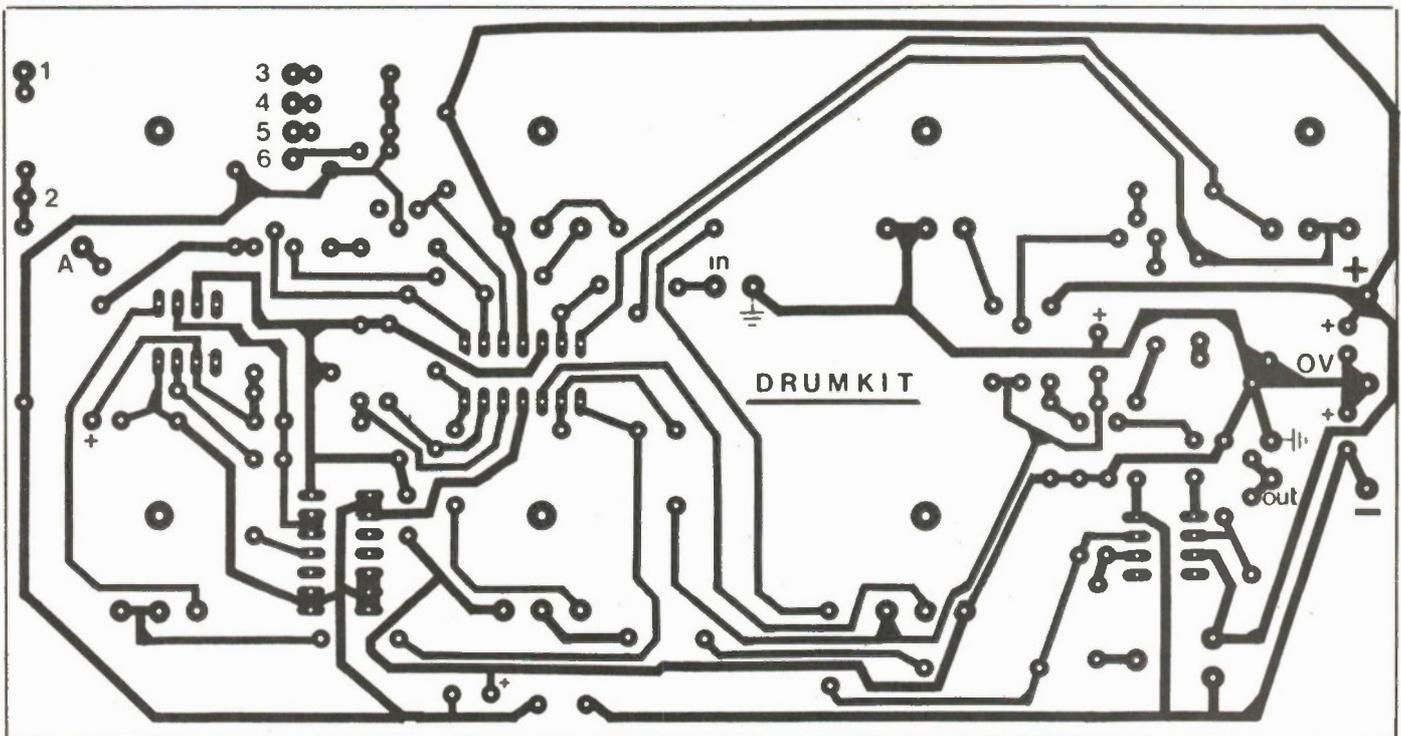

Fig. 2 PCB for the Percussion Synth.

bably be a faint click or else nothing.

Now advance VR3 and trigger again. If the noise generator is working there should be a short burst of noise like an explosion. If all is well check that VR3 varies the noise level and that S1 produces six different sounds. If the noise is present but only at a low level check IC1a, TR2 and associated components.

Next keep triggering and turn up VR7. A low frequency tone should now be present when triggered. Advance VR2 and check that much longer decay times can be obtained for both noise and tone outputs. Check that VR6 varies the pitch of the tone output.

Now check the effect of the Sweep control VR4. At each end of its range the effect should be a very pronounced shift of frequency, sweeping up or down as the note decays.

The circuit consists of a number of independent sections so fault finding should be straightforward. Work back from the output and make DC voltage checks around the stages with a multimeter.

The split supply configuration can be confusing so be careful to interpret the readings properly. One useful trick is to connect pin 5 of IC4 to 0V via a 100k resistor; this permanently turns on the output amplifier and enables the results of any tests to be heard.

When everything is working satisfactorily VR5 can be trimmed to null any DC offset in IC4. Turn VR3 and VR7 to minimum and keep triggering the input. Set VR5 to null out the click produced by each trigger pulse. The setting is not critical.

Parts List

Resistors

All 0.25W $\pm 5\%$ carbon film

R1, R3, R21, R27, R29	1M
R2, R8, R20	10k
R4, R24, R30	22k
R5	2k2
R6, R7, R12, R14, R15, R18, R26, R28	100k
R9	4k7
R10, R19, R22, R23	1k
R11	100R
R13	4M7
R16, R17	47k
R25	470K

Potentiometers

VR1	1M lin., with DPST switch
VR2	100k log.
VR3	10k log.
VR4	100k lin.
VR5	1M preset
VR6	2M2 reverse log.
VR7	10k log.

Capacitors

C1, C2, C6, C8, C14, C15	100n polyester
C3	3n3 ceramic plate
C4	10n polyester
C5	33n polyester
C7	470n polyester
C9, C11	10u elect. 16V radial
C10	220u elect. 16V radial
C12	220n polyester
C13	150n polyester
C16, C17	100u elect. 16V radial

Semiconductors

IC1	TL064
-----	-------

IC2, IC4 CA3080

IC3 4093

TR1, TR2 BC183/2N5825

TR3, TR4 BC213/2N6003

D1, D2 1N4148

Miscellaneous

L1 33mH inductor

X1 piezo pick-up

S1 2-pole, 6-way rotary switch

S2 Part of VR1

Two 9V batteries; IC sockets; two 1/4

mono jack sockets; battery clips (2); case to

suit; knobs (7);

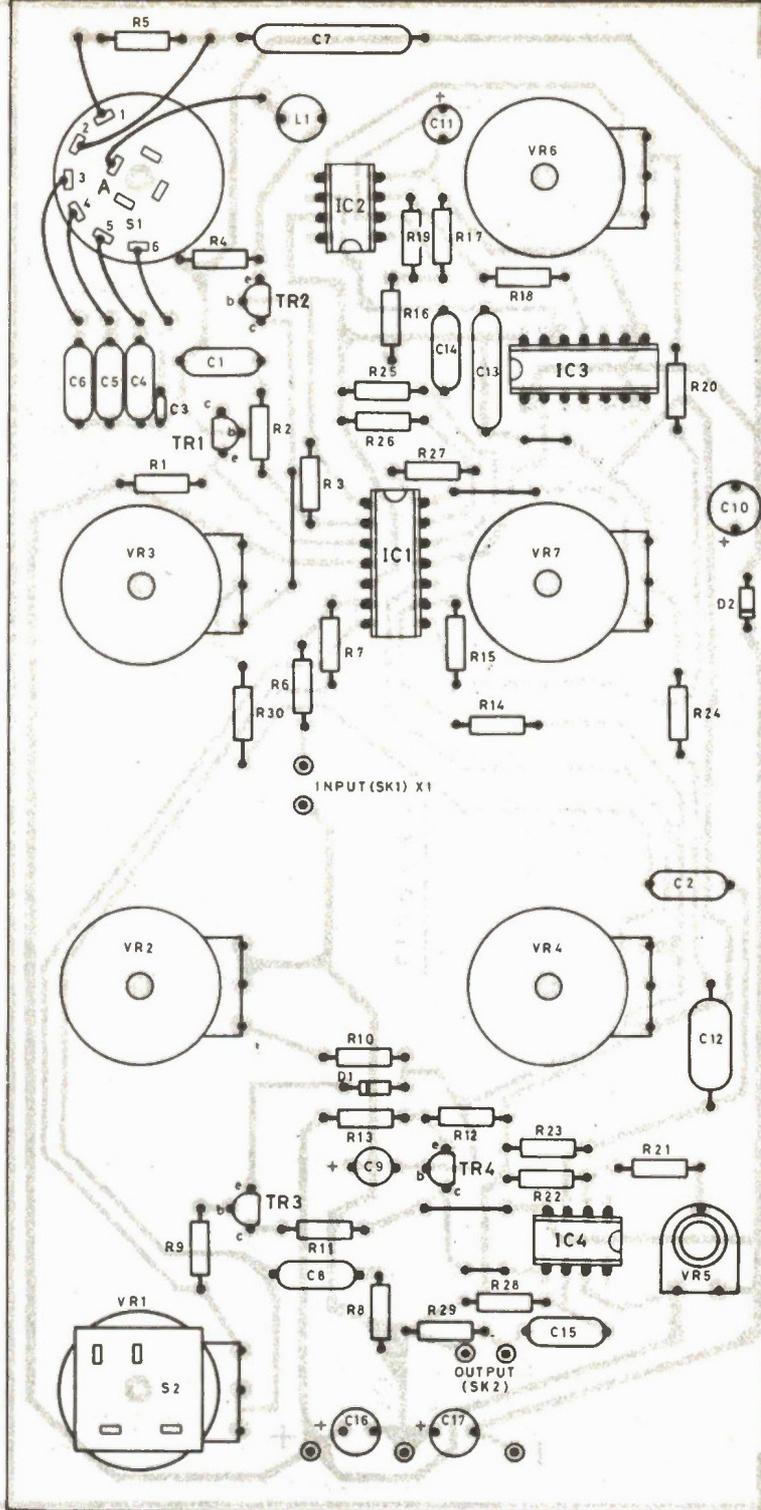
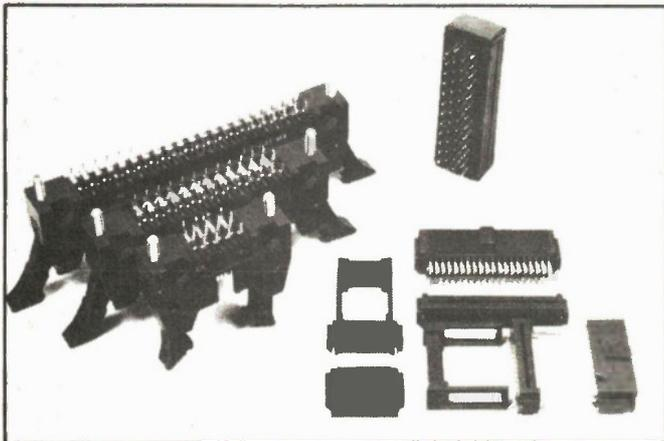

Fig. 3 Component layout of the Percussion Synthesizer.

High Density Connectors



A series of connectors for cable with 0.25 inch conductor spacings is available from Amphenol Products.

The 0.25 inch connectors, which include header, socket and transition styles, are designed for use

with 0.25 inch cable in applications requiring high signal density.

For more information contact: Amphenol Products, World Headquarters, 4300 Commerce Court, Lisle, IL 60532.

Circle No. 17 on Reader Service Card

True 1% Thin Film Resistor

Thin Film Technology Corp. is offering a 1206 thin film chip resistor with specifications which include $\pm 150\text{ppm/deg C}$ and $\pm 1\%$ resistance tolerance.

The device is useable for all different surface mount assembly technologies including vapor phase, solder reflow, and wave solder. Reliable design includes solder dipped wrap-around terminations and high-stability NiCr alloy resistive thin film with a Ni barrier to prevent leeching.

For more information contact: Thin Film Technology Corp., 6955 Washington Ave. S., Suite B, Edina, MN 55435. (612) 829-0930.

Circle No. 18 on Reader Service Card

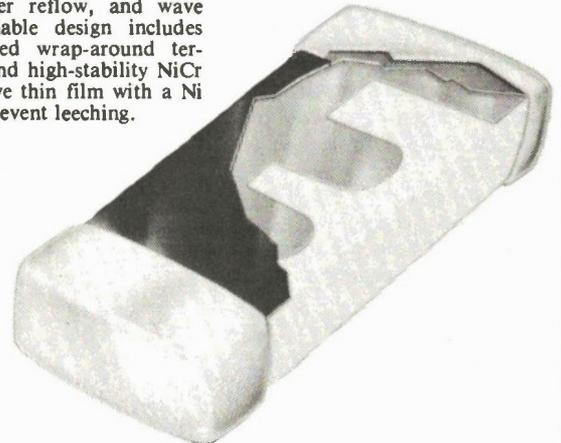

Technology Saving Lives



The first portable computerized voice prompter for cardiopulmonary resuscitation was demonstrated at a recent CPR Educational Symposium and Conference on Citizen CPR in Toronto.

The CPR Coach voice prompter, from Aurologic Inc., incorporates all the changes in CPR protocol approved this year by the American Heart Association and

the American Red Cross. Medical experts indicate immediate "bystander" CPR, coupled with other prompt emergency medical support, could save as many as 700,000 lives in Ontario alone.

The CPR Coach offers a simple, consistent method to show and tell people how the new procedures should be used in life-threatening emergencies. Rescuers are prompted to administer the procedures to

victims via a lighted interactive pushbutton display panel and lifelike synthetic speech.

The battery-powered unit measures 11 3/4 inches wide by 9 3/4 inches deep by 4 1/4 inches thick and weighs approximately three pounds. An integral headphone jack enables the use of private headphones so that instructors can have students run through the CPR rescue sequences repetitively

at their own pace without interfering with other nearby activities.

The suggested retail price of the unit is \$299US with optional extras being: headphones, AC adapter, carrying case and wall case.

For more information on Canadian prices and distributors contact: William S. Parker, Aurologic Inc., 111 Westport Ave., Norwalk, CT 06851. (203) 847-3700.

Circle No. 28 on Reader Service Card

This Month in **Computing! Now!**

Computer Data From Satellites!

Hidden deep inside the satellite signals meant for TV dishes you'll find ASCII data for weather, sports, etc. A bit of soldering plus a bit of programming and the data appears on your computer screen.

Music Supplement!

A computer music section in which, among other things, we look at MIDI guitars, the Yamaha FB01 sound module and the Roland MC500 sequencer.

A Card Game!

Written in C for the PC, the card game is either an example of programming skill, or something that's fun to play, or both.

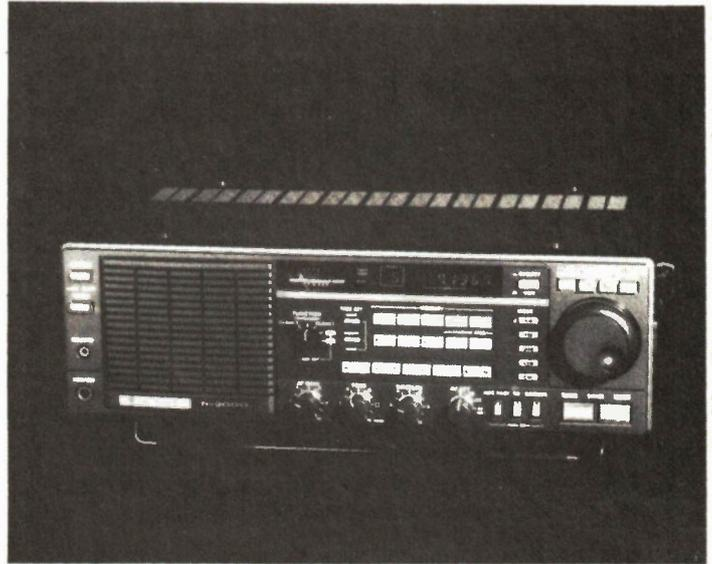

For subscriptions or advertising information
call (416) 445-5600

**BE SURE OF YOUR ISSUE EACH
MONTH. SUBSCRIBE TODAY.**

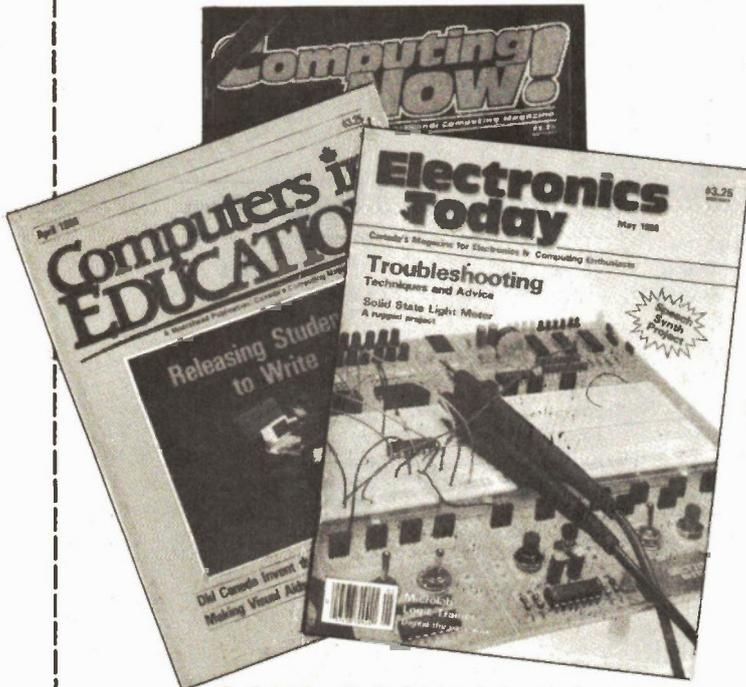

**BOOKS, BACK ISSUES,
SPECIAL PUBLICATIONS, BINDERS
— SEE OVER**

Moorshead Publications

1300 Don Mills Rd., Don Mills, Toronto, Ont. M3B 3M8

MERCHANDISE ORDER Please fill out form overleaf

SUBSCRIPTIONS: NEW SUBSCRIPTION RENEWAL

Electronics Today

One year (12 issues) \$22.95 Two years (24 issues) \$37.95

Computing Now!

One year (12 issues) \$22.95 Two years (24 issues) \$37.95

Computers in Education

One year (10 issues) \$25.00 Two years (20 issues) \$45.00

Outside Canada (US Dollars)

For U.S. please add \$3.00 per year other countries add \$5 per year

NAME _____

ADDRESS _____

TOWN/CITY _____ PROVINCE/STATE _____

CODE _____ DATE _____

POSTAL CODE _____

Cheque enclosed DO NOT send cash

Mastercard Account No. _____

Visa Account No. _____

American Express Account No. _____

Expiry Date _____

Signature _____

THE ELECTRONICS TODAY MAGAZINE BINDER/FIREWOOD TOTE

If you're like Dinny Fowler, shown here firing up her kitchen stove for the morning coffee, you hate carrying those splintery bits of kindling wood.



The Electronics Today binder is admirably suited for the task, being made of sturdy vinyl and suitable for carrying up to three small sticks of wood.

Once you have the blaze going nicely and your feet up, you can gather up all those copies of Electronics Today you've left all over the place and file a year's worth in the binder's clever spring contraptions that let you add or remove copies without cutting or punching. The issues also lay flat for reading or photocopying.

Available postpaid for \$9.75 each with either Electronics Today or Moorshead Publications imprinted on the spine (please specify). Ontario residents please add 7% provincial sales tax.

Binders
Moorshead Publications
1300 Don Mills Road
Toronto, Ontario
M3B 3M8

Electronics Today Order Form

Subscriptions:

Please complete reverse side to start or renew a subscription.

Back Issues: \$4.00 each; Ontario residents add 7% sales tax.
Please circle issues desired.

1977	1978	1979	1980	1981
Feb. July	May Sept. Nov. Dec.	Feb. April May July Aug. Sept. Oct. Nov.	Jan. May June Nov. Dec.	Jan. Feb. March April June July Aug. Sept. Oct. Nov. Dec.
1982	1983	1984	1985	1986
Jan. March April May June July Aug. Oct.	Jan. Feb. March April Aug. Sept. Oct. Nov. Dec.	Jan. Feb. March April May June July Aug. Sept. Nov. Dec.	Jan. Feb. March April May June July Sept. Oct. Dec.	Jan. Feb. March April May June July Aug. Sept. Oct.

Binders: Moorshead Publications
\$9.75 each plus 7% P.S.T.

SPECIAL PUBLICATIONS

ITEM	QTY	AMOUNT
Book of Computer Music	\$4.95	\$
Project Book No. 2	\$3.95	\$
Project Book No. 3	\$3.95	\$
50 Top Project	\$4.95	\$

BOOKSHELF — Order Form

Code (e.g. BP12)	Title (Short-form is O.K.)	Price
.....	\$
.....	\$
.....	\$
.....	\$
.....	\$

SOFTWARE — Order Form

.....	\$
.....	\$
.....	\$
Sub Total	\$
Tax (Ontario Residents)	\$
Postage	\$1.00
Total Enclosed	\$

Orders from the Bookshelf are tax exempt. Please add \$1.00 for postage. Remember to put your name and address on reverse side. See over for mailing details. Specials and Software add 7% PST.

THERE are many projects and kits on the market today. Unfortunately, most of these are costly and too complicated for the beginner to gain the satisfaction of completing a project that really works.

I would like to present projects for the beginner that are easy to assemble, reliable, and easily available. The first kit is a Stereo Miniature 4-watt Amplifier from Kit-King in Orangeville, Ontario, capable of producing up to 2 watts per channel.

This handy project is a great audio amplifier, to be used to convert that Walkman into a small cassette stereo. When connected to efficient bookshelf speakers, a clean, high frequency response is available for a low cost, do it yourself, project. Other uses could be 1) a head-phone amplifier, 2) a level adjusting amplifier, 3) a remote tape deck amplifier, and I am sure you can think of other uses for this project.

Getting Started

The first step is to obtain the parts. These are available by mail order from:

Kit-King,
Box 800,
Grand Valley, Ontario L0N 1G0
1-519-928-2139

Kit number KK300 contains the components without the printed circuit, and costs \$14.95 plus \$2.00 postage and handling. The kit number KK500 includes the parts plus the PCB, and costs \$16.95 plus \$2.00 postage and handling. Ontario residents should add 7% provincial sales tax.

The catalogue of all kits is free on request.

Parts Inventory

The second step is receiving your parts by mail, or getting them from your own supply inventory. Make certain that all parts ordered are received, and received in good condition.

If you have an ohmmeter, then test the value of resistors and confirm by colour code the correct operational value.

Capacitors are also checked with an ohmmeter. Small capacitors will quickly kick the needle from open to short and back to open circuit; larger ones will move the needle more slowly.

PCB Mounting

The following instructions are used with the KK-500 printed circuit board layout. Use the check-off system to keep track of your progress. Remember, that quality work means quality results.

- 1) Refer to Figure 2 printed Circuit Board Overlay
- 2) Mount all components from the blank side and solder on the foil side
- 3) Solder the integrated circuit sockets to

Electronics Today December 1986

Four Watt Amplifier Project

**Build a four-watt audio amp from
scratch or from a kit.**

By Bob Read

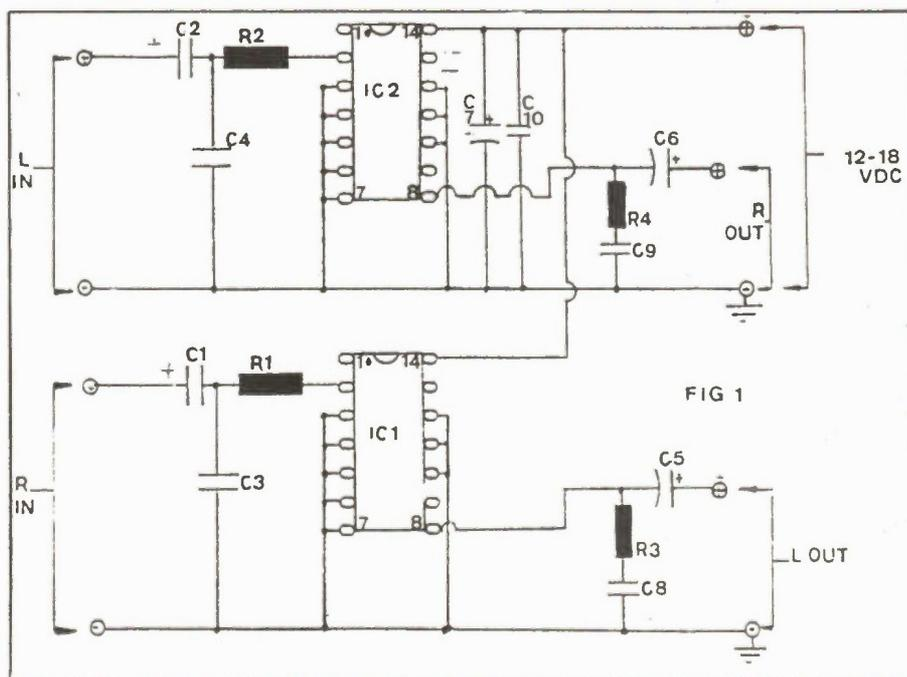

Fig. 1. The schematic for the stereo 4 watt amplifier.

the printed circuit board

- 4) Be careful not to short or bridge integrated circuit pads together. Check all soldered connections for quality work.
- 5) Do not place IC chips into their sockets at this time.
- 6) Place the fixed resistors R1, R2, R3, R4 into the correct positions.
- 7) Recheck the colour code of each resistor to verify correct positions.
- 8) Solder resistors into the board
- 9) Place the capacitors C3, C4, C8, C9,

and C10 into the correct positions. These capacitors are non-polarized and may be mounted in either direction.

- 10) Recheck the value of each capacitor to verify the correct position.
- 11) Solder the capacitors C3, C4, C8, C9 and C10 into the board.
- 12) Place the Electrolytic capacitors C1, C2, C5, C6 and C7 onto the board. Note: You must observe the correct polarity on these capacitors. The negative lead is generally marked.

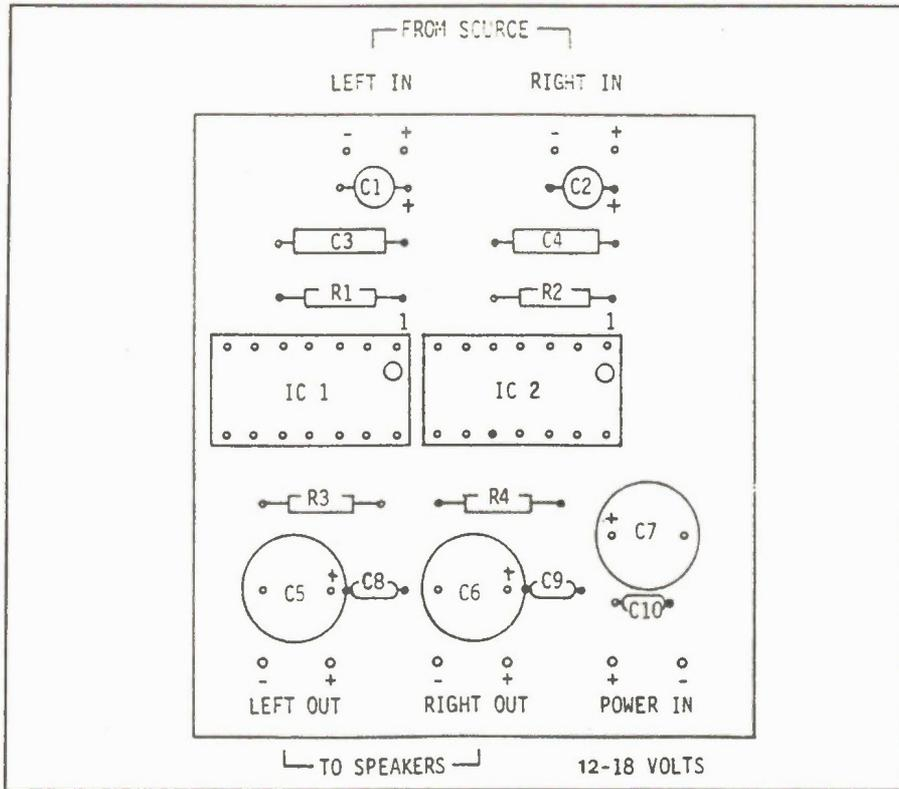

Fig. 2. The parts location for the printed circuit board.

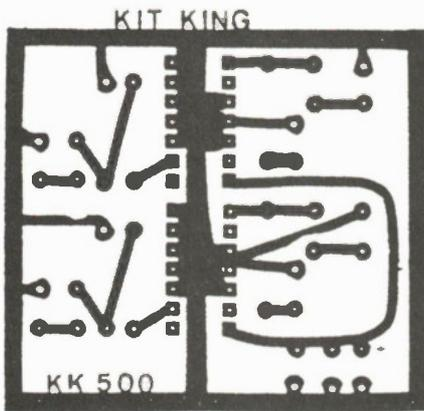

Fig. 3. The printed circuit for those who prefer to make their own.

- 13) Recheck the value of each capacitor to verify the correct positioning.
- 14) Solder capacitors into place.
- 15) Connect a 9cm piece of hookup wire to each terminal on power positive in, and power minus in. Use red for positive, black for negative.
- 16) Solder power leads into place.
- 17) Use shielded cable for best results (not supplied with kit). Connect the left Audio positive input and left Audio negative input. Note: you may choose to connect these leads to a phone jack, so make sure your leads are long enough to do this at a later date.
- 18) Connect the right audio positive input and right audio negative input. Observe the same length of shielded cable as used

in step 17.

- 19) Connect the left negative output and left positive output with at least 18 gauge wire. Again leave enough length to connect the output jacks.
- 20) Connect the right negative output and right positive output. Observe the same length of cable as in step 19.
- 21) Solder all leads to board.
- 22) Install IC1 into the socket. There is a dot or notch at one end of the IC; with this dot to the left, pin 1 is at the lower left corner. Double check this placement.
- 23) Install IC2 into the socket. Remember pin 1 has the dot or the notch.
- 24) Double check IC1 and IC2 placement.

Congratulations! You have just completed your first Audio Amplifier! Now will it work?

Connections to Batteries

For best results of volume and clarity, use two 9 volt batteries connected together in series to provide 18 volts. Nine volts DC will work, but provides a lower volume. Eighteen volts will provide the best results, as will alkaline batteries rather than the ordinary types.

Connection to Headset

The amplifier will connect into your portable cassette player through the Stereophones Outlet to Audio Input connections. You should use shielded cable to help reduce noise and hum.

PARTS LIST

Resistors

1/4 watt

R1, 2 1M
R3, 4 2R7

Capacitors

C1, 2 1u or 1u5, 35V electrolytic
C3, 4001u ceramic
C5, 6, 7 100u, 25V electrolytic, radial
C8, 9, 1001u ceramic

Semiconductors

IC1, 2 LM380 power amp IC

Miscellaneous

Printed circuit (part KT-500), two 14-pin IC sockets, resin core solder, two 9V batteries. See text for kit supplier.

Connections to Speakers

The output of your 4 watt amplifier is best coupled to a set of efficient bookshelf speakers. Use 18 gauge wire to help reduce line loss. Do not forget to observe the polarity marking on the output of your amplifier. For example, on lamp cord, one edge is raised, the other is round. Use the raised edge for positive and the round edge for negative.

I hope that you have enjoyed the construction of your amplifier and will enjoy using it as well. ■

DID YOU RECEIVE YOUR COPY?



This catalogue is a comprehensive description of the Almost Free Software available from Moorshead Publications.

If you would like a copy of this catalogue, please mail your request to:

**Moorshead Publications
Software Services**
1300 Don Mills Rd
Toronto, Ontario
M3B 3M8

Circle No. 20 on Reader Service Card

Tilt

Alarm

Protects cases, doors, car trunks, roof racks, jewel boxes, etc.

by I.P. Kemp

THIS simple Tilt Alarm was designed to be portable and easy to operate. It can be used in any situation where an attempted theft involves tilting something.

The initial idea was that it could be attached to the handle on the inside of a hotel room door, but there are many other applications. The lids of suitcases or camera cases are suitable places, as are garage doors, tail gates and car boots. It is also suitable for protecting items fitted to a roof rack. The list of possible applications seems to be unlimited. The unit is small enough to be built into a jewel box (or tool box).

The alarm is particularly suitable for use in situations where it is left unattended for long periods. A two-minute alarm timeout prevents the battery being exhausted and the possible annoyance of neighbours in the event of a false alarm (or an abandoned theft attempt).

After the timeout the alarm resets and will respond again when tilted. The alarm is set by removing a "key" made from a miniature jack plug. This method is cheap and easy and offers good security. An opportunist thief will be totally unprepared for an alarm of any kind and certainly won't hang around trying to turn it off.

Electronics Today December 1986

Circuit Description

The complete circuit diagram of the Tilt Alarm is shown in Fig. 1. The tilt is detected by S1, which is a mercury tilt switch. This is a simple glass bulb containing a blob of mercury which is free to move around if the bulb is tilted. Two wires which pass into the bulb at one end are short circuited when the mercury blob bridges them and open circuited when it does not.

In this application the tilt switch is positioned so that the mercury blob is normally away from the two wires but falls to bridge them when disturbed. The alarm circuit must, therefore, detect when the tilt switch changes from open circuit to short circuit.

The closing of the tilt switch is detected by IC1a. Normally both inputs to IC1a are held high. A truth table for all four NAND gates of IC1 is given in Table 1.

With its two inputs held high the output of IC1a will be low. Transistor TR1 will not receive any base bias current via resistor R5 and so will be turned off. The collector of TR1 will be held at the positive supply voltage via R3. IC1a also feeds one input each of IC1b and IC1c.

From Table 1 it can be seen that holding

either of the inputs of these gates low forces the outputs to remain in the high state regardless of the other inputs. The alarm stays quietly in this state until the tilt switch is disturbed and switches from open to short circuit. When this happens the input of IC1a is briefly pulled low via capacitor C1.

With one of its inputs low the output of IC1a switches from low to high, turning

INPUT 1	INPUT 2	OUTPUT
H	H	L
H	L	H
L	H	H
L	L	H

H — High or Logic 1
L — Low or Logic 0

Table 1. Truth Table for Two Input NAND Gate.

on TR1 via R5. As TR1 turns on its collector voltage falls from the positive supply voltage to almost zero. This fall in voltage is passed via capacitor C2 and pulls the other input of IC1a from high to low. The low on this input of IC1a now takes over and holds the output in the high state regardless of the state of the other input.

Continued on page 76 65

Designer's Notebook: Display Technology

A look at the various types of visual hardware that make computing possible.

By Jon Fairall

THE WONDERS of computing would be useless without the ability to communicate across the computer/operator interface. In many respects it's the most difficult, as well as one of the most interesting, challenges of modern electronic design, and as a result speech synthesis and voice recognition are all the rage in labs around the world.

However, much of the information human beings get about the world is visual. Honed by millions of years of evolution as tree-swinging, hunting apemen, our visual faculties are far more sensitive than any of our other senses. Our brains are wired to organize visual information far more quickly and readily than any other type. A picture, they say, is worth a thousand words.

Learning to talk to computers is important, but loudspeakers will never replace the display screen as a means of getting information out of them. The problem though, is to refine our methods of doing this. To an extent it's a software problem: making the displays easier to understand, getting more information out in less time. But it is also a hardware problem. Making displays easier to read, making them lighter, smaller (or bigger), above all making them less expensive in terms of manufacturing and power requirements.

This story is about the technology of the computer screen, about LCDs, tubes and plasma screens. It's about trends in the display industry and what's likely to happen in the next few years.

Types

The best place to start is probably with the most humble device of all, the LED. Light emitting diodes are simple to use and very cheap, and still used widely to monitor the state of individual lines. A step up in sophistication is the segment display, which is typically fabricated using

monolithic techniques akin to integrated circuit manufacture. Another method of construction is to mount an LED on a reflecting surface to give a bar display. Typical layouts include the seven segment LED used to denote the numbers 0 to 9, and the 14 segment display used to denote alphanumeric characters. Both these types are still used extensively where the output requirements are very simple and where cost and simplicity are vital considerations.

The LED has one problem, however, and that is that it takes a fair bit of current to drive it, typically several milliamps. That's not much by itself, but as soon as the display gets a little more complex it becomes a factor of overriding significance.

A considerable amount of effort has gone into solving this problem. Industry-standard ways of multiplexing have been developed for instance, which allow a designer to drive, say, half a dozen seven segment displays, using multiplexing based on standard TTL chips like the 7447, that can be purchased for a few cents.

Such techniques afford considerable savings in terms of power usage, but they can't be extended sufficiently far to allow LEDs to form part of practical computer display panels. For instance, if one assumes a typical LED might consume 10mA, it seems that a display of 600 x 400 pixels would consume 20A. There would also be heating problems.

Unfortunately for the LED, dot addressable display panels are increasingly where the action is. The complexity of a graphics-capable display is becoming the standard for displaying reasonably complex information quickly in a way that a human being can absorb. A second reason is probably more cultural than technological. The oriental characters known as Kanji, much beloved in China and Japan, are far more complex than our own oc-

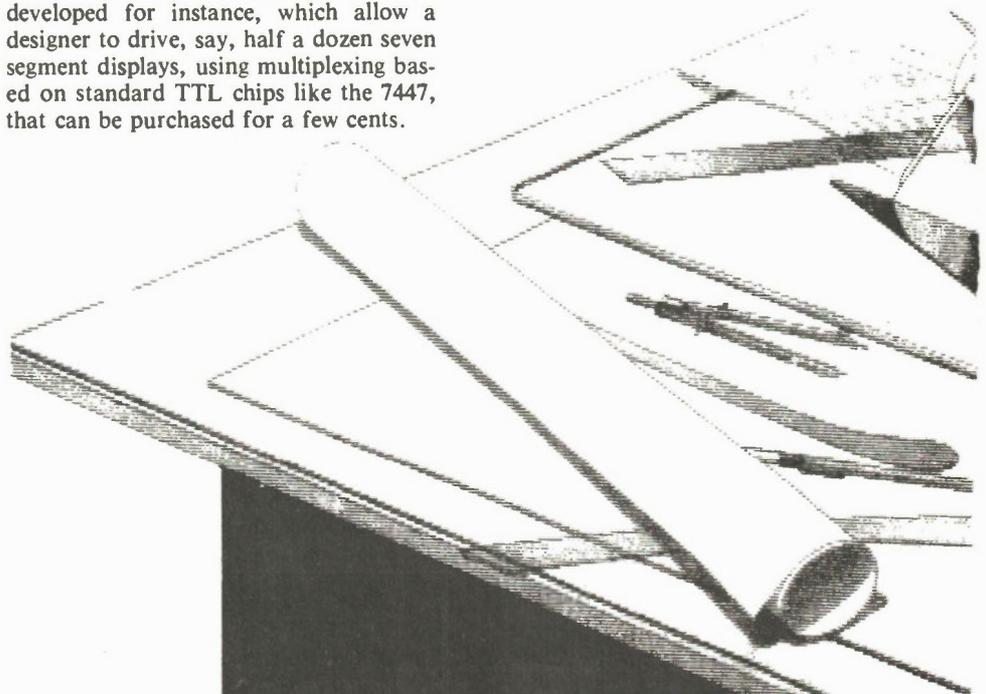

cidental character set. While the Japanese have been reasonably content to live with our letters for the last twenty years, the Chinese, one quarter of the world's population, are less amenable to change. The lesson being read in display headquarters around the world is if you want to get into China, get with the dots.

CRT

Of course, one technology is already into dots; indeed, it's all it can do. The CRT is still the most significant type of panel display technology. It's an example of the vacuum tube technology that founded modern electronics. With the exception of high power transmitter tubes, it is the last great hanger-on from that era. It's big, it's heavy, it's clumsy. In terms of screen brightness and resolution it is still quite unbeatable, however, and remains unchallenged in areas where such things are important.

And of course, such areas are plentiful. The cathode ray tube is the only practical technology that can cope with the wide ambient light conditions required for a domestic TV set. In the US, NASA specifies them for the space shuttle and in Europe they are all the rage in airbus cockpits. There is nothing old fashioned about the tube.

Not that tube designers are sitting on their duffs. Tube makers point to improved resolution, for instance, and to new folded screen technologies such as those developed by Sinclair Research in the UK as improvements in the product.

However, the CRT suffers from some considerable disadvantages that have affected the design of its host system for far too long. For instance, in most applications a separate power supply to derive the high voltage is required. Because it requires a vacuum for efficient operation, the glass needs to be thick and heavy. The problem is worsened by the need for a large flat panel at one end to use as a viewing screen. Typically it can be 3/4 of an inch thick, reducing to 1/8 of an inch at the neck of the tube. This requirement has implications for weight also.

As well as these electromechanical problems, fears have been expressed about health problems associated with CRTs. As computers have become more prevalent in the workplace, and more people have

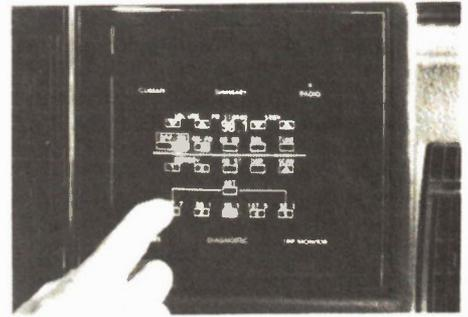

come to spend ever longer in front of computer screens, an epidemic of eye disease and nervous disorders has raged in offices. These health allegations can usually be divided into two kinds: those arising from ergonomic factors such as glare and flicker, and those that come from radiation.

Evidence has been tendered that shows an alarming incidence of eye problems in people who habitually spend time in front of VDUs. The argument is that staring at a flickering screen, full of annoying reflections from the surrounding area, probably with insufficient contrast between the characters and the background, does terrible things to your eyes, especially when you have to do it for hours on end. If it doesn't cause eye strain, it may well cause skeletal problems in the operator, who twists and turns into strange positions trying to alleviate the problem.

As a result a considerable amount of work is going into reducing glare. This includes the development of anti-glare layers bonded directly to the front of the screen, which are designed to cut out reflections from the surroundings and improve contrast.

There is also a great deal of interest in examining the position of the worker in relation to the keyboard and the screen, to see what effects this might have on posture.

Radiation from the tube is also alleged to be a problem. It's generally argued that X and gamma ray emission can cause a variety of complaints, including malfunctions of the reproductive system. However, in spite of a considerable amount of investigation, no really satisfactory statistics have been produced which show a correlation between any disease and exposure to radiation from a CRT. Nevertheless, constant exposure, eight hours a day, day after day, might be a problem. Certainly, the issue will not lie down and go away in spite of assuring noises from tube manufacturers. It's just another thing that makes alternatives look attractive.

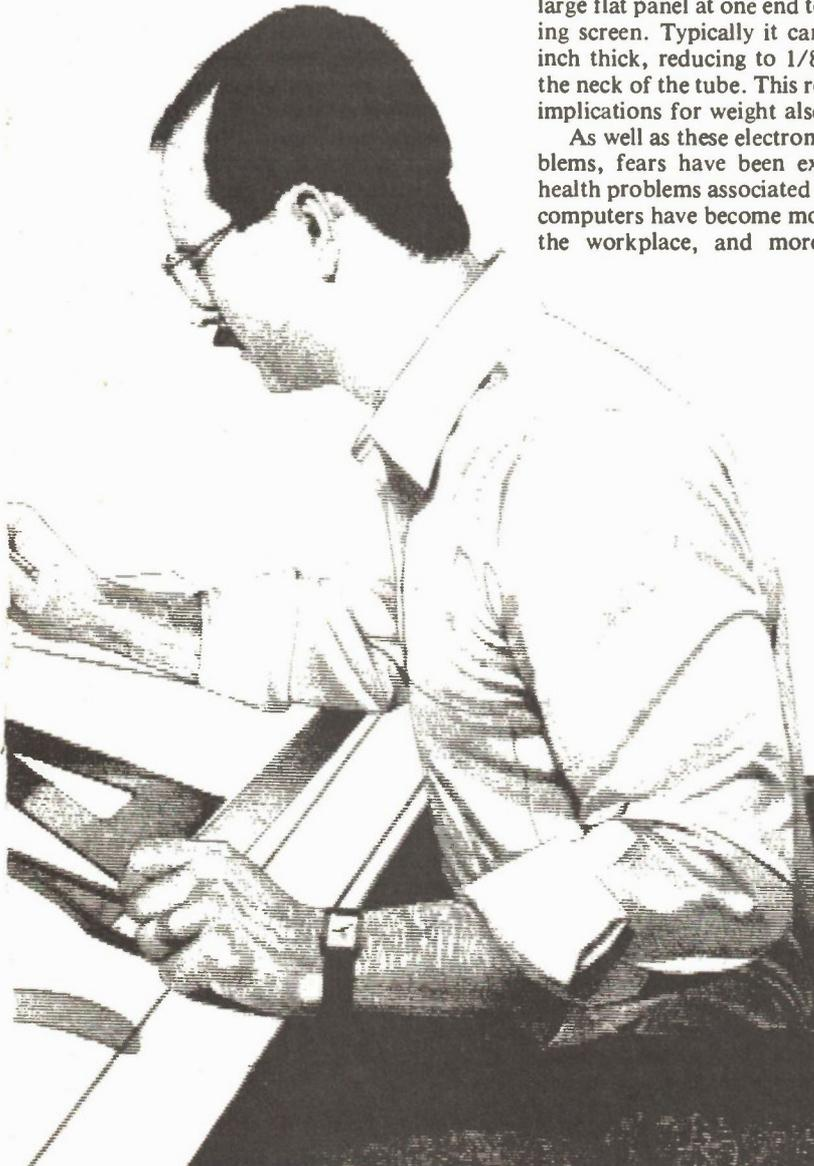

LCD

The biggest challenge to CRT technology is coming from liquid crystal displays. LCD technology was responsible during the seventies for the creation of a whole new industry around digital watches and portable calculators. During the eighties it has been responsible for the introduction of portable computers.

Liquid crystal starts with some tremendous advantages. It lends itself naturally to a flat compact screen which weighs little. It's a passive device, not dependent on emitting light, and as a result its power requirements are extremely low. In fact, LCD elements can be driven directly by CMOS logic.

From a manufacturing point of view the flexibility offered by LCDs is enormous, since the pattern of displays can be altered simply by changing the electrode masks. This has enormous implications,

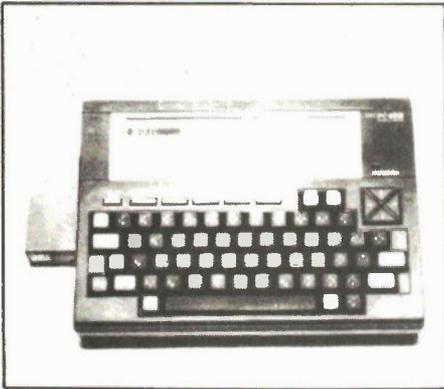

not only for small manufacturers, but also for large manufacturers considering rather small production runs. Philips, for instance, has designed car dashboards composed entirely of LCD elements customized to the requirements of the particular motor vehicle. The days of the standard speedo are numbered.

However, liquid crystal is still a very immature technology. It suffers badly by comparison with CRTs when it comes to resolution, and as a result no really satisfactory dot displays have yet been produced, although many manufacturers have made claims to the contrary. The problem is one of fabricating a small enough dot, while still keeping contrast at acceptable levels.

The other big challenges for LCD manufacturers in the near future are the introduction of colour screens and developing technology to make the screens bigger. Colour screens are well on the way, in fact Casio put out a portable TV with a colour LCD screen at the Summer Consumer Electronics Show in Chicago in July last year, and Sanyo has announced a large wall hanging display.

However, there are still lots of problems with colour LCDs. Usually it works with a "host-guest" system, ie, a special dye is mixed in with the liquid crystal host and moves with it. But the dyes are not particularly stable over time, especially when exposed to sunlight. Also, drive requirements are much higher for this type of display, limiting its usefulness in portable applications. A possible solution is to combine LCDs with LEDs. Another set of problems that plagues LCD screens relates to the viewing angle and the brightness of the screen. Since the screens depend on light being passed through them they depend on the ambient light level. Usually, a reflective layer is positioned behind the screen, so that ambient light will reflect back. In bright sunlight they are fine, but in the dark problems emerge. Illuminating the screen indirectly, say with an incandescent light on the side as is done in wrist watches, is not a very elegant or efficient solution for large displays. A better answer is to put a fluorescent sheet behind the display.

Another problem is that the operation of the system depends on the cholesteryl benzoate being in its liquid form. This has been solved to all intents and purposes by judicious mixing of chemicals. Modern screens can withstand -10 degrees to +60 degrees Celsius. If that is not enough, special mixtures are advertised for use from -30 degrees to +85 degrees C. more than the human operators could withstand in all probability.

Plasma

The plasma display panel (PDP) goes a long way toward solving some of these problems. It is extremely bright and can be viewed from any angle. Compared to a CRT, it is light, thin and easy to handle.

However, PDPs are far from being a perfect display vehicle. They are still monochrome in spite of the best efforts of physicists, and the trade off for the bright screen is a distressingly high supply voltage. A typical anode voltage is 250V for an orange screen: 280 V for green. Current flowing through the discharge cells can peak at 500 mA.

Price is another problem. The Japanese manufacturer OKI advertises screens at about twice the price of a comparable CRT. However, this situation is not likely to last indefinitely, because a plasma screen is intrinsically cheaper than a CRT. The present high price probably reflects manufacturing difficulties more than anything else, which may be expected to ease over time.

Drive

One advantage solid state devices have over the tubes is that they frequently come

with integrated drive circuitry on the back of the panel. Early generations used separate monolithic devices like TTL multiplexers, LED drivers and decoders which could be connected to the device by the designer. The modern trend is to integrate the display totally with the drive



circuitry using so called chip on glass techniques.

Chip on glass means pretty much what it says. The bare chips, ie, silicon substrate, are bonded directly on to the glass panels of the display. Connections are made by drawing fine gold wires across the glass to the required contact points on the display. The control inputs, which will accept display instructions from the host device, are taken to an edge connector or socket on the side.

The philosophy here is to make the device as easy to drive as possible. The need for the designer to consider expensive or difficult design decisions is removed. He simply treats the panel as an output port to which a stream of ASCII or binary symbols can be addressed.

Future Developments

The future is probably with solid state panels for they have on their side size, weight and economics. However, the tube manufacturers are not about to give in without a fight. Over the last five years the quality of CRTs has improved considerably and will probably continue to do so.

The result is that the solid state screens are presented with a moving target. The difference between the best resolution obtained with tubes and with flat screens has actually widened over the last few years. Designers of solid state screens still have real problems to overcome in terms of brightness and contrast, not to mention colour.

In the nature of the case the CRT will probably lose the fight, but it is not clear that the final victor will be any of the technologies we have discussed. If it is they will have to be very much advanced versions of what is available today.

Cathode Ray Tubes

Historically, the first important method of interfacing a man to a computer was via a cathode ray tube (CRT). Until comparatively recently it was the only wide screen display device in existence.

How does it work? A typical CRT consists of an electron gun, various control grids and a screen. The screen is covered in phosphor, a material that will emit light when bombarded with electrons. The function of the gun is to produce a stream of electrons, called the electron beam, which is shot at the screen. It does this by heating a conductor, called a cathode, in a vacuum chamber. Normally, when a conductor heats up, it liberates quantities of negatively charged electrons, which lose their excess energy by collision with atoms in the atmosphere.

However, when the cathode is heated in a vacuum, this mechanism no longer operates. The result is that the electrons, all negatively charged, will start to move towards the nearest positive charge. If this is made to be the screen itself, the electrons will fly off the cathode and head towards the screen.

The velocity of the electrons is determined by the potential difference between the cathode and screen. The bigger the potential the faster the electrons fly, and it is no very difficult matter to make electrons move at an appreciable fraction of the velocity of light in this fashion.

Velocity is of interest because of the relationship between the electron's velocity and the amount of light given off by the phosphor when it gets hit by an electron. Once

again, the bigger the better. The faster the electron is moving, the more energy it has, the more it can transfer to the phosphor, the more light the phosphor will emit.

A practical tube is a bit more complex than this. For a start there will be accelerating grids down the side of the tube, with their potential arranged so that they accelerate the electrons on their way. There will be a focusing grid, so that the beam illuminates as few phosphor particles as possible at any one time, and, last and most important of all, there will be a control grid, the purpose of which is to deflect the beam.

The place where the beam strikes the screen is controlled by the control grid, often known as a deflection plate or the yoke. It does this by imposing a voltage across the tube at right angles to the beam. If things are organized correctly the beam can be bent to strike any part of the phosphor screen at the front of the tube. Normally, things are arranged so that the control yoke consists of two separately controllable elements, the x plates and y plates. One pair will move the beam up and down, the other from side to side.

If a sawtooth wave is applied to the y plates, the wave will move relatively slowly from one side to the other, and then fly back to its starting point before repeating. The size of the voltage applied to the y plate at any instant will be precisely related to a specific spot on the screen. If a similar wave form is applied to the x plates the beam will move up and down. Now, if these two wave forms are applied together, with the y plate voltage having a frequency much faster

than the x voltage, the beam will trace out a series of lines on the screen. The number of lines will depend entirely on the difference in frequencies. If the y voltage runs twice as fast as the x there will be two lines on the screen, both sloping downwards strongly. If the y voltage is about 300 times x, which is more or less the situation in a TV set, then there will be 300 lines and the slope of the lines will be imperceptible.

To make a usable display there are only two other things to consider. Firstly, it must all happen quite quickly. Remember that only a single spot on the screen is illuminated at any one time. To make lines appear the dot must travel very quickly. Remember that only a single spot on the screen is illuminated at any one time. To make lines appear the dot must travel very quickly. In fact it turns out that if you cover the entire screen in 1/30 of a second, the illusion of a screenful of lines is created. This is known as a raster.

A raster, wonderful though it is, is of very little use to anyone. It conveys no information. To do that we need modulation, ie, the ability to change the intensity of the beam. With modulation, we can turn the beam off so that a black screen results. Then, when the beam reaches a certain spot, we can turn it on, then off again. If this is repeated over and over again, at a sufficiently high frequency, a single dot will appear on the screen. No prizes for guessing that timing is critical. Do it many times, and arrange the dots in specific patterns, and the result is a symbolic array, letters, numbers, lines, whatever.

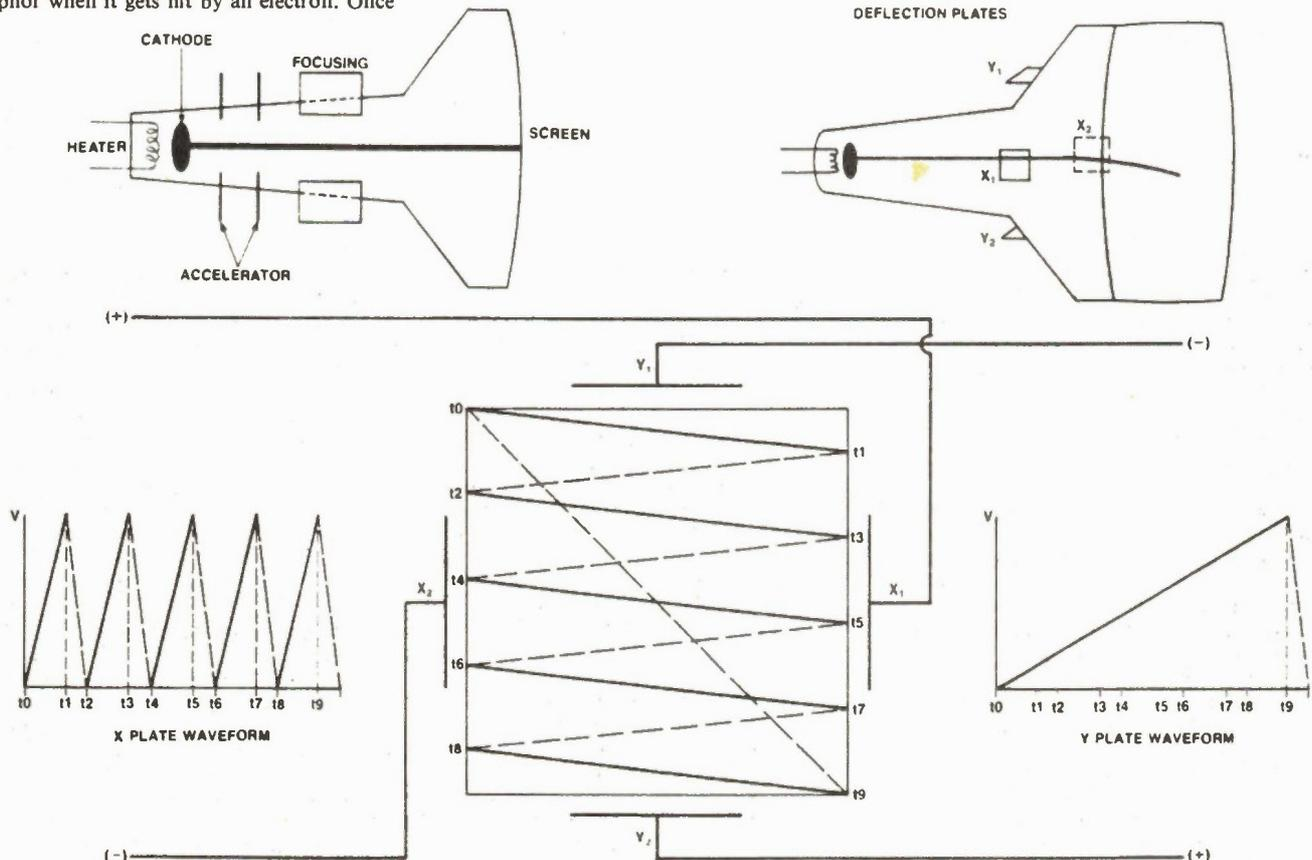

Plasma Screens

Plasma screens are a relatively recent invention, although the basic technology has been known for many years. A practical plasma display panel (PDP) is composed of a very large number of extremely small cells. A typical panel from the Japanese manufacturer OKI consists of 640 x 400 pixels in a 211 x 132 mm screen. Each dot is about 0.2mm in size.

A plasma display is a kind of cold cathode gas discharge tube in which a large potential is created between the anode and cathode in the presence of a rare gas. This ionizes the gas, ie, creates a plasma. The plasma liberates energy in the form of electromagnetic energy. Thus, the light lasts as long as the voltage is supplied.

The gases involved are mixtures of neon and argon or xenon. These gases are usually mixed together because it is found that a trace of argon or xenon in the neon reduces the voltage needed to create the plasma. Other factors affecting the light output are gas pressure and the distance between the electrodes.

In fact, a practical PDP is rather more complex than this outline would suggest. Typically, the anode and cathode are laid out in a matrix. Each consists of long thin conductors imbedded in glass substrates. The gas is contained in tiny tubes at each intersection, divided in three to form separate cells. Above the cathode, towards the front of the panel, is the display cell. When it gets excited, this cell will emit ultraviolet radiation, which in turn excites a fluorescent layer on the glass, thus creating visible light.

Below the display cell, between the cathode and anode, are the auxiliary cells, consisting of the constant discharge and scanning cells. It is these cells that actually use the anode-cathode potential. The constant discharge cell functions much like a capacitor, and is used to supply a constant stream of electrons and ions to all its neighbouring display and scanning cells to prebias them. The scanning cells act to transfer this mechanism from left to right across the screen, hence their name. This is necessary because it would take too long to turn the display cells on from cold, and so a flickering panel would result.

In order to make a dot illuminate, it is necessary to make a particular cathode go as low as possible and a particular anode as high as possible. When the potential between them rises to a certain level, called the firing level, ionization starts in the auxiliary cells at the intersection of the electrodes. Ionic transfer then excites the display cell which causes a dot to glow on the screen.

To keep the dot on it is not necessary to keep the voltage at the firing level. Discharge can be maintained with a considerably lower voltage, called the maintenance voltage. In practice then, the voltage waveform on the anode consists of a step function in which a sharp spike rises above the firing level and then sinks to a back porch which maintains discharge for the required length of time.

Because of these and other requirements,

plasma panels come with their drive circuits on board. A designer seeking to integrate such a unit into his or her device need only supply TTL data and timing signals. These are then buffered to voltage levels required by the device. Some units have on-board character generators made out of a bit of ROM. This simplifies the design task even further, since it is then possible to take to the display in ASCII or some similar code. Of course, such an approach means that each pixel is not addressable by the user, so graphics is not possible, but in many applications the saving in complexity outweighs the disadvantages.

Electroluminescent Screens

Natural luminescence was discovered in 1603 by an Italian alchemist called Cascariolo who had nothing better to do with his time than grind up rocks to see if he could turn them into gold. He didn't, but he did discover that if he took a special kind of stone that was common locally, and heated it with coal, the embers would glow long after they were cold. He called the material 'Lapis Solus' or sun stone. We call it barium sulphate and represent what he did with:



The BaSO₄ was the original stone and the carbon was supplied by the coal.

It is important to realize that luminescence is very different from incandescence. The latter happens because of heat, as in a light bulb. The former does not require heat at all, but is the result of a chemical process happening in a cold body. It seems that in certain substances, a proportion of the total population of atoms in the substance will have a higher than normal energy level. Modern quantum theory predicts that this situation will be unstable, and that each of these atoms will try to jump down to its 'ground state' or state of lowest energy. As they do so they release energy, and this is often detected in the form of electromagnetic radiation, some of which is in the visible part of the spectrum.

It took until 1923 to discover that this phenomenon could be effected in certain materials by electricity. Particular crystals could be made to glow if a large potential was placed across them. The energy absorbed by the crystal was liberated at the frequency of visible light.

In modern structures this technology is used to form electroluminescent panels. A typical example from Sharp has the active crystals implanted in a host medium which is moulded as a thin flat panel. It is then covered on both sides by another thin layer of transparent insulating material. A grid of electrodes is placed on both sides of the sandwich. Those on one side run in the up-down direction, those on the other side run from side to side. One set of electrodes is made out of transparent material so the operator can see the screen. So, whenever a particular column and a particular row are activated, a strong electric field is applied to the luminescent screen at the intersection and a spot glows on the screen.

LCDs

The story of LCDs goes back to 1888 when an Austrian named Reinitzer observed that a chemical brew called cholesteryl benzoate has some rather odd characteristics. When it's heated, the solid benzoate melts to a milky liquid, which, as the temperature is increased still further, clears to become transparent.

Chemists call the different states of a substance, whether solids, liquids or gases, phases. It was shown that this milky phase of the benzoate had some rather odd optical characteristics. In particular, it was doubly refracting. This is a phenomenon often seen in a crystal, but never in a liquid. As a result, the substance became known as liquid crystal.

It was discovered that the crystal-like behaviour of cholesteryl benzoate is due to the fact that the liquid phase has a rod like structure in which the molecules group together in an ordered manner. In an ordinary liquid the molecules are completely unordered. A few other effects were established. For instance, it was discovered that liquid crystals have different optical and electrical characteristics in different directions, depending on the alignment of the rods in the crystal.

In 1971 Schadt and Helfrich published a paper on the 'twisted Nematic' effect. It was really rather simple. Firstly you need two glass plates. The inside of each plate is coated with ITO, indium tin oxide, an electrically conducting, transparent material. Then you put a really thin layer of liquid crystal next to the ITO. The ITO can be used to apply an electric field to the liquid crystal so that the crystals line up along the field.

Schadt and Helfrich put a polarizing screen on the outside of the glass panels, thus making the screen transparent only to light waves vibrating in the plane of the polarized layer. They oriented the field in the same direction, thus lining up the crystals in the same plane as the polarization. One would expect that if you put two such panels together, with their polarization at 90 degrees to each other, the composite panel would be opaque. However, they discovered that, in fact, what happens is that the two liquid crystal layers coalesce into a film, in which the crystals slowly twist from one plane to the other. As they do so, they twist the polarizations of the light as well. So, the two panes of glass, each polarized at 90 degrees to the other, pass almost all the light that falls on them.

The key to all this is that if an external field is applied to the crystal, all the rods will align themselves to it. They crystal film will lose its twisted structure, and the polarization of the two panels will assert itself. No light will be transmitted.

From here it was but a short step to shaping the ITO layers into segments and forming a useful display. Applying a tiny amount of current to any bit of the ITO then causes the screen above it to become opaque. ■

8088 Programming, Part 2: Interrupts

*In which we start with some basic bytes
and routines.*

By Bill Markwick

LAST month we looked at the basic structure of a small program, just to give you an idea of what it all should look like. This month we'll back up and demonstrate the way that MS-DOS (or PC-DOS, which is the same thing) handles commands by using subroutines called interrupts.

We assume that you have at least a rudimentary knowledge of bits and bytes and at least a vague idea of the computer's hardware structure: CPU, memory, drives, etc. For this instalment, you can get by with Debug.Com, a simple assembler/disassembler that comes with the MS-DOS utility disk; later, you'll need the MASM, LINK and EXE2BIN assembler programs. It would be a good idea to get hold of some sort of reference books on DOS, something listing the various tables

of interrupts and so on. One example would be the IBM PC Technical Reference Manual or the Microsoft manuals on MS-DOS assembly language programming. A general listing of Debug's commands would be handy.

The Why of It

If you already program in a high-level language, you may wonder why anyone would bother with assembly language. It's incredibly slow to write because you have to tell the computer almost everything; it's about as close to machine language as you can get without programming in binary, and there are only a few built-in subroutines to make life easier for you.

Well, if you're writing a large program that does complex things, a high-level language is what you want. Unfortunately,

all high-level languages have inherent limitations. They may be slow at some particular task, or lack certain functions, or they may take up an enormous amount of room just doing simple things. For instance, I wanted a program to do word-counts of textfiles; it's easy to do in Pascal, but the compiler drags in all kinds of instructions when it makes the COM file, producing a 12K file where a few hundred bytes would do. Furthermore, a knowledge of assembler lets you get into the computer and its programs and tinker with them until they suit you. One example is the tiny program included this month; I wanted a more visible cursor in WordStar, and DOS will let you configure the cursor parameters.

So this series won't turn you into a programmer, but it'll let you see what's going

on in DOS and have some fun besides.

A Booting Review

Your computer has hardly any smarts at all at the instant that you turn the power on. About all it can manage, other than controlling the screen, is to do a memory check and then load in MS-DOS from the boot disk. On this disk are three files: Command.Com, the BIOS file and the DOS file. The latter two are hidden files and will not show in the directory unless you have a program like SDIR which reveals hidden programs. About 40K is used up by DOS when it's loaded.

After loading, at the bottom of memory, starting at 0000, are the interrupt tables and various BIOS routines, then the DOS routines, and then the resident part of Command.Com. Next comes the available user RAM for your programs, and then the transient part of Command.Com.

Command.Com accepts and executes the standard DOS commands like DIR, COPY, TYPE, etc. Because these commands aren't needed when you run most software, DOS allows the transient part of Command.Com to be overwritten by large programs. When you exit your software, Command.Com is reloaded from the disk. If it isn't there, you get a message to "Insert Command.Com in Drive A and press any key". The computer does a checksum routine, comparing the Command.Com it had with the one it's about to load. If you insert a different version, you'll get an error message, even if the new version is valid. Most manufacturers put their name and copyright on the DOS disk, and if you boot with an IBM disk, for instance, the computer will not reload Command.Com from a Compaq disk and vice versa, even though the MS-DOS workings may be identical.

Although the 8088 CPU can directly address one megabyte, only 640K is available. The addresses above 640K are reserved for video RAM and the ROM routines.

The ROM routines mostly do house-keeping chores: moving bytes from one peripheral to another or to memory—general in/out routines under the control of the BIOS file which loads in during booting.

The general hierarchy of the computer, then, is: the programmer enters commands to Command.Com which sends them through the DOS file (loaded from the disk). DOS processes the commands and turns the execution over to the BIOS file for routing to the proper peripherals. The actual hardware part of this is run by the ROM routines, which are stored in non-volatile memory.

Segments

Because the 8088 has 16-bit address lines, it can directly access only 64K of memory. To expand this to the one megabyte limit, the CPU uses extra control lines to divide memory into *segments*. These will be covered in a future article and don't really concern us yet. However, as a point of interest: there can be any number of segments of any size located anywhere in memory. It would be easier on the brain if we had only 10 segments of 64K each, but this would probably be wasteful of memory space.

If a program uses only one segment and never makes calls outside the boundary, it's called a COM file and obviously has a maximum size of 64K. If multiple segments are used, the program is called an EXE file and has a slightly different structure from an assembler point of view. More to follow in the future.

Register Review

The 8088 has four 16-bit general purpose registers, the AX, BX, CX, and DX. Each of these can be subdivided into two 8-bit registers, the H and the L, producing the AH, AL, BH, BL and so on. The registers each have special functions: the A, known as the accumulator, is best for arithmetic and logic, the B has special memory addressing, and the C is good for counting.

To see the registers, load Debug and type R for "registers". The display should look like Fig. 1. The four registers will be empty. SP is the stack pointer; this is an area at the top of the segment in use which is used for temporary storage of register values when we use PUSH/POP instructions. BP, the Base Pointer, is used in stack manipulation, which we'll get to in a future part. The SI and DI, Source and Destination Index, are used in string manipulation.

On the second line are the registers used to keep track of segmenting: the Data, Extra, Stack and Code segments. They all

```
A>debug
-r
AX=0000 BX=0000 CX=0000 DX=0000 SP=FFEE BP=0000 SI=0000 DI=0000
DS=2E98 ES=2E98 SS=2E98 CS=2E98 IP=0100 NV UP DI PL NZ NA PO NC
2E98:0100 42          INC     DX
```

Fig. 1. The Debug listing of the registers.

have the same number because only one segment is in use at the moment; this number is determined by DOS and may not be the same on your computer. IP, the index pointer, is the program counter and is set to the beginning: COM files begin at location 100, just as in CP/M. At the right of the middle line are the flags; the abbreviations change depending on whether the flags are set or cleared. The uses of the flags will be covered later.

At the bottom is the segment in use, the program counter reading (100), the byte in location 100 (42), and the instruction corresponding to 42 (INC DX). Since we have no program loaded, the byte at location 100 will be whatever was there before we loaded Debug and may be different on your computer.

Interrupts

If you're familiar with CP/M assembler for the 8080 or Z80, you'll remember that to perform basic functions such as writing to the screen or reading from the keyboard, certain values are loaded into the registers and a call made to the Basic Disk Operating System: CALL 5 or CALL BDOS. The 8088 interrupt system is much the same.

The interrupt is a subroutine stored in memory and used to execute nearly every basic I/O task you could want. In general, a value is loaded into the AH register and the type of interrupt entered: for instance, to make the computer print a character on the screen, you would look in the MS-DOS list of interrupts to find that you put a 2 into the AH register, the hex ASCII character into DL, and issue Interrupt 21. Let's do that using Debug.

We'll use Debug's A (Assemble) command. Type A100 to start the program at location 100, and enter:

```
A>debug
-A100
2E96:0100 MOV AH, 2
2E96:0102 MOV DL, 41
2E96:0104 INT 21
2E96:0106 INT 20
2E96:0108
```

Fig. 2. The interrupt to send a character to the screen.

MOV is "Move Immediate" and is the most-often used instruction in assembler; the INT 20 is the call to terminate the pro-

gram and reset the registers. Type a return after 108 to terminate the assembly. Now the program is sitting in memory. You can type D100 to see the bytes, or you can type U100 to disassemble the bytes and confirm that it entered properly.

To run the program, type a G. You should see the letter A (hex 41) appear on the screen, followed by "Program Terminated Normally". Type another G to run it again.

A caution here: Debug is a simple utility without much in the way of crashproofing. If you make a mistake, or if you should forget that an odd value got left in the IP register, the computer may hang, requiring you to power down. Before running or rerunning a program with the G command, always use the R command to be sure that the IP is set to 100, or your program may be off and running through the Twilight Zone.

If you'd like to see the program run step by step, you can use the T (Trace) command. Each time you type T, you'll see one instruction executed, or you can type T followed by the number of steps you want to see. Again, be sure you start with IP at 100. And one more caution: you can only take the stepping up to the first INT; you can't trace an interrupt. The register values get jumbled here and there and the Trace function will just go on endlessly. Later on, if need be, you can jump over the INTs by replacing them with NOP (No Operation).

Making a COM

Debug can write your program to a disk. To do this, it needs to know both the

name and the length in bytes. The name is entered in Debug's file control by typing:

nntest.com (return)

You can use any other name you like, as long as it has the extension COM. Now count up the number of bytes in your program. I find that the easiest way to do this is to use the D command to display the bytes horizontally. Remember that the byte count starts at 100, and that the last instruction may take up two bytes: for instance, the hex for INT 20 is CD20, taking up two bytes and making the program one byte longer than it appears. You'll see what I mean if you use the D command. Another way is to find the first byte that isn't part of the program; in this case, the ninth byte, 109. The length will be one less than this, or eight.

The length is placed in the CX register. Use the R command to type it in:

```
RCX
:0000 0008
```

Another caution: be sure that the BX register reads 0000. Otherwise, any

numbers in it will be taken as the most significant figures of the length and you'll get a program about a million times longer than you wanted.

Now type W and Debug should say "Writing 0008 bytes". Use Q to quit and try your program from DOS; it should print an A on the screen and return the prompt.

If it didn't, load debug and your file and then use the D and U commands to unravel it. The most likely problem will be a typing error, and the next likely will be a wrong length, cutting off the end of the file. If the latter happens, the truncated INT 20 will hang the computer for sure.

Interrupt Vectors

At the very bottom of memory at 0000 is a table of *interrupt vectors*. This is nothing more than a list of locations where subroutines will be found. Each address is four bytes long, consisting of a segment number and the address within the segment (this latter is known as the *offset*). There are 256 possible vectors, from 0 to 255.

To see the vector table from Debug, type D0000:0000. The extra zeros ensure

K.E.M.

High Speed EPROM Toaster For Apple and IBM More Powerful More Friendly Updated Model

From 2716 to 27256 all-round player. Function programming voltage (12.5V, 21V, 25V), and ROM selection totally software control. Just change I/F card, Can switch to IBM or Apple.

For Apple\$185.00
For IBM XT\$195.00
Extra I/F card Apple or IBM ... \$ 79.00



Also KEM High Speed Rom UV Eraser.
Erasing time only within 5 to 10 minutes.



1 set\$35.98
with Timer\$38.98

\$5.00 for shipping. Plus Provincial Tax for B.C. residents. Plus C.O.D. fee if required. Price and specification are subject to change without notice.

K.E.M. Electronics Ltd.

Mail to Box 69126 Station (K), Vancouver, B.C. V5K 4W4
Office 879 E. Hastings St. Vancouver Tel (604) 251-1514

Circle No. 20 on Reader Service Card

AFFORDABLE

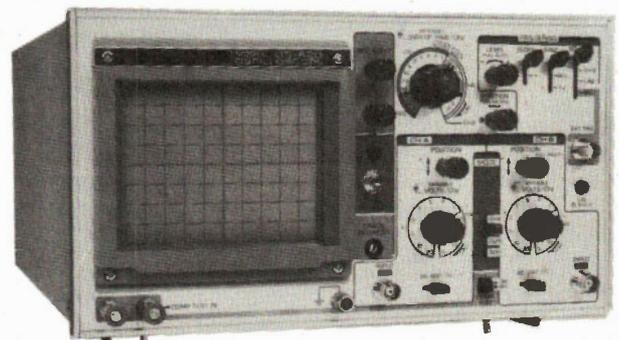

DUAL TRACE OSCILLOSCOPE

Here's exceptional value at a budget price! This 20 MHz dual trace scope has a built-in component tester ideal for troubleshooting solid state circuits and components with no circuit power, and features 6" high luminance CRT, TV sync measurement for vertical & horizontal circuitry, sensitivity 1 mV/div.

Model 33330 dimensions:
6.4" x 11.5" x 14".

All for an incredible price of

\$559⁰⁰

Set of 1:1/10:1 switchable probes \$59.

35 and 45 MHz scopes also available.

Order by phone or mail. Visa, money order, certified cheque or C.O.D. accepted. Add \$15. for shipping and handling. Ontario residents add 7% PST.

KB ELECTRONICS

355 Iroquois Shore Road, Oakville, Ont. L6H 1M3
(416) 842-6888 Telex: 06-982396 (KBEL OKVL)

Circle No. 21 on Reader Service Card

that you'll go to the bottom of memory rather than the bottom of the segment in use.

As an example, if you call INT 10 (the 10 is a hex number), the computer looks at the 16th interrupt vector, 64 bytes in from the start. The four bytes at this location read 0F0ECA1F. By Intel convention, the bytes are listed in reverse order, so the segment and offset pointed to is 1FCA:0E0F. At this location you should find the beginning of a short machine code subroutine to execute INT 10.

A full list of interrupts and what they do can be found in the technical manuals for MS-DOS or the IBM-PC.

Cursor.Com

I've never been partial to the tiny MS-DOS cursor, particularly in word processing, so I was pleased to find that the DOS interrupts include an interrupt for setting the cursor shape. The idea for the split cursor which follows came from a book whose title I've forgotten. My apologies to the original author.

Load Debug and use the A command to enter the four lines shown:

```
MOV AH,1
MOV CX,0502
INT 10
INT 20
```

Use the N command to enter the name Cursor.Com, and use the RCX command to put 0009 in register CX. Write to the disk, exit to DOS and run the program. The cursor should change from a single line to a rectangle block split in the middle, very easy to see in a spreadsheet or word processor.

The first instruction sets up Interrupt 10 to configure the cursor. Next, DOS wants us to put the starting number for the first of seven cursor lines in the CH register, and the ending line in the CL. Note that it's more convenient to put a four-place number into CX, rather than issue two separate commands for CH and CL. The trick here is that we start the cursor with line 5 rather than 0, forcing the cursor to begin in the middle. It then wraps around, leaving a space in the middle.

You can place Cursor.Com in an Autoexec batch file if you like, and then the cursor will be ready for you after booting.

I've found that some software will overwrite the cursor program and return it to the standard single line or other shape, but most programs accept it without trouble.

Next month we'll continue on with more basic instructions for the 8088, particularly the interrupts for sending characters to the screen or printer. ■

Electronics Today

Offers advertisers the opportunity to increase their sales and profits in the electronic field. Over \$200 million is spent annually for both electronics and micro-computer products by Electronics Today readers.

For advertising information

Call (416) 445-5600



DAVE WONG Pres

ASSEMBLE YOUR OWN PC & SAVE \$\$\$

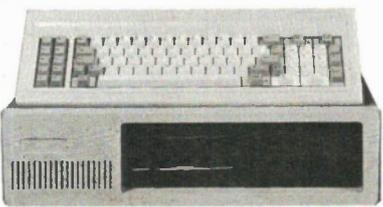

COMPLETE AT SYSTEM:

Dual Speed (6/8MHz), 80286 CPU (80287 Optional), 6 16-bit & 2 8-bit I/O Slots, RAM Expandable to 1M, Clock, Phoenix BIOS, CGA, 1.2Mb Disk Drive, Hard Disk Controller, Printer & Serial Ports, 192-watt Power Supply, 5160 Keyboard, Case, Assembled, Tested., 1-Year Warranty **\$2899.00**

AT COMPONENTS:

AT MOTHERBOARDS
Dual Speed (6/8MHz), 80286 CPU (80287 Optional), 6 16-bit & 2 8-bit Slots, Expandable to 1Mb, Clock, Phoenix BIOS, OK **\$1299.00**

FLOPPY-HARD DISK CONTROLLER
IBM AT-Compatible, 360K/1.2M Floppy & Hard Disks **\$599.00**

2.5Mb MULTI-FUNCTION CARD
2.5Mb RAM Expansion, Printer, 2 Serial Ports, OK **\$329.00**

PARALLEL & SERIAL PORTS CARDS **\$125.00**

KEYBOARD: 5160-type AT Keyboard **\$125.00**

POWER SUPPLY: 192-watt Side Switch **\$239.00**

CASE: IBM AT-style Sliding Case **\$139.00**

DRIVES:
1.2Mb 1/2-Height Floppy Disk Drive **\$269.00**
CDC WREN HARD DISK, Voice Coll, Park/Lock Head, Ultra Fast Access (20ms), 20Mb Capacity **\$1199.00**
30Mb Capacity **\$1499.00**
30Mb Capacity **\$1899.00**
80Mb Capacity **\$2599.00**

XT SYSTEMS:

COMPLETE STARTER KIT:
4.77MHz, 8088 MPU (8087 Optional), Phoenix BIOS, Hardware Reset, 8 IBM-comp. I/O Slots, 256K RAM Expandable to 640K, Panasonic or Mitsubishi Disk Drive, Printer Port, Color Graphics Adapter, 135-watt CSA Approved Power Supply, 5150 Keyboard, Flip-top Steel Case **\$899.00**

COMPLETE PRO XT KIT:
4.77MHz, 8088 MPU (8087 Optional), Phoenix BIOS, Hardware Reset, 8 Expansion Slots, 640K RAM, Color Graphics Adapter, 2 Panasonic or Mitsubishi Disk Drives, Printer, Serial & Joystick Ports, Clock/Calendar, 135-watt CSA Approved Power Supply, 5150 Keyboard, Flip-top Case **\$1199.00**

COMPLETE TURBO XT KIT:
Dual Speed (4.77/8MHz), 8088-2 MPU (8087 Optional), 640K RAM, Phoenix BIOS, Hardware Reset, 8 Slots, Printer, Serial & Joystick Ports, Clock, Color Graphics Adapter, 2 Panasonic or Mitsubishi Disk Drives, 135-watt CSA Approved Power Supply, 5150 Keyboard, Flip-top Case **\$1249.00**

XT COMPONENTS

MOTHERBOARDS:
XT: 640K Board, Phoenix BIOS, Hardware Rest, OK **\$259.00**
TURBO: 4.77/8MHz, Phoenix BIOS, Reset, OK **\$325.00**

VIDEO ADAPTERS:
MONOCHROME GRAPHICS ADAPTER
Hercules-Comp., Printer Port, Runs Lotus **\$139.00**
COLOR GRAPHIS ADAPTER
IBM-Comp., Composite (Mono & Colour) & RGB Outputs **\$115.00**
DUAL MODE GRAPHICS ADAPTER
Genoa Spectrum-Comp., Monochrome/Colour Graphics **\$329.00**
ENHANCED GRAPHICS ADAPTER
100% EGA-Compatible, 256K Video RAM, Flicker-free **\$549.00**

EXPANSION CARDS:
DISK DRIVE CONTROLLER w/Cable **\$ 59.00**
384K MULTI-FUNCTION CARD - OK 384k RAM Expansion, Printer, Serial & Game Ports, Clock, Ram Disk & Print Spooler Software, OK **\$159.00**
MULTI-FUNCTION DISK I/O Disk Controller, Printer, Serial (2nd Optional) & Game Ports, Clock, Ramdisk & Printer Spooler **\$ 39.00**
PARALLEL PRINTER ADAPTER **\$ 55.00**
SERIAL COMMUNICATION ADAPTER **\$ 99.00**
KEYBOARDS: 5150 Enhanced 84-key IBM-type **\$139.00**
5151 Keyboard w/Cursor Pad **\$ 59.00**
POWER SUPPLY: CSA Approved 135-watt **\$149.00**
CASES: Flip-top Steel Case, Side Switch **\$ 59.00**

DRIVES:
Panasonic or Mitsubishi 360K, DS/DD 5 1/4" Disk Drive **\$169.00**
20Mb SEAGATE Hard Disk w/WDC Controller **\$799.00**
MODEM: External 1200 Baud, Hayes-Compatible **\$299.00**

MONITORS:
12" DUAL MODE SMART MONOCHROME TTURGB compatible **\$185.00**
14" RGB MONITOR, 0.39 Dot Pitch, Green/Amber Modes **\$529.00**

GUARANTEE:

- Latest Technology
- Min. 48hr. Burn-in
- Tested Before Shipping
- Prompt Service
- Warranty: 90 Days Parts/Kits
1-Year Systems

ORDER NOW TOLL FREE: 1-800-663-KITS

BUY WHERE DEALERS & SMART BUYERS BUY

Business Hours: 10:00 am - 7:00 pm Monday through Saturday

CompuKits
4320 Fraser St.
VANCOUVER B.C. V5V 4G3
(604) 879-9288



Product Mart *Where Buyers Find Sellers*

BUGGED? WIREAPPED? Find out fast! Countermeasures equipment catalog \$1. OCTE, Dept. ET, Box 173, Montreal. H3X 3T4.

ELECTRONIC SURPLUS INDUSTRIES LIMITED, we sell used industrial/military test instruments, including oscilloscopes by HP Tektronix, Philips; Signal generators, meters, components, tubes, etc. 1191 Lawrence Avenue West, Toronto, Ontario M6A 1E2 416-787-1837.

CABLE TV DESCRAMBLING TECHNIQUES. 56 pages. \$13.95. TV Genie channel 14 transmitter \$99.95. Channel 3 notch filter \$39.95. Amazing see-in-the dark Infra-Red night viewer kit \$295. Catalogs \$1. **CROSLY (J)** Box 173, Montreal, Canada H3X 3T4.

SURPLUS Electronic Test Equipment: Oscilloscopes, Signal Generators, Frequency Counters, Meters and much more, Bargain prices, Guaranteed. **ALLIED INDUSTRIAL ELECTRONICS** Box 401 Pointe Claire Dorval Que. H9R 4P3 Tel: 514-631-6941.

PERSONAL COMPUTER OWNERS CAN EARN \$1000. to \$5000. monthly offering simple services part time. Free list 100 services. Write: **C.I.L.F.G.**, P.O. Box 60369, San Diego, CA., 92106-8369.

SATELLITE TV SYSTEMS: 6' systems, \$1299.00, 10' systems \$1599.00, also individual system components. Call or Write for details. Visa accepted. **COLESAT SYSTEMS**, R.R. #2, Tantallon, N.S. B0J 3J0. (902) 826-2875.

COMPUTER and Electronics parts. Priced to sell. Send for free catalogue and get on mailing list for frequent. "Sale Flyers." **M.O. ENTERPRISES**, Box 2066, Bramalea, Ontario, L6T 3S3.

EXCITING Surprise pack of Electronic Parts \$6.00, plus \$1.50 shipping. New catalogue 2-34c stamps. Our surprise pack would make an excellent Christmas Gift. **MP2 SCIENTIFIC**, 33255 S. Fraserway, Suite 472, P.O. Box 8000, Abbotsford, B.C. V2S 6H1. BC residents please add 7% Sales Tax.

PRODUCT MART

WHERE BUYERS
FIND SELLERS

For more information Call:

(416) 445-5600

J&J ELECTRONICS LTD., Box 1437E, Winnipeg Manitoba R3C 2Z4. Surplus and Semiconductor Specialists. Do you get our bargain flyer? Send \$1.00 to receive the current literature and specials and to be placed on the mailing list for future publications.

Pre-Christmas Sale

NEC V-20 Chlp \$ 13.95
STAR Micronics NX-10 Printer \$389.95
VOLKS Modem 12 300/1200 bps \$225.00

Plus much, much more.

Apple Users - "We put Apple back on top" with being the first to bring you applied engineering memory expansion products up to 1 meg on board.

RAMFACTOR \$Call
RAMWORKS III \$Call

See our wide selection of prime electronic components

"Quality, Price, Service & Service"

Come to our store, or return coupon to enter our free draw for a Logitech C7 Mouse and a Beckman Logic Probe.

SEND COUPON FOR FREE CATALOGUE
and membership to our exclusive club.

SILICON VALLEY COMPONENTS

287 Lakeshore Road, East, (just East of Highway 10)
Mississauga, Ontario L5G 1H3
(416) 271-0716

NAME: _____

ADDRESS: _____

CITY: _____ PROV: _____

POSTAL CODE: _____ PHONE: () _____

Prices subject to change without notice

SPEAKERS DRIVERS IN CANADA

DYNAUDIO®



vifa



FOTAL

CROSSOVER, SPEAKER COMPONENTS

SOLEND CROSSOVERS

Custom Computer Design
Passive Crossover for Professional, Hi-Fi and Car Hi-Fi
Application, Power up to 1000 Watt.

SOLEND INDUCTORS

Perfect Lay Hexagonal Winding Air Cored
Values from .10 mH to 30 mH,
Wire Sizes from #20 AWG to #10AWG

CHATEAUROUX CAPACITORS

Metallized Polypropylene (Non-Polarized)
Values from 1.0 mfd to 200 mfd,
Voltage Rating: 250 VDC / 150 VAC

CROSSOVER, SPEAKER PARTS

Mylar Capacitors, Power Resistors, Crossover Terminals,
Nylon Ty-Wrap, Binding Post, Banana Plugs, Speaker Terminals,
Grill Cloth, Plastic Grill Fast Snap, Neoprene Gasket, Misc. Parts.

COMPUTER AIDED DESIGN FOR ENCLOSURE AND CROSSOVER AVAILABLE TO CUSTOMER

Product specifications and prices available upon request.



SOLEND INC.
5940, AV. BERGVEIN
BROSSARD, QC
CANADA, J4Z 1Z2

ORDERS

Tel: (514) 656-2759

IC1a would remain latched in this state except for the effect of resistor R4, via which C2 gradually charges. After approximately 100 seconds the voltage on the positive end of capacitor C2 has risen sufficiently to take the input of IC1a from the low state to the high state. The other input of IC1a is already held in the high state via R2 and so with both inputs high the output of IC1a switches from high to low and turns off TR1.

The collector of TR1 rises to supply voltage and the circuit settles down once again with both inputs of IC1a in the high state and its output in the low state. Even if S1 remains closed the circuit action will be unaltered because capacitor C1 and resistor R1 only allows the input of IC1a to be pulled down for a few milliseconds.

The circuit will be retriggered next time S1 changes from open circuit to short circuit and the whole 100-second cycle will repeat. The 100-second time period is set by the values of C2 and R4. These values can be reduced for shorter periods but should not be increased much because the small charge current and the high leakage current of big electrolytic capacitors will give unpredictable results.

Alarm Tone Generator

IC1b and IC1c form a frequency modulated audio generator which produces a particularly penetrating sound when used with miniature piezo-acoustic transducers because it excites their natural resonances.

In the quiescent state the output of IC1a is low and holds one input each of IC1b and IC1c low. In this state the outputs of IC1b and IC1c are high and they cannot oscillate. When the alarm is triggered the output of IC1a and the inputs of IC1b and IC1c connected to it become high. From the truth table of Table 1 it can be seen that when one of the inputs of a gate is high, the output is always the opposite of the other input. That is, the gate can be treated as a simple inverter.

The gates in IC1 are not just straight CMOS NAND gates. They also have a Schmitt trigger action. Schmitt trigger gates have a built in hysteresis effect so that the output switches sharply between states even if the input changes slowly.

This feature enables the gates to function and oscillators with the addition of just one resistor and one capacitor. IC1b is connected as such an oscillator and operates as follows:

Initially assume that the input of IC1b is low and its output is therefore high. Capacitor C3 will be charged via R7 until the voltage across it rises to a voltage known as the upper input threshold voltage of IC1. At this point the output switches from high to low and C3 now begins to discharge via R7.

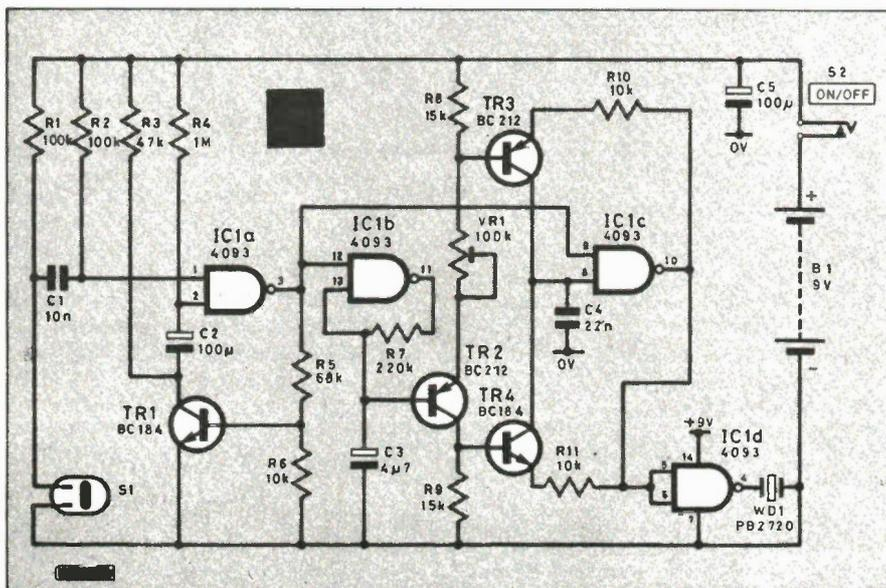

Fig. 1. The circuit diagram of the Tilt Alarm.

The hysteresis of the Schmitt trigger gate means that the output will not switch from low to high until the input voltage has fallen to a lower voltage known as the "lower input threshold". At this point the output switches from low to high. C3 begins to charge via R7 again, and the cycle repeats.

The output from the IC is a square wave as it switches backwards and forwards between states. The voltage across C3 is a gently rising and falling triangular waveform. This waveform is used to modulate the frequency of a second similar oscillator formed around IC1c.

Voltage Controlled Oscillator

In the second oscillator C4 is the capacitor which is charged and discharged via two transistors TR3 and TR4 instead of a single resistor. By varying the base voltage on the two transistors it is possible to alter the amount of current that they pass and hence the rate at which C4 is charged and discharged.

To understand how this circuit works assume the base of TR2 is held at half of the supply voltage. The emitter of TR2 will be above half of the supply voltage by 0.6V (the base-emitter voltage of TR2).

Preset potentiometer VR1 sets up the current that flows via resistors R8, R9 and transistor TR2 and would normally be adjusted so that there was 1.6V across R8 and R9 (the base current of TR2, TR3 and TR4 is insignificant, so the current in R8 is practically identical to that in R9, about 105 microamps in this case).

When the output of IC1c is high it almost reaches the supply voltage and so the voltage across TR3 and resistor R10 is 1.6V. Allowing 0.6V for the base-emitter junction of TR3, this leaves 1V across

R10, giving a current of 100 microamps passing through TR3 to charge C4. When the output of IC1c is low TR3 is turned off and TR4 turned on. As there is 1.6V across R9 there will be 1V across R11 and so the discharge current of capacitor C4 will also be 100 microamps.

The base voltage of TR2 is varied by the low frequency triangular waveform across capacitor C3. This causes the voltages across R8 and R9 to vary and so alters the charge and discharge currents of C4 and the frequency of oscillation.

The values are chosen so that the output of IC1c is a square wave which sweeps up and down between 2kHz and 3kHz at a rate of 2Hz. IC1d is a simple buffer stage which isolates IC1c from the loading effect of the output transducer WD1.

The alarm is turned on by removing the plug from the miniature switched jack socket S2. The socket is wired so that the alarm will keep sounding even if a nail or other (conducting) object is used to attempt to foil it. The choice of a 2.5mm jack socket ensures that matchsticks cannot be inserted.

The Tilt Switch

Mercury tilt switches are a bit difficult to locate. One source would be equipment in surplus stores; another would be old thermostats that have been replaced with the new setback types. Sometimes you can find them in local component stores. One source is Cardinal Electronics, with outlets in Edmonton, Calgary and Saskatoon. Their AS408V0 is an SPST light-duty mercury bulb listed in the catalog at \$9.49.

Another possibility is to make your own tilt switch, based on the pinball tilt mechanisms. These use a short length of

Parts List

Resistors

All 1/4 or 1/2 W, 5 percent

R1, R2	100k
R3	47k
R4	1M
R5	68k
R6, 10, 11	10k
R7	220k
R8, 9	15k

Potentiometers

VR1	100k trimpot
-----	--------------

Capacitors

C1	10n
C2, 5	100u, 10V
C3	4.7u, 10V
C4	22n

Semiconductors

IC1	4093 CMOS
TR1, 4	BC184, 2N3904 or other gen. purp. NPN
TR2, 3	BC212, 2N3905 or other gen. purp. PNP

Miscellaneous

S1	Mercury tilt switch (see text)
S2	2.5mm switched jack socket
WD1	Piezoelectric resonator Radio Shack 273-060 or equiv.
B1	9V battery and clip

Suitable utility case, 14-pin IC socket, 2.5mm plastic jack plug.

metal pull-chain inside a metal tube; tilting the tube lets the conductive chain touch the tube and make contact.

It is also quite possible to use any other sensor that changes from open circuit to closed circuit when disturbed. Pressure mats and micro switches wired in parallel with S1 could be used to give additional protection.

Construction

The alarm is built on a single small printed circuit board. A socket is recommended for IC1 as it aids trouble-shooting enormously if the IC can be removed. The electrolytic capacitors C2, C3 and C5 must be fitted the right way around as must the transistors and the IC. Take care not to confuse the two types of transistor.

The tilt switch can be mounted on the board as shown but may also be fitted remotely on wire leads. The main thing is to get the switch set at the correct angle so that it is normally open but closes on an attempted theft. The operation of the switch can be checked easily by watching the mercury blob fall from end to end.

Testing

When the alarm is complete check that S2 is working correctly so that power is only supplied to the circuit when the plug is

Electronics Today December 1986

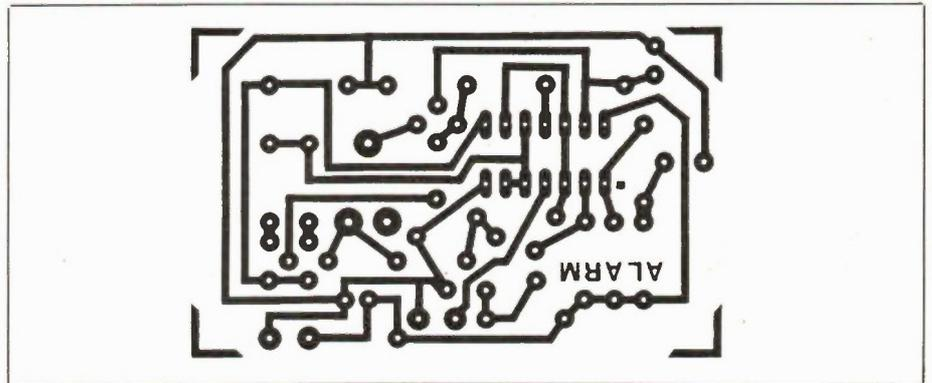
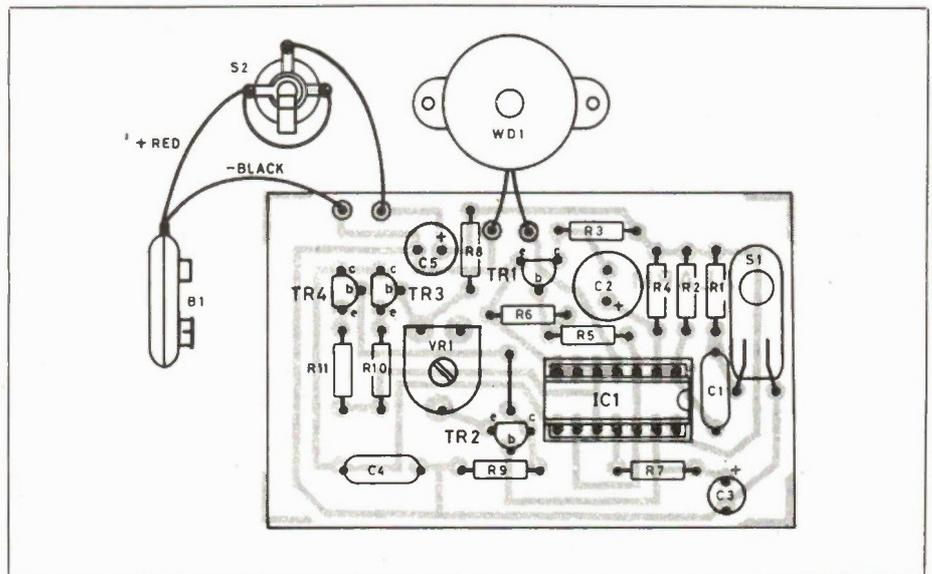

Fig. 2. The PCB and component layout.

removed. Insert the jack plug, connect a battery and set the position of S1 so that it is open circuit. Remove the plug and check that the alarm is silent. As soon as S1 is tilted to the short circuit position the alarm should sound. Tilting S1 to the open position should have no effect and the alarm should continue to sound for between 60 and 120 seconds. The frequency range of the alarm sound should be set by VR1 for the most penetrating effect. Resonances in WD1 are influenced by its mounting method so the setting of VR1 should be done with the alarm in as near to its final form as possible.

In Use

The alarm can be fixed to the object to be protected by using double-sided tape, Velcro strips or any other appropriate method. Battery drain is negligible when the alarm is not sounding and small even when it is. A 9V battery will probably last for a year's normal use. ■

Electronics Today

Each year Electronics Today delivers thousands of sales leads processed through our Reader Service Card Program. These sales leads are qualified with name, address and title of respondent.

For advertising information call

(416) 445-5600



**“Dad,
you’ve got to
help me.”**

“Sandy, what’s wrong? Are you hurt?”

“No, Dad, I’m fine.”

“Where are you?”

“At Pat’s. We all came over here to celebrate after the game.”

“It’s almost 12:30. Isn’t it time you called it a night?”

“That’s just it. Remember you always told me if I was out never to drive with anyone who’s had too much to drink? And not to be afraid to call you if I had no other way of getting home? Well, tonight I’m taking you at your word.”

“Stay right there. I’m coming to pick you up.”

“Thanks, Dad. Oh, and something else.”

“Shoot.”

“Are you angry with me?”

“Angry? No, Sandy. Not on your life.”

Seagram

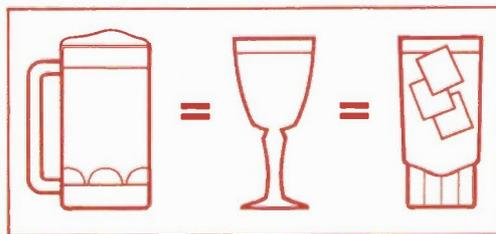

12 oz. regular beer, 5 oz. table wine and 1½ oz. spirits are equal in alcohol content. Be equally careful with each.

THE LATEST FROM HAMEG



CSA
APPROVED

HM203-6

- SIMPLE
- FUNCTIONABLE
- RELIABLE
- COMPLETE
- 2 YR. WARRANTY
- COMPONENT TESTER

The HM203-6 was designed for **general purpose applications** in industry and service. Its many operating modes, front panel layout, and **ease of operation** makes it an ideal oscilloscope for training, engineers and technicians.

And to introduce the NEW digital meters from Triplet BCS Electronics Limited will give absolutely FREE a Model 2030 pocket Autoranging 3½ Digit Triplet Meter with each HAMEG HM203-6 purchased until

January 31, 1987.

Everything is complete and all warranties will apply.

Circle No. 25 on Reader Service Card

- ACTIVE TV-SYNC
- 20MHz @ 3Db
- SENSITIVITY 2mV
- 40MHz TRIGGERING
- 2 DUAL x1-x10 PROBES

\$770⁰⁰

F.O.B. DOWNSVIEW
PRICES SUBJECT TO CHANGE

BCS
ELECTRONICS
LIMITED

980 Alness St. Unit 7,
Downsview, Ontario,
M3J 2S2
(416) 661-5585
TELEX 065-28169

Mon.-Fri. 8-5 p.m. Sat. 10 a.m.-1 p.m.

UNIVERSAL DMM's from HIOKI



- 8-mm Thick
- Resistance to 20 meg ohms
- Autorange

MODEL 3240
CARD SIZE DMM

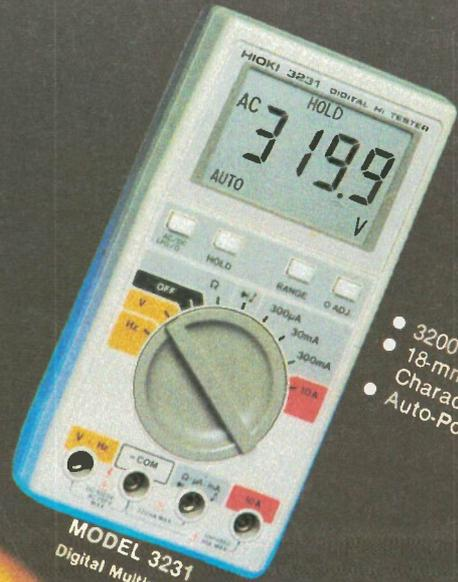

- 3200 Count
- 18-mm High Characters
- Auto-Power Off

MODEL 3231
Digital Multimeter



- MODEL 3232 DMM**
- 3200 Count
 - 18-mm High Characters
 - BCD Output

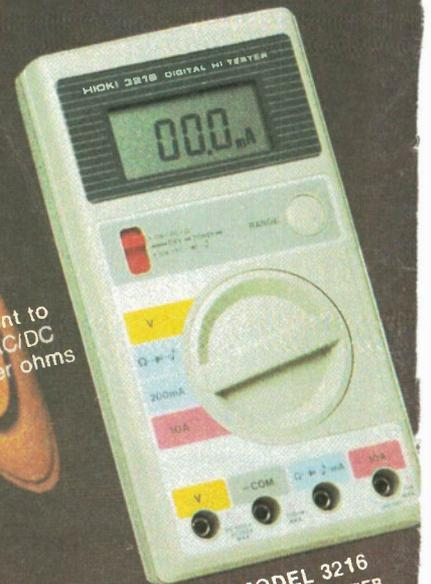

- Autorange
- High Current to 10 amps AC/DC
- Low Power ohms function

MODEL 3216
DIGITAL HI TESTER

Available in 82 countries.

RCC ELECTRONICS

310 JUDSON STREET, UNIT 19, TORONTO M8Z 5T6 (416) 252-5094 TELEX: 06-984874 FAX: (416) 252-3031
 Montreal: 6600 Trans Canada Highway, Suite 750, Point Claire, Quebec, H9R 4S2, Telephone: (514) 694-6080, Telex: 05-821762
 Vancouver: 119-255 West 1st Street, Unit 3, North Vancouver, B.C., V7M 3G8, Telephone: (604) 985-4065, Telex: 04-352841
 Toll Free Newfoundland to Saskatchewan 1-800-268-2281

Circle No. 25 on Reader Service Card