

Electronics Today

\$3.75
MM70924

October 1986

Canada's Magazine for Electronics & Computing Enthusiasts

Precision Power Supply

Low cost, easy to build

**Electrostatic
Detector**

Save those chips

**Transistor
Checker**

Test bipolar gain

**Computer
Interfaces**

More on the RS232

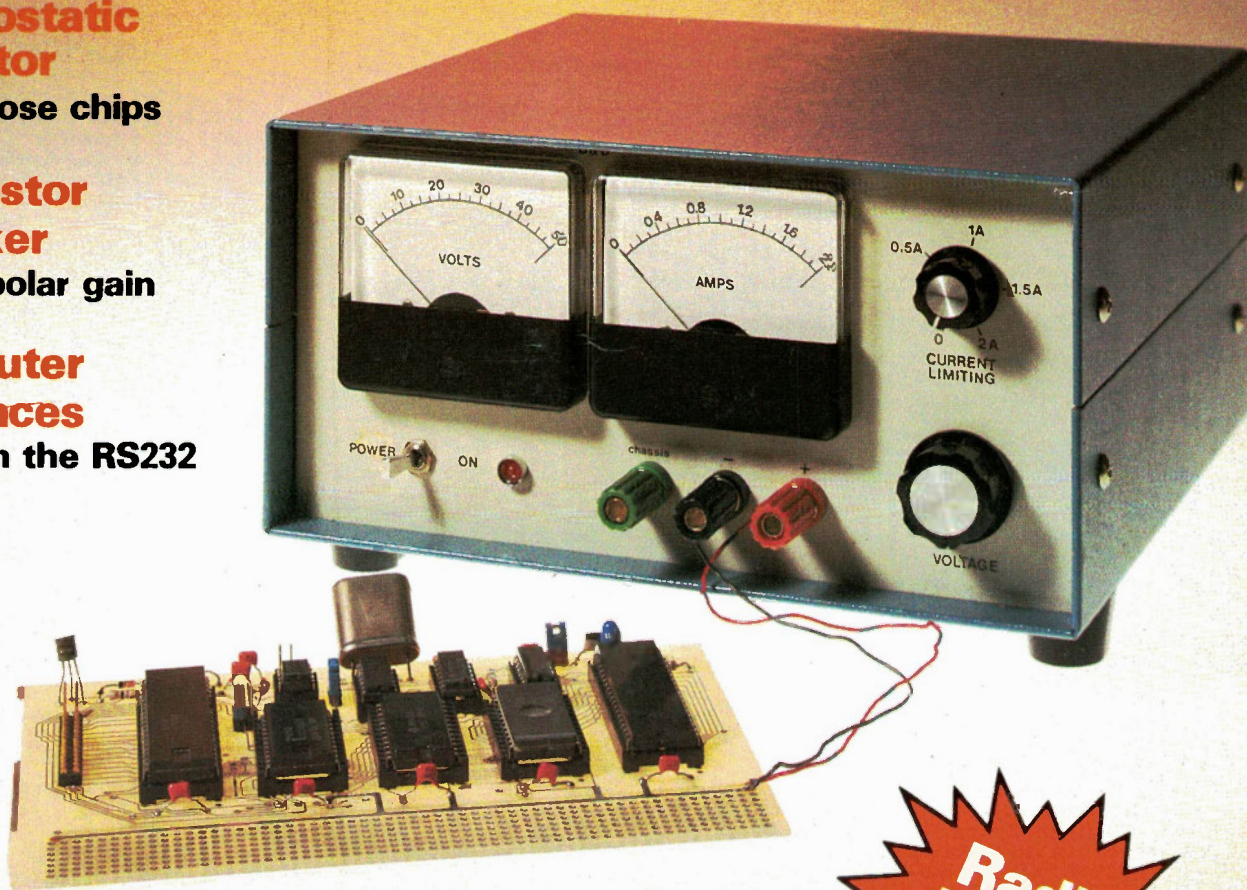

**Radio
Basics**



0
0
57438 70924
10
* 97 * BT03 *
THE AV AZ
SOUTH NS
3131 3N3

BEST Computers

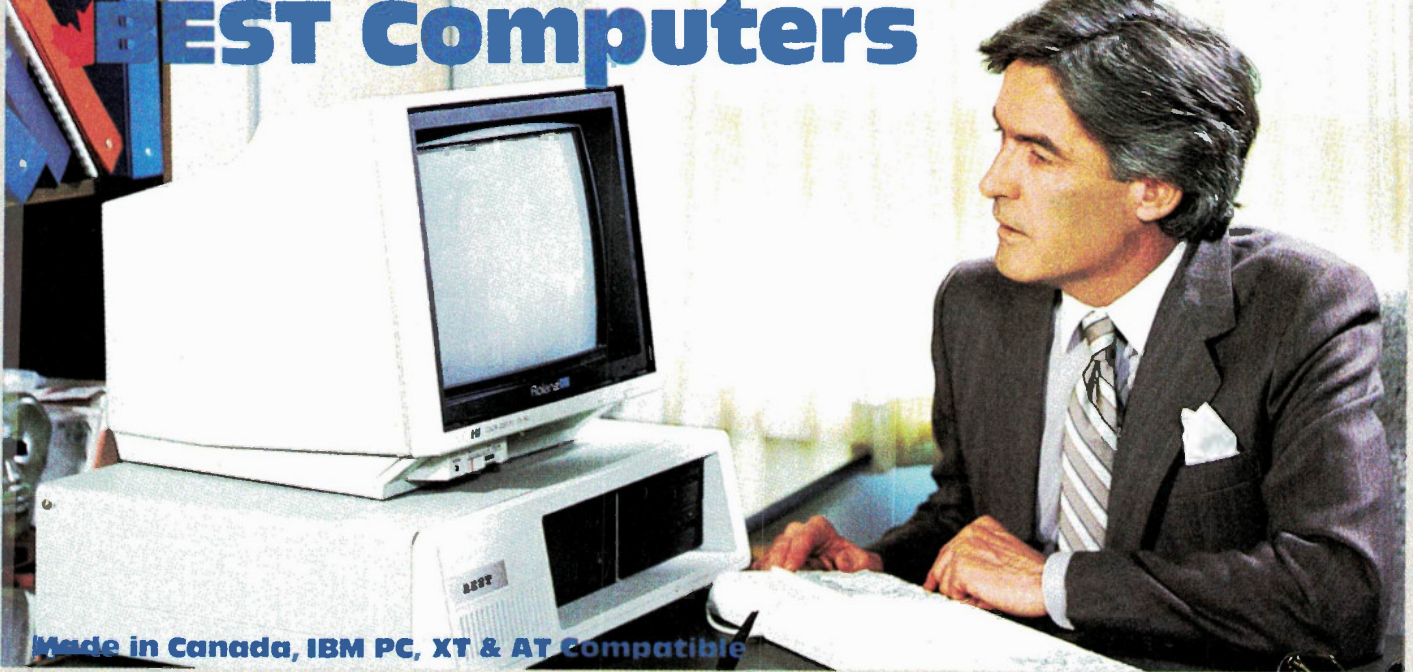

Made in Canada, IBM PC, XT & AT Compatible

Monitor not included. IBM, IBM PC, IBM XT and IBM AT are registered trademarks of IBM Canada Ltd.

Features common to BEST MK II, MK III & MK IV

- Superb IBM PC & XT Compatibility
- Canadian Made
- 256K RAM Standard minimum (uses 41256K RAM chips)
- Expandable on board to 640K RAM
- Parallel Port (for printer)
- Serial Port (for communications)
- Real Time Clock/Calendar (with Battery Backup)
Presocketed for optional co-processor — such as 8087 Math Processor
- IBM Compatible Keyboard
- Reset Switch
- Phoenix BIOS as used in many major brand IBM compatible systems.
- 150 Watt Power Supply which will handle a Hard Drive without upgrade.
- 7 Slots
- Flip top case
- 2 Slimline DS,DD 5 1/4", 360K Disk Drives
- Colour Video (RGB & Composite) Board or Hi-Res Monochrome Card (customer choice)
- Disk Controller Board

Warranty

We have such confidence in the time tested reliability of the BEST that we offer a ten (10) month warranty which is way above the industry standard. On-site service plan available at extra cost Nation-wide through 3M of Canada Ltd.

BEST MK II. Regular \$1695. This Month:

Two 350K DS,DD disk drives, Serial and Parallel Ports, Real Time Clock, Phoenix BIOS, uses 8088 processor — full specifications given above.

\$1595⁰⁰

TEN MONTH WARRANTY

Other Configurations:

With 640K RAM	\$1695
With 10 Meg Hard Drive/1 Floppy/256K	\$2495
With 10 Meg Hard Drive/1 Floppy/640K	\$2595
With 20 Meg Hard Drive/1 Floppy/256K	\$2795
With 20 Meg Hard Drive/1 Floppy/640K	\$2895

4.77MHz
DUAL
SPEED

The FAST BEST MK III

As BEST MK II plus speed selectable: 4.77 and 8MHz (most software will run on the higher speed), uses 8088-2 processor.

\$1895⁰⁰

TEN MONTH WARRANTY

Other Configurations:

With 640K RAM	\$1995
With 10 Meg Hard Drive/1 Floppy/256K	\$2795
With 10 Meg Hard Drive/1 Floppy/640K	\$2895
With 20 Meg Hard Drive/1 Floppy/256K	\$2895
With 20 Meg Hard Drive/1 Floppy/640K	\$2995
With 80 Meg Hard Drive/1 Floppy/640K	\$3995

SPECIAL

SUPER-FAST BEST MK IV

As BEST MK III plus TRUE 16-Bit machine, 8086-2 processor, IBM compatible 8-Bit I/O channel bus, even faster than MK III due to 16-Bit architecture. With 256K standard.

REGULAR \$2400

\$2095⁰⁰

TEN MONTH WARRANTY

Other Configurations:

With 640K RAM	\$2195
With 20 Meg Hard Drive/1 Floppy/640K	\$3195
The BEST Mk IV Main board processes data approx. 2.1 times faster than the IBM PC/XT or BEST Mk II.	

IBM
AT
Compatible

AVT-286

Superb IBM AT compatibility, 640K RAM, Two 5.25 in disk drives (one high density 1.2 Megabyte, one standard 360K), serial and parallel ports high quality keyboard, keyboard lock and status monitor.

\$3495⁰⁰

TEN MONTH WARRANTY.

With 20 Megabyte fast stepping Hard Disk and Controller:

\$4950⁰⁰

40 Megabyte systems also available at reasonable prices.

New, TURBO IBM AT compatible.

- 10 MHz CPU
- Up to 4 Meg RAM.

AXT-286

Superb IBM AT compatibility plus more:

- Standard 640K RAM and optionally up to 4 megabytes of RAM on main board.
- 6 MHz, 8 MHz, and 10 MHz selectable system speed.
- (2) 5 1/4" disk drives (1 high density 1.2 meg, one standard 360K).
- Serial and parallel ports, high quality keyboard, keyboard lock and status monitor.

With 640K RAM and 10 MHz CPU

\$4995⁰⁰

TEN MONTH WARRANTY

2 Meg RAM	\$6695.00
4 Meg RAM	\$8395.00
2 Meg RAM with 30 Meg Hard Drive	\$8695.00
4 Meg RAM with 30 Meg Hard Drive	\$10,295.00
2 Meg RAM with 40 Meg Hard Drive	\$8995.00
4 Meg RAM with 40 Meg Hard Drive	10,595.00
4 Meg RAM with 80 Meg Hard Drive	\$11,395.00
Scorpion Tape back-up (60 Meg) for any of the above system	
	\$1595.00

Exceltronix

319 College Street, Toronto, Ont. M5T 1S2
(416) 921-8941. Order line only 1-800-387-6995
Ottawa, 217 Bank Street (613) 230-9000
Visa, Mastercard and American Express accepted.

Exceltronix

319 College Street, Toronto, Ontario M5T 1S2

COPAL PRINTERS!

ECONOMY

COPAL ACCESSORIES

SC 1200 Ribbons	\$12.00
SC 1500 Ribbons	\$12.00
SC 5500 Ribbons	\$16.00
Serial interface for SC1200	\$95.00
Serial interface for SC1500/5500	\$80.00

PROFESSIONAL

SC1200 . . . \$329.00

- 120 cps, bi-directional
- dual mode, NLQ & draft standard
- tractor and friction feed
- parallel interface
- 1 year warranty
- 10 in. carriage
- foreign language characters
- IBM & Apple compatible

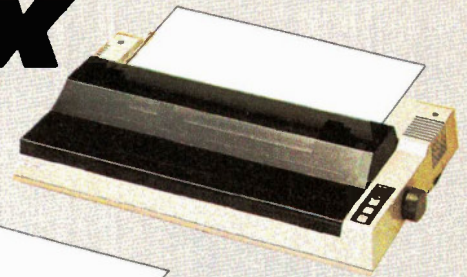

SC 5500
15" carriage \$699.00



SC 1500
10" carriage \$499.00

- 160 cps, bi-directional
- dual mode NLQ & draft standard
- tractor & friction feed
- 3K buffer
- parallel interface
- 1 year warranty
- IBM & Apple compatible



SAS Approved
1 year warranty.

For FREE Exceltronix 1986 Catalogue or FREE comprehensive Copal Brochure, please call or write to Exceltronix Inc.

Head Office (416) 673-5111

Toronto: (416) 921-8941

Ottawa (613) 230-9000

1-800-268-3798

Toshiba Printers P321

Impact Wire Dot Matrix, 24-pin overlapping. Letter quality 72 c.p.s.; Draft quality 216 c.p.s. (12 cpi), 180 c.p.s. (10 cpi). Accepts Font Cartridges and downloadable font disks, Qume Sprint 11 emulation, 4" to 11" paper widths, PC compatible and more.

Parallel and serial interface **\$1079.00**

P351

Impact wire dot matrix 24-pin overlapping 4" to 15" paper width.

Accepts font cartridges and downloadable font disks, Qume Sprint 11 emulation, IBM PC compatibility, and more. Parallel and serial interface.

- Letter quality at 100 cps
- High-speed drafts at 288 cps
- Superb graphics at 360 x 180 and 180 x 180 dots per inch. **\$2095.00**

NEW P351C

• Colour printer **\$2295.00**

Multiflex Low-Cost Logic State Analyzer

Ideal for educational institutions and hobbyist.

Complete, assembled and tested \$369

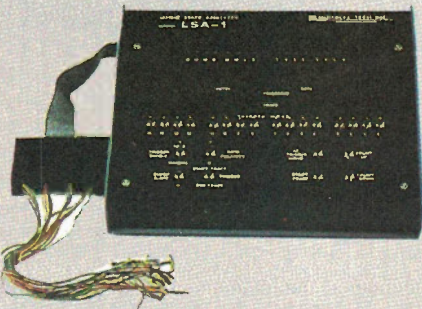

- Allows you to monitor 16 points in a digital system.
- Easy to operate and understand.

Cable Assemblies



DB25 Male to DB25 Female \$35.00

RS232 Cable (6ft of round conductor) \$39.00

RS232 other lengths and connector configurations available on request.

Parallel cable 36 pin Centronics type connectors, male joined by 6ft of ribbon cable to female **\$35.00**

Parallel Cable for IBM Interface DB25 through 6ft of ribbon to 36 pin centronics with appropriate connections **\$35.00**

Cable Assemblies for two 5-1/4in drives and controller (e.g. IBM) using three 34 pin connectors and appropriate length of 34 conductor cable **\$35.00**

20 pin Female header 24in. to 20 pin for Apple drives **\$6.95**

EPROM PROGRAMMER



External Card.

This card can program any one of the following EPROMs: 2716, 2732, 2732A, 2764 and 27128s. Two sockets are available on the adaptor board, one for the 28-pin EPROMs, the other for 24-pin types. These sockets are standard sockets, however as an option ZIF sockets can be used (we recommend ZIF sockets if large numbers of EPROMs will be programmed). Also as an option an extension board is available. This board attaches to the adaptor via a ribbon cable and extends out the back panel. This is to allow EPROMs to be programmed without removing the cabinet cover every time programming is to be performed. Also as a standard feature, the source software is supplied to allow users to modify the program to suit their needs.

As an option a serial port can be included on the card; this serial port has the same features as the port described with the floppy disk controller (see the floppy disk description for documentation of the serial port).

Serial Switch Box



.. \$59.00

Contains 3 RS232 connectors and a switch which switches all lines between input and one of two outputs.

Spectacular Gang EPROM Programmer & Emulator

Totally self-contained (has its own display, entry keypad and power supply).

Based on the Z-8 microprocessor. Can program up to 8 EPROM simultaneously (anywhere from one to 8 EPROMs at the same time with the information in its own memory or master EPROM).

The Gang Programmer can handle a wide selection of EPROMs: 2716, 2732, 2732A, P2732A, 2532, 2764, 27128, 27128A and optionally upgradeable to handle 27256, 27512, 2758 and 2724.

Complete package with EPROM Emulator, 8 ZIF sockets, Gang Programmer with 16Kx8 of RAM and RS232. **\$995.00**

Gang EPROM Programmer with 8 ZIF sockets, 16Kx8 RAM and RS232, without Emulator **\$695.00**

EPROM Programmer with only one ZIF socket, 16Kx8 RAM and RS232, without Emulator. Able to do all the functions describe but can handle only one EPROM at a time **\$499.00**

MAIN EPROM PROGRAMMER CARD (WITH SOFTWARE)

With 2 standard EPROM sockets **\$99.00**

EPROM PROGRAMMER WITH ZIF SOCKETS (WITH SOFTWARE)

With one 24-pin, ZIF socket and one 28-pin ZIF socket with provision for serial port **\$139.00**

EXTERNAL CARD

Ready to plug into the main EPROM Card (includes one 24-pin and 28-pin ZIF socket and cable). Saves you from opening the computer each time you want to program your EPROMs. **\$69.00**

SERIAL OPTION

For your main EPROM programmer. Provides you with a second RS232 serial port **\$49.00**

Exceltronix

319 College Street, Toronto, Ont. M5T 1S2

(416) 921-8941. Order line only 1-800-387-6995

Ottawa, 217 Bank Street (613) 230-9000

Visa, Mastercard and American Express accepted.

Toronto Computing Centre Inc.

Formerly Surplustronics

**8088 Computer Systems
with 90 day Warranty**



From \$995

Includes:

- 8088 motherboard
- High quality legal Bios
- One DS,DS 360K Drive
- Power Supply with Fan
- Keyboard
- Flip-Top case
- Disk Controller
- With plenty of spare slots
- All you need for complete System is Video Board

8088 motherboard with 256K (expandable on board to 640K) Fully assembled and tested with Phoenix Bios, Flow soldered provision for 8087.

\$339

AT Compatible Motherboard call for Best Price.

256K Memory

41256 (150nS)	\$ 4.99
Set of 9	\$44.00

64K Memory

4164 (150nS)	\$1.99
--------------	--------

Set of 8088, 8255A-5, 8237A-5, 8288, 8284, 8253A-5, 8259A	\$45.00
---	---------

IBM Compatible Keyboards

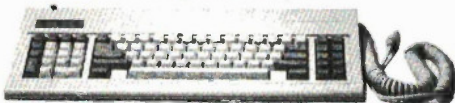

Taiwanese 5151 style keyboard	\$137.00
Keytronics 5151 keyboard	\$249.00
Taiwanese 5150 style keyboard	\$ 97.00
Keytronics 5150 keyboard	\$149.00
Maxiswitch Super Keyboard. Switch selectable between XT and AT compatibility	\$139.00

IBM Peripheral Cards

Colour Video Board	\$124.00
Monochrome Video Board	\$159.00
Floppy Controller with RS232	\$139.00
Floppy Controller	\$ 99.00
Modem 300 Baud	\$179.00
Multifunction Floppy Board	\$199.00
Multi I/O card with cables	\$175.00
384 MF-FL	\$289.00
384 MF W-OK	\$155.00
Parallel and Game Port Card	\$ 59.00
Cable and connector extra.	

Peripheral Interface Card	\$159.00
Includes two serial ports, parallel port, game port and provision for (but not including) real time clock.	
Clock/Calendar Option	\$ 29.00
With battery backup.	
256K & Multifunction Board.	
Includes: Serial port, parallel port, game port, provision for optional real time clock/calendar and socketed for up to 256K RAM.	
With 64K RAM	\$149.00
With 256K RAM	\$299.00
512K Board. Socketed for 512K including:	
64K RAM	\$149.00

We carry a wide selection of PC and AT Peripheral Cards.

Hard Drives

**Half-height, with Controller and Cables
20 Meg Seagate \$699.00**

Disk Drives for your IBM or Compatible

JU455 Shugart/Panasonic 5.25in. Silent DS/DD, 360K	\$149.00
JU475 Shugart/Panasonic 5.25 in. Silent AT Compatible 1.2Meg.	\$199.00

Monitors

Zenith ZVM1230 Green and ZVM1220 Amber	\$135.00
Tatung, TTL, Hi-Res, 22MHz	\$199.00
Tatung Colour Switchable to green or amber	\$649.00
IIL 14in, composite RGB and NTSC	\$549.00

Complete 6502 Board

- Assembled and fully tested (flow soldered)
- 64K, 80 x 24 video with soft-switch, floppy controller.
- System comes with blank EPROM's on board, does not come with any proprietary software or Basic

\$239.00

Complete System

- Using 6502 board above in IBM style flip-top case, using powerful 75 watt power supply with fan, programmable serial keyboard adaptor, IBM style keyboard

As above with one built in disk drive \$699.00

As above with two drives \$879.00

Power Supplies

Apple II+ Compatible. CSA approved
5V 5A, 12V 2.5A, -5V, 0.5A, -12V 0.5A

\$69.00

IBM Compatible. Hydro approved
150W 5V 15A, 12V 5.5A, -5V & -12V 0.5A

\$137.00

As above. CSA approved
150W 5V 15A, 12V 5.5A, -5V & -12V 0.5A

\$137.00

Panasonic Printers — Sale

Open Frame	\$29.95
Ideal for experimenters. No warranty.	

Printers

Copal SC550001 180 cps, 132 column	\$699.00
Copal SC1500T 180 cps, 80 column	\$499.00
Copal SC1200L 120 cps 80 column	\$329.00

Apple Compatible Boards Clearance Sale

Canadian Made, Flow Soldered, Super Quality. Boards fully socketed with all components except IC's and software.

80 column with hardware for softswitch	\$29.00
Super Serial Card	\$29.00
Parallel Card	\$18.00
Z80/64K	\$29.00
Deluxe Modem	\$59.00

As above but with all IC's except EPROMS and software.

80 column with hardware for softswitch	\$49.00
Super Serial Card	\$49.00
Parallel Card	\$29.00
Z80/64K	\$69.00
Deluxe Modem	\$109.00

All above boards come with schematics and component layout.

Apple Compatible Cards

Assembled, flow soldered/cleaned and 100% tested

16K RAM	\$37.00
Z80A Card	\$44.00
128K (with 128K RAM)	\$79.00
EPROM Programmer with software (programs 2716, 2732, 2732A, 2764)	\$79.00
Floppy Controller	\$45.00
Prototyping Board	\$14.95

Modem Bargain!

Apple Compatible plug-in Autoanswer, Autodial, Touch Tone or Pulse Dial. Excellent for use with most Bulletin Boards. 300 Baud. Final Sale as is

\$39.95

Apple Compatible Slimline

Disk Drives 5-1/4" \$159.00

IBM Style Case Suitable for

\$75.00

**8088 or
Apple
Boards**

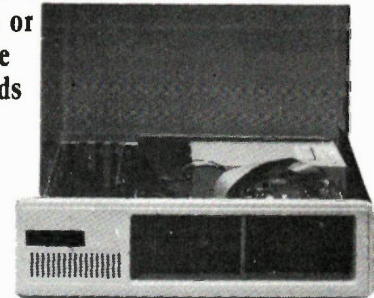

As above but no fronts and slightly scratched \$19.95

As above with fronts and slightly scratched \$29.95

These items final sale.

AT Style Case \$169.00

Mail Orders add \$7.50 minimum for shipping & handling. Ontario residents add 7% P.S.T. Visa, Mastercard and American Express cards accepted: send card number, expiry date, name of bank and signature. Send certified cheque or money order, do not send cash. All prices on this page are final sale. No warranty. No returns. No refunds but HUGE savings. Warranties available at extra cost.

More lines to serve you better **(416) 960-1350**

Toronto Computing Centre Inc. 310 College Street, Toronto, Ontario M5T 1S3

Our Cover

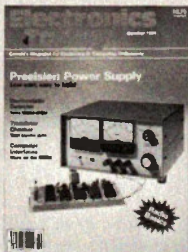

Doug Bedrosian's Precision Power Supply was photographed by Bill Markwick. The printed circuit used as a prop was stolen from the Computing Now! offices.

Electronics Today is Published by:
Moorshead Publications Ltd.
 (12 times a year)
 1300 Don Mills Road,
 Don Mills, Toronto, Ont. M3B 3M8
 (416) 445-5600

Editor: William Markwick
Assistant Editor: Edward Zapletal
Director of Production: Erik Blomkwist
Production: Naznin Sunderji
 Dolph Loeb
 Kevan Buss
Circulation Manager: Lisa Salvatori
Advertising Account Manager: Marlene Dempster

Publisher: H.W. Moorshead; **Executive Vice-President:** V.K. Marskell; **Vice-President - Sales:** A. Wheeler; **General Manager:** S. Harrison; **Controller:** B. Shankman; **Accounts:** P. Dunphy; **Reader Services:** N. Jones, L. Robson, M. Greenan, R. Cree, R. Amann; **Advertising Services:** H. Brooks; **Advertising Telemarketing:** W. Fleet, K. Crockford.

Newsstand Distribution:
 Master Media, Oakville, Ontario

Subscriptions:
 \$22.95 (one year), \$37.95 (two years).
 Please specify if subscription is new or a renewal.

Outside Canada (US Dollars) U.S.A. add \$3.00 per year. Other countries add \$5.00 per year.

Postal Information:
 Second Class Mail Registration No. 3955.
 Mailing address for subscription orders, undeliverable copies and change of address notice is:
 Electronics Today, 1300 Don Mills Rd.,
 Toronto, Ontario, M3B 3M8

Printed by Heritage Press Ltd., Mississauga
 ISSN 07038984.

Moorshead Publications also publishes Computing Now!, Pets Magazine, and Computers in Education.

Circulation Independently Audited
 by MURPHY and MURPHY
 Chartered Accountants.

Electronics Today

Canada's Magazine for Electronics & Computing Enthusiasts

October 1986

Vol. 10 No. 10

Features

Futures Training Program	9
Semiconductor Processing Advances	38
A Guide to IC Numbering	43

Projects

Electrostatic Detector	16
Apple Keyboard Modification	28
Precision Power Supply	31
Low-cost Transistor Checker	53

Product Review

MultiLink Network Software	30
-----------------------------------	-----------

Series

For Your Information	6
Designer's Notebook: Computer Interfaces	21
Beginner's Bench; Basics of Radio	47

Columns and Information

Next Month	11	Subscriptions	46
Books	12	Binders	46
Software	20	Computing Now! This Month	52
Product Mart	45	Market Place	56
Order Form	45	Advertising Index	33

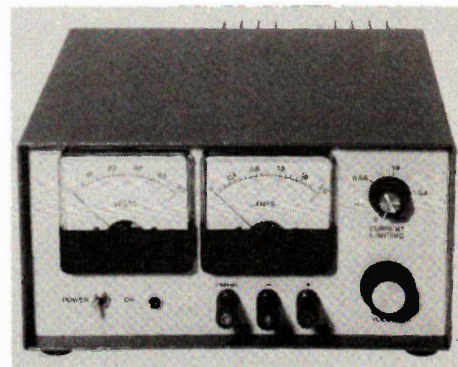
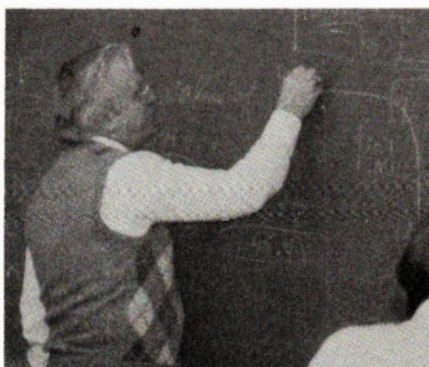

For Your Information

The Editor's Corner

I was thumbing through some 1983 books for a friend of mine who has just acquired a computer, and I was reminded of the hysteria that accompanied the introduction of the personal micro in the early 80s. All the computer companies decided to use the same advertising approach that's used by deodorant and toothpaste sellers: buy our product or you're going to be left out of the human race, you squalid little toad. This worked for a while, until word spread that people's closets were filling up with dusty computers after the kids got bored with PacMan.

Gradually the dust began to settle after a bit of desperation in which the computer companies told you to buy a micro or they'd come around to your house late at night and beat you up.

During this hysteria, I recall watching an educator's forum in which two teachers discussed the computer language of the future. Each presented a coherent, believable argument, one for BASIC and

the other for LOGO. The argument for the school's concentrating on teaching BASIC was that it's the standard beginner's language on every small machine, and the defence for LOGO was ease of use, the fact that the user can define the commands to suit the purpose.

Both points of view were wrong. The "language" of the future is turning out to be a good operating system, misnamed Disk Operating System (DOS) because it actually runs everything from disk accesses to screen display. The early systems such as Apple DOS or CP/M have been succeeded by really sophisticated comprehensive DOS types; the two most popular are MS-DOS (or PC-DOS, the same thing) and various flavors of UNIX.

The majority of people who use personal computers are not programmers and don't care to learn programming. The usual situation is that they run commercial software for word processing, spreadsheets, databases, etc., programs that are very difficult to create or

modify unless you're a specialist. There's more of a need to understand the file-handling features of DOS. If you can get a grip on the basic shuffles going on in the memory map, you can implement small utilities to make computing faster and more flexible; the use of RAMdisks, key-changing macros and windowing comes to mind.

What I've been coming to is this: I'd like to start a series in ET on how MS-DOS works. The aim is not to turn people into programmers, but to demonstrate the writing of simple utilities in 8088 assembly language. All that's needed is a PC-compatible running PC-Dos or MS-DOS, and the assembler programs (MASM, LINK, DEBUG, etc.).

We'll start next month with a program written, dissected and analyzed by Ellery Henn, notable software explainer and former BBS entrepreneur. Then, in the following issues, we'll back up a bit and start from the very beginning, watching some bytes go through the 8088 registers.

We regret that due to production difficulties, the second part of the Marine Security Alarm will be delayed until next month. Our apologies for the inconvenience.

Soltech Systems Inc., formerly Soltech Industries, would like to announce a move to their new premises at 3083 Grandview Hwy., Vancouver, BC 5M 2E4, (604) 439-1289. Please note the new telephone number as well.

In our July test equipment special, we listed some out-of-date information. The distributor for the NORMA line of test gear is in fact Mesurina Ltd., 57 Hyde Park, Beaconsfield, Quebec H9W 5L7, (514) 697-6581.

Under catalogs, we neglected to mention the line of Polar test instruments, represented by Atlas Electronics, 50 Wingold Avenue, Toronto, Ontario M6B 1P7, (416) 789-7761. We'll have more coverage of Polar equipment in an upcoming issue.

Finally, A New Reliable Source For...

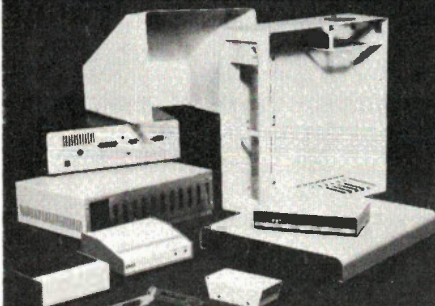

Complete Precision Custom Metal Cabinets Consoles etc.

Specializing in:

- Small/Medium Production Runs
- R&D/Prototype, Development
- Complete Paint Finishing
- Quality Screen Printing
- Contract Sub-Assembly to virtually any level of completion.

In-depth experience and state-of-the-art equipment assure repeatable accuracy of fabricated parts.

Integrated in-house capabilities provide shorter lead times and much lower costs to the Electronic Industry.

Work to military, DIN, VDE, VDI, CSA & NEMA SPECS.

CANADIAN
COMPUTER DESIGNERS MFG.

(416) 673-7773

7150 Torbram Road, Unit # 10,
Mississauga, Ontario, Canada L4T 4B5

32-AMP Insulated Gate Transistor

General Electric Semiconductor has introduced the industry's highest-current MOS-gated bipolar power transistors, rated at 32 amperes.

The devices, designated IG-

8E20, 8D21 and 8E21, are ideally suited to power switching applications at 20 KHz and below, where low conduction losses are essential. Applications could include AC and DC motor controls, power supplies and drivers for solenoids, relays and contactors.

The IGT series provide the high input impedance of MOSFETS, and the low on-state conduction losses of bipolar transistors.

For more information on the IGT series contact: Zentronics, 8 Tilbury Court, Brampton, Ontario. (416) 451-8445.

Circle No. 35 on Reader Service Card.



Copyright

All material is subject to worldwide copyright protection. All PCB patterns are copyright and no company can sell boards to our design without our permission.

Liability

While every effort has been made to ensure that all constructional projects referred to in this magazine will operate as indicated efficiently and properly and that all necessary components are available, no responsibility whatsoever is accepted in respect of the failure for any reason at all of the project to operate efficiently or at all whether due to any fault in the design or otherwise and no responsibility is accepted for the failure to obtain component parts in respect of any such project. Further no responsibility is accepted in respect of any injury or damage caused by any fault in design of any such project as aforesaid.

Editorial Queries

Written queries can only be answered when accompanied by a self-addressed, stamped envelope. These must relate to recent articles and not involve the staff in any research. Mark such letter Electronics Today Query. We cannot answer telephone queries.

Binders

Binders made especially for Electronics Today (ETI) are available for \$9.75 including postage and handling. Ontario residents please add provincial sales tax.

Back Issues and Photocopies

Previous issues of Electronics Today Canada are available direct from our office for \$4.00 each; please specify by month, not by feature you require. See order card for issue available.

We can supply photocopies of any article published in Electronics Today Canada; the charge is \$2.00 per article, regardless of length. Please specify both issue and article.

Component Notation and Units

We normally specify components using an international standard. Many readers will be unfamiliar with this but it's simple, less likely to lead to error and will be widely used everywhere sooner or later. Electronics Today has opted for sooner!

Firstly decimal points are dropped and substituted with the multiplier: thus 4.7uF is written 4u7. Capacitors also use the multiplier nano (one nanofarad is 1000pF). Thus 0.1 uF is 100nF, 5600pF is 5n6. Other examples are 5.6pF = 5p6 and 0.5pF = 0p5.

Resistors are treated similarly: 1.8Mohms is 1M8, 56kohms is the same, 4.7kohms is 4k7, 100ohms is 100R and 5.6ohms is 5R6.

PCB Suppliers

ETI magazine does NOT supply PCBs or kits but we do issue manufacturing permits for companies to manufacture boards and kits to our designs. Contact the following companies when ordering boards.

Please note we do not keep track of what is available from who so please don't contact us for information PCBs and kits. Similarly do not ask PCB suppliers for help with projects.

K.S.K. Associates, P.O. Box 266, Milton, Ont. L9T 4N9.

B-C-D Electronics, P.O. Box 6326, Stn. F., Hamilton, Ont. L9C 6L9.

Wentworth Electronics, R.R. No. 1 Waterdown, Ont. L0R 2H0.

Danocinths Inc., P.O. Box 261, Westland MI 48185 USA.

Arkon Electronics Ltd., 409 Queen Street W., Toronto, Ont., M5V 2A5.

Spectrum Electronics, 14 Knightswood Crescent, Brantford, Ontario N3R 7E6.

Thermistors

If you're looking for positive temperature coefficient thermistors, Fenwal's PTC Posi-Chip line is a silicon semiconductor, non-polarized type in seven resistance values from 50 to 2000 ohms, operating over the range of -55 to 150 degrees C. The normal tolerance is 10 percent, with other tolerances and resistances available on special order. Fenwal Electronics Division of Kidde Inc., 63 Fountain St., Framingham, Massachusetts 01701, (617) 872-8841.

Circle No. 36 on Reader Service Card.

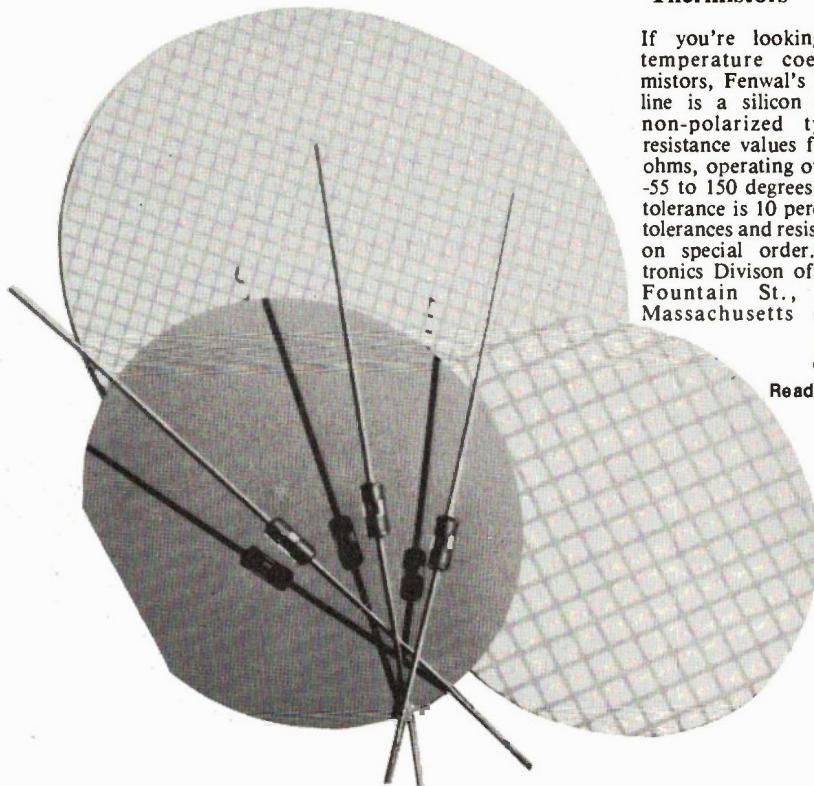

Can you figure out how many years you get from 20,000 hours?

(assume a 40 hour week)

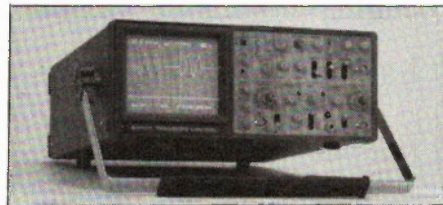

Hitachi Denshi

Who can vouch for Hitachi? — You can!

Just about everybody has experienced the quality of Hitachi products. The Hitachi scopes are of exceptional quality and with a MTBF (mean time before failure) in excess of 20,000 hours, it's not just a matter of opinion. If you're in the market for a scope, you don't have to be a math genius to figure the winner — Hitachi.

The V680 pictured above is one in a series of new readout scopes from Hitachi. This triple channel 60 MHz scope, complete with delayed sweep, cursor measurements and CRT readout, make wave form observation faster and more accurate than ever before. All in a compact 12.2 (W) x 5.1 (H) x 14.6 (D) inch package.

Remember — when you buy Hitachi you're buying a lot of Scope.



Masuko International Corporation
Electronics Div.

50 Alex Avenue, Unit 2, Woodbridge, Ontario Canada L4L 4K6
(416) 851-7764, 1-800-387-5881 Tor: 741-7371

Let us send you more details on the V680 or any of the other Hitachi models. Please specify your requirements and/or applications.

Answer: 20,000 ÷ 40 ÷ 52 = 9.615 Years.

Precision RTD Thermometer

The model A1011 Precision RTD Thermometer from Azonix, is a compact, user oriented instrument designed for precision temperature measurements.

The unit has a 0.001 °C resolution and 0.01 °C accuracy over the full RTD range of -200 °C to +800 °C. The high accuracy is achieved because the RTD probe coefficients such as R₀, alpha, delta, etc. are programmed directly into the unit from the front panel keyboard. Displayed temperature values are mathematically corrected for the individual probe characteristics, and up to four probes can be accommodated simultaneously for multiple temperature measurements.

RS232C or IEEE 488 communications, analog and Delta 'T' measurements are available with the A1011. Displayed values include: probe number, °C, °F, °Kelvin, and Ohms.

For further information contact: Alexander D. Smart Ltd., 351 Steelcase Rd. W., Unit 3, Markham, Ontario L3R 4H9. (416) 474-0550.

Circle No. 37 on Reader Service Card.

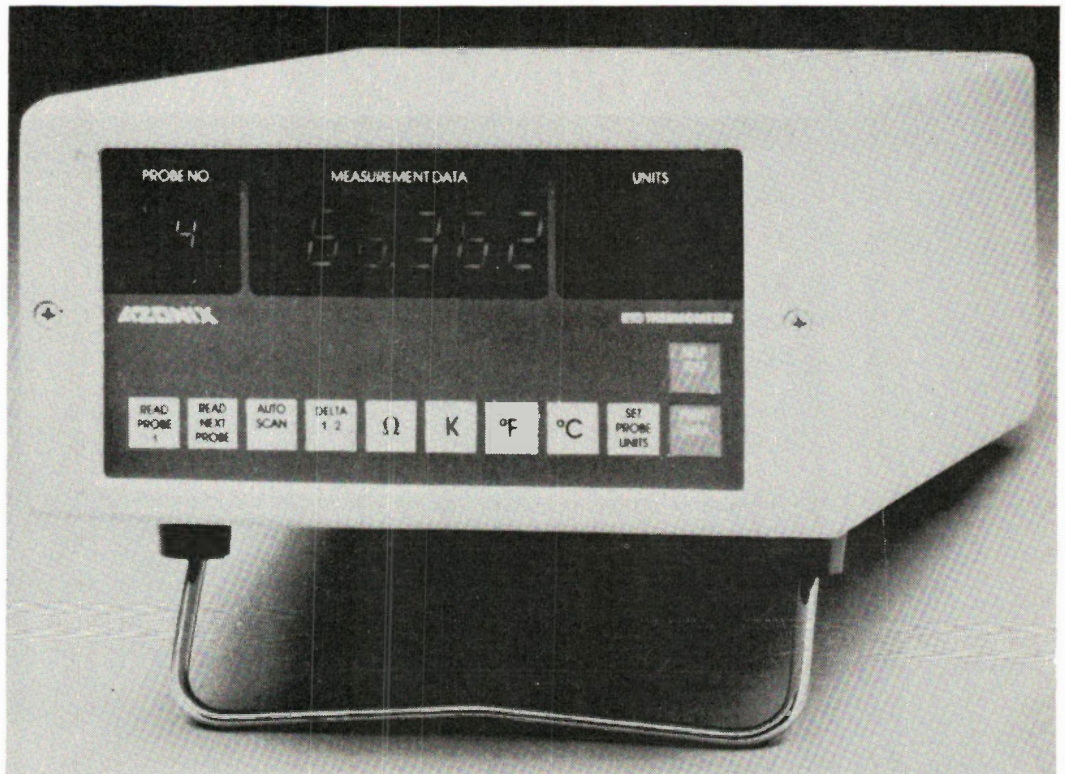

ASSEMBLE YOUR OWN PC & SAVE \$\$\$



COMPLETE AT SYSTEM:

Dual Speed (6/8MHz), 80286 CPU (80287 Optional), 6 16-bit & 2 8-bit I/O Slots, RAM Expandable to 1M, Clock Phoenix BIOS, CGA, 1.2Mb Disk Drive, Hard Disk Controller, Printer & Serial Ports, 192-watt Power Supply, 5150 Keyboard, Case, Assembled, Tested., 1-Year Warranty \$2899.00

AT COMPONENTS:

AT MOTHERBOARDS
Dual Speed (6/8MHz), 80286 CPU (80287 Optional), 6 16-bit & 2 8-bit Slots, Expandable to 1Mb, Clock, Phoenix BIOS, OK \$1299.00

FLOPPY-HARD DISK CONTROLLER
IBM AT-Compatible, 360K/1.2M Floppy & Hard Disks \$599.00

2.5Mb MULTI-FUNCTION CARD
2.5Mb RAM Expansion, Printer, 2 Serial Ports, OK \$329.00

PARALLEL & SERIAL PORTS CARDS \$125.00

KEYBOARD: 5150-type AT Keyboard \$125.00

POWER SUPPLY: 192-watt Side Switch \$239.00

CASE: IBM AT-style Sliding Case \$139.00

DRIVES:
1.2Mb 1/2-Height Floppy Disk Drive \$269.00
CDC WREN HARD DISK, Voice Coil, Park/Lock Head, Ultra Fast Access (20ms), 20Mb Capacity \$1199.00
30Mb Capacity \$1499.00
30Mb Capacity \$1899.00
80Mb Capacity \$2599.00

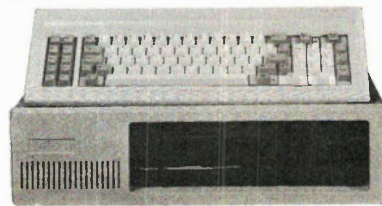

XT SYSTEMS:

COMPLETE STARTER KIT:
4.77MHz, 8088 MPU (8087 Optional), Phoenix BIOS, Hardware Reset, 8 IBM-comp. I/O Slots, 256K RAM Expandable to 640K, Panasonic or Mitsubishi Disk Drive, Printer Port, Color Graphics Adapter, 135-watt CSA Approved Power Supply, 5150 Keyboard, Flip-top Steel Case \$899.00

COMPLETE PRO XT KIT:
4.77MHz, 8088 MPU (8087 Optional), Phoenix BIOS, Hardware Reset, 8 Expansion Slots, 640K RAM, Color Graphics Adapter, 2 Panasonic or Mitsubishi Disk Drives, Printer, Serial & Joystick Ports, Clock/Calendar, 135-watt CSA Approved Power Supply, 5150 Keyboard, Flip-top Case \$1199.00

COMPLETE TURBO XT KIT:
Dual Speed (4.77/8MHz), 8088-2 MPU (8087 Optional), 640K RAM, Phoenix BIOS, Hardware Reset, 8 Slots, Printer, Serial & Joystick Ports, Clock, Color Graphics Adapter, 2 Panasonic or Mitsubishi Disk Drives, 135-watt CSA Approved Power Supply, 5150 Keyboard, Flip-top Case \$1249.00

XT COMPONENTS

MOTHERBOARDS:
XT: 640K Board, Phoenix BIOS, Hardware Reset, OK \$259.00
TURBO: 4.77/8MHz, Phoenix BIOS, Reset, OK \$325.00

VIDEO ADAPTERS:
MONOCHROME GRAPHICS ADAPTER
Hercules-Comp., Printer Port, Runs Lotus \$139.00
COLOR GRAPHIS ADAPTER
IBM-Comp., Composite (Mono & Colour) & RGB Outputs \$115.00
DUAL MODE GRAPHICS ADAPTER
Genoa Spectrum-Comp., Monochrome/Colour Graphics \$329.00
ENHANCED GRAPHICS ADAPTER
100% EGA-Compatible, 256K Video RAM, Flicker-free \$549.00

EXPANSION CARDS:
DISK DRIVE CONTROLLER w/Cable \$ 59.00
384K MULTI-FUNCTION CARD - OK 384k RAM Expansion, Printer, Serial & Game Ports, Clock, Ram Disk & Print Spooler Software, OK \$159.00
MULTI-FUNCTION DISK I/O Disk Controller, Printer, Serial (2nd Optional) & Game Ports, Clock, Ramdisk & Printer Spooler \$ 39.00
PARALLEL PRINTER ADAPTER \$ 55.00
SERIAL COMMUNICATION ADAPTER \$ 89.00
KEYBOARDS: 5150 Enhanced 84-key IBM-type \$139.00
5151 Keyboard w/Cursor Pad \$149.00
POWER SUPPLY: CSA Approved 135-watt \$ 59.00
CASES: Flip-top Steel Case, Side Switch \$ 59.00

DRIVES:
Panasonic or Mitsubishi 360K, DS/DD 5 1/4" Disk Drive \$189.00
20Mb SEAGATE Hard Disk w/WDC Controller \$799.00
MODEM: External 1200 Baud, Hayes-Compatible \$299.00

MONITORS:
12" DUAL MODE SMART MONOCHROME TTURGB compatible \$185.00
14" RGB MONITOR, 0.39 Dot Pitch, Green/Amber Modes \$529.00

GUARANTEE:

- Latest Technology
- Min. 48hr. Burn-in
- Tested Before Shipping
- Prompt Service
- Warranty: 90 Days Parts/Kits
1-Year Systems

ORDER NOW TOLL FREE: 1-800-663-KITS
BUY WHERE DEALERS & SMART BUYERS BUY

CompuKits
4320 Fraser St.
VANCOUVER B.C. V5V 4G3
(604) 879-9288



Futures

Looks To The Future

A training program in electronics with emphasis on practical experience.

By James W. Essex

AS they put it in today's paper: "Futures' means opportunity for youth." Involving a new Provincial program, it offers eligible young people training, even educational upgrading, to prepare for work experience. This is something new to young Canadians who want to work but can't because they lack training and experience. This isn't easy, especially in electronics. Can the government do it?

The history of offering radio/TV courses is not a long one, nor are the years we've actually had electronics many. The heyday of the do-it-yourself repairman, however useful at the time, has long since passed. For those of us oldtimers who for years watched government indifference it wasn't easy. This changing attitude towards the "forgotten man" of the trade was emphasized, for this writer at least, by a local electronics company who faced the problem of what to do to increase the fund of knowledge soon to be required by the advent of colour TV in the 60s. This change in attitude by the larger electronics firms was a precursor of what was to come. It favoured the technician helping himself and thereby gaining fairer and better returns for effort, not to mention gaining a better knowledge of the product serviced. Nor was this limited to their own franchised dealers as one might have thought, but was a carefully designed, concerted educational program for all interested would-be technicians, as well as those already trained. There was, of

Electronics Today October 1986

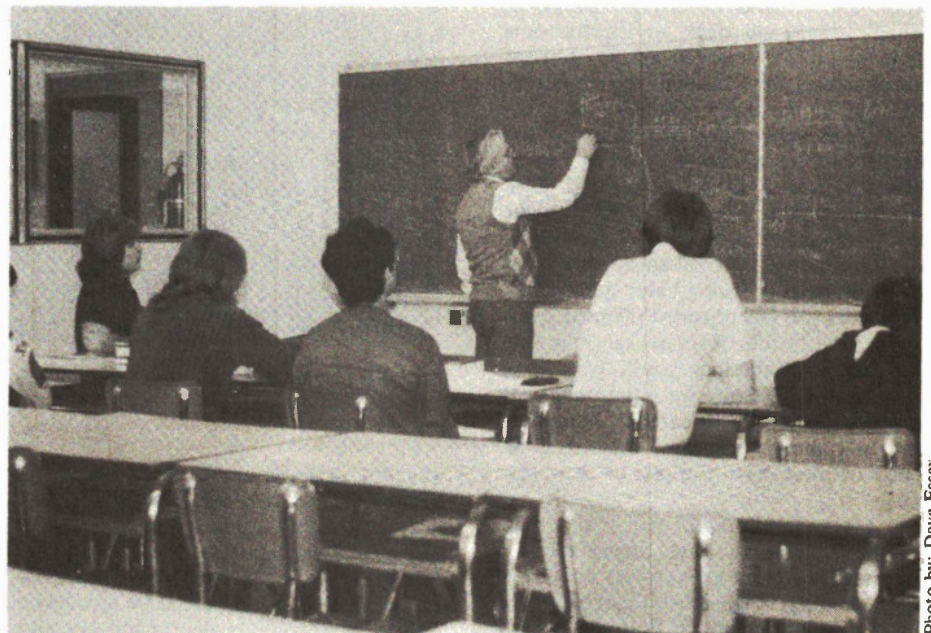

Ray Pierce instructs class.

course, a selfish interest here much as the Futures program incorporates today, though one I find commendable in that Ontario will be able to assure customers top service for their products no matter where in all of Canada. And this is not slanted to one particular electronics company, but runs the whole gamut of electronics anywhere.

A practical application might include instructional material mailed regularly to students. These are people, remember, just off the streets, who may have been out of school for several years and must take a quick turnaround from their perhaps get-rich-quick aspirations and return to the books. As the late Al Kleeger, service engineer for Elec-

Photo by: Dave Essex

trohome's Commercial Service Department and Director of Education in early 1960 put it: "One subject per bulletin per page." This may have included Forward and Reverse AGC, How to identify various transistor circuits, or How to Quick-check the Schmitt Trigger and so on. This way he made the point clear without "a lot of jargon added which may have only confused rather than enlightened". I am pleased to note today many of the late Al Kleeger's Bulletins are utilized by Conestoga College's Futures Program in the 1980s.

I believe this augurs well for this new government program which has taken a leaf from industry's books. This is appropriate, for industry eventually benefits. However, apart from using local College educational facilities, the Youth Futures Program is not an employment agency. As Mr. Ron Morgan, Co-Ordinator for the Waterloo Region's effort, "We aim to put the young (ages 16 to 24) into a Training environment." At the same time, Morgan points out "we don't want to put youth back into the classroom 'just for learnin' but to help them get a job." From this it follows the hiring company has to agree to help further train the person on the job and monitor each and everyone's progress. Which brings me back to Electrohome when color TV emerged as the number one challenge for Canadian electronics industry. The corollary still holds. For example, the upheaval in the color TV industry can be appreciated by a report which appeared in an influential U.S. journal at that time (mid 1960s) "The positive-negative attitude that many service technicians have taken against color has also been a strong sales deterrent." How does the Government propose overcoming this hurdle of similar ignorance on the part of Canadian youth who have come to believe Sony were the only ones to make a color TV or capable of making the ubiquitous earphone receivers so many of them have clapped to their ears today?

First, despite what you may think, there will be no wholesale importation of personnel to man our factories now built or a-building. (Mitsubishi currently are building a local plant in Waterloo which (they claim) will eventually push out over 100,000 color TVs a year, with Canadian help. Aside from their Japanese offices (who will send personnel to learn pertinent points about us) it will be Canadians doing the work. This means training, and lots of it.

The local program is administered from downtown Kitchener. It has started from scratch, although backed by a qualified roster of trained people, and Conestoga College provides the facilities.

Full use is to be made of slides and projection equipment in putting the course across. When I called at Conestoga recently, I watched a course in actual preparation. Mr. Ray Pierce (who I subsequently learned attended HMCS Signal School in St. Hyacinthe where I was an instructor during WW2 and which was then the largest Signal Establishment in the British Empire) lectured at the blackboard, a reverse of roles when he was the student and I the teacher. What I saw best illustrates the educational look of today's electronics. Pierce took time to explain the latest approach to teaching TV, something only glimpsed on the horizon in 1943.

I watched fully "projectionized" slides, larger than life, and which more than adequately illustrated every detail of the emerging world of solid state. This

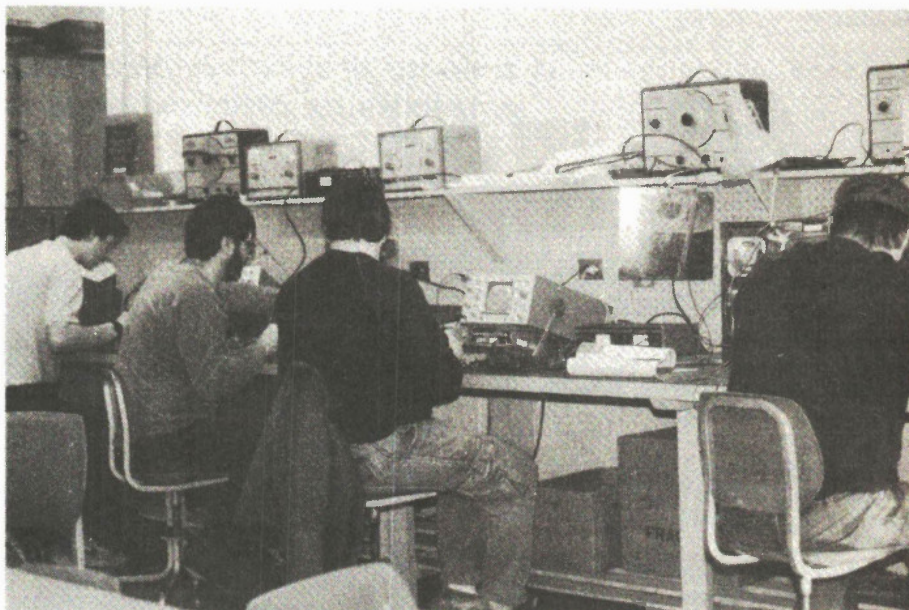

Photo by Dave Essex

Students in "Futures" Program are shown getting "hands-on" experience with an industrial slant...

was not even dreamed of in our time. "Experience is the Best Teacher" is not just an empty phrase here, because teachers of the caliber of Pierce can today easily bridge the gap of what went before and what new developments we now have. This helps provide the new technician with powerful new tools helped by a perspective bridging the old and new.

It is primarily, as Morgan put it, "to train men and women adequately to assure the pre-eminence of their skills. If this philosophy spills over and helps deserving technical aspirants, the Futures Program (electronics is just one facet of a wide range of subjects) is happy to contribute."

However, it is too early to gauge just how well this new effort will assist in-

dustry. They have already had to pull the program on Service oriented electronics because consumer electronics had become saturated. And because the industrial electronics program only began in November of 1985, it's too soon to tell if the industrial approach will do better, even if early indications suggest it will.

Lack of publicity, only now surfacing, has hurt the embryo program. When I visited Raytheon, about to embark on a multi-million dollar Airport Radar rehabilitation program, their communications co-ordinator Susan Cousineau said, "I can't imagine any technician wanting to work for \$4.00 per hour." But Morgan counters with the argument that minimum wage is paid over a 16 week period by the government in return for placing an aspirant in a job. Morgan adds, "By getting them in the door, we hope they will

reflect the time and training we've spent on them and convince the prospective employer they can profit by this pre-training, at no cost to them." Nor are prospective employers obligated to keep trainees if they find they don't measure up. But by the government taking the initial step at their expense, the 'Futures' Program believes it can sell the product of 'future' trainees better. Hence the title.

Several succeeding visits to prospective employers still left the impression that there's still a lack of understanding for the program. Hopefully training, combined with job experience, will lower the gates of prejudice. As one person put it, "We're not looking at Wendy's for job training; we want to be sure with the government bearing the tab, the student

Electronics Today October 1986

will get the training which will benefit the applicant..." There's no Journeyman's program for electronic technician, for example, unlike Mechanical and Electrical Trades which have had them for years. Apprenticeship programs were the stock-in-trade in the railways for years and "This program is a close approximation of that, only in electronics and on that basis it's a selling job we must do," he said.

If I have any criticism for the Program, it would be over the manner of grades. For example, what do you do with

a student (and this actually happened recently) who receives a grade mark of over 71 percent, only to receive a failing mark since a pass required a mark of 75. Remember, these are kids, young people, just off the street; many have been out of school nearly a decade. Yet, despite the fact that they indeed passed (in any High School, 63 is usually a pass) they are rejected from acceptance into a Technical Association merely by the fact they didn't get what is to me an arbitrary pass mark of 75. Think what it must do to their confidence when setting out for the first job

in this hi-tech world not to have that backing which comes from knowing you passed.

I suggest a provisional membership be allowed if the examining body (which incidentally is based in the U.S.) insists on a mark greater than a First Year Engineering grad, who, with some I've seen, may take upwards of several years to cover essentially the same subject spread as 'Futures' aspirants who do it in just under a year. ■

NEXT MONTH IN **Electronics Today**

Fifty Years of the CBC!

Author Jack Brickenden shares his wealth of anecdotes and photographs of Canadian radio and TV broadcasting to mark the 50th anniversary of the CBC.

A Tube Preamp!

Are vacuum tubes really dead? Well, yes. But you can have a bit of fun and nostalgia with the Electronics Today one-tube hybrid hifi pre-amplifier.

RF Oscillators!

The know universe doesn't end at 20KHz. Here's a look at the ways and means used to generate high frequency signals.

What famous cowboy actor was originally known in Canada in the 1940s as the "Voice of Doom"?





ESD Hazard Detector

This device gives warning of any moving electrostatic field which might zap your components.

By Ian Thomas

EVERYONE is aware that on a cold dry winter's day you tend to build up an electrostatic charge on your body so that when you touch some metal object such as a tap or door knob you cop an unpleasant shock. This zap is called an electrostatic discharge and if it happens to jump onto a lead of an IC or transistor, the poor device is never quite the same again. In the last few years it has become more and more commonly recognized that semiconductor devices are extremely sensitive to these stray high voltage transients, and MOS devices more than most. From a manufacturing point of view it isn't so much the outright broken bits that matter (they can be found during test) but the bits that are somewhat bent. They appear to work but will go toes-up after the equipment has been in use for a few days or weeks.

IC manufacturers are aware of this problem and go to great pains to build protection into the devices where pins are connected out. There is, however, a limit to what you can do without degrading the device performance. In general the distributors are pretty good and try to do the right thing; but you, dear reader, may not.

An electrostatic charge is generated when two insulating dissimilar materials are rubbed together or even touched together and then pulled apart. The degree of dissimilarity and the amount of charge generated is a function of the posi-

Continued on page 17

**AN OLD RESPECTED NAME.
A BOLD NEW LOOK.**

Computer Mail Order is one of the oldest computer mail order companies in the country. We've succeeded where others have failed, because year after year, we've delivered to you the most product performance for your dollar and given you the attentive service you desire and deserve. This month we launch a new look. We hope you'll find it as easy on your eyes as Computer Mail Order has been on your pocketbook. We also hope you'll do us the honor of calling us C-M-O.



FINE PRODUCTS.

When you call CMO toll-free, you order from a selection of the finest computer hardware, software and peripherals available. More than 5000 items from the best sources in the business (including PC-TOO,TM the tailor-made clone, direct from CMO!).

FINE PRICES.

Call us. Compare us. Talk to us. We won't hang up. We like talking price as much as we like talking computers.

FINE SERVICE.

We know computers. And we back that product knowledge with our best warranty package ever. And we deliver with next-day shipping on our entire inventory. At CMO, we're committed to keeping you up, running and satisfied.

NO FINE PRINT.

We're CMO. No hot air. No come-ons. No hang-ups. And no fine print. Turn the page. Explore CMO.



HOME COMPUTERS

ATARI

1040ST Colour Sys.	Call
1040ST Mono Sys.	Call
520ST Colour Sys.	Call
520ST Mono Sys.	Call
520ST Basic CPU	Call
65XE 64K CPU	\$149.00
130XE 128K CPU	213.00
800XL 64K CPU	116.00
1010 Disk Drive	79.99
1050 Disk Drive	206.00
1020 Printers	47.75
XM301 Modem	66.00
835 Modem	50.00
850 Interface	197.00
ICD Printer Connection	99.00
Ape face Modem	66.00

COMMODORE

C64 Package	\$ 824.00
C128 Package	1286.00
64C Keyboard	329.00
64C Geos	79.99
128 Keyboard	444.00
1571 Disk Drive	395.95
1541 Disk Drive	316.95
1902 Monitor Colour	494.00
Amiga 1020 5 1/2" Ext.	316.95
Amiga 1010 3 1/2" Ext.	365.00
Amiga 1080 RGB Monitor	477.00
1660 Modem	99.00
1670 Modem	229.95
1530 Datasette	64.00
C128 Univ. Mon. Cable	23.50
C128 512K Expansion	328.95
PP Printer Interface	58.00
XETEC S/Graphics 8K	116.00
XETEC	83.00
Candco Super G	87.99
Micro R & D M.W.350	83.00

SOFTWARE

Paradox/ANSA	\$855.00
DBASE III plus Ashton Tate	650.00
Framework II/Ashton Tate	660.00
Reflex/Borland	145.00
Lightening/Word Wizard/Borland	145.00
Copy II PC/Central Point	42.00
Fastback/5th Generation	142.00
Mouse W/Dr. Halo/IMSI	179.00
General Ledger/IUS	520.00
Super Calc III/IV	487.00
Super Project Plus	474.00
Volkswriter III/Lifetree	232.00
Lotus 1-2-3/Lotus	449.00
Symphony/Lotus	629.00

Managing Your Money/Meca	194.00
WordStar 2000 + /Micro Pro	512.00
Wordstar Pro w/GL Demo	270.00
R:Base 5000	435.00
Micro Soft Word	463.00
Micro Soft Mouse/Serial	222.00
Micro Soft Mouse/Bus.	207.00
Crosstalk XVI	156.00
Multimate 3.3	359.00
Multimate Advantage	457.00
Norton Utilities	75.00
First Choice/PFS	145.00
Professional Write/PFS	190.00
Professional File	236.00
Word Perfect 4.1/Satellite	364.00
Enable/Software Group	588.00
Wordstar 2000	380.95
Wordstar 2000 +	460.00
R:Base 5000	476.00
Clout 2.0	222.00
R:Base System V	555.00
Advantage	428.00
Enable	555.00

Decision Resources

Chart Master	365.00
Sign Master	253.00
Diagram Master	333.00
Map Master	412.00

MONITORS

Amdek

Amdek 310A TTL	\$263.00
Amdek 410 TTL	Call
Amdek 600 RGB	659.00
Amdek 722 RGB	824.00
Amdek 730 RGB	1154.00

Magnavox/NAP

8CM515 RGB Monitor 80	\$477.00
7BM623 PC Monitor 80	164.00

NEC

JB1285 TTL Amber	\$213.00
JB1280 TTL Green	230.00
JC-1401-P3A Multi-Sync	989.00

Princeton Graphics

MAX12 Amber	\$279.00
HX12 16 Colour	708.00
HX12E 64 Colour	823.95
SR12	823.95
SR12E Super Hi-Res	972.00
SR12E RGB Analog	1071.00

Taxon

220 Colour Composite	\$279.00
620 640 x 200	659.00
630 640 x 200	725.00
640 720 x 400	741.00
640 + RGB Hi-Res.	890.00

Zenith

ZVM1220/1230 Mono	\$165.00
ZVM1240 IBM Amber	246.00
ZVM1330 1-3" RGB	758.00

MODEMS

Anchor

Volks Modem 1200 Bd.	\$213.00
Signalman Express 1200 Bd.	329.00
Expressi 1/2 Card 1200 Bd.	246.00
6480 C64/128 1200 Bd	197.00
VM520/520/1040ST Atari	213.00
Omega 80 Amiga	213.00

Everex

Evercom 920 1200 Bd	\$229.95
--------------------------	----------

Hayes

Smartmodem 300	\$229.95
Smartmodem 1200	641.99
Smartmodem 1200B	593.00
Smartmodem 2400	956.00
Smartmodem 2400B	890.00
Smartmodem IIe	246.00

Peripherals

Practical Modem 1200SA	\$296.00
-----------------------------	----------

Quadram

Quadmodem II	\$494.00
-------------------	----------

SVPPRA

MPP 1064 AD/AA C64	\$116.00
1200AT Atari 8 Bit	246.00
1200ST Atari 520ST	246.00

DRIVES

Allied Technologies

Apple Half height	\$174.00
------------------------	----------

CMS

Drive Plus 20M Card	\$635.00
T-120 20MB Tape Backup	746.00
T-160 60MB Tape Backup	1112.00

Everex

60MB Internal Backup	\$1271.00
20MB Streamer Tape	1112.00

I Omega

A210H 10 + 10 Bernoulli Box ...	\$3020.00
A220H 20 + 20 Bernoulli Box ...	3974.00

Indus

Atari GT	\$316.95
Commodore GT	316.95

Mountain

Drive Card-20	\$1096.00
Drive Card-30	1509.00

Priam

ID-60AT Innerspace	\$2145.00
-------------------------	-----------

Racore

1501 Exp Chassls/DMA	\$508.00
2103 512K Memory Card	206.00

Seagate

ST-4026 20MB Hard Drive	\$1096.00
ST-4038 30 MB Hard Drive	1175.95

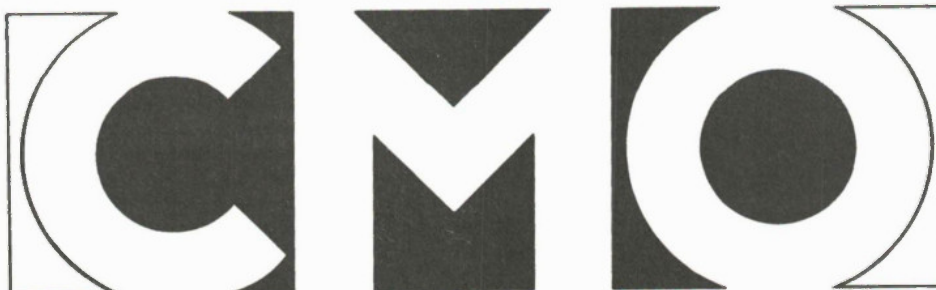

business, person to person.

PRINTERS					
Canon		Amansy		1200-2400 Baud Int. Modem Call	
LBP-8A1 Lazer	\$2846.00	Disk TUB 50 5 1/4"	\$16.99	I/O Board	Call
Citizen		Disk TUB 30 3 1/2"	16.99	XT-512K Expansion	Call
MSP-20 Dot Matrix	\$555.00	Innovative Concepts		EGA	Call
MSP-10 (80 CI) Dot Matrix	476.00	Flip & File 10	\$ 4.50	Serial	Call
Premier 35 LQ Daisywheel	714.00	Flip & File 50	19.99	2 Serial	Call
C-Itch				Parallel	Call
8510-SEP Dot Matrix	Call	MS DOS		Paradise	
Starwriter A10-30	444.00	AT & T	\$2799.00	Modular Graphics Card	\$444.00
Cor Data		Compaq	2499.00	Colour/Mono Card	229.95
The Desktop Printshop	\$3497.00	Corona	1699.00	Multidisplay	263.00
Diablo		IBM-PC	1999.00	Auto Switch EGA	593.00
635 Daisywheel	\$1748.00	IBM-XT	2999.00	Polaroid Palette	
Epson		IBM-AT	4699.00	Computer Image Recorder	\$2309.00
FX-85 Dot Matrix	Call	Leading Edge	2199.00	Quadram	
FX-286 Dot Matrix	Call	Sperry	3199.00	Quad EGA Plus-Graphics	
LQ-800 24 Pin	Call	Zenith	1699.00	Adapter	609.00
LQ-1000 24 Pin	Call	MULTIFUNCTION CARDS		Expanded Quadboard	229.95
Hewlett Packard		AST:		Silver Quadboard	395.00
2686A Laser	Call	Six Pak Plus PC/XT	\$279.00	Quadport XT	213.00
7475S Plotter	Call	Six Pak Premium PC/XT	609.00	Microfazer II	444.00
7550S 8 Pen Plotter	Call	Advantage IBM/AT	559.95	STB	
Juki		Rampage PC/XT	460.95	EGA Plus/Dr. Halo	\$527.00
6000 LQ. Daisywheel	Call	Rampage IBM/AT	791.00	SPECIALS	
6100 LQ Daisywheel	Call	DCA		5th Generation fastback ..	\$141.95
6300 LQ Daisywheel	Call	IRMA PC-3278 I/O	\$1400.95	Amdek 310A Amber	
5510C Colour Matrix	Call	IRMA 3270 Emulations	1319.00	Monitor	229.95
NEC		Everex		Paradise Auto Switch	
P560-660-760	Call	Edge Card	\$395.00	EGA Card	593.00
3550 Spinwriter	\$1239.00	EGA Video	461.00	Hayes-Smartmodem	
8850 Spinwriter	1748.00	EV640 Edge Card	428.00	1200 bd Ext	625.50
DISKETTES		Hercules		CMS 20MB Kit w/west.	
Maxell		Graphics Card	\$329.00	Dig. Cont.	635.00
MD1-SS/DD (10) 5 1/4"	\$19.50	Graphics Card Plus	362.00	Toshiba 1100 + Laptop	
MD2-DS/DD (10) 5 1/4"	20.95	Colour Card	279.00	Comp.	2781.00
MD2-HD AT (10) 5 1/4"	40.00	IDEA Associates		Canon LBP8-Laser Printer	2845.00
MD2E-DS/DD (10) 5 1/4"	Call	IDE 5251 Emulation Board	\$873.00	PCT00 256 EXP 640 -	
Sony		Intel		360K Floppy	824.00
MD1-SS/SD (10) 5 1/4"	\$15.95	AC Above Board 2MB/64K	\$395.00	Curtis SP-1 Diamond	
MD2-DS/DD (10) 5 1/4"	19.95	AT Above Board 2MB/128K	626.00	Surge Protector	48.00
MD2HD AT (10) 5 1/4"	40.00	8087, 80872, 80287, 802878	Call	Magnavox NAP 12" Comp.	
MFD1-SS/DD (10) 3 1/2"	31.00	Video-7		Monitor GR./Amb.	126.00
MFD2 DS/DD (5) 3 1/2"	13.99	EGA Graphics Card	\$543.00	Epson Homewriter 10.	
Verbatim		Vega Video Adapter EGA	560.00	with Pic	158.00
VE-1 SS/DD (10) 5 1/4"	\$15.99	Zuckerboard		Practical Peripherals	
Generic		Colour Card w/Parallel	\$149.00	Promodem 1200	279.00
NT02 DS/DD (10) 5 1/4"	\$ 9.99	Monochrome Card	165.00	Quadram Quadjet 7 colour	
Elephant		576 Memory Card	99.99	printer	296.00
EL2 DS/SD (10) 5 1/4"	\$13.99	Lava		Commodore Amiga 1000	
EI5 DS/D (10) 5 1/4"	16.25	Multifunction C,S,P, 51LK 0K	Call	Colour System	2127.00
EL6 Head Cleaning Kit 5 1/4"	9.75	Intelligence PC/XT	Call		
		Intelligence AT	Call		
		AT-128K Expansion	Call		

When you want to talk computers.

When you want to talk price.

Call toll-free: 1 800-268-4559 Canada, 268-3974 Ont/Que.

Toronto Area Call: 828-0866 Telex: #06-218960

Computer Mail Order Canada 2505 Dunwin Drive, Unit 3 • Mississauga, Ontario L5L 1T1

GET A TAILOR-MADE 20 MEG, XT-COMPATIBLE FOR AS LITTLE AS \$1499

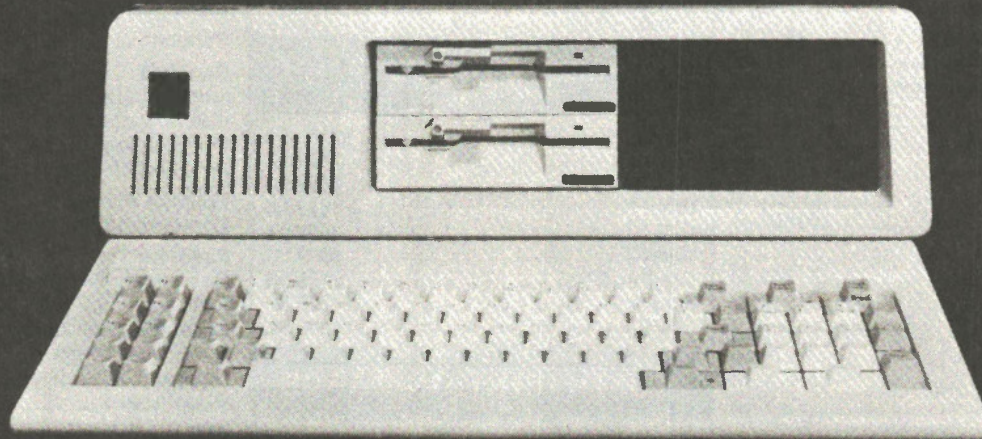

Presenting PC TOO™. Only from CMO.

When you think of tailor-made, you think expensive, right? Think again.

Now CMO can offer you a 20 Mb PC-compatible-one we assemble in our Pennsylvania lab just for you. To your specifications. With the attention to quality and performance you've come to expect from CMO. All for just \$1499.

Every tailor-made clone we make is backed with a full 90-day warranty on labor and parts, a 30 day money back guarantee and easy access to CMO technical support after the sale-the kind that keeps you up, running and satisfied.

For \$1499, you get: A 20 Mb, PC-XT compatible that runs thousands of programs, including Lotus 1-2-3™ ● A 4.77 Mh chip speed. An XT chassis with 256K (expandable to 640K) ● A 20 Mb hard drive ● A 360K floppy drive ● A floppy disk and hard drive controller.

A 150 watt power supply (not just 130) ● Open architecture with 8 expansion slots (not just 7) ● And an 84-key, XT-style keyboard.

Need more power and more flexibility? Call us. Let's talk about your tailor-made PC TOO.

Your options are unlimited.

CMO. Policies and particulars.

Next day shipping on all in-stock items ● Free technical support from our own factory-trained staff. ● Toll-free order inquiry. ● No surcharge on VISA or MasterCard orders. ● Credit cards will not be charged until the order is shipped. ● No limit and no deposit on COD orders. ● No sales tax on orders shipped outside Ont. ● No waiting period for cashier's cheques.

SHIPPING. Add 3% (minimum \$10.00) shipping and handling on all orders. ● Larger shipments may require additional charges. ● Returned items may be subject to a restocking fee. ● All items subject to availability and price changes.



When you want to talk computers.

When you want to talk price.

Call toll-free: 1 800-268-4559 Canada, 268-3974 Ont/Que.

Toronto Area Call: 828-0866 Telex: #06-218960

Computer Mail Order Canada 2505 Dunwin Drive, Unit 3 ● Mississauga, Ontario L5L 1T1

Circle No. 41 on Reader Service Card.

tion of the two materials in an order known as the Triboelectric Series, part of which is given in Table 1. It is also a function of the humidity of the air, intimacy of contact of the two materials and the rate of separation and is in general a pretty inexact sort of thing but there are clear trends. You can see from the table that cotton is pretty much neutral (and hence cotton shirts don't charge up and zap you). In general it's the materials that tend to reject moisture that create the worst charge problems as moisture tends to conduct and bleed charge away.

To give you an idea of the sorts of potentials that can be built up, Table 2 shows the effect of various actions on a dry day and a relatively humid one. It's easy to see why you can get a belt by walking across a carpet on a cold winter's day! A normal human body insulated by your average sort of running shoes has a self capacitance in the order of 100pF. A few quick prods at a calculator shows that the stored energy in your delicate body is about 60 millijoules. A piece of silicon, the dimensions of which are measured in micrometres, is blown to a thin haze!

In general, MOS devices tend to be the most delicate as a fundamental part of their structure is a very thin layer of silicon dioxide which can be absolutely guaranteed to rupture at the order of 100 volts or so. For this reason even power MOSFETs that can cope with tens of amps at hundreds of volts can be ruined by one little zap on the gate lead. This certainly doesn't mean that you can do what you want with bipolar devices. If sufficient energy is dumped into the input junction then the device will fail.

Design

Whenever a body is charged up to a high potential then it is surrounded by an electrostatic field normally expressed in volts/metre, and if the body moves then the field moves with it. If you've just been dancing on your lovely new nylon carpet and charged yourself up to 10 zillion volts then the field from that charge spreads out from your body quite a long way.

It seemed to me that an instrument that detected the approach of this field and sounded an alarm would go a long way to avoiding blasted silicon. At least you would be warned to discharge yourself. It's extremely difficult (read expensive) to detect a completely static electrostatic field, but a moving one is not such a great problem. A simple thought experiment will explain the problem and show how a detector could be built.

Suppose we have two parallel plates of a capacitor magically suspended in space 25mm apart and with an area of about 5000 square mm, a not inconvenient size for a detector. The capacitance between

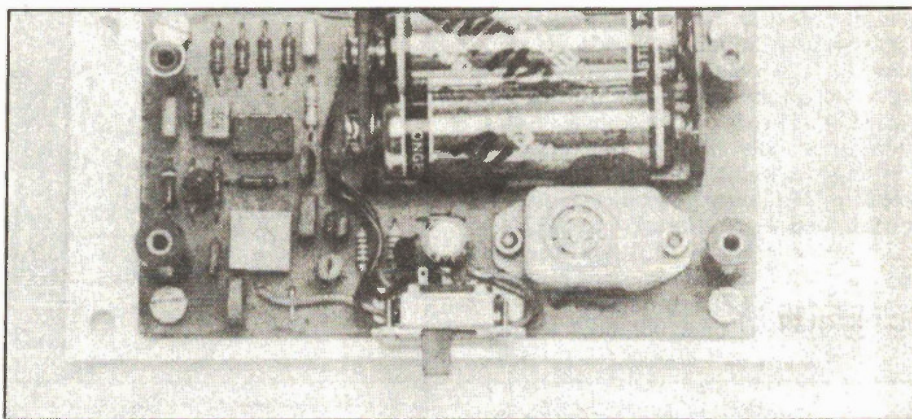

Air	}	POSITIVE
Human skin		
Glass		
Human hair		
Wool		
Fur	}	NEGATIVE
Paper		
Cotton		
Wood		
Hard rubber		
Acetate rayon		
Polyester		
Polyurethane		
PVC (vinyl)		
Teflon		

Table 1

its plates works out to be very roughly 2pF. Suppose a field of 500 volts/metre is suddenly imposed across these capacitor plates (definitely ESD hazard conditions!). The potential between the plates will immediately rise to 12.5 volts (500 volts/metre times 2.5/100 metres). The problem is that any attempt to measure the voltage (cheaply) will immediately bleed the charge away. Even a 10 megohm resistor gives a time constant of only 20 microseconds.

This transient could possibly be detected except for another major problem. The whole world is filled with (it would seem) literally thousands of volts/metre of 60Hz power line hum and if a detector was built with a bandwidth sufficient to detect the spikes then it would be continually set off by 60Hz fields. This means that the detector needed to operate on our parallel plate capacitor must have a filter that cuts off fast before 60Hz. If the detector doesn't respond to frequencies then the input RC time constant needs to be very long, about a second! Hence the problem in building such a device. It must have an incredibly

high input impedance or alternatively huge capacitor plates to up the sensing capacitance. With 2pF input capacitance this gives a detector input resistance of 500 gigohms. Even though the input impedance of some MOS input op amps approaches this figure, it isn't a lot of use as an actual resistor is needed to define reference voltages. As 500 gigohm resistors are just a little hard to buy this basic approach won't work.

It then occurred to me that we were trying to detect voltages in the order of tens of volts. This combined with the fact that these days gain is cheap gave me the clue. If one plate of the sensor capacitor plates was connected to the other through say a 5000pF capacitor then the input tens of volts would be attenuated to fours of millivolts, but then the detector capacitor forms a potential divider with the 5000pF and increases the size of the source capacitance. In this case the needed detector input resistance drops to around 100 megohms to be usable. This is still a bit gross but getting closer. From an engineering point of view you can get 100 megohm resistors but they are expensive and hard to procure. About the largest I could find easily was 10M. There are 22 meg resistors, but I settled for 10M for reasons I'll go into later.

The next problem is how one can magically change a 10 meg resistor into a 100 meg resistor. The method goes by the delightful term *bootstrapping*. Consider a resistor with a voltage applied to one end as shown in Figure 1. The current through the resistor due to the imposed voltage is I. If a buffer amplifier with a very high input impedance is connected to the top of the resistor with a gain of say 0.9 and its output is connected to the ground end of

Means of generation	Humidity	
	10-20%	80-90%
Walking across carpet	35,000	1500
Walking on vinyl floor	12,000	250
Worker at bench	6,000	100
Vinyl envelopes as per work instructions	7,000	600
Common poly bag picked up from bench	20,000	1200
Work chair padded with polyurethane foam	18,000	1500

Table 2

the resistor then the voltage drop across the resistor is no longer V as in Figure 1 but $V-0.9V$ or only $0.1V$. This means that even though the full V volts is being imposed on the resistor, the current flowing into it is only 0.11 so the effective resistance is multiplied by 10. This would seem to be a pretty good trick to use. It does have bad side effects like multiplying all offset problems by 10, but if these can be managed then a 10 meg resistor can be changed into a 100 meg resistor.

As the detector does not need a large bandwidth (in the final device there is a lot of circuitry to reduce it) a very low power op amp such as the National LM4250 can be used. The power drawn by this IC can be set to almost any value required by an external resistor. The op amp bandwidth varies accordingly but even at microamp levels has more than enough. The LM4250 is specified down to 3 volts total supply voltage so the detector could be powered off two penlight cells. If the total IC power drain is kept below a few microamps then the life of the cells in the detector is effectively their shelf life.

Circuit details

The actual filter used to attenuate the 60Hz is straightforward and 10M resistors were used throughout. As there is effectively 30 megohms between the positive input and ground it is necessary to add in about 30 megohms between the negative input and the output to balance the effect of bias currents in the op amp. For the LM4250 operating at a few microamps the offset current (that is, the difference in bias currents of the op amp inputs) is still up to 5 nanoamps. With 30 megohms this generates a differential offset voltage at the input in the worst case of 150 millivolts. This could be adjusted out with an offset adjust pot but the problem is further aggravated by the bootstrapping with R7 and R8. C7 had to be added to remove both the bootstrapping and the high gain for very low frequencies or the input simply floated all over the place.

However, for frequencies between 0.5Hz and 15Hz the detector gain is pretty much flat and set by the ratio of R10 to R7 + R8. When I slogged through the algebra to calculate the transfer polynomial for the circuit, one very interesting fact emerged: the gain of the detector is proportional to the size of C8. You will recall that the input to the detector is actually a capacitive divider made up of the detector plates and C8 so the larger C8 is the higher the input capacitive divider attenuation but then so is the amplifier gain! They cancel out. Most serendipitous. Once again, there are always limits like offset problems that don't show up in the mathematics but basically it's whatever is convenient in the filter for C8.

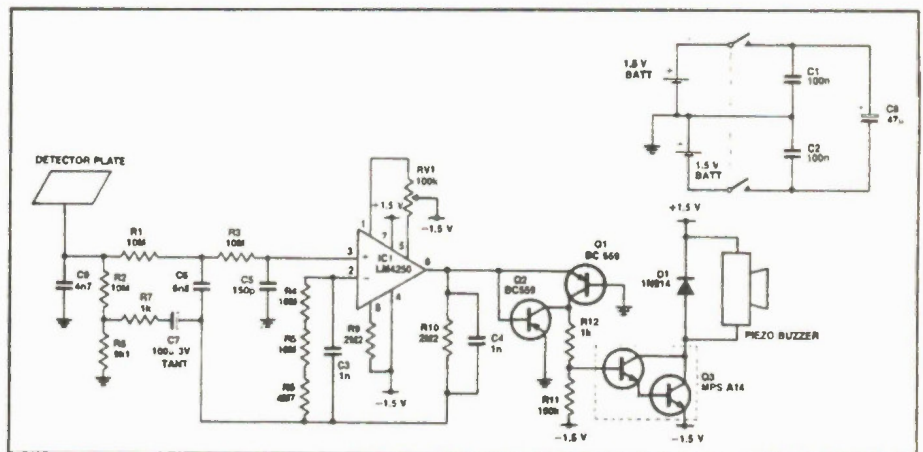
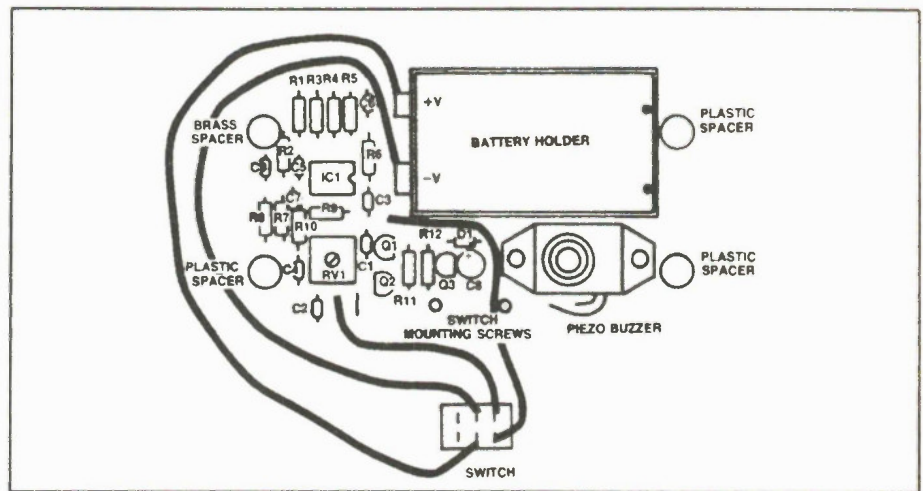

The parts overlay (top) and schematic diagram.

Transistors Q1 and Q2 act to turn on the Darlington transistor Q3 when the op amp output exceeds one V_{be} . I wanted a nice loud alarm when there was a hazard situation so I used one of the small 3 volt self contained alarms. They're nothing if not loud. A quick estimate of the board area showed it would fit nicely into a plastic utility box 130mm x 70mm x 40mm with a metal bottom. The metal case bottom serves as one plate of the sensing capacitor so plastic cases aren't any good.

Construction

Everything is mounted on the PC board, including the batteries. You can copy the artwork provided. However you do it, try to stick exactly to the layout given.

Mounted over the board on 25.4mm spacers is the second plate of the sensing capacitor. Three of the spacers are made of insulating material and the fourth is metal and carries the received voltage to the detector input. The switch is included in case a situation arises where high fields can't be avoided.

Before the board components are assembled it's a smart idea to use it as a template to drill the holes for the base plate and the detector plate.

Make sure that the IC and the electrolytic capacitors are in the right way. The battery case I used was one which held four penlight cells. You can get battery holders that only take two cells but if you look at where the holder is mounted you'll see that it would be impossible to get one of the cells in. The four cell holders come in various brands, some with nickel plated steel contacts and some with aluminum. The aluminum ones aren't so good here as it's necessary to solder to the springs and you can't solder aluminum! It's difficult enough with the nickel.

Carefully cut away the side of the battery holder that doesn't have terminal clips. This will leave you with a spring protruding which should be straightened out. On the piece of holder that was cut away there is a second spring still riveted to the plastic. Drill, bash or bend the rivet out and retrieve the spring. Straighten out the end of the spring that was riveted so it can be inserted in a hole in the printed circuit board. Mix up some epoxy or similar and glue down the battery holder then insert the straightened out spring so as to make a neat two cell battery holder as pictured.

The next and nastiest bit is to solder the nickel plated springs on to the large ground area of the printed board. Nickel is a beast of a material to solder. The buzzer is screwed down and both its leads soldered into the relevant pads. Be careful as the polarity must be right. Finally the board must be cleaned absolutely scrupulously of all flux and residue. There are a lot of high impedances and leakage could be a nuisance.

Testing

Testing is really quite easy. Insert two batteries and turn it on. The alarm should sound for about 20 seconds or so as C7 charges to the offset voltage then it shuts off. Let it settle for a few minutes then measure the voltage between pin 6 of the IC and ground. Adjust RV1 until it averages out to zero. This is a fiddly and odious task as you only have to (literally!) wave your hand near the detector input and pin 6 slams up against the rails. For-

tunately, it isn't all that critical. Once this is done, screw on the detector plate and the unit is ready to go into the box.

Finally before fitting the unit together you'll have to cut a hole for the power switch. It makes sense to drill a few holes to let the buzzer sound out. Slip the unit into the box and screw it in place with the four screws provided then turn it on. If you keep well away from it, it should sound for 10 seconds or so then go quiet. Just waving your hand close over it or touching the box will set it off. Then you may leave it on in a corner of your workbench and breathe a bit easier!

The Circuit

The alarm detects electrostatic fields by sensing the potential difference they generate on a parallel plate capacitor. One plate is the base plate of the case and the other is a plate held by spacers above the detector.

Resistors R1 and R3 form a low pass filter with C5 and C6 to attenuate AC hum. Further attenuation is provided by C4 which rolls off the operational amplifier IC1's response. R7 and R8 serve two purposes. The first is to act as a gain determining element which, together with R10 sets the gain of the op amp at 220. Also the node of R7 and R8 has a voltage of 0.9 times the voltage on the positive input of the amplifier (and the negative input too; such is the nature of operational amplifiers). R2, the input bias setting resistor, is connected to this node so that any signals that appear at the input to the detector are also imposed, multiplied by 0.9, on the other end of R2. This is known as bootstrapping and effectively multiplies the value of R2 by 10.

The overall effect of this is that any voltage that would be induced on a capa-

citor with plates about 20mm apart appears with a low source impedance at the output of the op amp, attenuated 10 times when everything is taken into account.

Transistor Q1 is turned on if the op amp goes more than 0.6 volts positive and Q2 is turned on if it goes negative. Both collectors drive the base of the Darlington transistor Q3 which in turn powers the alarm. Thus excursions of 0.6 volts set off the alarm or, tracing back through the circuit, the detector will pick up fields of greater than 300 volts/metre. ■

Parts List

Resistors

All 1/4W, 2% metal film

R1, 2, 3, 4, 5	10 megohm
R6	4M7
R7, 12	1k0
R8	9k1
R10, 9	2M2
R11	100k
RV1	100k trimpot

Capacitors

C1, 2	100n 10% met poly*
C3, 4	1n 10% met poly*
C5	150p 10% met poly*
C6	6n8 10% met poly*
C7	100u 10% 3V tag tantalum
C8	.47u Al electro
C9	4n7

Semiconductors

IC1	LM4250
D1	1N914
Q1, 2	2N6003
Q3	Motorola MPS-A14

Miscellaneous

2 x AA batteries; battery holder; Piezo buzzer; slide switch; 3 x 25.4mm insulated spacers; 1 x 25.4mm metal spacer; hookup wire; 130mm x 70mm x 40mm case with metal bottom; 5cm x 100cm metal plate.

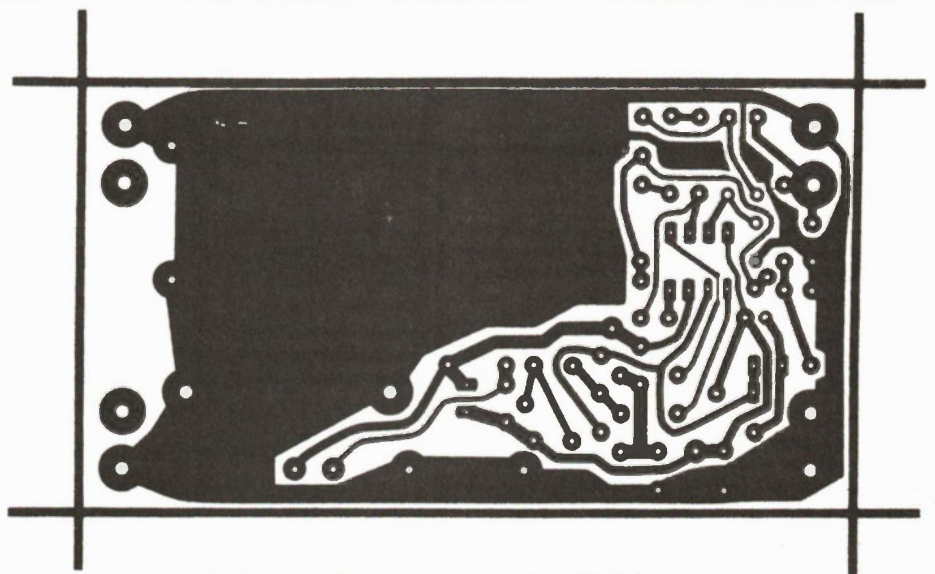
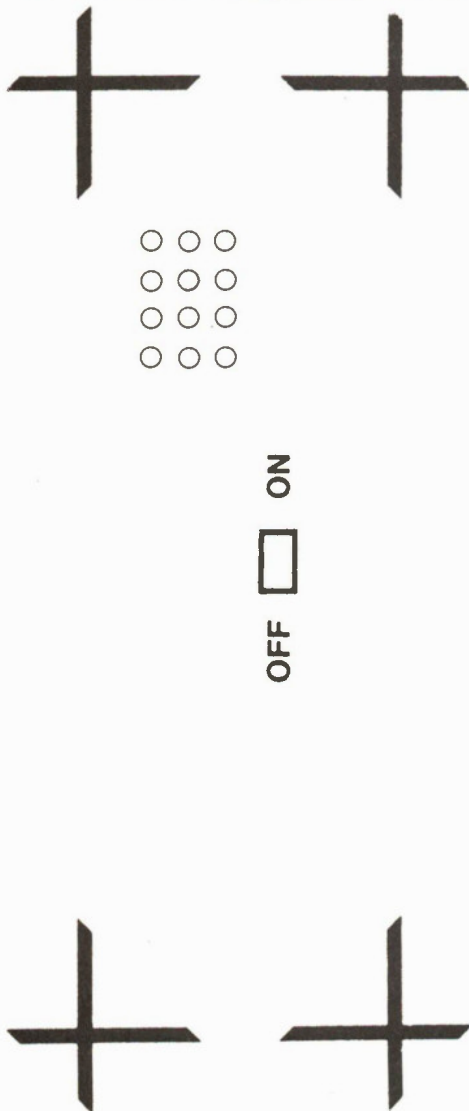

The front panel artwork (left) and the PCB foil pattern.

Almost Free PC Software

Volume XV

Programs to Blow Up Your Monitor With

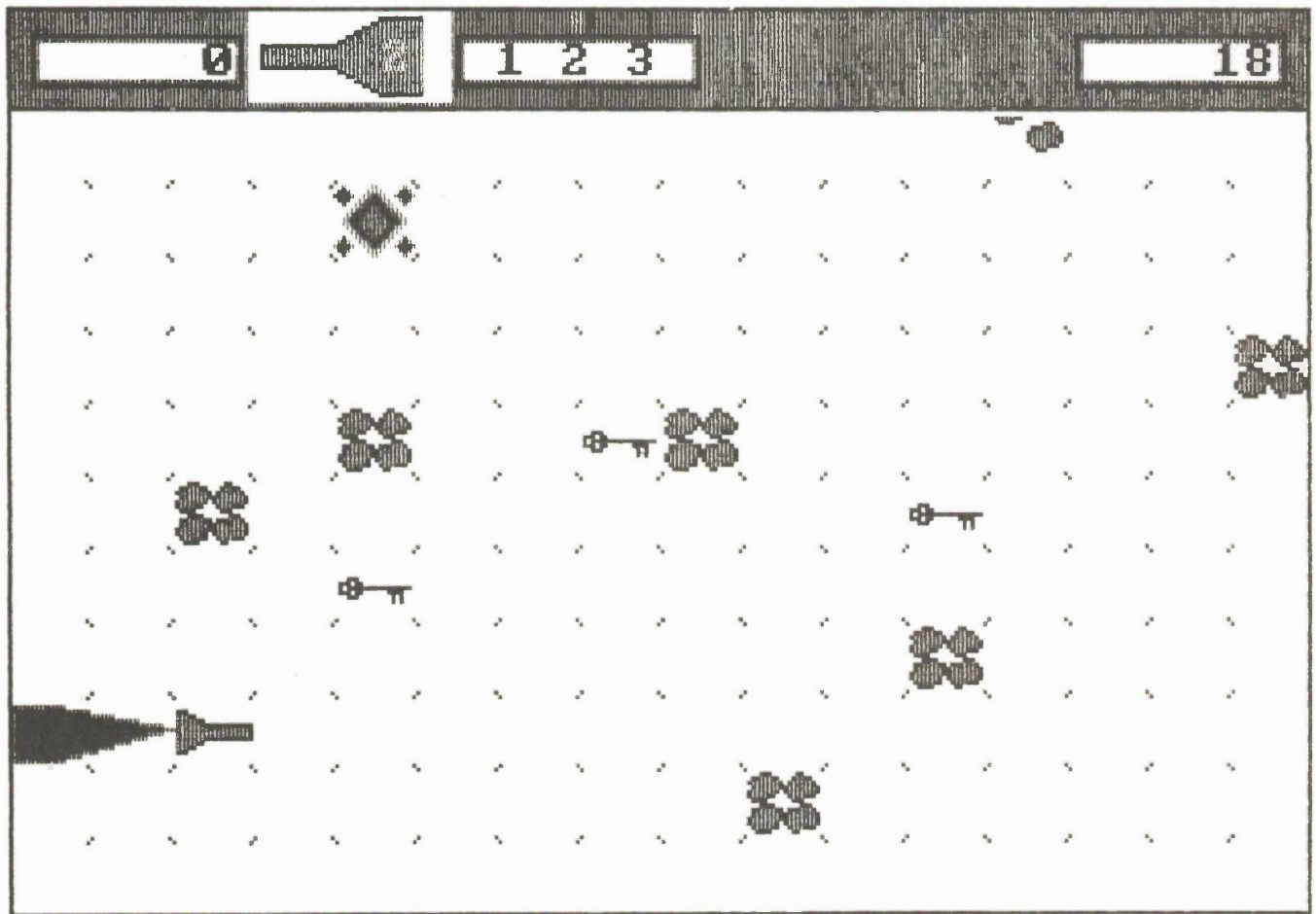

There is a lot of good stuff on this disk... but most important, there are two dynamite games herein. We could get into the graphics package, the CP/M emulator, the fractal program in C... however, it's the games that do it. Plan to lose at least a weekend over this one.

Altamira is one of the nicest public domain paint box programs available for the PC. Unlike most of the so called graphics packages available for the PC, this one isn't restricted to doing bar charts and graphs. It does first rate pictures. Requires a colour card.

Fractal is the source code for the fractal generator in C that we looked at in the August edition of Computing Now!. It's useful even if you don't like fractals, as it illustrates the use of high resolution graphics in C. Requires a C compiler and a colour card.

NEMON is a really weird game. You get stuck in the catacombs of king Nemon with nothing more than your wits and a flashlight. You have to find some keys, some treasures and, hopefully, a way around a host of arcade game nasties.

Thor used to be the god of thunder. Now he appears to be the world's most sophisticated desk calendar program. He'll remind you of appointments, keep track of your agenda and do things that would usually require a host of low tech objects, like pencils and note pads.

Round 42 is a wholly bizarre variation on the theme of space invaders. No longer the dusty arcade game that it once was, this thing breathes new and rather inchorous life into the ceaseless battle between you and the phospor aliens. This is one of the best computer games in creation. Requires a colour graphics card.

V20 is a CP/M emulator for users of the NEC V20 chip. Replace your existing 8088 with a V20, score this little program and most CP/M software will run on your system as if someone had stolen half the bits out of your PC. Regular MS-DOS isn't affected. Requires a V20.

All of this profound software is available for only

\$19.95

plus seven percent Ontario sales tax

from

Moorshead Publications
1300 Don Mills Road
Toronto, Ontario
M3B 3M8

alternately, you can order this disk by phone and talk to a real human instead of a mail box. Dig out your Visa, MasterCard or American Express card and call

1 (416) 445-5600

Fine print: This software has been collected from public domain bulletin boards or written by us, and is believed to be in the public domain. It has been checked for inherent bugs and destructive nasties and, so far as we can tell, doesn't contain any. Please note, however, that we assume no liability for anything these programs do.

Designer's Notebook: Computer Interfaces

The operation and connection of the three most common standard computer interfaces: Centronics, RS232C and IEEE488.

By R.A. Penfold

COMPUTING can be confusing, especially when you try to expand a basic system into something a little more elaborate and useful. There are probably as many different types of interfaces as there are computers, and although there is a vast array of computer add-ons available, only a few percent of these can be used directly with most computers. In fact many machines only have the manufacturer's own variety of interface or interfaces, and will only operate directly with add-ons manufactured specifically for the particular computer (or make of computer) concerned.

However, there are some standard computer interfaces, and fortunately there is a trend towards the inclusion of at least one of these on newly introduced computers. With one of these interfaces fitted there is usually a wide range of suitable peripherals to choose from, and not just one or two manufacturer's-own units. A standard interface does not overcome all interfacing difficulties though, and there can be problems when connecting two supposedly standard and identical interfaces. This is usually just a problem with connecting leads, and is caused by the use of inexpensive connectors at the computer (often just an edge connector formed by the printed circuit board) instead of the correct type called for by the interface specification. For instance, I have come across several home computers equipped with a Centronics-type printer port, but I have yet to see one which has the correct 36-way connector.

In this article we will look at the operation of the three most common standard computer interfaces, the Centronics, RS232C, and IEEE488 types. Hopefully this should help any prospective users to obtain good results when using any of these interfaces, and also to decide which is the most suitable for their requirements.

Centronics

The Centronics printer interface, or 'parallel' printer interface as it is often termed, is probably the best starting point as it is the most simple of the three types. It differs in one important respect from the others in that it is only usable as an output, and it cannot be used to feed data into the computer. This is perfectly satisfactory for use with printers of course, and for some other computer peripherals, but it is unsuitable for an application where two-way communication is required, such as a modem interface.

With the Centronics system the data is sent in parallel form. In other words, each byte of data is sent on eight wires plus a ground line, with all eight bits being transmitted simultaneously. It is worth noting that some computers do not actually implement all eight bits, and that in

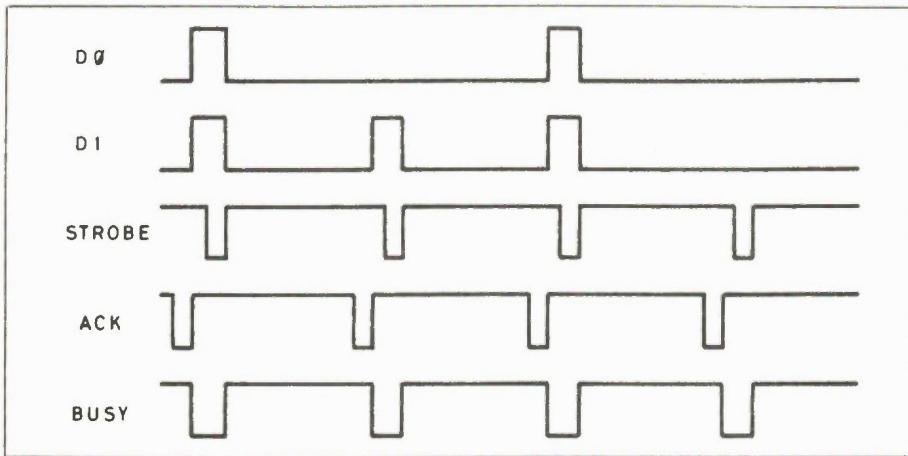

Fig. 1. Centronics timing diagram.

some cases the most significant bit is simply connected to ground. This method is usually satisfactory in practice as the ASCII Codes and ASCII based codes used in most computers only use the seven least significant bits. It can sometimes lead to problems though, as some printers use the eighth bit for control codes, and if the most significant bit is not implemented it is not possible to send these codes.

In practice a simple eight data line plus ground system cannot function properly, as the printer would have no way of determining when fresh bytes of data were available and waiting to be printed. This is overcome by the inclusion of a negative Strobe line, which is another output from the computer. This briefly pulses low each time a fresh byte of data is available, indicating to the computer that the data for the next character to be printed is available on the data lines. The timing diagram of Fig. 1 helps to show the way in which this operates. The printer has an eight bit data latch at its input, and this uses the strobe signal as the latching pulse.

Most computers drive the data lines from latching outputs which remain static between bytes, but this is not strictly necessary as the states on these lines between strobe pulses is irrelevant, and these lines could be used for other purposes during these periods. On the other hand, some home constructor add-ons which are driven from parallel printer ports rely on the port providing latching outputs, and will not work at all with those that do not.

Handshake

The system as described so far will only work if the printer can accept data as fast as the computer can send it. As the computer is likely to be able to send data at a speed of many kilobytes per second it is unlikely that the printer could do so, as even fairly high speed types can only print at around a couple of hundred characters per second. Even if the printer has a buffer, it is still possible that the computer

could output data at an excessive rate for the electronics in the printer, and the buffer might have an inadequate capacity to hold all the data from the computer anyway.

Some means of regulating the flow of data to a rate that can be handled by the printer is therefore essential, and the Centronics system gives two 'handshake' options. These are the Busy and Acknowledge lines. Note that it is only necessary to implement one or the other of these, and while connecting both might not actually cause a malfunction, it would be pointless. Although most (probably all) printers have both Busy and Acknowledge outputs, many computers only have an input for one or other of these.

If we start with the Busy line, this is normally low. When the computer outputs a byte of data the printer sets the Busy output high, and it holds it in that state until processing of that byte of data has been completed. The computer uses a software routine to monitor the Busy line and provide a hold-off until it returns to the low state. The next byte of data is then written to the port, the printer sets the

Busy line high again, and so on, until the transfer of data has been completed.

The Acknowledge line is normally in the high state, and when a byte of data is received by the printer it stays high. It is not until the byte of data has been processed and the printer is ready for the next byte that the Acknowledge line is pulsed low. The software routine in the computer must therefore monitor the Acknowledge line and provide a hold-off until the negative pulse is detected.

In practice you might find that the handshake input of the computer, regardless of what it is called, will operate with either handshake output of the printer, or even that it will only operate with the wrong one. This occurs because, as can be seen from Fig. 1, the Busy and Acknowledge signals are quite similar. What tends to complicate things slightly is that there seems to be less than total agreement on the correct polarity for the handshake signals. In some cases it might be necessary to invert the handshake signal in order to obtain satisfactory results, but in most cases a suitable handshake connection (even if it means resorting to cross coupling of Acknowledge and Busy) can be found.

Connector

The standard connector for the Centronics printer interface is a 36-way Amphenol type, but these are often sold simply as 'Centronics' plugs and sockets. Printers are fitted with sockets incidentally, and a 36-way Amphenol plug is therefore needed to make connections to a printer fitted with a Centronics interface.

Fig. 2 shows connection details for a standard Centronics interface (and 36-way Amphenol connector). There are several connections here which have not been discussed so far, but probably the only ones of these that you will need to use are

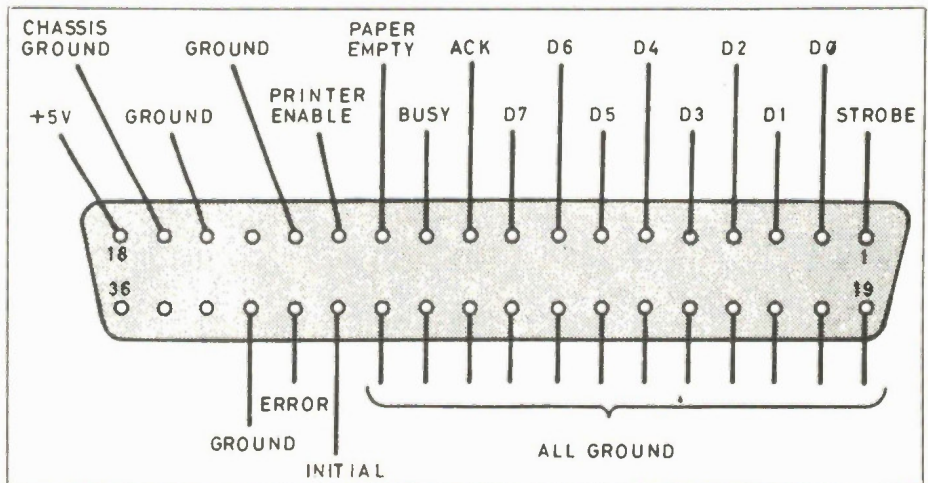

Fig. 2. Connection details for a standard Centronics interface.

the ground connections. There are a number of these, and this is done purposely so that they provide shielding between the signal lines of the ribbon cable used to connect the computer to the printer. Otherwise there is a danger of stray capacitance in the cable causing signals to be coupled from one lead to another, generating corruption of the data. Even with these shielding leads the maximum recommended cable length is only two metres. In practice there is usually no problem if a single ground lead is used, but the cable length is restricted to only about half a metre or so.

The other lines are provided on most printers, but are all absent from the printer ports of most home computers. The Error line is an output from the printer which simply goes low if an error condition occurs. This can be monitored by the computer and used to halt the flow of data when an error occurs. The Initial terminal is an input to the printer, and after an error condition has occurred the printer can be reset by a low pulse fed to this input. An alternative which can be used where Initial is not implemented on the computer is to just turn the printer off and then on again.

Paper Empty (or Paper End as it is sometimes termed), as its name suggests, goes low to indicate that the printer is out of paper. This feature is one which is only likely to be implemented on a printer with a cut sheet feeder, although it is a feature of some tractor feed printers. Print Enabled is an output which goes high when printer is selected (if it has a select/deselect switch). The output is a +5V DC supply which can normally provide currents of up to about 100 milliamps.

The facilities available vary slightly from one printer to another, and a clock signal of some kind is sometimes available at one of the normally unused pins. An input to give an automatic double line feed is another line which is sometimes included, either at one of the normally unassigned terminals or in place of one of the other minor facilities. Every printer should be supplied with a manual which gives at least basic details of its input port and the exact facilities it provides.

Serial Interfaces

The RS232C is the best known type of serial interface, but there are several other types that are really just variations on the same basic system. The RS232C and RS423 systems are compatible with one another and it makes little practical difference which one your computer has.

With a serial interface the signal is carried on just one data line plus a ground lead. Obviously no more than one bit at a time can be carried by the single wire, and

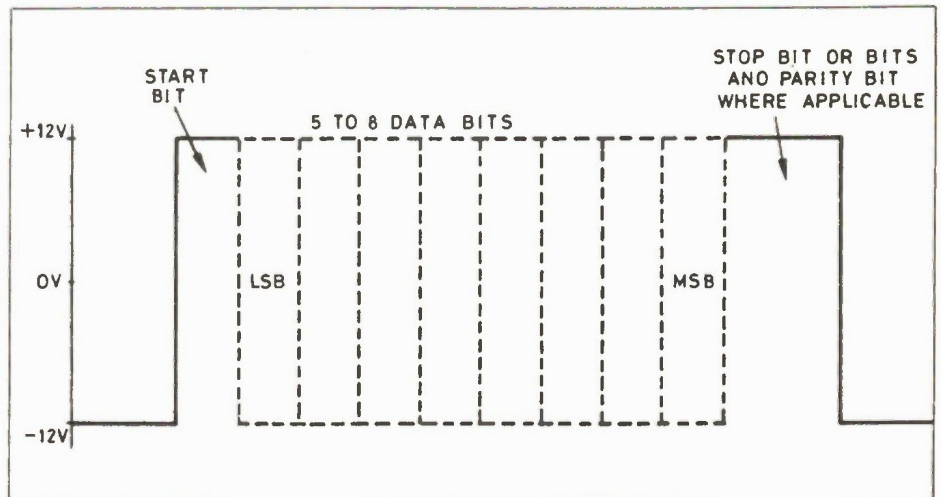

Fig. 3. The make up of an RS232C byte.

each byte therefore has to be transmitted literally bit-by-bit. The convention is for the least significant bit to be transmitted first, running in sequence through to the most significant bit which is transmitted last. Simply transmitting bursts of data in serial form is of no practical value, since there is no way for the receiving equipment to correctly interpret what would appear to be just a random series of pulses. One way around the problem is the synchronous approach where a third line is used to carry some form of synchronization signal. For instance, this could be a sort of clock or strobe signal to indicate the times when the data line should be sampled to determine the state of each bit.

Asynchronous

Synchronous interfaces are used in practical systems, but they seem to be in the minority, and most serial systems, including the RS232C and RS423 ones, use the asynchronous approach. Rather than relying on an additional signal line an asynchronous system uses extra signals on the data line. The most important one of these, and the only really essential one, is the start bit. Under standby conditions the data line is in the low logic state, but at the start of a byte it goes high for a certain period of time. This change in state indicates to the receiving equipment that a byte of data is about to commence, and that it must sample the data line at regular intervals thereafter until the state of each bit has been determined.

All practical asynchronous systems seem to use an additional bit or bits at the end of each byte, and these serve as a form of error checking. There is always at least one stop bit, and sometimes two stop bits are used. The data line is simply set high for a period of one or two bits, as appropriate.

Some systems use parity error check-

ing, or at least have the facility to do so. It is a system which seems to be little used in practice. With parity error checking each byte always contains either an odd number of 1s or an even number of 1s, depending on whether odd or even parity has been selected. Obviously either an odd number of 1s in every byte or an even number of 1s in every byte is something that will not happen without some assistance from the hardware, and this assistance takes the form of an additional high bit (the parity bit) added between the last data bit and the first stop bit, when necessary. A simple flip/flop circuit at the receiving equipment is practically all that is required to provide parity checking and to indicate any errors that occur. Parity checking is not infallible, and a double glitch can preserve correct parity but corrupt the data.

Fig. 3 helps to clarify the way in which an asynchronous system operates. An important point to note here is that the voltage levels are not ordinary 5V logic types, but are nominally -12V and +12V. In fact the maximum acceptable voltages are +25V and -25V, but the standard calls for a minimum of just +3V and -3V. The RS423 system has nominal signal levels of plus and minus 5V (plus and minus 4V to 7V is the acceptable range), together with higher drive current (150mA maximum instead of 10mA) and less stringent demands with regard to rise and fall time. This gives somewhat greater operating range for a given baud rate, but the RS423 system is compatible with RS232C equipment. In practice standard 5V logic levels will often drive RS232C and RS423 inputs satisfactorily, but this cannot be guaranteed to work in every case. An RS232C or RS423 output should not be used to directly drive an ordinary logic input as this could lead to the destruction of the input device.

Signal Polarities

Incidentally, serial interface explanations sometimes show the signal polarities as the opposite of those shown in Fig. 3 with the signal at +12V under quiescent conditions, and going to -12V during the start bit. Measurement on RS232C and RS432 interfaces seem to confirm the polarity indicated in Fig. 3. The confusion probably arises because serial interface devices do require and generate signals of the opposite polarity to that shown in Fig. 3. However, they are intended for use with line drivers and receivers that provide the necessary level shifting, and also provide and inversion of the signal. Not all serial interfaces use special interface devices to generate and decode signals, but instead rely on ordinary digital input and output lines plus suitable software routines to generate and decode the signals.

As will probably be apparent, wiring two serial interfaces together correctly will not necessarily give a proper transfer of data from one unit to another. To ensure correct data transfer both pieces of equipment must be set to use the same word format. The most common of these is one start bit, eight data bits, one stop bit, and no parity (which is the standard format for RS423 equipment). There are several others in common use though, and apart from the options of one or two stop bits, and odd, even, or no parity, five, six, seven or eight data bits can be used. In computing applications only seven or eight data bits are normally encountered, since ASCII and ASCII-based character codes require at least seven data bits; five data bits might also be encountered though, as five-bit word formats are used in radio communications (RTTY) systems.

There is another factor to take into account, and this is the rate at which data is sent. Obviously the receiving equipment must sample the data line at the appro-

priate intervals after the start bit has been detected if each bit is to be decoded properly. In order to ensure correct synchronization of the transmitting and receiving circuits there are a number of standard transmission/reception rates. These are 45.45, 50, 75, 150, 300, 600, 1200, 1800, 2400, 4800, 9600 and 19200 baud. The baud rate is the number of bits sent per second if a continuous data stream is transmitted. It is no coincidence that the higher baud rates are multiples of the lower ones (with the exception of 45.45 which is only used in amateur RTTY systems), and this enables a single clock oscillator plus binary divider chain to provide virtually a full range of baud rates.

The RS232C system is guaranteed to operate at up to 20k baud over a distance of 5 metres. Capacitance in the connecting cable could distort the signal and cause corruption of the data if higher baud rates and (or) longer cables were to be used. On the other hand, at low baud rates of around 75 to 1200 baud it is feasible to use connecting cables much longer than 15 metres. For communications over very long distances the serial signals are normally tone encoded at the transmitter and then decoded again at the receiver, as in a modem system. There is actually a form of serial interface (the RS422 system) which can handle baud rates of up to 10M baud over short distances, or up to 100k baud over a range of up to 1200 metres. This is achieved using a balanced (two signal wire) system, but it has made no impact in the home computing field as yet, and for most purposes the RS232C and RS423 systems are perfectly satisfactory.

Interconnections

At the most basic level RS232C interconnections just consist of two wires, one to connect the two signal grounds, and the other to connect the data output of the

transmitting device to the data input of the receiving device. For two-way communications three wires are required, a ground connection and two leads to cross-couple the data inputs and data outputs of the two devices. In other words, a separate signal wire is needed to carry signals in each direction.

Serial data systems are relatively slow, and handshaking to control the flow of data is sometimes unnecessary. Typically ten bits per byte are transmitted, which at 300 baud corresponds to a maximum transfer rate of just 30 characters per second. However, at high baud rates the transfer rate can be around one kilobyte per second or more, and some applications do require handshaking to be implemented. THE system of handshaking is very simple, and just requires one extra connecting lead (or two in a two-way system).

At the receiving equipment the handshake line normally implemented is DTR (data terminal ready) which connects to CTS (clear to send) of the transmitting equipment. DTR goes positive to indicate that the receiving equipment is ready to receive data, or negative to provide a hold-off. RTS (request to send) may be implemented in place of DTR, and DSR (data set ready) may be present instead of CTS, or you may have all four available. At a practical level it is often a matter of trying out a few options to determine which handshake arrangement gives correct operation, but a typical setup providing two-way communication with full handshaking would use a five-wire arrangement something like that shown in Fig. 4.

A point which is well worth noting is that it is sometimes necessary to implement handshaking even where it will not provide any regulation of the data flow. This occurs where a piece of equipment will not provide any output unless its handshake input is taken to the appropriate signal level.

RS232C Connectors

The standard RS232C connector is a 25-way D type, and this uses the method of connection shown in Fig. 5. Some of the pins are unused, and in practice, even if the port uses the proper type of connector, only the ground, main signal, and main handshake lines are likely to be implemented, with the other terminals just being left open circuit. The Sinclair QL, for example, only implements ground, data in and data out, CTS, DTR, and a +12 volt line to act as a dummy DSR line (for use with equipment that requires the handshake input to be taken positive in order to enable output). While this falls well short of the full RS232C standard, it

Continued on page 26

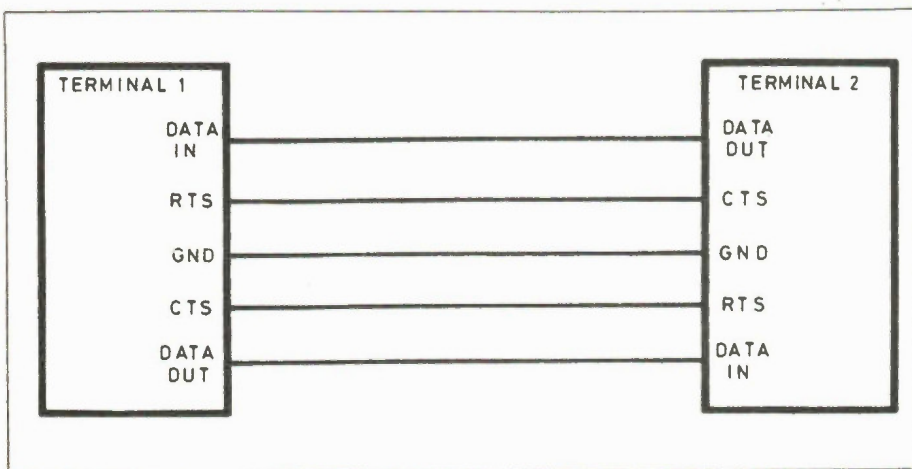
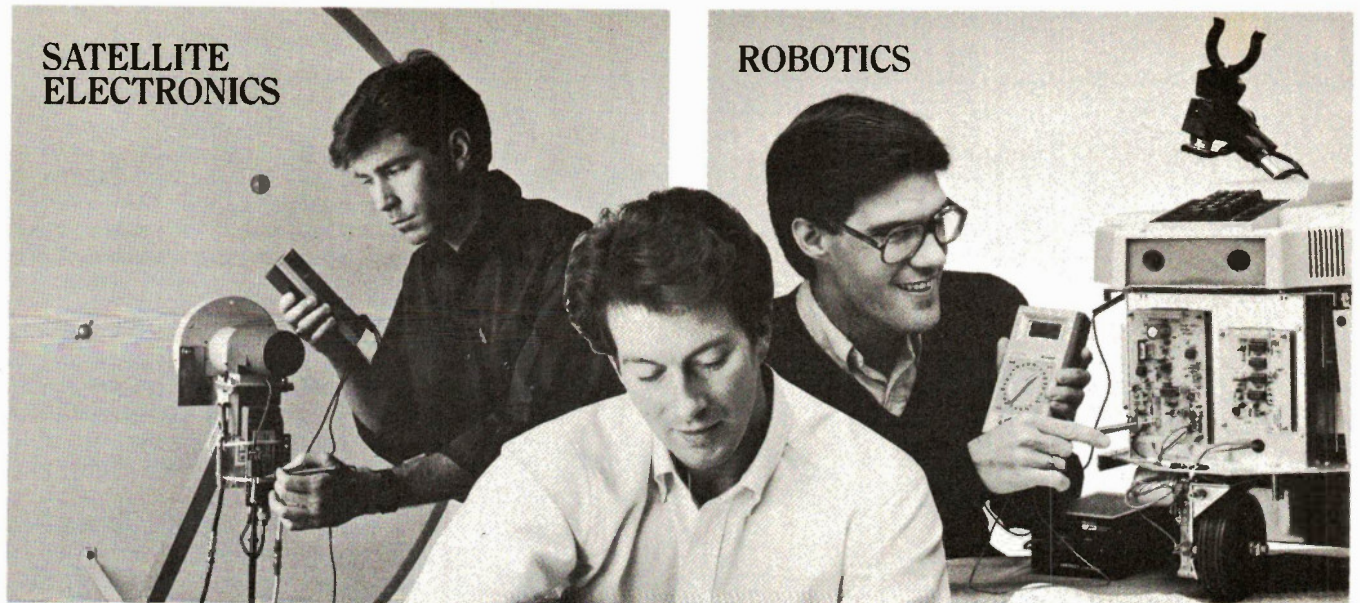

Fig. 4. A typical five wire serial interconnection system.

SATELLITE ELECTRONICS

ROBOTICS



**Catch the Excitement!
Today, High-Tech Job
Opportunities are
Everywhere!**

Now you can take control of your future with NRI's newest hands-on training and carve out your own place in today's electronics world. Select a new career field or start a business of your own. Now the choice is yours. And only NRI gets you where you're going with the *latest* professional instruments and test equipment you build and keep as you learn at home.

No other school of its kind has prepared so many people for successful careers in electronics. For over 70 years, NRI technical engineers and educators have demonstrated a unique ability to spot and anticipate the important technological trends, then develop state-of-the-art training that's prepared over 1.3 million ambitious people for successful careers in each new emerging field.

Now NRI presents *three* new state-of-the-art training opportunities in today's fastest growing electronics fields.

Build Your Own IBM-Compatible Computer as You Learn *Digital Electronics Servicing*.

A brand new course for an exciting new field... servicing computer peripherals (disk drives, printers, display terminals, modems, etc.) and the latest digital equipment found in industry today. Job opportunities for the trained digital technician have never been greater. It takes skilled personnel to keep today's digitally automated production lines and manufacturing equipment rolling. NRI trains you to be a high-demand digital technician or prepares you for your own independent service business.

As you learn, you'll get practical hands-on experience building your own 128K computer and disk drive. You'll also build, and learn to use and service, your own triggered-sweep oscilloscope, digital logic probe, and digital multimeter... instruments used by today's



DIGITAL ELECTRONICS SERVICING

Only NRI trains you for so many careers on the leading edge of today's electronics revolution.

electronics professionals.

You'll receive and learn to use NRI's specially developed diagnostic software programs that show you how to troubleshoot and service today's peripheral and digital equipment... another NRI "hands-on" exclusive. When you select NRI's training in Digital Electronics Servicing, you'll be preparing yourself to move into one of today's hottest careers!

Build an Operating Robot as You Learn *Robotics and Industrial Control*.

Already, advanced robotics systems are producing everything from electronic circuits to automobiles. By 1990, over 100,000 "smart" robots will be in use, creating over 30,000 new technical jobs.

NRI trains you to operate, program, service and troubleshoot industrial robots as you build your own remote controlled, programmable

mobile robot. You get professional instruments and up-to-date training to prepare you to handle the technology that's changing the face of industry today.

Install and Troubleshoot Your Own Home Satellite TV Equipment as You Learn *Satellite Electronics*.

You've seen them in backyards, beside motels, atop office buildings, and in military installations—those sensitive dishes reaching out for TV programs, computer transmissions, data signals, and messages of all kinds from the growing number of satellites stationed 22,300 miles above the earth. Now NRI training can get you in on the ground floor of a new career or even a business of your own in this exciting new growth field.

NRI trains you to service consumer TVRO systems, as well as the larger commercial and military equipment used to transmit and receive worldwide communications: news, weather, national security & defense transmissions and all types of voice, data and video signals.

Learn to install satellite systems... adjust, troubleshoot and repair dishes, amplifiers, converters, antennas and receivers. And get "hands-on"

experience as you install your own satellite TVRO system that will bring TV signals from around the world into your home.

Send for Free Catalog of High-Tech Career Opportunities.

Now you, too, can catch the excitement. Just send for your free copy of the 100-page NRI High-Tech Electronics Careers catalog. See the future open up for you as you explore exciting new opportunities for higher pay, advancement—even your own business. Review the complete descriptions of the training you get, the equipment that makes each opportunity come to life. Send today and get your start on tomorrow. If the card is missing, write to us.

NRI SCHOOLS

McGraw-Hill Continuing Education Center
330 Progress Avenue
Scarborough, Ontario M1P 2Z5
or telephone 416-293-8787

We'll Give You Tomorrow.



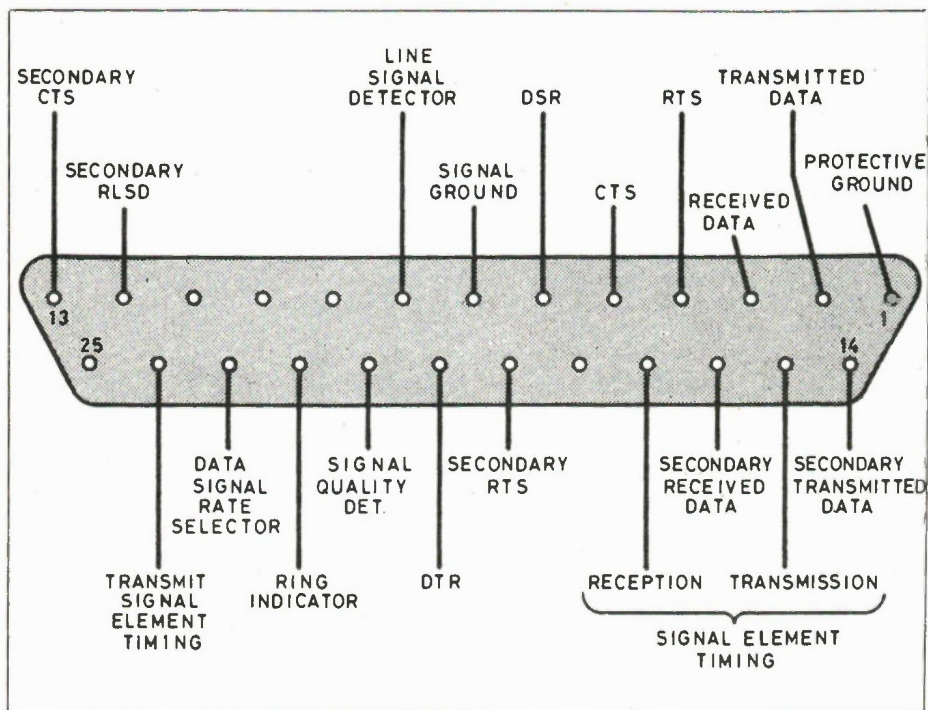

Fig. 5. A full RS232C interface uses a 25-way "D" connectors as shown here.

is perfectly adequate in normal use.

The original idea of the RS232C standard was to have two types of equipment, data communications equipment (DCE) and data terminal equipment (DTE). Data terminal equipment is the normal type, and it transmits on the data output and receives on the data input. With data communications equipment things are reversed, with transmission on the data input line and reception on the data output. The handshake lines are similarly reversed. This may seem a rather strange way of doing things, but the idea is to enable a piece of DTE equipment to be connected to a piece of DCE equipment using a standard 25-way D to 25-way D cable without the need for any crossed connections. This works fine if you have two suitable pieces of equipment, and some computers helpfully provide two serial ports, one DTE configured and the other DCE connected, so that they can be connected to any item of RS232C equipment (provided it has the correct type of connector) using a standard lead and the appropriate one of the two ports. Obviously some care needs to be exercised when interconnecting serial ports, but outputs have current limiting and if two outputs should be accidentally connected together it is unlikely to cause any damage.

IEEE488

The IEEE488 (or IEE488 as it is often but incorrectly called) is a much more complex form of interface than those described previously. Paradoxically it is the one which, on the face of it, readers of this

magazine would find most useful, but is also the one which few are ever likely to use. Its main application is in the field of automatic test gear and other scientific equipment, but the cost of the sophisticated equipment which uses this interface is quite high and beyond the means of most amateur users. Hopefully, the cost of such equipment will fall to a more affordable level in the future, or low cost surplus equipment will become available.

This type of interface is also used to some extent with such things as plotters and disc drives. Although I know of no home computer that is equipped with an IEEE488 interface, add-on types are available for some computers.

The IEEE488 interface is a parallel type with data carried on eight lines. It permits up to fifteen devices, including the controlling computer, to be interconnected in either the linear or the spider arrangement. There are three categories of device which are termed 'talkers', 'listeners', and 'controllers'. The controller is the one at the heart of the system which would normally be a microcomputer or minicomputer, and there can only be one controller per system. A talker is one which is set to output data onto the eight-bit bus, and a listener is one which is set to receive data.

Many devices are actually talkers and listeners (including the controlling computer), but they can only provide one action at a time, and there can only be one talker in the system at any one time. This is analogous to the internal structure of a microcomputer where various input/output devices are connected to the data bus, and the control and address buses ensure that only one device at a time outputs data onto the data bus.

Being a parallel system only short connecting leads are permitted, with a maximum individual cable length of four metres. In a system the maximum cable length is two metres per device or a total of 20 metres, whichever is shorter. The advantage of using a parallel system is the high maximum data transfer rate of up to 1M byte per second.

In addition to the data lines there are three handshake lines and five control lines. This may seem to be rather a lot, but it is a sophisticated setup in which each device has an individual address so that data can be directed to just one device. Furthermore, devices can have secondary addresses. One way in which this can be used is to enable the operating mode of a device to be varied, depending on the

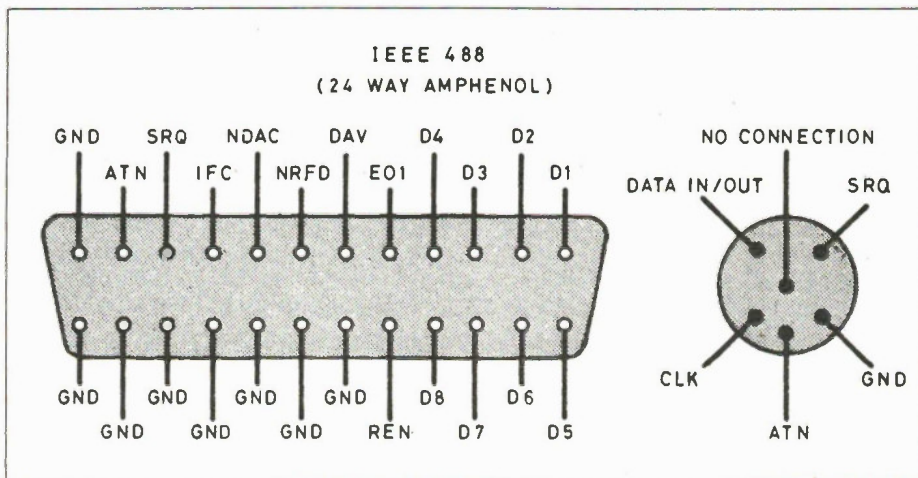

Fig. 6. The IEEE488 parallel port connections, and the "cut down" Commodore serial version.

secondary address to which data is written. For instance, a multichannel digital analogue converter could have a different secondary address for each channel, giving easy access to each channel. Remember that this is a two-way system, and it could equally well be used to read a multichannel analogue to digital converter.

Connectors

The standard IEEE488 connector is a 24-way Amphenol type and connection details for this are given in Fig. 6. Perhaps of more relevance to microcomputer users is the greatly cut down version used in the Commodore serial bus, as fitted to the VIC-20, Commodore 674, C16, and Plus 4 machines (the PETs have the full

IEEE488 interface incidentally). The Commodore serial version is a synchronous type with the clock signal providing a synchronization signal. This is not a clock signal in the sense of a straightforward clock oscillator, and it provides information such as positive transitions to indicate when valid bits of data are present on the bidirectional data line. The clock line is a bidirectional type, as the talking device and not the controller always provides the synchronization signal.

The SRQ (Serial Service Request) is an input to the computer which any device on the bus can pull low in order to indicate to the computer that it requires servicing. ATN (Attention) is used to start a command sequence. The computer takes this

line low in order to set all devices on the bus as listeners, and it then sends the appropriate address. If the selected device fails to respond within a certain period of time, it is assumed to be absent and the computer provides a 'Device Not Present' error message.

Further details of this interface, including some timing diagrams, can be found in 'Commodore 64 Programmer's Reference Guide', published by Commodore. Although the Commodore's serial version can probably do everything that the full IEEE488 interface can achieve, and an IEEE488 adapter can be obtained, the serial nature of the interface and simplified control and handshaking arrangement inevitably result in greatly reduced maximum operating speed. ■

DOES YOUR DIGITAL CAPACITANCE METER DO THIS?

FULL 4 DIGIT 0.5 INCH LCD DISPLAY COMPLETELY AUTORANGING WITH 10 RANGE MANUAL CAPABILITY

AND THIS

RANGE OF 0.0 pF to 1 FARAD (999.9 mF)
0.5% BASIC ACCURACY UP TO 100 uF

AND THIS

READS DIELECTRIC ABSORPTION

AND THIS

EXTENDED PSEUDO 5 DIGIT
RESOLUTION ON SOME RANGES ONLY

AND THIS

ABILITY TO ZERO LARGE CAPACITANCE
VALUES UP TO 99.99 uF

AND THIS

CALCULATES TRUE CAPACITANCE
IF CAPACITOR IS LEAKY

AND THIS

DIODE CLAMP AND FUSED
PROTECTED INPUT.
DISCHARGE RESISTOR IN OFF
POSITION AT TERMINAL INPUTS.
POWERED BY 9V BATTERY

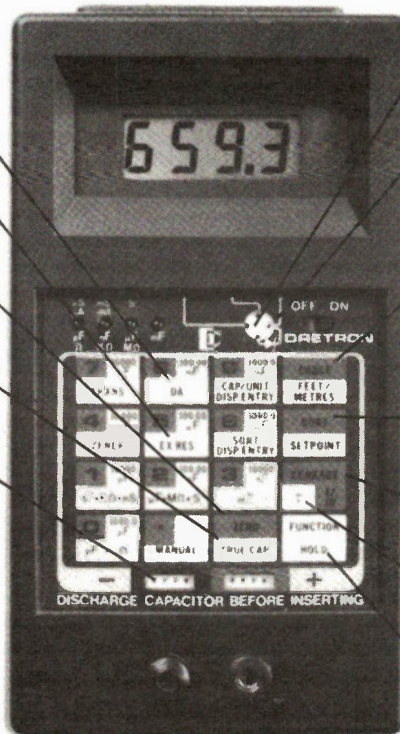

AND THIS

IDENTIFIES TRANSISTORS (NPN, PNP)
AND THEIR LEADS (E, B, C, ETC.)

AND THIS

TESTS ZENER DIODES AND RECTIFIERS.
UP TO 20V ZENER WITH AC ADAPTOR,
ZENER VOLTAGE WITH 9V BATTERY
DEPENDS ON ITS CONDITION

AND THIS

AUTOMATICALLY CALCULATES LENGTHS
OF CABLES IN FEET, METRES, MILES,
KILOMETRES (THEORETICAL RANGE
OF 9,999 MILES)

AND THIS

ABILITY TO SORT CAPACITORS IN
MANY DIFFERENT MODES

AND THIS

ABILITY TO READ LEAKY CAPACITANCE
(INSULATION RESISTANCE OR CURRENT)

AND THIS

CALCULATES TIME CONSTANTS WITH
USER DEFINED RESISTANCE VALUES

AND THIS

HOLD FUNCTION FREEZES DISPLAY

**ONE YEAR PARTS &
LABOUR WARRANTY**

FOR ONLY THIS

\$169.95

MADE IN CANADA

MODEL
MC300

Approx. Size
7" x 4" x 1 3/4"

DAETRON

A DIVISION OF BERGERON
TECHNOLOGIES INC.

7686 KIMBEL STREET

UNIT 5

MISSISSAUGA, ONT.

L5S 1E9

(416) 676-1600

DEALER ENQUIRIES INVITED

PLEASE SEND ME

— (QUANTITY) MC300(s) @ \$169.95 \$

CARRYING CASE \$19.95 \$

AC ADAPTOR \$11.00 \$

ONTARIO RESIDENTS ADD 7% PST \$

SHIPPING AND HANDLING @ 5.00 per Instrument, \$

I ENCLOSE CHEQUE MONEY ORDER VISA MASTERCARD

CARD NO. _____

EXPIRY DATE _____ SIGNATURE _____

NAME _____

ADDRESS _____

CITY _____ PROV. _____ POSTAL CODE _____

Apple IIe Keyboard Modification

*A variable rate key repeat board
for the Apple IIe.*

By Shawn Day

HAVE YOU EVER been frustrated by the slow speed of the keyboard repeat function on the Apple IIe? It is especially tiresome when copying over text using the arrow keys, and it's sometimes also useful to have audible feedback for each key press. These concerns led to the design of this variable rate key repeat board with audible key-click. It's designed to work with the Apple IIe, but it should also be compatible with any computer which uses the AY-5-3600-PRO as a keyboard encoder.

How it Works

To understand the operation of this circuit, you must first understand how the normal repeat function on the Apple IIe works. The IIe uses an AY-5-3600-PRO keyboard encoder to read the keyboard. This chip sends two control signals (AKD and KBDSTRB) to the computer. A high pulse on KBDSTRB (keyboard strobe) is sent every time a key is pressed, and AKD (any key down) is normally low, but goes high whenever any key on the keyboard is

held down. After detecting a pulse on KBDSTRB, the Apple waits for about 1 second, and then checks to see if AKD is still high. If so, the last key pressed is repeatedly made available to the currently executing program.

The circuit presented here intercepts the KBDSTRB signal between the AY-5-3600-PRO and the computer (see Fig. 1). The KBDSTRB pulse from the keyboard encoder triggers the monostable multivibrator (A), which has an adjustable pulse width via R1 (see Fig. 2). This pulse width determines the length of the pause after a key is struck, before it will begin to repeat. On the falling edge of this pulse, the J-K flip flop is set, allowing the pulse train from the astable multivibrator to be sent to the computer, causing the last key to repeat. As soon as the AKD signal goes low (the key is released) or another key is pressed, the flip flop is reset, and the repeat pulses stop.

Monostable (B) simply lengthens the KBDSTRB pulse so that it can be heard on the piezo buzzer. R3 is used to adjust

the length of this pulse, effectively adjusting the volume of the key clicks. R2 adjusts the key repeat rate.

Construction

The easiest way to construct this project is to use wirewrapping techniques. This offers a unique solution to the problem of where to put the resulting circuit (see Fig. 3). The AY-5-3600-PRO is a 40-pin DIP IC located on the far right of the motherboard of the Apple IIe (when looking into the case from the front). The chip must be removed and inserted into the key-repeat circuit. However, all lines from the chip (except KBDSTRB) must still connect with the socket in the motherboard. To accomplish this, mount the chip in a 40-pin wirewrap socket as shown in Fig. 3. To prevent the long pins of the wirewrap socket from being inserted too deeply into the original socket on the motherboard (and perhaps shorting together as a result), it is a good idea to solder a 40-pin DIP header or attach a low profile DIP socket to the pins, and then insert this

Electronics Today October 1986

header into the motherboard (see Fig. 3). Be sure to finish wirewrapping the board before this piece is attached, however, or it will get in the way of your work.

The necessary +5V can be taken from pin 30 of the AY-5-3600-PRO, and ground from pin 15. The KBDSTRB pin (pin 16) on the IC must be bent outwards

potentiometers for R1, R2, and R3. Mount them where they will be easily adjustable from the computer case opening.

An alternative method of construction is to mount all the components, excluding the AY-5-3600-PRO on the project board. Remove the AY-5-3600-PRO from its socket on the motherboard, bend out pin 16,

from any convenient place on the motherboard. This method of construction is probably simpler, but you must now find a place inside the computer case to mount the project. Please note that either method of construction will probably void your warranty.

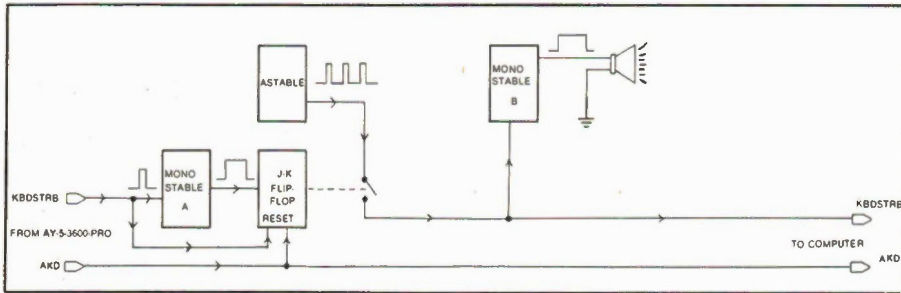

Fig. 1 The block diagram of the variable rate, key repeat board.

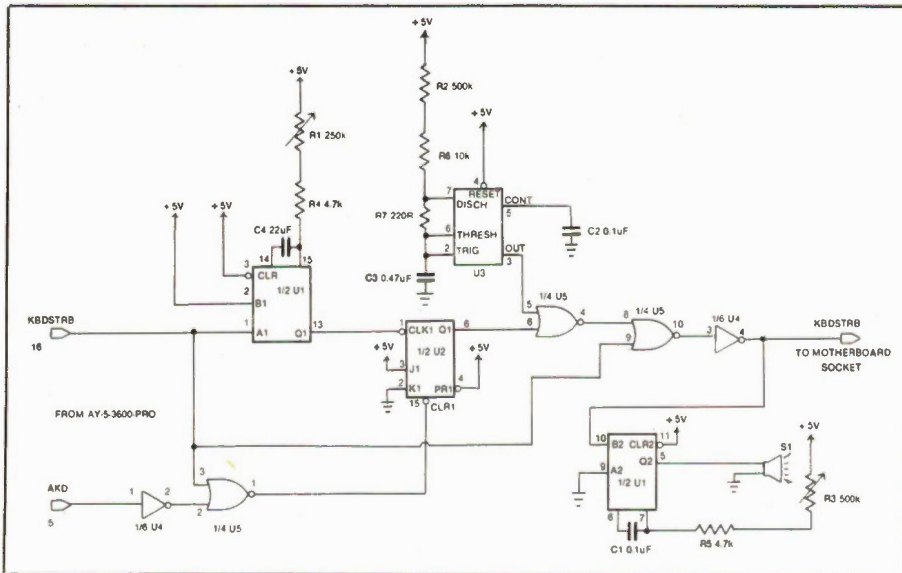

Fig. 2 The circuit diagram of the keyboard modification.

so that it does not contact the wirewrap socket. This allows the signal to be intercepted. Pin 16 should be connected to pin 1 of U1. The corresponding KBDSTRB pin on the wirewrap socket must be connected to pin 4 of U4 (see Fig. 2).

Before soldering the 40-pin wirewrap socket into the project board, check that it will fit comfortably into the computer case without impeding any cards in slot 7. You may have to adjust the position of this socket relative to the project board until you have a comfortable fit. If you choose to wirewrap the other IC's, you must first trim their wirewrap leads to about half their original length, so that they will clear the tops of the other components on the mother board. If you use a Radio Shack board (276-158) to mount the components, they will all fit comfortably, including the piezo buzzer. Try to find miniature, top-adjust, pc-mount

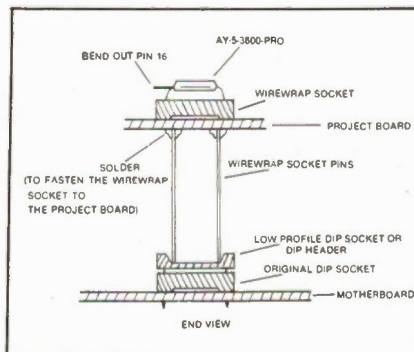

Fig. 3 Details of the wirewrap construction.

and then reinsert it into its original socket. Connect wires from pins 5 (AKD) and 16 (KBDSTRB) to the inputs of your project board, and connect the KBDSTRB output of your project to the vacated hole number 16 in the motherboard socket. The +5V line and ground can be taken

Parts List

- R1 250K trimmer potentiometer
- R2, R3 500K trimmer potentiometer
- R4, R5 4.7K 1/4 watt carbon resistor
- R6 10K 1/4 watt carbon resistor
- R7 220 ohm 1/4 watt carbon resistor
- C1, C2 0.1 uF ceramic capacitor
- C3 0.47 uF electrolytic capacitor
- C4 22 uF electrolytic capacitor
- U1 ... 74LS123 Dual retriggerable one shot with clear
- U2 74LS112 Dual J-K negative edge triggered flip flop
- U3 NE555 timer
- U4 74LS04 Hex inverter
- U5 74LS02 Quad NOR gate
- S1 Piezo buzzer (RS 273-060)

Miscellaneous parts:

Grid board (RS 276-158), 40-pin wire wrap IC socket, 8-pin wire wrap socket, 2-14 pin wire wrap sockets, 2-16 pin wire wrap sockets, wire, solder, mounting bolts.

MICROLAB 1 DIGITAL ELECTRONIC TRAINER

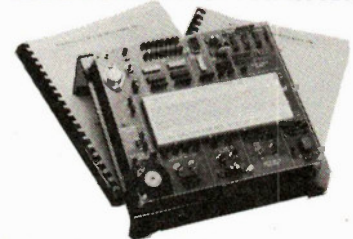

Microlab 1, by MASTERTECH, contains a thoroughly-designed protoboard, comprehensive manual and wonderful appendix, providing a complete course in basic logic circuits and digital techniques. Designed for people with little or no knowledge of electronic components, the course offers detailed explanations of each concept. Instructions for 40 lab experiments including all necessary jumper wires for completing the many circuits in addition to test questions and answers. Some topics are logic gates and invertors, flipflops, counters, shift registers, and data-handling. Further information through:

MASTERTECH LABORATORIES

302 Royal Trust Building
612 View St.,
Victoria, B.C. V8W 1T5.

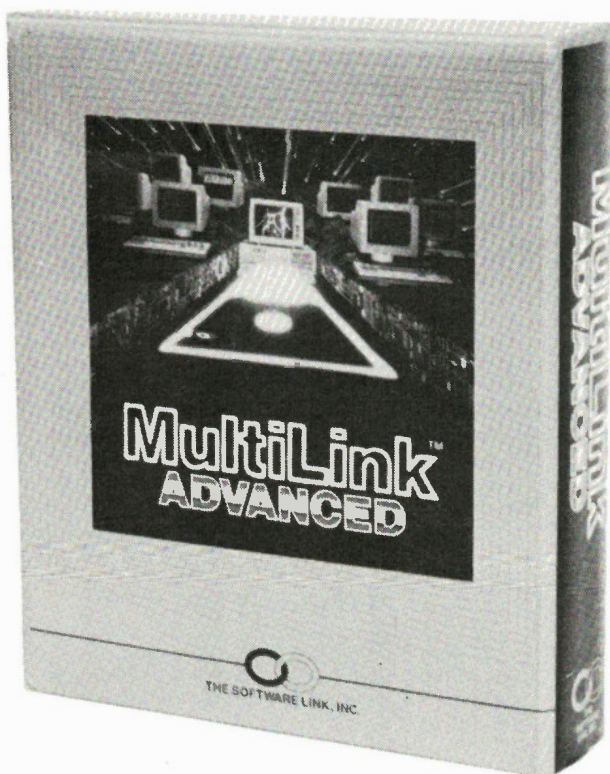

MultiLink Network Software

Connect your computers together with nothing more than a wire and a single floppy disk.

By Bill Markwick

IF you have a typical small company that uses a number of IBM PCs or compatibles, you probably have them sitting on various desks doing independent tasks. This means a fair amount of legwork to transfer files or programs from one to another, and it also means that your computers are probably spending a fair amount of time waiting idle. Another possibility is that you've discovered the usefulness of computers by buying one or two PCs and you'd like to install a lot more, but you're intimidated by the high cost of the hardware.

It's possible to hook some or all of your computers together in a network, allowing easy transfer of software from one station to another, but it usually means adding more printed circuit cards to each computer, a fair investment in capital. Also, the hardware method may or may not allow multi-tasking, in which a single computer can work away on one program in its memory while the operator runs a second, independent program on the screen. Furthermore, it's possible to expand the number of stations without purchasing full-featured computers; using a network, the main computer supplies software and control, allowing the stations to use less expensive terminals instead of PCs.

A novel method of giving you these facilities is MultiLink Advanced, a multi-user, multitasking software from Soft-

ware Link. All you need is the floppy disk and 3-conductor serial cable to really put those PCs to work.

Basic MultiLink

Even if you don't use a network, the multitasking feature alone is worth it. The system is booted and the MultiLink program loaded in. It then divides up the available memory into the number of partitions you've specified. Each partition is like an independent computer, and all partitions share the CPU, the keyboard, the screen and the drives. We tested Version 3.3, which allows up to nine partitions; as we went to press, Version 4 was being released with up to 17 partitions.

You can specify which keys toggle the partitions, but if you don't, the ALT and function keys are the default settings. ALT-F1 will access the first partition, ALT-F2 the second and so on; ALT-F10 is always the main or foreground partition.

I made two partitions, the main and the background, and loaded a spelling checker into the background. While I ran WordStar in the main partition, the spelling checker went through a textfile in memory; at any time I could type ALT-F1 to see how it was doing. It's just like switching one monitor and keyboard between two different computers.

Then we ran a serial cable over to

another office (ain't suspended ceilings wonderful) and installed it in the serial port of another PC compatible. We could have used a simpler terminal; for the time being we loaded the compatible with a short emulator program (supplied with MultiLink) that makes the computer think it's a Televideo 910 terminal.

Now the "terminal" could be installed as one more partition in the main PC. It could then load and save programs using the main computer's disks and files, and we could even type messages from one office to another. MultiLink sorts out the demands on the common CPU and prevents serious clashes. Of course, if you're both running the same program in the same partition, such as a word processor using the same file, keystrokes from both computers appear on both screens. Two editors can have a keyboard fight over a point of grammar.

Hardware

First, it should be obvious that the main computer is going to have serious demands put on its CPU. If you have three partitions, all going at once, each partition runs at only one-third the normal speed. Even though computers spend most of their time waiting around for keyboard entry, it wouldn't hurt to have the fastest computer you can afford for the main unit. We used ordinary 4.7MHz

compatibles for the review, and while they were adequate for two stations, we'd advise the 8MHz version for the main computer on larger setups, and an AT or compatible would be best of all.

The required memory size for the main computer isn't critical, but you need enough RAM in each partition to handle whatever programs you plan on running in that partition. You'll also need about 35K for DOS, 23K for MultiLink, and 7K extra for each partition, plus 3K in each partition itself. For example, if you have four background partitions of 100K each, you need 412K for these, plus 58K for DOS and MultiLink, plus 28K for partition control. This is 498K, leaving 142K free in the foreground if you have a 640K machine. Of course, you can divide up the memory any way you prefer, giving each partition only as much as necessary for the intended programs.

You'll also benefit from a hard disk. Although we used only floppy drives, we didn't begin to get maximum usefulness out of our network, and as you find more and more applications for it, you'll want lots of mass storage.

The wiring requires only a 3-wire cable terminated in a serial connector to suit your computer. This is far less expensive than a full multi-pair cable.

As mentioned, you can use a PC or compatible as a terminal, but there'll be a cost saving if you only need a dumb terminal. Software Link provides an excellent terminal called the PC Shadow; this features an PC-compatible keyboard and a monochrome monitor.

Installation

Other than running the serial wires between computers, installation consists mainly of manipulating a bit of software. There are a few problems, most of which have been anticipated by the authors of MultiLink. The main difficulty arises from programs which use unconventional ways of writing to the video screen. No doubt you've noticed that the IBM PC and compatibles have very slow screen scrolling when using the PC-DOS interrupt method; TYPE and DIR are examples of this. The screen speed can be increased considerably by writing bytes directly to the screen RAM, but if you have multitasking activated two or more programs may fight each other for video access.

Three utilities are provided on the MultiLink disk to smooth out concurrent programs. These can be used to either patch the program itself or modify the RAM area to increase compatibility during multitasking. We found that WordStar was initially unhappy, but the included MLVIDFIX program soon had it running. Still, the programmers can't cover every possible type of available software,

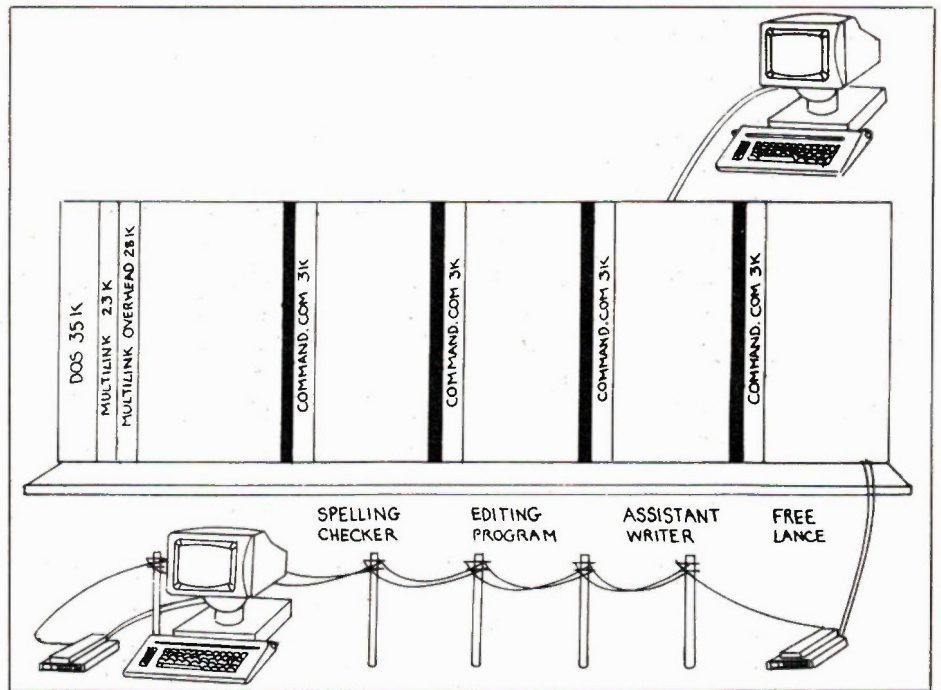

Fig. 1. The memory map of the main computer using MultiLink. In the example, there are two programs and two remote computers in the four partitions. 63K of memory is used for MultiLink with the rest divided to suit the user. (courtesy of Software Link).

so there's no guarantee that you won't have problems. We found that video games which use the 40-column display mode and the high-bit graphic set would scramble both themselves and the main partition, and the utilities were no help. Naturally, you'd have no reason to run video games at work, would you? In any case, all popular word processors and spreadsheets have been accounted for, and Software Link will try to provide solutions for incompatibility problems.

Software Link can provide a hardware solution to software problems if you have an AT compatible. Called the AT Gizmo card, it remaps video output right at the processor, ending the software fixing.

Limitations

Most of the limitations you'll run into will be hardware types. Murphy's Law for Memory states that you will always come up with applications requiring more RAM than you have (remember a few short years ago when you thought a 64K Apple was more than you could ever use?). And, of course, the CPU is never fast enough.

As far as limitations to MultiLink itself, a major drawback to Version 3 is that it does not support color or bit graphics. This has been cured on Version 4, though we didn't have time to test it before press time.

The transfer rate for Version 3 is only 19,200 baud. While this is respectable for file transfers, it's a bit slow for full-screen work, particularly if you want to page up

and down through a textfile. The new Version 4 has doubled the transfer speed, which should make working with word processors more convenient.

LANLink

LANLink, a Local Area Network, is another product from Software Link and is compatible with MultiLink, i.e., it can be run as a program in one of the MultiLink partitions. With LANLink one main computer can become a file server, or host, located as the hub with up to eight satellite computers as the spokes. Thus any operator can load a program, work on it, and send files to any other operator. The data transfer is 115,200 bits per second, with data compression giving an effective rate of up to twice as fast. Expansion boards are available for the serial ports on the file server computer. When used with MultiLink, it becomes possible to have a hybrid network linking both regular computers and dumb terminals.

In conclusion, MultiLink offers a great expansion of your computing facilities, letting various workstations do much more at a considerably reduced cost compared to buying more computers. Combined with LANLink, the hybrid network and file serving capability gives you the equivalent of a minicomputer installation for far less expense.

For further information, contact Software Link, 250 Cochrane Dr., Suite 12, Markham, Ontario L3R 6B7, (416) 477-5480. ■

Precision Power Supply

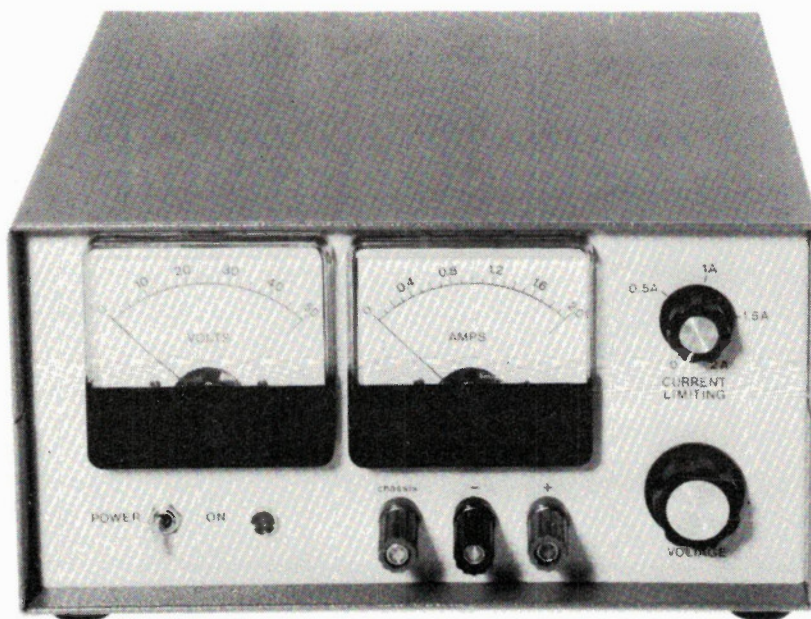

Zero to 40V and 2A with adjustable current limiting.

By Doug Bedrosian

TEST instruments are considered to be some of the most useful tools available when constructing a project. They are also considered to be the most expensive tools one could buy. For instance, a power supply of any quality and usefulness can range from several hundred dollars to several thousand dollars. The alternative to buying a power supply is to build one. The power supply in this article has a voltage range from 0 to 40 volts and a current range from 0 to 2 amps with current limiting set by the user. The quality of the supply is determined by the time and care the builder takes while constructing it.

Construction of PCB

The printed circuit board is highly recommended to be used when constructing the power supply, as it will save time and reduce the risk of wiring errors. It is also recommended that the PCB be assembled in the order that the instructions are given.

The first step is to check the PCB for any oxidation on the copper traces. If the copper looks oxidized, use some fine steel wool to remove it. Now JP1 can be installed and soldered. Next is the 14 pin IC socket, making sure that the pin 1 marking on the socket is aligned with the pin 1

marking on the PCB. Now Br₁ and Br₂ are soldered in place. Special care should be taken so that the positives on Br₁ and Br₂ are matched with the positives on the PCB. C₁, C₂ and C₃ are next. Again care should be taken so that the positives on the capacitors are matched to the positives on the PCB. Before anymore parts are installed the power supply sections of the board should be tested. Temporarily wire the 36 volt transformer to the appropriate section on the PCB. With the transformer on, measure the voltage across C₁ or C₂, the voltage should be approximately 50V

Continued on page 34

Electronics books with professional and at-home applications



Commodore 64 and 128 Programs for Amateur Radio and Electronics

Joseph J. Carr

The electronics hobbyist, programmer, engineer, and technician will enjoy the task-oriented programs for amateur radio and electronics in this book.

Includes: AI and BASIC - Game Playing Programs - Problem Solving - Programs that Reason - Computer Analysis of Arguments - Natural Language Processing - Expert Systems - Blue Sky Projects

176 pages, 672-22516-16 \$23.50

VCR Troubleshooting and Repair Guide

Robert C. Brenner

This helpful troubleshooting guide is for the electronics hobbyist, layperson, or technician who needs a preventive maintenance and troubleshooting reference for VCRs. Limited electronics experience is required to use it, but more sophisticated service and repair functions are discussed. Valuable information for the service technician is included.

225 pages, 672-22507-7 \$32.95

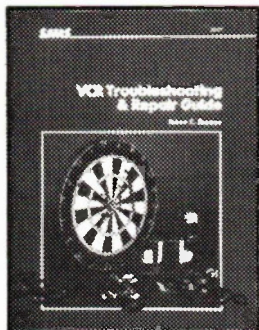

For more information and to order, please contact:
Copp Clark Pitman Ltd., 495 Wellington St. W.,
Toronto, Ontario M5V 1E9 (416) 593-9911

Circle No. 26 on Reader Service Card

Advertisers' Index

BCS Electronics Ltd.	62
Brunelle Instruments Inc.	56
Canadian Computer	6
Comptech Systems	57
Compukits	8
Computer Mail Order	13, 14, 15, 16
Computer Parts Galore	36, 37, 56
Copp Clark Pitman	33
Daetron	27
ECG Canada Inc.	57
Electronic Book Club	35
Electronic Control Systems	40
Eutha Enterprises	56
Exceltronix	2, 3
Hobbilt	40
Innovage Microsystems Inc.	60
Inverter Technology	40
Kaientai Electronic Merchants Ltd.	33, 56
KB Electronics	40
Mastertech Laboratories Inc.	29
Masuko International	7
McGraw Hill	25
RCC Electronics	63
Silicone Valley Components	33
Solen Inc.	57
Soltech Systems Inc.	39
Sunix Inc.	8, 59
The Software Link, Inc.	64
Toronto Computing Centre	4

For Advertising Information
Call 445-5600

K.E.M.

High Speed EPROM Toaster For Apple and IBM More Powerful More Friendly Updated Model

From 2716 to 27256 all-round player. Function programming voltage (12.5V, 21V, 25V), and ROM selection totally software control. Just change I/F card, Can switch to IBM or Apple.

For Apple \$185.00

For IBM XT \$195.00

Extra I/F card Apple or IBM ... \$ 79.00



Also KEM High Speed Rom UV Eraser.
Erasing time only within 5 to 10 minutes.



1 set \$35.98

with Timer \$38.98

\$5.00 for shipping. Plus Provincial Tax for B.C. residents. Plus C.O.D. fee if required. Price and specification are subject to change without notice.

K.E.M. Electronics Ltd.

Mail to Box 69126 Station (K), Vancouver, B.C. V5K 4W4
Office 879 E. Hastings St. Vancouver Tel (604) 251-1514

Circle No. 22 on Reader Service Card

Sale... always!!

TVM RGB 3 in 1 Monitor	\$539.00
Volks Modem 12 300/1200 B.P.S.	\$275.00
NEC V-20 Chip	\$ 18.95

Plus much, much more

See our wide selection of
prime electronic components

"Quality, Price, Service & Service"

SEND COUPON FOR FREE CATALOGUE
and membership to our exclusive club.

SILICON VALLEY COMPONENTS

287 Lakeshore Road, East
Mississauga, Ontario L5G 1H3
(416) 271-0716

NAME: _____

ADDRESS: _____

CITY: _____ PROV: _____

POSTAL CODE: _____ PHONE: () _____

Prices subject to change without notice

Circle No. 11 on Reader Service Card

$\pm 5V$. Now the 36 volt transformer can be disconnected and the 17 volt transformer can be connected to the appropriate section on the PCB. With the transformer on, measure the voltage at pin 14 and pin 7 of the IC socket; pin 14 being positive, pin 7 being negative. The voltage should be between 22 volts and 28 volts. If the voltage across pin 7 and 14 is out of this range the power supply will not work! It should be noted that the transformer(s) for the 17 and 36 volt supplies must be electrically isolated from each other. This can be achieved by using two separate transformers (which is recommended) on one transformer with two completely isolated windings. If this is not the case the power supply will fail to work.

With both power supply sections on the board functioning, construction of the board may continue. The seven diodes can be soldered in place; and care should be taken when installing them, so they are oriented correctly on the board. Next the eight resistors can be installed, then the four trim pots. The board has been laid out for two types of trim pots, the choice is left up to the builder as to which are used. Now the remaining capacitors can be installed. Q_1 is next to be installed, for proper orientation of Q_1 refer to Fig. 1. Finally IC_1 can be inserted.

With the board now complete, refer to the External Wiring Section for the remaining connections to the board.

External Wiring

The construction and choice of cabinet is left up to the builder. The cabinet used in this article was a Hammond 1458 series. This makes a compact, professional look-

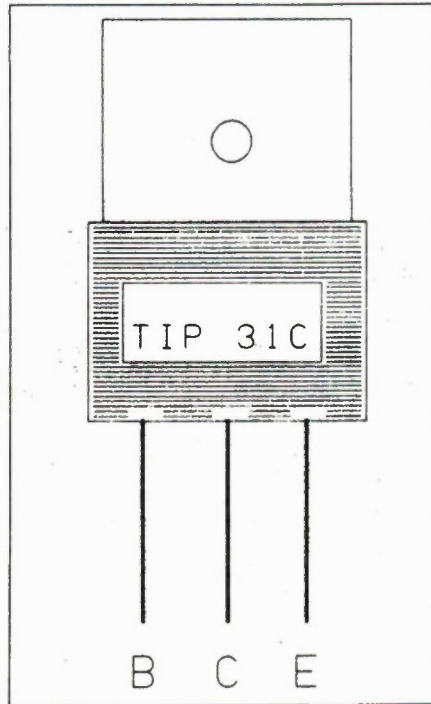

Fig. 1. Pin orientation of the TIP 31C.

ing power supply. Once the cabinet work is completed the wiring of the supply may begin.

The first step is to wire the line cord with the power switch and fuse. Next the power indicator is wired, an LED is used for this. Refer to the wiring diagram and schematic for these two steps. Now the primary of the transformers should be wired to the switched 110VAC. Next the secondaries of the two transformers can be connected to the main PCB. Now the two meters plus the voltage and current controls can be wired to the PCB. Refer to the wiring diagram for proper connections. Next Q_2 should be mounted to a heatsink, the heatsink used should be of appropriate size in order for proper cooling of Q_2 under high loads. The transistor should be mounted using an insulated wafer coated on both sides with heatsink compound. The insulating wafer is used to electrically isolate the transistor from the heatsink and the compound is used to improve the heat transfer from the transistor to the heatsink. When wiring Q_2 to the PCB a minimum of 18 gauge wire is recommended. The output terminals are wired to the PCB next. Again a minimum of 18 gauge wire is recommended.

The construction of the power supply is now complete. Refer to the Testing and Adjustment section for proper set up of the power supply.

Continued on page 41

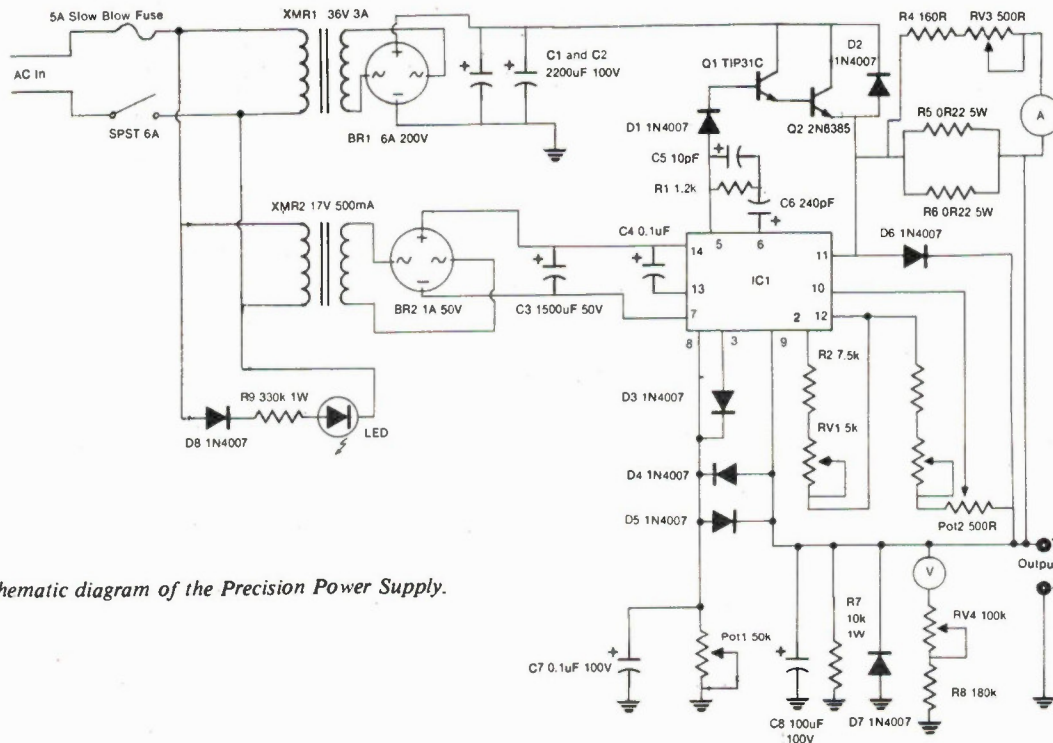

The schematic diagram of the Precision Power Supply.

Increase your knowledge about all aspects of electronics

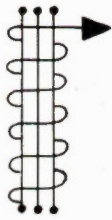

An absolutely no-risk guarantee.

Select 5 Books for only \$3⁹⁵ and get a Free Gift!

values to \$155.70

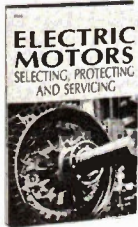
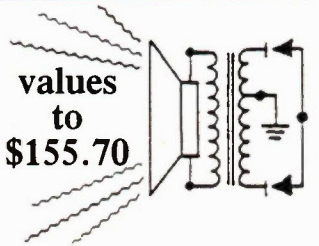

2663 \$15.99



1586 \$17.95

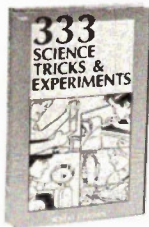

1825 \$15.95



800P \$19.95



1632P \$12.95

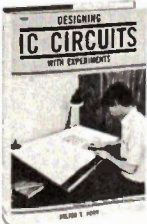

1925 \$24.95

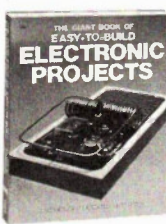

1599P \$15.95

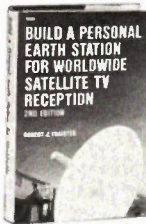

1909 \$21.95



1277 \$22.95



1529P \$14.95

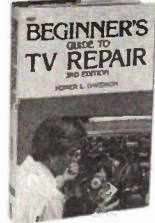

1897 \$18.95



1964P \$10.95

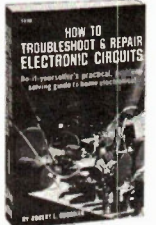

1218P \$13.95

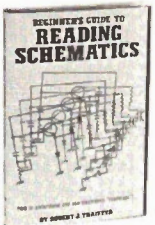

1536 \$14.95

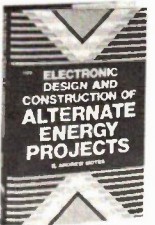

1672 \$18.95

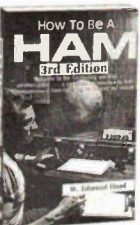

2653P \$12.95



1858 \$16.95

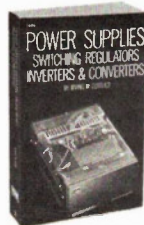

1665P \$16.95

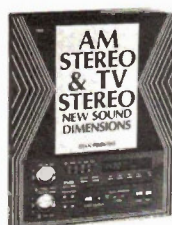

1932 \$17.95



2641 \$19.95



1977 \$26.95



1793 \$14.95

CIRCUIT DESIGN

- 1650. CMOS/TTL—A User's Guide with Projects. \$19.95
- 2609. Basic Integrated Circuits (design and construction techniques). \$26.95
- 1996. The 555 IC Project Book \$18.95

PRACTICAL PROJECTS

- 1498P. The Build-It Book of Electronics Projects. Paper \$11.95
- 2642. 101 Projects, Plans and Ideas for the High-Tech Household (from home control to decorative effects). \$24.95
- 2604.101 Sound, Light and Power IC Projects \$24.95

REFERENCE

- 2631. Switch Mode Power Supply Design (state-of-the-art power electronics techniques with applications examples). \$19.95
- 1625. Master Handbook of Electronic Tables & Formulas—4th Edition. \$21.95

BASIC ELECTRONICS

- 1531. Concepts of Digital Electronics (with example projects). \$17.95
- 1553. Understanding Electronics—2nd Edition (basic theory and practice). \$15.95
- 728P. Basic Digital Electronics: Understanding Number Systems, Boolean Algebra and Logic Circuits Paper \$10.95
- 1699. Basic Integrated Circuit Theory and Projects 19.95

TESTING & REPAIR

- 1339P. 101 Easy Test Instrument Projects Paper \$7.95
- 1927. Basic Electronic Test Procedures—2nd Edition. \$23.95
- 1183P. Troubleshooting Microprocessors and Digital Logic. Paper \$10.95
- 1663. Troubleshooting and Repairing Electronic Test Equipment—2nd Edition. \$24.95
- 1887. Pocket Digital Multimeter Techniques (test procedures). \$22.95

(Publisher's Prices Shown)

Membership Benefits • Big Savings. Save up to 75% on books sure to increase your electronics know-how. • **Ironclad No-Risk Guarantee.** If not satisfied with your books, return them within 10 days without obligation! • **Club News Bulletins.** All about current selections—mains, alternates, extras—plus bonus offers and special sales. Comes 14 times a year with hundreds of titles to choose from. • **Automatic Order.** Do nothing, and the Main Selection will be shipped automatically! But... if you want an Alternate Selection, or no books at all, we'll follow the instructions you give on the reply form provided with every News Bulletin. • **Bonus Books.** Immediately get Dividend Certificates with every book purchased and qualify for big discounts of 60% to 80%. • **Exceptional Quality.** All books are quality publisher's editions especially selected by our Editorial Board.



532 pgs
923 illus

An All-Purpose Collection of Easy-to-Build Circuits a \$26.95 value!

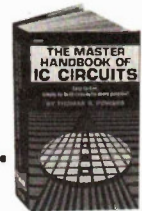

ELECTRONICS BOOK CLUB

c/o Moorshead Publications, 1300 Don Mills Road, Toronto, Ont. M3B 3M8

Please accept my membership in the Electronics Book Club and send the 5 volumes circled below, plus, my FREE copy of *The Master Handbook of IC Circuits*, (1370), billing me \$3.95 plus shipping and handling charges. If not satisfied, I may return the books within ten days without obligation and have my membership canceled. I agree to purchase 4 or more books at regular Club prices (plus shipping/handling) during the next 12 months, and may resign any time thereafter. Canada must remit in U.S. currency.

- | | | | | | | | | | |
|------|-------|-------|-------|-------|-------|-------|-------|------|------|
| 728P | 800P | 1183P | 1218P | 1277 | 1339P | 1498P | 1529P | 1531 | 1536 |
| 1553 | 1586 | 1599P | 1625 | 1632P | 1650 | 1663 | 1665P | 1672 | 1699 |
| 1793 | 1825 | 1858 | 1887 | 1897 | 1909 | 1925 | 1927 | 1932 | 1996 |
| 1977 | 1964P | 2604 | 2609 | 2631 | 2641 | 2642 | 2653P | 2663 | |

Name _____
 Address _____
 City _____
 Prov. _____ Code _____

Valid for new members only. Foreign applicants will receive ordering instructions. This order subject to acceptance by the Electronics Book Club.

ETY-1086

Prices subject to change without notice.

COMPATIBLE KEYBOARDS

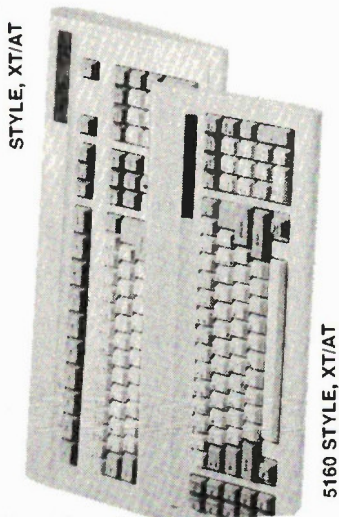

- (A) 5150 Style, 83 keys, std IBM layout, uses long lasting CHERRY keyswitches, 100% IBM compatible.....\$99.95
- (B) 5151 Style, 105 keys with numeric and cursor control pad, CHERRY KSW, 100% IBM compatible.....\$129.95
- (C) 5160 Style, XT/AT Autoswitch, 83 keys, + LED status array, CHERRY KSW, 100% XT/AT compatible.....\$149.95
- (D) 5161 Style, XT/AT Autoswitch, 105 keys with numeric and cursor pad, LED status array, 100% XT/AT compatible.....\$179.95
- (E) AES DATA, A surplus ASCII keyboard with serial and parallel output, open frame, with all data and hook-up plans, APPLE OK.....\$24.95
- (F) APPLE II+, Basic macro keyboard, for all real and clone APPLES, specify with/not the numeric keypad.....\$69.95
- (G) APPLE II+ Detached keyboard, in stand-alone case for custom uses.....\$149.95
- (H) APPLE IIe(FOX 2001) KB.....\$69.95
- (I) APPLE IIe (FOX2001) Detached KB.....\$99.95

SWITCHING POWER SUPPLIES



- (A) 150 WATT, Back/side SW, with =5v@15A +12v@5.5A and -5,-12v@0.5A. A good power supply.....\$139.95
 - (B) 150 WATT CSA approved, High Rel unit for top grade units.....\$159.95
 - (C) APPLE II+ or IIe power supply, with +5v @4A,+12v@2.5A and -5-12@.5A.....\$49.95
 - (D) OPEN FRAME from NORTHERN TELECOM a very good bench unit,+5v@4A,+12,-12,-5V @1A each, a steal.....\$19.95
 - (E) OPEN FRAME IBM, power supply from NCR, runs an IBM with 2 drives and cards +5v@7A,+12v@3A,-5-12v@0.5A.....\$59.95
- POWER CORDS, A,B,C, above are with cords extra 3 wire cords are \$3.50 EACH.....\$3.50

WIRED CARDS

- (A) 384K OK.....\$79.95
- (A) 384K OK.....\$79.95
- BARE PCB & PARTS LIST.....\$14.95
- (B) 576K OK.....\$59.95
- BARE PCB & PL.....\$14.95
- (C) KRAM, 2 MB RAM OK.....\$179.95
- BARE PCB & PL.....\$34.95
- (D) RAM BANK II, LOTUS/INTEL COMP 2 MB RAM CARD, OK.....\$189.95
- (E) COLOR GRAPHICS, 2 RCA \$119.95
- BARE PCB & PL.....\$24.95
- (F) MONO(HERCULES) GR PR \$139.95
- BARE PCB & PL.....\$24.95
- (G) 384K MULTI(AST6PACK)O \$149.95
- BARE PCB & PL.....\$24.95
- (H) DISC CONTROLLER, 1-4,.....\$49.95
- BARE PCB & PL.....\$12.95
- (I) DISC + I/O, Ser, Par, Clock, cal and drive controller in one.....\$169.95
- BARE PCB & PL.....\$24.95
- (J) I/O+2, AN I/O CARD.....\$99.00
- BARE PCB & PL.....\$18.95
- (K) RS232 SERIAL CARD.....\$49.95
- BARE PCB & PL.....\$12.95
- (L) PAR PRINTER CARD.....\$39.95
- BARE PCB & PL.....\$12.95
- (M) CLOCK CARD.....\$39.95
- BARE PCB & PL.....\$12.95
- (N) GAME CARD.....\$39.95
- BARE PCB & PL.....\$12.95
- (O) EXTENDER, 6".....\$19.95
- (P) WW PROTOTYPE, ALL HOLE \$29.95
- (Q) MEMORY PROTOTYPE, WW HOLES AND 256K/1MB RAM GRID.....\$34.95
- (R) BUS TERMINATOR, CLEANS UP LOTS OF NOISE, WIRED.....\$24.95
- BARE PCB & PL.....\$19.95

CONNECTORS

- DB-9MS.....\$1.95
 - DB-9FS.....\$1.95
 - DB-9MRA.....\$2.49
 - DB-9FRA.....\$2.49
 - DB-9MIDC.....\$3.49
 - DB-9FIDC.....\$3.49
 - DB-15MS.....\$1.29
 - DB-15FS.....\$1.29
 - DB-15MRA.....\$1.75
 - DB-15FRA.....\$1.75
 - DB-15MIDC.....\$2.95
 - DB-15FIDC.....\$2.95
 - DB-25MS.....\$1.49
 - DB-25FS.....\$1.49
 - DB-25MRA.....\$2.25
 - DB-25FRA.....\$2.25
 - DB-25MIDC.....\$3.49
 - DB-25FIDC.....\$3.49
 - DB-37MS.....\$3.75
 - DB-37FS.....\$3.75
 - DB-37MRA.....\$3.75
 - DB-37FRA.....\$3.75
 - DB-37MIDC.....\$5.95
 - DB-37FIDC.....\$5.95
- SHELLS**
- DB9 MET.....\$1.00
 - DB9 PLS.....\$1.75
 - DB15 MET.....\$1.25
 - DB15 PLS.....\$2.49
 - DB25 MET.....\$0.99
 - DB25 PLS.....\$1.95
 - DB37 MET.....\$2.25
 - DB37 PLS.....\$2.95
- CENTRONICS**
- CENTR 36MS.....\$2.95
 - CENTR 36FS.....\$2.95
 - CENTR 36MIDC.....\$4.95
 - CENTR 36FIDC.....\$4.95
 - CENTR SHELL.....\$1.95
- S=SOLDER CUP MET=METAL
M=MALE PLS=PLASTIC
F=FEMALE IDC= FLAT CABLE
S=SOLDER RA=RIGHT ANGLE

DUST COVER

A high quality translucent vinyl cover for the whole system. Saves the resale value as it stops the annoying gray dust film that makes things look scummy after a few weeks. Also saves Drive heads from dust and damaging cigarette smoke.

CABLES

The std IBM parallel printer cable, now in 3 lengths for most uses, specify.
6'.....\$14.95 8'.....\$16.95 10'.....\$18.95
The standard IBM SERIAL cable, now in 3 lengths for most uses, specify.
6'.....\$14.95 8'.....\$16.95 10'.....\$18.95
EXTENDER CABLE, with 36 wires and M/F ends for SW boxes, specify length
6'.....\$18.95 8'.....\$21.95 10'.....\$24.95

V-20 NEC 8087

The NEC NIPS have been at it again, they have now got copies of the 8087 and 8088 and the rumor is that the 8087 is faster in the same way the V-20 is. get order in now
V-20 NEC 8087
4.77 MHZ.....\$16.95 4.77 MHZ.....\$169.95
8.00 MHZ.....\$24.95 8.00 MHZ.....\$249.95

KRAM DATA

KRAM, The perfect clone of the JRAM card, all the schematics, and RAM DISC software plus theory, with disc.....\$19.95

RAM BANK II

RAM BANK II, A copy of the lotus/intel RAM protocol for use with the latest versions of lots of software, wired OK. \$189.95
Bare PCB and parts list.....\$34.95

IBM 8 SLOT XT COMPATIBLE 640K MOTHERBOARDS

FULLY TESTED

STD 4.77 MHZ, 2 LAYER

- SME-XT, WIRED, 0K, 3 HR BURN-IN.....\$199.00
- SME-XT, WIRED, 0K, NO IC'S.....\$99.00
- SME-XT, BARE PCB AND ASSY DATA.....\$34.95

TURBO 8 MHZ 2 LAYER

- SME-XTB WIRED, 3 HR BURN IN, 0K.....\$249.00
- SME-XTB WIRED, NO IC'S.....\$129.00
- SME-XTB, BARE PCB AND ASSY DATA...\$39.95

TURBO 8 MHZ 4 LAYER

- SME-XT4L, WIRED, 3 HR BURN IN, 0K.....\$299.00
- SME-XT4L, WIRED, NO IC'S.....\$149.00
- SME-XT4L, BARE PCB AND ASSY DATA....\$79.00

TURBO 10 MHZ 2 LAYER

- SME-XT10M WIRED, 3 HR BURN-IN, 0K.....\$299.00
- SME-XT10M WIRED, NO IC'S.....\$149.00
- SME-XT10M BARE PCB AND DATA.....\$69.00

SWIVEL BASE



How nice it is to be able to turn the monitor up and down and from side to side at will to show some-one, or rest your neck, you will like these as they make the std unit look much better

UPRIGHT STAND



This is a nice item to stand your IBM or copy on its side next your desk to save space. Heavy metal bracket with wide flanges holds any unit upright and steady, a good copy of the \$129.95 unit, for only.....\$49.95

FEEWARE

A collection of IBM compatible free software that we have assembled from assorted sources for the purpose of saving you long distance call costs and making us money. Each group is 4 diskettes full of data based on the area of interest. More coming, ask for full listing on diskette for only.....\$2.49

- (A) Communications package.....\$24.95 Full 1200/300 baud comm package, and many many more, about 100 files
- (B) D BASE Package.....\$24.95 Full spreadsheet, file and data transfer utilities and much more, over 100 files.
- (C) TURBO+HARD DRIVE Package.....\$24.95 Over 80 files of TURBO stuff for V-20, 8088, conversion and packing files.
- (D) GREAT DEAL, All the above files above in a nice plastic case(12 diskettes).....\$59.95

Do not worry about us making money on free software, you can do the same. The real money saver is you do not have to make all the calls or weed out all the disc and data destroyers that are all over the phone in data bases.

SWITCH BOX SWITCH



A series of high quality switch boxes that switch all the wires with an easy to use push button plate. Specify 2 or 4 out in serial or parallel. NEED extender cable?

IBM DRIVES PANASONIC JU455-5

(A) The new PANASONIC JU455-5, with new surface mount technology for near infinite solid state lifetime, SHUGART had theirs made by PANASONIC after they closed up their operation in the USA...A GREAT DEAL

\$149.95

- (B) The one and only QUME drives made for IBM with their LOGO on em(covers supplied) so you know they are good..... \$129.95
- (C) SEAGATE SA225 Hard Drive, 20 Meg after formatting, complete with controller and all cables installed with 1 year warranty\$749.95
- DRIVE only.....\$559.95
- CONTROLLER only(WD,N,DTC).....\$179.95
- CABLE SET FOR ABOVE.....\$24.95

GRAY SCALE ADAPTOR

Makes it possible to see composite color video on and amber/green/BW monitor by showing each color as a contrasting gray shade, wired/w cable.....\$24.95
 Kit of all parts.....\$19.95

MAIL ORDERS. We accept VISA, MC, AMEX, credit cards. Money orders, cheques (2 weeks wait) are also OK. Minimum packing and handling fee \$5.00 or 5%, whichever is larger. The only COD we use is via CANPAR (Add \$4.00 COD fee) or motor freight. We do not use postal COD at all. All Ont. res and 7% All prices are subject to change without notice. Returns are subject to a 20% restocking charge.

MIDI STUFF

Standard 6850 MIDI Interface for Apple®

This interface provides MIDI in and out connections allowing control and programming of external synthesizers and drum machines through software by the popular Apple® and its many imitators.
 Bare Board\$16.00
 Assembled and Tested\$69.00

Advanced 6850 MIDI Interface for Apple with drum and tape synch.

This card is an advanced version of the card described above. It maintains the same compatibility in software and offers the added features of external drum synch to control pre-MIDI drum machines and also offers the ability to synch tape recorders to MIDI.
 Bare Board\$19.95
 Assembled and Tested\$89.00

Digital sound sample/play card for Apple

High rate (30,000) digital sampler for audio to RAM and playback. RAM sample can be massaged in software for a wide variety of SFX.
 Bare Board\$16.00
 Software and Manual\$19.95
 Assembled and tested w/ software and manual\$120.00

6850 MIDI interface for IBM®

New card for MIDI interface to PC/XT computers. 1 tp, 3 o/p. Full data provided for software composition. Also with external QUAD MIDI connector board for easy use.
 Bare Interface Board\$18.95
 Quad connector Board\$9.95
 Assembled & tested with Quad\$119.00

6850 MIDI Source Book Specify IBM or Apple

This source book gives all the details needed to build, troubleshoot and program our new 6850 MIDI card
 Book/Includes diskette\$19.95

UPS-250W 250W INT 150W CONT UNINTERRUPTIBLE POWER SUPPLY

What is the most annoying thing you can have happen while you are using your XT, MAC or other computer? You guessed it, a power failure or sharp line transient that causes total loss of important work like data in RAM, and that can also cause hard drive head crash, ruining the data or even turning the drive. A UPS is the answer to this problem. This allows you to quickly back-up your files, and shut down your system in the proper sequence. You can even keep going as if nothing had happened and as long as the line power came back within a reasonable time you would not have any loss at all of operating time or data.

\$489.95

- 1. High efficiency 85%
- 2. Sinewave (avoid square wave) Sinewave
- 3. Internal no-spill battery Yes
- 4. External battery terminals Yes
- 5. Audible power loss warning Yes
- 6. Fast transfer time, under 5 ms Yes
- 7. Multiple output sockets 2
- 8. % of line transients filtered 100%



What a deal, the best price for fully burned in and working Xt compatible systems in 4 configurations. All have a legal BIOS and are fully wired and tested for 24 hours of auto-test in our burn in room followed by a hands-on step by step functional test before shipping in our fully cushioned carton. All turbo boards are hard switchable from low to high speed and back without data loss.

- XT 4.77 MHZ STD.....\$869.95
- XT 8.00 MHZ TURBO.....\$949.95
- XT 8.00 MHZ 4 LAYER TURBO.....\$1049.95
- XT 10.00 MHZ TURBO.....\$1049.95

- * 640K MOTHERBOARD, FULLY TESTED
- * 1 DSDD HALF HEIGHT DRIVE
- * DISC CONTROLLER, 1-4 DRIVES
- * KEYBOARD
- * GRAPHICS CARD, COLOR OR MONO
- * FREE SOFTWARE
- * 256K RAM ON BOARD
- * 8 XT SLOTS
- * FLIP TOP CASE
- * 150W POWER SUPPLY

OPTIONS

- * CLOCK/CAL/SER/PAR/GAME.....\$125.00
- * PRINTER CARD.....\$45.00
- * SERIAL CARD.....\$49.00
- * EXTRA DRIVE.....\$150.00
- * GAME CARD.....\$39.95
- * KRAM CARD, 0K.....\$179.95
- * RAM BANK II, 0K.....\$189.95

CASES CASES CASES

FLIP TOP CASE

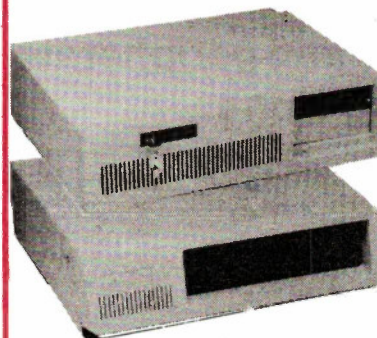

XT® CASE WITH AT® LOOK

- (A) Standard 8 slot hinged case XT® case. Fits side or back power supply (Specify) Has much heavier metal than competitors for stability, takes 1-4 1/2 sized drives and fits very well...\$79.95
- (B) Same as above, but the front looks like an AT case, with switch for KB and LEDS on front (picture).....\$89.95
- (C) ABS numeric case for II+...\$49.95
- (D) ABS case for FOX 201...\$49.95

Semiconductor Processing Advances

Various techniques for etching semiconductors are being developed to get more circuitry in less space.

By Dr. Keith Ryan

ONE area where surface modification technology is developing very rapidly is the etching of semiconductors for the fabrication of microelectronic devices.

The never-ending desire to pack greater numbers of circuits onto one chip has required pattern definitions to approach the submicron (that is less than one-thousandth of a millimetre) range. This has resulted in the abandonment of traditional wet chemical methods because of the inherently low resolution of those processes.

Plasma etching

The solution being applied now to this problem is the technique of plasma etching. A wafer containing more than 100 chips is placed on an electrode inside a radio frequency discharge. The electrical energy consumed by the discharge is used to generate a range of active species in the gaseous plasma.

A very important feature is that the charged species (ions and electrons) are constrained to move in the direction of the field and impact the wafer at normal incidence.

The photoresist is chosen to be impervious to attack, but those areas not covered by the resist are stimulated by ion bombardment, thus initiating chemical attack. This provides a mechanism for the evolution of a pattern with vertical side walls.

One intriguing aspect of plasma etching is the rapidity with which the technological advances have been made,

notwithstanding how little is known about the underlying science. The spectacular progress which has been achieved so far has arisen mainly by empirical approaches with most attention being paid to silicon-based semiconductors.

To find an explanation for the relative merits of various gas mixtures, which have been found effective in etching one silicon compound selectively in the presence of the other, is quite difficult. It is acknowledged that progress will be limited ultimately by the lack of scientific understanding of the problem.

The major difficulty is how to unravel the complex processes that occur both in the gas phase and at the gas-solid interface.

We have taken the view that the gas phase chemistry controls the identity of the species which arrive at, and etch, the

surface. Thus a knowledge of the chemistry allows one to focus attention on the gas-surface interaction mechanisms of clearly identified species.

Work in this area has provided very encouraging results. Potentially important gas-phase reactions were studied under carefully controlled conditions so that the rate of each of these reactions could be established. Armed with this vital experimental information, it has then been possible to build up a model which reproduces conditions employed for the etching of silicon.

Work from this laboratory has done much to remove uncertainties associated with gas-phase phenomena and is complemented by work in progress in other laboratories aimed at understanding the reactions of selected species on the surface.

There are many exciting scientific problems in the future of semiconductor processing. For example, the increasing preoccupation with gallium arsenide technology is certain to require a much better understanding of its etching chemistry.

One inherent disadvantage of plasma etching (apart from the complex chemistry mentioned above) is that damage can occur to the device because of ion bombardment. This can be more of a problem for devices with dimensions of less than 1 micron and has prompted the search for other methods. One possibility which is receiving a lot of attention is the use of lasers.

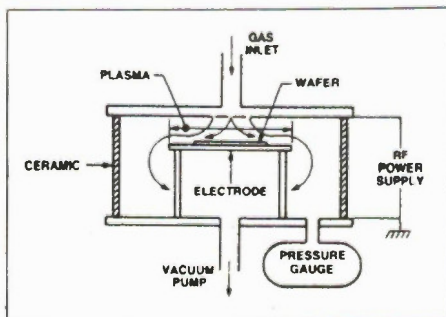

Figure 1. Plasma etching equipment. Active species (ions and electrons) generated in the gaseous plasma move in the direction of the field and impact the wafer.

Laser Chemistry

Laser chemistry offers a number of new methods that have advantages over plasma processes for altering the morphology (shape and contours) of a solid surface. One of the major attractions of this approach is that, with a suitable choice of materials, the chemistry is much less complex than when plasmas are used. Basically there are two different ways in which lasers can be used to induce surface reactions, pyrolytic and photolytic.

In the pyrolytic method the laser is focused on the surface where intense heat induces reactions between surface species and impinging gas molecules. The spatial resolution that can be achieved depends both on the size of the laser-heated spot and the thermal properties of the heated material. By using a pulsed laser of short duration compared to the relaxation time of the irradiated material, high spatial resolution can be obtained.

Most examples of laser-induced pyrolytic deposition so far have been adaptations of known chemical vapour deposition processes. These older processes have been used predominantly for growth of thin films and large surface-area coatings.

Lasers provide the opportunity to select a small portion of the surface and to deposit with high precision. Laser-induced pyrolytic deposition is clearly a powerful extension of existing coating methods.

Perhaps of greater potential are those deposition and etching processes which depend upon photolysis. In the photolytic method a focused laser beam interacts with gaseous molecules above the substrate surface. Careful choice of the

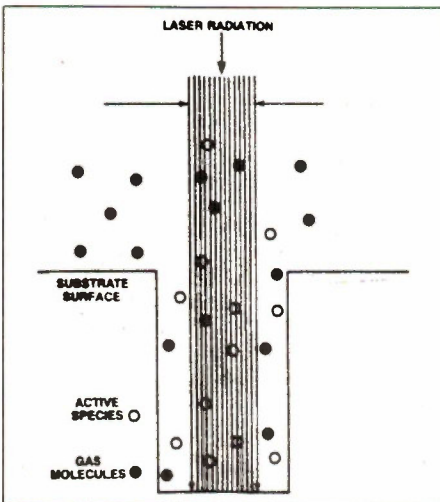

Figure 2. Photolytic laser etching. A focused laser beam interacts with gas molecules forming active species which diffuse to the surface where etching occurs. The mean distance over which the active species survive outside the irradiated zone is dependent on the density of bulk gas molecules.

gas species, the pressure and the laser wavelength ensures that only the required free radicals are produced and survive to interact with the surface. Active species generated in the laser pulse diffuse to the surface where etching occurs. Resolution is defined both by the focusing of the laser and the effect of a buffer gas which controls the diffusion of the active species.

Because silicon compounds and many fluorine-containing compounds that react with silicon absorb strongly in the infrared, the etching of silicon and silicon dioxide is particularly suited to investigation by infrared laser photochemistry.

Laser photolysis is equally powerful as a means of selective deposition. For example, cadmium, tin, aluminum, zinc, and germanium have all been deposited on ceramic substrates following laser photolysis of the metal-alkyl (that is, metal linked to single-bonded hydrocarbon group) compounds.

Using a laser operating at 275nm, photolysis produced a supersaturated metal vapour near the surface of the substrate. Metal-alkyl molecules adsorbed on the substrate are also dissociated and act as a nucleation centre for metal atoms arriving from the gas phase. Because this nucleation increases dramatically the sticking coefficient of the impinging metal atoms, the initially adsorbed molecules are an important factor in achieving highly localized decomposition.

MOCVD

One can attempt to predict important future developments in technology by examining how technologies, which are being established now, have themselves developed. In the semiconductor field, rapid and intense technological change is occurring through the application of metalorganic chemical-vapour deposition (MOCVD) of III-V compounds (that is, those formed from elements of Groups III and V in the Periodic Table, e.g., Ga_{1-x}Al_xAs).

These materials are used to produce lasers, solar cells, quantum well lasers, bipolar heterojunction transistors, photocathodes and pin detectors.

The interest in MOCVD arises from the fact that, of all the known epitaxial techniques, it has been demonstrated that MOCVD has the capability to grow the widest variety of III-V compounds with excellent uniformity.

The pioneering research in this area was performed in the late 1960s. It seems quite evident that important advances in this and related areas will come from the application of laser-induced photochemistry. Those communities which invest the scientific effort now will be in the best position to exploit the technology later. ■

ET-286 Plus

HyperSpeed SuperComputer

As artificial intelligence and expert systems become more the rule than the exception in personal computer software, and as office automation takes on larger and larger tasks, superior machines will emerge with attributes that support **faster speed, massive memory and more extensive storage**. Naturally, the drive to communicate will also stimulate a variety of **networking** applications.

In the OEM Marketplace, just such a superior machine already exists: The ET-286 plus. The ET-286 plus pushes back the envelope in personal computer performance without sacrificing compatibility with more conservative products.

The ET-286 plus is an IBM AT compatible singleboard computer from SOLTECH INDUSTRIES INC., designed for the most demanding applications in networking, office automation, CAD/CAM and high performance workstations. The ET-286 plus conforms to both the software and hardware compatibility requirements of the AT. It has the same form/fit characteristics, 6 full expansion slots, 2 PC/XT expansion slots, matching keyboard and power supply connectors plus high speed and high performance characteristics that set it apart from IBM and all the rest.

It isn't enough to be merely compatible... be the best

- 6/8/10 MHz 1 Wait State
- 6MHz 0 Wait State
- 12.5MHz Architecture
- 4 Meg On-Board Memory
- 6 Full AT Expansion Slots
- 2 PC/XT Expansion Slots
- 3 Serial Ports (Switchable)
 - RS-232
 - RS-422
- 2 Centronics Parallel Ports
- Built-In Clock/Calendar
- IBM AT Compatible BIOS

Also available: the standard for IBM PC/XT Compatibility, The ACS-1000 Super Computer.

- 1 Megabyte On-Board Memory
- Built-in Disk Controller
 - up to 4 Floppies
- 54 KB User Definable ROM
- Switchable: 4.77 or 8 MHz
- Built-in Multifunction Board
 - Parallel Printer Port
 - 2 Serial Ports
 - Time-of-day Clock

Seize Control of Your Hardware
Destiny

If you are using board level microcomputers you can have greater power, versatility and reliability by using ET-286 plus or the ACS-1000 Singleboard Supercomputers. These products have been designed for the serious OEM.

To order or for more details call
or write

Soltech Systems Inc.
3083 Grandview Highway
Vancouver BC
V5M 2E3
(604) 439-1289

WANT TO MAKE PROFESSIONAL P.C. BOARDS?

Send \$2.00 (Incl. postage & handling) for this extensive Handbook (Instruction Book) & Catalogue. Includes P.C.B. material and kits.

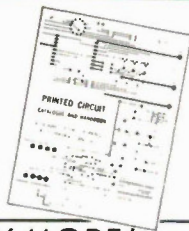

— THESE KITS AND MANY MORE! —



PRE-AMPLIFIER WITH GRAPHIC EQUALIZER
KA - PGE

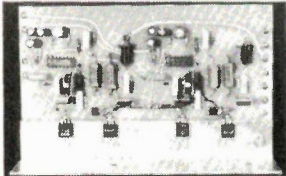

30 W. + 30 W. (60 WATTS STEREO) POWER AMPLIFIERS
KA - S30

This kit is a combination of two units which most audiophiles consider as the basic building blocks of a good audio system: a pre-amplifier and graphic equalizer. Frequency response is from 10 Hz to 100 kHz, and the equalizer adjusts the 10 bands by ± 12 dB. It will accept all inputs and is complete with its own power supply and enclosure.

PRICE **\$158⁶⁶**

This is an excellent "beginner's" kit which has two amplifiers assembled on a single fiberglass circuit board for stereo operation. Each amp features O.C.L. circuitry and has a complementary silicon output stage. Frequency response is from 10 Hz to 100 kHz, with 30 watts R.M.S. output per channel and less than 0.06% T.H.D.

PRICE **\$49⁷⁰**

 **KITS CANADIAN MADE**

ADD 10% POSTAGE & HANDLING FOR KITS.

INVERTOR TECHNOLOGY

P.O. Box 3874, Stn. 'B'
Calgary, Alberta T2M 4M5
(403) 932-5626

 **VISA**

DISTRIBUTOR ENQUIRIES WELCOME

Circle No. 18 on Reader Service Card

ELECTRONIC LOVERS WANTED

IF you're a Student and you Love our Discounts

IF you're a Small Business and you Love our Services

IF you Love our Choice of Parts

IF you Love our Prices and you Love Electronics

Then

HOBBILT is the Place You'll Love

 **HOBBILT**

NEW STORE

3117A Hochelaga St. Montreal PQ H1W 1G3

Mail Orders & catalogue contact:

(514) 259-5581

7454 Langelier St. Leonard, Quebec H1S 3B7

Your Name, Address and \$1.50 Gets You Our Current Catalogue

Circle No. 12 on Reader Service Card

AFFORDABLE

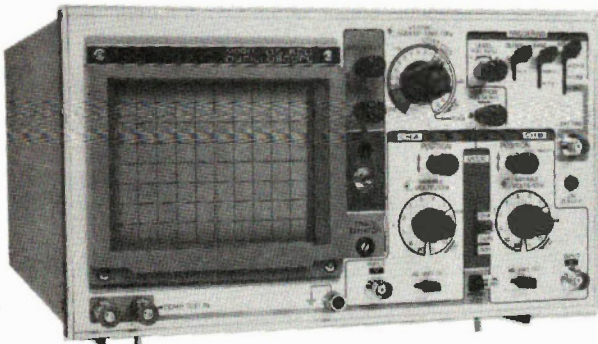

DUAL TRACE OSCILLOSCOPE

Here's exceptional value at a budget price! This 20 mHz dual trace scope has a built-in component tester ideal for troubleshooting solid state circuits and components with no circuit power, and features 6" high luminance CRT, TV sync measurement for vertical & horizontal circuitry, sensitivity 1 mV/div.

Model 33330 dimensions:
6.4" x 11.5" x 14"

All for an incredible price of

\$559⁰⁰

Set of 1:110:1 switchable probes \$59.

35 and 45 mHz scopes also available.

Order by phone or mail. Visa, money order, certified cheque or C.O.D. accepted. Add \$15. for shipping and handling. Ontario residents add 7% PST.

KB ELECTRONICS

355 Iroquois Shore Road, Oakville, Ont. L6H 1M3
(416) 842-6888 Telex: 06-982396 (KBEL OKVL)

ECS-8088 Computer Special

\$795.00

- 8088 processor
- optional Intel 8087
- numeric coprocessor
- 256K memory expandable to 640K
- double sided double density disk drive
- detachable keyboard
- 150 watt power supply
- support PC software
- One Year warranty
- 8 slot Mother board

Optional:

TURBO
8MHz motherboard
\$70.00

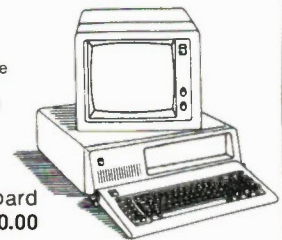

TTL Flat Screen Monitor

\$199.00

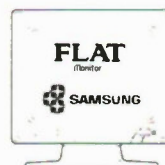

Mouse —
\$99.00



AT* Compatible

\$1995.00

- 512K memory
 - 1.12M drive
 - Colour card
 - Keyboard
 - 200 watt power supply
- *IBM is a registered trademark of International Business Machines.

XT/PC MAIN PERIPHERAL

Enhance Graphic Card ..	\$495.00
Mother Board 8 Slot	\$249.00
Color Graphic Card	\$ 90.00
Multifunction Card	\$119.00
Monochrome Card	\$ 90.00
Monochrome Graphic	\$129.00
Game Port	\$ 30.00
RS232 Card	\$ 59.00
Parallel Interface	\$ 59.00
Disc Controller Card	\$ 89.00
Case	\$ 59.00
Keyboard (Cherry)	\$ 99.00
Power Supply 130 Watts ..	\$139.00
Printer Cable	\$ 25.00
RS232 Cable	\$ 25.00
Disk Drive Cable	\$ 15.00
Moving Message Board ..	\$495.00
TTL and CMOF test Card ..	\$ 99.00
150 Watt Power Supply ..	\$149.00
Modem 1200 B	\$299.00
Network Card	\$495.00

ECS

ELECTRONIC CONTROL SYSTEMS

1590 Matheson Boulevard, Suite 1 & 2 Mississauga, Ontario L4W 1J1
(416) 625-8036 Hours — Mon. to Fri. 10-6. Sat. 10-2

Subscribe now to Electronics Today

Electronics Today is from the publishers of Computers in Education, and Computing Now!, and supplies the hobbyist and technician with a superb collection of:



Projects:

Build your own test equipment, audio gear, computer add-ons, and games.

Computers:

Reviews, listings, and how-it-works articles.

Technology:

Articles on the latest in hi-tech.

Tech Tips:

Handy hints for the testbench.

Subscribe now:

\$22.95 for one year (12 issues) or \$37.95 for two years

Electronics Today

Moorshead Publications

1300 Don Mills Road,
Don Mills,
Toronto, Ontario
M3B 3M8
Telephone (416) 445-5600

Continued from page 34

Precision Power Supply

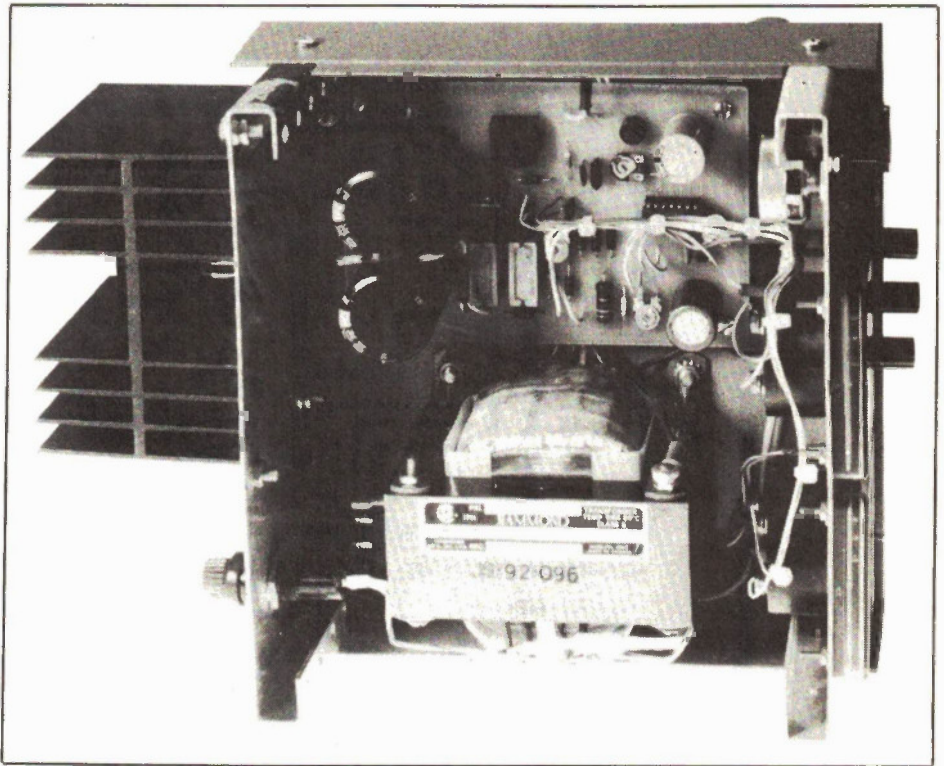

Interior of the completed power supply.

Testing and Adjustments

With the PCB and wiring completed the power supply is ready for testing. The first step is to set all trimpots to the midway position. Now turn the voltage and current controls to the midway position as well. Power may now be applied to the board. If all is working properly there should be a voltage reading at the voltmeter. If the needle of the volt meter is going in the wrong direction reverse the wires to the meter. If there is no voltage reading at the meter check to see if the current control is set at zero, if so turn it to the midway position. If the supply still appears to not function properly, use an external volt meter to measure the voltage at the output terminals. If there is a voltage then a problem with the supply's voltmeter is likely. If there is no voltage at the output or if there is a very small amount, measure the voltage across pins 7 and 14 of IC₁. If it is not between 22 and 28 volts the supply will not function. If the proper voltage is across pins 7 and 14 and the supply is not functioning properly then it is recommended that the PCB and wiring be thoroughly checked for flaws.

With the supply working properly it can now be adjusted for use. The first step is to set the maximum output voltage. With an external voltmeter connected across the output the voltage control

should be turned for maximum output. Now adjust RV₁ on the PCB until the external voltmeter reads 40 volts. Now adjust RV₄ so the power supply's voltmeter also reads 40 volts.

Next the maximum current should be set; an external ammeter capable of handling 2 amps is connected across the output. With this ammeter connected, the output will be driving close to a dead short. Now set the current control for maximum current; with the power supply on, adjust RV₂ until the external ammeter reads 2 amps. Once this is completed RV₃ should be adjusted so the ammeter of the power supply reads 2 amps.

Now the meters on the supply should be checked for accuracy. Using an external voltmeter connected across the output, adjust the voltage control for different readings on the supply's voltmeter. If the readings of the two voltmeters are inconsistent then the voltmeter of the supply should be readjusted using the procedure already given. With an external ammeter connected across the output adjust the current control for different readings on the supply's ammeter. If the two meters are inconsistent the ammeter of the supply should be readjusted using the steps given previously.

Assuming everything is adjusted properly the supply is ready for use.

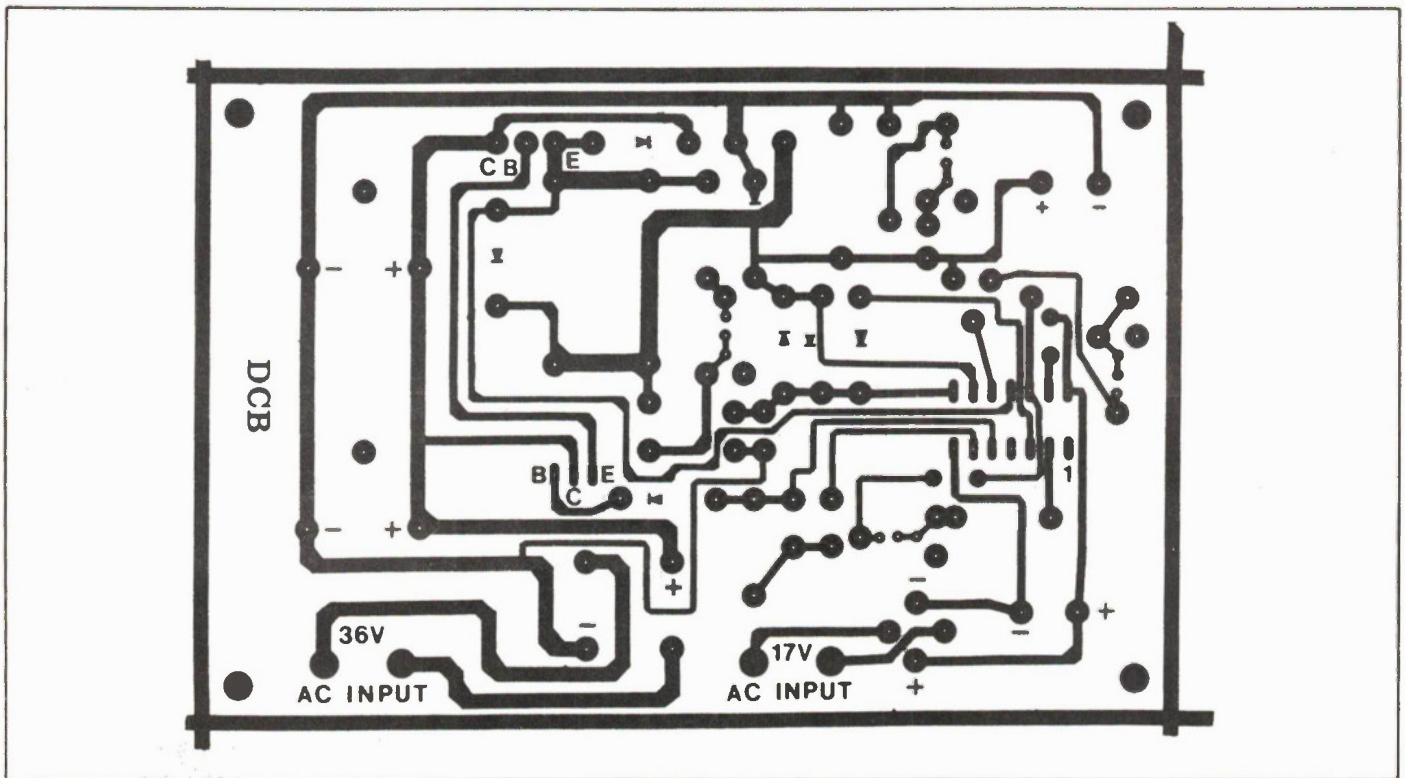

PCB artwork for the Precision Power Supply.

How it Works

The power supply is best understood when divided into separate parts.

The first parts to look at are the two power supply sections. The output supply section consists of XFMR₁, Br₁, C₁ and C₂. They supply the appropriate voltage and current required at the output. The IC supply consists of XFMR₂, Br₂ and C₃. The two power supply sections must be separate from one another because a floating ground is required for IC₁.

The next section is the voltage control section. RV₁ and R₂ determine the operating point of a constant current source out of pin 3 of IC₁. By varying RV₁ the maximum output voltage will be set. Pins 8 and 9 are inputs to a high gain differential amplifier contained in IC₁. By adjusting pot 1 the voltage at pin 8 will vary; this will cause the voltage at the output to change until it is equal to the voltage at pins 8. Due to the high gain of the differential amplifier the voltage at pins 8 and 9 will always remain equal.

The current control section is next. Pin 12 of IC₁ is an internal voltage reference, used with RV₂ and R₃ they set the maximum output current. RV₂ is adjusted to limit the maximum output current to 2

amps. The inputs to the high gain differential amplifier of the current control section are pins 10 and 11 of IC₁. By adjusting pot 2 the maximum voltage across R₅ and R₆ before current limiting is set. This voltage is proportional to the output current, therefore the maximum output current will be set.

Constant current/constant voltage is the next section to look at. The outputs from the voltage and current high gain differential amplifiers are fed through an OR gate. The output that is chosen by the OR gate will then be the output of the IC, which is at pin 5. This causes the supply to switch between the constant voltage or constant current mode.

The next sections to describe are the compensation and protection circuits. C₄ is used for internal compensation of IC₁. The RC network of C₅ and C₆ plus R₁ is also used for internal compensation of IC₁. D₄ and D₅ prevent the input voltage to the high gain differential amplifier from exceeding 0.7V. D₂ and D₇ protect the supply from damage that may be caused when an external power supply is connected.

The output section is next, Pin 5 is the output of IC₁. This drives Q₁ which in turn drives Q₂. The main power dissipated by the supply will be by Q₂, this is why an appropriate sized heatsink is required.

Use

The power supply is very easy to use. There are only two controls, one being the voltage, the other being the current. By adjusting the voltage control the output voltage varies. By adjusting the current control the maximum amount of current which the supply will generate is set. By understanding the function of each control the user will be able to operate the power supply for maximum performance in each situation.

Continued on page 58

Electronics Today

Each year Electronics Today delivers thousands of sales leads processed through our Reader Service Card Program. These sales leads are qualified with name, address and title of respondent.

For advertising information call

(416) 445-5600

A Guide to IC Numbering

An attempt to unravel the mystery behind the numbering systems used on ICs and other semiconductors.

By John Linsley Hood

INTEGRATED CIRCUITS are the easy route to circuit design, since many clever engineers have thought of ways of achieving the desired end, in conveniently packaged and often quite inexpensive circuit blocks. However, there are two main snags. The first of these is knowing which is the right IC to use, and the second is to decide which version of the IC in question is the device that you want.

The circuit diagram may show a 741, but the catalogue lists a whole range of these from MC1741SCG to LM1741CJ-14. What does this mean? And the problem doesn't stop there either, there are all the digital ICs as well.

To start with, the first two letters in the specification refer to the maker of the device. MC, for example, refers to Motorola, uA to Fairchild, and so on. The letters at the end of the specification refer to the packaging, the temperature range for permitted operation, or the reliability guarantee.

Transistor type designations are a bit simpler since they don't usually have a prefix identifying the maker or a suffix specifying one of a range of package forms. The package is usually implied by the actual type number of the transistor. Unless they are very popular devices, like a 2N930 or a 2N6015, a particular transistor will only be available from one or maybe two manufacturers.

The USA JEDEC listing, 1N-, 2N-, 3N-, only refers to the time at which that particular device was registered with the US military authorities, so a 2N5068 is a much

more recent device than a 2N697. There is, however, a small measure of type identification in that 1N-refers to diodes, 2N-refers to bipolar or junction field-effect transistors, and 3N-means MOSFETS.

The European type designation actually gives a description of the general type of the device in its letters. The letters at the end of the type number, for small signal devices, usually denote the current gain range or the pin configuration. Table 5 outlines the classification system used to describe these types of discrete semiconductors.

North American sourced transistors (and

Prefix	Manufacturer
AD	Analog Devices
AM	Advanced Micro Devices
CA	R.C.A.
DS, LM, LF, LH	National Semiconductor
DG	Siliconix
H, HA, HI	Harris
HA	Hitachi
ICL, ICM	Intersil
IR	International Rectifier
MC	Motorola
OP, PM	Precision Monolithics
N, NE, SE	Signetics (Mullard)
RC, RM	Raytheon
SG	Silicon General
SL, SP	Plessey
SN, TL	Texas Instruments
μ A	Fairchild
UCN, UDN, ULN	Sprague
XR	Exar
Z, ZD	Ferranti

Table 1 The codes used in the manufacturers prefix. These form the first group of letters in an IC type number, appearing before the number itself.

ICs) are usually second-sourced (meaning that there are at least two manufacturers), whereas the European devices may come from one manufacturer alone. This is awkward if a designer specifies a favourite device which is not stocked by a particular store, but that same store might have been able to supply a substitute, which in a pinch, could have done the same job.

In digital ICs, the device classification, if it isn't standard TTL or CMOS, is tucked into the middle of the part number. The LS in 74LS68 indicates a low power Schottky device, while the HC in 74HC160 refers to high speed CMOS.

As a general rule, plastic encapsulations are cheaper than metal can or ceramic dual-in-line packages, and commercial temperature range devices are cheaper than the industrial or military versions. Although I have my favourite brands, my experience is that most modern devices from Western Europe, Japan, or the United States (including *off-shore* factory sites such as Taiwan and San Salvador) are reliable in performance and packaging. The companies in question would have gone bust in this competitive age if this were not the case.

Finally, while there are very few magic differences between one device and another for a given voltage, power and current range, an NPN small signal transistor tends to be much the same as the next. Nevertheless it is fairer to the designer if you try to use the particular device specified; there may be a good reason for the choice.

Suffix	Temperature range
1 (Harris only)	-55°C to +200°C
M (2 for Harris, 54 for TTL)	-55°C to +125°C
I	-25°C to +85°C
C (5 for Harris, 74 for TTL)	0°C to 70°C

Family type	Description	Propagation delay (per gate)	Average Power (per gate)
74 ALS ..	Advanced Low-power Schottky	3-4ns	1-2mW
74 LS ..	Low-power Schottky	10ns	2mW
74 ..	Standard TTL	10ns	10mW
74 S ..	Schottky TTL	3ns	20mW
74 L ..	Low-power TTL	33ns	1mW
74 C or CD	CMOS	50ns	<1μW

Table 2 Permitted temperature range. One of these letters (or numbers in the case of Harris ICs and TTL) will usually appear immediately after the IC number.

Table 4 The letter codes used in the middle of 7400 series TTL type numbers to indicate the technology used.

Manufacturer	Metal can		Plastic DIL			Ceramic DIL			Power plastic	
	TO99 8 pin	TO100 10pin	8 pin	14 pin	16 pin	8 pin	14 pin	16 pin	TO92	TO220
Advanced Micro Devices			P	P	P	D	D	D		
Analog Devices	J									
Fairchild	H		T	P	P	R	D	D	W	U
Intersil	K									
ITT			N	N	N	D,J	D,J	D,J		
Harris (H, HA, HI)	2*	3*	3*	3*	3*	1*	1*	1*		
Motorola	H,G		P	P	P	V	L	L	P	T
National Semiconductor	H,G		N	N	N	J	J	J	Z	T
Precision Monolithics	J		P	P	P	Z	Y	Q		
Raytheon	H		DN	DB	MP	DE	DC	DD	S	U
Signetics	H		N,V,N,E	F,A,N,H	B,NJ	FE	FH	FJ		
Siliconix	A		J	J	J	K	K	K		
Sprague	H		M	A	A	H	H	H	Y	Z
R.C.A	T									
Texas Instruments	H		P	N	N	JG	J	J	LP	KC

mainly linear ICs
mainly commercial or industrial types
mainly military or industrial types
transistor types

Table 3 IC package description. One or more letters will usually be placed immediately after the temperature code letter, except in the case of Harris ICs where numbers are used (marked with an asterisk) and placed before the type number.

First letter	Second letter	Third letter (if any)	Number	Final letters
A = germanium	A = small signal diode			lead-out arrangement:- (Pin view)
B = silicon	B = varicap or rectifier diode			
C = gallium arsenide	C = small signal transistor			
	D = power transistor	not usually significant	manufacturers catalogue number	
	E = point contact diode			
	F			
	G } = high frequency transistor			
	L			
	R = special purpose device			
	S = switching diode or transistor			
	T = thyristor or triac			
	U = high voltage transistor			
	X = same as B			
	Y = power rectifier			
	Z = zener diode			

L =

NO LETTER =

current gain at 1mA:-
A = 40 - 120
B = 150 - 460
C = 270 - 800

Table 5 The European ProElectron classification system used to identify discrete semiconductors.

Product Mart *Where Buyers Find Sellers*

BUGGED? WIREAPPED? Find out fast! Countermeasures equipment catalog \$1. OCTE, Dept. ET, Box 173, Montreal. H3X 3T4.

CABLE TV DESCRAMBLING TECHNIQUES. 56 pages. \$13.95. TV Genie channel 14 transmitter \$99.95. Channel 3 notch filter \$39.95. Amazing see-in-the dark Infra-Red night viewer kit \$295. Catalogs \$1. **CROSLEY (J)** Box 173, Montreal, Canada H3X 3T4.

KIT-KING

75 fun projects that you can build. Start today by writing for our catalogue. It is free! Catalogues, **KIT-KING**, 21 Mill St., Orangeville, Ontario, L9W 2M2.

PRINTED CIRCUIT BOARDS for ETI and Ham Radio Projects. Our full list is free. Coleco Adam cassette drives new with schematic \$59.95, Joy sticks \$11.95, Keyboards \$76.50 new. **B-C-D ELECTRONICS**, P.O. Box 6325, Station F, Hamilton, Ontario. L9C 6L9.

"YOUR CHOICE of 8 total of the following high quality semiconductors for only \$9.70 which includes \$2.00 shipping; 74LS00N (QUAD2-NAND), 74LS04N (INVERTER), 74LS08N (AND), 74LS20N (DUAL4-NAND), 74LS27N (NOR), 74LS107AN (DUALJ-K WITH CLEAR), 2N2222A (NPN TRANSISTOR), MV5053 (REDLED), RL21 (REDLED). Print Items required, your name and address and send to **CEDAC**, 6 Douglas Cr., Hillsburgh, Ontario N0B 1Z0."

LED..LED...LED.... Always in stock for immediate delivery by return mail. (5mm dif-fused) Red. \$0.10 - Green \$0.12 - Yellow \$0.12 - Amber \$0.14 - Orange \$0.14 - 2 pcs Holder \$0.4. Minimum order 100 each. Add \$2. for postage. Free sample and selection guide on your letterhead. To **SURPLUS ELECTRO QUEBEC**, 2264 Montee Gagnon, Blainville, P.Q. J7E 4H5.

LUSCIOUS surprise pack of electronic parts \$6.00. 100% money back guarantee! Catalog 2-34¢ stamps. **MP2 SCIENTIFIC**, 33255 S. Fraserway, Suite 472, P.O. Box 8000, Abbotsford, B.C. V2S 6H1. BC residents please add 7% Sales Tax.

6502 MICROCONTROLLER

THE 6502 for your projects. 2 or 8k static ram, 2, 4, 8, 16, or 32K EPROM, 3 6522 VIA's, 1 or 2 Mhz clock, 65C02 hardware Compatible, small 8" x 4.5", **AGGA ELECTRONICS** a Division of RTP, P.O. Box 1848, Kelowna, BC, Canada, V1Y 8P2. Bare PCB with doc. \$44.95. BC Orders add 7% PST. U.S. orders add \$2.00 shipping.

PRODUCT MART

WHERE BUYERS FIND SELLERS

For more information Call:

(416) 445-5600

Electronics Today Order Form

Subscriptions:

Please complete reverse side to start or renew a subscription.

Back Issues: \$4.00 each; Ontario residents add 7% sales tax. Please circle issues desired.

1977	1978	1979	1980	1981
Feb. July	May Sept. Nov. Dec.	Feb. April May July Aug. Sept. Oct. Nov.	Jan. May June Nov. Dec.	Jan. Feb. March April June July Aug. Sept. Oct. Nov. Dec.
1982	1983	1984	1985	1986
Jan. March April May June July Aug. Oct.	Jan. Feb. March April Aug. Sept. Oct. Nov. Dec.	Jan. Feb. March April May June July Aug. Sept. Oct. Nov. Dec.	Jan. Feb. March April May June July Sept. Oct. Dec.	Jan. Feb. March April May June July Aug. Sept.

Binders: Moorshead Publications \$9.75 each plus 7% P.S.T.

SPECIAL PUBLICATIONS

ITEM	QTY	AMOUNT
Book of Computer Music \$4.95	\$
Project Book No. 2 \$3.95	\$
Project Book No. 3 \$3.95	\$
50 Top Project \$4.95	\$

BOOKSHELF — Order Form

Code (e.g. BP12)	Title (Short-form is O.K.)	Price
.....	\$
.....	\$
.....	\$
.....	\$
.....	\$

SOFTWARE — Order Form

.....	\$
.....	\$
.....	\$
.....	\$
Sub Total	\$
Tax (Ontario Residents)	\$
Postage	\$1.00
Total Enclosed	\$

Orders from the Bookshelf are tax exempt. Please add \$1.00 for postage. Remember to put your name and address on reverse side. See over for mailing details. Specials and Software add 7% PST.

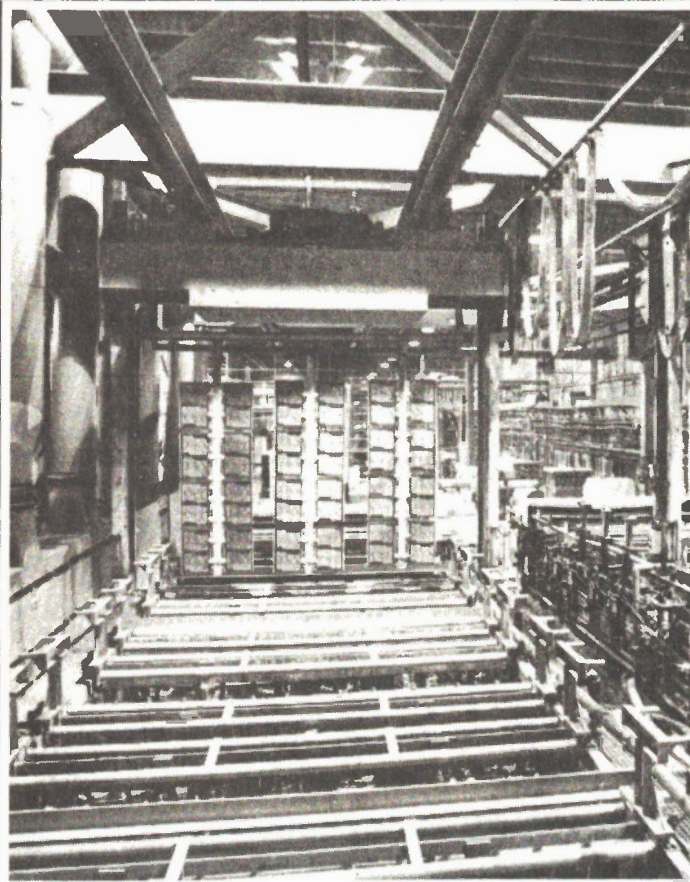

Electronics Today's New Binder Ad Plant!

Our new Binder Ad Facility, in which these binder ads are prepared for publication, is now in operation. The plant occupies 40,000 square feet and features the latest in computerized publishing and materials handling.

At the start of the production line random photographs, comic books, old Mad magazines and interoffice memos are fed into an IBM 360 system. The material is assembled into pasteups and sent down the conveyor tracks by a complex robotics installation.

In the photograph can be seen a year's supply of binder ads coming down the conveyors, ready for filing and future publication.

You can take advantage of this incredible technology by ordering one or more of our special Electronics Today binders. They're made of sturdy vinyl, hold a year's worth of issues without cutting or punching, and open flat for easy reference or photocopying.

They cost \$9.75 each (Ontario residents add 7% sales tax) from:

Binders
Moorshead Publications
 1300 Don Mills Road
 Don Mills, Toronto, Ont.
 M3B 3M8

**BE SURE OF YOUR ISSUE EACH
MONTH. SUBSCRIBE TODAY.**

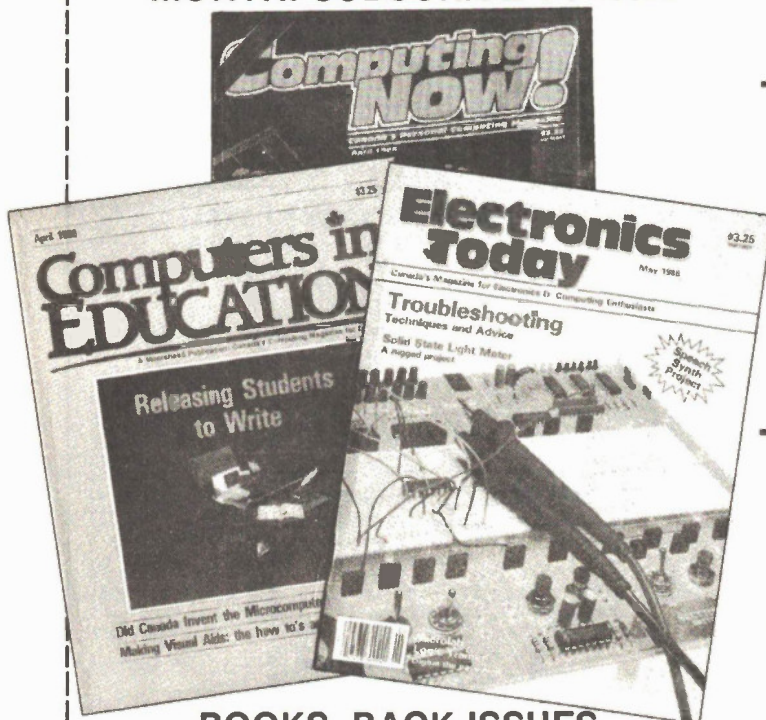

**BOOKS, BACK ISSUES,
SPECIAL PUBLICATIONS, BINDERS
— SEE OVER**

Moorshead Publications

1300 Don Mills Rd., Don Mills, Toronto, Ont. M3B 3M8

MERCHANDISE ORDER Please fill out form overleaf
SUBSCRIPTIONS: NEW SUBSCRIPTION RENEWAL
Electronics Today

One year (12 issues) \$22.95 Two years (24 issues) \$37.95
 Computing Now! (Special Time-Limited Rate)

One year (12 issues) \$14.95 Two years (24 issues) \$27.95

Computers in Education

One year (10 issues) \$25.00 Two years (20 issues) \$45.00

Outside Canada (US Dollars)

For U.S. please add \$3.00 per year other countries add \$5 per year

NAME _____

ADDRESS _____

TOWN/CITY _____ PROVINCE/STATE _____

CODE _____ DATE _____

POSTAL CODE _____

Cheque enclosed DO NOT send cash

Mastercard Account No. _____

Visa Account No. _____

American Express Account No. _____

Expiry Date _____

Signature _____

Beginner's Bench, Part 6:

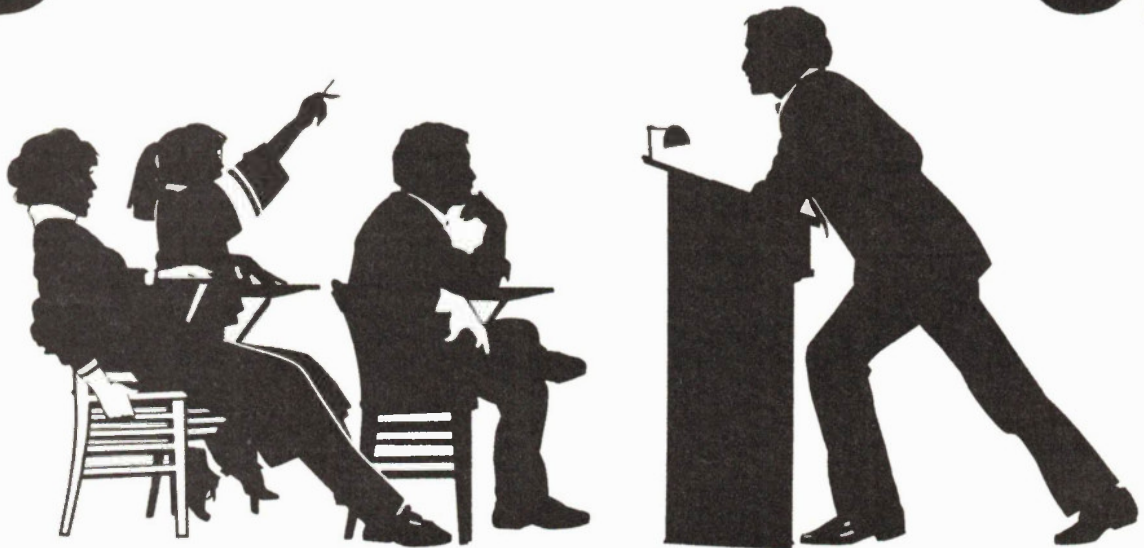

This month, we look at some of the basics of radio, beginning with the Field Effect Transistor.

By Michael Tooley and David Whitfield.

THE field effect transistor operates on a different principle from that used by the conventional junction transistor, the fundamental difference being that the FET is a unipolar device (only one type of charge carrier is involved).

Field effect transistors exist in various forms; the two major subfamilies being Junction Gate (JFET) and Insulated Gate (IGFET) types (see Fig. 1). At this stage we will only consider JFET devices and will go on to use one of these devices in a simple radio receiver.

Fig. 2 shows the simplified internal construction of an n-channel JFET. A thin slice of n-type silicon links the source and drain connections. A narrow p-type region is formed beneath a third electrode called a gate.

With no bias applied to the gate and with a potential difference (of either polarity) applied between the source and drain, electrons will travel within the n-type material in a region called the channel. We have illustrated this in Fig.

3(a) for the normal case in which the drain is made positive with respect to the source.

Now suppose that a negative bias voltage is applied to the gate. The p-n junction formed between the gate and the channel will become reverse biased. The increase in negative charge will repel the electrons away from the p-type region effectively reducing the width of the channel available for conduction, as shown in Fig. 3(b).

Increasing the reverse bias still further will reduce the width of the channel until we eventually reach a condition (known as pinch-off) in which the channel width has been reduced so much that electrons can no longer flow from source to drain. This condition is depicted in Fig. 3(c).

In terms of current flow, when no bias is applied to the gate (i.e. $V_{GS} = 0V$) current flowing into the drain and out of the source (remember that current and electron flows are opposite) will take a maximum value. Note that, since no cur-

rent flows at the gate, the drain and source currents must be identical in magnitude.

Negative Bias

When negative bias is applied, and depending upon the magnitude of this bias, the source and drain currents will be reduced. Furthermore, no source and drain current will flow at all when the bias exceeds the pinch-off value.

We can illustrate this relationship with the aid of the mutual characteristic curve shown in Fig. 4. This shows drain current (I_D) plotted against gate-source voltage (V_{GS}). From Fig. 4, it should be noted that the drain current falls linearly with increasing negative gate-source bias. A typical family of output characteristics for a JFET are shown in Fig. 5. Readers should note that JFETs are not normally operated with the gate-source junction forward biased. (For an n-channel JFET this corresponds to a positive value of gate-source voltage). The danger, of

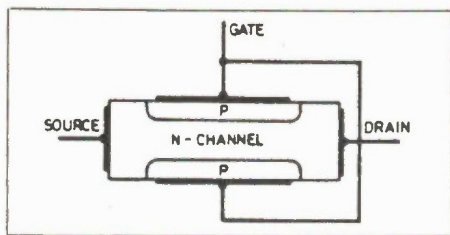

Fig. 1. JFET symbols.

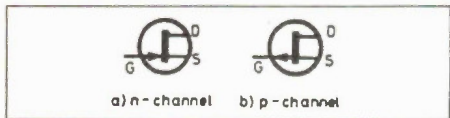

Fig. 2. Simplified internal arrangement of an n-channel JFET.

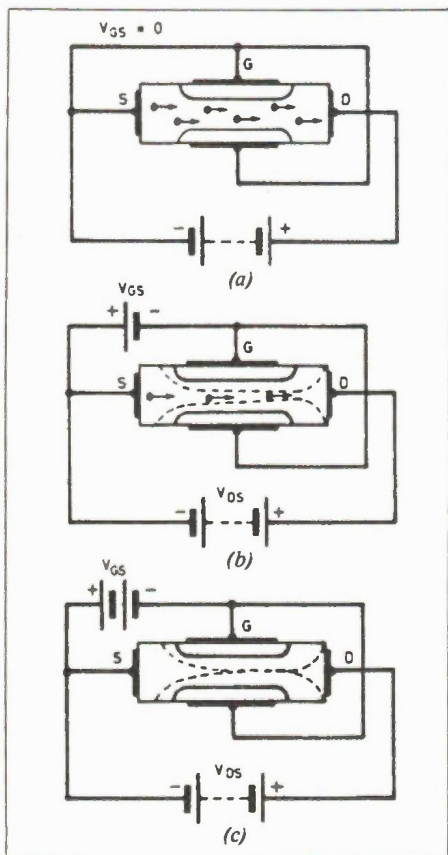

Fig. 3. JFET operation.

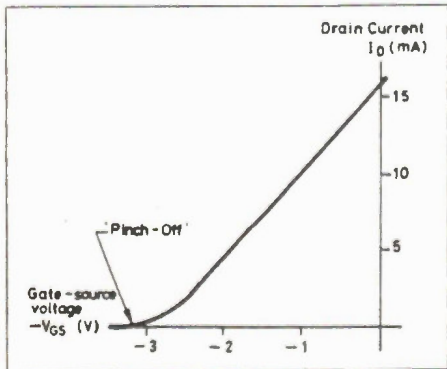

Fig. 4. Mutual characteristic for an n-channel JFET.

course, is that the gate-channel junction will become forward biased and an appreciable value of gate current will be drawn. In this condition the device will no longer operate in a linear manner indeed, an appreciable gate current may destroy the device!

One of the principal advantages of the FET (over conventional bipolar transistors) should now be becoming apparent. Since no current flows into the gate (it is operated by charge rather than current) the resistance looking into the gate of a FET is extremely high (in practice this can be tens of millions of ohms) and thus the device presents very little loading upon the input circuit. A typical JFET amplifier is shown in Fig. 6.

Radio

When a high frequency carrier is radiated into space (as an electromagnetic wave) the system is called radio, the sending and receiving ends being respectively known as a transmitter and receiver.

The modulated high frequency carrier may also be transmitted using a coaxial cable linking the sending and receiving ends of the circuit. By choosing appropriate carrier frequencies, systems of this type can permit a number of signals to be transmitted simultaneously down the same line. This Frequency Domain Multiplexing (FDM) is used in many long distance trunk telecommunication systems.

The Radio Frequency Spectrum

Radio signals occupy a very wide frequency range which itself is part of the complete electromagnetic spectrum, as shown

in Fig. 7. The wavelength of a radio signal is simply the distance between corresponding points on consecutive cycles of the electromagnetic wave, as depicted in Fig. 8. In air, or space, such a wave travels at a velocity equal to that of the speed of light (300 million metres per second).

Velocity of propagation, v , wavelength, w , and frequency, f , of a radio wave are related by the following equation:

$$v = fw$$

Hence, when $v = 3E8$ m/s (where E8 is ten to the eighth):

$$f = v/w = (3E8)/w$$

and

$$w = v/f = (3E8)/f$$

where w is the wavelength expressed in metres and f is the frequency expressed in Hertz.

A radio wave with a frequency of 3MHz, for example, will have a wavelength given by:

$$* = (3E8)/(3E6) = 100 \text{ metres}$$

Similarly, a radio wave having a wavelength of 1m will have a frequency given by:

$$f = (3E8)/1 = 300\text{MHz.}$$

The lowest frequencies used for practical radio communication are in the low tens of kHz. Very Low Frequency (VLF) waves travel close to the surface of the ground and rely on good ground conductivity. A typical application of VLF transmissions is, therefore, long distance telegraphic communication with submarines.

At the other end of the spectrum, frequencies of beyond 30GHz (i.e., 30,000,000,000 Hertz) travel only in straight lines over an unobstructed path.

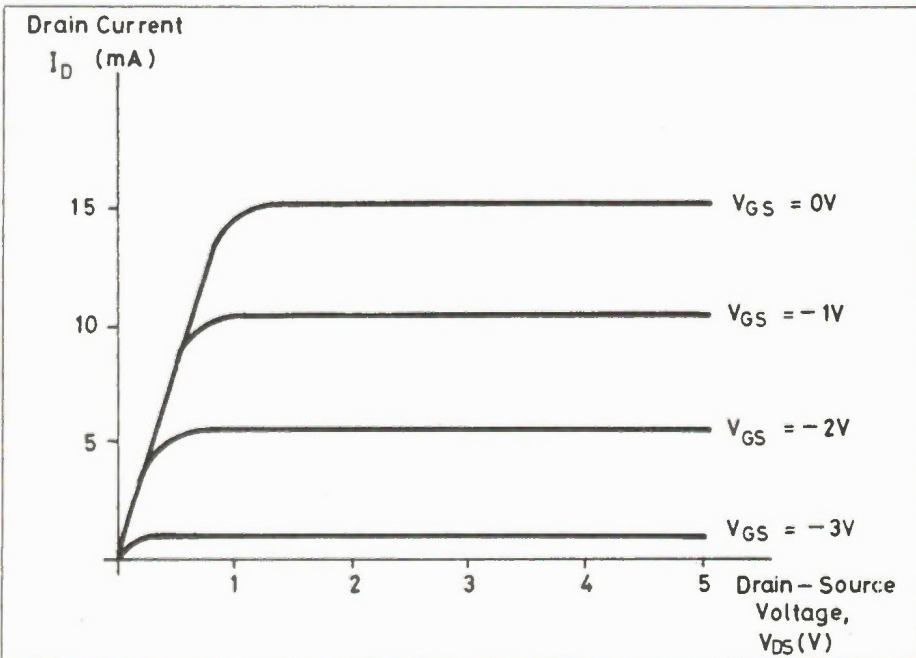

Fig. 5. Output characteristic for an n-channel JFET.

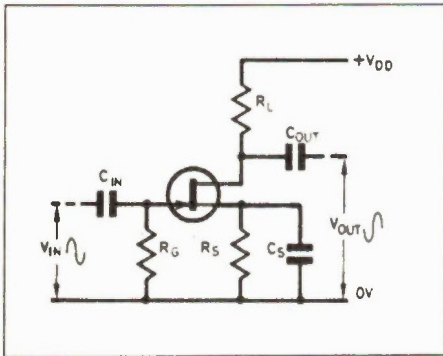

Fig. 6. Typical JUGFET amplifier state.

They are thus used for applications such as short range high resolution radar.

The use to which each frequency range is put depends upon a number of factors, paramount of which is the propagation characteristics within the range. Other factors that need to be taken into account include the efficiency of practical aerial systems in the range concerned and the bandwidth available.

Finally, though it may appear from Fig. 7 that a great deal of the frequency spectrum is unused, it should be stressed that competition for frequency space is fierce. Frequency allocations are, therefore, ratified by international agreement and the various radio services carefully safeguard their own areas of the spectrum.

Modulation

In order to convey information from one end of a radio circuit to another, the signal information must be modulated onto the high frequency carrier. The process of modulation is simply that of changing a particular property of the carrier wave in accordance with the instantaneous voltage (or current) of the signal to be conveyed.

Several methods of modulation are in common use, two of the most common being Amplitude Modulation (AM) and Frequency Modulation (FM). In the former case the carrier amplitude (its peak voltage) varies according to the voltage, at any instant, of the modulating signal. In the latter case the carrier frequency is varied in accordance with the instantaneous modulating signal voltage.

Typical waveforms showing a sinusoidal carrier modulated by a sinusoidal modulating signal are shown in Fig. 6.9. It should be noted that, in a practical case, far more cycles of the RF carrier would occur in the timespan of one cycle of the modulating signal than can actually be shown.

Consider, as an example, the case of a 1MHz carrier modulated by a 1kHz signal. One thousand cycles of RF carrier will occur during the time interval occupied by only one cycle of the modulating signal.

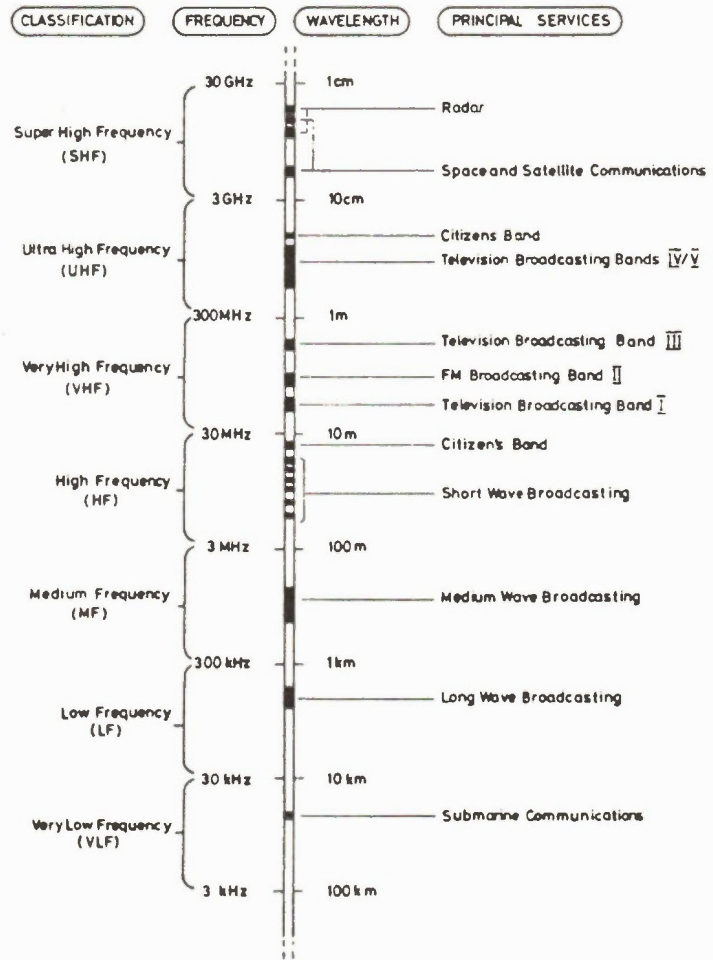

Fig. 7. The radio frequency spectrum.

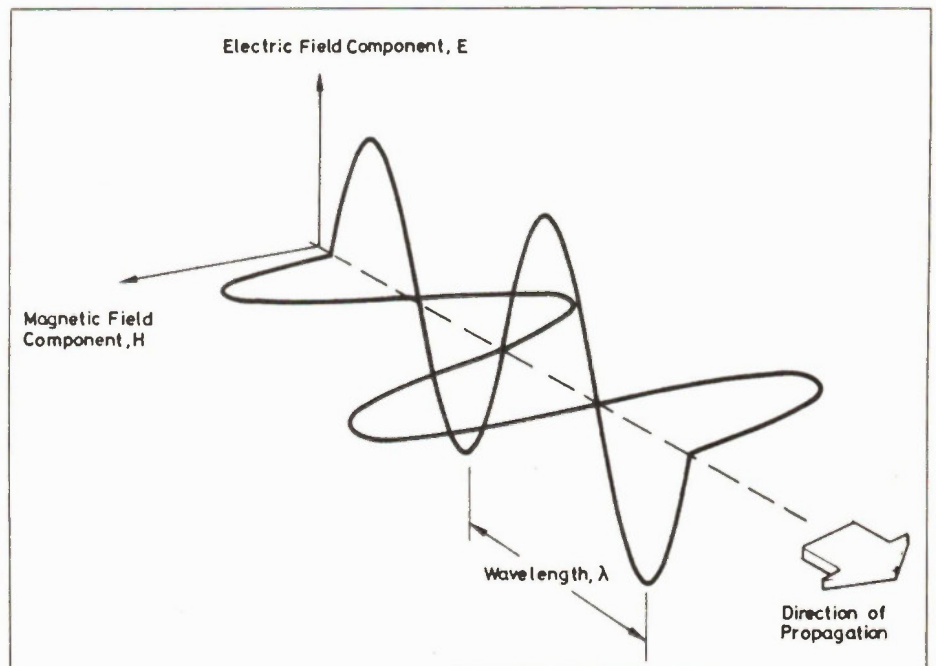

Fig. 8. An electro-magnetic wave.

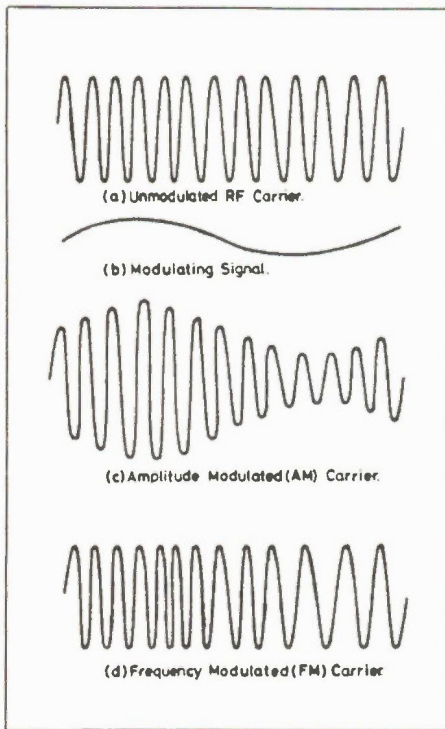

Fig. 9. Amplitude and frequency modulation.

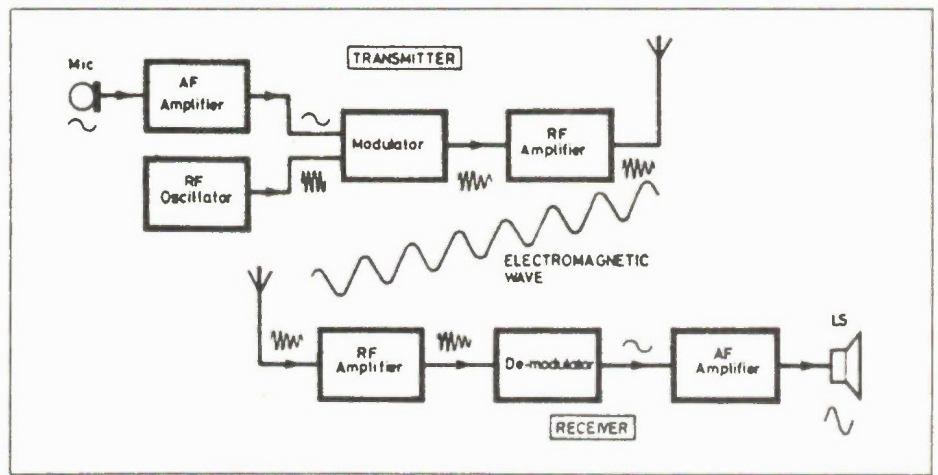

Fig. 10. Block schematic of a radio communication system.

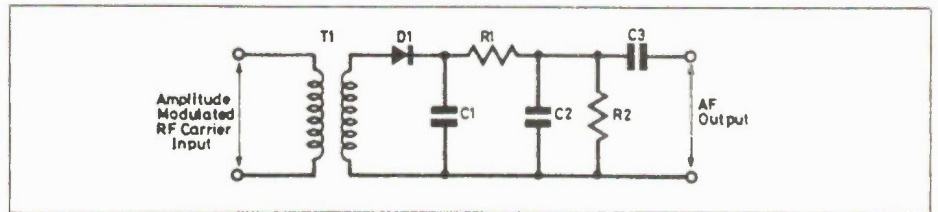

Fig. 11. A diode demodulator for AM signals.

Demodulation

The process of recovering the signal from a modulated carrier is known as demodulation. This process is carried out by a circuit known as a demodulator (sometimes also called a detector).

The block schematic of a complete AM radio system is shown in Fig. 10. The carrier wave (of constant frequency) is generated by means of an RF oscillator. In order to ensure unconditional stability of such an oscillator the frequency determining element is generally a quartz crystal. The output of the modulator (a modulated RF carrier) is amplified before outputting to an aerial system. The output is usually also carefully filtered to remove any spurious signals (harmonics) that may be present.

At the receiver, the signal produced by the receiving aerial is a much weaker copy of the transmitted signal. Also present will be countless other signals at different frequencies. These must be rejected in the receiver's RF tuned circuits if they are not to cause interference at the demodulator.

Besides selectivity, the RF amplifier stage also provides voltage and power gain so that a larger signal is presented to the demodulator. This stage then recovers the modulated information.

The signal recovered by the demodulator normally has quite a small amplitude (500mV, or less) and thus further (audio frequency) amplification is subsequently required to bring the signal to a voltage and power level suitable for connection to a loudspeaker.

Diode Demodulator

A simple diode demodulator is shown in Fig. 11 together with representative voltage waveforms in Fig. 12. The modulated RF carrier is applied (usually via a radio frequency transformer) to the diode which conducts on positive going half cycles of the RF input voltage. The diode used, incidentally, should be a germanium (rather than silicon) type by virtue of the much smaller forward bias voltage required for conduction to take place. This helps to improve the sensitivity and linearity of the detector.

Capacitor, C1, charges to the peak voltage of each RF cycle and maintains a voltage which resembles the shape of the envelope of the amplitude modulated input waveform.

Series resistor, R1, and shunt capacitor, C2, then form a simple low-pass filter which removes any residual carrier frequency components present on the recovered audio frequency output voltage. Finally, R2 completes the DC path (required by the detector) whilst C3 acts as a DC blocking/AC coupling capacitor to pass the signal to the next stage.

Tuned Circuits

We have already mentioned the need for selectivity within the RF amplifier stage. Selectivity is achieved with the aid of a tuned circuit comprising inductance, L, and capacitance, C. Where the frequency of the tuned circuit is to be made adjustable, either of the components may be

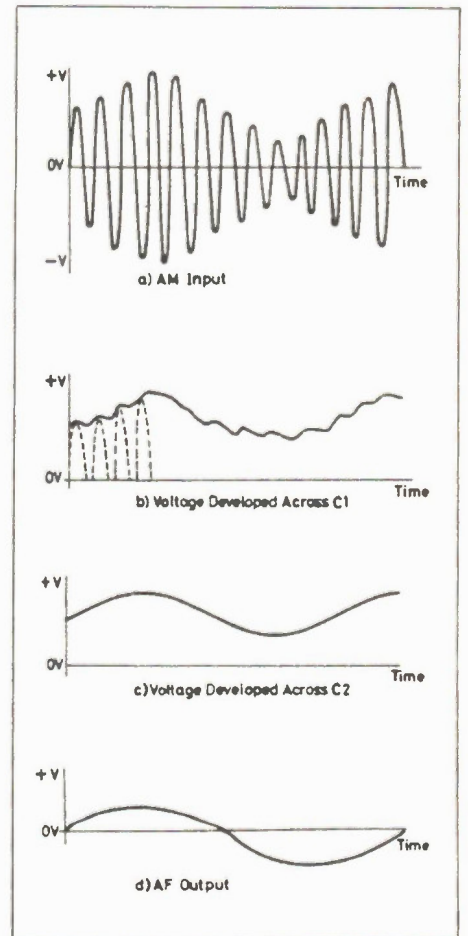

Fig. 12. Waveforms for the circuit of Fig. 11.

made variable. In practice, however, it is usually easier to make use of a variable capacitor rather than a variable inductor.

Two forms of series tuned circuit are possible; series and parallel, as depicted in Fig. 6.13. We have included, in each case, an equivalent loss resistance which accounts for the imperfections of the circuit (i.e. the leakage resistance associated with the capacitor and the winding resistance of the inductor).

Fig. 14 shows the impedance/frequency characteristic of each type of tuned circuit. It should be noted that the series and parallel tuned circuits have opposite characteristics and, furthermore, the series tuned circuit has a minimum impedance of R_s whilst the parallel tuned circuit has a maximum impedance equal to R_p .

The characteristics of the tuned circuit make it ideal for selecting or rejecting a range of frequencies. For this reason the series tuned circuit is often known as an acceptor circuit whilst the parallel tuned circuit is often called a rejector circuit.

A Simple Radio Receiver

A practical radio receiver can be produced by combining a tuned circuit with a diode demodulator, as shown in Fig. 15. The tuned circuit provides a degree of selectivity whilst the diode demodulator recovers the amplitude modulated signal. This arrangement is often called a crystal set since the first generation of such receivers employed a piece of galena crystal and a cat's whisker (a small piece of spring steel with a sharp point) to make a crude form of diode.

Provided that a reasonable efficient aerial and ground system can be realized, out simple radio receiver should be capable of providing acceptable reception of around half a dozen of the strongest broadcasting stations in the medium and long wave bands.

The selectivity and sensitivity of the receiver still leaves a great deal to be desired and thus the simple crystal set must now be considered as something of an antiquity.

TRF Receiver

A modern tuned radio frequency receiver using just one tuned circuit is shown in Fig. 16. This receiver uses a ferrite rod (the same as that employed for this month's practical assignment) and does not require any external aerial or ground connection. The integrated circuit provides all the functions of an RF amplifier, demodulator, automatic gain control (AGC) and audio amplifier all contained on the same 8-pin dual-in-line plastic packaged chip.

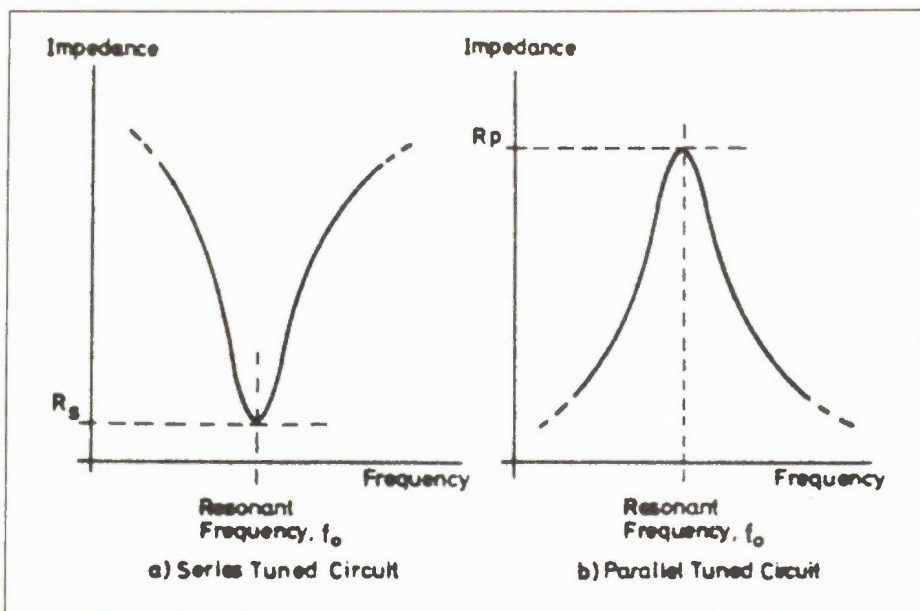

Fig. 14. Impedance frequency characteristics for the tuned circuits of Fig. 13.

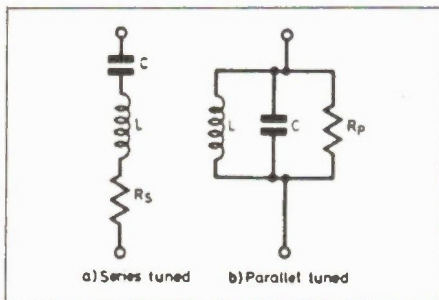

Fig. 13. Tuned circuit.

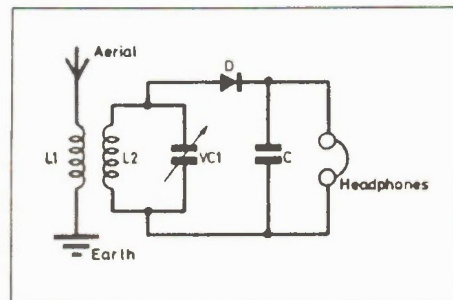

Fig. 15. A simple "crystal set".

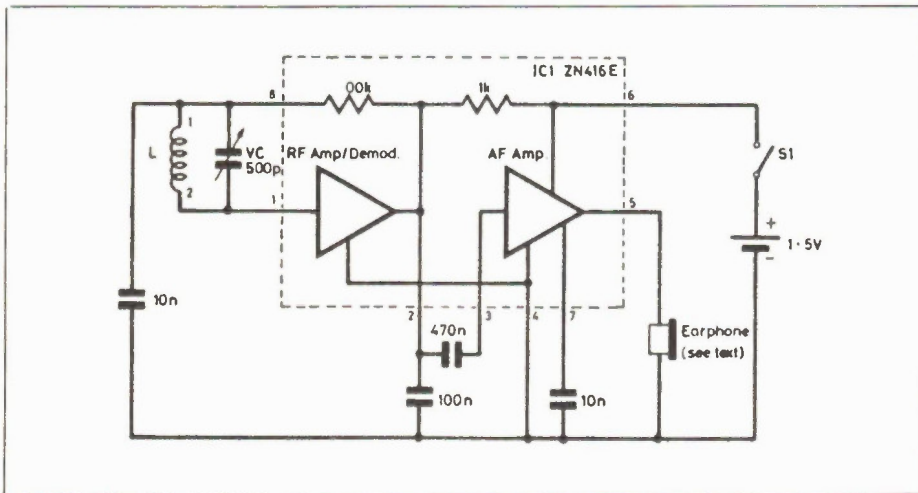

Fig. 16. a modern tuned radio frequency (TRF) receiver.

The circuit requires only six external components (excluding medium/high impedance headphones or small loudspeaker) and is capable of operation over the range 150kHz to 3MHz, depending upon the tuned circuit employed. The IC provides a typical power gain of 72dB and operates from a nominal 1.5V single dry cell.

Despite its simplicity, this little receiver is capable of quite astonishing performance producing reception of more than a dozen medium wave stations at reasonable volume. Hopefully, it should make an interesting constructional project for readers wishing to put the components used in this month's practical assignments to some good use.

Coming in the December issue! Canadian Satellite Downlink



We present a 24-page special section on satellite TV reception. The relay satellites have dozens and dozens of channels, and the new technology gives super quality video

Here are just some of the contents:

An Introduction - what's there to watch, and what you basically need to get it.

Choosing A System - a hands-on approach to the available hardware.

A Commercial Installation - how the pros install it.

A Do-It-Yourself Installation - how to manage it yourself.

The Truth About Scrambling - what's currently scrambled or about to be, and what's not scrambled and not about to be. How scrambling works.

Alternate Services - there's more than TV on TV. The extra channels carry FM radio, videotex, wire services, interlace data and more. How they work and how you can access them.

All this and more in the December issue of Electronics Today!.



This Month in *Computing!* **Now!**

Mouse Review

A tale of two mice: the Logimouse and the SummaMouse are unveiled.

BEST AT Review

CN! takes the **BEST AT** for a test drive. Check out the results.

Build The Sloth

That's what it said. Take a look at what it takes to build your own computing machine.

Amiga Peripheral Survey

Find out about all the neat stuff available for the Amiga.



Low-co\$t Transistor Tester

Build this simple, inexpensive gain checker for bipolar transistors.

By Jerry Penner

TRANSISTORS are one of the most basic components of active electronics. Building with them can be easy, but unless you know some basics, designing with them can range from mildly frustrating to completely unthinkable.

Have you ever wanted to match two complementary transistors exactly by gain? How about that digital power interface to control your house? Do the transistors in it have a high enough gain to work? Or do you just want to separate your junkbox into high and low gain transistors for future reference? In any of these cases a gain tester would provide the answer.

Transistor Gain

Transistor gain is equal to the amount of current through the collector divided by the amount of current through the base (I_b/I_c). In Fig. 1 the base resistor R_b is 10k and the voltage supply is 0.7 volts for silicon. The base current is equal to voltage supply minus the base emitter drop, divided by the base resistor value ($I_b = (V_t - V_{be})/R_b$). In the case of Fig. 1, $I_b = (5V - 0.7)/10 \text{ kohms} = 430\mu\text{A}$. If $B_{dc} = 100$ and $R_c = 1000 \text{ ohms}$, the

Electronics Today October 1986

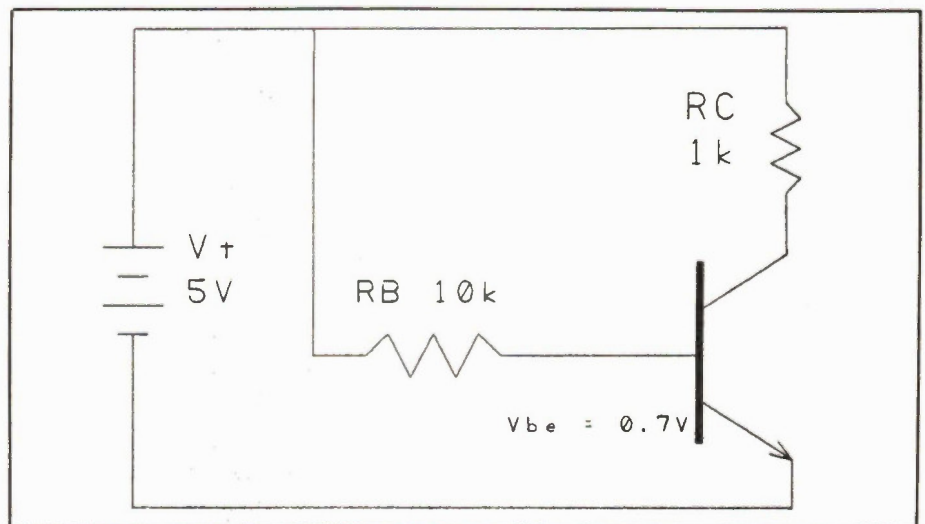

Fig. 1. The basic circuit used to measure Beta (HFE).

maximum current through R_c equals $I_b \times B_{dc}$, which equals $430\mu\text{A} \times 100 = 43\text{mA}$. This demonstrates the effects of transistor gain. Note that the collector current is 100 times greater than the base current. If the base current is changed to 1 microamp,

the collector current is equal to the B_{dc} in milliamps.

If you recall that the amount of voltage across a resistor is direct, voltage across R_c can be used to measure B_{dc} . Therefore if $I_b = 1\mu\text{A}$, $R_c = 1 \text{ kohm}$, and $B_{dc} =$

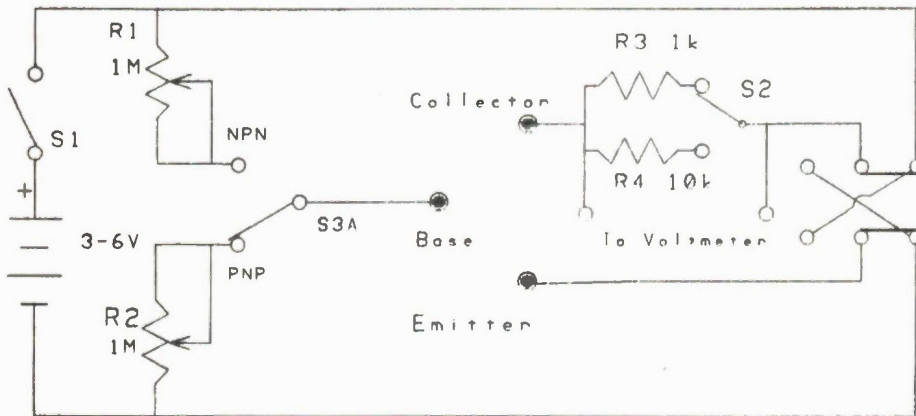

Fig. 2. The schematic of the tester for use with voltmeters with automatic polarity control.

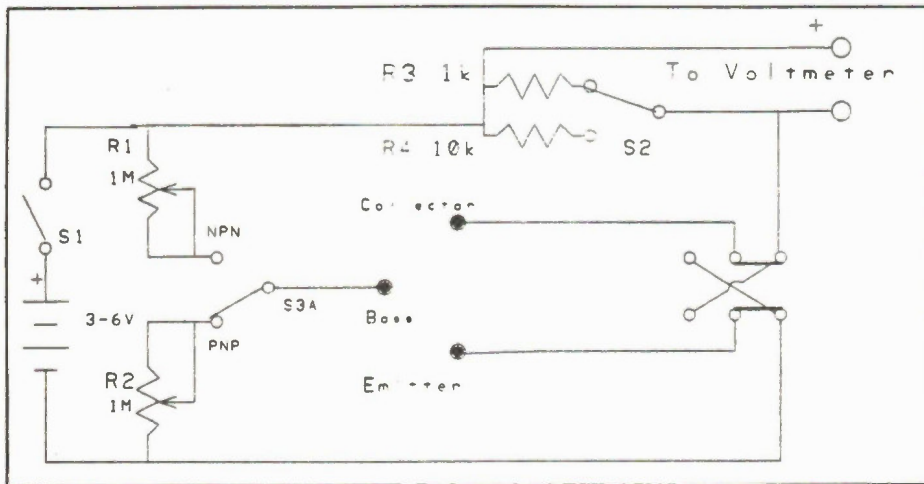

Fig. 3. The schematic of the tester for use with voltmeters which do not have automatic polarity control.

100, then:

$$V_c = I_b \times Bdc \times R_c$$

$$V_c = 1\mu A \times 100 \times 1000\text{ohms}$$

$$V_c = 100\text{mV.}$$

Since most voltmeters can't read in the millivolt range, I_b must be 10uA to give a measurable Bdc for low gain transistors. This means that a Bdc of 1 would actually read as 10mV.

Fig. 2 is the schematic for the meter itself. One problem exists with this project if you don't have a digital voltmeter. To maintain accuracy, the collector resistor should stay on the collector. However when the type selector is switched from NPN to PNP, the polarity on the collector resistor changes. If you don't have automatic polarity reversal on your meter, you should use Fig. 3. In Fig. 3 the load resistor switches between collector and emitter as the transistor selector is switched. Since the base current on a transistor runs out the emitter, Bdc for PNP will be measured one unit higher than it actually is.

Construction

Construction may be by any method, but

Veroboard or PCB are suggested to keep everything compact. Remember to use Fig. 5 if your meter doesn't have automatic polarity control. Resistors R3 and R4 should be as close to their ratings as possible. If they are within 1 percent either way, the tester will give good accuracy.

In order to make the device plug directly onto a meter, the connecting pins must be fastened to the back of the box. Because of this, a nonmetallic box must be used. The particular meter this tester was designed for has banana connectors. To get the exact fit needed, banana plugs were put into the V+ and common terminals and screws tightened into the plugs. Then the plastic box was placed on top of the screws and the screws heated with a soldering iron. The plastic melted enough to mark where holes must be drilled.

Note: When connecting the transistor lead wires, use three different coloured wires to make identification easier. Also identify the NPN and PNP trimpots to make calibration less frustrating.

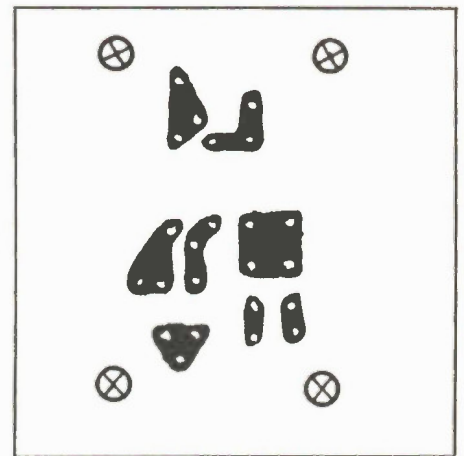

Fig. 4. The PCB for the automatic-polarity-control version.

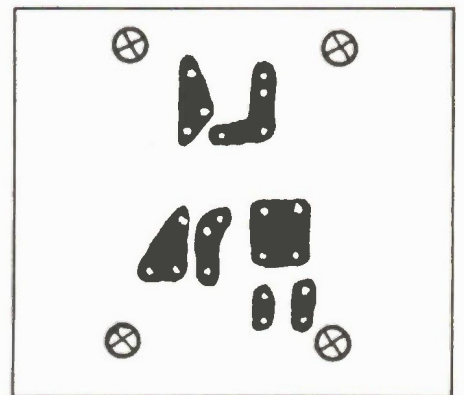

Fig. 5. The PCB for the non-automatic version.

Calibration

There are two methods of calibration. The easiest is to have an NPN and PNP transistor of known Bdc. Put the NPN transistor under test, connecting emitter, base, and collector correctly. Switch the type selector to NPN and set the LO/HI Bdc switch to LO if the calibration transistor has a Bdc of 20 or less. Adjust trimpot R1 until the known Bdc is indicated on the voltmeter in x 10mV, or x 100mV if the LO/HI Bdc Switch is in the HI position.

The second method is more complex, but Bdc need not be known. First find V_{base} by measuring the battery voltage and subtracting the 0.7 volt base-emitter drop (V_{be}). Divide V_{base} by I_{base} of 10uA to find the base resistance R_b ($R_b = V_t - V_{be} / 10\mu A$).

Switch your multimeter to the resistance scale. Adjust the NPN trimpot until the calculated resistance is reached. Repeat for PNP.

Now that the unit is calibrated remember what the battery voltage is. Battery voltage can be checked by switching the unit on and shorting the collector and emitter leads together. This tester

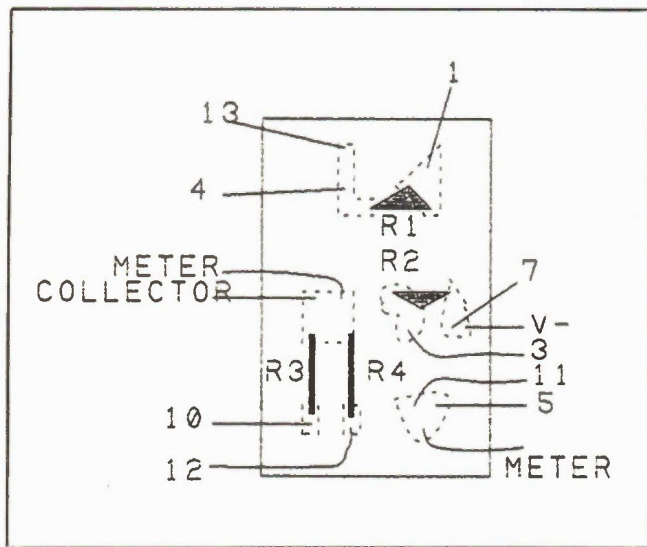

Fig. 6. The wiring of the automatic version PCB.

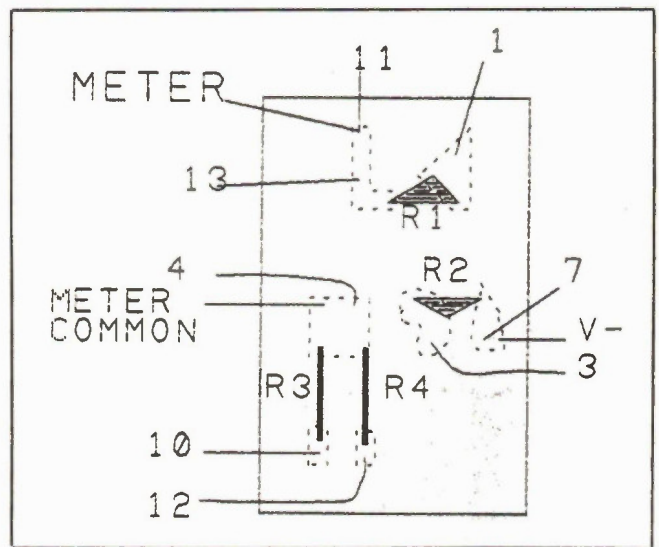

Fig. 7. The wiring of the non-automatic version PCB.

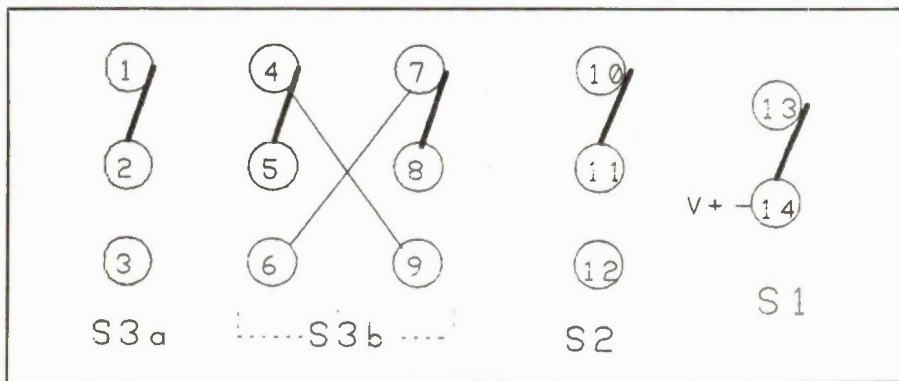

Fig. 8. The switch terminal numbering.

has the added advantage of testing its batteries under load. When the battery voltage drops by 100 mV, measured Bdc drops by five percent. Rechargeable batteries would be a good idea here because they tend to hold their rated voltage during discharge. Ordinary batteries do not. If you are willing to lose portability, a plug-in power supply would be the best idea. No worries about battery voltage.

The Circuit

Resistors R1 and R2 provide the precision resistance to the transistor base. S1 is the type switch. It switches between these two resistors and also reverses the polarity of the emitter and collector leads. The base resistance is adjusted to give a 10uA current into the transistor base. The test transistor amplifies the base current to by amount equal to $10\mu\text{A} \times \text{Bdc}$. Bdc is measured across either R3 or R4 as voltage. Low gain transistors can be measured accurately by switching the Lo-Hi Bdc selector to the Lo position. This places a 10k ohm resistor in series with the

transistor under test, allowing currents up to 20mA to pass and Bdc up to 20 to be measured. In the Hi position a 1000 ohm resistor is in series with the transistor, allowing Bdc up to 200 to be measured.

Current is converted to voltage potential across R3 or R4 and the Bdc measurement taken as voltage across one of these resistors. Higher Bdc may be measured if a higher battery voltage is used and the trimpots adjusted, or by substituting R3 or R4 with a lower resistance. Be careful that no transistor parameters are exceeded. This will cause the transistor to break down.

Conclusion

Now that you have a Bdc tester of your very own, that growing mound of used transistors in the corner may not look so menacing. They say that necessity is the Mother of invention. Currently, my desk is crawling with millions of homeless three-legged amplifiers. I think of this project as my latest weapon in the war of useable workspace. ■

DID YOU RECEIVE YOUR COPY?

This catalogue is a comprehensive description of the Almost Free Software available from Moorshead Publications.

If you would like a copy of this catalogue, please mail your request to:

**Moorshead Publications
Software Services**
1300 Don Mills Road
Toronto, Ontario
M3B 3M8

MARKET PLACE

Triplet Model 60 VOM

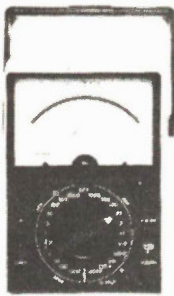

- 28 Ranges - to 1000 Volts DC or AC; 5 Ohmmeter Ranges to 10 Meg Ohms.
- Diode overload protection and 3 F arrangement.
- 3 year warranty.

Special **\$219.00**
Regular **\$269.00**

Add \$3.00 transaction PST extra.

- Quality + Price + Service = **BRUNELLE**



Brunelle Instruments Inc.
73-6th Range South
Saint Elie D'orford, Quebec, J0B 2S0
Tel: 1-819-569-1408 Telex: 05-836266

WAREHOUSE SALE

With this coupon

\$2.00 worth of Free Parts

AT OUR HUGE SURPLUS WAREHOUSE
Monday-Saturday 10:00 am — 5:00 pm at
20 Beverly Street, Toronto
416-977-0520



WE HAVE THOUSANDS OF ITEMS FOR SALE, ALL KINDS, OF POWER SUPPLIES AND CONNECTORS, ETC ETC, ALL THE SAMPLES WE HAVE LEFT OVER FROM THE APPLE CLONE ERA, ALL THE DEFECTIVE GOODS THAT WE DO NOT WANT TO REPAIR. ALL AT LOW LDW PRICES FOR THE HOBBYIST.

PC COMPATIBLE SYSTEM

includes:

- Keyboard & 150W power supply
- Fully loaded 640K
- 2 DS/DD Disk drive & controller
- Serial parallel and game port, clock and calendar monochrome graphics board.
- 6 Months warranty.

SALE **\$115.00**
PRICE

BONUS

If you buy this system we will offer you a high resolution TTL Monitor for \$165.00

EUTHA Enterprises
26 Kincaid Street, (613)
Brockville, 345-3524
Ontario K6V 4Z9

Shipping: Add \$20.00 for System and \$15.00 for Monitor. Certified cheque, personal cheque (allow time for clearance). Ontario residents add 7% P.S.T.

ELECTRONICS TODAY BACK ISSUES
50% OFF!

Regular price \$4.00 each. With this coupon \$2.00 each. Check availability from order form/advertisement in this issue.

Ontario residents, please add 7% P.S.T.

K.E.M.

Stepping Motor Controller and Driver

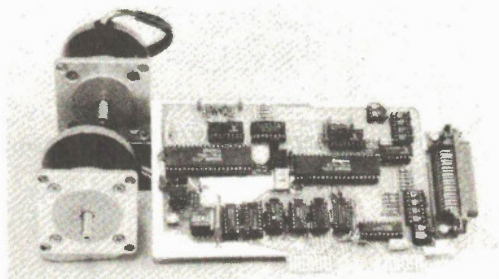

(Two motors are optional)

For IBM XT.

- Programmable Intelligent Stepping motor controller
New model KEM-806 **\$398.00** with demo-software
 - 2-CH intelligent motor controller interface I/F card for IBM XT. 2 custom MPU built-in to control 2 stepping motors (max. 16 motors) simultaneously by using BASIC or other high level languages. Photo isolator for input and output signals. 5000pps (10000pps option)
 - High Performance PWM type stepping motor driver
New model KEM-802 **\$98.00/ch**
\$205.00/2ch with heatsink
- High speed, high torque stepping motor driver. PWM constant current power driver IC and phase controller IC are used, current limiter and power down circuit built-in. Photo isolator signal input.
- output power 2.25V to 18V 1.5A max.
pulse rate 20000pps
mini size 55mm, 75mm, 30mm without heatsink
- **Rotary Encoder OSS Series**
Pulse rate 100P/R to 500P/R. Price range \$98.00 to \$198.00

K.E.M. Electronics Ltd.

Mail: Box 69126 Station (K), Vancouver, B.C. V5K 4W4
Office: 879E. Hastings St., Vancouver, B.C. Tel: (604) 251-1514

SPEAKERS DRIVERS IN CANADA

DYNAUDIO

morel

vifa

Peerless

seas

FOTAL

CROSSOVER, SPEAKER COMPONENTS

SOLEND CROSSOVERS

Custom Computer Design
Passive Crossover for Professional, Hi-Fi and Car Hi-Fi
Application, Power up to 1000 Watt.

SOLEND INDUCTORS

Perfect Lay Hexagonal Winding Air Cored
Values from .10 mH to 30 mH,
Wire Sizes from #20 AWG to #10AWG

CHATEAUROUX CAPACITORS

Metallized Polypropylene (Non-Polarized)
Values from 1.0 mfd to 200 mfd,
Voltage Rating: 250 VDC / 150 VAC

CROSSOVER, SPEAKER PARTS

Mylar Capacitors, Power Resistors, Crossover Terminals,
Nylon Ty-Wrap, Binding Post, Banana Plugs, Speaker Terminals,
Grill Cloth, Plastic Grill Fast Snap, Neoprene Gasket, Misc. Parts.

COMPUTER AIDED DESIGN FOR ENCLOSURE AND CROSSOVER AVAILABLE TO CUSTOMER

Product specifications and prices available upon request.



SOLEND INC.
5940, AV. BERGEVIN
BROSSARD, QC
CANADA, J4Z 1Z2

ORDERS

Tel: (514) 656-2759

Circle No. 10 on Reader Service Card

Now the best book of replacement semi's gets better



The expanded ECG **Semiconductors Master Replacement Guide** and its recently published **Supplement**, cross reference over 227,000 part numbers to over 3,500 ECG solid-state replacement devices* used as substitutes for a wide assortment of semiconductors found in entertainment, commercial and industrial equipment, as well as industrial maintenance, repair and operation (MRO). Both publications are available from ECG Canada Inc.

This comprehensive, 655-page Guide cross references the industry's largest selection of semiconductor devices to the ECG line. It features additions in practically every product category, including several all-new product sections. The 16-page Supplement, which is included with the Guide, contains technical information on 41 new types added since the master Guide was published, and lists some 4,500 new and revised cross references.

If it's ECG, It fits. And it works.

(To order, please send cheque or money order in amount of \$4.50, plus \$3.00 for postage and handling, to ECG Canada Inc.)

ECG CANADA INC.

Electronic Components and Systems
8580 Darnley Road, Montreal, Quebec H4T 1M6
A North American Philips Company

*Replacements meet or exceed the specs of the original parts.

Circle No. 25 on Reader Service Card

COMPTECH-1000 COMPUTER



Licensee of
Phoenix Bios
**XEROX WARRANTY
ACROSS CANADA**

Compatible to IBM* PC & XT*

Fully assembled and tested in Canada

IBM is a registered trademark of International Business Machine Corporation.

- * Phoenix Bios.
 - * 640K RAM memory on board
 - * 360K DS/DD disk drive with controller card
 - * Hinged case with 135W power supply. CSA Approved.
 - * Cherry switch keyboard
 - * 90 Day warranty
- ONLY \$875.00**

PERIPHERALS

- Colour graphic card \$ 95.00
- Monochrome graphic printer card . \$135.00
- Multi I/O card (parallel, serial game port, realtime clock) \$125.00
- 256K mother board no BIOS \$230.00
- Serial port \$ 65.00
- Parallel port \$ 30.00
- 384K multi function card OK RAM . . \$145.00
- 20M seagate with controller \$695.00
- National 360K DS/DD disk drive . . . \$155.00
- 135W CSA Approved power supply . \$150.00
- * TVM 3D-RGB color/green/amber . . . \$550.00
- 3-IN-1 High resolution monitor
- * **Mouse with software** \$ 95.00
- * Joystick with auto centre \$ 34.95
- * ACC-303 Modem phone (300 baud) . \$109.00

COMPTECH SYSTEMS

DIVISION OF COMPTECH CANADA INC.

780 Burnhamthorpe Rd., W. Unit 8
Mississauga, Ont. L5C 2R9
Tel: (416) 279-3084
Tlx: 06-965594 COMPTECH MSGA

423 Queen St. W. Unit 1/B
Toronto, Ontario
M5V 2A5
Tel: 585-2050, 2051

4961A Queen Mary
Montreal H3W 1X4
Tel: (514) 738-1269

MAIL ORDERS: Send certified cheque or money orders plus \$5.00 for shipping and handling. VISA accepted. Ontario residents add 7% P.S.T.



*Prices subject to change without notice.

Importer & Distributor

Dealers enquiries welcome.

Parts List

Resistors

R1	1.2K
R2	7.5K
R3	15K
R4	160R
R5	0.22R 5W
R6	0.22R 5W
R7	10K 1W
R8	180K
R9	330K 1W
RV15K
RV25K
RV3	500R
RV4	100K
Pot 1	50K ten turn
Pot 2	500R

Capacitors

C1220uF 100V electrolytic
C22200uF 100V electrolytic
C3220uF 50V electrolytic
C40.1uF ceramic
C510pF ceramic
C6240pF ceramic
C70.1uF ceramic
C8	100uF 100v electrolytic

Semiconductors

D1, 2, 3, 4, 5, 6, 7, 8	1N4007
Br ₁	6 amp 200V Bridge
B ₂	1 amp 50V Bridge
Q1	TIP 31C
Q2	2N6385
IC ₁	MC1466

Other:

17 VAC	300 ma
36 VAC	3A
Power Switch		
Led		
Heatsink		
Cabinet (Hammond 1458 series)		
3 binding posts		
2 knobs		

Meters

2	250 uA meters
---	-------	---------------

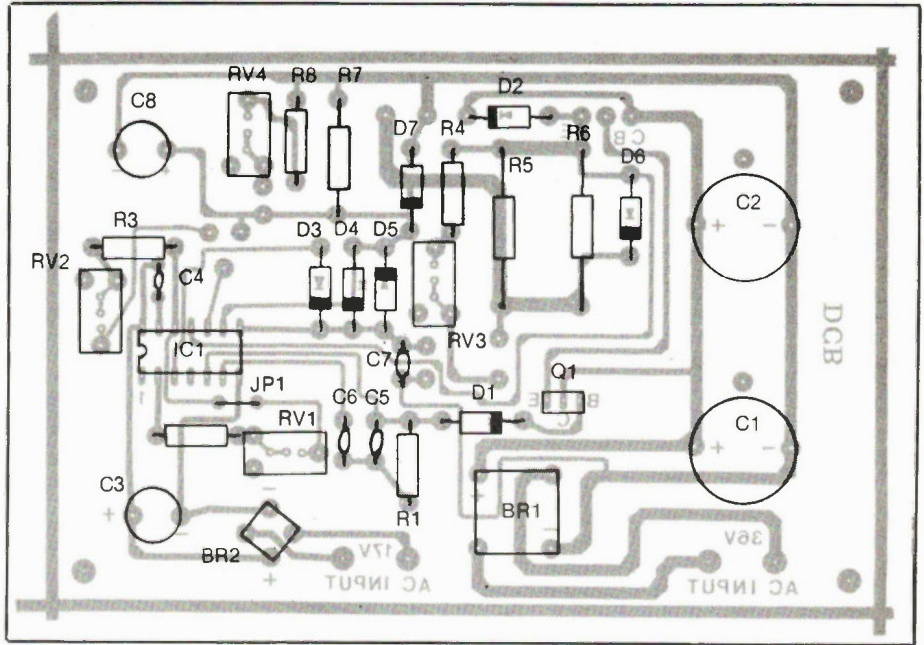

Parts overlay (top) and the wiring detail for the P.S.U.

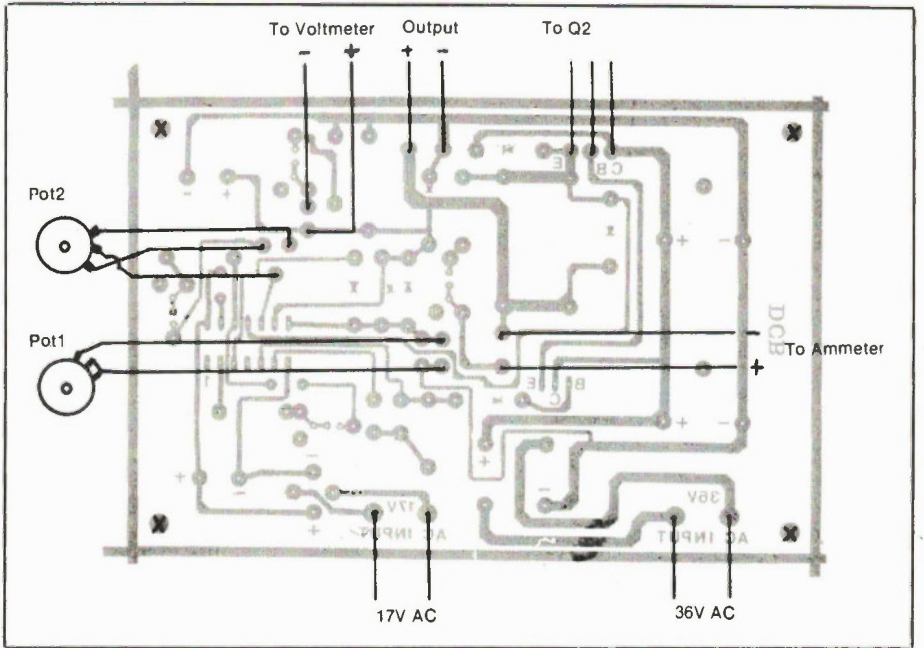

If you need to check the quality of the grounding on live 110VAC circuits, the Metrohm Ground Loop Impedance Tester generates a 25 ampere pulse for 40 milliseconds in the ground line loop. The resultant reading is displayed as total input resistance. Two neon lights indicate improper connections, and a plug-in test probe can be used to check the grounds of conduit, boxes, tools, etc. Contact Duncan Instruments, 121 Milvan Drive, Toronto, Ontario M9L 1Z8, (416) 742-4448.

Circle No. 23

One-day seminars on Microcomputers and Microprocessors will be held by the Ontario Centre for Microelectronics in Toronto, November 12, and Ottawa, December 10. It's a technical overview for managers, engineering personnel and general staff who work with microprocessors. For more information contact the Training Coordinator at OCM at 1-800-2267-8727, or in Ottawa call 596-6690. Ontario Centre for Microelectronics, Suite 400, 1150 Morrison Dr., Ottawa, Ontario K2H 9B8.

Circle No. 38

The Motorola Microprocessor Products Group announces a 25MHz version of the MC68020 32-bit microprocessor, along with a 20MHz version of the MC68881 Floating Point Coprocessor. The CPU now operates in the burst mode at 12.5 million instructions per second with a sustained throughput of 5MIPS. It's also available in versions that run at 12.5MHz, 16.67MHz and 20MHz. Contact local Motorola dealers, or the Products Group at PO Box 3600, Austin, Texas 78764, (512) 440-2839.

Circle No. 39

Yet another change: Lenbrook Electronics will henceforth be using their corporate name: Birde Marketing Inc. The address and telephone remain the same: 111 Esna Park Drive, Unit 1, Markham, Ontario L3R 1H2, (416) 477-7722.

The Hitachi Corporation will now be a second source for Fairchild's FACT line of CMOS digital logic circuits. The FACT line features power consumption levels as low as 0.1mw per gate and internal gate delays of 1ns.

Circle No. 40

Digital Controlled Solder Dispenser

Looking for a clean and efficient way to solder? Check out this digital controlled dispenser from Ersin Multicore Canada.

The unit is ideal for accurate and repeatable shot time application of solder creams, solder masks and SMD adhesives on a printed circuit board. Accuracy on all settings is better than 1% from 0.01 to 9.99 seconds. Dispensing pressure is fully adjustable and a manual override control and automatic foot lever operation are standard.

The system includes a unique vacuum pull back, before and after dispensing for precise cut-off and to eliminate dripping. It also includes a vacuum pick-up pen for SMD devices, dual outlets for simultaneous paste deposition and vacuum pick/place. Facilities required are a filtered air supply and standard 115V power. A selection of adapters, cartridges, and dispensing tips are available.

Ersin Multicore Canada, 3525 Robert Chevalier, P.A.T. Montreal, Quebec H1A 3R7. (514) 642-4095.

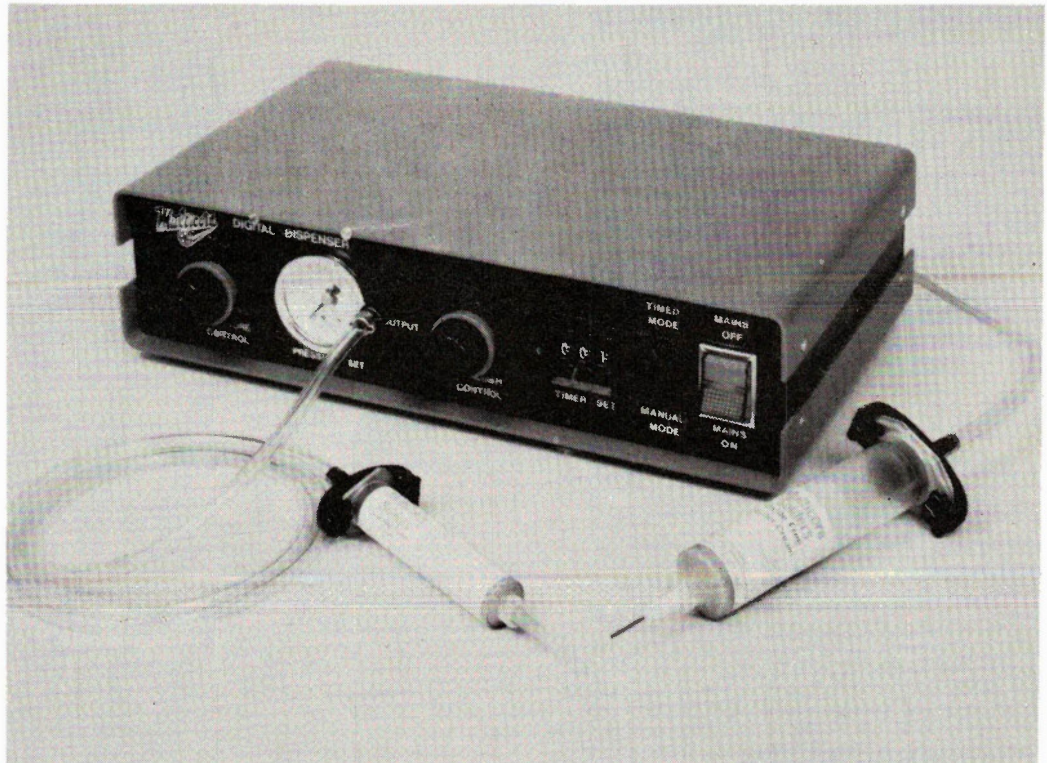

Circle No. 24 on Reader Service Card

SPECIAL OCTOBER PROMOTION SALE

HURRY, WHILE SUPPLIES LAST!

TERMS: Visa/Master Card, Money Order, Cheques (allow 2 weeks for clearance). Sorry No C.O.D. 5% (min. \$5.00) for shipping and handling. Ontario residence add 7% P.S.T. (Prices and availability are subject to change without notice. All returned non-defective merchandise are subject to a 20% restocking charges.)

COMPUTERS	MONITORS/CARDS	LASER PRINTERS	MODEMS
THE REAL THING . . . • IBM XT™, 256K, 1 DRIVE (DEMO) \$2,495 • IBM AT™, 256K, 1 DRIVE (DEMO) \$4,495 CONFIGURED TO YOUR REQUIREMENTS. COMPAQ PORTABLE 256K, 2 DRIVE \$2,550 THE AFFORDABLE . . . • 8088 Only \$1,100 640K, 2 DRIVES, COLOUR CARD, MULTI I/O. • 8088 PORTABLE \$1,550 640K, 2 DRIVES, TTL MONITOR, MULTI I/O. • 80286 Only \$2,150 640K, 1.2M DRIVE	COMPOSITE ZENITH, Green or Amber \$125 YJE, Green or Amber . . . 139 TTL ZENITH Amber 209 YJE, Green or Amber . . . 209 NEC, Green or Amber . . . 219 RGB COLOUR TVM, MD-3 489 MD-7 789 MD-8 739 MD-24 749 NEC, MULTISYNC 925 CARDS TECMAR EGA MASTER . 449 EVEREX EGA 499 PERSYST EGA MASTER . 519 PERSYST BOB/16 EGA . 699 QUAD EGA + 649	CANNON, LBP-8 \$3,895 BLAZER 3,495 PRINTERS EPSON, FX85 \$599 LQ 1000 1200 ROLAND, 1011 339 1111A 395 1215 695 SEIKOSHA, SP1000A . . . 329 MP1300 1,139 CANNON, INK JET 895 HARD DRIVE SYSTEMS SEAGATE, 20M \$649 30M 995 20M, AT 995 30M, AT 1,195 40M, AT 1,395 TAPE BACKUP, 60M 1,295	SMARTTEAM, 1200 \$299 MOUSE LOGITECH \$145 Z-NIX 98 SOFTWARE LOTUS 1-2-3 \$435 dBASE III + 545 IMSI DESIGNER 189 SUPER DEALS IN STORE PURCHASE ONLY • 5 1/4" DSDD DISKETTES BOX OF 10 \$6.50 (Limit 2 boxes per customer) • DISKETTE CONTAINER 100 Disk Capacity . . . \$12.50 • MITSUBISHI, 360K DSDD DISK DRIVE \$129.50 (Limit 2 per customer)

* IBM XT/AT are registered trademarks of International Business Machines Corp.

SUNIX INC.

578 MARLEE AVENUE
 (At Glencairn Subway)
 TORONTO, ONTARIO M6B 3J5
 Call (416) 781-3263 for

4800 SHEPPARD AVE. EAST, UNIT 114
 (East of McCowan Road)
 SCARBOROUGH, ONTARIO M1S 4N5
 (416)292-0588

Mail Orders or information Nationwide

*Importer, retailer, mail order since 1978. Fast delivery nationwide.



**INTRODUCING
the
TRACER*
100XTR**

Innovage Micro-systems Inc. now offers a system that can be used to develop and test code in conjunction with your IBM* PC, in addition to its troubleshooting capabilities for production test, field application and service work.

You can now write, assemble and download code to a target system without PROM burning or removal of your CPU.

Call your local **Active Components** dealer or **Cardinal Industrial Electronics**.

*IBM is a registered trade mark of International Business Machine Corporation.

Innovage Microsystems Inc.,
5-6125 12 St. S.E.
Calgary, Alberta
T2H 2K1
(403) 255-9590



Special VCR Tools

Philips ECG, of Waltham MA, have introduced a set of eight specially designed wrenches for use in the repair and maintenance of Video Cassette Recorders.

Part of a complete ECG line of Audio/Video repair and maintenance equipment, these wrenches are made to match the configuration of the recesses that adjust tape feed, tape tension, and various other functions within VCRs. Tools are offered for both VHS and Beta units.

To locate the nearest distributor, consult the 'Electronic Parts and Supplies' section in the Yellow Pages or contact: Philips ECG, 100 First Avenue, Waltham MA 02254. (617) 890-6107.

Circle No. 28 on Reader Service Card

Two New PC Add-Ons

Interface Technologies Inc. has introduced two new peripheral cards for the IBM PC/XT and compatibles - Command Performance and Prime Time I/O.

Command Performance is a high-resolution enhanced graphics adaptor (EGA) card combining the functions of the IBM-enhanced graphics adaptor, IBM color graphics adaptor and the IBM monochrome graphics adaptor with smooth scrolling, panning, and windowing. Resolution in the various graphics modes are: 640 x 350 in the EGA with 16 colors, 640 x 200 one color, 320 x 200 four color, and 640 x 350 in monochrome with 4 shades.

Prime Time I/O is a half-size, three function card featuring a serial port, parallel port, and real time clock with a four year calendar. Software is included for full function set-up.

Ron Wyvill, Interface Technologies Inc., 25-4 Connell Court, Toronto, Ontario M8Z 1E8. (416) 255-5551. 1-800-387-7313 Can., 1-800-387-7208 USA.

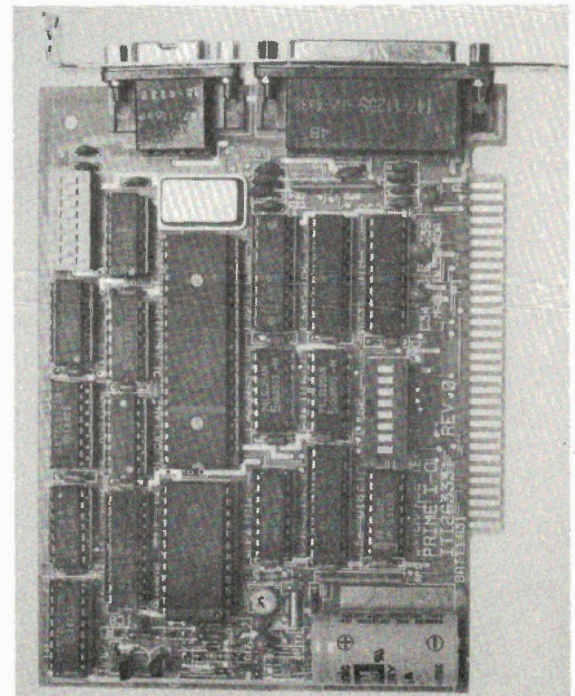

Circle No. 29 on Reader Service Card

Computers in EDUCATION 86

Computers and Software for Educators Hands-on Show and Conference

October 23, 24 and 25, 1986.

Arts Crafts Hobbies Building
Exhibition Place, Toronto
Thursday and Friday 10:00-9:00
Saturday 10:00-5:00

1 "Hands-on" Involvement

Unlike most shows, which are appendages to lecture series, this Conference will bring educators together with software, hardware and peripheral product suppliers for the first time on a large scale, permitting teachers to test their products in an unpressured, untimed environment, and thereby personally determine what's good, what isn't and where it fits in the curriculum.

2 125+ Machine Computer Lab

In the computer lab teachers will be able to test software at their leisure on the types of machines with which they are currently familiar, as well as on the newer machines.

3 Software Passport

Conference delegates will receive a Software Passport allowing them to borrow software from among the estimated 2,000+ packages available for individual testing in the computer laboratory.

4 Latest Hardware

Those teaching computer studies will be able to see and test educational electronics packages designed with secondary school courses in mind. To help teachers understand the full strength of the software packages available, the latest hardware and where it all fits into the curriculum, there will be demonstrations to individuals or small groups of teachers at their request.

5 Full Program of Educational Computing Seminars

To be opened by the Ontario Minister of Education, The Honourable Sean Conway, the Conference Seminars will only include subject areas of practical use to teachers in the classroom. A partial list of titles includes:

Copy Not, Want Not • Work Related Software, • The Educational Context for Computers in Education • Avoiding the Proprietary Software Trap • The Need for Large Courseware on CD ROM • Using Logo within the Existing Mathematics Curriculum • Towards Quality Courseware Development • The Classroom of the Future • Designing Exemplary Software for the Geography Curriculum • Selecting Appropriate Software - The Ins and Outs • ECONET • The UNIX and DOS Connection - Tapping Larger Software Sources for Classroom Use • Use of the Word Processor in Generating Examinations • Designing Computer Lessonware • Courseware and Authoring • Special Education Software • Using the York Educational Software Database • Using the Amiga in the Music Classroom • Using the Amiga in the Art Classroom • The Amiga in the Classroom.

Registration Information

Conference delegates who pay the \$25 registration fee by October 15, 1986 will be eligible for the special drawing for an ATARI 1040ST colour system to take place October 24. Your cancelled cheque will confirm your registration and eligibility for the draw. An official receipt will be attached to your conference passport, to be picked up on arrival at the Show. Visitors who pre-register but who are unable to attend can receive a full refund if written notice is provided on or before October 21, 1986. To register, complete the registration card included in the September or October issues of Computers in Education, or send a cheque directly to Moorshead Publications, or telephone (416) 445-5600 and charge it against your Visa, Master Card or American Express Card.

Computers in Education '86

Moorshead Publications
1300 Don Mills Road
Don Mills, Ontario
M3B 3M8



Registration prize computer donated by ATARI Canada



For Toronto accommodation information, contact Merrylee Greenan at the above address or at (416) 445-5600.

In co-operation with the Ontario Principals' Association.

Circle No. 30 on Reader Service Card

Reliability in Numbers



Full Line DMM's Protected by Triplet's 3-Year Warranty. Dependable Digital Multimeters

Triplet announces the three-year warranty on its complete line of high-tech digital multimeters. These accurate, reliable digital testers, with their exclusive warranty, reinforce Triplet's position as the world leader in the design and manufacture of test equipment and panel instrumentation.

Adaptable. Triplet's complete line of digital testers offers the convenience of an easy-to-read liquid crystal display housed in an impact-resistant, ergonomically designed case. All models feature overload protection, auto polarity, solid-state electronics and low battery indicators. They come complete with batteries, test leads and instruction manuals.

**In Canada, Complete
Sales and Service Available
Through...**

Circle No. 31 on Reader Service Card.

Cost-effective. Model-for-model, feature-to-feature, Triplet's digital testers are competitively priced with any other testers in today's market.

Quality. State-of-the-art technology identifies the entire line of Triplet digital testers. Assurance of quality allows Triplet to offer this unique 3-year warranty.

*Model 2030: 1-Year Warranty

When you are looking for the finest in high-tech digital multimeters, look to Triplet, the Company America has trusted for more than 80 years.

BCS
ELECTRONICS
LIMITED

980 Alness St. Unit 7,
Downsview, Ontario,
M3J 2S2
(416) 661-5585
TELEX 065-28169

Mon-Fri 8-5 pm, Sat 10 am-1 pm.

MEGURO/RCC - MORE FOR YOUR INSTRUMENT DOLLAR

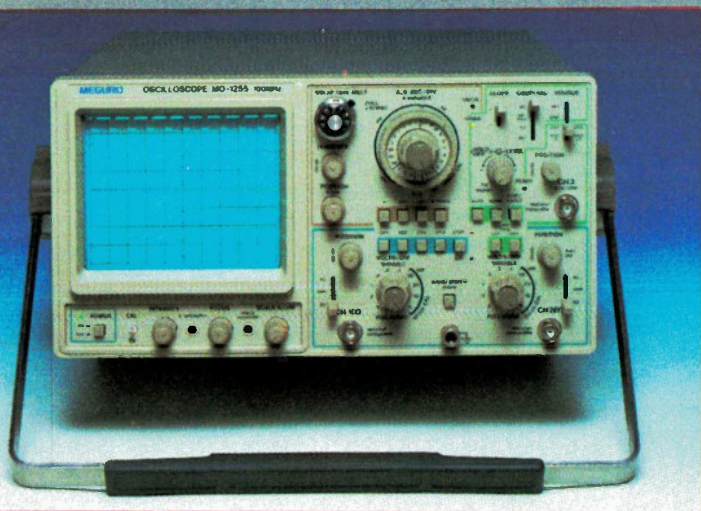

'SCOPE for 100 MHz

The MO-1255 100 MHz 'scope features 3-channels and 8 traces. Has alternate sweep, 6-inch rectangular high luminance internally calibrated CRT, wide dynamic range and 2-channel X-Y operation.

Control logistics make this unit exceptionally easy to operate. Has TV sync, separator circuit and 20 MHz bandwidth limiter.

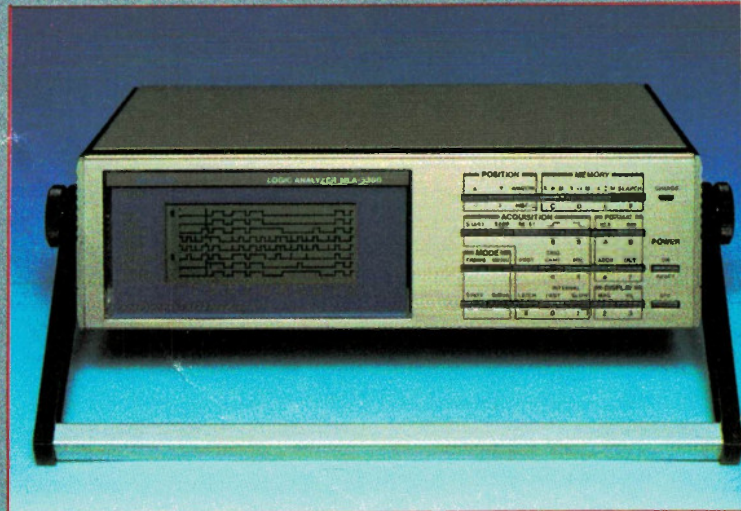

LOGIC ANALYZER - 16 channel

The MLA-3300 combines timing analyzer, state analyzer and signature analyzer in one. Has 16-channel input and 100 ns resolution at 10 MHz. Portable, battery or AC operation, low

power LCD display. Comparative acquisitions are easy with 256 bit/channel acquisition and reference memories. Menu operated.

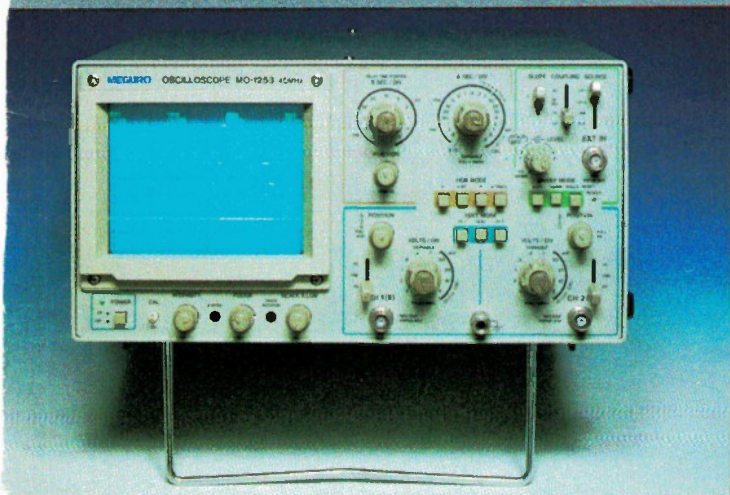

DUAL-TRACE OSCILLOSCOPE — 20 MHz

The MO-1251A dual trace 20MHz oscilloscope features sensitivity of 1 mV div. and speed of 20 ns/div., high luminance cathode ray tube,

measurement to 400 Vp-p and a stabilized power supply for accurate measurements.

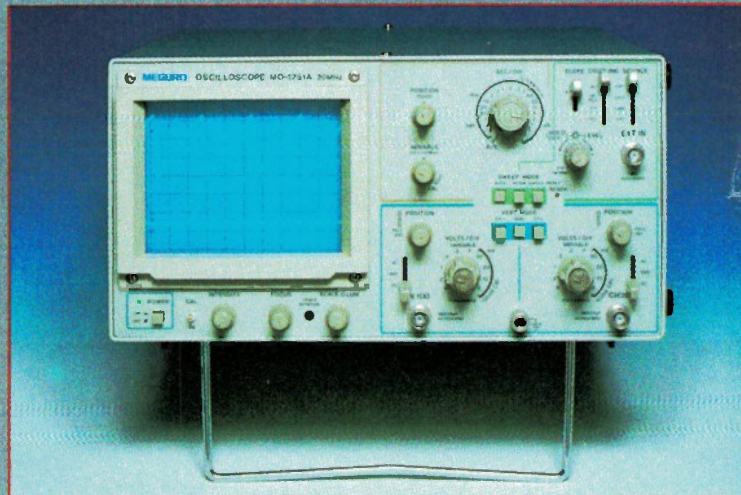

DUAL-TRACE OSCILLOSCOPE — 40 MHz

The MO-1253 has a delay time sweep function used to enhance the accuracy of fine measurements. It has an acceleration voltage of 12kV and a six inch high luminance cathode ray tube with beam intensity and scale illumination

controls. This provides for more accurate and readable measurements needed in the fields of research and development, production lines and maintenance/servicing sections.

meguro

RCC ELECTRONICS

310 JUDSON ROAD, UNIT 19, TORONTO M8Z 5T6 (416) 252-5094
 Moncton: P.O. Box 921, Moncton, N.B., E1C 8N8, Telephone: Toll Free 1-800-361-2909
 Quebec Toll Free 1-800-361-2909

Circle No. 32 on Reader Service Card.

To Over 30,000 Installations, MultiLink® MEANS Multi-User.

At over 30,000 sites, as many as one-quarter of a million users tap into the power of MultiLink® Advanced everyday.

Since 1981, they've come to rely on our multi-tasking, multi-user system for compatibility with their favorite software, and the ability to share disks, files, printers, and programs in a *true* PC-DOS environment.

From the largest of the Fortune 500 to the smallest in small business, MultiLink® has provided a cost-effective multi-user solution that's available from no one else.

MultiLink® Means Cost-Effective Timesharing on a PC. MultiLink® Advanced utilizes the principle of timesharing by sharing a central PC's peripherals, files, and processor time among nine users. Up to eight inexpensive terminals can be connected to a single non-dedicated IBM PC, XT, AT or 100% compatible using standard RS-232 ports. Each terminal effectively emulates a PC having up to 512K RAM.

PC-Shadow™ Workstations, shown below, even have an AT look-alike, as well as work-alike, keyboard, display, and serial port. In addition, password-protected remote access via modem can be made with either dumb terminals or PCs running our terminal emulation software.

MultiLink® Means PC-DOS Compatibility with a Software-Driven System. Lotus 1-2-3, Symphony, WordStar, dBASE III, & Multimate are just a sampling of the wide variety of PC-DOS software that's fully compatible.

Our software-driven system is also IBM NETBIOS compatible, so programs that are written for IBM's Token Ring will run on our multi-user system, as well.

MultiLink® Means Multi-User to Leading Computer Publications. Whether you read *PC Magazine*, "MultiLink® Advanced delivers on...convenience, speed, and flexibility," or *InfoWorld*, "If you want a low-cost multiuser system with up to eight terminals, MultiLink® Advanced is worth a serious look," it becomes clear that MultiLink® Advanced is a formidable contender in the multi-user marketplace.

See What MultiLink® Can Mean to You. Learn, firsthand, how our multi-user system can benefit your company. Call The Software Link TODAY for complete information and the authorized dealer nearest you. MultiLink® Advanced is \$745 and comes with a money-back guarantee.

MultiLink® is a registered trademark of The Software Link, Inc. MultiLink® Advanced & PC-Shadow™ are trademarks of The Software Link, Inc. IBM PC, XT, AT, PC-DOS, Token Ring, & NETBIOS are trademarks of IBM Corp. WordStar, dBASE III, Multimate, Lotus 1-2-3 & Symphony are trademarks of MicroPro, Ashton-Tate, Multimate International, & Lotus Development Corp., respectively.

MultiLink® ADVANCED



THE SOFTWARE LINK, INC.

250 Cochrane Drive, Suite 12 Markham, Ontario L3R 6B7

CALL: 416/477-5480

Dealer Inquiries Invited

Circle No. 33 on Reader Service Card.

