

Electronics Today

\$3.25
MM70924

February 1986

Canada's Magazine for Electronics & Computing Enthusiasts

Power MOSFETs

Approaching the ideal
transistor

Product Review:

Daetron
Capacitance
Meter



Pulse Generator Project

Great for logic testing

Cymbal Synth

Hi-tech beat

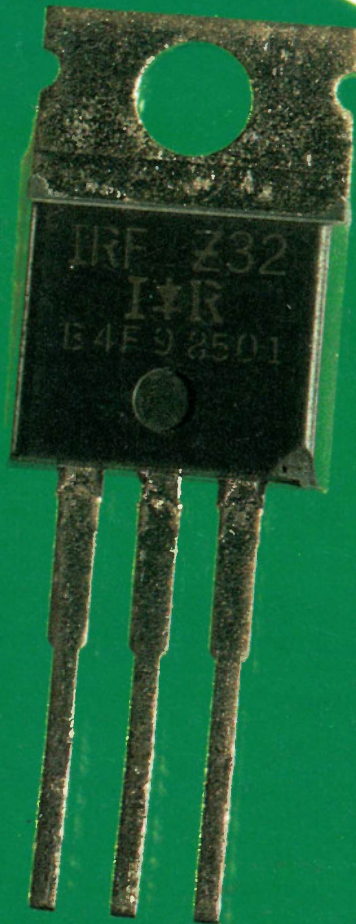

Power Line Filtering

Tips and techniques

BEST Computers

Made in Canada, IBM PC, XT & AT Compatible

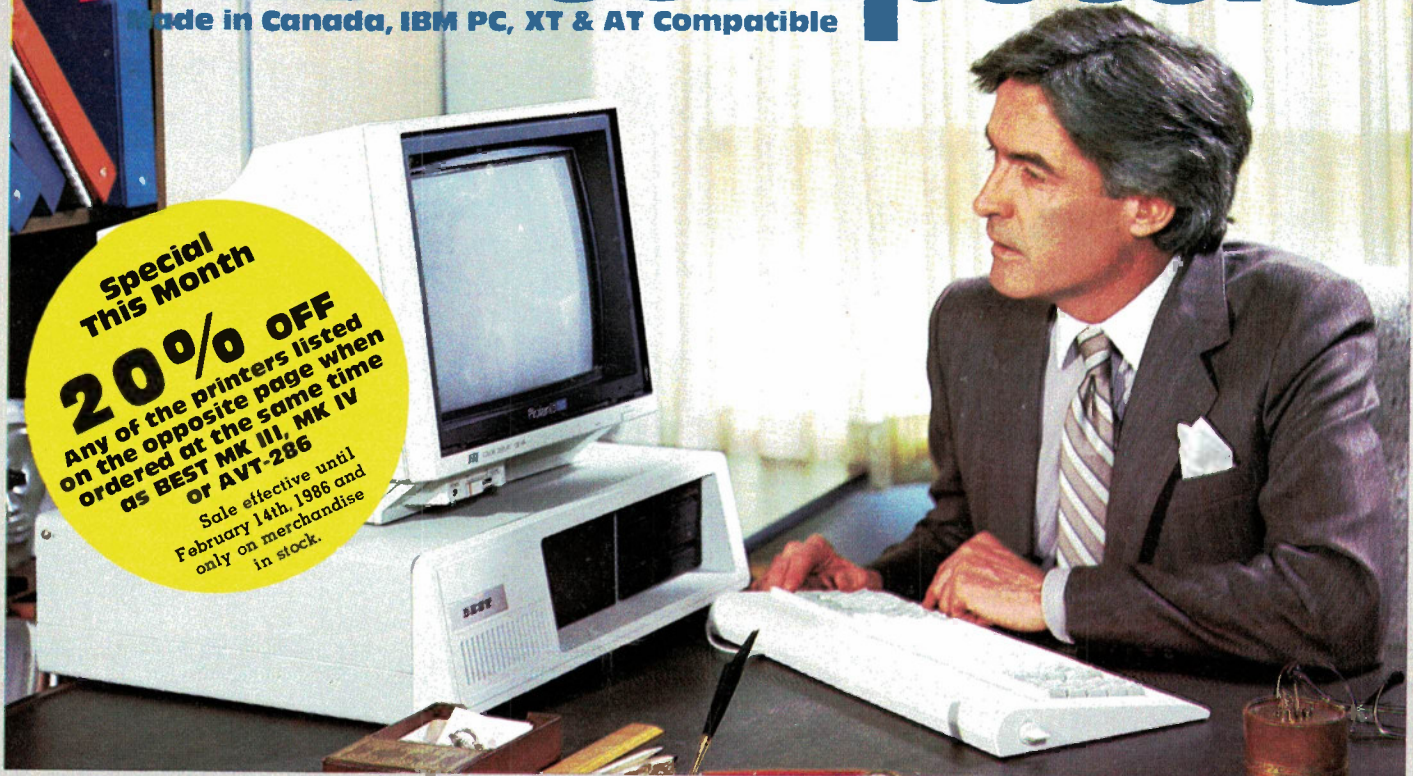

Special This Month
20% OFF
 Any of the printers listed on the opposite page when ordered at the same time as BEST MK III, MK IV or AVT-286
 Sale effective until February 14th, 1988 and only on merchandise in stock.

Monitor not included. IBM registered trade mark of IBM Canada Ltd.

Features common to BEST MK II, MK III & MK IV

- Superb IBM PC & XT Compatibility
- Canadian Made
- 256K RAM Standard minimum (uses 41256K RAM chips)
- Expandable on board to 640K RAM
- Parallel Port (for printer)
- Serial Port (for communications)
- Real Time Clock/Calendar (with Battery Backup)
- Presocketed for optional co-processor — such as 8087 Math Processor
- IBM Compatible Keyboard
- Reset Switch
- Phoenix BIOS as used in many major brand IBM compatible systems.
- 150 Watt Power Supply which will handle a Hard Drive without upgrade.
- 7 Slots
- Flip top case
- 2 Slimline DS,DD 5 1/4", 360K Disk Drives
- Colour Video (RGB & Composite) Board or Hi-Res Monochrome Card (customer choice)
- Disk Controller Board

Warranty

We have such confidence in the time tested reliability of the BEST that we offer a 300-day warranty, way above the industry standard.

Please Note: Don't be put off by our spectacularly low price; this is due to the fact we do not deal with middlemen and our volume buying power of parts. All BESTs are manufactured in Canada to the highest quality standards using prime, guaranteed components by our sister company. All systems are pretested (burnt-in) for about 48 hours before shipping. Hundreds of happy customers report excellent reliability and compatibility.

BEST MK II. Regular \$1695. This Month:

Two 360K DS,DD disk drives, Serial and Parallel Ports, Real Time Clock, Phoenix BIOS, uses 8088 processor — full specifications given below.

\$1595⁰⁰

Other Configurations:

- With 640K RAM \$1695
- With 10 Meg Hard Drive/1 Floppy/256K ... \$2495
- With 10 Meg Hard Drive/1 Floppy/640K ... \$2595
- With 20 Meg Hard Drive/1 Floppy/256K ... \$2795
- With 20 Meg Hard Drive/1 Floppy/640K ... \$2895

NEW

The FAST BEST MK III

As BEST MK II plus speed selectable: 4.77 and 8MHz (most software will run on the higher speed), uses 8088-2 processor.

\$1895⁰⁰

Other Configurations:

- With 640K RAM \$1995
- With 10 Meg Hard Drive/1 Floppy/256K ... \$2795
- With 10 Meg Hard Drive/1 Floppy/640K ... \$2895
- With 20 Meg Hard Drive/1 Floppy/256K ... \$3095
- With 20 Meg Hard Drive/1 Floppy/640K ... \$3195

NEW

SUPER-FAST BEST MK IV

As BEST MK III plus TRUE 16-Bit machine, 8086-2 processor, IBM compatible 8-Bit I/O channel bus, even faster than MK III due to 16-Bit architecture. With 640K standard.

\$2500⁰⁰

Other Configurations:

- With 10 Meg Hard Drive/1 Floppy/640K ... \$3395
- With 20 Meg Hard Drive/1 Floppy/640K ... \$3695

NEW

AVT-286

Superb IBM AT compatibility, 640K RAM, Two 5.25 in disk drives (one high density 1.2 Megabyte, one standard 360K), serial and parallel ports high quality keyboard, keyboard lock and status monitor.

\$3495⁰⁰

With 20 Megabyte fast stepping Hard Disk and Controller:

\$4950⁰⁰

40 Megabyte systems also available at reasonable prices.

Exceltronix

319 College Street, Toronto, Ont. M5T 1S2

(416) 921-8941. Order line only 1-800-268-3798

Ottawa, 217 Bank Street (613) 230-9000

Visa, Mastercard and American Express accepted.

Super Special on Printers

And save a further 20% - see opposite page!

New from Star Micronics SG-10 Printer



Ideal for Text & Graphics

• Dual Mode - NLQ/draft standard (NLQ = near letter quality) • 120 CPS and 20% faster throughput • Bidirectional, logic/seeking • 2K buffer (expandable to 6K with optional buffer interface) • 100% IBM PC or Star standard control codes-switch selected • Friction and tractor standard • full 1 year warranty • 10" wide carriage • Standard parallel interface (serial optional) **\$379.00**

SG-10 C for Commodore Computers

All the same features as the SG-10 but includes built-in interface which plugs directly into Commodore computers.

\$389.00

Star Micronics SG15

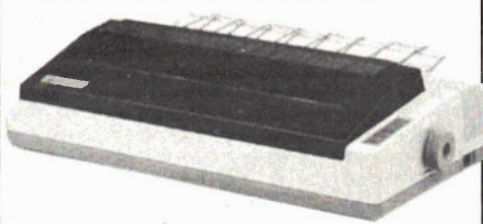

Same specifications as the SG-10 except with 15in. carriage and standard 16K buffer.

\$599.00

SR-15

• 200 cps and 20% faster throughput • IBM PC or Star standard control codes switch selected • Dual Mode - NLQ/draft standard • Friction/tractor and automatic single sheet feed - standard • 15" carriage • 16K buffer • Bidirectional, logic seeking • Price/performance leader • Parallel port standard, serial optional • Full 1 year warranty. **\$995.00**

Star Micronics — Power Type daisywheel printer Letter Quality



18 c.p.s., Bi-directional, Logic-seeking. 110, 132 or 165 columns. 100 Typefaces available, Proportional Spacing.

\$535.00

Call or write for our 1986 catalogue

Save Money — Time Limited Specials

Please note: These unbelievably good prices are due to a bulk purchase
Prices good while stocks last.

Star Micronics Gemini 10X Ideal for Text and Graphics

• 120 c.p.s., • 816 characters print buffer, option 4K or 8K • standard parallel optional RS232C • tractor & friction feed. **Super Special \$279.00**



Star Micronics Gemini 10X PC

All the above features but IBM Compatible.

\$279.00

Check out our catalogue for prices of Monitors, Disk Drives, Print Supplies and Printer Cables

We have excellent pricing on 10 and 20 Megabyte Hard Drives and Controllers

Star Micronics Gemini 15X PC IBM Compatible

Same as Gemini 10X PC but with 15in. carriage.

\$399.00

Delta 15 PC IBM Compatible

160 c.p.s. draft, 40 c.p.s. Near Letter Quality, Friction and Tractor feed, 8K Buffer, Serial and Parallel Interfaces. 15in. carriage. Ultra-High Resolution.

\$499.00

Delta 10 PC IBM Compatible

As above but 10in. carriage.

\$399.00

Radix 15 PC IBM Compatible

200 c.p.s. draft, 50 c.p.s. NLQ, Friction and Tractor Feed, Serial and Parallel Interfaces, 16K Buffer. 240 x 144 Ultra High Resolution.

\$689.00

Radix 10 PC IBM Compatible

As above but with 10in. carriage.

\$549.00

5 1/4" 360K DS/DD Drives for your IBM or Compatible

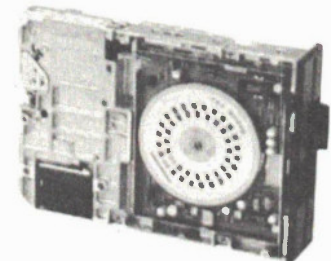

Toshiba ND-04D (Black) ... **\$159.00**

Toshiba ND-04DE-G (Grey) . **\$169.00**

Shugart/Panasonic SA455 \$144.00

Memory Special

41256 \$4.39

4164 150n5 \$1.79

Large Quantity Discounts Available

Check our catalogue for other spectacular memory pricing

EXCELTRONIX

319 College Street, Toronto, Ont. M5T 1S2

(416) 921-8941. Order line only 1-800-268-3798

Ottawa, 217 Bank Street (613) 230-9000

Visa, Mastercard and American Express accepted.

Circle No. 2 on Reader Service Card

★★★★★ **FIVE** ★★★★★

STAR PERFORMANCE FROM HITACHI



DIGITAL + ANALOG STORAGE SCOPES

Whether recording lightning strikes, crash impact data or heartbeats, these digital and analog storage scopes will capture them all.



HIGH PERFORMANCE CRT READOUT DISPLAY

If top of the line is what you demand, these outperformers will top your list with features such as cursors, DVM, programmable on screen text, etc.



VIDEO WAVEFORM + VECTOR MONITORS

In the studio or on location, the versatility and performance of these instruments will steal the show.



PERFORMANCE PROVEN GENERAL PURPOSE

From 20 MHz to 100 MHz
Hitachi's price/performance combination is second to none.



TOUGH MINI SCOPES

These rugged ultra-portables will take it, wherever the job takes them.



Call us for Performance Proven Electronics



Hitachi Denshi, Ltd. (Canada)

Head Office:

65 Melford Drive
Scarborough, Ontario M1B 2G6
Tel: (416) 299-5900
Toll Free: 1-800-268-3597
FAX: 1-416-299-0450
Tlx: 065-25324

Ottawa Office:

159 Colonnade Road, Unit 3
Nepean, Ontario K2E 7J4
Tel: (613) 727-3930
FAX: 1-613-727-3955
Tlx: 053-4533

Eastern Office:

8096 Route Trans Canadienne
St. Laurent, Quebec H4S 1M5
Tel: (514) 332-6687
FAX: 1-514-335-1664
Tlx: 0582-4768

Western Office:

3433-12th Street N.E.
Calgary, Alberta T2E 6S6
Tel: (403) 291-4388
FAX: 1-403-250-1634
Tlx: 03825-861

Electronics Today

February 1986
Vol. 10 No. 2



Our Cover

MOSFETs are the coming thing in discrete power transistors, page 17; photo by Bill Markwick. The Daetron capacitance meter is reviewed on page 21; photo by Ed Zapletal.

Electronics Today is Published by:
Moorshead Publications Ltd. (12 times a year)
1300 Don Mills Road,
Don Mills, Toronto, Ont. M3B 3M8
(416) 445-5600

Editor: William Markwick
Assistant Editor: Edward Zapletal
Director of Production: Erik Blomkwist
Production Manager: Douglas Goddard
Production: Naznin Sunderji
Dolph Loeb
Circulation Manager: Lisa Salvatore
Advertising Account Manager: Marlene Dempster

Publisher: H.W. Moorshead; Executive Vice-President: V.K. Marskell; Vice-President - Sales: A. Wheeler; General Manager: S. Harrison; Controller: B. Shankman; Accounts: P. Dunphy; Reader Services: M. Greenan, J. Fairbairn, R. Cree, L. Robson, N. Jones; Advertising Services: H. Brooks.

Newsstand Distribution:
Master Media, Oakville, Ontario

Subscriptions:
\$22.95 (one year), \$37.95 (two years). Please specify if subscription is new or a renewal.

Outside Canada (US Dollars) U.S. add \$3.00 per year. Other countries add \$5.00 per year.

Postal Information:
Second Class Mail Registration No. 3955. Mailing address for subscription orders, undeliverable copies and change of address notice is:
Electronics Today, 1300 Don Mills Rd., Toronto, Ontario, M3B 3M8

Printed by Heritage Press Ltd., Mississauga
ISSN 07038984.

Moorshead Publications also publishes Computing Now!, Computers in Education, and Pets Magazine.

Circulation Independently Audited by MURPHY and MURPHY Chartered Accountants.

Advertisers' Index

BCS Electronics Ltd.	31, 63
Brunelle Instruments Inc.	59
Canada Remote Systems	27
Computer Parts Galore	32, 33
Daetron	62
Electronic Control Systems	27
Electronic Supplies Inc.	40
Exceltronix	2, 3
Hitachi Denshi Ltd. (Canada)	4
Information Unlimited	30
KB Electronics	35, 51
Kaientaj Electronic Merchants Ltd.	36
McGraw Hill	25
RCC Electronics	26
Seagram	61
Solen Inc.	30
Soltech Industries Inc.	30
Sunix Inc.	36
Surplustronics	35
The Software Link Inc.	64
Technical Service Council	37
Transpac Trading Corp.	39
Varah's Direct	7

For Advertising Information
Call 445-5600

Canada's Magazine for Electronics & Computing Enthusiasts



Product Review p. 21



Memory Display p. 56

Features

MOSFETs	17
Designing Transistor Stages, Part 2	15
Camera Contest Results	45

Review

Daetron Capacitance Meter	21
---------------------------	----

Projects

Pulse Generator	8
Cymbal Synth	29
Heartbeat Monitor	52
Oscilloscope Memory Display	56

Series

Electronics From the start, Part 8	41
Designer's Notebook: Power Line Filters	48
For Your Information	6

Columns and Information

Next Month	10	Subscriptions	46
Computing Now! This Month	11	Order Form	45
Books	13	Binders	46
Software	23	Product Mart	55
Business Software	47		

For Your Information

Spectrum Analyzer

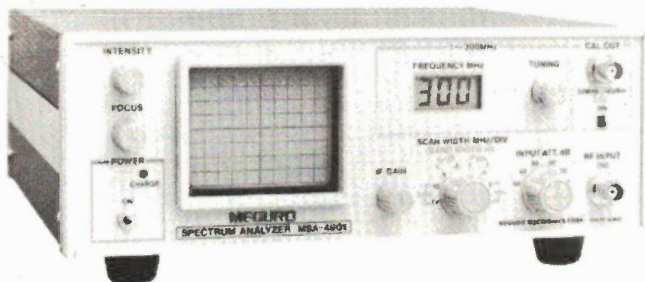

The Meguro MSA-4901 is a spectrum analyzer designed to cover the range from 1 to 300MHz. Distribution of frequencies, spectrum of waveforms and levels can be readily determined with the time-domain oscilloscope. The TV scanning mode permits measurements in CATV and VHF

TV bands for terminal levels and field strengths; it also tests amateur communications equipment. The MSA-4901 is usable with AC power, internal batteries or external DC. From RCC Electronics, 310 Judson St., Unit '6, Toronto, Ontario M8Z 5T6, (416) 252-5094.

Circle No. 61 on Reader Service Card.

Programmable Calculator



The Texas Instruments TI-74 BASICALC is a calculator programmable in BASIC. It has 70 scientific functions, error messages, 13-digit accuracy, statistics and probability, and more. It comes with 8k of memory retained when the calculator is off, and expandable to 16k with a cartridge. It also features an LCD

display with 31 characters, a typewriter-like keyboard, a cartridge port and a peripheral port for driving accessories. A 24-column printer is available. From TI dealers, or contact Texas Instruments, 280 Centre St. East, Richmond Hill, Ontario L4C 1B1, (416) 884-9181.

Circle No. 62 on Reader Service Card.

AT&T Bell Laboratories have demonstrated a high-speed semiconductor, said to be the fastest ever built, at least until next month. The switch, designed and fabricated in collaboration with Cornell University, can turn an electrical signal on or off in 5.8 picoseconds, the length of time it

takes light to travel 1.6mm or the length of time it takes to change channels when a game show comes on. The new junction uses gallium arsenide technology, and reached its best speed at the temperature of liquid nitrogen (77 degrees K). At room temperature the switching time was still an impressive 10.8ps.

Audio Processors

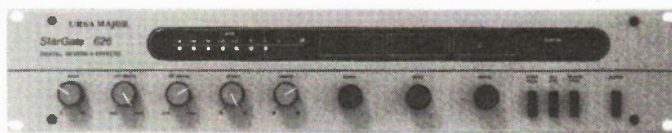

Ursa Major produces a series of professional audio processors for the small or large recording studio. The MSP-126 Stereo Processor provides forward and back discrete repetitions, stereo synthesis, delay-based panning, a musical interval filter, concert hall early reflections, and more. The Stargate 323 is a digital stereo reverb line with LF and HF decay controls, variable initial delay, a reverb mix control and a room-effect simulator. A digital readout indicates settings and levels. The Stargate 626 is a similar digital stereo reverb line with added effects, such as dual echo and 16 pre-tuned room effects with 256 possible variations on each effect. Contact Montclair Sound, a division of BWM Enterprises, 91 Montclair Avenue, Toronto, Ontario M5P 1P5, (416) 488-0603.

Circle No. 63 on Reader Service Card.

VDRs

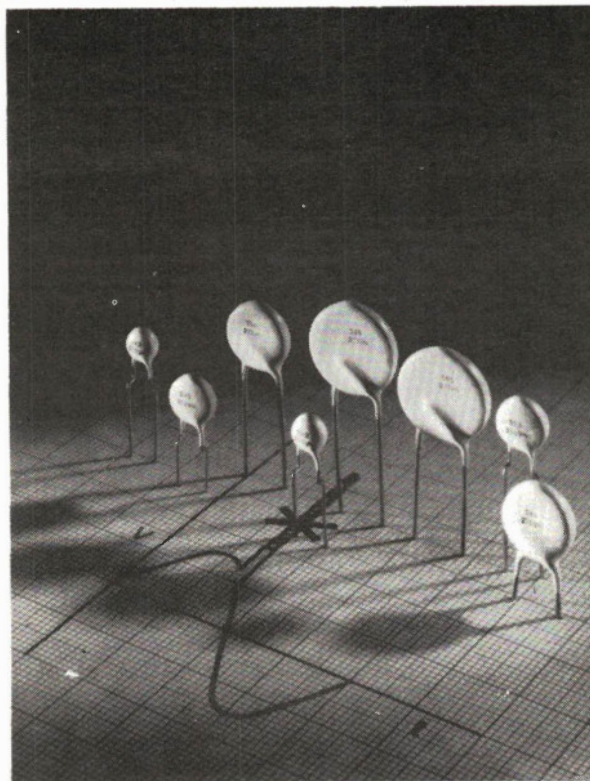

Voltage dependent resistors are used for protecting electronic devices such as semiconductors and contacts. The Philips 592, 593, 594, and 595 series in various voltage and current ratings (400 to 4500 ampere non-repetitive) for the

suppression of power line transients or internally generated spikes. Contact the Elcoma Division of Philips Electronics Ltd., 601 Milner Avenue, Scarborough, Ontario M1B 1M8, (416) 292-5161.

Circle No. 64 on Reader Service Card.

Copyright

All material is subject to worldwide copyright protection. All PCB patterns are copyright and no company can sell boards to our design without our permission.

Liability

While every effort has been made to ensure that all constructional projects referred to in this magazine will operate as indicated efficiently and properly and that all necessary components are available, no responsibility whatsoever is accepted in respect of the failure for any reason at all of the project to operate efficiently or at all whether due to any fault in the design or otherwise and no responsibility is accepted for the failure to obtain component parts in respect of any such project. Further no responsibility is accepted in respect of any injury or damage caused by any fault in design of any such project as aforesaid.

Editorial Queries

Written queries can only be answered when accompanied by a self-addressed, stamped envelope. These must relate to recent articles and not involve the staff in any research. Mark such letter Electronics TodayQuery. *We cannot answer telephone queries.*

Binders

Binders made especially for Electronics Today (ETI) are available for \$9.75 including postage and handling. Ontario residents please add provincial sales tax.

Back Issues and Photocopies

Previous issues of Electronics Today Canada are available direct from our office for \$4.00 each; please specify by month, not by feature you require. See order card for issue available.

We can supply photocopies of any article published in Electronics Today Canada; the charge is \$2.00 per article, regardless of length. Please specify both issue and article.

Component Notation and Units

We normally specify components using an international standard. Many readers will be unfamiliar with this but it's simple, less likely to lead to error and will be widely used everywhere sooner or later. Electronics Today has opted for sooner!

Firstly decimal points are dropped and substituted with the multiplier: thus 4.7uF is written 4u7. Capacitors also use the multiplier nano (one nanofarad is 1000pF). Thus 0.1 uF is 100nF, 5600pF is 5n6. Other examples are 5.6pF = 5p6 and 0.5pF = 0p5.

Resistors are treated similarly: 1.8Mohms is 1M8, 56kohms is the same, 4.7kohms is 4k7, 100ohms is 100R and 5.6ohms is 5R6.

PCB Suppliers

ETI magazine does NOT supply PCBs or kits but we do issue manufacturing permits for companies to manufacture boards and kits to our designs. Contact the following companies when ordering boards.

Please note we do not keep track of what is available from who so please don't contact us for information PCBs and kits. Similarly do not ask PCB suppliers for help with projects.

K.S.K. Associates, P.O. Box 266, Milton, Ont. L9T 4N9.

B—C—D Electronics, P.O. Box 6326, Str. F., Hamilton, Ont. L9C 6L9.

Wentworth Electronics, R.R. No. 1 Waterdown, Ont. L0R 2H0.

Danocinths Inc., P.O. Box 261, Westland M1 4B1R5 USA.

Arkon Electronics Ltd., 409 Queen Street W., Toronto, Ont., M5V 2A5.

Spectrum Electronics, 14 Knightswood Crescent, Brantford, Ontario N3R 7E6.

**Varah's
direct**

This Kit's A Hit!!!

The response to our December drive kit ad was so overwhelming that we sold out! Now a shipment of brand new Tandons has arrived. These terrific expanded capacity drive kits come in an all-inclusive do-it-yourself package. **And at great sale prices!**

NEW

- Fully pretested and formatted.
- Easy to follow instructions.
- Complete 90-day warranty.
- Simply plug in, boot up and go!

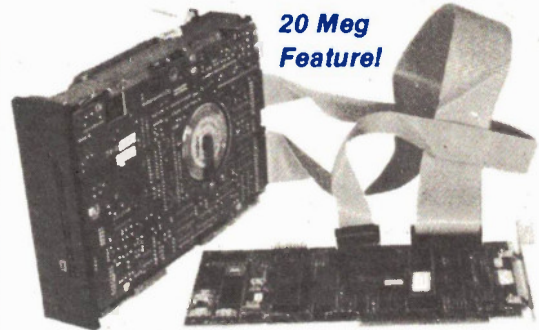

**20 Meg
Feature!**

Suggested List \$999

Limited Time Offer - \$879 complete

A **screwdriver** and one of these complete drive kits from Tandon instantly gives you up to 40MB of extra storage capacity. *Direct to you* from the world's #1 disk-drive manufacturer ... with controller card, cables, and all accessories for guaranteed do-it-yourself installation! **To order your drive kit**, write us or call (416) 842-8833 between 8:30 and 6:00 (EST), Monday to Friday. **Limited quantities, so act now!**

IBM or IBM-Compatible	360KB Kit ½ - Height Floppy	10MB Kit ½ - Height Winchester	20MB Kit ½ - Height - Full Winchester	40MB Kit ½ - Height Winchester		
PC						
XT						
AT						
Avg Access Time	90 mS	85 mS	80 mS	40 mS	35 mS	35 mS
Varah's Direct Stock Number	62601*	62611	62621	62625	62640	62645*
Introductory Price	\$169	\$729	\$879	\$999	\$2049	\$1749
Indicates compatibility			*No controller card needed			



For more information on the full-line of electronic components and supplies offered by Varah's Direct, *write, circle, or call* today for your free copy of the:

1986 Varah's Direct Reference Guide & Mail Order Catalogue

Not just a price listing, this is a fully referenced book supplying pin-outs, electrical specs, and dimensions on over 2500 items from our multi-million dollar industrial inventory. Contact us today for your **free copy!**



Locations:
Vancouver
Edmonton
Calgary
Winnipeg
Oakville
Nepean

Write:
Varah's Direct
504 Iroquois Shore Rd.
Oakville, Ontario
L6H 3K4
(please include your
return postal code)

Circle:
The reader service
number for this ad
Or Call:
(416) 842-8833
Monday to Friday
8:00 - 6:00, E.S.T.

Pulse Generator

A versatile pulse generator board, ideal for logic testing.

By Mike Meakin

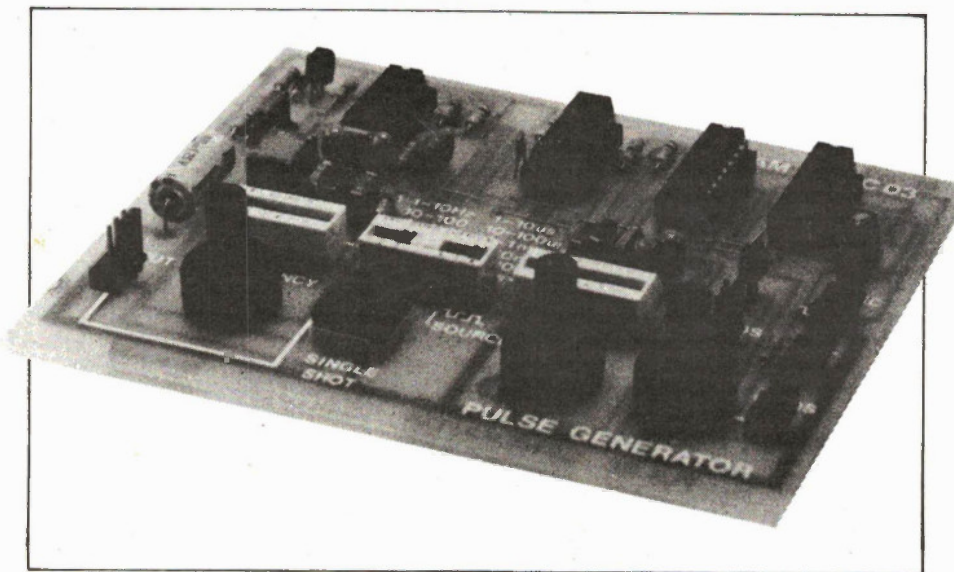

THIS pulse generator provides output pulses with widths variable from 1 μ s to 1s at repetition rates from 1 Hz to 1 MHz. CMOS, TTL and open collector outputs are provided together with a sync output. The internal clock can be switched out when not required and the generator can then be driven from an external clock or operated in single shot mode. The design is inevitably a compromise between complexity and cost but it is felt that most of the facilities the average hobbyist is likely to require are provided. No power supply design is included; the board runs from a single 15V positive supply. It can be run from the bench supply, the power supply of another piece of equipment or a small 15V regulated supply.

The heart of any pulse generator is the monostable timing circuit, and a large number of IC devices are available to provide this function. However, obtaining a very wide timing range with sensible values of R and C limits the field.

The 555 timer would seem well suited to this application but the practical

minimum pulse width obtainable from this device is about 10 μ s. The 74121 series of TTL monostables require large values of timing capacitors and behave erratically at high duty cycles. The 74C221 chosen for this circuit is a CMOS device with a performance which is superior to that of both the 4528 and 4538 monostables from the 4000 series. A six decade timing range can be achieved with changes of capacitance only and it behaves well at high duty cycles.

Three outputs are available on the board. The TTL output is provided by five inverters in parallel and is capable of driving ten standard TTL loads. The input is driven from a 15V CMOS output but protection is given by an internal diode. A Schottky device must be used in this position. The 0 to 15V variable output is obtained from five paralleled CMOS buffers and a potential divider, giving a maximum source impedance of about 300 Ω . Some protection is provided by the 47R series resistor. Finally a VMOS transistor provides an 'open collector' or more correctly

an open drain output. This sturdy device can sink up to 500mA and withstand 60V. It is ideal for use as a relay or LED driver.

Construction

Because the switches and potentiometers are all mounted directly onto the PCB, any labelling of functions and switch positions will also have to be done on the board itself. However, if you want a particularly neat end result you will have to either screen print the board or use rub-down lettering, and both of these processes must be undertaken before any other constructional work on the board is started.

Installation of the components should begin with the wire links and progress in the normal fashion through hardware devices (switches, sockets, etc.), passive components (resistors and capacitors) and finally the active components (the ICs, transistors and diodes). Take care that tantalum and electrolytic capacitors are all inserted into the board the right way around. It is best to use sockets

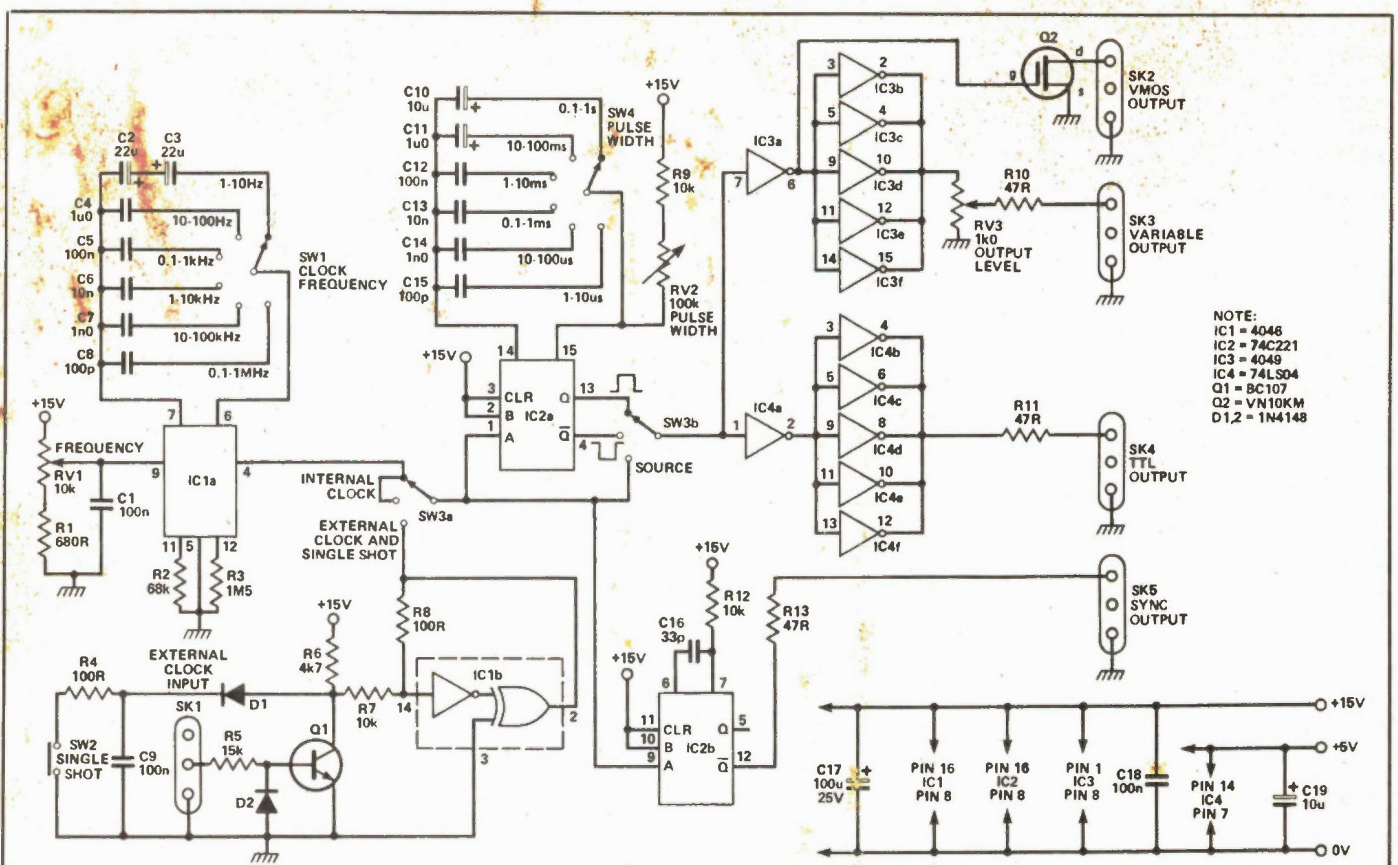

Fig. 1 Complete circuit diagram of the pulse generator. The board is intended for use with a 15V power supply so no PSU circuitry is shown here.

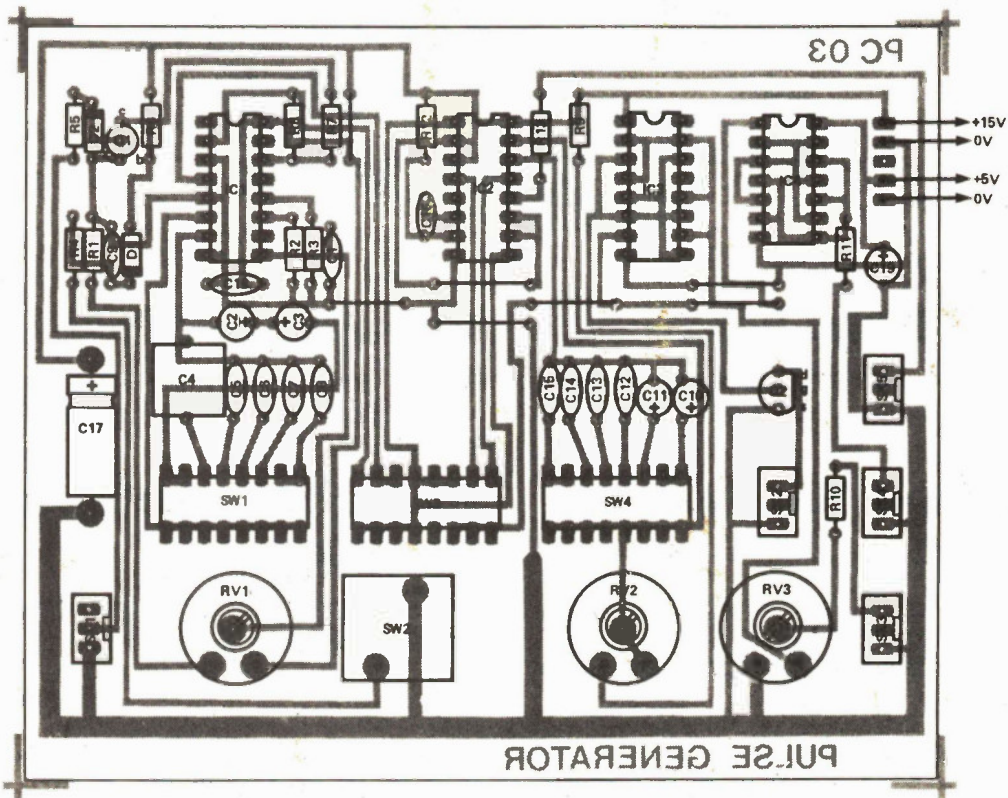
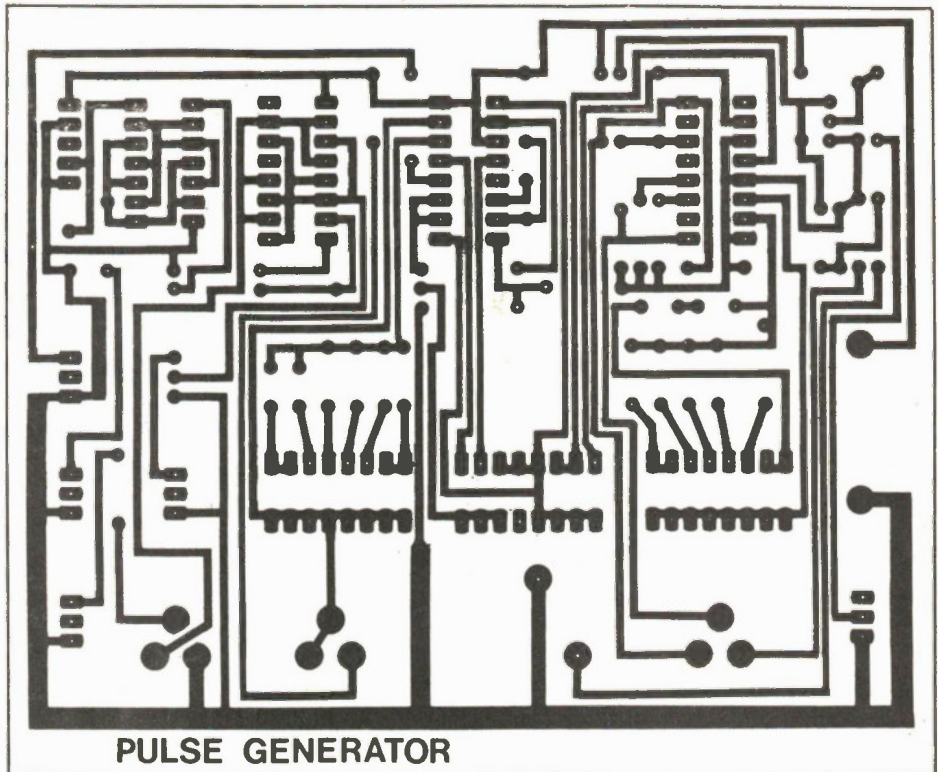

Fig. 2 The component overlay for the pulse generator PCB.
 Electronics Today February 1986

for the ICs but there is no reason why they should not be soldered directly into the board if you prefer and are careful. Since the DIP switches may suffer slight movement when operated, it is best to avoid sockets and solder them directly into place.

When the board is complete, connect up the +5V and +15V rails from the power supply module or from another regulated power supply. The current drawn from the main supply rail, the +15V one, will be about 25mA. Set SW3a to internal clock, the frequency control potentiometer to mid position and the frequency range to 0.1-1kHz. Select source and then apply power to the board.

Both the variable and the TTL outputs can be monitored either with an audio amplifier or a piezo sounder. The positive and negative going pulses should be checked with the width switch set to 0.1-1ms to confirm that the monostable is operating. Finally, a LED in series with a 1k Ω resistor should be connected between the VMOS output and the plus 15V supply, observing the correct polarity of the LED. Select negative going output pulse, external clock and pulse width range 0.1-1s. If the single shot switch is pressed the LED should momentarily illuminate.



This Month in

Computing! Now!

WordStar Serial Patch

Getting WordStar and CP/M to work together may seem like quite a task; we'll show you how.

A Hard Drive For Next to Nothing

Adding a hard disk to the IBM PC is easy, all you need is a free slot and lots of cash. Adding one to a CP/M based system is almost as easy.

Inventory in dBase II

If you stock everything from soup to nuts, we'll show you how to organize it all with dBase II.

NAPLPS Graphics for Business

A new generation of sophisticated business graphics display techniques.

For Subscription or Advertising Information Call (416) 445-5600

Those who have access to a scope can of course test the board more comprehensively.

How It Works

The VCO section of a 4046 phase lock loop IC is used as a clock. This circuit gives a 50-duty cycle square wave output at pin 4 of IC1. The six decade timing capacitors are selected by SW1. For the lowest frequency range two 22u tantalum capacitors are connected back to back to give a non-polarized capacitor whose value should ideally be 10u. The timing resistors R2 and R3 in conjunction with the voltage obtained from RV1 set a 1:10 frequency range.

SW3A selects either the VCO output or the external and single shot inputs. The section of the 4046 normally used as a phase comparator is connected as a Schmitt trigger to clean up the input pulses. These are obtained from an external clock via a transistor buffer whose input is protected by a series current limit resistor R5 and reverse polarity protection diode D2. The external clock input will operate either from a pulse source or an AC signal as long as it crosses the 0.6V turn-on potential of the transistor. The single shot of manual pulse is obtained by

shorting the Schmitt trigger input to 0V with SW2. It is de-bounced by the R6, C9 time constant.

Half of the 74C221 is connected as a negative-edge non-retriggerable monostable. SW4 selects the timing capacitor and RV2, R9 alter the time period over a 1:10 range. The input pulse also triggers the other half of IC2 to give a

negative going sync pulse of about 500ms at SK5. This is coincident with the leading edge of the output pulse and can be used to trigger an oscilloscope. SW3B directs either a positive going pulse, a negative going pulse or the source signal to the output stage. The VCO square wave signal, the external clock or manual pulses can thus be sent directly to the output.

PARTS LIST

Resistors

R1680R
R268k
R31M5
R4100R
R515k
R64k7
R7,9,1210k
R8100k
R10,11,1347R
RV1 10k	trimpot
RV2	100k trimpot
RV31k trimpot

Capacitors

C1,5,9,12,18	100n film
C2,3	22u 16V
C4 1u	film
C6,13	10n film
C7,14	1n film
C8,15100p

C10,19	10u 16V
C11	1u 35V
C1633p
C17	100u 25V

Semiconductors

IC14046
IC2	74C221
IC34049
IC4	74LS04
Q1	2N3904 or equiv
Q2	VN10KM or equiv
D1,2	1N4148

Miscellaneous

SK1-53-way Molex PCB plug
SW1-4	1-pole, 6-way DIP slide switch
SW2	PCB keyboard switch
SW3	2-pole, 3-way DIP slide switch

PCB, IC sockets if desired.

NEXT MONTH IN Electronics Today

Cabinets for Electronics

Looking for the best package for your project or for a small production run? Next month we investigate sources for the cabinets and boxes that will dress up your work.

Solid State Relays

Replace that noisy hunk of wire and pivots with one of the latest miniature SSRs. We look at what's available and how to apply them.

More On Transformers

Delayed from a previous issue, we present application hints for various types of power and special-purpose transformers.

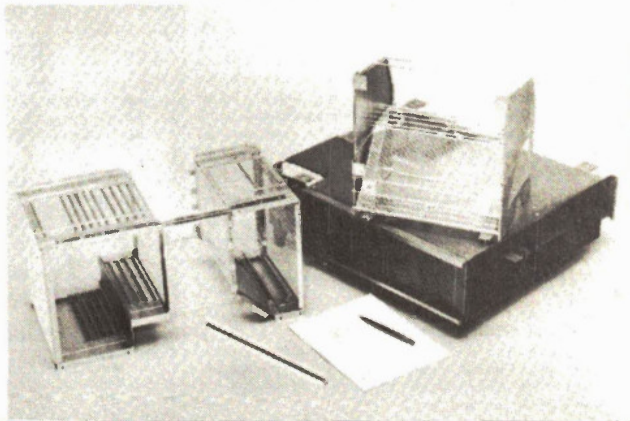

For Subscription or Advertising Information Call (416) 445-5600

BABANI BOOKS

Imported from England and exclusively available in Canada from Moorshead Publications.

BP53: PRACTICAL ELECTRONICS CALCULATIONS AND FORMULAE \$11.75

A book that bridges the gap between complicated technical theory and the 'cut and try' method. A good reference book.

BP136: 25 SIMPLE INDOOR AND WINDOW AERIALS \$6.65

People living in apartments who would like to improve short-wave listening can benefit from these instructions on optimising the indoor aerial.

BP147: AN INTRODUCTION TO 6502 MACHINE CODE \$7.75

The popular 6502 microprocessor is used in many home computers; this is a guide to beginning assembly language.

BP150: AN INTRO. TO PROGRAMMING THE SINCLAIR QL \$7.75

Helps the reader make the best use of the Sinclair QL's almost unlimited range of features. Complements the manufacturer's handbook.

BP225: A PRACTICAL INTRODUCTION TO DIGITAL ICs \$6.65

This book deals mainly with TTL type chips such as the 7400 series. Simple projects and a complete practical construction of a Logic Test Circuit Set are included as well as details for a more complicated Digital Counter Timer project.

BP130: MICRO INTERFACING CIRCUITS - BOOK 1 \$8.55

Aimed at those who have some previous knowledge of electronics, but not necessarily an extensive one, the basis of the book is to help the individual understand the principles of interfacing circuits to microprocessor equipment.

BP131: MICRO INTERFACING CIRCUITS - BOOK 2 \$8.55

Intended to carry on from Book 1, this book deals with practical applications beyond the parallel and serial interface. "Real world" interfacing such as sound and speech generators, temperature and optical sensors, and motor controls are discussed using practical circuit descriptions.

BP111: AUDIO \$13.25

This one is ideal for readers who want to really get into sound. A wide range of material is covered from analysis of the sound wave, mechanisms of hearing, room acoustics, microphones and loudspeakers, amplifiers, and magnetic disc recording.

BP141: LINEAR IC EQUIVALENTS AND PIN CONNECTIONS \$21.95

Find equivalents and cross-references for both popular and unusual integrated circuits. Shows details of functions, manufacturer, country of origin, pinouts, etc.; includes National, Motorola, Fairchild, Harris, Motorola, Intersil, Philips, ADC, AMD, SGS, Teledyne, and many other European, American, and Japanese brands.

BP156: AN INTRODUCTION TO QL MACHINE CODE \$7.75

The powerful Sinclair QL microcomputer has some outstanding capabilities in terms of its internal structure. With a 32-bit architecture, the QL has a large address range, advanced instructions which include multiplication and division. These features give the budding machine code programmer a good start at advanced programming methods. This book assumes no previous knowledge of either the 68008 or machine code programming.

BP47: MOBILE DISCOTHEQUE HANDBOOK \$5.25

Divided into six parts, this book covers such areas of mobile "disco" as: Basic Electricity, Audio, Ancillary Equipment, Cables and Plugs, Loudspeakers, and Lighting. All the information has been considerably sub-divided for quick and easy reference.

BP59: SECOND BOOK OF CMOS IC PROJECTS \$7.75

This book carries on from its predecessor and provides a further selection of useful circuits, mainly of a simple nature. The book will be well within the capabilities of the beginner and more advanced constructor.

BP32: HOW TO BUILD YOUR OWN METAL & TREASURE LOCATORS \$7.75

Several fascinating applications with complete electronic and practical details on the simple, and inexpensive construction of Heterodyne Metal Locators.

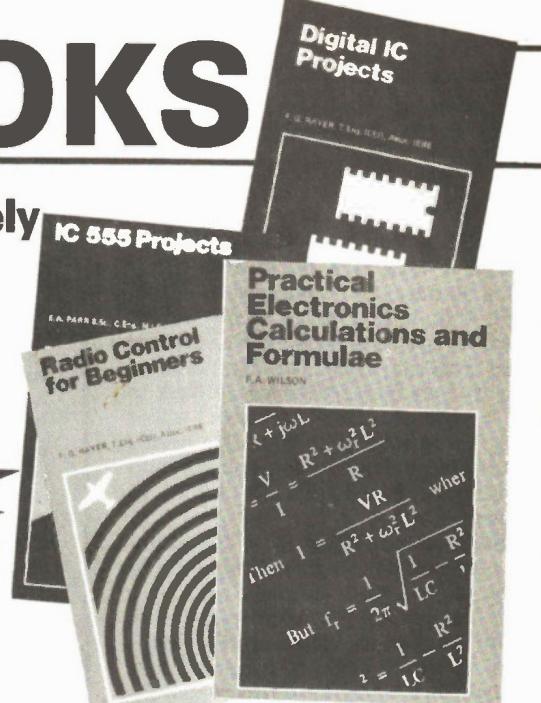

ELECTRONIC THEORY

ELEMENTS OF ELECTRONICS - AN ON-GOING SERIES
F.A. WILSON, C.G.I.A., C.Eng.

BP62: BOOK 1. The Simple Electronic Circuit and Components \$11.70

BP63: BOOK 2. Alternating Current Theory \$ 8.55

BP64: BOOK 3. Semiconductor Technology \$18.55

BP77: BOOK 4. Microprocessing Systems and Circuits \$11.70

BP89: BOOK 5. Communication \$11.70

The aim of this series of books can be stated quite simply — it is to provide an inexpensive introduction to modern electronics so that the reader will start on the right road by thoroughly understanding the fundamental principles involved.

Although written especially for readers with no more than ordinary arithmetical skills, the use of mathematics is not avoided, and all the mathematics required is taught as the reader progresses.

Each book is a complete treatise of a particular branch of the subject and, therefore, can be used on its own with one proviso, that the later books do not duplicate material from their predecessors, thus a working knowledge of the subjects covered by the earlier books is assumed.

BOOK 1. This book contains all the fundamental theory necessary to lead to a full understanding of the simple electronic circuit and its main components.

BOOK 2. This book continues with alternating current theory without which there can be no comprehension of speech music, radio, television or even the electricity utilities.

BOOK 3. Follows on semiconductor technology, leading up to transistors and integrated circuits.

BOOK 4. A complete description of the internal workings of microprocessor.

BOOK 5. A book covering the whole communication scene.

PROJECTS

BP48: ELECTRONIC PROJECTS FOR BEGINNERS \$ 7.75
F.G. RAYER, T.Eng.(CEI), Assoc.IERE

Another book written by the very experienced author — Mr. F.G. Rayer — and in it the newcomer to electronics, will find a wide range of easily made projects. Also, there are a considerable number of actual component and wiring layouts, to aid the beginner.

Furthermore, a number of projects have been arranged so that they can be constructed without any need for soldering and, thus, avoid the need for a soldering iron.

Also, many of the later projects can be built along the lines as those in the "No Soldering" section so this may considerably increase the scope of projects which the newcomer can build and use.

BP37: 50 PROJECTS USING RELAYS, SCR's & TRIACS \$ 7.75
F.G. RAYER, T.Eng.(CEI), Assoc.IERE

Relays, silicon controlled rectifiers (SCR's) and bi-directional triodes (TRIACS) have a wide range of applications in electronics today. This book gives tried and practical working circuits which should present the minimum of difficulty for the enthusiast to construct. In most of the circuits there is a wide latitude in component values and types, allowing easy modification of circuits or ready adaptation of them to individual needs.

BP221: 28 TESTED TRANSISTOR PROJECTS \$5.00
R. TORRENS

Mr. Richard Torrens is a well experienced electronics development engineer and has designed, developed, built and tested the many useful and interesting circuits included in this book. The projects themselves can be split down into simpler building blocks, which are shown separated by boxes in the circuits for ease of description, and also to enable any reader who wishes to combine boxes from different projects to realise ideas of his own.

BP71: ELECTRONIC HOUSEHOLD PROJECTS \$ 7.20
R. A. PENFOLD

Some of the most useful and popular electronic construction projects are those that can be used in or around the home. The circuits range from such things as '2 Tone Door Buzzer', Intercom, through Smoke or Gas Detectors to Baby and Freezer Alarms.

BP73: REMOTE CONTROL PROJECTS \$ 8.10
OWEN BISHOP

This book is aimed primarily at the electronics enthusiast who wishes to experiment with remote control. Full explanations have been given so that the reader can fully understand how the circuits work and can more easily see how to modify them for other purposes, depending on personal requirements. Not only are radio control systems considered but also infra-red, visible light and ultrasonic systems as are the use of Logic IC's and Pulse position modulation etc.

BP90: AUDIO PROJECTS \$ 7.60
F.G. RAYER

Covers in detail the construction of a wide range of audio projects. The text has been divided into preamplifiers and mixers, power amplifiers, tone controls and matching and miscellaneous projects.

BP74: ELECTRONIC MUSIC PROJECTS \$ 7.20
R.A. PENFOLD

Although one of the more recent branches of amateur electronics, electronic music has now become extremely popular and there are many projects which fall into this category. The purpose of this book is to provide the constructor with a number of practical circuits for the less complex items of electronic music equipment, including such things as a Fuzz Box, Waa-Waa Pedal, Sustain Unit, Reverberation and Phaser-Units, Tremelo Generator etc.

BP44: IC 555 PROJECTS \$ 7.75
E.A. PARR, B.Sc.(C.Eng.), M.I.E.E.

Every so often a device appears that is so useful that one wonders how life went on before without it. The 555 timer is such a device. Included in this book are Basic and General Circuits, Motor Car and Model Railway Circuits, Alarms and Noise Makers as well as a section on the 556, 558 and 559 timers.

BPB2: ELECTRONIC PROJECTS USING SOLAR CELLS \$ 7.75

A collection of simple circuits which have applications in and around the home using the energy of the sun to power them. The book deals with practical solar power supplies including voltage doubler and tripler circuits, as well as a number of projects.

BABANI BOOKS

BP49: POPULAR ELECTRONIC PROJECTS \$7.75

R.A. PENFOLD
Includes a collection of the most popular types of circuits and projects which, we feel sure, will provide a number of designs to interest most electronics constructors. The projects selected cover a very wide range and are divided into four basic types: Radio Projects, Audio Projects, Household Projects and Test Equipment.

BP94: ELECTRONIC PROJECTS FOR CARS AND BOATS \$7.60

R.A. PENFOLD
Projects, fifteen in all, which use a 12V supply are the basis of this book. Included are projects on Windscreen Wiper Control, Courtesy Light Delay, Battery Monitor, Cassette Power Supply, Lights Timer, Vehicle Immobiliser, Gas and Smoke Alarm, Depth Warning and Shaver Inverter.

BP95: MODEL RAILWAY PROJECTS \$7.60

Electronic projects for model railways are fairly recent and have made possible an amazing degree of realism. The projects covered include controllers, signals and sound effects; striboard layouts are provided for each project.

BP93: ELECTRONIC TIMER PROJECTS \$7.60

F.G. RAYER
Windscreen wiper delay, darkroom timer and metronome projects are included. Some of the more complex circuits are made up from simpler sub-circuits which are dealt with individually.

BP113: 30 Solderless Breadboard Projects-Book 2 \$8.85

R.A. Penfold
A companion to BP107. Describes a variety of projects that can be built on plug-in breadboards using CMOS logic IC's. Each project contains a schematic, parts list and operational notes.

BP104: Electronic Science Projects \$8.85

Owen Bishop
Contains 12 electronic projects with a strong scientific flavour. Includes Simple Colour Temperature Meter, Infra-Red Laser, Electronic clock regulated by a resonating spring, a Scope with a solid state display, pH meter and electrocardiograph.

BP110: HOW TO GET YOUR ELECTRONIC PROJECTS WORKING \$7.60

R.A. PENFOLD
We have all built circuits from magazines and books only to find that they did not work correctly, or at all, when first switched on. The aim of this book is to help the reader overcome just these problems by indicating how and where to start looking for many of the common faults that can occur when building up projects.

BP84: DIGITAL IC PROJECTS \$7.60

F.G. RAYER, T.Eng.(CEI), Assoc.IERE
This book contains both simple and more advanced projects and it is hoped that these will be found of help to the reader developing a knowledge of the workings of digital circuits. To help the newcomer to the hobby the author has included a number of board layouts and wiring diagrams. Also the more ambitious projects can be built and tested section by section and this should help avoid or correct faults that could otherwise be troublesome. An ideal book for both beginner and more advanced enthusiast alike.

BP67: COUNTER DRIVER AND NUMERAL DISPLAY PROJECTS \$7.05

F.G. RAYER, T.Eng.(CEI), Assoc. IERE
Numeral indicating devices have come very much to the forefront in recent years and will, undoubtedly, find increasing applications in all sorts of equipment. With present day integrated circuits, it is easy to count, divide and display numerically the electrical pulses obtained from a great range of driver circuits.

In this book many applications and projects using various types of numeral displays, popular counter and driver IC's etc are considered.

BP99: MINI-MATRIX BOARD PROJECTS \$7.60

R.A. PENFOLD
Twenty useful projects which can all be built on a 24 x 10 hole matrix board with copper strips. Includes Doorbuzzer, Low-voltage Alarm, AM Radio, Signal Generator, Projector Timer, Guitar Headphone Amp, Transistor Checker and more.

BP103: MULTI-CIRCUIT BOARD PROJECTS \$7.60

R.A. PENFOLD
This book allows the reader to build 21 fairly simple electronic projects, all of which may be constructed on the same printed circuit board. Wherever possible, the same components have been used in each design so that with a relatively small number of components and hence low cost, it is possible to make any one of the projects or by re-using the components and P.C.B. all of the projects.

BP107: 30 SOLDERLESS BREADBOARD PROJECTS - BOOK 1 \$8.85

R.A. PENFOLD
A "Solderless Breadboard" is simply a special board on which electronic circuits can be built and tested. The components used are just plugged in and unplugged as desired. The 30 projects featured in this book have been specially designed to be built on a "Verobloc" breadboard. Wherever possible the components used are common to several projects, hence with only a modest number of reasonably inexpensive components it is possible to build, in turn, every project shown.

BP106: MODERN OP-AMP PROJECTS \$7.60

R.A. PENFOLD
Features a wide range of constructional projects which make use of op-amps including low-noise, low distortion, ultra-high input impedance, high slew-rate and high output current types.

CIRCUITS

How to Design Electronic Projects \$8.95

BP127
Although information on standard circuit blocks is available, there is less information on combining these circuit parts together. This title does just that. Practical examples are used and each is analysed to show what each does and how to apply this to other designs.

Audio Amplifier Construction \$8.95

BP122
A wide circuit is given, from low noise microphone and tape head preamps to a 100W MOSFET type. There is also the circuit for 12V bridge amp giving 18W. Circuit board or strip-board layout are included. Most of the circuits are well within the capabilities for even those with limited experience.

BP80: POPULAR ELECTRONIC CIRCUITS - BOOK 1 \$7.75

R.A. PENFOLD
Another book by the very popular author, Mr. R.A. Penfold, who has designed and developed a large number of various circuits. These are grouped under the following general headings: Audio Circuits, Radio Circuits, Test Gear Circuits, Music Project Circuits, Household Project Circuits and Miscellaneous Circuits.

BP98: POPULAR ELECTRONIC CIRCUITS, BOOK 2 \$8.85

R.A. PENFOLD
70 plus circuits based on modern components aimed at those with some experience.

BP39: 50 (FET) FIELD EFFECT TRANSISTOR PROJECTS \$6.75

F.G. RAYER, T.Eng.(CEI), Assoc.IERE
Field effect transistors (FETs), find application in a wide variety of circuits. The projects described here include radio frequency amplifiers and converters, test equipment and receiver aids, tuners, receivers, mixers and tone controls, as well as various miscellaneous devices which are useful in the home.

This book contains something of particular interest for every class of enthusiast - short wave listener, radio amateur, experimenter or audio devotee.

BP87: SIMPLE I.E.D. CIRCUITS \$5.40

R.N. SOAR
Since it first appeared in 1977, Mr. R.N. Soar's book has proved very popular. The author has developed a further range of circuits and these are included in Book 2. Projects include a Transistor Tester, Various Voltage Regulators, Testers and so on.

BP24: 50 PROJECTS USING IC741 \$6.75

A unique book containing 50 projects that can be simply constructed using one op amp and a few components. Originally published in Germany, this book will be an valuable asset to any hobbyist.

BP88: HOW TO USE OP AMPS \$8.85

E.A. PARR
A designer's guide covering several op amps, serving as a source book of circuits and a reference book for design calculations. The approach has been made as non-mathematical as possible.

BP65: SINGLE IC PROJECTS \$6.05

R.A. PENFOLD
There is now a vast range of ICs available to the amateur market, the majority of which are not necessarily designed for use in a single application and can offer unlimited possibilities. All the projects contained in this book are simple to construct and are based on a single IC. A few projects employ one or two transistors in addition to an IC but in most cases the IC is the only active device used.

223: 50 PROJECTS USING IC CA3130 \$5.00

R.A. PENFOLD
In this book, the author has designed and developed a number of interesting and useful projects which are divided into five general categories: I - Audio Projects II - R.F. Projects III - Test Equipment IV - Household Projects V - Miscellaneous Projects.

BP117: PRACTICAL ELECTRONIC BUILDING BLOCKS BOOK 1 \$7.60

Virtually any electronic circuit will be found to consist of a number of distinct stages when analysed. Some circuits inevitably have unusual stages using specialised circuitry, but in most cases circuits are built up from building blocks of standard types.

This book is designed to aid electronics enthusiasts who like to experiment with circuits and produce their own projects rather than simply follow published project designs.

The circuits for a number of useful building blocks are included in this book. Where relevant, details of how to change the parameters of each circuit are given so that they can easily be modified to suit individual requirements.

BP102: THE 6809 COMPANION \$7.60

Written for machine language programmers who want to expand their knowledge of microprocessors. Outlines history, architecture, addressing modes, and the instruction set of the 6809 microprocessor. The book also covers such topics as converting programs from the 6800, program style, and specifics of 6809 hardware and software availability.

BP118: PRACTICAL ELECTRONIC BUILDING BLOCKS - Book 2 \$7.60

R.A. PENFOLD
This sequel to BP117 is written to help the reader create and experiment with his own circuits by combining standard type circuit building blocks. Circuits concerned with generating signals were covered in Book 1, this one deals with processing signals. Amplifiers and filters account for most of the book but comparators, Schmitt triggers and other circuits are covered.

BP24: 50 PROJECTS USING IC741 \$6.75

RUDI & UWE REDMER
This book, originally published in Germany by TOPP, has achieved phenomenal sales on the Continent and Babani decided, in view of the fact that the integrated circuit used in this book is inexpensive to buy, to make this unique book available to the English speaking reader. Translated from the original German with copious notes, data and circuitry, a "must" for everyone whatever their interest in electronics.

BP83: VMOS PROJECTS \$7.70

R.A. PENFOLD
Although modern bipolar power transistors give excellent results in a wide range of applications, they are not without their drawbacks or limitations. This book will primarily be concerned with VMOS power FETs although power MOSFETs will be dealt with in the chapter on audio circuits. A number of varied and interesting projects are covered under the main headings of: Audio Circuits, Sound Generator Circuits, DC Control Circuits and Signal Control Circuits.

RADIO AND COMMUNICATIONS

BP96: CB PROJECTS \$7.60

R.A. PENFOLD
Projects include speech processor, aerial booster, cordless mike, aerial and harmonic filters, field strength meter, power supply, CB receiver and more.

BP222: SOLID STATE SHORT WAVE RECEIVER FOR BEGINNERS \$47.60

R.A. PENFOLD
In this book, R.A. Penfold has designed and developed several modern solid state short wave receiver circuits that will give a fairly high level of performance, despite the fact that they use only relatively few and inexpensive components.

BP91: AN INTRODUCTION TO RADIO DXing \$7.60

This book is divided into two main sections one to amateur band reception, the other to broadcast bands. Advice is given to suitable equipment and techniques. A number of related constructional projects are described.

BP105: AERIAL PROJECTS \$7.60

R.A. PENFOLD
The subject of aerials is vast but in this book the author has considered practical designs including active, loop and ferrite aerials, which give good performances and are reasonably simple and inexpensive to build. The complex theory and math of aerial design are avoided.

OTHER PUBLISHERS

PH121: HARDWARE INTERFACING WITH THE TRS-80
J. UFFENBECK (1983) \$19.45
 TRS-80 Model I and Model III owners now have a book to help them understand how to use their personal computers to monitor and control electronics interfaces between the computer and the home or industrial environment. Contains 14 hands-on experiments using BASIC.

SB22026 POLISHING YOUR APPLE® \$7.45
 Clearly written, highly practical, concise assembly of all procedures needed for writing, disk-filing, and printing programs with an Apple II. Positively ends your searches through endless manuals to find the routine you need! Should be in the hands of every new Apple user, regardless of experience level. Ideal for Apple classrooms too!

A BEGINNER'S GUIDE TO COMPUTERS AND MICROPROCESSORS — WITH PROJECTS.
TAB No. 1015: \$14.45
 Here's plain English introduction to the world of microcomputers — its capabilities, parts and functions... and how you can use one. Numerous projects demonstrate operating principles and lead to the construction of an actual working computer capable of performing many useful functions.

TAB1370: A MASTER HANDBOOK OF IC CIRCUITS \$21.95
 A circuit for every occasion. You'll find all the circuits you're looking for in this 532 page volume. The 932 circuits are broken down according to specific functions and in six categories. It's literally a cornucopia of ideas, projects, and designs that you can build now.

TAB1544: ELECTRONIC PROJECTS FOR PHOTOGRAPHERS \$21.95
 This book gives you needed tips on the principles of electronics and building techniques, hints on how to set up a work area, and much more. Build all kinds of practical accessories for your camera, studio, or darkroom with this helpful guide.

SB22361: INTRODUCING THE APPLE MACINTOSH \$20.95
 A wealth of information on hardware, software etc. for the Mac. Included are such topics as: making your desktop more efficient, improving your productivity with the Mac, getting the most from your mouse, how the 6800 microprocessor works and much, much more.

PH131: ZAP! POW! BOOM! ARCADE GAMES FOR THE VIC 20
T. HARTNELL & M. RAMSHAW (1983) \$17.45
 Move through the maze eating dots with MAZEMAN. Sail through space zapping the ASTEROIDS. Outshoot the fastest draw in town GUNFIGHT. Owners of the VIC 20 can now play these games — and more — simply by following the programs outlined in this handy guide.

THE BASIC COOKBOOK.
TAB No. 1055: \$10.45
 BASIC is a surprisingly powerful language... if you understand it completely. This book, picks up where most manufacturers' documentation gives up. With it, any computer owner can develop programs to make the most out of his or her machine.

HANDBOOK OF MICROPROCESSOR APPLICATIONS
TAB No. 1203 \$16.45
 Highly recommended reading for those who are interested in microprocessors as a means of accomplishing a specific task. The author discusses two individual microprocessors, the 1802 and the 6800, and how they can be put to use in real world applications.

MICROPROCESSOR INTERFACING HANDBOOK: A/D & D/A
TAB No. 1271 \$16.45
 A useful handbook for computerists interested in using their machine in linear applications. Topics discussed include voltage references, op-amps for data conversion, analogue switching and multiplexing and more.

HOW TO BUILD YOUR OWN WORKING MICROCOMPUTER
TAB No. 1200 \$16.45
 An excellent reference or how-to manual on building your own microcomputer. All aspects of hardware and software are developed as well as many practical circuits.

PH180: 1984 CANADIAN BUSINESS GUIDE TO MICROCOMPUTERS
K. DORRICOIT \$11.95
 Written by the managing director of Deloitte, Haskins & Sells, a Canadian partnership of public accountants and other professional advisors to management, this book is one of the most complete comprehensive guides to microcomputers available. Starting with a general overview of microcomputers and their business applications, the author helps you assess your computer needs, compares and evaluates computer systems and application packages, and gives you tips on "doing it right". A must for anyone thinking of purchasing a microcomputer for business.

COMPUTER PROGRAMS IN BASIC
AB01 \$15.45
 A catalogue of over 1,600 fully indexed BASIC computer programs with applications in Business, Math, Games and more. This book lists available software, what it does, where to get it and how to adapt it to your machine.

PH217: BASIC COMPUTER PROGRAMMING FOR KIDS
P. CASSIDY & J. CLOSE \$16.45
 Fully illustrated with photographs and drawings, this book teaches the reader the history of computers and computing and gently introduces binary mathematics and the basic theory of how computers work. Written in an easy, conversational tone.

PH51: PASCAL FOR THE APPLE
IAIN MacCALLUM \$34.20
 A step-by-step introduction to Pascal for Apple II and Apple II Plus users. The package of text and software diskette provides readers with worthwhile and interesting programs which can be run immediately and the results studied. Includes over 200 exercises with full solutions. Book/Disk Package.

PH52: APPLE GRAPHICS GAMES
PAUL COLLETTA \$40.95
 Contains 10 arcade-style games written especially for Apple II, including Spider, Piano, Pairs and Poker, as well as education, math, and designing games. Book/Disk Package.

PH57: START WITH BASIC FOR THE COMMODORE VIC 20
D. MONRO \$33.45
 This book/cassette package shows the reader how easy it really is to create programs using the full capacity of the machine. Includes helpful exercises and step-by-step instructions to put the full power of the VIC 20 at the user's fingertips. Book/Cassette Package.

SB21822: ENHANCING YOUR APPLE® II — VOLUME 1
D. LANCASTER \$25.50
 Who but Mother Nature or Don Lancaster could successfully enhance an Apple? YOU can, with help from Volume 1 in Don's newest series for Sams. Among other things, you'll learn (1) to mix text, LORES, and HIREX together anywhere on the screen in any combination, (2) how to make a new-wire modification that will open up whole new worlds of 3-D graphics and other special effects, plus (3) a fast and easy way to tear apart and understand somebody else's machine-language program. Other goodies abound!

PH106: PROGRAMMING TIPS AND TECHNIQUES FOR THE APPLE II
J. CAMPBELL (1983) \$23.45
 An advanced exploration of the intricacies of structures programming. Further develops the skills necessary to solve programming problems. Special chapter on sound and graphics which discusses both high and low resolution graphics for the Apple II.

HB131: THE BEGINNER'S GUIDE TO BUYING A PERSONAL COMPUTER \$6.45
 Written for the potentially interested computer buyer, in non-technical language, this affordable book explains the terminology of personal computers, the problems and variables to be discussed and discovered while making that initial buying decision. The book does not make recommendations, but does present a great deal of information about the range of hardware available from the largest personal computing manufacturers. Readers discover the meaning and impact of screen displays, tape cassette storage and disk storage, graphics and resolution, and much more. Comparison charts clearly define standard and optional features of all the current mass market personal computers.

DESIGNING MICROCOMPUTER SYSTEMS
HB18: POOCH AND CHATTERGY \$18.95

This book provides both hobbyists and electronic engineers with the background information necessary to build microcomputer systems. It discusses the hardware aspects of microcomputer systems. Timing devices are provided to explain sequences of operations in detail. Then, the book goes on to describe three of the most popular microcomputer families, the Intel 8080 Zilog Z-80, and Motorola 6800. Also covered are designs of interfaces for peripheral devices, and information of building microcomputer systems from kits.

S100 BUS HANDBOOK
HB19: BURSKEY \$26.00

Here is a comprehensive book that exclusively discusses S-100 bus computer systems and how they are organized. The book covers computer fundamentals, basic electronics, and the parts of the computer. Individual chapters discuss the CPU, memory, input/output, bulk-memory devices, and specialized peripheral controllers. It explains all the operating details of commonly available S-100 systems. Schematic drawings.

110 THYRISTOR PROJECTS USING SCRs AND TRIACS
MARSTON HB22 \$13.45

A grab bag of challenging and useful semiconductor projects for the hobbyist, experimenter, and student. The project range from simple burglar, fire, and water level alarms to sophisticated power control devices for electric tools and trains. Integrated circuits are incorporated wherever their use reduces project costs.

PH104: ACCOUNTANT'S BASIC PROGRAMMING FOR THE APPLE II
A PARKER & J. STEWART (1983) \$20.45
 Shows the reader how to program the Apple II to perform a variety of accounting functions, such as payroll, accounts payable, accounts receivable, tax, inventory, customer statements, and more.

HOW TO PROFIT FROM YOUR PERSONAL COMPUTER: PROFESSIONAL, BUSINESS, AND HOME APPLICATIONS
LEWIS HB07 \$18.95

Describes the uses of personal computers in common business applications, such as accounting managing, inventory, sorting mailing lists, and many others. The discussion includes terms, notations, and techniques commonly used by programmer's. A full glossary of terms.

AN INTRODUCTION TO MICROPROCESSORS EXPERIMENTS IN DIGITAL TECHNOLOGY
HB07 SMITH \$18.95

A "learn by doing" guide to the use of integrated circuits provides a foundation for the underlying hardware actions of programming statements. Emphasis is placed on how digital circuitry compares with analog circuitry. Begins with the simplest gates and timers, then introduces the fundamental parts of ICs, detailing the benefits and pitfalls of major IC families, and continues with coverage of the ultimate in integrated complexity — the microprocessor.

MICROCOMPUTERS AND THE 3 R'S
DOERR HB09 \$16.45

This book educates educators, on the various ways computers, especially microcomputers, can be used in the classroom. It describes microcomputers, how to organize a computer-based program, the five instructional application types (with examples from subjects such as the hard sciences, life sciences, English, history, and government), and resources listings of today's products. The book includes preprogrammed examples to start up a microcomputer program, while chapters on resources and products direct the reader to useful additional information. All programs are written in the BASIC language.

HB107: GRAPHICS COOKBOOK FOR THE APPLE WADSWORTH HB107 \$15.95

Learn how to use your Apple II to "paint" shapes, objects, and letters in low-resolution graphics. The author provides a library of microcomputer graphics including such multicoloured illustrations as robots and flying saucers, trees, sailboats, and colourful picture backgrounds. Contains complete annotated Applesoft BASIC programs to draw all the pictures described in the book as well as suggestions for improving programming techniques.

HB116: THE BASIC CONVERSIONS HANDBOOK FOR APPLEII, TRS-80/II, and PET/II USERS
BRAIN BANK \$14.50

A complete guide to converting Apple II and PET programs to TRS-80, TRS-80 and PET programs to Apple II, and TRS-80 and Apple II programs to PET. Equivalent commands are listed for TRS-80 BASIC (Model I, Level II), Applesoft BASIC and PET BASIC, as well as variations for TRS-80 Model III and Apple Integer BASIC. Also describes variations in graphics capabilities.

SARGON: A COMPUTER CHESS PROGRAM
SPRACKLEN HB12 \$27.50

"I must rate this chess program an excellent buy for anyone who loves the game." — Kilobaud

Here is the computer chess program that won first place in the first chess tournament at the 1978 West Coast Computer Faire. It is written in Z-80 assembly language, using the TDL macro assembler. It comes complete with block diagram and sample printouts.

BASIC COMPUTER PROGRAMS FOR BUSINESS: STERNBERG (Vol. 1)
HB13 \$21.50

A must for small businesses utilizing micros as well as for entrepreneurs, volume provides a wealth of practical business applications. Each program is documented with a description of its functions and operation, a listing in BASIC, a symbol table, sample data, and one or more samples.

AUDIO AND VIDEO INTERFERENCE CURES
KAHANER HB21 \$8.95

A practical work about interference causes and cures that affect TV, radio, hi-fi, CB, and other devices. Provides all the information needed to stop interference. Schematic wiring diagrams of filters for all types of receivers and transmitters are included. Also, it supplies simple filter diagrams to eliminate radio and TV interference caused by noisy home appliances, neon lights, motors, etc.

PH107: APPLE LOGO PRIMER
G. BITTER & N. WATSON (1983) \$19.95

A pictorial starter book that will make LOGO easy for anyone. Includes easy to follow examples and reference tables. Also included is a workshop outline for teachers and leaders who want to train others.

SB22047: 26 BASIC PROGRAMS FOR YOUR MICRO
MICRO \$17.45

Features 26 previously unpublished, simple-to-complex games you can run on almost any brand of microcomputer as long as you have enough RAM on board. Most take between 500 and 5000 bytes, with the highest taking 13K. Conversion charts that let you key them into your Radio Shack, TRS-80, Apple II, Timex/Sinclair 1000 (ZX81), Spectrum, Atari, or PET are included. Also features notes on program techniques and structures.

Designing Transistor Stages, Part 2

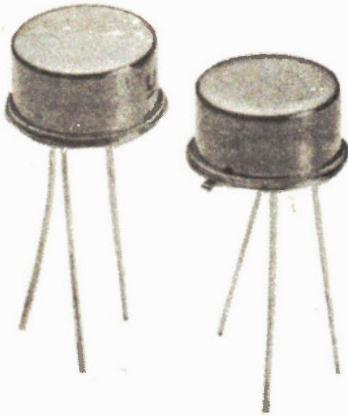

Examining the most popular single-transistor configurations.

By Les Sage

Having introduced the practical techniques involved in designing a common emitter transistor stage (ET, January, 1986), this month we'll concentrate on more general consideration of different configurations. Each circuit has been fully tested and its basic characteristics are given in the appropriate diagram. Component values have been calculated using similar techniques to those dealt with last month, involving emitter, collector and base voltages and currents and transistor gain. Two gain figures are used, one for signals (AC) and the other for notional DC levels (notional because most of the circuits are AC coupled). The DC gain figure, however, is an indication of circuit stability.

Bootstraps and Feedback

The main problem with the standard stabilized common emitter stage of last month is the rather low input impedance resulting largely from the base bias resistors shunting the input signal. A way around this problem is to use three bias resistors and include an extra "bootstrapping" capacitor (Fig. 1). The principle of operation is that any input signal present at the transistor's base will, by emitter follower action, appear at much the same magnitude at the emitter. Since C2 (the bootstrap capacitor) is relatively large, it will act as a short circuit to the AC signal at the emitter and couple it without any attenuation to the junction of R1 and R2. Resistor R3 will have more or less the same AC signal at both ends, so there cannot be any AC current flowing through it and all the signal input goes into the transistor.

The input impedance is then that of the transistor stage and is not shunted by the bias chain. The DC bias conditions have not been altered significantly by the presence of R3 although, in practice, emitter follower action is not 100% and the junction of R1 and R2 is at a slightly lower potential than the input signal,

meaning that a very small current still flows into the bias chain.

A second benefit of this configuration, and one not often realized, is that any noise on the supply lines will now be decoupled to the emitter through C2 instead of being fed down the bias chain into the transistor's base. Since the emitter circuit has a very low impedance, it will remove the noise.

The un-bypassed emitter resistor, R5, adds to the input impedance of this circuit by introducing current feedback. The input impedance is approximately equal to the $h_{fe} \times R5$ (typically greater than 100k). The output impedance is also quite high. This can be reduced, at the expense of also reducing input impedance, by a voltage feedback arrangement as in Fig. 2. In this circuit, a current proportional to output voltage is fed back to the input through R2, so that any tendency for the collector current to change is counteracted by an opposite tendency in the feedback current. This is a very economic arrangement, giving good stability at low cost and complexity. The circuit is probably most familiar for its DC stabilization characteristics, but among single transistor stages it is the closest thing to a virtual ground amplifier.

Ideally, the transistor should have a very high current gain, h_{fe} , which is not too difficult with contemporary silicon devices. If R1 is large compared to the source resistance and the transistor input resistance (it's in the order of ten times Q1's input resistance as it stands), then the circuit input impedance will be roughly equal to R1 and the gain roughly equal to the ratio of R2 to R1. The output impedance is reduced by the ratio of closed-loop gain to open loop gain. In an actual circuit, this worked out to be about three quarters, giving an output impedance of about $2k5$ ($0.75 \times R3$).

For high gains (and it is only with high gains that the approximate values are really reliable), R1 must be quite low.

Reducing R1, however, is also liable to upset the calculations and, in practice, a compromise is required. The circuit makes a good current-to-voltage converter, with output voltage equal to input current multiplied by feedback resistance.

Fig. 3 shows how to obtain a higher input impedance at high gains. Two feedback resistors, R1 and R2, are used, their junction being decoupled to ground through C2. This gives a moderate input impedance (which can be increased by the addition of an input resistor as in Fig. 2) and high gain but at the cost of increasing output impedance against the Fig. 2 circuit. The effect is due to the action of C2 in shunting signal frequencies to ground and avoiding AC feedback. The circuit may be considered the voltage feedback equivalent of the current feedback common emitter with a bypass capacitor across the emitter resistor (Fig. 1, ET, January, 1985, with R5 shorted out).

A refinement to Fig. 3 can be seen in the circuit shown in Fig. 4. Capacitor C2 now shunts signal frequencies to the transistor emitter. By bootstrap action, R1 is now effectively an open circuit to AC signals, giving high input impedance and an associated reduction in gain. This configuration combines good DC stability with reasonable gain and high input impedance. The output impedance remains fairly high, due to the absence of direct parallel-derived AC voltage feedback. The circuit, however, finds an ideal use as a ceramic cartridge input stage where a high input impedance is required with not much gain.

Because of its high input impedance and very low output impedance, the emitter follower (or, common collector) circuit (Fig. 5) makes an ideal buffer between stages. The low output impedance (in the order of $10R$) means that it will drive almost anything current-wise. The circuit also has an input impedance which is higher than that of all the previous circuits we've seen, even though the emitter circuit

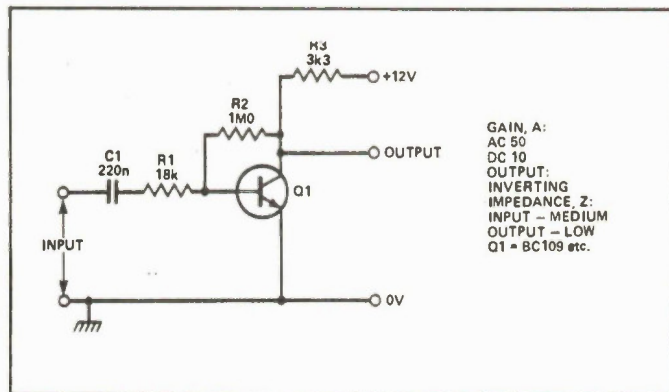
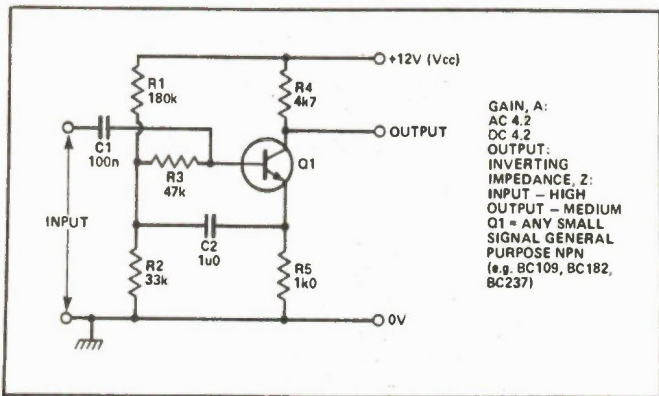

Fig. 1. The bootstrapped common emitter.

Fig. 2. Virtual ground common emitter.

impedance of around 500k is shunted by the bias resistors. It therefore presents a very small load to any preceding stage. Add to this the fact that voltage gain is practically unity and it is clear why many engineers, unable or unwilling to design circuits for a particular purpose, just stick an emitter follower at the input and the output of some conventional amplification stages.

In practice, many emitter followers can be omitted altogether, especially if circuits are custom-designed. Nevertheless, it remains a useful addition to the designer's armoury.

Ground to Base

So far, all the circuits described have been for low frequency applications. At the higher frequencies characteristic of radio and video, they will all show a distinct lack of gain. The responsibility largely belongs to the Miller capacitance effect. All transistors display a certain amount of capacitance between junctions. The capacitance between the base and collector is small and would not seem to be a cause for concern. However, the Miller effect says otherwise. A capacitance between the input and output of an inverting amplifier (for example, between the base and collector in a common emitter stage) appears to the input signal as having a value equal to the actual capacitance multiplied by the voltage gain. This is a form of negative feedback. What's more, the capacitance appears to shunt the signal to ground, so that base-collector capacitance multiplied by voltage gain is added to base-emitter capacitance. This

produces a considerable reduction of input impedance at high frequencies and, in conjunction with input source resistance and the transistor's base layer resistance, a loss of signal amplitude and therefore of effective gain. For somewhat different reasons, emitter follower performance (which is dependent on current gain) also falls off at high frequencies.

One way of overcoming such effects is to operate the transistor in grounded (or, common) base mode. The transistor conducts DC as normal and component values are calculated as with a common emitter, but the signal is injected into the emitter and the base is held at ground potential to AC by a large-value capacitor. Any feedback signal due to internal transistor junction capacitance between collector and base is now shorted to ground by the external capacitor (C2 in Fig. 6). In fact, the base-collector capacitance is no longer directly connected between input and output since the base itself acts as a screen. There is no Miller-amplified feedback capacitance, and the input signal feeds into the already low emitter impedance. Thus, voltage gain remains useful even at very high frequencies (up to the transition frequency f_T).

One characteristic worth noting is that the grounded base configuration is non-inverting since the signal is injected into the emitter and the output is taken from the collector. This is useful for video applications, as is the low input impedance of the circuit (suitable for terminating aerial feeder cables).

Non-inversion can also be achieved

with a common emitter stage by taking an output from the emitter itself. Fig. 7 shows a circuit commonly known as a phase-splitter, since output 1 and 2 are in antiphase, the first being equal in amplitude to the input but inverted in phase, the second being equal in amplitude and phase to the input. The amplifier has unity voltage gain. The main uses of this circuit are for driving balanced lines or as a means of obtaining variable phase for musical effects. R5 is included to ensure that both outputs are of equal impedance.

In the final part of this series we'll be dealing with some useful two-transistor stages. These will show how many of the compromises necessary in designing single transistor stages can be avoided.

Continued on page 40

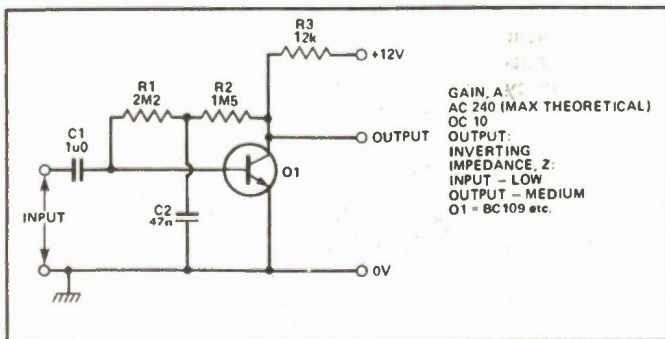

Fig. 3 A common emitter with AC feedback decoupled.

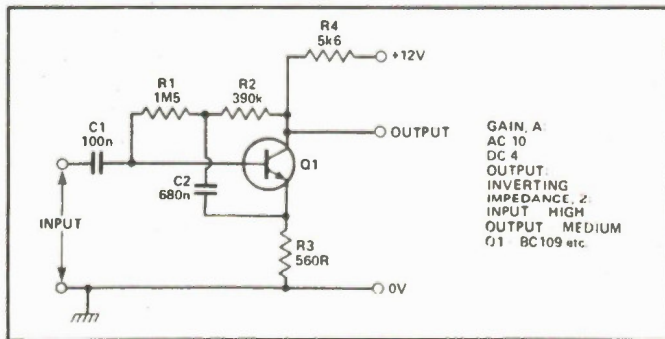

Fig. 4. A bootstrapped high impedance amplifier.

The Power MOSFETS

The power MOSFET, a device that's almost the ideal transistor.

By Bill Markwick

EVERYONE who designs circuits, or wants better hifi performance, or just tinkers with breadboards must do some teeth-gnashing at the limitations of regular bipolar power transistors. The single characteristic that accounts for most of the problems would be the bipolar's need for base current. You have to control the flow of base current in order to control the larger collector-emitter current; this ratio, in the popular common-emitter and common-collector configurations, is the current gain: *beta* or HFE, equal to I_c/I_b .

Typical values for HFE range from 10 for large power transistors to 500 for small-signal types. There are also devices available with current gain measured in the thousands, such as super-beta transistors with extremely thin base regions, or Darlington compound types made up of two transistors. These suffer from very low voltage ratings and very slow response, respectively. The super-beta types, in fact, are rarely found outside integrated circuits where the operating voltages can be tightly controlled.

To add to your troubles with controlling the base current, we have the fact that HFE rarely holds still; it varies both with collector current and with temperature, not to mention the variation from transistor to transistor. Should you decide to use a bipolar for a switch, you may find that the HFE is not specified at very high collector currents; this is probably because it falls to a very low value, perhaps as low as unity.

The high-frequency response of the bipolar isn't all that good, largely due to the problem of getting electrons and holes to move quickly through the complex geometry of the chip. For instance, the 2N6306, a 250V TO-3 switching bipolar, has rise and fall times of about .6us when

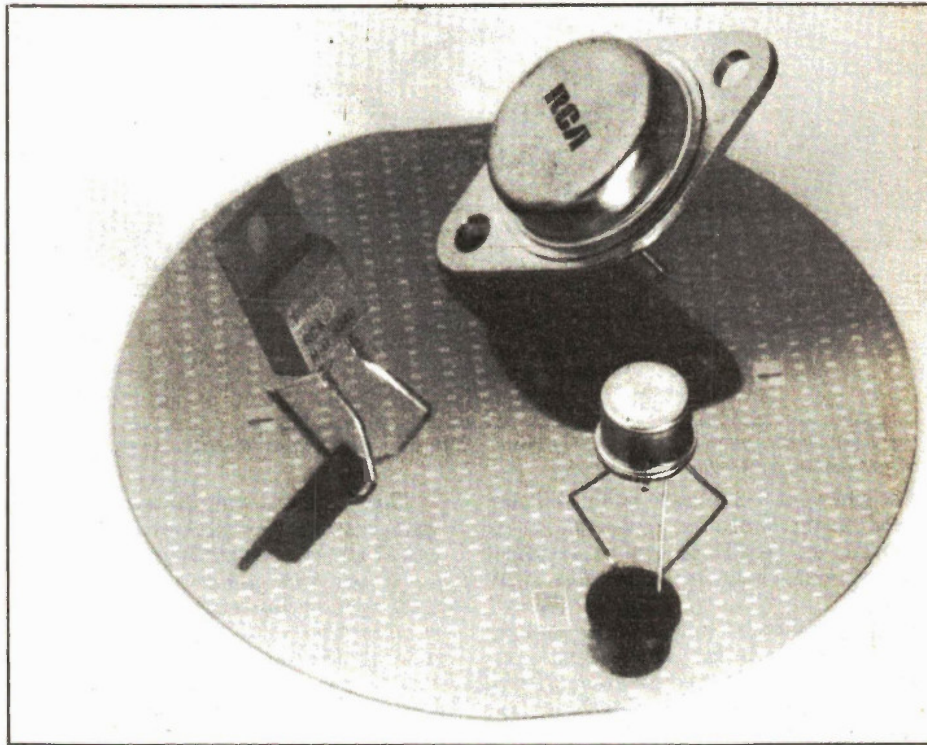

switching 3 amperes, and even worse, a 1.6us storage time; the latter spec is the time it takes from the application of a small change (10 percent) in the input voltage until the same percentage change happens in the output. In other words, it's the time that the transistor takes to realize that it has to do something. The rise or fall time is then added to this.

The delay problem is even worse with Darlington's because you have two junctions for the carriers to go through. The 2N6576 15A Darlington, for instance, has a rise time of 1us, a storage time of 2us, and a fall time of 7us when switching 10A.

The slow response times affect more than the performance as a switching element; they slow down the best of analog power amplifiers and limit the signal swing available at higher frequencies, an important factor in distortion and transient response figures. In general, it's the output devices that set the high frequency performance of any power amp.

If that isn't enough, there's also the problem that the maximum power capability of bipolars is limited to less than the expected: a high V_{ce} will reduce the allowable collector current to less than the rated maximum due to an effect called second breakdown, which we'll come back to.

After painting that gloomy picture, enter the power MOSFET.

A Tour of the FET

The power MOSFET is a unique transistor, sharing almost nothing with its cousin the bipolar. It consists mostly of a channel of silicon connected to the source and drain terminals; at the narrowest part is the silicon gate area, insulated from the channel itself by the non-conductive property of silicon oxide. When a voltage is applied to the gate area, the field effect controls conduction of current through the source-drain channel.

Like bipolars, MOSFETs are available in two polarities. The N-channel type (the one with the arrow pointing to the gate) is analogous to an NPN; the drain must be positive with respect to the source and a positive-going gate voltage increases conduction. For the P-channel, the drain must be negative with respect to the source and a negative-going gate voltage increases conduction. For this article, the MOSFETs discussed will be N-channel unless it's stated otherwise.

With the gate at zero volts with respect to the source, the transistor is non-conducting from source to drain. As the gate voltage rises from zero, the conduction threshold is approached; this threshold will be between 1 and 4 volts, depending on the particular transistor.

Any increase in gate voltage will now result in an increase in drain current until the maximum current figure is reached.

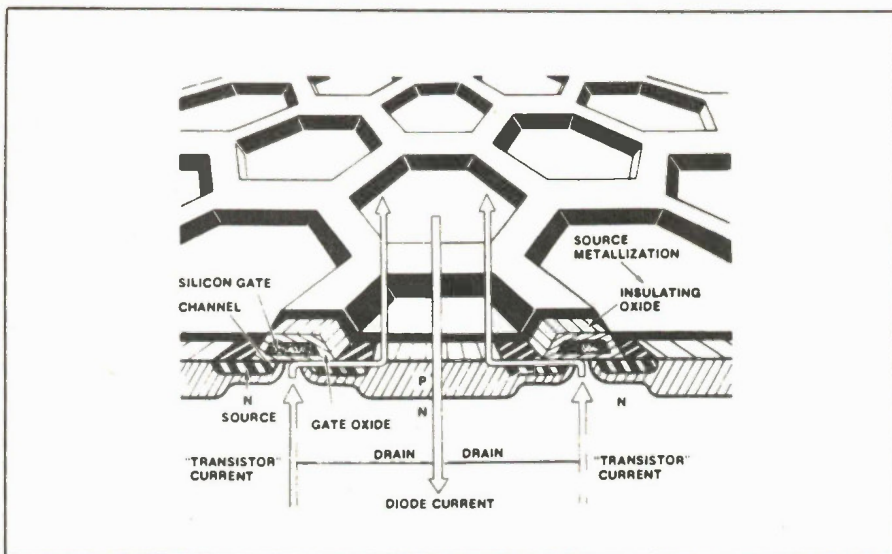

Fig. 1. The basic structure of a HEXFET power MOSFET. Unless noted, illustrations are courtesy of International Rectifier Canada Ltd.

The gate voltage it takes to do this will depend on the particular transistor, but in general, all MOSFETs can be switched full-on with a gate-to-source value of 10 volts.

When the gate voltage is high enough to cause maximum conduction, the MOSFET is said to be "saturated". It's not quite the same as a bipolar in saturation, which tends to look like a dynamic resistance; the more current through a bipolar, the lower the emitter resistance, keeping the saturated value of V_{ce} fairly constant below one volt or so. The MOSFET source-to-drain resistance tends to look more a fixed resistance, notated R_{ds} . The value of R_{ds} depends on the particular device, but it varies from a low of 0.028 ohms to 1 ohm or more for the larger packages (TO-3, TO-220). No doubt by the time you read this there will be devices with even lower R_{ds} values.

The Gate

The insulated gate region of the MOSFET results in an input current so low that the transistor can be considered to be a voltage-operated device; for steady-state conditions, the only current into the gate will be leakage on the order of a few nanoamps. For most DC purposes, you can safely take the gate as having infinite resistance. We'll come to the dynamic gate drive characteristics in a moment.

Since we have a change in voltage controlling a change in current, we can't use the familiar HFE current ratio for gain. The parameter used to describe the gain of a MOSFET is *transconductance*, notated g_{fs} , a term that will be familiar to users of vacuum tubes (you know, those glass things that glow and get hot). Transconductance is defined as the change in drain current for a one-volt change in gate voltage, and the unit used is the Siemen. Typical values vary from 2

to 12 or so; a one-volt change in the gate voltage results in a drain current change of 2 to 12 amperes, depending on the device.

It would be nice to have a perfectly linear relationship between applied volts and resulting output current, but the perfect product exists only in TV commercials. The g_{fs} of a MOSFET varies with drain current, just as HFE varies with collector current in a bipolar. With the IRF540, a 27 amp MOSFET, g_{fs} begins at less than 3 with low currents, reaches 6 at 5A and levels off at 8 at 25A. This means that the input-output relationship is not perfect for linear applications, though it isn't hard to fix with negative feedback. The silver lining in the cloud is that transconductance does not fall off with increasing current, even if you exceed the maximum drain amps, and therefore transconductance variations can be neglected for switching applications. This is in contrast to the bipolar transistor in which HFE falls to pieces as you drive it into high-current saturation. The benefit from this is that the MOSFET retains its voltage-controlled characteristics even when overdriven. Another advantage to

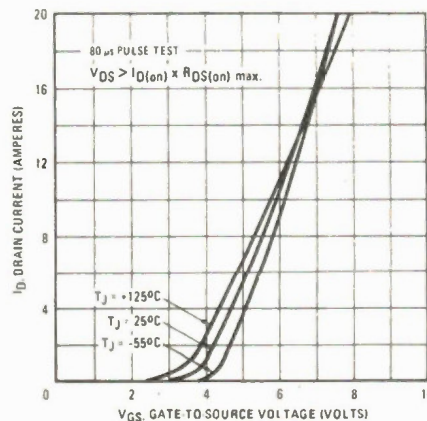

MOSFETs is that transconductance varies negligibly over the full operating temperature range.

As you might expect, the gate insulation layer actually forms a small capacitor, with typical values from 200 to 1200pF, and like any capacitor, there is a maximum applied voltage before breakthrough occurs. In general, this voltage is plus or minus 20 volts. If you want to turn the transistor full-on, the gate voltage should be limited to the maximum needed for full conduction, usually no more than 10 volts. If the gate becomes reverse-biased for any reason, the same limit should apply.

The Dynamic Gate

The capacitor mentioned above, as well as other stray capacitances, makes reality raise its ugly head. Our voltage-controlled MOSFET, which was beginning to look close to ideal, starts to draw gate current when we get into higher frequencies. Under DC conditions, such as switching a slow device like a lamp or relay, the gate can be regarded as not even being there. Under AC conditions, such as a power amp at the high end of the audio spectrum or a high-speed switching regulator, the inherent capacitances in the gate region begin to draw current as they're charged and discharged by the signal source.

The two most important capacitances are C_{gs} , the gate-to-source capacitor, and C_{gd} , the gate-to-drain capacitor. Although C_{gs} is affected somewhat by V_{gs} , it can generally be considered a fixed value. C_{gd} , on the other hand, is a dynamic quantity that varies considerably with V_{gs} . To make matters worse, it's in a position to permit capacitive feedback from the drain to the source. This is analogous to the Miller feedback effect in vacuum tubes or circuit models.

Suppose the MOSFET is in a circuit in which 100V on the drain is switched by a 5V gate signal. When switching occurs, there is suddenly a 100V pulse applied to the gate circuit through C_{gd} , 20 times the value of the input signal. This "bootstrapping" of the gate-to-drain capacitance makes it look like a much larger capacitor than it actually is. It also decreases with increasing voltage just to complicate your life.

This transient pulse from drain to gate may cause trouble. If it's positive-going, it can turn the transistor on, though it will probably be self-limiting in this respect as the turn-on makes the drain voltage fall. If it's negative-going, it will turn the transistor off and won't be self-limiting; it can actually exceed the 20V maximum gate voltage. If switching transients prove to be a problem, a zener diode from source to gate will clamp positive transients to the zener voltage, and negative transients to one forward diode drop.

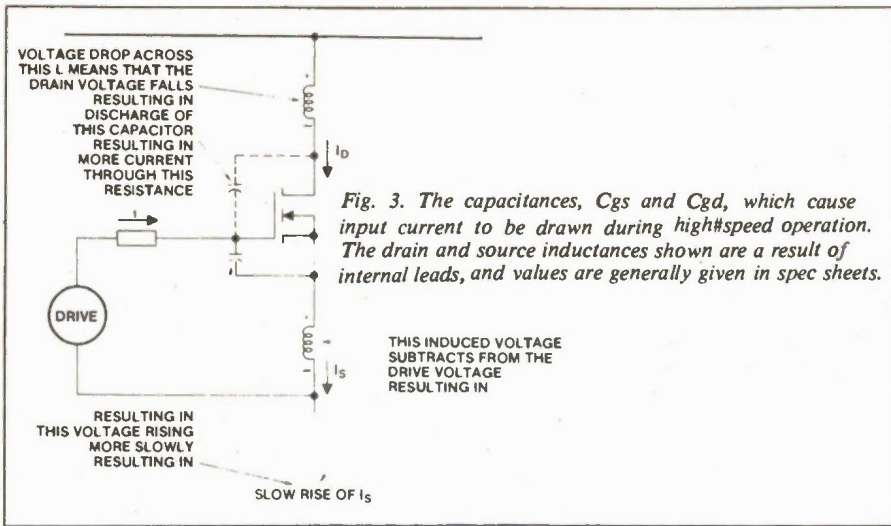

If you need to work out critical switching times for various loads and input drivers, the International Rectifier HEX-FET Databook, publication number HDB-3, is just full of application notes covering every aspect of calculating switching times, not to mention advice on designing regulators, amplifiers, motor controls, etc. In fact, a good deal of the technical information in this article is drawn from those very app notes. And, of course, there are extensive data sheets on each of the MOSFETs made by IR (HEX-FET is their trade name for MOSFETs).

SOA and Current

The MOSFET has some great advantages over bipolars when it comes to the Safe Operating Area (SOA) and current ratings. The bipolar's maximum power performance is limited by both gain and second breakdown. The gain problem was mentioned before, and simply consists of a falling off of HFE at collector currents

near the transistor's maximum. Secondary breakdown is a phenomenon due to the bipolar chip geometry: as V_{ce} rises at higher currents, the voltage field in the emitter-base region causes localized current crowding. This increase in current density in small areas leads to localized heating, and unfortunately, bipolars have a positive temperature coefficient: the resistance goes down with increasing temperature, aggravating the situation. A look at the SOA chart for bipolar power types shows that at high V_{ce} and I_c ratings, a bipolar can fail long before it reaches the specified maximums.

MOSFETs are free from both of these problems. As mentioned before, the transconductance does not fall off with increasing current, but increases to a maximum at which it stays. This allows pulsed current far higher than the continuous ratings. Secondary breakdown is no longer a limitation: if localized current crowding should occur, the MOSFET has

Fig. 4. The Safe Operating Area for a 75 watt IRF330. The safe area is simply the current times the voltage equalling the rated power dissipation, unlike the bipolar transistor which suffers from second breakdown (see text).

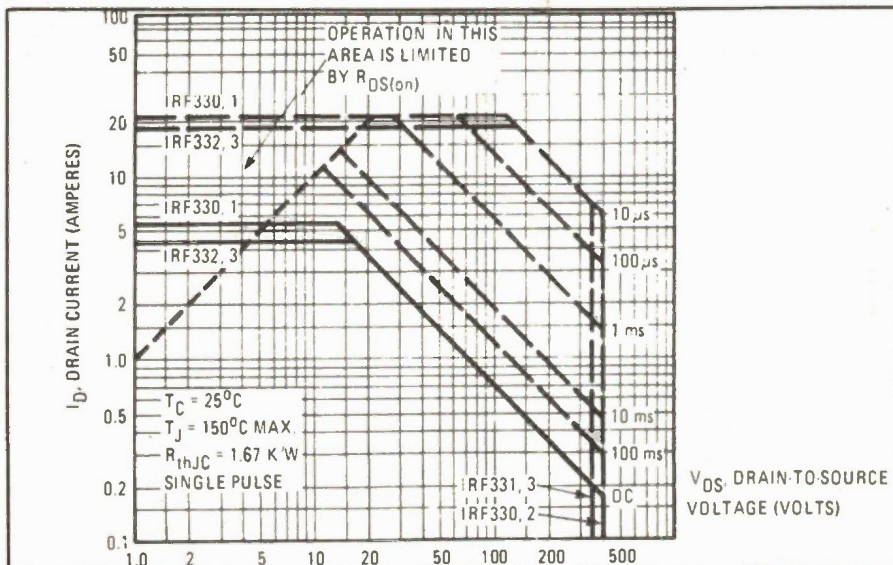

a negative temperature coefficient that makes the resistance of the area in question go up, restoring things to normal.

As far as current goes, the ratings given to bipolars by manufacturers are a bit on the optimistic side. The peak current is often given without regard to the very low HFE which will occur at these current levels, the saturation voltage (and stored carriers in the base region) will slow the high-frequency response, and the chip temperature would be much above the 25 degrees C shown on the specs. The MOSFET, on the other hand, is limited only by dissipation. There is no derating for second breakdown.

The dissipation of the MOSFET can be calculated by taking the drain-to-source resistance as a straight ohmic value, more or less; more on this follows in the next section.

Power, Current and Rds

The drain-to-source resistance, R_{ds} , is remarkably low compared to small-signal FETs; some power MOSFETs have an R_{ds} value as high as 3 to 5 ohms, but the majority will be 1 ohm or less. The minimum value of R_{ds} occurs when the gate voltage is high enough to get the transistor out of its linear region and into the area where maximum drain current is flowing; any further increase in V_{gs} will not increase I_d .

If the maximum current is kept below the rated continuous maximum, there is only a small variation in R_{ds} . For instance, at a junction temperature of 25 degrees C, the IRF330 has an R_{ds} of about 0.9 at 1 ampere; it rises to only 1 ohm at the rated maximum of 5.5A. However, the rated maximum is determined by power dissipation, and it can safely be exceeded if the current is a pulse rather than DC. At 15A, the IRF330 has an R_{ds} value approaching 1.5 ohms.

Also, R_{ds} increases with temperature. The IRF330 specs show an increase at 125 degrees of 2 times the 25 degree value. In other words, you can take R_{ds} as a pure ohmic value, but you should take drain current and junction temperature into account. The manufacturer's specs usually give good graphs showing the variations in R_{ds} .

This brings us to another advantage of the MOSFET: the negative temperature coefficient mentioned earlier makes the transistor free from thermal runaway. This is particularly important in linear applications such as power amplifiers. In the bipolar transistor, the heat from power dissipation lowers the effective resistance of the transistor, making it pass more current which in turn heats it more. Unless a power amplifier has some sort of thermal protection in the circuit, the output stage can destroy itself in seconds from overheating. The MOSFET is free from this problem; as the current causes

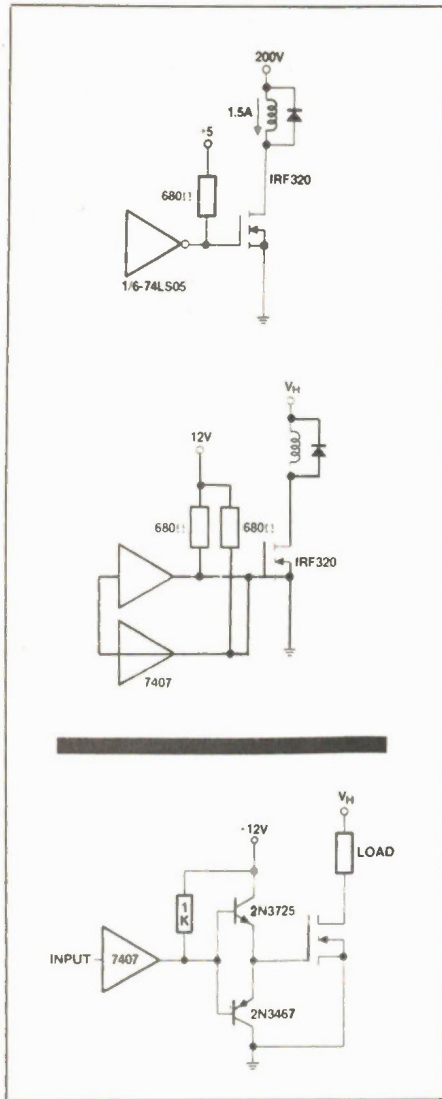
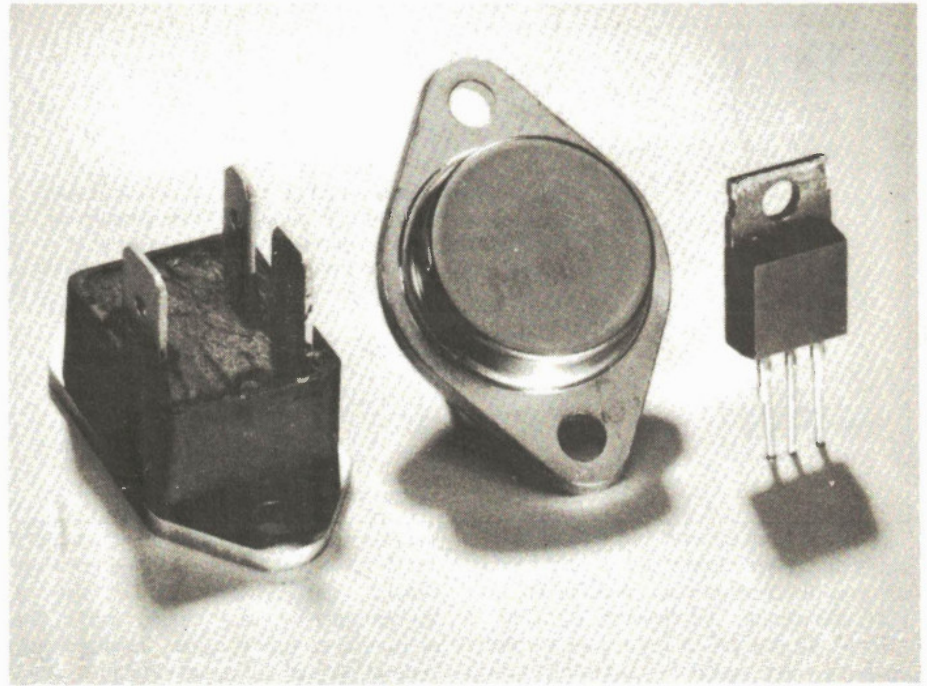

Fig. 5. Driving MOSFETs from high-speed logic circuitry. The output of the 74LS05 can be pulled up to 5V with the 680 ohm resistor, or an open-collector 7407 with a 12V supply can be used; both have slow on-times due to the resistors. The complementary bipolar transistor interface offers the highest speed.

heating, R_{ds} increases, acting as a sort of negative feedback to maintain equilibrium.

This feature is particularly useful when it comes to paralleling MOSFETs for extra current-handling. You just put more MOSFETs together; the familiar emitter resistors are gone, replaced by the inherent current-sharing characteristic produced as R_{ds} increases.

Handling the power generated by the MOSFET junction is the same as with bipolars: specifications are given for the junction-to-case thermal resistance, and it's just a matter of selecting the desired junction temperature and the heatsink required to maintain it for your power dissipation figure. For an explanation of the simple calculations, see *Heatsinks* in last month's issue.



If you're using the MOSFET as a switch, the calculation of the power dissipation is a bit more involved, particularly with duty cycles in which the off-time gives the junction a fair amount of time in which to cool. Good explanations of duty-cycle ratings can be found in manufacturers' application notes, in particular International Rectifier's 949A, *Current Ratings, Safe Operating Area and High Frequency Switching Performance* (in databook HDB-3 mentioned earlier), and also Fairchild Semiconductor's Application Note DIS-2, *Introduction to Power MOSFETS and Their Applications*.

Applications

The many advantages of the MOSFET over bipolars make them the choice in a number of applications, each exploiting one or more of the MOSFET's strong points.

Suppose you wanted to drive a 5A solenoid coil from a 47k collector resistor. A Darlington compound bipolar is unlikely to work without a buffer, since most of them draw at least 1mA of base current at 5A. The MOSFET, although about twice the cost of a bipolar, is the easiest solution.

If you want to interface the MOSFET to logic circuitry to take advantage of its superiority as a high-speed buffer, you have to keep in mind that the high-level output from TTL is only about 3.5V, not enough to ensure efficient switching with a MOSFET; a pull-up resistor solves the voltage problem at the expense of speed during positive-going pulses. The cures are using CMOS with a 12V supply, using

an open-collector TTL output with a 12V supply, using a 5V to 12V interface IC such as the Fairchild uA9643, or fitting a bipolar stage with a higher voltage supply.

When it comes to high-voltage, high-frequency switching, the MOSFET is unexcelled. Voltage ratings of 500V or more are readily available, and devices can be easily paralleled for very high current ratings. The reduction in input current over bipolars simplifies the driver circuitry, and the superb switching characteristics mean that switching speed can easily be increased to about 100kHz to take advantage of the resulting reduction in inductor and capacitor sizes (bipolar switching supplies usually operate at 20 to 40kHz).

In audio power amplifiers, the MOSFET's low input current means that driver stages are very much simplified; the front end can function largely as a voltage amplifier, easing design restrictions. The output current from the front end need only be large enough to handle the charging and discharging of gate capacitances. The speed of the MOSFET means a considerable improvement in bandwidth and response to transients. Thermal runaway is eliminated, and the output devices can be easily paralleled for higher output currents.

In short, the MOSFET shines if you want high speed, low input current, and freedom from temperature effects; the main disadvantages at the moment are higher cost and higher on-resistance compared to bipolars. No doubt the last two are only temporary drawbacks.

Daetron Capacitance Meter

The Daetron MC300 Digital Capacitance Meter does far more than measure capacitors.

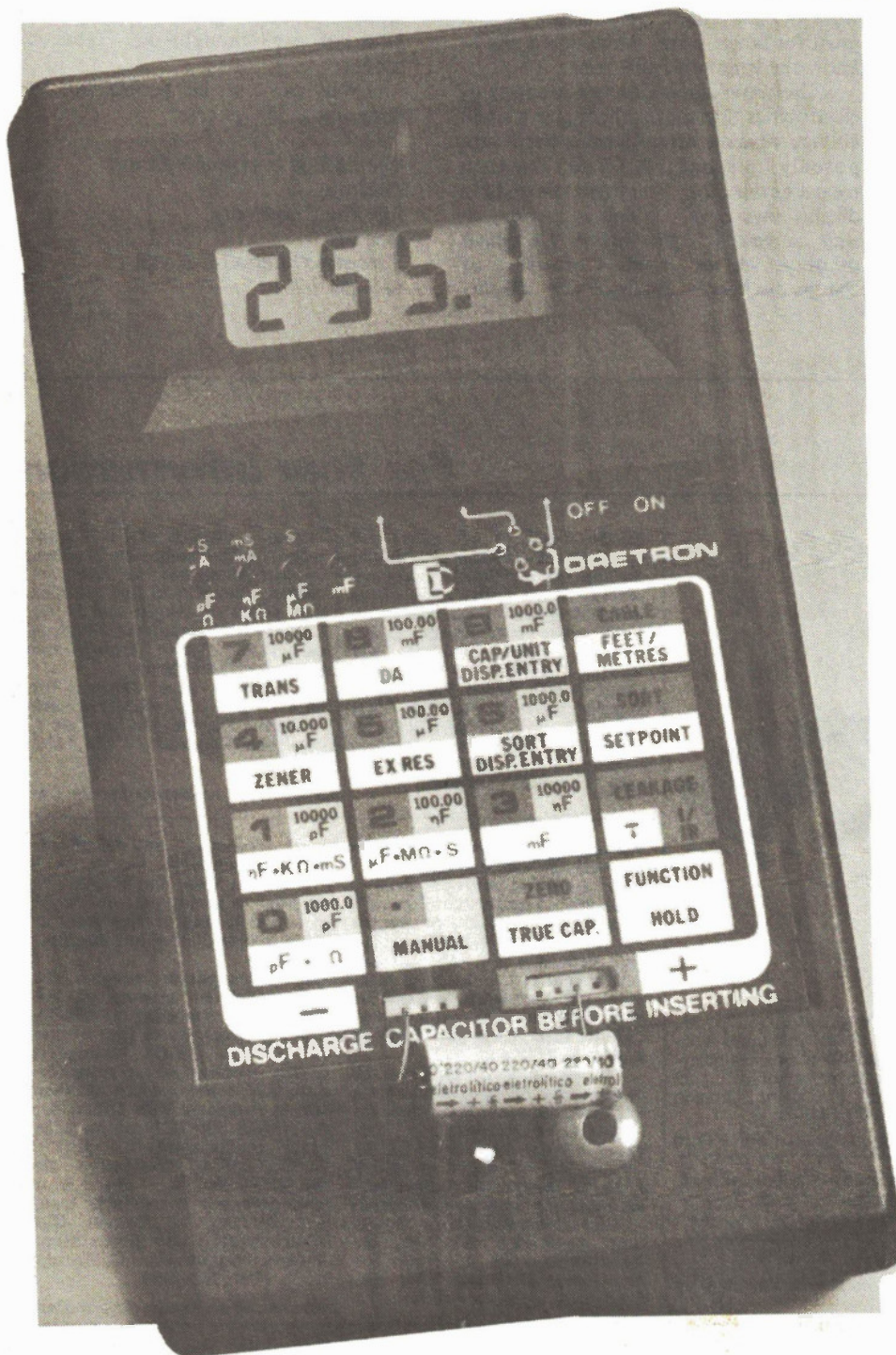

ONCE you decide to solve a design problem by using the microchip, you create another: how do you exploit the chip's remarkable potential? John Bergeron of Bergeron Technologies has done a grand job of it with his Daetron Model MC300 Capacitance Meter.

Start by discharging a capacitor, plugging it into the front panel jacks (or external leads), and switching the unit on. It will automatically range itself, displaying the four most significant digits and lighting an LED to indicate pF, nF, uF or mF (millifarads). The range is 0.1pF to 999.9mF. The display pops up your value accurate to 0.5% up to 100uF, 2.0% up to 10,000uF, and 5% for capacitors larger than that. The time required depends on the capacitance; a 250uF took about one second and a 1600uF took about 3 seconds. A really huge can, say 200,000uF, may take up to 40 seconds, though that size is a mite rare.

But that's nothing. It also has auto-zeroing, and if stray capacitance is causing a non-zero display, you can enter in the value of the unwanted farads and the meter will subtract it from the reading to give you zero again. There's a manual range key, should you want such a thing. There are 10 ranges selectable via the membrane keypad, and a range LED lights to indicate where you're at. Too large a cap for the range lights the word OVER on the LCD display. The biggest advantage to the manual feature is the ability to demonstrate the relationships between ranges as a teaching aid: one nano equals 1,000 picos or 10,000 kilometres, whichever comes first.

When a capacitor is leaky, that is to say it is passing DC current rather than liquids, the reading will be in error. The Daetron overcomes this when you press the TRUE CAP key. It monitors the ratio of charge and discharge times and calculates true capacitance. This feature can be used for in-circuit testing because it can null out the error-causing effects of circuitry around the capacitor, assuming the capacitor isn't bypassed by another or by a transistor or something.

If you don't know whether it's leaky or not, your suspicions can be checked with the LEAKAGE key. Pressing it once displays the effective resistance in ohms or kohms. Pressing it again displays the leakage current, and pressing once more returns you to capacitance measuring.

If you're making a whole pile of precision gadgets and have to select capacitors, the MC300 will help with that, too. The upper and lower capacitance limits that you choose are entered via the number keys, and then you just sit back and zip the caps through the socket. The display will indicate LOW, GOOD, and

HIGH when you press the SORT key. It also tells you the actual capacitance value.

Sometimes a 4-digit display isn't enough for the accuracy you want, and by pressing EX RES, the display shifts one digit to the left to reveal the fifth digit, which was inside the machine all along, but normally got rounded off.

You can measure cable length, too, in either metric or imperial, up to 10,000 miles, at least theoretically. First you inform the unit about the cable, either by putting in one foot or one metre of cut cable, or by entering the manufacturer's value for cable capacitance. It will then work out the length. This feature sounds great for house wiring when you'd like to know the length of cable runs.

Dielectric absorption is a property of electrolytics that makes them give a small voltage reading after they've been supposedly discharged. The Daetron measures that, too. You press DA and the display says UAIT, which is as close to wait as you can get with a 7-segment display. After some minutes of charge/discharge cycling, the display

shows a value between 0 and 1, the lesser the better.

It will even test transistors and diodes. Place any unknown transistor in the transistor socket, and it will read out the polarity and pin configuration, B, C, and E on the display (but not gain). The breakdown voltage of zener diodes can be tested up to 24 volts by means of an internal voltage multiplier that steps up the internal 9V battery or external 9V adapter (optional).

And on top of that, it's \$149.95. I'm amazed. Despite all the stuff about the wonders of the microchip, it's very, very seldom we see any products that give this kind of well-thought-out value for money.

Why can't we get people like John Bergeron to design cars?

The MC300 is available from:
Daetron,
935 The Queensway,
Box 641,
Toronto, Ontario M8Z 5Y9.
416-255-9701

For Your Information

Connector Covers

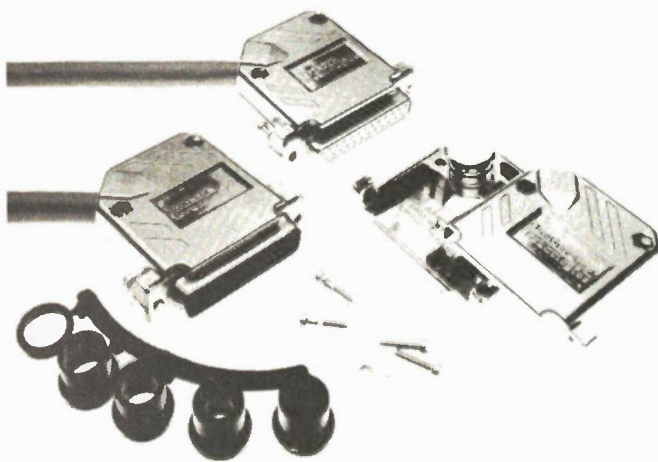

Northern Technologies has a complete family of shielded, metalized D connector covers. Made from nickel/copper plated ABS, the covers surpass FCC guidelines for RF emissions, and are easy to install. The made-in-Canada covers

are available to suit 9, 15, 25, 37, and 50 pin crimp and solder connectors from all major manufacturers. Northern Technologies, 85 Torbay Rd., Markham, Ontario L3R 1G7, (416) 475-9123.

Circle No. 65 on Reader Service Card.

Scope Calibrator

The Time Electronics Model 303 Scope Calibrator is a low-cost unit providing amplitude calibration of 0.25 percent, timebase calibration of 0.01 percent and risetime/bandwidth performance checks. The

unit is portable, with both AC and battery power. Contact Jerome and Francis Company Ltd., 1869 Welch St., North Vancouver, BC V7P 1B7, (604) 986-1286.

Circle No. 66 on Reader Service Card.

In the world of US mainframe computers, IBM holds eight out of the top ten positions, ranked according to the dollar value of the installed system. DEC was in second place with about 16,000 VAX11 systems installed, and Hewlett Packard was tenth with about 14,000 System 3000s. Most popular system was the IBM System 38 with about 82,000 installed. The figures were released by the Computer Intelligence company, La Jolla, California.

Semad, a division of DGW Electronics, added some new products to their lineup last fall. These included Chinon 5.25 and 3.5 inch disk drives for Apples and IBMs, Cypress Semiconductors, Nichicon capacitors, Seiko crystals and oscillators, and others.

They're also dealers for hard-to-find semiconductors such as Harris. They're at 85 Spy Court, Markham, Ontario L3R 4Z4, (416) 475-8500.

Circle No. 67 on Reader Service Card.

According to a report from International Resource Development Inc., a market research firm in Norwalk, Connecticut, there's quite a squabble going on over the proposed standards for high-definition TV. The US and Japan want to use the NHK standard, but Europeans feel that its 60Hz field rate may make conversion to their PAL and SECAM standards difficult.

However, by the time that the countries are ready to implement a standard, there may be no need for one: there are receivers being produced in West Germany which can decode any of the current TV systems. Microelectronics may eliminate any need for a standard.

Also according to the report, large direct-view TV sets are threatening the market for large-screen projection TVs. The direct-view types are substantially

more expensive, but the picture quality is superior.

Lastly, while flat-screen TVs do exist as prototypes, the report says that it may be five years or more before they're put into production.

Oki Semiconductor announces the fastest CMOS version of the 8085A CPU, operating at 5.0MHz. The big advantage to CMOS over the previous NMOS versions is greatly reduced power consumption: Oki's version draws less than 20mA, compared with 170mA for the NMOS. The IC is said to be an exact replacement for Intel's NMOS 8085A. Designated the MSM80C85A-2, the new microprocessor is available from Oki dealers, or contact Oki Semiconductor, 650 North Mary Avenue, Sunnyvale, California 94086, (408) 720-1900.

Circle No. 68 on Reader Service Card.

Almost Free PC Software

Volume Five

We've ventured once more into the phone lines, scouring the public domain for the cream of its software. Distilled from several megabytes of code, this disk represents the best of what's floating around on the bulletin boards of the continent. It wasn't easy, and a lot of disks bit the dust in the process of creating this collection.

Whether you are interested in business programs, games, hardcore hacking or just making your computer a more productive tool, you'll find something of interest on this disk.

AREACODE is a useful tool if you use the telephone a lot. Give it an area code and it will tell you what city it corresponds to.

D is another sorted directory program. However, this one emulates the CP/M style D, which is arguably a lot more useful for most applications.

FRACTALS This is an amazing implementation of the Mandelbrot microscope, generating unearthly fractal images on the tube of your system. More words fail to describe them.

FROGGER is an implementation of the classic arcade game. Just try not to get the highway littered with frog guts.

HIDE is a package of utilities which allow you to create, enter and remove invisible DOS directories. This allows you to set up a hard drive system with areas that are only available to users that know about them.

LAR This library utility allows you to concatenate several small files into a library to save on disk overhead and then extract the individual files when you need them. It saves a lot of space when it's used with files you don't use often.

MAIL1 is a mailing label utility in BASIC.

MORERAM This is an assembler program . . . you need MASM and LINK to make it work. It lets you do a number of things to the memory settings on your motherboard, including using more than 640 K and allowing for four floppies to facilitate RAM disks. It will also allow you to set the switch settings of your motherboard for 64 K so things will boot up quicker and then change the RAM setting after booting.

MORTGAGE generates amortization charts. Read 'em and weep.

MXSET lets you control the parameters of Epson compatible printers from the command line. It's a lot easier than LPRINTing characters from BASIC every time you want to change modes.

NUSQ uncompresses files that have been previously compressed to save space. It's primarily of use to BBS types . . . but it's extremely small.

PARCHK This is an assembler program . . . you need MASM and LINK to get it going. It installs a trap for parity errors in your computer so that they don't hang your system and helps you locate where the funky RAM is.

PCBOSS This is a more user friendly working environment than is MS-DOS. It makes your whole system menu driven, with absolutely no command names to remember. If IBM were dead it would be rolling in its grave over this.

VDEL This is a delete with verify program. You could type VDEL *.ASM and it would show you the name of every .ASM file in the current directory and ask you if you want it deleted.

WHEREIS finds files in a complex hard disk system.

ZAXXONPC This is a highly decent implementation of the game. Run it and rip.

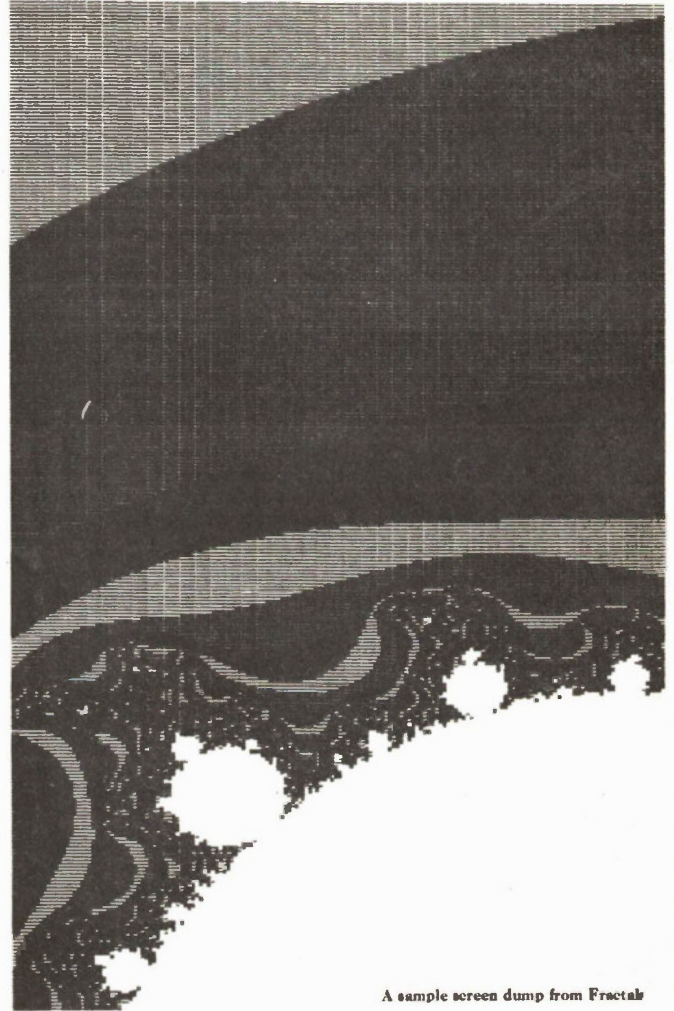

A sample screen dump from Fractals

The disk, with all the programs listed here plus the appropriate documentation files is available for a mere

\$19.95

plus seven percent Ontario sales tax

Almost Free Software
Moorshead Publications
1300 Don Mills Road,
Don Mills, Toronto, Ontario
M3B 3M8
1-416-445-5600

during business hours. Have your VISA, Mastercard or American Express card handy

Fine Print: This software has all been collected from public bulletin boards and is believed to be in the public domain. The fee charged for it is to defray our cost in collecting it, testing it and putting this collection together, and for the cost of the media and its handling.

While we have endeavoured to make sure that this software does what it says it does, and while it has exhibited no bugs while we were using it, it is possible that some of it may not function properly on some PC compatible system. We are unable to assist you in modifying the software for your applications.

Moorshead publications warrants that the disk you receive will be readable. However, the post-office may have other plans. If you are unable to read your disk please return it to us for replacement.

Almost Free PC Software

Volume 6

Special Two Disk Set

Five hundred years ago you could have been called a witch for having software like this.

The IBM PC public domain is one of the most lively aspects of micro computers just now. While actual paid for software companies are cheerfully flipping over and floating to the surface all around us, public domain authors seem to be everywhere. Some of them are brilliant, and some of the software that one finds out there is profound beyond mere words.

In volume six of our almost free PC software you'll come upon some of the larger applications that have been released in recent months. We've tried to get a fairly decent blend of both serious business stuff and good wholesome bloody video games. There is also some first rate code for computer hackers.

3-Demon is one of the most interesting variations on Pac-Man in the known universe. Rather than simply looking at a map of a maze, this program shows you a three dimensional view of it. You wander through endless corridors munching out on either food pellets or granola bars... your choice... and avoiding the deadly ghosts.

DU was one of the most powerful CP/M based disk utilities ever envisioned. This version for the PC captures much of its power and flexibility. It allows you to see what the tracks and sectors of your disks look like, recover erased or damaged files and meddle with the system tracks.

General Ledger This is a complete general ledger accounting package in BASIC. It's exceedingly well written and comprehensive. It'll do most of what the very expensive packages will do without laying an endless licensing agreement on you. An enormous documentation file is included.

PC-Chess is a pretty slick chess program for the PC. It features colour graphics... if you have a colour tube... and a running chess clock. While not as lively as Asteroids, chess has been around longer.

RAMDISK is the assembler source code for a memory disk program. If you've always wanted to know how these things work... or want to write some sort of variation on this useful utility... here's your chance.

VFILER is a file management utility without equal. It shows you all the files in a directory and allows you to copy them, type them, execute them, mass move them... in short, it does almost everything DOS does but it's user friendly.

QModem is unquestionably the best telecommunications package in existence. This is the most recent version of it, replete with windowing, multiple protocols, function keys and unspeakably well debugged code throughout. A modem without this software is like IBM without ties.

ARC is a very sophisticated file archiving package. It not only libraries multiple small files into one larger one, but it analyses each file and applies compression to it in the best of four ways to use up the least amount of disk space.

ZAPLOAD is a utility for programmers to handle Intel standard HEX files. It's seethingly fast and well documented.

SOPWITH lets you fly a World War One biplane around and blow up things. If you're not quick enough you may become one of the things. The graphics are superb and the carnage is no where near as bad as a moderately good news day.

JSB is another BASIC music program. You have to troll through a lot of these things to find the ones that don't make your ears fall off. This one plays a Bach sonata.

STAR is exceedingly stupid but fun to look at and very small. It draws... yes, you've guessed it... stars.

SURFACE draws the often seen and tediously reproduced "hat" function. It takes a very long time to do this, which proves that the task is very complex and thus well worth doing.

OP is the operator program we ran in the November edition of Computing Now!. It's very useful... even more so if you don't have to type in the source.



The complete volume six almost free PC software package... two disks for the price of two disks... is available for

\$24.95

plus 7% Ontario sales tax

We'll swap relatively worthless money for priceless software at

Moorshead Publications

1300 Don Mills Road,
Don Mills, Toronto, Ontario
M3B 3M8

or you can phone us at

1(416) 445-5600

during business hours. Have your Visa, Mastercard or American Express card handy.

Fine print: All of this software was obtained from public bulletin boards and is believed to be in the public domain. Some of it is freeware... its authors would like you to send them some money if you decide you like it. This is between you and your credit limit.

Please note that we aren't charging you anything for this software, but rather, for the cost of our downloading, sorting and assembling it and for the cost of the media and postage to get it to you.

We've tested this software thoroughly and it all appears to be working properly. Some of it, like the resource editor, will require a degree of expertise to use fully. Be prepared to experiment a bit. We are unable to assist you with adapting this software to your specific applications.

If you are unable to read the files on this disk contact us. We can jointly swear at the post office and we'll replace your disk.

This disk is provided without a system and will not boot. You will have to copy the files onto a bootable disk to use them.

With NRI training at home, you can...

Move up to a high paying career servicing computers



And you can start by actually building NRI's 16-bit IBM-compatible computer.

You can create your own bright, high paying future as an NRI trained computer service technician. The biggest growth in jobs between now and 1995, according to Department of Labor predictions, will occur in computer service and repair, where demand for trained technicians will double. There is still plenty of room for you to get in on the action—if you get the proper training now.

Total computer systems training, only from NRI

To learn how to work on computers, you have to get inside one. And only NRI takes you inside a computer, with total systems training that gives you hands-on experience with computers, peripherals, and software. You'll build a Sanyo MBC-550 series computer, which experts have hailed as the "most intriguing" of all the new IBM-compatibles. The Sanyo even surpasses the IBM PC in computing speed and graphics quality.

Even if you've never had any previous training in electronics, you can succeed with NRI training. You'll start with the basics, rapidly building on the fundamentals of electronics until you master advanced concepts like digital logic, microprocessor design and computer memory. You'll probe into electronic circuits, using the exclusive

NRI Discovery Lab® and professional Digital Multimeter, that you keep.

You'll assemble Sanyo's intelligent keyboard, install the power supply and disk drive, and attach the high resolution monitor—all the while performing hands-on experiments and demonstrations that reinforce your skills.

Learn to service today's computers

As you complete your Sanyo, you grasp the "secrets" that qualify you for a new career. You'll learn to program in BASIC and machine language. You'll use utility programs to check out the operation of the Sanyo's 8088 microprocessor (the same chip used in the IBM PC). And you also get over \$1,000 worth of software, including WordStar and CalcStar.

Most importantly, you'll understand the principles common to all computers. Only a person who fully understands all the fundamentals can hope to be able to tackle all computers. NRI makes sure that you'll gain the knowledge and skills to maintain, troubleshoot and service computers.

Learn at home in spare time

With NRI training, you'll learn at home on your own time. That means your preparation for a new career or part-time job doesn't have to interfere

with your current job. You'll learn at your own pace, in the comfort and convenience of your own home. No classroom pressures, no rigid night school schedules. You're always backed up by the NRI staff and your instructor, who will answer questions, give you guidance and be available for special help if you need it.

Let others worry about computers taking their jobs. With NRI training, you'll soon have computers making good paying jobs for you.

Send for Free NRI Catalog

Send the post-paid reply card today for NRI's 100-page catalog, with all the facts about computer training plus career training in Robotics, Data Communications, TV/Video Servicing and many other fields. If some other ambitious person beat you to the card, write to NRI at the address below.

NRI SCHOOLS

McGraw-Hill Continuing Education Center
330 Progress Avenue
Scarborough, Ontario M1P 2Z5
or telephone 416-293-8787

We'll Give You Tomorrow.



IBM is a Registered Trademark of International Business Machines Corporation.

MEGURO/RCC - MORE FOR YOUR INSTRUMENT DOLLAR

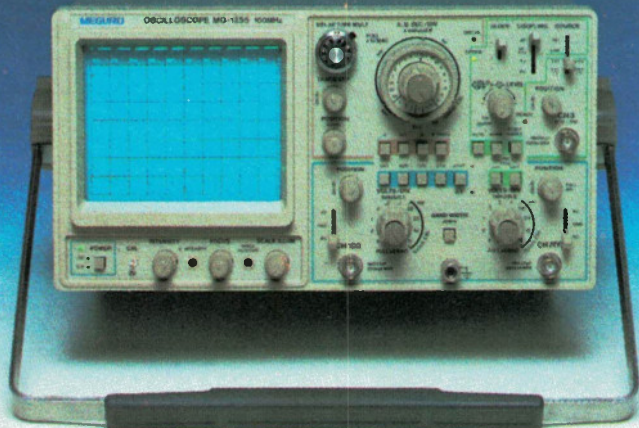

'SCOPE for 100 MHz

The MO-1255 100 MHz 'scope features 3-channels and 8 traces. Has alternate sweep, 6-inch rectangular high luminance internally calibrated CRT, wide dynamic range and 2-channel X-Y operation.

Control logistics make this unit exceptionally easy to operate. Has TV sync, separator circuit and 20 MHz bandwidth limiter.

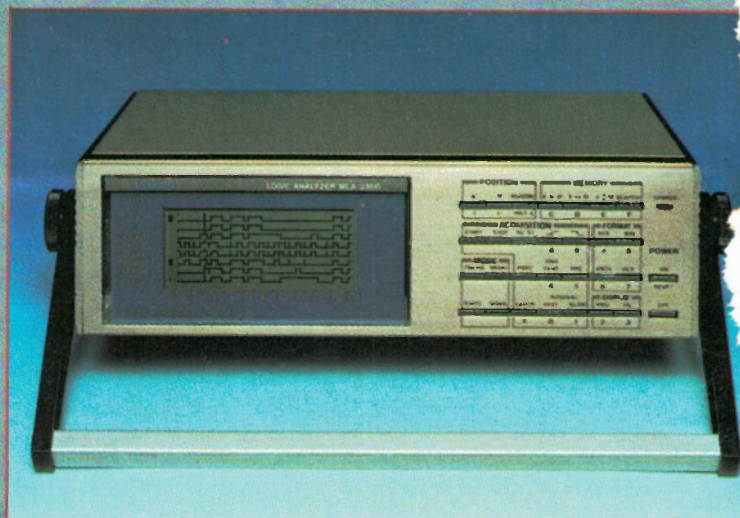

LOGIC ANALYZER - 16 channel

The MLA-3300 combines timing analyzer, state analyzer and signature analyzer in one. Has 16-channel input and 100 ns resolution at 10 MHz. Portable, battery or AC operation, low

power LCD display. Comparative acquisitions are easy with 256 bit/channel acquisition and reference memories. Menu operated.

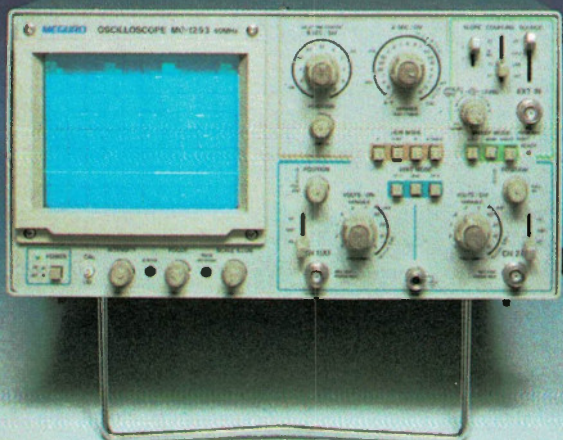

DUAL-TRACE OSCILLOSCOPE — 20 MHz

The MO-1251A dual trace 20MHz oscilloscope features sensitivity of 1 mV div. and speed of 20 ns/div., high luminance cathode ray tube,

measurement to 400 Vp-p and a stabilized power supply for accurate measurements.

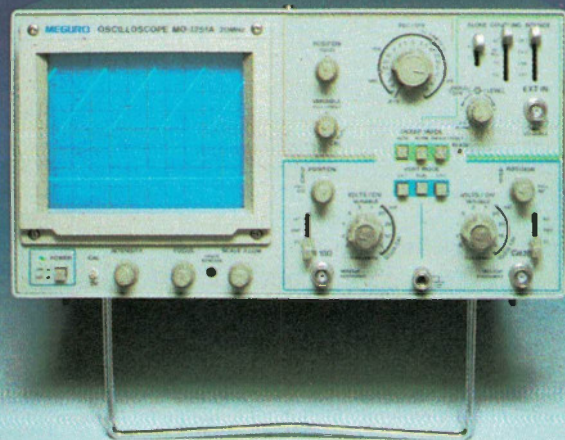

DUAL-TRACE OSCILLOSCOPE — 40 MHz

The MO-1253 has a delay time sweep function used to enhance the accuracy of fine measurements. It has an acceleration voltage of 12kV and a six inch high luminance cathode ray tube with beam intensity and scale illumination

controls. This provides for more accurate and readable measurements needed in the fields of research and development, production lines and maintenance/servicing sections.

meguro

RCC ELECTRONICS

310 JUDSON ROAD, UNIT 6, TORONTO M8Z 5T6, (416) 252-5094

Montreal: 6600 Trans Canada Highway, Suite 750, Pointe Claire, Quebec, H9R 4S2, Telephone: (514) 694-6080, Telex: 05-821762

Vancouver: 119-255 West 1st Street, Unit 3, North Vancouver, B.C., V7M 3G8, Telephone: (604) 985-4065, Telex: 04-352841

**PC/XT Compatible
ECS1-PC/XT
Special
\$975.00**

- 8088 processor
- optional Intel 8087
- numeric coprocessor
- 256K memory
- double sided double density disk drive
- detachable keyboard
- colour-graphic board
- 130 watt power supply
- support PC software
- 90 day warranty
- 8 slot Mother board



XT/PC MAIN PERIPHERAL

Mother Board 8 Slot	\$249.00
Color Graphic Card	\$149.00
Multifunction	\$149.00
Monochrome Card	\$139.00
Monochrome Graphic	\$199.00
Game Port	\$ 49.00
RS232 Card	\$ 59.00
Parallel Interface	\$ 59.00
Disc Controller Card	\$ 89.00
Case	\$ 69.00
Keyboard (Cherry)	\$ 99.00
Power Supply 130 Watts	\$139.00
Printer Cable	\$ 25.00
RS232 Cable	\$ 25.00
Disk Drive Cable	\$ 15.00
Moving Message Board	\$495.00
TTL and CMOS test Card	\$ 99.00
150 Watt Power Supply	\$159.00
Modem 1200 B	\$395.00

**AT Compatible
\$2995.00**

- 512K memory
- 1 1.2M drive
- Colour card
- Keyboard
- 200 watt power supply

ELECTRONIC CONTROL SYSTEMS



1590 Matheson Boulevard, Suite 1 & 2 Mississauga, Ontario L4W 1J1
(416) 625-8036 Hours — Mon. to Fri. 10-6. Sat. 10-2

Circle No. 49 on Reader Service Card.

CANADA REMOTE SYSTEMS

OFFERS YOU!

PUBLIC DOMAIN SOFTWARE

Canada's Largest Selection For CP/M, IBM, Macintosh Microcomputers

By Telephone — 12 remote Telecommunications Systems available 24 hours per day. Annual Access charge only \$55.00. No charge for downloading. For CP/M and IBM type microcomputers. Data Pac available.

By Mail — for over 200 different Computers. Over 1000 disks representing all major user groups including SIG/M and PCSIG. From \$10.00 per user group disk. Our special collection disks contain the most popular software and are priced from \$15 per disk.

COMMERCIAL SOFTWARE

Specializing in CP/M and IBM commercial software, Low overhead, low prices, good service. We work with what we sell, and provide full assistance.

COMMERCIAL HARDWARE

Including coprocessor boards for CP/M computers and a full line of modems. The new 2400 Baud U.S. Robotics Courier Modem is now available for only \$825.00

Call us at (416) 239-2835 or Circle Reader Service Number 15 for a free mini-catalog.



Circle No. 15 on Reader Service Card

LASER PROCESS 'PAINTS' CIRCUITS ON SILICON

Pulses of laser light flashing millions of times a second through selected gases have been used to "paint" integrated circuits directly onto silicon wafers. When fully developed, the revolutionary new process from Lawrence Livermore National Laboratory, Livermore, California, can reduce the time needed to design, make and test prototype and limited production specialized circuits from weeks to a few hours. The method, known as "laser pantography" has as part of the system a Livermore-created computer code.

Researchers were targeting a system painting 1,000 transistors a second. It will be possible to inscribe overnight the circuits of today's most powerful computers onto a silicon wafer 5 inches in diameter, more than a 1,000-fold reduction in size. Personal computers of the future using a single silicon wafer could easily have the power of today's supercomputers costing about \$10 million, according to Dr. Irving Herman, co-leader of the research team.

Though similar laser processes have been under study at a number of academic and industrial laboratories, the Livermore group claims to be the first to have produced operating circuits. The staff of more than 7,300 at Livermore conducts research in nuclear weapon design and testing, nuclear fusion, basic physics, energy, biomedical and environmental sciences. LLNL

researchers use of the world's most powerful computer centres to model and predict results from scientific experiments.

Current supercomputers can perform up to 60 million mathematical operations a second, about as fast as the entire human race can compute using pocket calculators and at least 10,000 times faster than personal computers, said Dr. Lowell Wood, head of the LLNL Special Studies Group. "We need computers that are 100 to 1,000 times faster than those now available," said another Lab spokesman. "We are working with the U.S. Navy and Department of Energy to develop a new type of 'multi-processor' supercomputer, the S-1, and are very interested in U.S. government, industry and universities working together, as they are in Japan, to advance our country's capability to make and use ever more powerful supercomputers."

The new Livermore laser pantography process could greatly increase the number of supercomputers available for use, shorten the time to develop improved computers and dramatically reduce their cost.

There are about 100 supercomputers in use in the world today. Carl Haussmann, Associate Director at Large said, "I could imagine 10 of these laser pantography units sitting in a single room with each making one supercomputer silicon wafer a day. That could mean several thousand new supercomputer modules could

be built in that one room in a year." Laser pantography can change the way integrated circuits are made.

An integrated circuit is merely a tiny, thin piece of a perfect silicon crystal emblazoned with a stack of intricate patterns. Each section of the pattern has the special electrical properties needed to form the transistors, capacitors, resistors and connectors that form the complex electrical and logical network that comprises the brain of a computer. The traditional method of making integrated circuits involves repeated series of processes such as photographic "burning" of the silicon surface, coating of thin layers of important electrical materials, and etching away unwanted areas. Especially for prototype circuits, the process is slow, expensive and, worst of all, yields a relatively low fraction of usable circuits. Most are "born dead", irrevocably damaged during the laborious processing.

In contrast, the Livermore laser pantography approach shows potential to be fast, direct and reversible. If a design is changed, a new circuit can be made easily from scratch. If a mistake is made, it can be erased and corrected.

Laser pantography involves rapid reactions using intense green laser light directed onto silicon surfaces with an intensity a billion times greater than noontime sunlight. At times, various gases are introduced into a reaction chamber. The laser is pulsed on and off so fast that reaction occurs

only in the centre of the focused laser spot, about one micron (a millionth of a meter or about one twenty-five-thousandth of an inch) in diameter. This equals the resolution of current integrated circuit terminology.

The intense light superheats the silicon surface for such a short time that heating and cooling rates of hundreds of billions of degrees per second are achieved, giving the laser pantograph process its great sensitivity and resolution. When the gases are admitted into the chamber, reactions occur on the hot surface that can remove or change the electrical properties of the silicon, or deposit the desired special electrical materials. It's like a 'set of laser paint brushes'. The resulting "paintings," however, become the brains of high-powered computers when electricity is applied.

- David Dempster

A Complementary Copy

com'ple-ment (kom'pla-mant) *n.*
1, that which fills up or completes.
2, one of two parts needed to room a
whole — *v.t.* (-ment'') fill out; com-
plete. —comp'ple-men'ta-ry, *ad.*

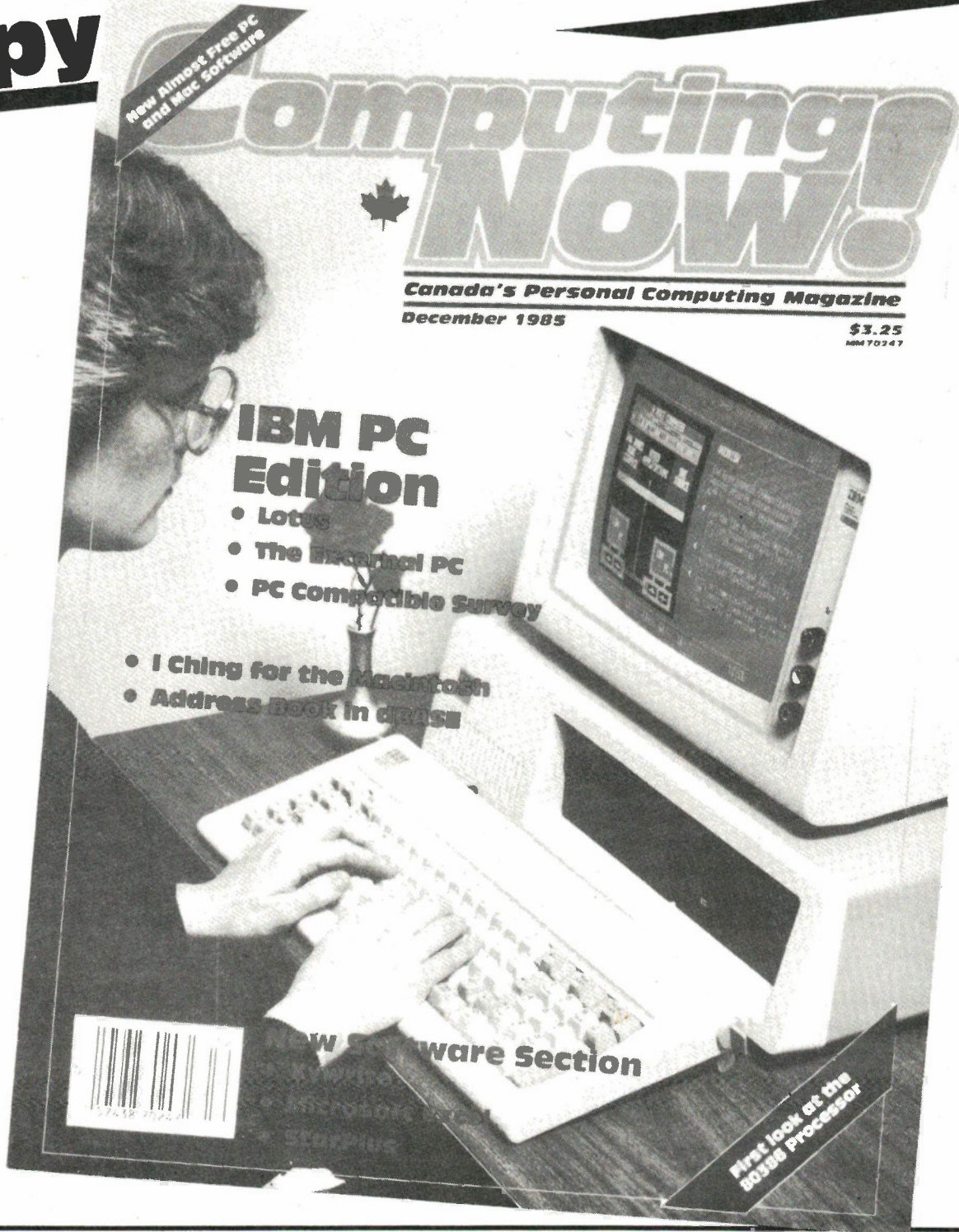

COMPUTING NOW! On sale now at newsstands or at electronics and computer stores across Canada.

Save up to 51% on the single copy price by subscribing. 12 issues (one year) \$22.95, 24 issues \$37.95. Send to Computing Now! Subscription Department, 1300 Don Mills Road, Don Mills, Toronto, Ont. M3B 3M8 or call (416) 445-5600 with Credit Card details.

Cymbal Synth

Beat your own drum with this status cymbal.

By D. Stone



THIS cymbal synthesizer, being a two chip affair, has the virtues of simplicity but is sufficiently adaptable to provide a useful adjunct to any drumkit. With a tunable noise output and a variable decay rate, the circuit could even be built into several units to form a more-or-less complete drum and cymbal kit, although, in all fairness, you'd be severely restricted as far as bass effects and touch sensitivity go. The unit does allow pure white noise to be fed to the envelope generator, which means it can be used for gunshots and similar effects. A degree of touch sensitivity is incorporated.

The prototype was built for live stage work, where it has proved very useful and rugged. If toughness is not a major criterion, the circuit could be built into any suitably sized and resonant container. The home or studio recordist could make good use of it as a crash cymbal or snare-typic drum.

Construction

The construction of the unit is straightforward if the recommended PCB is used. The assembly should follow the usual format of passive components first, followed by the semi-conductors and integrated circuits. The use of IC sockets is recommended to prevent damage to the chips by overheating and to ease the removal of chips should this become necessary. The microphone was fitted to the circuit board near IC1 in the prototype with double sided sticky fixing pads.

The prototype unit was housed inside an 8" Tambour. The Tambour has a removable drum skin which allows easy changing of the battery. Tambours can be bought from any good music shop. A base was fitted to the Tambour with white modellers' 'Plasticard'. The whole unit was then sprayed with enamel paint and labelled with rub down letters. As an alternative housing, for a number of these

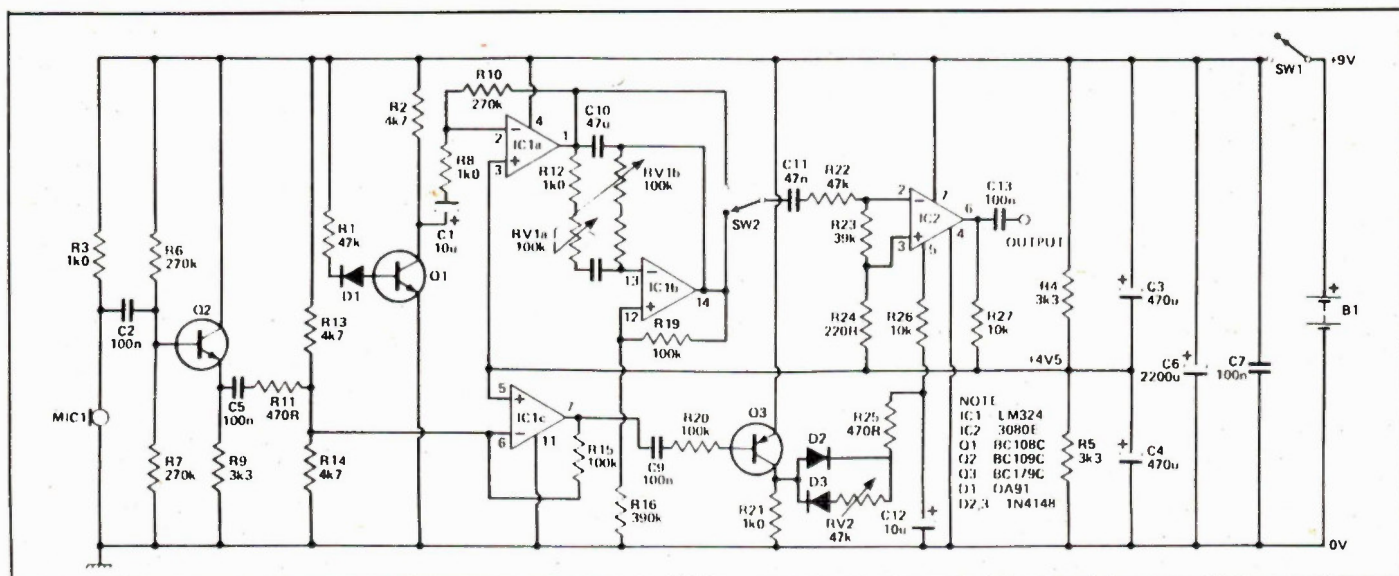
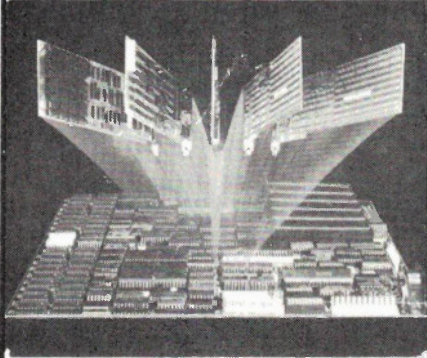

Fig. 1 Circuit diagram of the crash cymbal.

Continued on page 35

INTRODUCING: THE NEW STANDARD FOR IBM PC/XT COMPATIBILITY

The ACS-1000 Super Computer



- 1 Megabyte On-Board Memory
- Built-in Disk Controller
 - up to 4 Floppies
 - SASI Hard Disk Interface
- 54 KB User Definable ROM
- Switchable: 4.77 or 8 MHZ
- Built-in Multifunction Board
 - Parallel Printer Port
 - 2 Serial Ports
 - Time-of-day Clock

Seize Control of Your Hardware Destiny

If you are using board level microcomputers you can have greater power, versatility and reliability by using the ACS-1000 single board SuperComputer.

The ACS-1000 is compatible with both software and hardware designed for the IBM PC/XT. It even has the same mounting holes and the same power supply connections. The difference is that the ACS-1000 offers a much higher level of integration and costs less than \$575 when ordered in quantity.

Save your Expansion Slots for true expansion. Disk Controllers, I/O ports and extensive memory are already built-in, simplifying production and freeing the 6 expansion slots to take on specialized work of your process control, CAD/ CAM or office automation applications. There's even a special port for a low cost piggyback modem.

See for yourself. We are offering a system evaluation kit for \$995.00. The 256K system includes bios, documentation, and an XT compatible power supply.

Special introductory offer on peripherals and chips.

Panasonic/Hi-Tech Floppy Drives **\$159.00**, IBM Compatible cases **\$80.00**, 150 Watt CSA approved Power Supplies **\$250.00**, AT style Keyboard **\$160.00**, Chips 64K **\$3.00**, 256K **\$8.00**.

To order call 604-888-2606 or write:
Soltech Industries Inc.
9274 - 194th Street
Surrey, B.C. V3T 4W2

Circle No. 73 on Reader Service Card.

Burglar Alarm

By Vivian Capel

THIS burglar alarm control unit has the advantage of simplicity; it doesn't use any integrated circuits at all. It includes RF filtering to minimize false triggering from any RF pickup by the loop, and also has an 800ms delay to prevent triggering by intermittents caused by loose switches or magnets.

The base of Q3 is tied to the emitter by the two loops, and is nonconductive in the standby mode. The only current passing in this condition is through R1, the 120k base resistor, which with 12V is 0.1mA. C4 and C5 are the RF bypass capacitors.

SW3d connects the Q3 emitter to the negative rail when the alarm is on. If the main loop is opened, C1 starts to charge through R1 and takes 0.8 seconds. The base becomes positive and Q3 turns on, energizing the relay, RL1, in its collector circuit. One pole of the relay switch connects the bottom end of the relay coil to

the negative supply through SW3c, thus latching it on and cutting out Q3. The other pole switches the supply to the bells through SW3a and SW3b.

When the delay loop is opened, the same action occurs but C2 charges, and being ten times the value of C1, takes 8 seconds to do so. If the loop is closed within this time it discharges C2 (through R6 for current limiting) which will start to charge again with any re-opening of the delay loop. SW1 is a normally-closed test button in series with the loops. Pressing it gives immediate triggering. SW2 switches C2 out of the circuit, thus avoiding the delay.

The open circuit which serves the normally-open pressure mats and panic buttons connects the relay bottom end to the negative supply, thus energizing it directly. In the event of Q3 failing and not triggering when an intruder enters, the ressure mats and panic buttons would still be on guard.

SW3c, which at first glance seems unnecessary, serves to delatch the relay when switching between positions, since the switch must be break-before-make. Without this, there would be no way of switching off after the test button has been used without turning the circuit off.

AMAZING SCIENTIFIC and ELECTRONICS DEVICES

LASER DEVICES

- LC5 BURNING CUTTING CO2 LASER \$20.00
- RUB3 RUBY LASER RAY PISTOL 20.00
- LRG3 IR LASER RIFLE/PISTOL 10.00
- LGU3 VISIBLE RED LASER RIFLE 10.00
- LBT1 - LIGHT BEAM COMMUNICATOR 10.00
- LHC2 BEGINNER simulated VISIBLE LASER .50.00

SCIENTIFIC & ELECT

- TCL3 SOLID STATE TESLA COIL 35KV 7.00
- BTC3 250 THOUSAND VOLT TESLA COIL 10.00
- BTC5 1.5 MILLION VOLT TESLA COIL 15.00
- GRA1 - GRAVITY GENERATOR 10.00
- IOG3 ION RAY FORCE FIELD GUN 10.00
- PTG1 - PLASMA TORNADO GENERATOR 10.00

ULTRASONIC ACCOUSTICAL

- PPF1 PHASOR PAIN FIELD GENERATOR ... 15.00
- PSP3 PHASOR SHOCK WAVE PISTOL 8.00
- IPGS POCKET PAIN FIELD GENERATOR 8.00
- MDDI MAGNETIC DIORIENTATION DEVICE . 10.00
- HT9 HIGH FREQ. LISTENING DEVICE 8.00

SECURITY & PROTECTION

- STG1 - STUN AND PARALYZING GUN 7.00
- PPG1 PHASOR PROPERTY GUARD 15.00
- MFT1 MINI VOICE XMTR 2-3 MILE 7.00
- INF1 INFINITY TRANSMITTER 15.00
- PSW3 PHASOR BURNING STUN WAND 7.00
- ITMI INTIMIDATOR PLASMA GUN 10.00

WE STOCK ALL PARTS NECESSARY FOR CONSTRUCTION OF THE ABOVE PROJECTS

• CATALOG CONTAINING HUNDREDS MORE OF ALL NEW AMAZING and FASCINATING PLANS. EASY TO BUILD KITS AND ASSEMBLED ITEMS \$1.00. CATALOG INCLUDED FREE WITH ANY OF THE ABOVE PROJECT PLANS. SEND CASH, CHECK, MO, VISA, MC IN US FUNDS.

INFORMATION UNLIMITED

P.O. Box 716, DEPT. ET, AMHERST, NH 03031

Circle No. 74 on Reader Service Card.

always a head ahead



the innovators

DYNAUDIO LOUDSPEAKER COMPONENTS FEATURE

- PHA cones •
- Very High Power Hexacoils •
- Magnesium Diecast Baskets •
 - Tuned Cavity Tweeter •
 - and Mid-Range Units
- Vented Centre Magnets •

ALSO AVAILABLE

Computer Aided Design for Enclosures and Crossovers
Metalized Polypropylene Capacitors
Perfect Lay Winding Inductors
Speaker and Crossover Parts

WRITE OR PHONE FOR MORE INFORMATION
FREE CATALOGUE AVAILABLE



SOLE IN INC

5940 Bergevin
Brossard, Québec J4Z 1Z2
(514) 656-2759

Circle No. 75 on Reader Service Card.

In the test position, SW3a b place the two bells in series with an LED and current limiting resistor R4. On triggering the circuit with the test button, the LED will light only if both bells and their circuit are continuous. The current is insufficient to sound them. As the relay, switching and Q3 must also be in order to light the LED, it will not light before the button is pressed, so the loop too is tested. Only pressure mats and panic buttons are not checked this way.

Q1 and Q2 are connected as a Darlington pair across the relay coil and Q3 base-emitter junction via one pole of the relay switch. The relay is switched at 6 volts, obtained from the 12V supply via R3 which forms a potential divider with the relay coil (375 ohms). When the relay is first energized, Q1 and Q2 do not conduct and have no effect. However, C3 starts to charge slowly through R2. When the voltage across it rises, D1 is biased on, the transistors begin to conduct and shunt the relay coil, reducing the voltage across it. When the voltage drops to about 2V, the relay detaches, switching off the bells. The Darlington pair are also disconnected from the negative supply, and this causes C3 to discharge quite rapidly into the base circuit of Q1.

The circuit is now reset and ready for any further action. If the loop is still open, further triggering will be almost immediate, so the bells will continue to ring. Time for the bells to switch off is about 10 minutes. If a shorter or longer time is required, the value of C3 should be decreased or increased accordingly.

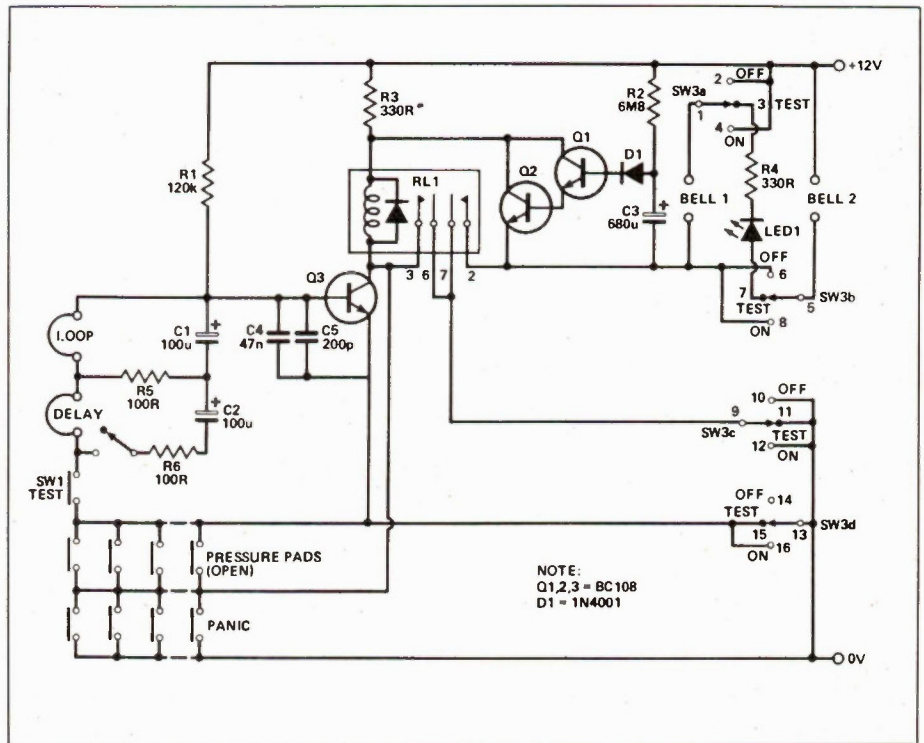

50 Top Projects
156 Pages \$4.95

Top Projects
From Electronics Today Magazine Summer 1982

Fifty all-time best projects from ETI magazine packed into one giant 156 pages special. There are projects for the beginner to the more advanced builder, including: Semiconductor Tester, Universal Counter, LED Level Meter, AM radio, and much, much more.

ORDER TODAY FROM
Moorhead Publications, 1300 Don Mills,
Don Mills Rd., Toronto, Ont. M3B 3M8 (416) 445-5600
Postage and Handling included.
Credit Card payment accepted.

PROBES FOR SALE

**FROM THE BEST SOURCE FOR OSCILLOSCOPE PROBES
AND DMM/VOM TEST LEAD SETS.**

- Low cost
- High Quality
- Excellent Performance
- Slender, Flexible Cable

- Wide Range of Choice
- Switchable X1 and X10 Attenuation Factor
- 100 MHz Bandwidth

MODEL SP100
\$25.00

Please add \$2.00 for shipping

Your Probe Specialists

BCS ELECTRONICS LIMITED

Coline Canadian Sales & Stocking Source
Store Hours: Monday to Friday 8:00 am to 5:00 pm.
Saturday: 10:00 am to 1:00 pm.

980 Alness St. Unit 7,
Downsview, Ontario,
M3J 2S2
(416) 661-5585
TELEX 065-28169

Toll Free Orders Only
1-800-387-1385
(416) 928-2161

MAIL ORDERS: We accept VISA, MC, AMEX, credit cards. Money orders, cheques (2 week wait) are also OK. Minimum packing and handling fee \$5.00 or 5%, whichever is larger. The only COD we use is via CANPAR (Add \$4.00 COD fee) or motor freight. We do not use postal COD at all. All Ont. res. add 7%. All prices are subject to change without notice. Returns are subject to a 20% restocking charge.

IBM CASE

We have the nicest case of all the various competing cases, ask any friend who has bought someone else's case and then has seen ours. The lid is hinged with pushbutton access. The back is cut for 8 XT slots and it comes with all the case back inserts for cards, card guides, blind disc filer plates, standoffs, feet, screws, all for **\$69.95**. SIDE SWITCH Please specify back or side cutout for power supply.

CLEARANCE, BACK SWITCH CASE **\$59.95**
We also have an IBM 8 Slot/6502 Board dual duty case for making IBM look-a-like 6502 systems **\$79.95**

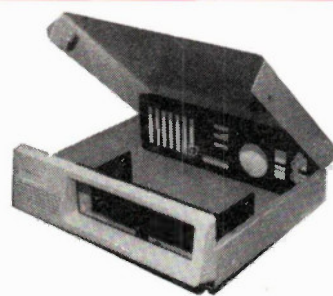

MEGABOARD CASE, similar to the above. Fits the MEGABOARD exactly for back power supply **\$99.00**

NICADS 8.4V 7 "D" 4A.H CELLS



A great buy, a pack of 7 brand new GE NICADS giving 8.4v at 4 Amp hours. Each cell is 12v and separates easy. Used as 5V backup through a 7805. Gives 5v 1 Amp for 4 hours. **\$14.95**

WIRED CARDS FOR IBM

- (A) 384K RAM CARD. A ¼ sized card that has 384K of 64K DRAM on board. With OK
- (B) 512K RAM CARD. A full sized card with 512K of 64K DRAM on board. With OK **\$119.00**
- (C) 576K RAM CARD. A very popular card with 576K of 64K and 256K DRAM on board. This is a ¼ sized card for portable use. With OK **\$ 79.95**
- (D) KRAM RAM CARD. A clone of the JRAM with up to 2 MBYTE on board using 256K DRAM. 100% compatible, complete with software for using as RAMDISC and RAMSPOLL. With OK **\$139.00**
- (E) COLOR GRAPHICS. A clone of the popular PERSYST color card. Has three outputs and one input. A. RGB for IBM color monitor. B Video 1v P to P composite color video. C. Video gray scale 1v P to P for seeing color on green or amber monitor **\$129.95**
- (F) MONOCHROME GRAPHICS/PRINTER. A workalike clone 100% IBM compatible for the HERCULES card. Has par printer port and hi-res text and graphics mono output **\$159.95**
- (G) 384K HEXPACK. A copy of the AST 6.PACK, 100% compatible with software. Has Clock/calendar/alarm and 384K DRAM and serial and parallel ports and game I/O. With OK **\$189.00**
- (H) 640K HEXPACK. Similar to above but with 640K on board using 256K and 64K DRAM. All other features the same. With OK **\$279.00**
- (I) DISC CONTROLLER. For 1-4 DS-DD drives. Full IBM standard with cable and instructions. **\$ 79.95**
- (J) DISK CONTROLLER + I/O CARD. A very good card that has a clock/calendar/alarm and game I/O and serial and parallel ports and a standard 1-2 drive controller card on a full sized card. Very efficient card **\$189.95**
- (K) I/O + 2. A clone of the very popular USA card of the same name. Has clock/calendar/alarm, with game I/O, serial and parallel ports **\$129.95**
- (L) PRINTER CARD. A standard canonics printer port for all parallel printers **\$ 59.95**
- (M) SERIAL CARD. A standard ASYNC serial card for modem use etc. **\$ 49.95**
- (N) MODEM CARD. A 300/1200 Baud modem using the 8910 WORLD chip. Compatible with many popular software packages. **\$189.00**
- (O) 8255 I/O CARD. Uses 2 8255's to give 16 lines of I/O for various uses. Fully locatable **\$129.95**
- (P) CLOCK CALENDAR CARD. A small card to add the clock/calendar/alarm battery to system **\$ 49.94**
- (Q) GAME PORT CARD. Adds two std game I/O ports to the system **\$ 39.95**

SYSTEMS

- All SME-XT systems share these attributes.
- High order compatibility due to the DTC bios which is recognized superior to others.
 - 8 Slots for plug in cards, just like IBM
 - Made right here in Canada
 - Socketed for the 8087 Co-processor
 - IBM compatible serial keyboard
 - Disc controller using 9216 IC, the most advanced, for error free operation.
 - Properly made 135W power supply with accessory plugs.
- (A) Basic system 256K, 1 DSDD drive, & controller monochrome card, 135W PS and keyboard **\$899.00**
OPTIONS, Add the amount indicated for the option.
- (1) 640K Motherboard with 640K **\$ 80.00**
 - (2) Color graphics card with gray scale **\$ 60.00**
 - (3) Parallel printer port card **59.00**
 - (4) Clock, calendar, alarm, serial, parallel, and game card **\$110.00**
 - (5) Extra drive, installed and tested. **\$150.00**
 - (6) 10 Meg hard drive, w/controller **\$699.00**
 - 20 Meg hard drive, w/controller **\$849.00**
 - (7) IRWIN 10 meg tape B/U **\$599.00**
 - IRWIN 20 meg tape B/U **\$749.00**
 - Tape cartridges for above **\$ 34.95**
 - (8) External hard drive box w/power supply for hard drive or tape B/U option, w/cables and ready to go **\$249.00**

NEW SME-XT 640K TO 1M BYTE

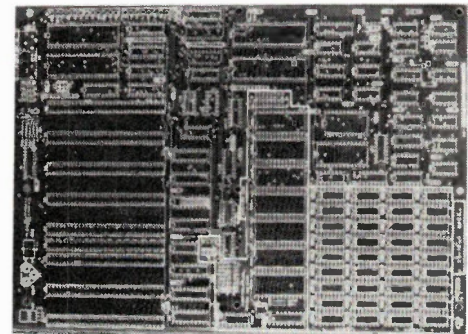

In response to popular demand we have developed an upgrade of the famous MBE-XT board. The new board is called the SME-XT and has space for up to 1 Mbyte on board. The most popular configuration is 640K which is the IBM max addressable memory. The extra RAM above 640K is normally used for system purposes such as video lookup, ROM sitting, and other uses. However, we can supply proms to allow full use of this overhead space on demand. The 256K RAMs are more highly evolved than 64K RAMs and board using them have far fewer problems with parity errors. We have decided to maintain the low-price we pioneered with the MBE-XT and sell the new PCB at \$39.95 as well. All other attributes stay the same as the original IBM and the MBE-XT.

SME-XT **\$39.95**
Manual and Schematic **\$ 4.95**

HARD DRIVE BOX

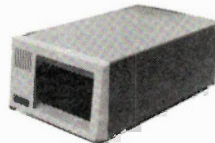

This nicely made box is ideal for externally mounted hard or floppy drives. It has space for one full height or two half height drives and power supply space at rear. This is a well made and rugged units for only **\$59.95**

LAZY BOARD

LAZYBOARD. No we are not lazy, it's for YOU!!!. We had a bunch of 640K motherboards expertly wave soldered with all solder-in parts with AMP style IC sockets but no IC's at all. You buy the IC's or use your own stock and you can get a system going really cheaply. We are selling this "LAZY BOARD" for only **\$135.00**

QUME

Yes we have the same QUME drives that IBM uses in their IBM-XT® system, 40 track, 1/2 height, double sided, double density. The exact ones you need to upgrade your old system or build your clone system up to the max. These are brand new drives that are from QUME's own inventory. They are absolutely perfect, at a perfect price of only **\$145.00**

MEMORY FLASH

- 64K-200Ns DRAM **\$2.00**
- 64K-150Ns DRAM **\$2.00**
- 256K-150Ns DRAM **\$5.75**
- Set of 941256 **\$44.00**

CABLES

- Disc Drive cable (3 Con & twist) **\$12.95**
- IBM Parallel printer cable **\$14.95**
- IBM serial printer cable **\$14.95**
- IBM 6' Keyboard extension (curly) **\$ 9.95**

KEYTRONICS 5150

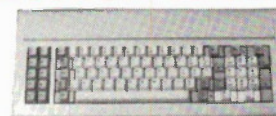

Yes the famous KEYTRONICS 5150 IBM® compatible keyboard. MADE IN USA. We bought a bunch and can sell them for only **\$129.00**

We also have some Taiwan copies that are quite good and all are checked for only **\$99.00**

And lastly we have some Taiwan copies of the famous KEYTRONICS 5151 keyboard with all the same enhanced features for only **\$139.00**

SWITCHING POWER SUPPLY

110V, 60Hz with Fan and two rear switched outlets

These power supplies fit our cases.

- 130 WATT +5V - 14A; +12v - 4.2A; ±12V - 1/2A
- Back Switch **\$135.00**
- Side Switch **\$139.00**
- CSA Approved 150W Side Switch P/S **\$159.95**



SURPLUSTRONICS

we will not be undersold



8088 Computer Systems

\$995

- Includes:
- 8088 motherboard
 - High quality legal Bios
 - One DS,DS 360K Drive
 - Power Supply with Fan
 - Keyboard
 - Flip-Top case
 - Disk Controller
 - With plenty of spare slots
- All you need for complete System is Video Board
- Colours: **\$159.00**
 Mono **\$159.00**

\$339

8088 motherboard with 256K (expandable on board to 640K) Fully assembled and tested with legal Bios, Flow soldered provision for 8087.

256K Memory

41256 (150nS) **\$ 4.35**
 Set of 9 **\$38.95**

64K Memory

4164 (150nS) **\$1.75**

IBM Compatible Keyboards

(Keytronics Serial Output), no housing **\$39.95**

IBM Style Case

Flip-Top 8 slot **\$75.00**

IBM Compatible Switching Power Supply, 130W, with Fan **\$134.00**

Set of 8088, 8255A-5, 8237A-5, 8288, 8284, 8253A-5, 8259A **\$45.00**

IBM Peripheral Cards

Colour Video Board **\$159.00**

Floppy Controller **\$ 99.00**

Floppy Controller with R5232 **\$139.00**

Floppy Controller with clock/ R5232 **\$149.00**

Parallel and Game Port Card **\$ 59.00**
 Cable and connector extra.

Peripheral Interface Card **\$139.00**
 Includes two serial ports, parallel port, game port and provision for (but not including) real time clock.

Clock/Calendar Option **\$ 29.00**
 With battery backup.

256K & Multifunction Board.
 Includes: Serial port, parallel port, game port, provision for optional real time clock/calendar and socketed for up to 256K RAM.
 With 64K RAM **\$149.00**

512K Board. Socketed for 512K including:

64K RAM **\$119.00**

IBM Compatible Disk Drives \$159.95
 Brand New, fresh from factory. Shugart SA455 40 track, double sided, double density Slimline. We have ordered 10,000 from Shugart - that is why we can pass the savings on to you.

IBM Compatible Keyboards
 Maxiswitch **\$135.00**
 Cherry **\$ 99.00**

Complete 6502 System

- Assembled and fully tested (flow soldered)
- 64K, 80 x 24 video with soft-switch, floppy controller.
- System comes with blank EPROM's on board, does come with any proprietary software or Basic **\$199.00**

Complete System

• 6502 board (as illustrated above) with case, keyboard and power supply **\$399.00**

Complete System

- Using 6502 board above in IBM style flip-top case, using powerful 75 watt power supply with fan, programmable serial keyboard adaptor, IBM style keyboard **\$459.00**

As above with one built in disk drive **\$599.00**

As above with two drives **\$749.00**

6502 Power Supply

For 6502 Case. CSA Approved 5V, 5A, + 12V 2.5A, -5V 0.5A, -12V 0.5A. **\$69.00**

Kepeco Power Supply

5V 5A, + 12V 2.8A, + 12V 2A, -12V 0.5A, Open Frame

\$38.95

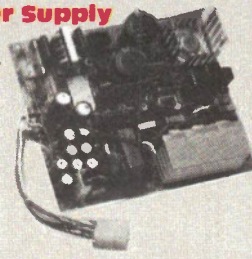

6502 Style Case



With Numeric Keyboard **\$129.00**

Panasonic Printers

Open Frame **\$29.95**

Ideal for experimenters

IBM Style Power Supply

130W, +5V 13A, -5V 0.5V, +12V 4.5A, -12V 0.5A **\$145.00**

Power Bars with Surge Protectors

..... **\$49.95**

Plug In Surge Suppressor

..... **\$11.95**

Apple Cards

Assembled, flow-soldered/cleaned and 100% tested

16K RAM Card **\$ 39.00**

80 x 24 video card **\$ 59.95**

Z80A Card **\$ 39.00**

Parallel Printer Card (cables extra) **\$ 29.00**

128K RAM Card with 128K **\$ 85.00**

EPROM Programmer with Software (programs 2716, 2732, 2732A, 2764) **\$ 63.00**

8" Floppy Controller. Final Sale

- As Is **\$ 39.00**

Modem Bargain!

Apple Compatible plug-in Autoanswer, Autodial, Touch Tone or Pulse Dial. Excellent for use with most Bulletin Boards. 300 Baud. Final Sale as Is **\$39.95**

Apple Compatible Disk Drives 5-1/4"

\$175.00

Apple Compatible Modem

EXCELLENT HAYES MICROMODEM COMPATIBILITY

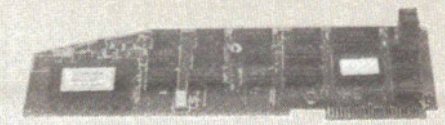

Plugs into your Apple or compatible computer, Direct connect, 300 Baud, Autodial, Autoanswer, Touch Tone/Pulse Dial, complete with documentation.

\$139.95

Hayes is a registered trade name.

Hard Drives Half-height, with Controller and Cables

10 Meg . . . \$639.00
20 Meg . . . \$975.00

Disk Drives for IBM Computers

Shugart/Panasonic, 5 1/4" slimline, DD, DS 360K, 40 track **\$199.00**

Monitors

Zenith ZVM123 Green and ZVM122 Amber . . . **\$129.00**

Mall Orders add \$5.00 minimum for shipping & handling. Ontario residents add 7% P.S.T. Visa, Mastercard and American Express cards accepted: send card number, expiry date, name of bank and signature. Send certified cheque or money order, do not send cash. All prices on this page are final sale. No warranty, No returns, No refunds but HUGE savings. Warranties available at extra cost.

Surplustronics, 310 College Street, Toronto, Ontario, M5T 1S3

More lines to serve you better
(416) 960-1350

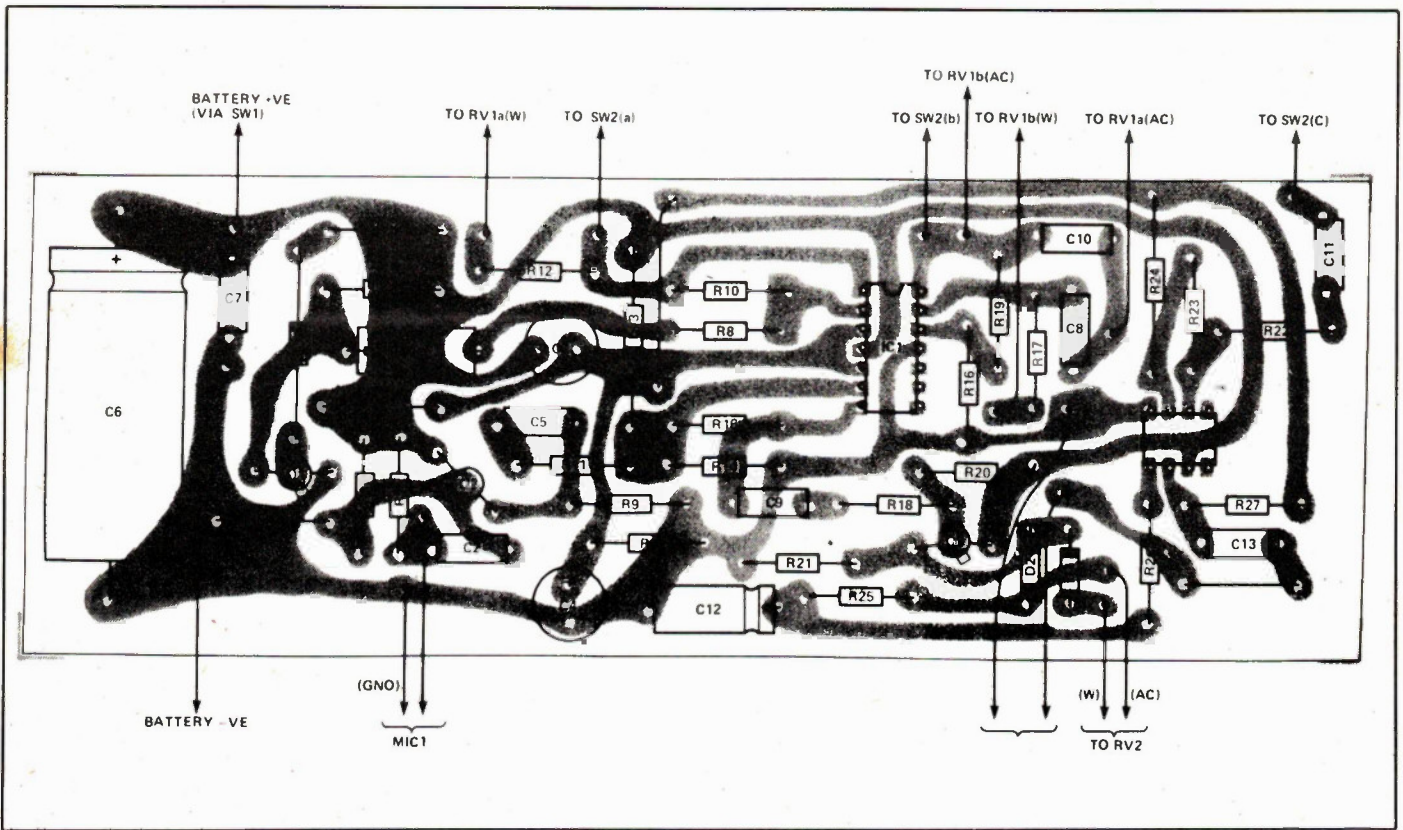

Fig. 2 Component overlay of the crash cymbal.

units, matching two litre ice-cream cartons could be used, and give a space-age effect when painted in suitably futuristic hues. Mounting the units in playing positions is left to the reader.

How It Works

The circuit associated with Q1 is the white noise generator, amplifying the noise produced in the diode D1 as a result of reverse leakage current. A germanium diode is used as the leakage current is higher than that of silicon for a given voltage, producing a higher noise signal level. This amplified signal is coupled by capacitor C1 to a further amplifying stage built around the op amp, IC1a.

IC1b is a constant bandwidth band-pass filter. The filter centre frequency is set by the dual-ganged potentiometer, RV1. This is a classic second order band-pass filter of the multiple-feedback tuned type, which turns the white noise into variable frequency range noise. SW2 is to choose either the filtered noise or the unfiltered white noise. The filtered noise is inaccurately described as pink.

The voltage controlled amplifier (VCA) is built around the 3080E transconductance op amp, IC2. Output current is a function of the control current fed to pin 5 of the package and the difference in voltage between the two input pins. The output current of the device is converted into a signal voltage by R27 and the signal is capacitive coupled to the output by C13.

Electronics Today February 1986

We Import Direct and We Service What We Sell
BEST QUALITY INSTRUMENTS AT LOWEST COST!
Why Pay More? . . . Just a Few Examples:

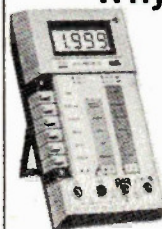

DMM 601
 3½ dig. 0.25% acc.
 0.1 mV - 1000 VDC
 0.1 uA - 2 A AC/DC
 0.1 mV - 750 VAC
 0.1 ohm - 20 M ohms
 Safety test leads incl.

\$63.90

Dmm 6010 (same as 601) except: max.
 10 A AC/DC **\$69.50**

Synthesized R.F. Generator SD 1003



8-512 (Model SD1004 MAX 1060 MHz) AM, O-90% FM in 10-30-100KHz steps. Output attenuation in 10dB steps with Vernier Fine Control. Price 30-40% below "Industry Standard" prices at \$3,600.00

OSCILLOSCOPE 33330

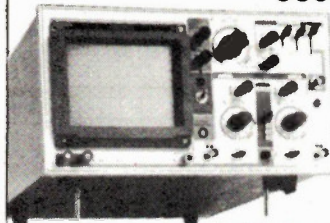

Precision Analog Multimeter Model 5050E

- Input resistance, 10M Ω /DC
- 43 measuring ranges
- AC/DC current max. 12A

Introductory Price **\$67.50**

Authorized Distributor:

Waterloo Electronics Supply Co. In. 219 Hartwood Ave., Waterloo, Ont. 745-9421.

Mail Orders: Visa, Certified Cheque, Money Order or C.O.D.'s F.O.B. Oakville, Ontario residents add 7% P.S.T.

- 2 Chan.
 20MHz bandwidth
 Built-in components tester
 5 mV vert. sensitivity
 Special Price **\$495.00**
 in areas not served by distributors.
 Probes extra.



Model 605 RF Generator

100KHz - 70 MHz
 On fundamentals

Introductory price **\$183.00**

KB ELECTRONICS

355 Iroquois Shore Rd., Oakville, Ont. L6H 1M3
 (416) 842-6888 Telex 06-982396 (KBEL OKVL)

Circle No. 50 on Reader Service Card.

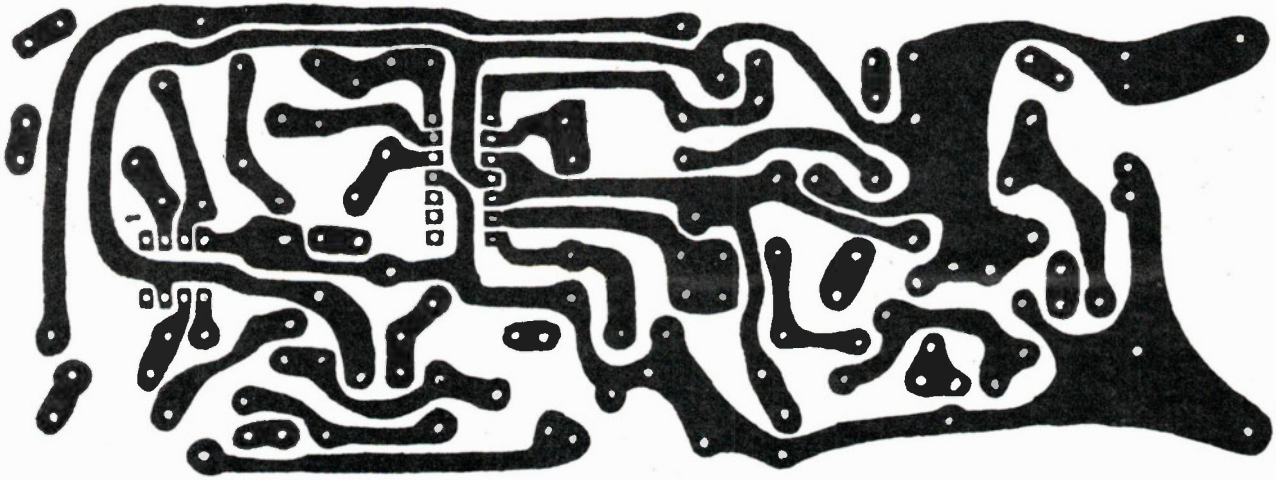

The Cymbal Synth foil pattern.

The signal from the microphone is first amplified by Q2 and then fed to a pulse amplifier built around IC1c. This section inverts the signal and amplifies it to give a negative going pulse at its output whenever a sound is picked up. The dura-

tion for which the pulse remains negative depends, to some extent, on the volume of the input signal to the mic. This gives some sensitivity to the impact of a beat. The negative going pulse is fed to Q3 which, with C12 and its associated circuit,

forms a simple envelope generator.

When the pulse is received by Q3, the transistor turns on. C12 charges up rapidly through the transistor, D2 and R25, giving the fast attack which is characteristic of a drum. The transistor then turns off

K.E.M.

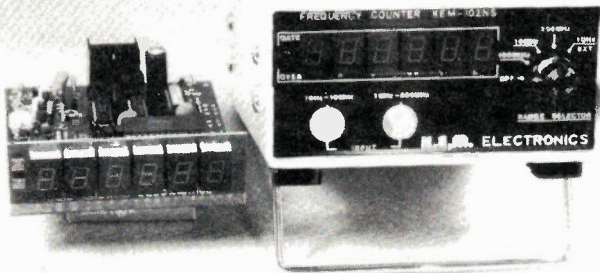

--- Assembled & tested metal case mounted Frequency Counter ---
(1 Year Guarantee)

- (1) VHF Freq.-counter Model KEM-102NS \$159.98
10Hz to 200MHz 3-range, 6-digit LED, zero blanking
Sensitivity 30mVr.m.s., Input impedance 1Mohm or 50ohm
Accuracy 1ppm (0.0001%)
 - (2) UHF Freq.-counter Model KEM-102NS-1G \$249.98
10Hz to 1000MHz (1GHz) 4-range, 6-digit LED, zero blanking
Sensitivity 30mVr.m.s., Input impedance 1Mohm or 50ohm
Accuracy 1ppm (0.0001%)
- Frequency counter Kit series without case-----
- (1) 10Hz to 10MHz counter Kit: Model KEM-102N KIT \$69.98
10Hz to 10MHz 2-range, 6-digit LED
Sensitivity 30mVr.m.s., Input impedance 1Mohm
Accuracy 3ppm (0.0003%) --- Last 10 sets only ---
 - (2) 10Hz to 200MHz counter Kit: Model KEM-102NS KIT \$94.98
10Hz to 200MHz 3 range, 6-digit LED zero blanking
Sensitivity 30mVr.m.s., Input impedance 1Mohm or 50ohm
Accuracy 3ppm (0.0003%) --- New Model ---
 - (3) 200MHz Pre-scaler (ratio 1/100) Kit \$19.98
Maximum input 200MHz, Sensitivity 30mVr.m.s.
 - (4) High-Quality Metal Case Kit \$40.00

\$5.00 for shipping. Plus Prov. Tax for BC residents.
Plus C.O.D. fee if required. Prices & specifications are
subject to change without notice.

K. E. M. Electronics Ltd
Mail to Office Box 69126 Station (K), Vancouver, B. C. V5K 4W4
879 E. Heating St. Van. Tel (604) 251-1514

RACK MOUNT CASES

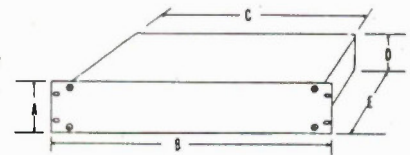

- High quality at reasonable prices • easy to work with. •
- Ideal for audio equipment and test instruments. • Black anodized aluminum front panel and handles • perforated steel top plates and side panels. • Interior mounting panel for control pots.

MODELS	DIMENSIONS (inches)					PRICE
	A	B	C	D	E	
19127	7	19	17	6.5	12	\$43.50
19126	5.75	19	17	5.5	12	42.50
19125	5.25	19	17	5	12	39.50
19124	4	19	17	3.5	12	38.50
19123	3.5	19	17	3	12	37.50
19122	2.5	19	17	2	12	36.50
1796	5.75	17	15.5	5.5	9	\$37.50
1794	4	17	15.5	3.5	9	32.50
1792	2.5	17	15.5	2	9	30.50
1286	5.75	12	11.5	5.5	7	\$26.50
1284	4	12	11.5	3.5	7	22.50
1282	2	12	11.5	1.75	7	21.50
825	2	8	7.5	2	5	\$16.50

- Each rack mount case kit contains one aluminum front panel, one steel interior mounting panel, two steel side panels, two steel covers, two aluminum handles, four rubber legs, one bag of assembly screws and an assembly diagram.

• MAIL ORDER: Certified cheque, money order, Visa or Master Card plus 5% delivery charge (minimum \$5.00 delivery charge). Ontario residents add 7% P.S.T. We send via Canada post, UPS.

SUNIX INC.
(Formerly Audiovision)

578 MARLEE AVE.
(At Glencairn Subway)
Toronto, Ontario
M8B 3J5

Telex: 06-217736 SUNIX TOR.
Tel: (416) 781-3283
In Dallas, USA: (214) 985-1842

and C12 discharges through R25, RV2, D3 and R21. This gives a variable decay, considerably slower than the attack. The voltage is converted into a current by R26 and fed to pin 5 of IC2, the VCA.

C6 provides necessary supply capacity to eliminate any power thump which may find its way into the circuit when the drum is struck. C7 provides high frequency supply decoupling. A false signal ground is supplied in the form of a decoupled 4.5V rail. This rail is formed by C3, C4, R4 and R5, and eliminates the need for a two battery split rail supply.

There is a spare op amp on IC1 available, should any adventurous constructor feel the need to expand the unit in some way.

Parts List

Resistors

R1,22	47k
R2,13,14	4k7
R3,12,17,21	1k
R4,9	3k3
R6,7,10	270k
R11,25	470R
R15,18,19,20	100k
R16	390k
R23	39k
R24	220R
R26,27	10k
RV1	100k dual ganged log pot
RV2	47k lin pot

Capacitors

C1,12	10u, 25V
C2,5,7,9,13	100n film
C3,4	470u, 10V
C6	2200, 16V
C8	10n film
C10,11	47n film

Semiconductors

D1	1N34, 1N60
D2,3	1N4148, 1N914
Q1,2	2N3904 NPN, etc
Q3	2N3906 PNP, etc
IC1	LM324
IC2	LM3080E

Miscellaneous

Condenser mic insert, on-off switch, 1 pole 2-pos switch, DIP sockets, 1/4 inch jack, knobs, wire, 9V battery and clips, casing.

KEEP INFORMED Of Career Opportunities Get in touch with your Placement Service

Engineers, Technicians, Technologists, Managers and Supervisors, Designers and Drawing office staff, Data Processing Specialists, Sales and Marketing Professionals.

...These people use TSC

Technical Service Council's placement service is for professional and technical manpower. Over 1000 companies are members of Technical Service Council. These and other companies regularly use us to search for experienced personnel.

A broad range of jobs are listed with TSC

You can obtain information on positions that suit your own experience and career development. Keep in touch. Our consultants can offer professional advice on your job search strategy. **There is no cost to you to be registered.**

Get in touch now!

Send resume to: Technical Service Council, #ET 7129, One St. Clair Avenue East, Toronto, Ontario M4T 2V7, or call us (416) 966-5030.



TECHNICAL SERVICE COUNCIL

Industry's own placement service for professionals

Montreal • Toronto • Winnipeg
Edmonton • Calgary • Vancouver

Low Profile Switches

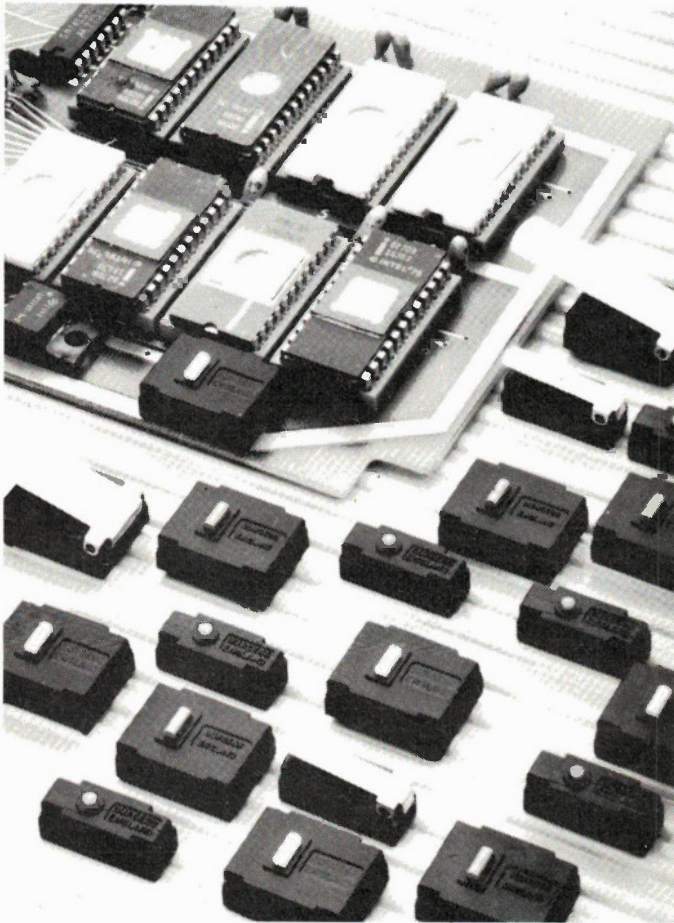

The Burgess low-profile switch has been designed for printed circuit mounting, using solder terminals on 0.1 inch centres. They can be keyed together for ganging, and have various clip-on actuators available. With single and

double-pole available, a wide range of switch configurations can be specified. Burgess Switch Company Ltd., 4800 Sheppard Ave. East, Scarborough, Ontario M1S 4N5, (416) 299-0852.

Circle No. 69 on Reader Service Card.

Distortion Meter

Hameg introduces the new HM 8027 distortion meter, a 20Hz-20kHz unit that can measure down to 0.01 percent. Distortion figures are displayed on a 3-digit readout; resolution is 0.01 percent. The single frequency dial features automatic capture with a plus or minus five percent range. A calibrated output allows visual inspection of the distortion products; minimum input level is 100mV. From BCS Electronics Ltd., 980 Alness Street, Unit 7, Downsview, Ontario M3J 2S2, (416) 661-5585.

Circle No. 81 on Reader Service Card

Some confusion occurred regarding the advertisement for Electronic Supplies Incorporated in the November issue. The price on all vacuum tubes is \$5.99 EXCEPT for the tubes listed in the ad. The list shows tube prices which may be higher or lower, depending on the part.

In any case, should you be looking for tubes, you can contact them at Electronic Supplies Inc., 306 Rexdale Blvd., Rexdale, Ontario M9W 1R6, (416) 741-6000.

RS232 Project Corrections: The following are the corrections to the RS232 project for the Commodore which appeared in the August 1985 issue.

a) The cross-connects as described in the text are incorrect. The dotted lines show the computer connected to the printer, and the solid lines show the connection to a modem.

b) The syntax for opening the RS232 channel was shown as OPEN 1,2,0,CHRS(8), it should have read: OPEN 1,2,0,CHRS(38).

c) Pins 2,5,9, and 12 of the 1489 chip are incorrectly shown connected to the plus 15V rail. These pins are not to be used.

We apologize for the delay in publishing the above problems, but with the efficiency of the post office (it took forty days to receive one letter from Saskatchewan) and our recent move, things have been a bit hectic.

Texas Instruments has introduced a speech-recognition feature for their Professional Computer. Called the Speech Command system, it stores 50 phrases or words in each of nine vocabularies. The photo on the press release shows an executive type talking into a microphone, though it can also be used with a headset or telephone. The phrases illustrated were commands like "Display the inventory worksheet" and "Graph the year-to-date sales". Although you have to "teach" the computer the phrases by speaking them, they didn't say whether or not the recognition feature would respond to any voice or only the user's.

Researchers at Bell Labs have transmitted a coherent, billion-bit-per second lightwave signal through 150km (93 miles) of glass fibre. This is the highest bit rate obtained so far with optical fibres, and required an extremely pure laser light with a linewidth 10,000 times narrower than current lasers.

The Intel Corporation has introduced a new microprocessor, the 80386. It features 32-bit architecture, 12 and 16 megahertz versions, 4 gigabytes of direct memory addressing and on-board features for memory management, multitasking and software debugging. In addition, it's compatible with 8086/88 and 80286 software. Sample quantities are about \$300 US each. Intel Corporation, 3065 Bowers Ave., Santa Clara, CA 95051, (408) 987-6031.

CAD Design Systems Inc., a regional distributor of the popular AutoCAD drafting and design software, has been named the national distributor for CADFont, a text-enhancement addition. Font sets can be created and the characters assigned to the user's keyboard. There are three sizes of characters and all sorts of special symbols, all of them using AutoCAD's user-defined files. It has to be better than AutoCAD's one-label-at-a-time subroutine. At AutoCAD dealers, or contact them at 1305 Remington Road, Suite D, Schaumburg, Illinois 60195, (312) 882-0114.

Circle No. 71 on Reader Service Card.

Trying to find linear slide pots for projects? Low cost types are a bit hard to find, but you can get a model with a 60mm travel from J&J mail order. Audio taper values are 5k, 10k, 50k, 100k, 500k and 1M; linears are 1k, 5k, 10k, 25k, 50k, 100k, 250k, 500k, and 1M. Price is \$2.95 each; deduct 10 percent for more than 10. J&J Electronics Ltd., PO Box 1437, Winnipeg, Manitoba R3C 2Z4, (204) 942-0963.

By the way, J&J's new catalogue is out, stuffed full of components, tools, electronic hardware, etc. You could request being put on their mailing list; they also run a 24 hour, 7 day a week BBS for placing orders or just browsing; it's at (204) 942-1109.

Although this system is probably aimed at overcoming people's reluctance to learn keyboard commands, it's a portent of more sophisticated voice units, like C3PO of movie fame. Soon you'll be able to argue with your computer:

"Syntax error!"

"Was not!"

"Was too!"

For now, we can be content with the sight of somebody alone in an office talking at a box.

At TI dealers, or contact them at Texas Instruments Inc., Data Systems Division, 41 Shelley Road, Richmond Hill, Ontario L4C 5G4, (416) 884-9181.

Circle No. 84 on Reader Service Card

Panasonic has teamed up with Triple E, a travel van converter in Guelph, Ontario, to produce the Execuvan for those who'd like to travel the highways in style. They start with a fully loaded Dodge van (A/C, PB, PS, PW, PDQ), add luxury fabrics and carpeting, swivel seats, a couch, and then lay on every conceivable bit of electronics they can find: two audio systems, a colour TV, a VCR, a compact disk player, six speakers, headphones, a mobile phone, and a computer (Panasonic's Link portable). Price wasn't officially listed (if you have to ask, you can't afford it) but will probably be in the area of \$75,000. If you picture yourself with your feet up reading Electronics Today while whizzing down the highway, contact Triple E Canada, 530 Governors Road, Guelph, Ontario N1K 1E3, or Panasonic Canada, 5770 Ambler Drive, Mississauga, Ontario L5W 2T3, (416) 624-5010.

Circle No. 85 on Reader Service Card

If you're involved in satellite communications as a dealer, manufacturer or private individual, you may be interested in the Satellite Communications Association of Canada. The subcommittee activities include Technical Trainings, Performance Standards, membership and other issues. You can contact them at the head office, PO Box 160, Station L, Toronto, Ontario M6E 4Y5, (416) 736-0352.

Circle No. 70 on Reader Service Card.

Those interested in our December photoflash, but who are looking for a readymade, higher powered system might want to check out our supplier of professional supplies, Vistek Limited, 100 Queen St. E., Toronto, Ontario M5C 1S6, (416) 365-1777. They're specialists in sales and service of electronic flash systems up to thousands of watt-seconds, and also stock all sorts of amazing stand and tripod systems. They've solved all sorts of problems for us, and we thought we'd let you know about them.

Circle No. 80 on Reader Service Card.

TRANSPAC

FOR THE 4 IN 1 SUPERCOMPUTER
THAT IS MADE IN CANADA AND COMES WITH A ONE-YEAR
WARRANTY FROM XEROX® SERVICE CENTERS THROUGHOUT CANADA



Monitor not included

THE SUPER FAST TRANSPAC II

CSA approved 150 watts power supply, genuine Keytronics Keyboard, 256K RAM, 2 serial and one parallel ports, real-time battery back-up clock plus speed selectable via external switch. 4.77 and 8MHz uses 8088-2 processor.

(Most software will run on the higher speed.)

\$1725.00

Other configurations

- TRANSPAC III
10 Meg Hard Drive/1 Floppy/256K \$2486.35
- TRANSPAC IV
10 Meg Hard Drive/2 Floppy/256K \$2649.00
- TRANSPAC V
20 Meg Hard Drive/1 Floppy/256K \$2704.88
- TRANSPAC VI
20 Meg Hard Drive/2 Floppy/256K \$2867.53

SUPERB IBM PC & XT COMPATIBILITY AND MORE...

Not just Hardware but also Software compatibility. Supports PC-DOS and CPM/86. Will run all your favourite software such as Lotus 123, Autocad, Flight Simulator, Dbase III etc.

MULTIFUNCTION FEATURES COMES AS STANDARD

- 2 Serial Ports (not just 1)
- 1 Parallel Port
- Real Time, Battery Back-up, Clock
- Memory expansion on-board to 1 megabyte
- 64K and 256K chips can be mixed
- Optional 8087-2co-processor
- Sasi Hard Disk Interface
- 54K User Definable Rom expandability
- Low Cost Modem Interface
- Ram Disk software included

FLOPPY CONTROLLER CARD COMES AS STANDARD

Will Support Up To 4 Floppies

HIGH-SPEED BOARD COMES AS STANDARD

Speed Selectable Between 4.77 MHz and 8 MHz via external switch.

Note: Up to now all these features were only available by purchasing expensive interface cards. Now with the ACS-1000 single board supercomputer (see reviews in March and May Issues of "Electronics Today") all these features come as standard on one board. What's more, since the ACS-1000 is a product of Top-Down integration all these functions will work together as never before. And, more importantly, since everything is already on the main board the remaining expansion slots will give you true expansion capability.

PLUS MORE

- genuine Keytronics Keyboard
- reset switch
- speed selection via external switch
- 150 watt CSA approved power supply
- quiet slim-line DS DD 5 1/4 360K disk drives
- colour video adaptor included. RGB and composite board or Hi-Res monochrome board. (customer choice)
- ONE YEAR WARRANTY
- even after all the above standard features you still have 6 expansion slots
- made in Canada
- 256K RAM standard minimum

WARRANTY

The TRANSPAC computer not only offers you high quality and high performance at low cost but also gives you one full year's service warranty — parts and labour — right across Canada from Xerox, one of the most reputable service organizations in Canada. This is possible because of the extra care we take in sourcing our components and our quality control. For example, every computer that leaves our site undergoes in total 72 hours of burning-in. This ensures a very high reliability rate in the field and of course, satisfied customers.

TRANSPAC TRADING CORP.

for the computer that is not just another look-a-like

5485 — 128th St., Surrey, B.C. Canada V3W 4B5

Order line only 1-800-663-0073 Telex: 04-365628

Master Charge & Visa, Certified Cheque, COD, Money Order accepted.
Shipping & Insurance extra.

IBM, PC, XT & PC DOS are registered trade marks of IBM Corp., CPM/86 is a registered trade mark of Digital Research, Inc. MS DOS, Flight Simulator are registered trade marks of Microsoft Corp. Lotus and 123 are registered trade marks of Lotus Development Corp., Dbase III is a registered trade mark of Ashton Tate. Autocad is a registered trade mark of Autodesk. Xerox is a registered trade mark of Xerox Canada.

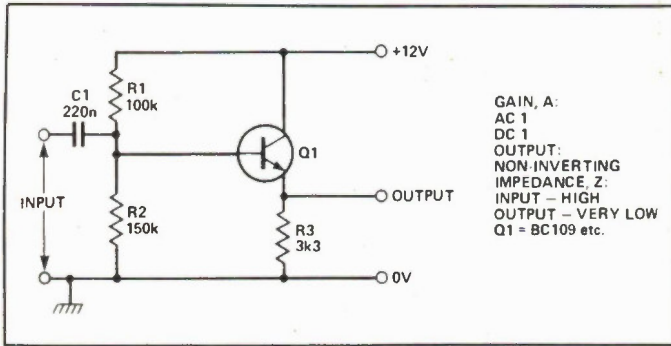

Fig. 5. The basic emitter follower.

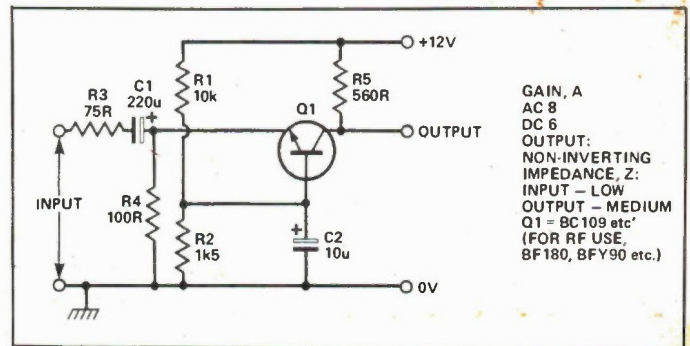

Fig. 6. The grounded base amplifier.

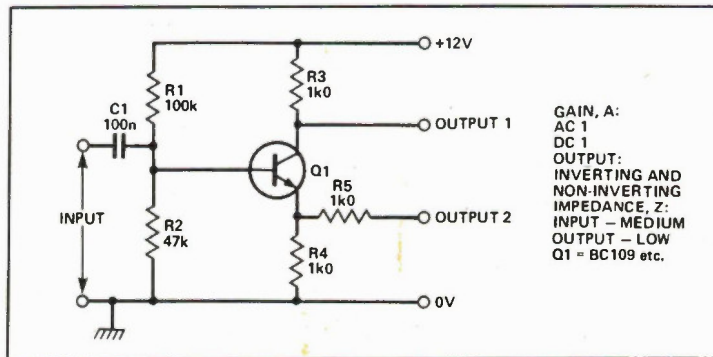
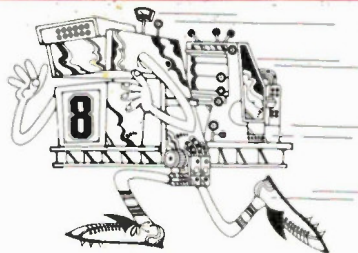

Fig. 7. The phase splitter.

FAST SERVICE



BEST PRICES

JERROLD STARCOM CS VOLUME CONTROL CONVERTER

• Enjoy the Ultimate in TV viewing program-mable convenience.

• Complete Volume Control Plus

• Mail Order:
Certified Cheque, Money Order, COD'S FOB
Rexdale. Ontario Residents add 7% P.S.T.

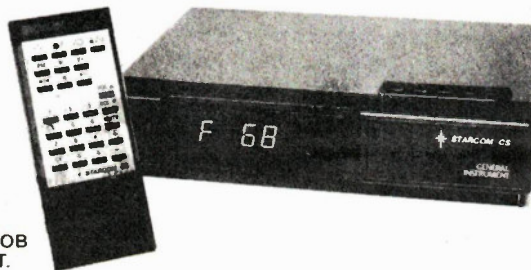

\$159⁹⁵ EA.

TRY US FOR:
• NEEDLES AND CARTRIDGES
• AUDIO AND VIDEO ACCESSORIES
• SEMICONDUCTORS
• WIRE AND CONVERTERS AND MUCH MORE

DEALERS:
PHONE FOR WHOLESALE QUANTITY PRICES

THE WHOLESALE SOURCE YOU'VE BEEN SEARCHING FOR!...

ELECTRONIC SUPPLIES INCORPORATED



306 Rexdale Blvd., REXDALE, Ontario
M9W 1R6 (416) 741-4000
INDUSTRIAL ORDER DESK
(416) 741-6000

BRANCHES:

32 Massey Lane at Beattie, CHATHAM, Ont., N7M 5W6, (519) 352-4000
269 Colborne St., LONDON, Ont. N6B 2S7, (519) 433-0101

1173 Michener St., Unit 4, SARNIA, Ont. N7S 5G5, (519) 344-2449
600 Wyandotte St., E., WINDSOR, Ont. N9A 3J2, (519) 258-2240

Electronics from the Start

A in-depth look at the operation of one of the simplest semiconductors: the diode.

By Keith Brindley

DIODES get their name from the basic fact that they have two electrodes (di-ode). One of these electrodes is known as the anode: the other is the cathode.



Fig. 1 The electronic symbol for an ordinary diode.

Figure 1 shows the symbol for a diode, where the anode and cathode are marked. Figure 2 shows some typical diode body shapes, again with the anode and cathode marked.

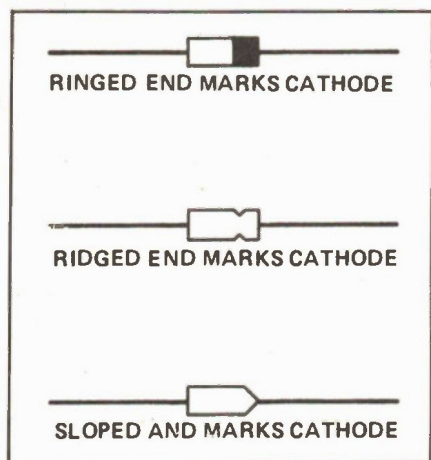

Fig. 2 Some typical diode body shapes.

Some components that you'll need for the circuits you're going to build are:

- 1 x 150R 1/2 watt resistor
- 1 x 14001 diode
- 1 x 1N34 or 1N60 diode
- 1 x 3V0 zener diode
- 1 x 1kO miniature horizontal preset

We're going to use the miniature horizontal preset in the following circuits as a variable voltage divider. To adjust it

Electronics Today February 1986

you'll need a small screwdriver or tool to fit in the adjusting slot; turning it one way and another will alter the position of the preset's wiper over the resistance track.

Figure 3 shows the first circuit we're going to build. It's very simple, using two components we're already familiar with (a resistor and a LED) together with the new component we want to look at: a diode. Before you build it, note which way the diode is oriented and make sure you get the LED polarized correctly, too. In effect, the anodes of each diode connect to the more positive side in the circuit.

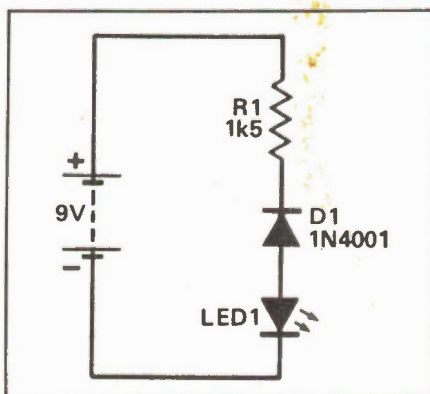

Fig. 3 A simple circuit using a diode.

Which Way Around?

If you've connected the circuit up correctly, the LED should now be on. This proves that current is flowing. To calculate what current we can use Ohm's law. Let's assume that the total battery voltage of 9V is dropped across the resistor and that no voltage occurs across the two diodes. In fact, there is voltage across the diodes but we needn't worry about it yet, as it is only a small amount. We'll measure it later.

Now, with a resistance of 1k5, and a voltage of 9V, we can calculate the current flowing, as:

$$I = V/R = 9/1500 = 6\text{mA}$$

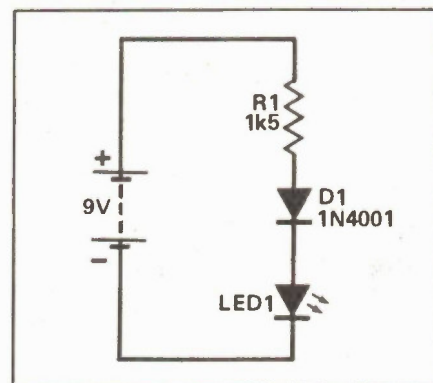

Fig. 4 The same circuit as Figure 3 but with the diode reversed.

The next thing to do is to turn the diode around, so that its cathode is more positive, as in the circuit of Figure 4. The breadboard layout is the same with anode and cathode reversed so we needn't redraw it.

What happens? You should find that absolutely nothing happens. The LED does not light up, and so no current must be flowing. The action of reversing the diode has resulted in the stopping of current. We can summarize this quite simply in Figure 5.

Figure 5a shows a diode whose anode is positive with respect to its cathode. Although we've shown the anode as positive with a '+' symbol, and the cathode as negative with a '-' symbol, they don't necessarily have to be positive and negative. The cathode could for example be at a voltage of +1000V if the anode was at a greater positive voltage of, say, +1001V. All that needs to occur is that the anode is positive with respect to the cathode.

Under such a condition, the diode is said to be forward biased and current will flow, from anode to cathode.

When a diode is reverse biased, ie, its cathode is positive with respect to the anode, no current flows, as shown in Figure 5b. Obviously, something happens within the diode which we can't see,

depending on the polarity of the applied voltage to define whether current can flow or not. We needn't know any more about it here because we're only concerned with the practical aspects at the moment. All we need to remember is that a forward biased diode conducts, allowing current to flow, while a reverse biased diode doesn't.

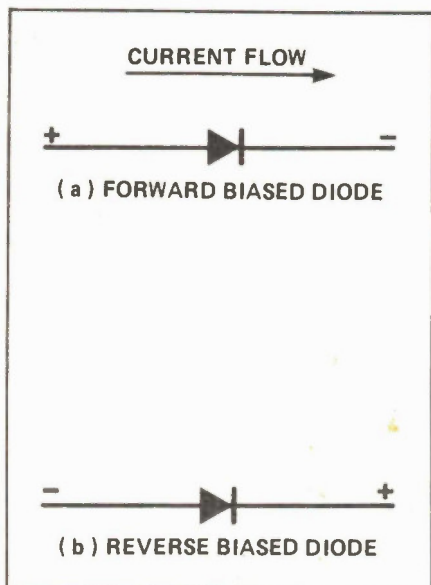

Fig. 5 Circuit diagrams for forward and reverse biased diodes.

What we do need to consider in more detail, however, is the value of the current flowing, and the small, but nevertheless apparent, voltage which occurs across the diode, when a diode is forward biased (the voltage we said earlier we needn't then worry about). The following experiment will show how the current and the voltage are related.

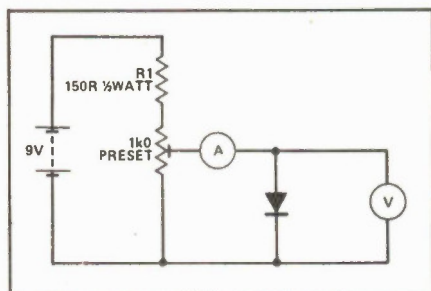

Fig. 6 A circuit to test the operation of a reverse biased diode.

Figure 6 shows the circuit you have to build. You'll see that two basic measurements need to be taken with your meter. The first measurement is the voltage across the forward biased diode, the second measurement is the current through it. Each measurement needs to be taken a number of times as the preset is varied in an organized way. Table 1, which is half complete, is for you to record your results. For a graphic representation you can plot your results on suitable graph paper. Do the experiment in the following way:

Current mA	Voltage (V)
0	0
	0.4
	0.6
2	
5	
10	
20	

1) Set up the components on the breadboard to measure only the voltage across the diode. The breadboard layout is given in Figure 7. Before you connect your battery to the circuit, make sure the wiper of the preset is turned fully anti-clockwise.

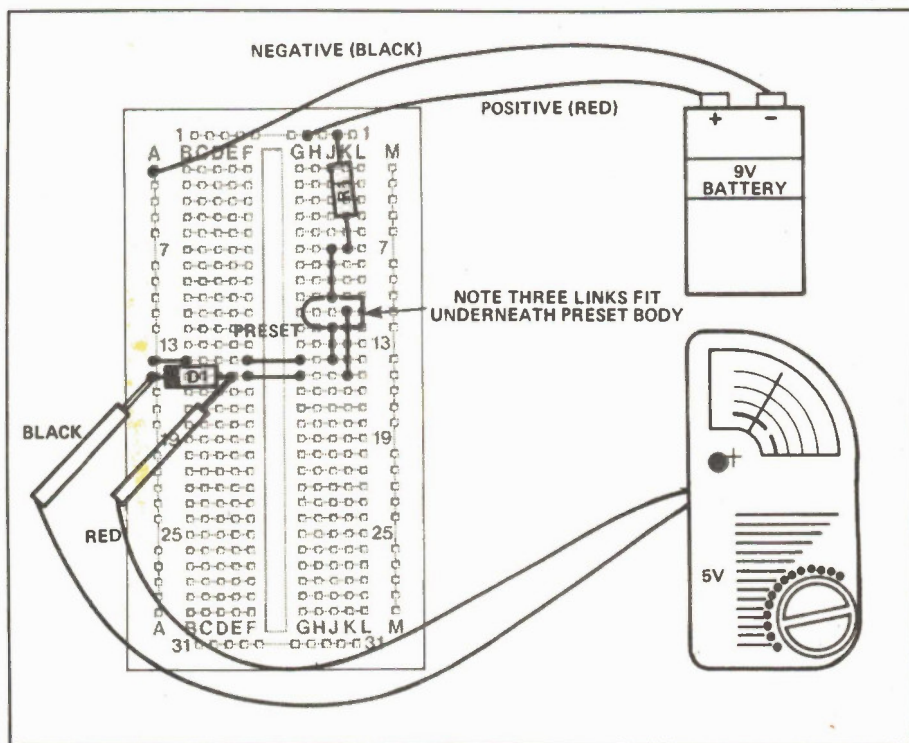

Fig. 7 The breadboard layout for the circuit in Figure 10.

- Adjust the preset wiper clockwise, until the first voltage in Table 1 is reached.
- Now set up the breadboard layout of Figure 8 measure the current through the diode; the breadboard layout is designed so that all you have to do is take out a short length of single-strand connecting wire and change the position of the meter and its range. Record the value of the current at the voltage of step 2.
- Change the position of the meter and its range and replace the link in the breadboard so that voltage across the diode is measure again.
- Repeat steps 2, 3 and 4 with the next voltage in the Table.
- Repeat step 5 until the Table shows a given current reading. Now set the current through the diode to this given value

and measure and record the voltage.

7) Set the current to each value given in the Table and record the corresponding voltage, until the Table is complete.

Our results are shown in Table 2. Repeat the whole experiment again, using the 1N34 or 1N60 diode this time. You can put your results in Table 3. Our results are in Table 4. Plot both your results as well as ours.

As you might expect, these two plotted curves are the same basic shape. The only real difference between them is that they change from a level to an extremely steep line at different positions. The 1N34 or 1N60 curve, for example, changes at about 0V3, while the 1N4001 curve changes at about 0V65.

The sharp changes in the curves correspond to what are sometimes called transition voltages; the transition voltage

for the 1N34 or 1N60 is about 0V3, the transition voltage for the 1N4001 is about 0V65. It's important to remember, though, that the transition voltages in these curves are only for the particular current range under consideration: 0 to 20mA in this case. If similar curves are plotted for different current ranges then slightly different transition voltages will be obtained. In any current range, however, the transition voltages won't be more than about 0.1V different to the transition voltages we've see here. The two curves, of the 1N34 or 1N60 and the 1N4001 diodes, show that a different transition voltage is obtained (0V3 for the 1N34 or 1N60, 0V65 for the 1N4001) depending on which semiconductor material a diode is made from. The 1N34

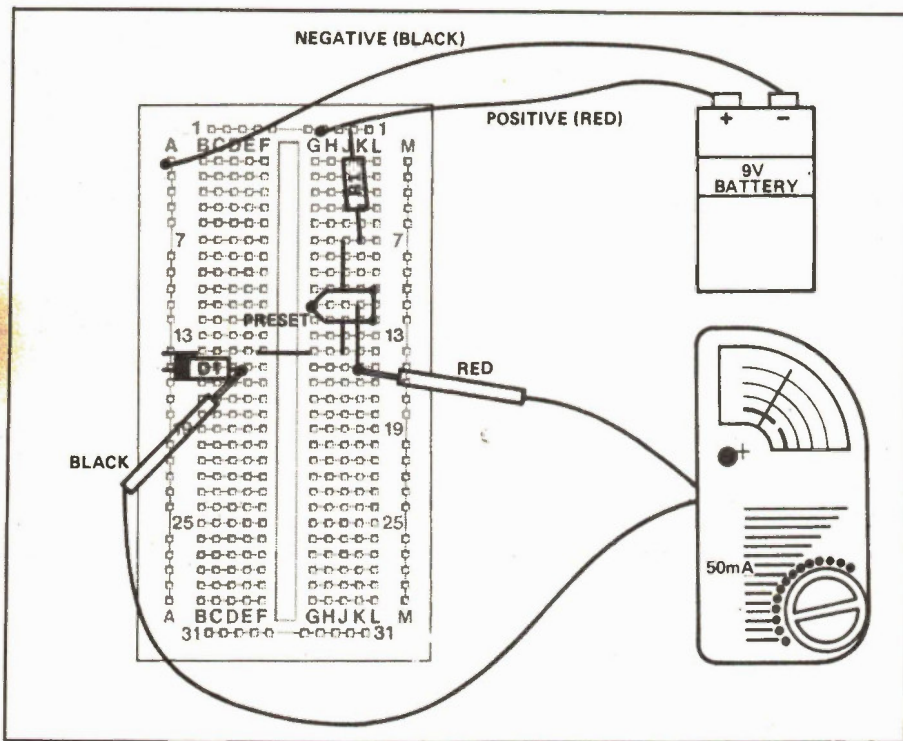

Fig. 8 The same circuit, set up to measure the current across the diode.

Table 2

Current (mA)	Voltage (V)
0	0
0	0.4
1	0.6
2	0.65
5	0.65
10	0.7
20	0.75

or 1N60 diode is made from germanium while the IN4001 is of silicon construction. All germanium diodes have a transition voltage of about 0V2 to 0V3, similarly all silicon diodes have a transition voltage of about 0.V6 to 0.V7.

Table 3

Current (mA)	Voltage (V)
0	0
	0.1
	0.2
	0.25
	0.3
3	
5	
10	
20	

The exponential curves obtained from the plotting, similar to capacitor charge/discharge curves, are called diode characteristic curves or sometimes simply diode characteristics. But the characteristics we have determined here

Table 4

Current (mA)	Voltage (V)
0	0
0	0.1
0.5	0.2
1	0.25
2	0.3
3	0.32
5	0.35
10	0.4
20	0.45

are really only half the story as far as diodes are concerned. All we have plotted are the forward voltages and resultant forward currents when the diodes are forward biased. If diodes were perfect this would be all the information we need. But to get a true picture of diode operation we have to extend the characteristic curves to include reverse biased conditions.

Reverse biasing a diode means that its anode is more negative with respect to its cathode. So by interpolating the x and y-axes of the graph, we can provide a grid from the diode characteristic which allows it to be drawn in both forward and reverse biased conditions.

It wouldn't be possible for you to plot the reverse biased conditions, for an ordinary diode, the way you did the forward biased experiment (we will, however, do it for a special type of diode soon), so instead we'll make it easy for you and give you the whole characteristic curve. Whatever type of diode, it will follow a similar curve to that of Figure 9 where the important points are marked.

Reverse Bias

From the curve you can see that there are two distinct parts which occur when a diode is reverse biased. First, at quite low reverse voltages, from about $-0.1V$ to the breakdown voltage there is a more or less constant but small reverse current. The actual value of this reverse current (known as the saturation reverse current, or just the saturation current) depends on the individual diode but is generally in the order of microamps.

The second distinct part of the reverse biased characteristic occurs when the reverse voltage is above the breakdown voltage. The reverse current increases sharply with only comparatively small increases in reverse voltage. The

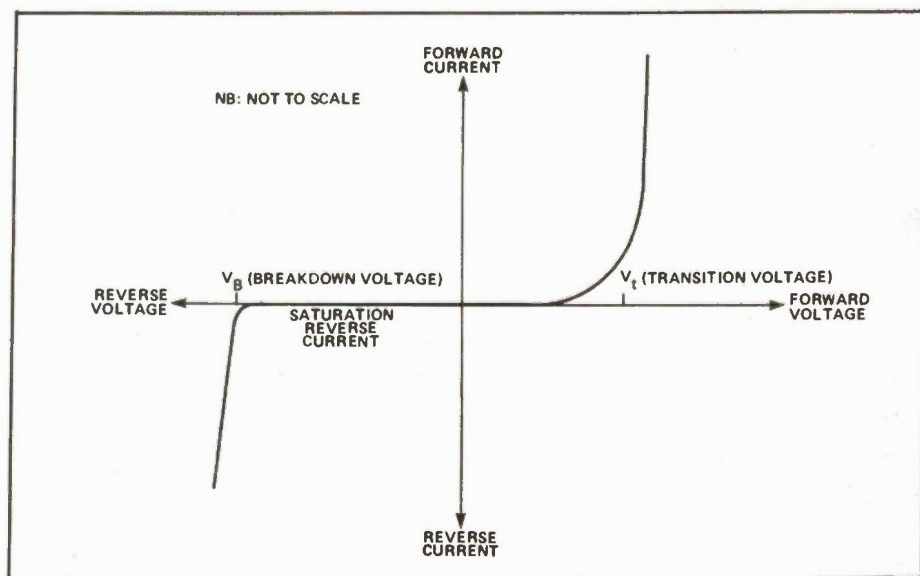

Fig. 9. Plotting the reverse bias characteristics for an ordinary diode is not practical, so we give you the characteristic curve here.

reason for this is because of electronics breakdown of the diode when electrons gain so much energy due to the voltage that they push into one another just like rocks and boulders rolling down a steep mountainside push into other rocks and boulders which, in turn, start to roll down the mountainside pushing into more rocks and boulders, forming an avalanche. This analogy turns out to be an apt one, and in fact the electronic diode breakdown voltage is sometimes referred to as avalanche breakdown and the breakdown voltage is sometimes called the avalanche voltage. Similarly the sharp 'knee' in the curve at the breakdown voltage is often called the avalanche point.

In most ordinary diodes the breakdown voltage is quite high (in the IN4001 it is well over $-50V$), so this is one reason why you couldn't plot the whole characteristic curve, including reverse biased conditions, in the same experiment — our battery voltage of $9V$ simply isn't high enough to cause breakdown.

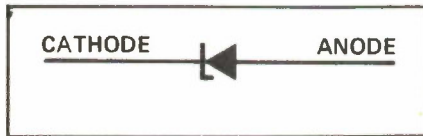

Fig. 10 The circuit symbol for a zener diode.

Some special diodes, on the other hand, are purposefully manufactured to have a low breakdown voltage, and you can use one of them to study and plot your own complete diode characteristic. Such diodes are named after the American scientist, Zener, who was one of the first people to study electronic breakdown. The zener diode you are going to use is rated at $3V_0$ which of course means that its breakdown occurs at $3V$ which is below the battery voltage and is therefore plotable in the same sort of experiment as the last one. The symbol for a zener diode, in-

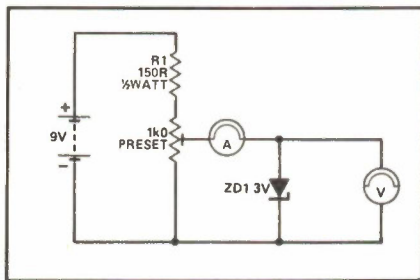

Fig. 11 A circuit with the zener diode forward biased.

identally, is shown in Figure 10: the bent line representing its cathode corresponds to the electronics breakdown.

The procedure is more or less the same as before. The circuit is shown in Figure 11 where the zener diode is shown forward biased. Complete Table 5 with the circuit as shown, then turn the zener

diode round as shown in the circuit of Figure 12 (this is the way zener diodes are normally used) so that it is reverse biased, then perform the experiment again completing Table 6 as you go along. Although all the results will in theory be negative, you don't need to turn the meter around, the diode has been turned around instead and so is already reverse biased.

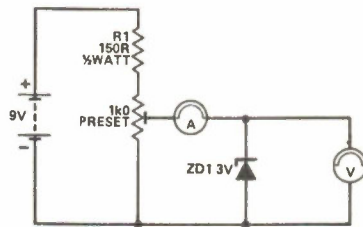

Fig. 12 The circuit, with the zener diode reverse biased.

Next, plot your complete characteristic. Our results and characteristics are in Table 7 and 8; plot our results as well.

Table 5

Current (mA)	Voltage (V)
	0
	0.4
	0.6
1	
2	
9	
5	
10	
20	

From the zener diode characteristic you will see that it acts like any ordinary diode. When forward biased it has an exponential curve with a transition voltage of about $0.7V$ for the current range observed. When reverse biased, on the other hand, you can see the breakdown voltage of about $-3V$ which occurs when the reverse current appears to be zero, but in fact, a small saturation current does exist — it was simply too small to measure on the meter.

Finally, it stands to reason that any diode must have maximum ratings above which the heat generated by the voltage and current is too much for the diode to withstand. Under such circumstances the

diode body may melt (if it is a glass diode such as the 1N34 or 1N60), or, more likely, it will crack and fall apart. To make sure their diodes don't encounter such rough treatment manufacturers supply maximum ratings which should not be exceeded. Typical maximum ratings of the two ordinary diodes we have looked at, the IN4001 and the 1N34 or 1N60 are listed in Table 9.

Answers to last month's quiz

- 1) d
- 2) 159n Sorry about this one. The correct answer was not given as one of the five choices. We regret the error.

Table 6

-Current (mA)	-Voltage (V)
0	0
	1
	2
	2.5
	3
10	
20	

Table 7

Current (mA)	Voltage (V)
0	0
0	0.4
0	0.6
1	0.7
2	0.75
5	0.75
10	0.8
20	0.8

Table 8

-Current (mA)	-Voltage (V)
0	0
0	1
0.5	2
2	2.5
5	3
10	3.2
20	3.5

Table 9

Maximum mean forward current	IN4001	0A47
Maximum repetitive forward current	1A	110 mA
Maximum reverse voltage	10A	150 mA
Maximum operating temperature	$-50V$	$-25V$
	$170^{\circ}C$	$60^{\circ}C$

Camera Contest Results

Thanks to the hundreds of readers who entered our contest for the Minolta Maxxum. The winner that we drew from the correct entries was:

Zoltan Daku, Prescott, Ontario

About half of the entrants had all the answers correct. The questions, incidentally, were based on The CET Study Guide, TAB book number 1791, a collection of questions and answers for electronics technicians in the USA.

The correct answers were:

1. When the base of a transistor is at the same voltage as the emitter, the transistor is (c) cut off.
2. A circuit in which a single amplifier acts as a sound IF and an audio amplifier is (b) a reflex-amplifier circuit.
3. A ferrite bead behaves like (a) an inductor.
4. The amplifier configuration used to match a high to a low impedance is (c) an emitter follower.
5. Removing the capacitor across an emitter resistor in a transistor amplifier will (b) increase the amplifier frequency response.



Moorshead Publications Order Form

Subscriptions:

Please complete reverse side of order form to start or renew a subscription.

Back Issues: \$4.00 each; Ontario residents add 7% sales tax. Please circle issues desired.

1977	February					July
1978	April	May	September	November	December	
1979	February		March	April	May	July
	August		September	October	November	
1980	January	February	May	June	November	December
1981	January	February	March	April	June	July
	August	September	October	November	December	
1982	January		March	April	May	June
	July	August	September	October	November	December
1983	January	February	March	April	May	June
	August	September	October	November	December	
1984	January	February	March	April	May	June
	July	August	October	November	December	
1985	January	February	March	April	May	June
	July	August	September	October	November	December

On the following items please add \$1.00 for postage and handling plus 7% Ontario provincial sales tax.

Special Publications:

ITEM	QTY	AMOUNT
Electronic Circuit Design \$3.95	\$
Projects Book No. 2 \$3.95	\$
Personal Computer Guide \$3.95	\$
50 Top Projects \$4.95	\$
Your First Computer \$3.95	\$
Computers in Small Business \$3.95	\$

Binders: Electronics Today; Computing Now!
 Moorshead Publications
 \$9.75 each plus 7% P.S.T.

BOOKSHELF ORDER FORM

Code (e.g. BP12)	Title (Short-form is O.K.)	Price
.....	\$
.....	\$
.....	\$
.....	\$
.....	\$

SOFTWARE ORDER FORM

.....	\$
.....	\$
.....	\$
Sub Total \$	
Tax (Ontario Residents) \$	
Postage \$	
Total Enclosed \$	

Orders from the Bookshelf are tax exempt. Please add \$1.00 for postage. Remember to put your name and address on reverse side. See over for mailing details.

Do you currently subscribe to Electronics Today Yes No Computing Now! Yes No Computers In Education Yes No Software Now Yes No

BE SURE OF YOUR ISSUE EACH MONTH. SUBSCRIBE TODAY.



BOOKS, BACK ISSUES, SPECIAL PUBLICATIONS, BINDERS — SEE OVER

Moorshead Publications

1300 Don Mills Rd., Don Mills, Toronto, Ont. M3B 3M8

MERCHANDISE ORDER Please fill out form overleaf
 SUBSCRIPTIONS: NEW SUBSCRIPTION RENEWAL

Electronics Today

One year (12 issues) \$22.95 Two years (24 issues) \$37.95.

Computing Now!

One year (12 issues) \$22.95 Two years (24 issues) \$37.95

Computers in Education

One year (10 issues) \$25.00 Two years (20 issues) \$45.00

Outside Canada (US Dollars)

For U.S. please add \$3.00 per year other countries add \$5 per year

NAME _____

ADDRESS _____

TOWN/CITY _____ PROVINCE/STATE _____

CODE _____ DATE _____

POSTAL CODE _____

- Cheque enclosed DO NOT send cash
- Mastercard Account No. _____
- Visa Account No. _____
- American Express Account No. _____

Expiry Date _____

Signature _____

INDEPENDENT LAB TEST SHOW
 NEW ELECTRONICS TODAY
 BINDERS TO BE NEW AND IMPROVED!

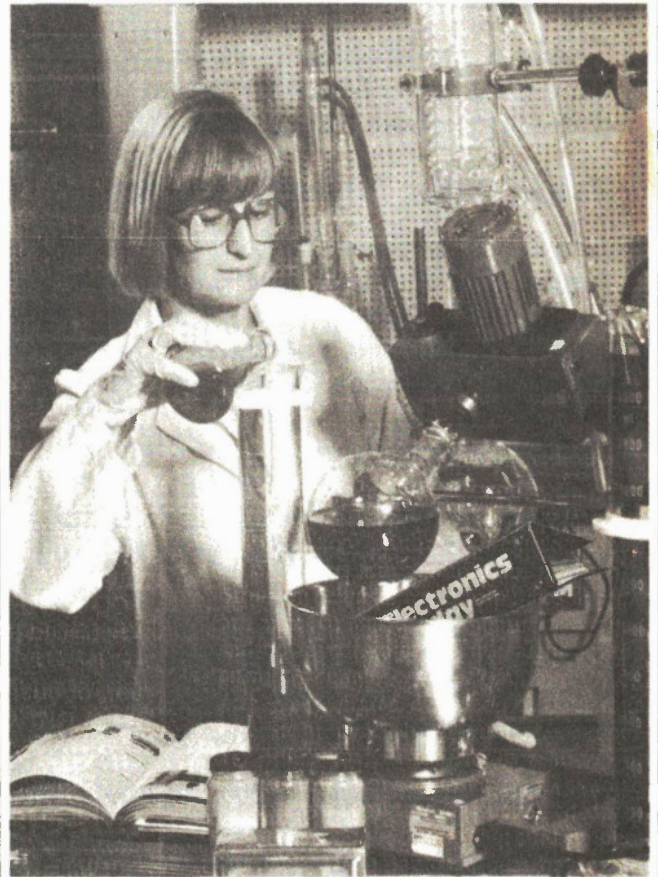

WE thought that the Electronics Today magazine binders had reached a state of perfection unmatched by any other product short of Brian Mulroney's suits.

Then the boys in the back room got at them and stayed up late at night redesigning the system that holds the rods that hold 12 issues of Electronics Today without cutting or punching.

They moved the rod holders further apart so that the spines of the magazines aren't ever crumpled, and they grouped the rods in pairs to hold the magazines neatly a nice distance apart.

We were overwhelmed. We called NASA to say that these binders should be taken on the next shuttle flight and shown to a grateful world on the evening news, but we haven't heard back yet.

The binders are available for \$9.75 each; the scientists in the lab haven't got around the fact that Ontario residents must add 7% Provincial Sales Tax. Send to:

Binders
Moorshead Publications
 1300 Don Mills Road,
 Don Mills, Toronto, Ont. M3B 3M8

Almost Free Business Software

The image displays several screenshots of business software. At the top left is a window titled 'PCWINDW22' showing a calendar for Friday, August 9, 1985, with a list of events such as 'Meeting with IBM' and 'Tuna Plant inspection'. To its right is a 'NOTE PAD' window with various keyboard shortcuts and printer settings. Below these is a 'MAXIT' window showing a 10x10 grid of numbers for a game. At the bottom right is a 'PC-TOUCH' window with a typing exercise and statistics.

Software Now! is pleased to make this amazing disk offer. Over the last year, Brian Greiner, our "By the Boards" columnist has been scanning Canada's computer bulletin boards for the best and most interesting public domain software available. We are pleased to make available a collection of the best business-oriented public domain software for PC-DOS and MS-DOS users. Naturally we've also included several fun programs as well, but we think you'll find this to be the most powerful set of public domain programs ever collected on a single disk . . . all for only \$19.95.

Here is what you get:

MA.BAS

The Micro Accountant is a complete, working accounting and check register program, with a 25K documentation file.

PCWINDW22

A "Sidekick" —like co-resident window utility. Pop-up window functions include ASCII table, stopwatch, alarm, printer set-up utility and notepad. The entire program takes up less than 30K of space on your disk.

PSHIFT

A time saving and convenient 'memory partition' utility. Lets you define up to nine memory areas. Load programs such as DBase II and WordStar into separate partitions and 'flip' between them instantly with simple keystrokes.

PC-TOUCH.BAS

Increase typing speed and accuracy with this easy-to-use typing tutor. Also provides accuracy and speed statistics.

PCYEARBK.EXE

Appointments and reminder program to help you keep track of your time.

TASKPLAN.BAS

Project management software which lets you track up to 50 tasks during 50 time periods (days, weeks or months).

NO COLOR

A handy little utility for users with monochrome monitors and colour software.

MAXIT

A simple but subtle game for two human opponents, or one player and the computer. Hours of fun!

PERTCHT

A sophisticated project management tool using the Program Evaluation Review Technique.

PLUS

More utilities to help organize maintain and copy your files, including a 'monitor saving' program which blanks out your screen when it is not in use.

\$19.95

plus 7% sales tax for Ontario residents

Almost Free Business Software
Moorshead Publications
1300 Don Mills Road,
Don Mills, Toronto, Ontario
M3B 3M8

1-416-445-5600

Have your Visa MasterCard or American Express card ready.

Please note: Software Now! distributes this software 'as is' and makes no guarantee that the software will perform on all systems. Programs with a .BAS file name extension require BASIC in order to run. Though all programs on the disk are freely distributed on public bulletin boards, some request users to send a token 'user fee' to the program's author. Please note that payment of such user-fees is entirely optional, but users who do send it in may be eligible for program enhancements and support.

Designer's Notebook: Power Line Filtering

*A look at getting clean power from the utility line,
and some of the techniques used.*

By Martin Pill

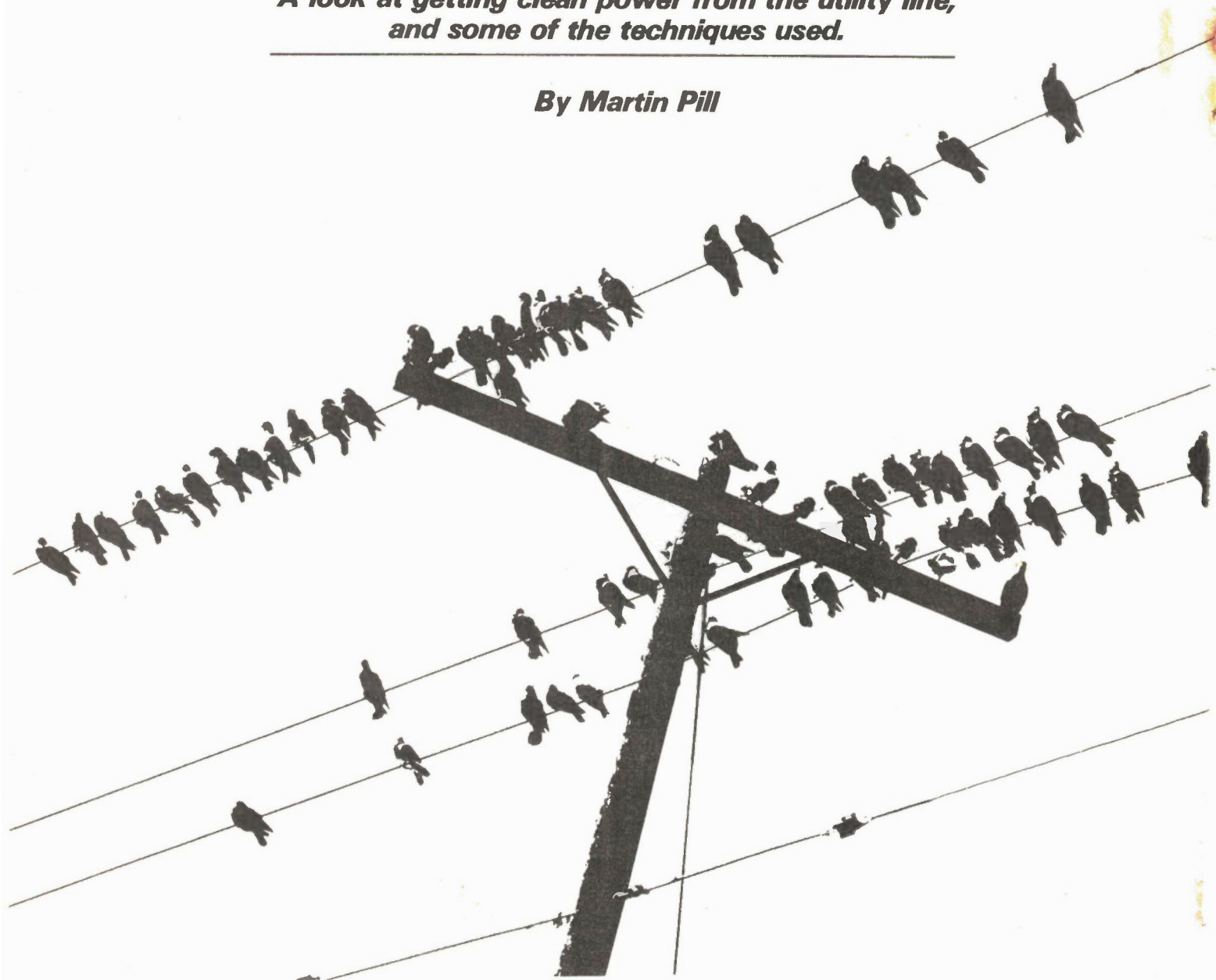

NOISE on the power line is at its worst when it consists of transients or radio-frequency interference (RFI). These go right through most power supply units and can be maddening when it comes to instrumentation or potentially disastrous if they cause data loss in computers.

The 120V, 60Hz supply is normally a fairly pure sine wave, but can be con-

taminated by appliances connected to the circuit, the main culprits being appliances whose operation produces sudden changes in the current drawn from the line. These sharp fluctuations can produce RFI noise currents which are transmitted via the power wiring.

There are two ways in which RFI can be propagated. In the transverse or sym-

metrical mode, the RF current travels down one side of the line and returns via the other side. In the common or asymmetrical mode, the RF current flows down both the line and neutral and returns via the ground circuit.

Transverse mode signals are more likely to cause problems than common mode, but are more easily filtered out.

Electronics Today February 1986

Common examples of offending appliances are vacuum cleaners, drills, industrial machinery and devices controlled by thermostats. Examples of filters which can be fitted by manufacturers or installed by the designer are shown in Fig. 1.

At What Cost?

Ideally, all this should be taken into account at the time of manufacture of the equipment likely to cause RFI; induction motors generate little radio noise and are preferable to commutator motors, quick acting thermostats reduce arcing at the contacts and cause less interference, and so forth. Where an appliance is known or likely to cause interference, suppression components should be fitted, or provision made for easy retrofit.

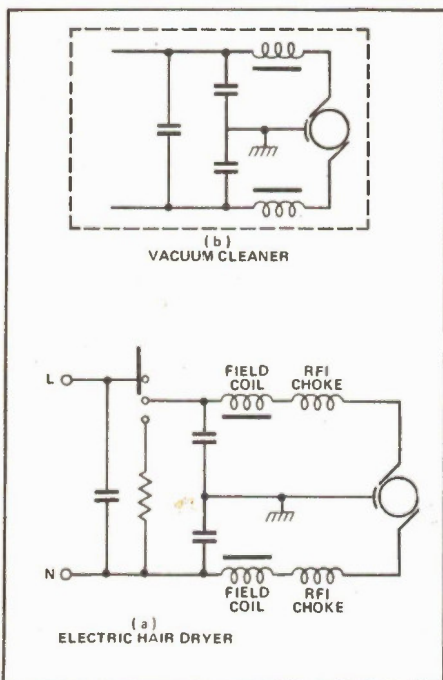

Unfortunately, this adds to the cost of the product and so is not often done. It is not possible for the home user to fit full internal RFI protection to equipment, but if it is observed that the operation of a particular appliance is associated with interference, connection of a high voltage 0.1 μ F capacitor across the line and neutral at the appliance may help. The voltage rating should be as high as possible to allow for voltage spikes; 600V is a reasonable figure.

Even if all your equipment were to be suppressed, the computer or instrument would still be susceptible to interference from any other equipment on nearby property. In order to obtain full protection, a filter should be fitted in the line to the sensitive load.

The circuit for a filter generally consists of a solid-state transient suppressor, shunt capacitors and series inductors. The

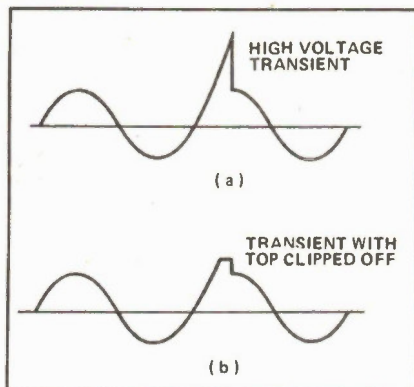

Fig. 2. The action of a transient suppressor. The high voltage spike has its top clipped off to bring it down from several thousand volts to a few hundred.

transient suppressor removes high voltage spikes caused by such things as lightning and the switching of inductive loads, and acts like a high-power bidirectional zener diode. It is connected across the line and neutral and conducts when the voltage across it exceeds a set value, often 200-300V, thus cutting off the top of the spike (Fig. 2). Part of the spike is left, and the fast-rising edge could still trigger a logic gate. However, the edge is rounded by the inductor in the RFI section.

Filters

RFI filters are made up from either capacitors or inductors, or a combination of the two. The reactance of a capacitor, the AC equivalent of resistance, is inversely proportional to the frequency and thus the capacitor provides a low impedance path for RF while presenting a high impedance at the power line frequency.

Taking the previously mentioned 0.1 μ F capacitor, at the power line frequency of 60Hz its reactance is about 26k ohms, and at a 1MHz interference frequency reduces to 1.6 ohms. From this it can be seen that little current will flow at 60Hz (about 4.5mA), but the RFI will be shorted out. The attenuation of the spike by a single capacitor across the line depends on the source impedance; if the power line impedance at 1MHz rises considerably due to its inductance, the spike will be nicely reduced.

Unfortunately, all capacitors have inherent inductance and resistance as shown in Fig. 3, so each capacitor must be considered as a complex impedance consisting of L, C, and R. The inductance and resistance are very small, but limit the upper frequency at which the capacitor will be effective: about 30MHz, depending on the physical construction of the capacitor. Increasing the capacitance would lower the impedance, but for safety reasons C1 should not be greater than 0.1 μ F.

A practical circuit is shown in Fig. 4. As explained, C1 should not exceed 0.1 μ F (100nF), and the ground capacitors C2 and C3 should not exceed 0.005 μ F (5nF) in case the unit is used with a faulty grounding system; the chassis of the load

could then be energized via C2 and C3. The higher the voltage rating, the better. There are specially designed capacitors available with low inductance; if these can be obtained, so much the better.

Inductive Section

To improve the performance of the filter an inductive section is added. Inductors have the opposite property of capacitors in that the reactance increases with increasing frequency. Since the inductor presents a rising "resistance" to high frequencies it chokes out the RFI currents.

In order to provide suppression of the asymmetrical currents which flow down each lead, it will be necessary to connect an inductor in both the line and neutral leads. For VHF suppression, 5 μ H to 10 μ H will give good results. The two inductors can be wound on a common core (see below).

Despite the use of high quality components, there is always the chance that they might break down, and therefore a fuse has been inserted in the line lead. Note that the electrical code frowns on any fuses or switches in the neutral wire.

Construction

Design and construction of a filter is straightforward. The parts can be mounted in a utility box or other suitable enclosure. The transient suppressors are usually listed in parts catalogues as thyrectors or varistors; typical examples would be the GE-MOV 130 series or the International Rectifier Zenamic series.

The dual inductor can be wound on a 24mm toroidal ferrite core; the method

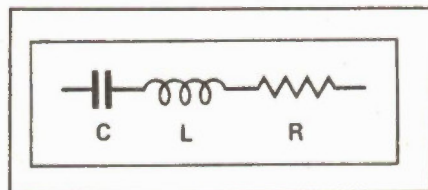

Fig. 3. The AC circuit equivalent of a capacitor: a capacitor incorporates capacitance, inductance and resistance.

used is bifilar winding: both leads are paralleled and then eight turns are wound onto the core and secured with epoxy (see Fig. 5). Since the unit is meant to be used with low-power devices such as instrumentation, a 2 or 3 ampere fast-acting fuse should be adequate.

Airborne Radiation

Sometimes the interference arrives (or leaves) in the form of external radio waves rather than the wire-conducted type we've been discussing. Many computers and even instruments have plastic cabinets for the sake of economy, and these permit unhampered entry and exit of radio waves. Computer and test equipment logic circuits generate a fair amount of RF due to the fast rise and fall times, and if radio and/or TV interference occurs, it

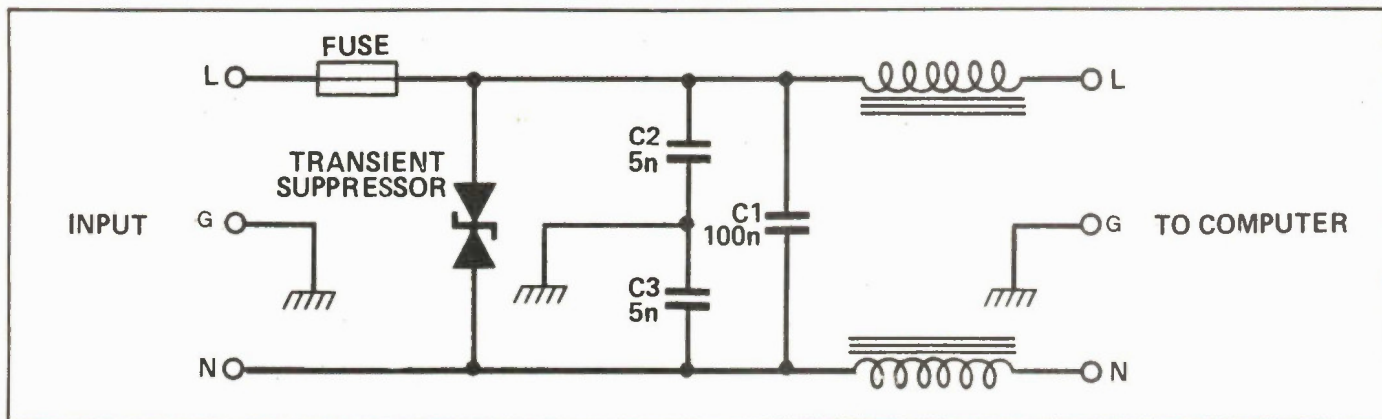

Fig. 4. The circuit diagram of the radio frequency interference filter.

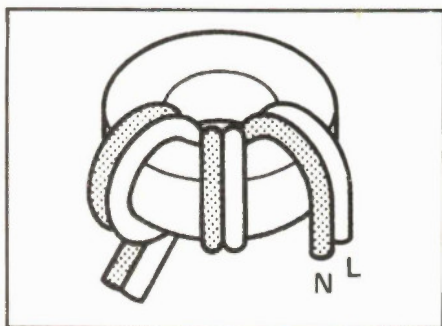

Fig. 5. Bifilar winding on a ferrite core.

will be conducted out through the power leads, radiated through the cabinet, or both. The power filter will stop RF from being injected into the power lines, but a plastic cabinet means some grounded shielding must be added, perhaps with

thin aluminum sheets or foil. If the RF is leaving via signal cables, it becomes a test of the designer's skill in shielding, grounding, and relocating them to minimize interference. ■

WHY YOU SHOULD SUBSCRIBE TO ELECTRONICS TODAY!

What's new in electronics. From our information columns to feature articles on new devices and methods, we bring you up-to-date on what's happening in the constantly changing world of technology.

How it works. We take the practical approach to circuits, computers, gadgets, components, and techniques, giving you an explanation of how it works and how you can make it work for you.

Your favourite projects. From doorbells to complex computer additions, our projects include everything you need to build projects for fun, for practical use, for learning.

Whether you're a beginner or an old hand, Electronics Today has what you want. There are series for beginners who want to learn basic theory as well as practical techniques, series for the advanced designer who'd like to share the ideas of other technicians, circuit ideas, reviews of new products of technical interest, and more.

And, it's Canadian, giving you Canadian sources for your needs.

A subscription to Electronics Today also makes a great gift both for someone just getting started in technology and for the advanced technician.

Electronics Today: the book of ideas.

See the subscription form in this issue, or contact:

Moorshead Publications
 Subscription Department,
 1300 Don Mills Road, Don Mills, Ontario
 M3B 3M8 (416) 445-5600



Switching Regulator

By D.E. Moffitt

Q5 is a MOSFET used as a pass transistor. Q3 acts as a constant current source giving 1mA into the emitters of Q1 and Q2. The portion of the current that each transistor

ponents is described elsewhere. C2 and R3 serve to pull Q1 and Q2 quickly through their linear region to improve the comparator action.

This type of circuit is known as a ripple regulator because the switching is controlled entirely by the ripple on the output. It has the advantage of simplicity but the disadvantage is that the switching fre-

quency will vary considerably with changes in the load, so it is not possible to tune the circuit for optimum performance at one particular frequency. Output filtering to give a perfectly smooth voltage is also more difficult.

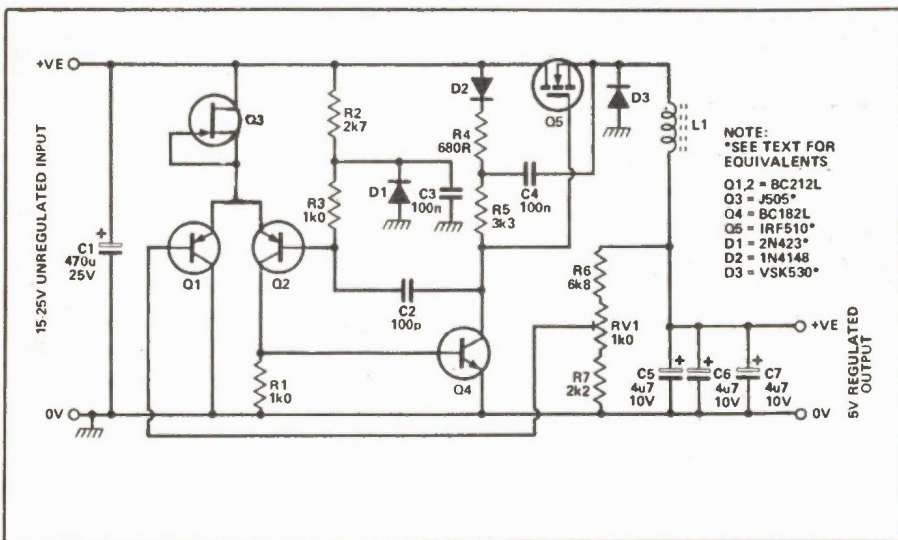

will take depends on the relative voltages of their bases. If Q1 base is at a much lower voltage than Q2 base, Q1 will take the current. If Q2 base is lower than Q1 base, Q2 gets the current. There is a small linear region when the base voltages are almost equal and the transistors share the current, but otherwise one transistor or the other gets all of it. A portion of the output voltage is tapped off by RV1 and applied to the base of Q1 while Q2 base is held at a constant voltage by D1. (I used a band-gap reference diode there, by the way, but in this application a zener would be just as good.) RV1 is set so that when the output is at exactly 5V, the voltage at the slider equals the voltage of the reference diode. If the voltage at the output rises, so will the voltage of Q1 base, so current will be steered into Q2, turning on Q4 which in turn takes the gate of Q5 low. This turns off Q5, the current in the inductor begins to decay, and when the inductor current becomes lower than the load current the output voltage will begin to drop. When the output voltage drops below 5V, Q1 base goes low with respect to Q2 base so current is steered into Q1 and away from Q2. Q4 then turns off, allowing the bootstrap action of C4 and R5 to take the gate of Q5 high. Q5 turns on, the current in L1 builds up, the output voltage eventually rises slightly and the whole cycle takes place again. The entire circuit will therefore be in a state of continuous oscillation, around 100kHz in the prototype.

The action of the bootstrap com-
Electronics Today February 1986

ONLY FEW LEFT 50% OFF LIST PRICE:

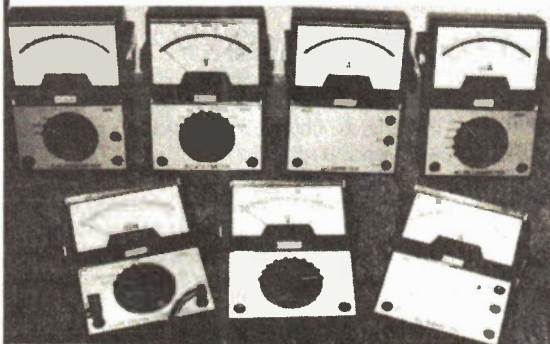

- SINGLE FUNCTION
- PRECISION METERS
- BENCH/PORTABLE
 - 2% ACCURACY
- MIRRORED SCALE
- FOR EDUCATION
 - INDUSTRY
 - HOBBYIST

\$28.85
EACH
WHILE THEY LAST

Model 6000 AC Milliammeter
Model 6001 AC Ammeter
Model 6003 DC Microammeter
Model 6005 DC Ammeter
Model 6007 DC Voltmeter

0-5/25/100/250/1000mA
0-1/5/10/25A
0-50/100/250/500/1000uA
0-1/5/10/25A
0-1/2.5/5/10/25/50/100/
250/500/1000V

PRECISION WATTMETERS

120/240/480V Scales. 0.5 and 1A ranges,
1% Accuracy.

NOW ONLY \$85.00 each — less than
half original price.

MANY OTHER INSTRUMENTS — ONE OF A
KIND, DEMOS ETC.
TOO NUMEROUS TO LIST!

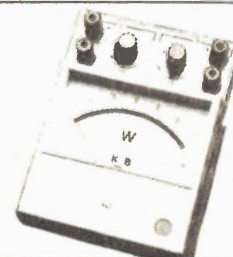

KB ELECTRONICS

355 Iroquois Shore Rd. Oakville, Ont. L6H 1M3 Telex: 06-982396 (KBEL)

Phone: 416-842-6888

**Into the fitness craze?
Build this heartbeat
monitor to see how
you're doing.**

By R.A. Penfold

THE MAIN application for a heart rate monitor is in fitness testing, where the time taken for the heart rate to return to normal after some fairly strenuous exercise has been taken is used as an indication of fitness. For those who are not interested in exercising to keep fit, a heart rate monitor represents an unusual and interesting project which is still worthy of consideration. This unit has an analogue display with a full scale reading of 200 beats per minute, and it operates by detecting electrical signals in the user's body. It requires just a couple of simple hand-held electrodes which pick up the signals, and no specialized electrodes or other components are needed.

Heart Beat Detection

There are actually several ways of electronically detecting heart beats. One system is to use sound in what is a sort of electronic version of an ordinary stethoscope. Another system uses a strong light which is shone through one of the user's fingers, with a photocell to detect variations in the intensity of the light passing through the finger. These vary in sympathy with the heart beat. Both these systems suffer from the problem that the user must remain perfectly still if spurious signals are to be avoided.

The system used in this case is to simply monitor the electrical signals within the body, the most powerful of which is the one associated with the heartbeat. This method is not without its difficulties, the main one being that the electrical signals within the human body are extremely small. In fact signal levels of under a millivolt peak to peak are obtained even from the heart beat signal. Apart from necessitating the use of high levels of amplification there is the attendant problem of stray pick-up of AC hum and other electrical interference. This interference is normally strong enough to completely swamp the wanted signals. Fortunately, the signals that are of interest in this application are at very low frequencies of around 1 to 4 Hz, whereas stray pick up consists almost entirely of frequencies at 50 Hz or more. Lowpass filtering can therefore be used to eliminate problems with interference.

Use of a differential amplifier to balance out interference also helps to give

Heartbeat Monitor

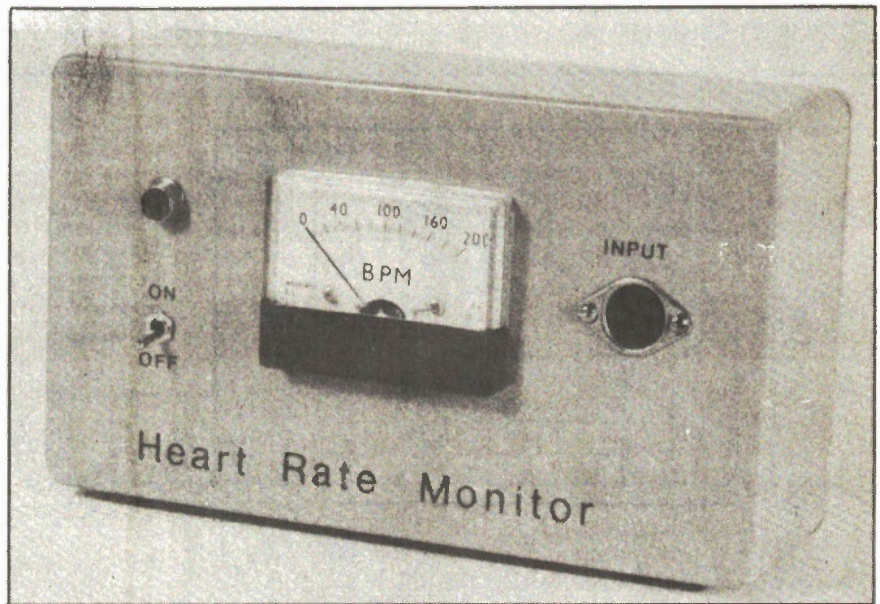

reliable results. The interference signals are virtually identical at any two points of the body, and largely cancel out one another when fed to a differential amplifier. On the other hand, the wanted signals vary considerably from one point to another, and provide a good voltage difference between practically any two well separated points.

One other problem with the monitoring of electrical signals in the body is that of actually making suitable connections to the user. This is not quite as easy as one might think, and simply holding a couple of electrodes, one in each hand, is not likely to give good results. The main problem is that of maintaining a constant contact between each electrode and the skin. Intermittent or even slight variations in the degree of contact generate signals which give spurious operations of the monitor and totally useless results. The standard way of tackling the problem is to use three electrodes that are either taped in place or secured by self-adhesive pads. One electrode is placed on each wrist, and one (the earth electrode) is fitted to the left ankle. A sort of conductive jelly is used to ensure that a good contact is provided between each electrode and the skin. Here we are not concerned about monitoring waveforms, and are only interested in obtaining signals to trigger a frequency counter. This enables a simplified system to be adopted, where an electrode consisting of a pad soaked in salt solution is held in each hand.

System Operation

The block diagram of Figure 1 shows the overall make-up of the unit.

With the low frequencies involved in this application it would be feasible to use a single operational amplifier to provide all the gain, but better results are obtained using a three stage circuit which is basically a differential amplifier having a non-inverting amplifier added at each input. On the face of it the unit lacks the all important lowpass filtering, but this is in fact incorporated into the three amplifying stages. As only two filters are encountered through each signal path this gives only 12dB per octave filtering, and the cutoff frequency is at just a few Hertz. This gives adequate suppression of AC hum and other interference, and a certain amount of breakthrough is tolerable in this application.

In order to drive a frequency counter circuit reliably a 'clean' pulse signal is required. This is obtained by feeding the output of the differential amplifier to a simple trigger circuit which has a substantial amount of hysteresis. This hysteresis gives good immunity to noise on the input signal. The output of the trigger circuit drives a LED indicator which will flash on and off in sympathy with the user's heart beat when the system is operating properly. This is useful when initially setting up the equipment, and irregular flashing of the LED makes it clear if the electrodes are not properly in place or there is some other problem giving spurious triggering.

Electronics Today February 1986

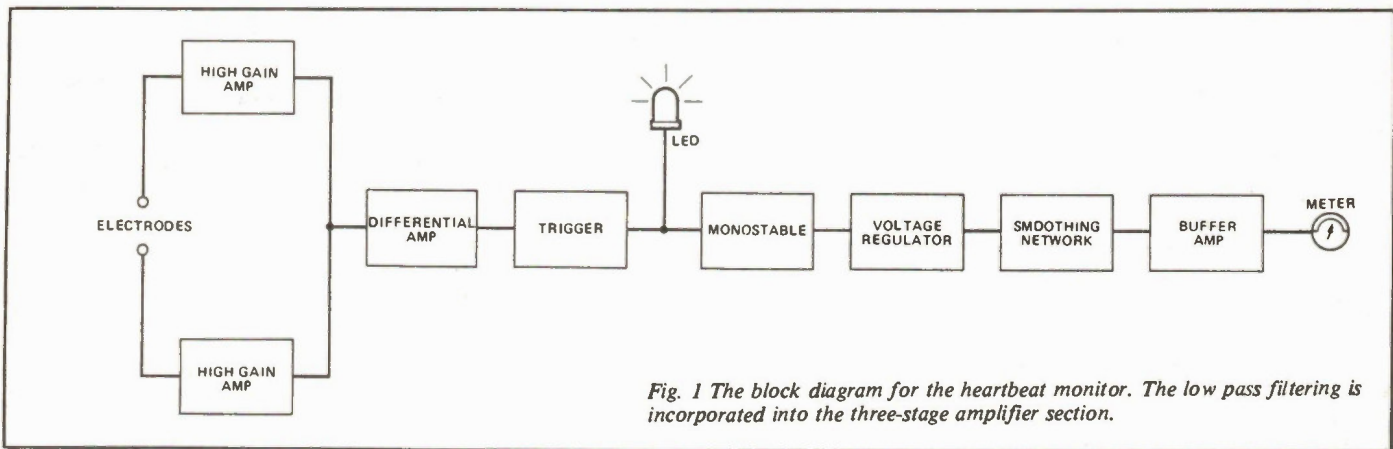

Fig. 1 The block diagram for the heartbeat monitor. The low pass filtering is incorporated into the three-stage amplifier section.

There are difficulties in producing a frequency meter to register the heart rate due to the low frequencies involved. For the ultimate in speed and accuracy a digital system to measure the duration of each input cycle would be used, but this would be excessively complex and expensive. The more usual solution, and the one used here, is to use a slightly modified version of an ordinary analogue frequency meter.

This type of circuit is based on a monostable, which is merely a circuit that produces an output pulse of fixed duration each time it is triggered by an input pulse. With a series of input pulses at a fixed frequency an output of the type shown in Figure 2(a) is obtained. In this example the mark space ratio is 1 to 5, and the average output voltage is one sixth of the high state output voltage. If the input frequency is doubled, as in figure 2(b), the mark space ratio becomes 1 to 2 and the average output voltage is then one third of the high state output potential, or double its previous level. In other words, the average output voltage is linearly proportional to the input frequency.

When dealing with audio frequencies the meter circuit can be driven from the output of the monostable without the need for any further signal processing since the meter will be unable to follow the rapidly changing output voltage, and

will respond to the average potential. Here the output frequency is so low that the meter reading would be very unstable, and the required average reading would not be obtained. This is overcome by using a smoothing circuit to reduce the ripple to an acceptable level. The attack and decay times of the smoothing circuit are identical so that the output potential is equal to the average input potential. A drawback of this system is that in order to obtain a low ripple level on the output (and a stable meter reading) the unit is quite slow to reach an accurate initial reading, and to then respond to any changes in rate. However, neither of these are serious drawbacks in practice where something less than an instant response is perfectly acceptable.

The power source is a 9 volt battery, and the supply is not stabilized. A zener regulator is therefore used to stabilize the high stage output voltage of the monostable so that variations in supply voltage do not significantly affect meter readings. The smoothing circuit has a high output impedance, and a buffer amplifier therefore has to be used between this circuit and the meter.

Circuit Operation

Figure 3 shows the full circuit diagram of the Heart Rate Monitor.

The circuit is powered by a single 9V

battery, but R1, R2 and C1 form a centre tap on the supply rails to give what is effectively a centre 0V rail and dual balanced 4.5V rails for the operational amplifier circuitry. The resistor-capacitor network at the input of each preamplifier helps to avoid problems with noise caused by poor electrode contact. IC1 provides the operational amplifiers for the preamplifiers, and these both operate in what is almost the standard non-inverting mode. The departure from the standard configuration is the use of a common resistor (R7) in the feedback networks. This is done to aid the phasing out of signals that are common to both channels. C5 and C6 the filter capacitors.

IC2 is the differential amplifier, and this uses a standard operational amplifier configuration for this stage. C10 is the filter capacitor for this stage. C4, C7, and C8 are DC blocking capacitors, and although these may seem to be superfluous, due to the high gain of the circuit these are in fact beneficial. They prevent the inevitable small DC offset voltages from seriously upsetting the biasing of the amplifier.

The trigger circuit is based on another operational amplifier (IC3). This device operates here as a voltage comparator with the output of IC2 coupled to the non-inverting input and the inverting input biased to the centre tap on the supply rail. The output of IC3 therefore trig-

The printed circuit foil side for the Heartbeat Monitor.

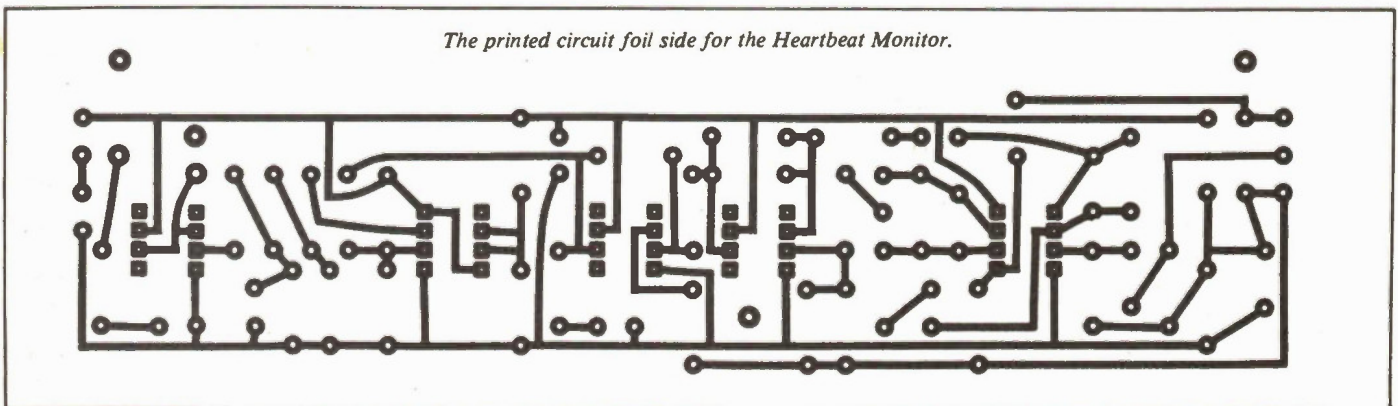

gers to the high state on positive output half cycles from IC2, and to the low state on negative output half cycles. R16 introduces the hysteresis to the trigger circuit. D1 is the LED indicator which is switched on when the output of IC3 goes high.

IC4 is a 7555, the low power (CMOS) version of the popular 555 timer. The CMOS version is preferable in this circuit as it keeps the total current consumption of the circuit down to a reasonable figure around 10 milliamps. It acts as the monostable, and the trigger pulses are coupled to its trigger input by C11. The highpass filtering effect of C11 plus R17 and R19 ensures that IC4 receives suitably short trigger pulses.

R21 and D2 clip the output of IC at 6V8 and R22, R23, and C13 are the smoothing circuit. The value of C13 has to be chosen to give a good compromise between response time and reading stability. If preferred a lower value can be used here to give a faster response time, but

this could result in significant meter 'jitter'. IC5 is the buffer amplifier, and as there is no negative supply rail this has to be a type capable of providing voltages right down to the ground rail potential. ME1, R25, and RV1 form the voltmeter circuit. RV1 permits accurate calibration of the unit.

Construction

Refer to Figure 4 for details of the printed circuit board. Construction of the board is quite straightforward and should pose no real problems. Be careful to fit IC4 the right way around; this has the opposite orientation to the other integrated circuits. Although IC4 is a CMOS device it has built-in static protection circuits which render any special handling precautions unnecessary. The same is not true of IC5 which has a MOS input stage. It should consequently be mounted in an integrated circuit holder and the other antistatic handling precautions should be

Parts List

Resistors

R1,2	3k9
R3,4,5,6,20	1M8
R7,10,11	27k
R8,9	3M3
R12,13	3M9
R14,15	15k
R16	39k
R17,24,25	10k
R18,21	1k
R19	33k
R22,23	1M5
RV1	47k sub-min horiz. preset

Capacitors

C1	1000uF 16V PC elect.
C2,3	470nF carbonate
C4,7,8	4u7 63V PC elect.
C5,6	22nF carbonate
C9,10	10nF polyester
C11	47nF polyester
C12	100nF polyester
C13	10uF 50V PC elect.
C14	100uF 10V PC elect.

Semiconductors

IC1	LF353
IC2	LF351
IC3	741 (8 pin DIL)
IC4	7555
IC5	CA3140E
D1	Red Led
D2	6V8 zener diode

Miscellaneous

SW1	SPST ultramin toggle
ME1	100uA panel meter
SK1	3-way DIN
B1	9V battery

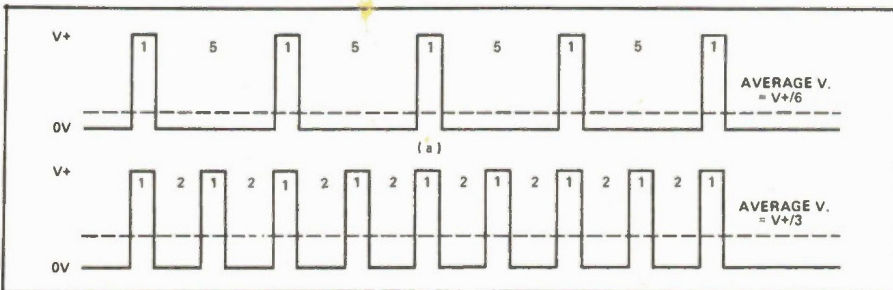

Fig. 2 Two waveforms showing the markspace ratios of the output in response to (a) a fixed frequency input and (b) the same input at double the frequency.

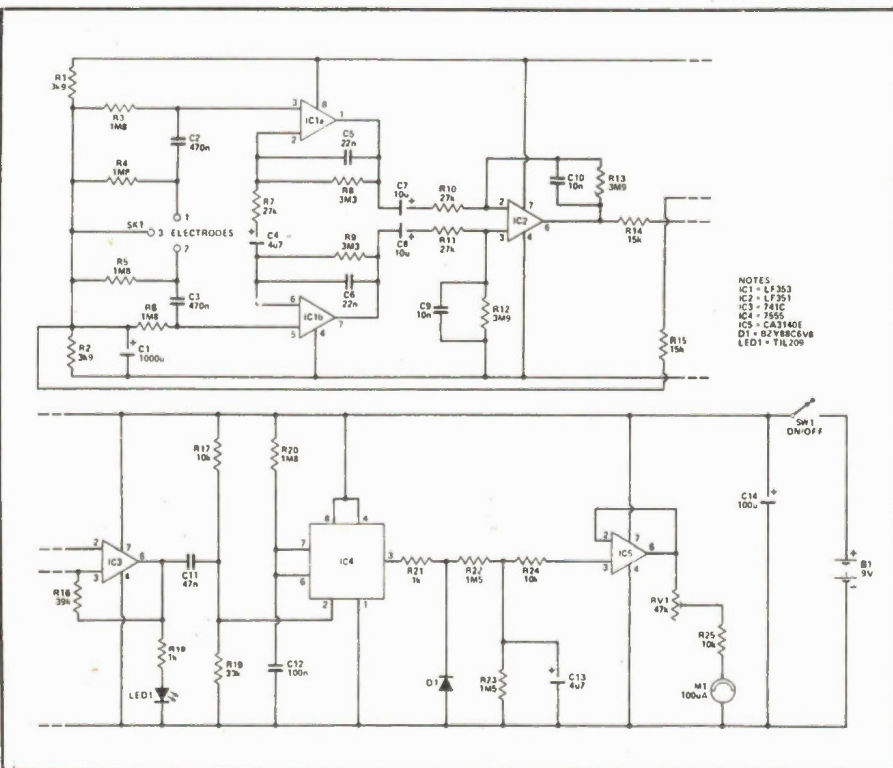

Fig. 3 The full circuit for the Heartbeat Monitor. SK1, a three-way DIN, connects to the probes.

observed when dealing with this device. Single-sided Veropins are fitted to the board at the points where connections to off-board components will be made.

The front panel layout utilized for the prototype can be seen in the photographs, but any layout that leaves the base section of the case free can be used. The base area must be left clear as the printed circuit board is mounted here, and it simply slots into the guide rails moulded into the case. There is provision for mounting holes in the printed circuit board if the specified case is not used. Mounting the meter can be a little difficult as a main mounting hole some 38 millimeters in diameter is required. A fairly easy way to make this is to first drill a series of small, closely spaced holes just inside the periphery of the required cutout. A needle file is then used to join up the holes, after which a large round file is used to tidy up the cutout and enlarge it to precisely the required size. The meter can then be used as a sort of template when marking the positions of the four small (about 3.3 millimetres in diameter) mounting holes.

To complete the unit the small amount of hard-wiring is then added. Power can be provided by a small 9V battery. For safety reasons the unit should not be powered from an AC supply.

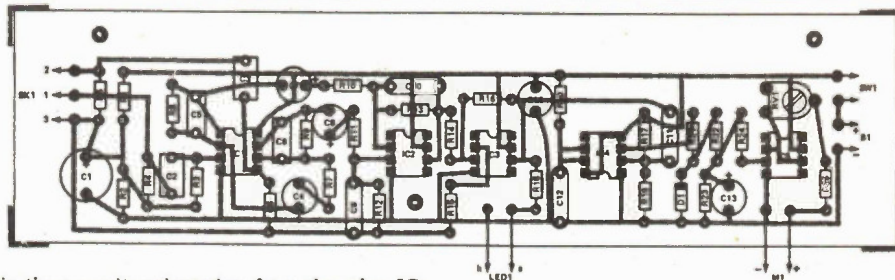

Fig. 4 The pcb overlay. Note that IC4 is in the opposite orientation from the other ICs.

A plug and cable assembly is needed to connect the electrode pads through to SK1. This merely consists of a three way DIN plug wired to a couple of crocodile clips via insulated leads up to about 1 meter long. An ground connection is provided on SK1 should you wish to use it, but this is not really necessary in a simple heart rate monitor application.

Testing and Use

The electrodes can be made by cutting a paper kitchen towel in half. Each half is folded up into a small rectangle about 20 millimetres or so square, and they are then held in the crocodile clips, one in each clip. Finally, both pads are soaked in a solution of table salt. In fact ordinary tap

water may well give a sufficiently good contact, but initially at any rate, it is better to be certain of good results by using salt solution. With the unit switched on and one electrode held between the thumb and forefinger of each hand the LED should flash on and of at a reasonably steady rate, and a meter reading should be obtained. It might take a short while for the LED to settle down to a steady rate, and it will also take a while for the meter reading to stabilize. Do not worry if the LED does not flash at an absolutely steady rate as a normal heart beat does vary slightly in frequency. For example, one's heart rate when inhaling is generally slightly different to the rate when exhaling. A grossly irregular flashing of the LED indicates a circuit fault or poor elec-

trode contact rather than a serious heart condition.

Probably the best way to calibrate the unit is to first take one's pulse in the conventional manner, and then use the monitor. Once the reading has stabilized a helper can set RV1 to give the correct meter reading. The reading on ME1 must be doubled to give the heart rate in beats per minute, but a new scale can, of course, be marked on ME1 using rub-on transfers if desired. However, meter movements are very delicate and great care would have to be taken in order to avoid damaging this component.

After use the pads should be removed from the crocodile clips, and to avoid corrosion the clips should be wiped clean.

Product Mart *Where Buyers Find Sellers*

HOBBITT ELECTRONIQUE

**WE DON'T SELL COMPUTERS.
WE JUST SELL THE PARTS!**

Send your name and address along with \$1.00 to: 7454 Langelier, St. Leonaud Montreal, Que. H1S 3A7.
Tel: (514) 259-5581.

ELECTRONIC SURPLUS INDUSTRIES LIMITED, we sell used industrial/military test instruments, including oscilloscopes by HP Tektronix, Philips; Signal generators, meters, components, tubes, etc. 1191 Lawrence Avenue West, Toronto, Ontario M6A 1E2 416-787-1837.

FOR \$10 per kit \$2 handling, receive free flyer and any of the following. #1: 1000 asst'd pcs choke — capacitor — resistor — transistor — hardware — etc. #2: 200 asst'd ceramic — #3: 100 asst'd silver mica — #4: 100 asst'd mylar — #5: 50 asst'd tantalum — #6: 50 asst'd electrolytic — #7: 50 asst'd feed-through — #8: 50 asst'd metallic silver mica (Elmenco) #9: 25 asst'd variable — #10: 100 asst'd 5MM L.E.D. — #11: 100 asst'd l/c sockets — #12: 6 AA nicad batteries — #13: 15 PL-259 connectors — #14: 10 UG88 connectors — #15: 10 asst'd Lorlin switch. All new material. Unconditional guarantee. **SURPLUS ELECTRO QUEBEC**, 2264 Montee Gagnon, Blainville, Quebec J7E 4H5.

J&J ELECTRONICS LTD., Box 1437E, Winnipeg Manitoba R3C 2Z4. Surplus and Semiconductor Specialists. Do you get our bargain flyer? Send \$1.00 to receive the current literature and specials and to be placed on the mailing list for future publications.

**DO SMALL
ADVERTISEMENTS
ATTRACT ATTENTION?
WELL, THIS ONE DID!**

WHERE BUYERS FIND SELLERS

For more information Call:
(416) 445-5600

PRODUCT MART

Oscilloscope Memory Display

Does your oscilloscope persistently refuse to display slowly-changing waveforms? Here's a digital update for it.

By Ian Marshall

ANYONE who uses an oscilloscope will know how frustrating it is trying to view slowly-varying signals on a standard short-persistence screen. Waveforms such as capacitor charge/discharge curves, modulation envelopes in electronic music generators, transducer outputs and physiological signals just cannot be satisfactorily displayed and studied on a general-purpose oscilloscope.

This add-on memory display allows flicker-free viewing of such signals by storing ten seconds of signal and constantly refreshing the screen fast enough to eliminate visual flicker. The displayed waveform scrolls across the screen in real-time or can be frozen for closer examination.

A microprocessor need not be used to take advantage of Random Access Memory (RAM) and analogue/digital interface ICs. The memory display uses simple gates, flip-flops and counters to perform a function which does not warrant the complexity of microprocessor control. Apart from an inexpensive 2K RAM, an ADC and a DAC, only a few popular CMOS logic ICs are required to build the

display and all components should be readily available from a number of mail-order suppliers.

The Circuit

The input signal is first filtered and then sampled 200 times per second by the ADC. The resulting 8-bit data is stored in the 2K of RAM. In between the storing of samples, the entire memory contents are read out to the DAC and are displayed on the scope screen, with the timebase triggering from the scroll/freeze logic. The refresh rate of 200 per second (5ms per frame) is high enough to create the illusion of a continuous, flicker-free display.

In the normal scroll mode the control logic ensures that successive samples are stored in consecutive memory locations, so the memory contents are gradually updated at the rate of one location per display sweep of 5ms. The displayed waveform thus appears to scroll across the screen, taking ten seconds for all 2048 addresses to be updated.

In the freeze mode, successive samples are stored repeatedly at the same memory address at the extreme left-hand

side of the display. The stored data corresponding to the other 2047 addresses remains unchanged from sweep to sweep, so the display appears stationary.

The circuitry conveniently breaks down into the control logic (Fig. 2), the memory channel (Fig. 3) and the power supply (Fig. 4). The elements of the block diagram are readily identified in the complete circuitry.

The input signal is passed through anti-aliasing filter IC9 before being sampled by the ADC converter IC10. Samples are stored in the 2K x 8 memory IC8 at the address present on the outputs of display counter IC7. Except when a sample is being stored, the RAM is in read mode and as the addresses are sequentially counted through, data is read out to the DAC, IC11. The resulting analogue signal is low-pass filtered by IC12 before being displayed on the oscilloscope.

The scroll/freeze logic (IC2 and IC3a) dictates the relationship between sampling interval and display memory address and, with ICs 4, 5 and 6, produces the pulses necessary to take a sample, store it at the correct address, and trigger

the oscilloscope sweep. In the scroll mode, IC3a introduces a one cycle delay so that 2049 clock cycles elapse in between samples. During this time the memory address counter IC7 has progressed through all its states and advanced one further count. Samples are thus stored progressively one memory location later each time, creating the scrolling action. In the freeze mode, the sampling pulses are synchronized with the memory address so that only the one location is updated repeatedly while the rest of the data remains frozen.

Construction

With the exception of the power transformer, all the circuitry is contained on a single printed circuit board of standard dimensions (160 x 100mm). For ease of etching and assembly, the board is single-sided and requires several wire links to be inserted as shown on the overlay diagram. The short links can be of bare tinned copper wire, but the longer runs carrying the ADC control signals should be of insulated wire.

Once the links are in place, proceed with the IC sockets, resistors, capacitors and terminal pins. The copper tracks are quite fine and closely spaced around counter IC7 and the RAM IC8, so care is necessary to avoid forming solder bridges between adjacent tracks and pads around this part of the layout. Solder in the regulator IC13, but do not insert any of the other ICs at this stage.

The choice of transformer is not critical, and practically any type capable of providing between 6 and 9V RMS at 200mA will suffice. The raw DC voltage at the input of IC13 should not fall below 6.5V or the regulating action will be lost. If this happens, the output will track the input voltage but at about 1.5V lower. On the other hand, the mean input-output differential at the load current of 90mA should not be greater than 6V or the dissipation in the regulator will exceed the safe limit (0.6W for the TO-92 package). If you already have, say, a 12V transformer in the junk box, the excessive power can be burned off by using a TO-220 packaged 7805 regulator for IC13. This device has a maximum dissipation of 2W in free air, rising to about 8W with a 10 degree C/W heatsink fitted.

Mount the BNC sockets, the switch and the potentiometer on the front panel. A toggle switch is specified for the Freeze control, but if momentary action is preferred a biased toggle switch or a pushbutton could be used instead. The contacts should be normally closed.

Testing

Apply power to the Memory Display and check the DC voltages present at the input and output of the regulator, IC13. The output should be within 0.3V of 5V. If all is well, insert the negative rail generator IC14 and check that -5V is present on its output, pin 5.

Having established that the power

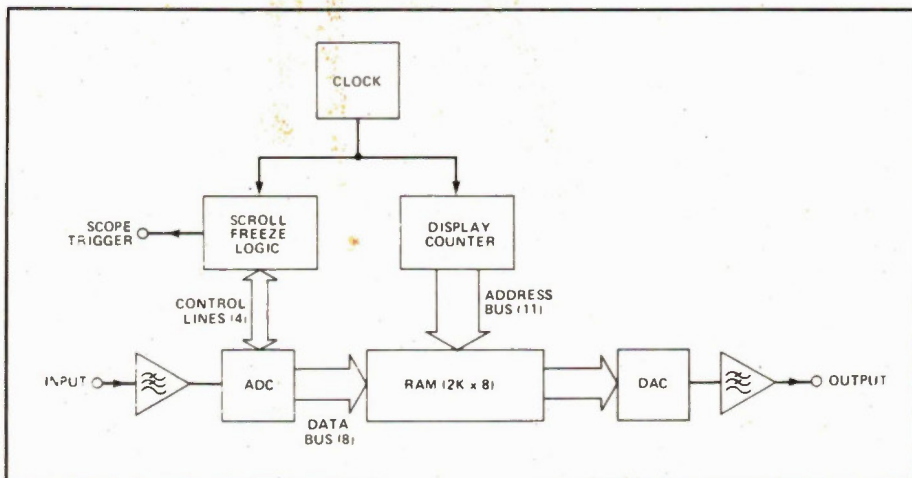

Fig. 1 Block diagram of the complete memory display.

supply is working correctly, testing of the logic circuitry can begin. It is assumed that the constructor has access to an oscilloscope, and waveform diagrams are given in Fig. 6. Proceeding systematically, using these waveforms and the circuit description given in How It Works, it is possible to insert the ICs in easy stages and check circuit operation. In this way any problems due to solder bridges, bent IC pins and so on will be quickly brought to light.

Begin with the master clock (0) generator IC1. A square wave at a frequency of approximately 400kHz should be seen at its output, pin 3, and should appear on the appropriate pins of other IC sockets across the board. Next insert IC2 and IC3 and monitor the Q11 output (pin 15) of IC2, which should be a squarewave of period 5ms. Now insert IC4 and check that each rising edge of Q11 produces a Start Convert (SC) pulse. At this stage the ADC (IC10) can be inserted, ensuring that

SC and the clock 0 reach it, and that its Busy line goes low for nine clock cycles after the SC pulse. With ICs 5 and 6 in place, the rising edge of Busy should be seen to produce the OE and WE pulses.

With the control logic tested and working properly, proceed to the memory channel. Insert the address counter IC7 and check that its outputs are clocked round by 0. If all is well, the RAM IC8 can be carefully put in its socket, and the DAC IC11 and the two op-amps IC9 and IC12 inserted. It should now be possible to apply a signal or a voltage level to the input socket and see the scroll/freeze action at the output socket, with the 'scope display sweep triggered by the OE pulse which is brought out to SK3, the Trigger output.

In Use

The waveform to be displayed is applied to the input socket and the oscilloscope trigger input is connected to the trigger

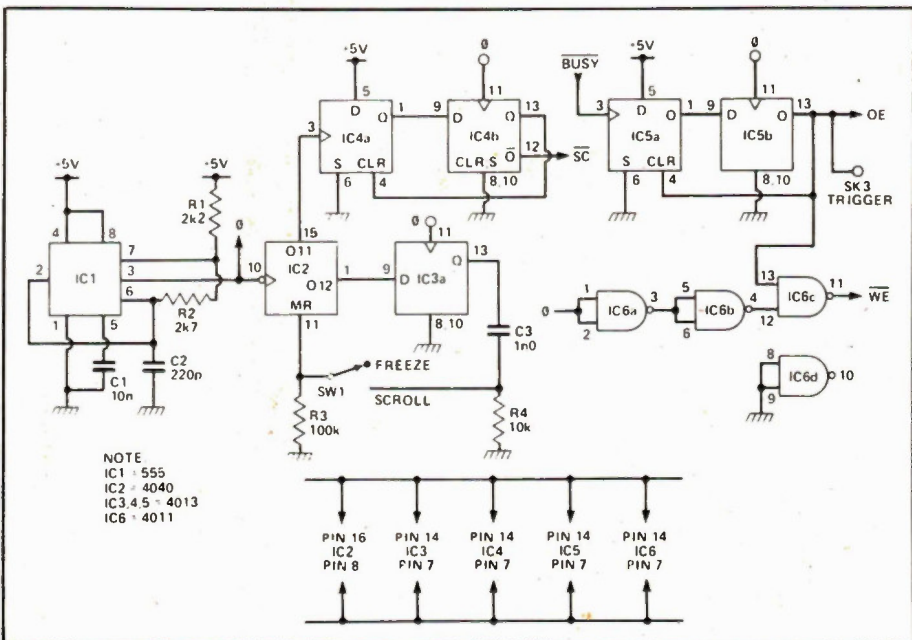

Fig. 2 Circuit diagram of the control logic.

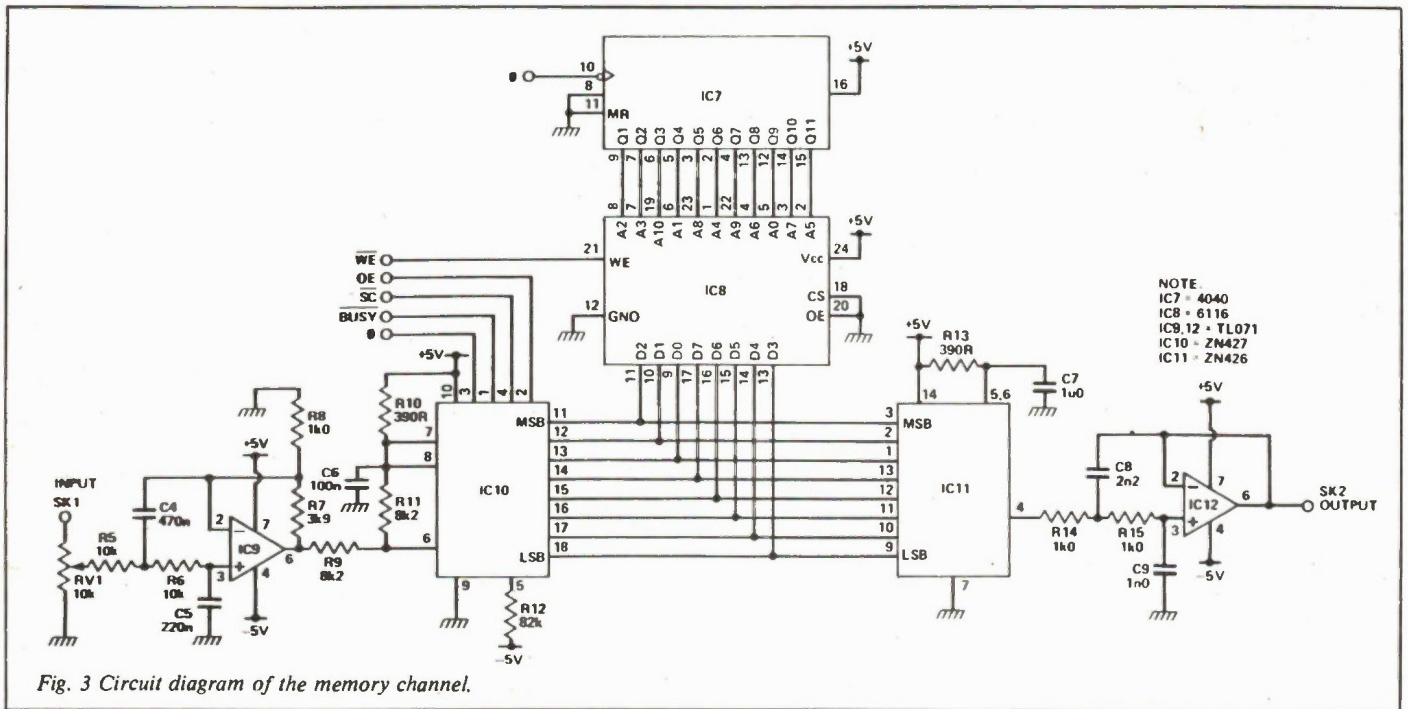

Fig. 3 Circuit diagram of the memory channel.

socket. The scrolling display is taken from the output socket to the scope Y-input. Set the scope timebase to produce a sweep of approximately 5ms so that the memory contents are read out once per sweep. Adjust the gain control until the displayed waveform is as large as possible without exceeding the range of the ADC. This will be apparent as clipping of the display in much the same way that analogue circuits clip if over-driven.

The frequency response is from DC up to a theoretical maximum of 50Hz (set by the low pass filter, IC9), but if sine waves are being viewed the practical upper limit is set by the number of cycles that can be resolved across the screen. This is a function of the trace width, screen size and viewing distance.

Potentiometer RV1 sets the input impedance at 10k, so some form of buffer amplifier will be required if you wish to look at high-impedance sources such as capacitor charge/discharge curves.

How It Works: Control Logic

The ubiquitous 555 timer, IC1, is used in the astable mode to produce a clock of approximately 400kHz. The clock signal drives both the scroll/freeze counter IC2 and the memory address counter IC7.

In the normal scroll mode of operation, the Q12 output of counter IC2 is taken back to its reset input via flip-flop IC3a which introduces a delay of one clock cycle before the count sequence restarts. Thus 2049 clock cycles elapse before the count sequence repeats itself. The rising edge of output Q11 drives flip-flops IC4a and IC4b to generate a Start Convert (SC) pulse for the ADC. This pulse is synchronized with the clock, and is one clock cycle in duration.

Once the ADC conversion is initiated, its Busy line goes low until conver-

sion is complete (in nine clock cycles) when it returns to the high state. The rising edge of Busy sets flip-flop IC5a, and flip-flop IC5b generates an Output Enable (OE) pulse to request data from the ADC. OE is gated with 0 to produce a Write Enable (WE) pulse for the RAM; the gating is necessary to ensure that WE is not still low when the RAM address lines are changed as counter IC7 advances on the next clock edge. Gates IC6a and IC6b are used to provide a delay from 0 to the WE gating, matching the propagation delay through flip-flop IC5b. By means of the OE and WE pulses, the new sample of data is stored at the address specified by IC7. Samples are taken every 2049 clock periods, giving a sampling rate of approximately 200 per second. Because

2049 clock cycles elapse in between successive sample/store operations, the address counter IC7 will have advanced 2049 states, one complete count sequence of 2E11 plus one extra state. Thus each sample is stored progressively one memory location later, overwriting the old data. With the oscilloscope sweep triggered from OE the display appears to scroll, the input signal appearing at the right-hand side, moving to the left across the screen, and disappearing. At the sampling rate of 200, all 2K addresses are updated in just over 10 seconds which is therefore the amount of signal displayed.

In the freeze mode, the reset line of IC2 is held low by R3 and the counter is allowed to cycle freely in natural binary fashion. Output Q11 has positive transi-

Parts List

Resistors (all 1/4W, 5%)

R1	2k2
R2	2k7
R3	100k
R4-6	10k
R7	3k9
R8,14,15	1k0
R9,11	8k2
R10,13	390R
R12	82k
RV1	10k linear pot

Capacitors

C1	10n
C2	220p
C3,9	1n0
C4	470n
C5	220n
C6,12	100n
C7,11	1u0 10V elect.
C8	2n2
IC10	330u 25V elect.
C13,14	10u 25V elect.

Semiconductors

IC1	NE555
IC2,7	4040
IC3-5	4013
IC6	4011
IC8	6116 RAM
IC9,12	TL071
IC10	ZN427
IC11	ZN426
IC13	78L05 or LM340L-5
IC14	ICL7660
BR1	100V, 1.5A bridge rectifier

Miscellaneous

SK1-3	BNC chassis-mounting sockets
SW1	Single pole toggle, slide or push button with NC contacts
T1	6V, 200mA (1.2VA) transformer

PCB; mounting pillars; case strain relief; knob; IC sockets, 4 8-pin, 5 14-pin, 2 16-pin, 1 18-pin, 1 24-pin; nuts; bolts, etc.

Ferranti ZN semiconductors are available from Carsten Electronics, with offices in Toronto, Ottawa and Montreal.

tions every 2048 clock cycles and the resulting SC pulses, ADC conversion and sample storage are thus synchronized with the memory address counter. Successive samples are stored at the same one location in memory whilst the contents of the other 2047 RAM addresses remain unchanged. The display therefore appears stationary with the latest 10 seconds of signal frozen.

How It Works: Memory

In the memory channel, the signal to be displayed is applied to potentiometer RV1 and a portion of it is taken from the wiper to the second-order low-pass filter (LPF) formed by IC9. With a frequency cut-off of approximately 50Hz, this filter prevents aliasing of the signal by removing frequency components above half the sampling rate. The filter has a passband gain of 5, (set by resistors R7 and R8), so that in conjunction with the gain control RV1, a wide range of signal levels can be accommodated.

The ZN427 analogue-to-digital converter (ADC) IC10 is an 8-bit successive approximation type, taking nine clock cycles to complete a conversion. It has an on-chip reference voltage of 2.56V which is available at pin 8, and in this design it is used as the reference input by connecting it to pin 7. A conversion is initiated by an

SC pulse, whereupon the Busy line goes low. At the end of the conversion period, Busy returns high, signalling the control logic that a sample has been taken and is ready to be stored in memory. The subsequent OE pulse from IC5 enables the ADC outputs (which are normally in the high impedance state) placing the new data on the data bus. Simultaneously, WE is taken low so that the new data is written into the 2Kx8 RAM IC8, the address be-

ing dictated by address counter IC7. This sampling and storage operation occurs in between successive display sweeps.

During a display sweep, the RAM is in read mode and counter IC7 clocks round the address lines. The data from the RAM is read out in sequence to the digital-to-analogue converter (DAC) IC11, and the reconstructed analogue signal is available at pin 4. The output from the DAC is passed through low-pass

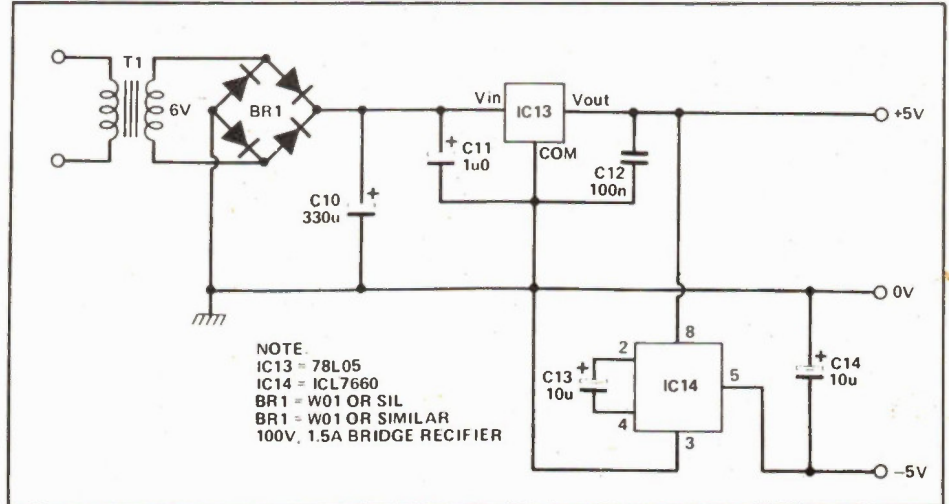

Fig. 4. The power supply schematic.

THE BRUNELLE Commander SERIES

Dependability you can count on. Meets Toughest Demands.

MODEL 5050 Digital Multimeter

Model 5050 is a compact lightweight 3½" digit multimeter suited for all types of lab or bench operation.



\$299.00

Featuring:

- 5 functions (AC/DC voltage, AC/DC current ranges up to 20 amps and resistance)
- 0.5" large 3½" digit reg. LED display
- High resolution 0.1mV, 0.1R, 0.1UA
- High accuracy 0.1%
- High current range 20A
- High voltage range 1,200V
- Automatic Zero Circuitry
- All range with protection circuit
- 2 year warranty

Model 4060 Digital

The Multimeter you've been waiting for... at the price you've been hoping for.



\$99.95

Featuring:

- Handheld 7-function, 35 ranges with 200 uA, AC and DC. HI-low ohms diode check.
- Built-in transistor test function.
- Overload protection. 2 amp fuse protects all meter ranges.
- Safety designed input jacks and test leads, tilt stand for bench use. Easy external battery access.
- Calibration certificate traceable to NRC supplied with meter.
- 1 year parts/labour guarantee.

Model 3030 Function Generator

Providing Sine, triangle, square, pulse and ramp out-puts over the 0.2Hz to 2MHz frequency ranges.



\$415.00

Featuring:

- Accuracy of ± 5%
- VCF input
- Variable DC offset
- TTL or CMOS pulse output
- Measurement range from 0.1Hz to 10MHz
- High input sensitivity of 20mv RMS
- 2 year warranty
- Digital display

Model 2200 Digital Capacitance Meter

The Digital Capacitance Meter you've been waiting for... at the price you've been hoping for!

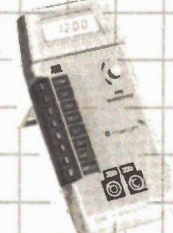

\$114.95

Featuring:

- Reading Rate: 0.5 seconds
- Overrange Indication: indication of "++"
- Test Voltage: 3.2 volts peak maximum
- "+" input terminal voltage is always higher than "-" input terminal
- Power Requirement: 9V battery
- Battery Life: Up to 200 hours typical with Alkaline. Up to 100 hours typical with Zinc-carbon.
- Accessories Supplied: Test Lead (1), spare fuse (1), instruction manual (1) 9V Battery (Zinc-carbon).



Brunelle Instruments Inc.
 69th 6th Range South (Industrial Park)
 Saint Elie D'orford, Quebec, J0B 2S0
 Tel: 1-819-569-1408 Telex: 05-836266

Mail orders accepted. Send certified cheque or money order. Add 10% F.S.T. Add \$3.00 for shipping. Quebec residents add 9% P.S.T.

Available at leading component stores across Canada.

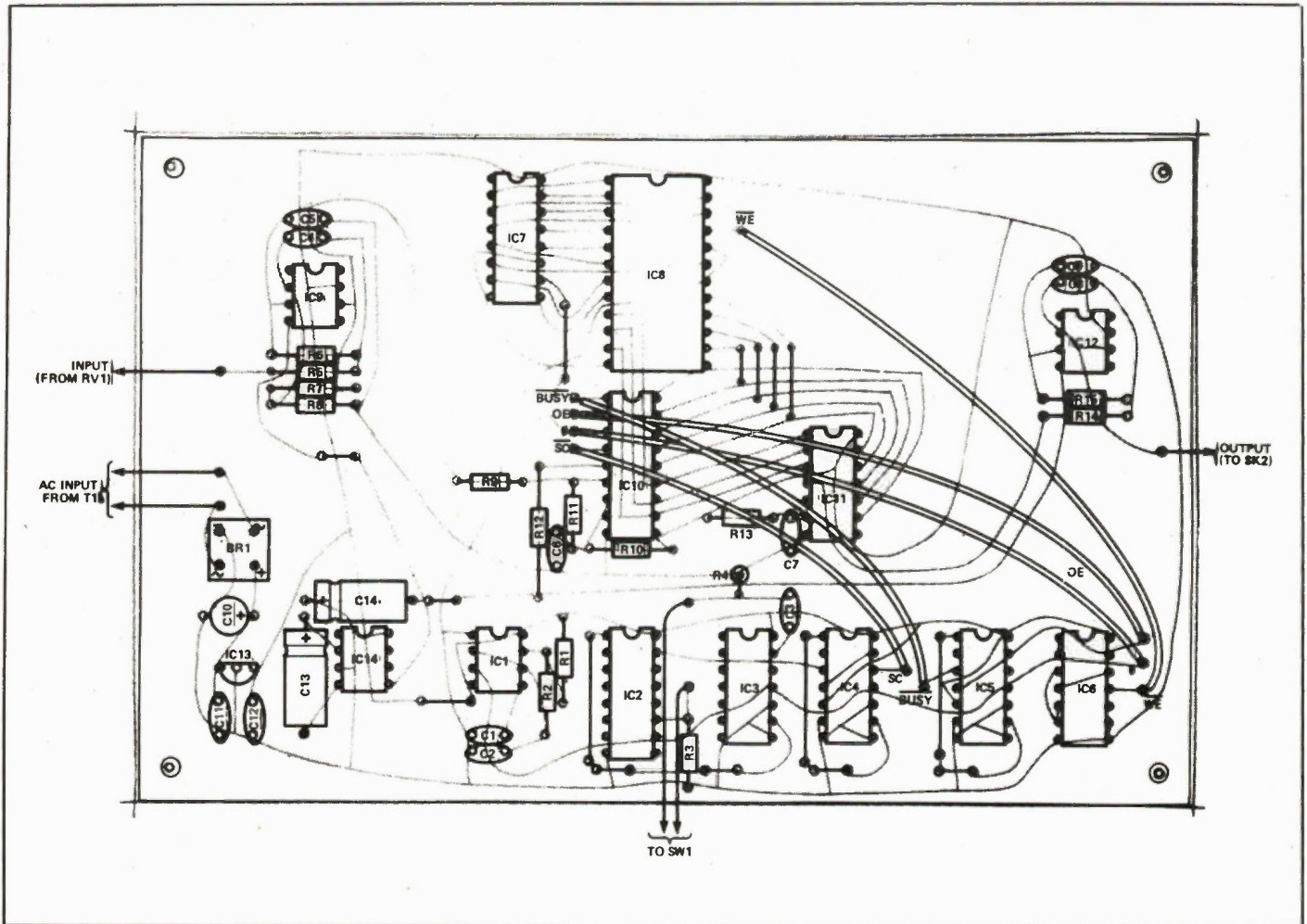

Fig. 5 Component overlay for the memory display PCB.

filter IC12, which cleans up the discrete step-like nature of the waveform for subsequent display. The output signal lies in the range of zero to +2.55V, so a zero input voltage will emerge from the memory channel with an offset of 1.27V. This is of little consequence as the output signal is displayed on an oscilloscope which will have a Y-shift control.

How It Works: PSU

Power transformer T1 together with bridge rectifier BR1 and reservoir capacitor C10 provide an unregulated supply of approximately 8V DC. This is regulated to 5V by IC13 to supply the logic circuitry and the positive rail of op-amps ICs 9 and 12. Capacitors C11 and C12 are situated close to the regulator to improve its stability and noise performance.

The op-amps and the ADC also require a negative supply, at a total current of typically 3mA. Rather than use a centre-tapped transformer and another reservoir capacitor/regulator combination, this low current is provided by voltage converter IC14. This is configured to generate a mirror-image of its supply voltage, -5V from +5V. The total current drain of the memory display at 5V is approximately 90mA.

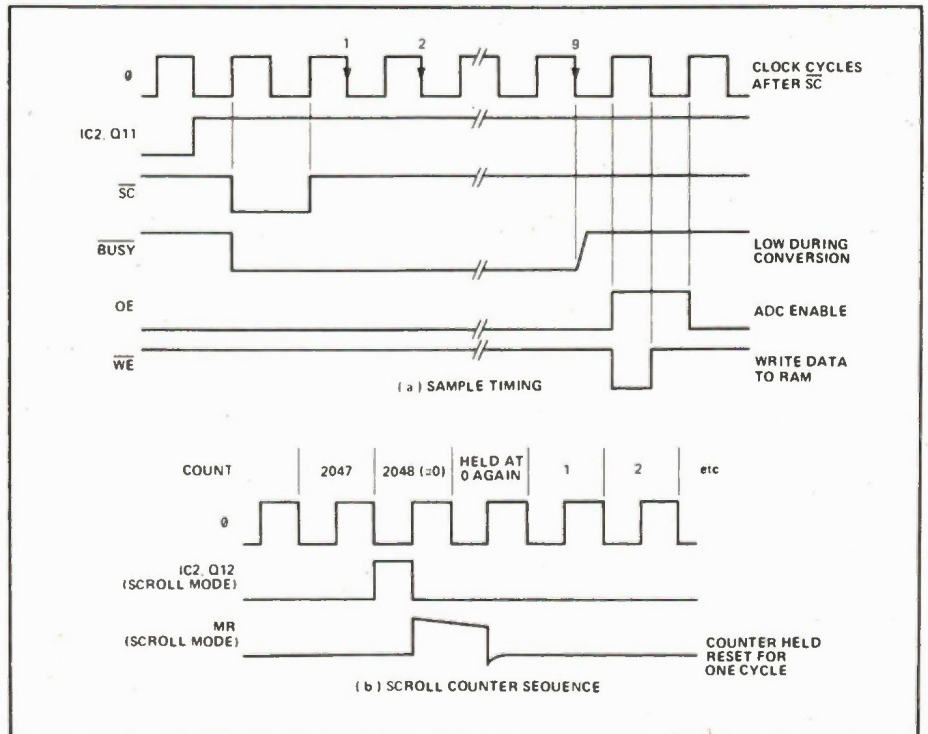

Fig. 6 Timing diagram for the control logic.



Will they still be your friends if you say no?

Jerry's a good driver. But this time he's had one too many and the thought of him behind the wheel makes you nervous. Can the gang persuade you to get in the car anyhow or will you stick by your guns and say no?

Nobody who's had too much to drink should ever be on the road. So speak up. Suggest that you or one of the others drive

instead. Better still, Jerry should leave the car parked then everyone could share a cab home.

If your friends are really your friends they'll thank you, not put you down, for pointing out the dangers of drinking and driving. What you're really doing is caring about their safety as well as your own. And isn't that what a friend is for?

Seagram

*We believe in moderation and
we've been saying so since 1934.*

Do you know how much alcohol you can safely handle? Write to us and we'll send you a valuable free chart on drinking limits. P.O. Box 847, Station H, Montreal, Quebec. H3G 2M8

A specifically designed superconducting quantum interference device (SQUID) now makes it possible to directly measure iron stores in the liver safely, rapidly and non-invasively. This new, quantitative technique for the clinical study of iron metabolism provides a means for the rapid evaluation of treatment regimens for iron overload due to multiple blood transfusions, as well as for early detection of hereditary hemochromatosis, a disease characterized by excessive iron deposits in the body. A quantitative technique such as this relies on the unusual paramagnetic property of ferritin and hemosiderin, the major forms of storage iron in human beings, to determine tissue concentrations on the iron in these compounds. The use of the magnetic properties of ferritin and hemosiderin for measuring iron stores was first proposed and developed by Dr. John W. Harris, MD., Professor of Medicine, in his laboratory at

Cleveland Metropolitan General Hospital over a decade ago.

His work at that time outlined the theoretical basis for the technique and succeeded in demonstrating its practicality in small animals. However, the limitations of available instruments for susceptibility studies prevented further progress at that time. Subsequently, Dr. David E. Farrell, professor of physics at Case Western University, used the new superconducting technology in the design of the prototype SQUID susceptometer used in these studies. "In brief," say the researchers, "this susceptometer uses one set of field coils to generate a constant magnetic field and another set of detector coils to sense field changes." They added that because the detector coils are specifically configured to reject magnetic noise, the SQUID can be operated in a normal hospital environment, without magnetic shielding.

Magnetic measurements were made with the SQUID susceptometer in 20 normal control subjects and 110 patients admitted to CMGH with liver disease, iron deficiency, hereditary hemochromatosis or transfusional iron overload.

Measurements obtained from the subjects by the susceptometer of liver nonheme iron were closely correlated with chemical in vitro measurements in liver biopsy specimens, according to the researchers' reports.

Other results of the study demonstrated that magnetically determined storage-iron concentrations were raised in 12 of 67 patients with liver disease and were greatly increased in patients with untreated hereditary hemochromatosis or transfusional iron overload. Noting that the prototype SQUID susceptometer used in these studies was designed specifically for measurements of iron overload, the researchers ex-

plained that, "our major aims in examining volunteers who had no clinical indication for liver biopsy were to show that magnetic between normal subjects and patients with various disorders affecting iron metabolism."

It is anticipated that the use of SQUID could be used as a method for detection of iron deficiency. According to the researchers, there are no known hazards associated with, or contradictions for, magnetic susceptibility measurement. "The procedure is paramount to putting a toy magnet over the liver."

The only limitation is contamination of the magnetic field by surgical clips, steel plates, artificial joints or cardiac pacemaker units.

DOES YOUR DIGITAL CAPACITANCE METER DO THIS?

FULL 4 DIGIT 0.5 INCH LCD DISPLAY COMPLETELY AUTORANGING WITH 10 RANGE MANUAL CAPABILITY

AND THIS

RANGE OF 0.0 pF to 1 FARAD (999.9 mF)
0.5% BASIC ACCURACY UP TO 100 uF

AND THIS

READS DIELECTRIC ABSORPTION

AND THIS

EXTENDED PSEUDO 5 DIGIT
RESOLUTION ON SOME RANGES ONLY

AND THIS

ABILITY TO ZERO LARGE CAPACITANCE
VALUES UP TO 99.99 uF

AND THIS

CALCULATES TRUE CAPACITANCE
IF CAPACITOR IS LEAKY

AND THIS

DIODE CLAMP AND FUSED
PROTECTED INPUT.
DISCHARGE RESISTOR IN OFF
POSITION AT TERMINAL INPUTS.
POWERED BY 9V BATTERY

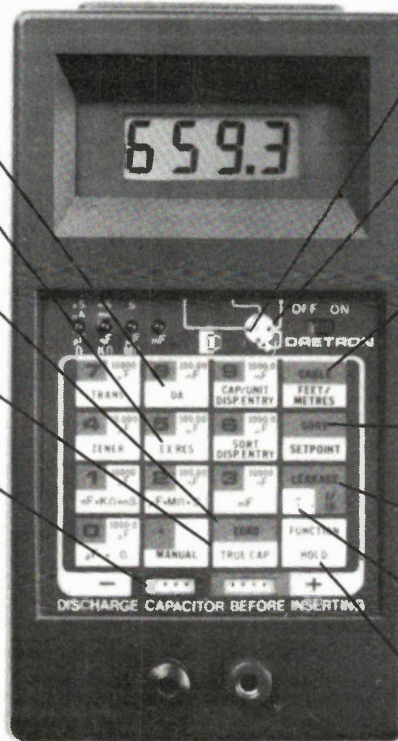

AND THIS

IDENTIFIES TRANSISTORS (NPN, PNP)
AND THEIR LEADS (E, B, C, ETC.)

AND THIS

TESTS ZENER DIODES AND RECTIFIERS.
UP TO 20V ZENER WITH AC ADAPTOR,
ZENER VOLTAGE WITH 9V BATTERY
DEPENDS ON ITS CONDITION

AND THIS

AUTOMATICALLY CALCULATES LENGTHS
OF CABLES IN FEET, METRES, MILES,
KILOMETRES (THEORETICAL RANGE
OF 9,999 MILES)

AND THIS

ABILITY TO SORT CAPACITORS IN
MANY DIFFERENT MODES

AND THIS

ABILITY TO READ LEAKY CAPACITANCE
(INSULATION RESISTANCE OR CURRENT)

AND THIS

CALCULATES TIME CONSTANTS WITH
USER DEFINED RESISTANCE VALUES

AND THIS

HOLD FUNCTION FREEZES DISPLAY

ONE YEAR PARTS &
LABOUR WARRANTY

FOR ONLY THIS

\$149.95



MODEL MC300

Approx. Size
7" x 4" x 1 3/4"

DAETRON
A DIVISION OF BERGERON
TECHNOLOGIES INC.
935 THE QUEENSWAY
BOX 641
TORONTO ONTARIO M8Z 5Y9
(416) 255-9701

DEALER ENQUIRIES INVITED

MADE IN CANADA

PLEASE SEND ME (QUANTITY) MC300(s) @ \$149.95 \$ _____

CARRYING CASE \$19.95 \$ _____

AC ADAPTOR \$11.00 \$ _____

ONTARIO RESIDENTS ADD 7% PST \$ _____

SHIPPING AND HANDLING @ 4.45 per instrument \$ _____

TOTAL \$ _____

I ENCLOSE CHEQUE MONEY ORDER BILL MY VISA

VISA CARD NO. _____

EXPIRY DATE _____ SIGNATURE _____

NAME _____

ADDRESS _____

CITY _____ PROV. _____ POSTAL CODE _____

Test Cable — 4mm Banana 126074

Coaxial test cable; length 1.15m, characteristic impedance 50 OHM, cable capacitance 12pF. Input voltage max. 500V_p. **\$12.17**

Test Cable BNC-BNC 126023

Coaxial test cable; length 1.2m, characteristic impedance 50 OHM, cable capacitance 126pF. Input voltage max. 500V_p. **\$9.78**

Adapter 4mm Banana to BNC T627

Two 4mm binding posts (19mm between centers) to standard BNC male plus. Input voltage max. 500V_p. **\$11.50**

50 OHM Through-Termination 805-53-000

For terminating systems with 50 OHM characteristic impedance. Maximum load 2W. Max. voltage 10V_{ms}. **\$37.67**

Carrying Cases

For HM203-1, HM203-3, HM203-5, HM204 and HM605. **HZ46 \$76.00**

For HM307, HZ62, and HZ64. **HZ44 \$42.00**

Viewing Hoods HZ47

For HM203, HM204, HM208, HM605, HM705, HM808, HM312, HM412, HM512, and HM812. **\$15.00**

Scope Tester HZ60

For checking the Y amplifier, timebase, and compensation of all probes, the HZ60 provides a crystal-controlled, fast-rising (typ.3ns) square-wave generator with switchable frequencies of 1, 10, 100kHz, and 1MHz. Three BNC outputs provide signals of 25mV_{pp} into 50 OHM, 0.25V_{pp} (open circuit for 10X and 100X probes); accuracy ± 1%. Battery-powered or AC supply operated (optional). **\$86.10**

Component Tester HZ65

Indispensable for trouble-shooting in electronic circuits. Single component and in-circuit tests are both possible. The HZ65 operates with all scopes, which can be switched to X-Y operation (ext. horizontal deflection). Non-destructive tests can be carried out on almost all semiconductors, resistors, capacitors, and coils. Two sockets provide for quick testing of the 3 junction areas in any small power transistor. Other components are connected by using 2 banana jacks. Test leads supplied.

LIST \$70.00

Examples of Test Display

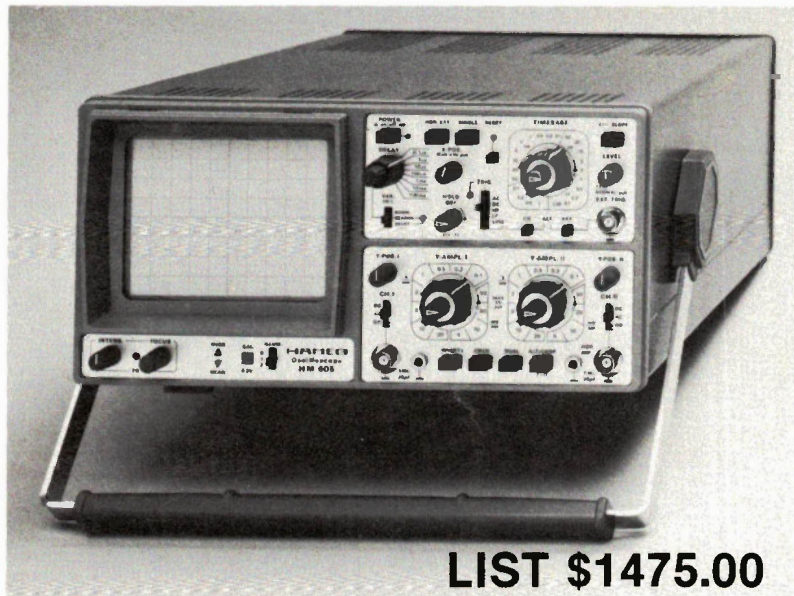

LIST \$1475.00

60MHz Multifunction Oscilloscope

Y: 2 channels, DC-60MHz, max. 1mV/cm, delay line;
X: 2.5s/cm-5ns/cm incl. x10 magnification, delayed sweep;
triggering up to 80MHz; var. hold-off time; Component Tester.

The new **HM 605** is a truly **versatile scope** satisfying a wide variety of exacting requirements in **laboratory, production, and service**. The maximum input sensitivity of **1mV/div.** facilitates the display of extremely low-level signals. Despite their high sensitivity, the HM 605's vertical amplifiers are of **excellent stability** and **low drift** design with not more than, 1% overshoot.

The built-in **delay line** permits viewing of the trigger edge at all times. The **overscan feature** indicates if any part of the trace passes the vertical limits of the CRT screen. An **analog Y-output**, switchable to Channel I or II, allows further processing of the signal.

Reliable triggering is ensured up to at least **80MHz**, and trigger facilities include vertical mode **alternate triggering**, line trigger and single sweep operation. Other trigger features are **variable hold-off time**, RF- and LF-filters at any sweep speed for TV frame and line displays, as well as normal and **automatic peak-value triggering**. An LED indicates when the sweep is triggered. Sweep ranges from **5ns/div.** to **2.5s/div.** ensure optimum resolution of slow and fast signals. The **variable sweep delay** facility enables any section of the waveform to be expanded by **1000** and more for detailed signal analysis. A rectangular **14kV CRT** with illuminated graticule provides exceptionally bright and sharp displays.

A **unique feature** for scopes in this price range is the built-in **switchable 1kHz/1MHz squarewave generator** providing **0.2V** and **2V** calibration signals with a risetime < **5ns**. It is now possible to self-test instantly the transient response of the vertical amplifiers and compensation of **modular attenuation probes** for utilization of the **full bandwidth of scope and probe**.

A **Component Tester** is also incorporated. The HM 605's **outstanding price/performance capability** is not likely to be matched by similar products in the near future.



980 Alness St. Unit 7,
Downsview, Ontario.
M3J 2S2

(416) 661-5585
TELEX 065-28169

Mon-Fri 8-5 pm, Sat 10 am-1 pm



Networking Raised to a Greater Power

Advanced Technology. With it, IBM tripled the speed of the PC and increased its memory capacity five-fold. Nowhere is this increase in computing power more important than in networking situations. If the AT's technological advances have prompted you to look into a multi-user network, you owe it to yourself to take a closer look at MultiLink Advanced™ . . . a unique multi-tasking, multi-user networking system that runs programs under PC-DOS 3.0.

Eight Workstations for the Price of an AT. MultiLink Advanced™ represents the next generation in networking systems for IBM microcomputers. The system enables terminals, connected to a single AT, to emulate IBM-PC's having up to 448K of RAM (The PC-Shadow™ terminal, shown above, even has a PC look-alike, as well as work-alike keyboard and display).

This means that instead of spending \$3,000 per workstation for a PC with a Kilobuck "Network Interface Board," you can use inexpensive terminals . . . eight of which cost less than an IBM AT. Even if you need only one workstation connected to your AT, you'll realize significant savings.

MultiLink Advanced™ . . . Instant Access to All of Your Resources. Central to most multi-user situations is the need to coordinate a variety of printers. With what's been described by *PC-Tech Journal* as ". . . by far, the best print spooler for the IBM PC," MultiLink Advanced™ gives users the option to print either at their workstations, or at a central location. In addition, programs and files can be shared by multiple users locally or through use of a modem. Just think of it . . . having remote access to an AT with a lightweight terminal/modem.

Although designed to take advantage of the AT, MultiLink Advanced™ runs on all versions of PC-DOS, except 1.0, and certain implementations of MS-DOS. A wide range of leading programs are supported which include WordStar, dBASE III, Multimate, and Lotus 1-2-3.

Get the Advanced Story Today. Call The Software Link Today for complete details and the dealer nearest you. MultiLink Advanced™ is immediately available at the suggested retail price of \$745 and comes with a money-back guarantee. VISA, MC, AMEX accepted.

MultiLink[™] ADVANCED

 THE SOFTWARE LINK, INC.

IBM, PC, AT, & PC-DOS are trademarks of IBM Corp. MS-DOS, WordStar, dBASE III, Lotus 1-2-3, and Multimate are trademarks of Microsoft Corp., MicroPro, Ashton-Tate, Lotus Development Corp., & Multimate International, respectively.

400 Esna Park Drive, Suite 18, Toronto (Markham), Ont. L3R 3K2

CALL: 416/477-5480

Dealer Inquiries Invited

Circle No. 34 on Reader Service Card.

MultiLink Advanced™ & PC-Shadow™ are trademarks of The Software Link, Inc.