

Electronics Today

\$3.25
MM70924

December 1985

Canada's Magazine for Electronics & Computing Enthusiasts

Electronics In Photography

Automating everything with a CPU



The ET Photoflash
Designing your own

Heat Pen Project
Degrees for your DMM



Impedance
What it means

Christmas Gift Ideas

Spectacular Savings

New from Star Micronics SG-10 Printer

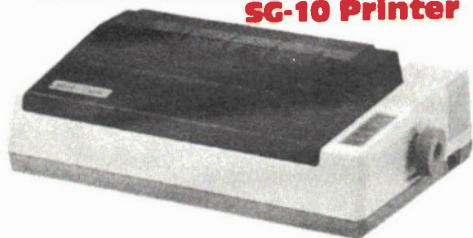

Ideal for Text & Graphics

• Dual Mode - NLQ/draft standard (NLQ = near letter quality) • 120 CPS and 20% faster throughput • Bidirectional, logic/seeking • 2K buffer (expandable to 6K with optional buffer interface) • 100% IBM PC or Star standard control codes-switch selected • Friction and tractor standard • full 1 year warranty • 10" wide carriage • Standard parallel interface (serial optional) **\$379.00**

SG-10 C for Commodore Computers

All the same features as the SG-10 but includes built-in interface which plugs directly into Commodore computers.

\$389.00

Star Micronics SG15

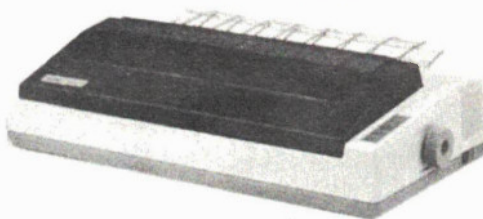

Same specifications as the SG-10 except with 15in. carriage and standard 16K buffer.

\$599.00

SR-15

• 200 cps and 20% faster throughput • IBM PC or Star standard control codes switch selected • Dual Mode - NLQ/draft standard • Friction/tractor and automatic single sheet feed - standard • 15" carriage • 16K buffer • Bidirectional, logic seeking • Price/performance leader • Parallel port standard, serial optional • Full 1 year warranty. **\$995.00**

Star Micronics — Power Type daisywheel printer Letter Quality



18 c.p.s, Bi-directional, Logic-seeking. 110, 132 or 165 columns. 100 Typefaces available, Proportional Spacing.

\$535.00

**See the second Issuing of
our Catalogue at the centre
of this Issue.**

Save Money — Time Limited Specials

Please note: These unbelievably good prices are due to a bulk purchase
Prices good while stocks last.

Star Micronics Gemini 10X Ideal for Text and Graphics

• 120 c.p.s., • 816 characters print buffer, option 4K or 8K • standard parallel optional RS232C • tractor & friction feed. **Super Special \$279.00**



Star Micronics Gemini 10X PC

All the above features but IBM Compatible.

\$279.00

**Check out our catalogue for
prices of Monitors, Disk
Drives, Print Supplies and
Printer Cables**

**We have excellent pricing
on 10 and 20 Megabyte
Hard Drives and Controllers**

Star Micronics Gemini 15X PC IBM Compatible

Same as Gemini 10X PC but with 15in. carriage.

\$399.00

Delta 15 PC IBM Compatible

160 c.p.s draft, 40 c.p.s Near Letter Quality, Friction and Tractor feed, 8K Buffer, Serial and Parallel Interfaces. 15in. carriage. Ultra-High Resolution.

\$499.00

Delta 10 PC IBM Compatible

As above but 10in. carriage.

\$399.00

Radix 15 PC IBM Compatible

200 c.p.s draft, 50 c.p.s. NLQ, Friction and Tractor Feed, Serial and Parallel Interfaces, 16K Buffer. 240 x 144 Ultra High Resolution.

\$689.00

Radix 10 PC IBM Compatible

\$549.00

ND-04D and ND-04DE-G 5 1/4" 360K DS/DD

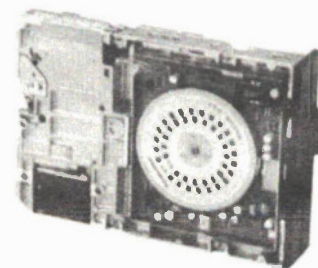

For your IBM PC/XT or compatible.
Grey or black available.

\$169.00

Memory Special
41256 \$4.39!
Large Quantity Discounts
Available

**Check our catalogue for
other spectacular
memory pricing**

EXCELTRONIX

319 College Street, Toronto, Ont. M5T 1S2

(416) 921-8941. Order line only 1-800-268-3798

Ottawa, 217 Bank Street (613) 230-9000

Visa, Mastercard and American Express accepted.

Circle No. 1 on Reader Service Card

BEST Computers

Made In Canada, IBM PC, XT & AT Compatible

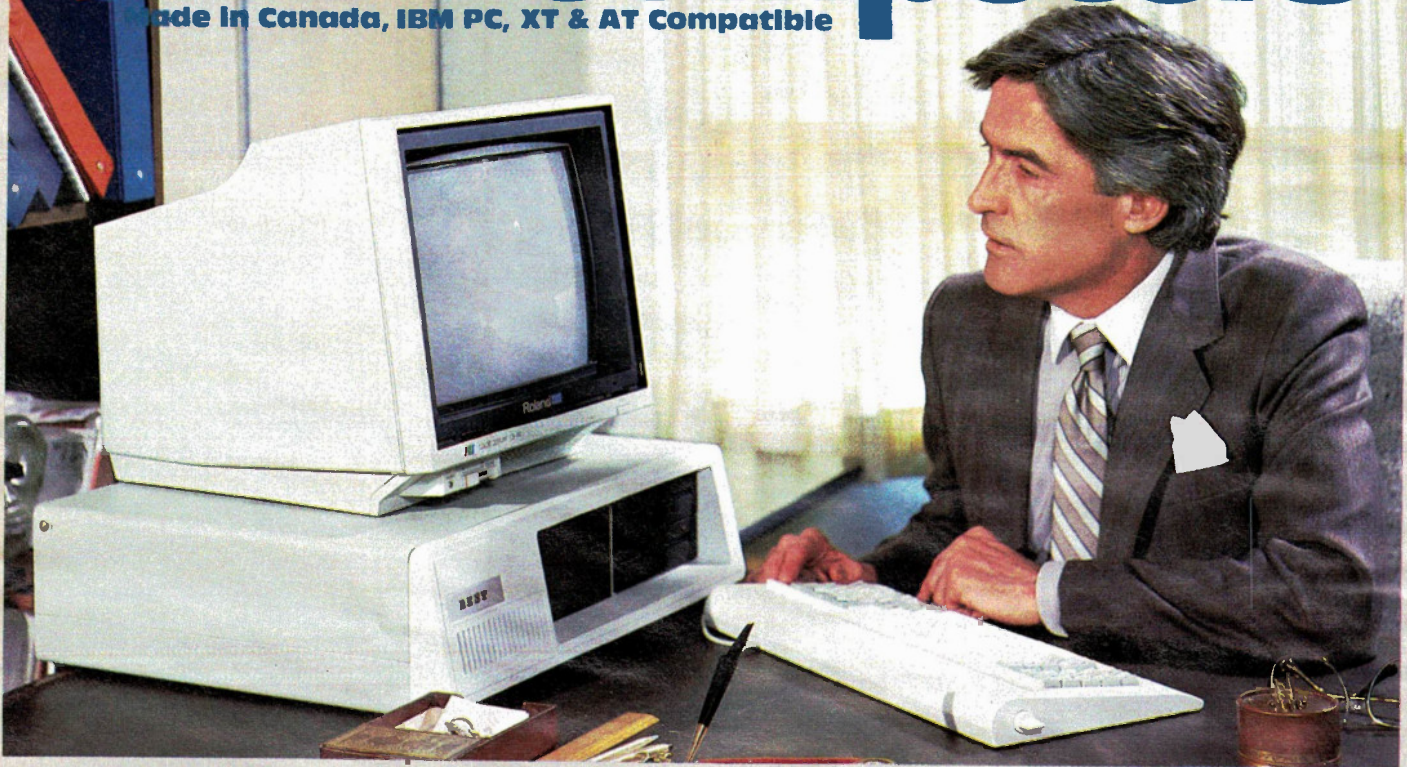

Monitor not included. IBM registered trade mark of IBM Canada Ltd.

Features common to BEST MK II, MK III & MK IV

- Superb IBM PC & XT Compatibility
- Canadian Made
- 256K RAM Standard minimum (uses 41256K RAM chips)
- Expandable on board to 640K RAM
- Parallel Port (for printer)
- Serial Port (for communications)
- Real Time Clock/Calendar (with Battery Backup)
- Presocketed for optional co-processor — such as 8087 Math Processor
- IBM Compatible Keyboard
- Reset Switch
- Phoenix BIOS as used in many major brand IBM compatible systems.
- 150 Watt Power Supply which will handle a Hard Drive without upgrade.
- 7 Slots
- Flip top case
- 2 Slimline DS,DD 5 1/4", 360K Disk Drives
- Colour Video (RGB & Composite) Board or Hi-Res Monochrome Card (customer choice)
- Disk Controller Board

Warranty

We have such confidence in the time tested reliability of the BEST that we offer a 300 day warranty, way above the industry standard.

Please Note: Don't be put off by our spectacularly low price; this is due to the fact we do not deal with middlemen and our volume buying power of parts. All BESTs are manufactured in Canada to the highest quality standards using prime, guaranteed components by our sister company. All systems are pretested (burnt-in) for about 48 hours before shipping. Hundreds of happy customers report excellent reliability and compatibility.

BEST MK II. Regular \$1695. This Month:

Two 360K DS,DD disk drives, Serial and Parallel Ports, Real Time Clock, Phoenix BIOS, uses 8088 processor — full specifications given below.

\$1595⁰⁰

Other Configurations:

| | |
|--------------------------------------|--------|
| With 640K RAM | \$1695 |
| With 10 Meg Hard Drive/1 Floppy/256K | \$2495 |
| With 10 Meg Hard Drive/1 Floppy/640K | \$2595 |
| With 20 Meg Hard Drive/1 Floppy/256K | \$2795 |
| With 20 Meg Hard Drive/1 Floppy/640K | \$2895 |

NEW

The FAST BEST MK III

As BEST MK II plus speed selectable: 4.77 and 8MHz (most software will run on the higher speed), uses 8088-2 processor.

\$1895⁰⁰

Other Configurations:

| | |
|--------------------------------------|--------|
| With 640K RAM | \$1995 |
| With 10 Meg Hard Drive/1 Floppy/256K | \$2795 |
| With 10 Meg Hard Drive/1 Floppy/640K | \$2895 |
| With 20 Meg Hard Drive/1 Floppy/256K | \$3095 |
| With 20 Meg Hard Drive/1 Floppy/640K | \$3195 |

NEW

SUPER-FAST BEST MK IV

As BEST MK III plus TRUE 16-Bit machine, 8086-2 processor, IBM compatible 8-Bit I/O channel bus, even faster than MK III due to 16-Bit architecture. With 640K standard.

\$2500⁰⁰

Other Configurations:

| | |
|--------------------------------------|--------|
| With 10 Meg Hard Drive/1 Floppy/640K | \$3395 |
| With 20 Meg Hard Drive/1 Floppy/640K | \$3695 |

NEW

AVT-286

Superb IBM AT compatibility, 640K RAM, Two 5.25 in disk drives (one high density 1.2 Megabyte, one standard 360K), serial and parallel ports high quality keyboard, keyboard lock and status monitor.

\$3495⁰⁰

With 20 Megabyte fast stepping Hard Disk and Controller:

\$4950⁰⁰

40 Megabyte systems also available at reasonable prices.

Exceltronix

319 College Street, Toronto, Ont. M5T 1S2

(416) 921-8941. Order line only 1-800-268-3798

Ottawa, 217 Bank Street (613) 230-9000

Visa, Mastercard and American Express accepted.

See our 1986 catalogue in the centre of this issue.

SURPLUSTRONICS

we will not be undersold



8088 Computer Systems

\$995

- Includes:
- 8088 motherboard
 - High quality legal Bios
 - One DS,DS 360K Drive
 - Power Supply with Fan
 - Keyboard
 - Flip-Top case
 - Disk Controller
 - With plenty of spare slots
- All you need for complete System Is Video Board
- Colours: **\$159.00**
Mono **\$159.00**

\$339

8088 motherboard with 256K (expandable on board to 640K) Fully assembled and tested with legal Bios, Flow soldered provision for 8087.

256K Memory

41256 (150nS) **\$ 4.95**
Set of 9 **\$43.95**

64K Memory

4164 (150nS) **99¢!**

IBM Compatible Keyboards

(Keytronics Serial Output), no housing **\$39.95**

IBM Style Case

Flip-Top 8 slot **\$75.00**

IBM Compatible Switching Power Supply, 130W, with Fan **\$134.00**

Set of 8088, 8255A-5, 8237A-5, 8288, 8284, 8253A-5, 8259A **\$45.00**

IBM Peripheral Cards

Colour Video Board **\$159.00**

Floppy Controller **\$ 99.00**

Floppy Controller with RS232 **\$139.00**

Floppy Controller with clock/RS232 **\$149.00**

Parallel and Game Port Card **\$ 59.00**

Cable and connector extra.

Peripheral Interface Card **\$139.00**
Includes two serial ports, parallel port, game port and provision for (but not including) real time clock.

Clock/Calendar Option **\$ 29.00**
With battery backup.

256K & Multifunction Board.

Includes: Serial port, parallel port, game port, provision for optional real time clock/calendar and socketed for up to 256K RAM.

With 64K RAM **\$149.00**

512K Board. Socketed for 512K including:

64K RAM **\$119.00**

IBM Compatible Disk Drives **\$159.95**

Brand New, fresh from factory. Shugart SA455 40 track, double sided, double density Slimline. We have ordered 10,000 from Shugart - that is why we can pass the savings on to you.

IBM Compatible Keyboards

Maxiswitch **\$135.00**

Cherry **\$ 99.00**

IBM Style Case



Flip-Top, 8 Slot **\$75.00**

With 150W Power Supply **\$219.00**

Disk Drives for IBM Computers

Shugart/Panasonic, 5 1/4" slimline, DD, DS 360K, 40 track **\$159.95**

Printers

Gemini 10X **\$299.00**

Gemini SG10 **\$379.00**

Gemini Daisy Wheel Powertype **\$599.00**

18 cps, Bi-Directional.

Monitors

Zenith ZVM123 Green and ZVM122 Amber .. **\$129.00**

Complete 6502 System

- Assembled and fully tested (flow soldered)
- 64K, 80 x 24 video with soft-switch, floppy controller.
- System comes with blank EPROM's on board, does come with any proprietary software or Basic **\$199.00**

Complete System

• 6502 board (as illustrated above) with case, keyboard and power supply **\$395.00**

Complete System

• Using 6502 board above in IBM style flip-top case, using powerful 75 watt power supply with fan, programmable serial keyboard adaptor, IBM style keyboard **\$459.00**

As above with one built in disk drive **\$599.00**

As above with two drives **\$749.00**

6502 Power Supply

For 6502 Case. CSA Approved 5V, 5A, + 12V 2.5A, -5V 0.5A, -12V 0.5A. . . . **\$69.00**

Kepeco Power Supply

5V 5A, +12V 2.8A, +12V 2A, -12V 0.5A, Open Frame

\$38.95

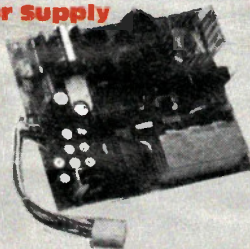

6502 Style Case



With Numeric Keyboard **\$129.00**

Panasonic Printers

Open Frame **\$29.95**

Ideal for experimenters

Mail Orders add \$5.00 minimum for shipping & handling. Ontario residents add 7% P.S.T. Visa, Mastercard and American Express cards accepted: send card number, expiry date, name of bank and signature. Send certified cheque or money order, do not send cash. All prices on this page are final sale. No warranty, No returns, No refunds but HUGE savings. Warranties available at extra cost.

IBM Style Power Supply

130W, +5V 13A, -5V 0.5V, +12V 4.5A, -12V 0.5A **\$145.00**

Power Bars with Surge Protectors **\$49.95**

Plug In Surge Suppressor **\$11.95**

Apple Cards

Assembled, flow-soldered/cleaned and 100% tested

16K RAM Card **\$ 29.00**

80 x 24 video card **\$ 59.95**

Z80A Card **\$ 39.00**

Parallel Printer Card (cables extra) **\$ 29.00**

128K RAM Card with 128K **\$ 85.00**

EPROM Programmer with Software **\$ 63.00**

(programs 2716, 2732, 2732A, 2764)

8" Floppy Controller. Final Sale

- As Is **\$ 39.00**

Modem Bargain!

Apple Compatible plug-in Autoanswer, Autodial, Touch Tone or Pulse Dial. Excellent for use with most Bulletin Boards. 300 Baud. Final Sale as Is .. **\$39.95**

Apple Compatible Disk Drives 5-1/4" **\$175.00**

Apple Compatible Modem

EXCELLENT HAYES MICROMODEM COMPATIBILITY

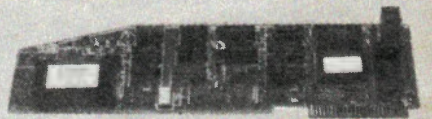

Plugs into your Apple or compatible computer, Direct connect, 300 Baud, Autodial, Autoanswer, Touch Tone/Pulse Dial, complete with documentation.

\$139.95

Hayes is a registered trade name.

Surplustronics, 310 College Street, Toronto, Ontario, M5T 1S3

More lines to serve you better
(416) 960-1350

Electronics Today

December 1985
Vol. 9 No. 12

Our Cover



The cover photograph illustrating totally automatic cameras was taken by Bill Markwick with a totally manual Cambo 4 x 5.



Audit Bureau of Circulations

Electronics Today is Published by:

Moorshead Publications Ltd. (12 times a year)
Suite 601, 25 Overlea Blvd.
Toronto, Ont. M4H 1B1
(416) 423-3262

Editor: William Markwick
Assistant Editor: Edward Zapletal
Director of Production: Erik Blomkwist
Production: Douglas Goddard
Naznin Sunderji
Sandra Hemburrow
Lisa Salvatori
Circulation Manager: Lisa Salvatori
Advertising Account Manager: Marlene Dempster

Publisher: H.W. Moorshead; Executive Vice-President: V.K. Marskell; Vice-President - Sales: A. Wheeler; General Manager: S. Harrison; Controller: B. Shankman; Accounts: P. Dunphy; Reader Services: M. Greenan, H. Brooks, R. Cree, L. Robson, N. Jones; Advertising Services: H. Brooks.

Newsstand Distribution:
Master Media, Oakville, Ontario

Subscriptions:
\$22.95 (one year), \$37.95 (two years). Please specify if subscription is new or a renewal.

Outside Canada (US Dollars) U.S. add \$3.00 per year.
Other countries add \$5.00 per year.

Postal Information:
Second Class Mail Registration No. 3955. Mailing address for subscription orders, undeliverable copies and change of address notice is:
Electronics Today, Suite 601, 25 Overlea Blvd., Toronto, Ontario, M4H 1B1

Printed by Heritage Press Ltd., Mississauga
ISSN 07038984.

Moorshead Publications also publishes Computing Now!, Computers in Education,

Advertisers' Index

| | |
|-------------------------------------|------------|
| Active Components Sales Corp | 40 |
| Apron Design Ltd. | 30 |
| Atlas Electronics Ltd. | 40 |
| BCS Electronics Ltd. | 39, 69 |
| Canada Remote Systems | 30 |
| Canadian Distribution Inc. | 41 |
| Complex Systems | 40 |
| Computer Mail Order | 40 |
| Computer Parts Galore | 8, 9 |
| Dacor Ltd. | 68 |
| Daetron | 63 |
| Duncan Instruments | 64 |
| EDG | 31, 33, 35 |
| Electronic Control Systems | 30 |
| Electronic Supplies Inc. | 64 |
| Exceltronix | 2, 3, 36 |
| Hitachi Denshi Ltd. (Canada) | 72 |
| Information Unlimited | 32, 41 |
| Interfax Systems Inc. | 65, 67, 40 |
| Kaonitai Electronics Merchants Ltd. | 30 |
| KB Electronics | 6, 41 |
| Leasomatic Canada | 40 |
| Len Finkler & Co. | 41 |
| Mark Gee Enterprises Ltd. | 62 |
| McGraw Hill | 29 |
| Mesurina Ltd. | 41 |
| Metermaster | 34 |
| Micromega Electronics | 62 |
| Orion Electronics Supplies Inc. | 66 |
| Patron Components Inc. | 35 |
| RETS Electronic Training | 41 |
| Solen Electronics Inc. | 32 |
| Soltech Industries Inc. | 70 |
| Sunix Inc. | 62 |
| Surplusronics | 4 |
| The Software Link Inc. | 71 |
| Tranpac Trading Corp. | 42 |
| Varah's Direct | 7 |
| Westown Electronics | 61 |

Canada's Magazine for Electronics & Computing Enthusiasts



The ET Photoflash p.10.

Electronics in
Photography p. 37.

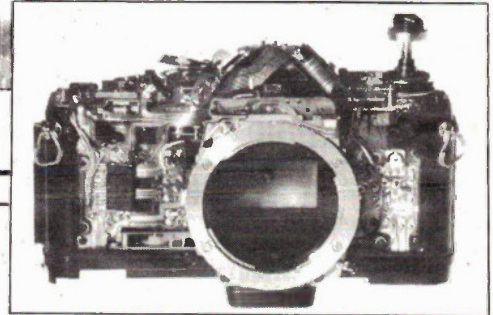

Features

| | |
|----------------------------|----|
| Impedance | 18 |
| Surface Acoustic Waves | 27 |
| Electronics In Photography | 37 |

Projects

| | |
|-------------------|----|
| The ET Photoflash | 10 |
| Heat Pen | 43 |
| FET Amplifier | 47 |

Series

| | |
|------------------------------------|----|
| For Your Information | 6 |
| Designer's Notebook: Diodes | 54 |
| Electronics From The Start, Part 6 | 58 |
| Computing Today: Data Encryption | 25 |

Columns and Information

| | | | |
|------------------------------|----|---------------------------|----|
| Software | 14 | Computing Now! This Month | 51 |
| Books | 22 | Order Form | 45 |
| Literature Review | 40 | Subscriptions | 46 |
| Electronics Today Next Month | 50 | Binders | 46 |

For Your Information

IBM Unix

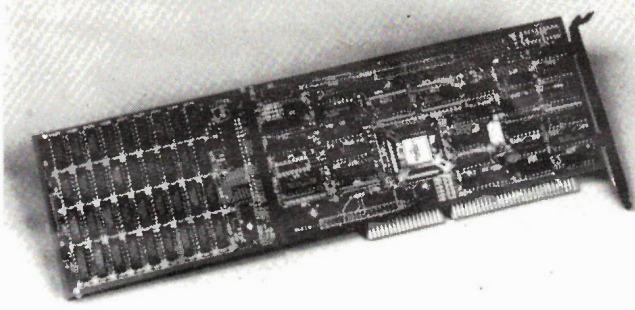

The full Unix operating system is available for the IBM PC by adding the new Motorola PC/68000 card. This adds an MC68000 CPU and converts the PC into a multi-processor host with a complete operating system functionally equivalent to the AT&T System V Unix. The user can switch from Unix to PC-DOS with ALT-M,

and files can be transferred between systems. The PC should have a minimum 10MB hard disk. From authorized Motorola semiconductor dealers, or contact the head office: Motorola Semiconductor Products Inc., PO Box 20912, Phoenix, Arizona 85036.

Circle No. 35 on Reader Service Card.

Waveform Generator

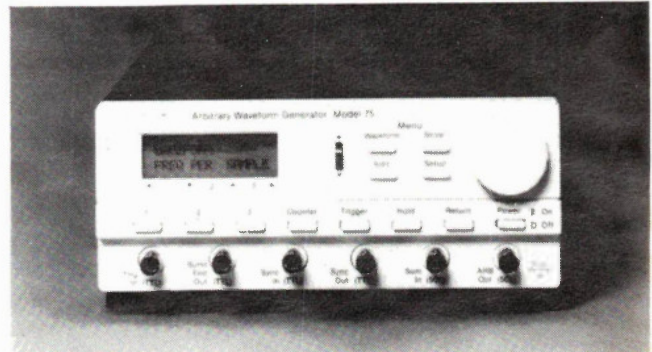

Wavetek's new Model 75 can construct any waveform using cursor-assisted editing and an oscilloscope; waveforms can be expanded or compressed in real time. Standard waves such as sine and triangle can be modified in phase, offset and magnitude using the cursor movements. The adjustable time period is crystal controlled

from 1µs to 113 hours and an internal counter keeps track of the output up to 1000,000 cycles. From Allan Crawford Associates, Electronic Instruments and Systems Division, 5835 Coopers Ave., Mississauga, Ontario L4Z 1Y2, (416) 890-2010.

Circle No. 36 on Reader Service Card.

**We Import Direct and We Service What We Sell
BEST QUALITY INSTRUMENTS AT LOWEST COST!
Why Pay More? . . . Just a Few Examples:**

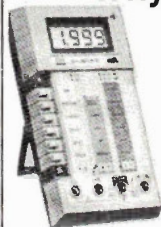

DMM 601
3½ dig. 0.25% acc.
0.1 mV - 1000 VDC
0.1 µA - 2 A AC/DC
0.1 mV - 750 VAC
0.1 ohm - 20 M ohms
Safety test leads incl.

\$63.90

Dmm 601C (same as 601) except: max. 10 A AC/DC

\$69.50

Synthesized R.F. Generator SD 1003



8-512 (Model SD1004 MAX 1060 MHz) AM .O-90% FM in 10-30-100KHz steps. Output attenuation in 10dB steps with Vernier Fine Control. Price 30-40% below "Industry Standard" prices at \$3,600.00

OSCILLOSCOPE 33330

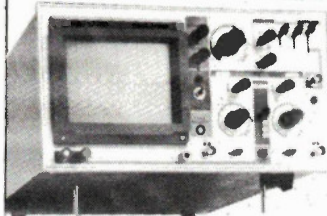

- 2 Chan.
20MHz bandwidth
Built-in components tester
5 mV vert. sensitivity
Special Price \$495.00
In areas not served by distributors. Probes extra.

Precision Analog Multimeter Model 5050E

- Input resistance, 10M Ω/DC
- 43 measuring ranges
- AC/DC current max. 12A

Introductory Price **\$67.50**



Model 605 RF Generator

100KHz - 70 mHz
On fundamentals

Introductory price **\$183.00**

Authorized Distributor:

Waterloo Electronics Supply Co. In. 219 Hartwood Ave., Waterloo, Ont. 745-9421.

Mail Orders: VISA, Certified Cheque, Money Order or C.O.D.'s F.O.B. Oakville, Ontario residents add 7% P.S.T.

KB ELECTRONICS

355 Iroquois Shore Rd., Oakville, Ont. L6H 1M3
(416) 842-6888 Telex 06-982396 (KBEL OKVL)

Stay Cool, Now



If you have problems with overheating in transistors used in outputs or power supplies, you might be interested in the new KOOL-KUBE, a revolutionary approach to semiconductor cooling. The Kool-Kube is precision manufactured from selected hydrogen oxide by reducing the ambient temperature until a special crystalline structure forms. The Kool-Kube is then inserted under the transistor with or without the heatsink attached, absorbing excess heat. The Kool-Kube is self-disposable for convenience. Widely sold in large plastic bags at milk stores and gas stations everywhere.

continued on page 36

Copyright

All material is subject to worldwide copyright protection. All PCB patterns are copyright and no company can sell boards to our design without our permission.

Liability

While every effort has been made to ensure that all constructional projects referred to in this magazine will operate as indicated efficiently and properly and that all necessary components are available, no responsibility whatsoever is accepted in respect of the failure for any reason at all of the project to operate efficiently or at all whether due to any fault in the design or otherwise and no responsibility is accepted for the failure to obtain component parts in respect of any such project. Further no responsibility is accepted in respect of any injury or damage caused by any fault in design of any such project as aforesaid.

Editorial Queries

Written queries can only be answered when accompanied by a self-addressed, stamped envelope. These must relate to recent articles and not involve the staff in any research. Mark such letter Electronics TodayQuery. We cannot answer telephone queries.

Binders

Binders made especially for Electronics Today (ETI) are available for \$9.75 including postage and handling. Ontario residents please add provincial sales tax.

Back Issues and Photocopies

Previous issues of Electronics Today Canada are available direct from our office for \$4.00 each; please specify by month, not by feature you require. See order card for issue available.

We can supply photocopies of any article published in Electronics Today Canada; the charge is \$2.00 per article, regardless of length. Please specify both issue and article.

Component Notation and Units

We normally specify components using an international standard. Many readers will be unfamiliar with this but it's simple, less likely to lead to error and will be widely used everywhere sooner or later. Electronics Today has opted for sooner!

Firstly decimal points are dropped and substituted with the multiplier: thus 4.7uF is written 4u7. Capacitors also use the multiplier nano (one nanofarad is 1000pF). Thus 0.1 uF is 100nF, 5600pF is 5n6. Other examples are 5.6pF = 5p6 and 0.5pF = 0p5.

Resistors are treated similarly: 1.8Mohms is 1M8, 56kohms is the same, 4.7kohms is 4k7, 100ohms is 100R and 5.6ohms is 5R6.

PCB Suppliers

ETI magazine does NOT supply PCBs or kits but we do issue manufacturing permits for companies to manufacture boards and kits to our designs. Contact the following companies when ordering boards.

Please note we do not keep track of what is available from who so please don't contact us for information PCBs and kits. Similarly do not ask PCB suppliers for help with projects.

K.S.K. Associates, P.O. Box 266, Milton, Ont. L9T 4N9.

B—C—D Electronics, P.O. Box 6326, Stn. F., Hamilton, Ont. L9C 6L9.

Wentworth Electronics, R.R. No. 1 Waterdown, Ont. L0R 2H0.

Danocinths Inc., P.O. Box 261, Westland M1 4B1 8S USA.

Arkon Electronics Ltd., 409 Queen Street W., Toronto, Ont., M5V 2A5.

Spectrum Electronics, 14 Knightswood Crescent, Brantford, Ontario N3R 7E6.

Varah's direct

20 Meg Kit Blast Off!

Varah's Direct unveils the latest from Tandon. Terrific new 1/2-height drive kits with expanded capacity in an all-inclusive package. Now at special introductory prices!

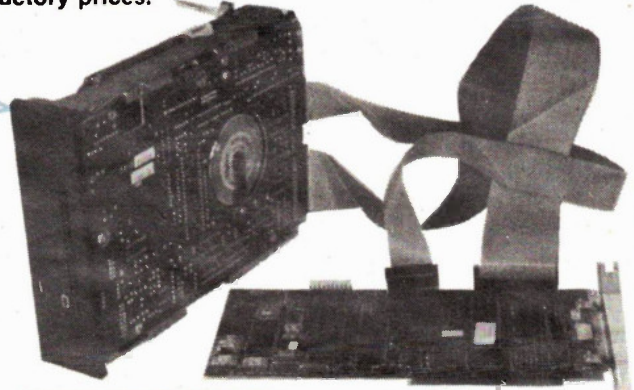

- Fully pretested and formatted.
- Easy to follow instructions.
- Complete 90-day warranty.
- Simply plug in, boot up and go!

E. T. Launch Price — \$879 complete

A screwdriver and one of these complete drive kits from Tandon instantly gives you up to 40 MB of extra storage capacity. Direct to you from the world's #1 disk-drive manufacturer ... with controller card, cables, and all accessories for guaranteed do-it-yourself installation! To order your drive kit, write us or call (416) 842-8833 between 8:30 and 6:00 (EST), Monday to Friday. *Limited quantities, so act now!*

| IBM or IBM-Compatible | 360KB Kit 1/2 - Height Floppy | 10MB Kit 1/2 - Height Winchester | 20MB Kit 1/2 - Height - Full Winchester | 40MB Kit 1/2 - Height Winchester | | |
|-----------------------------|-------------------------------------|--|---|--|---------|---------|
| PC | | | | | | |
| XT | | | | | | |
| AT | | | | | | |
| Avg Access Time | 90 mS | 85 mS | 80 mS | 40 mS | 35 mS | 35 mS |
| Varah's Direct Stock Number | 62601 * | 62611 | 62621 | 62625 * | 62640 | 62645 * |
| Introductory Price | \$ 169 | \$ 729 | \$ 879 | \$ 999 | \$ 2049 | \$ 1749 |

Indicates compatibility

*No controller card needed



For more information on the full-line of electronic components and supplies offered by Varah's Direct, write, circle, or call today for your free copy of the:

1985/86 Varah's Direct Reference Guide & Electronic Mail Order Catalogue

Not just a price listing, this is a fully referenced book supplying pin-outs, electrical specs, and dimensions on over 2000 items from our multi-million dollar industrial inventory. Contact us today for your free copy!



Member, Canadian Direct Marketing Association

Locations:

Vancouver
Edmonton
Calgary
Winnipeg
Oakville
Nepean

Write:

Varah's Direct
504 Iroquois Shore Rd.
Oakville, Ontario
L6H 3K4
(please include your return postal code)

Circle:

The reader service number for this ad
Or Call:
(416) 842-8833
Monday to Friday
8:00 - 6:00. E.S.T.

Toll Free Orders Only
1-800-387-1385

Order Checking (416)925-8291
Technical Data (416)925-1105

MAIL ORDERS: We accept VISA, MC, AMEX, credit cards. Money orders, cheques (2 week wait) are also OK. Minimum packing and handling fee \$5.00 or 5%, whichever is larger. The only COD we use is via CANPAR (add \$4.00 COD fee) or motor freight. We do not use postal COD at all. All Ont. res. add 7%. All prices are subject to change without notice. Returns are subject to a 20% restocking charge.

We have the nicest case of all the various competing cases, ask any friend who has bought someone else's case and then has seen ours. The lid is hinged with pushbutton access. The back is cut for 8 XT slots and it comes with all the case back inserts for cards, card guides, blind disc filer plates, standoffs, feet, screws, all for **\$69.95**.

Please specify back or side cutout for power supply.

We also have an IBM 8 Slot/6502 Board dual duty case for making IBM look-a-like 6502 systems **\$79.95**

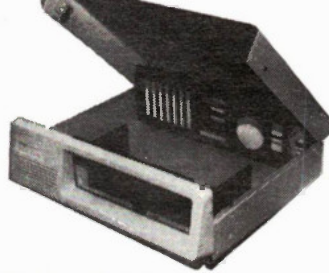

MEGABOARD CASE, similar to the above. Fits the MEGABOARD exactly for back power supply **\$99.00**



A great buy, a pack of 7 brand new GE NICADS giving 8.4v at 4 Amp hours. Each cell is 12v and separates easy. Used as 5V backup through a 7805. Gives 5v 1 Amp for 4 hours. **\$14.95**

WIRED CARDS FOR IBM

- (A) 384K RAM CARD. A 3/4 sized card that has 384K of 64K DRAM on board. With OK **\$ 89.95**
- (B) 512K RAM CARD. A full sized card with 512K of 64K DRAM on board. With 64K **\$119.00**
- (C) 576K RAM CARD. A very popular card with 576K of 64K and 256K DRAM on board. This is a 3/4 sized card for portable use. With OK **\$ 79.95**
- (D) KRAM RAM CARD. A clone of the JRAM with up to 2 MBYTE on board using 256K DRAM. 100% compatible, complete with software for using as RAMDISC and RAMSPOLL. With OK **\$139.00**
- (E) COLOR GRAPHICS. A clone of the popular PERSYST color card. Has three outputs and one input. A. RGB for IBM color monitor. B Video 1v P to P composite color video. C. Video gray scale 1v P to P for seeing color on green or amber monitor **\$129.95**
- (F) MONOCHROME GRAPHICS/PRINTER. A workalike clone 100% IBM compatible for the HERCULES card. Has par printer port and hi-res text and graphics mono output **\$159.95**
- (G) 384K HEXPACK. A copy of the AST 6-PACK, 100% compatible with software. Has Clock/calendar/alarm and 384K DRAM and serial and parallel ports and game I/O. With OK **\$189.00**
- (H) 640K HEXPACK. Similar to above but with 640K on board using 256K and 64K DRAM. All other features the same. With OK **\$279.00**
- (I) DISK CONTROLLER. For 1-4 DS-DD drives. Full IBM standard with cable and instructions. **\$ 79.95**
- (J) DISK CONTROLLER + I/O CARD. A very good card that has a clock/calendar/alarm and game I/O and serial and parallel ports and a standard 1-4 drive controller card on a full sized card. Very efficient card **\$189.95**
- (K) I/O + 2. A clone of the very popular USA card of the same name. Has clock/calendar/alarm, with game I/O, serial and parallel ports **\$129.95**
- (L) PRINTER CARD. A standard centronics printer port for all parallel printers **\$ 59.95**
- (M) SERIAL CARD. A standard ASYNC serial card for modem use etc. **\$ 49.95**
- (N) MODEM CARD. A 300/1200 Baud modem using the 8910 WORLD chip. Compatible with many popular software packages. **\$189.00**
- (O) 8255 I/O CARD. Uses 2 8255's to give 16 lines of I/O for various uses. Fully locatable **\$129.95**
- (P) CLOCK CALENDAR CARD. A small card to add the clock/calendar/alarm battery to system **\$ 49.94**
- (Q) GAME PORT CARD. Adds two std game I/O ports to the system **\$ 39.95**

SYSTEMS

All SME-XT systems share these attributes.

- High order compatibility due to the DTC bios which is recognized superior to others.
- 8 Slots for plug in cards, just like IBM
- Made right here in Canada
- Socketed for the 8087 Co-processor
- IBM compatible serial keyboard
- Disc controller using 9216 IC, the most advanced, for error free operation.
- Color graphics card with gray scale and video output for optimum useability.
- Properly made 135W power supply with accessory plugs.
- Strong steel case with push-button operable flip-top hinged at rear for easy access to insides.

- (A) Base system, 256K, 1 DS, DD Drive & Controller, color graphics, 135W PS & Keyboard ... **\$ 995.00**
- (B) Enhanced system, 640K 2 DS, DD Drives and Controller Color Graphics, Clock, Calendar, Serial, Parallel Ports, 135W PS & Keyboard **\$1295.00**
- (C) HARD DRIVE OPTIONS
10 Meg formatted with controller **\$ 799.00**
20 Meg formatted with controller **\$ 999.00**
- (D) IRWIN TAPE BACKUP OPTIONS
10 Meg formatted, use your controller ... **\$ 799.00**
20 Meg formatted, use your controller ... **\$ 999.00**
- (E) EXTERNAL HARD DRIVE OPTION
In box with all cables and power supply formatted
10 Meg **\$1099.00**
20 Meg **\$1299.00**
WITH IRWIN TAPE B/U UNIT ADD
10 Meg **\$ 799.00**
20 Meg **\$ 999.00**

NEW SME-XT 640K TO 1M BYTE

BARE PCB \$39.95
WIRED WITH 256K \$299.00

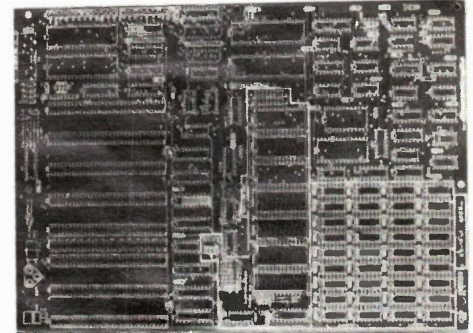

In response to popular demand we have developed an upgrade of the famous MBE-XT board. The new board is called the SME-XT and has space for up to 1 Mbyte on board. The most popular configuration is 640K which is the IBM max addressable memory. The extra RAM above 640K is normally used for system purposes such as video lookup, ROM sitting, and other uses. However, we can supply proms to allow full use of this overhead space on demand. The 256K RAMS are more highly evolved than 64K RAMS and board using them have far fewer problems with parity errors. We have decided to maintain the low price we pioneered with the MBE-XT and sell the new PCB at \$39.95 as well. All other attributes stay the same as the original IBM and the MBE-XT.

SME-XT **\$39.95**
Manual and Schematic **\$ 4.95**

HARD DRIVE BOX

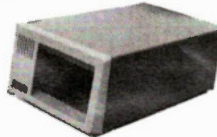

This nicely made box is ideal for externally mounted hard or floppy drives. It has space for one full height or two half height drives and power supply space at rear. This is a well made and rugged units for only **\$59.95**

QUME

Yes we have the same QUME drives that IBM uses in their IBM-XT® system, 40 track, 1/2 height, double sided, double density. The exact ones you need to upgrade your old system or build your clone system up to the max. These are brand new drives that are from QUME's own inventory. They are absolutely perfect, at a perfect price of only **\$135.00**

MEMORY FLASH

- 64K-200Ns DRAM **\$1.25**
- 64K-150Ns DRAM **85¢**
- 256K-150Ns DRAM **\$4.75**
- Set of 941256 **\$39.95**

SWITCHING POWER SUPPLY

110V, 60Hz with Fan and two rear switched outlets

These power supplies fit our cases.
130 WATT +5V - 14A; +12v - 4.2A; ±12V - 1/2A
Back Switch **\$135.00**
Side Switch **\$139.00**



KEYTRONICS 5150

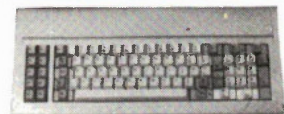

Yes the famous KEYTRONICS 5150 IBM® compatible keyboard. MADE IN USA. We bought a bunch and can sell them for only **\$119.00**

We also have some Taiwan copies that are quite good and all are checked for only **\$99.00**

And lastly we have some Taiwan copies of the famous KEYTRONICS 5151 keyboard with all the same enhanced features for only **\$139.00**

Toll Free Orders Only
1-800-387-1385
Order Checking (416) 925-8291
Technical Data (416) 925-1105

SOLDERLESS BREADBOARD

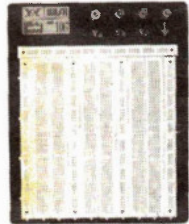

Solderless prototyping boards are the best way to quickly breadboard up a circuit. The holes are made especially for IC's, resistors, and other small parts with 22-28 gage wire leads, takes WW pins too.

- WB-106 \$39.95
- 3 IC strips, 5 power strips
- 4 Binding posts, Aluminum plate
- WB-104.3 \$24.95
- 2 IC strips, 1 power strip
- 2 Binding posts, aluminum plate
- WB-108 \$49.95
- 4 IC strips, 7 power strips
- 4 Binding posts, aluminum plate
- WB-104 \$29.95
- 2 IC strips, 4 power strips
- 2 Binding posts, aluminum plate.

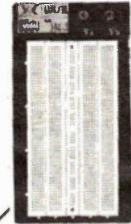

MOTHER BOARD

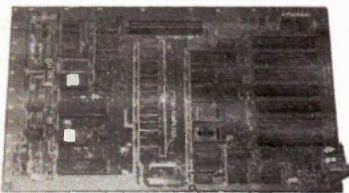

100% Iie® Compatible, for those of you who wish to build a clone of the very popular APPLE Iie®. This board is a reverse engineered copy of the Iie® and is 100% compatible. We have the motherboard and the custom ICs only. All other parts are widely sold. The custom ICs are workalike chips that do not infringe any copyrights. The software for operating the board must be obtained elsewhere as we do not have it for sale. When we say 100% we mean it.

- A very good buy at \$49.95
- Custom IC set(2) \$49.95
- Keyboard encoder (AY3-3800) \$14.95
- Character generator, U/LC \$14.95
- 48K 6502 Motherboard, same old 100% compatible 2 + clone \$29.95

Iie® ABS PLASTIC CASE \$59.95



This case is made to fit the Mother Board listed here for making Iie® clones and it makes a very nice looking copy. There is just enough difference to avoid design infringement. The case also has no brand names or other marks on it.

- A good buy at \$59.95
- ABS numeric case for 48K motherboard. Exact fit. \$49.95

APPLE Iie® DETACHED NUMERIC KEYBOARD \$99.00



For those of you who would like to put your Iie in another case we have a high quality 100% plug in compatible Matrix keyboard with all Iie keys plus the highly desirable numeric keypad for quick entry of numeric data \$99.00

Iie® MATRIX KEYBOARD \$79.95



This keyboard fits the above case and has 100% clone compatibility, it will allow operation of all Iie commands. Another bargain at \$79.95

- 2 + numeric keyboard for 48K mother boards, 100% comp, 88 basic functions for only \$69.95
- Standard same as above \$69.95

SWITCHING POWER SUPPLY



Another great bargain from PARTS GALORE, A small power supply switching style that give +5v -4A; ±12v 1A and -5v (adjustable) on a compact 4x8" open frame PCB. Cost Northern Telecom \$50.00 when they bought 5000 pieces. We got em when a subcontractor went belly up for 10% of that price and we are selling em for

\$18.95 NEW IN BOX TESTED

AC power cable (3 Wire) for above \$2.50



This is a high quality Hall Effect keyboard made by Microswitch of Canada for AES data and now bought by us for 10% of the \$169.00 that AES paid for them in 10,000 lots. They are a very good word processing keyboard with both serial and parallel data outputs for use with APPLE and IBM type systems and come complete with a ribbon cable connector and complete pinout. \$24.95

IBM POWER SUPPLY

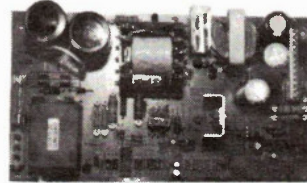

One of the nicest open frame IBM type switching power supplies we have ever seen. Came from the defunct NCR IBM compatible. runs the whole thing, has +5V-7A, +12V-3A, -5, -12-¼ A. A very good unit for starter system. Will not run hard disc system. A real Steal at \$49.95

8" DRIVE SWITCHING POWER SUPPLY

\$39.95

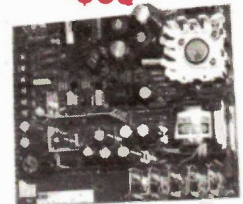

The greatest 8" Drive supply we have ever found. Has 24V-2.2A 5V-3A and -12V-17A. All you need for a dual 8" Drive system. A switching power supply by ASTEC

PARTS, PARTS,

| | |
|--|------------|
| 8088 CPU | \$12.95 |
| 8087 Math Processor | \$219.00 |
| 8237A 5 Prog. DMA Cntrl. | \$8.95 |
| 8250 Serial Port | \$9.95 |
| 8253A-5 Prog. Interval timer | \$5.95 |
| 8255A-5 P.I.A. | \$4.95 |
| 8259A Prog. Interrupt Cntrl. | \$4.95 |
| 8284A ADC clock gen & driver | \$5.95 |
| 8288 Bus Controller | \$9.95 |
| 8272 Floppy Disk Controller | \$9.95 |
| NEC 765 Floppy Disk Controller (equivalent to 8272) | \$9.95 |
| Set of 8088, 8255A-5, 8237A-5, 8288, 8284, 8253A-5 and 8259A | \$44.00 |
| 6502 CPU | \$ 5.50 |
| 6845 CRT controller | \$ 8.50 |
| 6844S CRT controller | \$ 9.95 |
| Z80A CPU (4 MHZ) | \$ 4.99 |
| MC3242 | \$11.95 |
| 74LS367 | \$.82 |
| 74LS259 | \$ 1.39 |
| 74LS161 | \$.99 |
| 74S74 | \$.82 |
| 74S174 | \$ 1.70 |
| 74LS323 | \$ 4.55 |
| Card edge connector (50 pin) | \$ 2.49 |
| RCA Jack PC mount | \$.69 |
| 6 pin power square connector | \$.99 |
| Phono jack (small) | \$.99 |
| MPSA-13 trans | \$.55 |
| 2N3904 trans | \$.19 |
| 2N3906 trans | \$.27 |
| MPSU1 trans | \$.79 |
| 2N4258 transistor or equiv | \$.69 |
| 1K SIP 10 pin | \$.69 |
| 1K SIP 8 pin | \$.69 |
| 10K SIP 10 pin | \$.75 |
| 4 pos dip sw | \$.95 |
| 20 pin female header for disk drive | \$ 1.79 |
| 20 pin male | \$ 1.69 |
| 50 pf trim cap | \$.89 |
| 220 ohm trimpot | \$.69 |
| 20 conduct or ribbon cable | \$.89/ft. |

PARTS, PARTS,

| | |
|--|---------|
| 100ns delay line | \$5.00 |
| 7ns delay line | \$13.95 |
| 62 pin edge con (high quality) | \$1.89 |
| 5pin Din conn | \$1.25 |
| Power conn | \$1.25 |
| Dip switch 8 pos | \$2.49 |
| 4.7k x 8 Bip | \$.69 |
| 4.7k x 8 pin slip | \$.69 |
| 8.2k or 10k 16 pin Resistor or net | \$.99 |
| 33ohm x 8 network | \$1.10 |
| Small speaker | \$1.99 |
| .1uf 50V high quality bypass capacitors x 10 | \$.10 |
| Trimcap | \$.99 |
| 34 pin card edge con. | \$5.95 |
| 2716 | \$3.49 |
| 2732 | \$3.95 |
| 2764 | \$4.95 |

MBE-XT AN IBM® XT Compatible 8 Slot Motherboard

MBE-XT BARE PCB WITH MANUAL AND SCHEMATICS.
\$34.95

LAZY BOARD

What Is your time worth?? We have had a bunch of MBE-XT boards stuffed and wave soldered so you can save all that time soldering them up. All you need are the IC's memory and BIOS and you are set to go \$149.00

FULLY WIRED AND TESTED WITH 64K ON BOARD WITH MEGABIOS AND MANUAL

\$299.00

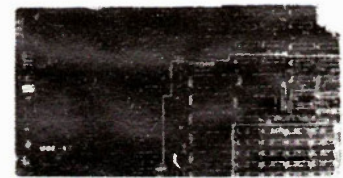

- 8088 16 Bit Microprocessor
- 8087 Math Processor, Optional
- Up to 256K Dram on Board
- Has Digital Delay Line for Error Free Memory Refresh
- 8 IBM Compatible Expansion Slots
- 4 DMA and Timer Channels
- 64K/128K Eptroms Jumper Selectable
- Will run any Compatible BASIC
- IBM Power Plug Compatible
- Same PCB size as IBM XT
- Runs PC-DOS and CPM-86
- Compatible BIOS in stock

MEGA BIOS

The amazing MEGABIOS® from DTC of Dallas. A fully rewritten BIOS that allows you to make a fully compatible legal system. Note they do not ask MEGABUCKS® for it, only \$49.95

TAIWAN BIOS, not as good or 100% compatible but it will get you running and save you bucks \$24.95

IBM BARE PCB

| | |
|---|---------|
| (A) Color Graphics (Persyst) | \$27.95 |
| (B) Monochrome graphics | \$24.95 |
| (C) Disc controller | \$17.95 |
| (D) Disc controller + Printer | \$24.95 |
| (E) Disc controller + Game | \$24.95 |
| (F) IO + 2 I/O clock etc. | \$24.95 |
| (G) Multifunction card 11 function | \$24.95 |
| (H) AST SIX CARD COPY | \$34.95 |
| (I) Parallel printer | \$17.95 |
| (J) RS-232 card | \$17.95 |
| (K) Simple modem card | \$17.95 |
| (L) Disc for above | \$ 8.00 |
| (M) 512K card | \$24.95 |
| (N) 256K short card | \$19.95 |
| (O) IBM 6" extender for service | \$18.95 |
| (P) WW Proto, full sized with DB-9 & DB25 footprint | \$24.95 |
| (Q) WW Memory proto, full sized with 256K (1Meg) memory laid out on one end with DB-9, DB25 footprint | \$29.95 |
| (R) 512K Mapping PROM | \$12.55 |
| (S) Multifunction PROMS(2) | \$24.95 |
| (T) 2732 for color graphic | \$10.00 |

All cards come with a detailed parts list and placement drawing, we also have all parts needed for them.

Photoflash Project

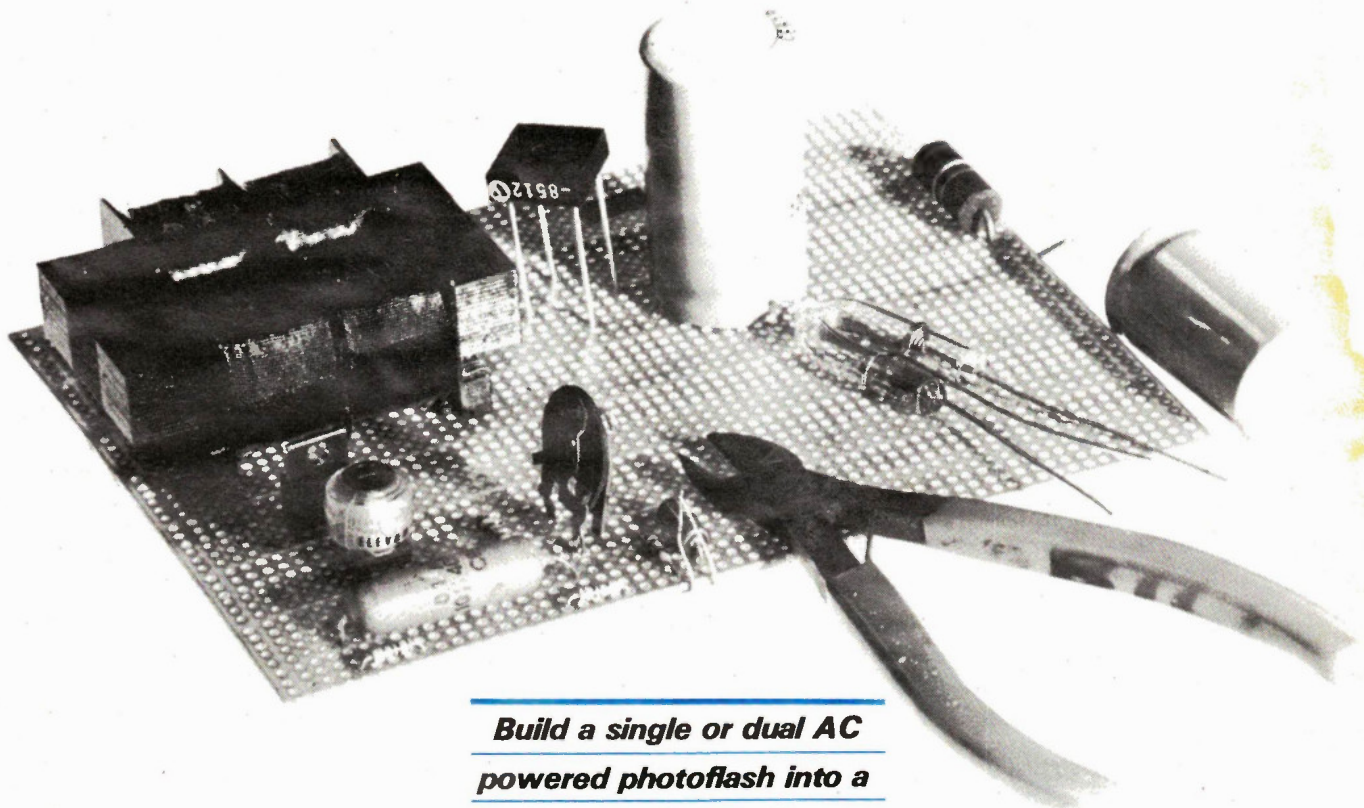

***Build a single or dual AC
powered photoflash into a
softbox or direct reflector;
includes design formulas.***

By Bill Markwick

IF YOU do any studio photography, or you'd like to have a larger flash unit that will fill a room with soft light, or you'd just like to tinker with xenon tubes, here's the Electronics Today Photoflash. Most of the parts are available from Radio Shack, and you can substitute without too much trouble.

However, because of the variables involved, I'd like to point out that this project is for the determined tinkerer. The construction details and mounting methods are left largely to you.

You can use one or more flashtubes, each with a maximum power of 50 watt/seconds (joules). The tube (or tubes) can be mounted in a homemade softbox, or fit into a reflector or other lamp, or just used bare-bulb for a floodlight effect. The recycle time at full power is about seven seconds, limited to avoid overheating the low-cost flashtubes.

Feel free to tinker with the various components. About all that can go wrong is that you overheat and blow the \$4.95

flashtube, or take a poke from the 300V supply (painful but not likely to be lethal).

Oh, speaking of the things going wrong — ('*here it comes... he's gonna tell us we can't get some of the parts.*') you may not be able to get some of the parts. At least not at the corner Radio Shack. At the time of planning this project, RS stocked trigger coils, photoflash capacitors, and flash tubes. As we went to press, the coil and capacitor had been discontinued, but there may still be stock available on the shelves. If not, there are substitutions listed for you, but they may mean top dollar. The RS versions were light-duty, very inexpensive, and suitable for tinkering. The subs are a bit more robust and rather more expensive. However — onward.

Theory

The flashtube consists of a glass tube with electrodes at each end and a filling of xenon gas. A third small electrode is attached to the outside of the tube. The in-

ternal electrodes are connected across a large capacitor charged to a high voltage (the tube is normally non-conductive), and the external electrode is attached to the output of a very high voltage trigger coil.

When the main reservoir capacitor is fully charged and you're ready to go, a smaller charged capacitor is switched across the primary of the trigger transformer, producing a decaying pulse with a maximum amplitude of about 4kV. This high voltage pulse on the external electrode ionizes the xenon gas inside the flashtube and makes it conductive; the effect is rather like triggering an SCR. The sudden low resistance of the flashtube discharges the main capacitor in about a millisecond, and the sudden rush of high current through the gas produces a burst of light. The light has an odd, discontinuous spectrum, rather spiky, but the eye and the film see it as pretty much the same thing as daylight. Its colour temperature may not be tightly specified

| | | |
|---|---|--|
| <p>200 VOLTS</p> <p>CAP. = 100 W/S = 2 CAP. = 200 W/S = 4 CAP. = 300 W/S = 6 CAP. = 400 W/S = 8 CAP. = 500 W/S = 10 CAP. = 600 W/S = 12 CAP. = 700 W/S = 14 CAP. = 800 W/S = 16 CAP. = 900 W/S = 18 CAP. = 1000 W/S = 20</p> | <p>225 VOLTS</p> <p>CAP. = 100 W/S = 2 CAP. = 200 W/S = 5 CAP. = 300 W/S = 7 CAP. = 400 W/S = 10 CAP. = 500 W/S = 12 CAP. = 600 W/S = 15 CAP. = 700 W/S = 17 CAP. = 800 W/S = 20 CAP. = 900 W/S = 22 CAP. = 1000 W/S = 25</p> | <p>250 VOLTS</p> <p>CAP. = 100 W/S = 3 CAP. = 200 W/S = 6 CAP. = 300 W/S = 9 CAP. = 400 W/S = 12 CAP. = 500 W/S = 15 CAP. = 600 W/S = 18 CAP. = 700 W/S = 21 CAP. = 800 W/S = 25 CAP. = 900 W/S = 28 CAP. = 1000 W/S = 31</p> |
| <p>275 VOLTS</p> <p>CAP. = 100 W/S = 3 CAP. = 200 W/S = 7 CAP. = 300 W/S = 11 CAP. = 400 W/S = 15 CAP. = 500 W/S = 18 CAP. = 600 W/S = 22 CAP. = 700 W/S = 26 CAP. = 800 W/S = 30 CAP. = 900 W/S = 34 CAP. = 1000 W/S = 37</p> | <p>300 VOLTS</p> <p>CAP. = 100 W/S = 4 CAP. = 200 W/S = 9 CAP. = 300 W/S = 13 CAP. = 400 W/S = 18 CAP. = 500 W/S = 22 CAP. = 600 W/S = 27 CAP. = 700 W/S = 31 CAP. = 800 W/S = 36 CAP. = 900 W/S = 40 CAP. = 1000 W/S = 45</p> | <p>325 VOLTS</p> <p>CAP. = 100 W/S = 5 CAP. = 200 W/S = 10 CAP. = 300 W/S = 15 CAP. = 400 W/S = 21 CAP. = 500 W/S = 26 CAP. = 600 W/S = 31 CAP. = 700 W/S = 36 CAP. = 800 W/S = 42 CAP. = 900 W/S = 47 CAP. = 1000 W/S = 52</p> |

Watt/second values for various capacitors and operating voltages.

on the hobbyist tubes, but it will be in the neighbourhood of 5500 degrees K, matching nicely to daylight colour films.

Once the voltage of the main capacitor drops to 50V or so, the tube becomes non-conductive once again and the capacitor begins charging for the next blast.

The Flashtube

The flashtube we used, Radio Shack number 272-1145, is ideal for this application because it's inexpensive, runs at 300V, and puts out 50 watt/seconds of power if you don't overdo it (the specs say maximum 4 flashes per minute at 50W/S). It was still in stock the last time we checked.

If you want to try others, the FT152A from Canadian General Electric is a good one, with its 125W/S rating. If you keep to the 50W/S figure, you can fire it off continuously every five seconds or so. Most camera stores that deal with professional photographers can order it for you, but it takes a long time to get one if it's not in stock, and it's over \$50. The CGE FT118 and FT151 are more common, but I hesitate to recommend them because they prefer to run from 400V.

Flashtubes will only operate over a narrow range of voltages. The RS, for instance, must be run between 200 and 300V. If you go below the minimum, you'll get erratic triggering or none at all, and if you exceed the maximum, the tube

may fire on its own as the gas breaks over and becomes conductive.

There's yet another flashtube that used to be available from Radio Shack: the Jumbo Xenon Strobe, number 272-1147. If you can still get this one (it's unlikely), it's a good sub. The specs on its packaging are wrong, though, and your RS dealer may not want to talk about it since its deletion.

If you've managed to locate a source of other tubes, make sure the tube can: put out 50W/S per flash at a rate of four flashes per minute, run at 300V, trigger from 4kV, and dissipate 12 watts or more.

The dissipation, incidentally, is found by multiplying the energy per flash (explained later) times the number of flashes per second:

$$\text{Power} = \text{W/S} \times \text{flashes/sec}$$

Our flash is held to a recycle time of about seven seconds to give the tube a chance to cool. You can fire it off as fast as the capacitor recharges, as long as you don't exceed four flashes per minute total. The above formula works out to a dissipation of 3.3 watts at 50W/S and a F/S rate of .067 (four flashes/min). You can fire four flashes in rapid sequence, but then let it cool for a while.

A word of caution: a General Electric application note points out that tubes can be damaged in one flash by an overload, and we found out the hard way that

they're right. The tube life (normally 8,000 flashes at full power for the RS) will be shortened drastically if it flashes at all. Don't exceed the maximum watt-second rating if you can avoid it.

The Capacitor

The capacitor determines the stored energy for the flash for a given voltage. The formula is:

$\text{W/S} = \text{CV}^2/2$ where C is in farads and V is in volts. The energy varies directly with the capacitance and directly with the square of the voltage; small changes in voltages make a big difference.

However, should you like a flash with different settings, the best way to do it is usually to change capacitors, because the tube may not take kindly to having its voltage changed; too low and you get erratic firing, too high and you shorten the life or make it fire from breakover. If you're interested in using the variable-voltage method, the 272-1145 is supposed to run as low as 200V; this gives a one-stop variation over the range from 200 to 300V.

The capacitors we used were the Radio Shack 272-1148, 500u at 330V, two in parallel for 1000u. If you can't find these, you can use any large electrolytic, or parallel several together, as long as the voltage ratings are 330V or more (more is better). Surplus stores are a good place to look, or you can go for computer-grade

from any major electronics supplier.

In another more powerful flash that I built for use around here, I used surplus-store capacitors, 1000u at 450V. They only cost \$5 each, but they're the size of a 28 oz. can of tomatoes. Because they were a good deal, I built a separate power supply so I could run the tubes in various softboxes, reflectors, spotlights, etc.

You could also invest in some real heavy-duty proper photoflash capacitors. The Mallory EAF102 X 36 OU4C3PL is a 1000u, 360V unit available on special order from Mallory dealers. These are high quality professional units with very low internal resistance, but a bit expensive. Since photoflash capacitors are a bit rare, you might have to contact the makers: Emhart Canada Ltd., Mallory Components Division, 222 Dixon Road, Weston, Ontario, M9P 2M2, (416) 244-4239.

Resist the temptation to put capacitors in series; there's the problem of dividing up the operating voltage properly between them.

If you'd like to have a variable-power flash, you can switch in different capacitors. Each doubling or halving of capacitance represents one stop, photographically speaking. The listing shows the output in watt-seconds for various combinations of voltages and capacitances.

If you're building a multiple unit, remember that *each tube requires its own capacitor*. If you try to run several tubes from a single capacitor bank, the tube with the lowest resistance gets most of the power. It could be high enough to damage it. I've only used one trigger coil for simplicity, but for more than two tubes, you should add another for each pair of tubes.

You can add lots more than two tubes if you want, though the recycle time will get longer.

The Resistors

The purpose of the series resistor (the 2k2) is twofold: first, and most important, it isolates the tube from the transformer to make sure that the tube cuts off and doesn't keep glowing when the capacitor is discharged; second, it increases the recycle time to give the tube a chance to cool. The value of 2k2 was arbitrarily chosen for a reasonable recycle time; you can substitute if you like. By the way, these 1W resistors will get very hot during charging; because it's for such a short time you can get away with it. If you prefer, you can use 2W to 5W units.

There should be an isolating series resistor for *each* flashtube used. The minimum value for the resistor is: $R = T/7C$, where T is the time between flashes in seconds and C is the storage capacitor in farads. For longer charge times, the formula for the time in seconds is: $T =$

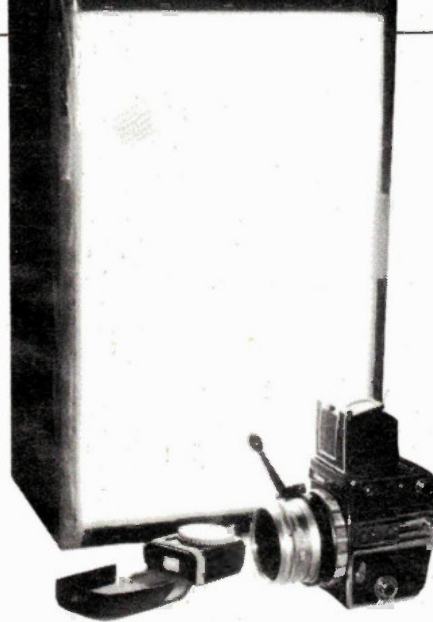

The well-worn ET mini softbox, about 1 x 1 x 2 feet. A sheet of glass protects the double layer of frosted film.

5RC. It may turn out to be slightly longer or shorter than calculated because the R should include the effective resistance of the transformer secondary, and also, electrolytic capacitors have very wide tolerance ranges.

The 47k shunt resistors are important to prevent the output voltage from rising; we used a 229-series transformer because it was small and inexpensive, but its 230V output means that the rectified and filtered output can rise to well over 330V, exceeding the capacitor's voltage rating. The 47k keeps the power supply under load at all times. If you're using more than two tubes, you don't need extra 47k resistors as long as there's at least one in the circuit.

The Transformers

Anything will do for a power transformer as long as the DC output doesn't exceed the capacitor voltage ratings. The 229B230 I used has a 50mA, 230V secondary, adequate for fast recharge even with multiple tubes. You can also use the 229A230, a 25mA unit, or any other suitable transformer. The AC voltage from the secondary is: $VAC = VDC \times .707$. Just work backwards from the desired DC, or if you already have a junkbox full of transformers, the DC will be: $VDC = VAC \times 1.414$.

Measure the AC secondary voltage with no load connected; if we ignore the 47ks for the moment, the capacitor voltage will rise to the peak of the *unloaded* AC voltage. Remember that commercial specs for power transformers are usually full-load values. You may have to adjust the shunt resistor if the voltage exceeds your capacitor's rating. The current rating isn't too important; the lower it is, the longer the recycle time, and vice versa.

The trigger coil is designed for Class I

triggering, which is what most photoflash tubes use. This requires an output pulse of 4kV, an energy of at least 3.2 millijoules (a millijoule is 1/1000 of a watt/second) and a duration of at least 50uS. The 272-1146 coil specs want a primary inductance of 300V from a .022u capacitor; this is only 1mJ. I've increased the trigger capacitor to .1u, giving 4.5mJ, enough to fire two tubes. If you get occasional misfiring with two tubes, solder another .1u 400V across the first.

If you can't find this coil, Hammond makes a photoflash trigger, the 616B Class I type. It's a heavy-duty unit that costs you about \$20, though it will last forever. It prefers 120V on the capacitor instead of 300V. Not to worry; put a resistor across the .1u trigger capacitor.

Occasionally you'll come across tubes that require a high-energy trigger, such as the CGE FT151. These use Class II triggering: 10kV and 20mJ. Hammond makes the 616E Class II trigger; it will work with the Radio Shack tubes, though I've found that the 10kV pulse will break through normal wire insulation. You may need sleeving or HV wire for the trigger leads should you use Class II.

The Firing Circuit

You could use the shutter contacts to trigger your camera to directly connect the trigger capacitor across the coil, but this means slight sparking of the contacts and 300V on your leads. I've used an SCR, the 276-1020 (6A, 400V), to reduce the trigger current to a few milliamps and the operating voltage to about 25V. The SCR can be almost any unit with a current rating of 1A or more and a voltage rating of 400V or more (2N3529, C6D, S401, etc.). It doesn't need heatsinking because it doesn't dissipate any significant power.

The 1M resistor in series with the capacitor charges it up to the supply

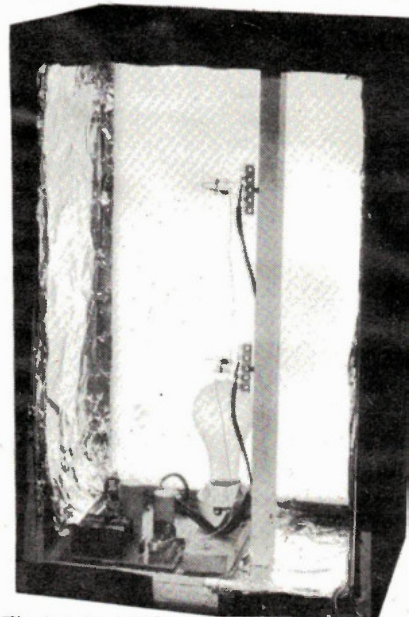

The interior of the softbox, showing the power board, 150W lamp and two 50W/S tubes.

voltage within 1/2 second. When the SCR is triggered, it effectively connects the coil primary across the capacitor, discharging it rapidly to produce the required HV pulse.

The 1uF capacitor is used to make sure that a good strong initial current is applied to the gate for reliable triggering. This can be any value you have on hand from 1u to 10u, with a minimum voltage rating of 35V.

Occasionally SCRs can be triggered by static or noise on the shutter leads. If this happens, try connecting a small capacitor from the gate to the cathode; a .001u is a good starting point and should short-circuit noise voltages.

Other Components

A neon light (with or without an internal resistor) is included to let you know when the flash is charged. Neons won't come on until they reach a specified firing voltage; because of variations in this voltage I've included a trim pot. You'll find that neon firing is "soft"; as the voltage rises, the tube lights long before it reaches maximum brightness, especially if the neon has an internal current-limiting resistor. For this reason, the capacitor continues charging after the lamp has lit, even if you're finicky about setting the trim pot. Refer to the watt-second listing and use a DC voltmeter on the power supply to see how much the power will increase after the lamp lights. You might find another 10 or 15 percent is added after the neon triggers. I've never found it makes much difference photographically.

If you're using a softbox, you'll probably want to add a modelling light;

Two alternate mounting methods that we used; a hardware store clip-on reflector with its electrical socket replaced by a flashtube, and a miniature focusing spotlight with its lid up.

otherwise you're using it blindly as far as shadowing goes. I used a 150W kitchen bulb; it isn't much light, but it gives you an idea of the effect.

The rectifier bridge is a readily available VS447; you can use any other 400V bridge, or use four 400V diodes such as the 1N4004.

Construction

I used perfboard for the components because it's a small circuit. You could use Veroboard or make your own PCB. There isn't anything critical about the circuit; use common sense when dealing with the

300V wiring. A 1000u at 300V discharging through your pinkies is very startling. The 4kV out of the trigger coil is harmless but unnerving to touch.

The softbox can be made from almost anything. I used 1 x 2 spruce covered in fibreboard and fastened together with an electric glue gun and a few nails. The inside is lined with aluminum foil to minimize light absorption, and the front is covered with two layers of drafting film ("mylar"). Any translucent white film will do, even paper. The circuit is fastened to the wood frame, and the tubes are mounted on terminal

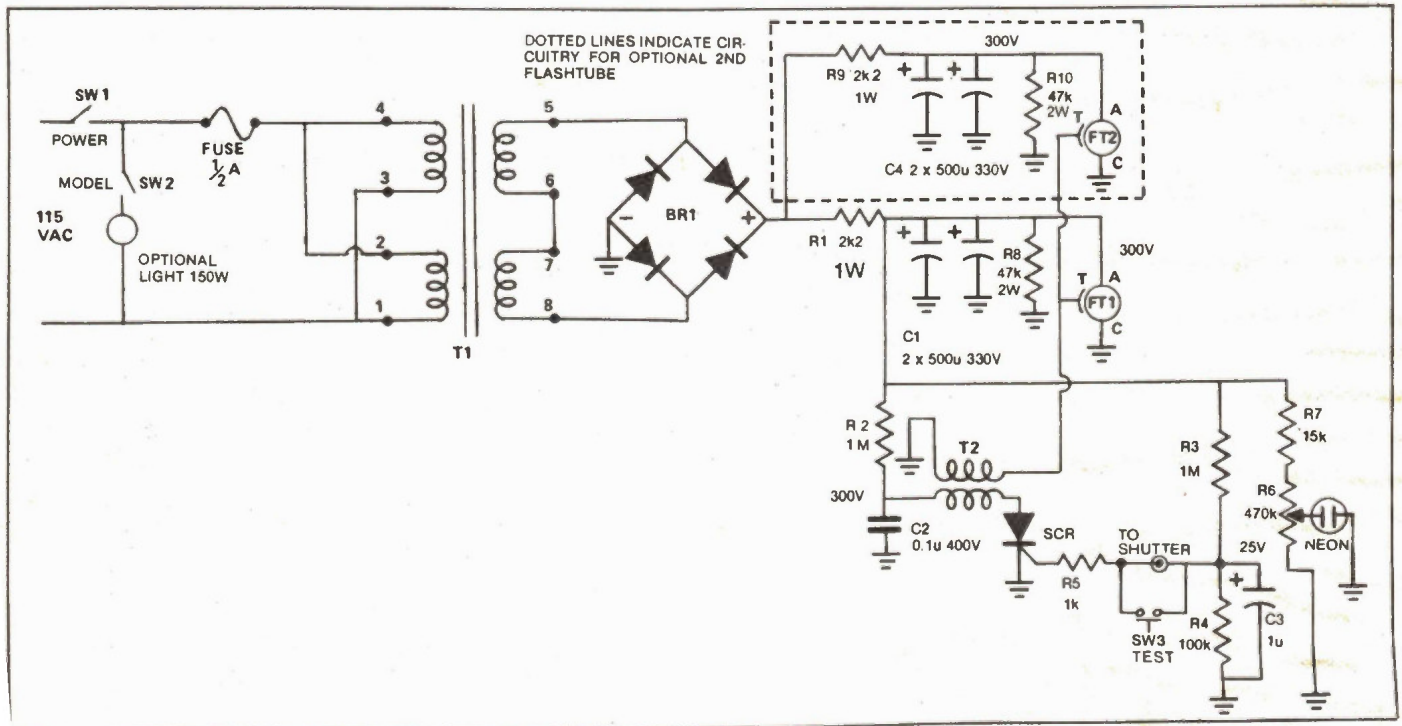

The schematic of the photoflash, single or dual tube. See the text for parts substitutions.

Computers In Small Business

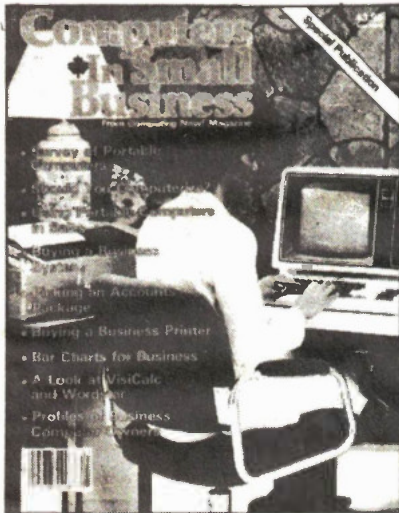

Small companies across Canada are hungry for knowledge about the microcomputer revolution. Many of them believe that they alone are ignorant about what is going on and what equipment is available.

This Special publication is addressed exclusively to this market. The articles comprise reprints of the very best material already published in *Computing Now!* magazine together with several specially commissioned features to form a well balanced publication. We believe this Special is of real use to the hundreds of thousands of small companies on the verge of buying a micro-computer.

**First Published
March 1984**

\$3.95 plus \$1.00 postage and handling. Ontario Residents add 7% PST. For a copy call (416) 423-3262 or write:

**Moorhead Publications
25 Overlea Boulevard,
Suite 601,
Toronto, Ontario, M4H 1B1**

PARTS LIST

| | |
|-----------|----------------------|
| Resistors | 1/2W 5% unless noted |
| R1, 9 | 2k2, 1W |
| R2, 3 | 1M |
| R4 | 100k |
| R5 | 1k |
| R6 | 470k trimpot |
| R7 | 15k |
| R8, 10 | 47k, 2 to 3W |

Capacitors

| | |
|-------|---------------------|
| C1, 4 | 2 x 500uF, 330V |
| C2 | 0.1u, 400V |
| C3 | 1u electro., 35-63V |

Other (see text for substitutions)

| | |
|--------|--|
| SW1, 2 | SPST power toggle switch |
| SW3 | SPST push-to-make pushbutton |
| Neon | any neon pilot light |
| FT1, 2 | Radio Shack 272-1145 |
| T1 | Hammond 229B230 |
| T2 | Class I trigger coil, Radio Shack 272-1146 |
| BR1 | VS447 or equiv |
| SCR | Radio Shack 276-1020 |

Misc

Flash cord with sync connector, 1/2 amp pigtail fuse, socket for domestic lightbulb, 150W bulb, perfboard, etc.

strips (RS 274-688) fastened to a crossbar with wood screws.

We couldn't locate a chassis-mount sync connector in time, so I bought a short flash extender cord from the local camera store and cut one end off. It hangs out of the box, a bit inelegant, but it works.

If you go for the clip-on reflector, you might want to locate an old or new tube socket to hold the flashtube. Strip out the regular bulb socket from the insides of the unit and you'll find that a tube socket fits in nicely. Pull out the tube pins, solder the wire leads to the tube, and epoxy everything in place. To avoid trying to run 4kV up the cable, glue the trigger coil in behind the tube socket; the leads from the SCR/capacitor can be light duty paired wire. The leads to the flashtube should be fairly heavy (at least 18 ga.), particularly if the extension cable is lengthy.

Also shown in the photo is a focussing spotlight we found at a store-window decoration supplier. It originally had a 150W miniature bulb on a platform that slid for focussing. I removed the original wiring and epoxied a tube socket and coil in its place, giving us a photoflash that focuses from a tiny spot to a wide flood. Next I have to add a small modelling lamp, probably a 115VAC halogen projector lamp.

Use

If you make the softbox version, you'll have the equipment to make first-rate still photos. The worst way to do a product shot or portrait is on-camera direct flash. Despite all the hoopla about intelligent flashes and so on, there's no getting away from the fact that on-camera flash wipes out surface detail and depth by flooding light along the camera axis (detail and

depth are created by shadows). Put the flash above and to the side, and you'll create a much better illusion of 3-D; soften the shadows with the softbox and you're on your way to super quality.

The exposure is something of a guess because of so many variables: power, tubes, method of mounting, etc. However, a starting point for the softbox is a guide number of 60 with ISO 100 and two 50W/S tubes; this will get you started. Divide the distance in feet into 60 to get the aperture. Make a series of test shots at various apertures to find the optimum. I know it isn't much of a guide number, even when you compare it to tiny portables, but a lot of light is lost in the softbox itself; you're also covering a much larger area than the little portables.

The bare-bulb effect is the easiest: just mount the tube or tubes in a tube socket or utility box or what have you. The light obtained is a combination of direct and bounce, and it's ideal for photos of entire rooms. Whatever mounting method you use, put sleeving on any exposed tube leads to prevent shocks.

If the tube (or tubes) are in a clip-on reflector, you'll get the equivalent of a powerful floodlight. The guide number for a single tube at 50W/S and ISO 100 is 100.

The flash duration can only be guessed at because I don't have proper specs for the tubes, something typical of a large number of Radio Shack components. The duration depends on the capacitance, the voltage at which the tube stops conducting, and the effective resistance of the tube during conduction. A typical value for small tubes is 1 millisecond, and even if it strays considerably from this, the flash is short enough for sharp photos even if the subject is moving. Perhaps one of our readers might accept the challenge of designing a flash-duration measurement method. Photograph a fan blade rotating at a known speed? Use a photo-cell in place of the film? If you come up with a working method, let us know and we'll mention it in a future issue.

Super Subscription BONUS!

Three Special Publications — worth \$12.85 — FREE!

ONE MONTH ONLY

Electronics Today is moving to new larger premises shortly and we're like everyone else, we are taking this opportunity to clear out storage. We have a number of *Special Publications* that we thought we would offer readers rather than move with us.

Subscribe now and we will send you **THREE** of these as a 'Thank you': **50 Top Projects, Projects Book No.2 PLUS** either **Electronic Circuit Design** or **Circuits File** (we do not have enough of either of the last two to guarantee a choice). Mostly these are in perfect condition but a few are slightly dog-eared; after all, this is a genuine clear-out!

Offer applies to both one and two year subscriptions. Not valid with any other bonuses or discounts. Offer expires January 31st, 1986; 'Bill me' subscriptions must be paid by that date to qualify.

WHAT YOU DO: Use the card in this issue (or any other card in *Electronics Today* after March 1985) and write in the central long box in the centre of card 'Specials offer' — we'll do the rest.



• **50 Top Projects**
156 Pages

\$4.95
Fifty all-time best projects from ETI magazine packed into one giant 156 pages special. There are projects for the beginner to the more advanced builder, including: Semiconductor Tester, Universal Counter, LED Level Meter, AM radio, and much, much more.

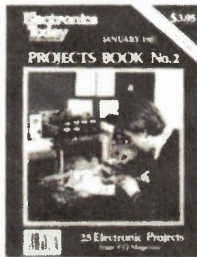

• **Projects Book No. 2**
100 pages

\$3.95
Contains 25 of the best projects from recent issues including the High Performance Series 4000 Amplifier (Including Preamps and Power Supply), Rumble Filter, Dynamic Noise Filter, Logic Probe, Cable Tester, Function Generator, Rain Alarm, Digital Tacho, Two Octave Organ, Light Chaser, Shutter Speed Timer, Ni-Cad Charger and more. First published January 1981.

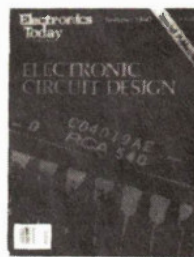

• **Electronic Circuit Design**
92 pages

\$3.95
A collection of major articles on various aspects of circuit design including CMOS, Audio Amplifiers, Power Supplies, SCR's, Op-Amps, Using the 3080 and Temperature Control. A large number of useful circuits are given but the emphasis is on guidance and how to design for yourself.

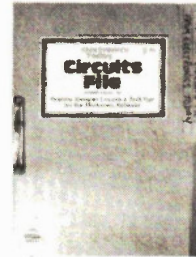

• **Circuits File**
100 Pages

\$3.95
A huge collection of circuits and tech tips for the experimenter. Includes hifi, alarm circuits, power control, electronic music, and lots of testbench accessories. Most of the circuits have not been previously published.

Electronics Today

Offer expires January 31st, 1985

Moorshead Publications Almost Free Software

Almost Free Software #1

Almost Free Software #2

Almost Free Software #3

Almost Free PC Software #1

Almost Free Software #1, #2 and #3 are for CP/M and are available in a variety of formats: Apple II + CP/M, 8 inch SSSD*, Access Matrix, Morrow Micro Decision, Superbrain, Xerox/Cromemco*, Epson QX-10VD, Sanyo MBC 1000, Nelma Persona, Kaypro II, Osborne Single* and double densities, Televideo, DEC VT-180, Casio FP-1000, Zorba.

*single density formats require two disks. The package cost for these formats is \$22.95.

For IBM PC's and genuine compatibles. Available in Double-Sided or two Single-Sided Disks.*

Modem7. Allows you to communicate with any CP/M based system and download files. Complete details were in Computing Now! November 1983.

PACMAN. You can actually play PACMAN without graphics, and it works pretty fast.

FORTH. A complete up-to-date version of FIG FORTH, complete with its own internal DOS.

DUU. The ultimate disk utility allowing you to recover accidentally erased disk files, fix garbled files, rebuild and modify your system. A real gem.

D. A sorted directory program that tells you how big your files are and how much space is left on the disk.

USQ/SQ. Lets you compress and uncompress files. You can pack about 40% more stuff on a disk with this system.

Finance. A fairly sophisticated financial package written in easily understandable, modifiable Microsoft BASIC.

BADLIM. Ever had to throw out a disk with a single bad sector? This isolates bad sectors into an invisible file, making the rest of the disk useable.

DISK. Allows you to move whole masses of files from disk to disk without having to do every one by hand, you can also view and erase files with little typing.

QUEST. A "Dungeons and Dragons" type game.

STOCKS. This is a complete stock management program in BASIC.

SEE. Also known as TYPE17, will TYPE any file, squeezed or not allowing you to keep documents in compressed form while still being able to read them.

BISHOW. The ultimate file typer, BISHOW version 3.1 will type squeezed or un-squeezed files and allow you to type files which are in libraries (see LU, below). However, it also pages in both directions, so if you miss something, you can back up and see it again.

LU. Every CP/M file takes up unnecessary overhead. If you want to store lots of data in a small space, you'll want LU, the library utility. It permits any number of individual files to be stored in one big file and cracked apart again.

RACQUEL. Everyone should have one printer picture in their disk collection.

MORTGAGE. This is a very fancy mortgage amortization program which will produce a variety of amortization tables.

NSBASIC. Large disk BASIC packages, such as MBASIC, are great... and very expensive. This one, however, is free... and every bit as powerful as many commercial programs. It's compatible with North Star BASIC, so you'll have no problem finding a manual for it.

Z80ASM. This is a complete assembler package which uses true Zilog Z80 mnemonics. It has a rich vocabulary of pseudo-ops and will allow you to use the full power of your Z80 based machine... much of which can't be handled by ASM or MAC.

VFILE. Easily the ultimate disk utility, VFILE shows you a full screen presentation of what's on your disk and allows you to mass move and delete files using a two-dimensional cursor. It has heaps of features, a built-in help file and works extremely fast.

ROMAN. This is a silly little program which figures out Roman numerals for you. However, silly programs are so much fun...

CATCHUM. If you like the fast pace and incredible realism of Pacman, you'll go quietly insane over Catchum... which plays basically the same game using ASCII characters. Watch little "C's" gobble periods while you try to avoid the deadly "A's"... It's a scream.

OIL. This is an interesting simulation of the workings of the oil industry. It can be approached as either a game or a fairly sophisticated model.

CHESS. This program really does play a mean game of chess. It has an on-screen display of the board, a choice of colours and selectable levels of look ahead.

DEBUG. The DDT debugger is good but this offers heaps of facilities that DDT can't and does symbolic debugging... it's almost like being able to step, trace and disassemble through your source listing.

DU87. The older DUU program does have some limitations. This version overcomes them all and adds some valuable capacities. It will adapt itself to any system. You can search, map and dump disk sectors or files. It's invaluable in recovering damaged files, too.

ELIZA. This classic program is a micro computer head shrinker... It runs under MBASIC, and, with very little imagination, you will be able to believe that you are conversing with a real psychiatrist.

LADDER. This is... this program is weird. It's Donkey Kong in ASCII. It's fast, bizarre and good for hours of eye strain.

QUICKKEY. Programmable function keys allow you to hit one key to issue a multi-character command. This tiny utility allows you to define as many functions as you want using infrequently used control codes and to change them at any time... even from within another program.

RESOURCE. While a debugger will allow you to disassemble small bits of code easily enough, only a true text based disassembler can take a COM file and make source out of it again. This is one of the best ones available.

PCWRITE. While not quite Wordstar for nothing, this package comes extremely close to equalling the power of commercial word processors costing five or six bills. It has full screen editing, cursor movement with the cursor mover keypad, help screens and all the features of the expensive trolls.

SOLFE. This is a small BASIC program that plays baroque music. It's also a fabulous tutorial on how to use BASICA's sound statements.

PC-TALK. A Telecommunications package for the IBM PC which does file transfers in both ASCII dump and MODEM7/X-MODEM protocols and comes with... get this... 119424 bytes of documentation.

SD. This sorted directory program produces displays which are a lot more readable than those spewed out by typing DIR.

FORTH. This is a small FORTH in Microsoft BASIC. You can build on the primitives integral with the language.

LIFE. An implementation of the classic ecology game written in 8088 assembler.

MAGDALEN. This is another BASIC music program.

CASHACC. This is a fairly sophisticated cash acquisition and limited accounting package written in BASIC. It isn't exactly BPI, but it's a lot less expensive.

DATAFILE. This is a simple data base manager written in... yes, trusty Microsoft BASIC.

UNWS. Wordstar has this unusual propensity for setting the high order bits on some of the characters in the files it creates. Here's a utility to strip the bits and "unWordstar" the text. The assembler source for this one is provided.

HOST2. This is a package including the BASIC source and a DOC file to allow users with Smart-Modems to access their PC's remotely. It's a hacker's delight.

Order as AFS #1 and specify system

Order as AFS #2 and specify system

Order as AFS #3 and specify system

Order as AFPCS #1 Specify Double-Sided or 2x Single-Sided.*

All of this software has been obtained from public access sources and is believed to be in the public domain. The prices of the disks defer the cost of reproducing them and mailing them, plus the cost of the medium. The software itself is offered without charge. A few items include messages imbedded in the code asking for voluntary donations on behalf of the authors.

Moorshead Publications warrants that the software is readable and if there are defects in the medium, we will replace it free of charge. While considerable effort has been made to ensure that programs are thoroughly debugged, we are unable to assist in adapting them for your own applications.

\$19.95 each

Except for 8" disks and those with two disks which are marked with an asterisk (*) above which are:

\$22.95

Ontario Residents add 7% P.S.T.

Software Services
Moorshead Publications
25 Overlea Boulevard,
Suite 601,
Toronto, Ontario M4H 1B1
Phone orders using Visa,
Mastercard or American Express:
(416) 423-3262

Almost Free PC Software

Volume Five

We've ventured once more into the phone lines, scouring the public domain for the cream of its software. Distilled from several megabytes of code, this disk represents the best of what's floating around on the bulletin boards of the continent. It wasn't easy, and a lot of disks bit the dust in the process of creating this collection.

Whether you are interested in business programs, games, hardcore hacking or just making your computer a more productive tool, you'll find something of interest on this disk.

AREACODE Is a useful tool if you use the telephone a lot. Give it an area code and it will tell you what city it corresponds to.

D is another sorted directory program. However, this one emulates the CP/M style D, which is arguably a lot more useful for most applications.

FRACTALS This is an amazing implementation of the Mandelbrot microscope, generating unearthly fractal images on the tube of your system. Mere words fail to describe them.

FROGGER is an implementation of the classic arcade game. Just try not to get the highway littered with frog guts.

HIDE is a package of utilities which allow you to create, enter and remove invisible DOS directories. This allows you to set up a hard drive system with areas that are only available to users that know about them.

LAR This library utility allows you to concatenate several small files into a library to save on disk overhead and then extract the individual files when you need them. It saves a lot of space when it's used with files you don't use often.

MAIL1 is a mailing label utility in BASIC.

MORERAM This is an assembler program . . . you need MASM and LINK to make it work. It lets you do a number of things to the memory settings on your motherboard, including using more than 640 K and allowing for four floppies to facilitate RAM disks. It will also allow you to set the switch settings of your motherboard for 64 K so things will boot up quicker and then change the RAM setting after booting.

MORTGAGE generates amortization charts. Read 'em and weep.

MXSET lets you control the parameters of Epson compatible printers from the command line. It's a lot easier than LPRINTING characters from BASIC every time you want to change modes.

NUSQ uncompresses files that have been previously compressed to save space. It's primarily of use to BBS types . . . but it's extremely small.

PARCHK This is an assembler program . . . you need MASM and LINK to get it going. It installs a trap for parity errors in your computer so that they don't hang your system and helps you locate where the funky RAM is.

PCBOSS This is a more user friendly working environment than is MS-DOS. It makes your whole system menu driven, with absolutely no command names to remember. If IBM were dead it would be rolling in its grave over this.

VDEL This is a delete with verify program. You could type VDEL *.ASM and it would show you the name of every .ASM file in the current directory and ask you if you want it deleted.

WHEREIS finds files in a complex hard disk system.

ZAXXONPC This is a highly decent implementation of the game. Run it and rip.



A sample screen dump from Fractals

The disk, with all the programs listed here plus the appropriate documentation files is available for a mere

\$19.95

plus seven percent Ontario sales tax

**Almost Free PC
Moorshead Publications
25 Overlea Boulevard
Suite 601
Toronto, Ontario
M4H 1B1**

or, if you want to be high tech you can order by phone. Call

1-416-423-3262

during business hours. Have your VISA, Mastercard or American Express card handy

Fine Print: This software has all been collected from public bulletin boards and is believed to be in the public domain. The fee charged for it is to defray our cost in collecting it, testing it and putting this collection together, and for the cost of the media and its handling.

While we have endeavoured to make sure that this software does what it says it does, and while it has exhibited no bugs while we were using it, it is possible that some of it may not function properly on some PC compatible system. We are unable to assist you in modifying the software for your applications.

Moorshead publications warrants that the disk you receive will be readable. However, the post office may have other plans. If you are unable to read your disk please return it to us for replacement.

Impedance

Impedance is one of the first electronic terms the non-specialist encounters, yet it is one of the hardest to comprehend. An explanation.

By Nigel Cawthorne

THE WORD 'impedance' turns up all over the place. Microphones, loudspeakers, antennas, 'Inputs' and 'Outputs' are all described in terms of impedance, which is misspelled 'impedence' about half the time.

The symbol of impedance is the letter Z. Impedance is a very important concept in electronics and can cause much confusion. Why is one piece of coax described as 75 ohm and another as 50 ohm? Why is one microphone high impedance and another low?

To find the answers to these questions, we can start by revisiting that old friend of electronics, Mr. Ohm, and have another look at his law.

Ohm's Law

Before solving the mysteries of impedance it is worth just making sure that we know what happens when different DC voltages are applied across a resistor. In summary, Ohm's Law says that the current (I) flowing through a resistor (R) is proportional to the voltage (V) applied across it. Fig. 1 illustrates this with a 12V battery and two different values of resistor.

Ohm's Law applies to DC voltages and currents. 'Direct' currents are drawn from sources such as batteries where the '+' and '-' sides do not change. The voltage across the terminals of a 12V car battery is always in the same direction or 'polarity'.

Alternating Current

If there were only DC in the world, calculations in electronics would be much easier, but on the other hand, without AC most of electronics would not work anyway.

Alternating Current (AC) is the common currency in the electrical and electronics world (excuse the pun). The power line is AC, radio signals that leave transmitting aerials and travel through

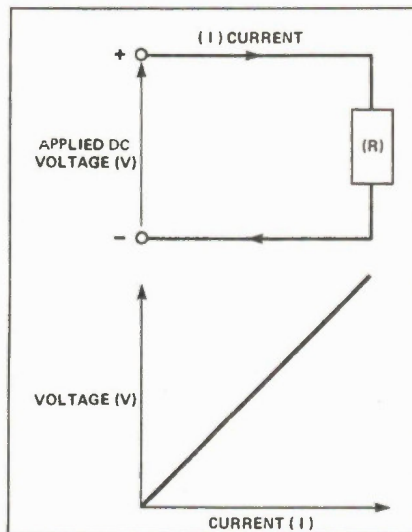

Fig. 1. Ohm's Law. a) With a 12V battery and 75R resistor. The current (I) is $V/R = 12/75$ amps = $12 \times 1000/75$ milliamps = 160 mA. (b) With a 240VDC supply and a 6k8 resistor. The current (I) is $V/R = 240/6800 = 240 \times 1000/6800 = 35.3$ mA.

space are in the form of AC, the human voice when transformed into electrical voltages by a microphone is also in the form of AC. The output of a signal generator, whether it is a low frequency audio signal or a high frequency radio signal is in the form of AC.

AC is where the '+' and '-' sides are alternating (see Fig. 2). At one moment, one of the two wires will be positive with respect to the other, and just a very short moment later, the reverse will be true. The two wires will have changed polarity with respect to each other. The speed at which they change polarity is the 'frequency'.

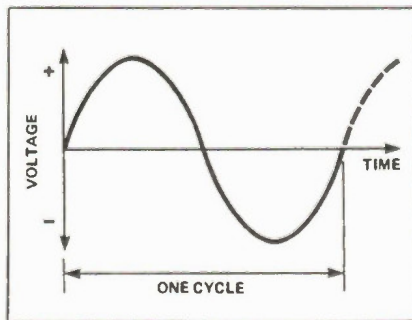

Fig. 2. The waveform of alternating current, which continually reverses its polarisation.

Frequency

Frequency is a measure of the number of 'cycles per second', or the number of times that the signal changes from one polarity to the other during a second. A frequency of one cycle per second is called a Hertz. The frequency of the power line in the UK and Europe is 50Hz (in some countries of the world, including the USA and Japan, the power line is at 60Hz). That is why many pieces of electrical equipment which are designed to work in all countries of the world will be described as being suitable for a 50-60Hz power line. The voltage in one country may not be the same as in another, but that is another matter.

Although voltages may differ from one country to another, there are several types of equipment that depend on the power line frequency. Among these are turntables and electric clocks, both of which depend on the power line for their accuracy.

Radio signals which are also in the form of AC change polarity not at tens of cycles per second as does the power line supply, but at millions (MHz) or billions (GHz) of times per second.

Ohm's Law Again.

Now back to Mr. Ohm and his law. Fig. 3 shows an alternating voltage being applied across the same resistance as in Fig. 1. The only difference this time is that voltage is alternating and changing polarity. As you would expect when the voltage varies, the current also varies in a similar way. The voltage and current keep in step with each other. As the voltage increases in one direction, so the current also increases. Ohm's Law is still holding true even though the voltage is not staying still.

In fact Ohm's Law would not be much use as a 'law' if it didn't hold true even when things were moving.

With a resistance and an AC voltage source nothing has changed from the DC voltage example in Fig. 1, other than the voltage source itself which is now swinging from one way to the other and back again rather than staying still.

Impedance can be defined as the Alternating Current (AC) equivalent of DC 'resistance'. The example in Fig. 3 has illustrated that for a pure resistance, the impedance is the same as the resistance. It is only when components other than

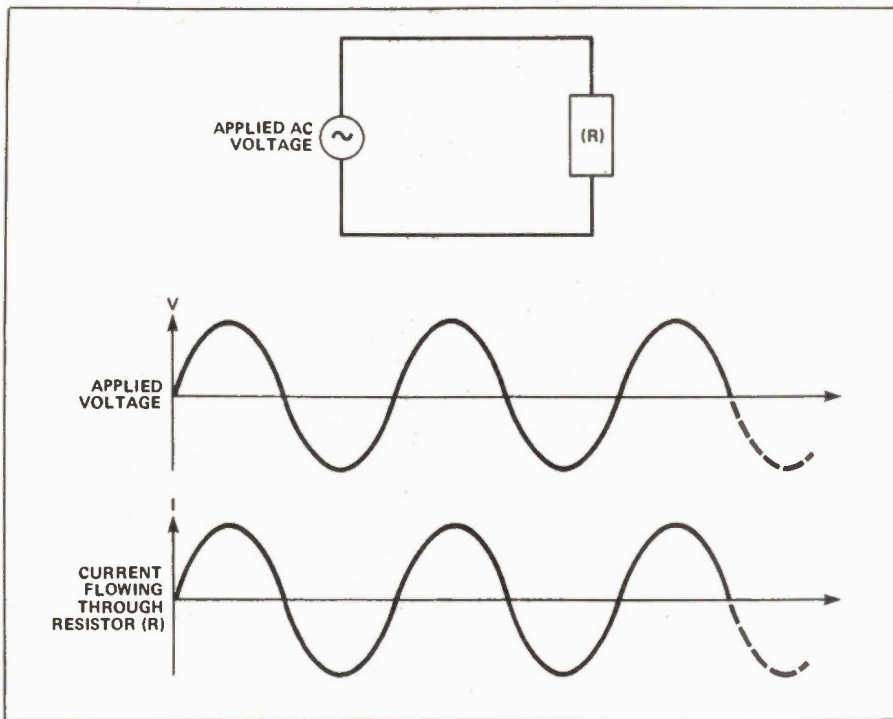

Fig. 3. When alternating voltage is applied through a resistor, the current varies with the voltage just as it does with direct current.

resistors are introduced that the definition of impedance begins to get more complicated.

Coils and Capacitors

Fig. 4(a) shows a simple capacitor circuit. When a DC voltage is applied across a capacitor a current will flow initially until the capacitor is fully charged up, i.e., until the voltage across the plates of the capacitor equals the voltage that is being applied to it from the battery. Once that state is achieved, which for a normal sized capacitor would be in a very short space of time (say a few milliseconds) nothing else happens after the voltage is applied.

Once the capacitor is charged up, there will be no further flow of current and the circuit will be static (this assumes for the moment that the capacitor is pure, i.e., that it has no leakage resistance). In practice all capacitors have some leakage resistance, which may be very high (thousands of millions of ohms perhaps), but this is ignored for the purposes of our discussion, which is aimed at getting a clear idea of what 'impedance' is all about.

Coils

In a similar way to a capacitor, a coil also reaches a steady state soon after a DC voltage has been applied. With a theoretical coil, however, the steady state is a current flowing through the coil, which will depend only on the 'source resistance' of the voltage supply. Where the source resistance is zero (impossible in practice) the current through the coil

case of the coil) reach a steady state. Other than disconnecting the supply nothing further will change.

This is where Alternating Current comes in again, because with AC, the voltages and currents are changing all the time. That is why both coils and capacitors act very differently under the influence of AC and DC. With DC they both reach a steady state where nothing further happens, but with AC where the voltages and currents are changing all the time, both these components start to behave in more complicated ways. Without going into the mathematics involved, we shall look at the way these two components, coils and capacitors, behave when AC is applied. It is an important part of coming to grips with the real meaning of impedance.

Reactance

Before getting to fully understand impedance, we have to grapple with another of those 'nasties' of the electronics world: reactance.

Whenever 'Reactance' appears in electronics textbooks it is usually tied in with a lot of mathematical hieroglyphics and symbols. To understand reactance

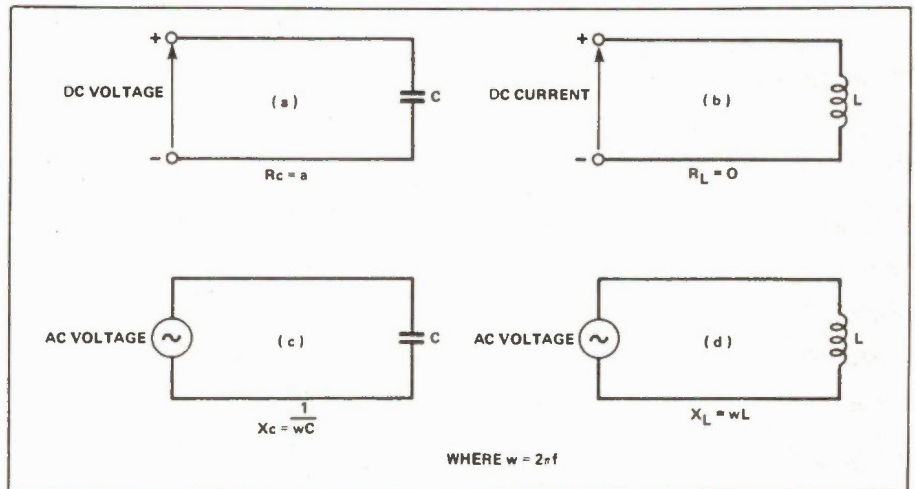

Fig. 4 Shows four simple circuits, (a) with DC voltage across a capacitor, (b) with DC current across a coil (c) with AC voltage across a capacitor and (d) with AC voltage across a coil. See the text for a full explanation.

would be infinite. For coils it is more usual to consider a 'constant current' source being applied across them rather than a constant voltage as in the case of the capacitor.

The idea of a 'constant current' source is always hard to imagine. We can easily understand the idea of a constant voltage source such as a well charged battery, but a 'constant current' source is not so easy to swallow. Fig. 4 (b) shows a simple coil circuit being fed from a constant current source.

Both the coil and the capacitor will under influence of DC supplies (voltage in the case of the capacitor and current in the

let's go back to our simple circuits in Fig. 4. This time, instead of applying DC to our simple coil and capacitor, we are now going to apply AC.

Capacitors with AC

Fig. 4c shows a capacitor connected to an AC source such as a signal generator. There are two things that can be varied on an AC source: the voltage and the frequency. What happens if the frequency of the applied voltage is varied?

As we saw with the DC applied to the capacitor, once the capacitor was charged up, nothing else happened. Because AC implies that the voltage applied across the

capacitor is continually being reversed in polarity, the capacitor will be charged in one direction and then discharged as the voltage is reversed. The way that the capacitor reacts to this will depend on the frequency of the AC. If the frequency is relatively low, the capacitor will have time to fully charge in one direction, before being discharged as the voltage changes polarity.

However if the frequency of the applied AC source is high, the capacitor will never be able to fully charge nor discharge, because the applied voltage will keep changing direction before it gets a chance to do so.

A capacitor will behave in different ways depending on the frequency of the AC that is applied to it. Electrically the way that a capacitor reacts to different applied frequencies of AC is called 'reactance'. For a capacitor, the higher the frequency of the applied AC, the lower the reactance.

This makes sense when you consider that the lowest possible frequency of AC is 0Hz, which of course is DC. At a frequency of 0Hz the reactance of a capacitor is infinite, which ties in with our previous experiment with the capacitor and the DC voltage source, i.e., that no current passes through the capacitor once it has charged up. At higher frequencies the reactance of the capacitor is less and correspondingly more current passes through it.

Coils With AC

A similar but opposite argument applies to a coil. For a coil, the reactance is proportional to the frequency. At the lower frequencies the reactance of the coils is low, as shown by our experiment with DC which showed that a high current would pass through a coil at DC (which is 0Hz AC).

As the frequency increases the reactance of the coil increases. The exact relationship between reactance (X), frequency (F) and coil (L) and capacitor (C) size is shown in Fig. 4. These relationships include the expression 'omega' which is 2 x frequency. The purpose of this article is to describe the meaning of impedance without resorting to the use of any complex mathematics. We shall leave aside the fuller mathematical implications of reactance because these are not necessary for a basic understanding of what impedance is all about.

Impedance

In a nutshell, the impedance of a circuit or component is the combined effect of its resistance and its reactance. Unfortunately we cannot just add these two figures together to get the right answer. They have to be added together using another of those nasties: vectors.

The impedance of a resistance is the same as its resistance, but as soon as inductance or capacitance are added to the circuit, these will add components of reactance which have to be combined with the resistance to give the impedance.

Impedance thus has two parts to it. The non-reactive part which does not change with frequency and the reactive part (coils and capacitors) which does change with frequency.

Incidentally if you are into vector addition, the impedance is the vector sum (components at right angles) of reactance and resistance. See Fig. 5.

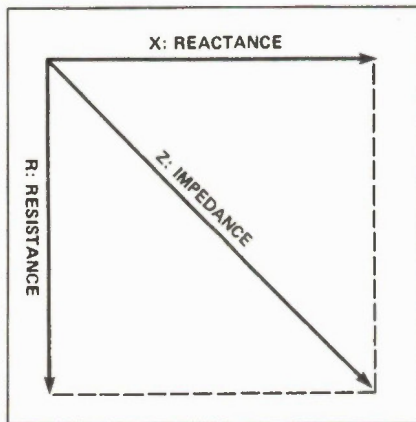

Fig. 5. A vector graph of the relationships between impedance, resistance and reactance.

Coaxial Cable

Let's take a practical example and see if we can use it to explain impedance more fully. Coaxial cable is a very good example. Coax is described as having an impedance (typically 75 ohms or sometimes 50 ohms). What does this mean?

Fig. 6a shows a straight piece of coax cable with its inner conductor connected to one side of a battery and its outer shield connected to the other side. The far end of the coax is connected to a voltmeter. An ammeter is connected in series with the input. What happens when the battery is connected? Well, absolutely nothing.

The voltmeter at the far end will show the same voltage as across the terminals of the battery and the ammeter in series will read zero.

Because of the insulation between the inner and outer conductors of the coax, no current at all will flow across the coax. So what is happening and why on earth is the coax called '75 ohm', or whatever? Where is the 75 ohms? It looks like an open circuit, because no current is flowing at all. To get the answer we have to apply AC.

Coax with AC

Ohm's Law showed us that if we had a 12 volt battery and a 75 ohm resistor, we would get a current of 160mA. So what has happened to our piece of coax? Where are the 75 ohms gone?

The answer is that for a DC voltage

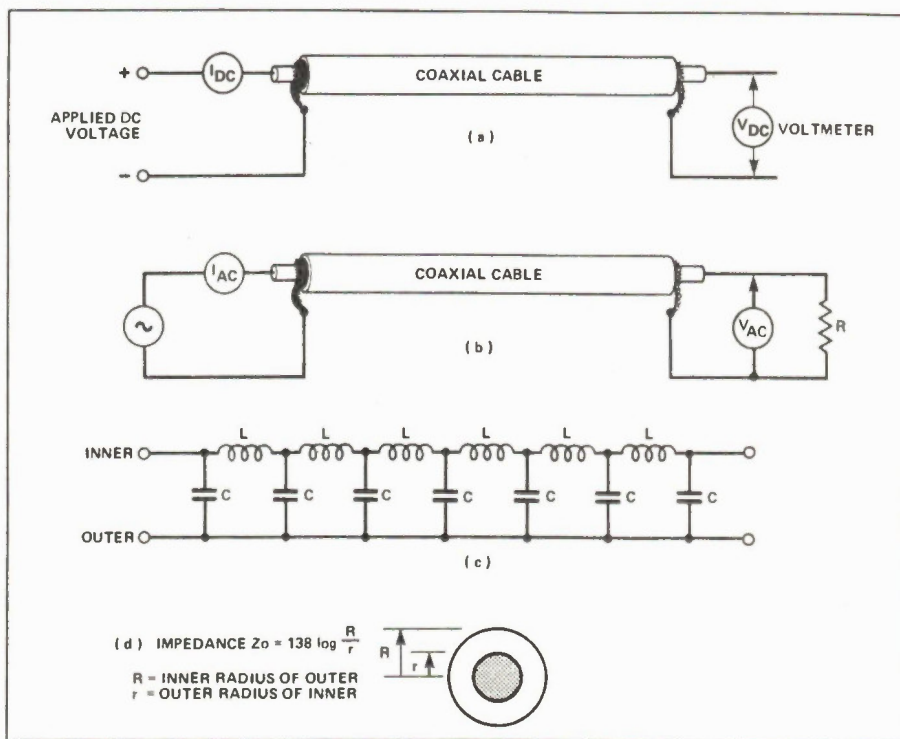

Fig. 6. The behaviour of coaxial cable (a) with DC (b) with AC and (c) how the length of the cable 'looks' to an electrical current. 6d gives a graphic illustration of the impedance of the cable related to its dimensions (see overleaf).

coaxial cable is not 75 ohms. The actual resistance measured across the end of a non-terminated piece of coaxial cable will depend on the quality of the insulator. Normally no current at all will flow through the insulator, which is confirmed by our simple experiment at DC.

The mystery of the missing '75 ohms' is solved by doing two things. Firstly an AC voltage is applied at one end of the coax cable and secondly, the other end is terminated with a resistor of the same value as the nominal impedance i.e., 75 ohms. See Fig. 6b.

Coax Analysed

Inside the coax itself, there is capacitance between the inner and the outer conductors. This 'capacitor' within the coax is cylindrical in form, and runs the whole length of the cable. Although not strictly speaking in the shape of a coil, the coax does have a measure of inductance. All wires, even those running in straight lines, have some degree of inductance. This also applies to coax cable.

The mechanical structure of the coax is constant all along its length. As shown in Fig. 6c, coaxial cable can be considered electrically as being the equivalent of a whole series of tiny capacitors and coils in series one behind the other. The capacitance and inductance values of these distributed components run along the whole length of the coax.

So what AC 'sees' when it is applied to coax is not an open-circuit as DC does, but a component made up of countless small capacitors and inductors. That is why AC behaves very differently when applied to a piece of coax than does DC.

It can be shown that the impedance of coaxial cable is related only to the 'inner diameter of the outer conductor' and the 'outer diameter of the inner conductor'. Fig. 6d gives the exact definition.

The impedance of a particular design of coax cable is independent of the frequency being fed to it. At all frequencies the impedance of the coax will be the same. For most other circuitry in electronics this is not true. The impedance of a circuit or component (unless it is purely resistive, in which case it has no reactance anyway) will normally vary with frequency. This is why for products such as microphones, headphones or antennas, the impedance should be defined at a specific frequency or across a band of frequencies.

Resonance

No discussion of impedance is complete without introducing the idea of resonance. If we take the simple coil and capacitor circuit in Fig. 7, we can use it to demonstrate resonance. Resonance is said to occur when the reactance of the capacitor and the inductance are equal and opposite and cancel out. As the frequency applied to the circuit is increased the reactances in the two components will change. The graph in Fig. 7 shows that at

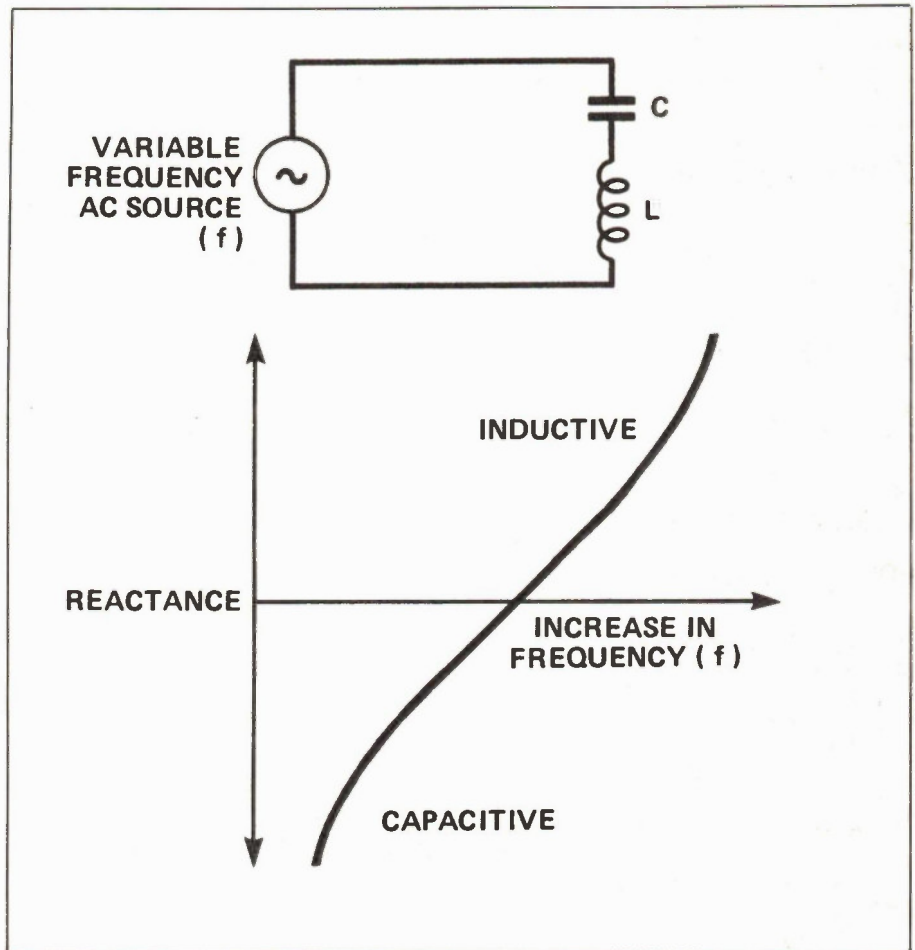

Fig. 7. A simple coil and capacitor circuit demonstrating resonance. Resonance occurs when the induction and capacitance combine to cancel each other out at a certain frequency. The principle is used in tuning radio receivers.

one frequency the reactances of the two components will add up to zero. This is where the reactance line crosses the horizontal axis.

This resonance effect is used in many electronic circuits. It is used for 'tuning in' receivers. By using a variable capacitor rather than a fixed one, the resonant frequency of the tuned circuit can be varied and different stations tuned in.

Impedance Varies

In summary we can say that impedance is a way of describing the 'resistance' offered to an alternating current applied to a circuit or component. It is important to note that for individual components such as circuits containing coils and capacitors, aerials, microphones or even loudspeakers that the impedance will vary with frequency.

Impedance comes about because circuit components which are inductive or capacitive or which 'look like' coils or capacitors behave differently at different frequencies: their reactance changes. The impedance of a circuit is the combination of the inductive or capacitive reactance with the resistance in the circuit. Because the reactance of coils and capacitors is dif-

ferent at different frequencies, the impedance of the circuit changes with frequency too.

Coax cable is an exception. Because of the 'distributed' nature of the inductance and capacitance along the length of the cable, the impedance will be independent of frequency. It has been shown that the impedance of coaxial cable is made up of purely reactive elements (i.e., the effects of the imaginary coils and capacitor that run all along the length of the cable).

Mystery Solved

For many years in his early days in electronics, the writer could never understand why coax cable was described as 75 ohms, when nowhere with a multimeter could this Fig. be measured.

Without having gone too deeply into the morass of complex numbers and calculus that can so easily surround any discussion that gets near to what in the text books is termed 'AC theory', it is hoped that the above explanation will go some way to explaining the apparent mystery of the 'ohms' in coax cable as well as outlining the meaning of 'impedance' in electronics. ■

BABANI BOOKS

Imported from England and exclusively available in Canada from Moorshead Publications.

BP53: PRACTICAL ELECTRONICS CALCULATIONS AND FORMULAE \$11.75
A book that bridges the gap between complicated technical theory and the 'cut and try' method. A good reference book.

BP136: 25 SIMPLE INDOOR AND WINDOW AERIALS \$6.65
People living in apartments who would like to improve short-wave listening can benefit from these instructions on optimising the indoor aerial.

BP147: AN INTRODUCTION TO 6502 MACHINE CODE \$7.75
The popular 6502 microprocessor is used in many home computers; this is a guide to beginning assembly language.

BP150: AN INTRO. TO PROGRAMMING THE SINCLAIR QL \$7.75
Helps the reader make the best use of the Sinclair QL's almost unlimited range of features. Complements the manufacturer's handbook.

BP225: A PRACTICAL INTRODUCTION TO DIGITAL ICs \$6.65
This book deals mainly with TTL type chips such as the 7400 series. Simple projects and a complete practical construction of a Logic Test Circuit Set are included as well as details for a more complicated Digital Counter Timer project.

BP130: MICRO INTERFACING CIRCUITS - BOOK 1 \$8.55
Aimed at those who have some previous knowledge of electronics, but not necessarily an extensive one, the basis of the book is to help the individual understand the principles of interfacing circuits to microprocessor equipment.

BP131: MICRO INTERFACING CIRCUITS - BOOK 2 \$8.55
Intended to carry on from Book 1, this book deals with practical applications beyond the parallel and serial interface. "Real world" interfacing such as sound and speech generators, temperature and optical sensors, and motor controls are discussed using practical circuit descriptions.

BP111: AUDIO \$13.25
This one is ideal for readers who want to really get into sound. A wide range of material is covered from analysis of the sound wave, mechanisms of hearing, room acoustics, microphones and loudspeakers, amplifiers, and magnetic disc recording.

BP141: LINEAR IC EQUIVALENTS AND PIN CONNECTIONS ADRIAN MICHAELS \$21.95
Find equivalents and cross-references for both popular and unusual integrated circuits. Shows details of functions, manufacturer, country of origin, pinouts, etc.; includes National, Motorola, Fairchild, Harris, Motorola, Intersil, Philips, ADC, AMD, SGS, Teledyne, and many other European, American, and Japanese brands.

BP156: AN INTRODUCTION TO QL MACHINE CODE \$7.75
The powerful Sinclair QL microcomputer has some outstanding capabilities in terms of its internal structure. With a 32-bit architecture, the QL has a large address range, advanced instructions which include multiplication and division. These features give the budding machine code programmer a good start at advanced programming methods. This book assumes no previous knowledge of either the 68008 or machine code programming.

BP47: MOBILE DISCOTHEQUE HANDBOOK \$5.25
Divided into six parts, this book covers such areas of mobile "disco" as: Basic Electricity, Audio, Ancillary Equipment, Cables and Plugs, Loudspeakers, and Lighting. All the information has been considerably sub-divided for quick and easy reference.

BP59: SECOND BOOK OF CMOS IC PROJECTS \$7.75
This book carries on from its predecessor and provides a further selection of useful circuits, mainly of a simple nature the book will be well within the capabilities of the beginner and more advanced constructor.

BP32: HOW TO BUILD YOUR OWN METAL & TREASURE LOCATORS \$7.75
Several fascinating applications with complete electronic and practical details on the simple, and inexpensive construction of Heterodyne Metal Locators.

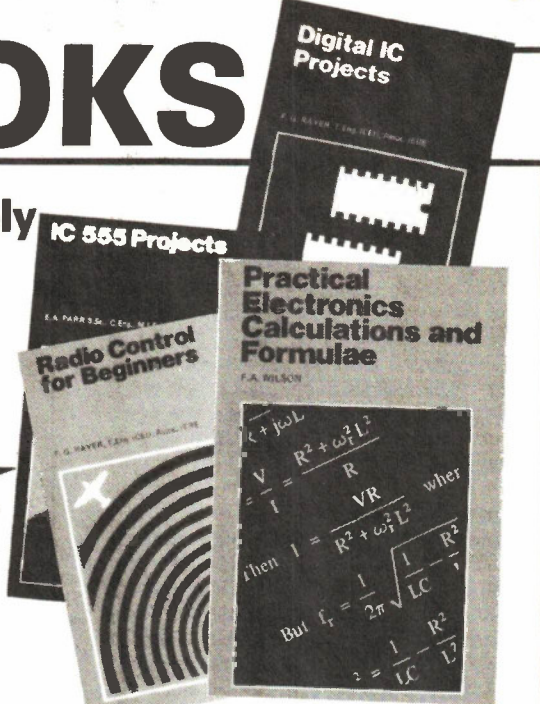

ELECTRONIC THEORY

ELEMENTS OF ELECTRONICS - AN ON-GOING SERIES

- F.A. WILSON, C.G.I.A., C.Eng.,
- BP62: BOOK 1. The Simple Electronic Circuit and Components \$11.70
 - BP63: BOOK 2. Alternating Current Theory \$ 8.55
 - BP64: BOOK 3. Semiconductor Technology \$18.55
 - BP77: BOOK 4. Microprocessing Systems And Circuits \$11.70
 - BP89: BOOK 5. Communication \$11.70

The aim of this series of books can be stated quite simply — it is to provide an inexpensive introduction to modern electronics so that the reader will start on the right road by thoroughly understanding the fundamental principles involved.

Although written especially for readers with no more than ordinary arithmetical skills, the use of mathematics is not avoided, and all the mathematics required is taught as the reader progresses.

Each book is a complete treatise of a particular branch of the subject and, therefore, can be used on its own with one proviso, that the later books do not duplicate material from their predecessors, thus a working knowledge of the subjects covered by the earlier books is assumed.

BOOK 1: This book contains all the fundamental theory necessary to lead to a full understanding of the simple electronic circuit and its main components.

BOOK 2: This book continues with alternating current theory without which there can be no comprehension of speech, music, radio, television or even the electricity utilities.

BOOK 3: Follows on semiconductor technology, leading up to transistors and integrated circuits.

BOOK 4: A complete description of the internal workings of microprocessor.

BOOK 5: A book covering the whole communication scene.

PROJECTS

- BP48: ELECTRONIC PROJECTS FOR BEGINNERS \$ 7.75

F.G. RAYER, T.Eng.(CEI), Assoc.IERE
Another book written by the very experienced author — Mr. F.G. Rayer — and in it the newcomer to electronics, will find a wide range of easily made projects. Also, there are a considerable number of actual component and wiring layouts, to aid the beginner.

Furthermore, a number of projects have been arranged so that they can be constructed without any need for soldering and, thus, avoid the need for a soldering iron.

Also, many of the later projects can be built along the lines as those in the "No Soldering" section so this may considerably increase the scope of projects which the newcomer can build and use.

- BP37: 50 PROJECTS USING RELAYS, SCR's & TRIACS \$ 7.75

F.G. RAYER, T.Eng.(CEI), Assoc.IERE
Relays, silicon controlled rectifiers (SCR's) and bi-directional triodes (TRIACS) have a wide range of applications in electronics today. This book gives tried and practical working circuits which should present the minimum of difficulty for the enthusiast to construct. In most of the circuits there is a wide latitude in component values and types, allowing easy modification of circuits or ready adaptation of them to individual needs.

- BP221: 28 TESTED TRANSISTOR PROJECTS R. TORRENES \$5.00

Mr. Richard Torrens is a well experienced electronics development engineer and has designed, developed, built and tested the many useful and interesting circuits included in this book. The projects themselves can be split down into simpler building blocks, which are shown separated by boxes in the circuits for ease of description, and also to enable any reader who wishes to combine boxes from different projects to realise ideas of his own.

- BP71: ELECTRONIC HOUSEHOLD PROJECTS \$ 7.20

R. A. PENFOLD
Some of the most useful and popular electronic construction projects are those that can be used in or around the home. The circuits range from such things as '2 Tone Door Buzzer', Intercom, through Smoke or Gas Detectors to Baby and Freezer Alarms.

- BP73: REMOTE CONTROL PROJECTS \$ 8.10

OWEN BISHOP
This book is aimed primarily at the electronics enthusiast who wishes to experiment with remote control. Full explanations have been given so that the reader can fully understand how the circuits work and can more easily see how to modify them for other purposes, depending on personal requirements. Not only are radio control systems considered but also infra-red, visible light and ultrasonic systems as are the use of Logic ICs and Pulse position modulation etc.

- BP90: AUDIO PROJECTS \$ 7.60

F.G. RAYER
Covers in detail the construction of a wide range of audio projects. The text has been divided into preamplifiers and mixers, power amplifiers, tone controls and matching and miscellaneous projects.

- BP74: ELECTRONIC MUSIC PROJECTS \$ 7.20

R.A. PENFOLD
Although one of the more recent branches of amateur electronics, electronic music has now become extremely popular and there are many projects which fall into this category. The purpose of this book is to provide the constructor with a number of practical circuits for the less complex items of electronic music equipment, including such things as a Fuzz Box, Waa-Waa Pedal, Sustain Unit, Reverberation and Phaser Units, Tremelo Generator etc.

- BP44: IC 555 PROJECTS \$ 7.75

E.A. PARR, B.Sc., C.Eng., M.I.E.E.
Every so often a device appears that is so useful that one wonders how life went on before without it. The 555 timer is such a device. Included in this book are Basic and General Circuits, Motor Car and Model Railway Circuits, Alarms and Noise Makers as well as a section on the 556, 558 and 559 timers.

- BP82: ELECTRONIC PROJECTS USING SOLAR CELLS \$ 7.75

A collection of simple circuits which have applications in and around the home using the energy of the sun to power them. The book deals with practical solar power supplies including voltage doubler and tripler circuits, as well as a number of projects.

BABANI BOOKS

BP49: POPULAR ELECTRONIC PROJECTS \$7.75

R.A. PENFOLD

Includes a collection of the most popular types of circuits and projects which, we feel sure, will provide a number of designs to interest most electronics constructors. The projects selected cover a very wide range and are divided into four basic types: Radio Projects, Audio Projects, Household Projects and Test Equipment.

BP94: ELECTRONIC PROJECTS FOR CARS AND BOATS

R.A. PENFOLD

Projects, fifteen in all, which use a 12V supply are the basis of this book. Included are projects on Windscreen Wiper Control, Courtesy Light Delay, Battery Monitor, Cassette Power Supply, Lights Timer, Vehicle Immobiliser, Gas and Smoke Alarm, Depth Warning and Shaver Inverter.

BP95: MODEL RAILWAY PROJECTS \$7.60

Electronic projects for model railways are fairly recent and have made possible an amazing degree of realism. The projects covered include controllers, signals and sound effects: stripboard layouts are provided for each project.

BP93: ELECTRONIC TIMER PROJECTS \$7.60

F.G. RAYER

Windscreen wiper delay, darkroom timer and metronome projects are included. Some of the more complex circuits are made up from simpler sub-circuits which are dealt with individually.

BP113: 30 Solderless Breadboard Projects-Book 2

R.A. Penfold

A companion to BP107. Describes a variety of projects that can be built on plug-in breadboards using CMOS logic IC's. Each project contains a schematic, parts list and operational notes.

BP104: Electronic Science Projects

Owen Bishop

Contains 12 electronic projects with a strong scientific flavour. Includes Simple Colour Temperature Meter, Infra-Red Laser, Electronic clock regulated by a resonating spring, a 'Scope with a solid state display, pH meter and electrocardiograph.

BP110: HOW TO GET YOUR ELECTRONIC PROJECTS WORKING

R.A. PENFOLD

We have all built circuits from magazines and books only to find that they did not work correctly, or at all, when first switched on. The aim of this book is to help the reader overcome just these problems by indicating how and where to start looking for many of the common faults that can occur when building up projects.

BP84: DIGITAL IC PROJECTS \$7.60

F.G. RAYER, T.Eng.(CEI), Assoc. IERE

This book contains both simple and more advanced projects and it is hoped that these will be found of help to the reader developing a knowledge of the workings of digital circuits. To help the newcomer to the hobby the author has included a number of board layouts and wiring diagrams. Also the more ambitious projects can be built and tested section by section and this should help avoid or correct faults that could otherwise be troublesome. An ideal book for both beginner and more advanced enthusiast alike.

BP67: COUNTER DRIVER AND NUMERAL DISPLAY PROJECTS

F.G. RAYER, T.Eng.(CEI), Assoc. IERE

Numeral indicating devices have come very much to the forefront in recent years and will, undoubtedly, find increasing applications in all sorts of equipment. With present day integrated circuits, it is easy to count, divide and display numerically the electrical pulses obtained from a great range of driver circuits.

In this book many applications and projects using various types of numeral displays, popular counter and driver IC's etc. are considered.

BP99: MINI-MATRIX BOARD PROJECTS \$7.60

R.A. PENFOLD

Twenty useful projects which can all be built on a 24 x 10 hole matrix board with copper strips. Includes Doorbuzzer, Low-voltage Alarm, AM Radio, Signal Generator, Projector Timer, Guitar Headphone Amp, Transistor Checker and more.

BP103: MULTI-CIRCUIT BOARD PROJECTS \$7.60

R.A. PENFOLD

This book allows the reader to build 21 fairly simple electronic projects, all of which may be constructed on the same printed circuit board. Wherever possible, the same components have been used in each design so that with a relatively small number of components and hence low cost, it is possible to make any one of the projects or by re-using the components and P.C.B. all of the projects.

BP107: 30 SOLDERLESS BREADBOARD PROJECTS - BOOK 1

R.A. PENFOLD

A "Solderless Breadboard" is simply a special board on which electronic circuits can be built and tested. The components used are just plugged in and unplugged as desired. The 30 projects featured in this book have been specially designed to be built on a "Verobloc" breadboard. Wherever possible the components used are common to several projects, hence with only a modest number of reasonably inexpensive components it is possible to build, in turn, every project shown.

BP106: MODERN OP-AMP PROJECTS \$7.60

R.A. PENFOLD

Features a wide range of constructional projects which make use of op-amps including low-noise, low distortion, ultra-high input impedance, high slew-rate and high output current types.

CIRCUITS

How to Design Electronic Projects

BP127

Although information on standard circuit blocks is available, there is less information on combing these circuit parts together. This title does just that. Practical examples are used and each is analysed to show what each does and how to apply this to other designs.

Audio Amplifier Construction

BP122

A wide circuits is given, from low noise microphone and tape head preamps to a 100W MOSFET type. There is also the circuit for 12V bridge amp giving 18W. Circuit board or stripboard layout are included. Most of the circuits are well within the capabilities for even those with limited experience.

BP80: POPULAR ELECTRONIC CIRCUITS - BOOK 1

R.A. PENFOLD

Another book by the very popular author, Mr. R.A. Penfold, who has designed and developed a large number of various circuits. These are grouped under the following general headings: Audio Circuits, Radio Circuits, Test Gear Circuits, Music Project Circuits, Household Project Circuits and Miscellaneous Circuits.

BP98: POPULAR ELECTRONIC CIRCUITS, BOOK 2

R.A. PENFOLD

70 plus circuits based on modern components aimed at those with some experience.

BP39: 50 (FET) FIELD EFFECT TRANSISTOR PROJECTS

F.G. RAYER, T.Eng.(CEI), Assoc. IERE

Field effect transistors (FETs), find application in a wide variety of circuits. The projects described here include radio frequency amplifiers and converters, test equipment and receiver aids, tuners, receivers, mixers and tone controls, as well as various miscellaneous devices which are useful in the home.

This book contains something of particular interest for every class of enthusiast - short wave listener, radio amateur, experimenter or audio devotee.

BP87: SIMPLE L.E.D. CIRCUITS

R.N. SOAR

Since it first appeared in 1977, Mr. R.N. Soar's book has proved very popular. The author has developed a further range of circuits and these are included in Book 2. Projects include a Transistor Tester, Various Voltage Regulators, Testers and so on.

BP24: 50 PROJECTS USING IC 741

RUDI & UWE REDMER

A unique book containing 50 projects that can be simply constructed. It covers op amp and a few components. Originally published in Germany, this book will be an invaluable asset to any hobbyist.

BP88: HOW TO USE OP AMPS

E.A. PARR

A designer's guide covering several op amps, serving as a source book of circuits and a reference book for design calculations. The approach has been made as non-mathematical as possible.

BP65: SINGLE IC PROJECTS

R.A. PENFOLD

There is now a vast range of ICs available to the amateur market, the majority of which are not necessarily designed for use in a single application and can offer unlimited possibilities. All the projects contained in this book are simple to construct and are based on a single IC. A few projects employ one or two transistors in addition to an IC but in most cases the IC is the only active device used.

223: 50 PROJECTS USING IC CA3130

R.A. PENFOLD

In this book, the author has designed and developed a number of interesting and useful projects which are divided into five general categories: I - Audio Projects II - R.F. Projects III - Test Equipment IV - Household Projects V - Miscellaneous Projects.

BP117: PRACTICAL ELECTRONIC BUILDING BLOCKS BOOK 1

R.A. PENFOLD

Virtually any electronic circuit will be found to consist of a number of distinct stages when analysed. Some circuits inevitably have unusual stages using specialised circuitry, but in most cases circuits are built up from building blocks of standard types.

This book is designed to aid electronics enthusiasts who like to experiment with circuits and produce their own projects rather than simply follow published project designs.

The circuits for a number of useful building blocks are included in this book. Where relevant, details of how to change the parameters of each circuit are given so that they can easily be modified to suit individual requirements.

BP102: THE 6809 COMPANION

R.A. PENFOLD

Written for machine language programmers who want to expand their knowledge of microprocessors. Outlines history, architecture, addressing modes, and the instruction set of the 6809 microprocessor. The book also covers such topics as converting programs from the 6800, program style, and specifics of 6809 hardware and software availability.

BP118: PRACTICAL ELECTRONIC BUILDING BLOCKS - Book 2

R.A. PENFOLD

This sequel to BP117 is written to help the reader create and experiment with his own circuits by combining standard type circuit building blocks. Circuits concerned with generating signals were covered in Book 1, this one deals with processing signals. Amplifiers and filters account for most of the book but comparators, Schmitt triggers and other circuits are covered.

BP24: 50 PROJECTS USING IC 741

RUDI & UWE REDMER

This book, originally published in Germany by TOPP, has achieved phenomenal sales on the Continent and Babani decided, in view of the fact that the integrated circuit used in this book is inexpensive to buy, to make this unique book available to the English speaking reader. Translated from the original German with copious notes, data and circuitry, a "must" for everyone whatever their interest in electronics.

BP83: VMOS PROJECTS

R.A. PENFOLD

Although modern bipolar power transistors give excellent results in a wide range of applications, they are not without their drawbacks or limitations. This book will primarily be concerned with VMOS power FETs although power MOSFETs will be dealt with in the chapter on audio circuits. A number of varied and interesting projects are covered under the main headings of: Audio Circuits, Sound Generator Circuits, DC Control Circuits and Signal Control Circuits.

RADIO AND COMMUNICATIONS

BP96: CB PROJECTS

R.A. PENFOLD

Projects include speech processor, aerial booster, cordless mike, aerial and harmonic filters, field strength meter, power supply, CB receiver and more.

BP222: SOLID STATE SHORT WAVE RECEIVER FOR BEGINNERS

R.A. PENFOLD

In this book, R.A. Penfold has designed and developed several modern solid state short wave receiver circuits that will give a fairly high level of performance, despite the fact that they use only relatively few and inexpensive components.

BP91: AN INTRODUCTION TO RADIO DXing

R.A. PENFOLD

This book is divided into two main sections one to amateur band reception, the other to broadcast bands. Advice is given to suitable equipment and techniques. A number of related constructional projects are described.

BP105: AERIAL PROJECTS

R.A. PENFOLD

The subject of aeriels is vast but in this book the author has considered practical designs including active, loop and ferrite aeriels, which give good performances and are reasonably simple and inexpensive to build. The complex theory and math of aerial design are avoided.

OTHER PUBLISHERS

PH121: HARDWARE INTERFACING WITH THE TRS-80
J. UFFENBECK (1983) \$19.45
 TRS-80 Model I and Model III owners now have a book to help them understand how to use their personal computers to monitor and control electronics interfaces between the computer and the home or industrial environment. Contains 14 hands-on experiments using BASIC.

SB22026 POLISHING YOUR APPLE® \$7.45
 Clearly written, highly practical, concise assembly of all procedures needed for writing, disk-filing, and printing programs with an Apple II. Positively ends your searches through endless manuals to find the routine you need! Should be in the hands of every new Apple user, regardless of experience level. Ideal for Apple classrooms too!

A BEGINNER'S GUIDE TO COMPUTERS AND MICROPROCESSORS — WITH PROJECTS.

TAB No. 1015: \$14.45
 Here's plain English introduction to the world of microcomputers — it's capabilities, parts and functions... and how you can use one. Numerous projects demonstrate operating principles and lead to the construction of an actual working computer capable of performing many useful functions.

TAB1370: A MASTER HANDBOOK OF IC CIRCUITS \$21.95
 A circuit for every occasion. You'll find all the circuits you're looking for in this 532 page volume. The 932 circuits are broken down according to specific functions and in six categories. It's literally a cornucopia of ideas, projects, and designs that you can build now.

TAB1544: ELECTRONIC PROJECTS FOR PHOTOGRAPHERS \$21.95

This book gives you needed tips on the principles of electronics and building techniques, hints on how to set up a work area, and much more. Build all kinds of practical accessories for your camera, studio, or darkroom with this helpful guide.

SB22361: INTRODUCING THE APPLE MACINTOSH \$20.95

A wealth of information on hardware, software etc. for the Mac. Included are such topics as: making your desktop more efficient, improving your productivity with the Mac, getting the most from your mouse, how the 68000 microprocessor works and much, much more.

PH131: ZAP! POW! BOOM! ARCADE GAMES FOR THE VIC 20

T. HARTNELL & M. RAMSHAW (1983) \$17.45
 Move through the maze eating dots with MAZEMAN. Sail through space zapping the ASTROIDS. Outshoot the fastest draw in town GUNFIGHT. Owners of the VIC 20 can now play these games — and more — simply by following the programs outlined in this handy guide.

THE BASIC COOKBOOK. TAB No. 1055: \$10.45

BASIC is a surprisingly powerful language... if you understand it completely. This book, picks up where most manufacturers' documentation gives up. With it, any computer owner can develop programs to make the most out of his or her machine.

HANDBOOK OF MICROPROCESSOR APPLICATIONS TAB No. 1203 \$16.45

Highly recommended reading for those who are interested in microprocessors as a means of accomplishing a specific task. The author discusses two individual microprocessors, the 1802 and the 6800, and how they can be put to use in real world applications.

MICROPROCESSOR INTERFACING HANDBOOK: AID & DIA TAB No. 1271 \$16.45

A useful handbook for computerists interested in using their machine in linear applications. Topics discussed include voltage references, op-amps for data conversion, analogue switching and multiplexing and more.

HOW TO BUILD YOUR OWN WORKING MICROCOMPUTER TAB No. 1200 \$16.45

An excellent reference or how-to manual on building your own microcomputer. All aspects of hardware and software are developed as well as many practical circuits.

PH180: 1984 CANADIAN BUSINESS GUIDE TO MICROCOMPUTERS K. DORRICOFF \$11.95

Written by the managing director of Deloitte, Haskins & Sells, a Canadian partnership of public accountants and other professional advisors to management, this book is one of the most complete comprehensive guides to microcomputers available. Starting with a general overview of microcomputers and their business applications, the author helps you assess your computer needs, compares and evaluates computer systems and application packages, and gives you tips on "doing it right". A must for anyone thinking of purchasing a microcomputer for business.

COMPUTER PROGRAMS IN BASIC AB01 \$15.45

A catalogue of over 1,600 fully indexed BASIC computer programs with applications in Business, Math, Games and more. This book lists available software, what it does, where to get it, and how to adapt it to your machine.

PH217: BASIC COMPUTER PROGRAMMING FOR KIDS P. CASSIDY & J. CLOSE \$16.45

Fully illustrated with photographs and drawings, this book teaches the reader the history of computers and computing and gently introduces binary mathematics and the basic theory of how computers work. Written in an easy, conversational tone.

PH51: PASCAL FOR THE APPLE IAIN MacCALLUM \$34.20

A step-by-step introduction to Pascal for Apple II and Apple II Plus users. The package of text and software diskette provides readers with worthwhile and interesting programs which can be run immediately and the results studied. Includes over 200 exercises with full solutions. Book/Disk Package.

PH52: APPLE GRAPHICS GAMES PAUL COLLETTA \$40.95

Contains 10 arcade-style games written especially for Apple II, including Spider, Piano, Pairs and Poker, as well as education, math, and designing games. Book/Disk Package.

PH57: START WITH BASIC FOR THE COMMODORE VIC 20 D. MONROE \$33.45

This book/cassette package shows the reader how easy it really is to create programs using the full capacity of the machine. Includes helpful exercises and step-by-step instructions to put the full power of the VIC 20 at the user's fingertips. Book/Cassette Package.

SB21822: ENHANCING YOUR APPLE® II — VOLUME 1 D. LANCASTER \$25.50

Who but Mother Nature or Don Lancaster could successfully enhance an Apple? YOU can, with help from Volume 1 in Don's newest series for Sams. Among other things, you'll learn (1) to mix text, LORES, and HIREX together anywhere on the screen in any combination, (2) how to make a new-wire modification that will open up whole new worlds of 3-D graphics and other special effects, plus (3) a fast and easy way to tear apart and understand somebody else's machine-language program. Other goodies abound!

PH106: PROGRAMMING TIPS AND TECHNIQUES FOR THE APPLE II J. CAMPBELL (1983) \$23.45

An advanced exploration of the intricacies of structures programming. Further develops the skills necessary to solve programming problems. Special chapter on sound and graphics which discusses both high and low resolution graphics for the Apple II.

HB131: THE BEGINNER'S GUIDE TO BUYING A PERSONAL COMPUTER \$6.45

Written for the potentially interested computer buyer, in non-technical language, this affordable book explains the terminology of personal computers, the problems and variables to be discussed and discovered while making that initial buying decision. The book does not make recommendations, but does present a great deal of information about the range of hardware available from the largest personal computing manufacturers. Readers discover the meaning and impact of screen displays, tape cassette storage and disk storage, graphics and resolution, and much more. Comparison charts clearly define standard and optional features of all the current mass market personal computers.

DESIGNING MICROCOMPUTER SYSTEMS HB18: \$18.95

POOCH AND CHATTERGY

This book provides both hobbyists and electronic engineers with the background information necessary to build microcomputer systems. It discusses the hardware aspects of microcomputer systems. Timing devices are provided to explain sequences of operations in detail. Then, the book goes on to describe three of the most popular microcomputer families: the Intel 8080, Zilog Z-80, and Motorola 6800. Also covered are designs of interfaces for peripheral devices, and information of building microcomputer systems from kits.

S100 BUS HANDBOOK HB19: \$26.00

BURSKY
 Here is a comprehensive book that exclusively discusses S-100 bus computer systems and how they are organized. The book covers computer fundamentals, basic electronics, and the parts of the computer. Individual chapters discuss the CPU, memory, input/output, bulk-memory devices, and specialized peripheral controllers. It explains all the operating details of commonly available S-100 systems. Schematic drawings.

110 THYRISTOR PROJECTS USING SCRs AND TRIACS MARSTON HB22 \$13.45

A grab bag of challenging and useful semiconductor projects for the hobbyist, experimenter, and student. The project range from simple burglar, fire, and water level alarms to sophisticated power control devices for electric tools and trains. Integrated circuits are incorporated wherever their use reduces project costs.

PH104: ACCOUNTANT'S BASIC PROGRAMMING FOR THE APPLE II A PARKER & J. STEWART (1983) \$20.45

Shows the reader how to program the Apple II to perform a variety of accounting functions, such as payroll, accounts payable, accounts receivable, tax, inventory, customer statements, and more.

HOW TO PROFIT FROM YOUR PERSONAL COMPUTER: PROFESSIONAL, BUSINESS, AND HOME APPLICATIONS LEWIS HB01 \$18.95

Describes the uses of personal computers in common business applications, such as accounting managing, inventory, sorting mailing lists, and many others. The discussion includes terms, notations, and techniques commonly used by programmers. A full glossary of terms.

AN INTRODUCTION TO MICROPROCESSORS EXPERIMENTS IN DIGITAL TECHNOLOGY HB07 \$18.95

SMITH
 A "learn by doing" guide to the use of integrated circuits provides a foundation for the underlying hardware actions of programming statements. Emphasis is placed on how digital circuitry compares with analog circuitry. Begins with the simplest gates and timers, then introduces the fundamental parts of ICs, detailing the benefits and pitfalls of major IC families, and continues with coverage of the ultimate in integrated complexity — the microprocessor.

MICROCOMPUTERS AND THE 3 R'S DOERR HB09 \$16.45

This book educates educators, on the various ways computers, especially microcomputers, can be used in the classroom. It describes microcomputers, how to organize a computer-based program, the five instructional application types (with examples from subjects such as the hard sciences, life sciences, English, history, and government), and resources listings of today's products. The book includes preprogrammed examples to start up a microcomputer program, while chapters on resources and products direct the reader to useful additional information. All programs are written in the BASIC language.

HB107: GRAPHICS COOKBOOK FOR THE APPLE WADSWORTH HB107 \$15.95

Learn how to use your Apple II to "paint" shapes, objects, and letters in low-resolution graphics. The author provides a library of microcomputer graphics including such multicolored illustrations as robots and flying saucers, trees, sailboats, and colourful picture backgrounds. Contains complete annotated Applesoft BASIC programs to draw all the pictures described in the book as well as suggestions for improving programming techniques.

HB116: THE BASIC CONVERSIONS HANDBOOK FOR APPLE II, TRS-80™, and PET™ USERS BRAIN BANK \$14.50

A complete guide to converting Apple II and PET programs to TRS-80, TRS-80 and PET programs to Apple II, and TRS-80 and Apple II programs to PET. Equivalent commands are listed for TRS-80 BASIC (Model I, Level II), Applesoft BASIC and PET BASIC, as well as variations for TRS-80 Model III and Apple Integer BASIC. Also describes variations in graphics capabilities.

SARGON: A COMPUTER CHESS PROGRAM SPRACKLEN HB12 \$27.50

"I must rate this chess program an excellent buy for anyone who loves the game." Kilobaud.

Here is the computer chess program that won first place in the first chess tournament at the 1978 West Coast Computer Faire. It is written in Z-80 assembly language, using the TDL macro assembler. It comes complete with block diagram and sample printouts.

BASIC COMPUTER PROGRAMS FOR BUSINESS: STERNBERG (Vol. 1) HB13 \$21.50

A must for small businesses utilizing micros as well as for entrepreneurs, volume provides a wealth of practical business applications. Each program is documented with a description of its functions and operation, a listing in BASIC, a symbol table, sample data, and one or more samples.

AUDIO AND VIDEO INTERFERENCE CURES KAHANER HB21 \$8.95

A practical work about interference causes and cures that affect TV, radio, hi-fi, CB, and other devices. Provides all the information needed to stop interference. Schematic wiring diagrams of filters for all types of receivers and transmitters are included. Also, it supplies simple filter diagrams to eliminate radio and TV interference caused by noisy home appliances, neon lights, motors, etc.

PH107: APPLE LOGO PRIMER G. BITTER & N. WATSON (1983) \$19.95

A pictorial starter book that will make LOGO easy for anyone. Includes easy to follow examples and reference tables. Also included is a workshop outline for teachers and leaders who want to train others.

SB22047: 26 BASIC PROGRAMS FOR YOUR MICRO \$17.45

Features 26 previously unpublished, simple-to-complex games you can run on almost any brand of microcomputer as long as you have enough RAM on board. Most take between 500 and 5000 bytes, with the highest taking 13K. Conversion charts that let you key them into your Radio Shack, TRS-80, Apple II, Timex/Sinclair 1000 (ZX81), Spectrum, Atari, or PET are included. Also features notes on program techniques and structures.

Computing Today: Data Encryption

*A look at the techniques
used in protecting data
from unauthorized
interference.*

By Paul Chappell

CODES and ciphers have been used throughout history to protect information. Julius Caesar is reputed to have used a simple shift cipher, well known to all schoolboys, in which the original message (plaintext in the jargon) is enciphered by replacing each letter with the next letter of the alphabet. This is a shift of one; the next-but-one letter would be a shift of two, and so on.

There is a difference between a code and a cipher, by the way. Suppose I agree with you that the word 'fusebox' means 'meet me outside the newsstand' and 'fish' means 'I've lost my copy of Electronics Today'. To make use of this form of communication I might write you a letter and contrive, in the most natural way possible, to include a sentence like 'There is a fish in my fusebox'. This is a code.

A cipher, on the other hand, is a general purpose method of substituting new symbols for those used to express the original message. The shift cipher is one example, morse code (morse cipher?) is another.

Codes have the advantage of being impossible to break given only the coded message. As any word can quite legitimately be used to represent any other word or phrase, there is no way for anyone without extra information to get any leverage. The drawback of codes is that they can only be used to convey messages for which code words have previously been arranged. If I wanted to say 'meet me outside the store' there is no way to modify 'fusebox' to convey this new message.

Ciphers, with a few exceptions, can be cracked given sufficient time and computing power but have the advantage of being able to convey any message at all.

For electronic data communication we are concerned almost exclusively with information that can be represented in binary form. The preceding discussion applies equally well to this; a code may involve agreeing that 010 will mean 1101011100, a cipher may say that every third '1' in the plaintext message is changed to '0' and every second '0' is changed to '1'. The general term for scrambling a message is encryption, and unscrambling is called decryption.

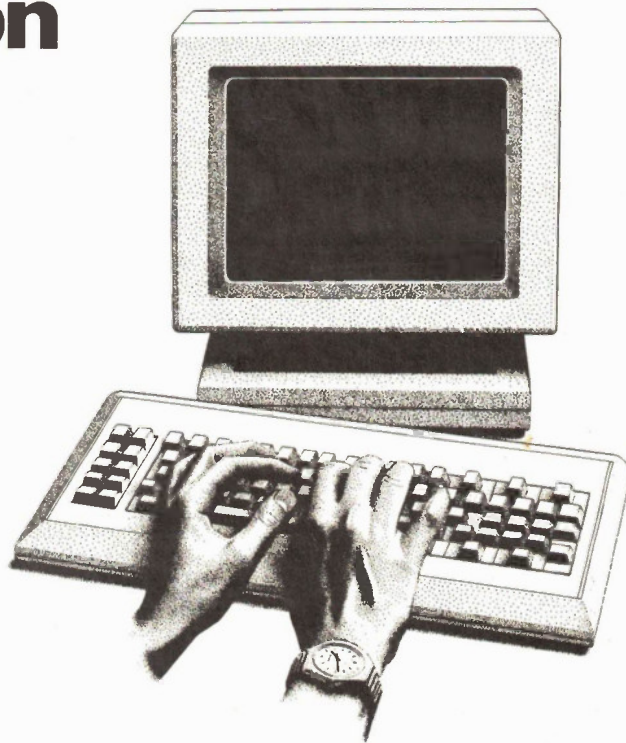

Requirements

Before leaping into a description of current data encryption techniques, it would be as well to take a look at what we'd like them to do.

First of all, it goes without saying that we'd like the system to be secure; nobody should be able to make sense of any message they intercept, nor should they be able to inject their own message into the system and have it accepted as genuine. Oddly enough, it is not difficult to make a completely secure system if this is the only requirement.

An example of such a system is the one-time pad. Both the sender and the receiver have identical lists (or pads) of random numbers. The encryption process proceeds in the same way as the shift cipher, except that the number of letters you shift by is taken from the number on the pad.

The drawback of this system is that it is extremely cumbersome to use. A pad of numbers at least as long as the total number of characters in all the messages must be prepared and conveyed in some safe way to the intended recipient, and must be closely guarded against prying eyes. The encryption process can be automated but will not be easy to use because somebody must feed in the numbers as well as the text to be sent. The system is, in fact, in daily use for communication between governments and military commanders, but is not suitable for general use.

If we can't have an unconditionally secure system we must content ourselves with a computationally secure one. The idea is that, although the system can be broken with unlimited time and computing power, the effort and time involved would be so immense that it is for all practical purposes perfectly secure. Here we hit another little problem: how can we tell how much computation a cryptanalyst will be faced with?

I'll come back to this later on with reference to specific systems, but I should mention that it's not enough just to calculate the astronomic number of permutations that would have to be investigated on a trial and error basis. Time after time, systems that were judged to be secure in this way have been broken by the discovery of a mathematical pattern in the cipher that the designer was not aware of.

It should be possible to enter the message and have it conveyed safely to the intended recipient without having to take any further part in the encryption process or observe any special precautions. It may also be necessary to use the system to communicate with a number of different people, so standardization of the hardware is essential.

Now, if the hardware is to be standard and readily available, any kind of encryption that involves performing some fixed process on the plaintext will not be secure. Transposing characters, substituting one symbol for another and similar procedures, however complicated, just won't do. Anyone intercepting the

ting one symbol for another and similar procedures, however complicated, just won't do. Anyone intercepting the ciphertext can also buy the hardware and use it to obtain the original message.

The way around this is to standardize the hardware but allow it to be personalized by means of a key, in the form of a string of digits chosen by the user which controls the way the message is encrypted. The point is that anyone intercepting the message will also need to know the key to make any sense of it.

Finally, the possibility of adding a 'signature' to the message would be useful. It would allow the system to be used for transmitting contracts, for instance, and in general would allow verification that the sender is who he claims to be.

Private Key Encryption

In this system the encryption algorithm is standardized and security depends on the use of a private key. The following example demonstrates how it works.

My algorithm is simple: modulo 2 addition. This is built into my encryption machine and I make no attempt to keep it secret. What I do keep secret is my key: 10010110. Let's suppose I want to send a message to the Editor explaining why this feature is a month late. The first thing I must do is to send him my key by courier. Then I type in my message 'I overslept', whereupon my encryption machine generates the corresponding ASCII codes (ciphers?):

```
1001001 0100000 1001111 1010110
1000101....
```

I O V E

My private key is added modulo 2 to each group of 8 bits: plaintext

```
10010010000010111100101101011010-
001.....
key
```

```
10010110100101101001011010010110-
100.....
ciphertext
```

```
00000100100111010101110111001100-
101.....
```

The editor's decrypting machine uses the same key and also applies modulo 2 addition to give the plaintext version of my message.

A more realistic system would involve using a much longer key. The key itself would not be added to the message but would be used to generate pseudo-random sequences of bits to be added.

This type of cipher is known as a stream cipher because it operates on each bit of the data stream individually. Another type that is widely used is the block cipher where chunks of data, or even the entire message, are altered as a whole by a combinatorial process controlled by the key.

By far the most common private key system is DES, the Data Encryption Standard adopted in 1977 by the American National Bureau of Standards. The key used in this system is 56 bits long. ICs incorporating the DES algorithm are available from a number of manufacturers.

The Data Encryption Standard

A DES IC will operate on a 64-bit input block to produce a ciphertext block of the same length. The easiest way to use one is to split the plaintext message into 64-bit blocks and encrypt each block individually. This is known as an Electronic Code Book implementation. It is suitable for use with data to be stored on disk which would be dealt with in blocks anyway. For general purposes, however, it violates a golden rule of security; never encrypt data in the same way twice, as this makes the system easier to break.

With a little extra hardware a Chain Block system can be made. The first data block of 64 bits is added modulo 2 to an Initial Vector, which is just an impressive name for a 64-bit long string of 1's and 0's. The vector for the first block to be encrypted will probably be supplied by the hardware; the person who is to receive the message must also have the vector. The result of the modulo 2 addition is then encrypted by the DES algorithm.

When the next block of 64 bits is read in, it is added modulo 2 to the encrypted version of the previous block and the result is then processed by the DES algorithm. The encrypted version of each block thus becomes an initial vector for the subsequent block.

An example will make the process a little clearer. For this we will use the ET miniDES algorithm which, in the form of a look-up table, goes like this:

| Input | Key=0 Output | Key=1 Output |
|-------|-----------------|-----------------|
| 00 | 01 | 10 |
| 01 | 11 | 00 |
| 10 | 00 | 11 |
| 11 | 10 | 01 |

You will see that miniDES operates on two bit data blocks and has a single bit key. For the purposes of the example we'll assume that a key of 0 has been chosen, so it's the first two columns of the table we're concerned with.

Let's suppose our plaintext data is 0110010001. The Electronic Code Book encryption of this will be 1100110111. Notice that whenever the plaintext block 01 is enciphered, it always results in 11.

Now we'll choose an initial vector for the Chain Block system, let's say 10. The encryption process will now proceed as shown in Table 1.

Notice that the plaintext block 01 is encrypted a different way on each occurrence: first as 10, then 01 and finally 00. Another feature of this arrangement is

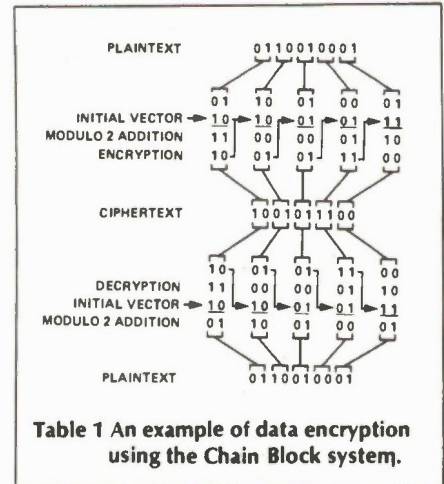

Table 1 An example of data encryption using the Chain Block system.

that errors in any block will carry through into all subsequent blocks (perhaps not in this simplified system, but they certainly do with the real DES algorithm). This prevents any tampering with the encrypted message. For instance if someone attempts to alter 'delete file 14' to 'delete file 15', the entire message will be corrupted.

Other possible implementations are Cipher Feedback and Output Feedback. Output Feedback in effect uses DES as a random number generator for a stream cipher. Cipher Feedback is similar, but the random numbers generated are 8-bits long and are added modulo 2 to 8-bit blocks from computer peripherals, etc.

Public Key Encryption

The main drawback of the private key system is the inconvenience of having to distribute the key to everyone you wish to communicate with. As the key should be changed from time to time, ideally after each message, and as multiple encryption with different keys is often used for additional security, the question of key distribution can become quite a headache.

Just imagine that a system could be developed which would allow any user to send this key quite openly to another, or even publish it in a public directory. It seems impossible at first sight; armed with your key and the method you've used to encrypt your data, even an amateur should be able to decipher any messages you send. Surprisingly enough, it is possible. The theoretical method was published in the mid-70s and the basis of a practical implementation shortly afterwards. The process described here is the Rivest-Shamir-Aldeman system, named after its inventors.

The basis of the system is a mathematical trick known as a one-way function. Many arithmetic processes are more difficult to perform in one direction than the other. For instance, it is generally more difficult to find square roots than it is to find the square of a number. For some mathematical functions the difficulty of reversing them is so immense as to be virtually impossible, or at least unfeasible

Surface Acoustic Waves

Acoustic waves sent and received over a piezoelectric crystal make nearly ideal filters.

By Andrew Armstrong

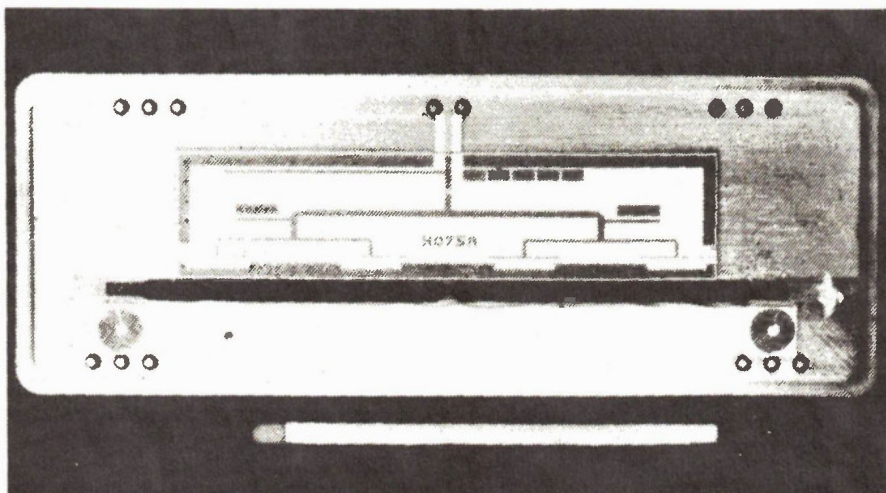

FILTERS, RESONATORS and delay lines are essential elements in a wide range of electronic equipment and a great deal of time and effort has been devoted to improving them, either by perfecting existing techniques or developing new ones. Filters and resonators have traditionally relied upon frequency-selective properties of reactive networks and much has been written about the best ways of combining reactive components (capacitors, inductors and crystals) to obtain the desired results. Delays can be produced by passing the signal from a transmitting transducer to a receiving transducer and placing between them some substance which slows down the passage of the wave. Examples range from the glass block and piezoelectric transducers used in television receivers to the coil-spring and magnetic transducers used in some audio effects units.

These effects remained largely unchanged until the development of the field effect transistor (FET) with its excellent switching characteristics, and the introduction of integrated circuitry which made it possible to build circuits of previously unimaginable complexity. The devices which resulted were the switched capacitor filter and the bucket brigade delay line, or charge coupled device (CCD), both of which use linear circuit elements controlled by electronic switching. The advantages in each case include greater flexibility; the break frequency of the filter and the delay period of the bucket brigade device can both be

altered simply by changing the frequency of the external clock.

The development of the complex digital integrated circuits has taken this flexibility several stages further. It is now possible to convert an analogue signal into digital form and then carry out a wide range of filtering operations, if necessary under software control, so that the parameters can be readily changed to meet specific requirements. Delay can be obtained simply by using readily available memory chips, allowing longer periods to be achieved without attendant degradation of the signal. Unlike linear systems, in which phase and frequency are heavily interdependent and it is not easy to design for one without affecting the other, digital filtering allows many different parameters to be specified to a high level of accuracy.

The last few years have seen the emergence of another new signal processing technology which combines many of the advantages of linear and digital techniques. Surface Acoustic Wave (SAW) devices use a tiny transducer to launch a wave across the surface of a piezoelectric crystal and another transducer to pick the wave up again. In this respect they are not unlike conventional glass delay lines, but the crucial difference is that the behaviour of the wave can be modified by use of complex transducers which work, in effect, as multiple taps on the delay line. The result is a filter whose characteristics can be controlled almost as well as can those of a digital system but which can be produced at a fraction of the cost.

The Nature Of The Wave

Before going any further, we'll look at what a surface acoustic wave actually is and how they are generated.

The easiest way to understand what is involved is to consider a very simple crystal structure; a cubic lattice with identical atoms at each vertex. An ordinary wave set up in the structure simply involves compression and rarefaction of the structure of the atoms. To put it crudely, one could imagine the little model atoms bouncing back and forth on their springs. The atoms are stiffly supported, being anchored by six bonds. This type of wave is called a bulk wave, and is of the type generated in conventional glass delay lines.

A surface wave involves atoms on the surface swinging about in an arc rather than a straight line. Atoms on a face of the crystal are less firmly anchored, with only five bonds attached, so the propagation speed of a surface wave is lower than that of a bulk wave. This means that a surface wave is confined to the surface, and does not tend to excite bulk waves. It is possible to launch bulk waves when trying to launch surface waves, and vice-versa, but they are different entities and there is limited interchange between the two. The rate of propagation of these acoustic waves is very much less than that of electromagnetic waves, so a relatively long delay line may be made in a small space.

Surface acoustic wave devices are made on crystals of particular types, the main ones being quartz, lithium niobate, and lithium tantalate, all of which are piezoelectric crystals. This is essential, because the transducers which launch the wave consist of interleaved strips or fingers of metalization which are energized with an electrical signal to excite a piezoelectric response and therefore launch a wave.

Figure 1 shows the layout of a typical SAW filter. The transducers are sym-

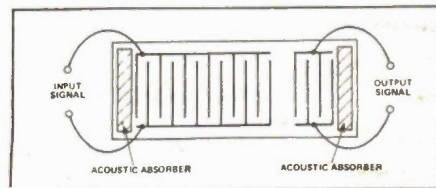

Fig. 1 The layout of a typical SAW filter. The two transducers consists of a number of fingers of metalization on the surface of the crystal.

metrical, so acoustic waves are radiated in both directions. The acoustic absorber on the far side is there to prevent the reverse wave from either propagating around the crystal or being reflected from the edge. Either event would interfere mightily with the intended function of the device. Similar reasoning applies to the presence of the absorber behind the receiving transducer.

In this simple example, the waves launched by each pair of fingers in the transducer may either reinforce or cancel the waves from other pairs, depending on the acoustic wavelength. The even spacing of the fingers shown would give rise to a flat-topped filter response.

LC filters can provide a good approximation to any reasonable amplitude response characteristic, but the resulting phase response is likely to be less than ideal. An enormous complexity is required to achieve a particular phase response as well, and it is normally very impractical. A SAW filter, however, can meet this kind of requirement because phase and amplitude response may be determined separately.

The example in Figure 1 shows a transducer which has evenly spaced, fully overlapping fingers. The spacing may be varied to adjust the phase response, and the degree of overlap may be varied to control the intensity of the wave. Figure 2 shows a $\text{Sin}(x)/x$ transducer which will give a bandpass response showing some resemblance to the square response often found in textbooks. Real transducer patterns have many more fingers, of course.

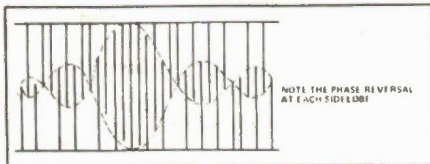

Fig. 2 Simplified view of a transducer arranged to give a $\text{sin}(x)/X$ characteristic.

The method used to design SAW filters is clearly unlike that used for LC filters. SAW filters are normally of a type described as transversal filters, which is a fancy way to describe the process of producing a desired output by adding many signals tapped from a delay line. CCD filters also work on this principle, and another technology which lends itself to this method is digital filtering.

It is interesting to compare digital and SAW devices when used for signal processing rather than filtering. In digital terms, the accuracy of a SAW device would be perhaps five bits, but the processing speed is two orders of magnitude faster than that of any digital IC currently in use or under development. There are applications which use digital and SAW technologies together to give the best of both worlds, but such applications are a specialized topic on their own.

Real Devices

So far all I've said about SAW devices sounds almost too good to be true, but there are some drawbacks. A look at some device configurations will help us understand the problems and their effects on the functioning of SAW devices.

One annoying phenomenon is signal coupling via bulk waves. While the method of excitation is designed to produce surface waves, bulk waves can be launched at frequencies outside the passband. If these waves reach the receiving transducer, a response out of the normal passband will be generated. The angle between the direction of the propagation of these waves and the plane of the transducers affects things in much the same way as coloured light is split by a diffraction grating. This effect is illustrated in Figure 3.

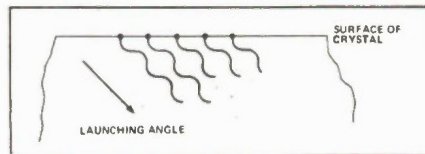

Fig. 3 Although the method of excitation is desired to produce surface waves, bulk waves are also generated and if launched at certain angles to the surface of the crystal they may reinforce and give rise to a response out of the normal passband of the filter.

To cause problems, the bulk wave launched by the transmitting transducer must be reflected back from the bottom face of the crystal to the receiving transducer. This effect can be minimized by roughening the bottom face of the crystal, making it as thin as possible, and coating the bottom with a sound-absorbing glue.

A far more effective measure is to offset the transducers and couple energy between them by means of a multistrip coupler. This idea is now widely used. In simple terms, the coupler acts as both a receiving transducer at one end and as a transmitting transducer at the other.

Another important advantage of this coupling technique is that both transmitting and receiving transducers may be weighted to give a particular response, a process known as apodising. If two apodised transducers are not offset but used directly in line, to work out the response one has to consider the effect of the wave pattern launched by each pair of fingers in the transmitting transducer as a whole, and the effect of the wave pattern on each receiving finger. This is equivalent to the mathematical process of convolution, which is rather complicated. Offsetting the transducers simplifies things considerably.

Driving Techniques

To use SAW filters it is necessary to couple signals to and from them, which is not made easier by the complex impedances of the transducers. To take a practical example, the Signal Technologies BP1102

70MHz bandpass filter (2MHz bandwidth) is quoted as having input and output impedances of 6R in series with 10p. At 70MHz, 10p has a reactance of 227R, which makes a series inductor to tune out the capacitance very desirable.

This is only the start of the problems. The BP1102 is quoted as having a 24dB insertion loss with a matching inductor. Without one, it has a midband attenuation of 44dB. Unfortunately, even at 2 MHz bandwidth the use of a matching inductor can cause response ripple due to an effect called triple transit, in which the acoustic wave bounces from the receiving transducer back to the transmitter and then back again.

Acoustic absorbers are used to minimize reflections from the end of the crystal, but the reflections in question here are from the actual transducers. They occur whenever there is a significant electrical load coupled to the transducers because power is drawn from any incident wave and dissipated. This inevitably disturbs the wave and causes reflections.

The transducer is in fact a three-port network with a matched load on one of the ports. If an extra load is added on the electrical port, the mechanical impedance of the acoustic wave no longer matches.

One solution to this dilemma is to match the input source to the transmitting transducer, and use a high impedance input amplifier on the on the receiving transducer (the output of the SAW device). This means that there is little reflection from the receiving end and the triple transit effect is small. Another solution is to drive the input of the device from a high impedance and with a high voltage signal, either by means of a step-up transformer or a cascode amplifier with a high-voltage supply. This delivers plenty of power to the input while presenting an electrical mismatch.

Material Characteristics

The BP1102 is made on a quartz substrate, ST cut (similar to the more familiar AT cut used for oscillator crystals) and has the advantage of almost zero temperature coefficient. In general, a given material can only offer a bandwidth which is a certain percentage of the operating frequency before the insertion loss becomes too high: for quartz this bandwidth is only a few percent.

One of the wider bandwidth filters from the same family has a 9MHz bandwidth at 72MHz and is made of lithium niobate. It boasts an insertion loss of 24dB without any electrical matching at all, but it has a temperature coefficient of -90 PPM/degree C. The percentage bandwidth available with lithium niobate and lithium tantalate is about 40 percent, which might suggest that they are suitable for use as an input filter in, say, TV receivers. Such a filter could provide a flat response over the entire TV broadcast band and about 60dB rejection outside it.

NEW!

Satellite Communications Training from NRI!

Move into commercial satellite communications and home satellite TV with NRI's latest training breakthrough

Explore Every Aspect of Satellite Transmission and Reception As You Assemble, Install, and Train With the Complete TVRO System Included in Your Course

With today's satellite technology a call to Paris is as clear and as easy to make as a call next door . . . executives use video conferencing to "meet" without leaving their offices . . . simultaneously, a billion people witness a single event (a soccer game, an inauguration, a benefit rock concert) . . . and scientists explore the mysteries of outer space without leaving their labs.

These amazing applications of satellite technology have opened up opportunities for the technician trained to install, maintain, troubleshoot, and repair satellite communications equipment.

Home Satellite TV is Just at the Start of Its Explosive Future

In suburban backyards and alongside country farmhouses, home satellite TV systems are springing up all across the country.

Already there are over a million TVRO (Television Receive-Only) systems in place in North America, and experts predict that by 1990, a remarkable 60% of all homes will have a satellite dish.

New Jobs, New Careers for the Trained Technician

NRI's new training prepares you to fill the increasing need for satellite communications technicians.

As an NRI-trained technician, you can concentrate on consumer-oriented TVRO equipment or use your NRI training to build a career servicing the larger commercial or military equipment used to transmit and receive voice, data, and video signals.

NRI Brings Satellite Technology Down to Earth

Only NRI has the resources and the skills necessary to transform today's most sophisticated technology into understandable, step-by-step training.

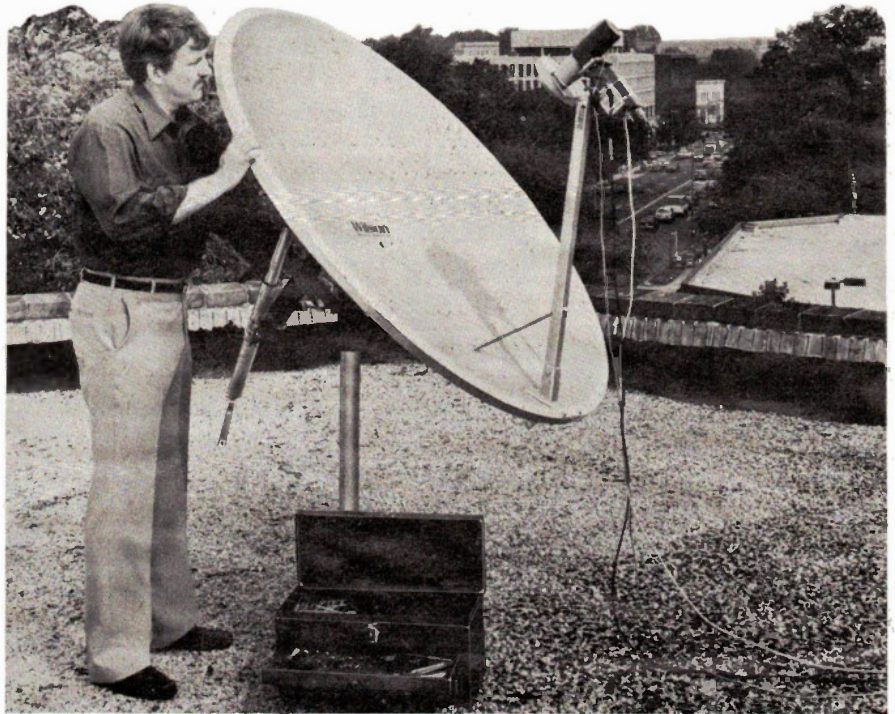

NRI trains you thoroughly in basic electronics, communications, and television principles. Using the remarkable NRI Discovery Lab® and your digital multimeter, you perform critical experiments, tests, and measurements. Then, using your NRI Antenna Applications and Design Lab, you assemble and test various types of antennas and matching sections.

You then concentrate on both commercial and consumer satellite earth station equipment, putting theory to practice as you assemble and install the complete satellite antenna system included in your course.

Your Home Satellite TV System Brings Theory to Life!

Your Wilson TVRO system comes complete with 5' parabolic dish antenna system, low-noise amplifier (LNA), down converter, receiver, low-loss coaxial cable, and even a permanent polar mount.

By training with an actual TVRO system, you'll come to understand first-hand the function and operation of a satellite earth station. And once completed, your TVRO system will provide the best

television entertainment available—direct from the satellite to your home.

Train the Uniquely Successful NRI Way

It's hands-on training, at home . . . designed around the latest state-of-the-art equipment. You discover by doing . . . and you do it at your own pace.

And built into your NRI training is the enormous experience of our development specialists and instructors, whose training skills and personal guidance are available to you on a one-to-one basis.

Make Your Move Into the Future Today! Send for Your FREE NRI Catalog

Only NRI can train you at home for an exciting and rewarding career as a satellite communications technician. But now is the time to act. Return the post-paid card to us today. You will receive your 100-page NRI School of Electronics catalog free. It details our training methods and materials and our more than 70 years of successful innovation in hands-on career training. (If the card is missing, write to us at the address below.)

NRI SCHOOLS

McGraw-Hill Continuing Education Center
330 Progress Avenue
Scarborough, Ontario M1P 2Z5
or telephone 416-293-8787
We'll give you tomorrow.



All Equipment Included With Your Training.



BUGS EATING YOU ALIVE?

Single stepping through a program works but...
Break points help but...

how do you kill those really
frustrating software bugs quickly?

The BUGBUSTER is a powerful hardware assisted debug package which runs on all Apple II/III and compatibles. It will trap and store a REAL-TIME disassembled trace on ANY program condition you specify. The 512 cycle trace can be viewed on screen or stored on a printer or diskette. Optional hardware inputs can be used to debug Apple hardware.

ONE YEAR PARTS AND LABOUR WARRANTY
Dealer enquiries invited



APTRON DESIGN LTD.

P.O. Box 13193, Kanata, Ontario, Canada K2K 1X4 (613) 831-0163

Please send:

- more information
- demo disk & manual @ \$10 \$ _____
- BUGBUSTER AP512 board & software @ \$199 \$ _____
- optional hardware probes @ \$25 set \$ _____
- Ontario residents add 7% PST \$ _____
- Cheque Enclosed Money Order Enclosed Total \$ _____
- Bill my VISA Bill my MasterCard
- Card# _____ Expiry Date _____

Signature _____ (not valid without signature)

Name _____ Company _____

Address _____

City _____ Prov. _____ Postal Code _____

Mail to Apron Design Ltd., P.O. Box 13193, Kanata, Ont. K2K 1X4

Circle No. 8 on Reader Service Card

PC/XT Compatible ECS1-PC/XT Special \$1095.00

- 8088 processor
- optional Intel 8087
- numeric coprocessor
- 256K memory
- double sided double density disk drive
- detachable keyboard
- colour-graphic board
- 130 watt power supply
- support PC software
- 90 day warranty
- 8 slot Mother board



XT/PC MAIN PERIPHERAL

| | |
|------------------------|----------|
| Mother Board 8 Slot | \$249.00 |
| Color Graphic Card | \$149.00 |
| Multifunction | \$149.00 |
| Monochrome Card | \$139.00 |
| Monochrome Graphic | \$199.00 |
| Game Port | \$ 49.00 |
| RS232 Card | \$ 59.00 |
| Parallel Interface | \$ 59.00 |
| Disc Controller Card | \$ 89.00 |
| Case | \$ 69.00 |
| Keyboard (Cherry) | \$ 99.00 |
| Power Supply 130 Watts | \$139.00 |
| Printer Cable | \$ 25.00 |
| RS232 Cable | \$ 25.00 |
| Disk Drive Cable | \$ 15.00 |
| Moving Message Board | \$495.00 |
| TTL and CMOS test Card | \$ 99.00 |
| 150 Watt Power Supply | \$159.00 |
| Modem 1200 B | \$395.00 |

AT Compatible \$2995.00

- 512K memory
- 1 1.2M drive
- Colour card
- Keyboard
- 200 watt power supply



ELECTRONIC CONTROL SYSTEMS

1590 Matheson Boulevard, Suite 1 & 2 Mississauga, Ontario L4W 1J1
(416) 625-8036 Hours — Mon. to Fri. 10-6, Sat. 10-2

CANADA REMOTE SYSTEMS

OFFERS YOU!

PUBLIC DOMAIN SOFTWARE

Canada's Largest Selection For CP/M, IBM, Macintosh Microcomputers

By Telephone — 12 remote Telecommunications Systems available 24 hours per day. Annual Access charge only \$35. No charge for downloading. For CP/M and IBM type microcomputers. Data Pac available.

By Mail — for over 200 different Computers. Over 1000 disks representing all major user groups including SIG/M and PC/SIG. From \$10.00 per user group disk. Our special collection disks contain the most popular software and are priced from \$15 per disk.

COMMERCIAL SOFTWARE

Specializing in CP/M and IBM commercial software, Low overhead, low prices, good service. We work with what we sell, and provide full assistance.

COMMERCIAL HARDWARE

Including coprocessor boards for CP/M computers and a full line of modems. The new 2400 Baud U.S. Robotics Courier Modem is now available for only \$825.00

Call us at (416) 239-2835 or Circle Reader Service Number 15 for a free mini-catalog.



Circle No. 10 on Reader Service Card

K.E.M.

X'MAS ON-SALE



--- Assembled & tested metal case mounted Frequency Counter ---
(1 Year Guarantee)

- | | | |
|--|--------------------|----------|
| (1) VHF Freq.-counter 10Hz to 200MHz 3-range, 6-digit LED, zero blanking Sensitivity 30mVr.m.s., Input impedance 1Mohm or 50ohm Accuracy 1ppm (0.0001%) | Model KEM-102NS | \$159.98 |
| (2) UHF Freq.-counter 10Hz to 1000MHz (1GHz) 4-range, 6-digit LED, zero blanking Sensitivity 30mVr.m.s., Input impedance 1Mohm or 50ohm Accuracy 1ppm (0.0001%) | Model KEM-102NS-1G | \$249.98 |

----- Frequency counter Kit series without case -----

- | | | |
|---|---------------------|---------|
| (1) 10Hz to 10MHz counter Kit: 10Hz to 10MHz 2-range, 6-digit LED Sensitivity 30mVr.m.s., Input impedance 1Mohm Accuracy 3ppm (0.0003%) --- Last 10 sets only --- | Model KEM-102N KIT | \$69.98 |
| (2) 10Hz to 200MHz counter Kit: 10Hz to 200MHz 3 range, 6-digit LED zero blanking Sensitivity 30mVr.m.s., Input impedance 1Mohm or 50ohm Accuracy 3ppm (0.0003%) --- New Model --- | Model KEM-102NS KIT | \$94.98 |
| (3) 200MHz Pre-scaler (ratio 1/100) Kit Maximum input 200MHz, Sensitivity 30mVr.m.s. | | \$19.98 |
| (4) High-Quality Metal Case Kit | | \$40.00 |

\$5.00 for shipping. Plus Prov. Tax for BC residents.
Plus C.O.D. fee if required. Prices & specifications are
subject to change without notice.

K. E. M. Electronics Ltd
Mail to Box 69126 Station (K), Vancouver, B. C. V5K 4W4
Office 879 E. Hastings St. Van. Tel (604) 251-1514

sinclair1736 Avenue Rd.
Toronto, Ontario M5M 3Y7
(416) 787-1448

QL

Sinclair's Breakthrough Computer... 32 Bit Power At the Lowest Price Ever



- Cross-Canada warranty service by AABEX
- 7-Day Money Back Guarantee.

Gladstone's New Low Price
blows away all competition!

\$599⁹⁵

- Includes Four Software Programs

Here are some of the incredible features of the Sinclair QL:

The Sinclair QL revolutionizes the computer revolution. It offers the utmost in performance, speed and power at the remarkably low price of only \$599.95.

The QL is a full-size computer designed around the most powerful and advanced microprocessor yet created for the personal computer: the Motorola 68008. With 128K RAM, expandable to 640K. High resolution color or black and white display, on either monitor or TV. Two RS-232C serial interfaces. Joystick cursor control.

The QL also comes with all the software you need to get started right away doing useful work. Wordprocessing, Spreadsheet, Graphics, Database management. A powerful set of programs as sophisticated and as easy to use as any on the market.

Two Powerful Processors: 32-bit main processor (68008), and Intel 8049 to control keyboard, sound, and RS232.

New Operating System: In addition to conventional DOS commands, the 32K ROM (expandable) provides single-user multi-tasking, allowing you to run several programs individually and simultaneously. It also allows up to twenty independent windows to be viewed.

Fully expandable memory: The QL comes with 128K and is fully expandable up to 640K.

Professional keyboard: Full size QWERTY keyboard with 64 keys including shift, function and four separate cursor control keys.

Two built-in microdrives: Sinclair's cartridge tape storage system provides high capacity data

storage at a fraction the cost of floppy disk. Each stores up to 100K, easily and quickly accessible. Up to six more microdrives can be added externally.

Sinclair SuperBASIC: Adds new features to BASIC to allow the full power of the QL to be exploited. 'Procedure' facility allows code to be written in clearly-defined blocks. 'Extendability' allows new procedures to be added. 'Constant execution speed' allows long programs to run much faster than other BASICS.

Your QL is supplied complete with everything you need to start computing immediately: cables, power supply, blank Microdrive cartridges, comprehensive instruction and programming manual, and complete guides to the software.

Call 416-787-1448 to Order — Credit Cards Welcome — Mail Order Form on Page 35

Circle No. 12 on Reader Service Card

DYNAUDIO[®]
AUTHENTIC FIDELITY

the innovators

DYNAUDIO LOUDSPEAKER COMPONENTS FEATURE

- PHA cones •
- Very High Power Hexacoils •
- Magnesium Diecast Baskets •
 - Tuned Cavity Tweeter •
 - and Mid-Range Units
- Vented Centre Magnets •

ALSO AVAILABLE

Computer Aided Design for Enclosures and Crossovers
Metalized Polypropylene Capacitors
Perfect Lay Winding Inductors
Speaker and Crossover Parts

WRITE OR PHONE FOR MORE INFORMATION

Mail orders accepted. Cheques, money orders, Visa and MasterCard.



SOLEIN INC

5940 Bergevin
Brossard, Québec J4Z 1Z2
(514) 656-2759

Circle No. 13 on Reader Service Card

AMAZING
SCIENTIFIC and ELECTRONICS
DEVICES

LASER DEVICES

- LC5 BURNING CUTTING CO2 LASER \$20.00
- RUB3 RUBY LASER RAY PISTOL 20.00
- LRG3 IR LASER RIFLE/PISTOL 10.00
- LGU3 VISIBLE RED LASER RIFLE 10.00
- LBT1 - LIGHT BEAM COMMUNICATOR 10.00
- LHC2 BEGINNER simulated VISIBLE LASER .50.00

SCIENTIFIC & ELECT

- TCL3 SOLID STATE TESLA COIL 35KV 7.00
- BTC3 250 THOUSAND VOLT TESLA COIL 10.00
- BTC5 1.5 MILLION VOLT TESLA COIL 15.00
- GRA1 - GRAVITY GENERATOR 10.00
- IOG3 ION RAY FORCE FIELD GUN 10.00
- PTG1 - PLASMA TORNADO GENERATOR 10.00

ULTRASONIC ACCOUSTICAL

- PPF1 PHASOR PAIN FIELD GENERATOR ... 15.00
- PSP3 PHASOR SHOCK WAVE PISTOL 8.00
- IPG5 POCKET PAIN FIELD GENERATOR 8.00
- MDDI MAGNETIC DIORIENTATION DEVICE . 10.00
- HT9 HIGH FREQ. LISTENING DEVICE 8.00

SECURITY & PROTECTION

- STG1 - STUN AND PARALYZING GUN 7.00
- PPG1 PHASOR PROPERTY GUARD 15.00
- MFT1 MINI VOICE XMTR 2-3 MILE 7.00
- INF1 INFINITY TRANSMITTER 15.00
- PSW3 PHASOR BURNING STUN WAND 7.00
- ITMI INTIMIDATOR PLASMA GUN 10.00

WE STOCK ALL PARTS NECESSARY FOR CONSTRUCTION OF THE ABOVE PROJECTS

• CATALOG CONTAINING HUNDREDS MORE OF ALL NEW AMAZING and FASCINATING PLANS. EASY TO BUILD KITS AND ASSEMBLED ITEMS \$1.00. CATALOG INCLUDED FREE WITH ANY OF THE ABOVE PROJECT PLANS. SEND CASH, CHECK, MO, VISA, MC IN US FUNDS.

INFORMATION UNLIMITED

P.O. Box 716, DEPT. ET, AMHERST, NH 03031

32 Circle No. 14 on Reader Service Card

The drawback is that the loss is much too great, and the resultant noise figure would render reception impossible in any but the strongest signal areas. Development work aimed at low loss devices is being carried out and there are several angles from which the problem can be attacked. One of the obvious ones is to develop a transmitting transducer which launches all energy in one direction, and a receiving one which picks up almost all the energy flowing past it.

The normal types of transducer launches the same power in each direction, so one half of the signal actually transferred to the substrate is wasted in the acoustic absorber. By the same token (because of reciprocity) the receiving transducer can pick up only one-half of the incident signal power. This immediately gives a 12dB loss, even if every other aspect of the device is free of losses.

A unidirectional characteristic can be achieved by clever phasing which cancels the wave in one direction. It is difficult to prevent unwanted reflections or other response ripples when designing this type of transducer, which is why it is only used where low loss is important.

Other Applications

So far we have concentrated mainly on transversal filters, but this is not the only application of SAW devices. It is also possible to produce resonators which are similar in principle to microwave resonator cavities, and if two of these are coupled, a narrow bandpass filter with low insertion loss may be made.

The diagram in Figure 4 shows a transducer between two reflectors. The reflectors consist of many strips rather than one thick one, suitably phased for frequency of operation. If too heavy a strip is placed in the path of the wave, the mechanical impedance mismatch causes bulk waves to be launched. As it stands, this type of resonator may be used as the frequency determining element in an oscillator.

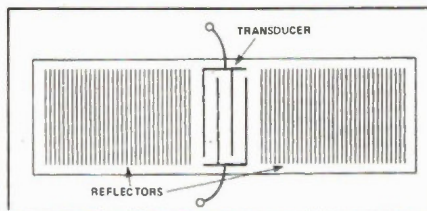

Fig. 4 A SAW device designed to act as a resonator. The reflectors on either side of the transducer consist of metallisation which are phased to suit the frequency of operation.

It may also be coupled electrically to another similar resonator, in which case a bandpass response can be generated similar to the response given by coupling two ordinary tuned circuits. The response is similar to that obtained with electrical coupling but only one substrate is used, making it preferable for large volume applications. The device layout and energy

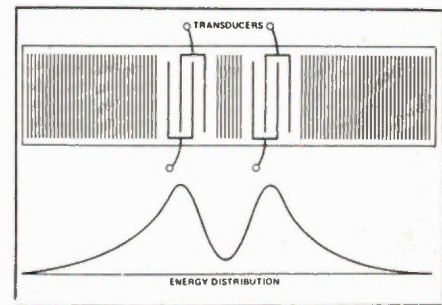

Fig. 5 Two SAW resonators fabricated on one substrate to produce a bandpass response.

distribution is illustrated in Figure 5. Little of the energy coupled into the input resonator is wasted, so a narrow bandwidth low insertion loss device may be made.

Another interesting SAW application not so far mentioned is the convolver, a device which carries out the mathematical process of convolution in real time on two input waveforms. Effectively it multiplies the two waveforms and integrates the result. In order for the multiplication to take place, the signal level must be high enough for non-linearity to occur. To achieve this, wide transducers are used to launch the waves, and they are then focused to a narrow beam by a metalization structure which looks like a lens.

To maintain a focused beam, a metalized track is deposited. This works in a way closely analogous to that of an optical fibre in guiding the wave. The piezoelectric effect generates a voltage in the strip which is integrated by its capacitance.

The Future

It is likely that the developments in low insertion loss devices will continue and will result in their extensive use in receiver inputs stages. We may eventually achieve a low enough loss to permit the use of SAW devices in input filters for TV reception covering the range from 40 to 800MHz. The technology is already at the stage where an input filter having a 2MHz bandwidth at a centre frequency of 900MHz and an insertion loss of 2dB is becoming practical. This would be ideal, for example, in cordless telephone applications.

If satellite TV ever turns out to be as major a development as it's been cracked up to be, there will be a strong incentive for developments such as the use of a SAW resonator to make a quadrature detector working at 1GHz. Along with a specially developed IC for the job, it is easy to imagine that a TV receiver head about the size of a matchbox could be developed.

It is quite likely that some of the signal processing application of SAW devices, for example in chirp radar, will gradually be taken over by higher and higher speed digital processors, but there is likely to be more than enough expansion in other applications to offset this for the foreseeable future.

QL

The Software

The 4 Programs, Included with your QL

Spectacular Hi-Resolution Color!
Actual screen shot QL Graphics

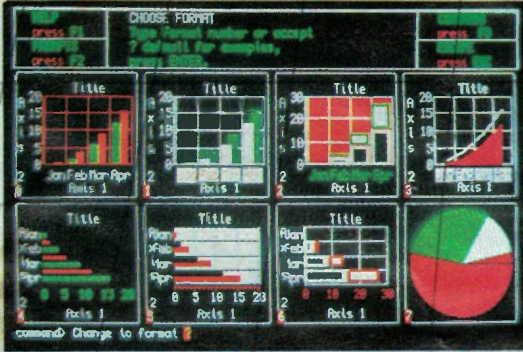

WORDPROCESSING

QL Quill is a total word processing package featuring: on-screen, step-by-step HELP menus, word wrap, full delete options, including cut-and-paste; wide view documents; boldface; superscript, subscript, underlining; hyphenations; overwrites; and will combine with data from other QL programs.

SPREADSHEET

QL Abacus provides instantaneous 'what if' spreadsheet manipulation functions featuring: single stroke assignable function keys; spreadsheet linkage; multiple-windows; text justification; scroll windows, and single name reference to rows, columns and cells.

DATABASE MANAGEMENT

QL Archive is an extremely sophisticated yet easy to use filing system featuring: 84 single command words for queries, cross-references and file searches; easy statistical and accounting calculations; screen editor for report formats, and complete HELP menus.

GRAPHICS

QL Easel produces spectacular color graphics. The program features: design handling and scaling either automatically or under user-control; text addition or deletion; nine graph styles; data manipulation and evaluation using command math functions and formulas, and complete HELP menus.

Select More QL Software Here

LANGUAGES & UTILITIES

QL ASSEMBLER. Converts M68000 assembly language sources files into QL-compatible binary files. Includes multi-tasking full screen editor which can run simultaneously with SuperBASIC \$99.95

QL MONITOR. Machine Code monitor. \$69.95

QL TOOLKIT Over 70 programs and extensions to SuperBASIC. Includes print spooling, improved file access (full random input/output command), job control (allows management of multi-tasking) and SuperBASIC screen editor. \$74.95

for HOME, EDUCATION & BUSINESS

Q-STAR Spelling check and text editing program with 28,000 word capacity, including 4000 words of your own choice. Works with any QL file including the Word Processor supplied with the QL. \$99.95

DBASE MASTER. 9 separate filing programs to build and maintain lists of all descriptions. Written in QL Database. Includes Mailing List (record and select by 15 categories), inventory control, stamp collection, sports record, teacher's helper. etc. \$74.95.

SUNDIAL. 15-year calendar, appointment scheduler and daily diary. Up to 20 events each day can be stored, and accessed by searching on date, time, and name — or combination of the three. Bonus on-screen calculator. \$79.95

QL TOUCH 'N' GO Learn touch typing. Unique approach designed to give you mastery over the QWERTY keyboard in 24 hours. \$74.95

QL HOME FINANCE \$74.95

QL GARDENER. Garden design for the amateur or professional. \$54.95

BCPL. QL compiler ideal for systems programming, writing utilities, games and applications. Generated native 68000 code. Easy QDOS interface. Link separately compiled segments. Can be linked with Pascal or Assembler. \$149.95

LISP. Features turtle graphics for exploring the language of artificial intelligence. Structure editor; pretty printer; garbage collector and tracer. Full screen editor. \$149.95

PASCAL. True single pass compiler producing native 68000 code meeting ISO 7185 standard. Direct addressing of full QL address space. Key routines on ROM for speed and convenience. \$199.95

PACK 116. Programs and routines for science and maths including permutations, combinations, capacitance, inductance, frequency, gaussian circuits, power supply circuits, and about 100 more \$79.95

Q-CAD. Computer Aided Design for the QL. Complete resident graphics library as well as user definable shapes, symbols, forms, formulas, and tables which can be scaled, rescaled, moved, saved, recalled, modified. Compare with other CAD systems 5 times more expensive. \$99.95

Q-CALL. Communications software for use with Hayes or equivalent 300 or 1200 baud modem. Will handle telephone connections, and manage file transfer. Ideal for use with Compuserve and other data services. Gets you online now! \$79.95

Q-FONT. Total printer control to use the "hidden" fonts in your Centronics or Epson or compatible printer. Also provide "hi-res" screen dumps to your printer. \$54.95

CANADIAN INCOME TAX GUIDE — 1985 \$79.95

QL CHESS. Developed by PSION. Features high resolution display, animated 3-D graphics, 28

C. Powerful QL implementation including full screen editor. \$229.95

THE PROGRAMMER. Program generator; you specify the input and the output. . . It writes the program. Uses cursor control and a few simple commands to generate fully written, tested and working program which can be stored and recalled. \$99.95

QDOS BOSS. Examine and change any sector of data on a microdrive cartridge. Print or display on screen in hex or ascii. DOS utility "shell" simplifies QDOS functions and commands. \$79.95

levels of play from novice to champion. Opening book of nearly 4000 moves, HINT and TAKE-BACK functions, and the option to play a human opponent or the computer. \$84.95

QL DECISION MAKER. Set up a decision tree to help evaluate the costs and results of decisions. Complex 'what if' questions are dealt with rapidly and graphically. \$110.00

QL PROJECT PLANNER. Divides complex activities into critically important stages to help in the planning and monitoring. When you decide on a starting time, it tells you when each activity must start and finish and when the project will be completed. \$110.00

QL ENTREPRENEUR. Uses a 'what if' format to help develop a workable business plan. Break-even point. Cash flow forecast. Balance sheet and profit and loss statement. Builds your skills and techniques. \$110.00

HARDWARE EXPANSIONS

Coming soon are 256K and 512K memory expansion boards and a disk drive Interface.

Call 416-787-1448 to Order —

Credit Cards Welcome —

Mail Order Form on Page 35

Circle No. 15 on Reader Service Card

ESCORT TEST INSTRUMENTATION

QUALITY AT THE RIGHT PRICE!

WE DARE YOU TO COMPARE

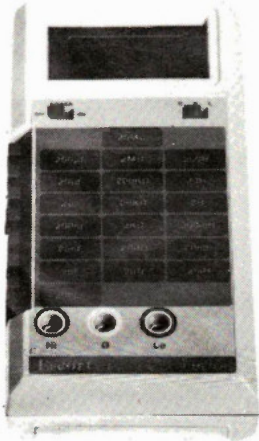

MODEL ELC 120
3 1/2 DIGIT LCR METER
Feature Packed Priced Right

- 3 1/2 Digit LCD Display
- Capacitance, Resistance, and Inductance Measurements
- Basic Accuracy 1.0%
- 200 HR Operation
- Test Frequency of 1KHZ

\$266.43 List Price
\$219.00 Introductory Offer



MODEL ECT 620
3 1/2 DIGIT CLAMP-ON
Extra Convenience

- 3 1/2 Digit LCD Display
- DCV, ACV, ACA, RES.
- Data Hold, Audible Continuity Test
- Diode Test, Peak Hold
- 0.5% Basic DC Accuracy

\$159.43 List Price
\$124.00 Introductory Offer

Offer expires January 31st 1986



MODEL EDM 2347
4 1/2 DIGIT MULTIMETER
Feature Packed Bench Model

- 4 1/2 Digit LCD Display
- 0.03% Basic DC Accuracy
- True RMS ACA/ACV Measurement
- Frequency Measurement to 200KHZ
- Audible/Visual Continuity
- Conductance Measurement
- dB Measurement
- Battery or AC Operation
- Diode Test Function
- Data Hold Function
- 20A AC/DC Current Measurement

\$422.65 List Price
\$359.00 Introductory Offer

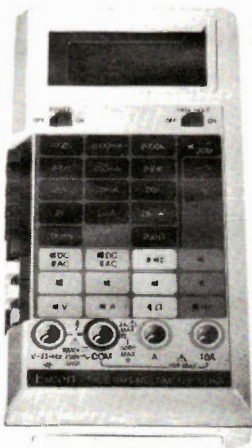

MODEL EDM 1346A
4 1/2 DIGIT MULTIMETER
Feature Packed Handheld

- 4 1/2 Digit LCD Display
- 0.5% Basic DC Accuracy
- True RMS Measurement (ACA/ACV)
- Frequency Measurement to 200KHZ
- Audible/Visual Continuity Test
- Data Hold Function
- Diode Test Function
- 10A AC/DC Current Measurement
- Up to 1000 Volt DC Measurement

\$299.60 List Price
\$249.00 Introductory Offer

ESCORT: A line of quality Electronic Test Instruments is the latest addition to Metermaster, backed by a full one year warranty. . . at an unbeatable price!

Metermaster

A Div. of R.H. NICHOLS CO. LTD.

Head Office: 80 Vinyl Court
 Woodbridge, Ontario L4L 4A3



5% Discount for Cash
 plus Student Discount 5% on all products
 Certified Cheque, or Money Order
 DEALER INQUIRIES INVITED

All prices F. B.
 Woodbridge Ontario
 subject to change without
 notice P.S.T. extra
 where applicable

TORONTO (416) 741-9381 • MONTREAL (514) 337-0425 • EDMONTON (403) 432-7746 • OTTAWA (613) 727-3974
 • VANCOUVER (604) 937-3622

PATRON COMPONENTS INC.

XT COMPATIBLE ONLY \$999.

System includes:

- 256K XT (Japan)
- One DSDD Disk Drive
- Controller Card
- Colour Graphics or Monochrome Display Card
- Case, Keyboard & 130W Power Supply
- Option: two DSDD Drive system for \$1159.00
- 90 day warranty.

PERIPHERAL BOARDS

| | Retail |
|---|---------------|
| 512K Ram Card (OK) | \$ 90.00 |
| 384K Multifunction Card (Loaded) | \$240.00 |
| Monochrome Display Card | \$111.50 |
| Monochrome Graphic/Printer Card | \$161.50 |
| Colour Graphic Card | \$124.00 |
| Keyboard for IBM | \$ 99.00 |
| Tatung RGB Colour Monitor (12") | \$499.00 |
| Panasonic JA551-2/5 Disk Drive | \$160.00 |
| Shugart (10MB) Hard Disk & Controller | \$850.00 |
| Seagate (20MB) Hard Disk Controller | \$1100.00 |
| Control Card + Cable | \$ 79.00 |
| Mainboard (8 slot) 256K (Loaded) | \$312.50 |
| Mainboard (OK) | \$250.00 |

**Stock Distributor of Memories I.C. (U.S.A./Japan),
All New Parts. Min. 100 pieces**

RAM/EPROM:

- 16K DRAM (4116) from \$0.50 EPROM (2716) \$2.45
- 64K DRAM (4164) from \$1.10 EPROM (2764) \$3.15
- 128K DRAM (4128) from \$8.05 EPROM (27128) \$3.95
- 256K DRAM (41256) from \$5.45 EPROM (27256) \$11.85
- 16K SRAM (6116,2016) from \$2.10
- 64K SRAM (6264,5565) from \$6.70

T.T.L.:

(74LS00 etc.) from \$0.17

4000 CMOS:

(CD4001 etc.) from \$0.17

LINEAR:

(LM324 etc.) from \$0.21

MICROPROCESSOR:

8088 Kit set (8088, 8253, 8237, 8284, 8288, 8259, 8255)
from \$33.10 per set

Please call for other 8000 series MPU/O.E.M. price and delivery.

Dealer inquiries invited — Prices lowest in town.

PATRON COMPONENTS INC.

4002 Sheppard Ave. E., Suite 506,
Agincourt, Ont. M1S 1S6
Tel: (416) 299-7731

Office Hours:
Mon-Fri. 10 -6 p.m.
Saturday 10-5 p.m.

SHEPPARD AND KENNEDY

Mail Orders accepted. Postage and Handling - Min. \$5.00. Ontario residents please add 7% P.S.T. Visa, Certified Cheque accepted.

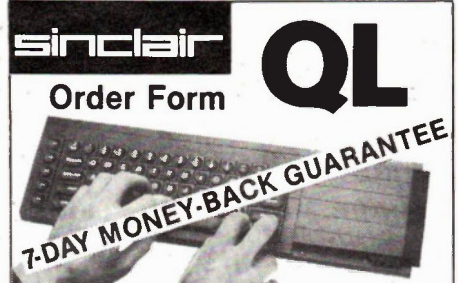

Order Form

QL

- 32-bit processor
 - 128K Ram
 - Two built-in microdrives
 - Software included
 - Hires color
 - National warranty service by AABEX
 - New low price!
- \$599.95**

Monitors & Printers for QL

14" Hitachi RGB Monitor. Bright seven color display. Up to 1500 characters. **\$549.90**

JIL 12" Green Screen Monitor **\$149.95**

Centronics GLP Printer. Compact size. 132 columns. Near letter quality dot matrix. **\$399.95**

Smith Corona D200 Printer. 120 cps. 2K buffer. Series & parallel interface. **\$699.95**

ORDER FORM • MAIL TO

**Gladstone Electronics, 1736 Avenue Rd,
Toronto, Ontario M5M 3Y7**

| Please send | Each | Total |
|--|----------|-------|
| ___ Sinclair QL Computer including manual-power supply-4 software titles | \$599.95 | ___ |
| ___ Hitachi RGB Monitor | 549.95 | ___ |
| ___ Cable for Hitachi monitor | 29.95 | ___ |
| ___ JIL Green Screen Monitor | 149.95 | ___ |
| ___ Cable for JIL monitor | 9.95 | ___ |
| ___ Centronics GLP Printer | 399.95 | ___ |
| ___ Smith Corona D200 Printer | 699.95 | ___ |
| ___ Cable for above printers | 39.95 | ___ |
| QL Software | | |
| ___ QL Assembler | 99.95 | ___ |
| ___ QL Monitor | 74.95 | ___ |
| ___ QL Toolkit | 74.95 | ___ |
| ___ BCPL | 149.95 | ___ |
| ___ LISP | 149.95 | ___ |
| ___ PASCAL | 199.95 | ___ |
| ___ C Language | 229.95 | ___ |
| ___ QL Programmer | 99.95 | ___ |
| ___ QDOS Boss | 79.95 | ___ |
| ___ Q-Star | 99.95 | ___ |
| ___ DBASE Master | 74.95 | ___ |
| ___ Sundial | 79.95 | ___ |
| ___ QL Touch 'N' Go | 74.95 | ___ |
| ___ QL Home Finance | 74.95 | ___ |
| ___ QL Gardener | 54.95 | ___ |
| ___ Pack 116 | 79.95 | ___ |
| ___ Q-CAD | 99.95 | ___ |
| ___ Q-Call | 79.95 | ___ |
| ___ Q-Font | 54.95 | ___ |
| ___ Can. Income Tax | 79.95 | ___ |
| ___ QL Chess | 84.95 | ___ |
| ___ QL Decision Maker | 110.00 | ___ |
| ___ QL Project Planner | 110.00 | ___ |
| ___ QL Entrepreneur | 110.00 | ___ |
| ___ Shipping (per order) | \$15.00 | ___ |
| ___ Ont. residents add 7% PST | ___ | ___ |
| TOTAL | | ___ |

Enclosed is: Cheque Money Order Visa Mastercard

Card # _____ Expiry _____
Signature _____
Name _____
Address _____
City _____ Prov. _____
Telephone _____ Code _____

CREDIT CARD ORDERS: Call (416) 787-1448
Gladstone Electronics
1736 Avenue Rd., Toronto, Ontario M5M 3Y7

For Your Information

continued from page 6

DIP Network

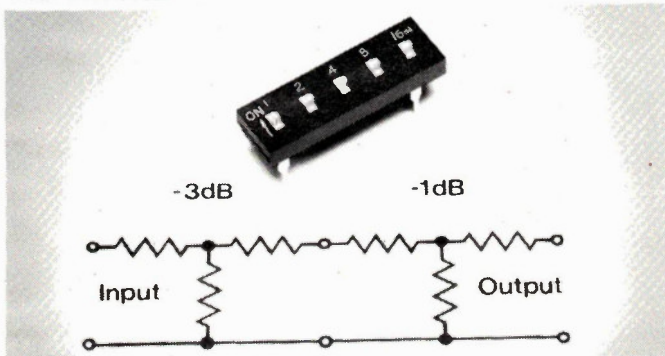

Augat/Alcoswitch introduces an adjustable T-attenuator DIP switch, the ATT, with auto-insertable PCB mounting. Attenuation can be set in 1dB steps from 1 to 31 dB. It's a thick film resistor network screened onto a ceramic substrate molded inside the base of a slide actuated DIP

switch. Nominal impedance values are 50, 75, 150, 300, or 600 ohms. From Alcoswitch dealers, or contact Alco Electronic Products, Inc., 1551 Osgood St., North Andover, Massachusetts 01845, (617) 685-4371.

Circle No. 37 on Reader Service Card.

IBM Keyboard



The Unitech K-150L Cherry keyboard for the IBM PC/XT and compatibles features the same layout as the IBM Selectric typewriter for ease of typing. It's directly interchangeable and has

several improvements over the IBM keyboard. Contact Budgetron Inc., 1320 Shawson Drive, Unit 1, Mississauga, Ontario L4W 1C3, (416) 673-7800.

Circle No. 38 on Reader Service Card.

Logic Programmer



Duncan Instruments Ltd. announces the latest version of the Stag ZL30 Logic Programmer, a tool for development and production work on all currently available PALs and IFLs in 20, 24, and 28 pin configurations. A CUPL high

level language is included; it has both RS232C and IEEE-48 interfaces. Duncan Instruments Ltd., 121 Milvan Drive, Toronto, Ontario M9L 1Z8, (416) 742-4448.

Circle No. 39 on Reader Service Card.

Exceltronix

Many, indeed most of you, will have seen this Exceltronix Catalogue in the November issue of Electronics Today.

Why have it in again? It is not a mistake. We know that each copy of Electronics Today is seen by an average of three people; several go to companies, libraries and schools and we know from experience that the catalogues are taken — removed by an early reader. If you did not get the last issue, we very much want you to see it now. If the catalogue was already removed, here's your chance.

If you don't share your copy and you've already seen the catalogue, it's in the way so why not pass it along to a friend? Our product range and prices are so good you'll be doing them a favour.

A photograph of the Space Shuttle Columbia on the launch pad, viewed from a low angle looking up. The orbiter is attached to the external tank and solid rocket boosters. The boosters are lit up, showing the intense heat and light from the engines. The background is a clear blue sky.

Exceltronix

Computers and Components

**1986
Catalogue**

\$1.00

Toronto Store and Mail Orders
319 College Street,
Toronto, Ontario M5T 1S2
(416) 921-8941

Ottawa Store
217 Bank Street, Ottawa
(613) 230-9000

**Warehouse
Pickup Counter**
335 Evans Ave.,
Toronto
(416) 252-5285
QEW and Kipling
- plenty of
parking but \$25
minimum

Long Distance Ordering
1-800-268-3798

(Operators on 800 number cannot handle enquiries other than orders)

Local Orders (416) 921-8941

Order Form P. 23

The History and Development

of our successful and rapidly expanding All-Canadian company committed to high technology.



Our original store in Toronto is still at the same location (319 College Street — College and Spadina) but has greatly expanded to incorporate adjacent stores.



Multiflex and Versa-Digital developed and manufactured the digital display signs used on the Toronto Subway System and the Vancouver LRT Transit System — and they are now controlled and updated using several BEST computers!



Our newly purchased 25,000 square foot facility, near Toronto airport, will allow us to expand research and development in the computer field. It will also take us into a new field of development: advanced underwater intelligent robotics.



In excess of \$1 million was devoted by Multiflex to development of new high tech products in 1985.

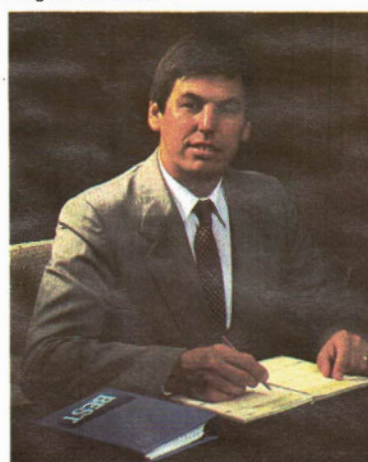

Eugen F. Hutka, the founder and President of Exceltronix, Multiflex and all the associated companies.

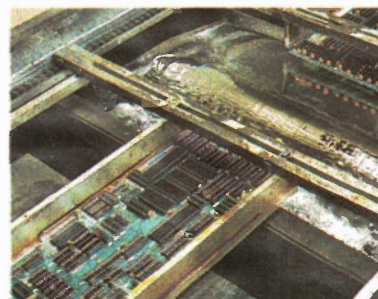

All our own products are manufactured in Canada to the highest quality, including being flow-soldered and ultrasonically cleaned.

All prices and specifications in this catalogue are subject to change without notice.

Our Cover: We would like to thank NASA for the cover picture of the Challenger. We feel that this picture symbolizes our own success — it combines high tech, rapid growth and the fact that we are really taking off!

Now in its seventh year, Exceltronix and its associated companies, has grown from a single store, to three retail outlets, a large mail order division, and an ever expanding engineering and manufacturing facility with revenues for 1986 expected to exceed \$15 million.

Many of the products sold at our own retail outlets are manufactured by our associated company, Multiflex Inventions and Technology in Toronto. This direct link between manufacturing and retailing benefits our customers in several ways. Our competitive prices result from not having to deal with middlemen (with their markups) and enables us to respond rapidly to the changing needs of customers. We are proud of both the high quality of our products and their excellent reliability and consequently we are able to offer warranties far better than the industry standard. Exceltronix is probably most widely known for its highly successful line of IBM compatible BEST personal computers and peripherals, but when an off-the-shelf product will not satisfy your needs, the engineering division at Multiflex is able to analyze your problem and develop a cost effective solution. Proof of this is the Advanced Message Display System in the Toronto Subway System and the Vancouver LRT, manufactured by Versa-Digital, another associated company. These examples are just some of the many solutions that we have provided for Canadian industry and commerce and we will be happy to discuss your particular requirements.

Even though we have grown enormously, we have not lost the personal touch that contributed to that growth. Although we are now one of the largest manufacturers of computers in Canada, our dedicated and knowledgeable staff are happy to discuss your needs, be it for a computer to solve a problem or a single electronic component.

In the recent past, the microcomputer business has seen huge booms and some massive recessions. Despite this, Exceltronix and its associated companies have grown consistently and we continue to increase our market share. Being diversified, we have the resources to research and develop our products properly. Not being dependent on a single line, we have avoided the mistake of many computer companies of bringing out products before they are properly developed.

Our company is proud of the fast and excellent service in our stores and we now have available a team of specialists who can provide on-site analysis of your hardware, software and interfacing needs.

We have yet to see what tomorrow has to offer, but you can be assured that the Exceltronix group of companies will be accepting the challenge.

Associated Companies:
Exceltronix Inc.
Multiflex Inventions and Technologies Inc.
BEST Computers Inc.
Toronto Computing Centre Inc.
Versa-Digital Technology Inc.
Digi-Media Inc.
XL Electronix Computer Music Centre Inc.

We are proud to introduce the New FAST BEST Mark III

Made in Canada with pride.

To meet the demanding needs of industry for faster information processing, Exceltronix is pleased and proud to introduce the Mark III personal computer. Based on the success of the BEST Mark II, the Mark III goes a step beyond. The system is based on the 8088-2 microprocessor, which is capable of running almost twice as fast as any 8088 based system.

- Superb IBM PC/XT software and hardware compatibility has been retained.
- A hardware switch allows you to go from 4.77MHz to 8MHz operation. Any software that implements a lot of memory manipulation will run visibly faster. Compilers work much faster, spreadsheets will speed through calculations, and even video intensive games run quicker.
- All the same cost effective package that made the Mark II a success, has been continued in the Mark III. We consider features such as a Real Time Clock, Parallel Printer Port, Serial Communications Port and a minimum of 256K RAM memory, necessities in today's personal computer. These have been included in the base price along with a colour video board, so even if you don't need the options today, tomorrow you will not have to pay to have them installed.

**Superb
IBM PC/XT
Compatibility**



Monitor and printer not included. IBM is a registered trade mark of IBM Canada Limited.

NEW

The FAST BEST MK III

As BEST MK II plus speed selectable: 4.77 and 8MHz (most software will run on the higher speed), uses 8088-2 processor.

\$1895⁰⁰

Other Configurations:

| | |
|--|--------|
| With 640K RAM | \$1995 |
| With 10 Meg Hard Drive/1 Floppy/256K | \$2795 |
| With 10 Meg Hard Drive/1 Floppy/640K | \$2895 |
| With 20 Meg Hard Drive/1 Floppy/256K | \$3095 |
| With 20 Meg Hard Drive/1 Floppy/640K | \$3195 |

Standard Features common the BEST Mk II and MK III

- Superb IBM Compatibility.
- Phoenix BIOS, as used in many major brand IBM compatible systems.
- Minimum of 256K Memory using 41256K RAM chips, expandable to 640K or higher on the main board.
- Seven Expansion slots
- Real Time Clock/Calendar, with software with battery backup.
- Parallel Printer port
- Serial Communications Port with option for a second for only \$39 extra.
- Two double sided, double density 360K 5.25 inch floppy disk drives
- Colour graphics video board, with both RGB and composite video outputs.
- Pre-socketed for the optional Intel 8087 math co-processor
- A reset switch ● A 150 watt power supply, which will handle additional boards and a hard disk drive.
- IBM compatible, high quality keyboard.

Warranty

We have such confidence in the time tested reliability of the BEST that we offer a 300 day warranty which is way above the industry standard. On-site service plan available at extra cost.

Options:

| | |
|-------------------------------------|--------|
| Tape Drive-from | \$1295 |
| Second Floppy on H.D. systems | \$180 |
| Second Serial Port | \$39 |

The BEST Mark II

Made In Canada

Superb IBM PC/XT Compatibility

In the past two years, thousands of BEST personal computers have been working their way into the Canadian business, educational and home environment. Based on the 8088 microprocessor, the BEST Mark II is an inexpensive entry into the personal computer field.

As with all the BEST product range, it is made in Canada to the highest standard of quality.

It is the success of the original BEST and the Mk II that prompted us to develop the newer and faster Mk III and Mk IV.



Monitor not included. IBM is a registered trade mark of IBM Canada Limited.

BEST MARK II

Standard Mark II with 256K RAM and two 360K DD/DS diskette drives, Serial and Parallel Ports, Real Time Clock, Phoenix BIOS. Uses 8088 processor.

\$1695⁰⁰

Other Configurations:

| | |
|--|--------|
| With 640K RAM | \$1795 |
| With 10 Meg Hard Drive/1 Floppy/256K | \$2595 |
| With 10 Meg Hard Drive/1 Floppy/640K | \$2695 |
| With 20 Meg Hard Drive/1 Floppy/256K | \$2895 |
| With 20 Meg Hard Drive/1 Floppy/640K | \$2995 |

If you want the Best, buy the BEST

SUPER-FAST BEST Mark IV

Made in Canada with pride.
Superb IBM PC/XT Compatibility

In today's industry, more than ever, time is money. It is for that reason we developed the Mark IV personal computer.

Still retaining IBM PC and XT software and hardware compatibility, the Mark IV uses the true 16-bit 8086-2 microprocessor. Although the system runs at the same clock speed as the Mark III, the 8086-2 has a 16-bit external data bus compared to the 8088 and 8088-2's 8-bit data bus. This allows memory access to occur much faster than with most other IBM PC/XT and compatible computers.

The bus structure of the Mk IV remains compatible with the standard IBM 8-bit I/O channel but still has the benefits of the 16-bit architecture.

Couple the 8086-2 microprocessor with the 8087 math co-processor and you have one of the fastest, most reliable business or engineering aids available in this price range.

Since the BEST Mark IV is geared towards the serious microcomputer user, a standard complement of 640K RAM is installed on the main board, along with a long list of standard features.



Monitor and printer not included. IBM is a registered trade mark of IBM Canada Limited

Standard Features of the BEST Mk IV

- Superb IBM Compatibility.
- Canadian made
- Phoenix BIOS, as used in many major brand IBM compatible systems.
- 640K of RAM (Random Access Memory).
- Seven Expansion slots, so that you have lots of room to tailor the system to your needs, with the wide range of peripheral cards available.
- Real Time Clock/Calendar, with software and battery backup.
- Parallel Printer port, to interface dot matrix, letter quality printers and

digital plotters.

- Serial Communications Port that supports all RS232-C signals (a second serial port can be added for only \$39.00 extra).
- Two double sided, double density 360K 5.25 inch floppy disk drives, with the option of adding an additional two drives.
- Colour graphics video board, with both RGB and composite video outputs. Four modes of operation are available with this board.
- Pre-socketed for the optional Intel 8087 math co-processor.

- A reset switch, which can be a life saver, in the event of a program hanging your system.
- A 150 watt power supply, with more than enough power to supply expansion boards, disk drives, and hard disk drives.
- IBM compatible, high quality keyboard.

Warranty

We have such confidence in the time tested reliability of the BEST that we offer a 300 day warranty which is way above the industry standard. On-site service plan available at extra cost.

SUPER-FAST BEST MK IV

As BEST MK III plus TRUE 16-Bit machine, 8086-2 processor, IBM compatible 8-Bit I/O channel bus, even faster than MK III due to 16-Bit architecture. With 640K RAM.

\$2500⁰⁰

Other Configurations:

| | |
|--|--------|
| With 10 Meg Hard Drive/1 Floppy/640K | \$3395 |
| With 20 Meg Hard Drive/1 Floppy/640K | \$3695 |
| Options: | |
| Tape Drive from | \$1295 |
| Second Floppy on H.D. systems | \$180 |
| 300/1200 Baud Modem Board | \$379 |
| BEST Monochrome Card | \$179 |

The History of the BEST line

As the personal computer industry expands at an unbelievable rate, it is comforting to know that a retail outlet has had many years experience of serving the computer buying public.

Equipped with the popular PHOENIX BIOS, the BEST satisfies the needs of students, educators, engineers and business people all across Canada. As more software and hardware appears on the market, peoples needs diversify and the BEST computer is keeping pace with these changes with astounding success.

Now we are pleased to offer you a complete line of personal computers to match all of data processing needs. All of the BEST personal computers are manufactured to the highest quality at our facility in Toronto.

You now have the option of four different models of the BEST series of personal computer ranging from the Mark II (an IBM PC/XT compatible) with a minimum of 256K of on-board memory through to the AVT-286 (an IBM AT Compatible), a personal computer based on the Intel 80286 microprocessor.

All of the BEST personal computers come with standard features that other manufacturers consider expensive options. It is our belief that by including options such as printer ports, serial communications

ports, real time clock and video board, your use of a personal computer will be more profitable, and reliable. The excellent reliability enables us to offer warranties far, far better than the industry standard.

A complete description of the personal computers manufactured is included in this catalogue. Before you buy your system our computer fluent sales staff can provide you with advice on the hardware and software required to solve your problem. And remember that after you purchase the BEST computer that suits your needs, Exceltronix and its sister companies will be around long after some other retailers have come and gone, to offer you unparalleled service and selection, as we have been for the last six years.

Special Requirements?

We have the in-house experts in both hardware and software to interface a lot of complex equipment to IBM, BEST or compatible computers. We can recommend or customize existing software packages for your business or industrial needs. We have excellent in-store and on-the-road sales staff with computer expertise and a superb team of in-house hardware and software engineers.

We can probably help you with every aspect of your computer needs at reasonable, honest prices. Call us.

If you want the Best, buy the BEST

BEST AVT-286: the IBM AT Compatible

Designed and made in Canada with pride.

Proving once again that Multiflex is an Industry leader, by producing more than just affordable alternatives in personal computer design, we are pleased to announce the **BEST AVT-286 Microcomputer**, our new, fast IBM AT compatible. The AVT-286 is based on the 80286 microprocessor. The AVT-286 is supported by the *Phoenix AT compatible Bios*, the same software house that supplies the Bios for all other **BEST** computers as well as many of the well known IBM compatibles currently manufactured.

Check the long list of standard features that are included on the new **BEST AVT-286**:

- The AVT-286 runs faster than the (12MHz) IBM AT but retains superb software compatibility.
- The main board features a standard 640K RAM using state-of-the-art memory chips for fast, reliable data processing.
- Seven expansion slots of which five support IBM AT signals. The two remaining slots are compatible with IBM PC or XT peripheral boards.
- Presocketed for the optional 80287 math co-processor
- Two floppy diskette drives, one formatted for a capacity of 1.2 Megabytes, the other for 360K to read and write normal diskettes.
- The **BEST Colour Video board** which offers the user four modes of operation, composite and RGB output.
- An AT compatible keyboard.
- On board Real Time Clock/Calendar with battery backup.
- Parallel Port (for printers etc.) and Serial Port (for communications).



Monitor not included. IBM PC, IBM XT and IBM AT are registered trade marks of IBM Canada Limited.

- Heavy duty Power Supply as standard allows for adding extra cards as well as a Hard Disk without requiring an upgrade.
- Attractive flip-top case.
- A keyboard lock with unique security key which prevents any unauthorised use of the system.
- A front control status panel provides information on the keyboard lock status, reset, power-on, disk activity and parity errors.
- A hardware reset button so the system can restart without having to power down.

The BEST AVT-286

Canadian designed and made, Super IBM AT compatibility, 640K RAM, Two 5.25in. Disk Drives (one high density 1.2Mb, one 360K), Serial and Parallel Ports, High quality keyboard, Keyboard lock and Status Panel. See detailed description above.

Simpler or more complex configurations available at most competitive prices.

\$3495⁰⁰

As standard configuration with a 20 Megabyte, fast stepping Hard Drive and Controller.

\$4950

Warranty

We have such confidence in the time tested reliability of the BEST that we offer a 300 day warranty which is way above the industry standard. On-site service plan available at extra cost.

Phoenix Pfaster286

Why throw away your PC or XT investment to achieve the performance of a 80286 based microcomputer? You can run software up to five times faster than an XT, and 60% faster than an AT. The Pfaster286 card is installed in your PC/XT motherboard, with no hardware changes and the software utilities included with the card allow you to boot your system in either the normal 8088 mode or go directly into the 286/coprocessor mode.

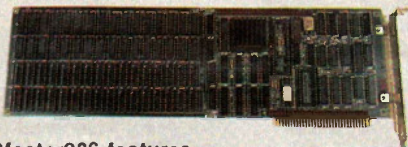

Pfaster286 features

- AT ROM compatibility
- 80286 CPU
- Optional 80287 floating point co-processor
- 8 MHz processing speeds, no wait states
- 1Mb RAM, expandable to 2Mb on-board

- Expandable to 4Mb RAM with the optional piggyback board
- 16Kb of EPROM, expandable to 256Kb
- Supports eight levels of priority interrupts, and four DMA channels
- Compatible with networking software
- Utilities to perform disk caching, print spooling and diagnostics.

The Pfaster286 can be used with any programs written for the 8088, but a few timing programs sensitive will only run on the 8088. Compilers, assemblers, development tools and most applications (such as 1-2-3 from Lotus) run on the Pfaster286 without modification at greatly increased speed.

Pfaster286 with 1M RAM Please Call
Each additional 512K RAM . . . Please Call
80287 option Please Call

The BEST IBM AT Compatible 4 Meg Memory Card

In order to take advantage of the memory addressing capabilities of the IBM AT or the BEST AVT-286

business computer, we developed a memory card to give the user up to 4 Megabytes of dynamic RAM. The memory card will run at speeds up to 16MHz, which is fast enough to meet the needs of any 80286 microprocessor on the market today. The design uses state-of-the-art (256K x 9) memory arrays, to allow for maximum memory in the smallest physical space. The ninth bit is used as a parity bit to insure the validity of the data. The card is available in memory sizes from 512K to 4 Megabytes in steps of 512K. Boundaries are switch selectable above 1 Meg in blocks of 512K.

Please call for most competitive prices.

BEST AT Compatible Enhancement Card

This card includes the following features: Two Serial Communications Ports, One Parallel Printer Port and Memory starting from 128K to 512K in selectable boundaries. This card will allow IBM AT users with 256K or 512K of on-board memory to expand their AT machine to full 640K capability as well as provide them with two serial ports and one parallel port.

\$299.00

If you want the Best, buy the BEST

Upgrade your IBM

BEST External Hard Disk Drive and Tape Back-up Unit

Easily Convert your IBM PC or Compatible Into a Hard Drive System with Tape Backup.

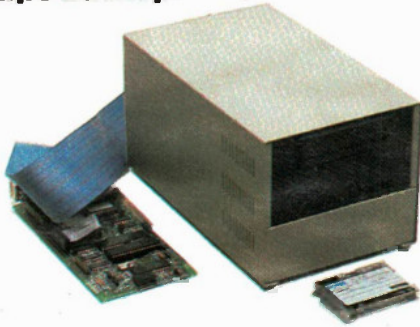

As more people become educated in the use of personal computers, the office computer becomes victim to late night hackers and curiosity seekers. The data upon which your business decisions are made every day is in danger of being wiped away by a wrong sequence of key presses or the data may be seen by those without proper authorization. Protect your data and yourself by removing the hard disk drive from the system.

Multiflex has designed a unit which allows you to physically remove the mass data storage device and lock it in another room without disassembling your entire system. The external hard disk drive and tape backup unit is self contained with its own power supply and connects to back of your system through a ribbon cable. Simply follow normal shut down procedures then unplug the unit and carry it to a safe location.

**With Seagate 20 Megabyte Hard drive and Scorpion Tape Backup unit
\$2795.00**

**With 10 Megabyte Hard Drive and Irwin Tape Backup unit
\$2395.00**

**Convert your IBM PC or XT into a Hard Drive System within Minutes
Do it yourself with no mechanical alterations.**

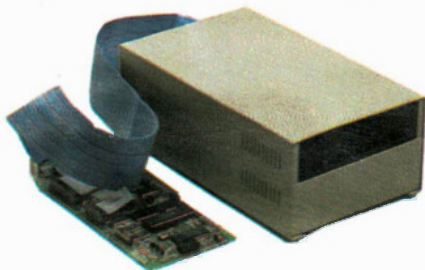

This unit rapidly converts your system into a Hard Drive unit, and it is compact enough to fit in a brief case. The unit contains its own power supply, fan, a reliable Seagate 20 Megabyte hard drive and a controller card which plugs into your existing system.

**With Seagate 20 Megabyte Hard Drive
\$1495.00**

**With 10 Megabyte Hard Drive
\$1295.00**

BEST EXPANSION System for your IBM PC

If you are one of the many who invested thousands of dollars in an IBM PC, you may be realizing the limitations of the hardware you own. The power supply may not be able to handle the addition of a hard disk drive or the five expansion slots may already be filled with necessities, leaving no room for the luxuries of more memory or communications hardware.

The BEST Expansion System was designed to function in a transparent fashion to the IBM operating system. The host system (IBM PC or XT) will look at a peripheral card in any of the eight slots of the expansion system as if it were installed in the slots on its own main board.



The Expansion System is packaged in an attractive flip-top case with its own power supply and ventilation fan. Two 3 foot long ribbon cables connect the host computer to the expansion system, which allows the expansion system to be placed on top, beside or underneath of your existing IBM PC or XT system.

The expansion chassis is powered by a 150 watt power supply with power connectors for two disk drives included as a standard feature. This power supply has enough power to run four diskette drives, expansion cards, or hard disk drives.

Although the system provides you with more slots and the capacity for a hard drive, your existing system will run with less load and therefore cooler. Complete BEST Expansion System including the peripheral adapter to plug into your existing IBM PC or XT system, 8-slot expansion bus, with flip-top case and 150W power supply and cooling fan.

Price \$499.00

Add a Tape Drive to your Existing System

Those who have used computers for any length of time can explain the absolute necessity for an external backup of the data held in a Hard Disk. Our self-contained unit, including power supply, (which looks similar to the Hard Drive Unit illustrated left) has a cable and peripheral card which simply plugs into your IBM or compatible system.

Tapes for these systems are readily available.

**With Irwin Tape Drive and BEST Controller
\$1495.00**

**With Scorpion Tape Drive and Controller
\$1695.00**

Add Extra 360K Disk Drives to your System

If you need more than the two existing drives for your system, our self-contained external unit with two 5.25in. 360K disk drives with its own power supply, fan and controller will be of interest.

\$695.00

The BEST Colour Graphics Video Board

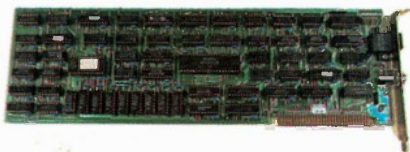

The BEST Colour Graphics Video Board was designed for those personal computer users who require an inexpensive, but versatile video display. The user has a choice of three types of monitors that can be connected to the card, a composite monochrome monitor, composite colour monitor or direct drive RGB colour monitor. Software utilizing a light pen can be run since the BEST Colour Video board supports the necessary hardware.

The video board is capable of operating in four modes, two text and two modes of graphics display

Text display

The BEST Video Card can display either 80 or 40 characters on one line. The character generator contains all the standard ASCII characters plus block graphic characters and a set of International characters such as the English pound and Japanese Yen. Depending on your choice of monitor, the application text can be displayed with a variety of foreground and background colours. In addition, black and white mode allows for the following attributes: reverse video, blinking and highlighting.

The operator can switch between 40 and 80 column display by using the DOS MODE command. The 80 column mode gives crisp characters on either colour or monochrome monitors. The 40 column text mode is suitable to use if you were to use a common television set in conjunction with a RF modulator that can be directly attached to the video board.

Graphics Display

The BEST video board is capable of displaying three styles of graphics.

Low resolution — Monochrome or Colour

In the low resolution mode either colour or monochrome graphics can be displayed. The screen is capable of displaying 200 rows of 320 pixels (a pixel is one dot on the screen). In the colour graphics mode each pixel can be one of four colours, and the background can be one of 16 colours. Many software packages are written with colour graphics capabilities. LOTUS 123, and Symphony for example become more powerful and easier to use with the addition of crisp and vivid colour graphics.

High resolution — monochrome

For applications such as computerized drafting or intricate business charts, colour may not be desired, but high resolution is required. The BEST card is able to double the resolution of the display to 200 rows of 640 pixels, by selecting the monochrome instead of colour graphics. In the high resolution mode an inexpensive composite monitor can still be used.

\$179.00 with Warranty

The BEST Monochrome Card

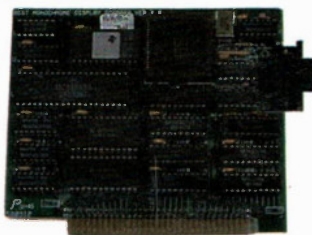

In the office environment where a great deal of word processing, or data entry takes place, eye fatigue may be a problem. A solution to this problem is an upgraded text display card for your BEST, IBM PC or compatible. The monochrome card displays a character that is made up of 7 x 9 matrix of dots in comparison to the 5 x 7 matrix used on the standard colour graphics video board. The finer dot pattern makes text appear much cleaner and easier to read. The monochrome card will display characters in four modes; normal, intensified, reverse video and blinking. The display is 80 x 25 characters.

Note: This is a half size board which will fit even those computers with restricted space.

\$179.00 with Warranty

Hercules

Colour Graphics Board **\$312.00**

4 colour graphics and printer board that fits into standard PCXT or compatible slot. Also included is a parallel interface.

Monochrome Board **\$600.00**

A high resolution monochrome display of graphics. Supports word processor, and business graphics software.

Phoenix Video Board

The choice of a video display card can be a difficult one. There are many different capabilities for each style of video card available. If your display needs are as diverse as the number of cards available, you may have to install two or three video cards in your system. Not only is this expensive, but it also steals precious expansion slots from your system. Phoenix Computer corp. has a designed an expansion card to satisfy all of your display needs. The Phoenix video card can emulate the following styles of display cards.

IBM colour graphics card — 40 or 80 column character display

320 x 200 colour graphics

640 x 200 monochrome graphics

IBM monochrome text display — 80 column high resolution text display

Techmar

Hercules high resolution monochrome graphics display 120 x132 column colour text display mode

Depending on which display mode you choose any monitor up to 25kHz colour monitors can be interfaced to the Phoenix video card. The setup software is menu driven, and allows the user to program its own character set, as well as selecting from a 64 colour pallet.

\$395.00 with Warranty

Tecmar

Graphics Master Board/Paint . . . **\$799.00**

Displays alphanumeric text and graphics on any monochrome display or other standard composite or RGB monitors. Comes complete with a light pen and PC paint brush.

EPROM PROGRAMMER

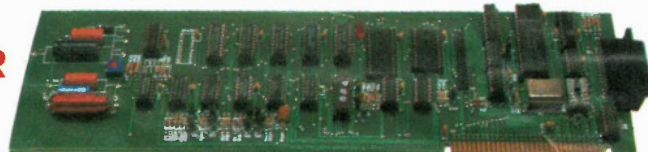

External Card.

This card can program any one of the following EPROMs: 2716, 2732, 2732A, 2764 and 27128s. Two sockets are available on the adaptor board, one for the 28-pin EPROMs, the other for 24-pin types. These sockets are standard sockets, however as an option ZIF sockets can be used (we recommend ZIF sockets if large numbers of EPROMs will be programmed). Also as an option an extension board is available. This board attaches to the adaptor via a ribbon cable and extends out the back panel. This is to allow EPROMs to be programmed without removing the cabinet cover every time programming is to be performed. Also as a standard feature, the source software is supplied to allow users to modify the program to suit their needs.

As an option a serial port can be included on the card; this serial port has the same features as the port described with the floppy disk controller (see the floppy disk description for documentation of the serial port).

MAIN EPROM PROGRAMMER CARD (WITH SOFTWARE)

With 2 standard EPROM sockets **\$99.00**

EPROM PROGRAMMER WITH ZIF SOCKETS (WITH SOFTWARE)

With one 24-pin, ZIF socket and one 28-pin ZIF socket with provision for serial port **\$139.00**

EXTERNAL CARD

Ready to plug into the main EPROM Card (includes one 24-pin and 28-pin ZIF socket and cable). Saves you from opening the computer each time you want to program your EPROMs. **\$69.00**

SERIAL OPTION

For your main EPROM programmer. Provides you with a second RS232 serial port **\$49.00**

BEST MODEM

The BEST modem is a smart 1200/300 direct connect modem. It can either be a stand-alone unit in which case it requires a small wall adaptor, or it plugs in one of the IBM slots. When used as a stand-alone unit, the modem looks like a Hayes 1200 Smart Modem, that is, it emulates the same instruction set. When it is used in the IBM, it looks like an intelligent serial communications port which also supports a super-set of the Hayes instruction set.

The modem supports auto-dial, auto-answer, and auto-speed select directly from software control. The modem also has a speaker so that aural monitoring of the call is possible. There are also LED monitors so that the state of the modem can always be known. These LEDs are: Modem Ready, Auto-Answer enabled, Carrier Detected, Transmitting,

Receiving, Data Set ready.

Software packages such as Crosstalk, PC-talk, and Hayes' Smartcom II also will run with this modem.

A version with 300 Baud only is available.



300 Baud **\$179.00** 300/1200 Baud **\$379.00**

The BEST Quanta Board

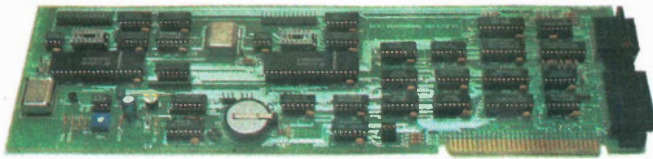

Do you find that your PC is not able to communicate with the outside world and you are constantly having to tell it the correct time and date? A simple solution for a system's short coming would be the BEST Quanta Board. Another of the multi-function boards designed with the personal computer user in mind, its features include the following:

Serial Ports

- Two serial communication ports that are configured under PC or MS-DOS as COM1 or COM2. Both communications ports support RS232-C signals (TxD, RxD, DTR, DSR, RTS, CTS, CD, and RI) at communication rates of up to 9600 Baud. One or both the serial ports can be disabled, to alleviate contention between any other serial port your system may already contain. The serial ports can also be configured to support the IBM PC mA current loop. The current loop allows the system to communicate with some types of teletype printers.

Parallel Printer Port

- A parallel printer port which supports many of the popular dot matrix and letter quality printers, as well as digital plotters that are commercially available. The parallel port can be selected as the primary or secondary printer port (PL2 or PL3 using DIP switches).

Games Port

- A game port which allows up to four game paddles, or two joy sticks to be connected to the system. The port is not limited to entertainment software. The port actually gives a value proportional to the resistance on the input, which allows your system to control industrial applications and CAD (computer aided design) software.

Real Time Clock/Calendar

- A real time clock/calendar with software to interface the clock hardware with the TIME and DATE functions of MS-DOS and PC-DOS. The clock continues to keep the correct time when the system is powered down by utilizing a replaceable lithium battery. The clock is based on the MM58274 CMOS chip and it is accurate to within seconds every year.

\$159.00 Cables Extra.

BEST Multi-Function Disk Drive Controller

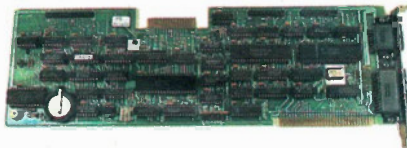

The BEST Multi-Function disk drive controller is much more than its name implies. This card makes the most use of an expansion slot in your system by including many needed options on one card. This board may be the last you will have to install in your IBM PC or compatible system because of the extra features we have included.

Floppy Controller

- Floppy disk drive controller, which can handle up to four double sided, double density 5.25in. 360K disk drives.

The controller circuitry will also control some Tape Back Up units such as those manufactured by Irwin Magnetics in place of one of the four disk drives.

Serial Ports

- Two serial communications ports that support RS232-C standard signals (TxD, RxD, CTS, RTS, DSR, DTR, and RI).

Parallel Printer Port

- Parallel Printer Port that can be configured as either your primary or secondary printer port.

Real Time Clock/Calendar

- Real Time Clock with software, to integrate the clock with your version of PC-DOS or MS-DOS. The clock is designed around an ICL clock chip and is accurate to within seconds a year. A battery back up continues to keep the time during power down.

This is the same floppy controller used in all versions of the BEST personal computer, with excellent reliability and compatibility. Using PC-DOS 2.0 or later, each diskette has a formatted capacity of 360 Kilobytes.

\$199.00

The BEST Economy Floppy Controller

If all you need is an IBM Floppy Controller for your IBM or compatible 360K DS/DD disk drives, we have an economy BEST Floppy Controller which does not have provision for the extra features described in the Multi-Function Disk Drive Controller.

\$99.00

The BEST 256K/512K Pentaram Board

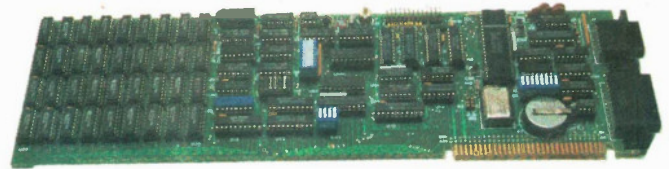

Almost every option your system is lacking can be supplied by the BEST Pentaram board. This combination of options is one of the most economical ways (from the point of view of both your pocketbook and the expansion slots on your system) to expand your system. All communication ports follow the industry standards. The additional memory continues on from where your main board's memory stopped, in a completely transparent fashion. In detail the features of the BEST Pentaram board are as follows:

Memory

- Up to 256K RAM using 4164's or 512K RAM using state-of-the-art 41256's can be added to your system. The starting memory boundary can be set to 256K, 384K, 512K, or 640K by configuring a bank of dip switches. The added memory is necessary for anyone wishing to operate a RAMdisk, and much of today's software requires a minimum of 384K RAM (Symphony, Framework, etc.) which many of the older PC's are not capable of holding on the main board. Each bank of memory contains an extra chip to support a parity bit for reliable data handling. (If the above boundaries do not match your system's configuration, they can be modified at the factory).

Serial Port

- A serial communication port that is configured under PC-DOS or MS-DOS as COM1 or COM2. The communications port supports RS232-C signals (TxD, RxD, DTR, DSR, RTS, CTS, CD, and RI) at communication rates of up to 9600 Baud. The serial port can be disabled, to alleviate contention between any other serial port your system may already contain. The serial port can also be configured to support the IBM PC mA current loop. The current loop allows the system to communicate with some types of teletype printers.

Parallel Printer Port

- A parallel printer port which supports many of the popular dot matrix and letter quality printers, as well as digital plotters that are commercially available. The parallel port can be selected as the primary or secondary printer port (PL2 or PL3 using DIP switches).

Games Port

- A game port which allows up to four game paddles, or two joy sticks to be connected to the system. The port is not limited to entertainment software. The port actually gives a value proportional to the resistance on the input, which allows your system to control industrial applications and CAD (computer aided design) software.

Real Time Clock/Calendar

- A real time clock/calendar with software to interface the clock hardware with the TIME and DATE functions of MS-DOS and PC-DOS. The clock continues to keep the correct time when the system is powered down by utilizing a replaceable lithium battery. The clock is based on the MM58274 CMOS chip and it is accurate to within seconds every year.

Pentaram Board with 256K and all options \$299.00

Pentaram Board with 512K and all options \$379.00

The BEST Parallel/ Game Card

\$69.00 (Cables Extra)

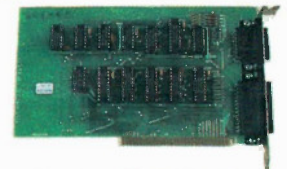

The BEST parallel/game card is an inexpensive addition to any BEST, IBM PC or compatible, which gives you the ability to connect almost any parallel printer or plotter to your system. The Parallel port is accessible through a DB25 connector located on the back of the card, which eliminates the need to disassemble the system case to connect the interface cable to the card. Printers such as the Epson family and Star Micronics, Toshiba and others work with the BEST printer card with no special hardware except the connecting cable.

The game port is compatible w/ game paddles. Up to four game paddles or two joysticks can be connected via a 15-pin connector on the back of the card.

BEST 512K RAM Board

Switch selectable boundaries

Complete with 512K-\$229.00 With 64K-\$149.00

BEST PROTOTYPING BOARD

\$28.95

Mail Orders: 319 College Street, Toronto, Ontario, M5T 1S2

Apple Compatible Products

MULTIFLEX 128K MEMORY CARD . . \$99.00 (with 128K of RAM on board)

128K Card can be used to function as RAM disk with your Apple.



128K RAM Card

MULTIFLEX PARALLEL PRINTER INTERFACE CARD WITH CABLE \$59.00

This card plugs into any of the Apple II+, IIe, or work-alike computers, and provides the user with a parallel interface capable of handling graphics and characters. Ideal for use with the Star Gemini and Epson Printers.



Parallel Printer Card

MULTIFLEX Z80-64K CARD

This spectacular card provides you with the functions of a Z80 card along with giving you extra 64K of self contained memory, on top of the existing memory in your Apple computer. (Software not included)

\$149.00



Z80/64K Card

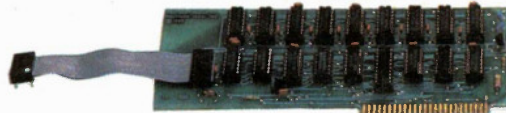

16K RAM Card

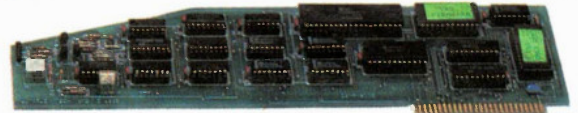

80 x 24 Card



Serial Card

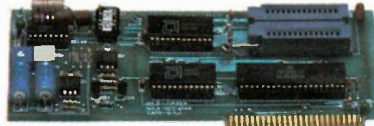

EPROM Programmer

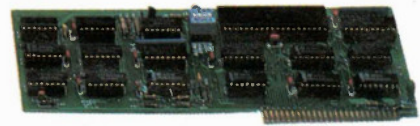

Z80 Card

MULTIFLEX SUPER SERIAL CARD . . . \$69.00

This card allows you to: • select desired baud rate • connect to a serial RS-232 modem, terminal, or a serial printer port • for example, connect two Apple computers (using this card) to communicate with each other, through the RS-232 link over hundreds of feet.

MULTIFLEX NEW SUPER 80 X 24 VIDEO CARD WITH SOFTSWITCH \$69.00

This new Multiflex card features: • superb 80 columns by 24 lines display, with upper and lower case, reverse video • includes built-in soft switch, allowing you to switch between the Apple's 40 column and the video cards 80 column from the keyboard. • superb compatibility.

WIZARD IPI INTERFACE \$69.00

MULTIFLEX EPROM PROGRAMMER \$69.00

Features:
• Eprom programmer for Apple computers • Programs 2716, 2732, 2732A, 2764 • ZIF socket for the EPROM
• Complete with software • Comes with a built-in programming voltage supply.
Included with the card is a disk full of software, which using menus allows the user to program or verify EPROMS, check if they are blank, set pointers anywhere in memory, and save or load memory ranges to/from the disk drive, making this unit a very versatile piece of hardware for the hardware developer or hobbyist.

MULTIFLEX 16K RAM CARD \$43.00

Expand your 48K Apple II+ to 64K. The Multiflex 16K Ram Card allows other languages to be loaded into your Apple from disk or tape.

MICROTEK SERIAL CARD FOR THE APPLE . . \$139.00

Similar functions to MULTIFLEX super serial card.

MULTIFLEX UPGRADED Z80 CARD \$45.00

This card allows the user to run Z80/8080 programs on his Apple II+ or IIe computer. Specifically, it allows him to run the CP/M operating system with all its attendant software such as word processors, accounting packages, etc. (CP/M software not included).

MULTIFLEX APPLE COMPATIBLE MODEM

EXCELLENT HAYES MICROMODEM COMPATIBILITY

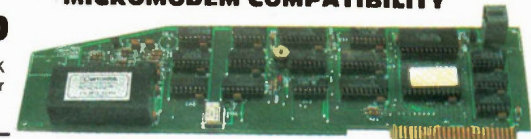

Plugs into your Apple or compatible computer. Direct connect, 300 Baud, Autodial, Autoanswer, Touch Tone/Pulse Dial, complete with documentation.

Hayes is a registered trade name. **\$159.00**

Apple is a registered trade mark of Apple Canada Inc.

6502 Style Case

6502 Power Supply

CSA Approved, 5V 5A, 12V 2.5A, -5V 0.5A -12V 0.5A
\$69.00



With Numeric Keypad
\$129.00

IBM Style Flip Top Case

APPLE COMPATIBLE DISK DRIVES

\$199.00

for Apple II+ and IIe

Now available for Apple IIc **\$229.00**

Features:
• Apple compatible • Attractively packaged • Professionally built and tested
• Canadian Made • We believe that Multiflex put out more drives in the last year than all other Canadian manufacturers combined.



SLIMLINE DISK DRIVE \$179.00

Attractively packaged, Apple compatible, ultra reliable (90 day warranty).

IBM Compatible Software and Books



Accounting

| | |
|---------------------------|----------|
| IUS | |
| Accounts Payable | \$779.45 |
| Accounts Receivable | \$779.45 |
| Gen. Ledger-Fin. Reporter | \$779.45 |
| Inventory Control | \$779.45 |
| Order Entry | \$779.45 |
| Payroll | \$975.95 |

Databases Integrated

| | |
|---------------|----------|
| Ashton Tate | |
| dBASE III | \$608.00 |
| P.C. Tutorial | \$ 63.96 |
| dBASE Upgrade | \$167.00 |

| | |
|--------------------|----------|
| Micropro | |
| Infostar Plus | \$520.20 |
| Stoneware | |
| Advanced DB Master | \$621.29 |

Databases - Non Integrated

| | |
|------------|----------|
| Sorclm | |
| Easy Filer | \$417.78 |

| | |
|-----------------|----------|
| Thorn EMI | |
| Perfect Library | \$518.99 |

| | |
|----------------|----------|
| Timework | |
| Data Manager 3 | \$ 93.90 |

Filing

| | |
|-------------------------|----------|
| Software Publishing | |
| PFS File | \$148.21 |
| PFS Report | \$130.55 |
| PFS Solutions Mail List | \$ 20.83 |
| PFS Proof | \$ 99.21 |

Spreadsheets

| | |
|------------------|---------|
| Lotus | |
| Lotus 1-2-3 | \$ Call |
| Symphony | \$ Call |
| Symphony Upgrade | \$ Call |

Word Processors

| | |
|--------------------|----------|
| Broderbund | |
| Bank Street Writer | \$ 83.50 |

| | |
|--------|----------|
| Hayden | |
| Writer | \$ 41.99 |

| | |
|----------------|----------|
| IUS | |
| Easy Writer II | \$396.00 |

| | |
|------------------------|----------|
| Lifetree | |
| Volkswriter Delux. | \$267.80 |
| Volkswriter Scientific | \$646.63 |

| | |
|---------------------------|----------|
| Micropro | |
| Wordstar | \$307.97 |
| Wordstar 2000 | \$433.18 |
| Wordstar 2000 Upgrade Kit | \$433.18 |

| | |
|-----------|----------|
| Multimate | |
| Multimate | \$304.89 |

| | |
|---------------------|----------|
| Satellite | |
| Word Perfect | \$399.00 |
| Word Perfect Sorter | \$ 82.75 |

| | |
|--------------------------|----------|
| Microsoft | |
| Microsoft WD/Mouse/Spell | \$563.72 |

Graphics Applications

| | |
|--------------|----------|
| Fox & Geller | |
| Dgraph III | \$258.42 |

| | |
|---------------|----------|
| Power Up | |
| Sign Designer | \$ 73.02 |

| | |
|---------------------|----------|
| Software Publishing | |
| PFS Graph | \$148.25 |

| | |
|--------------------------|----------|
| Unison Advanced Products | |
| Print Master | \$ 82.61 |

Communication Terminal Pckg.

| | |
|------------------|----------|
| Microsoft | |
| Microsoft Access | \$262.00 |

| | |
|---------------|----------|
| Microstuff | |
| Crosstalk XVI | \$168.00 |

| | |
|---------------------|---------|
| Software Publishing | |
| PFS Access | \$99.25 |

| | |
|--------------|----------|
| Thorn EMI | |
| Perfect Link | \$215.07 |

Programming Aids

| | |
|-----------------------------|----------|
| Borland | |
| Turbo Pascal | \$ 75.00 |
| Turbo Pascal MS DOS Generic | \$ 75.00 |
| Turbo Pascal W/8087 | \$114.77 |
| Turbo Tutor | \$ 36.50 |

| | |
|-----------------------|-----------|
| Digital Research | |
| C BASIC 86 | \$208.88 |
| CIS COBOL for CP/M 86 | \$ 867.75 |
| DR LOGO | \$156.60 |
| Personal Basic | \$157.46 |
| PL/I | \$783.31 |

| | |
|--------------------------|----------|
| Holt Rhinehart Winston | |
| Programming IBM PC BASIC | \$ 42.35 |

Programming Languages

| | |
|-------------------|----------|
| Digital Research | |
| Concurrent PC DOS | \$308.10 |
| CP/M 86 | \$ 62.66 |

| | |
|-----------------------|----------|
| R Brand/Prentice Hall | |
| Pascal programming | \$ 87.80 |

Utilities

| | |
|-------------|----------|
| Ashton Tate | |
| Framework | \$653.29 |

| | |
|------------------------|----------|
| Borland | |
| Sidekick unprotected | \$ 88.72 |
| Super Key | \$ 73.05 |
| Turbo Graphics Toolbox | \$ 57.36 |
| Turbo Toolbox | \$ 57.38 |

| | |
|----------------------|----------|
| Digital Research | |
| Access Manager | \$417.77 |
| Animator (3103-AA) | \$635.53 |
| C BASIC Compiler C86 | \$626.65 |
| Display Manager 86 | \$522.21 |
| DR Graph (5017-AA) | \$203.66 |
| Forms 2 (3104-AA) | \$208.88 |
| Graph Draw | \$156.60 |

| | |
|-----------------|----------|
| Microsoft | |
| Macro Assembler | \$156.66 |
| Microsoft Mouse | \$231.80 |

| | |
|------------|----------|
| Rosesoft | |
| Prokey 3.0 | \$135.02 |

| | |
|--------------------------|----------|
| Software Research TECH | |
| Smart Key II Plus MS DOS | \$104.36 |

Entertainment

| | |
|---------|----------|
| Infocom | |
| Zork 1 | \$ 41.99 |
| Zork 2 | \$ 46.94 |
| Zork 3 | \$ 46.94 |

| | |
|------------------|----------|
| Simon & Schuster | |
| Frogger II | \$ 36.50 |
| Super ZAXXON | \$ 36.50 |

| | |
|------------------|----------|
| Microsoft | |
| Flight Simulator | \$ 52.10 |

| | |
|--------------------|----------|
| Muse | |
| Castle Wolfenstein | \$ 31.27 |

| | |
|-------------|----------|
| Blue Chips | |
| Tycoon | \$ 82.61 |
| Millionaire | \$ 82.61 |

| | |
|----------|----------|
| Datasoft | |
| PAC Man | \$ 31.25 |

| | |
|--------------------|----------|
| Simon & Schuster | |
| The New York Times | \$ 20.83 |

Miscellaneous

| | |
|----------|----------|
| MS DOS | \$129.00 |
| PC DOS | \$129.00 |
| GW BASIC | \$121.00 |

IBM Books

| | |
|-------------------------------|----------|
| Handbook for the IBM PC | \$ 20.89 |
| MS DOS Manual Reference | \$ 52.40 |
| IBM Basic from Ground up | \$ 32.68 |
| Book of IBM Software | \$ 26.13 |
| IBM PC Encyclopedia | \$ 85.00 |
| IBM PC User's Ref Manual | \$ 32.68 |
| Lotus Guide to Learn Symphony | \$ 30.06 |
| Through Micro Maze | \$ 13.03 |
| Everyman's Dbase Primer | \$ 26.13 |
| 32 Visicalc Worksheets | \$ 26.13 |
| Get Started w/MS Word | \$ 22.20 |
| Manag. Bus. w/Multiplan | \$ 23.51 |
| Basic Prog. W/Pro DOS | \$ 39.29 |
| Inside Dbase III | \$ 52.00 |
| Inside Frame Work | \$ 52.00 |
| Inside Symphony | \$ 52.00 |
| All About 1-2-3 | \$ 13.03 |
| 1-2-3 Managerial Wrkshk | \$ 28.13 |

| | |
|-----------------------|----------|
| Misc. Titles | |
| Programming in C | \$ 27.44 |
| CP/M Bible Auth. Ref. | \$ 28.13 |
| Microcook Book Vol. 1 | \$ 20.89 |
| Microcook Book Vol. 2 | \$ 20.89 |
| MPU Based Robot | \$ 22.20 |
| Unix Primer Plus | \$26.13 |

Data Books

| | |
|----------------------------|---------|
| Motorola | |
| DL128 Linear Data Book | \$14.95 |
| DL129 High Speed CMOS | \$ 9.95 |
| DL118 Opto Device Data | \$ 6.75 |
| DL130 Cmos Integrated CCTS | \$ 9.95 |
| DL110 RF Data Manual | \$14.95 |
| DL111 Power Data Book | \$14.95 |
| DL113 Memory Data Book | \$ 9.95 |
| DL121 TTL Data Book | \$12.95 |
| DL122 Mecl Data Book | \$ 9.95 |
| DL126 Small Signal Trans. | \$15.00 |
| DL105 Cmos Data | \$14.95 |
| HB206 Voltage Regulator | |

| | |
|--------------------------------|---------|
| Handbook | \$ 9.95 |
| SG73 Master Selection Guide | \$ 5.55 |
| TB303 Basic Micro. & The 6800 | \$35.00 |
| TB303 The 6800 Family using | |
| Micropro & Microcom. | \$34.00 |
| MC6800um AD4 68000 Users Guide | \$12.50 |

| | |
|-----------------------------------|---------|
| Single Chip Microcomputer Data | |
| (Includes 6800 Series and Support | |
| Chips | \$19.95 |

Other Data Books

| | |
|--------------------------------------|---------|
| Intel Micro System Components Hand- | |
| book Vol. 1 and 2 (includes 8088 and | |
| support chips) | \$26.00 |

| | |
|-----------------|---------|
| National Linear | \$19.95 |
| National TTL | \$14.95 |
| National CMOS | \$14.95 |

Keyboards



| | |
|------------------------------------|----------|
| Keytronics 5151 (PC/XT compatible) | \$249.00 |
| Keytronics 5150 (PC/XT compatible) | \$135.00 |
| Keytronics 5151A (AT compatible) | \$279.00 |
| Maxiswitch | \$135.00 |

Printer Ribbon's

| | | | |
|----------------|---------|-----------------------|---------|
| Star Micronics | | Epson | |
| SG10 | \$ 4.50 | FX80 | \$10.95 |
| SG15 | \$ 4.50 | FX100 | \$15.95 |
| SR10 | \$ 4.50 | LQ1500 | \$24.00 |
| SR15 | \$4.50 | | |
| Power Type | CALL | Copal | |
| Radix 10 | \$16.00 | SC-1200 | CALL |
| Radix 15 | \$19.00 | SC-55001 | CALL |
| Toshiba | | Oki Data | |
| P-1351 | \$15.50 | ML80, 82A, 83, 92, 93 | \$ 3.50 |
| P-1340 | \$15.50 | ML182 | CALL |
| P-351 | \$15.50 | ML183 | CALL |
| | | ML184 | CALL |

TOSHIBA High Quality Printers

P351

The Ultimate 3 in One Printer



Accepts font cartridges and downloadable font disks, Qume Sprint 11 emulation, IBM PC compatibility, and more.

- Letter quality at 100 cps
- High-speed drafts at 288 cps
- Superb graphics at 360 x 180 and 180 x 180 dots per inch.

\$1995⁰⁰

P1340

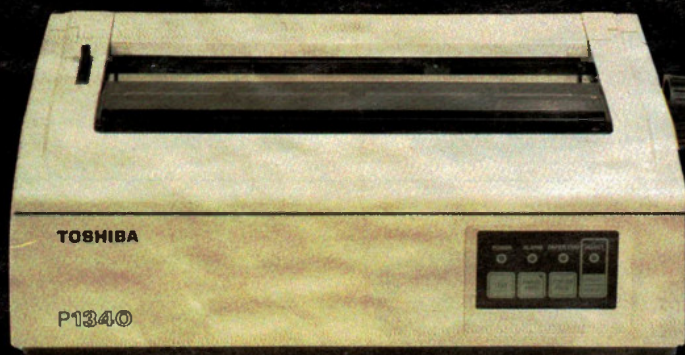

3 in One printing in the economy size. Superb graphics at 180 x 180 dots per inch. Letter quality and draft speeds. Qume Sprint 5 Emulation.

\$926⁵⁰

Specifications — P351

| | |
|---------------------------|--|
| Print Method | Impact wire dot matrix |
| Print Head | 24 pin; overlapping |
| Print Speed | Letter quality: 100 CPS Draft quality: 288 CPS (12 CPI) 240 CPS (10 CPI) Condensed print: 240 CPS (16.7 CPI) |
| Resolution | Graphic mode: 180 x 180 dots/inch 180 x 360 dot/inch |
| Line Lengths: | 226 Characters per line (16.7 CPI) 163 Characters per line (12 CPI) 136 Characters per line (10 CPI) |
| Character Set | 96 standard ASCII characters 31 graphics characters Special character sets for USA, UK, Sweden, France, Germany, Norway, Spain and IBM. |
| Character Fonts | Letter quality courier, prestige elite proportional spaced prestige elite are resident draft quality and condensed print are also resident. Downloadable fonts on disk and plug-in font cartridges are optional. |
| Horizontal Spacing | To 1/120" under software control 10 CPI, 12 CPI, 16.7 CPI, etc. |
| Vertical Spacing | To 1/48" under software control 10 CPI, 12 CPI, 16.7 CPI, etc. |
| Line Spacing | 6.25 IPS (continuous) |
| Speed | |
| Paper/Copies | From 4" to 15" wide 4 parts carbonless paper including original. |

Specifications — P1340

| | |
|---------------------------|---|
| Printed Method | Impact wire dot matrix |
| Printed Head | 24 pin; overlapping |
| Print Speed | Letter quality: 54 CPS Draft quality 144 CPS (12 CPI) 120 CPS (10 CPI) Condensed print: 78 CPS (16.7 CPI) |
| Line Lengths: | 132 Character per line (16.7 CPI) 96 Characters per line (12 CPI) 80 Characters per line (10 CPI) |
| Character Set | 96 standard ASCII characters |
| Character Fonts | Letter quality 24 x 36 dot matrix (proportional spacing). Draft quality 24 x 9 dot matrix, condensed draft quality 24 x 9 dot matrix. |
| Horizontal Spacing | 10 CPI, 12 CPI, condensed 16.7 CPI, etc. Proportional spacing |
| Vertical Spacing | 6LPI, 8LPI, etc. |
| Paper/Copies | From 4.5" to 10" wide, 4 parts carbonless paper including original. Single sheet or continuous form. |

IBM-PC is a trademark of IBM Canada. Sprint 11 and Sprint 5 are trademarks of Qume Corporation. Prices and specifications are subject to change without notice.

**New from Star Micronics
SG-10 Printer**



Ideal for Text & Graphics

• Dual Mode - NLQ/draft standard (NLQ = near letter quality) • 120 CPS and 20% faster throughput • Bidirectional, logic/seeking • 2K buffer (expandable to 6K with optional buffer interface) • 100% IBM PC or Star standard control codes-switch selected • Friction and tractor standard • full 1 year warranty • 10" wide carriage • Standard parallel interface (serial optional) **\$379.00**
SG-10C for Commodore **\$399.00**
(No Interface required)

SR-15

• 200 cps and 20% faster throughput • IBM PC or Star standard control codes switch selected • Dual Mode - NLQ/draft standard • Friction/tractor and automatic single sheet feed - standard • 15" carriage • 16K buffer • Bidirectional, logic seeking • Price/performance leader • Parallel port standard, serial optional • Full 1 year warranty. **\$995.00**

**OKIMATE 20 (IBM) \$345.00
COLOUR**



• Color Screen Print Software Package • 80 cps unidirectional printing • 40 cps correspondence quality • 24 element, long-life printhead with snap-in "no tool" replacement • IBM character sets 1 & 2 • High resolution 144 x 144 DPI graphics • Plain, thermal or acetate paper • Friction and pin feed paper handling (roll paper stand optional) • Variable width tractor feed.

Star Micronics SG15

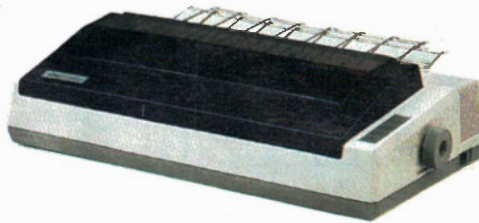

Same as SG10 except with 15" carriage and standard 16K buffer **\$599.00**

Radix

15" 200 cps, 100% duty cycle • 16k buffer • serial & parallel standard • proportional & downloadable characters • 240 x 144 Ultra High Res. • tractor & friction...
Radix 15 PC (for IBM PC)..... **\$995.00**

Star Printer Accessories

Printhead \$80.00
Printwheel \$18.00
Ribbons \$4.50
Paper (500 sheets) (8 1/2 x 11) \$9.95
Paper (2,000 sheets) (8 1/2 x 11) \$32.00
Dust covers \$8.50
Printer Stand (plastic) 10" \$34.00
Printer Stand (plastic) 15" \$38.00

**Star Micronics — Power
Type daisywheel printer
Letter
Quality \$535.00**



Print Speed: 18 c.p.s. bi-directional, logic seeking
Interface standard parallel (Centronics compatible) and serial RS232C-20mA current loop
Paper Slew Speed: 12 l.p.s. @ 1/6" spacing
Print Buffer: One line
Print Size: 10,12, 15 c.p.i and proportional spacing
Number of Columns: 110,132, 165
Character Sets: over 100 Type fonts available.
Special Features: proportional spacing; dual interface; standard printer mode and word processing mode; 32 easy access format switches reverse paper feed; short form tear-off;
Line Spacing: 3,4,6,8 lines/inch; switch and software selectable
Paper Handling: single sheet: 5.5" to 8.5" wide; sprocket 4" to 13" wide; copies 3 carbonless sheets
Ribbon standard cassette

ML182 \$390 IBM

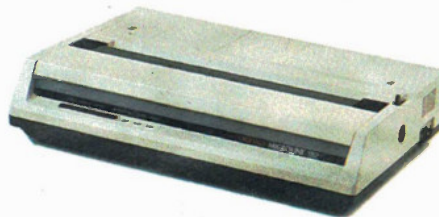

• 120 cps bidirectional printing • Friction and adjustable pin feed paper handling • Parallel interface (serial optional) • All Points Addressable graphics • 5 foreign language sets. • IBM Graphics compatible.

Okidata ML192 \$699.00

(Apple Imagewriter or compatible, Ile, Iic, Mac)
• 120 cps • 2K Buffer, Serial Int., upgradeable to 10K • Tractor and friction • 10" • 19.2K Baud max. • Cable extra.

Okidata ML192 (IBM) \$679.00

• 160 cps • Parallel (optional Serial) • Correspondance quality • 10".

Okidata ML193 \$1089.00

(Apple Imagewriter compatible Ile, Iic, Mac)
• 120 cps • 2K Buffer, Serial int., upgradeable to 10K • Tractor and friction • 15" • 19.2K Baud max. • Cable extra.

Okidata ML193 (IBM) \$1069.00

• 160 cps • Parallel (optional Serial) • Correspondance quality • 15".

Copal

SC5500I 180cps, 132 column
\$699.00



Copal SC1500T \$499.00
180 cps, 80 column

Copal SC1200L \$329.00
120 cps, 80 column

Epson

CR220 **CALL**
Homewriters **CALL**
LX80 **CALL**
RX80 **CALL**
FX185 **CALL**
FX100 **CALL**
LQ1500 **CALL**
JX80 (Colour) **CALL**

**We also carry Toshiba
Printers 1340 and 351
See page 11**

Prices subject to change without notice

Apple is a registered trademark of Apple Canada Inc.

Cable Assemblies



DB25 Male to DB25 Female \$35.00
RS232 Cable (6ft of round conductor) \$39.00
RS232 other lengths and connector configurations available on request.
Parallel cable 36 pin Centronics type connectors, male joined by 6ft of ribbon cable to female \$35.00
Parallel Cable for IBM Interface DB25 through 6ft of ribbon to 36 pin centronics with appropriate connections \$35.00
Cable Assemblies for two 5-1/4in drives and controller (e.g. IBM) using three 34 pin connectors and appropriate length of 34 conductor cable \$35.00
20 pin Female header 24in. to 20 pin for Apple drives \$6.95

**Serial A or B or C
Switch Box . . \$59.00**

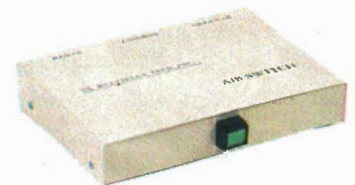

Contains 3 RS232 connectors and a switch which switches all lines between A and output connector A and output connector C or connector B and output connector C. Example Applications. Switch between Serial printer and modem If you have only one serial port or switch on serial port or printer between two printers.

MONITORS and DISK DRIVES

Zenith Data Systems



NEW

ZVM1220A

12in. diagonal screen • non-glare amber display
• composite input • 25 lines x 40/80 characters
\$135.00

NEW

ZVM1230A

12in. diagonal screen • non-glare green display
• composite input • 25 lines x 40/80 characters
\$135.00

CV-2560 • 25" diagonal screen • RGB/composite input • 25 lines x 80 characters • sound capability • green screen only switch • video "loop thru" feature
\$1049.00

ZVM 124 • 12" diagonal screen • non-glare amber display • PC monochrome input (TTL) • 25 lines x 80 characters • 720 x 350 pixels • IBM PC & compatibles
\$229.00

ZVM 131 • 13" diagonal screen • RGB/composite inputs • 25 lines x 40 characters • 320 x 240 pixels • sound capability • green screen only switch • video "loop thru" feature
\$479.00

ZVM 133 • 13" diagonal screen • RGB input • 25 lines x 80 characters • 640 x 240 pixels green screen only switch • 16 colours including PC brown
\$759.00



ZVM 135 • 13" diagonal screen • RGB/composite inputs • 25 lines x 80 characters • 640 x 240 pixels • sound capability • green screen only switch • video "loop thru" feature
\$877.00

ZVM 136 • 13" diagonal screen • RGB input • 25 lines x 80 characters • 640 x 480 pixels • long persistence phosphors for interlaced applications
FOR BEST PRICE \$1195.00

Amdek

300A Amber **\$218.00**
310A Amber, 18MHz **\$229.00**
700 Ultra High Resolution **\$call**

NEC Monitors now available — Call for price

Irwin 10 Meg Tape Drive Backup

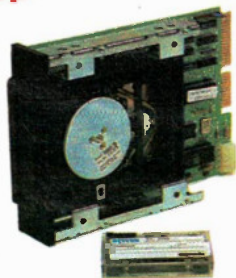

Hooks up to your existing floppy controller.
\$1199.00

5.25in. Disk Drives

SA455 \$169.00

• Shugart/Panasonic 5.25in. slimline, double sided, double density disk drive with 360K storage capacity. IDEAL FOR IBM COMPUTERS.

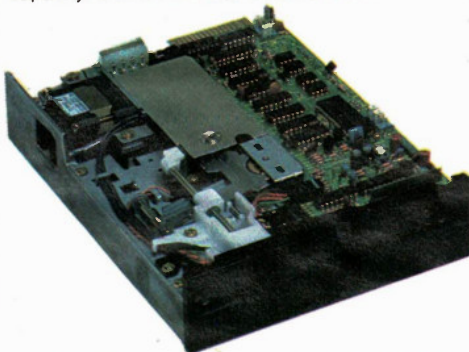

Toshiba Disk Drives

ND-04D 360K DS/DD
(black or grey) **\$169.00**

ND-08DE-G 1.2Mbyte AT Compatible,
Grey **\$299.00**

For more details see page 14

Hard Disk Drives

10 MEG Seagate, slimline drive and hard disk controller. This controller can handle up to two 10 MEG hard drives.
\$995.00

Seagate 20 MEG. with controller **\$1195.00**

Cables (for 10 or 20 MEG) **\$38.00**

Quantity discounts available on two or more
See also Toshiba Hard Drives on p.14.

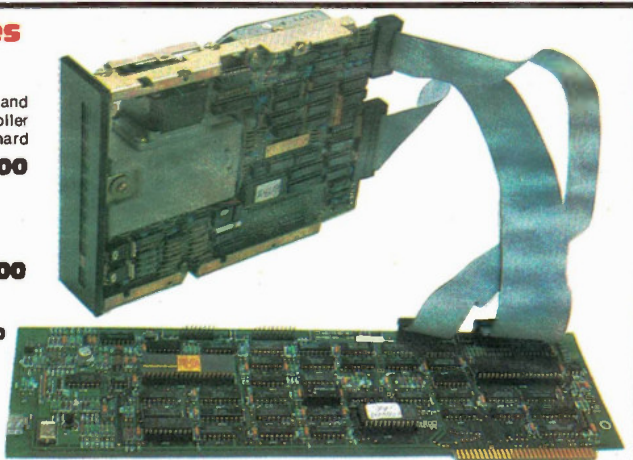

Scorpion 20 Meg Tape Drive Backup and Controller. \$1495.00

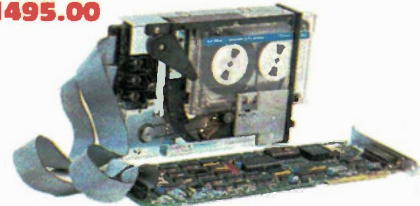

Diskettes

Prices per box of 10

10% discount on 3 or more boxes.

Dysan DS/DD \$35.95/10
Dysan SS/DD \$27.50/10
Maxell DS/DD \$35.95/10
Maxell SS/DD \$28.95/10
Exeltronix DS/DD \$24.95/10
BASF DS/DD \$29.95/10
BASF SS/DD \$22.95/10
Pinnacle DS/DD \$21.95/10
Pinnacle SS/DD \$16.50/10
Elephant DS/DD \$24.95/10

Modems

Anchor Automation

Singleman 1200
300/1200 baud smart modem \$469.00
Volks Modem (300-1200) \$399.00

Hayes

1200B Modem (stand alone) \$605.00
1200 Modem \$620.00
300 Modem \$365.00
Smartcom II \$188.00

Joysticks & Input Pads

CH Products

Mach II \$ 67.00
Mach III \$ 67.50

Koala Technologies

Koala Pad W/PC Design \$199.00
The Speed Key System \$259.95

Kraft

Kraft Joysticks \$ 65.00

Mice

Microsoft

Microsoft Mouse \$227.50

Mouse Systems

PC Mouse \$239.20
PC Mouse/PC Paint \$277.20

Bill Boards

Compusers Starter Kit \$ 59.00

TOSHIBA

Wide selection of Floppy and Fixed Disk Drives

Upgrade your IBM PC/XT/AT or compatible with high quality Toshiba Drives.

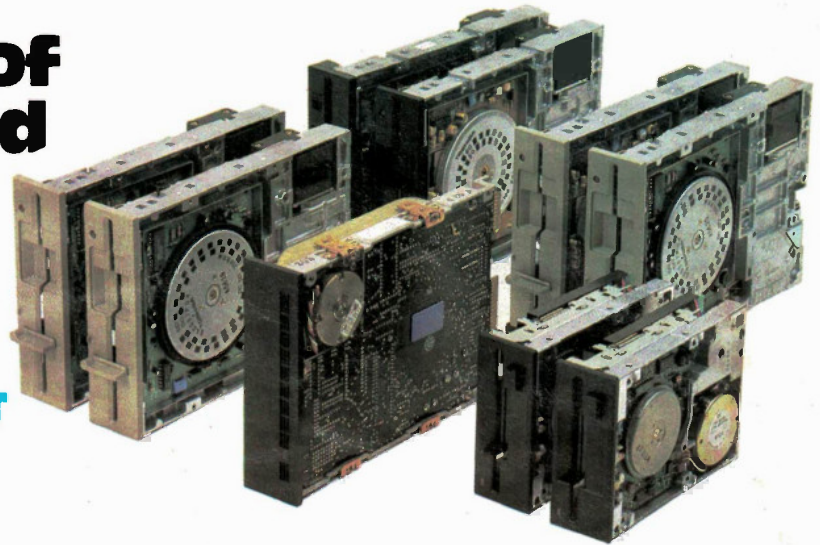

ND-04D and ND-04DE-G 5 1/4" 360K DS/DD

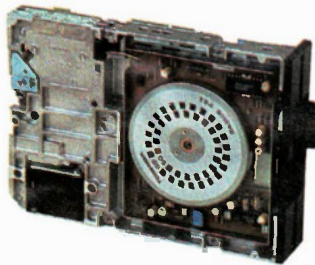

For your IBM PC/XT or compatible.
Grey or black available.

\$169.00

ND-353A and ND-354A 3 1/2" Drives

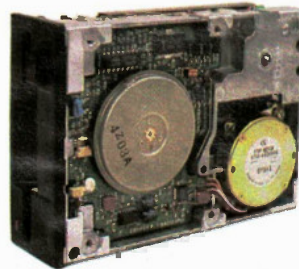

**500K and 1 Meg types
Call for best prices**

ND-08DE 5 1/4" 1.2 Meg/360K

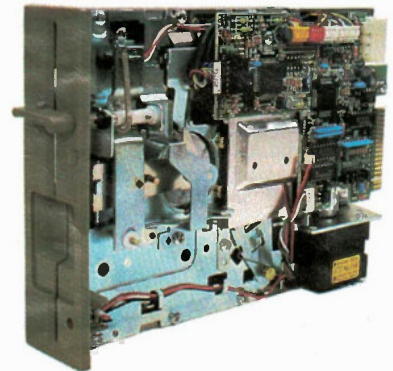

**For your IBM AT or
compatible. Grey
\$299.00**

Wide Selection of Hard Disk Drives

10 Megabyte (MMI) . . . **\$650.00**
MK 53FA, 43.5 Meg . . . **\$2579**
MK 54FA, 60.5 Meg . . . **\$2725**
MK 56FA, 86.5 Meg . . . **\$2898**
Controllers available.

Prices and specifications subject to change without notice.

SPECIFICATIONS + CHARACTERISTICS

| Unformatted Capacity: | MK-53FA | MK-54FA | MK-56FA |
|------------------------|---------|---------|---------|
| Mbytes per Drive (MFM) | 43.2 | 60.5 | 86.5 |
| Mbytes per Drive (RLL) | 64.8 | 90.7 | 129.8 |
| Bytes per Track (MFM) | 10,416 | 10,416 | 10,416 |
| Bytes per Track (RLL) | 15,624 | 15,624 | 15,624 |
| Heads per Surface | 1 | 1 | 1 |
| Data Surfaces | 5 | 7 | 10 |
| Cylinders per Drive | 830 | 830 | 830 |

| | All Drives |
|---------------------------------------|------------|
| Data Transfer Rate (Mbits/sec) (MFM) | 5.0 |
| Data Transfer Rate (Mbits/sec) (RLL) | 7.5 |
| Access Time (ms) (includes settling): | |
| Track-to-Track | 8.0 |
| Random Average | 30.0 |
| Maximum | 55.0 |

Quantity Discounts available.

Presents: NEW DIRECTIONS FOR THE CREATIVE ARTIST.

**THE YAMAHA CX5M MUSIC COMPUTER
ATTENTION YAMAHA DX-7 OWNERS:
CX YOUR DX!**

- Has the tedium of FM voice editing humbled you to factory presets?
 - With the CX5M's multi-menu graphic display, voice creation is a snap!
 - Why purchase \$150 RAM packs to save 32 voices when you could save hundreds on a CX5M cassette?
 - Plus you receive free: 200 voices for your DX-7!
- TAP YOUR DX-7'S POTENTIAL FOR ONLY \$675.00 (CX5M Computer, DX-7 Voicing Program, 200 Voices)**

**PERSONAL COMPOSER
THE ULTIMATE STUDIO SYSTEM ON AN IBM PC/XT**

- 32 trk sequencer (50,000 notes) w/full editing.
- Instant conversion of sequenced tracks to score including individual part extraction, multiple-format scoring and complete on-screen editing.
- Ultra high resolution graphics for copyright-quality printing.
- DX-7 graphic voicing program.

PROGRAM: \$595.00

Requires:
IBM compatible 320K min. (Our Loaded BEST w/512K & 2 Drives is \$1795.00)
Hercules compatible graphic card: \$380.00
Roland MPU-401 processor and interface: \$399.00
Monochrome monitor: \$229.00 (Zenith ZVM 122)
Epson FX-80 printer: \$649.00

THE COMPLETE PERSONAL COMPOSER PACKAGE: \$4049.00

THE CX5M IS:

- A dynamic DX-9 sound module on-board (96 voices, graphically programmable)
- An efficient 8 part scoring system w/hardcopy printout.
- PLAYS 8 VOICE MULTI-TYMBRAL
- Send your music out over 8 independent MIDI channels.
- Produce audio-visual performances incorporating graphics and music.
- And the CX5M is a fully-fledged MSX computer for all your home and business needs.

THE COMPLETE CX5M PACKAGE IS ONLY \$825.00
(Computer, YK-01 Keyboard, FM Composing & Voicing Programs)

COMPUTER MUSIC CENTRE EXCLUSIVES:

- CMC 1 Voice Library (100 Voices: \$39.95)
- CMC 2 Song Library (15 Songs: \$39.95)
- CMC 3 DX-7 Voice Library (200 Voices: \$49.95)
- CMC 4 DX-7 Voice Library (500 Voices: \$99.95)

CX5M DISK DRIVES AND PRINTERS ARE HERE!

Disk Drive \$395.00
Printer \$365.00

Now Available: 4 track real-time sequencer
RX drum machine rhythm editor
Keyboard chord construction and progression tutorials

New! The MSX book - a must for CX5M owners. Complete documentation: \$32.95

HOT MIDI PRODUCTS FROM THE NAMM SHOW

TEXTURE FROM CHERRY LANE ON THE IBM PC/APPLE 11

The most complete 'workhorse' professional recording software on the market! Complete real-time, step-time, and MIDI data editing. Link up to 64 8 track sequences to create songs or sets of music.
PROGRAM PRICE: \$295.00

APPLE MACINTOSH MIDI HAS ARRIVED!

Southworth TOTAL MUSIC SYSTEM
99 tracks, 50,000 notes, automatic transcriptions, full editing of recording and scoring, even visual editing! Fully mouse driven.
SOFTWARE AND INTERFACE ONLY: \$649.00

IVL Technologies PITCHRIDER 7000:
The affordable MIDI Guitar interface is here!
Fully-polyphonic, velocity and pitch bend control.
OUR PRICE: \$849.00
PITCHRIDER 2000: MIDI interface for brass/woodwinds.
OUR PRICE: \$425.00

**MAJOR REDUCTIONS ON MIDI DEVICES
AND SIGNAL PROCESSORS**

ROLAND MIDI:

- SDE-2500 MIDI DIGITAL DELAY: \$765.00
- MPU-101 MIDI to CV interface: \$315.00
- MPU-103 MIDI Channel/Filter Converter: \$249.00
- MPU-104 MIDI Output Selector: \$109.95
- MPU-105 MIDI Input Selector: \$89.95
- MM-4 MIDI thru box: \$74.95

NEW BCSS MICRO RACK SERIES:
RDD-10 Digital Delay: \$315.00
RGE-10 Graphic Equalizer: \$219.00

SOME VERY SPECIAL PRICES

- Roland Compu-Music: complete system \$295.00
- Passport compatible MIDI Interface: \$165.00
- Boss DE-200 Digital Delay: \$395.00
- Alpha Syntauri 5 octave System: complete with Mountain Music cards and software \$995.00
- Yamaha DX-9 FM Synthesizer: \$1195.00
- E-MU Systems Drumulator: \$749.00
- Roland System 100M Analog Module Rack: \$1395.00

Order By Phone/Mail/or Drop In
Phone Orders and Enquiries: (416) 921-8941
Canada-Wide Long Distance (Order Line Only) 1-800-268-3798

The 8088 Controller and Trainer System

Based on the success of our Multiflex starter systems, we are proud to announce the arrival of the 8088 Controller and educational Trainer System. With the option to upgrade to a full IBM PC compatible, the starter system is the perfect education tool to learn 8088 based hardware and assembler code. It is also ideal for use as a complex, high speed industrial controller at an affordable price. This 8088 System consists of two boards. The first board (as seen in the picture) is the motherboard which can be used as a general purpose controller and contains the following:

- Socketed for 64K static RAM
- Socketed for 64K of EPROM
- RS232-C serial communications port
- Controller Port
- 300 baud modem
- 3 IBM PC compatible expansion slots (when the multifunction board is used)
- Wire Wrap area

The motherboard is a very versatile controller for which it is very easy to write software on the IBM PC/XT.

The second component is a console which connects to the motherboard via a ribbon cable. The console contains a display, hex keypad and another keypad containing function keys to perform memory block moves, register examination, the examination of I/O ports and a myriad of other functions. This board also contains an EPROM programmer.

A further multi-function board which has been designed specifically for the system to make it IBM PC compatible is available. This multi-function card contains a floppy diskette controller, DMA controller and up to 512K dynamic RAM.

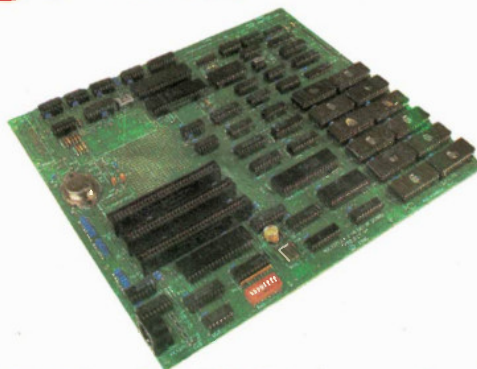

**Controller Board with 16K RAM
(optionally expandable to 64K)
\$250.00**

**Keyboard and Display Board with EPROM
programmer and monitor software
\$159.00**

**Multi-function Board with 64K RAM
(expandable to 512K)
\$250.00**

SPECTACULAR GANG EPROM PROGRAMMER AND EMULATOR

Totally self-contained (has its own display, entry keypad and power supply).

Based on the Z-8 microprocessor.

Can program up to 8 EPROMs simultaneously (anywhere from one to 8 EPROMs at the same time with the information in its own memory or or master EPROM).

Each of the 8 EPROM programming sockets is individually buffered and isolated from one another providing protection in situations when there is a bad EPROM among the eight being programmed. Clearly indicates and singles out any defective or marginal EPROMs prior to or after programming.

After programming the unit does a full VERIFY routine of the EPROM (at a Max Vcc of 5.4V and at a Min Vcc of 4.5V) to ensure high reliability of your EPROMs. Very simple to use.

A standard unit contains 8x16K of on-board memory which is sufficient in most cases, but can easily optionally be upgraded to 8x64K of on-board memory.

The Gang Programmer can handle a wide selection of EPROMs: 2716, 2732, 2732A, P2732A, 2532, 2564, 2764, 27128, 27128A and optionally upgradeable to handle 27256, 27512, 2758 and 2724.

Gives you option of entering the data which you want to be programmed on the EPROM through a built-in keypad and display into the EPROM programmer's built-in RAM or by downloading the data to be programmed by

RS232 interface (110 to 9600 Baud). The RS232 is standard — not optional!

Data can be checked or modified, since you can examine any memory location of the programmers built-in RAM, this holds true even after you have down-loaded through the RS232 from your computer; you can check or modify the memory before finally programming it on your EPROMs.

Read Master EPROMs; you can plug in a programmed EPROM, dump it into the programmers RAM, check the contents on display by stepping through the memory and, if you wish, you can alter any location before copying to other EPROMs.

EPROM Programmer can also be (optionally) used as an EPROM emulator, saving hours of frustration, reprogramming and waiting.

Using the Emulator option, you can enter via the keyboard or down-load through the RS232 from your computer or development system, the information which you think is right for whatever project you are building. This is the same information which you would normally burn into an EPROM, plug into your new undebugged processor and moments later you realise that you forgot to enter a code or that you must add or delete some codes. This normally would mean waiting 20 minutes for erasing of the EPROM and reprogramming and wasting time.

Using the Emulator option, you simply plug in a 24 or 28 Pin buffered pod into the socket on your board where you would normally fit the



EPROM, the difference being now that you can have all the information in the programmers RAM, connected to the pod by a ribbon cable and you can start your testing. If you wish to change, add, delete any codes, you can modify the contents of the programmers RAM using the keypad and display and continue testing moments later. Keep in mind that the RAM is protected from being accidentally altered.

Complete package with EPROM Emulator, 8 ZIF sockets, Gang Programmer with 16Kx8 of RAM and RS232 **\$995.00**

Gang EPROM Programmer with 8 ZIF sockets, 16Kx8 RAM and RS232, without Emulator **\$695.00**

EPROM Programmer with only one ZIF socket, 16Kx8 RAM and RS232, without Emulator. Able to do all the functions describe but can handle only one EPROM at a time **\$499.00**

UV EPROM Erasers

Industrial quality EPROM erasers.
Erase time about 15-20 minutes
Starting at \$129.00

MICROPROCESSOR CHIPS

8500 Series

| | | |
|-------|-------------------------------------|-------|
| 6502 | 8-bit CPU (1 MHz) | 4.95 |
| 6502A | 8-bit CPU (2 MHz) | 8.90 |
| 6522 | VIA Versatile Interface Adaptor | 6.95 |
| 6522A | VIA Versatile Interface Adaptor | 6.95 |
| 6532 | RIOT (128K RAM, I/O, Timer) | 7.45 |
| 645 | CRT Controller | 12.95 |
| 6551 | ACIA Async. Comm. Interface Adaptor | 8.75 |

6800 Series

| | | |
|---------|----------------------------------|-------|
| 6800 | 8-bit CPU (1 MHz) | 4.30 |
| 6802 | On Chip 128 x 8 1MHz CPU | 5.99 |
| 68000 | 8-bit CPU (2 MHz) | 7.39 |
| 6809 | 8/16-bit CPU (1 MHz) | 9.95 |
| 6809B | 8/16-bit CPU (2 MHz) | 23.00 |
| 6810 | 128K static RAM | 4.15 |
| 6821 | PIA Peripheral Interface Adaptor | 3.59 |
| 6840 | Programmable Timer | 8.10 |
| 6844 | DMA Controller | 14.00 |
| 6845 | CRT controller | 8.95 |
| 6845.45 | CRT controller | 9.95 |
| 6847 | Video Display Generator | 4.15 |
| 6850 | ACIA | 3.45 |
| 6852 | Synchronous Serial Data Adapter | 5.80 |
| 6860 | 0-600 Baud Modem | 11.95 |

68000 Series

| | | |
|----------|------------------------------|--------|
| 68000L8 | 16-bit CPU (8 MHz) | 50.00 |
| 68000L10 | 16-bit CPU (10 MHz) | 59.00 |
| 68006 | 16-bit CPU (8 bit data path) | 52.00 |
| 68230 | Parallel Interface Adapter | 25.95 |
| 68450 | 8MHz 16-bit DMA Controller | 110.00 |
| 68451 | Memory Management Controller | 189.00 |
| 68561 | MUCC (68000 Compatible) | 96.00 |
| 68681 | DPC | 19.50 |

8080 Series

| | | |
|---------|--|--------|
| 8080 | 8-bit CPU | 9.90 |
| 8085 | 8-bit CPU | 9.95 |
| 8087 | Math Processor | 179.00 |
| 8087-2 | Math Processor Fast 8 MHz (intel) | 219.00 |
| 8088 | 16-bit CPU 8-bit Databus (AMD) | 7.90 |
| 8088 | 16-bit CPU 8-bit Databus (intel) | 9.95 |
| 8088-2 | 16-bit CPU 8-bit Databus 8 MHz (intel) | 14.95 |
| 8212 | 3-bit I/O Port | 3.35 |
| 8214 | Priority Interrupt Controller | 8.54 |
| 8216 | 4-bit Bidirectional Bus Driver | 2.65 |
| 8224 | Clock generator for 8080/8085 | 5.10 |
| 8226 | Inverting Bus Driver | 5.36 |
| 8228 | System controller for 8080/8085 | 9.75 |
| 8237A-5 | High Speed DMA Controller (AMD) | 8.90 |
| 8237A-5 | High Speed DMA Controller (intel) | 10.95 |
| 8250 | Serial 8250 | 9.99 |
| 8251A | Programmable Communications Interface | 8.32 |

| | | |
|----------|--|-------|
| 8253A-5 | Programmable Interval Timer (AMD) | 5.95 |
| 8253A-5 | Programmable Interval Timer (intel) | 8.95 |
| 8254A-5 | Latest Programmable Interval Timer (improved version of 8253A-5) | 7.95 |
| 8255 | Programmable Interface Adapter | 4.89 |
| 8255A-5 | Programmable Interface Adapter | 4.89 |
| 8257-5 | Programmable DMA Controller | 9.95 |
| 8259A | Programmable Interrupt Controller | 4.85 |
| 8275 | Programmable CRT Controller | 24.00 |
| 8279-5PC | Programmable Keyboard Display Interface | 7.50 |
| 8282PC | Octal latch, non-inverting | 8.55 |
| 8283PC | Octal latch, inverting | 12.00 |
| 8284A | Clock and drive | 8.55 |
| 8286 | 8-Bit Bus trans. Non-Inverting | 8.50 |
| 8287PC | 8-Bit Bus trans. Inverting | 10.50 |
| 8288 | Bus Controller | 8.95 |
| 8289 | Bus Arbiter | 40.95 |
| 8279 | Floppy Disk Controller (Equi. to NEC 765) | 8.95 |
| 8741ADC | Univ. Programmable Interface | 34.95 |
| 8748DC | CPU, 4K EPROM, I/O | 28.00 |
| 8749DC | CPU, EPROM, RAM, I/O | 35.00 |
| 8755ADC | 2048 x 8 EPROM, I/O | 37.95 |

8086 Series

| | | |
|------|------------|-------|
| 8086 | 16-bit CPU | 13.50 |
|------|------------|-------|

We now carry a wide selection of 80286 parts at most competitive prices.

Z80 Series

| | | |
|-------------|--|-------|
| Z800A-CPU | 8-bit CPU (4 MHz) | 4.50 |
| Z800B-CPU | 8-bit CPU (6 MHz) | 10.00 |
| Z800A-PIO | Parallel I/O | 5.95 |
| Z800A-CTC | Counter Timer | 7.79 |
| Z800A-DART | Dual Asynchronous Receiver Transmitter | 12.95 |
| Z800A-DMA | Direct Memory Access | 16.50 |
| Z800A-SIO-0 | Serial I/O ver. 0 | 18.95 |

Communications & Timers

| | | |
|----------|---|-------|
| AY3-1015 | UART (Single 5V Supply) | 7.95 |
| AY5-1013 | UART | 5.90 |
| S1902 | UART | 4.49 |
| TMS9918 | Sprite Graphics Generator | 18.95 |
| TMS9953C | FSK Modem | 17.95 |
| COM5016 | Dual Baud Rate Generator | 18.10 |
| COM8116 | Dual Baud Rate Generator (5V supply only) | 18.75 |
| AY53800 | Keyboard Encoder | 10.95 |
| KR3600 | Keyboard Encoder | 8.95 |
| MSM5832 | Real-Time Clock | 18.10 |
| MSM5832C | Real-Time Clock | |
| SND5037 | CRT Video Timer Controller | 32.25 |

Floppy Controllers

| | | |
|---------|---|-------|
| WD2143 | 4-phase Clock Generator for Floppy | 14.50 |
| FDC1771 | Single Disk Controller | 19.00 |
| FDC1783 | Double Density Disk Controller | 47.00 |
| FDC1795 | Double Density/Sided Disk Controller | 69.00 |
| FDC2793 | Dbl. Density Disk Controller c/w precomp. | 45.00 |
| FDC2795 | Dbl. Density Disk Controller c/w precomp. | 59.95 |
| FD9216 | Floppy Disk Data Separator | 10.50 |
| NEC765 | | |
| (8272) | Floppy Disk cont. | 8.95 |

74LS00 SERIES

| | | |
|---------|---|------|
| 74LS00 | Quad 2 Input NAND gate | 29 |
| 74LS01 | Quad 2 Input NAND gate O/C | 45 |
| 74LS02 | Quad 2 Input NOR gate | 29 |
| 74LS03 | Quad 2 Input NOR gate O/C | 45 |
| 74LS04 | Hex Inverter | 32 |
| 74LS05 | Hex Inverter O/C | 45 |
| 74LS06 | Quad 2 Input AND gate | 29 |
| 74LS09 | Quad 2 Input AND gate O/C | 45 |
| 74LS10 | Triple 3 Input NAND gate | 40 |
| 74LS11 | Triple 3 Input AND gate O/C | 50 |
| 74LS12 | NAND gate inverter | 21 |
| 74LS13 | Dual Schmidt trigger | 50 |
| 74LS14 | Hex Schmidt trigger inverter | 59 |
| 74LS15 | Triple 3 Input AND gate | 75 |
| 74LS20 | Dual 4 Input NAND gate | 45 |
| 74LS21 | Dual 4 Input AND gate | 45 |
| 74LS22 | Dual 2 Input NAND Schmidt trigger | 75 |
| 74LS24 | Quad 2 Input NAND Schmidt trigger | 75 |
| 74LS26 | Quad 2 Input positive NAND gate | 45 |
| 74LS27 | Triple 3 Input NOR gate | 45 |
| 74LS28 | Quad 2 Input NOR buffer | 45 |
| 74LS30 | 8 Input NAND gate | 45 |
| 74LS32 | Quad 2 Input NOR gate | 45 |
| 74LS33 | Quad 2 Input NOR gate O/C | 45 |
| 74LS37 | Quad 2 Input NAND gate | 55 |
| 74LS38 | Quad 2 Input NAND gate O/C | 50 |
| 74LS42 | BCD to 10 segment decoder | 60 |
| 74LS47 | BCD to 7 segment decoder | 90 |
| 74LS48 | BCD to 7 segment decoder driver | 99 |
| 74LS49 | BCD to 7 segment decoder driver | 79 |
| 74LS51 | And/or Invert gate | 45 |
| 74LS54 | 4 wide and/or invert gate | 45 |
| 74LS55 | 2 wide 4 input and/or invert gate | 45 |
| 74LS56 | Hex current sensing switch | 1.70 |
| 74LS59 | Dual JK flip flop w/ clear | 55 |
| 74LS74 | Dual D flip flop | 48 |
| 74LS75 | 4 bit bistable latch | 50 |
| 74LS76 | Dual JK master/slave flip flop | 99 |
| 74LS77 | 4 bit bistable latch | 1.00 |
| 74LS78 | Dual JK flip flop preset, common clear | 55 |
| 74LS83 | 4 bit binary full adder | 80 |
| 74LS88 | 4 bit magnitude comparator | 50 |
| 74LS90 | Quad input XOR gate | 55 |
| 74LS91 | Decade counter | 65 |
| 74LS92 | 8 bit shift register | 75 |
| 74LS92 | Divide by 12 counter | 86 |
| 74LS93 | 4 bit right shift register | 66 |
| 74LS96 | 5 bit shift register, async. preset | 80 |
| 74LS107 | Dual JK flip flop with clear | 55 |
| 74LS109 | Dual JK pos. edge triggered flip flop | 60 |
| 74LS112 | Dual JK edge triggered flip flop | 60 |
| 74LS113 | Dual JK edge triggered flip flop | 55 |
| 74LS122 | Dual JK edge triggered flip flop Retriggerable monostable multivibrator | 90 |
| 74LS123 | Dual retriggerable monostable multivibrator | 53 |
| 74LS125 | Tri state output buffer | 50 |
| 74LS126 | Quad 3 state buffer | 60 |
| 74LS132 | Quad 2 input NAND gate | 89 |
| 74LS133 | 13 input NAND gate | 70 |
| 74LS136 | Quad XOR gate | 60 |
| 74LS137 | 3 bit 8 decoder/multiplexer | 68 |
| 74LS138 | 3 to 8 decoder/multiplexer | 68 |
| 74LS145 | Dual 1 of 4 decoder/multiplexer | 68 |
| 74LS147 | BCD to decimal decoder/driver | 1.25 |
| 74LS148 | 8 to 3 line priority encoder | 2.00 |
| 74LS151 | 8 channel digital multiplexer | 75 |
| 74LS153 | Dual 4/1 multiplexer | 1.15 |
| 74LS154 | 4 to 16 decoder/multiplexer | 1.05 |
| 74LS155 | Decoders/multiplexer | 90 |
| 74LS156 | Quad selector/multiplexer | 85 |
| 74LS157 | Quad 2 input multiplexer (inverting) | 75 |
| 74LS160 | Decade counter with async. clear | 99 |
| 74LS181 | Sync. 4 bit counter | 95 |
| 74LS182 | Sync. 4 bit counter | 95 |
| 74LS183 | Sync. 4 bit counter | 95 |
| 74LS164 | 8 bit serial shift register | 89 |
| 74LS165 | Parallel load 8 bit shift register | 1.08 |
| 84LS166 | 8 bit PISO shift register | 1.95 |
| 74LS169 | Up/down decade counter | 2.25 |
| 74LS170 | 4 bit sync. binary counter | 1.38 |
| 74LS171 | 4 x 4 register file | 1.95 |
| 74LS173 | 4 bit tri state register | 78 |
| 74LS174 | Hex D flip flop with clear | 80 |
| 74LS175 | Quad D flip flop w/ clear | 85 |
| 74LS151 | 4 bit shift register | 75 |
| 74LS182 | Look-ahead carry | 2.75 |
| 74LS192 | Sync. up/down counter BCD | 93 |
| 74LS191 | Sync. up/down counter binary | 93 |
| 74LS192 | Binary up/down counter | 93 |
| 74LS193 | Binary up/down counter | 93 |
| 74LS194 | 4 bit bidirectional shift register | 93 |
| 74LS195 | 4 bit shift register | 75 |
| 74LS196 | Decade counter | 1.50 |
| 74LS197 | Presettable binary counter | 1.05 |
| 74LS221 | Octal monostable multivibrator | 1.25 |
| 74LS240 | Octal inverting bus driver | 1.25 |
| 74LS241 | Octal bus driver | 1.25 |
| 74LS242 | Quad inverting transceiver | 1.20 |
| 74LS243 | Quad transceiver | 1.17 |
| 74LS244 | Tri state octal driver | 1.39 |
| 74LS245 | Octal bus transceiver | 1.39 |
| 74LS247 | BCD to 7 segment decoder driver | 1.05 |
| 74LS248 | BCD to 7 segment decoder driver | 1.35 |
| 74LS249 | BCD to 7 segment decoder driver | 1.35 |
| 74LS251 | Tristate data selector multiplexer | 78 |
| 74LS253 | Dual 4 bit multiplexer | 75 |
| 74LS257 | Quad 2 input multiplexer | 80 |
| 74LS258 | Quad 2-1 multiplexer | 80 |
| 74LS259 | 8 bit addressable latch | 1.90 |
| 74LS260 | Dual 5 input NOR gate | 79 |
| 74LS266 | Quad 0 input NOR/OIC | 50 |
| 74LS273 | Octal D flip flop | 1.18 |
| 74LS275 | 7 bit slice Wallace tree | 5.55 |
| 74LS279 | Quad S-P latches | 59 |
| 74LS280 | 9 bit odd/even parity checker generator | 3.25 |
| 74LS283 | 4 bit binary full adder | 79 |
| 74LS289 | 64 bit RAM | 6.25 |
| 74LS290 | Decade counter | 90 |
| 74LS293 | 4 bit binary counter | 95 |
| 74LS295 | 4 bit shift register | 1.50 |

| | | |
|-----------|--|-------|
| 74LS296 | Quad 2 Input multiplexer | 1.12 |
| 74LS299 | 8 bit storage register | 2.75 |
| 74LS320 | Crystal oscillator | 4.75 |
| 74LS321 | Crystal oscillator | 3.90 |
| 74LS324 | 8 bit shift register | 5.49 |
| 74LS323 | 8 bit bidirectional universal shift register | 3.49 |
| 74LS348 | 8 to 3 priority encoder | 2.75 |
| 74LS352 | Dual 4 bit multiplexer | 1.05 |
| 74LS353 | Dual 4 bit multiplexer | 1.05 |
| 74LS354 | Data selector multiplexer | 4.75 |
| 74LS355 | Data selector multiplexer | 4.75 |
| 74LS356 | Data selector multiplexer | 4.75 |
| 74LS357 | Data selector multiplexer | 4.99 |
| 74LS365 | Hex bus driver tri state | .62 |
| 74LS366 | Hex bus driver | .82 |
| 74LS367 | Hex bus driver | .82 |
| 74LS368 | Hex bus driver (inverted output) | .62 |
| 74LS373 | Octal transparent latch | 1.20 |
| 74LS374 | Octal dual flip flop | 1.20 |
| 74LS375 | 4 bit bistable latch | .65 |
| 74LS377 | Octal D register | 1.23 |
| 74LS378 | Hex D register | 1.85 |
| 74LS379 | 4 bit register | 1.85 |
| 74LS380 | Multi function octal generator | 9.00 |
| 74LS384 | 8 bit multiplier | 9.95 |
| 74LS386 | Quad 2 input XOR gate | 1.20 |
| 74LS390 | Dual decade counter | 1.12 |
| 74LS393 | Dual 4 bit binary counter | 1.12 |
| 74LS395 | Tri state shift register | 1.89 |
| 74LS396 | Octal storage register | 2.75 |
| 74LS398 | Quad D flip flop | 2.75 |
| 74LS399 | Quad 2 input multiplexer with storage | 1.45 |
| 74LS629 | Voltage controlled oscillator | 3.30 |
| 74LS612 | Octal bus transceiver | 28.00 |
| 74LS640 | Octal bus transceiver | 2.20 |
| 74LS641 | Octal bus transceivers AND registers | 3.20 |
| 74LS642NT | Octal bus transceivers AND registers | 10.95 |
| 74LS647NT | Octal bus transceivers AND registers | 10.95 |
| 74LS648NT | Octal bus transceivers AND registers | 10.95 |
| 74LS652NT | Octal bus transceivers AND registers | 10.95 |
| 74LS670 | 4 x 4 register file 3 state | 1.85 |
| 74LS673 | 18 bit SISO shift reg. | 19.95 |
| 74LS682 | 8 bit magnitude comparator | 3.99 |
| 74LS683 | 8 bit magnitude comparator-open collector | 3.99 |
| 74LS684 | 8 bit magnitude comparator, 3-state | 3.99 |
| 74LS688 | 8 bit magnitude comparator, 3-state | 3.99 |
| 74LS689 | 8 bit magnitude comparator open collector | 5.35 |
| 74LS795 | Octal buffer (81LS98), 3-State | 1.29 |
| 74LS796 | Octal buffer (81LS98), 3-State | 1.29 |
| 74LS797 | Octal buffer (81LS97), 3-State | 1.29 |
| 74LS798 | Octal buffer (81LS98), 3-State | 1.29 |
| 74LS799 | Octal buffer (81LS99), 3-State | 1.29 |
| 74LS807 | Octal buffer (81LS97), 3-State | 1.29 |
| 74LS796 | Octal buffer (81LS96), 3-State | 1.29 |

MEMORY

Check latest prices each month in Electronics Today and Computing Now!

Untouchable Prices!
Guaranteed Prime Stock
Call for large quantities prices.

| | | |
|--------------------------|----------|--|
| Dynamic RAMs | | |
| 4116 1x16k (150ns) | \$ 0.75 | |
| 4164 1x64k (150ns) | \$ 1.10 | |
| 4164's (150ns). Set of 9 | \$ 9.50 | |
| 41256 1x256k (150ns) | \$ 4.99 | |
| 41256 (150ns). Set of 9 | \$ 44.75 | |
| Static RAM | | |
| 2114L 4x1k 200ns | \$ 2.25 | |
| 6514 4x1k CMOS 450ns | \$ 1.20 | |
| 6116 8x2k 150ns | \$ 4.95 | |
| 2016 8x2k 150ns | \$ 3.99 | |
| 62 64 8x8k 150ns | \$ 9.95 | |
| EPROMs | | |
| 2716 450ns 8x2k | \$ 5.50 | |
| 2716 300ns 8x2k | \$ 6.50 | |
| 2732 450ns 8x4k | \$ 3.75 | |
| 2732 250ns 8x4k | \$ 3.75 | |
| 2764 300ns 8x8k | \$ 4.50 | |
| 27128 350ns 8x16k | \$ 6.95 | |

Commonly used parts for your IBM compatible (8088) systems and peripherals

| | |
|--|-----------|
| Only prime quality parts sold. | |
| Quantity Discounts Available | |
| 8088 CPU | \$ 7.90 |
| 8087 Math Processor | \$ 179.00 |
| 8237A-5 Prog. DMA Cntrl. | \$ 8.90 |
| 8250 Serial Port | \$ 9.89 |
| 8253A-5 Prog. Interval timer | \$ 5.89 |
| 8255A-5 P.I.A. | \$ 4.89 |
| 8259A Prog. Interrupt Cntrl. | \$ 4.95 |
| 8284A ADC clock gen & driver | \$ 5.95 |
| 8288 Bus Controller | \$ 9.75 |
| 8272 Floppy Disk Controller | \$ 8.95 |
| NEC 765 Floppy Disk Controller (equivalent to 8272) | \$ 8.95 |
| 8086 CPU | \$ 13.50 |
| Set of 8088, 8255A-5, 8237A-5, 8288, 8284, 8253A-5 and 8259A | \$ 48.00 |
| 100ns delay line | \$ 4.95 |
| 7ns delay line | \$ 12.45 |
| 62 pin edge con (high quality) | \$ 1.79 |
| 5 pin Din conn | \$.99 |
| Power conn | \$ 1.25 |
| Dip switch 8 pos | \$ 1.75 |
| 4.7k x 6 slip | \$.39 |
| 4.7k x 8 pin slip | \$.44 |
| 8.2k or 10k 16 pin Resistor or network | \$.99 |
| 33ohm x 8 network | \$.99 |
| Small speaker | \$ 1.99 |
| .1uf 50V high quality bypass capacitors | \$.10 |
| Trimcap | \$.99 |
| 34 pin card edge con. for your floppy controller | \$ 5.85 |
| 74LS322A | \$ 5.49 |
| 74LS629 | \$ 3.30 |
| 74LS670 | \$ 1.70 |
| 74S280 | \$ 3.19 |
| 74LS125 | \$.60 |
| 74S157 | \$ 1.59 |
| 74LS244 | \$ 1.20 |
| 74LS245 | \$ 1.39 |
| 74LS273 | \$ 1.18 |
| 75477 | |

| | | | | | |
|------|--|-------|---------|---|-------|
| 4000 | Dual 3 input NOR gate | .33 | 346 | Quad low power 741 | .86 |
| 4001 | Quad 2 input NOR gate | .33 | 347 | JAK 3 term. passive adjust. regulator | .75 |
| 4002 | Quad 2 input NOR gate | .33 | 355 | FET input op amp | .89 |
| 4006 | 18 static shift register | .66 | 357 | Monolithic J-FET input op amp | 1.95 |
| 4007 | Dual complementary pairs/inverters | .35 | | Monolithic J-FET input op amp (uncompensated) | 1.95 |
| 4008 | 4 bit full adders | .84 | 358 | Dual version of 324 | .55 |
| 4009 | Hex buffer/converter (inverting) | .89 | 380 | 2W audio amp | 11.10 |
| 4010 | Hex buffer/converter | .89 | 393 | Dual version of 339 | .60 |
| 4011 | Quad 2 input NAND gate | .33 | 398 | Sample and hold amplifier | 5.94 |
| 4012 | Dual 4 input NAND gate | .33 | 555 | Timer | .85 |
| 4013 | Dual D edge triggered flip flop | .45 | 566 | Dual timer | .42 |
| 4014 | 8 bit static shift register | .79 | 567 | Quad timer | 1.90 |
| 4015 | Dual 4 bit static shift register | .89 | 508 | 1 tone decoder | 9.35 |
| 4016 | Quad bilateral shift register | .46 | 509 | Op amp | .78 |
| 4017 | Decade counter/divider | .75 | 710 | Differential comparator | 1.32 |
| 4018 | Presetable divide by N counter | .82 | 711 | Dual channel differential comparator | .99 |
| 4019 | Quad and/or select gate | .85 | 714 | Precision op amp | 4.45 |
| 4020 | 14 stage binary/ripple counter | .82 | 715 | High speed op amp | 5.25 |
| 4021 | 8 bit static shift register | .85 | 725 | Voltage regulator | .59 |
| 4022 | Divide by 8 counter/divider | .85 | 725 | Instrumentation op amp | 2.99 |
| 4023 | Triple 3 input NAND gate | .34 | 733 | Differential video amp | 1.15 |
| 4024 | 7 stage binary counter | .55 | 739 | Dual high performance op amp | 2.05 |
| 4025 | Triple 3 input NOR gate | .34 | 741 | Operational amplifier | 5.99 |
| 4026 | Decade counter/divider | 1.30 | 747 | Dual op amp | .75 |
| 4027 | Dual JK flip flop | .50 | 748 | Op amp | .69 |
| 4028 | BCD to decimal decoder | .65 | 749 | Dual audio preamplifier | 2.99 |
| 4029 | Presetable up/down binary/decade counter | .90 | 750 | Power op amp | 2.89 |
| 4030 | Quad XOR gate | .45 | 759 | High speed differential comparator | 1.10 |
| 4033 | 7 segment LED cad counter | 1.00 | 796 | Multipurpose programmable op amp | 11.10 |
| 4034 | 8 stage universal bus register | .95 | 1372 | RF modulator | 3.25 |
| 4035 | 4 stage PISO shift register | .97 | 1436 | High voltage op amp | 4.44 |
| 4038 | Triple serial register | 2.00 | 1458 | Dual op amp | 5.49 |
| 4040 | 12 stage binary/ripple counter | .78 | 1489 | Quad RS232 line receiver | .59 |
| 4041 | Quad true complement buffer | .79 | 1495 | Multiplexer | 5.25 |
| 4042 | Quad D latch | .59 | 1496 | Modulator/demodulator | 1.39 |
| 4043 | Quad tri state NOR/R latch | .58 | 1558 | Dual op amp | 1.95 |
| 4044 | Quad tri state NAND/R latch | .80 | 1596 | Four quad multiplexer | 7.78 |
| 4046 | Micropower phase locked loop | .95 | 1800 | Modulator/demodulator | 5.49 |
| 4047 | Low power monostable/astable multivibrator | .75 | 1889 | Demodulator | 6.25 |
| 4049 | Inverting hex buffer | .45 | 1899 | Video modulator | 0.95 |
| 4050 | Hex buffer | .45 | 3900 | Quad op amp | 6.25 |
| 4051 | Single 8 channel multiplexer/demultiplexer | .80 | 26LS29 | Quad RS422 line driver | 1.49 |
| 4052 | Dual 4 channel multiplexer | .90 | 26LS30 | Quad RS422/432 line driver | 3.95 |
| 4053 | Triple 2 channel multiplexer/demultiplexer | .90 | 26LS32 | Quad differential line driver RS422 | 2.30 |
| 4054 | 4 segment display driver | .99 | 26LS33 | Quad differential line driver RS422 | 2.40 |
| 4055 | BCD to 7 segment recorder/LCD driver | 1.75 | 3470 | Floppy disk read amplifier | 5.99 |
| 4056 | BCD to 7 segment recorder/LCD driver | 1.75 | 3487 | Quad RS422/432 line receiver | 5.25 |
| 4061 | 4 stage binary counter/oscillator | .83 | 76477 | Quad line driver RS422 | 2.35 |
| 4066 | Quad bilateral switch | .52 | 76478 | Analog complex sound generator | 5.00 |
| 4068 | 8 input NAND gate | .34 | | dr amp | 6.90 |
| 4069 | Hex inverter | .34 | 76489 | Microprocessor cont. complex sound generator | 8.30 |
| 4070 | Quad 2 input XOR gate | .34 | 8T26 | Quad tri-state bus transceiver | 1.75 |
| 4071 | Quad 2 input OR gate | .34 | 8T28 | Quad tri-state bus transceiver | 1.50 |
| 4072 | Dual 4 input OR gate | .34 | TL070 | Low noise bifet op amp | .86 |
| 4073 | Triple 3 input gate | .34 | TL071 | Low noise bifet op amp | .77 |
| 4075 | Triple 3 input OR gate | .34 | TL072 | Low noise bifet op amp | 1.10 |
| 4076 | 4 bit D register | .30 | TL074 | Low noise bifet op amp | 1.95 |
| 4078 | 8 input NOR gate | .34 | TL075 | Low noise bifet op amp | 2.99 |
| 4081 | Quad 2 input AND gate | .34 | TL080 | General purpose bifet op amp | .69 |
| 4082 | Dual 4 input AND gate | .32 | TL081 | General purpose bifet op amp | 1.49 |
| 4086 | Expandable 4 by 2 AND/OR invert gate | .52 | TL082 | General purpose bifet op amp | 2.50 |
| 4093 | Quad 2 input NAND Schmitt trigger | .59 | TL084 | General purpose bifet op amp | 1.85 |
| 4094 | 8 stage Schmitt register | .99 | TL497 | Switching voltage regulator | 2.35 |
| 4097 | Diff 8 channel analog mux/demux | 1.90 | ULN2002 | 7 segment transistor array | 1.00 |
| 4099 | 8 bit addressable latch | .99 | ULN2003 | 7 segment transistor array | 1.00 |
| 4501 | Industrial control unit | 2.99 | ULN2004 | 7 segment transistor array | 1.00 |
| 4502 | Strobex Hex inverter/buffer | 1.25 | XR200 | Multifunction I.C. | 67.95 |
| 4503 | Hex tri-state buffer | .89 | XR205 | Monolithic waveform generator | 8.10 |
| 4504 | Hex level shifter | 1.49 | XR210 | FSK modulator/demodulator | 4.99 |
| 4506 | Dual Expandable A/Q gate | 2.50 | XR211 | Phase lock loop | 11.95 |
| 4508 | Dual 4 bit latch tri-state | 1.75 | XR240 | PCM repeater | 11.95 |
| 4510 | BCD up/down counter | .95 | XR320 | Monolithic timing circuit | 1.64 |
| 4511 | BCD to 7 segment latch decoder/divider | .95 | XR1310 | Stereo demodulator | 1.25 |
| 4512 | 8 channel data separator | 1.10 | XR2206 | Monolithic function generator | 2.95 |
| 4514 | 1 of 16 decoder/demultiplexer | 1.85 | XR2207 | Voltage controlled oscillator | 1.10 |
| 4515 | 1 of 16 decoder/demultiplexer | 1.85 | XR2208 | Operation multiplier | 2.99 |
| 4516 | Binary up/down counter | .95 | XR2209 | Precision oscillator | 3.25 |
| 4518 | Dual BCD up counter | .89 | XR2211 | FSK demodulator/line decoder | 6.99 |
| 4519 | 4 bit AND OR set gate | .65 | XR2212 | Precision phase locked loop | 8.99 |
| 4520 | Dual binary up counter | .79 | XR2242 | Long range line mux | 2.50 |
| 4521 | 24 state frequency divider | 1.99 | XR2267 | Dual monolithic tone decoder | 1.40 |
| 4522 | BCD divide by N counter | 1.25 | XR4739 | Dual low noise op amp | 2.55 |
| 4528 | 4 bit binary divide by N counter | 1.10 | XR14412 | FSK modem system | 8.75 |
| 4527 | BCD to 7 segment | 1.10 | | | |
| 4528 | Dual retriggerable/resettable monostable | 1.10 | | | |
| 4529 | Dual 4 channel mux | 1.30 | | | |
| 4530 | Dual 5 input majority logic gate | 1.05 | | | |
| 4531 | 12 bit parity generator/checker | 1.35 | | | |
| 4532 | 8 bit priority encoder | 1.35 | | | |
| 4534 | Real time 5 decade counter | 7.50 | | | |
| 4536 | Programmable timer | 2.37 | | | |
| 4538 | Dual precision monostable multivibrator | 1.30 | | | |
| 4539 | Dual 4 channel digital multiplexer | 1.30 | | | |
| 4541 | Quad 2 input analog mux | 1.15 | | | |
| 4543 | BCD to 7 segment latch/decoder/divider | 1.05 | | | |
| 4553 | 3 digit BCD counter | 2.89 | | | |
| 4555 | Dual binary 1 of 4 decoder | .83 | | | |
| 4556 | Dual 1 of 4 decoder | .75 | | | |
| 4557 | 4 bit shift register | .67 | | | |
| 4558 | BCD to 7 segment decoder | 1.55 | | | |
| 4560 | NBCD adder | .569 | | | |
| 4561 | 9's complementer | 1.05 | | | |
| 4562 | 12 bit static shift register | 7.95 | | | |
| 4566 | Industrial time base generator | 1.89 | | | |
| 4568 | Phase comparator/programmable counter | 2.50 | | | |
| 4572 | Hex gate | .65 | | | |
| 4573 | Quad programmable op amp | 3.43 | | | |
| 4575 | Quad programmable comparator | 3.25 | | | |
| 4580 | 4 x 4 multiplex register | 6.49 | | | |
| 4581 | 4 bit A/U | 2.25 | | | |
| 4582 | Carry look ahead generator | 1.78 | | | |
| 4583 | Dual Schmitt trigger | .95 | | | |
| 4584 | Hex Schmitt trigger | .60 | | | |
| 4585 | 4 bit magnitude comparator | .99 | | | |
| 4702 | Programmable bit rate generator | 11.99 | | | |

7400 SERIES TTL

| | | |
|------|---------------------------------------|------|
| 7400 | Quad 2 input NAND gate | .49 |
| 7401 | Quad 2 input NOR gate | .49 |
| 7402 | Quad 2 input NAND gate O/C | .49 |
| 7403 | Hex inverter | .55 |
| 7404 | Hex inverter gate O/C | .54 |
| 7405 | Hex inverter buffer/divider | .65 |
| 7406 | Hex buffer/divider | .65 |
| 7407 | Hex buffer/divider | .65 |
| 7408 | Quad 2 input AND gate | .49 |
| 7409 | Quad 2 input AND gate with O/C | .49 |
| 7410 | Triple 3 input NAND gate | .49 |
| 7411 | Triple 3 input AND gate | .39 |
| 7412 | Hex Schmitt trigger | .75 |
| 7413 | Hex inverter buffer/divider | .65 |
| 7414 | Hex buffer/divider | .65 |
| 7415 | Quad 4 input NAND gate | .50 |
| 7416 | Dual 2 input NAND gate | .59 |
| 7417 | Dual 2 input positive-NOR gate | .59 |
| 7418 | Dual 4 input NOR gate | .56 |
| 7419 | Quad 2 input NAND gate | .56 |
| 7420 | Triple 3 input NOR | .49 |
| 7421 | 8 input NAND gate | .65 |
| 7422 | Quad 2 input gate | .52 |
| 7423 | Quad 2 NAND buffer | .53 |
| 7424 | Quad 2 input NAND buffer | .65 |
| 7425 | Dual 4 input buffer | .69 |
| 7426 | 8 bit shift register | 1.29 |
| 7427 | BCD-to 7 segment driver | 7.9 |
| 7428 | BCD-to 7 segment decoder/divider | 1.58 |
| 7429 | 1 to 1 input or invert gate | .49 |
| 7430 | And/or invert gate | .49 |
| 7431 | 4 wide and/or invert gate | .49 |
| 7432 | Dual D flip flop | .76 |
| 7433 | 4 bit bistable latch | .76 |
| 7434 | Dual JK master/slave flip flop | .69 |
| 7435 | 4 bit magnitude comparator | .69 |
| 7436 | Quad 2 input exclusive or gate | .75 |
| 7437 | 64 bit read/write memories | 3.84 |
| 7438 | Decade counter | .77 |
| 7439 | 8 bit register | .60 |
| 7440 | Divide by 12 counter | .63 |
| 7441 | 4 bit binary counter | .63 |
| 7442 | 4 bit right shift/left shift register | .79 |
| 7443 | 5 bit shift register | .95 |
| 7444 | Synchronous rate multiplier | 1.29 |
| 7445 | Gated JK master/slave flip flop | 1.45 |
| 7446 | Gated JK master/slave flip flop | 1.45 |
| 7447 | Dual JK flip flops with clear | .75 |
| 7448 | Dual JK edge triggered FF | .75 |
| 7449 | Dual pulse Sync | 2.19 |
| 7450 | Monostable multivibrator | .75 |

| | | |
|-------|--------------------------------------|------|
| 74123 | Dual retriggerable one shot | .87 |
| 74125 | Tri-state quad bus buffer | .95 |
| 74126 | Tri-state quad bus buffer | .95 |
| 74128 | 50-ohm line driver | .95 |
| 74130 | 4 bit 4 multiplexer | .95 |
| 74136 | Exclusive or NAND gate | .92 |
| 74141 | BCD to decimal decoder driver | 1.79 |
| 74142 | Counter/latch/decoder/divider | 5.59 |
| 74143 | Center decoder | 6.95 |
| 74144 | Center decoder | 6.95 |
| 74145 | BCD to decimal decoder driver | 1.29 |
| 74147 | 10-4 priority encoder | 2.45 |
| 74148 | Priority encoder | 1.59 |
| 74150 | 16 line to 1 line multiplexer | 2.35 |
| 74151 | 8 channel digital multiplexer | .89 |
| 74152 | 4 bit 4 multiplexer | .89 |
| 74154 | 4 line to 16 decoder | 1.99 |
| 74155 | Decoder/demultiplexer | .79 |
| 74156 | Decoder/demultiplexer | .99 |
| 74157 | Quad 2 input multiplexer | .82 |
| 74159 | 4-16 decoder | .89 |
| 74160 | BCD to decimal counter, async. reset | 1.35 |
| 74161 | Synchronous 4 bit counter | 1.09 |
| 74162 | Sync. 4 bit counter | 1.19 |
| 74163 | Sync. 4 bit counter | 1.09 |
| 74164 | 8 bit serial shift register | 1.09 |
| 74165 | 4 bit parallel access shift register | 1.29 |
| 74166 | 8 bit shift register | 1.79 |
| 74167 | Sync. rate multiplexer | 4.65 |
| 74170 | 4 by 4 register file | 2.99 |
| 74172 | 16 bit register file | 6.75 |
| 74173 | 4 bit 16 register file | 1.59 |
| 74174 | Hex D flip flop with clear | 1.19 |
| 74175 | Quad D flip flop with clear | .89 |
| 74176 | Presetable counter/latch decoder | 1.45 |
| 74177 | Presetable counter/latch binary | 1.45 |
| 74178 | 4 bit shift register | 1.75 |
| 74179 | 4 bit parallel access shift register | 1.75 |
| 74181 | Arithmetic logic unit | 3.55 |
| 74182 | Look ahead carry generator | 1.45 |
| 74184 | Code converter BCD to binary | 3.55 |
| 74185 | Binary to BCD converter | 3.50 |
| 74190 | Synchronous up/down decade counter | 1.29 |
| 74191 | Up/down b.cnr. | 1.29 |
| 74192 | Binary up/down counter | 1.09 |
| 74193 | Binary up/down counter | 1.09 |
| 74194 | 4 bit bi-directional shift register | 2.19 |
| 74195 | 4 bit parallel access shift register | 1.09 |
| 74196 | Presetable decade counter | 1.45 |
| 74197 | Presetable binary counter | 1.45 |
| 74198 | 8 bit shift register | 2.19 |
| 74199 | 8 bit shift register | 2.19 |
| 74201 | Dual Monostable multivibrator | 6.19 |
| 74202 | Tri-state 8 input multiplexer | 1.45 |
| 74203 | 8 bit adder latch | 3.19 |
| 74204 | Octal D-type flip flop | 3.19 |
| 74205 | Quad JK flip flop | 3.75 |
| 74206 | Quad JK flip flops | 6.19 |
| 74207 | 4 bit binary full adder | 1.78 |
| 74208 | Tri-state 4 bit multiplexer | 4.65 |
| 74209 | Hex bus drivers 3 state output | .89 |
| 74210 | Hex bus drivers inverted | .89 |
| 74211 | Hex bus drivers inverted data | .89 |
| 74212 | Dual decade counter | 2.19 |
| 74213 | Dual 4 bit binary counter | 2.19 |

74ALS00 Advanced Low Power Schottky TTL

| | | |
|----------|---|------|
| 74ALS00 | Quad 2 input POS NAND gate | .57 |
| 74ALS02 | Quad 2 input POS NOR gate | .57 |
| 74ALS03 | Quad 2 input POS NAND gate O/C | .57 |
| 74ALS04 | Hex inverter | .57 |
| 74ALS05 | Hex inverter O/C | .57 |
| 74ALS08 | Quad 2 input POS AND gate | .57 |
| 74ALS09 | Quad 2 input POS AND gate O/C | .57 |
| 74ALS10 | Triple 3 input POS NAND gate | .57 |
| 74ALS11 | Triple 3 input POS AND gate | .57 |
| 74ALS12 | Triple 3 input POS NAND gate O/C | .57 |
| 74ALS13 | Triple 3 input POS AND gate O/C | .57 |
| 74ALS20 | Dual 4 input pos AND gate | .57 |
| 74ALS21 | Dual 4 input pos AND gate O/C | .57 |
| 74ALS22 | Triple 3 input POS NOR gate | .57 |
| 74ALS27 | Quad 2 input POS NOR buffer | .57 |
| 74ALS30 | 8 input POS NAND gate | .57 |
| 74ALS32 | Quad 2 input POS NOR gate | .57 |
| 74ALS33 | Quad 2 input POS NOR buffer O/C | .57 |
| 74ALS35 | Hex non inverter with O/C output | .58 |
| 74ALS37 | Quad 2 input NAND buffer | .67 |
| 74ALS38 | Quad 2 input POS NAND buffer O/C | .67 |
| 74ALS51 | Dual D type POS edge triggered FF | .77 |
| 74ALS54 | Dual D type POS edge triggered FF | .77 |
| 74ALS56 | Quad 2 input exclusive OR gate | .77 |
| 74ALS109 | Dual JK NEG edge triggered FF | .77 |
| 74ALS112 | Dual JK NEG edge triggered FF with preset, clear, clock | .77 |
| 74ALS113 | Dual JK NEG edge triggered FF with preset, clear, clock | .77 |
| 74ALS134 | 13 input POS NAND gate | .67 |
| 74ALS136 | Quad exclusive OR gate O/C | .77 |
| 74ALS138 | 3 to 8 line decoder/demultiplexer | 1.19 |
| 74ALS139 | Dual 1 of 4 decoder | 1.85 |
| 74ALS151 | Dual 4 line to 1 line data Selector/multiplexer | 1.19 |
| 74ALS157 | Quad 2 input multiplexer non inverting | 1.55 |
| 74ALS160 | Sync. 4 bit counter | 1.65 |
| 74ALS162 | Sync. 4 bit counter | 1.65 |
| 74ALS163 | Sync. 4 bit counter | 1.65 |
| 74ALS169 | 4 bit up/down sync. counter | 1.19 |
| 74ALS174 | Hex D type flip flop | 3.19 |
| 74ALS175 | Quad D type flip flop (BCD) | 1.55 |
| 74ALS191 | Sync. up/down counter (binary) | 1.55 |
| 74ALS192 | Sync. up/down dual clock counter | 1.55 |
| 74ALS240 | Octal buffer line driver/rec. | 2.19 |
| 74ALS241 | Octal buffer line driver/rec. | 2.19 |
| 74ALS242 | Quad 4 bus transceiver | 2.15 |
| 74ALS243 | Quad 4 bus transceiver | 2.15 |
| 74ALS244 | Octal buffer line driver/rec. | 2.45 |
| 74ALS245 | Octal bus transceiver | 2.45 |
| 74ALS251 | Data selector/multiplexer | 2.37 |
| 74ALS253 | Dual data selector/multiplexer | 2.37 |
| 74ALS256 | Quad data selector/multiplexer | 2.37 |
| 74ALS273 | Octal D type flip flop | 2.35 |
| 74ALS290 | 8 bit bidirectional universal snit/storage register | 5.45 |
| 74ALS352 | Dual 4 line to 1 line data selector/multiplexer | 1.19 |
| 74ALS353 | Dual | |



Features:

- Fully enclosed power supply
- On/off switch with indicator light
- Voltage plus 5V at 5A, plus 12V at 2A, minus 12V at 0.5A and 0 to 12V at 2A.
- With Prototyping Breadboard mounted right on the power supply box.

All this for only \$149.00

Other combination of set voltages and variable voltages available to order at slightly higher cost.

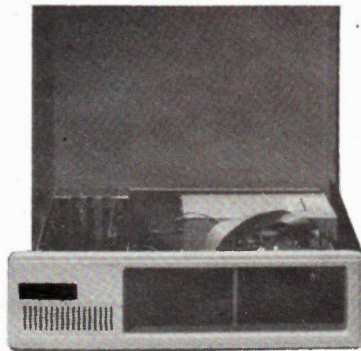

Flip-Top, 8 Slot \$ 75.00
With 150W Power Supply \$219.00

IBM Compatible Keyboards

Maxiswitch \$135.00
Keytronics 5150 \$135.00
Keytronics 5151 (Enhanced) \$249.00

Rated 90W Max
RFI filter and
fuse on board
115/230V

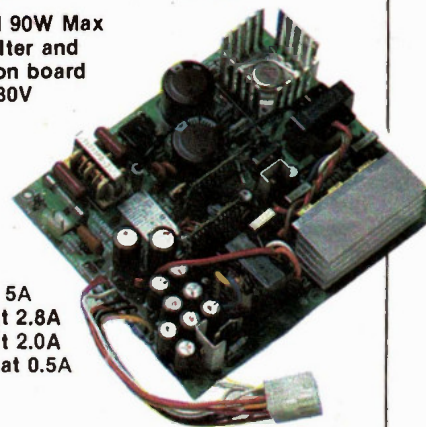

5V at 5A
12V at 2.8A
12V at 2.0A
-12V at 0.5A

Open Frame \$ 49.00

MISCELLANEOUS PARTS

DB Connector Series

| | |
|---|--------|
| DB9P Solder Tall Male | \$1.75 |
| DB9S Solder Tall Female | \$1.69 |
| DP9P Right Angle PCB Mount Male | \$2.49 |
| DP9S Right Angle PCB Mount Female | \$2.49 |
| DB9P Flat Ribbon IDC Crimp Type Male | \$5.75 |
| DB9S Flat Ribbon IDC Crimp Type Female | \$6.25 |
| DB9 Shell (Economy Type) | \$0.75 |
| DB9 Shell, High Quality | \$1.99 |
| DB15 Solder Tall Male | \$1.95 |
| DB15S Solder Tall Female | \$1.95 |
| DP15P Right Angle PCB Mount Male | \$2.95 |
| DP15S Right Angle PCB Mount Female | \$2.95 |
| DB15P Flat Ribbon IDC Crimp Type Male | \$7.95 |
| DB15S Flat Ribbon IDC Crimp Type Female | \$8.50 |
| DB15 Shell (Economy Type) | \$0.95 |
| DB15 Shell, High Quality | \$1.99 |
| CB25 Solder Tall Male | \$1.95 |
| DB25S Solder Tall Female | \$1.95 |
| OP25P Right Angle PCB Mount Male | \$4.95 |
| DP25S Right Angle PCB Mount Female | \$4.95 |

| | |
|--|---------|
| DB25P Flat Ribbon IDC Crimp Type Male | \$8.99 |
| DB25S Flat Ribbon IDC Crimp Type Female | \$9.99 |
| DB25 Flat Ribbon IDC Crimp, Economy M or F | \$5.95 |
| DB25 Shell (Economy Type) | \$0.95 |
| DB25 Shell, High Quality | \$4.25 |
| DB37S Solder Tall Male | \$4.25 |
| DP37P Right Angle PCB Mount Male | \$7.75 |
| DP37S Right Angle PCB Mount Female | \$8.95 |
| DB37P Flat Ribbon IDC Crimp Type Male | \$14.00 |
| DB37S Flat Ribbon IDC Crimp Type Female | \$14.95 |
| DB37 Shell, High Quality | \$2.95 |

Female Screen Lock Assemblies for DB Connectors \$2.49/Set

Delta Ribbon Connectors

Quantity Discounts Available

| | |
|--|--------|
| (Centronics Parallel Printer Connector) | |
| 36 Contacts Plug (IDC) Flat Ribbon Crimp Type Male | \$8.95 |
| 36 Contacts Socket (IDC) Flat Ribbon Crimp Type Female | \$9.95 |
| 36 Contacts Chassis Mount female | \$8.95 |
| 36 Contacts Solder Cable Male | \$8.85 |
| 36 Metal Shell (for solder male) | \$2.95 |

| | |
|---|--------|
| Flat Cable Card Edge Connectors (Disk Drive Connectors) | |
| 50 Pin Edge Connector (8" Drive) | \$5.95 |
| 40 Pin Edge Connector | \$4.95 |
| 34 Pin Edge Connector (5 1/4") | \$5.85 |
| 20 Pin Edge Connector (Hard Drive) | \$4.79 |

Capacitors

.1uF 50V Bypass 10c
Monolithic
100 of the above \$8.95

| | | | |
|---------------------|--------|-----------|--------|
| TANTALUM CAPACITORS | | | |
| 0.1uF 35V | \$.28 | 6.8uF 25V | \$.45 |
| 0.15uF 35V | \$.28 | 6.8uF 35V | \$.58 |
| 0.22uF 35V | \$.28 | 10uF 25V | \$.58 |
| 0.33uF 35V | \$.28 | 10uF 35V | \$.61 |
| 0.47uF 35V | \$.28 | 15uF 25V | \$.95 |
| 0.68uF 35V | \$.28 | 15uF 35V | \$1.79 |
| 1.0uF 35V | \$.27 | 22uF 25V | \$1.30 |
| 1.5uF 35V | \$.27 | 22uF 35V | \$2.25 |
| 2.2uF 25V | \$.25 | 33uF 25V | \$1.95 |
| 2.2uF 35V | \$.30 | 33uF 35V | \$2.49 |
| 3.3uF 25V | \$.35 | 47uF 10V | \$1.25 |
| 3.3uF 35V | \$.40 | 47uF 25V | \$2.70 |
| 4.7uF 25V | \$.40 | 47uF 35V | \$3.99 |
| 4.7uF 35V | \$.50 | 68uF 10V | \$1.90 |
| 8.8uF 16V | \$.40 | 68uF 25V | \$2.79 |

Other Values Available on Request.

Ceramic

Ceramic Disc. Large Selection of Values
All 10 Cents each.

Note, when ordering these, specify what voltage you require. Mosts are available in 50V and 100V.

Good In-Store Stock of Electrolytic Capacitors
Special Quantity Discounts Available.

Trim Pots

| | | | |
|-------------------------------|-----|------|------|
| P.C. MOUNT MULTITURN TRIMPOTS | | | |
| RESISTANCE | 500 | 10K | 200K |
| 20 | 1K | 20K | 500K |
| 50 | 2K | 50K | 1M |
| 100 | 5K | 100K | 2M |
| 200 | | | |

\$1.65 ea.

| | | | |
|------------|------|---------------|------|
| TRIMPOTS | | | |
| RESISTANCE | 10K | 100K | 1M |
| 250 | 500 | 25K | 250K |
| 500 | 5000 | 50K | 500K |
| 500K | | | 5M |
| OPEN CASE | 35c | ENCLOSED CASE | 85c |

| | | | |
|---------|--------|---------|--------|
| DEVICE | | | |
| 2N697 | \$.50 | 2N3391A | \$.45 |
| 2N2219A | \$.60 | 2N3394 | \$.60 |
| 2N2221A | \$.40 | 2N3415 | \$.28 |
| 2N2222A | \$.50 | 2N3440 | \$1.10 |
| 2N2270 | \$.50 | 2N3442 | \$2.25 |
| 2N2359A | \$.50 | 2N3566 | \$.78 |
| 2N2646 | \$1.42 | 2N3568 | \$.78 |
| 2N2906 | \$.49 | 2N3638A | \$.78 |
| 2N2907A | \$.52 | 2N3642 | \$.78 |
| 2N3053 | \$.70 | 2N3643 | \$.78 |
| 2N3055 | \$1.89 | 2N3645 | \$.78 |
| 2N3117 | \$1.50 | 2N3703 | \$.28 |
| 2N3227 | \$4.18 | 2N3704 | \$.31 |
| 2N3250 | \$.70 | 2N3705 | \$.29 |
| 2N4339 | \$.45 | 2N5771 | \$.75 |
| 2N4400 | \$.25 | 2N5772 | \$.37 |
| 2N4401 | \$.25 | 2N6028 | \$.45 |
| 2N4402 | \$.25 | MJ802 | \$4.50 |
| 2N4403 | \$.25 | MJ2955 | \$1.83 |
| 2N4416 | \$1.40 | MJ502 | \$5.50 |
| 2N4453 | \$4.22 | MJE340 | \$2.50 |
| 2N4556 | \$1.30 | MJE802 | \$4.95 |
| 2N4891 | \$.85 | MPF102 | \$.85 |
| 2N5245 | \$.75 | MP86515 | \$.42 |
| 2N5400 | \$.27 | MPSA05 | \$.35 |
| 2N5457 | \$.57 | MPSA13 | \$.35 |
| 2N5485 | \$.57 | MPSA14 | \$.35 |
| 2N5770 | \$.49 | MPSA18 | \$.35 |
| MPSA20 | \$.30 | TIP49 | \$1.20 |
| MPSA55 | \$.48 | TIP115 | \$.98 |
| MPSU51 | \$.78 | TIP122 | \$1.60 |
| MPSU56 | \$.99 | TIP125 | \$1.00 |
| PN2222A | \$.39 | TIP142 | \$2.95 |
| PN2906 | \$.70 | TIP148 | \$2.98 |
| TIP300 | \$.70 | TIP2955 | \$1.85 |
| TIP31C | \$.70 | TIP3055 | \$1.50 |
| TIP32C | \$1.10 | | |
| TIP33C | \$1.60 | | |
| TIP34C | \$1.65 | | |
| TIP35C | \$3.10 | | |
| TIP41C | \$1.15 | | |
| TIP42C | \$1.90 | | |

Heat Sinks

| | |
|-------|--------|
| T0220 | \$0.39 |
| T03 | \$2.99 |

LEDs

| | |
|--------------------------|--------|
| Large LEDs | |
| T-1 3/4 (Normal Size) | |
| Red (General purpose) | \$.25 |
| Green (General purpose) | \$.38 |
| Yellow (General Purpose) | \$.39 |
| Red (Extra Bright) | \$.59 |
| Green (Extra Bright) | \$.85 |
| Yellow (Extra Bright) | \$.85 |

Small LEDs (T-3/4)

| | |
|--------|---------|
| Red | \$ 0.30 |
| Green | \$ 0.35 |
| Yellow | \$ 0.35 |

Rectangular LEDs 75 cents each

| | |
|-----------------------------------|--------|
| Bar Graph Display | |
| 8-Segment, (Red, Green or Yellow) | \$4.95 |
| 35 LED Matrix 2' or 3' | \$9.95 |
| (Great for Digital Signs) | |

Rectifier Diodes

| | |
|-----------------|--------|
| 1N4001 50V 1A | \$.07 |
| 1N4004 400V 1A | \$.09 |
| 1N4007 1000V 1A | \$.11 |
| 1N5403 300V 3A | \$.40 |
| 1N5404 400V 3A | \$.40 |
| 1N5406 600V 3A | \$.60 |

Switching and Signal Diodes

| | |
|--------|--------|
| 1N34A | \$.19 |
| 1N914 | \$.5 |
| 1N4148 | \$.5 |
| 1N4448 | \$.5 |

Zener Diodes

| | |
|---|--|
| 1 Watt. All Values 25 cents each. | |
| Voltages Available: | |
| 3.9, 4.3, 4.7, 5.1, 5.6, 6.2, 7.5, 8.2, 9.1, 10, 12, 13, 15, 16, 18, 20, 22, 24, 27, 30, 33, 36 | |

Switches

| | |
|-------------------------------------|--------|
| Momentary push-button switches | \$0.99 |
| Momentary push-button switches SPDT | \$3.95 |
| On-Off Switch, SPDT | \$3.95 |

Parts for your Modem

| | |
|---|---------|
| Small Speakers | \$1.64 |
| 600 ohm to 600 ohm (1, 1) Isolation Transformers | \$9.95 |
| Relay for your modem (HE721A0500) 5V | \$4.99 |
| DAA 1812 for Modem (Contains Built-In Transformer, relay and surge protector) | \$39.00 |

Resistors

We carry a full range of 1/4 Watt, 5% resistors...5 cents each.

SCR's

| | | | |
|---------|--------|----------|--------|
| 2N5064 | \$.75 | MCT6 | \$1.25 |
| 2N6337 | \$.55 | MCT6 | \$1.99 |
| TIC106D | \$1.25 | 4N25 | \$1.10 |
| TIC116D | \$1.99 | 4N35 | \$1.20 |
| TIC126D | \$1.99 | 4N30 | \$1.39 |
| | | 4N33 | \$.88 |
| | | MOC3011 | \$1.75 |
| | | MOC3031 | \$2.25 |
| | | MOC3002 | \$2.99 |
| | | FND500 | \$2.99 |
| | | FND507 | \$2.99 |
| | | TIL313 | \$1.95 |
| | | TIL312 | \$1.95 |
| | | RBG-1000 | \$5.99 |

OPTO

TRIACS

| | |
|---------|--------|
| TIC206D | \$1.55 |
| TIC216D | \$1.99 |
| TIC226D | \$1.87 |
| TIC263D | \$4.25 |

Voltage Regulators

| | |
|--------------------|---------|
| POSITIVE | |
| 7805 + 5V 1A | \$.99 |
| 78L05 + 5V 1A | \$.75 |
| 78H05 + 5V 5A | \$ 4.44 |
| 78P05 + 5V 10A | \$14.97 |
| 7808 + 8V 1A | \$.99 |
| 78L08 + 8V 1A | \$.75 |
| 7812 + 12V 1A | \$.99 |
| 78L12 + 12V 1A | \$.75 |
| 78H12 + 12V 5A | \$10.95 |
| 7815 + 15V 1A | \$.99 |
| 7824 + 24V 1A | \$.99 |
| 78UC Adjust. 1A | 1.85 |
| 79HGASC Adjust. 5A | \$17.99 |
| NEGATIVE: | |
| 7906 -5V 1A | \$.99 |
| 79L05V 1A | \$.75 |
| 7906 -6V 1A | \$.75 |
| 7912 -12V 1A | \$.85 |
| 79L 12-12V 1A | \$.99 |
| 7915 -15V 1A | \$.99 |
| 79JUC Adjust. 1A | 1.85 |
| 79HGASC Adjust. 5A | \$17.99 |

CRYSTALS

| | | | |
|-----------|--------|-----------|--------|
| 32.768KHZ | \$1.15 | 10.24MHZ | \$2.99 |
| 1.00MHZ | \$6.95 | 12.00MHZ | \$2.25 |
| 1.8432MHZ | \$3.99 | 14.00MHZ | \$2.99 |
| 2.00MHZ | \$2.50 | 14.318MHZ | \$2.19 |
| 2.457MHZ | \$3.75 | 16.00MHZ | \$1.99 |
| 3.57MHZ | \$1.55 | 18.00MHZ | \$2.29 |
| 4.00MHZ | \$1.99 | 18.432MHZ | \$1.99 |
| 5.00MHZ | \$1.95 | 20.00MHZ | \$2.15 |
| 5.017MHZ | \$3.50 | 17.43MHZ | \$2.99 |
| 5.068MHZ | \$1.95 | 22.118MHZ | \$2.99 |
| 8.00MHZ | \$1.95 | 48.00MHZ | \$3.99 |
| 10.00MHZ | \$1.95 | | |

Wire Wrap Wire. All Colours (30 gauge)

| | |
|-----------------------------------|---------|
| 25 ft | \$2.80 |
| 50 ft | \$5.00 |
| 100 ft | \$8.95 |
| Wire Wrap /Unwrap Tool/Strip Tool | \$18.25 |
| Wire Wrap Gun and BH | \$63.00 |

| | |
|----------------------------------|---------|
| IC Extractor | \$3.99 |
| IC Insertion Tool | \$18.95 |
| High Quality 24-40 Pin Extractor | \$23.50 |

SIP Resistor Networks

| | | | |
|----------|------|--------------|------|
| Part # | Pins | Common Pin # | |
| 6-1-XXX | 6 | 1 | 0.39 |
| 8-1-XXX | 8 | 1 | 0.44 |
| 10-1-XXX | 10 | 1 | 0.59 |

XXX = Value

Multiflex Products

Multiflex Economy Video Display Terminal

Now available from MULTIFLEX is an economy video display terminal. Originally designed as a low cost access unit for our mail-ordering and bulletin board system, this terminal is a semi-intelligent system which is controlled by a Z80A microprocessor and a 6845 CRT controller chip. The keyboard is fully ASCII encoded and the character generator contains the full 128-character set as well as a 128-character alternate set both of which are in the 5x7 dot matrix format. The screen display is 80 characters by 24 lines if the unit is hooked to an external monitor. (Monitor not included). There are 3 software selectable attributes (dim, reverse video, and alternate character set) which can be chosen one at a time for the whole screen. The attribute can then be switched on and off for each individual character. A 2K buffer is provided for normal operation. However when the optional 6K memory upgrade is purchased, 4 screen pages can be loaded from the host machine, edited, locally, and then downloaded back to the host again saving on connect time and phone line bills. Also included are 2 RS232 ports: one for a modem and one so that a printer can be attached to the terminal. The baud rates on these ports are software programmable and can range from 110 to 9600 baud. With all these features, you would expect to pay a lot for this system, but all this is available to you, complete with an attractive case, for an extremely low price.

A&T board with keyboard (as picture top right) with one RS232 and 2K buffer \$169.00



Terminal Complete: Tested and 90 days warranty with 2 RS232 ports, 2K buffer case and power supply (Hydro approved)

\$299.00

Special Pricing is available when both items on this page are purchased together

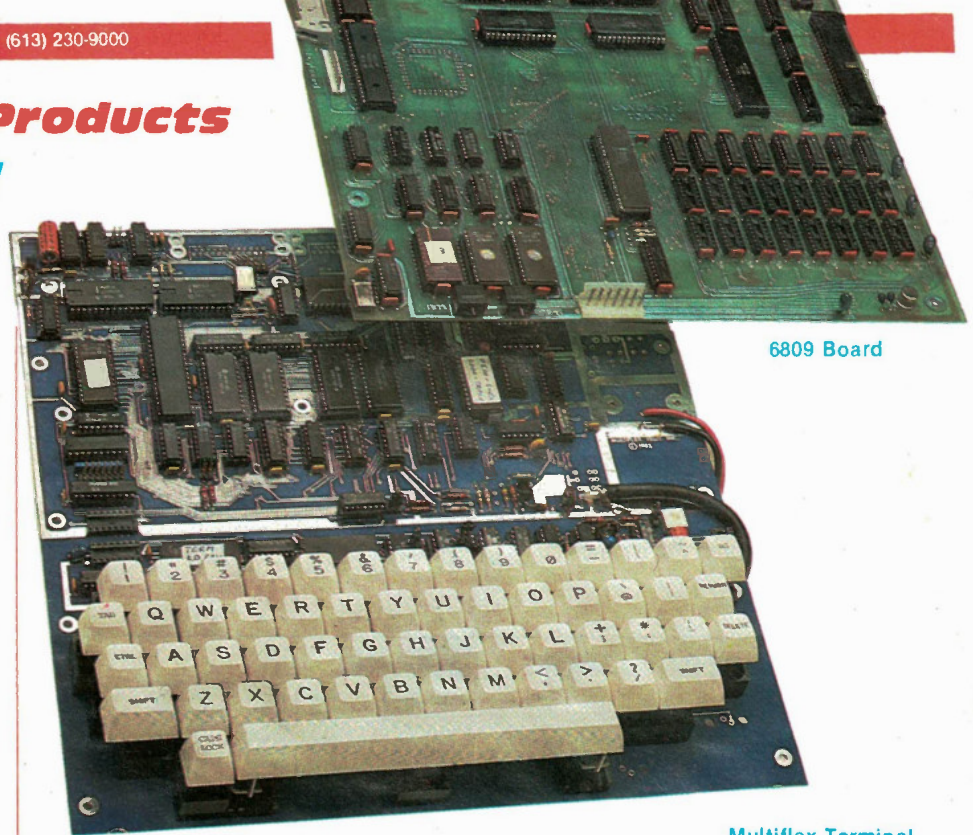

6809 Board

U of T 6809 Single Board Computer

The 6809 Single Board Computer, designed at the University of Toronto and distributed exclusively by EXCELTRONIX, is a compact hardware unit which was designed originally as a lab board for teaching students about microprocessor systems. Its many features, however, make it an ideal unit for stand-alone control applications or software development systems as well.

The system is designed around the Motorola MC6809 microprocessor. This is an 8-bit processor with full 16-bit internal architecture, 2 index registers, 2 stack pointers, 2 8-bit or 1 16-bit accumulators, a direct page register and a wide range of addressing modes, including a program-counter-relative mode. This mode allows the user to write completely position independent software, important in systems software development.

There is provision for up to 48K bytes of dynamic RAM on-board. The refreshing of this RAM is controlled by an 8202 Dynamic RAM Controller. This chip allows for completely transparent refreshing of the RAM (ie. no wait states to slow the system down). There is also provision for up to 12K of EPROM using 2532 chips.

There are 4 complete I/O circuits built onto the board. 2 of them are serial (RS232); one is used for a terminal (which is required for use of the board with the supplied monitor software), and the other one is user defineable, but it is set up to

Multiflex Terminal

communicate with either a modem or a printer. Also on-board are 2 6522 VIA chips. These provide 2 parallel ports per chip along with 2 16-bit timer/counters. One of the parallel ports and one of the timers are used by the monitor software to provide a cassette interface (which operates at 300 baud). The second parallel port on that chip is wired into a connector which is ideal for interfacing a parallel printer or keyboard. The 2nd VIA is not used at all and is completely free for the user. For further expansion of the system, a fully buffered version of the CPU signals (data, address, control lines and a signal indicating whether or not the current address is located on the board) is available at a cable connector.

The software provided with the system is in a 2532 EPROM and allows the user to: test the memory; dump blocks of memory; examine and modify single memory locations; read or write from the cassette port; set and examine breakpoints; single step and/or execute machine language programs and set and examine the processor registers. All this is accomplished through a 9600-baud terminal interface (one of the serial ports) included is a full screen editor/assembler which allows the user to work in 6809 assembly language rather than machine language. All this makes this board an ideal trainer, control unit or software development unit for just about anyone.

Includes U of T course documentation

A&T with 48K \$299

Europe's best selling oscilloscopes, made in West Germany

HAMEG

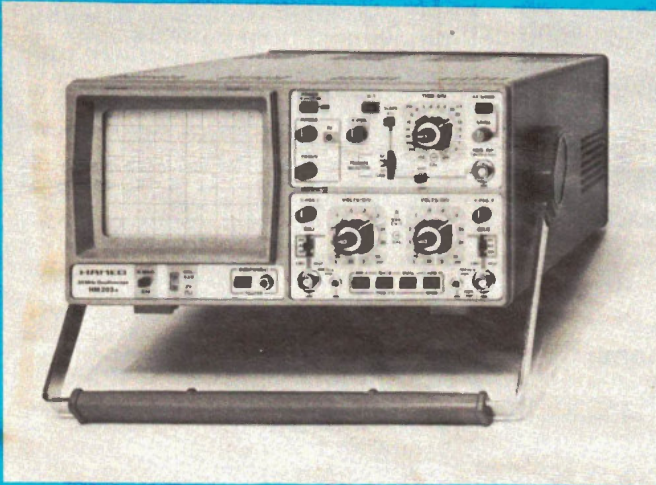

OSCILLOSCOPE HM 203-5

20 MHz Standard Oscilloscope

Y: 2 channels, DC-20 MHz, max. sensitivity 2mV/cm;
X: 0.2s/cm-20ns/cm incl. x 10 magnification;
triggering up to 40 MHz; Component Tester

\$770.00

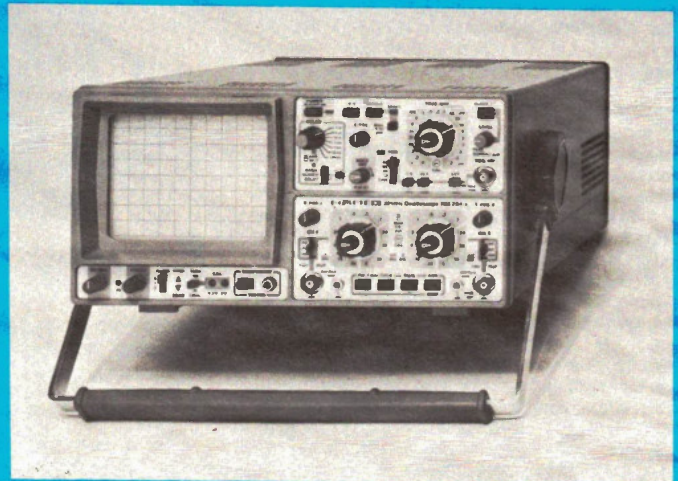

OSCILLOSCOPE HM 204-2

20 MHz Multifunction Oscilloscope

Y: 2 channels, DC-20 MHz, max. 1mV/cm, delay line;
X: 1.25s/cm-10 ns/cm incl. x 10 magnification, delayed sweep;
triggering up to 50 MHz; var. hold-off time; Component Tester.

\$1055.00

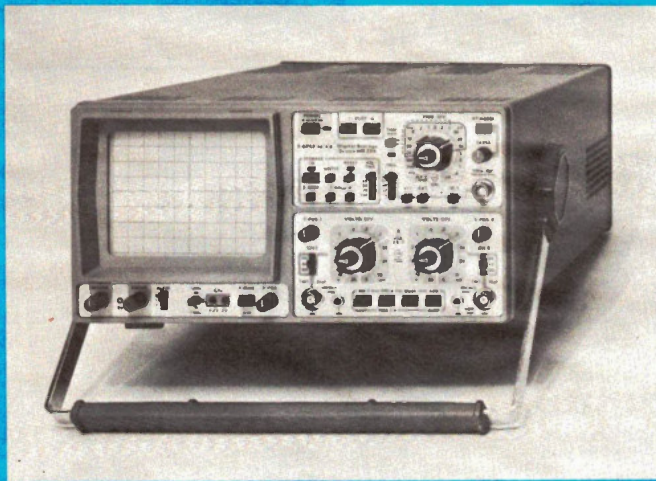

OSCILLOSCOPE HM208

20 MHz Digital Storage Oscilloscope

Y: 2 channels, DC-20 MHz, max. sensitivity 1mV/cm;
X: 0.25 s/cm-20ns/cm incl. x 10 magnification, trig. to 40 MHz.
Storage: max. clock rate 20 MHz; Single and X-Y operation.

\$3166.00

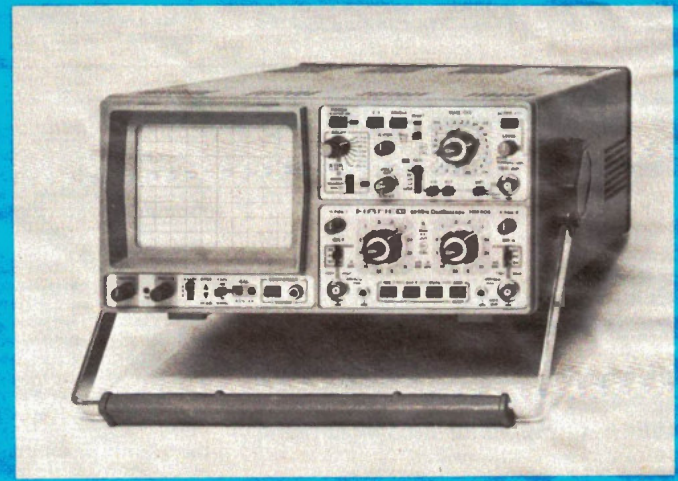

OSCILLOSCOPE HM 605

60 MHz Multifunction Oscilloscope

Y: 2 channels, DC-60 MHz, max. 1mV/cm, delay line;
X: 2.5s/cm-5ns/cm incl. x 10 magnification, delayed sweep;
triggering up to 80 MHz; var. hold-off time; Component Tester.

\$1405.00

HAMEG GmbH

West Germany is represented,
distributed and serviced in Canada by:



980 Ainess St. Unit 7,
Downsview, Ontario,
M3J 2S2
(416) 861-5585
TELEX 065-26169

Now Available from Stock
for the complete line of HAMEG instruments write or phone

Exceltronix

319 College Street, Toronto, Ont. M5T 1S2
(416) 921-8941 1-800-268-3798

Ideal for educational institutions and hobbyists.

You've just completed a microprocessor system, and it doesn't work. What next? You can use an oscilloscope to check for clock signals and the like, but if everything appears to be in order you can't go much further without sophisticated equipment. In these situations, professionals turn to their logic state analyzers, each of which cost thousands of dollars. MULTIFLEX has the answer for all those people who don't want to take a mortgage on their house just to get a computer working. The MULTIFLEX Logic State Analyzer has all the essential features of those more expensive units at a fraction of the cost. This is a high-quality piece of test equipment, suitable for industrial or scientific use, but its price is well within the price range of a hobbyist.

Easy to understand and operate, the Logic State Analyzer allows you to monitor 16 points in a digital system (i.e. data and/or address bus, or control lines) which carry continually changing signals. You can select a bit pattern you expect will appear at these points. Once the pattern appears the Analyzer will trigger and record ("freeze") the next 1023 bit patterns so that they can be examined step by step even though data is no longer available in the unit being examined. For software development the Analyzer is invaluable, especially in dedicated systems. If you design a microprocessor system for a specific function, and you have no monitor, assembler or other such software, the best and often only way to debug the system is to use a logic analyzer. It will let you look closely at the data flow as a program is executing, or monitor the address lines to make sure that the instructions are being executed in the proper sequence. The various control lines such as memory read and write, DMA, interrupts, or enable and disable signals can also be examined. You can, of course, monitor any combination of these signals, such as the data bus and half of the address bus, or half of each plus 4 control lines. The combinations are endless.

Complete, assembled and tested \$369

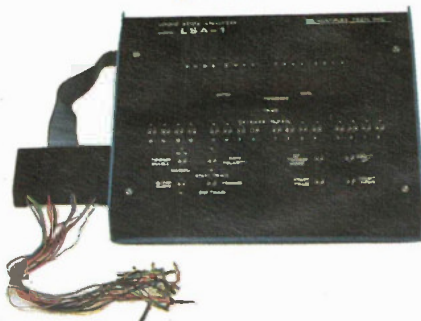

Note from Industry to Educational Institutions:

At Multiflex we interview many technicians each year, from a variety of Colleges. Only a few applicants know what a Logic State analyzer is and even fewer know how to use one.

Yet in our industry, it is almost as important to know how to operate logic analyzers as it is to use an oscilloscope since the technician will need to use a logic or timing analyzer to trouble-shoot complex equipment.

We have spoken to many other companies and found that they are experiencing the same problems with technicians coming fresh from College. So, we asked educational institutions why they don't teach this aspect of electronic engineering. The teachers are fully aware of the problem but explained that they cannot afford the high cost of logic analyzers; even those institutions which have them can afford only one or two which gives the students little chance to learn them.

Our LSA is a time-proven product which is considerably less expensive than the alternatives.

Here is your chance to prepare technicians for the real world!

If you are a computer designer who values your time, you can't afford to be without this!

Did you ever write a piece of code, burn it into an EPROM, plugged it in and it didn't work?

Did you then go through the code (using an analyzer or your brain power) and then discover you left out some crucial Byte which caused the processor go the point of no return?

If the above holds true, how many EPROMs have you reprogrammed, erased and damaged? More important how many hours have you wasted?

Put an end to all the above problems and save time, money and frustration: Buy an EPROM Emulator.

It allows you to download over RS232 (at 300 to 9600 Baud) a program from your computer into the Emulator's memory (16Kx8) and then simply plug a 24 or 28 Pin header connected via ribbon cable to the Emulator in place of your EPROM and you have successfully emulated an EPROM.

If you need to change your code, simply change it on your computer, download to the Emulator's memory and you are back in business in seconds.

This stand-alone product emulates the following EPROMs: 2716, 2732, 2764 and 27128. Can be used with any computer with an RS232 Interface.

This product is a must for any hardware development since it allows the user to test and modify EPROM data roughly 20 times faster than conventional methods.

The Emulator normally comes attractively packaged and contains its own power supply. However, to make it more affordable for beginners, we have separated the price into several categories:

1. Complete Emulator with 16Kx8 memory, attractively packaged with power supply. Fully assembled and tested with warranty. **\$189.00**
2. As above but with 8Kx8 of memory. **\$159.00**
3. Emulator with 4K RAM, no housing or power supply (requires +5V at 1.5A Max, +/- 12V at 0.03A). Fully assembled and tested. **\$99.00**

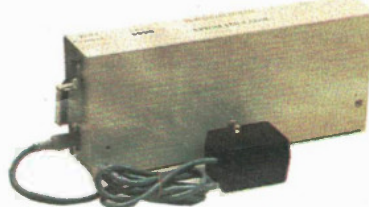

S100 Starter System

Complete, Assembled and Tested

\$299

Options:

64K Dynamic RAM and Multiplexers

\$19.95

Big Piggyback Board with RS232 and Real Time Clock

\$179

RS232 Option for Motherboard

\$38.00

DC to DC Converter Option

\$29

Extra S100 Connectors

\$5.95

S100 Video Board

\$149

S100 Floppy Disk Controller

\$199

S100 256K RAM Card (with 256K)

\$250

S100 CPU Board with 64K

\$149

MULTIFLEX's Z80 computer is a versatile and expandable stand-alone computer system designed and built right here in Canada. It uses the newest technology to provide the user with the most capabilities for the smallest price-tag. Its adaptability to any situation and extremely low cost allow it to be used in many applications ranging from a trainer to a complete CP/M-based computer comparable to the best on the market, at a fraction of the price.

The actual layout of the system is a two board design. One board (the "motherboard") contains a 24-line parallel I/O chip for interfacing to the external world, an RS232C serial port with baud rates selectable from 110 to 9600 baud, a hex address and data display, a

hex keypad, 14 monitor function keys, 2 user definable keys, a 40-chip wire wrap area with full access to all the bus signals, on-board provision for regulators so that the board can be supplied with standard S-100 voltages, an EPROM programmer which will handle 2708 (1Kx8), 2716 (2Kx8), 2732 (4Kx8) 2532 (4Kx8), 2764 (8Kx8) and the brand new 27128 (16Kx8) EPROMs, a DC-to-DC converter to supply the programming voltage to the EPROM programmer and four (4) slots for IEEE S-100 compatible boards for further expansion. This is an extremely useful and important feature as it allows expansion of the system with all boards using this industry-standard bus structure, which are available from MULTIFLEX, as well as from hundreds of manufacturers worldwide.

The other board is the CPU card. This card plugs into one of the S-100 slots on the motherboard and is IEEE 696/S-100 compatible with the full 24-bit address path to allow up to 16 megabytes of memory to be addressed. The processor used is the Z80 (running up to 6 MHz) and there is provision on-board for 64K of dynamic memory (using 4164 chips) which will operate without wait states. Provided for as well is a 2K to 32K (selectable in 2K blocks) common resident area in memory for use with multiple memory banks. There are also 4 sockets on board which will handle 2732 (4Kx8) or 2764 (8Kx8) EPROMs or the new 6116/2016 (2Kx8) static RAMs (all of which can be software deselected if desired) to allow the user complete versatility in setting up the board to meet his own specifications. Also on board is 1 parallel port with 24 lines of I/O and 3 16-bit counter/timers for applications which require the unit to keep track of real time. Another feature of the CPU board is that it was designed by our engineers to run the CP/M 2.2 disk operating system so that if a floppy disk controller board is added to the system a fully configured CP/M machine can be set up for a very low cost.

The monitor software that comes with the kit is a well-written extensive package which allows the user to have complete versatility in machine language programming and execution as well as control of all the features on the board. The monitor functions include: examine/modify memory locations, memory block moves, compare 2 blocks of memory, examine CPU register, ex-

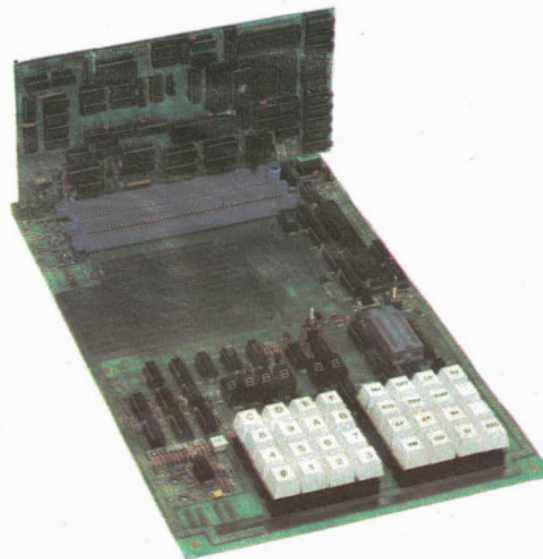

amine I/O ports, load and save from cassette calculate relative branch offsets, set breakpoints single step programs, execute programs, and program EPROMs. Each of these process is invoked by a single keypress. Also available to the user are 2 spare keys definable for special functions a required by specific applications and applicator programs.

The standard kit includes the CPU board with a Z80A (4MHz) processor, 2K of RAM (a 6116), and 4K of EPROM (a 2732) as well as the motherboard with all the features mentioned above except the RS232C port and the DC-to-DC converter. Also supplied are sockets for all IC's and 1 S-100 connector.

Every business needs attention. In today's competitive marketplace you need to get the customers' attention and you need to get your message across - as boldly and as dynamically as possible.

Two versions are available, single and double row. Each row holds up to 21 standard characters and can be expanded to up to 42 characters. The LED (Light Emitting Diode) display is available in red (standard or extra bright), green and yellow. Standard, wide (2", upper and lower case) and bold tall (4", upper case) come with the display. All can be displayed normally or in inverse (black characters on a lit background) image format. You can even program your own characters and graphic symbols. As well as the standard LED display, larger, brighter incandescent light bulb displays can be built to your specifications. All programming features are retained, and the standard LED display is included for ease of programming.

A wide variety of features allow you to catch the public's attention - choose from Wipe-On and Wipe-Off, Spell-On, Flash and Blink, Shift left and right, Scroll up and Down - in any order and at individually selectable speeds.

Up to six different events can be displayed simultaneously within dynamically selectable boundaries. Up to 128 labelled messages can be stored within the units memory for display at any preselected time and date and in any order. 12,288 character memory is standard on the Versadigital Display. This can be expanded to 36,864 with optional external read only memory modules.

Text can be entered through the Display's own keyboard, from an ordinary cassette recorder, from optional external memory modules, or optionally over telephone lines, radio or infra-red link or over AC wiring. A comprehensive set of commands allow complete control over the display's facilities. A powerful word processor type editor lets you easily write, edit, run, save (on cassette) and transmit messages.

The Sign That Can Sell Your Product

Research has shown that digital displays can increase sales by up to 30%. The Versadigital Display virtually assures that figure by increasing the readers' involvement. An optional inter-



Versadigital signs are in use throughout the Toronto subway system and Vancouver LRT. Send for reprint of article in Computing Now!, July 1984.

The sign that also talks

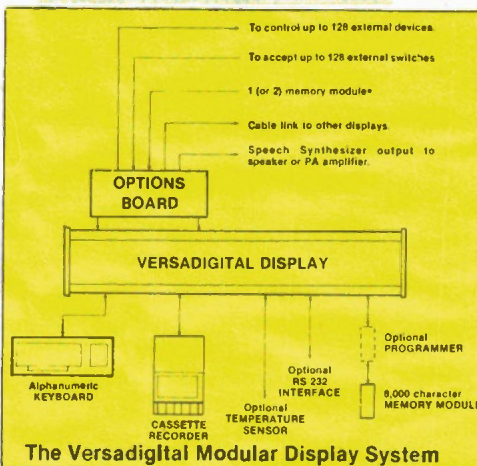

face allows up to 128 switches to be connected to the Display, enabling customers to select specific messages without having to wait for the sign to cycle through its repertoire.

The optional External Accessory Interface allows you to write messages that actually point to the product being discussed. At selected points within your message you can program the Display to turn on an external light or a bell. Thus your message might be saying "You won't find these shoes anywhere else ..." and the Display will then activate a lamp highlighting the product. Up to 128 external devices can be controlled in this fashion. This feature alone makes the Versadigital Display the most effective sales tool you can have.

Versadigital Technology in conjunction with Multiflex Inc. also manufactures Time and Temperature displays and can build dynamic plaza maps to your specifications. Our extensive engineering experience enables us to design to a wide variety of situations. Whether it is modifying a current product, or designing new equipment, tell us what you need, we can deliver!

All prices in this catalogue are subject to change without notice.

Distributed by Exceltronix Inc.
319 College Street, Toronto, Ont., M5T 1S2
(416) 921-8941

Digital Modem

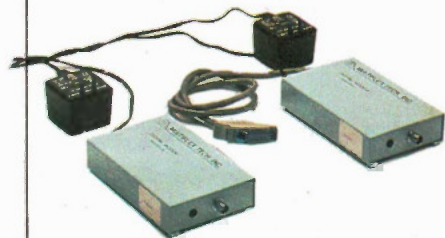

DO YOU HAVE A PROBLEM? Lack of wires for two-way communications? Do you have a single coax cable between four floors of a building?

If the above holds true for you, as it may well do, if you wish to put equipment in some older Government buildings which were wired years ago, using a single coax to communicate between main frames and which may now be obsolete, you need our solution. If you want to communicate using RS232 between your computers and all you have is a single coax between rooms or floors or buildings, now you can do it without rewiring using our economical solution.

About a year ago we were approached by a Government agency asking if we could solve the problem described above. Well, we solved their problem economically, in fact it worked so well that they bought hundreds of units from us.

The Digital Modem consists of two boxes (approx. 6" x 4") and two wall adaptors. Now you can simply have the RS232 of your computer terminal or other devices plugged directly into one of our Digital Modem boxes (which has a wall plug adaptor to get its power) and you can run up to 800 feet over a single wire to another of our Digital Modem boxes (which again has its own CSA approved power supply) and you again plug in the RS232 DB25 connector to your equipment. Now you can communicate at 9600 Baud or faster (or slower) simultaneously in both directions using your existing single coax cable wiring.

Digital Modem Pair . . . \$350.00

(Two Boxes and two adaptors) Quantity Discounts. It works perfectly!

All prices and specifications in this catalogue are subject to change without notice. Please follow our ads monthly in Electronics Today and Computing Now!. Whatever market conditions exist, you will find our prices the most competitive in Canada.

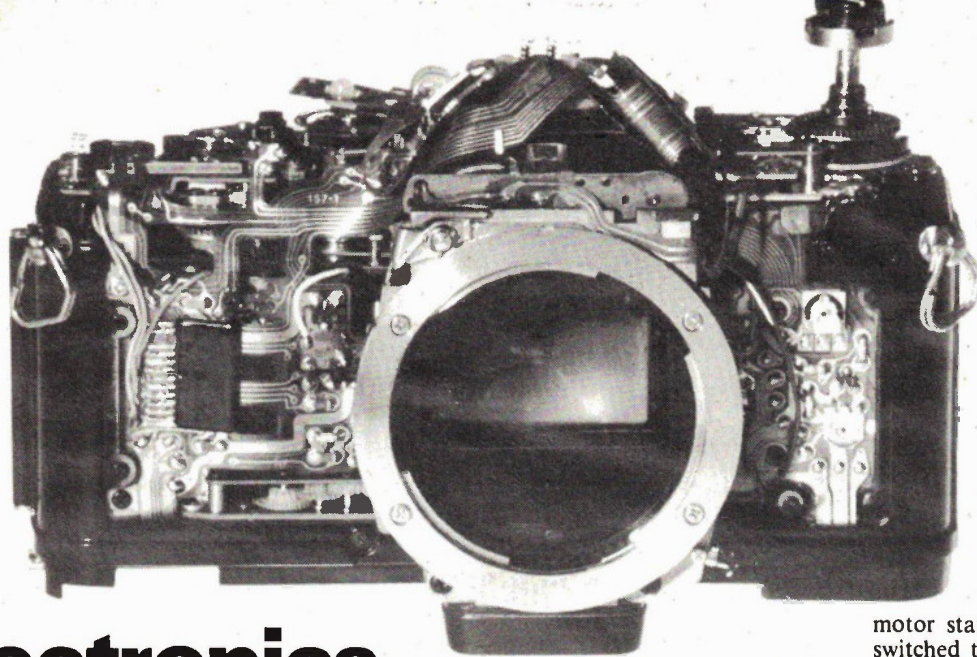

Electronics in Photography

The ubiquitous microprocessor finds its way into photo gear to eliminate number-crunching and make battery manufacturers happy.

By Bill Markwick

WHEN I bought my first camera in the 60s, it had a selenium meter on top which read out an exposure value. You then matched this value by turning the shutter and/or aperture rings. The selenium cell wasn't sensitive enough to respond to anything but daylight, but I thought it was great.

About the same time, cameras began to appear with through-the-lens, battery-powered meters coupled to the shutter. Then you could add filters or go from sunlight to candlelight, all without fiddling with exposure controls. These cameras, in varying degrees of sophistication, held sway until recently.

Once microprocessors and dedicated ICs became available for next to nothing, gadget designers went crazy designing them into everything. All sorts of features now became possible with the new low-cost control circuitry.

Cameras

Once designers decided to replace the transistor with the microprocessor, they were faced with the dilemma of finding something for it to do. After all, if you've got all this computing power sitting there, it seems a shame to have it do nothing but calculate the exposure and then just sit on its bytes.

At the moment, the Minolta Maxxum 7000 is the best example of the full-blown microprocessor camera. Everything but the shutter button is under electronic con-

trol, and you can even get a remote control for that. Here's a tour of the Maxxum, chosen because it has just about every possible microelectronic feature in one camera body.

The first thing you'll notice if you pick it up and touch the shutter button lightly is that it has autofocus. The lens will turn automatically to focus on the area inside the tiny focussing rectangle. The next thing you'll notice is that the camera suddenly takes a picture with an accompanying whine from the motor drive. Everybody around here did that: focus and jump when they held the button down too long. The autofocus has its own IC, a small surface-mount, one of eight on the flexible PC board that wraps around the innards.

The Minolta autofocus uses a rangefinder approach rather than sending out beams of infrared or ultrasonic sound. The image is split through two tiny lenses which project it onto a CCD array; the two signals produced are checked for phase difference, and the resulting output is converted to micromotor rotation signals by the autofocus IC. The lens is then rotated until the images are coincident; the time required for the entire procedure depends on the lens in use: the normal 50mm lens takes 300mS to focus from 1m to infinity, a speed typical of most of the Minolta AF lenses. The micromotor, incidentally, uses four speeds. If the lens has to be turned most of the way, the

motor starts at the highest speed and is switched to slower and slower speeds as the lens approaches proper focus. This prevents overshooting and hunting for the correct stop point.

Like any rangefinder, the AF system prefers to look at vertical lines rather than horizontal, and pointing it at a blank wall confuses it. Under most conditions, however, it's *very* difficult to fool. It even focussed accurately on a ceiling tile covered with those random holes for sound absorption. The AF can be set to manual focussing if you prefer; if you don't like the split-second lag while the motor runs, Minolta makes a continuous-focus version, the Maxxum Professional, Model 9000.

Now to get some film in it. You don't have to fiddle and fumble with the film leader and spools any more; just lay the film in and close the back. Cameras such as the Maxxum, the Canon T70, the Konica FT-1, the Nikon 2000 and others feature autoloading, not necessarily an electronic feature, but certainly a mechanical marvel. The electronics comes into it with the contact pins for Kodak's DX film encoding. The subject was covered in a previous article (*Kodak DX Coding*, August, 1985), so we'll limit it to saying that the camera will set the ISO speed automatically and also optimize exposure for negative or positive colour films; it does this by contacting conducting or non-conducting patches on the cassette. If there are small contacts in the right-hand side of the well that holds the film cassette, the camera has DX coding.

The next major use of the microelectronics is in controlling the exposure. First of all, most cameras these days use the silicon blue cell for light sensing; it's a photodiode with a flat response to visible light. The diode produces a current proportional to the light intensity and is connected to a current-to-voltage converter such as a high-gain amplifier with resistive feedback from output to input. The output voltage of the converter can be used directly, as in simpler match-the-needle metering, or converted to a digital code to light the LEDs or run the LCD display in electronic cameras.

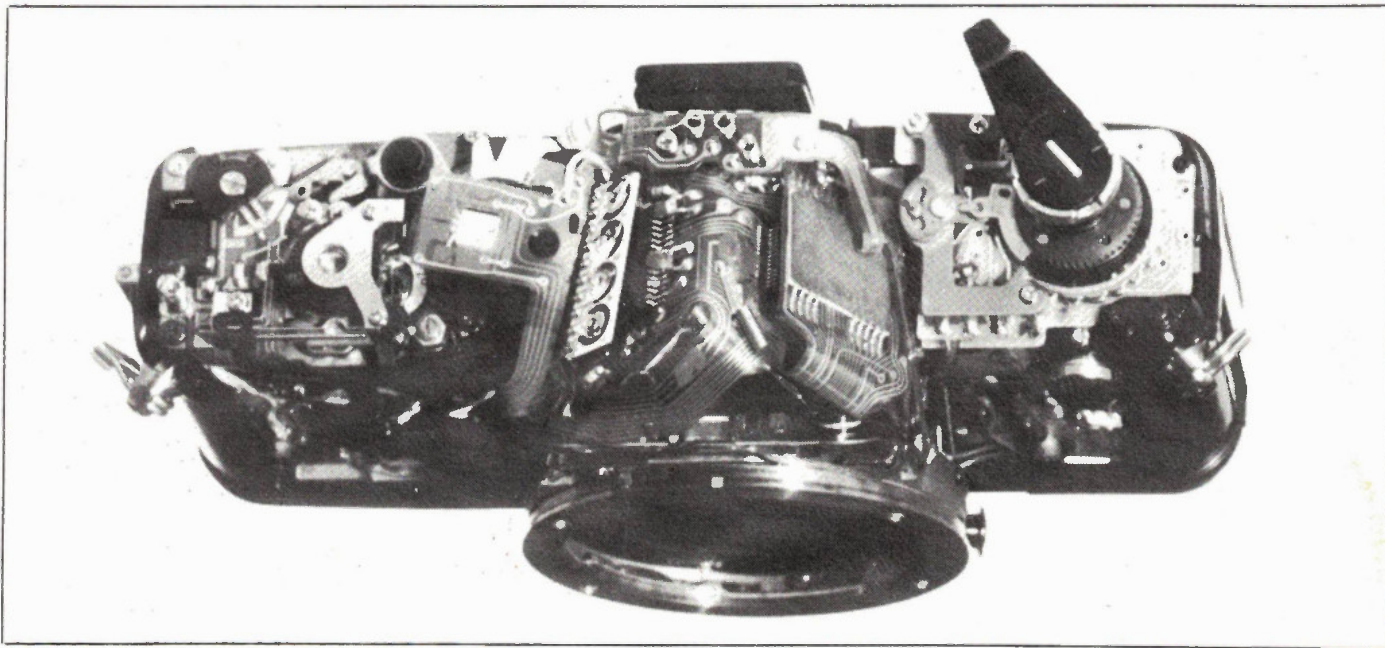

Top view of a naked electronics camera supplied by Yashica. Unless noted, photos for this article were taken by Ed Zapletal using either a Pentax ME Super or a Maxxum.

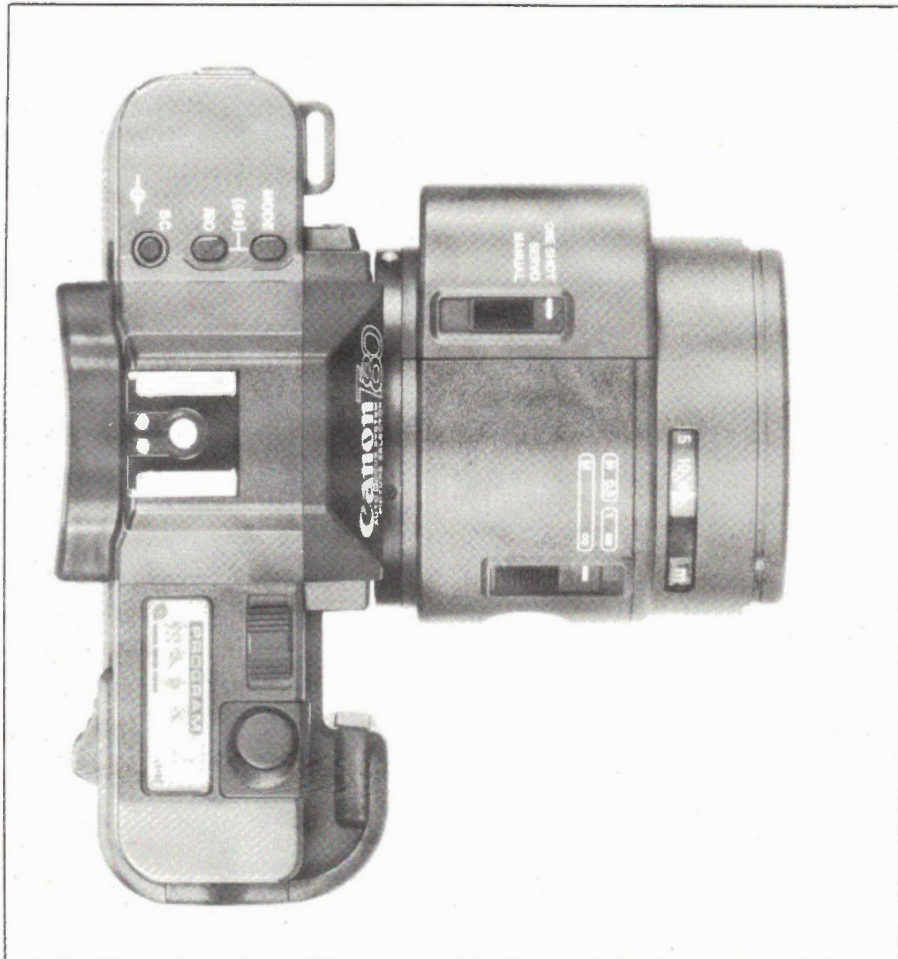

Top view of the Canon T80 showing the LCD program display and an add-on autofocus lens.

The great advantage to the silicon cell is a nearly instant response to changes in light intensity, unlike the older cadmium sulphide cells which had slow attack and release times as well as a "memory" effect (they take a while to adjust their resistance levels after being in bright light). Not only can the camera respond instantly to changing light, but the light from dedicated flash units can be controlled by interrupting the flash duration when the through-the-lens cell tells the controlling IC that enough light has happened.

But that's nothing; controlling the exposure value is the simple part. The designers used some of that CPU potential by coming up with different exposure modes. The Minolta boggles the mind. You can have shutter-priority to hold a selected shutter speed and vary the aperture, aperture-priority for the other way around, a locking mode to hold a desired reading, and manual. In addition, when you change lenses a ROM in the lens tells the CPU that it's just arrived and to reset the program; long lenses get a faster shutter speed to prevent shake, and so on. Besides that, you can step any program in 1/2 stop increments. All the various gyrations display on an LCD window as well as in a tiny frame in the viewfinder. Gad-zooks. What would George Eastman say?

The major camera manufacturers all have some version of the gee-whiz electronic camera: Canon, Nikon, Pentax, Vivitar, etc. We only used the Minolta as an example of what can be done.

You might wonder whether you should take out a second mortgage to buy batteries to run all these dooies. Actually, the cameras are remarkably efficient in turns of power consumption; the Maxxum spec sheet claims 25 rolls of 24-exposure film from its four AAA cells. There's also a tiny lithium battery with a 10-year life; it keeps the memory alive if you have to change batteries in the middle of things.

The most remarkable achievement in batteries is from Kodak: their 4000 disk camera has a lithium battery that runs the motor drive, the flash and the electronics, and it lasts so long it isn't even user-replaceable.

Before leaving cameras, we should point out that you don't have to buy a top-of-the-line camera to get electronic control. You've probably noticed the proliferation of pocket cameras with auto-everything. The Vivitar TEC45 on our cover, for instance, is a compact 35mm with a CPU that controls DX coding, infrared autofocus, autoloop, autowind, exposure, and flash. Like all similar pocket cameras in this price range, it's designed for point-and-shoot only; there are no controls to play with. There's one serious omission from the hi-tech of the simpler cameras: there are some people who don't like gadgetry of any kind and when they take a picture, they flinch as if they were firing a shotgun. The only answer is an IC-controlled 50-pound flywheel to lock the camera onto the subject and prevent heads from being cut off.

Flash Units

All major manufacturers supply flash units dedicated to their particular camera model: pins on the hotshoe or extension cord let the camera and flash coexist peacefully, and some flash units have settings to suit different cameras. When set for the Leica R4, for instance, the presence of a 1.3V signal on the extra flash pin tells the CPU that the flash is present and to set the shutter to the flash sync speed (to make sure that the shutter is fully open during the flash duration). When the flash reaches full charge, the 1.3V increases to 2.5V and begins to pulse between these limits, lighting the indicator in the viewfinder that says the flash is ready. Most cameras have a similar system.

For some years now, the old full-power, adjust-the-aperture flash method has been replaced with the thyristor system. The flash fires, a photocell in either the camera or the flash body measures the light, and when the proper exposure is reached, an SCR cuts off the flashtube. This has the advantage of conserving battery power and shortening recycle times as well as eliminating that irritating aperture twiddling.

Enter the microprocessor once again. A good example of what can be done is the Vivitar 5200. First, the bottom part that mates to the camera is actually a small module available in versions to suit the requirements of most popular cameras. The flash unit itself has the usual 4-stop automatic control range plus 12 manual stops, but the electronics really come into it with the LCD readout. This window displays the ISO speed, the maximum distance, the zoom head setting, and the f-stop. If you're on manual, there's no more measuring and calculating. If you're on automatic, there's nothing to do at all.

Electronics Today December 1985

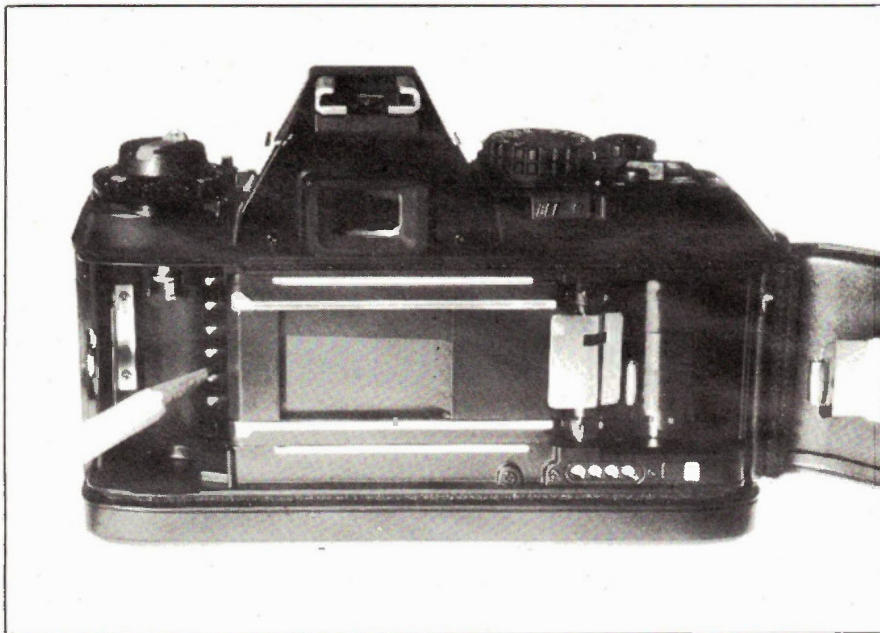

The pencil points to the contacts that touch conductive patches on DX-coded film cassettes. The four circles under the takeup spool are databack contacts.

continued on page 65

PROBES FOR SALE

FROM THE BEST SOURCE FOR OSCILLOSCOPE PROBES AND DMM/VOM TEST LEAD SETS.

- Low cost
- High Quality
- Excellent Performance
- Slender, Flexible Cable

- Wide Range of Choice
- Switchable X1 and X10 Attenuation Factor
- 100 MHz Bandwidth

MODEL SP100

\$25.00

Please add \$2.00 for shipping

Your Probe Specialists

BCS

ELECTRONICS LIMITED

980 Alness St. Unit 7,
Downsview, Ontario,
M3J 2S2
(416) 661-5585
TELEX 065-28169

Coline Canadian Sales & Stocking Source

Store Hours: Monday to Friday 8:00 am to 5:00 pm.
Saturday: 10:00 am to 1:00 pm.

Electronics Today

LITERATURE REVIEWS



KIK OSCILLOSCOPES

From Kikusui Electronics, Japan's leading scope manufacturer, comes a range of 17 20 to 150 MHz scopes. Most have Level Lock™ automatic peak-to-peak triggering, and all offer high-resolution display with across-the-screen autolinear focus. Built for MTBF of 10,000 hours, yet 10 to 15% cheaper than competing scopes. Available features include five-wave simultaneous viewing, multi-channel X-Y operation, and more. From INTERFAX SYSTEMS INC.

Circle No. 58 on Reader Service Card.

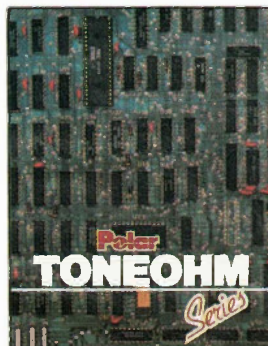

POLAR TONEOHM SERIES

Designed to locate PCB faults without cutting tracks or lifting components, the TONEOHM series features digital and sound output. The 580 is a low-cost current tracer, suitable for finding bus faults, multilayer shorts and wiring loom problems. The 550 is designed for location of short circuits, even by semi-skilled or unskilled operators. The Top of the line 700 offers 1uV resolution, allowing DC current to be followed. Available from ATLAS ELECTRONICS.

Circle No. 61 on Reader Service Card.



RENTAL CATALOG

LEASAMETRIC (CANADA) INC. — leader in ELECTRONIC EQUIPMENT RENTAL — offers general purpose test equipment, microprocessor development systems, telecommunications equipment, video display terminals, desktop controllers and personal computers.

LEASAMETRIC'S strength is its broad inventory and full range of service. Tell us your application and we'll help you to select the equipment that's right for you. Rent from LEASAMETRIC and you get equipment that is ready to work.

Circle No. 59 on Reader Service Card.



DYNAMIC PC/XT

From COMPTON SYSTEMS you get more features from IMC's Dynamic PC/XT. Seven slot motherboard with two floppy disks or one floppy disk and a 10MB hard disk. Multi-I/O Card includes floppy controller, parallel printer port, RS-232 serial port, joystick port and realtime clock. Easy opening swing-top cabinet with ABS front panel, hardware reset button and locking key. Power supply generates ample 135 watts.

Circle No. 62 on Reader Service Card.

Order your 1986 Catalog Today!

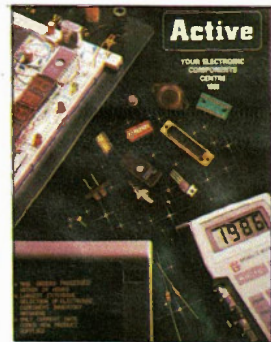

ACTIVE COMPONENTS

Canada's coast to coast leader in electronic distribution has just released its comprehensive 1986 catalog. Packed with everything you need in electronics from resistors to state of the art microprocessors and microcomputer I.C.'s. A comprehensive selection of tools, test equipment, computer peripherals and more. Over 10,000 items available and complimentary specifications and cross references that answer your every need. Eight stores from Mtl. to Van., mail or phone orders processed within 24 hours. You get convenience and fast service from one source.

Circle No. 60 on Reader Service Card.

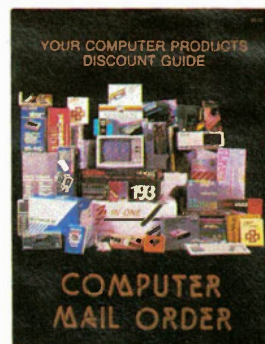

COMPUTER MAIL ORDER

Whether you're looking at name-brand computer systems, top-name peripherals or classic software, you're bound to find it in the COMPUTER MAIL ORDER catalogue, at discounts of up to 50% over your local retail store. Take advantage of free product consultation, large selection and next-day computerized shipping. Any purchase qualifies you to automatically receive two catalogues a year to keep you up to date on the latest products and prices.

Circle No. 63 on Reader Service Card.

Tools and Tool Cases for Technicians who travel.

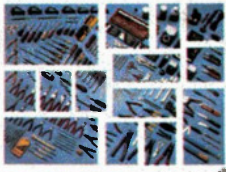

LENLINE TOOLS AND TOOL CASES

If you're a technician on the go, a well stocked tool kit is a must. Len FINKLER & CO. carry a wide range of tool kits, well stocked with standard and hard to get secondary tools. The cases are made by Platt from tough, durable industrial materials. Lenline is flexible too. Because you know what tools you need to get the job done, you can design the tool kit that is best suited to your needs, from student to professional engineer.

Circle No. 64 on Reader Service Card.

WYSE WY-30 TERMINAL

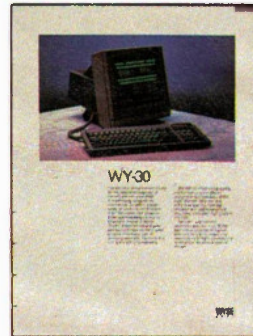

The WY-30 is designed specifically for the entry-level segment of the ASCII terminal market. Offers high-quality mechanical switch keyboard, crisp 80-column display, sturdy Touch-Tilt mechanism, multiple emulation modes, and 41 user-programmable functions. Tilt/swivel base and height-adjustable arm optional for users with specific ergonomic requirements. Available from COMPUTER DISTRIBUTION INC.

Circle No. 68 on Reader Service Card.

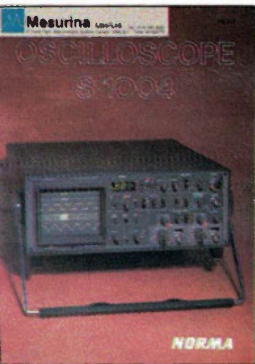

NORMA OSCILLOSCOPES

From Norma, of Vienna, Austria, comes a complete line of high-quality oscilloscopes. The new two-beam, 50 MHz S1004 features high sensitivity and rapid time-base, plus a number of user-friendly display facilities. The S1007 is a lightweight, portable 20 MHz dual-channel scope, with integrated digital memory unit. The S1010 and S1011 are versatile, low-cost two-channel scopes. All are available in Canada from MESURINA LTD.

Circle No. 65 on Reader Service Card.

KB ELECTRONICS



Why pay more? Most popular brand oscilloscopes, digital and analogue multimeters, insulation testers, economy and laboratory type R.F. generators, function generators, etc. Lowest industry cost.

**We Import and Sell Direct...
You Save**

Circle No. 69 on Reader Service Card.

Color Pinwriter

NEC



NEC COLOR PINWRITER

COMPUTER DISTRIBUTION INC. introduces two new printers from NEC. With the 80-column CP2 or 136-column CP3 you can print in seven colors (plus black), selecting any of 8 fonts from the operator panel. Featuring serial or parallel interface, 18-wire print head, 180 cps draft mode, 90 cps near-letter quality (NLQ). Standard 3.5K bufer, optional international character sets, cut sheet feeder.

Circle No. 66 on Reader Service Card.

INFORMATION UNLIMITED SCIENCE CATALOG



INFORMATION UNLIMITED INC. is a New Hampshire Corporation formed solely for the development of scientific and electronic products and devices. These are made available as do-it-yourself projects, as plans and kits, or fully assembled and tested. Complete catalog of 'Amazing and Fascinating Devices' covers lasers, ultrasonic and high sound pressure acoustical devices, geiger counters, infrared see-in-the-dark viewers... and much more.

Circle No. 70 on Reader Service Card.

RETS HIGHTECH TRAINING

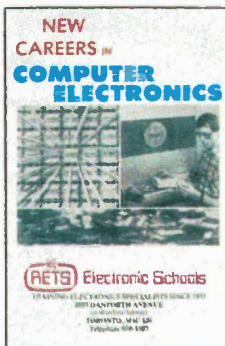

RETS practical training is for those who want a career in repair and maintenance of electronics and computer hardware. Few courses give as much "learn by doing" experience as RETS. The electronics technician course is open to those with no previous electronics knowledge. The computer technician course is open only to those with previous digital electronics knowledge. Both courses are given part and full time and financial assistance is possible. Call 698-5287 for a free booklet and complete information.

Circle No. 67 on Reader Service Card.

Courses: Electronics Technician and Computer Technology.

TELEVIDEO AT COMPUTER



The TeleVideo AT provides performance you can't get from the IBM PC/AT. Switch-selectable 80286 CPU runs at either 6 or 8 MHz — up to 30% faster than the IBM PC/AT. Space on board for up to 640K of RAM. Serial and parallel ports, monochrome graphics are standard. Both 1.2 Mb floppy and 20 Mb hard disk drives available. Six PC/XT slots. Available from COMPUTER DISTRIBUTION INC.

Circle No. 71 on Reader Service Card.



Monitor not included

THE SUPER FAST TRANSPAC II

CSA approved 150 watts power supply, genuine Keytronics Keyboard, 256K RAM, 2 serial and one parallel ports, real-time battery back-up clock plus speed selectable via external switch. 4.77 and 8MHz uses 8088-2 processor. (Most software will run on the higher speed.)

\$1825.00

Other configurations

- TRANSPAC III
10 Meg Hard Drive/1 Floppy/256K \$2586.35
- TRANSPAC IV
10 Meg Hard Drive/2 Floppy/256K . . . \$2749.00
- TRANSPAC V
20 Meg Hard Drive/1 Floppy/256K . . . \$2804.88
- TRANSPAC VI
20 Meg Hard Drive/2 Floppy/256K . . . \$2967.53

SUPERB IBM PC & XT COMPATIBILITY AND MORE...

Not just Hardware but also Software compatibility. Supports PC-DOS and CPM/86. Will run all your favourite software such as Lotus 123, Autocad, Flight Simulator, Dbase III etc.

MULTIFUNCTION FEATURES COMES AS STANDARD

- 2 Serial Ports (not just 2)
- 1 Parallel Port
- Real Time, Battery Back-up, Clock
- Memory expansion on-board to 1 megabyte
- 64K and 256K chips can be mixed
- Optional 8087-2co-processor
- Sasi Hard Disk Interface
- 54K User Definable Rom expandability
- Low Cost Modem Interface
- Ram Disk software included

FLOPPY CONTROLLER CARD COMES AS STANDARD

Will Support Up To 4 Floppies

HIGH-SPEED BOARD COMES AS STANDARD

Speed Selectable Between 4.77 MHz and 8 MHz via external switch.

Note: Up to now all these features were only available by purchasing expensive interface cards. Now with the ACS-1000 single board supercomputer (see reviews in March and May Issues of "Electronics Today") all these features come as standard on one board. Whats more, since the ACS-1000 is a product of Top-Down integration all these functions will work together as never before. And, more importantly, since everything is already on the main board the remaining expansion slots will give you true expansion capability.

PLUS MORE

- genuine Keytronics Keyboard
- reset switch
- speed selection via external switch
- 150 watt CSA approved power supply
- quiet slim-line DS DD 5 1/4 360K disk drives
- colour video adaptor included. RGB and composite board or Hi-Res monochrome board. (customer choice)
- ONE YEAR WARRANTY
- even after all the above standard features you still have 6 expansion slots
- made in Canada
- 256K RAM standard minimum

WARRANTY

The TRANSPAC computer not only offers you high quality and high performance at low cost but also gives you one full year's service warranty — parts and labour — right across Canada from Xerox, one of the most reputable service organizations in Canada. This is possible because of the extra care we take in sourcing our components and our quality control. For example, every computer that leaves our site undergoes in total 72 hours of burning-in. This ensures a very high reliability rate in the field and of course, satisfied customers.

TRANSPAC TRADING CORP.

for the computer that is not just another look-a-like

5485 — 128th St., Surrey, B.C. Canada V3W 4B5

Order line only 1-800-663-0073 Telex: 04-365628

Master Charge & Visa, Certified Cheque, COD, Money Order accepted. Shipping & Insurance extra.

IBM, PC, XT & PC DOS are registered trade marks of IBM Corp., CPM/86 is a registered trade mark of Digital Research, Inc. MS DOS, Flight Simulator are registered trade marks of Microsoft Corp. Lotus and 123 are registered trade marks of Lotus Development Corp., Dbase III is a registered trade mark of Ashton Tate. Autocad is a registered trade mark of Autodesk. Xerox is a registered trade mark of Xerox Canada.

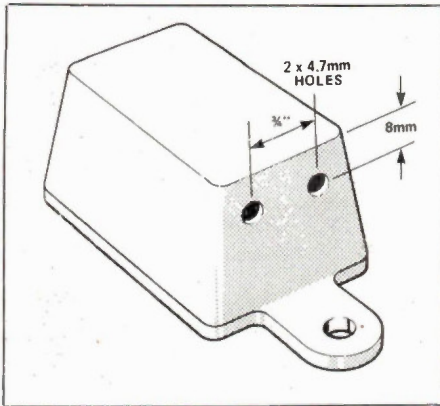

Fig. 2 Case details for the heat pen.

First of all it is necessary to make a cover for the box. This may be made from glass fibre sheet or plastic sheet. Use the box as a template and draw around its shape on the plastic sheet with a scriber. Cut out the shape with a hacksaw. After dressing up the cover with a file, temporarily clamp it to the box and drill two mounting holes through the lugs of the box and cover. Drill and file a hole in the cover for the on/off switch.

The hole will have to be carefully positioned so that the switch does not foul the 9V battery when the unit is assembled. Fit the switch to the cover. Drill two 4.7mm holes in the side of the box (Fig. 2) to allow the 4mm terminals to protrude from the box and one small hole in the opposite end of the box for the shielded cable.

Tie a knot in the shielded cable about 25mm away from the PCB and then pass the cable through the small hole in the box. Pass the two 4mm terminals on the PCB through the two holes in the box and continue to pull the shielded cable through the hole until the PCB is positioned at the bottom of the box.

Pass the shielded cable through the empty ball point pen casing and solder it carefully to the Intersil temperature sensor. The AD590JH has an accuracy of 5 degrees, the AD590IH is 10 degrees, and the AD590KH is 2.5 degrees. The 590-type ICs will be about five dollars, except for the KH version, which will be about ten. The Intersil ICL8069 is available in various tolerances, with the suffix DCZR indicating .01 percent and a price of about two dollars.

Connect the shield to the +ve lead and the case lead of the sensor. Connect the core to the -ve lead of the sensor. Insulate the leads from each other with sleeving; then the sensor can be positioned at the tip of the pen casing and secured with adhesive. Solder the +ve lead of the battery clip and the +ve lead from the PCB to the two switch terminals. The Heat Pen is now ready for calibration.

Calibration

A crude but effective way of calibrating the Heat Pen is in iced water. Ideally the water should be distilled and free from contaminants which may alter the freezing

point temperature. It is important to ensure that water does not penetrate the leads of the temperature sensor as it will cause a leakage current to flow and thus give an erroneous reading. Therefore place the heat pen probe in a plastic bag and place in a vessel of iced water. Switch on the Heat Pen and with your DVM monitor the voltage at pin 7 of IC1 with respect to 0V. Adjust RV2 for 2.73V.

Now plug the Heat Pen into the DVM. Adjust RV1 until 0.00V is obtained. The unit is now calibrated to 0 degrees C. Cut out a piece of foam rubber to fit on top of the PCB in the box. This is to prevent the battery casing from short-circuiting the components, and also to prevent everything from rattling around inside the box. Fit the battery on top of the foam rubber and fit the cover with its switch to the box and secure with two nuts and bolts. □

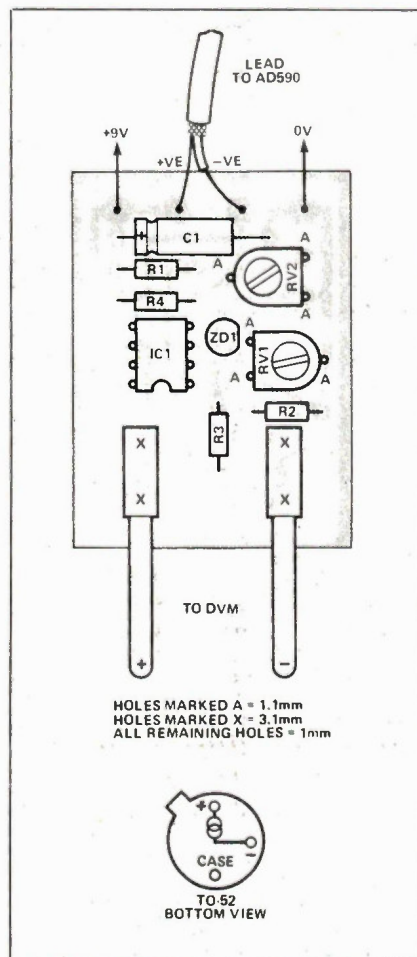
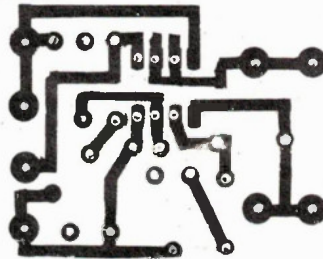

Fig. 3 Overlay diagram and pin-out of the AD590 temperature transducer.

PARTS LIST

| Resistors (All 1% metal film) | |
|-------------------------------|-----------------------------|
| R1 | .68 |
| R2 | .56k |
| R3 | .75k |
| R4 | .9k 1 |
| RV1 | 10k horizontal line pre-set |
| RV2 | 2k horizontal line pre-set |

| Capacitors | |
|------------|----------------------------|
| C1 | 1u0 16V axial electrolytic |

| Semiconductors | |
|----------------|---|
| IC1 | LM358N |
| IC2 | AD590JH |
| ZD1 | TSC9491BJ or ICL8069DCZR or any 1.225V bandgap voltage reference with tolerance ± 2% and temperature coefficient of 100ppm/degC |

Miscellaneous
PCB; 4mm terminals; battery clip; small on/off toggle switch; 9V battery; ball point pen casing.



**This ad is for all those
who ever wonder
where the money goes.**

It goes to children like this one. And to millions of other children and adults who require the services funded by a local United Way.

If you gave in your community last year, your gift to your local United Way went to make this kind of help possible. And, it was also used to help many others in your community who need help.

That's the way the United Way works. One gift, one time each year, helps hundreds of thousands of people all year round. Thousands of different, good causes in communities all across the country. Including yours.

Thanks to you, it works,
for ALL OF US  **United Way
Centraide**

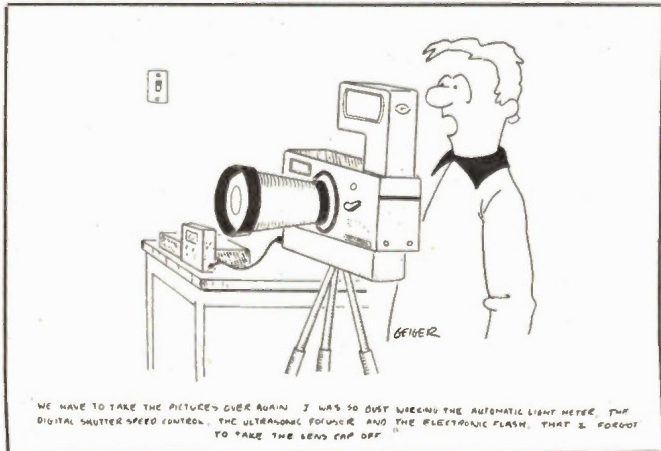

WE HAVE TO TAKE THE PICTURES OVER AGAIN I WAS SO DUMB WIRING THE AUTOMATIC LIGHT HERE, THE DIGITAL SHUTTER SPEED CONTROL, THE ULTRASONIC FOCUSER AND THE ELECTRONIC FLASH, THAT I FORGOT TO TAKE THE LEAD CAP OFF.

Electronics Today December 1985

Moorshead Publications Order Form

Subscriptions:

Please complete reverse side of order form to start or renew a subscription.

Back Issues: \$4.00 each; Ontario residents add 7% sales tax.
Please circle issues desired.

| | | | | | | |
|------|----------|-----------|-----------|----------|----------|----------|
| 1977 | February | | | | | July |
| 1978 | April | May | September | November | December | |
| 1979 | February | March | April | May | July | |
| | August | September | October | November | December | |
| 1980 | January | February | May | June | November | December |
| 1981 | January | February | March | April | June | July |
| | August | September | October | November | December | |
| 1982 | January | March | April | May | June | |
| | July | August | September | October | November | December |
| 1983 | January | February | March | April | May | June |
| | August | September | October | November | December | |
| 1984 | January | February | March | April | May | June |
| | July | August | September | October | November | December |
| 1985 | January | February | March | April | May | June |
| | July | August | September | October | November | |

On the following items please add \$1.00 for postage and handling plus 7% Ontario provincial sales tax.

Special Publications:

| ITEM | QTY | AMOUNT |
|------------------------------------|-------|----------|
| Electronic Circuit Design \$3.95 | | \$ |
| Projects Book No. 2 \$3.95 | | \$ |
| Personal Computer Guide \$3.95 | | \$ |
| 50 Top Projects \$4.95 | | \$ |
| Your First Computer \$3.95 | | \$ |
| Computers in Small Business \$3.95 | | \$ |

Binders: Electronics Today; Computing Now!
 Moorshead Publications
\$9.75 each plus 7% P.S.T.

BOOKSHELF ORDER FORM

| Code (e.g. BP12) | Title (Short-form is O.K.) | Price |
|---------------------|-------------------------------|----------|
| | | \$ |
| | | \$ |
| | | \$ |
| | | \$ |
| | | \$ |

SOFTWARE ORDER FORM

| | |
|--------------------------------|-----------------|
| | \$ |
| | \$ |
| | \$ |
| Sub Total | \$ |
| Tax (Ontario Residents) | \$ |
| Postage | \$ |
| Total Enclosed | \$ |

Orders from the Bookshelf are tax exempt. Please add \$1.00 for postage. Remember to put your name and address on reverse side. See over for mailing details.

Do you currently subscribe to Electronics Today Yes No Computing Now! Yes No Computers in Education Yes No



BOOKS, BACK ISSUES, SPECIAL PUBLICATIONS, BINDERS — SEE OVER

Moorshead Publications

Suite 601, Overlea Blvd., Toronto, Ontario M4H 1B1.

MERCHANDISE ORDER Please fill out, form overleaf
SUBSCRIPTIONS: NEW SUBSCRIPTION RENEWAL

Electronics Today
 One year (12 issues) \$22.95 Two years (24 issues) \$37.95.

Computing Now!
 One year (12 issues) \$22.95 Two years (24 issues) \$37.95

Computers in Education
 One year (10 issues) \$25.00 Two years (20 issues) \$45.00

Outside Canada (US Dollars)
 For U.S. please add \$3.00 per year other countries add \$5 per year

NAME _____

ADDRESS _____

TOWN/CITY _____ PROVINCE/STATE _____

CODE _____ DATE _____

POSTAL CODE _____

- Cheque enclosed DO NOT send cash
- Mastercard Account No. _____
- Visa Account No. _____
- American Express Account No. _____

Expiry Date _____

Signature _____

**INDEPENDENT LAB TEST SHOW
 NEW ELECTRONICS TODAY
 BINDERS TO BE NEW AND IMPROVED!**



WE thought that the Electronics Today magazine binders had reached a state of perfection unmatched by any other product short of Brian Mulroney's suits.

Then the boys in the back room got at them and stayed up late at night redesigning the system that holds the rods that hold 12 issues of Electronics Today without cutting or punching.

They moved the rod holders further apart so that the spines of the magazines aren't ever crumpled, and they grouped the rods in pairs to hold the magazines neatly a nice distance apart.

We were overwhelmed. We called NASA to say that these binders should be taken on the next shuttle flight and shown to the grateful world on the evening news, but we haven't heard back yet.

The binders are available for \$9.75 each; the scientists in the lab haven't got around the fact that Ontario residents must add 7% Provincial Sales Tax. Send to:

Binders
Moorshead Publications
 Suite 601, 25 Overlea Blvd.,
 Toronto, Ontario M4H 1B1

FET Power Amp

A simple design for a 50 watt amp using complementary power FETs.

By Jeff Macaulay

WHEN power MOSFETs were first introduced a few years ago, they were heralded as the audio designer's dream device. Nevertheless, despite several designs in popular magazines, they haven't yet fulfilled their promise of causing the demise of normal transistors.

This writer is sure that one of the reasons for this may simply be that the designs published so far have all been rather complicated. Normally several transistors are used in cascaded Darlington and differential pairs. It is not necessary to have a complex circuit to adequately exploit the potential of FETs.

The circuit described here uses a pair of complementary FETs in a six-transistor circuit. As it stands, the circuit will deliver 50 watts into 8 ohms and about 75 watts into 4 ohms. Capacitor coupling to the speaker avoids the usual problem of blown speakers in the unlikely event of complete circuit failure. FETs will withstand a certain amount of abuse during an output short circuit, though the latter is not highly recommended.

Read the specifications of the devices, and you'll see that the input impedance is thousands of megohms. From this it would seem that almost anything would be capable of driving them, but this is not so because there is a gate to source capacitance that has to be charged and discharged by the driver circuit.

With the devices chosen, this capacitance is on the order of a nanofarad. The maximum rate at which this capacitance can be charged depends on the current available from the driver. The highest audio frequency encountered is 20kHz. To enable the amplifier to deliver this a slew rate of 2V/uS is required. With a 5mA driver current a slew rate of 5V/uS is obtained, a comfortable enough margin.

The other peculiarity of power FETs is their temperature characteristic. In complete reverse to normal transistors, they have a negative temperature coefficient. This means that as the device gets hotter it attempts to cut itself off and delivers less current for a given bias voltage.

With normal bipolar devices, the hotter they get the harder they turn on. This effect, called thermal runaway, can lead to disastrous consequences. As a result, the bias arrangements found in power amps are often highly complicated, using transistors to compensate for temperature rises in the output. Without this sophistication, bipolar devices would get hotter and pass more current, a vicious circle that can destroy the outputs.

Because of the more civilized behaviour of power FETs, all that is needed for bias is a trimpot.

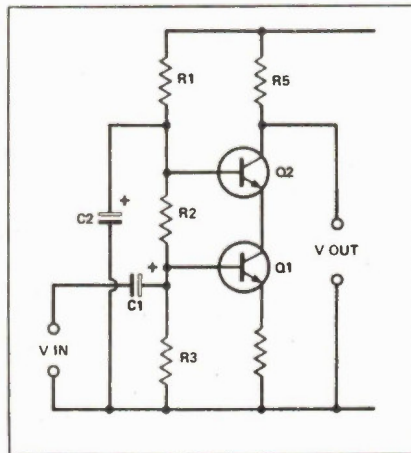

Fig. 1 The circuit of a simple cascode amplifier: our circuit is opposite.

The Cascode

Fig. 1 shows a simple cascode amplifier. The two active devices, in this case bipolar transistors, are in a 'totem pole' arrangement. To understand it properly it must be broken down into two sections.

Q1 is used in the emitter follower mode. Base bias for both transistors is obtained from the resistive divider formed by R1, R2 and R3. The junction of R1 and R2 is decoupled to ground by C2, removing any supply line noise and producing smooth, quiet DC on Q2's base. Consequently a smooth DC appears on Q2's emitter. Thus Q1 operates from a low impedance, low noise supply: Q2's emitter.

As I mentioned previously, Q1 is operated as an emitter follower. In this configuration the input impedance is high, equal to the transistor's current gain multiplied by the transistor's current gain in ohms. In a practical circuit, the input impedance is shunted by the parallel resistance of R2 and R3. R1 doesn't enter the picture because it is effectively shunted to ground by C2. The signal that

appears at the emitter of Q1 is very nearly equal to the input signal, but the current gain is high. That is, the input voltage effectively appears across the emitter resistor, causing large current variations in Q1.

The overall effect of Q1 is producing a varying current drive for Q2. This kind of circuit, a voltage to current converter, is known as a transconductance amplifier.

Q2 is employed as a common base amplifier. This configuration is rarely seen, but has advantages over the common emitter stage. Chief among these is high linearity; the major disadvantage is the high output impedance and low input resistance. In our application these are not important considerations.

The cascode will normally be biased so that the emitter current of Q1, flowing through R5, sets the collector of Q1 at half the supply voltage. Under these circumstances, the voltage gain is equal to R5 divided by the emitter resistor.

Thus the stage is a high impedance, highly linear voltage amplifier with considerably better performance than can be obtained with other configurations.

The Circuit

The full circuit of the amplifier is shown in Fig. 2. With reference to Fig. 1, signals are coupled into the base of Q1A/1B which are connected as a Darlington pair which acts as a single very high gain transistor.

The pair is the transconductance part of a cascode driver, the rest of the circuit being completed by a second Darlington pair, Q2 and Q3. To obtain maximum open loop gain, no emitter resistor is used. The current provided by the cascode generates a highly amplified voltage at Q3's collector.

Drive for the FETs is taken from this point in the circuit. As Q4 and Q5 are complementary, a small amount of bias is required to prevent crossover distortion. Crossover distortion is produced when the output transistors don't conduct soon enough as the signal rises from zero; the voltage across trimpot RV1 provides a small forward bias so the outputs will follow the signal at low levels.

C3 is called the bootstrapping capacitor. Its function is to ensure that Q4 can turn on hard enough during positive cycles. Imagine that Q1 and Q3 are turned off; all that remains to turn Q4 and pull it up to the positive supply is the resistive bias divider. However, one end of C3 is charged by the output line, and when the output goes in the positive direction, it dumps the charge on C3 into the bias resistors, providing an extra voltage boost

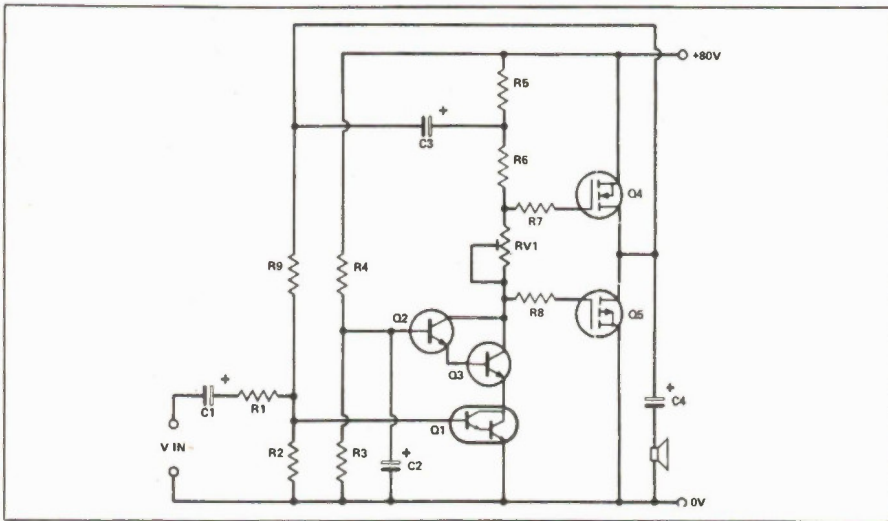

Fig. 2 The circuit of our cascode amplifier. Q1 contains in effect two transistors connected as a Darlington pair.

for Q4. C3 also provides the same signal at R5/R6 as is present on the collector of Q3, isolating the driver from power supply noise.

R7 and R8 provide stability by forming a lowpass filter in conjunction with the FET input capacitance. The output is connected to the speaker via a large electrolytic capacitor, isolating the speaker from DC; this is particularly important should a transistor fail. The low frequency cutoff point is determined by this capacitor. Using the value specified gives the amp a -3dB point of 10Hz.

Overall shunt feedback is applied from the output stage to the base of Q1 via R9 and R2. Together they form a potential divider to bias the amplifier so that the output is at half the supply voltage. R1 defines both the input impedance and the voltage gain of the amplifier. With 27k for this resistor the sensitivity is 600mV for full output. The voltage gain is R9/R1, assuming that the amp is being driven by a fairly low impedance source (less than 2000 ohms). R1 can be reduced to about 10k if more gain is required.

The amp can be powered by a simple fullwave supply consisting of a transformer, a rectifier, and a large

capacitor. The transformer should be 50 to 55 volts, with a current rating of 2A or more.

Construction

Most of the components are mounted on the board as shown in Fig.3. Q4 and Q5 are mounted on a heatsink with the usual mica washers, nylon bushings, and silicone grease for electrical isolation and good heat conduction.

All that is required for setting up is a multimeter. Set it on a range that will indicate 50mA DC and connect it in series with the power supply lead. Set RV1 for minimum resistance and apply power. If the needle bangs over, shut the power off immediately and check for faults, particularly components with wrong polarity or solder bridges. If everything is OK, the meter will read something like 5mA. Gradually turn RV1 until the reading is 30mA. Reconnect the power lead and measure the voltage at the positive side of the output capacitor C4 (i.e., the junction of the two FETs). It should be about half the supply voltage, give or take a few volts.

If these tests are OK, all you need is a speaker and a signal source. ■

PARTS

Resistors (All 1/4 W 5%)

| | | |
|-------|-------|------|
| R1 | | 27k |
| R2, 3 | | 22k |
| R4 | | 330k |
| R5, 6 | | 3k9 |
| R7, 8 | | 560R |
| R9 | | 820k |

Capacitors

| | | |
|-------|-------|----------------|
| C1 | | 10u 16V |
| | | radial electro |
| C2, 3 | | 100u 25V |
| | | radial electro |
| C4 | | 2200u 50V |
| | | axial electro |

Semiconductors

| | | |
|----|-------|----------|
| Q1 | | MPSA 13 |
| Q2 | | MPSA 42 |
| Q3 | | MJE340 |
| Q4 | | MTN10N10 |
| Q5 | | MTMP810 |

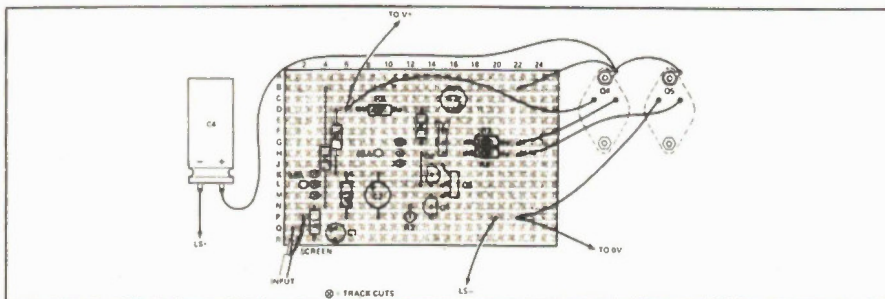
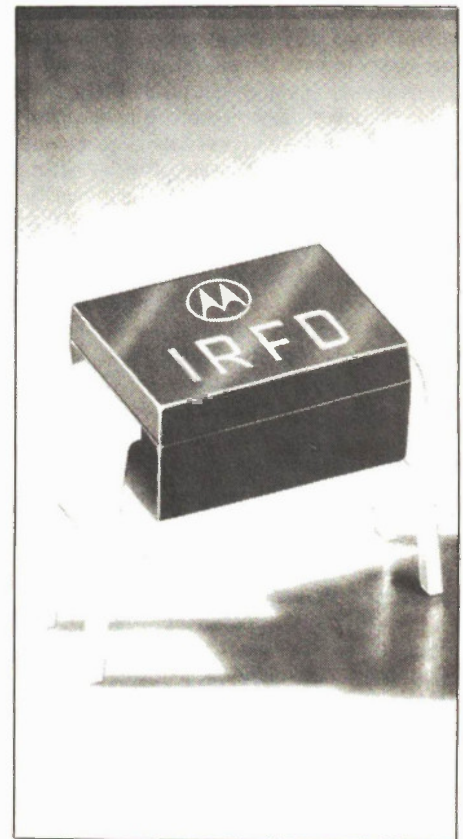

Fig. 3a. The component layout on Veroboard: construction is simple, but pay attention to the track cuts and components orientation.

given the current state of computing power and mathematical theory. These functions can form the basis of a public key encryption process.

Imagine for a moment that you are a cryptanalyst in the pay of Universal Generality Inc, and you have just intercepted a message intended for International Monolithic Co (IMC). The message is the encrypted form of a single ASCII character and looks like this: 0110010.

From a public directory, you obtain IMC's encrypting keys which are: a) 5 and b) 221.

You also know that IMC uses a standard form of encryption which is: raise the message to the power of the first key, 5, and express the answer modulo the second key (mod. 221).

It seems as if you have plenty to work with; you know how the encrypted message was produced from the plaintext and you also know the keys used to generate it. Surely you can just reverse the process to get back to the original message?

A little experiment will quickly convince you that this is indeed a one-way function; you can't go back by the same route that you took on the way out. But where does that leave IMC? Surely they can't get the plaintext message back

either? Here we have the essence of the Public Key system: yes, IMC can recover the message because there is a trapdoor in the encryption process which allows them to go back by a different route. IMC can use this trapdoor because they have the deciphering key, UGI can't because they haven't.

As an expert cryptanalyst you will have even more information at your disposal than I have already given you. You will know how IMC's secret key can be generated. IMC's second public key is the product of two prime numbers, 'p' and 'q'. These were selected at random by IMC when they were first setting up the system. The product of the primes (221) is published, but the primes themselves are known only to IMC.

The secret key was generated as follows: one was subtracted from each of the primes 'p' and 'q' and another number 'r' was formed by multiplying together the results, so $r = (p-1) \times (q-1)$. The secret key 's' was then formed by taking the multiplicative inverse modulo r of the first public key (5), in other words a number s was found such that s is less than r and $s \times 5 = 1$ modulo r. Decryption is then carried out in the same way as the encryption process, with the secret key substituted for the first public key.

Your main task as cryptanalyst to UGI is to factor IMC's second public key. If you can do this, you will be able to generate their private key and decipher their message. In this case it is not difficult, but suppose the second public key had been 6533431. Can you find the factors of this? (It can be done.)

Finding primes and testing for primality is a fairly fast process: to test a 130 digit number for primality would take a matter of minutes on an average minicomputer. On the other hand, to find the prime factors of a 130 digit composite formed by multiplying together two 65-digit primes would take quadrillions of years with the fastest computers and most efficient factorization algorithms available today. It is this vast difference in computing times that allows the system to be set up, yet makes it unfeasible to break.

Before getting too carried away by big numbers, it's worth remembering that a public key system devised by mathematicians at Stanford University in the USA, using a different process, has already been broken, and that was just for a \$1000 bet. If anyone can find a factorization algorithm that will operate in a time comparable with finding primes the system will be useless; it would take as long to set up as it would to break. ■

Product Mart *Where Buyers Find Sellers*

EVER want parts or information from U.S. Electronics Manufactures? Over 200 listed in new book. Everybody from Apple to Zenith. \$5.00 to the Address Book, IWS, P.O. Box 19810, Indianapolis, IN 46219-0810 Dept. 24.

HOBBILT ELECTRONIQUE

**WE DON'T SELL COMPUTERS.
WE JUST SELL THE PARTS!**

Send your name and address along with \$1.00 to: 7454 Langelier, St. Leclerc
Montreal, Que. H1S 3A7.
Tel: (514) 259-5581.

"DIGITAL ORGAN AND DRUM KITS, Demo LP \$8.00 (Plus \$2.00 P/H), Professional Mixer and Speaker Kits, Eprom Programmer Kit, Free Information from SELTRON INSTRUMENTS, 39 Southbridge St., Leamington, Ontario N8H 4N4.

**DO SMALL
ADVERTISEMENTS
ATTRACT ATTENTION?
WELL, THIS ONE DID!**

WHERE BUYERS FIND SELLERS

For more information Call:
(416) 423-3262

PRODUCT MART

J&J ELECTRONICS LTD., Box 1437E, Winnipeg Manitoba R3C 2Z4. Surplus and Semiconductor Specialists. Do you get our bargain flyer? Send \$1.00 to receive the current literature and specials and to be placed on the mailing list for future publications.

SALE-TIMEX-SINCLAIR SOFTWARE

LARGEST selection in Canada. Many new. Send \$1.00 refundable, for free catalogue. Hardware, Software, Audio, Electronics, Robotics, Free DMM offer. More **GLADSTONE ELECTRONICS**, 1736 Avenue Rd., Toronto, Ontario M5M 3Y7.

EXCITING scientific and electronic devices you can build. Many fascinating plans and kits available. Catalogue \$2.00. Mail order only. **DUKER ENTERPRISES** 8307-160 Street, Edmonton, Alberta T5R 2H2.

Force Sensor

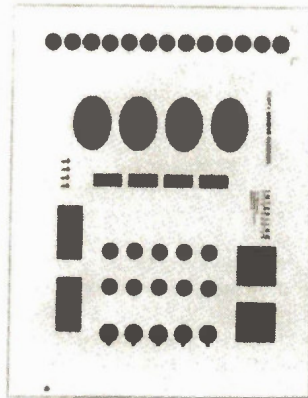

Interlink Electronics announces a new electronic component called a Force Sensing Resistor. The device consists of a sheet resistor on a film backing; a sheet conductor is placed over the resistor. The resistance with very light contact is in the megohm range; as force is applied, the resistance falls to a minimum value which can be tailored from 100 ohms to 100k

ohms. Applications for the FSR include low-cost switching devices, motor controls, electronic drum pads, etc. A sample sent to ET worked as claimed; now we have to find something to make with it. From Interlink Electronics, 331 Palm Avenue, Santa Barbara, CA 93101, (805) 965-5155.

Circle No. 40 on Reader Service Card.

Copyboard

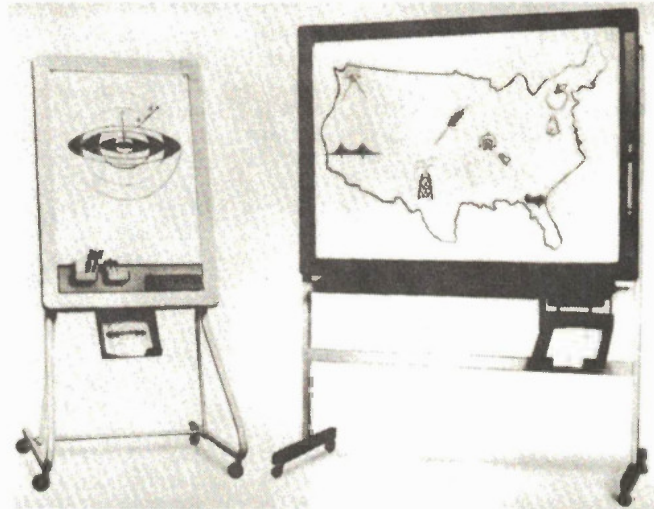

The Oki Copyboard consists of a white writing surface similar to a blackboard, connected electronically to a thermal printer. It allows each member of the audience to receive an 8 1/2 by 11 copy of whatever appears on the board. There are two versions; the

largest is 58 by 75 inches. After the print is made (about 10 seconds), the board can be erased for the next presentation. From Office Equipment of Canada Inc., 525 Denison St., Markham, Ontario, (416) 491-9330.

Circle No. 41 on Reader Service Card.

NEXT MONTH IN Electronics Today

Heatsinks

How to find out what power your semiconductors are dissipating and how to select a heatsink for any given temperature rating.

More On Transformers

Delayed from last month, we present the continuation of October's Guide To Transformers; find out how to select transformers for unusual applications such as autotransforming and DC conversion.

Soldering Tools

Using a proper soldering station is a delight compared to the pencil types; we cover some of the units available, along with desoldering tools as well.

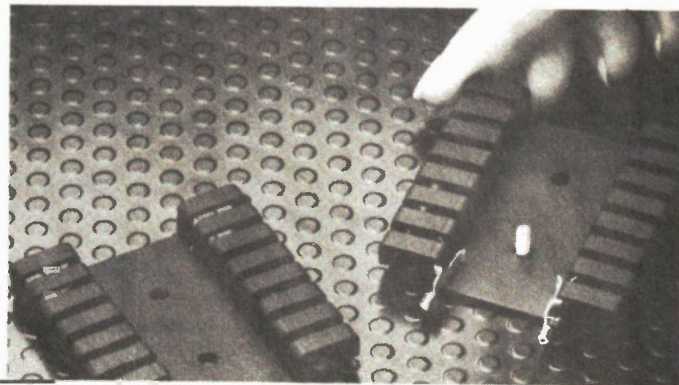

For Subscription or Advertising Information Call (416) 423-3262

Audio Generator

The BTL audio frequency generator features 5 ranges from 10Hz to 1Mhz, a 7V RMS no-load output, and a 6-step 10dB attenuator; sine waves or square waves are switch-selectable.

Amplitude stability is within 0.5dB. From Brunelle Instruments, 73 — 6th Range South, St. Elie d'Orford, Quebec J0B 2S0, (819) 563-9096.

Circle No. 42 on Reader Service Card.

Vacuum Tweezers

Pick up small objects or vacuum tiny carpets. The MH-100 vacuum tweezers feature 0.02 to 0.06 pounds of suction, depending on the pad used. Its pump is oil-free.

ideal for clean rooms. Medo USA Inc., 808-C North Central Avenue, Wood Dale, IL 60191, (312) 860-0500.

Circle No. 43 on Reader Service Card.

This Month in

Computing!

NOW!

RTTY For The Apple

Takes radio-teletype code from a shortwave receiver and converts it to an ASCII display on your screen.

I Ching For The Mac

High tech meets mysticism with a program to display and interpret hexagrams.

Personal Composer Review

We check out this remarkable music software for the PC.

Video Cards For The PC

We discuss the various video display cards that are available for the PC; find the optimum card for your text and/or graphics applications.

For Subscription or Advertising Information Call (416) 423-3262

Microlab

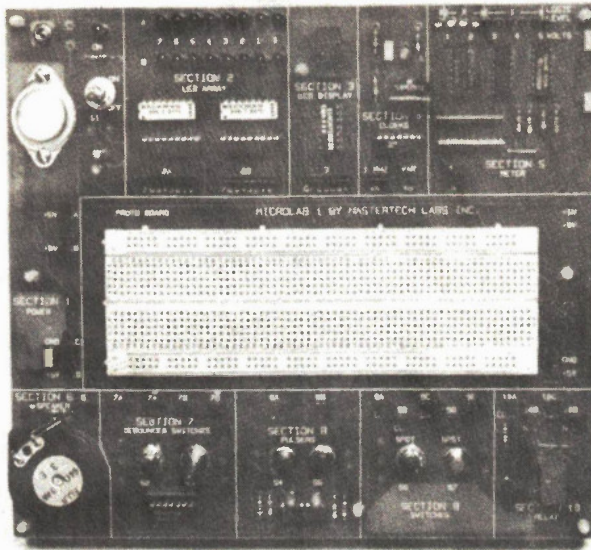

The Microlab 1 Digital Electronics Course consists of a solderless breadboard with accessories and a manual with theory, explanations, and self-tests. It's designed to teach digital techniques to those with little or no electronics knowledge. The 40 topics covered by the course include logic gates, flip-flops, dividers, counters,

various types of shift registers, multiplexers and more. All the bits of hardware needed, such as switches, a speaker, a regulator, LEDs, etc., are included on the board itself. From Mastertech Labs Inc., 6792 Kirkpatrick Cres., Victoria, BC V8X 3X1, (604) 652-1544.

Circle No. 44 on Reader Service Card.

Data Recorder



TEAC now has data recorders using Philips cassettes, the MR10 4-channel and the MR30 7-channel. Both are compact enough to be easily portable, and feature microprocessor controlled self-test, counter search functions,

dual meters, and complete front panel operation. From Metermaster Division of R.H. Nichols Co. Ltd., 80 Vinyl Court, Woodbridge, Ontario L4L 4A3, (416) 851-8871.

Circle No. 45 on Reader Service Card.

This July, Canada's first telecommunications satellite earth station was dismantled in Mill Village, Nova Scotia. The Mill Village 1, built by the federal Department of Transport in 1964, ushered Canada into the era of satellite telecommunications; it is now replaced by the new 32 metre Mill Village 4 dish.

Readers who were fans of Electronics Today's former editor, Steve Rimmer, may recall when he ran one of his unique ad spoofs, "Big Round Things". That was Mill Village 1. The Big Round Thing has been dismantled and cut down.

New DMM

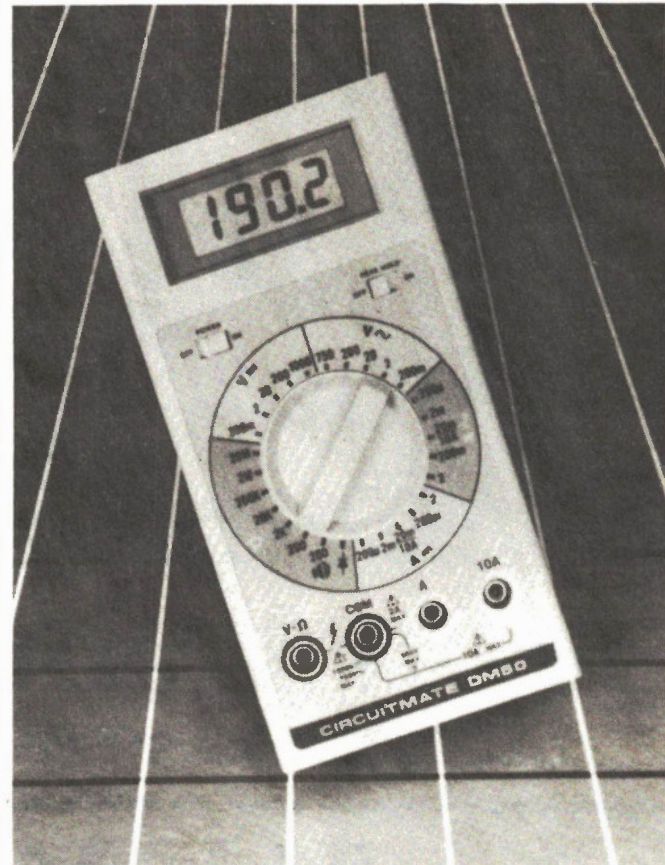

Beckman has introduced their new DM50 digital multimeter that features Peak Hold for \$149.95 Canadian. Peak Hold is the ability to detect, store, and display voltage or current peaks as short as 6ms. When used with a proper current clamp, the meter will detect

starting surges in AC or DC systems. Other features are 0.5 percent accuracy and 10M input impedance. Lenbrook Electronics, Unit 1, 111 Esna Park Drive, Markham, Ontario L3R 1H2, (416) 477-7722.

Circle No. 46 on Reader Service Card.

Programmable Thermometer



The Keithley Instruments Model 740 Programming Scanning Thermometer can linearize the outputs from the seven most popular thermocouple types, and includes a separate mV range for non-standard types requiring a microvolt sensitivity. It supports up to 81 channels, scans at 20

channels/sec and includes a non-volatile memory. It can send data to a printer, and a 24-hr clock can time stamp each measurement. Keithley Instruments, Inc., 28775 Aurora Rd., Cleveland, Ohio 44139, (216) 248-0400.

Circle No. 47 on Reader Service Card.

Voltage Reference

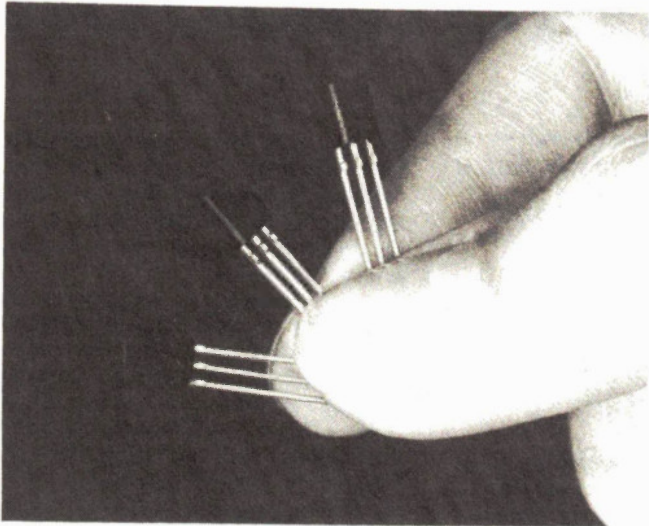

Ferranti's low power reference in a TO-92 package, the REF25Z, offers an output voltage accuracy of plus or minus 2 percent and a temperature coefficient of 60 parts per million per degree C. Only a

single resistor is needed to operate it from a DC supply. Ferranti is stocked by Carsten Electronics, 3791 Victoria Park Avenue, Toronto, Ontario, (416) 495-9999.

Circle No. 48 on Reader Service Card.

New Compatible

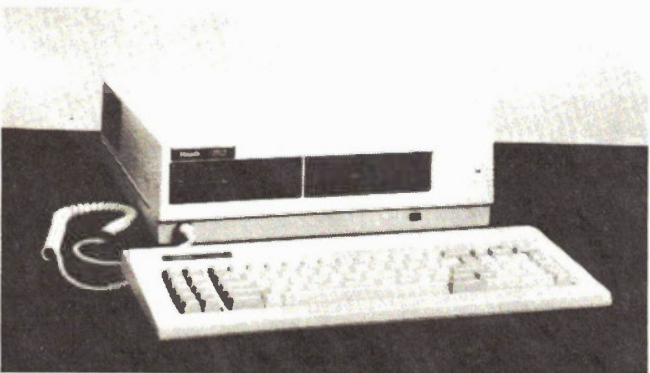

The Heath HF-148 is an IBM-compatible computer kit, featuring an 8MHz clock, one or two drives, 256K expandable to 640K on-board, a redesigned IBM-compatible keyboard, and one ex-

pansion slot. A serial and a parallel port are standard. Contact the Heath Company, 1020 Islington Avenue, Toronto, Ontario M8Z 5Z3, (416) 232-2686.

Circle No. 49 on Reader Service Card.

Sci-fi buffs have a picture of what a space station looks like engraved on their minds: a donut-shaped rotating platform, like the one in "2001: A Space Odyssey". Unfortunately, this shape isn't going to happen just yet. Aside from the fact that the artificial gravity would be stronger at your feet than at your head, it doesn't lend itself to what space station planners have in mind. The one planned by the US for the early 1990s looks more like a highway bridge with huge solar panels sticking out the sides. This girder format allows living quarter, communication, and shuttle docking modules to be

placed for best access.

According to the National Research Council, Canada is in on the station program, and we're developing several options for participation. One is a robotic servicer and Integrated Servicing and Test Facility for space assembly and testing. Second would be the solar arrays which provide primary power for the man-tended platforms and auxiliary power for the station. Third would be a remote sensing facility. In January, 1986, NASA will hold a review to discuss Canadian hardware design and development.

Computer Labels

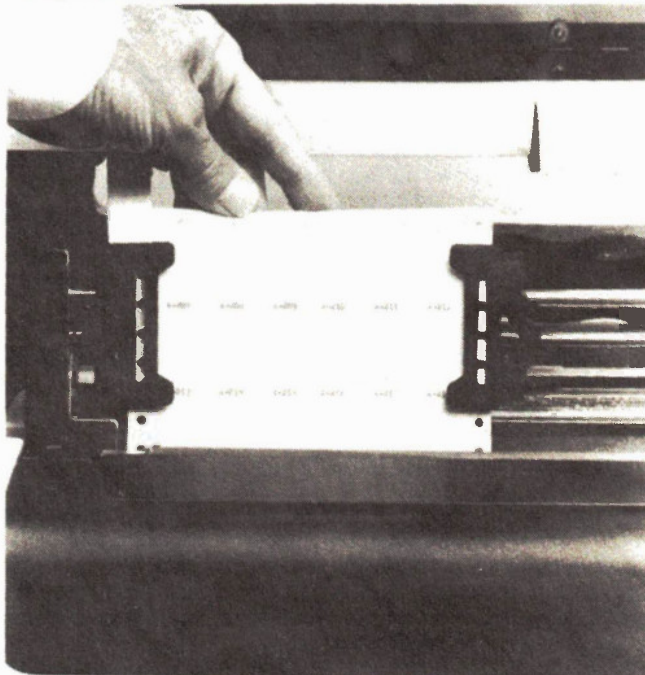

Labelling of wires, control panels, harnesses, etc., can be done using a computer/printer and 3M Scotchcode SCS vinyl labels. They're self-adhesive and can be fan-folded; each .8 by 1.44 inch label has a transparent tail which is

wrapped around the wire and the printing itself for protection. From 3M dealers, or contact 3M Canada Inc., Electrical Products, PO Box 5757, London, Ontario N6A 4T1, (519) 451-2500.

Circle No. 50 on Reader Service Card.

In the August issue we reported that Mitsubishi has produced a prototype flat-panel TV. Philips Research Labs in Redhill, England, have come up with one of their own. The monochrome CRT measures 12 inches diagonally by three inches thick; a colour version is said to be feasible. The unit uses a very low power electron beam (1uA, 400eV) which, because of its low energy, can be deflected in an unorthodox way. The beam travels down the back of the panel and is deflected 180 degrees into

the front section. There, more deflection plates turn the beam onto an electron multiplier; this amplifies the beam several hundred times before it reaches the screen. Vertical scan is achieved by progressively ramping the potentials on the screen plates. The resolution and grey scale capability is said to be "appropriate for TV applications". So far, the panel exists only as a lab prototype; no production plans were announced.

One of the biggest problems in editing Electronics Today is getting enough technically-oriented manuscripts. If you have an idea or circuit or project ranging in depth from beginner to expert, chances are close to 100 percent that we'll publish you. It doesn't

matter about literary ability; we'll even write the article if you'll supply the ideas in point form. Write to the Editor, Electronics Today, at the address shown on the contents page.

continued on page 63

Designer's Notebook

GETTING TO KNOW diodes requires an understanding of the basic P-N junction (Fig. 1). These are created by taking a rod, approximately 2-4 inches in diameter, of very highly purified silicon or other semiconductor material in single crystal form, and cutting it into slices with a diamond edged circular saw. The very thin discs formed are cleaned and polished, and finally heated in a vacuum oven with a carefully chosen atmosphere so that selected impurities will diffuse into the semiconductor material to a precisely controlled depth.

Silicon is tetravalent, which means that the atomic structure is such that there are four surplus valency electrons present in the outermost electron shell within the atom. If one diffuses in a trace quantity (one or two parts per million) of an impurity such as arsenic which is pentavalent (it has five outer orbital electrons), the net result will be that there are some 'spare' electrons floating around in the crystal structure.

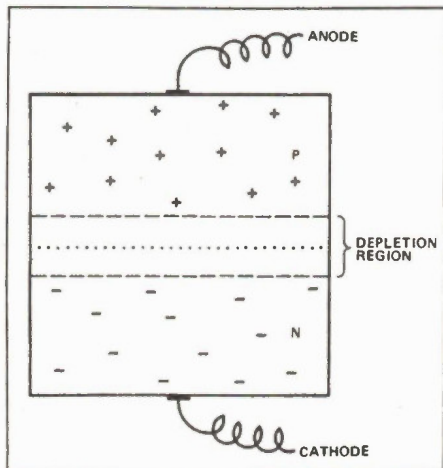

Fig. 1 A basic PN junction.

We call such a material an N doped silicon, or simply N type. If the material is heavily doped, we call it N+, if it is lightly doped we call it N- and so on.

Similarly, if we diffuse in boron which is trivalent (it has only three outer valency electrons), the result will be a number of holes where electrons should be, but are not. These holes behave like positive electrons, but are a bit more sluggish. This is because their movement takes place only as a result of an electron coming from somewhere else to fill the gap, leaving another hole where it had been, and so on. Think of it as a kind of electronic leap-frog.

A leak at diodes, including some unusual types and their uses.

By John Linsley Hood

When a P and an N doped semiconductor material are in contact, usually as a result of deliberately contrived impurity zones within the single crystal slice, a diffusion of these 'spare' electrons and holes occurs across the junction. This leaves a depletion zone on either side of the junction region which is completely stripped of both holes and electrons, as shown in Fig. 1.

This depletion region is, therefore, effectively a non-conductor, so even in the conducting direction of the diode it is necessary to apply a certain forward voltage before any current will flow, to give the electrons enough kinetic energy to traverse the potential gap. The effect of this is to make the depletion zone appear to decrease in width, to the point at which it disappears when the forward conduction potential for the junction is reached. The converse is true for a reverse biased junction.

This results in the voltage/current graph shown in Fig.2. A very important characteristic to note is that the forward voltage drop, V_f , for a diode connected in its forward biased mode, is one of pure conduction and is therefore not very noisy, whereas operation in the reverse conduction mode is very noisy.

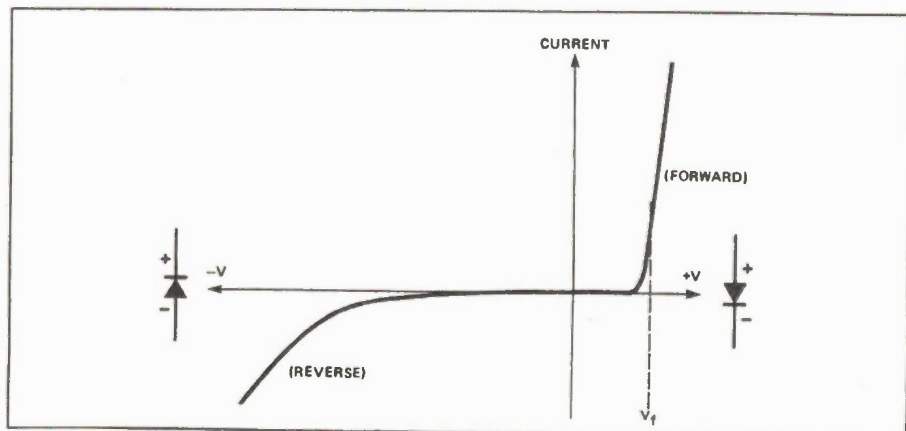

Fig. 2 Voltage/current characteristic of a junction diode.

So, when you need a voltage drop in low noise circuitry, use a string of forward diodes or an 'amplified diode' as shown in Fig.3 rather than a zener diode, in which the conduction occurs as a result of reverse breakdown.

A consequence of the greater mobility of electrons and holes as a result of thermal excitation is that the forward voltage drop of a PN diode decreases with temperature. This seems to contradict the concept that the depletion region arises as the holes and electrons migrate across the junction, so that greater mobility of these should cause a wider depletion zone, but in reality the increased carrier mobility simply acts to lessen the forward bias which needs to be applied before conduction occurs.

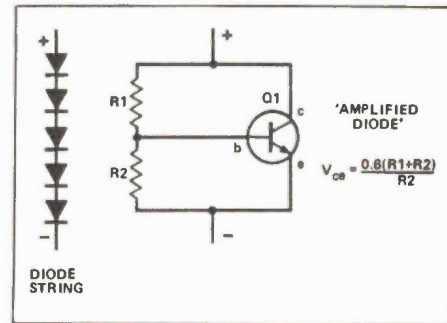

Fig. 3 Arrangements which can be used instead of a zener diode where a voltage drop is required in low noise circuitry.

However, an important feature of doped regions is that the width of the depletion zone at the junction decreases as the impurity concentration, and the consequent number of holes and electrons, is increased. This phenomenon is used in tailoring device characteristics, as shown later.

Small Signal Diodes

There are three different types in general use:

Germanium point-contact diodes, useful for very low level signals in radio applications, but otherwise becoming obsolete.

Germanium diffused junction diodes, similar in characteristics to silicon ones, but with a lower forward voltage drop (0.15V typically, as compared with 0.55V for silicon), worse reverse leakage current (by a factor of about 1500x), and worse temperature coefficient and maximum working temperature.

Silicon diffused junction diodes, such as the 1N4148. These are inexpensive and very reliable (if from a good manufacturer) and can be used as low power rectifiers up to about 30V RMS and 50mA. Their four nanosecond recovery time (the length of time which it takes for the electrons and holes generated by current flow to recombine, so that the diode would be nonconducting in the reverse biased direction) limits their use to about 100MHz. For higher frequency use more suitable diode types as available.

Power Rectifier Diodes

These are basically similar to the small signal diode. However, the power handling capability of the diode is determined by the maximum junction temperature, which in turn depends on the conducting resistance of the diode which determines the power dissipation for any given current and the ease with which the heat generated in the junction can diffuse away. These will usually have a large junction area to minimize the conduction resistance, in good thermal contact with a metal plate or stud whereby the heat can be taken to some kind of heat sink.

Also, such diodes must be able to withstand a high reverse voltage. This is achieved partly by their junction geometry, as shown in Fig.4. In early designs of the rectifier diode, it was noted that failure almost always took place at the edge of the junction area. If the sides of the chip are etched away at an angle, the electrical stress at the edge of the junction can be reduced so that this kind of breakdown is prevented.

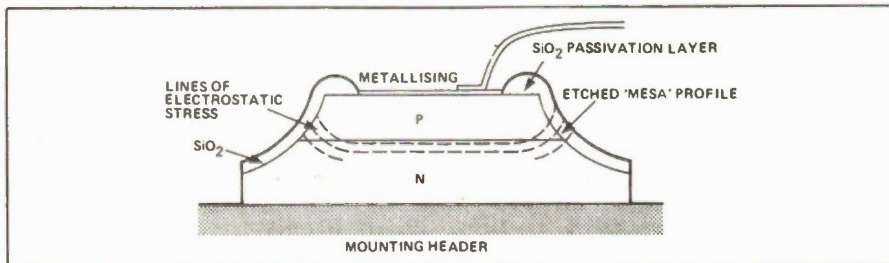

Fig. 4 The sides of a high voltage rectifier chip are etched away at an angle to deflect electrostatic stress away from the edge of the junction.

The other technique employed is to keep the doping impurity levels relatively low, so that the depletion region is wider and the stress, per unit thickness, is consequently less. This unfortunately, increases the resistance of the silicon per unit area with a consequently higher forward voltage drop; hence more thermal dissipation for a given current. In lower voltage rectifier diodes relatively high doping levels will be employed, simply to reduce the forward conduction power losses.

Avalanche Diodes

A further technique which is used in power rectifiers is to tailor the diffusion process and the doping levels of the P and N regions on either side of the junction so that the depletion region is very uniform in thickness. Then, provided that the doping levels are not too high, any carrier (electron or hole) entering the depletion region under conditions of reverse bias will be so accelerated that impacts with atoms will generate further electron-hole pairs. These, in turn, will be accelerated by the applied electric field and will collide with other atoms, giving rise to a situation very similar to that of an avalanche of rocks falling down a sloping hillside.

This process is known as ionization but is most commonly seen only in gases, such as neon signs or sodium vapour street lamps.

The purpose of the avalanche diode approach is to avoid destructive damage to the rectifier occurring as a result of very short duration high voltage spikes. These arise all too frequently on power lines. A straightforward rectifier diode could break down under these conditions, and the very high temperatures generated by even small local current flow at high reverse voltages could fuse portions of the junction, leading to a short-circuit.

A typical voltage/current graph for an avalanche diode is shown in Fig. 5. In a well designed device, the reverse turn on is very abrupt and conduction will be distributed uniformly across the whole of the junction area.

Although a maximum static thermal dissipation of some tens of watts might be permitted for such a diode, this could well absorb a spike energy equivalent to tens of kilowatts for a duration of only a few microseconds without any harm.

Zener Diodes

These are very heavily doped diodes, with, in consequence, a very thin depletion region between the PN junction. The reverse bias electrical stress across this causes ionization of the semiconductor material in the depletion zone, and consequent current flow. Beyond about 7V, zener diodes are not used. All of the so-called zeners above this voltage will, in

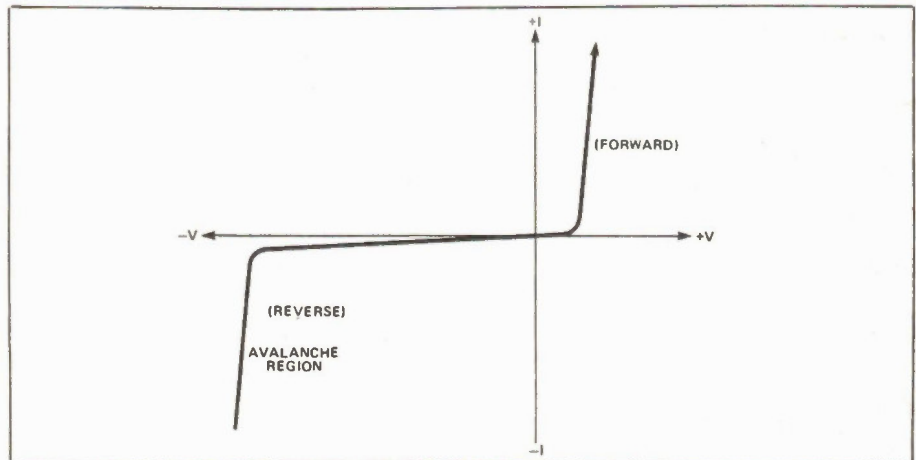

Fig. 5 Voltage/current characteristics of a typical avalanche diode.

fact, be avalanche diodes. As mentioned above, reverse leakage current is noisy, and a zener diode will make quite a good wide-band noise source.

The fact that zeners are all very highly doped tends to give them a low and fairly sharp turn-on characteristic in the forward direction, which can be useful.

High Frequency Diodes

The major requirements in this application are high carrier mobility and low junction capacitance. These requirements

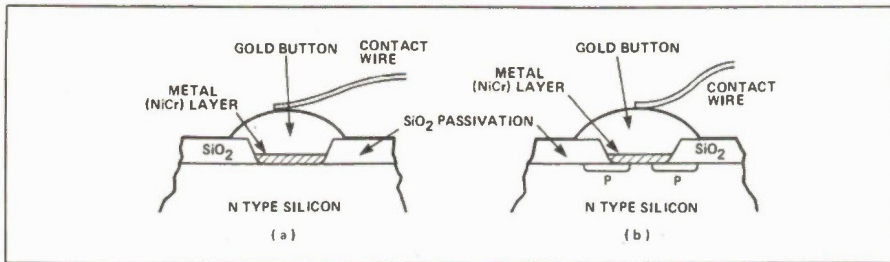

Fig. 6 Cross-sectional views of a) a normal Schottky diode and b) a hybrid Schottky device.

are met fairly well by the old point contact or gold-bonded germanium diodes, but the most commonly employed type nowadays is the Schottky diode, shown in Fig. 6a. This relies only on majority carrier action (electron flow), and is, in consequence, fast in action. The snag is that there are sharp corners where the metal inlay abuts on the N type silicon slice, and the electrical stress at these points leads to a low reverse breakdown voltage which can be as little as 5V. The advantages of this construction are that the forward voltage drop is reduced to some 180-220mV, and that the operating frequency can be as high as 18-20GHz.

The electrical stress at the edges of the metallic layer in a Schottky diode can be lessened by the inclusion of an annular ring of P-type silicon under the edge, as shown in Fig. 6b. However, although it can increase the reverse breakdown voltage to 60-70V, the maximum operating frequency is reduced to about 4GHz. These are sometimes called hybrid Schottky diodes.

Depending on the construction employed, the junction capacitance can be as low as 1pF - compared with 5-50pF for a standard small-signal silicon junction diode and 500-5000pF for a rectifier diode.

An important characteristic of diode

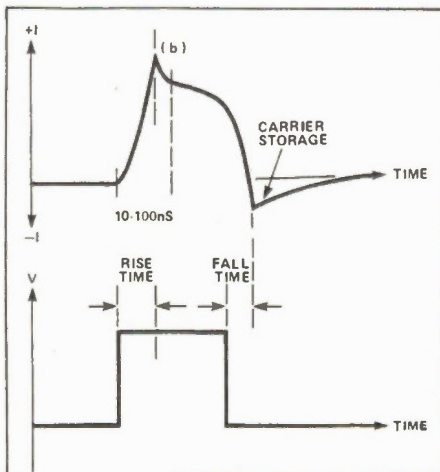

Fig. 7 Carrier storage following a reversal of the applied voltage in a PN junction diode.

behaviour, which influences pulse and switching performance in addition to RF behaviour, is the transient response of the diode junction. This is determined by a variety of phenomena such as:

Carrier storage, due to the minority carriers (holes) still left uncombined at the conclusion of a forward conduction period. This causes conduction to continue for a short period following a reversal of potential, as shown in Fig. 7a. The stored charge can be expressed in picocoulombs (1 coulomb is the charge stored in a 1 farad capacitor at an EMF of 1 volt), and typical values are 100-10,000pC.

Turn-on transient, due to the time taken for conduction to settle down to a steady value. Typically 10-100ns for a small signal silicon junction diode.

Voltage dependence of junction capacitance is a characteristic which is exploited in varicap diodes, but occurs in all reverse-biased PN junctions and has some of the characteristics of inductance.

Varicap Diodes

The capacitance of a reverse biased PN junction is, roughly, inversely proportional to the square of the voltage across it. Such a diode appears to consist of two conducting regions separated by the depletion layer between them, which acts as a dielectric. Typical devices have capacitance values in the range 3-50pF, depending on device and applied voltage.

The way in which they can be used as a remote voltage-controlled tuning element is shown in Fig. 8. Back-to-back connection is frequently employed where large signal levels are likely, to prevent the

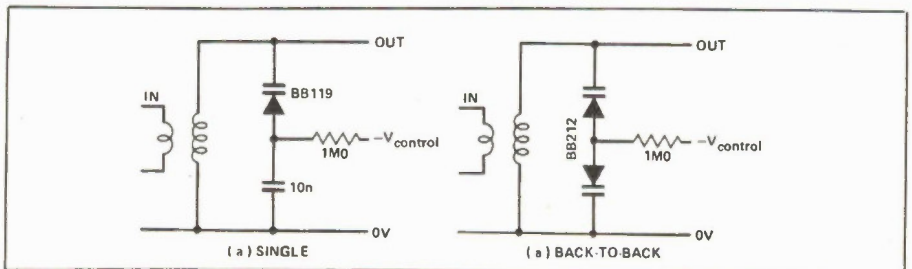

Fig. 8 The use of varicap diodes to provide remote voltage controlled tuning.

signal voltage itself from modulating the capacitance.

A similar type of construction is employed in the varactor diode, in which the diode is connected across an oscillator coil and the dependence of the capacitance on instantaneous voltage is used to generate harmonics of the signal.

Step Recovery Diode

This is a device which is designed, by geometry and doping levels, to have a very abrupt switching characteristic when the applied potential is reversed. It can be used to shock excite a coil into oscillation at a much higher frequency (up to the sixth harmonic) than the input voltage. This is useful for microwave signal generation, as is the impatt diode.

Impatt Diode

This is a device whose design is deliberately contrived to give a very wide depletion layer, assisted by the inclusion of a layer of intrinsic (un-doped) silicon, in the form shown in Fig. 9a. When this is used in the type of circuit shown in Fig. 9b., quite useful amounts of microwave power (up to 1W CW at 50GHz, or 50W pulsed) can be generated. The trepatt diode is a structural modification of this to cause bunching of the electrons, which allows some increase in power levels.

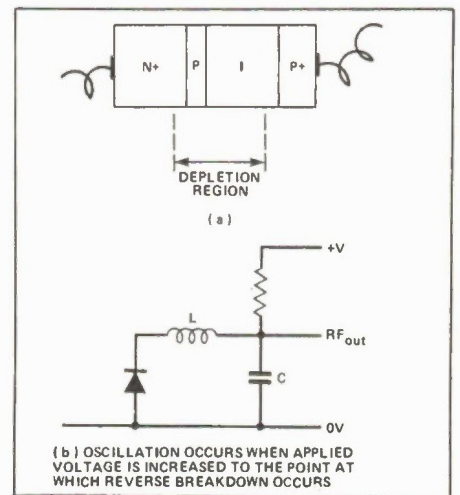

Fig. 9 The construction of an impatt diode and a microwave power oscillator using the device.

Gunn Diode

In spite of its name, this isn't really a true diode at all. Made from N-type gallium arsenide, it is what is known as a two-valley semiconductor in which the conduction band (that energy level in which the electrons can move as in a normal conductor) has two different levels, with different mobilities.

When current is caused to flow through a slice of this material between two ohmic contacts, the fast electrons overtake the slow electrons to form a bunch which travels through the slice. The result of this is an accumulation of charge at the cathode, until it neutralizes the field due to the applied voltage at the contact. Charge accumulation then stops, and the charge domain then travels through the semiconductor slice in the form of a sharp spike of current at a speed determined by the applied voltage. This process then repeats to generate a rapid series of such spikes.

Such devices are often used as the microwave power sources in such things as microwave Doppler intruder and fire alarms.

Tunnel Diodes

A decade or so ago, these devices were seen as the bright new hope for simple RF oscillator circuits. Unfortunately, their price never became low enough for them to achieve popularity, and they may soon become just a historical curiosity. They are based on the use of a very highly doped junction, with a consequent very thin depletion layer.

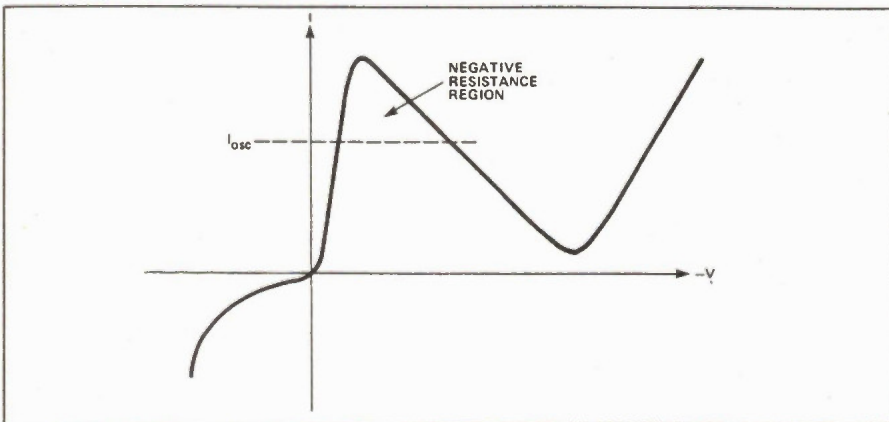

Fig. 10 Voltage/current characteristics of a typical tunnel diode.

At very low reverse bias levels, the thermal energy of the electrons in the semiconductor is high enough for them to 'tunnel' through this depletion layer, and the junction conducts. However, as the reverse voltage is increased the thickness of the depletion layer increases, so the tunneling effect, even with an increased potential difference, begins to lose ground. The current then begins to fall as the potential is increased, giving what is

known as a negative resistance characteristic.

In due course, the leakage current begins to increase once more leading to the type of reverse voltage/current graph shown in Fig 10. If this is connected in series with a coil as shown in Fig. 11, a simple HF oscillator circuit with a stable output voltage is produced. However, tunnel diodes are quite easily damaged by excessive currents.

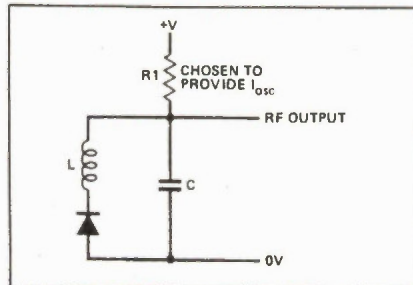

Fig. 11 A simple HF oscillator circuit using a tunnel diode.

Light Emitting Diodes

Apart from the ubiquitous transistor, this is, I think, the bit of modern semiconductor technology which has made the biggest impact on the public at large, as a long-life replacement for filament indicator bulbs.

These work because radiation is emitted by an atom when an electron, having been excited into a higher energy level by some input of energy such as a current, falls back into its original rest level; a similar mechanism operates when an excited electron falls into a hole. The pro-

cess is known as electroluminescence.

Since the light is emitted from the junction, the diode must be designed so that the light can escape, and usually they are encapsulated in a plastic moulding so designed that it acts as a magnifying glass with the junction at its focus. In order to get radiation emitted in the visible part of the spectrum, it is necessary to have a material with a large energy band gap, such as gallium arsenide (red), gallium

arsenide phosphide (amber and yellow), gallium phosphide (yellow or green, depending on oping).

Early LEDs were not very efficient in terms of the light output for current input, efficiencies of the order of 0.005% being not untypical. However, more modern 'high-brightness' LEDs can reach 3% efficiency, especially in the red colours where they are beginning to compete with filament bulbs. Also, by tailoring the geometry of the device, semiconductor lasers are possible and these are used as the 'reading' device in compact disc players.

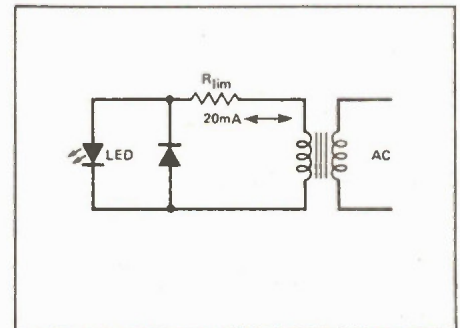

Fig. 12 Driving an LED from an AC supply.

Care must be taken not to reverse bias an LED (light is emitted when current flows in the forward direction) since reverse breakdown will damage the device. An LED can be used on an AC source if it is shunted by an ordinary silicon diode as shown in Fig. 12.

Reverse Leakage

This is one of the major problems with semiconductor diodes, apart from reverse breakdown, and is strongly dependent on temperature. Such leakage currents increase by 10% for each 1 degree C rise in temperature, which means that the leakage current will double every 8 degree C. This sets an upper limit for the use of germanium diodes at about 70 degrees C and for silicon at about 160 degrees C.

Although diodes do not appear to have a lot to do with ICs, most microcircuits are made on a substrate of silicon with all the bits of circuitry isolated from the substrate simply because they are sitting on top of a reverse-biased diode junction.

As I mentioned above, such leakage currents are noisy, and this was (and to a lesser extent, still is) the reason why low noise circuits built up from discrete semiconductors would often be better than their op-amp equivalents. However, technology improvements have lessened this penalty, and nowadays, for most practical purposes, if an IC is available to do the job it is not sensible to do it any other way. ■

Electronics from the Start

Part 6

This month we're starting on circuits which use capacitors, specifically electrolytic capacitors.

By Keith Brindley

CAPACITANCE VALUES are measured in a unit called the farad (named after the scientist Faraday) and given the symbol F. We'll define exactly what the farad is later; suffice to say here that it is a very large unit. Typical capacitors have values much, much smaller. Fractions such as a millionth of a farad (i.e., one microfarad: 1 μ F), a thousand millionth of a farad (i.e., one nanofarad: 1nF) or one million millionth of a farad (i.e., one picofarad: 1pF) are common.

The circuit for our first experiment is shown in Fig. 1. You should see that it bears a striking resemblance to the voltage divider resistor circuits we looked at some time ago, except that a capacitor has taken the place of one of the resistors. Also included in the circuit of Fig. 1 is a switch. These circuits have a number of dynamic properties which occur for only a while after the circuit is connected. We can use the switch to make sure that we see all of these dynamic properties, from the moment electric current is allowed to flow into the circuit.

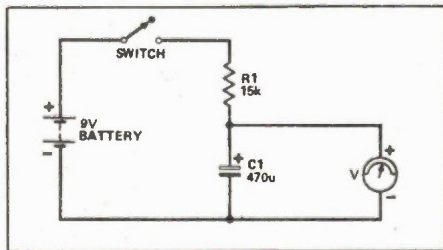

Fig. 1 A simple resistor and capacitor circuit.

A breadboard layout for the circuit is shown in Fig. 2. You'll notice from the diagram that the meter is connected across the capacitor using alligator clips. These are useful additions to buy for your meter, as they allow you to do other things while taking measurements.

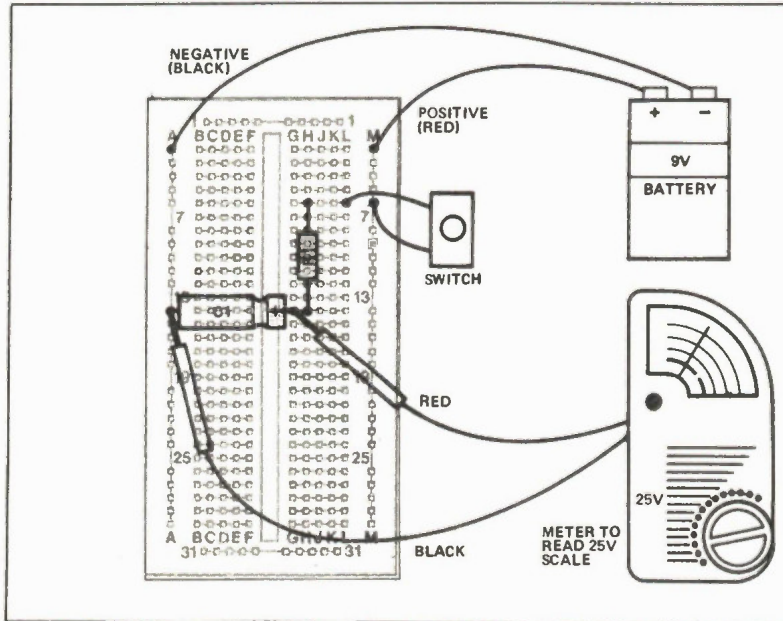

Fig. 2 A breadboard layout of the circuit in figure 1.

As the switch is off, no current should flow and the meter reading should be 0V. If you've accidentally had the switch on and current has already flowed, you'll have a voltage reading other than this, even after the switch is consequently turned off. In such a case, get a short length of wire and touch it to both leads of the capacitor simultaneously, for a few seconds, so that a short circuit is formed. The voltage displayed by the meter should rapidly fall to 0V and stay there. Now you're ready to start, but before you switch on, read the next section!

Getting Results

As well as watching what happens when the circuit is switched on, you should make a record of the voltages displayed by the meter, every few seconds. To help you do this a blank table of results is given in Table 1. All you have to do is carefully fill in the voltages you have measured, at the times given. You will find that the voltage will increase, rapidly at first but slowing down to a snail's pace at the end. Don't worry if your measurements of time and voltage aren't too accurate; we're only trying to prove the principle of the experiment, not the exact details. Besides, if you switch off and then short circuit the capacitor, as described above, you can

repeat the measurements as required.

When you've got your results transfer them as points onto the blank graph of Fig. 3 and sketch in a curve which goes approximately through all the points. Table 2 and Fig. 4 show the results we obtained when we performed the experiment.

What we have seen is that the voltage across the capacitor (any capacitor, in fact) rises, not instantaneously as with the voltage across a resistor, but gradually following a curve. Is the curve the same, do you think, for all capacitors? Change the capacitor for one with a value of 220 μ F (about half the previous one). Using the blank table of Table 3 and blank graph in Fig. 5, perform the experiment again, to find out.

Table 4 and Fig. 6 show the results of our second experiment (yours should be similar) which shows that although the curves of the two circuits aren't exactly the same as far as the time axis is concerned, they are exactly the same shape.

This proves that the rising voltage across a capacitor follows some sort of law. It is an exponential law, and the curves you obtained are known as exponential curves. These exponential curves are related by their time constants. We can calculate any rising exponential

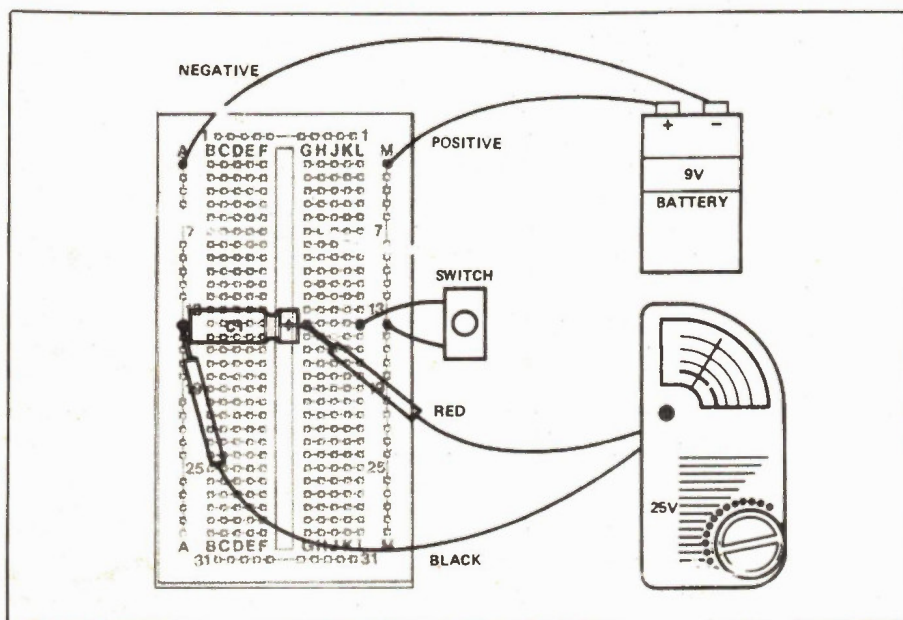

Fig. 9 The breadboard layout for the experiment in figure 8.

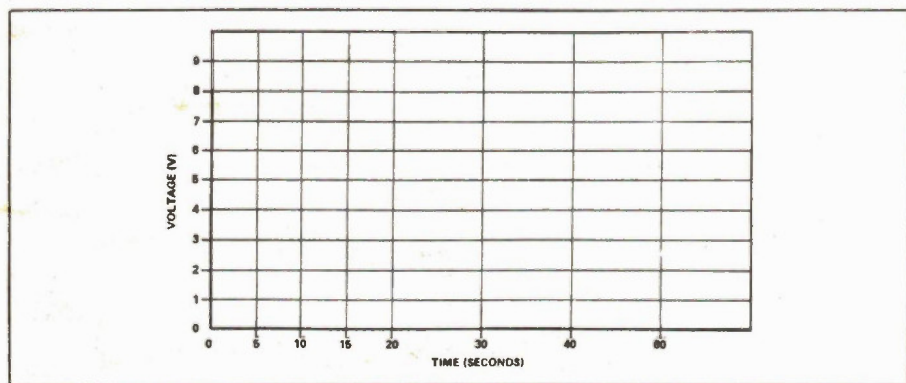

Fig. 10 A blank graph to fill in.

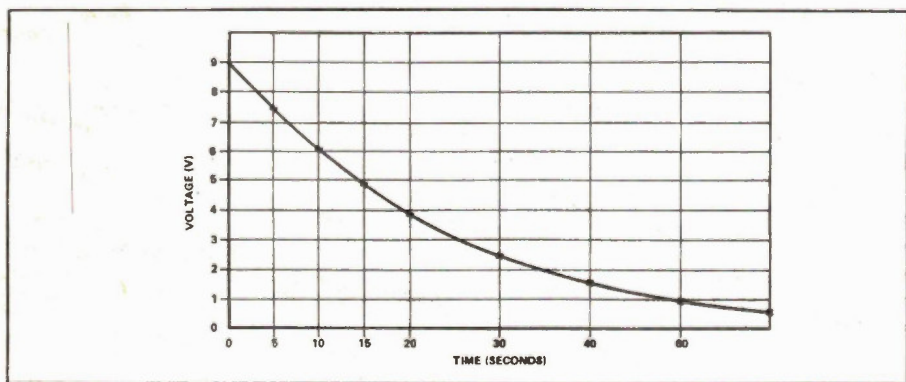

Fig. 11 The graph showing our own results.

see that the curve obtained is similar to the curves we got earlier, but are falling instead of rising. Like the earlier curves, this is an exponential curve, too.

If you wish, you can calculate the time constant here in the same way, but remember that it must now be the time at which the voltage falls to 0.63 of the total voltage drop, i.e.,

$$\begin{aligned} \text{when } V &= 9 - (0.63 \times 9) \\ &= 3.3V \end{aligned}$$

Theoretical Aspects

So what is it about a capacitor which causes this delay in voltage between switching on or off the electricity supply and obtaining the final voltage across it? It's

almost as if there's some mystical time delay inside the capacitor. To find the answer we'll have to consider a capacitor's innards again.

Fig. 12 shows the capacitor we first saw in Fig. 1. A number of electrons gather on the capacitor plate connected to the battery's negative terminal, which in turn repel any electrons on the other plate towards the battery's positive terminal. A deficiency in electrons causes molecules of this capacitor plate to have a positive charge, so the two plates of the capacitor now have equal, but opposite, electric charges on them.

Current only flows during the time when the charges are building up on the capacitor plates, not before and not after. It's also important to remember that current cannot flow through the capacitor; a layer of insulator (known correctly as the dielectric) lies between the plates. Remember: current only flows in the circuit around the capacitor.

If we now completely disconnect the charged capacitor from the battery, the equal and opposite charges remain, in theory indefinitely. In practice, charge is always lost due to leakage current between the plates. You can try this for yourself, if you like: put a capacitor into the breadboard then charge it up by connecting the battery directly across it. Now disconnect the battery and leave the capacitor in the breadboard for a time (overnight, say). Then connect your meter across it to measure the voltage. You should still get a reading, but remember that the resistance of the meter itself will always drain the charge stored.

The size of the charge stored in a capacitor depends on two factors: the capacitor's capacitance (in farads) and the applied voltage. The relationship is given by:

$$Q = C \times V$$

where Q is the charge measure in coulombs. C is the capacitance and V is the voltage. From this we can see that a charge of one coulomb is stored by a capacitor of one farad when a voltage of one volt is applied.

Alternatively, we may define the farad (as we promised we would) as being the capacitance which will store a charge of one coulomb when a voltage of one volt is applied.

We can now understand why it is that changing the capacitor value changes the associated time delay in the changing voltage across the capacitor. Increasing the capacitance, say, increases the charge stored. As the current flowing is determined by the resistance in the circuit, and is thus fixed at any particular voltage, this increased charge takes longer to build up or longer to decay away. Reducing the capacitance reduces the charge, which is therefore more quickly stored or more quickly discharged.

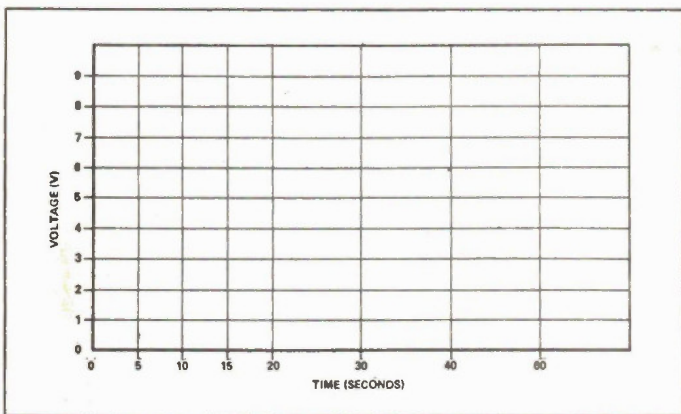

Fig. 3 Blank graph to fill in: see text.

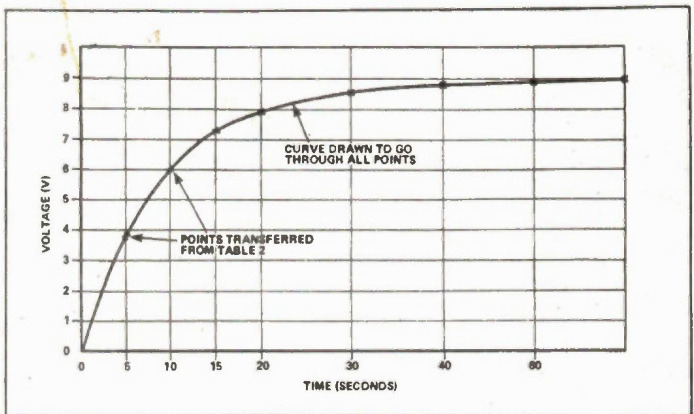

Fig. 4 The results we found ourselves.

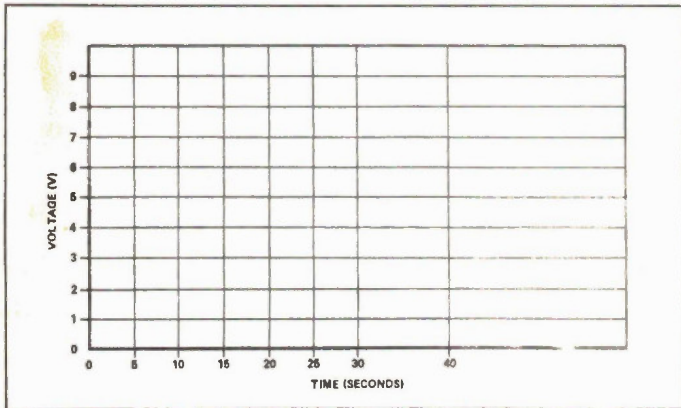

Fig. 5 Another blank graph to fill in: see text.

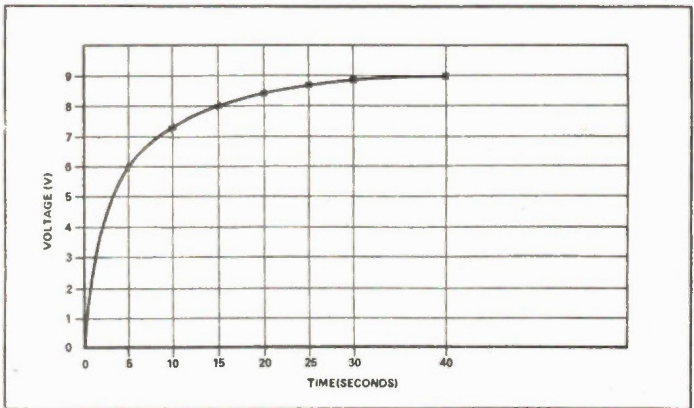

Fig. 6 Our own results.

curve's time constant, as shown in Fig. 7, where a value of 0.63 times the total voltage change cuts the time axis at a time equalling the curve's time constant, (the Greek letter 'tau').

In a capacitor circuit like that of Fig. 1, the exponential curve's time constant is given simply by the product of the capacitor and resistor value. So, in the case of the first experiment, the time constant is:

$$t_1 = 470 \times 10t \times 15,000$$

$$= 7 \text{ seconds}$$

and, in the case of the second experiment:

$$t_2 = 220 \times 20t \times 15,000$$

$$= 3.3 \text{ seconds}$$

You can check this, if you like, against your curves, or those in Figs 4 and 6, where you will find that the times when the capacitor voltage is about 5V7 (ie. 0.63 times the total voltage change of 9V) are about 8 seconds and 4 seconds. Not bad when you consider possible experimental errors, the biggest of which is the existence of the meter resistance.

One final point of interest about exponential curves, before we move on, is that the measurement denoted by the curve can be taken to be within about 1% of its final value after a time corresponding to five time constants. Because of this, it's taken as a rule-of-thumb that the changing voltage across a capacitor is complete after 5 time constants, or $5 \times R \times C$ seconds.

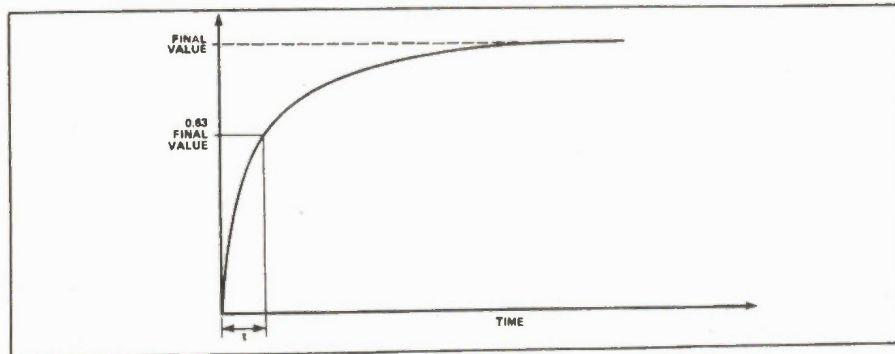

Fig. 7 A graph showing an exponential curve, related to the time constant.

The Other Way

During these experiments you should have noticed how the voltage across the capacitor appeared to stay for a while, even after the switch had been turned off. How could this be so?

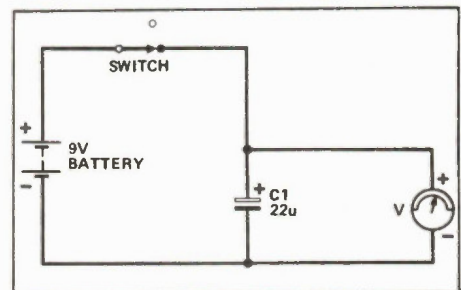
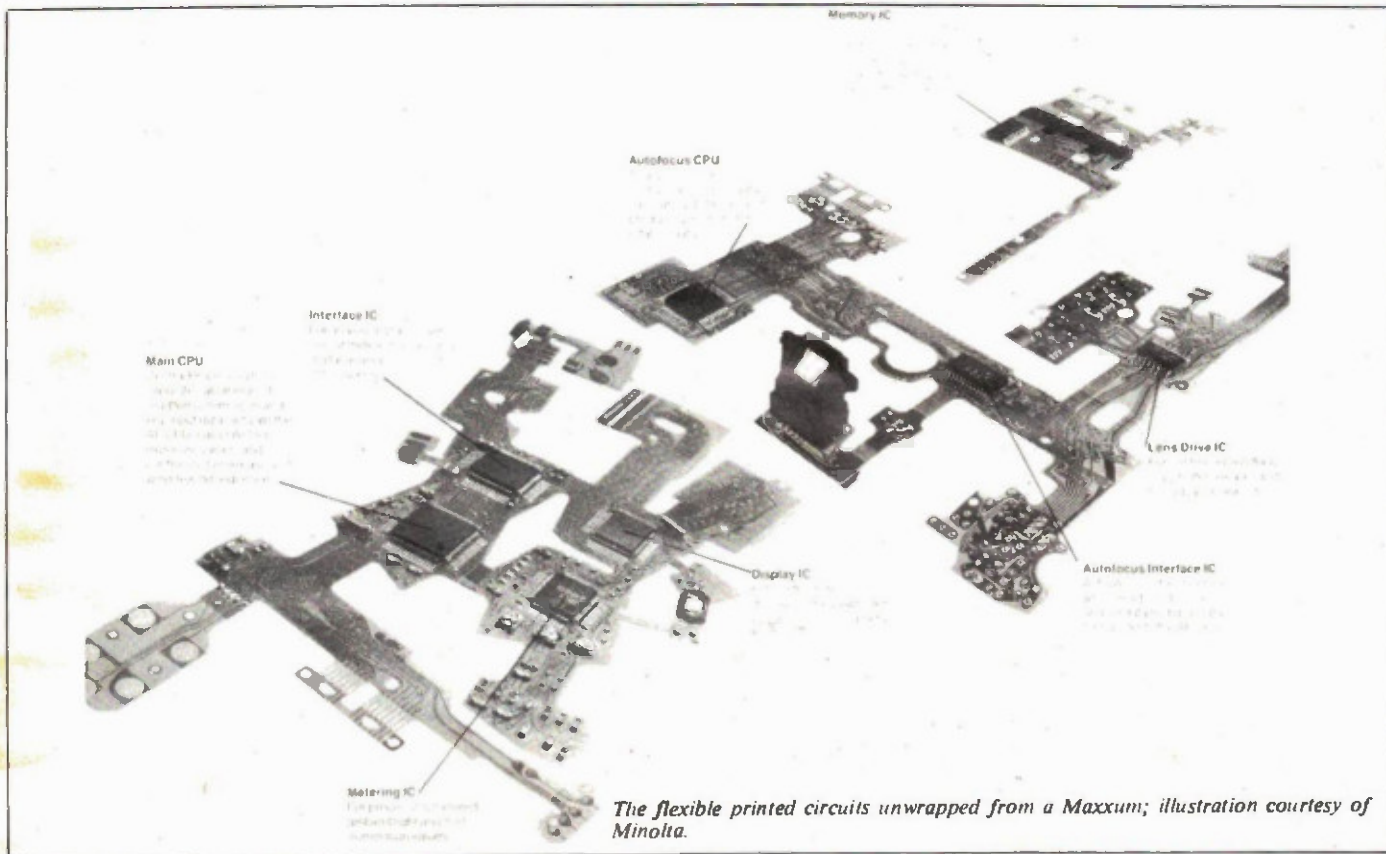

Fig. 8 An experimental circuit to demonstrate how a capacitor stores voltage (or 'charge').

Fig. 8 shows the circuit of an experiment you should now do, which will help you to understand this unusual capability of capacitors to apparently store voltage. Build the circuit up as in the breadboard layout of Fig. 9, with the switch in its on position.

Now, measure the voltages at selected time intervals, and fill in the results into Table 5, then transfer them to form a curve in Fig. 10, after switching the switch off.

The results we obtained are tabulated in Table 6 and plotted in Fig. 11. You can



The flexible printed circuits unwrapped from a Maxxum; illustration courtesy of Minolta.

Other models include photocells that can be removed and placed near the subject for precise control, remote triggers that set off a slave flash by detecting the fast risetime of the main flash, high voltage (510V) rechargeable battery packs to speed up recycling by eliminating the step-up oscillator, and many more. The flash for the Maxxum, for instance, even sends out a quick burst of red light to aid the autofocus mechanism, making autofocused flash possible in complete darkness, should you want to do such a thing.

Meters

As cameras get smarter, the market for separate exposure meters dwindles. However, they're indispensable in still photography and film work. Despite the small demand, the manufacturers haven't been idle; meters are now far more than the former cell-plus-movement. The Gossen Mastersix and the Minolta Flashmeter can read ambient or electronic flash or both, and can accumulate the total effect of multiple flashes. Both display their information on an LCD readout.

With appropriate optional accessories, you can read colour temperature, make measurements off the groundglass, do densitometry or darkroom work, and convert to a narrow-angle spot meter. Of course, the price of these systems is fairly high because of the small market; a top-of-the-line LCD exposure meter probably costs more than the 35mm camera it's being used with.

40 MHz

3 MODELS FROM \$950



5% discount when you call Tom and order direct.

| | |
|--|--|
| <ul style="list-style-type: none"> ■ 3 CH, Alternate Time Base Simultaneous Trigger View \$1,215 ■ 2 CH, Delayed Sweep \$1,075 | <ul style="list-style-type: none"> ■ 2 CH, Single Time Base \$950 ■ P-P Auto Trigger ■ Nationwide Sales and Service |
|--|--|

interfax

KIK

514-336-0392
416-671-3920

613-726-8888
604-430-1410

\$34.95

Timex Software \$3.75 each

Autor The Gator • Alien Spaceship • American Shootout • Blackjack • Basic Course 1 • Basic Course 2 • Backgammon • Crown Specter • Constellation • Chess 16K • Capitalization Master • Flashcard • Games Pack • Games Pack 1K • Games Pack 2K • Galactic Commando • Grimm's Fairy Tales • 80 Hours Around Europe • Inheritance • Invaders • Inventory Control • Krakit • Movie-Hangman • Marine Rescue • Mixed Game Bag 1 • Mixed Game Bag 2 • Money Analyzer • Protector • Planet of Fear • Program of Days • Portfolio Analysis • Power Pack • Punctuation Master • Personal Finance Planner • Pop Star • Run The Country • Real Estate Investment Analysis • Ram Runner • Slots • Super Math • Stock Market Game • Supermaze • Statistics • Tic Tac Toe 3D • Tiny Logo • Time Machine • Top Secret • Trackdown in the Old West • The Budgeter • The Chequebook Manager • The Cube Game • The Challenger • The Flight Simulator • The Gambler • The Home Improvement Planner • The Loan/Mortgage Amortizer • The List Manager • The Organizer • The Puzzler • The Stock Option Analyzer • VU-File • VU-Calc • ZX Chess 1K • ZX Chess 2K • ZX Chess 1 Enhanced • ZX Bug • Zombies • ZOR • The Business Pack I • The Business Pack II.

**ORION 5XT
IBM XT COMPATIBLE
100% IBM™ COMPATIBLE**

\$949 OPTIONS
2ND DRIVE \$149.00
HIRES MONITOR \$139.00

Includes:
• 256K Memory • 8 Expansion Slots • One 360K DS/DD Disk Drive • 135 Watt Power Supply • Disc Controller Card • Choice of Colour or Monochrome Card • will run 1-2-3 Flight Simulator Base II TM Super Calc, Visi Calc and others.

IBM Compatible Boards

- 1F02 384K Multifunction (S/P/C/G) - OK ... \$199.00
- 1F03 384K RAM Ver 11 - OK ... \$ 89.00
- 1F03 512K RAM Ver II - OK ... \$ 99.00
- 1F05 Color Graphic ... \$135.95
- 1F06 Monochrome ... \$125.95
- 1F07 Mono-Graphic with printer port ... \$199.95
- 1F09 I/O + II + (S/P/C/G) ... \$129.95
- 1F11 Parallel Printer (Cable extra) ... \$ 35.95
- 1F12 Serial - RS232C ... \$ 49.95
- 1F13 Game ... \$ 29.95
- 1F14 Floppy Drive Controller + Cable ... \$ 85.95
- 360K DS/DD Disk Drive ... \$149.95
- XT Compatible Mother Board OK ... \$225.95

IBM Hard Disk Drives

- 10M External w/power supply ... \$895.95
- 10M Internal ... \$849.95
- 20M Internal ... \$999.95

Diskettes (Box of 10) LIFETIME WARRANTY

- Orion SS/DD ... \$14.95
- Orion DS/DD ... \$17.95
- Datatech SS/DD ... \$15.95
- Datatech DS/DD ... \$19.95
- Verbatim (Bonus) SS/DD (Box of 11) ... \$15.95
- No Name DS/DD ... \$ 9.95

COLOUR MONITORS Reg. \$395.00

RGB or COMPOSITE NOW \$275.00

DRAM 41256 150NS \$6.95
4164 150NS .99

64K COLOUR COMPUTER

- 12" Green Hi-Res Monitor
- 1 Disk Drive & Controller Card
- IBM Style Case and Keyboard

\$895



SALE PRICE

64KZ80 Colour

- Built in Key Words for Apple Soft DOS
- Room for two Slim Line • Detachable Keyboard Drives

Orion Electronic Supplies Inc.

40 Lancaster Street West
Kitchener, Ont. N2H 4S9
(519) 576-9902



The Vivitar Model 5200 flash. The processor module is tailored to suit popular camera electronics and fastens to the flash via a multipin connector.

Other Equipment

Other equipment? It's a gadget freak's delight out there. We'll just look at a few of the trainload of things that eat batteries and bank accounts.

If you're dying to have autofocus on your standard camera, Vivitar makes a series of autofocus lenses for all popular 35mm lens mounts. The 200mm unit shown on the cover takes 3 AAA batteries and weighs 750g (26.4 oz). It's huge; the camera is sort of an accessory to the lens. You'll have to really want autofocus. Maybe it's good for remote control stuff, photographing the neighbours or something.

Camera backs have sprouted brains, if only electronic ones. If your camera can take a special recording back, you can probably tell by a row of contacts just below where the pressure plate would be. They let you imprint the date on the film, and some of them are right smart, letting you program all the camera's functions and run them unattended via an interval timer.

The darkroom is a natural place to put CPUs. The Durst AC707 and AC650, for example, have electronic control of filtering and exposure to minimize test strips and aid in uniformity of colour. Colour analyzers may not be inexpensive, but then, neither is colour paper. The features added through the microprocessor should make the equipment pay for itself, if only because you don't have to throw so many prints in the garbage.

But...

There are certain tasks that deserve to be taken over by microprocessors. Who really needs to stand in the darkroom timing the flow of liquids? If you're not interested in freaky colour effects, wouldn't you rather have perfect consistent filtration figured out by a machine? Flash calculation is a chore best left to circuitry.

But... I don't want to sound like a fuddy, and I know that this is not a photography review, but this does bear on the philosophy of microelectronics in consumer products. I don't take to automation just for the sake of doing it. I don't like the myriad of symbols and numbers and little pictures that flash at me. If you're doing still photography, you don't need automation, and when you're shooting under rapidly changing conditions, it's unnerving to have to decipher some arbitrary program symbol in a display: is the camera at 125th at f8 or isn't it?

Good photography has nothing to do with how smart the CPU is. I think that automation has its place in the point-and-shoot cameras with no controls on them, great for people who just want a picture. As far as creative photography goes, I think the new designs amount to photographic overkill.

There. So much for that. On the other hand, if you're enchanted with gadgets and having the camera do lots for you, the new electronic units are a miracle of economical miniaturization.



The Vivitar self-contained autofocus 200mm lens. Just add batteries and a camera.

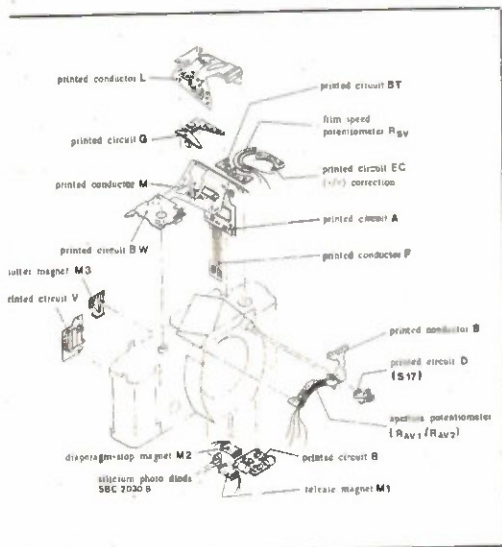

The basic construction of an electronic camera, the Leica R4 (courtesy of Wild Leitz).

100 MHz 3 CHANNELS...\$1,995



- Alternate Time Base
- Multimode Display
- Simultaneous Trigger View
- P-P Auto Trigger
- 2 ns/div, Max Sweep
- 60 MHz . . . \$1,550

interfax

KIK #3 in scope sales

514-336-0392
416-671-3920

613-726-8888
604-430-1410

write:

NATIONAL ELECTRONICS

Box 6883

Stn. Q

TORONTO, CANADA, M4T 2N5

FULLY COMPATIBLE
256K MEMORY
8 EXPANSION SLOTS
8 ROMS OK
8087 OK
MEGA - BIOS

TWO SLIM DRIVES 360K DS/DZ
COLOUR VIDEO
DISK CONTROLLER
130 WATT SUPPLY
KEYBOARD
FLIP-TOP CASE

**SPECIAL
FREE
TRIAL**

MONITOR

1498

* LIMITED
TIME
OFFER

NE

8088

COMPUTER

continued from page 63

For Your Information

Manupress

Prototype developers and small-run manufacturers will be interested in the hand-operated, bench mounted Lever Press from Manupress of the UK. Over 100 standard tools are available to punch holes for components such as "D", BNC and DIN connectors, switches and fuseholders.

The range includes nibbling tools, bending and forming tools and even louvre tools for ventilation. Contact Len Finkler and Co., 80 Alexdon Road, Downsview, Ontario M3J 2B4, (416) 630-9103.

Circle No. 51 on Reader Service Card.

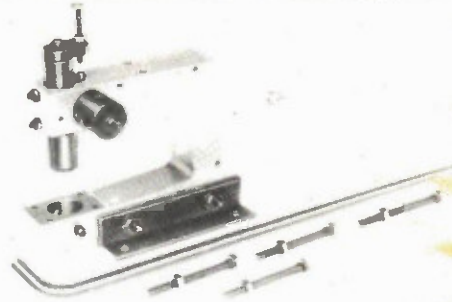

Mini Breakout

The Datacom Model 15 is a communications breakout box that allows line jumpering, monitoring and cross connecting of the line between a terminal and a modem or other communications equipment. Small enough to fit in a shirt pocket, the box allows fast troubleshooting or modifications. Contact Allan Crawford Associates Ltd., Test and Measurements Division, 5835 Coopers Ave., Mississauga, Ontario L4Z 1Y2, (416) 890-2010.

Circle No. 52 on Reader Service Card.

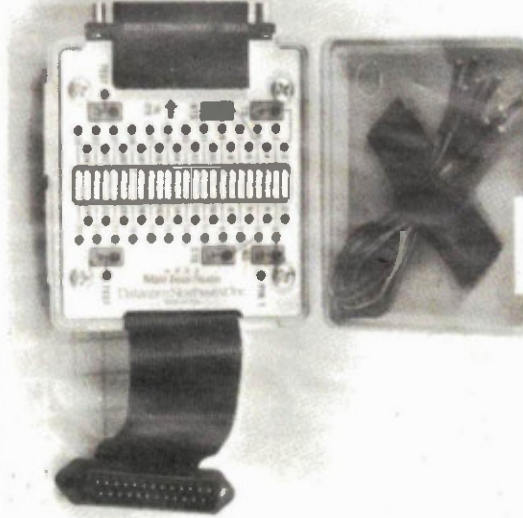

Metal-film Resistors

The Mini-Melf resistor from Beyschlag are designed for current PC boards requiring surface-mount components for greater density. The new metal-film resistors are said to have advantages over rectangular thick-film types: better stability, easier handling, lower current noise, better linearity and tolerances, lower temperature coefficients and a wider range of values. Contact Siemens Electric Ltd., 1180 Courtney Park Drive, Mississauga, Ontario L5T 1P2, (416) 673-1995.

Circle No. 53 on Reader Service Card.

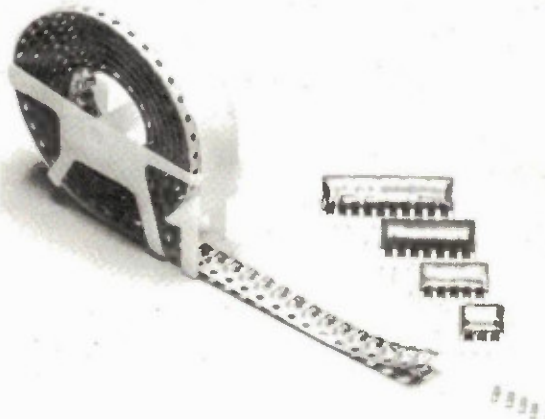

continued on page 7

The **BEST** is still "made in West Germany"

HAMEG model **HM203-5**

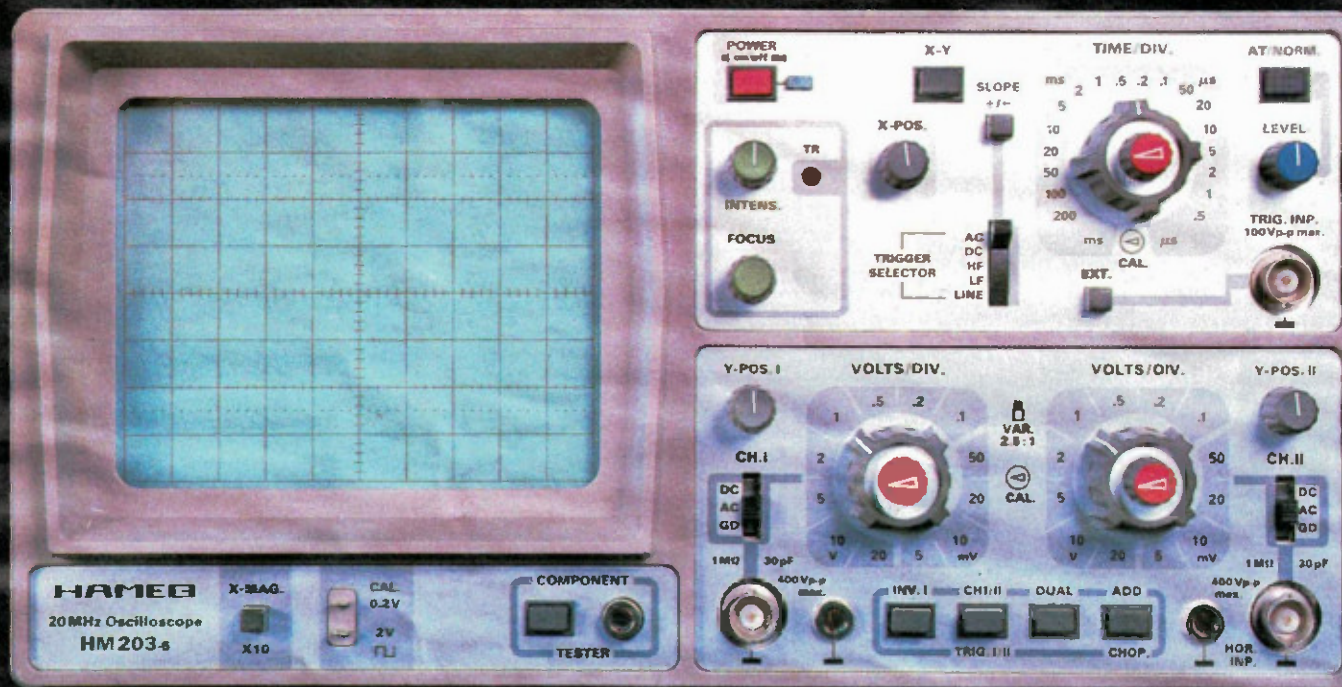

The 20MHz Oscilloscope that outsells all others in Western Europe. The model **HM203-5** is available complete with two switchable (X1-X10) probes. This CSA approved Oscilloscope is covered by a **two year** parts and labour warranty.

Immediate delivery from Stock
All major credit cards accepted.

\$810⁰⁰

F.O.B. Downsview, Ont. FST Incl'd

for the complete line of HAMEG instruments write or phone

HAMEG GmbH
West Germany is represented
and distributed in Canada by

BCS
ELECTRONICS
LIMITED

980 Alness St. Unit 7,
Downsview, Ontario
M3J 2S2
(416) 661-5585
TELEX 065-28169
Mon-Fri 8-5 pm, Sat 10-1 pm

*Price subject to change

**INTRODUCING:
THE NEW STANDARD
FOR IBM PC/XT
COMPATIBILITY**

The ACS-1000 Super Computer

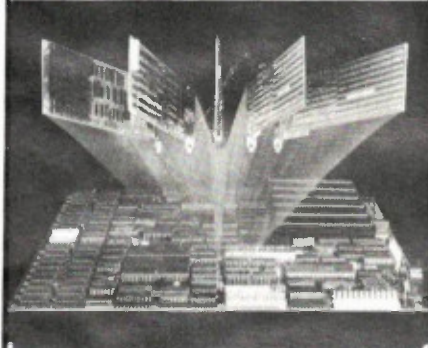

- 1 Megabyte On-Board Memory
- Built-in Disk Controller
 - up to 4 Floppies
 - SASI Hard Disk Interface
- 54 KB User Definable ROM
- Switchable: 4.77 or 8 MHZ
- Built-in Multifunction Board
 - Parallel Printer Port
 - 2 Serial Ports
 - Time-of-day Clock

**Seize Control of Your
Hardware Destiny**

If you are using board level microcomputers you can have greater power, versatility and reliability by using the ACS-1000 single board SuperComputer.

The ACS-1000 is compatible with both software and hardware designed for the IBM PC/XT. It even has the same mounting holes and the same power supply connections. The difference is that the ACS-1000 offers a much higher level of integration and costs less than \$600 when ordered in quantity.

Save your Expansion Slots for true expansion. Disk Controllers, I/O ports and extensive memory are already built-in, simplifying production and freeing the 6 expansion slots to take on specialized work of your process control, CAD/ CAM or office automation applications. There's even a special port for a low cost piggyback modem.

See for yourself. We are offering a system evaluation kit for \$995.00. The 256K system includes bios, documentation, and an XT compatible power supply.

Special introductory offer on peripherals and chips.

Shugart SA 455 Floppy Drives \$185.00, IBM Compatible cases \$80.00, 130 Watt Power Supplies \$220.00, Keyboard \$200.00, Chips 64K \$3.00, 256K \$14.00.

To order call 604-888-2606 or write:
Soltech Industries Inc.
9274 - 194th Street
Surrey, B.C. V3T 4W2

Toshiba Computer

The newly introduced "Advanced PC/XT" from Toshiba is a fully IBM-compatible computer system. The 256K base system (expandable to 640K) features a keyboard, mouse, and single drive. A second drive and a hard disk are available; there are ports for serial, parallel, LCD, composite video and RGB. The system has a full function keyboard and three expansion slots. From Toshiba computer dealers.

Circle No. 54 on Reader Service Card.



Clamp Meter

Brunelle Instruments has added the DM-6015 to their line of clamp-on meters. The 6015 features a 0.5" digital readout, DVC, ACV, ohms, and ACA as well as a diode check. A temperature measuring option is available. Brunelle Instruments Inc., 73 - 6th Range South, St-Elie d'Orford, Quebec J0B 2S0, (819) 563-9096.

Circle No. 55 on Reader Service Card.

Hygro-Thermometer

The Pacer Model DH201 Hygro-thermometer measures relative humidity within 2 percent or temperature within 1 degree F. The humidity response time is up to 90 percent of the measurement value within 15 seconds. It's complete with a combination RH/temperature probe, a case and a 9V battery for \$435 US. Pacer Industry Inc., 1450 Chippewa Falls, Wisconsin 54729, USA, (715) 723-1141.

Circle No. 58 on Reader Service Card.

Heath Computer

The Heath Company has increased the speed and expansion capabilities of their line with the new HF-158 computer kit. It's PC-compatible, runs at 8MHz instead of the usual 4.77MHz and has six expansion slots. The keyboard has been redesigned for ease of use. Standard equipment consists of 256K, one parallel port, one serial port, and one or two drives. Hard disks are available. From Heath dealers nationwide, or contact the Heath Co., 1020 Islington Ave., Toronto M8Z 5Z3, (416) 232-2686.

Circle No. 57 on Reader Service Card.



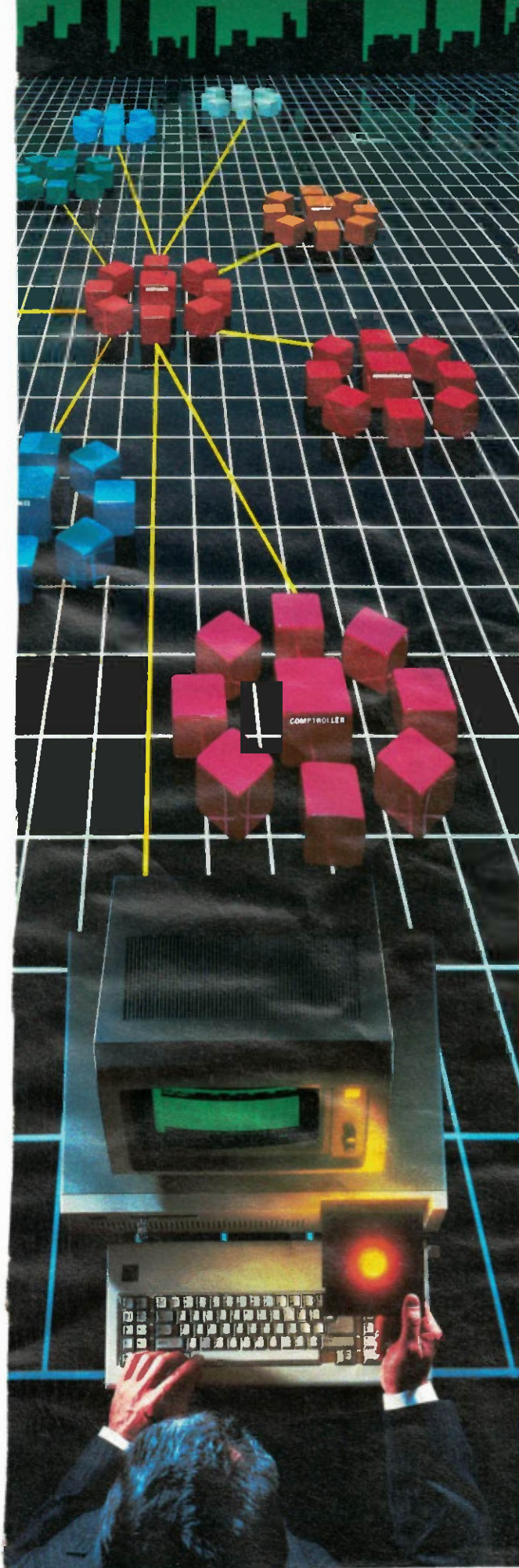

We've Put a Local Area Network on a Disk

Corporate Information Sharing. It's been described as the key to increasing a company's productivity. It's also why large networks of PC's are becoming more and more common in the workplace...in spite of the fact that they're costly, difficult to install, and incompatible with much existing software.

Finally, there's a solution to this corporate dilemma. Its name is LANLink™

A Software-Driven LAN That Uses Standard, RS-232 Ports. A major breakthrough in local area networks, LANLink™ uses your computers' existing serial ports and runs under PC-DOS.

Because all of the intelligence the network requires is on the server and satellite diskettes, expensive network interface boards aren't required.

A Powerful Network That's Cost-Conscious. If you've been pricing board-driven LAN's, you already know that they can cost over \$1,000 per workstation.

LANLink™ is different.

Boasting a data transfer rate in excess of 100,000 BPS, LANLink™ is compatible with a wide range of programs. And because special boards aren't required, installation costs are one-third that of a traditional network.

A Network Designed the Way Business Works. With LANLink™ you're able to customize your network along departmental lines using a data-sharing hierarchy and password-protected access.

Get Started With LANLink™ TODAY. Call The Software Link TODAY for complete details and the authorized dealer nearest you. The LANLink™ Starter Kit, priced at \$745, comes complete with network software for both a server and a satellite computer. For a limited time, 50 feet of RS-232 cable will be included free of charge.

LANLink™ is immediately available and comes with a money-back guarantee. VISA, MC, AMEX accepted.

Circle No. 32 on Reader Service Card.

LANLink™



THE SOFTWARE LINK, INC.

Developers of MultiLink™ and MultiLink Advanced™

400 Esna Park Drive, Suite 18, Toronto (Markham), Ont. L3R 3K2

CALL: 416/477-5480

Dealer Inquiries Invited

MultiLink, MultiLink Advanced & LANLink are trademarks of The Software Link, Inc. PC-DOS is a trademark of IBM Corp.

★★★★★ **FIVE** ★★★★★
STAR PERFORMANCE
FROM



**DIGITAL + ANALOG
STORAGE SCOPES**

Whether recording lightning strikes,
crash impact data or heartbeats,
these digital and analog storage
scopes will capture them all.



**HIGH PERFORMANCE
CRT READOUT DISPLAY**

If top of the line is what you demand,
these outperformers will top your list
with features such as cursors, DVM,
programmable on screen text, etc.



**VIDEO WAVEFORM +
VECTOR MONITORS**

In the studio or on location,
the versatility and performance
of these instruments will steal the show.



**PERFORMANCE PROVEN
GENERAL PURPOSE**

From 20 MHz to 100 MHz
Hitachi's price/performance
combination is second to none.

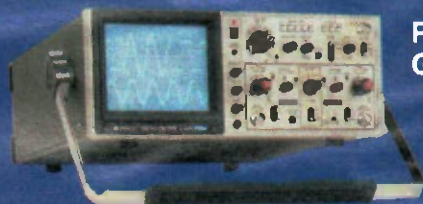

TOUGH MINI SCOPES

These rugged ultra-portables
will take it, wherever the job
takes them.



Call us for Performance Proven Electronics

 **Hitachi Denshi, Ltd. (Canada)**

Head Office:
65 Melford Drive
Scarborough, Ontario M1B 2G6
Tel: (416) 299-5900
Toll Free: 1-800-268-3597
FAX: 1-416-299-0450
Tlx: 065-25324

Ottawa Office:
159 Colonnade Road, Unit 3
Nepean, Ontario K2E 7J4
Tel: (613) 727-3930
FAX: 1-613-727-3955
Tlx: 053-4533

Eastern Office:
8096 Route Trans Canadienne
St. Laurent, Quebec H4S 1M5
Tel: (514) 332-6687
FAX: 1-514-335-1664
Tlx: 0582-4768

Western Office:
3433-12th Street N.E.
Calgary, Alberta T2E 6S6
Tel: (403) 291-4388
FAX: 1-403-250-1634
Tlx: 03825-861