

Electronics Today

\$3.25
MM70924

September 1985

Canada's Magazine for Electronics & Computing Enthusiasts

Cellular Telephones

Affordable portables

CSA Certification
Obtaining approval

Noise Gate Project
Easy noise reduction

Switching PSU
A Miniature Switcher

Micro-Cap II
Electronic Analysis Software

**Avoiding
PSU Noise**



042564MAY 87* E103*
AV A2 [redacted]
DARTMOUTH NS B2Y 3N3



The BEST MK II

Super PC and XT Compatibility

Look what you get as standard!

- Uses 8088 microprocessor.
- New Feature. 256K RAM as standard.
- New Feature. Comes with the latest 41256 RAM chips.
- Expandable up to 512K and more on main board using 41256 RAM chips.
- New Feature. 7 expansion slots, each being identical for the user to upgrade as required.
- New Feature. Fitted with 150W power supply so system can be upgraded to a hard disk without changing power supply.
- New Feature. Flip-Top case.
- DMA controller. Three of the DMA channels are available to the user.
- New Feature. Even most basic versions come with Parallel and Serial Ports and Real Time Clock.
- Half watt speaker.
- Pre-socketed for optional coprocessors such as the 8087 math processor.
- Keyboard Interface compatible with IBM compatible keyboards through a 5-pin DIN connector.
- Three ROM sockets are available to the user, one generally holding the Phoenix BIOS.
- New Feature. Reset switch.
- Timer/Counter used by the system for Real Time Clock, time base and for tone generation.
- Complete with the Phoenix BIOS, identical to that used by many of the large US companies manufacturing IBM compatible computers.
- Comes with two Slimline DS, DD 5 1/4" 360K Disk Drives.
- Colour Video (RGB and composite) and Disk Controller cards Included.
- 230V models available.
- 300 Day warranty.



SEPTEMBER SPECIALS

Tape Drive option backup suitable for all systems **\$Call**

IBM is registered trademark of IBM Canada Ltd.

The BEST Mark II
 As described above using 41256 RAM chips. Two 360K DS, DD disk drives, RS232 and parallel port, Real Time Clock, 7 slots, Phoenix BIOS, Colour Video and Disk Controller Cards, Keyboard and much, much more

With 256K	With 512K
\$1695	\$1795

The BEST 10 Meg Hard Drive
 As the BEST Mark II but with 10 Meg Hard drive (supplied with one Floppy Drive. For second drive add \$200).

With 256K	With 512K
\$2695	\$2769

The BEST 20 Meg Hard Drive
 As the BEST Mark II but with 20 Meg Hard drive (supplied with one Floppy Drive. For second drive add \$200).

With 256K	With 512K
\$2995	\$3069

Also the Basic BEST \$1595.00
 As the BEST Mark II described above but without Parallel Port or Real Time Clock

The Best 256K PENTARAM BEST SELLER



\$299.00 with 256K RAM, Real Time Clock Parallel, serial and Game Port.
New Multifunction Floppy Controller for your IBM or Compatible.
 Includes: Floppy Controller (up to 4 DS, DD drives) Parallel Port, Real Time Clock/Calendar (with battery backup) and 2 Serial Ports (of which only one is installed, the second is an optional extra at \$29.00) **\$199.00**
 (Real Time Clock software is Included — cables are extra)
 Parallel/Game Port (For IBM or Compatible) **\$79.00** (cables extra)
 Quanta Board with Parallel and Game Port, 2 Serial Ports and Real Time Clock **\$159.00** (cables extra)
EPROM Programmer \$99.00 (with ZIF Socket Adapter **\$159.00**)

BEST 512K RAM BOARD

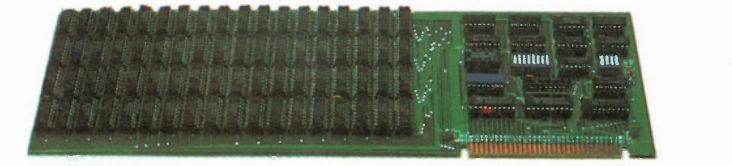

SPECIAL: \$229.00 with 512K. With 64K **\$149.00**
Colour Graphics Video Board \$179.00 (Composite and RGB Output)

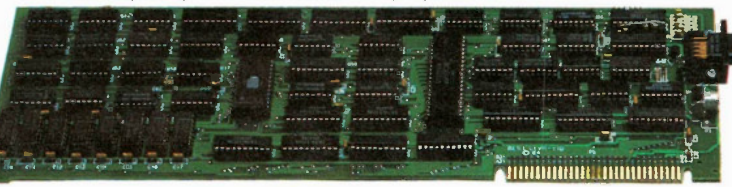

Quantity, Students and Teacher discount's available.

CHARGE X master charge. **Exceltronix Computer Division Computers at unbeatable prices! (416) 921-8941, 319 College St., Toronto, Ontario**
 No returns or exchanges after 7 days. 15% restocking charge. **MST 152**
 Prices may change without notification 1-800-268-3798 —
EXCELTRONIX 217 Bank Street, Ottawa (613) 230-9000 Order line only

319 College Street, Toronto, Ont, M5T 1S2 (416) 921-8941
217 Bank Street, Ottawa, (613) 230-9000 Mail Order Enquiries (416) 252-5285
We guarantee you the combination of BEST Prices & Service In Canada!

APPLE COMPATIBLE DISK DRIVES

Now also available for Apple IIc

Famous Multiflex Disk Drive

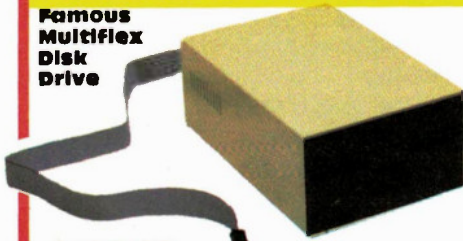

\$199.00

1 year full warranty

Features:

- Apple compatible • Attractively packaged • Professionally built and tested • Canadian Made. We believe that Multiflex put out more drives in the last year than all other Canadian manufacturers combined.

Monitors Zenith Data Systems



BEST SELLER ZVM 122A • 12" diagonal screen • non-glare amber display • composite input • 25 lines x 40/80 characters **\$135.00**

BEST SELLER ZVM 123A • 12" diagonal screen • non-glare green display • composite input • 25 lines x 40/80 characters **\$125.00**

ZVM 133 • 13" diagonal screen • RGB input • 25 lines x 80 characters • 640 x 240 pixels green screen only switch • 16 colours including PC brown **\$749.00**

Peripherals for your Apple

Z80	\$ 43.00
80 x 24 Video Card with Soft Switch	\$ 67.00
16K RAM Card	\$ 43.00
128K RAM Card with 128K	\$ 99.00
Parallel Card with Cable	\$ 59.00
Serial Card	\$ 69.00
Apple Programmer	\$ 65.00

Multiflex 300 Baud Modem

For your Apple (Super compatibility) **\$159.00**

BEST IBM Compatible Modem

- Plugs into motherboard
 - Excellent Hayes compatibility
 - Auto Dial, Auto Answer, Directconnect
- 300 Baud **\$179** 300/1200 Baud **\$379**

New from Star Micronics 5G-10 Printer

- Dual Mode - NLO/draft standard (NLO = near letter quality) • 120 CPS and 20% faster throughput
- Bidirectional logic/seeking • 2K buffer (expandable to 6K with optional buffer interface) • 100% IBM PC or Star standard control codes-switch selected • Friction and tractor standard • full 1 year warranty • 10" wide carriage • Standard parallel interface (serial optional) **\$399.00**

5G-15 same as 5G-10

Except with 15" carriage and standard 16K buffer **\$599.00**

Radix — \$995.00 SR-15 \$995.00

Star Micronics Gemini 10X 1 year warranty

- 120 c.p.s., • 816 characters print buffer, option 4K or 8K • standard parallel optional RS232C • tractor & friction feed. **Super Special \$299.00**

(Time limited offer)

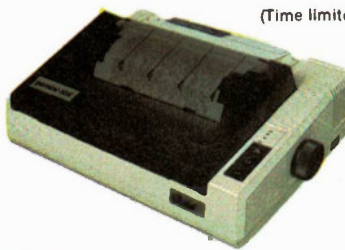

POWER TYPE LETTER QUALITY \$599.00
 • 18 CPS bidirectional logic seeking.
 • 96 Petal Wheel

IBM COMPATIBLE KEYBOARDS

Cherry	\$135.00
Maxiswitch	\$135.00

Super Special Keytronic Programmable Keyboard (no case) \$69.00

IBM Compatible Disk Drive SA455 (with warranty) \$169

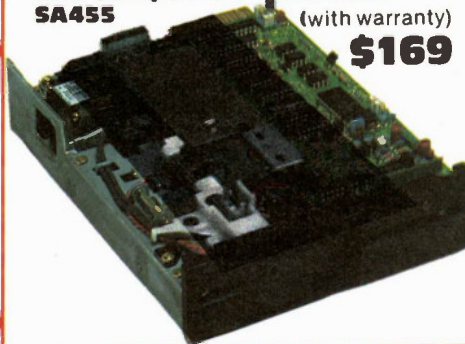

CASES FOR YOUR IBM Compatibles

- Hinged top cases allowing easy access by opening top half of the case. Can be supplied with plain back or for 5 or 8 slots. Please specify when ordering. **\$74.95**
- Above case with power supply and fan For Apple compatible 75 Watt **\$169.00**
 For IBM compatible 150 Watt **\$219.00**
 Hinged Case with 90W (max.) Power Supply with fan **\$178.00**
 As above with 175W (max.) Power Supply and fan **\$228.00**

Hard Disk Drives

Seagate (Industry favoured)	
10 MEG. slimline	\$889.00
10 MEG Seagate, slimline drive and hard disk controller. This controller can handle up to two 10 MEG hard drives. LOWEST PRICE OF \$1099.00	
Quantity Discounts Available	
Seagate 20 MEG. slimline	\$999.00
Seg 20 MEG. with controller	\$1295.00
Controller alone (for 10 or 20 MEG)	\$349.00
Cables (for 10 or 20 MEG)	\$38.00

MEMORY Untouchable Prices! Guaranteed Prime Stock

Dynamic RAMs	
4116 1x16k (150ns)	\$ 0.75
4164 1x64k (150ns)	\$ 1.29
4164's (150ns). Set of 9	\$10.80
41256 1x256k (150ns)	\$ 7.89
41256 (150ns). Set of 9	\$69.00
Static RAM	
2114L 4x1k 200ns	\$ 2.25
6514 4x1k CMOS 450ns	\$ 1.20
6116 8x2k 150ns	\$ 4.95
2016 8x2k 150ns	\$ 3.99
6264 8x8k 150ns	\$14.95
EPROMS	
2716 450ns 8x2k	\$ 5.50
2716 300ns 8x2k	\$ 6.50
2732 450ns 8x4k	\$ 3.75
2732 250ns 8x4k - SPECIAL	\$ 3.75
2764 300ns 8x8k	\$ 4.75
27128 350ns 8x16k	\$ 6.95

NEW LOW PRICES

EPROM Program \$99.00 (with ZIF Socket Adapter \$159.00)

Special Parts for your IBM & Apple Compatibles

Intel Parts

8087-2 (High Speed)	\$219.00
8087	\$189.00
8088	\$ 7.90
8237A-5	\$ 8.90
8250	\$ 9.89
8253A-5	\$ 5.89
8255A-5	\$ 4.89
8259A	\$ 4.95
8284A	\$ 5.95
8288	\$ 9.75
NEC765/8272 Equip.	\$ 8.95
74LS322	\$ 5.95
62 Pin Card Edge Connectors	\$ 2.19
5 Pin Din Connector	\$ 0.99
100ns Delay Line	\$ 5.89
6502 CPU	\$ 5.45
Z80A CPU	\$ 4.50
68A45 CRT cont.	\$ 9.75
TMS99532 FSK Modem	\$17.95
Set of 8088, 8255A-5, 8237A-5, 8288, 8284, 8253A-5, 8259A	\$48.00

NEW LOW PRICES

High Quality AMP IC sockets

8, 14, 16, 18, 20, 24, 28 and 40

1.5 cents per pin

Quantity discounts available

Bypass Capacitors

0.1 uF, 50V	.13¢
100 pieces	\$9.00

Fans

New 3in fan	\$12.95
New 4in fan	\$13.95

We have the best prices on 74LSXX TTL Series e.g:

74LS-00, 02, 04, 08, 10, 32 at **29¢ each**
 74LS-138, 139, 158, 175 at **69¢ each**
 74LS-244, 245, 273 at **\$1.19 each**

SURPLUSTRONICS

8088 Computer

The Price Barrier Smashed!
\$995



Includes:

- 8088 motherboard with 256K and all parts (except 8087)
- Phoenix Bios
- One 360K DS, DD disk drive and controller
- Power Supply with fan
- Flip-top case

All you need extra is a keyboard, video board and monitor.

8088 Motherboard only with 64K, fully assembled and tested, no Bios (one blank 2764). Expandable to 1Meg on-board memory. Flow soldered. Provision for 8087..... **\$299.00**

6502 Systems

The Famous 6502 Board



- Assembled and fully tested (flow soldered)
- 64K, 80 x 24 video with soft-switch, floppy controller.
- System comes with blank EPROM'S on board, does not come with any proprietary software or Basic... **\$249.00**

Complete System

- 6502 board (as illustrated above) with case, keyboard and power supply **\$399.00**

Complete System

- Using 6502 board above in IBM style flip-top case, using powerful 75 watt power supply with fan, programmable serial keyboard adaptor, IBM style keyboard **\$499.00**
- As above with one built in disk drive **\$749.00**
- As above with two drives **\$899.00**
- Switching Power Supplies. +5V 5A, +12V 2.8A, +12V 2.0 Amps - 12V 0.5A (open frame) **\$39.00**
- Panasonic Printers (open frame) **\$39.95**

PERIPHERAL CARDS FOR YOUR IBM AND COMPATIBLE COMPUTER

- Colour Video Board** **\$159.00**
Composite video or RGB Video
- Floppy Controller** **\$119.00**
- Floppy Controller with RS232** ... **\$149.00**
- Floppy Controller w. clock/RS232** **\$159.00**
- Parallel and Game Port Card** **\$59.00**
Cable and connector extra.
- Peripheral Interface Card** **\$139.00**
Includes two serial ports, parallel port, game port and provision for (but not including) real time clock.
- Clock/Calendar Option** **\$29.00**
With battery backup.
- 256K & Multifunction Board
Includes: Serial port, parallel port, game port, provision for optional real time clock/calendar and socketed for up to 256K RAM.
- With 64K RAM** **\$149.00**
- 512K Board.** Socketed for 512K including:
- 64K RAM** **\$119.00**
- IBM Compatible Disk Drives** **\$159.95**
Brand New, fresh from factory. Shugart SA455 40 track, double sided, double density Slimline. We have ordered 10,000 from Shugart - that is why we can pass the savings on to you.

We will be under

- IBM Compatible Keyboards**
- Keytronics programmable (no case) **\$ 59.00**
- Maxiswitch **\$129.00**
- Cherry **\$ 99.00**

Cases - High Quality

- Hinged for easy access, can be supplied with plain back or for 5 or 8 slots. Please specify **74.95**
- Above case with power supply and fan.
- For Apple compatible (75W) **\$169.00**
- For IBM compatible (150W) **\$219.00**

PERIPHERAL CARDS FOR YOUR APPLE & COMPATIBLE

- Assembled, flow-soldered/cleaned and 100% tested
- 16K RAM Card **\$ 39.00**
- 80x24 video card **\$ 59.95**
- Z80A Card **\$ 39.00**
- Parallel Printer Card (cables extra) **\$ 29.00**
- 128K RAM Card with 128K **\$ 85.00**
- EPROM Programmer with Software **\$ 63.00**
(programs 2716, 2732, 2732A, 2764)
- 8" Floppy Controller **\$ 79.00**
- Modem Autoanswer/autodial, touch tone or pulse dial. Plugs right into the system **\$ 69.00**
- Apple Compatible Disk Drives (SA390) **\$175.00**
- Case with numeric keyboard **\$129.00**
- Power Supply (Hydro Approved) **\$ 69.00**

IBM is a registered Trade Mark of IBM Canada Limited. Apple is a registered Trade Mark of Apple Canada Limited

Mail Orders add \$5.00 minimum for shipping & handling. Ontario residents add 7% P.S.T. Visa, Mastercard and American Express cards accepted: send card number, expiry date, name of bank and signature. Send certified cheque or money order, do not send cash. All prices on this page are final sale. No warranty, No returns, No refunds but HUGE savings. Warranties available at extra cost.

Surplustronics, 310 College Street, Toronto, Ontario, M5T 1S3

More lines to serve you better
(416) 960-1350

Electronics Today

September 1985

Vol. 9 No. 9

Canada's Magazine for Electronics & Computing Enthusiasts



Our Cover

Cellular telephones herald a new era in being bothered by phone calls even when you're driving, page 30; equipment courtesy of Cantel Inc. Photo by Bill Markwick.



Audit Bureau of Circulations

Electronics Today is Published by:

Moorshead Publications Ltd. (12 times a year)
Suite 601, 25 Overlea Blvd.
Toronto, Ont. M4H 1B1
(416) 423-3262

Editor:

William Markwick

Editorial Assistant:

Edward Zapletal

Director of Production:

Erik Blomkwist

Creative Manager:

Ann Rodrigues Mala

Production:

Douglas Goddard

Naznin Sunderji

Sandra Hemburrow

Circulation Manager:

Lisa Salvatori

Account Manager:

Marlene Dempster

Advertising (Que.)

John McGown & Associates

(514) 735-5191

Advertising (B.C.)

(604) 688-5914

Publisher: H.W. Moorshead; **Executive Vice-President:** V.K. Marskell; **Vice-President - Sales:** A. Wheeler; **General Manager:** S. Harrison; **Controller:** B. Shankman; **Accounts:** P. Dunphy; **Reader Services:** M. Greenan, H. Brooks, R. Cree, L. Robson, N. Jones;

Newsstand Distribution:

Master Media, Oakville, Ontario

Subscriptions:

\$19.95 (one year), \$34.95 (two years). Please specify if subscription is new or a renewal.

Outside Canada (US Dollars) U.S. add \$3.00 per year. Other countries add \$5.00 per year.

Postal Information:

Second Class Mail Registration No. 3955. Mailing address for subscription orders, undeliverable copies and change of address notice is: Electronics Today, Suite 601, 25 Overlea Blvd., Toronto, Ontario, M4H 1B1

Printed by Heritage Press Ltd., Mississauga

ISSN 07038984.

Moorshead Publications also publishes Computing Now!, Computers in Education, and Software Now!.

Advertisers' Index

Active Components Sales Corp.	37
Atlas Electronics	67, 72
BCS Electronics Ltd.	11, 69
Bell Cellular	31
Brunelle Instruments	33
Budgetron Inc.	44
Canada Remote Systems	44
Computer Parts Galore	64, 65
Dacor	35
Daetron	42
EDG Electronics Distributors	70
Electronic Control Systems	37
Exceltronix	2, 3
Inevitable	12
Information Unlimited	62
Kaientai Electronics Merchants Ltd.	37
K.B. Electronics	63
Kitstronics	36
McGraw-Hill	29
Nicologix	66
Patron Components Inc.	38
Phase 4	9
Protec Microsystems Inc.	61
Soltech Industries Inc.	12
Sunix Inc.	68
Surplustronics	4
Tektronix Canada Inc.	71
The Software Link, Inc.	8
Varah Direct	7



CSA Certification p. 10

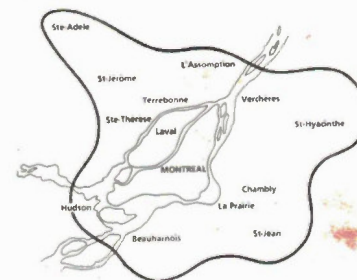

Cellular Telephones p.30

Features

CSA Certification	10
Cellular Telephones	30

Review

Micro Cap II Circuit Software	47
-------------------------------	----

Projects

Noise Gate	13
Probe Project	28
Switching Plugpack	19

Series

Designer's Notebook: PSU Noise	25
Computing Today: Z80, Part 4	39
Electronics From The Start	58
Electronics In Canada	41
For Your Information	6

Columns and Information

Software	46
Electronics Today Next Month	16
Computing Now! This Month	17
Software Now! This Month	17
Order Form	45
Subscriptions	46
Binders	48
Product Mart	48
Books	50
Back Issues	45

For Your Information

Copyright

All material is subject to worldwide copyright protection. All PCB patterns are copyright and no company can sell boards to our design without our permission.

Liability

While every effort has been made to ensure that all constructional projects referred to in this magazine will operate as indicated efficiently and properly and that all necessary components are available, no responsibility whatsoever is accepted in respect of the failure for any reason at all of the project to operate efficiently or at all whether due to any fault in the design or otherwise and no responsibility is accepted for the failure to obtain component parts in respect of any such project. Further no responsibility is accepted in respect of any injury or damage caused by any fault in design of any such project as aforesaid.

Editorial Queries

Written queries can only be answered when accompanied by a self-addressed, stamped envelope. These must relate to recent articles and not involve the staff in any research. Mark such letter Electronics TodayQuery. We cannot answer telephone queries.

Binders

Binders made especially for Electronics Today (ETI) are available for \$9.75 including postage and handling. Ontario residents please add provincial sales tax.

Back Issues and Photocopies

Previous issues of Electronics Today Canada are available direct from our office for \$4.00 each; please specify by month, not by feature you require. See order card for issue available.

We can supply photocopies of any article published in Electronics Today Canada; the charge is \$2.00 per article, regardless of length. Please specify both issue and article.

Component Notation and Units

We normally specify components using an international standard. Many readers will be unfamiliar with this but it's simple, less likely to lead to error and will be widely used everywhere sooner or later. Electronics Today has opted for sooner!

Firstly decimal points are dropped and substituted with the multiplier: thus 4.7uF is written 4u7. Capacitors also use the multiplier nano (one nanofarad is 1000pF). Thus 0.1 uF is 100nF, 5600pF is 5n6. Other examples are 5.6pF = 5p6 and 0.5pF = 0p5.

Resistors are treated similarly: 1.8Mohms is 1M8, 56kohms is the same, 4.7kohms is 4k7, 100ohms is 100R and 5.6ohms is 5R6.

PCB Suppliers

ETI magazine does NOT supply PCBs or kits but we do issue manufacturing permits for companies to manufacture boards and kits to our designs. Contact the following companies when ordering boards.

Please note we do not keep track of what is available from who so please don't contact us for information PCBs and kits. Similarly do not ask PCB suppliers for help with projects. K.S.K. Associates, P.O. Box 266, Milton, Ont. L9T 4N9.

B—C—D Electronics, P.O. Box 6326, Stn. F., Hamilton, Ont. L9C 6L9.

Wentworth Electronics, R.R. No. 1 Waterdown, Ont. L0R 2H0.

Danocinths Inc., P.O. Box 261, Westland MI 48185 USA.

Arkon Electronics Ltd., 409 Queen Street W., Toronto, Ont., M5V 2A5.

Spectrum Electronics, 14 Knightswood Crescent, Brantford, Ontario N3R 7E6.

RSC: Do you use our Reader Service Cards? When you select numbers and mail the card to us, we forward your request for information to the companies concerned. It's a convenient way for you to contact several companies at once, and it's a benefit to us because corporations can gauge advertising effectiveness. When you see "Write for free catalogue", you might not be up for finding an envelope and a sheet of paper and a stamp; the RSC simplifies all that for you. In addition, reader response lets us look at whether or not we're doing a good job at selecting material to put in For Your Information.

Star Wars: Some years ago, the British electronics magazine *Wireless World* published a reader's forum on whether or not technical people should protest working on defence contracts in which they did not believe. The response was overwhelming, with readers about evenly divided on the question; half felt that many defence contracts were accelerating the arms race in return for profits, and the other half thought the weaponry was necessary for security.

We're now at the stage where Canadian contractors may be receiving orders for products or research related to the Reagan government's Strategic Defence Initiative. Aside from the growing opinion that it will result in an increased arms buildup rather than the reverse, there is also the prospect that explosions may take place over Canada. Supporters of the plan feel that it is the only real alternative to the balance-of-terror arms race.

If you'd like your opinions published, Electronics Today offers a section of the For Your Information series as a reader's forum. Media coverage of the debate has tended towards American academics and politicians; it's time that the technical and engineering people had a say. Perhaps they're the ones best able to say whether or not it will work.

Your letters may have to be edited for space, but we'll do our best to keep your argument intact. If you're interested, write The Editor, Electronics Today, 25 Overlea Blvd., Suite 601, Toronto, Ontario M4H 1B1.

Tool Cases



Lenline tool kits for field visits sure beat putting everything into a cardboard carton. They're available in various shapes and sizes and complements of tools. The TC600 shown, for instance, contains 64 tools in a compact nylon case with handles and an outside space for a VOM. Other

models include heavy-duty types made from ABS thermoplastic in the style of an attache case. From various electronics parts distributors across Canada, or contact Len Finkler & Co., 80 Alexdon Road, Downsview, Ontario M3J 2B4, (416) 630-9103.

Circle No. 60 on Reader Service Card

New Storage Scope

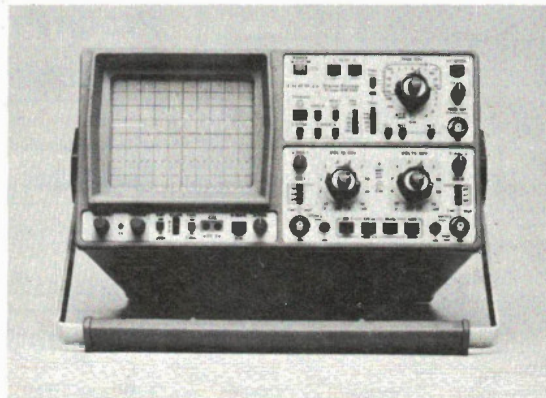

The technology that shrank the computer to desk size is providing for more and better test equipment features, all without an astronomical price tag. The Hameg HM208 digital storage scope, for instance, can capture waveforms at timebase speeds from 10uS/div to 50S/div with a sampling rate of 20MHz in the single-trace mode or 10MHz in the single-trace mode. Two independent 2k by 8-bit memories allow

comparison of different traces; a roll mode with a moving window effect is ideal for low-frequency signals, displaying as much as eight minutes of input signal. Trace data can be sent to an XY recorder or to an optional IEEE-488 interface. The 208 is priced at \$2750, FST included. From BCS Electronics, 980 Alness St., Unit 7, Downsview, Ontario M3J 2S2, (416) 661-5585.

Circle No. 59 on Reader Service Card

Nostalgia Tubes

For those who cut their electronic teeth on triodes and consider the transistor to be a passing fad, the American Business Collectors Guild has amassed a collection of radio, radar, and communications tubes of the 20s through 50s, and has crafted them into unusual lamps, desk, and showcase pieces. Each tube is cleaned, surface-restored, and mounted on a base of transparent acrylic. The tubes are said to have high value as collector's items, and the series is called the Classic Tube Collection. At select US department and gift stores, or direct from the A.B.C. Guild, PO Box 213, 107 Trumbull St., Elizabeth, New Jersey 07206.

Circle No. 57 on Reader Service Card



Corrections: First of all, the editor apologizes profusely to author Paul Hurly (NAPLPS, July, 1985) for inserting an "e" into his name. This despite the author's business card sitting on the editor's desk.

In the Power Supply project, also in July, there was a correction in the Parts List that didn't quite make it. You'll notice that capacitors C10 to C112 are crossed out but uncorrected. The proper value is 1000uF. Also, the labels for R28 and R29 on the Fig. 5 component overlay should be interchanged (R29 is the 500k trimpot).

Several readers wrote to ask about the mysterious "R" in the resistor list. We've been using this for some time now, though not consistently. It means "ohms" and takes the place of the decimal point; 5R6 is the same as 5.6 ohms.

A reader points out that in the ZX-EPROMer article in the July issue, diode D1 at the top of page 53 is shown reversed. The anode should face the ZX81 Wait pin.

continued on page 23

IT'S PACKED & READY

OUR NEW CATALOGUE IS:

- ★ PACKED with over 2000 top-grade, fully spec'd components
- ★ READY to ship to you

FREE!

Respond to this ETI ad and get yours free!



Not just a product listing, it's a fully referenced guide giving you operating specs, pin-outs, and dimensions for each part.

Everything you need to build your project:

- semiconductors
- cabinetry
- resistors
- connectors
- power supplies
- capacitors
- test equipment
- PCB Supplies
- literature

AND MUCH MORE in the Varah's Direct Reference Guide & Electronic Mail Order Catalogue



Member, Canadian Direct Marketing Association

Locations:

Vancouver
Edmonton
Calgary
Winnipeg
Oakville
Nepean

Write:

Varah's Direct
504 Iroquois Shore Road
Oakville, Ontario
L6H 3K4
(please include your return postal code)

Circle:

The reader service number for this ad
Or Call:
(416) 842-8833
Monday to Friday
8:00 - 5:00, E.S.T.

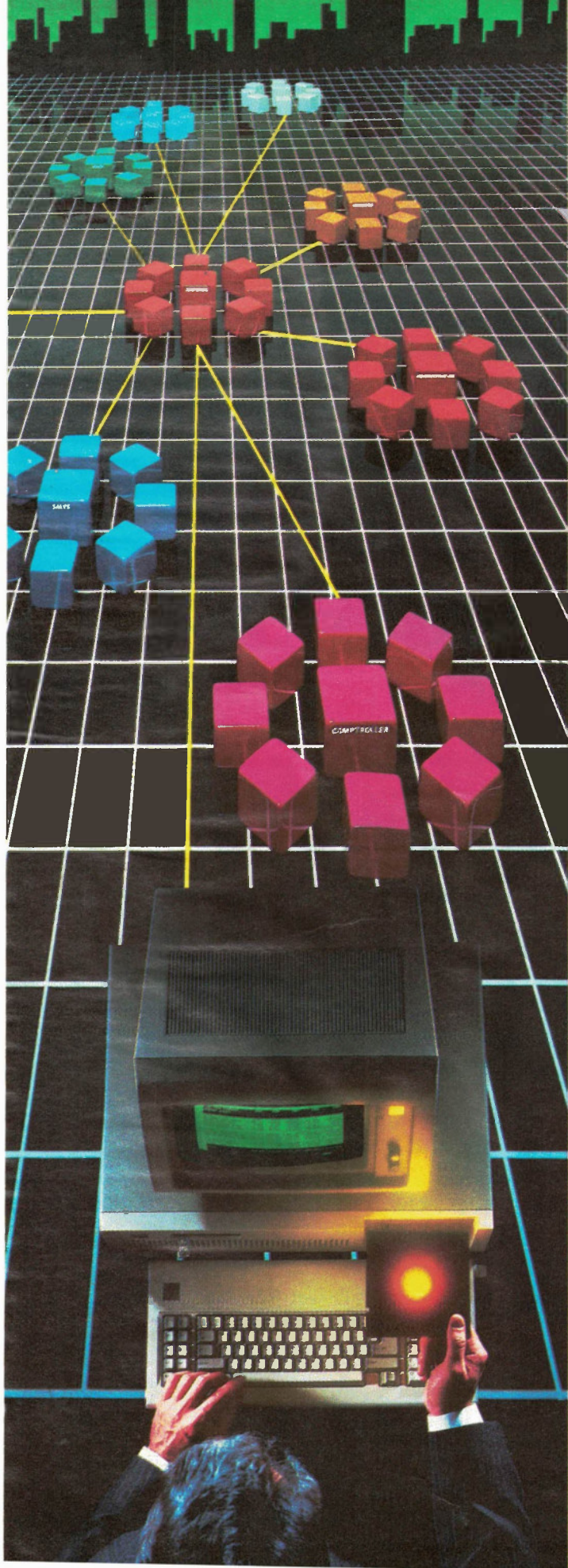

We've Put a Local Area Network on a Disk

Corporate Information Sharing. It's been described as the key to increasing a company's productivity. It's also why large networks of PC's are becoming more and more common in the workplace...in spite of the fact that they're costly, difficult to install, and incompatible with much existing software.

Finally, there's a solution to this corporate dilemma. Its name is LANLink™

A Software-Driven LAN That Uses Standard, RS-232 Ports. A major breakthrough in local area networks, LANLink™ uses your computers' existing serial ports and runs under PC-DOS.

Because all of the intelligence the network requires is on the server and satellite diskettes, expensive network interface boards aren't required.

A Powerful Network That's Cost-Conscious. If you've been pricing board-driven LAN's, you already know that they can cost over \$1,000 per workstation.

LANLink™ is different.

Boasting a data transfer rate in excess of 100,000 BPS, LANLink™ is compatible with a wide range of programs. And because special boards aren't required, installation costs are one-third that of a traditional network.

A Network Designed the Way Business Works. With LANLink™ you're able to customize your network along departmental lines using a data-sharing hierarchy and password-protected access.

Get Started With LANLink™ TODAY. Call The Software Link TODAY for complete details and the authorized dealer nearest you. The LANLink™ Starter Kit, priced at \$745, comes complete with network software for both a server and a satellite computer. For a limited time, 50 feet of RS-232 cable will be included free of charge.

LANLink™ is immediately available and comes with a money-back guarantee. VISA, MC, AMEX accepted.

Circle No. 38 on Reader Service Card.

LANLink™

 **THE SOFTWARE LINK, INC.**

Developers of MultiLink™ and MultiLink Advanced™

400 Esna Park Drive, Suite 18, Toronto (Markham), Ont. L3R 3K2

CALL: 416/477-5480

Dealer Inquiries Invited

MultiLink, MultiLink Advanced & LANLink are trademarks of The Software Link, Inc. PC-DOS is a trademark of IBM Corp.

HEADACHE #43:

"There has to be a way to keep track of overdue accounts!"



Now available for IBM-PC, Compaq, PC-compatibles, and many multi-user Systems

Remedy: IntoTeam™ All-in-One

Reach for the InfoTeam, The All-in-One family of software that calculates numbers, maintains important records, bills customers, prints checks, produces financial statements, tells you who's paying on time and who's delinquent.

InfoTeam is designed for growing businesses in manufacturing, wholesaling, retailing, service industries and accounting.

IBM® -PC Productivity and Accounting Software that works together

The All-in-One is a series of proven software that includes these applications:

- WordStar® and CorrectStar™ word processing and spelling correction
- CalcStar® advanced electronic spreadsheet
- DataStar® records management system
- InfoManagement Accounting including: General Ledger, Accounts Receivable, Invoicing and Accounts Payable

Your Benefit

InfoTeam helps improve your cash flow, eliminates paperwork, pinpoints profitable and non-profitable areas, saves money by eliminating bookkeeping services, and speeds up collections.

Painless integration

No hype! InfoTeam software works together so you can easily move information from one application to another. For example, you can use data from your accounting system in your spreadsheet for financial analysis, or use your prospect mailing list to send personalized letters. InfoTeam also works with other leading products including Lotus 1-2-3™ and dBase II®

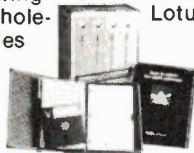

Software you can grow with

InfoTeam is available in single-user and multi-user versions, featuring "record lockout" for true networking. So you can start with one PC then upgrade to a total network as your business grows.

Backed by a leader

Info Designs is a leader in microcomputer software. We now support over 120,000 accounting users worldwide. We back every product with our commitment of quality and service.

Find out how InfoTeam can benefit your business... send us your business card or letterhead for our 48-page booklet "How to Select the Right Software."

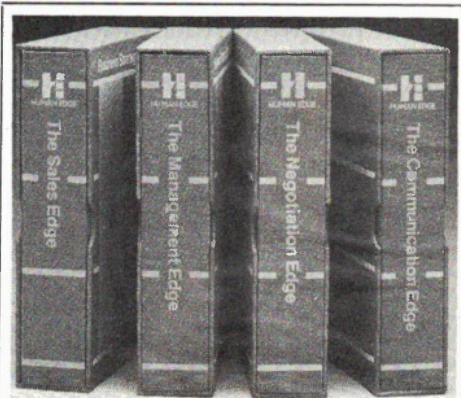

For success-minded business people

"Get the edge"

Human Edge Software
Use it to guarantee your success

- Sell more products
- Get better management results
- Win more negotiations
- Speak more effectively
- Delegate decision-making effectively
- Read others accurately

Human Edge Software Corporation, the leader in practical expert systems, brings you software products to improve your effectiveness in your career, to share your expertise with others and to have fun:

- The Communication Edge
- The Management Edge
- The Negotiation Edge
- The Sales Edge
- Expert Ease
- Mind Prober

These products give you a collection of the strategies and tactics winners use to succeed, fit to your personality—and the personality of the person you choose to persuade—by your computer.

IBM — Apple —
Macintosh — Commdore*

**Orwell Said It Would Happen.
And It Has.**

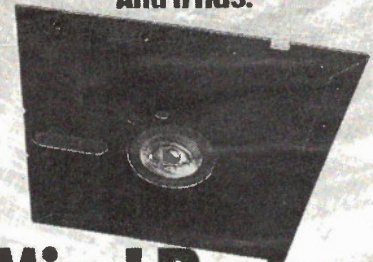

Mind Prober

Phase 4 Distributors Inc.
7157 Fisher Road South East
Calgary, Alberta T2H 0W4
HEAD OFFICE (403) 252-0911

Toronto (416) 928-1081 Vancouver (604) 943-5703

InfoDesigns™

The business software worth buying a computer for.

Dealer inquiries invited

Phase 4 Distributors Inc.

7157 Fisher Road South East
Calgary, Alberta T2H 0W4

HEAD OFFICE (403) 252-0911

Toronto (416) 928-1081 Vancouver (604) 943-5703

Circle No. 5 on Reader Service Card



Photography courtesy of Canadian Standards Association.

CSA Certification

How to get the Canadian Standards Association approval for your electronic design.

By Bill Markwick

SOONER or later, everyone who loves tinkering with electronic gear comes up with a design of some sort that's original or an improvement on existing products. Naturally you wonder if your invention could be a commercial success, and there's no reason it can't be, given the necessary injections of time and elbow grease. There are lots of giant corporations that have started as a glimmer in someone's eye and a few evenings of soldering in the basement or garage.

However, before you can legally market any device that's energized by the power line, you'll need approval from the authorities certifying that your gadget will not electrocute someone or set them on fire, not an unreasonable requirement.

Types of Approval

First of all, you may not require approval at all; devices that are battery-powered are exempt, for instance, although any included battery chargers or adapters powered by the AC line must be certified (using a certified AC adapter eliminates the need for inspection). The basic rule is that if it uses power from the commercial lines, it requires certification.

If your device needs certification, you'll be following one of two paths. The first is the regular Canadian Standards Association approval and certification number for devices that will be manufactured in quantity in ongoing production runs. The second is for devices manufactured on a one-time basis, varying in quantity from one unit to a large shipment; the essential difference is that the approval, which CSA refers to as the Special Acceptance Program, is applied only to the units inspected at the time of manufacture.

In some cases, you can get rapid approval for small one-time production runs from the local AC power authority. In Ontario, the Ontario Hydro special ap-

proval is gradually being taken over by the CSA Special Acceptance Program; in other provinces you'll have to check with the local authorities. Remember that local approval applies only within the province doing the inspecting; if you have your gadgets approved by the power company in Manitoba, you can't sell them in Ontario, and so forth. On the other hand, CSA certification is valid nationwide.

The Inspection

In the case of blanket certification (i.e., ongoing production), CSA needs at least one representative model of the product. This unit will be fully tested to see if it meets standards. The time required is four weeks of engineering time, plus whatever lab time is required for testing; this lab time naturally varies with the complexity of the product. The cost will also vary with complexity, perhaps over a range of \$200 to \$2500.

In the Special Acceptance Program for one-time inspections, a field visit may simplify things if you're getting an entire production run certified at once, or for a few small units you may prefer to ship

them to the nearest CSA testing laboratory. Units are not tested to destruction, although an engineer may feel that a fire or shock hazard exists and put it through some severe paces; the moral of the story is to have everything prepared according to the book before submitting products for testing.

The cost of the Special Acceptance Program is less than the full certification, although it depends on the complexity of the product and the required testing time; if you've gotten off to a good start less time is required for the whole procedure.

Where To Start

There is no better place than CSA to find out what CSA is going to be looking for when they begin the approval procedure. This may seem self-evident, but people tend to send in samples of their product on the basis of guesswork; it just wastes their time and money when the product fails to meet the standards. The more research you do before submitting, the better your chances of a rapid acceptance.

Because CSA sets standards for an enormous number of product types, there isn't any simple list of Things To Look For. First, write or telephone the nearest CSA office (see the list at the end of the article) and request their free Service and Information catalogue. This contains a list of published standards some of which are marked to show that they are used as a basis for certification, as well as general information on the certification procedure.

Next, decide the category for your product and send for the appropriate standard. Chances are you'll be ordering C22.2 (Consumer and Commercial Products category), number 1-M1981 (Radio, Television and Electronic Apparatus). At present, this manual of standards lists for \$22.00. While you may get by with only this book, there are other standards which may be applicable, such as Electromagnetic Interference Filters or Conductors for Power-Operated Electronic Devices.

Sample Standards

Here's a quick look at the sort of requirements you'll be dealing with:

4.2.1.4 The enclosure of parts involving fire or shock hazard shall be capable of withstanding a single impact from a solid, smooth steel sphere 51mm in diameter ... without developing any opening that will result in failure of the device...

Obviously, CSA doesn't expect you to go looking for a solid, smooth 51mm steel ball, much less try to work out the impact energy in joules. The point is that you're supposed to build rugged enclosures if there are bad things inside. I had an imported, unapproved high-inten-

sity lamp once that couldn't have withstood the impact of a peanut, much less that steel ball. The thin steel bottom eventually crumpled and contacted the 115VAC transformer terminals, making me feel the light as well as see it. It was soon pulled off the market.

4.2.5.3(a) (Cathode ray tubes require implosion protection of) ...laminated or tempered glass not less than 5.5mm thick for cathode ray tubes having a maximum face diagonal of 660mm...

If you're ordering CRTs for your oscilloscope design, how do you know if the face is 5.5mm thick, especially if the supplier wants to give you a substitute? The answer is to make sure that the CSA monogram appears. There's a considerable difference between a device listed as "meets CSA specifications" and one that says "CSA certified". By insisting on components bearing a CSA certification number, you simplify the procedure in the long run.

4.2.2.3(b) (The maximum current flow between) Any exposed parts ... having a potential difference of 30V or more and which can be contacted with both hands at the same time shall not exceed 0.5mA through a 1500 ohm resistance...

No problem here. Exposed conductors above 30V are a shock hazard, so don't have any exposed parts above 30V.

4.9.2.6 The ring terminal of a post extractor fuseholder shall be connected to the load side of the circuit.

In general, most of the CSA standards look like the above requirement for fuseholders: easy to work with. The manuals are very well written and rarely give ambiguous meanings. Of course, words being what they are, there are bound to be moments when you can't quite grasp the interpretation, but George Sutherland, CSA's Manager of Customer Services, stressed that they're always willing to assist applicants with getting the unit to meet requirements. Besides, a phone call or letter is a lot less trouble and expense than having your product fail the testing and have to go around again.

CSA also checks for openings in the cabinetry through which a conductive rod could be inserted. They have to be designed in such a way that the curious among us cannot insert a screwdriver, contact a live terminal, and end said curiosity in a big way. Temperature rise is also important; if you're drawing too much power from the power transformer, it will probably show up as an unacceptable

continued on page 68

PROBES FOR SALE

FROM THE BEST SOURCE FOR OSCILLOSCOPE PROBES AND DMM/VOM TEST LEAD SETS.



- Low cost
- High Quality
- Excellent Performance
- Slender, Flexible Cable

- Wide Range of Choice
- Switchable X1 and X10 Attenuation Factor
- 100 MHz Bandwidth

MODEL SP100
\$25.00

Please add \$2.00 for shipping

Your Probe Specialists

Coline Canadian Sales & Stocking Source

Store Hours: Monday to Friday 8:00 am to 5:00 pm.
Saturday: 10:00 am to 1:00 pm.



BCS
ELECTRONICS
LIMITED

980 Ainess St. Unit 7,
Downsview, Ontario,
M3J 2S2
(416) 661-5585
TELEX 065-28169

**INTRODUCING:
THE NEW STANDARD
FOR IBM PC/XT
COMPATIBILITY**
The ACS-1000 Super Computer

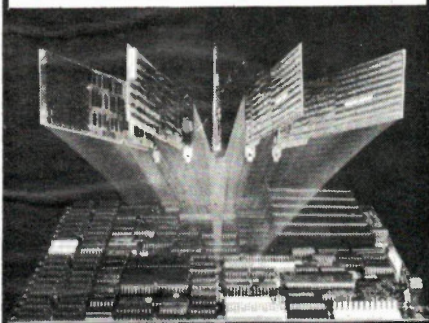

**INTRODUCING:
THE NEW STANDARD
FOR IBM PC/XT
COMPATIBILITY**
The ACS-1000 Super Computer

- 1 Megabyte On-Board Memory
- Built-in Disk Controller
 - up to 4 Floppies
 - SASI Hard Disk Interface
- 54 KB User Definable ROM
- Switchable: 4.77 or 8 MHZ
- Built-in Multifunction Board
 - Parallel Printer Port
 - 2 Serial Ports
 - Time-of-day Clock

**Seize Control of Your
Hardware Destiny**

If you are using board level microcomputers you can have greater power, versatility and reliability by using the ACS-1000 single board SuperComputer.

The ACS-1000 is compatible with both software and hardware designed for the IBM PC/XT. It even has the same mounting holes and the same power supply connections. The difference is that the ACS-1000 offers a much higher level of integration and costs less than \$600 when ordered in quantity.

Save your Expansion Slots for true expansion. Disk Controllers, I/O ports and extensive memory are already built-in, simplifying production and freeing the 6 expansion slots to take on specialized work of your process control, CAD/ CAM or office automation applications. There's even a special port for a low cost piggyback modem.

See for yourself. We are offering a system evaluation kit for \$995.00. The 128K system includes bios, documentation, and an XT compatible power supply.

**Special introductory offer on
peripherals and chips.**

Shugart SA 455 Floppy Drives **\$185.00**,
IBM Compatible cases **\$80.00**, 130 Watt
Power Supplies **\$220.00**, Keyboard
\$200.00, Chips 64K **\$3.00**, 256K **\$14.00**.

To order call 604-888-2606 or write:
Soltech Industries Inc.
9274 - 194th Street
Surrey, B.C. V3T 4W2

SEE CANADA BY MODEM!

THE ACCESS TIMESHARING SYSTEM
brings Canada into your home or office!

All you need is a computer or terminal equipped with a modem. Participate in an electronic community featuring . . .

- | | |
|--------------------------|-------------------|
| Electronic Mail | The Online Office |
| Bulletin Boards | Public Databanks |
| Multi-Player Games | Free Software |
| Online Programming | Communications |
| Polls and Surveys | Suggestion Box |
| Lots of Online Help | Chess League |
| Easy-to-use commands | Conferences |
| BASIC Subroutine Library | Much more! |

WE HAVE SPECIAL-INTEREST GROUPS!

Bulletin boards, databanks, surveys, up/download, specially dedicated to Apple Atari TRS-100 IBM-PC

LINK UP!

You owe it to yourself to find out what computer communication can do for you! The Access Timesharing System is the best way to link up — and it's inexpensive!

Get it all, 24 hours per day, for

ONLY \$5.95 PER HOUR

Special rate for local Montreal users
Only \$2.50 per hour

For the past 3 years, we have provided low-cost, high-quality service within Montreal. Now, anybody in Canada can enjoy The Access Timesharing System!

WRITE TODAY FOR MORE INFORMATION

The Inevitable Corporation
8400 Cote de Liesse, Suite 217
St. Laurent, Quebec, Canada H4T 1G7

OR CALL US AT (514) 342-8147
Circle No. 11 on Reader Service Card

Noise Gate

Open up the way to noise-free music with this versatile unit. It also doubles as an envelope shaper.

By Ian Coughlan

EVERY MUSICIAN knows the problems caused by noisy leads and effect units: whenever you stop playing, the snaps, crackles and pops are still there. This may be acceptable for practising, but it's a major headache when recording or playing live. One solution is a noise-gate, the electronic equivalent of pulling the jack-plugs out every time you stop playing. In fact, the noise-gate does it so unobtrusively that you'd never know it was there.

Important parameters of a noise-gate are:

Threshold: this is the input signal level required to open the gate, and is adjustable from approximately -35dBm down to -65dBm . Normally it will be set just above the noise-floor, so that when playing begins, the increase in signal level is sufficient to open the gate.

Response-time: this is the time taken for the noise-gate to begin opening once the threshold has been crossed. Ideally it should be instantaneous, and in practice should be less than a millisecond and not adjustable.

Attack-time: the amount of time the gate takes to go from fully closed to fully open. Most noise-gates open instantly; this is what is usually required. This design will do so if you want, but it can also be adjusted to take up to 100ms to open.

Hold-time: this is the period for which the gate remains fully open after playing has stopped. It is adjustable between 100ms and 2s.

Decay-time: this is the time taken for the noise-gate to close after the Hold-time has elapsed. It is adjustable between 100ms and 2s.

As well as being triggered by the incoming signal, the noise-gate may also be opened by another signal from the EXT KEY socket, by a logic level on the REM socket, or by a switch contact (on the REM socket), or by the built in footswitch. Regardless of the triggering method used, the attack, hold, and decay controls still

function. Because the envelope shape is completely adjustable and the unit can be controlled by a variety of inputs, it can be used as an envelope shaper in its own right.

Construction

Before soldering anything into place, check that the PCB has a hole under PR1 and, if not, carefully drill a 1/4 inch hole there. This will allow the preset to be adjusted from the underside of the board when the unit is assembled into its case. Start by installing the wire link, the jack sockets and, if desired, sockets for ICs 3 and 5. The jack sockets must be of the recommended type if they are to fit correctly into the prepared holes on the PCB.

Next, solder in the resistors and capacitors, making sure that capacitors near the connector end of the board are mounted flat so as to make room for the potentiometers when the board is mounted into the case. Fit the diodes, transistors and ICs 1, 2 and 4, which must be soldered directly to the board allowing clearance for the pots. Cut four pieces of ordinary connecting wire to the proper lengths and solder them between the points shown on the overlay. Next mount the works into a box the same size or larger than the one shown in Fig. 4.

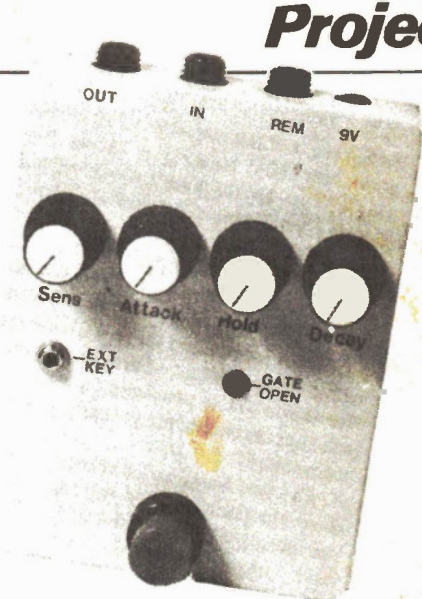

Setting Up

Connect a 9V battery and apply a signal of about 2V peak-to-peak to the input. The LED should light up. Monitor the output with an oscilloscope or an AC millivoltmeter and adjust PR1 until the output level is the same amplitude as that of the input level. Once this has been set, leave it.

In use, the noise-gate should be connected between any effects and the amplifier or tape-recorder. The unit is switched on by connecting a mono jack to the input socket.

When doing the initial setup, turn the sensitivity control fully clockwise and the attack, hold, and decay fully counterclockwise. The LED should be off: if it isn't, press the footswitch. If using any effects, switch them on to produce all the noises you're trying to get rid of. Rotate the threshold control counterclockwise until the LED lights; at this stage you should be able to hear the noise getting through to your amplifier. Turn the threshold control slightly clockwise, raising the threshold to just above the noise-floor. The LED should go off, and the noise should stop.

As you play your instrument, the gate should open, and should close when you stop. The other controls are still set at

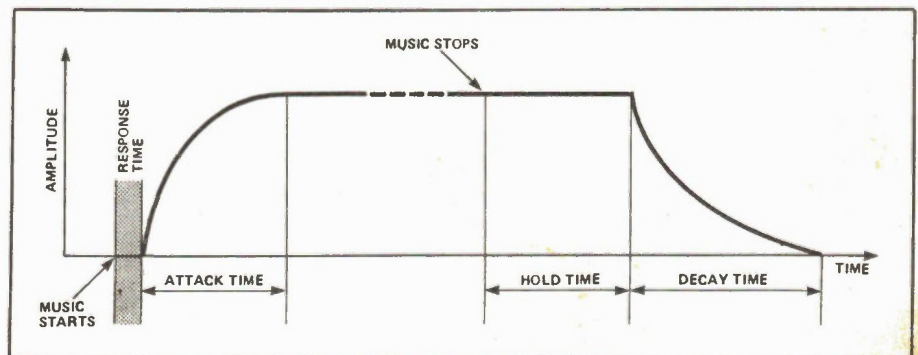

Fig. 1 The response envelope produced by the noise-gate.

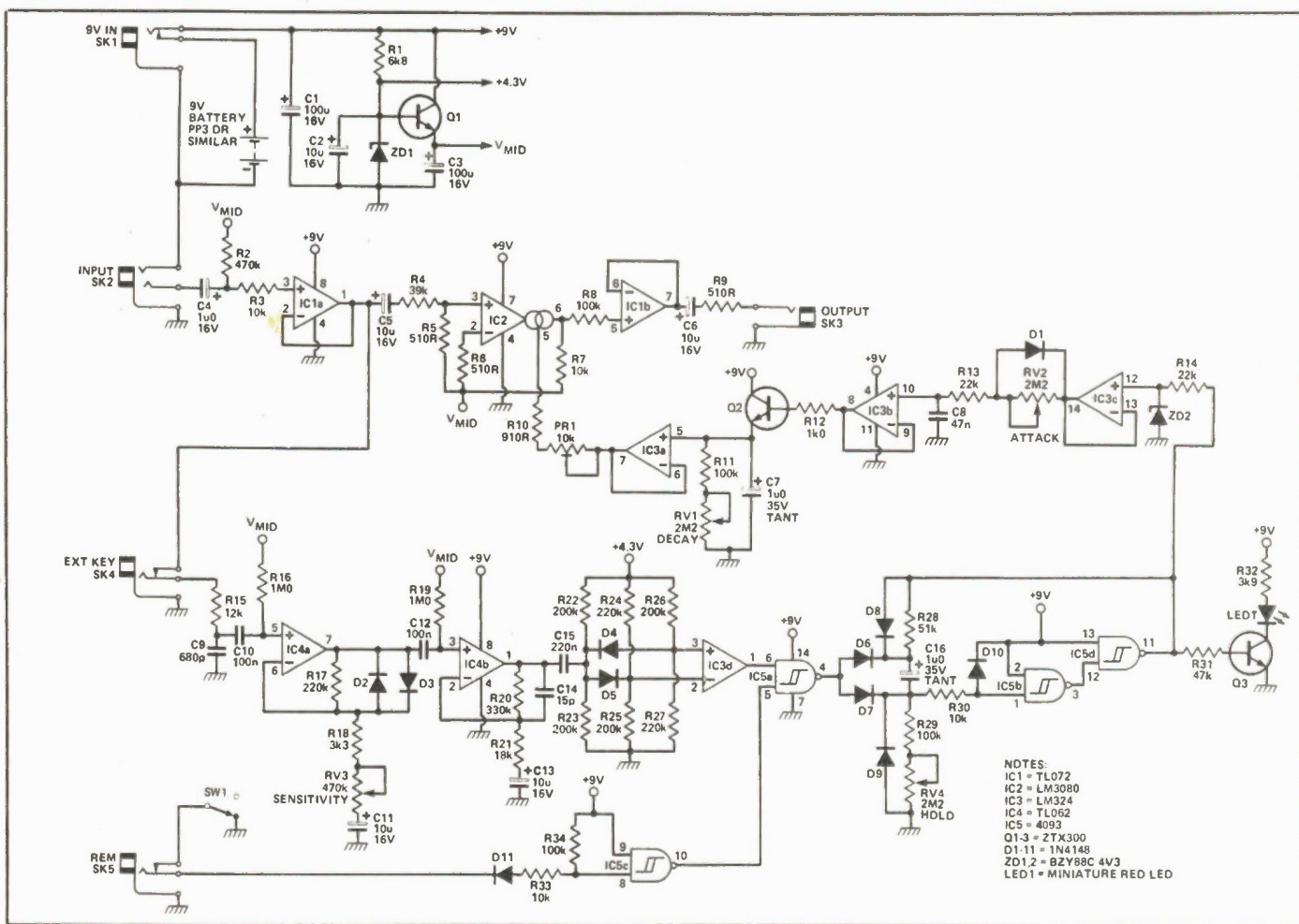

Fig. 2 The complete circuit diagram of the noise-gate.

HOW IT WORKS

The gate is IC2, a transconductance amplifier whose gain is controlled by the current flowing into pin 5. The two halves of IC 1 are connected as unity gain buffers, one before and one after the transconductance amp. The gain of this amp is adjusted to unity by PR1, so the overall gain of the audio path is also unity when the gate is open.

The threshold detector consists of IC3d and the two halves of IC4. The input is taken either from the main audio path, immediately after the buffer stage IC1a, or from the EXT KEY socket. R15 and C9 form a low-pass filter which removes RF noise and the signal is then passed to the amplifier stage IC4a whose gain is set by the sensitivity control. This is followed by a fixed gain stage, IC4b, which ensures that sufficient level is available to reach the threshold of the comparator.

The window comparator is based around IC4d and is slightly unusual in using only one op-amp. When the output of IC4b is of sufficient amplitude, it will push pin 2 of IC3d higher than pin 3 via D5, or pull pin 3 lower than pin 2 via D4. Provided the gate is not in the bypass mode, pin 5 of the NAND Schmitt trigger IC5a will be at a logic high level and the stream of negative

going pulses from the output of IC3d will produce positive going pulses on pin 4 of the Schmitt.

As long as these pulses are present, diodes D6 and D7 will conduct and hold the two ends of C16 at the same potential, preventing it from charging. IC5b and IC5d both have one input connected to the positive supply and will act as Schmitt inverters. Pin 1 of IC5b will be held high via R30 causing its output to stay low, and this low appearing on pin 12 of IC5d will force pin 11 high.

When the pulses at the output of IC5a cease, D6 and D7 will no longer conduct and C16 will begin to charge via D8 from the logic high on IC5d's output. The rate of charging will be determined by the setting of RV4. As the voltage across the capacitor rises, the voltage across R29 and RV4 will fall and pin 1 of IC5b will be pulled low via R30. At a point determined by the operation of the Schmitt, IC5b will change state, its output going high and switching IC5d whose output will go low. Since it was the voltage from this gate which charged the capacitor, no further charging can now take place and the circuit will remain in this state until a further train of pulses is received from IC3d and IC5a.

If the bypass mode is selected either by

operation of SW1 or by means of a logic signal into SK5, IC5a pin 5 will be held low via the Schmitt inverter IC5c. This will cause IC5a pin 4 to remain high, and D6 and D7 will conduct. IC5b pin 1 will be held high via R30 causing pin 3 to go low, and the resulting low on pin 12 of IC5d will cause pin 11 to remain high. This pin will then stay high for as long as the unit is in the bypass mode.

This high drives the GATE OPEN LED via Q3 and R31, R32 and also provides a voltage into pin 12 of IC3c. This voltage is held down to 4.3V by ZD2 and R14. IC3c is a unity gain buffer stage which, on receiving an input voltage, charges C8 via R13 and RV2. The time taken to charge C8 is the attack time and is adjusted by RV2. The voltage on this capacitor is buffered in turn by IC3d and used to drive Q2 which then charges C7. The voltage across the capacitor corresponds to the decay portion of the envelope shape and the discharge period is adjusted by RV1. IC3a is another unity gain buffer which couples the composite envelope shape voltage to the gain-determining pin of the transconductance amp, IC2. PR1 allows the overall gain of the audio path to be adjusted back to unity.

- NOTES:
 IC1 = TL072
 IC2 = LM3080
 IC3 = LM324
 IC4 = TL052
 IC5 = 4093
 Q1-3 = 2TX300
 D1-11 = 1N4148
 ZD1,2 = BZY88C 4V3
 LED1 = MINIATURE RED LED

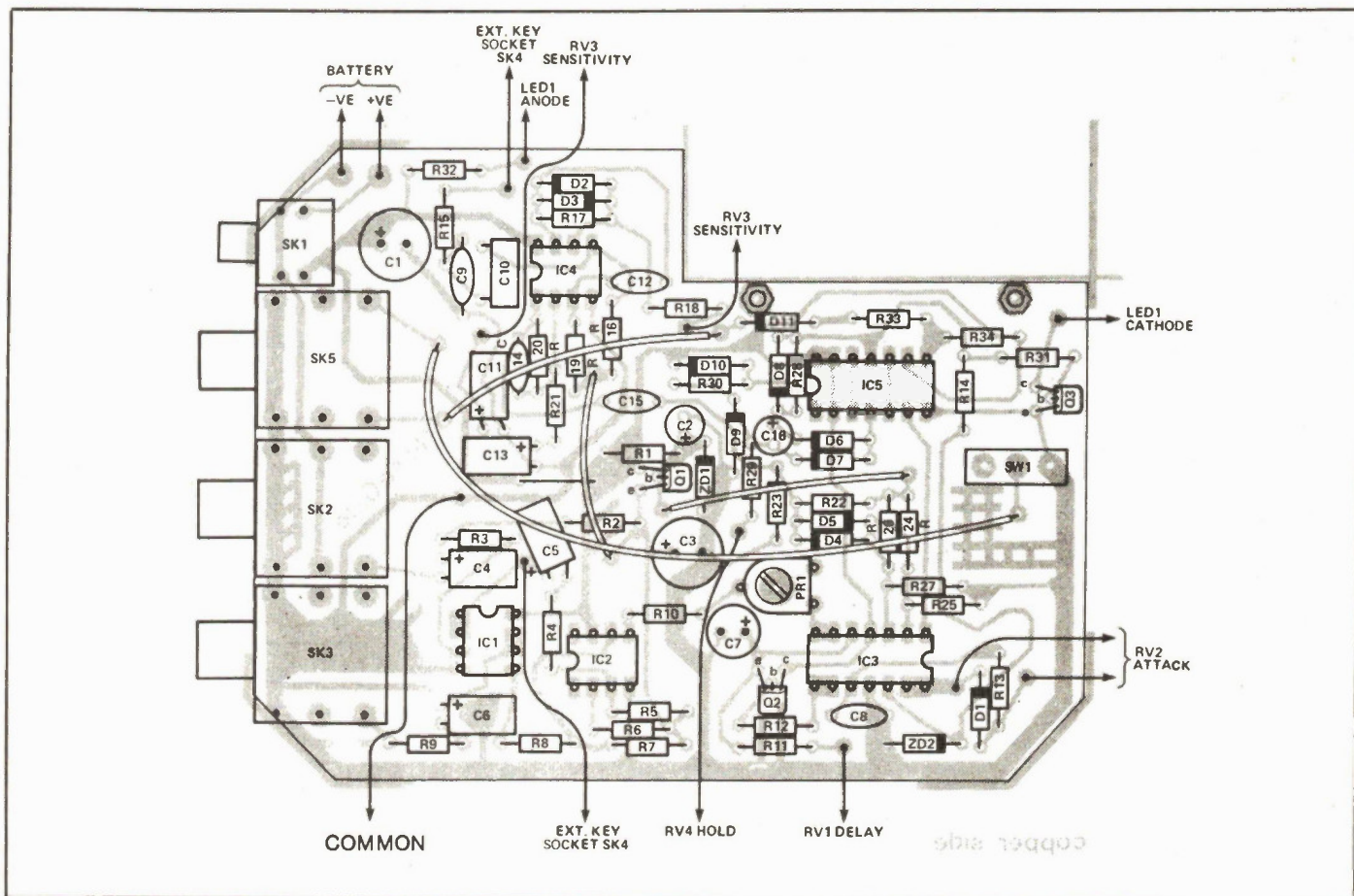

Fig. 3 The component overlay for the noise-gate PCB. Note the four wire links.

PARTS LIST

RESISTORS (all 1/4W, 5% unless otherwise stated)

R1	6k8
R2	470k
R3, 7, 30, 33	10k
R4	39k
R5, 6, 9	510R
R8, 11, 29, 34	100k
R10	910R
R12	1k0
R13, 14	22k
R15	12k
R16, 19	1M0
R17, 24, 27	220k 2%
R18	3k3 2%
R20	330k
R21	18k
R22, 23, 25, 26	200k 2%
R28	51k
R31	47k
R32	3k9
RV1, 2, 4	2M2 logarithmic
RV3	470k logarithmic
PR1	10k horizontal skeleton preset

CAPACITORS

C1, 3	100u 16V radial electrolytic
C2, 5, 6, 11, 13	10u 16V radial electrolytic
C4	1u0 16V radial electrolytic
C7, 16	1u0 35V tantalum bead
C8	47n multi-layer
C9	680p polystyrene
C10, 12	100n multi-layer
C14	15p polystyrene
C15	220n multi-layer

SEMICONDUCTORS

IC1	TL072
IC2	LM3080
IC3	LM324
IC4	TL062
IC5	4093
Q1-3	2N4401
D1-11	1N4148
ZD1,2	BZY88C 4V3
LED1	miniature red LED with mounting bezel

MISCELLANEOUS

SK1	3.5mm miniature jack socket, PC mounting, with switch
SK2	1/4" stereo jack socket, PC mounting, with switch
SK3	1/4" mono jack socket, PC mounting
SK4	3.5mm miniature jack socket, panel mounting, with switch
SK5	1/4" mono jack socket, PC mounting, with switch
SW1	SPDT alternate action push switch, panel mounting
PCB; case; knobs, (4); battery connector; and screws or bolts to suit; 14-pin DIL IC sockets, (2); thin foam rubber; 9V battery.	

minimum and should now be set to suit.

Pressing the footswitch will open the noise-gate regardless of input level, and is very useful when tuning-up. A remote footswitch can be connected up to the REM socket, disconnecting the unit's own footswitch.

The noise-gate can also be used as an envelope shaper with the attack, hold, and decay cycle being triggered in a number of ways. An audio signal can be connected via the EXT KEY socket and will trigger the envelope shaper but still allow the threshold control to be used. Alternatively, the EXT KEY should be shorted with a miniature jack plug and the unit triggered from the REM socket either by making and breaking a mechanical contact or by applying a logic signal. Closing the REM contacts or applying a 0V level will close the gate, while opening the contacts or applying a +5 to +15V signal will open it.

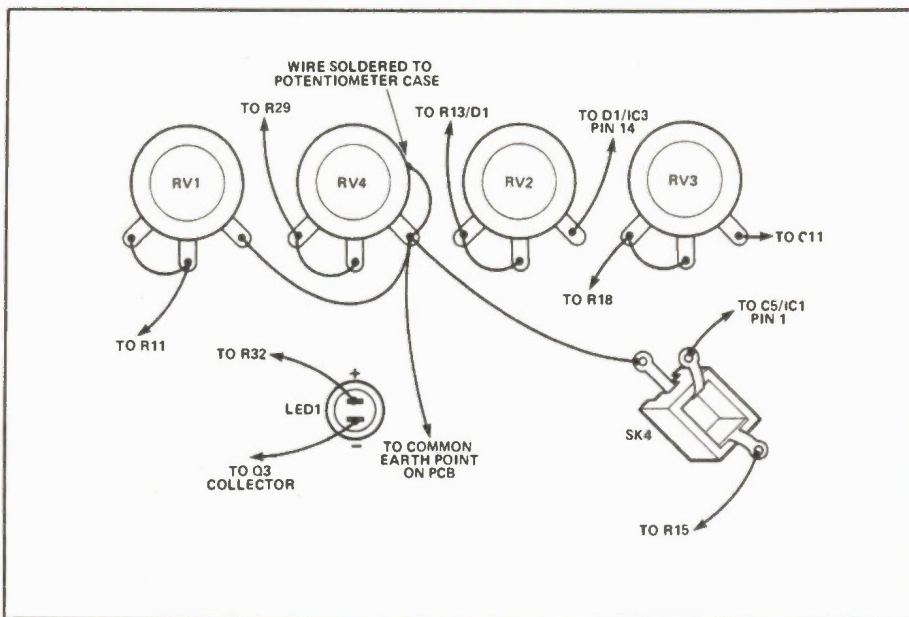
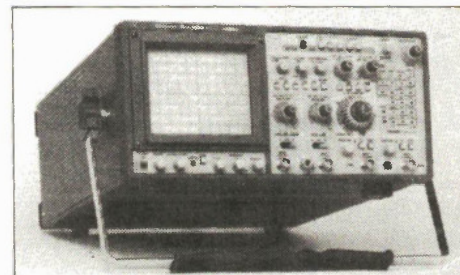

Fig. 5 Connecting details for the front panel components.

NEXT MONTH IN Electronics Today

Oscilloscopes!

The microchip industry has revolutionized more than computers: features formerly out of reach to all but huge labs are now available for the average testbench.



For Subscription or Advertising Information Call (416) 423-3262

Reviews!

DCNAP circuit analysis software, the Cross-8 assembler program, and the Zopan function generator.

A Guide To Transformers

Find out the true meaning of life, or at the very least the true meaning of transformer specifications and how to select them for your needs; a guide for pros and beginners alike.

Large Digit Scoreboard

Build your own triac-driven scoreboard with digits as large as you'd like.

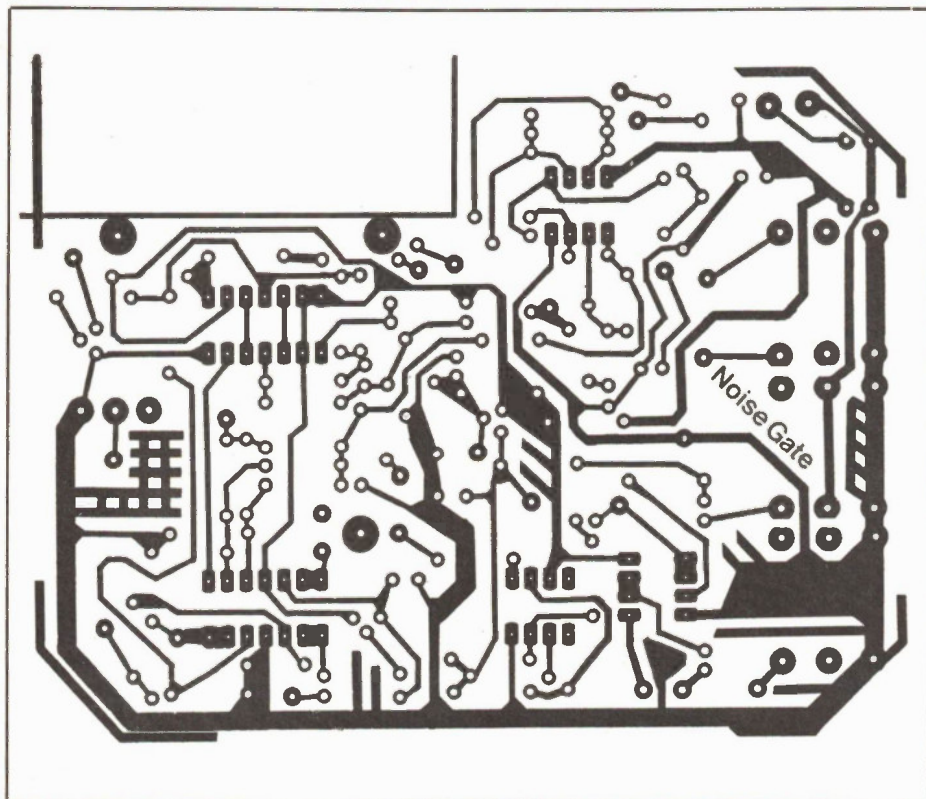
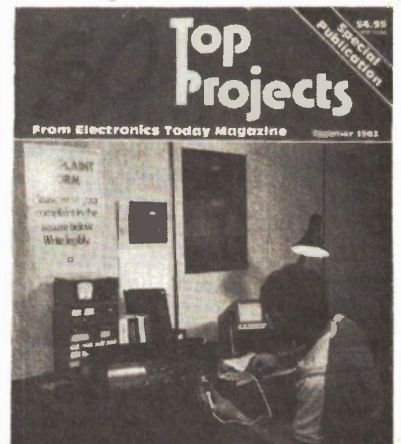

Fig. 6 The PCB for the noise-gate.

50 Top Projects
156 Pages \$4.95



Fifty all-time best projects from ETI magazine packed into one giant 156 pages special. There are projects for the beginner to the more advanced builder, including: Semiconductor Tester, Universal Counter, LED Level Meter, AM radio, and much, much more.

ORDER TODAY FROM
Moorshead Publications, 25 Overlea Boulevard,
Toronto, Ont. M4H 1B1 (416) 423-3262
Postage and Handling included.
Credit Card payment accepted

This Month in

Computing! NOW!

Software NOW!

Boards of the Rings

Computing Now! takes a three hundred baud odyssey around the continent checking out the most interesting bulletin boards. Some of these things are intensely useful... others are extremely weird. Many are extremely specialized, and offer all sorts of new insights into things like the space shuttle and electric music. Did you know there's a Greatful Dead board?

Patching WordStar on the PC

There are a lot of things about the IBM implementation of WordStar that its users would dearly love to change. This month we take a shot at adapting WordStar to make it convenient for your applications. You can patch it, change its defaults and generally make it into what you want it to be, rather than the other way round.

Local Area Networks:

An examination of various systems and applications with a focus on new products from Novel, Corvus and The Software Link.

Keyboard Enhancement Software:

Programs that let you integrate and streamline your applications with timesaving macro commands: a comparison of the newest versions of Prokey, Smartkey and Superkey.

Utilities:

An assortment of public domain and commercial printer utilities to help you get the most out of your printer.

For Subscription or Advertising Information Call (416) 423-3262

Switching Plugpack

A switched-mode power supply that can fit in a plugpack; the voltage can be set during construction.

By Andrew Armstrong

THIS project is a small switched power supply to operate gadgets having a DC input socket, or you can mount it in an ordinary utility box with your choice of connectors. In its plugpack form, it operates from any 115VAC outlet, and its output voltage can be selected during construction.

Efficiency

The reason for using a switched mode supply in this application is that the efficiency is much higher than with a linear regulator. This means much less heat developed in the main pass transistor (Q1), and this in turn means that less power is required from the transformer, reducing its size.

This may even apply to using the power supply with equipment that has its own internal regulator. The number of milliamps drawn may be the same regardless of voltage over the range that the regulator can work. The useful aspect of a switched mode supply here is that as its output voltage is reduced, the available output current (for any given input current) is increased.

There is also a subsidiary advantage here. Equipment running from an

unregulated supply must be able to operate even if the power line sags or else it will be unreliable in some areas. If this equipment has a high internal operating voltage to allow for this, the heat dissipation is unnecessarily high. Using an external regulator to send it the minimum required voltage minimizes this. The ZX81 is a case in point: its internal 5V regulator requires a minimum input of 7V for

the permissible amount is drawn, then it will get too hot. Assuming that the overload is not severe and continues only for a short time, no harm is done, but the output voltage will fall below rated, and a linear regulator might not be able to function effectively under these circumstances.

Many loads draw heavy currents for short periods of time, such as LEDs or displays switching on and off. As long as

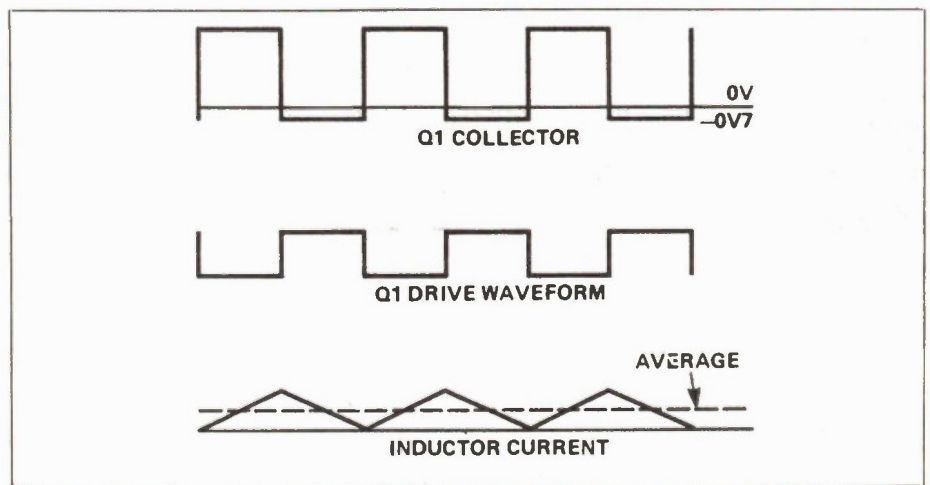

Figure 2a. Switching waveforms of the type found in the circuit in Figure 1.

reliable operation, and to get around the problem of power line sag, the makers use an unregulated input of about 9V. By feeding the microcomputer from a preregulated 7V source, the internal dissipation can be reduced to about half.

Intermittent Rating

In practice, if a power transformer is overloaded, i.e., more load current than

the circuit is suitably fused and the average load somewhat inside the ratings, the transformer can be run at a slight overload for a few seconds at a time. This allows a smaller power transformer to be used for the projects.

Primary Supply

This is the DC supply to the input of the regulator circuit. The selection of the main smoothing capacitor's voltage rating must allow for high line voltage and light loading. In this case, the capacitor DC voltage rises to the peak value of the AC input; this is equal to the AC RMS value times 1.414, or root 2. If we assume that the line voltage rises to 10% higher and no load is attached, then the capacitor voltage becomes $6.3 \times 1.1 \times 1.414$, or 9.8V (note that the two-diode centre-tapped fullwave rectifier sees a 12.6V transformer as two 6.3V windings). A 10V capacitor will do; higher voltage ratings can be used if there's space in the box.

Circuit Principles

The circuit used is the series regulator type. The principle used is illustrated in

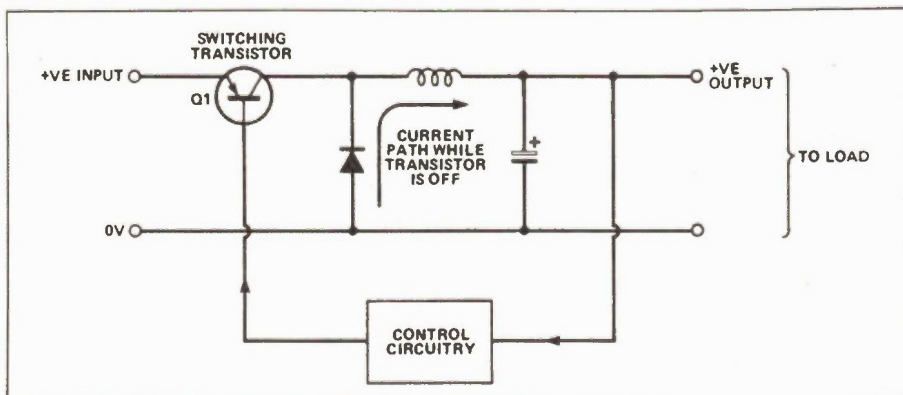

Figure 1. A sample circuit illustrating the series regulator principle.

Fig. 1. The series pass transistor, Q1, is always switched on or off. When it is switched on, the current in the inductor rises, and the output voltage rises at the same time as energy is being stored in the inductor in the form of a magnetic field. When the on period of the internal oscillator expires, or when the current rises to its set point, the transistor is switched off.

The current continues to flow in the inductor, but it now flows via the diode once the transistor is turned off. The voltage across the inductor is now in the other direction, so the current declines steadily. The output voltage starts to fall once the current in the conductor has fallen below the load current. When the output voltage has fallen below the aiming point, the pass transistor is enabled to switch on at the start of the next cycle of the internal oscillator.

Once again the current rises and the cycle repeats itself. If the pass transistor is switched off due to the current sensing rather than due to the normal period of the oscillator, then current limiting is reached and no more load current can be supplied. Obviously, it is normal to choose this current limit so that a prolonged short circuit will not damage anything. The switching waveforms to be expected in this type of circuit are shown in Fig. 2.

The Circuit In Detail

The circuit used is shown in Fig. 3. The operation of the circuit is all controlled by the switchmode IC, the 78S40. The internal circuit of this is shown to make the

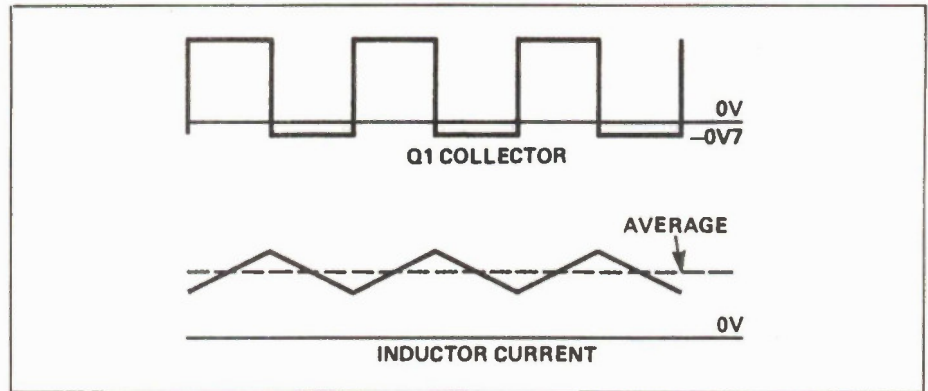

Figure 2b. A reduction in transistor peak current and output ripple voltage achieved by increasing the turns of the inductor.

overall functioning clear. Not all the internal parts of the IC are used for this project; the op amp is not needed and the internal diode is not rated for a high enough current.

The basic operating frequency of the oscillator is set by the capacitor C2, and this controls the on-off times of the pass transistor. The off time is normally chosen to be greater than 10 microseconds so that the time that the transistor spends switching between the two states is not too high a proportion of the total time. The capacitor value may be calculated from the formula $C = .00045 \times T_{off}$, where C is in farads and T in seconds.

This is not the whole story, of course, because there is an advantage in keeping the frequency high enough to minimize the ripple on the output for any given

capacitor value. A good rule of thumb is that the total cycle time, at full load, should not exceed 50 microseconds. This corresponds to a frequency of 20kHz from the formula $F = 1/T$. It is necessary to have some estimate of how long the transistor should be on as compared to the off time in order to determine the total cycle time.

Disregarding resistive losses in the coil, the time for a given change of current (increase or decrease) is inversely proportional to the voltage across the inductor. For example, if the output voltage is 5V, and the input voltage is 10V, then there is 5V across the inductor whether it is charging or discharging. Only the direction changes. Therefore the on and off times will be about equal in this case.

If a 12.6V centre-tapped transformer

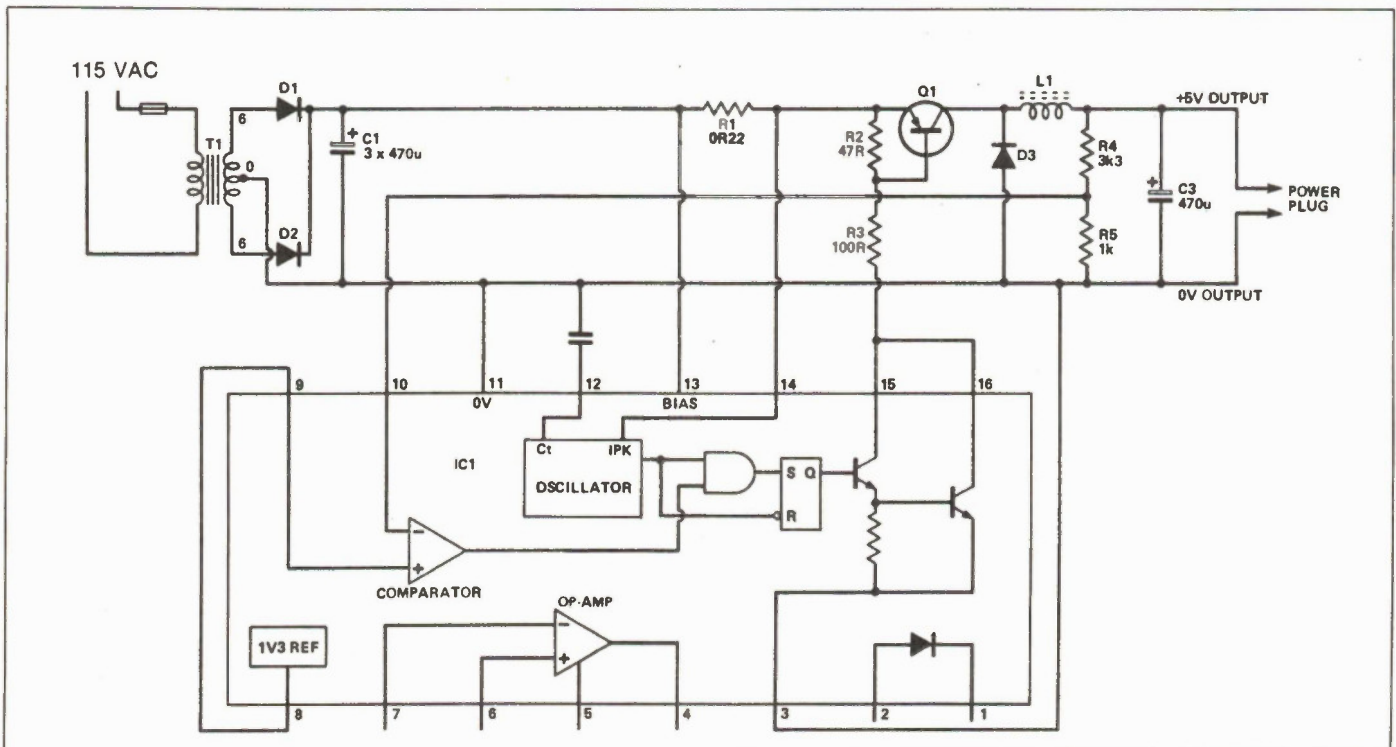
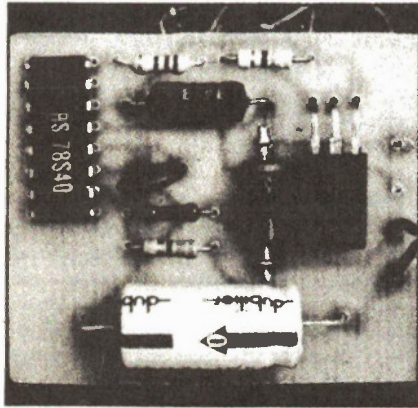

Figure 3. The circuit. Note that the lower part of the circuit illustrates the inside of the 78S40.

is used, the on time will be about 1.5 times the off time, while if an 18VCT transformer is used (with a 16V main capacitor) the times will be about equal, allowing for losses in the rectifier, capacitor voltage sag, etc. Therefore, an off time of 20 microseconds would seem reasonable. From the formula above (taken from the IC data), a capacitor of 9nF would be required. 10nF is close enough.



Energy Transfer

The control IC used in this project is designed on the basis that all the energy in the inductor should be transferred to the output during the off period. This means that there should be a change in the inductor current from the peak current to zero during the off time. This in turn means

that the maximum load current is half the peak current in the inductor, because the average of a triangular waveform starting at zero is half its peak.

The peak current can be calculated from the maximum load current to be drawn, which can be 1A for this example. We now know that the peak current is 2A

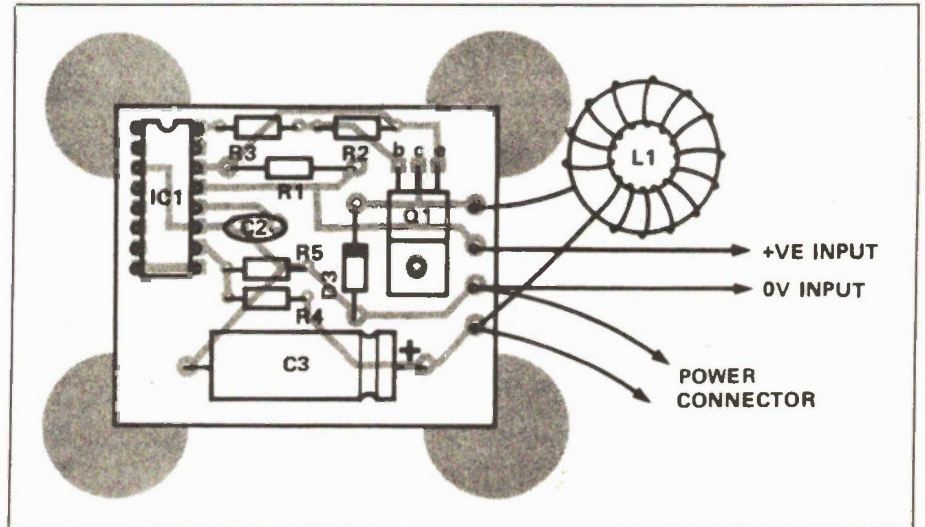

Figure 4. The components layout. C1 is off the board. Q1 lies flat.

The Electronics Today Resistor Chart

For those new to working with electronic components, here is the chart of standard colour coding for resistors. You'll probably find it confusing at first, but you'll be amazed at how fast colours and numbers become interchangeable in your mind.

You can also use these colours for capacitor values:

most film capacitors (dipped, or "candy-stripe") use these, with the value in picofarads. Thus a yellow-violet-yellow capacitor is 470,000pF, or 0.47uF. Keep in mind that the colour bands run together on both resistors and capacitors; a component that appears to be all red is actually three red bands, or 2200.

FOUR BAND RESISTORS					FIVE BAND RESISTORS					
Colour	Band 1 1st Figure	Band 2 2nd Figure	Band 3 Multiplier	Band 4 Tolerance	Colour	Band 1 1st Fig	Band 2 2nd Fig	Band 3 3rd Fig	Band 4 Multiplier	Band 5 Tolerance
Black	0	0	x1	—	Black	0	0	0	x1	—
Brown	1	1	x10	1%	Brown	1	1	1	x10	1%
Red	2	2	x100	2%	Red	2	2	2	x100	2%
Orange	3	3	x1000	—	Orange	3	3	3	x1000	—
Yellow	4	4	x10,000	—	Yellow	4	4	4	x10,000	—
Green	5	5	x100,00	—	Green	5	5	5	x100,000	0.5%
Blue	6	6	x1,000,000	—	Blue	6	6	6	x1,000,000	0.25%
Violet	7	7	—	—	Violet	7	7	7	x10,000,000	0.1%
Grey	8	8	—	—	Grey	8	8	8	—	0.01%
White	9	9	—	—	White	9	9	9	—	—
Gold	—	—	x0.1	5%	Gold	—	—	—	x0.1	5%
Silver	—	—	x0.01	10%	Silver	—	—	—	x0.01	10%
None	—	—	—	20%						

and that the inductor must fall from 2A to zero in 20 microseconds. The rate of change of current in an inductor is proportional to the voltage across it, and inversely proportional to the inductance. Ignoring any resistive effects, the rate of change of current = V/L . The voltage across the inductor while it is discharging energy into the load is the output voltage plus the diode drop, say 5V5 in all. The rate of change of current is 2A in 20 μ S, or 100,000 amps per second. Putting the figures into the formula, we have $L = 5.5/100,000 = 55$ microhenries.

Switching Inductor

The general design of the switching inductor is one of the most important aspects of the overall design. If this is far astray, the whole design is useless. One of the most likely problems in more powerful designs is the saturation of the inductor core at maximum currents. If the inductor begins to saturate, the current in the transistor rises more rapidly when it is on. The control circuitry cannot switch instantaneously, so the transistor will likely have to switch off more current than the designer bargained for, and in so doing it will get hotter than may have been expected.

It is better, if possible, to use a core which has a little in reserve. In fact, the core chosen has a lot in reserve and is not

particularly large; it's a powdered iron toroid slightly over an inch in diameter.

The permeability of most magnetic materials (how much they concentrate the magnetic field) is such that they saturate very easily. When ferrite cores are used for switched mode supplies, they normally have an air gap between the two halves. This considerably lowers the effective permeability and raises the saturation point.

Powdered iron cores, as the name implies, have a built-in air gap between each of the tiny particles. This produces a nice predictable magnetic field which does not saturate easily and has low eddy current loss due to the small size of the particles. It is good both for switched-mode supplies and triac noise suppression.

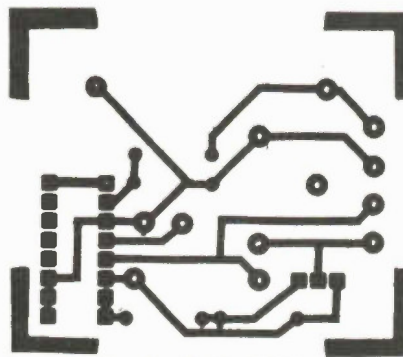

Figure 5. The printed circuit foil side.

than a tenth will flow, wasting power by warming up resistors needlessly. A good compromise would be one-twentieth of the collector current.

The value for R3, which sets the base current, is calculated on the basis of the voltage on C1 sagging to 7V and the peak current being 1.4A. If a higher voltage transformer is used, the value for R3 can be increased proportionately.

R2 assists the transistor in turning off rapidly by draining charge carriers from the base region. R1 sets the short circuit current. The IC switches when the current sense voltage reaches 0V3, which with a 0R22 resistor gives a peak current of 1.4A. This peak current comes close to the output design figure of 1A.

Construction

Not all the parts mount on the PCB due to lack of space. Diodes D1 and D2 are mounted on the transformer pins, which is a PCB type. Capacitor C1 is actually three 470 μ F capacitors to better suit the case dimensions. Insulating tape should be wound over the inductor turns.

You can either rebuild an existing plugpack, buy the commercial plugpack listed in the Parts Lists, or build it into a utility box with a line cord and suitable output connectors.

Testing

First, see that there are 7 to 10 volts (positive) across C1. The output should be 5V, though it can vary due to parts tolerances; if it's off, check R4 and R5. An output the same as the input indicates that Q1 is probably shorted.

Finally...

Q1 is not on a heatsink because it barely gets warm. A pot can be wired in place of R4 to provide variable output voltages; the output voltage is $1.3(1 + R4/R5)$. The output voltage should be about one volt less than the lowest input, and the voltage rating of C3 should allow for the highest output voltage. ■

PARTS LIST

Resistors

(minimum rating .25W, 5%)

R1	0R22
R247R
R3100R
R43k3
R51k

Capacitors

(higher voltages can be used if they fit)

C1	3 x 470 μ F, 10V
C2	10n
C3470 μ F, 10V

Semiconductors

D1,2,3	1N4001
Q1	TIP34 or equiv.
IC1	78S40

Miscellaneous

12.6V centre-tapped power transformer (Hammond 166G12 or larger), powdered iron toroid (Miller T-106-2 or equiv.), plugpack (Hammond 1593 P3 and 1593 BC2 or similar), pigtail fuse 100 to 250 mA, hookup wire, 0.5mm enamelled magnet wire, etc.

The 78S40 is available from Active Components, 4800 Dufferin St., Downsview, Ontario or their branch outlets. The Miller toroid and Hammond products are available from Electrosonic, 1100 Gordon Baker Rd., Willowdale, Ontario.

Winding

The coil selected, a Miller T-106-2, requires only 40 turns for the required value of 55 μ H. However, if the inductance is increased somewhat, the peak current in the transistor is reduced, increasing the efficiency of the supply and prolonging its life. The output ripple is reduced as well. The effect is shown in Fig. 2b..

A reasonable compromise between the improvement and the effect of putting extra turns on the core is to choose 50 turns. This raises the inductance to about 68 μ H. Fairly wide variations from this will still result in a working project.

One tedious thing which is important: fairly thick wire should be used. It makes the job more difficult, but gives lower resistive losses. 0.5mm wire is a good choice.

Transistor Switching

To achieve high efficiency, the transistor should switch on to saturation and off again as rapidly as possible; heat is generated as it passes from one state to another because the collector voltage and collector current are both at a fairly high value at the same time.

The rule of thumb for saturation says that the base current should be one-tenth of the collector current. However, this means that under some conditions more

Digitizer

The GTCO Micro Digi-Pad is an electromagnetic digitizing tablet available for popular personal computers, and comes in 6 by 6 or 12 by 12 inch sizes; the elimination of ICs from around the grid means a front edge thickness of only .35

inches. The digitizing is done with either a stylus or a mouse. The system is compatible with many existing digitizers. From Interworld Electronics and Computer Industries Ltd., 1442 Pemberton Ave., North Vancouver, BC V7P 2S1, (604) 984-4171.

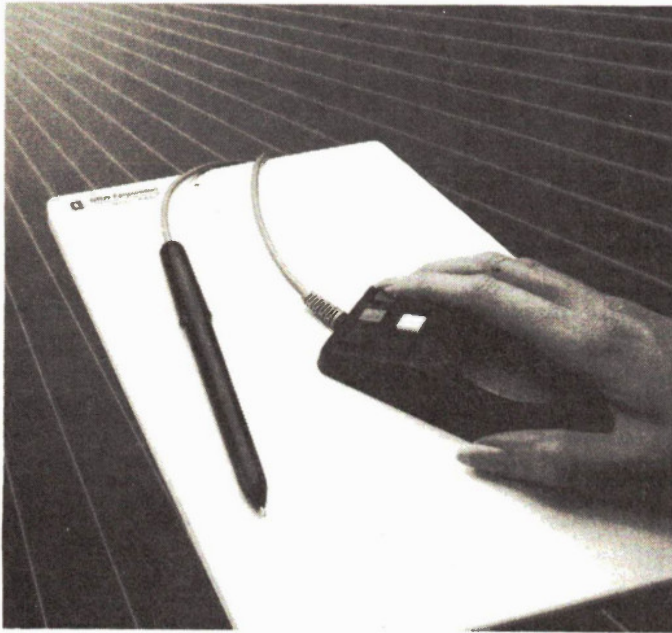

New Plotter

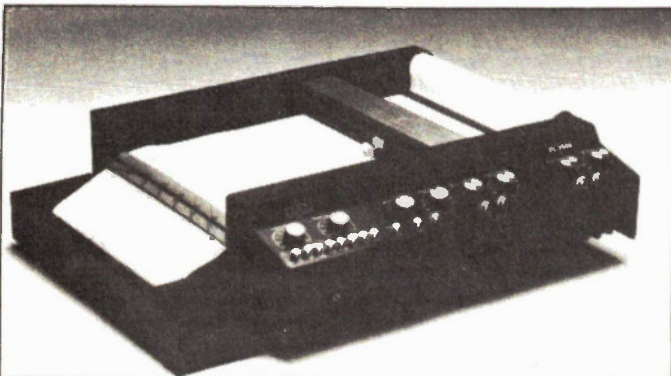

The J.J. Lloyd PL1500 and PL2500 XY recorders can be fitted with one or two pens on the Y axis. X and Y channels are identical, with 18 calibrated sensitivities. An accuracy of 0.2 percent and a writing speed of 1m/sec ensure faithful recordings. 18 chart speeds

from .1mm/sec to 20mm/sec with full or half frame advance; also accepts graph sheets. Omnitronix Ltd., 2410 Dunwin Drive, Unit 4, Mississauga, Ontario L5L 1J9, (416) 828-6221.

Tape Backup

If you use a hard disk to hold all your important software and data, you no doubt know how poorly they like being dropped on the floor, or even breathed on. To allow you to make backup copies in the easiest possible way, Kaytronics offers the Irwin series of Tape Drives. They work from a standard floppy controller, eliminating the need for a special

interface card, and data is stored on a cartridge which can be removed and stored with the relevant computer. The units are small; one will fit in the space for one floppy drive in an IBM-PC case, for instance. The Irwin 110 holds 10 megabytes and the 125 holds 20 megabytes. Kaytronics, 331 Bowes Road, Unit 1, Concord, Ontario L4K 1J2, (416) 669-2262.

Thermal Wire Stripper

The AMP Thermal Wire Stripper is a small, lightweight tool for stripping thermoplastic insulation from solid, stranded or shielded wire from 14 to 30 AWG. The nichrome element heats up to 450 degrees F in less than five seconds;

the low thermal mass means that it won't burn the skin if touched. May be table-mounted or hand-held; power consumption is 2.8W. Contact AMP Products Corporation, PO Box 1776, Southeastern, PA 19399.

Time Componder

The Lexicon 1200C allows you to lengthen or shorten running times of audio recordings without changes in pitch or tempo; for instance, it can shorten a commercial to fit into a tighter time slot, or shorten feature film tracks to

minimize the need for cuts. The unit is stereo-compatible; upgrades to stereo are available for owners of previous, mono models. Contact Lexicon Inc., 60 Turner St., Waltham, MA 02154, (617) 891-6790.

Fairchild MOSFETs

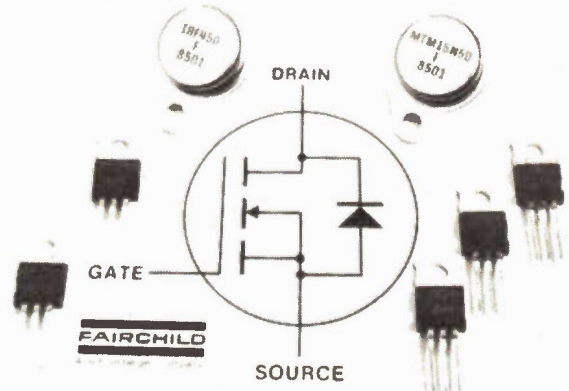

Fairchild's Power Systems Division has entered the power MOSFET market with six series of high voltage devices. The new transistors range from 350 to 500V and 4.5 to 15A with either plastic TO220 or metal TO204AA (formerly TO3), and are ideal for high-speed applications such as switching power supplies or motor

controls. Devices in the metal package are the IRF300 and 400 series as well as the MTM4N45 series. Plastic devices are the IRF700 and 800 series, as well as the MTP4N45 series. Fairchild Semiconductor, 2375 Steeles Avenue W., Downsview, Ontario M3J 3A8, (416) 665-5903.

Looking for ultrasonic transducers for remote control projects? The inexpensive 40KHz type are the ones generally specified and they're available from Parts Galore, 316 College St., Toronto M5T 1S3, or from J & J Electronics Ltd., PO Box 1437, Winnipeg, Manitoba R3C 2Z4 (mail order) or 310 Notre Dame Ave., Winnipeg R3B 1P4 (store address).

Incidentally, the new J & J mail order flyer is out now, listing all sorts of specials on semiconductors, hardware, books, computer gear, etc.

Proximity Sensor

Who could resist a proximity sensor called the Yodeller? The Yodeller-1000, which sells for under \$500 US, can ultrasonically sense distances from 1-10 inches and can see into an aperture as small as a quarter of an inch. The unit is accurate to .005 inch. Noise, air blasts, motors, etc., will not affect its accuracy. Can also be used for sensing liquid levels. From Yodel Technology, PO Box 8445, Red Bank, NJ 07701, (201) 741-2348.

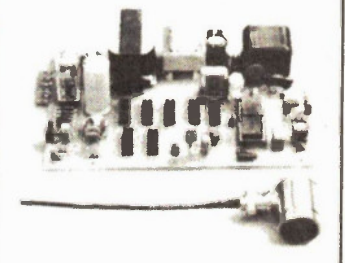

Power Bar

The Isobar is available in four or eight outlet versions, both of which incorporate noise and surge suppressors. The suppressors are wired in series, increasing the level of protection from the first to the last. Contact Tripp Lite, Chicago, Illinois, (312)329-1777.

Vehicle Locator: An Automated Position Locator (APL), the possible forerunner of electronic systems that cities may someday install as a means of continuously monitoring the location of buses, police cars, ambulances, and work trucks, has been developed and successfully tested at Sandia National Laboratories. The new system uses a small electronic package in the vehicle being monitored to calculate its location in terms of longitude and latitude. The electronic package, essentially a small computer, then transmits the location fix over a special radio frequency to a manned control room. A metropolitan control room would feature a wall-size map with blinking lights representing the vehicles that are being monitored. APL combines two navigational techniques--dead reckoning and receipt of radio transmissions from the TRANSIT satellite system--to produce its vehicle position fix.

Dead reckoning is an age old way of moving from one point to another solely with the use of instruments like a compass and visual information. The TRANSIT satellite system, on the other hand, was established 15 years ago by the

U.S. Navy as a means of updating the inertial navigation systems of submarines. Its five satellites, all in polar orbits, transmit continuous radio signals that contain several kinds of data about their positions above the earth. The small computer in the APL-equipped vehicle accomplishes its dead reckoning from magnetometer (more reliable on rough roads than a navigational compass) and odometer data, plus a known starting point for a vehicle. Although this computerized dead reckoning technique provides regularly updated vehicle position readings, errors gradually build up because of magnetometer and odometer inaccuracies. Consequently, the computer periodically uses an algorithm--mathematical formula--to translate incoming TRANSIT satellite data into a new known vehicle "starting point."

Sandia's APL, derived from commercially available equipment that the Labs adapted for this purpose, is designed to operate across the continental U.S., requires no special "pre-mapping" of routes, and control room operators and drivers need not conduct periodic recalibration of the system since TRANSIT data

remove dead reckoning errors.

"The goal of APL is to provide reliable, continuously updated information about vehicles that carry valuable cargo, whether it is material or passengers," says Clayton Erickson of Sandia's Communication Systems Division, which designed the APL for the U.S. Department of Energy. "For instance, the efficiency of ambulances could improve significantly because of such tracking. Personnel in a control centre would be able to spot ambulances and advise drivers of the best and quickest routes to their destination," he says. "Financial institutions could also incorporate an APL system into their security plans for transporting important or valuable cargo." The key to widespread commercial use of APL-type systems is development of relatively inexpensive receiving for information that will be transmitted to earth by the Global Positioning system (GPS). GPS, which could be in operation within the next several years, is scheduled to include 18 communication satellites orbiting the earth's poles.

The location information its satellites transmit to earth is expected to be more accurate than TRANSIT data; additionally, the need for dead reckoning will be eliminated.

- David Dempster

Probes

Spring loaded probes for test equipment and fixtures have been introduced by the E.F. Johnson Co. They meet virtually every in-circuit loaded board or bare-board ATE testing application, including IC leads, surface mounts, components and track testing. Contacts are 50 milliohms with spring forces ranging from 1.2oz to 16.4oz. Contact Lenbrook Electronics, Unit 1, 111 Esna Park Drive, Markham, Ontario L3R 1H2, (416) 477-7722.



Sweep Marker

A new sweep marker generator has been introduced by Leader Instruments. The LSW 359 covers the range from 1-1500MHz in three bands with four sweep functions. Each band has sweep speeds varying from 10mS to 100S in four bands, plus manual sweep. 1, 10, 50, and 100MHz markers are available, plus a variable control and three other optional markers. Contact Omnitronix Ltd., 2410 Dunwin Drive, Unit 4, Mississauga, Ontario L5L 1J9, (416) 828-6221.

Custom IC Design

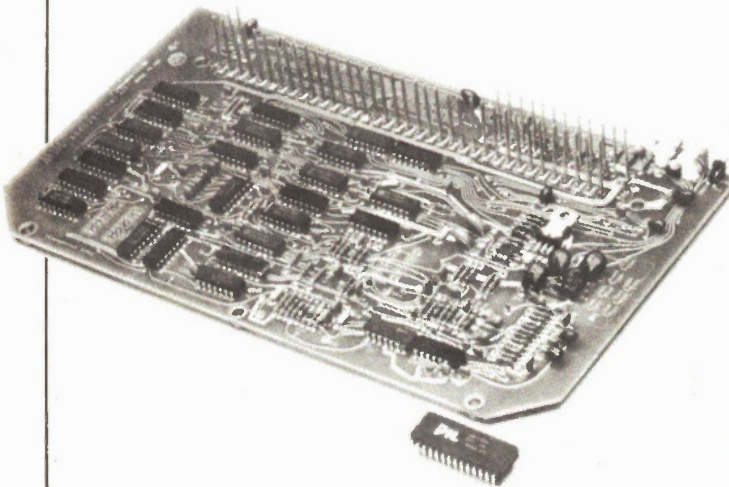

A single custom-designed IC can replace a printed circuit containing dozens of ICs and 50 to 100 resistors and capacitors. Supply currents can be reduced by a factor of 100. The ISO CMOS technology can go from diagrams to silicon in

as little as 18 weeks. Both analog and digital functions can be incorporated into the same chip. For information, contact Philip Stern, Pacific Microcircuits Ltd., 1645-140th St., White Rock, BC V4A 4H1 (604) 536-1886.

Low Profile Clip

A P Products introduces a low profile test clip to eliminate the need for extender boards or umbilical connectors. The height of the clip is 0.33 inches, making it possible to test circuit cards that

are mounted close together; the supplied cable is 18 inches in length, with either 40 or 60 conductors. Custom terminations are available. Lenbrook Electronics, Unit 1, 111 Park Drive, Markham, Ontario L3R 1H2 (416) 477-7722.

Frequency Meter

Newport Electronics announce the Quanta Q200H 3 1/2 digit panel meter with control capability for monitoring line frequency, RPM, flow and speed. It interfaces to transducers with frequency or pulse outputs; the meter can be scaled so that inputs from 100Hz to 20KHz produce a full-scale reading. The DC trigger level is adjustable and an analog output produces 1mV/count. Contact Metermaster, a division of R.H. Nichols



Co., Ltd., 80 Vinyl Court, Woodbridge, Ontario L4L 4A3, (416) 851-8871.

Automated Meter: In Sweden they're testing a program which allows domestic power users to pay for their power with a special plastic payment card. A new style power meter has been developed for houses and apartments by Siemens AB, Stockholm. The device is now being considered by several Swedish electricity supply companies who feel it would make it easier for consumers to keep a closer check on power costs and help reduce the overhead associated with billing in the ordinary manner.

It works this way. Users purchase a "pay-card" from the power company; values can vary, for example, 500, 1,000, 2,000 or 4,000 kWh; it's then placed in the meter. When the paid-for electricity has been used, a buzzer-signal sounds each hour and after four weeks

electricity is disconnected if a new card is not inserted into the meter. Should a card be removed from the meter before its time, power is discontinued shortly thereafter.

The meter, which can be one- or three-phase, is equipped with a display which indicates how many kWh remain to be used and three signal lights which tell the user that "Supplies will be discontinued in four weeks," "Wrong card inserted," and "Card exhausted."

The present method is for Swedish consumers to be billed for electricity three times annually which, it is said, tends to make them somewhat insensitive to short-term price fluctuations. Through the use of a pay card, Siemens says, they will be able to more effectively control their costs.

- David Dempster

Designer's Notebook: Power Supply Noise

The best hifi design can still be improved by optimizing the power supply components and layout.

By Neil Munro

I HAD ALWAYS thought that the only real differences in pre-amps came down to hiss and the facilities offered, once adequate specifications had been achieved. But then, in between repairing and designing various small bits of hi-fi, studio and PA equipment for others, I knocked together a turntable pre-amp for myself. I brought it to the shop where I was working at the time and one of the sales staff set it up for a comparison with a newly introduced, expensive commercial design. I sat down, closed my eyes and listened. To my amazement, my pre-amp gave a noticeably clearer and less cluttered performance. I could hear the difference.

Since both pre-amps used broadly similar circuitry (based on the NE5534 and TL072 op-amp chips), both had less than 0.01% distortion at normal levels and both had similarly accurate EQ, I had no idea as to why they should sound so different. I set about developing the design, replacing the moving magnet input with one for a moving coil cartridge. After playing with several ideas, I found the familiar LM394/NE5534 hybrid configuration worked well. I filtered the supply to the LM394 input pair and was rewarded with perfect stability and a sensible slewwrate. This MC circuit was predictably noisier than my original pre-amp but it sounded even clearer; the difference between hearing three voices or four voices was more distinguishable.

This didn't seem to be entirely due to cartridge variations, since a very expensive commercial MM pre-amp was just as clear. I was puzzled. What was behind all these evident differences?

I checked the marginal stability of the NE5534 circuit, but it was fine. I considered power supply rejection in the 5534 stage. The MC circuit used a 5534 stage and it performed very well. In fact, the 5534 has a stated power supply rejection ratio (PSSR) of 100uV/V and a stated common mode rejection ratio (CMMR) of

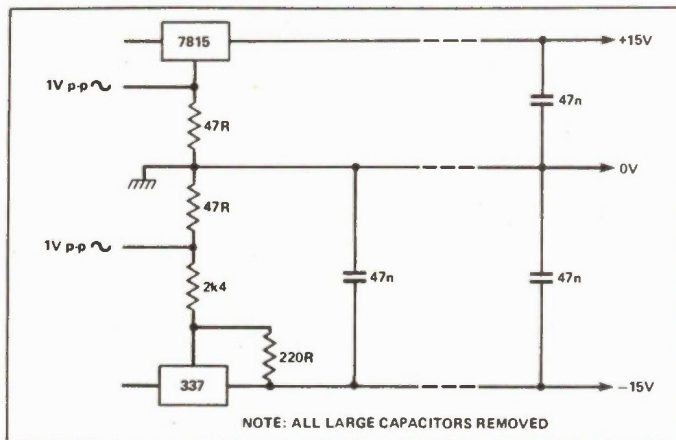

Fig. 1. Injecting modulation into the power supply.

100dB. But this started me thinking. The figures are referred to input and should be reduced by whatever gain follows. They're also quoted at DC. Then there was the fact that the MC circuit's gain comes mostly from the LM394 input pair while the 5534's inverting and non-inverting inputs are fed from equal impedances.

I felt that I needed to check the real wideband PSSR referred to output, in order to get a true idea of what would happen when you actually listened to some of the music. I rigged up a power supply with a modulating input (Fig. 1), injected 1V p-p on both the positive and negative supply rails and checked the output of the MM circuit. The modulation appeared at -30dB to -40dB. Taking into account an assumed figure, -70dB for main supply noise, the modulation noise would drop to -100dB to -110dB when referred to a nominal 1V output from the pre-amp.

This was good news. But when I came to replace the 330 ohm dummy load at the input to the pre-amp with a real MM cartridge (typically 500R + 1200uH), I was surprised. In the 5-20KHz region, the modulated supply noise increased to -10dB. With the power supply back to normal and the cartridge still in place, I found that high frequency input signals gave up to 3mV or -50dBV of noise, which could appear at the output at an alarming -60dB. On the other hand, when I came to test the MC circuit I found that it fared well with a real cartridge in place. These are predominantly resistive at between 3R5 and 30R. It was even acceptable open circuited: -30dB to -40dB except at 20KHz; this was cured by enlarging the input coupling capacitor and using an

active filter for the LM394 stage. The trouble with the capacitor was that low frequency reactance caused an impedance mismatch which reduced CMMR. And on reflection, I realized that it was the inductance of the MM cartridge that caused a mismatch on the inverting and non-inverting inputs to the 5534 op-amp, which ruined the PSSR and CMMR figures for the MM circuit (Fig. 2).

The Heart of Noise

These things were all curable, but they didn't reach to the heart of the problem - the power supply noise in an actual circuit. Clearly, the first place to look for noise in a regulated power supply is the regulation itself. I was using 78/79 types and, as luck would have it, their quiescent noise (20-20z hum and hiss) was -70 to -80dBV. Later, I bought a batch for evaluation and found that some showed as much as -40dBV and often came complete with nasty splutterings.

But that's only part of the story. In operation, active circuitry tends to draw varying current. In Class A amplifiers, this is in step with the signal, but in Class B it becomes half-wave rectified as the positive and negative sections of the audio signal are driven into low impedance

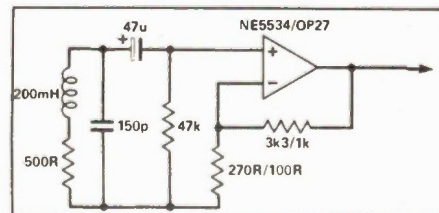

Fig. 2. PSSR test circuit with MM cartridge.

loads. The output impedance of the supply and the impedance of intervening wires and connectors become important, introducing modulation on the IC terminals. From this point-of-view, the quality of the power supply is irrelevant. What matters is the modulation.

The all-too-common practice of decoupling with a filter (typically, composed of a 10R resistor and 10uF capacitor) can actually make things worse because it assumes that the local signal common is 0V. But conventionally, the 0V rail is also signal common and should be treated as a signal path. You wouldn't connect capacitors from the supplies to the actual signal path because they will inject noise and modulation rubbish into it, producing a potential that adds to the signal output. This is because of the practical finite impedance of the signal path.

A 10uF capacitor also has an impedance of 8 ohms at 20 KHz, so signal modulation will be worse. Using a larger capacitor, say 470uF, will help, but at the cost of injecting noise more efficiently (Fig. 3). The only really effective approach (expensive) to ensuring stability on the signal common is to use local active regulation. Even here, care must be taken to avoid injecting DC or other noise into signal common.

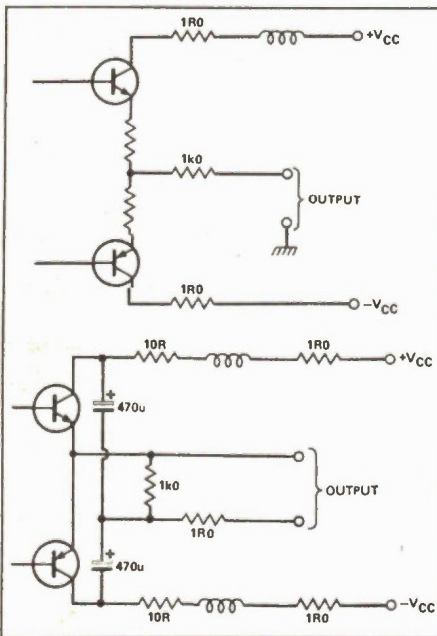

Fig. 3. PSU noise resulting from impedance of leads and signal common corruption in Class A and B output stages.

Another problem resulting from the finite impedance of signal common is that heavy load currents will generate errors. This is usually not offensive from an acoustic point-of-view, but with turntable input stages the feedback current is the pre-emphasized version of the signal with high frequencies boosted. The result

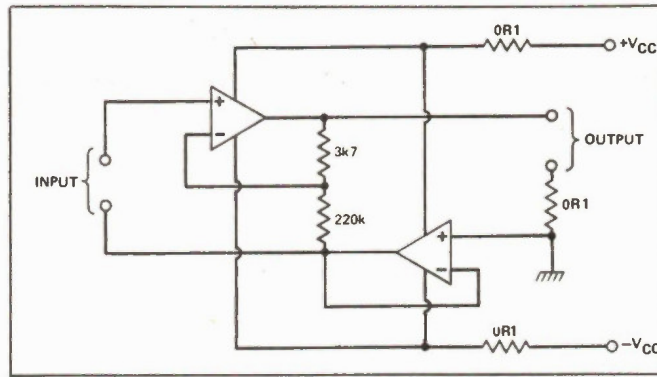

Fig. 4. Constant current series feedback giving OV regulation.

can be nasty harsh noise when added to the equalized output. There are several methods for avoiding this: the use of true independent supplies in different stages, differential sensing of output, and shunt feedback or 0V regulation. I chose the last of these as it kills two birds with one stone (Fig. 4). The feedback is handled by a local op-amp that transfers it to the opposite supply line instead of signal common, effectively reducing signal common impedance to the output impedance of the op-amp (for 1/2x5532 in unity gain configuration this is 10 milliohms, rising to 30 milliohms at 20 KHz). Also, the increase of current in the output stage is complemented by a reduction in the 0V regulator, which means that while the amplifier is operating in Class A mode (about 99% of the time), the overall current is constant.

This is especially important in a modular design like ours, using stage connectors, since the power supply modulation is negligible.

My comments on the 5534 op-amp and 78/79 series regulators are not intended to be derogatory. I'm sure the original designers would fall down laughing if they saw some of the uses these devices are put to. The 78/79s are perfectly good general purpose regulators, but they're not intended for precision supplies. The computer-optimized LM340 series (eg. LM340T-15) are consistently better, though the complementary LM320 series is rather expensive for negative supply regulation. The LM337 series are a better value, especially if TL072s are used, since their negative supply input is very noise sensitive. The 5534 is an excellent line processing block when driven from low kilohms with clean supplies. The power supply circuit shown in Fig. 5 has noise in the 20-20KHz range better than -80dBV with 100mA drawn and an output impedance of around 0R3 at 100KHz thanks to the 470uF output capacitors.

On the general topic of power supply decoupling, the use of separate filters for each channel is not recommended. It would be rather like isolating two people with the same contagious disease; it doesn't cure either of them. It's actually

useful to have two channels sharing the same supply at each stage, since one can be driven with a signal and the other used to detect any noise generated in the process. And now to capacitors.

A Couple of Points

A 1958 *Radio and Electronics* handbook that I unearthed has an excellent section on power supply topography and mentions that paralleling a 220uF electrolytic with a 100nF film type overcomes some the problems connected with the equivalent series resistance (ESR) and leakage of the electrolytic. That was some time ago and it still applies if you're talking about the stability of wideband amplifiers, as long as the bypass capacitor

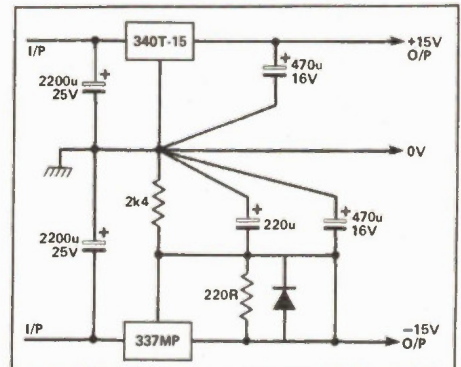

Fig. 5. Suggested PSU regulation circuit.

is placed close to the circuitry, not the amplifiers. But anyone who believes that such bypassing has a significant effect in the audio band either hasn't bothered to look into the characteristics of modern electrolytics or is still using 27 year-old ones.

For example, the 220uF-16V cap used in my power amp feedback decoupling has an ESR of 0.3 to 0.4 ohms at 20KHz and 15 degrees C. A 470nF polyprop has an impedance of 17 ohms under the same conditions. So what's bypassing what? It's only when you get above the 500KHz range that inductive reactance starts taking over and the impedance of electrolytic and film caps begin to match. Bypassing at ICs can be important because inductive supplies in the MHz region can easily

Probe in a Pen

An inexpensive voltage probe you can make from nothing more than a couple of dead ballpoints.

By I. Rees.

OFTEN it is required to know if a voltage is present without the need for an accurate indication of exactly how much voltage. A small inexpensive voltage probe is then a useful piece of equipment. The following is a description of two such probes; one which determines whether a voltage is positive, minus, or AC, and one which indicates the logic state of a digital circuit.

Voltage Probe

The voltage probe (Fig. 1) has a red and a green LED connected in parallel, back to back with a limiting resistor in series. A positive voltage applied to the probe tip (clip to neg.) will cause the red LED to glow, and a negative voltage will illuminate the green.

If AC is input, each LED will receive a half cycle of the correct direction to light it, causing both to light up together.

The range of voltage which can be tested is limited by the luminosity and knee of the LED at the low end and the limiter wattage/max LED current at the high end.

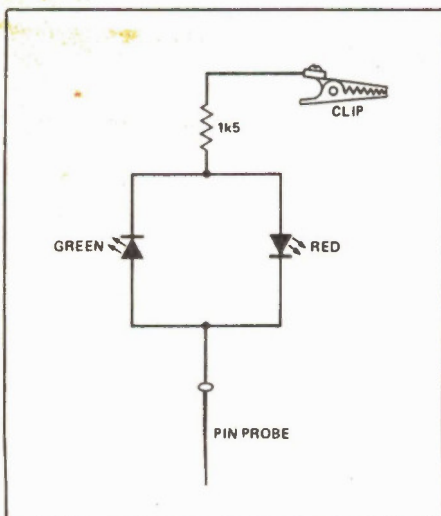

Fig. 1 The circuit of the voltage probe.

A compromise 1k5 limiting resistor allows the tester to be used safely from 3 to 30 volts.

Avoid using the probes on any CMOS running over 6V, or on any A-series CMOS at all, as the CMOS may be overloaded.

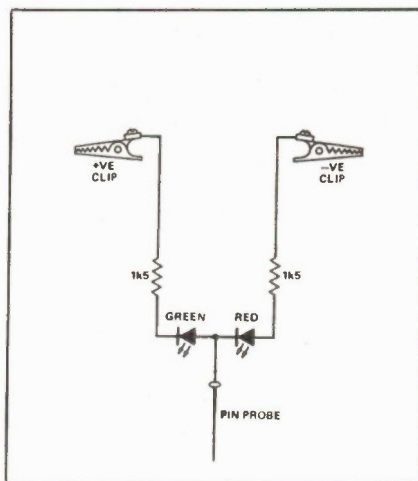

Fig. 2 The circuit of the logic probe.

Logic Probe

In this simple circuit (Fig. 2) the LEDs are connected in series with one another and their respective limiting resistors. The two flylead clips are connected to the +/- power supply of the circuit under test.

As the probe tip is terminated at the junction of the red and green LEDs, application of a 0V will bypass the red LED and extinguish it, lighting up the green. The opposite will happen if a +4V occurs.

With nothing connected to the tip, both LEDs will glow. Logic 1 = RED, Logic 0 = GREEN.

Construction

The use of 3mm LEDs should enable the use of a standard transparent-bodied ball-

point pen (or similar) for housing the probes. The wiring layout diagram is shown in (Fig. 3 and Fig. 4)

It's important, in the connection of the LEDs, to ensure correct polarity (Fig. 5), as permanent damage will result if wrongly wired.

The bodies of the pens are used in reverse, with the fly leads emerging where the writing points once were.

The voltage probe easily slips into the pen and no problems will be encountered if the layout is followed. However, the logic probe is a tight fit due to the sleeved wire coming past the red LED. Moistening the rubber sleeve and gently pulling and pushing will get it into place in the pen.

Steel dressmaking pins or needles (not stainless steel) which can be soldered easily are required for the probe tips. The small plastic plug in the end of the pen should be pierced from the outside inwards to ensure a central hole, using the pin.

PARTS LIST

Voltage Probe

1-green 3mm LED; 1-red 3mm LED; 1-1k5 0.5W resistor; 1-black alligator clip; insulated connecting wire; a steel pin or needle; a transparent or similar type ballpoint pen; 1mm rubber sleeving.

Logic Probe

Same as above with one more resistor of same value and a red alligator clip.

To fix the probe tip firmly, take care that the soldered joint is small enough (when wrapped with a bit of tape) to be

cause instability, but 10–47nF is quite adequate, cheaper and lessens noise injection into signal common.

And then you should be asking yourselves, why the pursuit of pure capacitance in coupling components? Ideally, a coupling component should block DC and have zero or constant impedance from at least 20Hz up to 20KHz. A perfect capacitor would do the former but would have a 1000:1 variation in impedance over the audio band. Admittedly,

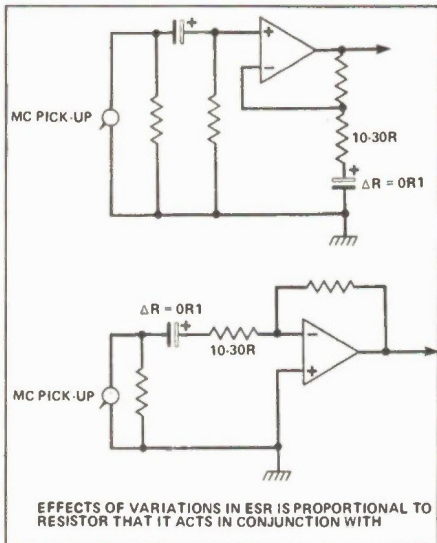

Fig. 6. ESR variation in electrolytics – some typical configurations.

in dB terms this variation is miniscule, but the point still stands. Now, a large electrolytic can approach the second requirement for a coupling component. The variation of impedance with frequency in an electrolytic is not simple and there is a "break" frequency at which the slope flattens out. The electrolytic can be chosen so that this frequency is very low and in the critical mid to high frequency area ESR is practically constant. Inductive reactance is negligible below about 500KHz in any reputable make of capacitor in the sub 1000uF range.

So why do electrolytics sometimes sound so odd? I've found that ESR can vary, particularly with temperature, by up to 0.1 ohms. In conjunction with a 10R resistor, as in all too many MC circuits (Fig. 6), the variation can amount to -40dB. With considerably higher resistances (above 1 kilohm), this figure drops to -80dB or so.

Voltage modulation can also affect the performance of coupling electrolytics. In a competently designed circuit an electrolytic is operated well above its break frequency so that the voltage drop across it is a small fraction of the applied voltage – at most, hundreds of millivolts. I have found no evidence of acoustic effects at this level. Even these slight reverse

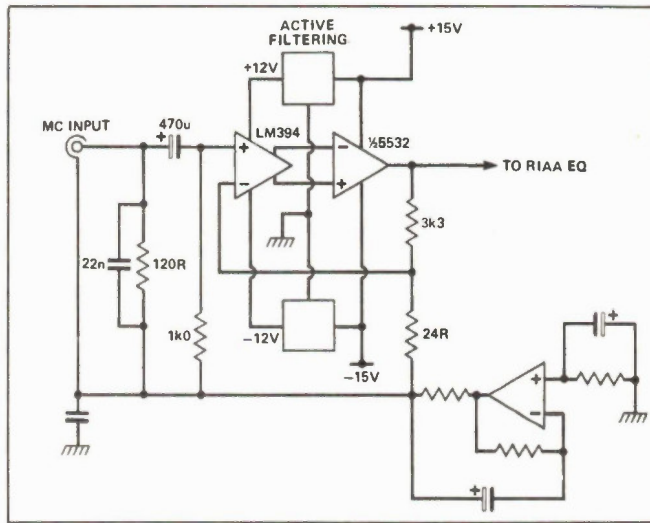

Fig. 7. Basic configuration of MC pre-amp input stage.

voltages can be eliminated by using predictable offsets to polarize the electrolytics to the peak expected reverse voltage. We have done this with our design, and while I'm not convinced that it has any significant impact, it certainly does no harm (Fig. 7 and 8).

Electrolytics may also suffer from microphonics, a feature used to positive advantage in capacitor microphones. At 200uV sensitivity, microphonics in input and feedback capacitors in an MC input stage is hardly surprising, although it varies with the type and make. Generally, tantalums produce a "boing" while aluminum electrolytics give more of a 'dump' – which may explain why tantalums are out of favour. In both cases, mounting in a glob of silicon rubber helps enormously, damping the resonance due to vibration of the body relative to the leads. Incidentally, other components can suffer from microphonics, particularly FETs. It can be helpful to gently tap all components with a plastic pen to test them.

When it comes to power amp main capacitors, bypassing becomes even more ridiculous. To achieve 100 milliohms at 20KHz would require 80uF of pure (expensive) capacitance. There is no substitute for low ESR electrolytics, now

widely available thanks to their development for switch-mode power supplies. Phillips manufactures 10000uF-63V types with low ESR values and they are available from Electro Sonic in Willowdale, Ontario, (416) 494-1555.

Stiff and Nonsense

Before getting obsessed with basic power supply impedance, it's useful to stop and ask, "why does it matter?" In a sense, the only power supply to an amplifier is usually the 120V AC line, conditioned as required for the sake of convenience so that an input voltage can control this power source to produce an analogous output. All too often, designers become obsessed with the intermediate energy store and do not view the systems as a whole. So we get stories of "stiff" supplies using massive transformers and capacitors with the idea that this will achieve quality, not just (overkilled) quantity. Once you realize the irrelevance of this, you can start investigating what it is about the intermediate store that corrupts the controlling process.

There are many more complicated factors than the ones I've been able to deal with here: induced coupling from supply and load cables to the input stage,

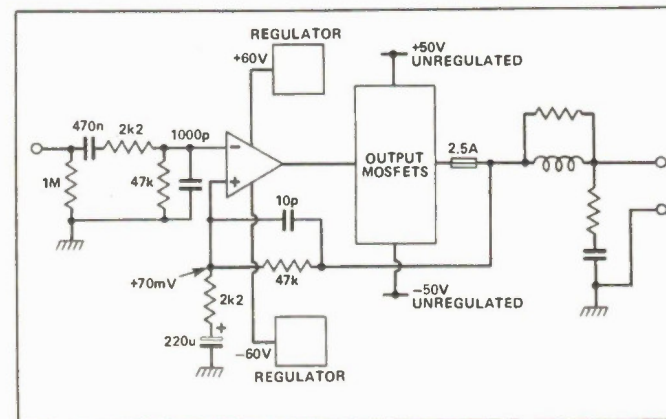

Fig. 8. Basic configuration of power amp module.

With NRI training at home, you can...

Move up to a high paying career servicing computers



And you can start by actually building NRI's 16-bit IBM-compatible computer.

You can create your own bright, high paying future as an NRI trained computer service technician. The biggest growth in jobs between now and 1995, according to Department of Labor predictions, will occur in computer service and repair, where demand for trained technicians will double. There is still plenty of room for you to get in on the action—if you get the proper training now.

Total computer systems training, only from NRI

To learn how to work on computers, you have to get inside one. And only NRI takes you inside a computer, with total systems training that gives you hands-on experience with computers, peripherals, and software. You'll build a Sanyo MBC-550 series computer, which experts have hailed as the "most intriguing" of all the new IBM-compatibles. The Sanyo even surpasses the IBM PC in computing speed and graphics quality.

Even if you've never had any previous training in electronics, you can succeed with NRI training. You'll start with the basics, rapidly building on the fundamentals of electronics until you master advanced concepts like digital logic, microprocessor design and computer memory. You'll probe into electronic circuits, using the exclusive

NRI Discovery Lab® and professional Digital Multimeter, that you keep.

You'll assemble Sanyo's intelligent keyboard, install the power supply and disk drive, and attach the high resolution monitor—all the while performing hands-on experiments and demonstrations that reinforce your skills.

Learn to service today's computers

As you complete your Sanyo, you grasp the "secrets" that qualify you for a new career. You'll learn to program in BASIC and machine language. You'll use utility programs to check out the operation of the Sanyo's 8088 microprocessor (the same chip used in the IBM PC). And you also get over \$1,000 worth of software, including WordStar and CalcStar.

Most importantly, you'll understand the principles common to all computers. Only a person who fully understands all the fundamentals can hope to be able to tackle all computers. NRI makes sure that you'll gain the knowledge and skills to maintain, troubleshoot and service computers.

Learn at home in spare time

With NRI training, you'll learn at home on your own time. That means your preparation for a new career or part-time job doesn't have to interfere

with your current job. You'll learn at your own pace, in the comfort and convenience of your own home. No classroom pressures, no rigid night school schedules. You're always backed up by the NRI staff and your instructor, who will answer questions, give you guidance and be available for special help if you need it.

Let others worry about computers taking their jobs. With NRI training, you'll soon have computers making good paying jobs for you.

Send for Free NRI Catalog

Send the post-paid reply card today for NRI's 100-page catalog, with all the facts about computer training plus career training in Robotics, Data Communications, TV/Video Servicing and many other fields. If some other ambitious person beat you to the card, write to NRI at the address below.

NRI SCHOOLS

McGraw-Hill Continuing Education Center
330 Progress Avenue
Scarborough, Ontario M1P 2Z5
or telephone 416-293-8787

We'll Give You Tomorrow.



IBM is a Registered Trademark of International Business Machines Corporation.

Cellular Telephones



Installation of the cell site antenna at the Cantel head office in Montreal. This receives the digital signal from the mobile phone and relays it to the control centre.

The radio-telephone of yesteryear has been replaced by a network using computer-controlled cells.

By Bill Markwick

ONCE UPON a time, having a telephone in your car meant a large transceiver box in the trunk, a large aerial on the outside, and complete dependence on the whims of reception from one main transmitter. The call had to go through a radio-telephone operator and from there into the regular networks; there were a limited number of channels available, say about one dozen, and even if you managed to get a clear frequency, the sound quality wasn't the greatest.

Hi-tech has changed all that with

cellular radio telephone transceiving. In general, the idea is that the same set of frequencies can be reused several times within a metropolitan area by installing low-powered transmitters or cells, each covering an area two to ten miles in radius. As the mobile phone is moved across a cell boundary, computerized switching is used to transfer the call to the next transmitter; the idea of low-powered transmitters isn't new, but the communications industry had been unable to solve the problem of cell-switching until the advent of today's small, powerful computers.

Switching

The call travels between the mobile phone and the cell transmitter on the 800-900MHz band; three levels of computer control are used to ensure a smooth transition from one cell to the next. The first is the microchip within the portable itself. The second is the cell transmitter's, and the third is the main switching centre,

or office, which coordinates the switching of the mobile phone in and out of the cells within the service area, as well as linking the signal into the regular telephone network.

When the cell transmitter finds that the mobile phone's signal is dropping below a preset level, the changeover sequence (called the "hand-off") is initiated. The main office is signalled by the cell, and begins to monitor the signal strength at cells surrounding the portable phone's. When a cell registers a higher signal than the one already handling the call, a changeover takes place under control of digital codes that link the cells to the main centre.

The main centre selects an idle channel out of the 45 available at the new cell site. The cell is ordered to activate that channel, and the original cell is instructed to send a control code to the portable phone, causing it to tune to the new channel. Finally, the new channel is switched into the call's land-line (telephone net-

Bell Cellular brings you its new Rental Program for just

\$89⁹⁵ a month*

Now you can enjoy the exceptional productivity benefits of instant communications with the new Bell Cellular Rental Program.

At Bell Cellular we are committed to offering you the extraordinary productivity advantages of superior cellular mobile telephone service at a price you can afford.

And you can choose one of the world's most sophisticated cellular mobile telephones; the General Electric GE-STAR, the Motorola Dyna TAC 2000X or Lenbrook's OKI CDL-201, from Bell Cellular's Authorized Representatives.

So now you can transform your car into a mobile office. Turn your travel time into profitable working time. And have new freedom in your business affairs.

Bell Cellular means drive-away service

You can drive into a service center to have your cellular telephone installed and drive away with Bell Cellular Service—all in one simple step.

Bell Cellular means instant, clear communications

With the most extensive array of calling features, instant communications are at your fingertips. And with Bell Cellular Service, voice reception is as clear as your office or home telephone.

Bell Cellular's unique option to purchase

Through this exclusive Rental Program, you can "rent-to-own" your cellular telephone.

A \$400 deposit is required. At the end of 36 months you can own your cellular telephone by waiving your deposit. Or the deposit is refundable upon return of your cellular telephone.

GE-STAR

Motorola Dyna T-A-C 2000X

OKI CDL-201



Here's what Bell Cellular gives you for just \$89⁹⁵ a month*

- Bell Cellular Mobile Telephone Service, including monthly service fee, plus 30 minutes of peak calling time
- Rental of your cellular telephone—with no long-term commitment required
- A choice of three state-of-the-art cellular telephones
- Complete installation
- Custom antenna
- Full equipment warranty

For a small additional monthly charge you can get the hands-free calling option too!

Find out how you can profit from Bell Cellular Service by writing today to: *Bell Cellular, 190 Attwell Drive, Suite 600, Rexdale, Ontario, M9W 6H8*, or call today for a FREE demonstration.

1-800-387-1446

*Based on 36-month "rent-to-own", with a minimum rental of three months. Deposit of \$400 required; non-refundable if rental is cancelled at any time during the 36-month term. Subject to cellular telephone availability. Substitute telephones of comparable value may be offered in lieu of telephones shown.



ecutive rate is only \$4.95 per month, but costs 60 cents per minute of peak-time usage. This is only for connection to the network; the equipment is extra. They also offer package deal: for \$89.95 per month you get the equipment, the monthly service, the installation, and 30 minutes of peak calling time. In addition, if you make a deposit of \$400, you have the choice after 36 months of either waiving the deposit, in which case you now own the equipment, or getting your \$400 back. In addition, Bell Cellular offers extra features such as call forwarding, three-way calling and call waiting for \$2.50 each or \$6.95 for all three. Call restrictions, such as local-dialing-only, are free to subscribers.

Cantel: the basic service is \$15.00 per month, plus 50 cents per minute for the first 130 minutes, 35 cents per minute for the next 170 minutes, and 25 cents per minute for any additional time over that. Those are peak rates; for off-peak you can take 2/3 of the above. The extra services listed above (call forwarding, etc.) are free to Cantel subscribers.

Both companies have an additional charge for long-distance, i.e., calls placed to outside the defined local user area.

Mobile Equipment

Things have changed since the time when you had only two choices in telephone sets: take it or leave it. Now both companies offer a wide range of mobile phones, both for in-vehicle and portable use. Cantel's telephones are made by NovAtel, Ericsson, Mitsubishi, Mobira of Finland, and others. Bell uses phones by Oki, Motorola, and General Electric. Even the simplest models are state-of-the-art pushbutton models with transceivers that can be considered to be miniature compared to the trunk-fillers of the past.

As an example, the Oki B-4 from Bell Cellular is the size of today's small pushbutton domestic models, with a transceiver about 10 by 10 by 2 inches and weighing only 12 pounds. At 13.7VDC, it draws only 1.8A from the car's electrical system and has an RF output of three watts. The modulation is FM with a compander for best voicegrade sound, and data can be also be transmitted via FM. Other features include a volume control, a system lock, a button for activating the car horn alert, and an indicator that you're outside the cellular service area. You can also enter up to 30 numbers in

the auto-dialer, use last-number redial, and even enter a new number without interrupting the conversation.

The Motorola 8000X (Bell) and the Cantel Liberty are both portable cellular phones. They not only have all the fancy pushbutton features of the in-vehicle series, but can be taken out of the vehicle mount and used in remote locations via rechargeable batteries.

Both Bell and Cantel offer a wide variety of phones with various features; brochures are available from the service centres.

Service Centres

Aside from their own outlets, both Bell and Cantel have contracted with other firms for setting up authorized service centres. Bell has an agreement with Tandy (Radio Shack), Motorola, Brooktel and CGE for equipment supply and installation, and Cantel has a similar agreement with Canadian Tire stores; Cantel also has an agreement with Budget car rentals to supply cellular phones in luxury rental models. It shouldn't be difficult to locate installation and repair facilities: Cantel has eight centres in the Metropolitan Toronto area, plus centres in Hamilton, Oshawa, Ottawa and Montreal, with more to come in other parts of the province. The companies can supply you with the location of the nearest facility:

Bell Cellular can be contacted at 190 Attwell Drive, Rexdale, Ontario M9W 6H8, 674-2233 for Toronto, or toll-free 1-800-387-4869.

Cantel can be contacted in Montreal at 340-9220, or in other parts of Quebec toll-free at 1-800-361-5410. In Toronto, the number is 440-1300, or toll-free 1-800-268-7347; in Ottawa, call 722-3375.

Lastly

People concerned with safe driving may be unnerved with the idea of drivers fiddling with telephones while tooling along in traffic. Both Cantel and Bell Cellular have addressed the issue, and both caution the user to restrict radiotelephone use to times when the level of distraction does not compromise safety. The distraction of dialing is largely bypassed by using the memory recall and autodial feature, and the problem of having a phone in your hand can be circumvented with a hands-free speakerphone model.

Perhaps cellular service will usher in a new era of mobile wrong numbers or obscene phone calls while driving. In any case, it's still a remarkable mix of telephone, radio and computer technologies, and the best portable communications system we've invented yet.

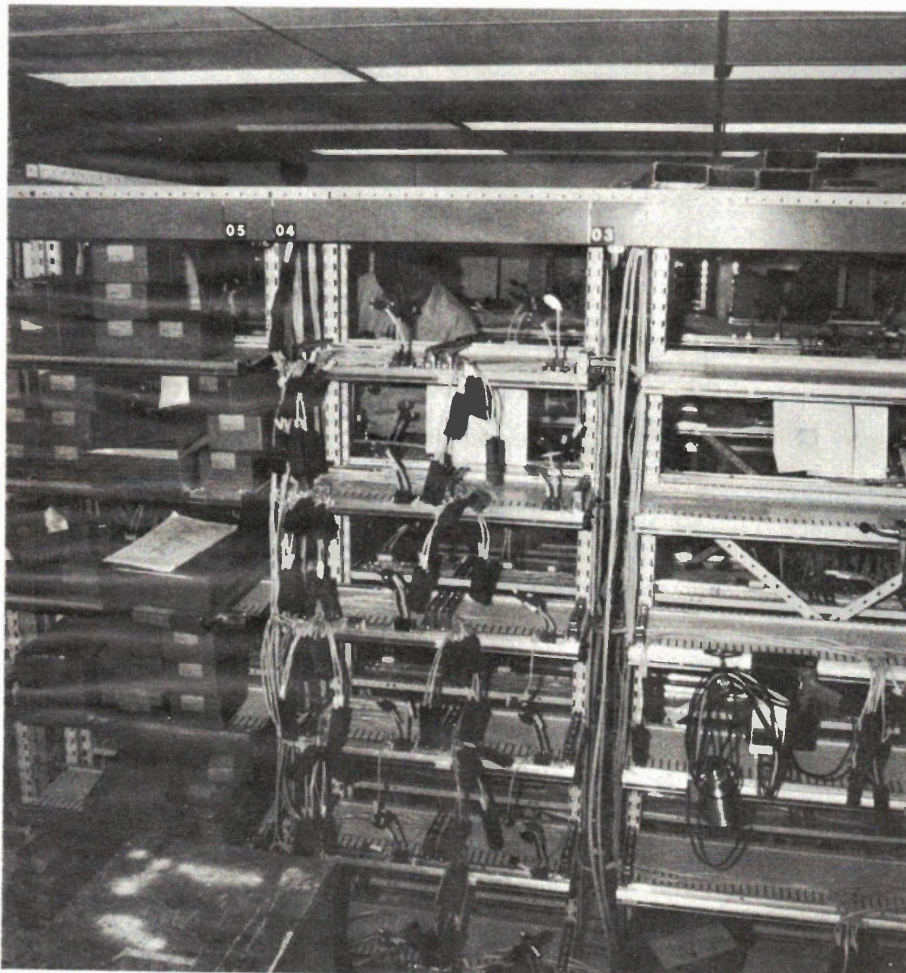

The Cantel switching office in Toronto is located in the CN Tower, and consists of equipment supplied by Ericsson of Sweden and NovAtel of Calgary.



The Motorola 8000X from Cellular is a self-contained portable with rechargeable batteries.



The Motorola 6000X from Bell Cellular has a 32-number memory with a 14-digit review display; other features include incoming call screening and programmable call restrictions.



The NovAtel Voyager used by Cantel has a time display, programmable call restriction and connectors for additional handsets or hands-free units.



The Cantel Liberty shown on the cover is a battery portable made by Mobira of Finland. It has a 30-number dialer and a 16-digit display; and auto power-off extends battery life.

CABINETS

GASSES

BOXES

NATIONAL ELECTRONICS, Box 683, Stn Q, TORONTO, M4T 2N5

Tandy IEEE-488

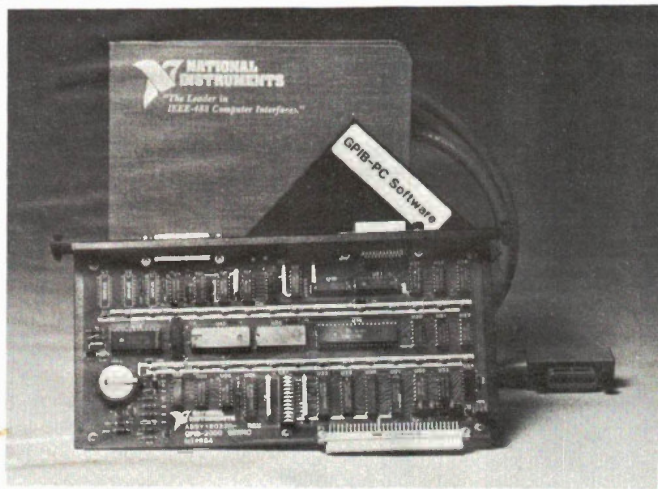

The National Instruments Model GPIB-PC2000 interface card and software permits the Tandy 2000 PC to communicate with over 4,000 GPIB compatible devices, such as digitizing oscilloscopes, gas chromatographs, mass spectrometers, plotters, digitizing cameras, etc. There's an optional RS232 port that's user-configurable and supports data rates up to 9,600 bits per second with

full modem support; there's also an optional clock with battery backup. Also included in the package is an interactive control program for training, troubleshooting and software development. Pac-man is an extra-cost option. From Allan Crawford Associates Ltd., 5835 Coopers Ave., Mississauga, Ontario L4Z 1Y2 (416) 890-2010.

Circle No. 18 on Reader Service Card

PC Cards

Low-cost but powerful IBM-compatible expansions are being manufactured by a Quebec firm, Sweet Electronics Ltd. The 4 by 5 inch CPS board, for instance, has a suggested retail price of \$195 and gives you a real-time clock with included software, an IBM-compatible parallel printer interface, and an RS232 port; all ports are user addressable. The 640k board retails for \$270 with 256k of RAM, and is used to expand the memory up to 640k; it allows mixed use of 64k and 256k memory chips. Sweet Electronics, 6767 Cote des Neiges, Suite 320, Montreal, Quebec H3S 2T6 (514) 340-1895.

Circle No. 19 on Reader Service Card

HP Bargraphs

Hewlett-Packard has released two new bargraphs, both with 101 elements: the HDSP-8825 High Efficiency Red and the HDSP-8835 Green. They feature high resolution and low power requirements. From Zentronics, 8 Tilbury Court, Brampton, Ontario L6T 3T4, (416) 451-9600.

Circle No. 58 on Reader Service Card

Looking for ultrasonic transducers for remote control projects? The inexpensive 40KHz type are the ones generally specified and they're available from Parts Galore, 316 College St., Toronto M5T 1S3, or from J & J Electronics Ltd., PO Box 1437, Winnipeg, Manitoba R3C 2Z4 (mail order) or 310 Notre Dame Ave., Winnipeg R3B 1P4 (store address).

Incidentally, the new J & J mail order flyer is out now, listing all sorts of specials on semiconductors, hardware, books, computer gear, etc.

The Inevitable Corporation of Montreal has announced that it will be making its telecomputing service, the ACCESS Timesharing System, available across Canada; it's been available in Montreal for the past two years. It offers electronic mail, conferencing, bulletin boards, opinion polls and public databanks, along with numerous entertainment features. The service is aimed at consumers and small-to-medium businesses. The service is especially attractive because of its low cost: \$5.95 per connect hour across Canada and a special rate of \$2.50/hr for Montreal users (at 300 Baud). ACCESS also offers the idea of the "electronic office", which enables businesses to conduct various communications functions without regard for geographical separation. For more information, contact Neil Baron, The Inevitable Corporation, 8400 Cote de Liesse, Suite 217, St. Laurent, Quebec H4T 1G7, (514) 342-8147.

Circle No. 2 on Reader Service Card

According to a press release from Accountemps, a large US accounting firm, a national survey of executives showed that Monday is chosen by far to be the worst day of the week. Hope they didn't spend a lot of money finding this out.

Unsolicited Plug: Do you use technical pens in your drafting or schematics? Do you tear your hair out when the tiny nibs dry out and plug up? We use a cleaning solvent called Speedball Pen Cleaner, and it works so well we thought we'd tell you about it. It dissolves the oldest, hardest ink deposits with a 30 minute soak; if the pen won't work after two dips, there's probably mechanical damage. It's made by Hunt Manufacturing Co. in Huntsville, S.C., and we ordered ours from Loomis and Toles, a large drafting supply company with offices in Toronto, Ottawa, Montreal, Fredericton and Halifax.

continued on page 46

INTERNATIONAL LTD.
(416) 298-3280
Telex - 065-26150

Service Centre and Retail Outlet. 4051 Sheppard Ave., East, Agincourt, Ontario M1S 1S8
Japanese Parts Specialists — Parts 100% guaranteed

RAM'S		XTPC PERIPHERALS	
4116-200NS or 150NS	\$.70	a) 256K Super XT Main Board (No ROM)	
4164-150NS	\$ 1.25	Made in Japan	\$299.00
41256-150NS	\$ 7.99	b) 512K RAM Card (OK)	\$105.00
STATIC RAM'S		c) 384K Multifunction Card (OK)	
2114 200NS 150NS	\$ 1.85	QUAD Compatible	\$225.00
2016, 2116, 4016 8K X 2	\$ 4.90	d) Monochrome Card	\$149.00
6116P 150NS 8K X 2	\$ 5.50	e) Monochrome Graphic Card	\$235.00
HM6264 LP-15 8K X 8	\$12.50	f) Disk Drive Card w/Cable	\$ 95.00
4416, 120NS 4K X 16	\$ 5.99	g) RS-232 Card	\$ 55.00
EPROM'S		h) Printer Card	\$ 37.00
2716-450NS NEC	\$ 4.99	Colour Graphics Card	
2716 450NS AMD	\$ 3.50	(Composite and RGB output	\$155.00
2732 450NS	\$ 4.99	256K RAM Card w/printer port	\$129.00
2764 250NS	\$ 4.99	DISK DRIVE	
27128 300NS	\$10.99	IBM Compatible	
2532 450NS	\$ 7.25	Panasonic JA551-3	
		(same as Shugart SA455)	\$155.00
DX85		Apple II, E, Compatible	
DX38		Super 5 or ASUKA	\$189
\$19.95		Half Height. 1 Year full warranty.	
DX85 5-1/4 Floppy Disk Case (storage up to 150 diskettes)		IBM Compatible Keyboard	\$109.00
Lock included		20 MB Segate Hard Disk	
\$24.95		w/controller	\$1299.00
Mail Orders: Send a certified cheque or money order plus \$4.00 for shipping and handling. For Special Delivery, please add \$1.00 extra. Ontario residents add 7% P.S.T. Visa & Master card accepted.		150W Power Supply	\$195.00
		135W Power Supply	\$169.00
		8088 Kit Set (7PCS)	\$45.00
		(special) 8237A intel	\$ 9.95
		8088 intel	\$12.95
		74LS322	\$ 4.99
		6502	\$ 4.50

Circle No. 47 on Reader Service Card

NEW FALL '85 CATALOG

JUST CLIP AND RETURN THIS COUPON

THIS MONTH'S SPECIALS

Memories

DRAMs

4116	16K	1.55
4164	64K 150ns	2.40
4164	64K 200ns	1.99
41256	256K 150ns	10.95

EPROMs

2708	1K x 8 450ns 8K	9.35	ALL NEW CURRENT PRODUCTION PRODUCTS
2716	2K x 8 450ns 16K	5.65	
2732A	4K x 8 300ns 32K	7.75	
2764	8K x 8 300ns 64K	7.15	
27128	16K x 8 300ns 128K	11.85	
27256	32K x 8 250ns 256K	23.65	
27512	64K x 8 250ns 512K	134.30	

TECHNICAL INSTRUMENTS
MOTOROLA
Advanced Micro Devices

FULL LINE OF MICROPROCESSORS AVAILABLE

WE ALSO STOCK...

- Books • Breadboard & Accessories
- Capacitors • Chemicals • Connectors
- Crystals • Plugs & Jacks • Fans
- Enclosures • Filters • Fuses • Heat Shrink Tubing • Heat Sinks • Kits
- Knobs • Peripherals • Probes • Opto
- PCB Products • Potentiometers ...



USA
P.O. BOX 9100
WESTBOROUGH, MASS
1-800-343-0874

Active

CANADA
5651 FERRIER ST
MONTREAL, QUEBEC
1-800-361-5884

MAIL ORDERS
PROCESSED WITHIN
24 HOURS

YOUR ELECTRONIC
COMPONENT
CENTER

ORDER FROM
OUR CATALOG
VOLUME DISCOUNTS

SELF SERVE STORES LOCATED NEAR YOU. JUST CALL...

WESTBOROUGH, MASS. 366-9684	OTTAWA, ONT. 728-7900	EDMONTON, ALTA. 438-5888
BELLEVUE, WASH. 881-8191	TORONTO, ONT. 977-7692	CALGARY, ALTA. 235-5300
MONTREAL, QUEBEC 731-7441	DOWNSVIEW, ONT. 630-0400	VANCOUVER, B.C. 438-3321

Circle No. 15 on Reader Service Card

PC/XT Compatible



~~\$1295.00~~
**ECS1-PC/XT
Special
\$1195.00**

- 8088 processor • optional Intel 8087 numeric coprocessor • 256K memory
- double sided double density disk drive
- detachable keyboard • colour-graphic board • 130 watt power supply • support PC software • 90 day warranty. 8 slot Mother board.

ECS4 Systems

~~\$1179.00~~
**Special
\$995.00**

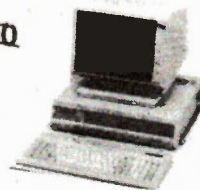

- dual processor 6502 and Z80 • 64K RAM • controller card • disk drive • Hi-res 1011 amber monitor • colour graphics • detachable keyboard with special function • 90 days warranty.

XT/PC MAIN PERIPHERAL

- | | |
|------------------------|----------|
| Mother Board 8 Slot | \$269.00 |
| Color Graphic Card | \$159.00 |
| Multifunction | \$159.00 |
| Monochrome Card | \$139.00 |
| Monochrome Graphic | \$249.00 |
| Game Port | \$ 49.00 |
| RS232 Card | \$ 59.00 |
| Parallel Interface | \$ 59.00 |
| Disc Controller Card | \$ 89.00 |
| Case | \$ 69.00 |
| Keyboard (Cherry) | \$ 99.00 |
| Power Supply 130 Watts | \$139.00 |
| Printer Cable | \$ 25.00 |
| RS232 Cable | \$ 25.00 |
| Disk Drive Cable | \$ 15.00 |
| Moving Message Board | \$495.00 |
| TTL and CMOS test Card | \$ 99.00 |
| 150 Watt Power Supply | \$159.00 |

UNIQUODEM 1200 HC 1200/300 BPS Intelligent Modem Hayes Compatible



The UNIQUODEM 1200 HC is Hayes Compatible, a high quality, low cost modem for use with personal computers, stand-alone terminals, or other intelligent communications devices or systems.

\$395.00

ELECTRONIC CONTROL SYSTEMS

ECS

1590 Matheson Boulevard, Suite 1 & 2 Mississauga, Ontario L4W 1J1
(416) 625-8036 Hours — Mon. to Fri. 10-6. Sat. 10-2

Circle No. 16 on Reader Service Card

K.E.M.

HIGH SPEED EPROM PROGRAMMER ---- \$175.00

FROM 2716 UP TO 27256. ALL ROUND TYPES. ONE TOUCH OPERATION INCLUDING 'A' AND 'CMOS' VERSIONS.

(EXAMPLE)

2764 — 30 SEC
27256 — 120 SEC

I/F CARD FOR **APPLE** OR **IBM**

UP TO 256!

IBM I/F CARD

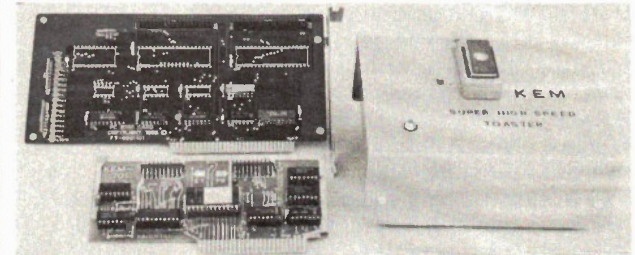

APPLE I/F CARD

ROBOTICS TRAINING I/O "ODEN" ----- \$149.00

INCLUDES STEPPING MOTOR DRIVER, SPEAKER OUTPUT, 8 BIT LED DISPLAYS, PHOTO-, THERMAL-, SOUND-SENSORS, MANUAL DATA ENTRY SWITCHES, RELAYS.

& I/F CARD FOR **APPLE** OR **IBM**

DC MOTOR CONTROLLER & ULTRA SONIC RADAR UNIT (OPTION)

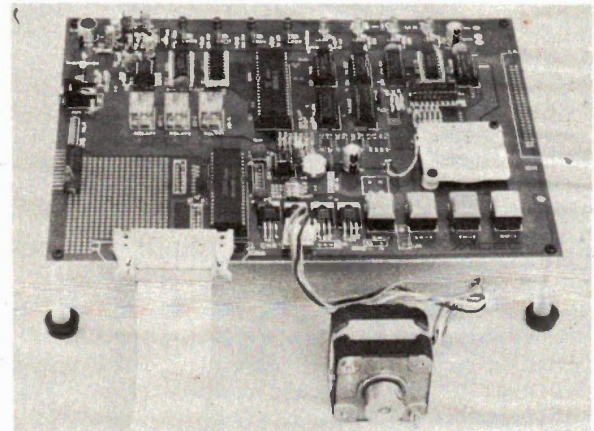

JUST CHANGE YOUR I/F CARD. YOU CAN SWITCH TO IBM OR APPLE.

EXTRA I/F CARD FOR 'PROGRAMMER' OR 'ODEN' ----- \$69.00

STEPPING MOTORS & DRIVERS (ASK FOR DETAIL)

MOTORS (SEVERAL MODELS)	TORQUE RANGE	280g-cm --- 20Kg-cm
	PRICE RANGE	\$16.00 --- \$165.00
DRIVERS		\$65.00 --- \$169.00

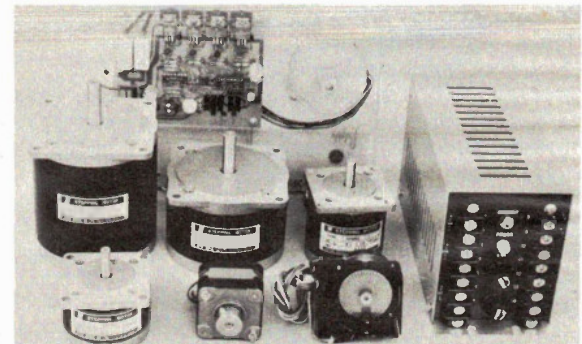

PLUS \$5.00 FOR SHIPPING. PLUS PROV. TAX WHERE APPLICABLE.
PLUS CANADA POST COO FEE IF REQUESTED.
PRICES & SPECIFICATIONS ARE SUBJECT TO CHANGE WITHOUT NOTICE.

KEM (KAIENTAI) Electronics Ltd.

870 EAST HASTINGS STREET, VANCOUVER, B.C. V5K 4W4
PHONE (604) 251-1514

Circle No. 46 on Reader Service Card

continued from page 27

transformer induced hum, the accuracy of reference points, as well as capacitive coupling and voltage modulation. Voltage modulation is crucial. If the voltage rails are jumping up and down, then they will affect the "brains" of the operation considerably. The most effective way of preventing this is to regulate the driver section and only let the output stage suffer the abuses of a jumpy supply (Fig. 8). In our design, this results in crosstalk noise on one undriven channel of -110dB at 20Hz while the other channel is delivering 75W into 8 ohms. As I mentioned earlier, in connection with pre-amps, a common supply is used for both channels, so the figure shows true rejection capabilities.

As with all engineering, there is no 'right' answer to the subtle problems of audio design. There are only better answers judged against a whole range of criteria: subjective sound quality, reliability, consistency, availability of components and, for a commercial product, appearance. As for the designer's ego—that can be massive. An important part of designing is to get an objective assessment of the results of process. It's too easy to convince yourself that a technique will improve performance and so find, through your prejudice, that it does. It's equally easy to find yourself not knowing when to stop developing a design, even though the improvements you are making no longer affect the final sound.

I've concentrated on power supplies because far too often they are just an afterthought tacked on to some sophisticated low noise, ultra low distortion circuit. In reality, the PSU and the circuit itself are complementary and must be designed together. The thing I find most astonishing is that all this is well known. The 1958 book mentioned earlier analyzes power supply design and the various corruptive possibilities very clearly. Yet too many designs still completely overlook these things. Part of the blame lies with the approach to ICs. Using them, you can throw a circuit together that will work fairly well. Using discrete components requires understanding to get the circuit to work at all. The pay-off is that the shortcomings of your design are far more obvious. Although a contented user of ICs, I strongly recommend that full data and internal circuits be consulted and that the chips be treated not so much as ICs but as CIs - circuits that have been integrated, a subtle but philosophically fundamental difference. ■

PATRON COMPONENTS INC.

Stock Distributor of Memories I.C. (U.S.A./Japan),
All New Parts. Min. 1000 pcs.

RAM/EPROM:

- 16K DRAM (4116) from \$0.50 EPROM (2716) \$2.45
- 64K DRAM (4164) from \$1.10 EPROM (2764) \$3.15
- 128K DRAM (4128) from \$8.05 EPROM (27128) \$3.95
- 256K DRAM (41256) from \$5.45
EPROM (27256) \$11.85
- 16K SRAM (6116,2016) from \$2.10
- 64K SRAM (6264,5565) from \$6.70

T.T.L.:

(74LS00 etc.) from \$0.17

4000 CMOS:

(CD4001 etc.) from \$0.17

LINEAR:

LM324 etc.) from \$0.21

MICROPROCESSOR:

8088 Kit set (8088, 8253, 8237, 8284, 8288, 8259, 8255)
from \$33.10 per set

Please call for other 8000 series MPU/O.E.M. price and delivery.

8088 XT/PC PERIPHERAL BOARDS:

Main Board 8 Slot CAN.....	\$199.00
Colour Graphic Card CAN.....	\$99.00
Multifunction Card CAN.....	\$99.00
765 Controller Drive Card CAN.....	\$69.00
512K RAM CARD CAN.....	\$95.00
150 WATT Power Supply CAN.....	\$129.00
Monochrome Card CAN.....	\$89.00
JA 551-3 Disk Drive.....	\$129.00

Price subject to final confirmation.

Please call for details.

MAIL ORDERS:

For quantities under 1000 pcs, please add 25% extra from above price plus postage and provincial tax.

We can ship C.O.D. freight collect for larger quantities.

4002 Sheppard Ave. E., Suite 506,
Agincourt Commercial Centre,
Scarborough, Ontario, M1S 1S6 Canada
Tel: (416) 299-7731 FAX: 416-298-4569
Telex:065-25256

Computing Today

Designing Z80

Projects, Part 4

Programming the PIO and real world interfacing

NOW THAT THE PIO is properly interfaced to the CPU it must be programmed first before any I/O operation can occur. Programming the PIO is very much like writing to an I/O port; in this case the I/O port is either the port A or port B control register.

To define or change the parameters, an 8 bit word is written to the control register. The first control word that is written to the PIO is the mode control byte; a characteristic of this byte is that the lower 4 bits are all set to 1. The upper 2 bits define one of four operating modes available on the PIO. Figure 1 contains a list of all the control words.

Operating Modes

In mode 0 of operation the port is defined as an 8 bit output port. The two handshaking lines are used to transfer data from the PIO to the external device, and when data is placed on the output port the PIO places the ready line (ARDY or BRDY) at a logic level one. The external device monitors the ready line and reads the data when the ready line goes high. After reading the data, the external device pulses the strobe line low (ASTB or BSTB) to indicate to the PIO that the data has been received. This mode is used for communicating to external devices such as parallel printers.

Mode 1 of operation is almost the same as mode 0 except this time the port is defined as an input port. The two handshaking lines are used again to transfer data, and when the PIO is ready for an input transfer the RDY line is placed at a logic level one. The input device decodes this signal and pulses the STB line low when the data is ready; the PIO responds by placing the RDY line at a logic level zero. When the CPU has read the data at the port, the PIO once again asserts the RDY line high and the process continues. This mode of operation is used for communicating to external devices such as decoded keyboards.

Mode 2 operation is a combination of

Programming The PIO

Defining the operating mode

bit 7 6 5 4 3 2 1 0

m1	m0	X	X	1	1	1	1
----	----	---	---	---	---	---	---

Mode Control byte

m1	m0	
0	0	mode 0
0	1	mode 1
1	0	mode 2
1	1	mode 3

bit 7 6 5 4 3 2 1 0

d	d	d	d	d	d	d	d
---	---	---	---	---	---	---	---

Data Direction byte (mode 3)

d = 1 - input d = 0 - output

Setting the Interrupt Vector

bit 7 6 5 4 3 2 1 0

v	v	v	v	v	v	v	0
---	---	---	---	---	---	---	---

Interrupt Vector byte

Setting the Interrupt Control byte

bit 7 6 5 4 3 2 1 0

EI	A/O	H/L	MF	0	1	1	1
----	-----	-----	----	---	---	---	---

Interrupt Control byte

- EI - 1 = interrupts allowed, 0 = not allowed
- A/O - 1 = and bits, 0 = or bits (mode 3)
- H/L - 1 = Active high, 0 = Active low (mode 3)
- MF - 1 = mask follows, 0 = doesn't follow (mode 3)

bit 7 6 5 4 3 2 1 0

m	m	m	m	m	m	m	m
---	---	---	---	---	---	---	---

Interrupt Mask byte
 m = 1 do not monitor,
 = 0 monitor

Enabling/Disabling Interrupts

bit 7 6 5 4 3 2 1 0

EI	X	X	X	0	0	1	1
----	---	---	---	---	---	---	---

EI = 1 interrupts allowed,
 = 0 not allowed

X = don't care

Fig. 1 A graphic representation of the PIO command bytes.

modes 0 and 1 and is only available on port A. In this mode port A is defined as a bidirectional port, and the handshaking lines are used when the port is outputting data to the external device. Port B handshaking lines are used when inputting data from an external device. This mode is rarely used except for special devices using bidirectional data transfers.

Modes 0, 1, and 2 use a technique called interrupt driven I/O. This method allows the CPU to perform other func-

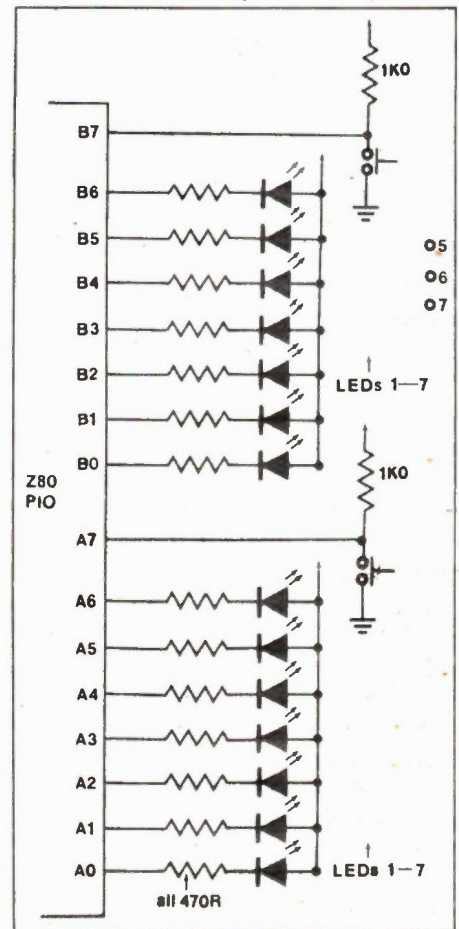

Fig. 2 Schematic of the digital dice arrangement.

tions while slow I/O devices store or retrieve data from the PIO. Once the data exchange has taken place the PIO interrupts the CPU and CPU will perform some I/O operation (i.e. read the port or place new data on the port.) This technique will be further explained when we discuss interrupts on the Z80.

Mode 3 operation, the most useful for small projects, does not use handshak-

ing. In this mode each bit on each port can be programmed for output operation or input operation. Every time data is written to the port, the output lines are updated automatically and remain unchanged until new data is written to the port. Data input from the port represents the data at the time the port was read. Any varying data is not noted until the port is read again.

To program the port for mode 3 operation, first the mode control word 0CFH is written to the port control register. The next word written to this register defines which bits on the port are used for output or input operation. A logic zero defines the corresponding bit position to be programmed for output operation, and a logic 1 defines the input operation. For example, if the upper four bits on the port are to be used for input and the lower four bits for output then the word written to the register would be FOH.

Listing 1 shows various examples of programming the PIO in modes 0, 1, 2, and 3. In the software examples it is assumed that the PIO is connected in the same manner as described in a previous part of this series.

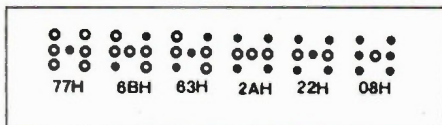

Fig. 3 The six bit patterns of a die.

Digital Dice

By connecting 14 LED's and two switches to the *minimum Z80 computer system* as described last month, a digital dice game can be implemented. Figure 2 shows how to connect the LED's and the switches to the PIO. Seven LED's are required for each die to represent the six different possible patterns on the die. One button is provided to 'shake' the dice and the other button is provided to 'roll' them. The LED's are connected to bits 0-6 on port A and port B, and the two switches are connected to bit 7 on ports A and B. Therefore, each port should be programmed for mode 3 operation with bits 0-6 programmed as outputs and bit 7 programmed as an input.

To illuminate an LED, a low or zero should be written to the appropriate bit in the port. Consequently, a high or one bit represents an LED that is off. For example, to turn on LEDs 1 through 4 and turn off LEDs 5 through 7 on port A, the bit pattern 1110000 should be written to the port. Note that this represents the hex byte 70H.

Figure 3 shows the six possible patterns found on the faces of a die; below each pattern is the hex byte that represents

continued on page 53

```
A>TYPE B:LISTING.5
;***** LISTING 1 *****
;
; PIO PROGRAMING EXAMPLES
;
; IN THE FOLLOWING EXAMPLES IT IS ASSUMED THE PIO IS CONNECTED SUCH
; THAT-   PORT A DATA - F8H
;         PORT B DATA - F9H
;         PORT A CONTROL -FAH
;         PORT B CONTROL -FBH

PORTA EQU    0FBH
PORTB EQU    0F9H
CNTLA EQU    0FAH
CNTLB EQU    0FBH

;*****
; PROGRAMING PORT A FOR MODE 0 OPERATION

LD    A,0FH           ;MODE CONTROL BYTE-00XX1111
OUT   (CNTLA),A      ;OUTPUT TO PORT A CONTROL

;*****
; PROGRAMMING PORT B FOR MODE 1 OPERATION

LD    A,4FH           ;MODE CONTROL BYTE-01XX1111
OUT   (CNTLB),A      ;OUTPUT TO PORT B CONTROL

;*****
; PROGRAMMING PORT A FOR MODE 2 OPERATION

LD    A,8FH           ;MODE CONTROL BYTE-10XX1111
OUT   (CNTLA),A      ;OUTPUT TO PORT A CONTROL

;*****
; PROGRAMMING PORT A AND B FOR MODE 3 OPERATION
;
; PORT A BITS 0-4 -INPUT   BITS 5-7 OUTPUT
; PORT B ALL OUTPUT

LD    A,0CFH          ;MODE CONTROL BYTE-11XX1111
OUT   (CNTLA),A      ;OUTPUT MCB TO PORT A CONTROL
LD    A,1FH           ;DATA DIRECTION BYTE-00011111
OUT   (CNTLA),A      ;OUTPUT DDB TO PORT A CONTROL

LD    A,0CFH          ;MODE CONTROL BYTE-11XX1111
OUT   (CNTLB),A      ;OUTPUT MCB TO PORT B CONTROL
LD    A,00H           ;DATA DIRECTION BYTE-00000000
OUT   (CNTLB),A      ;OUTPUT DDB TO PORT B CONTROL
```

Listing 1. PIO programming examples.

```
***** LISTING 2 *****
; DIGITAL DICE GAME

START:
LD    A,0CFH          ;INITIALIZE PIO'S
OUT   (CNTLA),A      ;MODE CONTROL BYTE-11XX1111
OUT   (CNTLB),A      ;OUTPUT MCB TO PORT A CONTROL
LD    A,080H         ;OUTPUT MCB TO PORT B CONTROL
OUT   (CNTLA),A      ;DATA DIRECTION BYTE-10000000
OUT   (CNTLB),A      ;OUTPUT DDB TO PORT A CONTROL
OUT   (CNTLB),A      ;OUTPUT DDB TO PORT B CONTROL

WAIT:
IN    A,(PORTA)      ;WAIT FOR SHAKE BUTTON TO BE PRESSED
AND   080H
JR    NZ,WAIT

LD    BC,0000H       ;PRESET COUNTERS

SHAKE:
IN    A,(PORTB)      ;INCREMENT COUNTERS WHILE WAITING FOR
AND   080H           ;ROLL BUTTON TO BE PRESSED
JR    Z,ROLL

INC   B              ;INCREMENT FIRST COUNTER
LD    A,B            ;TEST IF B=0
CP    06
JR    NZ,SHAKE

LD    B,D            ;YES-RESET FIRST COUNTER
```

Listing 2 continued on page 53

Electronics in Canada



ILP president Howard Gladstone outlining some of the qualities of ILP toroidal transformers.

ILP Manufacturing Inc.

Electronics Today staff looks at the growing success of toroidal transformers in Canada and the company behind it.

UP UNTIL recently in Canada and the United States, the cumbersome stacked laminated core transformer has been powering the electronic gadgetry that we the consumers so eagerly buy up. However, a new (to consumer products), lighter, and more efficient type of power transformer with a name that might be

better suited to an extra-terrestrial being is now coming into its own: the toroidal, a donut-shaped device that has some excellent design characteristics that make it a designer's dream in terms of space/power efficiency. To top that off, there is only one Canadian company claiming to manufacture toroidals with modern

equipment: ILP Manufacturing Inc. of Downsview Ontario.

New Kid On The Block

The toroidal transformer has been a hot item in Europe for many years, but it's a relative newcomer to the Canadian scene. The driving force behind the increasing notoriety of the toroid in Canada is ILP's personable president, Howard Gladstone.

Keeping one eye on the electronics industry in Europe and one on the home territory, Mr. Gladstone quickly noticed the potential for toroidal equipment in Canada and the U.S. In early 1983 he finalized a licensing agreement with ILP Electronics of the U.K., one of the largest suppliers of toroidal transformers in Europe, and by the end of that year, with all the details worked out, orders were beginning to roll in. In fact, production of the iron donuts didn't begin until January of 1984; since then there has been an increasing market for the compact units.

Efficient Power

A transformer that's typically 50% lighter and smaller than traditional laminate core types, the extremely low profile design makes toroids the obvious choice for installation into today's mini-cabinets. The days of measuring the weight of an amp by its wattage will soon be over.

Toroids are efficient. The fact that they have a continuously wound core means that there is no air gap, resulting in a stacking factor of 95% of its theoretical weight. All the windings are symmetrical over the entire round gapless core, giving a higher flux density. High electrical efficiencies are achieved because the magnetic flux is in the same direction as the grain-oriented silicon steel core.

Toroids are quiet. No air gap means an 8:1 reduction of induced noise. The windings which envelope the core are effective in reducing magnetostriction, the main source of hum found in vertical laminate type transformers.

Toroids are compact. The largest transformer in the ILP lineup to date is the 625VA model. It measures 140mm in width by 80mm in height, and weighs only 5.00 kilograms. Designing high-wattage equipment will mean reduced cabinet sizes and decreased shipping charges.

Applications

ILP's primary market at this time is the OEM, but they do supply all nine models of their toroidal transformers through distributors. Apart from transformers, ILP carries a complete line of power amplifiers up to 360 watts utilizing toroidal power supplies.

According to Mr. Gladstone, there is a growing market for toroids in the audio and musical instrumentation fields. Amplifiers which normally weigh in at fifty or so pounds can be reduced by almost half that with the lighter components. Musicians, sound persons and stage crews alike will welcome the less hefty cabinets as well.

Manufacturers of video monitors, telecommunications switching systems, and security equipment are also beginning to benefit from the compact size and reduced weight afforded by toroidal technology. Wherever there is need for power in restricted space, the toroid is increasingly becoming the choice for small and large manufacturers alike.

Growing Market

It wasn't easy for ILP right from the start; the first year was slow, typical of new

companies. Their main business consisted of OEMs, which are still the company's foundation today. As well as manufacturing, ILP offers a Design Service for engineers to help with determining their exact physical and electrical requirements for transformers. At present, the ten employees of ILP are supplying a multi-million dollar transformer market covering all of Canada and parts of the U.S., more proof that small business in Canada is a major contributor on the world scene. Their goal for the future is to become the largest supplier toroidal transformers in North America.

ILP Manufacturing is located at 3950 Chesswood Dr., Downsview Ontario, M3J 2W6 (416) 636-9404.

DOES YOUR DIGITAL CAPACITANCE METER DO THIS?

FULL 4 DIGIT 0.5 INCH LCD DISPLAY COMPLETELY AUTORANGING WITH 10 RANGE MANUAL CAPABILITY

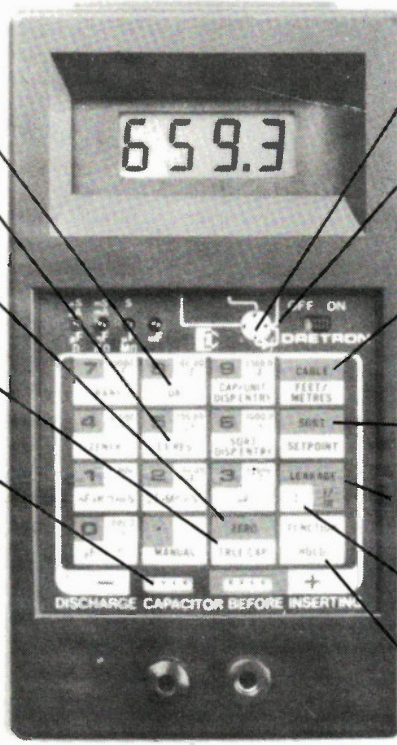

- AND THIS**
RANGE OF 0.0 pF to 1 FARAD (999.9 mF)
0.5% BASIC ACCURACY UP TO 100 uF
- AND THIS**
READS DIELECTRIC ABSORPTION
- AND THIS**
EXTENDED PSEUDO 5 DIGIT
RESOLUTION ON SOME RANGES ONLY
- AND THIS**
ABILITY TO ZERO LARGE CAPACITANCE
VALUES UP TO 99.99 uF
- AND THIS**
CALCULATES TRUE CAPACITANCE
IF CAPACITOR IS LEAKY
- AND THIS**
DIODE CLAMP AND FUSED
PROTECTED INPUT.
DISCHARGE RESISTOR IN OFF
POSITION AT TERMINAL INPUTS.
POWERED BY 9V BATTERY

- AND THIS**
IDENTIFIES TRANSISTORS (NPN, PNP)
AND THEIR LEADS (E, B, C, ETC.)
- AND THIS**
TESTS ZENER DIODES AND RECTIFIERS.
UP TO 20V ZENER WITH AC ADAPTOR,
ZENER VOLTAGE WITH 9V BATTERY
DEPENDS ON ITS CONDITION
- AND THIS**
AUTOMATICALLY CALCULATES LENGTHS
OF CABLES IN FEET, METRES, MILES,
KILOMETRES (THEORETICAL RANGE
OF 9,999 MILES)
- AND THIS**
ABILITY TO SORT CAPACITORS IN
MANY DIFFERENT MODES
- AND THIS**
ABILITY TO READ LEAKY CAPACITANCE
(INSULATION RESISTANCE OR CURRENT)
- AND THIS**
CALCULATES TIME CONSTANTS WITH
USER DEFINED RESISTANCE VALUES
- AND THIS**
HOLD FUNCTION FREEZES DISPLAY

ONE YEAR PARTS & LABOUR WARRANTY

FOR ONLY THIS

\$149.95

MODEL MC300

Approx. Size
7" x 4" x 1 1/4"

DAETRON
935 THE QUEENSWAY
BOX 641
TORONTO ONTARIO M8Z 5Y9
(416) 255-9701

DEALER ENQUIRIES INVITED

MADE IN CANADA

PLEASE SEND ME _____

____ (QUANTITY) MC300(s) @ \$149.95 \$ _____

CARRYING CASE \$19.95 \$ _____

AC ADAPTOR \$11.00 \$ _____

ONTARIO RESIDENTS ADD 7% PST \$ _____

SHIPPING AND HANDLING @ 4.45 per instrument \$ _____

TOTAL \$ _____

I ENCLOSE CHEQUE MONEY ORDER BILL MY VISA

VISA CARD NO. _____

EXPIRY DATE _____ SIGNATURE _____

NAME _____

ADDRESS _____

CITY _____ PROV. _____ POSTAL CODE _____

Random-Tone Alarm

By P. Cooper

THIS CIRCUIT was originally designed to drive a computer maniac away from his machine in time for meals, however, its uses are left to your imagination. In its completed form, it emits an annoying pseudo-random sequence of tones about two minutes after being switched on. The prototype was arranged to be activated by the removal of a jack plug so that it could not be easily disabled.

A two minute delay is produced by monostable IC1, which is triggered by C1 when the power is applied. IC1's output is inverted to give an active high enable signal which allows astables IC2 and IC5 to run after the delay. IC2 clocks a 4-bit shift register (IC3) at about 5Hz while IC5 generates an audio tone whose frequency is modulated by IC3's outputs and R1 to R5. The first and last outputs of the shift register are Exclusive-NOR'ed and the result is fed to the data input to produce the pseudo-random code. The two terminals of the piezoelectric buzzer are driven in antiphase to increase sound output.

of signal values, then consider this circuit.

The circuitry consists of two CMOS ICs, two transistors and associated passive components. It requires a clean pulse wave input, so if your signal is noisy or irregular you should add a Schmitt-trigger stage at the front end of the circuit. The supply voltage can be between +5V and +15V — although this will affect the precise pulse widths involved, which should therefore be independently measured for accurate calibration. With a low Vcc, R4 can be as low as 470R, however, if the Vcc is +15V R4 should be a minimum of 1k5.

IC1 is a dual retriggerable monostable. IC1a detects the input frequency and a positive-going input pulse will trigger an output pulse of a width given by $R1 \times C1$. If another pulse appears on the input before the output pulse finishes, the output will be retriggered. So, if the frequency of the input exceeds a given limit, f_{max} (equal to $1/R1 \times C1$), the output on pin 6 will be high for the duration of the input signal and for a short time thereafter until IC1a resets itself. The signal on pin 12 (IC1b input) will then go high and stay there, so that the output on pin 10 will be a single pulse of width given by the time constant $R2 \times C2$.

If the frequency of the input is below the limit f_{max} , the output on pin 6 will be

An input frequency above f_{max} will result in a single pulse of width $R2 \times C2$ on pin 10 of IC1, and an input frequency below f_{min} will result in a train of $R2 \times C2$ pulses on pin 10. An input frequency between f_{max} and f_{min} will result in a high level output on pin 10. The RC network on pin 10 should have component values which ensure that $R2 \times C2$ pulses do not reach logic high on the input to IC2a, a Schmitt-triggered NAND gate wired as an inverter. R3 and C3 should have a time constant at least three times greater than $R2 \times C2$. R4 should be considerably lower than R3; between 470R and 1k5 depending on the Vcc. Along with the steering diode, D1, R4 ensures a rapid discharge of C3, while R3 is designed to charge it slowly. With suitable values, pins 1 and 2 of IC2 will be low except when the input signal frequency lies between f_{max} and f_{min} . This low will enable IC2c and d to transmit a 10Hz signal provided by the simple oscillator formed by IC2b, R5, and C4. This signal is directly available on pin 4 of IC2 and is fed to the LED via a constant current source comprised of transistors Q1, Q2, and their associated components.

The constant current source ensures that LED brightness does not vary with supply voltage. It should be noted that R1 and R2 must both be greater than 5k,

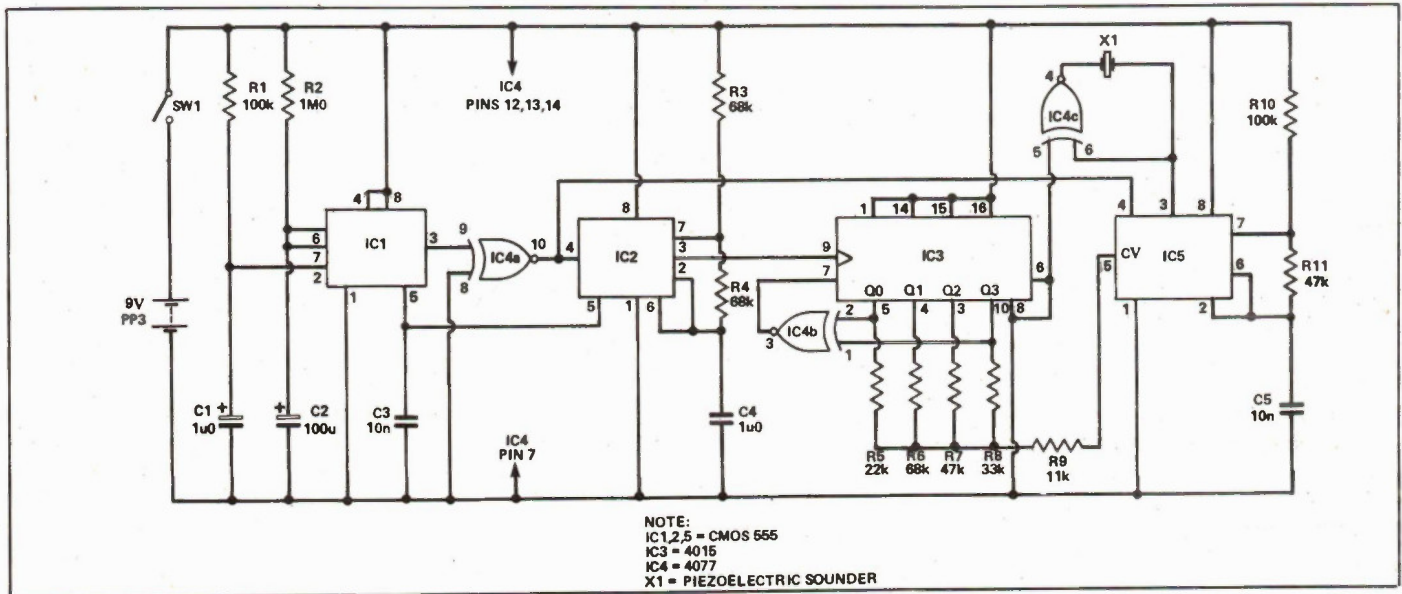

Simple CMOS Frequency-Window Discriminator

By Thomas Schaerer

IF YOU HAVE to convert any environmental signal (temperature, pressure, or humidity etc.) using a voltage-to-frequency converter, and you have to pay attention to an allowed range

a pulse wave of frequency equal to the input but of a width equal to $R1 \times C1$. Should the frequency go higher than f_{min} ($1/R2 \times C2$) the output of IC1b will be continuously retriggered giving a high on pin 10 for the duration of the input signal and for a short time until IC1a resets itself. If the frequency is lower than f_{min} , the output of IC1b will be a pulse wave of frequency equal to the input but of pulse width equal to $R2 \times C2$.

although there is no limit on C1 and C2.

The maximum input frequency in this circuit can be in excess of 100kHz, although the accuracy of this circuit at this end of the range, and even more so at the low end, may be uncertain. For adjustment of ranges and calibration, it would be possible to replace R1 and R2 by suitable pots in series with fixed resistors of 5k or more. Continued on next page.

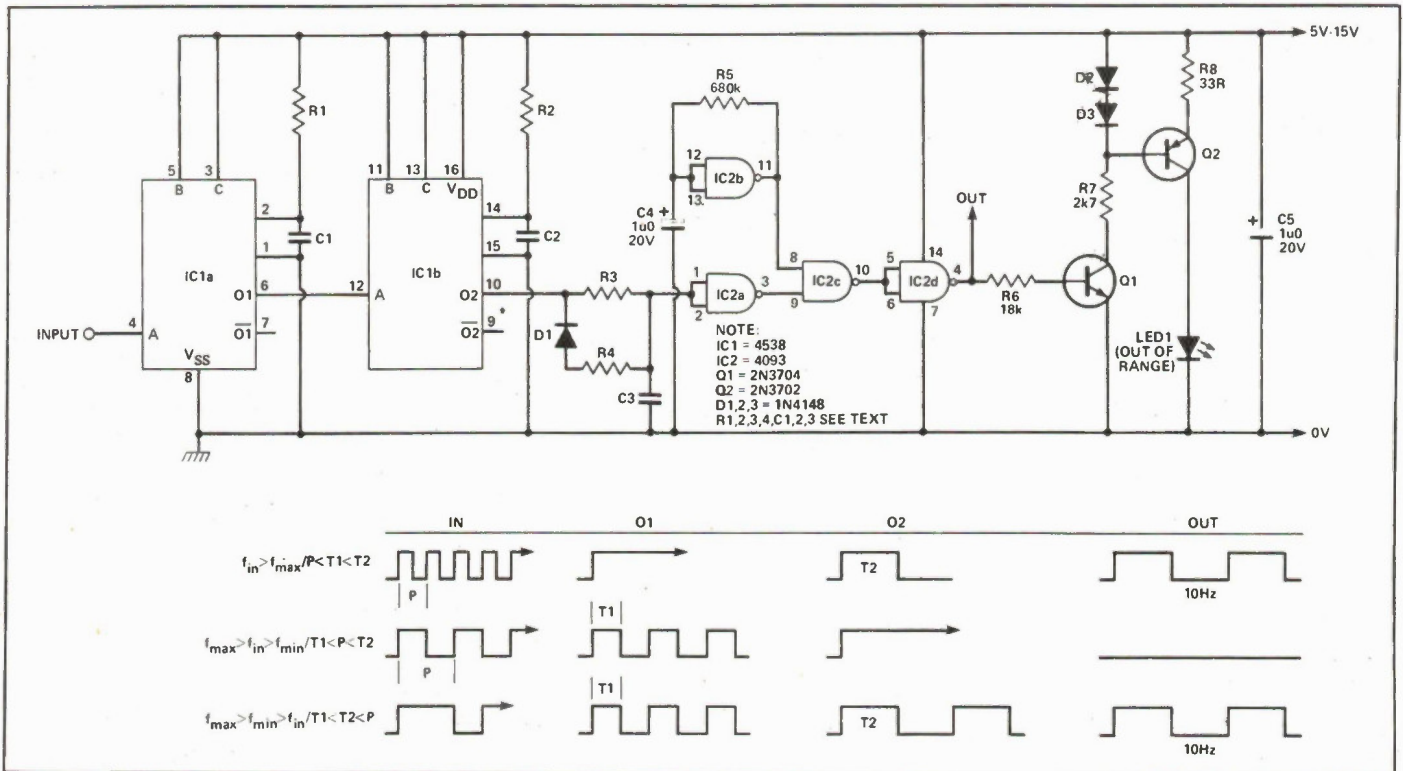

CANADA REMOTE SYSTEMS

**OFFERS YOU!
 PUBLIC DOMAIN SOFTWARE**

Canada's Largest Selection For CP/M and IBM Microcomputers

By Telephone — 11 remote Telecommunications Systems available 24 hours per day. Annual Access charge only \$35. No charge for downloading. For CP/M and IBM type microcomputers. Data Pac available.

By Mail — for over 200 different Computers. Over 1000 disks representing all major user groups including SIG/M and PCSIG. From \$10.00 per user group disk. Our special collection disks contain the most popular software and are priced from \$15 per disk.

COMMERCIAL SOFTWARE

Specializing in CP/M and IBM commercial software, Low overhead, low prices, good service. We work with what we sell, and provide full assistance.

COMMERCIAL HARDWARE

Including coprocessor boards for CP/M computers and a full line of modems. The new 2400 Baud U.S. Robotics Courier Modem is now available for only \$825.00

Call us at (416) 239-2835 or Circle Reader Service Number 8 for a free mini-catalog.



Circle No. 34 on Reader Service Card.

DEALERS/OEMS Add Value to Your IBM™ Build Your Own PC/XT COMPATIBLE

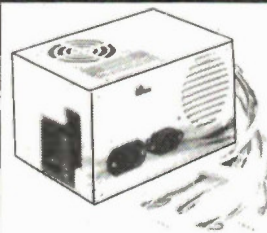

**CPS-1130M 130 WATT
 SIDE SWITCHING
 POWER SUPPLY**

- Direct Replacement for IBM™ 63.5 Watt
- CSA PENDING

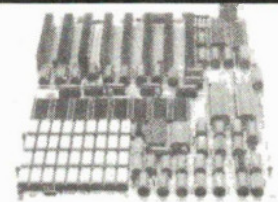

XT COMPATIBLE MOTHER BOARD

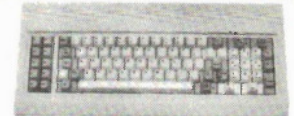

**NEW
 UNITECH K-150L KEYBOARD**

"IBM SELECTRIC TYPEWRITER compatible Layout"
 IBM is a registered Trademark of IBM
 Canada Ltd.

DELTA TECHNOLOGIES

- IBM™ PERIPHERAL CARDS**
- FLOPPY DRIVE CONTROLLER
 - MONO GRAPHICS/W PARALLEL
 - COLOUR GRAPHICS • SERIAL
 - PARALLEL • 256/512 RAM
 - 384K MULTIFUNCTION
 - JOYSTICK - MONOCHROME



IN HOUSE TECHNICAL SUPPORT 90 DAY WARRANTY ON ALL PRODUCTS

BUDGETRON IMPORTER DISTRIBUTOR INC.

1320 Shawson Drive, Unit 1, Mississauga, Ontario, Canada L4W 1C3
 Telephone (416) 673-7800 TELEX 06-968080

Circle No. 48 on Reader Service Card

HELP SAVE RICK'S BACK!

Rick works in our Reader Service Department, dealing with the mail, filling book orders, packaging software, just generally the great unsung hero of the company.

Recently, the Management decided to move the permanent stock room to other quarters, necessitating Rick having to hump large numbers of boxes containing back issues of all five of our magazines from Point A to Point B.

In an attempt to save Rick's back and reduce the volume required in the new storage area, Management has been persuaded to have a sale of back issues of Electronics Today for a limited time only.

The deal is this: Back issues listed on our order form are available at \$20.00 for 10, or \$15.00 for five, including postage and handling (Ontario residents add 7% sales tax). Bundles may be mix and match, limited only by availability.

List the back issues shown on the order form (it wouldn't hurt to add some substitutes just in case) and send with payment (including applicable sales tax) to:

Back Issues
Moorshead Publications,
 Suite 601, 25 Overlea Blvd.,
 Toronto, Ontario M4H 1B1

Moorshead Publications Order Form

Subscriptions:

Please complete reverse side of order form to start or renew a subscription.

Back Issues: \$4.00 each; Ontario residents add 7% sales tax.
 Please circle Issues desired.

1977	February					July
1978	April	May	September	November	December	
1979	February	March	April	May	July	
	August	September	October	November		
1980	January	February	May	June	November	December
1981	January	February	March	April	June	July
	August	September	October	November	December	
1982	January	March	April	May	June	
	July	August	September	October	November	December
1983	January	February	March	April	May	June
	August	September	October	November	December	
1984	January	February	March	April	May	June
	July	August	October	November	December	
1985	January	February	March	April	May	June

On the following items please add \$1.00 for postage and handling plus 7% Ontario provincial sales tax.

Special Publications:

ITEM	QTY	AMOUNT
Hobby Projects \$3.95	\$
Electronic Circuit Design \$3.95	\$
Projects Book No. 2 \$3.95	\$
Personal Computer Guide \$3.95	\$
50 Top Projects \$4.95	\$
Your First Computer \$3.95	\$
Computers in Small Business \$3.95	\$

Binders: Electronics Today; Computing Now!
 Moorshead Publications
 \$9.75 each plus 7% P.S.T.

BOOKSHELF ORDER FORM

Code (e.g. BP12)	Title (Short-form is O.K.)	Price
.....	\$
.....	\$
.....	\$
.....	\$
.....	\$

SOFTWARE ORDER FORM

.....	\$
.....	\$
.....	\$
.....	\$
Sub Total	\$
Tax (Ontario Residents)	\$
Postage	\$
Total Enclosed	\$

Orders from the Bookshelf are tax exempt. Please add \$1.00 for postage. Remember to put your name and address on reverse side. See over for mailing details.

Do you currently subscribe to Electronics Today Yes No Computing Now! Yes No Computers In Education Yes No Software Now Yes No

BE SURE OF YOUR ISSUE EACH MONTH. SUBSCRIBE TODAY.



BOOKS, BACK ISSUES, SPECIAL PUBLICATIONS, BINDERS — SEE OVER

Moorshead Publications

Suite 601, Overlea Blvd., Toronto, Ontario M4H 1B1.

MERCHANDISE ORDER Please fill out, form overleaf

SUBSCRIPTIONS: NEW SUBSCRIPTION RENEWAL

Electronics Today

One year (12 issues) **\$19.95** Two years (24 issues) **\$34.95.**

Computing Now!

One year (12 issues) **\$22.95** Two years (24 issues) **\$37.95**

Computers in Education

One year (10 issues) **\$25.00** Two years (20 issues) **\$45.00**

Software Now!

One year (12 issues) **\$19.95** Two years (24 issues) **\$34.95**

For U.S. please add \$3.00 per year other countries add \$5 per year

NAME _____

ADDRESS _____

TOWN/CITY _____ PROVINCE/STATE _____

CODE _____ DATE _____

POSTAL CODE _____

Cheque enclosed DO NOT send cash

Mastercard Account No. _____

Visa Account No. _____

American Express Account No. _____

Expiry Date _____

Signature _____

THE ELECTRONICS TODAY RADIO DISGUISER/MAGAZINE BINDER



When you're on a secret surveillance mission, you can't very well stick your walkie-talkie up to your ear and send a report when you're surrounded by bikers. The Electronics Today Radio Disguiser/Magazine Binder lets you look real cool while you talk to headquarters.

When you get home, you can then use it to store 12 issues of Electronics Today without cutting or punching. Available with Moorshead Publications or Electronics Today imprint (please specify).

You'll be the best-read, best-disguised surveillance officer in the district, and your magazines copies will be organized for easy future reference. Oh, yes, one more thing. When you're on a stake-out, don't forget to take off your hat.

Binders are \$9.75 each; Ontario residents please add 7% sales tax. Send to:

Binder,
Moorshead Publications,
 Suite 601, 25 Overlea Blvd.,
 Toronto, Ontario M4H 1B1

MICRO-CAP II

Electronic circuit analysis software available for the IBM PC, Apple and HP 150. Draw a circuit from its library of components and test away.

By Brian Greiner

UNTIL recently, most of the design packages for personal computers concentrated on graphics applications, such as drafting. However, a few very clever people have begun to develop design packages for such things as electronics. MICRO-CAP II is one such package. In brief, it is an interactive analog circuit design and analysis tool. The user draws the circuit on the screen, then the software calculates how the circuit will behave under different circumstances. The types of analysis types available include Fourier, transient, AC, and DC. The results can be displayed as either a graph or a table of numbers.

From the command viewpoint, MICRO-CAP is a menu-driven program.

The command options are summarized on a single line at the top of the screen. The first menu, the designer module, is the primary menu that allows the user to draw circuits, save and retrieve them from disk, manage the component library, and select the analysis option. Each major option then offers a menu of commands. As with the first menu, the commands are displayed at the top of the screen, making them easy to see while not cluttering up the work space.

The Grand Design

Drawing a circuit is surprisingly easy, I found. The user simply moves the cursor to the desired location, presses "E" to give the "enter a component" command, then responds to the prompts for component type, direction, reflection, and parameter. The software then draws the symbol for the component with the requested direction and reflection, with the parameter typed neatly nearby. The reflection option specifies that the component symbol is to be drawn as though it

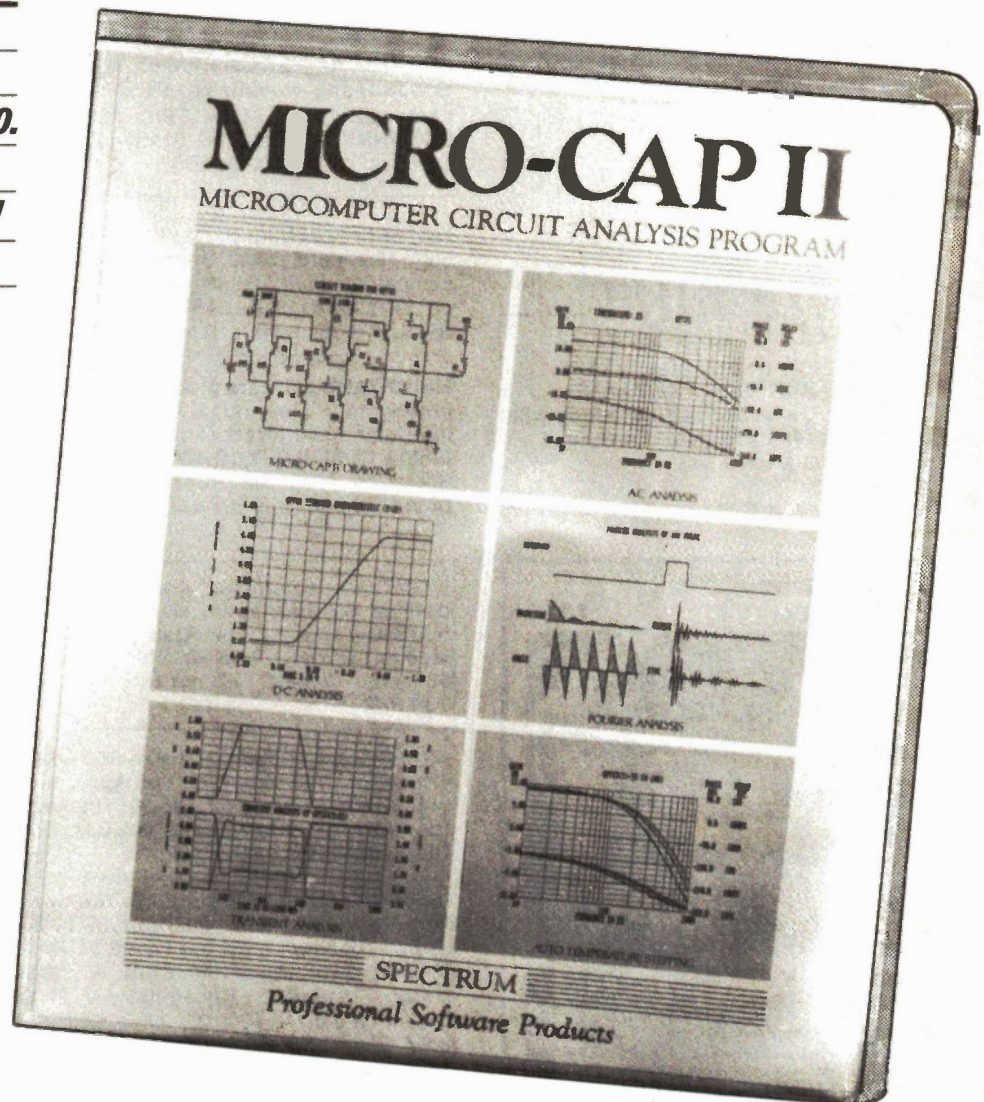

were reflected in a mirror. The "mirror" can be specified to lie along the x-axis, y-axis, or not exist. This allows more flexibility in orienting the position of the symbol, and is really quite useful.

The parameter option simply defines the component type more exactly. For example, a resistor's parameter would be the resistance in ohms, a capacitor's parameter would be expressed in farads, and so forth. These component values can be expressed in commonly-used multipliers, e.g., 9Meg for a 9 megohm resistor, 10uF for a 10 microfarad

capacitor, and so on. The component types are chosen from a library, and include batteries (10), resistors (150), capacitors (150), inductors (50), user-defined sources (1), switches (50), transmission lines (5), diodes (100), bipolar transistors (50), transformers (25), MOS devices (50), op amps (30), sinusoidal voltage sources (10), programmable voltage sources (10), and polynomial sources (25). The numbers in the brackets refer to the maximum number of that component that a circuit may have.

Product Mart *Where Buyers Find Sellers*

MPF III Apple IIe Compatible \$1395.00 64K Slim Drive, Z80 Printer Card, 80 Columns Amber or Green Monitor, Shipping \$10.00. Send SASS for catalog. **RAITRONIC'S**, 6650 Ross St., Vancouver, B.C. V5X 4B2.

CENTRONICS printer extension cords. Add up to 30 feet between your existing cable and printer. Cable comes with male and female centronics-type plugs. \$45.00 + \$3.00/foot over 10 feet. **PARALLEL EXTENSION COMPANY** P.O. Box 2636 Prince George, B.C. V2N 4T5 (604) 563-3962.

HOBBIT ELECTRONIQUE

**WE DON'T SELL COMPUTERS.
WE JUST SELL THE PARTS!**

Send your name and address along with \$1.00 to: 7454 Langelier, St. Leonard Montreal, Que. H1S 3A7.
Tel: (514) 259-5581.

Projects Book No. 2
100 pages

\$3.95

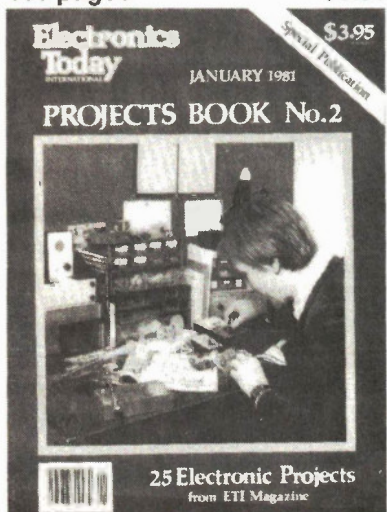

Twenty-five of the best projects from recent issues including the High Performance Series 4000 Amplifier (including Preamp and Power Supply), Rumble Filter, Dynamic Noise Filter, Logic Probe, Cable Tester, Function Generator, Rain Alarm, Digital Tacho, Two Octave Organ, Light Chaser, Shutter Speed Timer, Ni-Cad Charger and more. First published January 1981.

ORDER TODAY FROM
Moorshead Publications, 25 Overlea Boulevard
Toronto, Ont. M4H 1B1 (416) 423-3262
Postage and Handling included.
Credit Card payment accepted

INCREDIBLE Savings EPROMS 2732 (NEC) - \$4.50, 2764 (Toshiba) - \$4.00 27128 (Fuji) - \$6.00. Guaranteed first rate. **G.B. ELECTRONICS**, 206-6414 Travois Place, N.W., Calgary, Alberta T2K 3T2. Add \$2.50 shipping.

TECHNICAL BOOKS. Metalworking, woodworking, electronics, plans, science. Large catalogue \$1.00. **ERIC KEATS & COMPANY**, P.O. Box 796, Station A, Scarborough, Ontario, M1K 5C8.

TS2068 or Spectrum compatible disk drive controller card. Uses Shugart SA455 or compatible drive. 160 KB per disk, 2K DOS on EPROM \$119.95 **LARKEN ELECTRONICS**, R.R. #2, Navan, Ontario K4B 1H9.

HARDWARE/software product design and prototyping. Mainframe communication interfacing and protocol conversion. **THE LISMA COMPUTER CORPORATION**, 4865 Sheppard Ave., East, Scarborough, Ontario M1S 3V8 (416) 297-0287.

EXCITING scientific and electronic devices you can build. Many fascinating plans and kits available. Catalogue \$2.00. Mail order only. **DUKER ENTERPRISES** 8307-160 Street, Edmonton, Alberta T5R 2H2.

APPLE Software Rental. The Pacific Apple Computer Club lists over 600 Apple programs. Most rentals only \$6.00. You keep the disk. For catalog write **P.A.C.C.** Box 25, Point Roberts WA., 98281.

INSTRUMENTS FOR SALE: 2-(U) Tektronix type 105 square wave generator - \$150.00 each, 1-(U) Hewlett Packard 410B VTVM - \$175.00, 1-(U) Ballantine 310B AC Volt Meter - \$100.00, 1-(U) Honeywell 2703 Potentiometer - \$200.00, 1-(U) Kelthley 600A Electrometer - \$250.00, 1-(U) Bliley 100KC frequency standard - \$100.00, 4-(N) Triplett 3525 Digi-Probe (DMM) - \$69.00 each, 1-(N) Triplett 4000 Bench DMM - \$199.00, 1-(N) Triplett 7000 Universal Counter - \$299.00, 1-(N) Triplett 3500 DMM - \$114.00, 1-(U) Ballantine 420 AC/DC calibrator - \$200.00. CODE: (U) Used/in Working Order, 30 Day Warranty. (N) New (Demo Equipment) 90 Day Warranty. **BRUNELLE INSTRUMENTS INC.**, 73 - 6th Range South, St. Elie D'Orford, Quebec, JOB 2S0, 1-819-563-9096.

FREE samples when you order our wholesale parts catalogue. Send \$5.00 to cover postage and handling to: **MISTER RESISTOR ELECTRONIC WHOLESALE** 2203 1st Avenue N. Saskatoon, Sask. S7K 2A4 Dept. E.T.

FOR \$10 per kit \$2 handling, receive free flyer and any of the following. #1: 1000 asst'd pcs choke - capacitor - resistor - transistor - hardware - etc. #2: 200 asst'd ceramic - #3: 100 asst'd silver mica - #4: 100 asst'd mylar - #5: 50 asst'd tantalum - #6: 50 asst'd electrolytic - #7: 50 asst'd feed-through - #8: 50 asst'd metallic silver mica (Elmenco) #9: 25 asst'd variable - #10: 100 asst'd 5MM L.E.D. - #11: 100 asst'd i/c sockets - #12: 6 AA nicad batteries - #13: 15 PL-259 connectors - #14: 10 UG88 connectors - #15: 10 asst'd Lorlin switch. All new material. Unconditional guarantee. **SURPLUS ELECTRO QUEBEC**, 2264 Montee Gagnon, Blainville, Quebec J7E 4H5.

**DO SMALL
ADVERTISEMENTS
ATTRACT ATTENTION?
WELL, THIS ONE DID!**

PRODUCT MART

For Insertion Call:
(416) 423-3262

CERESIST, the guaranteed line of dry transfers for direct etching of PCBs (also for layouts on mylar film etc.) comes in over 65 patterns, including 1:1 and 2:1 scale - Alphanumerics and Schematic Symbols too. 1-of-a-kind and assortment packages available. Send stamp for free catalog w/sample, or \$3 for our SP-6 Hobby Pak with 100s of symbols. Mailing address only: **CERES**, 866 Bloor St. W., Toronto, M6G 1M5.

J&J ELECTRONICS LTD., Box 1437E, Winnipeg Manitoba R3C 2Z4. Surplus and Semiconductor Specialists. Do you get our bargain flyer? Send \$1.00 to receive the current literature and specials and to be placed on the mailing list for future publications.

Electronics Today September 1985

**MOORSHEAD
PUBLICATIONS
READER OFFER**

**ZX81 & TS1000 EXPANSION
50% OFF**

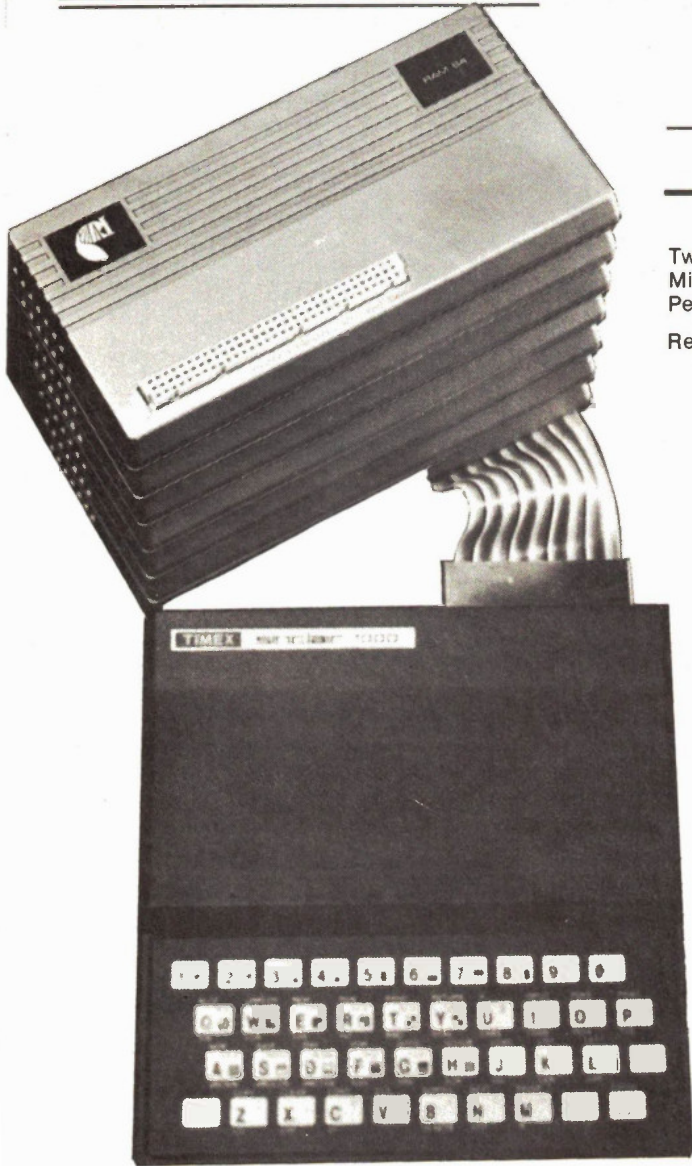

SYSTEM #1

32K — includes

Two 16K RAM Modules
Minimap Bank switching module
Persona Interface module

Reg. \$300.00 **\$149.95**

SYSTEM #2

128K — includes

Two 64K RAM Modules
Minimap Bank switching module
Persona Interface module

Reg \$540.00 **\$269.95**

These systems can be further expanded by the addition of any of the following modules:

SONUS: Three voice music & sound synthesizer with independent envelope control under BASIC commands. Reg. \$79.95
READER OFFER \$39.95

2K DROM: Ultra-low-power memory backed by a rechargeable battery for non-volatile storage of programmes and data. Use it, for example, to "instant start" any short routine in regular use. Reg. \$99.95
READER OFFER \$49.95.

PERICON B: Peripheral controller device provides 24 lines of heavy duty output to access and control the outside world. For example: robotics, motor switching, relays etc. Reg. \$69.95
READER OFFER \$34.95

PERICON C: Peripheral controller to drive an 80 column printer with standard Centronics type parallel interface. Reg. \$89.95
READER OFFER \$44.95



Take advantage of this time/limited quantity **SPECIAL READER OFFER!**

BASICare modules are what is required to turn any Timex Sinclair into a serious computer for business, education, industrial, and hobby applications. In order to open the door to this exciting new world of expansions you require a Persona module. It simply (and firmly) plugs into your computer. No soldering. No modifications of any sort!

BASICare uses a unique 64 way Organic Bus. This bus is the pathway to all modules. You have **INSTANT** access to all modules simply and easily through the PEEK and POKE commands.

Memory can be added **AS REQUIRED** in blocks of 16K or 64K up to one MEGABYTE. This is memory that is **INSTANTLY AVAILABLE**. This is unlike any other system available for home computer and compares in capability to multi-tasking systems costing thousands of dollars!

MAIL TO:

MOORSHEAD PUBLICATIONS

25 Overlea Boulevard, Suite 601,
Toronto, Ontario M4H 1B1
(416) 423-3262

Name _____

Address _____

City _____ Province _____

Post Code _____ Telephone _____

Please send:

- System # 1 \$149.95
- System # 2 \$269.95
- Sonus Music & Sound Synth \$ 39.95
- 2K DROM \$ 49.95
- Pericon B \$ 34.95
- Pericon C \$ 44.95

Add \$5.00 per order shipping. Ontario residents add 7% p.s.t.

Imported from England and exclusively available in Canada from Moorshead Publications.

BP153: PRACTICAL ELECTRONICS CALCULATIONS AND FORMULAE \$11.75
A book that bridges the gap between complicated technical theory and the 'cut and try' method. A good reference book.

BP136: 25 SIMPLE INDOOR AND WINDOW AERIALS \$6.65
People living in apartments who would like to improve short-wave listening can benefit from these instructions on optimising the indoor aerial.

BP147: AN INTRODUCTION TO 6502 MACHINE CODE \$7.75
The popular 6502 microprocessor is used in many home computers, this is a guide to beginning assembly language.

BP150: AN INTRO. TO PROGRAMMING THE SINCLAIR QL \$7.75
Helps the reader make the best use of the Sinclair QL's almost unlimited range of features. Complements the manufacturer's handbook.

BP225: A PRACTICAL INTRODUCTION TO DIGITAL ICs \$6.65
This book deals mainly with TTL type chips such as the 7400 series. Simple projects and a complete practical construction of a Logic Test Circuit Set are included as well as details for a more complicated Digital Counter Timer project.

BP130: MICRO INTERFACING CIRCUITS - BOOK 1 \$8.55
Aimed at those who have some previous knowledge of electronics, but not necessarily an extensive one, the basis of the book is to help the individual understand the principles of interfacing circuits to microprocessor equipment.

BP131: MICRO INTERFACING CIRCUITS - BOOK 2 \$8.55
Intended to carry on from Book 1, this book deals with practical applications beyond the parallel and serial interface. "Real world" interfacing such as sound and speech generators, temperature and optical sensors, and motor controls are discussed using practical circuit descriptions.

BP111: AUDIO \$13.25
This one is ideal for readers who want to really get into sound. A wide range of material is covered from analysis of the sound wave, mechanisms of hearing, room acoustics, microphones and loudspeakers, amplifiers, and magnetic disc recording.

BP82: ELECTRONIC PROJECTS USING SOLAR CELLS \$7.75
A collection of simple circuits which have applications in and around the home using the energy of the sun to power them. The book deals with practical solar power supplies including voltage doubler and tripler circuits, as well as a number of projects.

BP156: AN INTRODUCTION TO QL MACHINE CODE \$7.75
The powerful Sinclair QL microcomputer has some outstanding capabilities in terms of its internal structure. With a 32-bit architecture, the QL has a large address range, advanced instructions which include multiplication and division. These features give the budding machine code programmer a good start at advanced programming methods. This book assumes no previous knowledge of either the 68008 or machine code programming.

BP47: MOBILE DISCOTHEQUE HANDBOOK \$5.25
Divided into six parts, this book covers such areas of mobile "disco" as: Basic Electricity, Audio, Ancillary Equipment, Cables and Plugs, Loudspeakers, and Lighting. All the information has been considerably sub-divided for quick and easy reference.

BP59: SECOND BOOK OF CMOS IC PROJECTS \$7.75
This book carries on from its predecessor and provides a further selection of useful circuits, mainly of a simple nature, the book will be well within the capabilities of the beginner and more advanced constructor.

BP32: HOW TO BUILD YOUR OWN METAL & TREASURE LOCATORS \$7.75
Several fascinating applications with complete electronic and practical details on the simple, and inexpensive construction of Heterodyne Metal Locators.

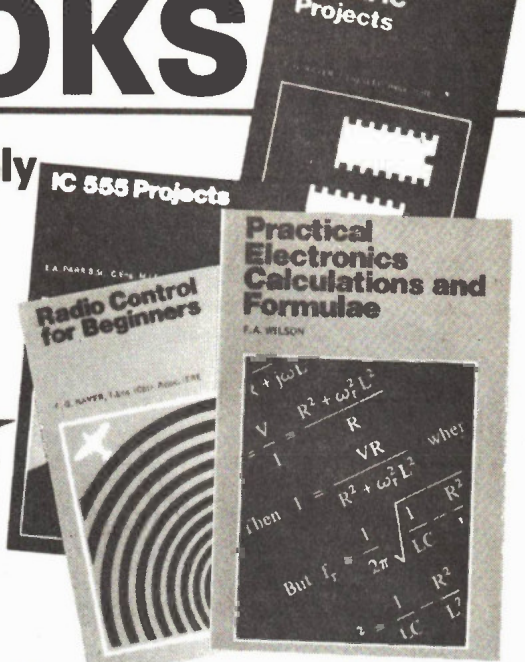

ELECTRONIC THEORY

ELEMENTS OF ELECTRONICS - AN ON-GOING SERIES

F.A. WILSON, C.G.I.A., C.Eng.

BP62: BOOK 1. The Simple Electronic Circuit and Components \$11.70

BP63: BOOK 2. Alternating Current Theory \$ 8.55

BP64: BOOK 3. Semiconductor Technology \$18.55

BP77: BOOK 4. Microprocessing Systems and Circuits \$11.70

BP89: BOOK 5. Communication \$11.70

The aim of this series of books can be stated quite simply - it is to provide an inexpensive introduction to modern electronics so that the reader will start on the right road by thoroughly understanding the fundamental principles involved.

Although written especially for readers with no more than ordinary arithmetical skills, the use of mathematics is not avoided, and all the mathematics required is taught as the reader progresses.

Each book is a complete treatise of a particular branch of the subject and, therefore, can be used on its own with one proviso, that the later books do not duplicate material from their predecessors, thus a working knowledge of the subjects covered by the earlier books is assumed.

BOOK 1 This book contains all the fundamental theory necessary to lead to a full understanding of the simple electronic circuit and its main components.

BOOK 2 This book continues with alternating current theory without which there can be no comprehension of speech, music, radio, television or even the electricity utilities.

BOOK 3 Follows on semiconductor technology, leading up to transistors and integrated circuits.

BOOK 4 A complete description of the internal workings of microprocessor.

BOOK 5 A book covering the whole communication scene.

PROJECTS

BP48: ELECTRONIC PROJECTS FOR BEGINNERS \$ 7.75

F.G. RAYER, T.Eng.(CEI), Assoc.IERE

Another book written by the very experienced author - Mr F.G. Rayer - and in it the newcomer to electronics, will find a wide range of easily made projects. Also, there are a considerable number of actual component and wiring layouts, to aid the beginner.

Furthermore, a number of projects have been arranged so that they can be constructed without any need for soldering and, thus, avoid the need for a soldering iron.

Also, many of the later projects can be built along the lines as those in the 'No Soldering' section so this may considerably increase the scope of projects which the newcomer can build and use.

BP37: 50 PROJECTS USING RELAYS, SCR's & TRIACS \$ 7.75

F.G. RAYER, T.Eng.(CEI), Assoc.IERE

Relays, silicon controlled rectifiers (SCR's) and bi-directional triodes (TRIACS) have a wide range of applications in electronics today. This book gives tried and practical working circuits which should present the minimum of difficulty for the enthusiast to construct. In most of the circuits there is a wide latitude in component values and types, allowing easy modification of circuits or ready adaptation of them to individual needs.

BP221: 2B TESTED TRANSISTOR PROJECTS \$5.00
R. TORRENS

Mr Richard Torrens is a well experienced electronics development engineer and has designed, developed, built and tested the many useful and interesting circuits included in this book. The projects themselves can be split down into simpler building blocks, which are shown separated by boxes in the circuits for ease of description, and also to enable any reader who wishes to combine boxes from different projects to realise ideas of his own.

BP71: ELECTRONIC HOUSEHOLD PROJECTS \$7.20

R. A. PENFOLD

Some of the most useful and popular electronic construction projects are those that can be used in or around the home. The circuits range from such things as '2 Tone Door Buzzer', Intercom, through Smoke or Gas Detectors to Baby and Freezer Alarms.

BP73: REMOTE CONTROL PROJECTS \$8.10

OWEN BISHOP

This book is aimed primarily at the electronics enthusiast who wishes to experiment with remote control. Full explanations have been given so that the reader can fully understand how the circuits work and can more easily see how to modify them for other purposes, depending on personal requirements. Not only are radio control systems considered but also infra-red, visible light and ultrasonic systems as are the use of Logic ICs and Pulse position modulation etc.

BP90: AUDIO PROJECTS \$7.60

F.G. RAYER

Covers in detail the construction of a wide range of audio projects. The text has been divided into preamplifiers and mixers, power amplifiers, tone controls and matching and miscellaneous projects.

BP74: ELECTRONIC MUSIC PROJECTS \$7.20

R.A. PENFOLD

Although one of the more recent branches of amateur electronics, electronic music has now become extremely popular and there are many projects which fall into this category. The purpose of this book is to provide the constructor with a number of practical circuits for the less complex items of electronic music equipment, including such things as a Fuzz Box, Waa-Waa Pedal, Sustain Unit, Reverberation and Phaser Units, Tremelo Generator etc.

BP44: IC 555 PROJECTS \$ 7.75

E.A. PARR, B.Sc., C.Eng., M.I.E.E.

Every so often a device appears that is so useful that one wonders how life went on before without it. The 555 timer is such a device. Included in this book are Basic and General Circuits, Motor Car and Model Railway Circuits, Alarms and Noise Makers as well as a section on the 556, 558 and 559 timers.

BP82: ELECTRONIC PROJECTS USING SOLAR CELLS \$7.75

A book of simple circuits which have applications in and around the home and that are designed to be powered by the energy of the sun. Although, if the reader wishes, they could be powered by ordinary button cells or batteries.

BABANI BOOKS

BP49: POPULAR ELECTRONIC PROJECTS \$7.75

R.A. PENFOLD

Includes a collection of the most popular types of circuits and projects which, we feel sure, will provide a number of designs to interest most electronics constructors. The projects selected cover a very wide range and are divided into four basic types: Radio Projects, Audio Projects, Household Projects and Test Equipment.

BP94: ELECTRONIC PROJECTS FOR CARS AND BOATS

R.A. PENFOLD

Projects, fifteen in all, which use a 12V supply are the basis of this book. Included are projects on Windscreen Wiper Control, Courtesy Light Delay, Battery Monitor, Cassette Power Supply, Lights Timer, Vehicle Immobiliser, Gas and Smoke Alarm, Depth Warning and Shaver Inverter.

BP95: MODEL RAILWAY PROJECTS

R.A. PENFOLD

Electronic projects for model railways are fairly recent and have made possible an amazing degree of realism. The projects covered include controllers, signals and sound effects. Striboard layouts are provided for each project.

BP93: ELECTRONIC TIMER PROJECTS

F.G. RAYER

Windscreen wiper delay, darkroom timer and metronome projects are included. Some of the more complex circuits are made up from simpler sub-circuits which are dealt with individually.

BP113: 30 Solderless Breadboard Projects-Book 2

R.A. PENFOLD

A companion to BP107. Describes a variety of projects that can be built on plug-in breadboards using CMOS logic IC's. Each project contains a schematic, parts list and operational notes.

BP104: Electronic Science Projects

Owen Bishop

Contains 12 electronic projects with a strong scientific flavour. Includes Simple Colour Temperature Meter, Infra-Red Laser, Electronic clock regulated by a resonating spring, a Scope with a solid state display, pH meter and electrocardiograph.

BP110: HOW TO GET YOUR ELECTRONIC PROJECTS WORKING

R.A. PENFOLD

We have all built circuits from magazines and books only to find that they did not work correctly, or at all, when first switched on. The aim of this book is to help the reader overcome just these problems by indicating how and where to start looking for many of the common faults that can occur when building up projects.

BP84: DIGITAL IC PROJECTS

F.G. RAYER, T.Eng.(CEI), Assoc. IERE

This book contains both simple and more advanced projects and it is hoped that these will be found of help to the reader developing a knowledge of the workings of digital circuits. To help the newcomer to the hobby the author has included a number of board layouts and wiring diagrams. Also the more ambitious projects can be built and tested section by section and this should help avoid or correct faults that could otherwise be troublesome. An ideal book for both beginner and more advanced enthusiast alike.

BP67: COUNTER DRIVER AND NUMERAL DISPLAY PROJECTS

F.G. RAYER, T.Eng.(CEI), Assoc. IERE

Numeral indicating devices have come very much to the forefront in recent years and will, undoubtedly, find increasing applications in all sorts of equipment. With present day integrated circuits, it is easy to count, divide and display numerically the electrical pulses obtained from a great range of driver circuits.

In this book many applications and projects using various types of numeral displays, popular counter and driver IC's etc. are considered.

BP99: MINI-MATRIX BOARD PROJECTS

R.A. PENFOLD

Twenty useful projects which can all be built on a 24 x 10 hole matrix board with copper strips. Includes Doorbuzzer, Low-voltage Alarm, AM Radio, Signal Generator, Projector Timer, Guitar Headphone Amp, Transistor Checker and more.

BP103: MULTI-CIRCUIT BOARD PROJECTS

R.A. PENFOLD

This book allows the reader to build 21 fairly simple electronic projects, all of which may be constructed on the same printed circuit board. Wherever possible, the same components have been used in each design so that with a relatively small number of components and hence low cost, it is possible to make any one of the projects or by re-using the components and P.C.B. all of the projects.

BP107: 30 SOLDERLESS BREADBOARD PROJECTS - BOOK 1

R.A. PENFOLD

A "Solderless Breadboard" is simply a special board on which electronic circuits can be built and tested. The components used are just plugged in and unplugged as desired. The 30 projects featured in this book have been specially designed to be built on a "Verobloc" breadboard. Wherever possible the components used are common to several projects, hence with only a modest number of reasonably inexpensive components it is possible to build, in turn, every project shown.

BP106: MODERN OP-AMP PROJECTS

R.A. PENFOLD

Features a wide range of constructional projects which make use of op-amps including low-noise, low distortion, ultra-high input impedance, high slew-rate and high output current types.

CIRCUITS

How to Design Electronic Projects

BP127

Although information on standard circuit blocks is available, there is less information on combing these circuit parts together. This title does just that. Practical examples are used and each is analysed to show what each does and how to apply this to other designs.

Audio Amplifier Construction

BP122

A wide variety of circuits is given, from low noise microphone and tape head preamps to a 100W MOSFET type. There is also the circuit for 12V bridge amp giving 18W. Circuit board or strip-board layout are included. Most of the circuits are well within the capabilities for even those with limited experience.

BP80: POPULAR ELECTRONIC CIRCUITS - BOOK 1

R.A. PENFOLD

Another book by the very popular author, Mr. R.A. Penfold, who has designed and developed a large number of various circuits. These are grouped under the following general headings: Audio Circuits, Radio Circuits, Test Gear Circuits, Music Project Circuits, Household Project Circuits and Miscellaneous Circuits.

BP98: POPULAR ELECTRONIC CIRCUITS, BOOK 2

R.A. PENFOLD

70 plus circuits based on modern components aimed at those with some experience.

BP39: 50 (FET) FIELD EFFECT TRANSISTOR PROJECTS

F.G. RAYER, T.Eng.(CEI), Assoc. IERE

Field effect transistors (FETs) find application in a wide variety of circuits. The projects described here include radio frequency amplifiers and converters, test equipment and receiver aids, tuners, receivers, mixers and tone controls, as well as various miscellaneous devices which are useful in the home.

This book contains something of particular interest for every class of enthusiast - short wave listener, radio amateur, experimenter or audio devotee.

BP87: SIMPLE L.E.D. CIRCUITS

R.N. SOAR

Since it first appeared in 1977, Mr. R.N. Soar's book has proved very popular. The author has developed a further range of circuits and these are included in Book 2. Projects include a Transistor Tester, Various Voltage Regulators, Testers and so on.

BP24: 50 PROJECTS USING IC 741

RUDI & UWE REDMER

A unique book containing 52 different projects that can be simply constructed using the 741 op amp and a few components. Originally published in Germany, this book will be an valuable asset to any hobbyist.

BP88: HOW TO USE OP AMPS

E.A. PARR

A designer's guide covering several op amps, serving as a source book of circuits and a reference book for design calculations. The approach has been made as non-mathematical as possible.

BP65: SINGLE IC PROJECTS

R.A. PENFOLD

There is now a vast range of ICs available to the amateur market, the majority of which are not necessarily designed for use in a single application and can offer unlimited possibilities. All the projects contained in this book are simple to construct and are based on a single IC. A few projects employ one or two transistors in addition to an IC but in most cases the IC is the only active device used.

223: 50 PROJECTS USING IC CA3130

R.A. PENFOLD

In this book, the author has designed and developed a number of interesting and useful projects which are divided into five general categories: I - Audio Projects II - R.F. Projects III - Test Equipment IV - Household Projects V - Miscellaneous Projects.

BP117: PRACTICAL ELECTRONIC BUILDING BLOCKS BOOK 1

R.A. PENFOLD

Virtually any electronic circuit will be found to consist of a number of distinct stages when analysed. Some circuits inevitably have unusual stages using specialised circuitry, but in most cases circuits are built up from building blocks of standard types.

This book is designed to aid electronics enthusiasts who like to experiment with circuits and produce their own projects rather than simply follow published project designs.

The circuits for a number of useful building blocks are included in this book. Where relevant, details of how to change the parameters of each circuit are given so that they can easily be modified to suit individual requirements.

BP102: THE 6809 COMPANION

R.A. PENFOLD

Written for machine language programmers who want to expand their knowledge of microprocessors. Outlines history, architecture, addressing modes, and the instruction set of the 6809 microprocessor. The book also covers such topics as converting programs from the 6800, program style, and specifics of 6809 hardware and software availability.

BP118: PRACTICAL ELECTRONIC BUILDING BLOCKS - BOOK 2

R.A. PENFOLD

This sequel to BP117 is written to help the reader create and experiment with his own circuits by combining standard type circuit building blocks. Circuits concerned with generating signals were covered in Book 1, this one deals with processing signals. Amplifiers and filters account for most of the book but comparators, Schmitt triggers and other circuits are covered.

BP24: 50 PROJECTS USING IC 741

RUDI & UWE REDMER

This book, originally published in Germany by TOPP, has achieved phenomenal sales on the Continent and Babani decided, in view of the fact that the integrated circuit used in this book is inexpensive to buy, to make this unique book available to the English speaking reader. Translated from the original German with copious notes, data and circuitry, a "must" for everyone whatever their interest in electronics.

BP83: VMOS PROJECTS

R.A. PENFOLD

Although modern bipolar power transistors give excellent results in a wide range of applications, they are not without their drawbacks or limitations. This book will primarily be concerned with VMOS power FETs although power MOSFETs will be dealt with in the chapter on audio circuits. A number of varied and interesting projects are covered under the main headings of: Audio Circuits, Sound Generator Circuits, DC Control Circuits and Signal Control Circuits.

RADIO AND COMMUNICATIONS

BP96: CB PROJECTS

R.A. PENFOLD

Projects include speech processor, aerial booster, cordless mike, aerial and harmonic filters, field strength meter, power supply, CB receiver and more.

222: SOLID STATE SHORT WAVE RECEIVERS FOR BEGINNERS

R.A. PENFOLD

In this book, R.A. Penfold has designed and developed several modern solid state short wave receiver circuits that will give a fairly high level of performance, despite the fact that they use only relatively few and inexpensive components.

BP91: AN INTRODUCTION TO RADIO DXing

R.A. PENFOLD

This book is divided into two main sections one to amateur band reception, the other to broadcast bands. Advice is given to suitable equipment and techniques. A number of related constructional projects are described.

BP105: AERIAL PROJECTS

R.A. PENFOLD

The subject of aerials is vast but in this book the author has considered practical designs including active, loop and ferrite aerials, which give good performances and are reasonably simple and inexpensive to build. The complex theory and math of aerial design are avoided.

BABANI BOOKS

BP125: 25 Simple Amateur Band Aerials
E.M. NOLL \$7.60
Starting from simple dipoles through beam, triangle and even mini-rhombics (made from TV masts and 400ft of wire) this title describes several simple and inexpensive aerials to construct yourself. A complete set of dimension table are included.

BP92: ELECTRONICS SIMPLIFIED—CRYSTAL SET CONSTRUCTION
F.A. WILSON \$6.80
Aimed at those who want to get into construction without much theoretical study. Homewound coils are used and all projects are very inexpensive to build.

BP70: TRANSISTOR RADIO FAULT-FINDING CHART
CHAS. E. MILLER \$2.50
Across the top of the chart will be found four rectangles containing brief descriptions of various faults; viz: — sound weak but undistorted, set dead, sound low or distorted and background noises. One then selects the most appropriate of these and following the arrows, carries out the suggested checks in sequence until the fault is cleared.

BP79: RADIO CONTROL FOR BEGINNERS
F.G. RAYER, T.Eng.(CEI), Assoc. IERE. \$6.80
The aim of this book is to act as an introduction to Radio Control for beginners to the hobby. The book will commence by dealing with the conditions that are allowable for such things as frequency and power of transmission. This is followed by a "block" explanation of how control-device and transmitter operate and receiver and actuator(s) produce motion in a model.

Details are then given of actual solid state transmitting equipment which the reader can build. Plain and loaded aerials are then discussed and so is the field-strength meter to help with proper setting up.

The radio receiving equipment is then dealt with which includes a simple receiver and also a crystal controlled superhet. The book ends with the electro-mechanical means of obtaining movement of the controls of the model.

AUDIO

BP51: ELECTRONIC MUSIC AND CREATIVE TAPE RECORDING
M.K. BERRY \$7.75
Electronic music is the new music of the Twentieth Century. It plays a large part in "pop" and "rock" music and, in fact, there is scarcely a group without some sort of synthesiser or other effects generator.

This book sets out to show how electronic music can be made at home with the simplest and most inexpensive of equipment. It then describes how the sounds are generated and how these may be recorded to build up the final composition.

BP81: ELECTRONIC SYNTHESISER PROJECTS
M.K. BERRY \$6.80
One of the most fascinating and rewarding applications of electronics is in electronic music and there is hardly a group today without some sort of synthesiser or effects generator. Although an electronic synthesiser is quite a complex piece of electronic equipment, it can be broken down into much simpler units which may be built individually and these can then be used or assembled together to make a complete instrument.

TEST EQUIPMENT

BP75: ELECTRONIC TEST EQUIPMENT CONSTRUCTION
F.G. RAYER, T.Eng. (CEI), Assoc. IERE \$6.80
This book covers in detail the construction of a wide range of test equipment for both the Electronics Hobbyists and Radio Amateur. Included are projects ranging from an FET Amplified Voltmeter and Resistance Bridge to a Field Strength Indicator and Heterodyne Frequency Meter. Not only can the home constructor enjoy building the equipment but the finished projects can also be usefully utilised in the furtherance of his hobby.

REFERENCE

BP114: THE ART OF PROGRAMMING THE 16K ZX81
\$9.90

A sequel to BP109, The Art of Programming The 1K ZX81, this book outlines how to best use the 16K RAM pack and ZX printer. Topics include: usage of the extra storage space, creating a memory test program, utilities, games, cassette storage, and much more.

BP109: THE ART OF PROGRAMMING THE 1K ZX81
\$7.60

This book shows the best methods for using the features of the ZX81 to create programs for the 1K machine. Topics such as graphics, random number generation, PEEKs and POKEs, and character string handling are discussed.

BP85: INTERNATIONAL TRANSISTOR EQUIVALENTS GUIDE
ADRIAN MICHAELS \$11.75

This book will help the reader to find possible substitutes for a popular user-orientated selection of modern transistors. Also shown are the material type, polarity, manufacturer selection of modern transistors. Also shown are the material type, polarity, manufacturer and use. The Equivalents are sub-divided into European, American and Japanese. The products of over 100 manufacturers are included. An essential addition to the library of all those interested in electronics, be they technicians, designers, engineers or hobbyists. Fantastic value for the amount of information it contains.

BP108: INTERNATIONAL DIODE EQUIVALENTS GUIDE
ADRIAN MICHAELS \$8.95

This book is designed to help the user in finding possible substitutes for a large user orientated selection of the many different types of semiconductor diodes that are available today. Besides simple rectifier diodes also included are Zener diodes, LEDs, Diacs Triacs, Thyristors, Photo diodes and Display diodes.

BP1: FIRST BOOK OF TRANSISTOR EQUIVALENTS AND SUBSTITUTES
B.B. BABANI \$5.75

This guide covers many thousands of transistors showing possible alternatives and equivalents. Covers transistors made in Great Britain, USA, Japan, Germany, France, Europe, Hong Kong, and includes types produced by more than 120 different manufacturers.

BP14: SECOND BOOK OF TRANSISTOR EQUIVALENTS AND SUBSTITUTES
B.B. BABANI \$6.75

The "First Book of Transistor Equivalents" has had to be reprinted 15 times. The "Second Book" produced in the same style as the first book, in no way duplicates any of the data presented in it. The "Second Book" contains only additional material and the two books complement each other and make available some of the most complete and extensive information in this field. The interchangeability data covers s' miconductors manufactured in Great Britain, USA, Germany, France, Poland, Italy, East Germany, Belgium, Austria, Netherlands and many other countries.

VIDEO

BP100: AN INTRODUCTION TO VIDEO
D.K. MATHEWSON \$7.60

Presents in as non-technical a way as possible how a video recorder works and how to get the best out of it and its accessories. Among the items discussed are the pros and cons of the various systems, copying and editing, international tape exchange and understanding specifications.

MISCELLANEOUS

BP101: HOW TO IDENTIFY UNMARKED IC'S
K.H. RECORDER \$2.75

Originally published as a feature in 'Radio Electronics', this chart shows how to record the particular signature of an unmarked IC using a test meter, this information can then be used with manufacturer's data to establish the application.

BP121: How to Design and Make Your Own PCBs
R.A. Penfold \$7.60

The emphasis is on practical rather than theoretical techniques. Starts by giving simple methods of copying from magazines, carries on with photographic methods of producing PCBs and continues with layout design.

BP115: THE PRE-COMPUTER BOOK \$

Aimed at the absolute beginner with no knowledge of microcomputing, this entirely non-technical discussion of computer bits and pieces and programming will give valuable insight to those who are considering purchasing a computer or who just want to learn something about the

BP126: BASIC AND PASCAL IN PARALLEL \$

This book takes the two language BASIC and Pascal, develops programs in both languages simultaneously, emphasis is on structured programming by the systematic use of control structures; and modular program design is throughout.

BP135: SECRETS OF THE COMMODORE 64 \$

An excellent book intended as a beginner's guide to the Commodore 64. It gives masses of useful information and programming tips as well as describing how to get the best from the powerful sound and graphics facilities.

BP66: BEGINNERS GUIDE TO MICROPROCESSORS AND COMPUTING

This book is intended as an introduction to the basic theory and concepts of binary arithmetic, microprocessor operation and machine language programming.

BP72: A MICROPROCESSOR PRIMER \$

Through the use of a simple microprocessor model, this book will try to convey some of the rudimentary aspects of microprocessor control. Such ideas as Relative Address, Index Registers etc. will be developed. A glossary of microprocessor terms is included.

BP78: PRACTICAL COMPUTER EXPERIMENTS \$6

The aim of this book is to enable the reader to simply and expensively construct and examine the operation of a number of basic computer circuit elements and it is hoped gain a fuller understanding of how the mysterious computer "chip" works.

BP86: AN INTRODUCTION TO BASIC PROGRAMMING TECHNIQUES \$7

Based on the author's own experience in learning BASIC and in helping others, mostly beginners, to understand the language. Included are a library of programs, appendices containing questions and answers on each chapter, and glossary of computer terms.

BP205: FIRST BOOK OF HI-FI LOUDSPEAKER ENCLOSURES

B.B. BABANI \$3.

BP223: 50 PROJECTS USING IC CA3130

R.A. PENFOLD \$5.

BP222: SOLID STATE SHORT WAVE RECEIVERS FOR BEGINNERS

R.A. PENFOLD \$7.

OTHER PUBLISHERS

HOW TO BUILD YOUR OWN SELF PROGRAMMING ROBOT

TAB No.1241 \$13.95

A practical guide on how to build a robot capable of learning how to adapt to a changing environment. The creature developed in the book, Rodney, is fully self programming and can develop theories to deal with situations and apply those theories in future circumstances.

AUDIO AND VIDEO INTERFERENCE CURES

KAHANER \$8.95

HB21 A practical work about interference causes and cures that affect TV, radio, hi-fi, CB, and other devices. Provides all the information needed to stop interference. Schematic wiring diagrams of filters for all types of receivers and transmitters are included. Also, it supplies simple filter diagrams to eliminate radio and TV interference caused by noisy home appliances, neon lights, motors, etc.

PH247: DIGITAL TECHNIQUES

\$29.00

Covers logic circuits, Boolean Algebra, flip-flops, register, combinational logic circuitry, and digital design.

PH121: HARDWARE INTERFACING WITH THE TRS-80 Model I and Model III owners now have a book

J. UFFENBECK (1983) \$19.

help them understand how to use their personal computer to monitor and control electronics interfaces between a computer and the home or industrial environment. Contains 14 hands-on experiments using BASIC.

```

INC    C           ; INCREMENT SECOND COUNTER
LD     A,C         ; TEST IF C=6
CP     06
JR     NZ, SHAKE
LD     C,0         ; YES-RESET SECOND COUNTER
JR     SHAKE

ROLL:
LD     HL, TABLE  ; DISPLAY DICE
LD     D,0         ; POINT TO LED BIT PATTERNS
LD     E,B         ; SET D=0
ADD    HL,DE       ; GET FIRST COUNTER IN DE
LD     A,(HL)      ; ADD COUNTER TO HL TO GET PROPER BIT PATTERN
OUT    (PORTA),A   ; OUTPUT BIT PATTERN ON PORT A

LD     HL, TABLE  ; DO SAME FOR SECOND COUNTER
LD     E,C
ADD    HL,DE
LD     A,(HL)
OUT    (PORTB),A   ; OUTPUT BIT PATTERN TO PORT B

JR     WAIT       ; GO BACK TO WAIT
END
    
```

Listing 2. The software program for the digital dice.

that pattern. The software has these six bytes stored in a table in memory. To output an LED pattern to represent one face of the die, the software simply looks up the table, selects the proper hex byte, and outputs this byte on one of the two ports.

When rolling two dice there are 36 different combinations that can be rolled. When the shake button is pressed two counters start counting really fast from 1 to 6; these counters represent the six faces on the die. When the roll button is pressed the counters stop and LED bit patterns are output on each port to represent two dice.

Listing 2 shows the software program of the digital dice game. The software provides an example of how the PIO is programmed as well as an example of how data can be output to the port using look-up tables.

Interfacing

Hooking-up to the real world is more complicated than connecting other digital logic devices to the Z80 CPU. In most cases knowledge of both digital and analog circuits is essential.

Perhaps the simplest real world device to interface is the push-button switch. Figure 4 shows the simple circuit needed to interface this switch to bit 7 of any input port. Note that the switch can also be connected to any of the other bits. When the switch is open the input is tied to 5V via a pull-up resistor producing a logic one at the input; if the switch is closed the input is grounded producing a logic zero.

To read the state of the push-button switch the input port is read and the other bits are masked off with an AND instruction. A conditional branch can be performed right after the AND instruction and a jump-if-zero instruction (JR Z or JP Z) transfers execution to a different address if the switch is closed. A

jump-if-not-zero command transfers execution to a different address if the switch is open.

In some cases problems will arise if the software does not compensate for push-button bounce during the transition period from open to closed. Figure 5 shows the wave form presented at the input of the CPU when the switch is closed. The transition period is usually less than 20 milliseconds, and if push-button bounce presents a problem a simple solution might be to scan the input twice 20ms apart. (The software listing for each of the examples shown will be given in the next installment of this series.)

Connecting more push-button switches is a simple matter of connecting more switches to different inputs on a port. However, for something like a 8 x 8 keypad connecting 64 switches to 8 input ports can be a wiring nightmare plus it is not a very efficient design.

Connecting Keyboards

Figure 6 shows how a typical 8 x 8 keyboard is connected to the Z80 CPU.

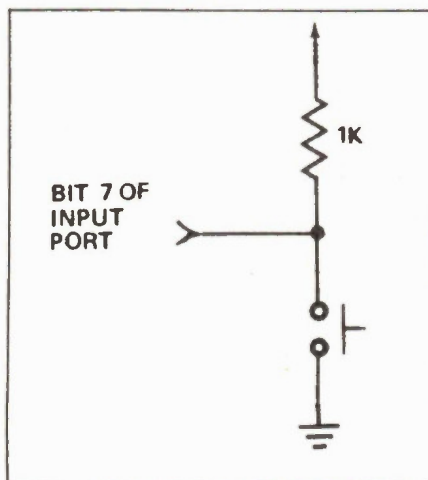

Fig. 4 The schematic of a push-button input.

Notice that each key has one side connected to a keyboard column output and the other side to a keyboard row input. Each row input is tied to 5V via a pull-up resistor, and if no keys are pressed the input from the port will always be FFH.

The keyboard is scanned for keys pressed by outputting a low on one of the column outputs while keeping the other column outputs high. If a key is pressed in one of the columns selected, a low will be present in that keyboard row on the input port. To input from the keyboard each column is scanned until one does not contain a FF hex byte. The switch that is pressed is computed from the row and column number that contains a low.

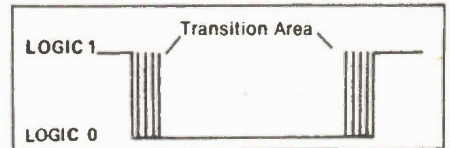

Fig. 5 A graphic representation of push-button bounce.

Reed Switches

Magnetic reed switches can be used instead of push button switches in the same manner. Figure 7 shows how magnetic reed switches can be used to determine linear position of an object. Reed switches can also be used to determine the speed of rotation of a wheel as in Fig. 8; other uses of magnetic reed switches include door closure detectors and custom made switches.

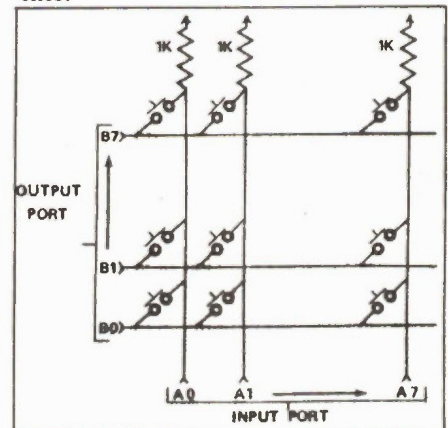

Fig. 6 The 8 by 8 keyboard matrix, in its abbreviated form.

A more accurate method of detecting the position of an object is to use a potentiometer. However, the output of a potentiometer is purely analog; analog to digital converter chips could be used but these chips are usually too expensive for small projects. Another idea is to connect the potentiometer to a 555 timer (Fig. 9). Adjusting the potentiometer varies the pulse duration, and by using a counter to determine the length of the pulse the position of the potentiometer can be determined. One bit from an output port is used to

The most important peripheral you'll ever use: \$19.95 Software Now! Magazine

Each month Software Now! is crammed with reviews, surveys and news about business, home and hacker programs. If you buy only one software package a year, it is still valid because it can make sure that you buy the right package. And because we are Canadian, we give Canadian sources and prices — we don't leave you with that "Yankee Magazine Frustration" feeling.

Available across Canada on newsstands and in many computer stores for \$2.95 a month, a lot less if you subscribe.

\$19.95 a year (12 issues).
\$34.95 for two years (24 issues)

Remember, you can get a refund on the unexpired portion of a subscription at any time, for any reason or no reason.

Software Now! Subscriptions, 25 Overlea Blvd., Suite 601, Toronto, Ontario, M4H 1B1

Please see subscription card in this issue.

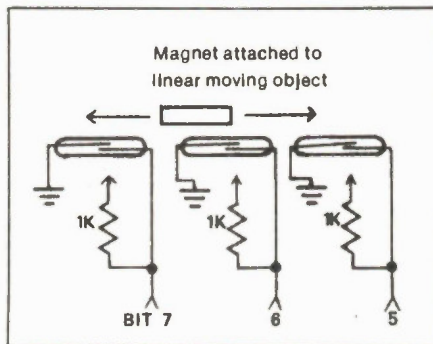

Fig. 7 Reed switches used to detect a linear position.

trigger the timer, and one bit from an input port is used to detect the duration of the pulse.

The most common use for a potentiometer as an input device is the joystick. Two pots are connected to a stick or control lever by a set of gimbals. Moving the joystick up and down changes the resistance of one potentiometer, while moving it left and right changes the resistance of the other. Other uses include measuring the angle of rotation of an object such as a wheel, or measuring the fluid level of a container.

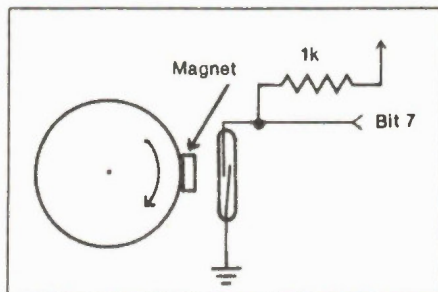

Fig. 8 A reed switch used to detect the speed of rotation of an object.

The Phototransistor Pair

Other types of resistors can be used in place of the potentiometer. Light sensitive resistors can be used to measure the amount of light, or fancier still, placing different coloured filters in front of these resistors makes it possible to detect the colour of objects. Pressure sensitive resistors used in pressure mats can detect the presence of intruders.

Yet another method of detecting the position of an object is to use an LED and a phototransistor pair (Fig. 10). The idea here is that an LED is pointed at the phototransistor producing a steady state at the input of the PIO. When the object blocks the light source the state changes.

The use of LED and phototransistor pairs is quite common in disk drives and printers to detect the position of the R/W head or print head. Modules containing

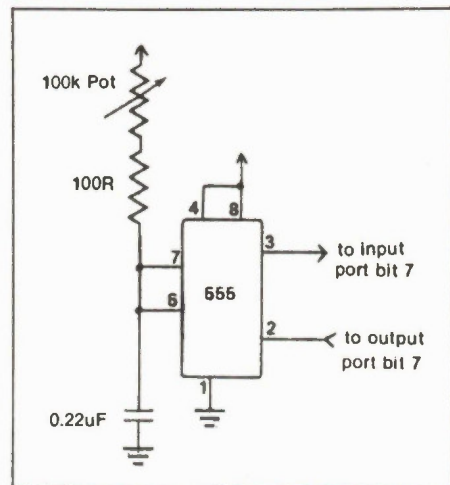

Fig. 9 Connecting a potentiometer to a PIO input.

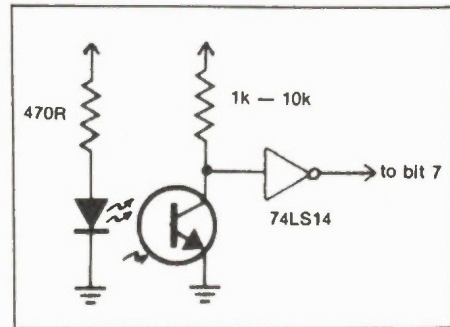

Fig. 10 Using a phototransistor pair for sensing the movement or presence of an object.

LED and phototransistor pairs are quite readily available. Some contain the LED and the phototransistor across from each other so an object must pass between the pair to break the light beam; others have the LED and the phototransistor pointing in the same direction. In this case the object must have a reflective material on it to transmit the light beam. For uses where the phototransistor is quite a distance away from the light source, lenses in front of the light source and the phototransistor will increase the sensitivity significantly. To be continued. ■

ALMOST FREE SOFTWARE

OFFER

Moorshead Publications

Almost Free Software

Almost Free Software (CP/M) #1

Almost Free Software #1, #2 and #3 are for CP/M and are available in a variety of formats: Apple // + CP/M, 8 inch SSSD*, Access Matrix, Morrow Micro Decision, Superbrain, Xerox/Cromemco*, Epson QX-10VD, Sanyo MBC 1000, Nelma Persona, Kaypro II, Osborne and double densities, Televideo, DEC VT-180, Casio FP-1000, Zorba.

Modem 7. Allows you to communicate with any CP/M based system and download files. Complete details were in Computing Now! November 1983.

PACMAN. You can actually play PACMAN without graphics, and it works pretty fast.

FORTH. A complete up-to-date version of FIG FORTH, complete with its own internal DOS.

DUU. The ultimate disk utility allowing you to recover accidentally erased disk files, fix gorged files, rebuild and modify your system. A real gem.

D. A sorted directory program that tells you how big your files are and how much space is left on the disk.

USQ/SQ. Lets you compress and uncompress files. You can pack about 40% more stuff on a disk with this system.

Finance. A fairly sophisticated financial package written in easily understandable, modifiable Microsoft BASIC.

BADLIM. Ever had to throw out a disk with a single bad sector? This isolates bad sectors into an invisible file, making the rest of the disk useable.

DISK. Allows you to move whole masses of files from disk to disk without having to do every one by hand, you can also view and erase files with little typing.

QUEST. A "Dungeons and Dragons" type game.

STOCKS. This is a complete stock management program in BASIC.

SEE. Also known as TYPE17, will TYPE any file, squeezed for not allowing you to keep documents in compressed form while still being able to read them.

Order as AFS #1, and specify system

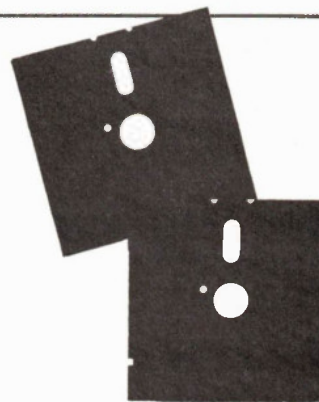

\$19.95 each

Except for 8" disks and those with two disks which are marked with an asterisk (*) above which are:

\$22.95

*single density formats require two disks. The package cost for these formats is \$22.95.

Almost Free Software (CP/M) #2



BISHOW The ultimate file typer, BISHOW version 3.1 will type squeezed or unsqueezed files and allow you to type files which are in libraries (see LU, below). However, it also pages in both directions, so if you miss something, you can back up and see it again.

LU Every CP/M file takes up unnecessary overhead. If you want to store lots of ata in a small space, you'll want LU, the library utility. It permits any number of individual files to be stored in one big file and cracked apart again.

MORTGAGE This is a very fancy mortgage amortization program which will produce a variety of amortization tables.

NSBASIC Large disk BASIC packages, such as MBASIC, are great . . . and very expensive. This one, however, is free . . . and every bit as powerful as many commercial programs. It's compatible with North Star BASIC, so you'll have no problem finding a manual for it.

RACQUEL Everyone should have one printer picture in their disk collection.

Z80ASM This is a complete assembler package which uses true Zilog Z80 mnemonics. It has a rich vocabulary of pseudo-ops and will allow you to use the full power of your Z80 based machine . . . much of which can't be handled by ASM or MAC.

VFILE Easily the ultimate disk utility, VFILE shows you a full screen presentation of what's on your disk and allows you to mass move and delete files using a two dimensional cursor. It has heaps of features, a built-in help file and works extremely fast.

ROMAN This is a silly little program which figures out Roman numerals for you. However, silly programs are so much fun . . .

CATCHUM If you like the fast pace and incredible realism of Pacman, you'll go quietly insane over Catchum . . . which plays basically the same game using ASCII characters. Watch little "C"'s gobble periods while you try to avoid the delay "A's" . . . it's a scream.

Order as AFS #2 and specify system

\$19.95 each

Except for 8" disks and those with two disks which are marked with an asterisk (*) above which are:

\$22.95

*single density formats require two disks. The package cost for these formats is \$22.95.

OIL. This is an interesting simulation of the workings of the oil industry. It can be approached as either a game or a fairly sophisticated model.

CHESS. This program really does play a mean game of chess. It has an on-screen display of the board, a choice of colours and selectable levels of look ahead.

DEBUG. The DDT debugger is good but this offers heaps of facilities that DDT can't and does symbolic debugging... it's almost like being able to step, trace and disassemble through your source listing.

DU87. The older DUU program does have some limitations. The version overcomes them all and adds some valuable capacities. It will adapt itself to any system. You can search map and dump disk sectors or files. It's invaluable in recovering damaged files too.

ELIZA. This classic program is a micro computer head shrinker... it runs under MBASIC, and with very little imagination, you will be able to believe that you are conversing with a real psychiatrist.

LADDER. This is... this program is weird. It's Donkey Kong in ASCII. It's fast, bizarre and good for hours of eye strain.

QUIKKEY. Programmable function keys allow you to hit one key to issue a multicharacter command. This tiny utility allows you to define as many functions as you want using infrequently used control codes and to change them at any time... even from within another program.

RESOURCE. While a debugger will allow you to disassemble small bits of code easily enough, only a true text based disassembler can take a COM file and make source out of it again. This is one of the best ones available.

**Order as AFS #3
and specify system**

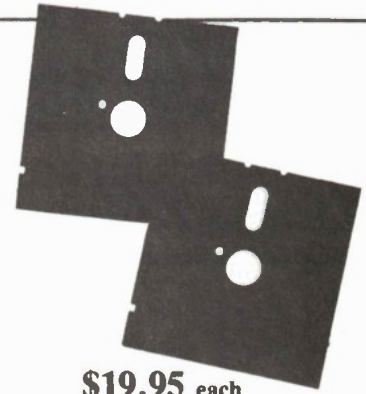

\$19.95 each

Except for 8" disks and those with two disks which are marked with an asterisk (*) above which are:

\$22.95

*single density formats require two disks. The package cost for these formats is \$22.95.

Almost Free Apple DOS Software

Almost Free Apple DOS Software#1

While CP/M is a wonderful thing in its own right, the Apple computer can also, and usually does, operate under DOS. For this reason, there's a multitude of programs available for it. Below, we offer a mini-multitude of our own.

The following programs will operate on any Apple //+, //e, //c, or true compatible operating under DOS 3.3. Apple users operating only under ProDOS may have to make alterations to some programs.

Picture Coder: All Apple HiRes pictures take up 36 sectors in their binary form. This program creates a textfile of a program in memory, squeezing out the zero bytes, that can later be EXECd into memory. The textfile often takes up less room on the disk.

DNA Tutorial: Operating under Integer BASIC, this program might appeal to 'clone' owners. In actuality, though, it's an interactive low-res graphics tutorial of DNA in its inherent forms. And you thought your Apple was only good for games...

Toad: Speaking of games, this program is an Applesoft BASIC implementation of 'Frogger' that can be controlled with either a joystick or the keyboard. The user's high scores are saved to disk.

Function Plotter: A fairly extensive Applesoft BASIC program that takes any inputted function and plots it on the HiRes Screen.

Data Disk Formatter: Apple DOS disks need not be bootable to be useful. This binary program formats a disk without setting DOS on the tracks, conserving useful disk space.

BASIC Trace: A program for the advanced Applesoft programmer, this file, when EXECd, displays the hexadecimal locations of each Applesoft line number of a program in memory.

Gemini Utility: A word processor pre-boot for Gemini printer users, this BASIC program initialises the printer's font or pitch before you boot your word processor.

Payments: This BASIC program allows you to keep track of payments and credits to and from up to 100 accounts on a single disk. A sample account is included.

Databox: A small but useful database program in Applesoft BASIC. Sample files are included to get you started.

Nullspace Invaders: A quick BASIC HiRes game testing coordination and judgement as you manipulate a monolith through mysterious gates.

Fine Print: The majority of this software has been obtained from on-line public access sources, and is therefore believed to be in the public domain. Any remaining programs were written in-house. The prices of the disks defer the cost of collecting the programs, debugging them, reproducing and mailing them, plus the cost of the media they're supplied on. The software itself is offered without charge.

Moorshead Publications warrants that the software is readable, and if there are any defects in the medium, we will replace it free of charge. While considerable efforts has been made to ensure that the programs have been thoroughly debugged, we are unable to assist you in adapting them for your own applications.

**Order as AFAD #1
and specify system**

Each disk is
\$19.95
or, as an introductory offer you
can order all three for
\$39.95

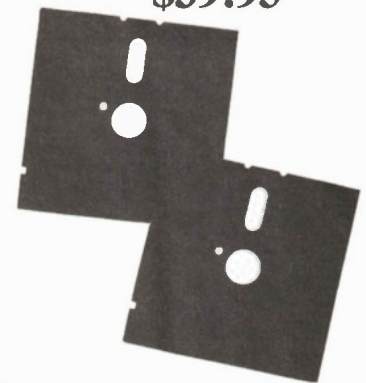
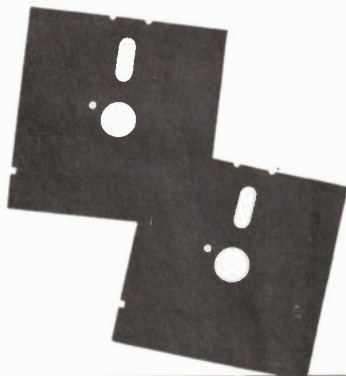

Software Services Moorshead Publications

**25 Overlea Boulevard, Suite 601, Toronto, Ontario M4H 1B1
Electronics Today September 1985**

Almost Free Apple DOS Software #2

Amort: A monthly amortization program that calculates monthly payments to an inputted figure, calculates principle, interest on every balance, and prints out the resulting chart.

Voiceprint: An unusual program that uses the HiRes screen to sample sounds inputted through the cassette jacks at the back of your Apple. Sampling rate and other variables can be controlled, and two sounds may be compared side-by-side.

Calc NOW!: Written in BASIC, this spreadsheet program is somewhat slower than VisiCalc, but still offers the power you expect from a spreadsheet. With sample files.

Cavern Crusader: A mix of BASIC and binary programming, winning this HiRes game is difficult, to say the least. For every wave of aliens shot in the cavern, there's always a meaner bunch in the wings.

Newcout: With source file. This binary program replaces the I/O hooks in the Apple with its own so you can operate your Apple through the HiRes screen. Comes with a character set.

Charset Editor: A utility to help you create your own character sets to use with Newcout.

Calendar: A BASIC utility useful for finding a particular day of any inputted month and year, or for printing out any given year.

LCLODR: With source. This binary utility BLOADS any given file into the 16K language card space at \$D000. The source is useful in showing how to use DOS commands through assembly language.

Cristo Rey: An animated HiRes BASIC program showing Cristo Rey by moonlight. For apartment-bound romantics.

ATOT: That's an acronym for 'Applesoft to Text'. EXEC this textfile to produce a textfile of your program.

Applesoft Deflator: This program takes a textfile made by ATOT and squeezes it, replacing PRINT statements with '?' and removing unnecessary spaces from the listing.

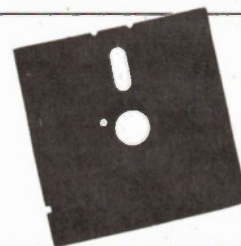

Order as AFAD #2
and specify system

Each disk is

\$19.95

or, as an introductory offer you
can order all three for

\$39.95

Almost Free PC Software

Almost Free PC Software #1

Our Almost Free Software disks, volumes one through three, for systems running CP/M have been so thunderingly popular that we have assembled a volume for IBM PC users. The considerably greater power of a sixteen bit system, coupled with its larger capacity disk drives, have enabled us to offer a collection of programs that will knock the socks off virtually any sentient life form booting the disk. Be warned... wear sandals when you unwrap this thing.

This software will run superbly on genuine IBM PC's and compatible systems.

PC-WRITE While not quite Wordstar for nothing, this package comes extremely close to equalling the power of commercial word processors costing five or six bills. It has full screen editing, cursor movement with the cursor mover keypad, help screens and all the features of the expensive trolls.

SOLFE This is a small BASIC program that plays baroque music. While it has little practical use, it's just a kick to toodle with. It's also a fabulous tutorial on how to use BASICA's sound statements.

PC-TALK Telecommunications packages for the IBM PC are typically intricate, powerful and huge. This one is no exception. It has menus for everything and allows full control of all its parameters, even the really silly ones. It does file transfers in both ASCII dump and MODEM7/XMODEM protocols and comes with... get this... 119424 bytes of documentation.

SD This sorted directory program produces displays which are a lot more readable than those spewed out by typing DIR. It's essential to the continued maintenance of civilization as we know it.

FORTH This is a small FORTH in Microsoft BASIC. It's good if you want to get used to the ideas and concepts of FORTH... you can build on the primitives integral with the language.

LIFE This is an implementation of the classic ecology game written in 8088 assembler. While you may grow tired of watching the cells chewing on each other, in time the source will provide you with a powerful example of how to write code.

MAGDALEN This is another BASIC music program. We couldn't decide which of the two we've included here was the best trip, so we wound up putting them both on the disk. Ah... the joys of double sided drives.

CASHACC This is a fairly sophisticated cash acquisition and limited accounting package written in BASIC. It isn't exactly BPI, but it's a lot less expensive and suitable for use in most small business applications.

DATAFILE This is a simple data base manager written in... yes, trusty Microsoft BASIC.

UNWS Wordstar has this unusual propensity for setting the high order bits on some of the characters in the files it creates. Looks pretty weird when you try to do something other than Wordstar the file, doesn't it... Here's a utility to strip the bits and "unWordstar" the text. The assembler source for this one is provided.

HOST2 This is a package including the BASIC source and a DOC file to allow users with SmartModems to access their PC's remotely. It's a hacker's delight.

The disk also includes various support and documentation files needed to run the software.

We can provide the Almost Free PC Software Disk volume one on either one standard double sided disk or on two single sided ones.

Order as AFPC #1
and specify system.

Only

\$19.95

or **\$22.95**

for two single sided disks.



Moorshead Publications warrants that the software will be readable. If defects in the medium prevent this, we will replace your disk at no cost. While we have made every effort to assure that these programs are completely debugged, we are unable to assist you in adapting them for your application.

Electronics From The Start

Part 3

Calculating and measuring the overall resistance of complete resistor networks.

By Keith Brindley

USING THE LAWS of series and parallel resistors from last month's installment of this series, we can see that circuits may be broken down, step by step, into an equivalent circuit consisting of only one equivalent resistor. In Fig. 1 we have a circuit consisting of several resistors and a battery power supply. Our goal here is to calculate the current I from the battery by finding the single equivalent resistance of the whole network, and then using Ohm's law to calculate the current.

Fig. 2a shows us the first step to tackling the problem. By dividing the network up into a number of smaller networks and using the two above-mentioned laws, we can begin to calculate the equivalent resistances of each smaller network.

Network A

Network A consists of two resistors in parallel. The equivalent resistance, R_A , may therefore be calculated from the expression for parallel resistors or by the following shorter method:

$$R_A = \frac{R_2 \times R_3}{R_2 + R_3}$$

which gives:

$$R_A = \frac{20k \times 12k}{32k} = 7k5$$

Network B

Using the expression for parallel resistors we can calculate the equivalent resistance to be:

$$\frac{1}{R_B} = \frac{1}{15k} + \frac{1}{15k} + \frac{1}{15k} + \dots$$

yielding:

$$R_B = 5k$$

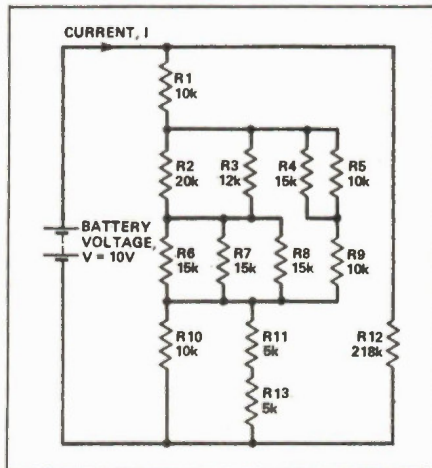

Fig. 1 A resistor network in which the total resistance can only be calculated by breaking it down into blocks.

This result shows that the equivalent resistance of a number of equal, parallel resistors may be calculated by dividing the resistance of one resistor by the total number of resistors.

Network C

Using the simple expression for two unequal parallel resistors we get:

$$R_C = \frac{R_4 \times R_5}{R_4 + R_5} = 6k$$

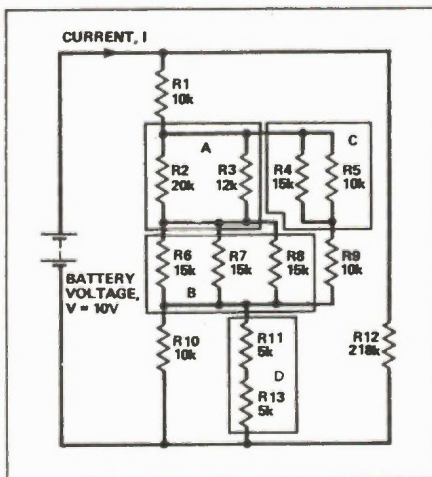

Fig. 2a The same resistor network with four blocks (networks A, B, C, and D) isolated for calculation.

Network D

The overall resistance of two series resistors is found by adding their individual resistances. Resistance R_D turns out to be 10K.

We can now redraw the whole network using the equivalent resistances, as in Fig. 2b, and further simplify the resulting networks.

Networks E, F, G, and H

This equivalent resistance is found by adding R_A and R_B . It is therefore 12k5. The method used in calculating F is the same as E; the resistance should be 16k. The two equal parallel resistors in G give a value of 5k for R_G . Fig. 2c shows the overall network simplified even further.

Two unequal, parallel resistors combine to yield R_H through:

$$R_H = \frac{R_E \times R_F}{R_E + R_F} = \frac{12k5 \times 16k}{12k5 + 16k} = 7k02$$

Fig. 2d shows yet another simplification of the network.

Network I

Resistance R_I is found by adding resistances of resistors R_1 , R_H , R_G . Resistance R_I is therefore 22k02. Fig. 2e shows the next stage of the simplification

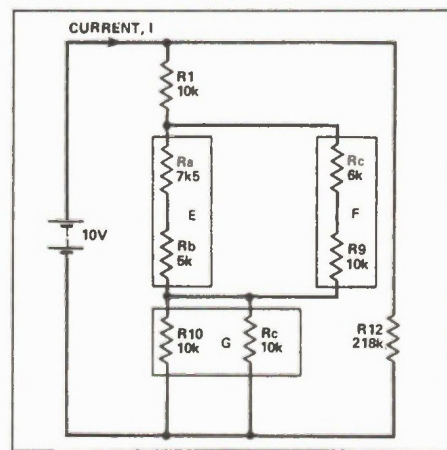

Fig. 2b The same network broken down into smaller networks using equivalent resistances (networks E, F, and G).

with two unequal parallel resistors. The whole network's equivalent resistance is given by:

$$R_N = \frac{R_1 \times R_{12}}{R_1 + R_{12}}$$

$$= 20k$$

From Ohm's law, I is calculated using the expression:

$$I = V/R$$

$$= 9/20k$$

$$= 0.45A \times 10^{-3} = 0.45mA$$

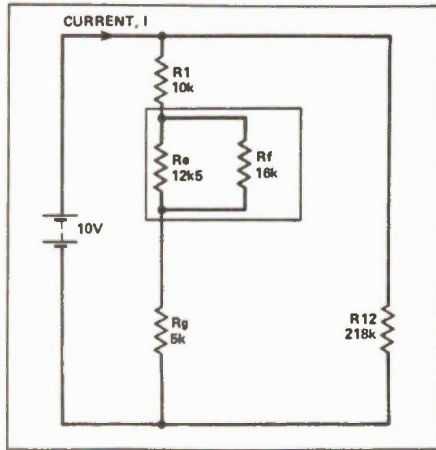

Fig. 2c The network further simplified (network H) into two unequal parallel resistances.

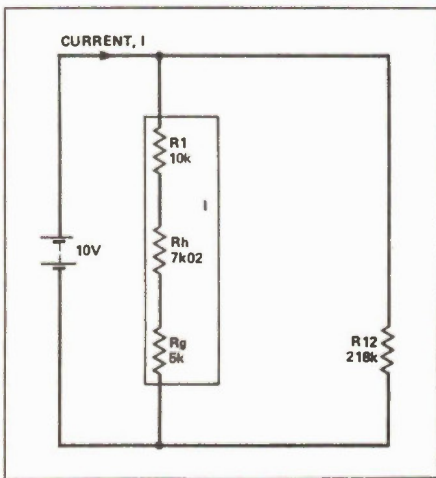

Fig. 2d The network simplified into a string of series resistances (network I).

The Meter Method

Instead of calculating the equivalent resistance of the network you could measure it using a meter. You would first have to obtain resistors of all the values in the network and then build the network up on a breadboard. The measured result may not be the same due to resistor and meter tolerances. Finally, from this measured result and the use of Ohm's law, the current I can be calculated.

Electronics Today September 1985

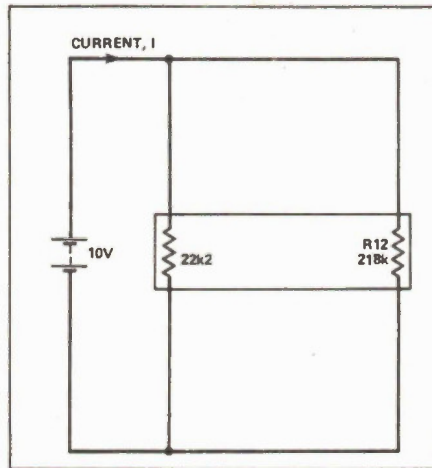

Fig. 2e The final version showing two parallel resistances. From this the current can be calculated.

If you're using a multimeter, it's possible to set up the resistor network as before and read the current directly from the scale. In doing this, the meter becomes part of the circuit and care must be taken to properly orient the red and black leads so as not to damage the meter movement. The location of the meter in the circuit is not of utmost importance. However, always connect the red lead to that part of the circuit which is of a higher potential, and the black to a lower potential. Fig. 3 shows the red and black leads as being marked with a + or - respectively.

Current Events

Figures 1 through 3 all show current flowing from the positive terminal of the battery to the negative terminal; this is known as conventional current. We know that current is made up of a flow of electrons so we might assume that the electrons also flow from positive to negative. But, since electrons are negatively charged, their flow is from the negative terminal to the positive

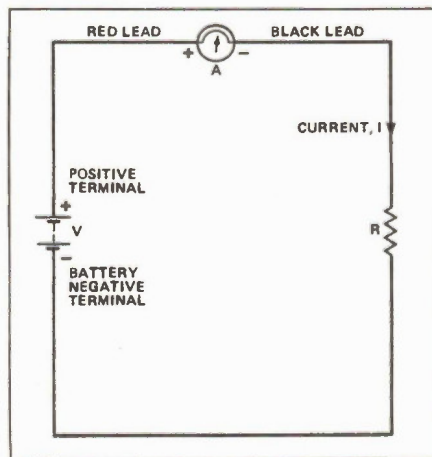

Fig. 3 A diagram showing a meter connected in circuit, with the red lead at the point of higher potential.

terminal of the battery. This is an interesting twist as it now appears that there are two currents flowing at once (Fig 4).

To simplify matters, we'll consider electron current to be a study in electron physics, and conventional current, as is always the case, will be used in our circuit analysis work.

Voltage Measurement

If you're using a multimeter, it can also be used to measure voltage. Since voltage is measured across a component, and not through it, the meter must be connected across the component as well. Fig. 5 shows a simple example of a circuit comprised of two resistors and a battery. To find the voltage across the lower resistor,

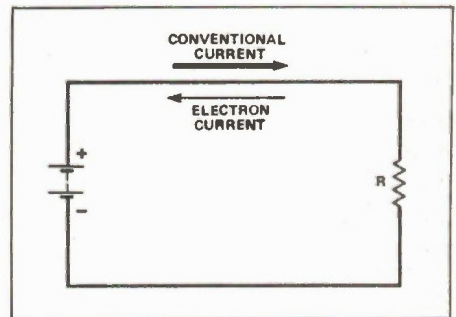

Fig. 4 Conventional current travels from positive to negative; electron current travels in the opposite direction.

the meter is only connected across that resistor. Like the measurement of current, the red (+) lead of the meter is connected to the more positive side of the circuit and the black (-) lead to the more negative side.

A Practical Solution

Now that we've looked at the theory behind current and voltage measurement, let's go on and build a few simple circuits to put it into practice. Fig. 6 shows the breadboard layout of the circuit in Fig. 3, where a single resistor is connected in series with a meter and a battery. With

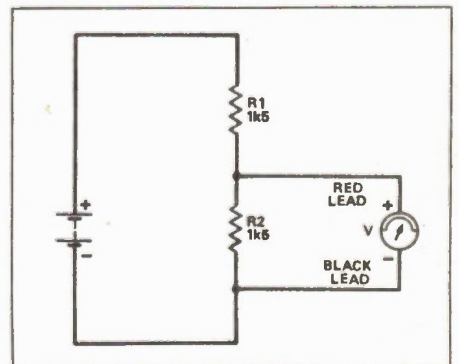

Fig. 5 Meter connections to find the voltage across a single resistor.

this circuit we can actually prove Ohm's law. The procedure is as follows:

- 1) set the meter's range switch to a current range, ie, 2.5A.
- 2) insert a 1k5 resistor into the breadboard and connect the battery leads
- 3) touch the meter leads to the points indicated.

The pointer of the meter should move just slightly as you complete step 3. The range you have set the meter to is too high, meaning that the current is a lot smaller than this range. Try adjusting the meter down to the 0.5A range and repeat step 3.

This time the pointer should move just a bit further, but still not enough to allow an accurate reading. Turn down the range switch again, this time to the 50mA range, and repeat step 3. You should get a fairly adequate reading which should be approximately 6mA allowing for small experimental errors.

We can now compare this reading with the result of the substitution of known values of voltage and resistance into the expression of Ohm's law:

$$I = V/R$$

$$I = 9/1500 = 6 \times 10^{-3} = 6\text{mA}$$

If you decide to try this experiment again using different resistor values, it's important to remember to adjust the meter to a high current range and work down from there. This will protect the meter movement against damage from unknown high currents.

Note that the current and voltage scales read in the opposite direction to the resistance scale, and they are linear. This makes them considerably easier to use than resistance scales and they are also more accurate as you can more easily judge a value if the pointer falls between actual marks on the scale.

Voltages

When measuring voltages, the same precautions should be taken as with measuring current. Select the highest voltage range on the meter and work your way down from there. The voltages you'll be measuring here will all be direct voltages as they are taken from a 9V DC battery. There's no need to use any of the AC (alternating current) voltage scales here.

As an example, build the circuit of Fig. 5 onto your breadboard as in Fig. 7. Take your first measurement on the highest voltage range and step down until you can get a good reading; it should be about 4 1/2V.

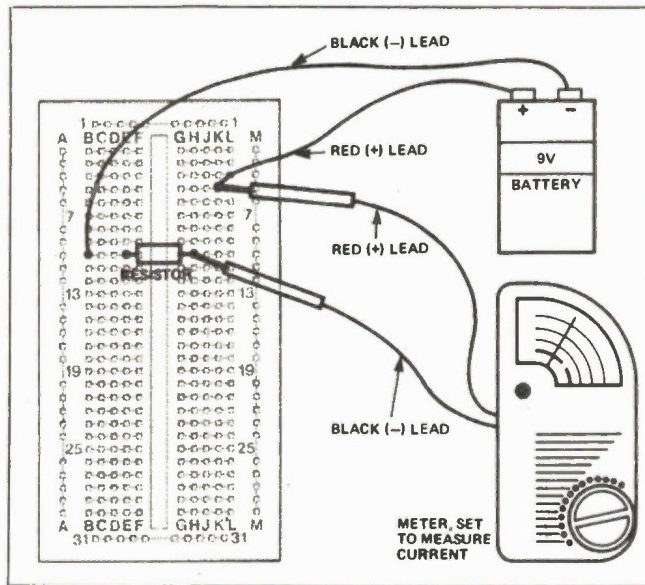

Fig 6 A breadboard layout for the circuit of Fig. 3. The meter is in series with the resistor; only the meter itself makes the circuit complete.

A reading across the other resistor should yield a value of about 4 1/2V as well. Adding the two voltage readings together gives 9V across the two resistors. What we've demonstrated here is that resistors in series act as a *voltage divider* or *potential divider* dividing up the total voltage applied across them. What happens if we take two resistors of unequal value though?

Build the circuit of Fig. 8 onto your breadboard, connect the battery as before and measure the voltage across R2. You should find it to be around 2.1V. The relationship between this result, the values of the two resistors and the applied battery voltage are given by the *voltage divider rule*:

$$V_{out} = \frac{R_2}{R_1 + R_2} \times V_{in}$$

where V_{in} is the battery voltage and V_{out} is the voltage measured across resistor R2.

We can check this by inserting the values used in the circuit of Fig. 8:

$$\begin{aligned} V_{out} &= \frac{1k5}{1k5 + 4k7} \times 9 \\ &= \frac{13500}{6200} \\ &= 2.18V \end{aligned}$$

This result should be close enough to our measured 2.1V. The voltage divider rule, along with the Ohm's law and the laws of series and parallel resistors, is one of the fundamental laws which should be burned into your memory.

By changing resistance values in a voltage divider, the voltage we obtain at the output is correspondingly changed. Certain types of components exist for do-

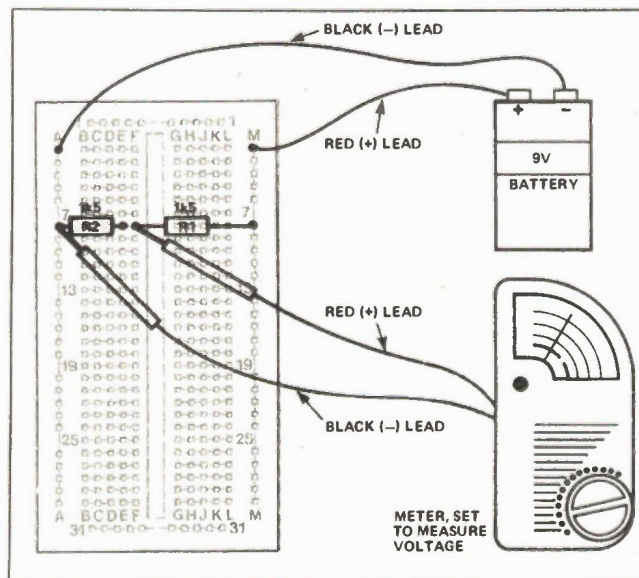

Fig 7 The layout on breadboard of the circuit in Fig. 5: measuring the voltage across R2. This will be the same as for R1, and each will be around 4 1/2V — half the battery voltage.

ing this, known as **potentiometers**. They consist of some form of resistance track, across which a voltage is applied, and a **wiper** which can be moved along the track forming a variable voltage divider. The total resistance value of the potentiometer track doesn't change, only the ratio of the two resistances formed on each side of the wiper. The basic symbol of a potentiometer is shown in Fig. 9a.

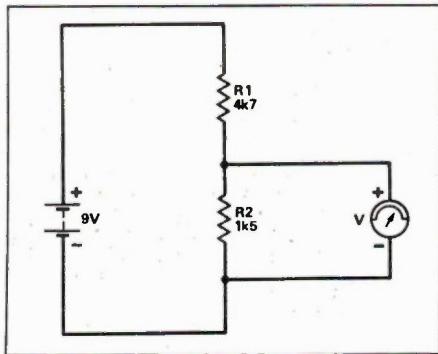

Fig. 8 A circuit with two unequal series resistors making up a voltage divider.

A potentiometer, or pot, may be used as a variable resistor by connecting the wiper to one of the track ends as shown in Fig. 9b. Varying the position of the wiper varies the effective resistance from zero to its maximum. This is useful if we wish to control the current in a particular part of the circuit; increasing the resistance decreases the current and vice versa.

These two types of pots are typically used when some function of an appliance, eg, the volume of a television must be easily adjustable. Other types of pots are available which are set at the factory upon manufacture and are not generally tinkered with afterwards, eg, the TV's height adjustment. This type of pot is more widely known as a **preset** type. The only difference as far as a circuit diagram is concerned is that the symbols used may be differ slightly. Fig. 9c and Fig. 9d show preset potentiometers in the same configurations as the pots of Fig. 9a and Fig. 9b. Mechanically however they are different.

When measuring the voltage in any given circuit it must be remembered that the meter has its own internal resistance.

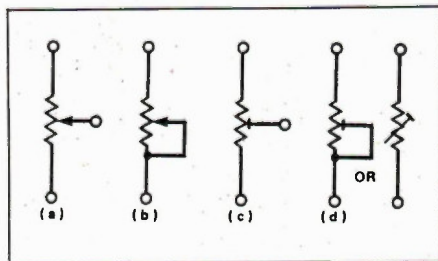

Fig. 9 A variety of symbols used to denote variable resistors, or potentiometers.

Building the circuit in Fig. 10 will allow us to see exactly the effect of meter resistance. As both resistors in the circuit are equal, we can see that the measured voltage should be half of the battery voltage, 4 1/2V. But when the meter is applied across R2 you will find that the voltage indicated is only about 3V.

The fact is that when the meter is not connected to the circuit the voltage is 4 1/2V, but as soon as the meter is connected, the voltage across R2 falls to 3V. Also, the voltage across resistor R1 rises to around 6V (both voltages must add up to the applied battery voltage). Applying the meter affects the operation of the circuit because the meter is in parallel with R2.

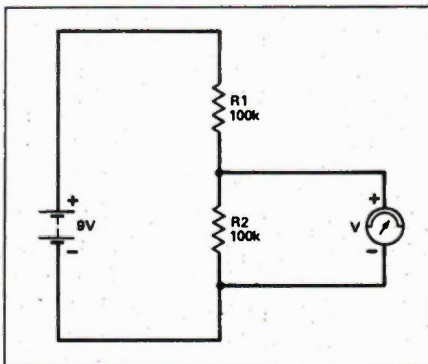

Fig. 10 A circuit which is used to show the effect of the meter's own resistance in a circuit.

Ohms Per Volt

The measurement of a meter's internal resistance is always given in *ohms per volt*. The average analogue meter has a resistance of 20,000 ohms per volt (written 20kV⁻¹ so when it's to read 4 1/2V its resistance is 90K. This resistance which is in parallel with resistor R2 forms an equivalent resistance which can be calculated using the law of parallel resistors as being:

$$R_{eq} = \frac{100k \times 90k}{100k + 90k} = 47k4$$

This resistance is now the new value of R2 in the circuit so, applying the voltage divider rule, the measured voltage will be:

$$V_{in} = \frac{47k4}{100k + 47k4} \times 9 = 2.9V$$

which is roughly what we measured.

Any difference between the actual measurement and this calculated value may be accounted for because this lower

voltage causes a lower meter resistance which, in turn, affects the voltage which, in turn, affects the resistance, and so on until a balance is reached. All of this occurs instantly as soon as the meter is connected to the circuit.

When using your meter to measure voltage it is important to remember that if the circuit-under-test's resistance is high, the meter resistance will affect the circuit operation, causing an incorrect reading.

Any meter will affect the operation of any circuit to a greater or lesser extent — but the higher the meter resistance, the more accurate the reading. A good rule-of-thumb is that the meter resistance should be ten times that of the circuit's resistance. Modern digital multimeters have extremely high resistances in the order of millions of ohms; a fact which allows them to accurately measure voltages in circuits with very high resistances ■

COMMUTEX

A SYSTEM DESIGNED FOR AN EFFICIENT MANAGEMENT OF A LIMITED NUMBER OF PRINTERS SHARED BY SEVERAL MICRO-COMPUTERS.

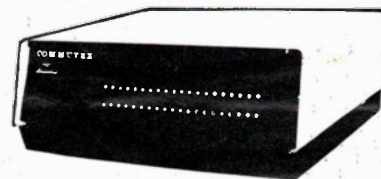

This intelligent controller features:

- Menu-Driven software configuration.
- No manual commutation.
- Use of different types of printers and computers.
- Up to 40 computers and printers can be handled by Commutex.

Obviously there is a lot more to tell about Commutex.

For more information please write or call:

PROTEC MICROSYSTEMS INC.
8090A Trans Canada Highway
St. Laurent, Que. H4S 1M5
Tel.: (514) 335-9555
Tlx: 05-25134/PROTEC

Fast Op Amp

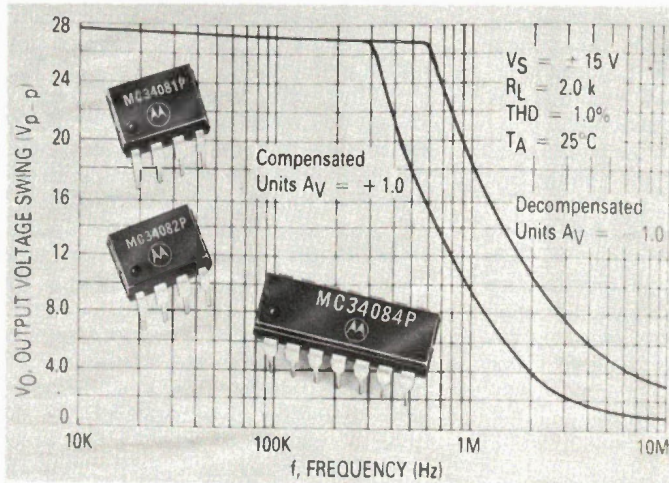

Motorola's new MC34080/MC35080 JFET op amps offer four times the bandwidth and slew rate of previous industry standards: 8MHz and 25V/us for compensated, 16MHz and 50 V/us for decompensated devices. The maximum supply voltage is 44 volts, allowing them to be operated from plus-and-minus 20V supplies for better headroom. The 35000

numbering is the military temperature range; the 34000 series is commercial (0 to 70 degrees C). Available in single, dual and quad versions. From Motorola dealers, or you can contact the head office of Motorola Semiconductors, PO Box 20912, Phoenix, Arizona 85036, (602) 897-3951.

Circle No. 56 on Reader Service Card

Despite the existence of space travel as big business for more than 25 years, it still sounds like Star Trek when we get a press release from the Ministry of State for Science and Technology entitled "Interim Space Plan, 1985-86". It sounds as though they're planning to go where no man has gone before by 1987. Here are the basic Canadian plans for outer space: to join the US Space Station Program, to support the implementation of a commercial Mobile Communications Satellite System, to continue development of a remote sensing satellite for resource monitoring, and to maintain and develop Canadian capabilities in space.

Funding for the 85/86 space program comes to \$194 million, with \$60 million for technology development, \$73.5 million for remote sensing, \$38 million for communications, and \$22 million for space science. If you'd like further information, contact Mr. Mac Evans, Space Policy and Plans, Ministry of State for Science and Technology, (613) 996-0326.

Circle No. 55 on Reader Service Card

Word-Spell

Brother International is offering a spelling checker for Brother electronic typewriters. Each word you type is checked by the 50,000 word electronic dictionary, producing a beep if the word is unknown. There's a 300 word user dictionary which can be edited; a battery maintains it for years if it's unplugged. The suggested retail is \$229.95 from authorized dealers across Canada.

Circle No. 54 on Reader Service Card

Ink Jetter

This is a jet-setter and then some. The Epson SQ-2000 inkjet printer retails for a suggested price of \$3795; it runs at 106 cps in Letter Quality or 176 cps in the draft mode. It can do expanded, compressed, superscripts, subscripts, etc. Graphics are handled in nine modes up to 240 dots per inch. The ink nozzle is cleaned by an internal purging system. A printout from the SQ-2000 was sent to us from Epson and it showed excellent quality, particularly in the Letter Quality mode. Epson Canada, Ltd., 285 Yorkland Blvd., Willowdale, Ontario M2J 1S5 (416) 495-9955.

Circle No. 52 on Reader Service Card

AMAZING SCIENTIFIC and ELECTRONIC DEVICES

- LASER DEVICES**
- LC5 BURNING CUTTING CO2 LASER \$15.00
 - RUB3 RUBY LASER RAY PISTOL 15.00
 - LRG3 IR LASER RIFLE/PISTOL 10.00
 - LGU3 VISIBLE RED LASER RIFLE 10.00
 - LHP/LLD LASER LIGHT XMTR/RCVR SYS 10.00
 - LHC2 BEGINNER simulated VISIBLE LASER . 5.00
- SCIENTIFIC & ELECT**
- TCL3 SOLID STATE TESLA COIL 35KV 6.00
 - BTC3 250 THOUSAND VOLT TESLA COIL ... 9.00
 - BTC5 1.5 MILLION VOLT TESLA COIL 15.00
 - HVM3 125 THOUSAND VOLT DC SUPPLY 8.00
 - IOG3 ION RAY FORCE FIELD GUN 8.00
 - HEG1 MILLION WATT 500 JOULE SOURCE .. 10.00
- ULTRASONIC ACCOUSTICAL**
- PPF1 PHASOR PAIN FIELD GENERATOR ... 15.00
 - PSP3 PHASOR SHOCK WAVE PISTOL 7.00
 - IPG5 POCKET PAIN FIELD GENERATOR 7.00
 - RAT2 RAT AND PEST ELIMINATOR 6.00
 - HT9 HIGH FREQ. LISTENING DEVICE 8.00
- SECURITY & PROTECTION**
- DEVI DEVASTATING DEVICES 10.00
 - PPG1 PHASOR PROPERTY GUARD 15.00
 - MFT1 MINI VOICE XMTR 2-3 MILE 7.00
 - INF1 INFINITY TRANSMITTER 15.00
 - PSW3 PHASOR BURNING STUN WAND 7.00
 - ITMI INTIMIDATOR PLASMA GUN 10.00

WE STOCK ALL PARTS NECESSARY FOR CONSTRUCTION OF THE ABOVE PROJECTS

• CATALOG CONTAINING HUNDREDS MORE OF ALL NEW AMAZING and FASCINATING PLANS. EASY TO BUILD KITS AND ASSEMBLED ITEMS \$1.00. CATALOG INCLUDED FREE WITH ANY OF THE ABOVE PROJECT PLANS. SEND CASH, CHECK, MO, VISA, MC IN US FUNDS.

INFORMATION UNLIMITED

P.O. Box 716, DEPT. ET, AMHERST, NH 03031

Circle No. 28 on Reader Service Card

IBM Touchpad

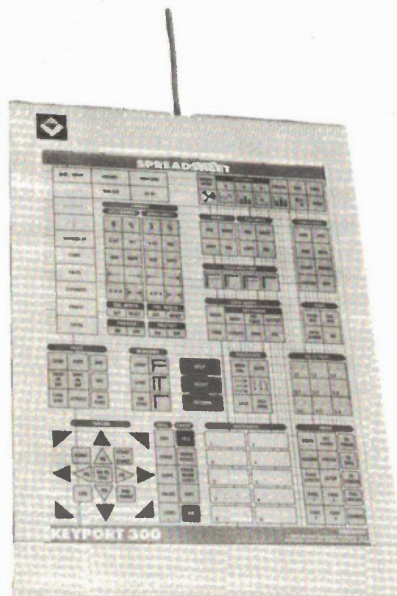

The Keyport 300 is a touchpad that simplifies the use of IBM-PC (and compatible) spreadsheet and word processing software, and is available for Lotus, WordStar, VisiCalc, Multiplan, PFS and Easy Writer. A utility package allows custom programming. The system consists of a 300-key pad, cabling, and tablet overlay sheets. Only 128k of RAM is required. From Datamex Ltd., 115 Norfinch Drive, Downsview, Ontario M3N 1W8, (416) 665-1808.

Circle No. 53 on Reader Service Card

EECO Inc., a manufacturer of switches in Santa Clara, California, has chosen Future Electronics of Quebec as an authorized distributor. Future operates Active Components, with stores in Montreal, Toronto, Downsview, Ottawa, Calgary and Vancouver.

Hewlett-Packard (Canada) Ltd. has donated a \$150,000 microprocessor development system to the University of Waterloo. It consists of three HP 64000 Logic Development Systems, a disk unit, and a printer, interconnected by a local area network. Designing a micro-based system, or even its software, is such a time-consuming process that engineers could easily spend six months on a project. The new network, which allows up to three students at a time to do debugging, will automate the process, speeding it up considerably; teaching and research capabilities are upgraded at the same time.

Component Notation

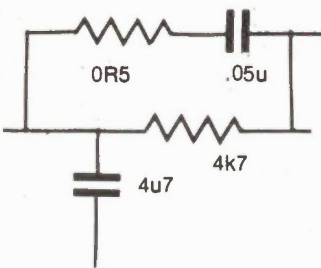

We had a letter from reader Gary Landry of Halifax asking about the component notation used in Electronics Today, and judging from other similar letters, the answer to his questions will be of interest. Here's a summary of the notation you'll generally find in our articles and projects:

The Mysterious R: the R means "ohms", and replaces the decimal point. 6R8 is 6.8 ohms, 68R is 68 ohms, 0R6 is 0.6 ohms and so on. If there's no R on the schematic

number, such as just plain 680, you can be sure it means ohms.

Transformers: The "CT" means "centre-tapped". Thus 12VCT means a transformer with 6 volts on either side of the centre tap connection; it's often written as 6-0-6 volts.

Capacitors: the "u" or "uF" is the microfarad, and also takes the place of the decimal point; the same goes for the "n" or "nF", the nanofarad. 1n5 is the same as 1.5 nanofarads. The same for "p" or "pF", the picofarad. As far as capacitor types go, projects listing non-electrolytics usually specify polycarbonates or polyesters, both common film types. You can generally use any film type here, especially if the project doesn't specify any particular type at all. If there's a special requirement for capacitor types because of temperature or tolerance, the author usually specifies it.

TTL: sometimes we'll write 74S04 and sometimes just S04. Both refer to the same generic TTL chip. You may find it in a manufacturer's catalogue as something like MC774S04. Still the same thing.

Printed Circuits: see the list of PCB makers at the front of each issue. These are generally mail order companies who don't list their phone numbers.

Don't forget **Electronicom '85**, Canada's biggest exposition for the electronics and electrical industries, and formerly known as the IEEE show. It'll be at the Metro Toronto Convention Centre, Oct. 7-9, 1985. Aside from displays by major manufacturers and distributors, Electronicom will be illustrating the complex interaction of the industry with the overall Canadian economy by mapping out the major developments in the electronics, telecommunications and computer fields and their critical importance to the future of Canada. Contact them at 1450 Don Mills Road, Don Mills, Ontario M3B 2X7 (416) 445-6641.

Stereo TV: Toronto's CFMT, Channel 47, will have inaugurated TV stereo sound in Canada by the time you read this. The broadcast signal has been equipped to meet the BTSC standards with the Zenith dbx system. If your set isn't stereo-compatible already, decoders are being supplied by Gytek Inc. of Scarborough, Ontario. The Superstereo 4700 decoder, for instance, retails at a suggested list price of \$129, and operates in conjunction with a cable converter. For more information, contact CFMT, 545 Lakeshore Blvd. W., Toronto, Ontario M5V 1A3 (416) 593-4747.

Circle No. 6 on Reader Service Card

Centre of Gravity

Our award for the most unusual piece of test equipment this month goes to D.J. Instruments for their CGI-DIGI Centre of Gravity Locator. Handling objects up to 5000 pounds and 75 feet long, the unit uses strain gauges to find the COG within 0.001 inch. The locator starts at \$9800 US; the optional Saturn V is \$350 million. D.J. Instruments, 18 Republic Road, North Billerica, Maryland 01862 (617) 667-5301.

Miniature Drill

Grind, mill, slot and drill, tote that bale. OK Industries offer a precision miniature drill with variable speed from 0-16,500 RPM; ideal for prototype metalwork, printed circuits, polishing, etc. It operates from an included 115VAC power-pack with a 12V output. All sorts of drilling and grinding accessories are available. Len Finkler and Co., 80 Alexdon Road, Downsview, Ontario (416) 630-9103.

Circle No. 7 on Reader Service Card



Pocket Data Recorder

TEAC's range of data recorders includes the HR-10 pocket cassette version. The HR-10 is a 4-channel device, also available in seven channels as the HR-30. Up to 24 hours of data can be recorded; data can also be played back at high speeds. They can be externally powered from a 7-11V source, or by a 9V alkaline battery. Contact Metermaster, R.H. Nichols Co. Ltd., (80 Vinyl Court, Woodbridge, Ontario L4L 4A3, (416) 851-8871.

We Service What We Sell BEST QUALITY INSTRUMENTS AT LOWEST COST! Why Pay More? . . . Just a Few Examples:



DMM 601

3½ dig. 0.25% acc.
0.1 mV - 1000 VDC
0.1 uA - 2 A AC/DC
0.1 mV - 750 VAC
0.1 ohm - 20 M ohms
Safety test leads incl.

\$63.90

Dmm 6010 (same as 601) except: max. 10 A AC/DC

\$69.50

Synthesized R.F. Generator SD 1003



8-512 (Model SD1004 MAX 1060 MHz) AM .O-90% FM irr 10-30-100KHz steps. Output attenuation in 10dB steps with Vernier Fine Control. Price 30-40% below "Industry Standard" prices.

OSCILLOSCOPE 33330 - 2 Chan.

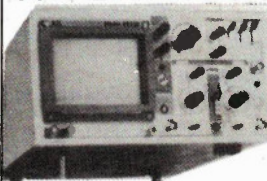

20MHz bandwidth
Built-in components tester
5 mV vert. sensitivity
Special Price \$495.00 in areas not served by distributors.
Probes extra.

Precision Analog Multimeter Model 5050E

• Input resistance, 10M /DC
• 43 measuring ranges

Introductory Price **\$67.50**
AC/DC current max. 12A



Model 605
RF Generator
100KHz - 70 mHz
On fundamentals

Introductory price **\$179.00**

Authorized Distributors: A-1 Electronics, 5062 Dundas St. W. Toronto, 231-4331.

Waterloo Electronics Supply Co. In. 219 Hartwood Ave., Waterloo, Ont. 745-9421.

Mail Orders Accepted: Certified Cheque, Money Order, C.O.D.'s F.O.B. Oakville. Ontario residents add 7% P.S.T.

KB ELECTRONICS

355 Iroquois Shore Rd., Oakville, Ont. L6H 1M3
(416) 842-6888 Telex 06-982396 (KBEL OKVL)

COMPUTER PARTS GALORE INC.
316 College St.
Toronto, Ontario M5T 1S3

**APPLE IIe®
DETACHED NUMERIC KEYBOARD
\$99.00**



For those of you who would like to put your IIe in another case we have a high quality 100% plug in compatible Matrix keyboard with all IIe keys plus the highly desirable numeric keypad for quick entry of numeric data \$99.00

**Toll Free Orders Only
1-800-387-1385**
Order Checking (416)925-8291
Technical Data (416)925-1105

ASCII KEYBOARDS



Now, we have a new keyboard, micro controlled with 3 levels of pre-coded functions for Basic, CPM etc. and at the same old price as before.

Function Keyboard, Numeric \$89.95
Function Keyboard, Standard \$73.95

**SOLID ABS
CASE
NUMERIC
\$59.95**

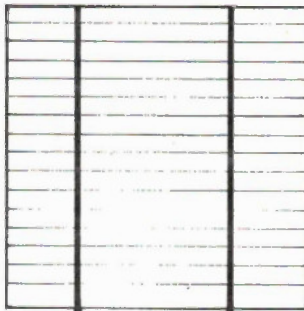

**SOLAR
CELLS**

SOLAR CELLS. These square polycrystalline silicon solar photo-voltaic cells have many uses from car top battery chargers, sony walkman power supplies, calculators, radios, nicads, etc. Each cell has an open circuit potential of 0.5 volts that is area independent, and a short circuit current that is area dependent, see list. We

have been playing with them here and they are lots of fun, we are going to make up a few large banks of cells as an emergency lighting system. Note can also be used for the ETI solar powered night light. Each order comes with a data sheet and instructions on how best to use the cells.

- High Efficiency
- Polycrystalline
- Antireflective Coating
- Fine Collector Grid
- High Area Factor Square Cells

- (a) 1" x 4", 1/2 Amp. \$3.95
- (b) 2" x 2", 1/2 Amp. \$3.95
- (c) 2" x 4", 1 Amp. \$6.95
- (d) 4" x 4", 2 Amp. \$8.95

**MOTHER
BOARD**

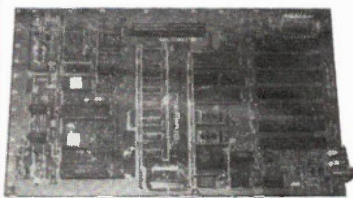

100% IIe® Compatible, for those of you who wish to build a clone of the very popular APPLE IIe®. This board is a reverse engineered copy of the IIe® and is 100% compatible. We have the motherboard and the custom ICs only. All other parts are widely sold. The custom ICs are workalike chips that do not infringe any copyrights. The software for operating the board must be obtained elsewhere as we do not have it for sale. When we say 100% we mean it.
A very good buy at \$49.95
Custom IC set(2) \$49.95
Keyboard encoder (AY3-3600) \$14.95
Character generator, U/LC \$14.95

**IIe® ABS PLASTIC CASE
\$59.95**



This case is made to fit the Mother Board listed here for making IIe® clones and it makes a very nice looking copy. There is just enough difference to avoid design infringement. The case also has no brand names or other marks on it.
A good buy at \$59.95

**IIe® MATRIX
KEYBOARD
\$79.95**



This keyboard fits the above case and has 100% clone compatibility. It will allow operation of all IIe® commands. Another bargain at \$79.95



This is a high quality Hall Effect keyboard made by Microswitch of Canada for AES data and now bought by us for 10% of the \$169.00 that AES paid for them in 10,000 lots. They are a very good word processing keyboard with both serial and parallel data outputs for use with APPLE and IBM type systems and come complete with a ribbon cable connector and complete pin-out. \$24.95

WIRED CARDS

- 16K \$ 45.00
- 128K no IC \$ 34.95
- 128K OK .. \$ 55.00
- 128 64K ... \$ 99.00
- 128K 128K \$150.00
- MC3242 IC \$ 12.00
- DISC \$ 45.00
- Z-80 \$ 45.00
- Applicard . \$150.00
- Applaext 128K \$140.00
- Sprite gr. \$ 69.95
- TMS9918A IC .. \$ 18.95
- DISC SHMRCK \$ 45.00
- 80 Column \$ 65.00
- 80 Col. Sofsw .. \$ 69.00
- Gripper \$ 50.00
- Grip cable \$ 19.95

**NEW LOW BARE
PCB PRICES***

- Real time clock
- Rana 4 drive
- 9 V Music
- Disc Controller
- Disc Controller (Shamrock)
- Gripper
- 80 Column
- 80 Column Soft Switch
- Z-80
- PIA card
- EPROM
- WILD CARD
- SAM TALKS
- COMMUNI-CATIONS
- GROUP 2 \$9.00 each
- RGB
- Sprite graphics
- APPLACARD 128K
- ADD ON

- GROUP 3 \$11.00 each
- SSM MODEM
- PARAT EPROM
- PROG
- 16K
- 128K

All boards come with a parts list and placement diagram. We have all the parts of the PCB's just ask for them.

*Prices so low we require payment with order

MEMORY FLASH

- 256K-150Ns DRAM \$7.95
 - 64K-150Ns DRAM \$1.00
 - 64K-200Ns DRAM \$1.25
- Prime stock, limited quantity.

**IBM POWER
SUPPLY**

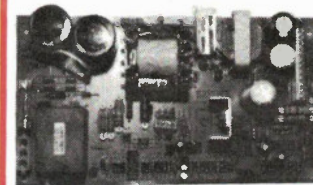

One of the nicest open frame IBM type switching power supplies we have ever seen. Came from the defunct NCR IBM compatible. runs the whole thing, has +5V-7A, +12V-3A, -5, -12-1/4 A. A very good unit for starter system. Will not run hard disc system.
A real steal at \$49.95

**SWITCHING
POWER SUPPLY**



Another great bargain from PARTS GALORE, A small power supply switching style that give +5v-4A; ±12v 1A and -5v (adjustable) on a compact 4x8" open frame PCB. Cost Northern Telecom \$50.00 when they bought 5000 pieces. We got em when a subcontractor went belly up for 10% of that price and we are selling em for

\$18.95 NEW IN BOX TESTED

AC power cable (3 Wire) for above \$2.50

KEYTRONICS
PROGRAMMABLE KEYBOARD
An excellent ASCII Keyboard, fully Apple Compatible. Full size with numeric pad, fully programmable key switches with full data \$9.95

**POWER
SUPPLY
CSA APPROVED**

Our Famous "BLACK BEAUTY" power supply, now reduced in price but not in quality. Our ratings are 5V-5A; 12V-2.5A; 5A-1/2 A; -12V-1/2A for real \$79.95

OUR 6502 BOARD

Now only \$29.95 still with all the versatility of the original and a full 8 slots.



**APPLE® DETACHED
KEYBOARD \$159.00**



The excellent MARK-II Apple detached keyboard using serial data (IBM) format. Plugs directly into Apple PCB \$159.00

**GREAT
DEAL**

THE GREAT DEAL CARRIES ON FOREVER AND GETS BETTER
Our proven 6502 motherboard plus a numeric case plus a black beauty power-supply plus a numeric function keyboard plus any 4 bare pcb for \$225.00

CONNECTORS



DB SERIES

- DB-25 M solder \$1.95
- DB-25 F solder \$1.95
- DB-25 M IDC, Flat cable \$5.95
- DB-25 F IDC, Flat cable \$5.95
- DB-25 M Right angle PCB \$4.95
- DB-25 F Right angle PCB \$4.95
- DB-25 Shell \$1.00
- DB-15 M solder \$1.95
- DB-15 F solder \$1.95
- DB-15 F IDC, flat cable \$3.95
- DB-15 M right angle PCB \$2.95
- DB-15 F right angle PCB \$2.95
- DB-15 Shell \$1.00
- DB-9 M solder \$1.75
- DB-9 F solder \$1.75
- DB-9 M right angle PCB \$2.50
- DB-9 F right angle PCB \$2.50
- DB-9 Shell \$0.75

DRIVE CONNECTORS

- 50 Pin Edge C, 8" drive \$5.95
- 40 Pin Edge C \$4.95
- 34 Pin Edge C, 5-1/4" drive \$5.95
- 20 Pin Edge C, Hard drive \$4.95
- 34 Pin Fem header 17 x 2 \$3.50
- 26 Pin Fem header 13 x 2 \$3.00
- 20 Pin Fem header 10 x 2 \$2.00

**ASSORTED SEMI-
CONDUCTORS AND
OTHER STUFF**

- (A) RED LED S/M/L 10/\$1.00
- (B) GREEN LED S/M/L 8/\$1.00
- (C) AMBER LED S/M/L 8/\$1.00
- (D) PIN PHOTODIODES, INFRA-RED 2/\$1.00
- (E) PHOTO TRANSISTOR, NPN VISIBLE 2/\$1.00
- (F) FLDR (LIGHT DEP RESISTOR) \$1.00

**NICADS 8.4V 7 "D"
4A.H CELLS**

A great buy, a pack of 7 brand new GE NICADS giving 8.4v at 4 amp hours. Each cell is 1.2v and separates easy. Used as 3V backup through a 700Ω. Gives 5.1 Amp for 4 hours \$14.95

COMPUTER
PARTS GALORE INC.
316 College St.
Toronto, Ontario M5T 1S3

Toll Free Orders Only
1-800-387-1385
Order Checking (416)925-8291
Technical Data (416)925-1105

MAIL ORDERS: We accept VISA; MC; AMEX; credit cards. Money orders, cheques (2 week wait) are also OK. Minimum packing and handling fee \$5.00 or 5%, whichever is larger. The only COD we use is via CANPAR (Add \$4.00 COD fee) or motor freight. We do not use postal COD at all. All Ont. res. add 7%. All prices are subject to change without notice. Returns are subject to a 20% restocking charge.

CHERRY SWITCH \$99.00
IBM® KEYBOARD

At last a good low cost keyboard for the IBM PC, XT or compatible machine. Uses capacitive keys, has a very good feel, and has TYPEWRITER LAYOUT for easy word processing at the very low price of \$99.00

MBE-XT
AN IBM®
XT Compatible
8 Slot Motherboard

MBE-XT BARE PCB WITH
MANUAL AND SCHEMATICS.

\$49.95

LAZY BOARD

What is your time worth?? We have had a bunch of MBE-XT boards stuffed and wave soldered so you can save all that time soldering them up. All you need are the IC's memory and BIOS and you are set to go **\$149.00**

FULLY WIRED AND TESTED WITH 64K ON BOARD WITH MEGABIOS AND MANUAL

\$365.00

- 8088 16 Bit Microprocessor
- 8087 Math Processor, Optional
- Up to 256K Dram on Board
- Has Digital Delay Line for Error Free Memory Refresh
- 8 IBM Compatible Expansion Slots
- 4 DMA and Timer Channels
- 64K/128K Eproms Jumper Selectable
- Will run any Compatible BASIC
- IBM Power Plug Compatible
- Same PCB size as IBM XT
- Runs PC-DOS and CPM-86
- Compatible BIOS in stock

DTC DISPLAY TELECOMMUNICATIONS CORPORATION

MEGA-BOARD

*IBM and IBM PC are trademarks of International Business Machines

Eight Compatible I/O Interface Connectors (Full PC compatible) compatible with all IBM PC "plug-in cards"

Special J1 Interface (Allows horizontal mounting of compatible expansion cards for easy but a custom and custom computing) (Board has 82 pin gold plated comp. connector)

Extended ROM Capability (Runs all compatible PC ROMs) (Lamp program table to accommodate all available 8K, 16K, 32K and 64K ROM chips and NEW EP ROMS) (VPP power pin available for EP ROM burning) (External VPP source required)

Board Size 10.5 inch x 13.5 inch

Full Mega-Byte Ram Capacity! On board!
(16 pins)
256K Bytes using 64K chips
1 Mega Bytes using 256K chips

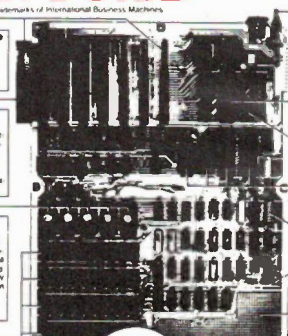

- Standard Keyboard Interface** (Full PC compatible)
- Hardware Reset** (Overcomes reset fail in PC)
- Power Connector** (Full PC compatible)
- 8088 Processor** (Same as PC)
- 8087 Numeric Processor** (Same as PC)
- Peripheral Support Circuits** (Same as PC)
- Configuration Switches** (Same as PC)
- Speaker/Audio Port** (Same as PC)
- Wire Wrap Area** (Available for custom applications)

ONLY! \$99.95 Evaluation Board kit
Evaluation Board kit
Includes highest quality PC board with gold plating, wire screen, solder mask

ORDER NOW!!!

CHERRY SWITCH \$99.00
IBM® KEYBOARD

At last a good low cost keyboard for the IBM PC, XT or compatible machine. Uses capacitive keys, has a very good feel, and has TYPEWRITER LAYOUT for easy word processing at the very low price of \$99.00

The amazing MEGABIOS® from DTC of Dallas. A fully rewritten BIOS that allows you to make a fully compatible legal system. Note they do not ask MEGABUCKS® for it, only ... **\$29.95**

TAIWAN BIOS, not as good or 100% compatible but it will get you running and save you bucks **\$19.95**

IBM BARE PCB

- (A) Color Graphics (Persyst) \$27.95
- (B) Monochrome graphics \$24.95
- (C) Disc controller \$17.95
- (D) Disc controller + Printer \$24.95
- (E) Disc controller + Game \$24.95
- (F) IO + 2 I/O clock etc. \$24.95
- (G) Multifunction card 11 function \$24.95
- (H) AST SIXPACK COPY \$34.95
- (I) Parallel printer \$17.95
- (J) RS-232 card \$17.95
- (K) Simple modem card \$17.95
- (L) Disc for above \$ 8.00
- (M) 512K card \$24.95

- (N) 256K short card \$19.95
- (O) IBM 6" extender for service \$19.95
- (P) WW Proto, full sized with DB9 & DB25 footprint \$24.95
- (Q) WW Memory proto, full sized with 256K (1 Meg) memory laid out on one end with DB9, DB25 footprint \$29.95
- (R) 512K Mapping PROM \$12.95
- (S) Multifunction PROMS(2) \$24.95
- (T) 2732 for color graphic \$10.00

All cards come with a detailed parts list and placement drawing, we also have all parts needed for them.

MBE-XT

MBE-XT Motherboard, wave soldered with no IC's at all with manual and schematics **\$149.00**
As above with 64K, BIOS, tested with all IC's and fully burned in, 8 Slots **\$325.00**

BASIC SYSTEM, MBE-XT, A & T with 256K with one 360K drive & controller with power supply, hinged lid case and MEGA-BIOS **\$895.00**

MBE-XT SYSTEM +. The fully loaded MBE-XT system with 256K on board, BIOS, Cherry keyboard, color graphics, 2-360K DSDD Drives with controller and serial, parallel ports, calendar, clock and many more small features, fully tested, ready to go **\$1395.00**

MEGABOARD

MEGABOARD Motherboard, Wave soldered with no IC's at all with parts list and schematics **\$195.00**

MEGABOARD Motherboard, Wave soldered with all IC's and 64K on board, with schematics and test data, no BIOS but fully burned in and tested with one **\$399.00**

BASIC SYSTEM, MEGABOARD, A & T with 256K (256K DRAMS) with one 360K DSDD Drive & controller with power supply and hinged lid case, and megabios **\$995.00**

MEGABOARD SYSTEM +. The fully loaded MEGABOARD with 640K on board (256K & 64K DRAM) with 2-360K DSDD drives and controller, color graphics board, with serial, parallel, clock, calendar, and many small features fully tested and ready to go **\$1999.00**

IBM CASE

We have the nicest case of all the various competing cases, ask any friend who has bought someone else's case and then has seen ours. The lid is hinged with pushbutton access. The back is cut for 8 XT slots and it comes with all the case back inserts for cards, card guides, blind disc filler plates, standoffs, feet, screws, all for **\$79.95**
Please specify back or side cutout for power supply.

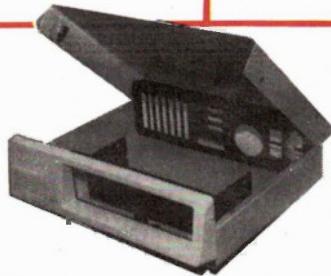

We also have an IBM 8 Slot/6502 Board dual duty case for making IBM look-a-like 6502 systems **\$79.95**

MEGABOARD CASE, similar to the above, but no pushbuttons or hardware, from DTC in Dallas Texas. A stronger US made case, but less finishing parts. Fits the MEGABOARD exactly with side cut extender, for back power supply **\$99.00**

SWITCHING POWER SUPPLY

110V, 60Hz with Fan and two rear switched outlets.

- These power supplies fit our cases:
- 100 WATT +5V-10A; +12V-3.5A; ±12V-1/2A **\$139.00**
- 130 WATT +5V-14A; +12V-4.2A; ±12V-1/2A **\$149.00**

Please specify, side or back switch



PARTS, PARTS, PARTS, PARTS, PARTS

Hard to get parts for your IBM compatible (8088) systems and peripherals

- 8088 CPU \$7.95
- 8087 Math Processor \$219.00
- 8237A-5 Prog. DMA Cntrl. \$8.95
- 8250 Serial Port \$9.95
- 8253A-5 Prog. Interval Timer \$5.95
- 8255A-5 P.I.A. \$4.85
- 8259A Prog. Interrupt Cntrl. \$4.95
- 8284A ADC clock gen & driver \$5.95
- 8288 Bus Controller \$9.95
- 8272 Floppy Disk Controller \$9.95
- NEC 765 Floppy Disk Controller (equivalent to 8272) \$9.95
- Set of 8088, 8255A-5, 8237A-5, 8288, 8284, 8253A-5, 8250, 8259A \$55.00
- 2716 \$3.95
- 2732 \$3.95
- 2764 \$4.95

LS for IBM Systems

- 00 \$0.39
- 02 \$0.39
- 04 \$0.39
- 08 \$0.39
- 10 \$0.45
- 20 \$0.45
- 27 \$0.45
- 30 \$0.45
- 32 \$0.60
- 34 \$0.50
- 38 \$0.70
- 158 \$0.75
- 175 \$0.80
- 243 \$1.20
- 244 \$1.25
- 245 \$1.50
- 273 \$1.50
- 322A \$5.00
- 323 \$3.50
- 373 \$1.40
- 374 \$1.40
- 377 \$1.25
- 670 \$1.75
- 7407 TTL \$1.00

Hard to get parts for your 6502 Systems and Apple Compatible Peripherals.

- 6502 CPU \$ 5.50
- 6845 CRT controller \$ 9.50
- 6845A CRT controller \$ 9.95
- 280A CPU (4 MHz) \$ 4.99
- MC3242 \$11.95
- 74LS367 \$.62
- 74LS259 \$ 1.39
- 74LS161 \$.99
- 74S74 \$.82
- 74LS174 \$ 1.70
- 74LS323 \$ 4.55
- Card edge connector (50 pin) \$ 2.49
- RCA jack PC mount \$.69
- 6 pin power square connector \$.99
- Phono jack (small) \$.99
- MPSA 13 trans \$.55
- 2N3904 trans \$.19
- 2N3906 trans \$.27
- MPSU51 trans \$.78
- 2N4258 transistor or equiv \$.99
- 1K SIP 10 pin \$.69
- 1K SIP 8 pin \$.69
- 10K SIP 10 pin \$.75
- 4 pin dip sw \$.95
- 20 pin female header for disk drive \$ 1.79
- 20 pin male \$ 1.69
- 50 pf trim cap \$.89
- 220 ohm trimpot \$.89
- 20 conductor ribbon cable \$.89/ft

DELAY LINES

- 100ns delay line \$5.00
- 7ns delay line \$13.95
- 62 pin edge con (high quality) \$1.89
- 5 pin Din conn \$1.25
- Power conn \$1.25
- Dip switch 8 pos \$2.49
- 4.7k x 6 slip \$.89
- 4.7k x 8 pin slip \$.89
- 8.2k or 10k 18 pin Resistor or network \$.99
- 33ohm x 8 network \$1.10
- Small speaker \$1.99
- 1 uf 50V high quality bypass capacitors \$.10
- Trimcap \$.99
- 34 pin card edge con. for your floppy controller \$5.95

S SERIES

- S00 \$0.75
- S02 \$0.75
- S04 \$0.75
- S08 \$0.75
- S16 \$0.85
- S18 \$1.75
- S19 \$1.85
- S158 \$1.85
- S374 \$3.25

MISC

- 75477 \$1.25

MONOLITHIC CAPS

MONOLITHIC CERAMIC CAPS
We bought 100,000 of em dirt cheap, they are very good quality. 63V, 0.2" lead spacing. Now only 10¢ ea.
50 pcs \$ 5.00
100 pcs \$ 9.00
1000 pcs \$85.00
more? ask!

5-1/4" WE'VE GOT EM!

HALF SIZE DRIVES!
For IBM PC, TI PC, XEROX 820

- Shugart/Panasonic 1/2 size SA455-3AEC **\$179.00**
- TEAC (A Cadillac Drive) 1/2 size FD55B **\$179.00**

CANON 1/2 HEIGHT
Canon entered the 1/2 height drive market with the nicest drive we have seen for a while. Fully IBM compatible. 40 Track. Very quiet. With all hookup data **\$149.95**

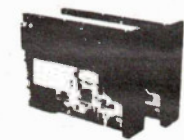

- 40 Track per side 48 TPI
- Double-sided, double density
- Same as SA455
- Latest head & drive technology
- Fast access time

TEAC

TEAC the nicest drive
FD55F \$219.00
with free DOS patch for 80 track.

- 80 Track per side 96 TPI
- Double sided, quad density
- Same as SA465
- Latest head & drive technology
- Fast access time

The Device Library

The device library includes a mathematical model of each of these components which in turn is defined by a number of device parameters. The device parameter selects the particular component to be used. Resistors, capacitors, inductors, batteries and switches use a simple parameter that specifies the value of the component. The other devices, such as op amps, use the parameter to define a particular device type. For example, the parameter "0" for the op amp devices specifies a part with the characteristics of a 709 op amp. Similarly, the bipolar transistor of parameter "0" corresponds to a 2N2222A. The user can modify the characteristics of the pre-defined devices, or add new devices. However, to add new devices, the user must be very familiar with the model parameters. For example, to define a new op amp the user must know the input resistance, open loop gain, output resistance, maximum output voltage, first pole, second pole, and slew rate. The manual details the actual model used for each device. There is a command that allows the user to list all the available devices in the component library, as well as to edit it.

Displaying

With the large number of possible components, one could quite easily fill up a single screen. Thus, MICRO-CAP allows

the user to spread a circuit over four screens, called pages, although only a single page can be viewed at one time. I should mention at this point that it is possible to get a copy of the schematic, or any other graphic display, on a printer by means of a "screen dump". This is done by using the standard GRAPHICS.COM utility and an Epson-type dot-matrix printer. If you don't have such a printer, then I'm afraid you're out of luck as far as getting a hard copy of the graphics goes, but then, that's the way most of the software for the PC works. The other way of getting a copy of the circuit is to have the program print out a copy of the netlist. This is a listing of what components are in a circuit, their value, and what nodes they are connected to.

One way to simplify a complex circuit is through the use of macros. This feature allows the user to define a circuit as a "black box" with from one to four connections to the outside world. Doing this would allow, for example, testing how a new circuit would interact with other types of circuits.

Once a circuit has been defined it can then be analyzed and its behavior simulated. With Fourier analysis, the user inputs a signal to the circuit and analyzes the output waveform for its frequency and phase components. This allows the designer to see exactly how the circuit modifies the input signal. The results can be seen in graphical form on the screen, or a table of numbers sent to the printer.

Transient Analysis

To simulate the actual operation of the circuit the designer would use the transient analysis option. The software in this case allows the user to view waveforms at any set of nodes (up to four at one time) in the circuit. The display looks and behaves very much like an oscilloscope. The user has a choice of showing voltage, current, power, or energy versus time. As with a real oscilloscope, the user must be careful to scale the ranges carefully to see the waveform of interest properly. One additional feature is that the software can calculate these waveforms for a range of temperatures, allowing the designer to monitor the effects of temperature. Since the user can specify the temperature coefficient of any component, one can easily determine which components are the most critical as far as temperature is concerned.

One can also use this feature to see the effect of varying the value of a single component. To do this, the user sets the temperature coefficient of all the components, except the one of interest, to zero. The result of all this is a series of waveforms superimposed on the screen that graphically shows the effect of this variation. As well, the user has the option of printing out this information in tabular

form on a printer.

The AC analysis option allows the user to determine the response versus frequency for the circuit. The actual parameters calculated are the gain (in dB), the phase shift, and the group delay. The results are displayed either graphically on the screen or in tabular form on a printer. As well, the user can perform the analysis over a range of temperatures.

Using the DC analysis option allows the user to study the circuit's steady-state response to an input voltage. The output is available as a graph on the screen or a table of values on the printer. The analysis can also be done over a range of temperatures.

Manual Labor

To my mind, one of the most important features of any software package is the manual. Without a good manual it is usually difficult to use a powerful package properly. The manual for MICRO-CAP II is excellent. Its 200 pages fully explain all the features of the package and how it works. The manual is divided into eight sections, introduction, designer module, analyzer module, transient module, AC analysis, DC analysis, component models, and appendices. The introduction briefly introduces the package, tells how to install it on the different computers, and offers a short "first time" tutorial. The other sections then go into detail about the various modules and options. The section on component models details the specifics of the mathematical models used for each component type. Every parameter is explained in enough detail to allow the user to add his own device types. There are seven appendices which discuss the maximum specs of the program, the required hardware, things to watch for, license agreement, generating user-defined sources, creating new data disks, and some examples. The examples, seventeen of them, range from very simple RLC circuits to the design for an op amp. Looking through the examples will give the user some idea of the tremendous power of this package.

Summing It Up

MICRO-CAP II is a powerful electronic design tool. It allows the user to easily define a circuit and then model its behavior. The documentation is extensive and well done, with lots of examples. This is not a general purpose tool, by any means, but for those people involved with electronic design, it will prove to be a valuable tool. I liked it.

Micro-Cap II is published by Spectrum Software, 1021 South Wolfe Road, Sunnyvale, California 94086.

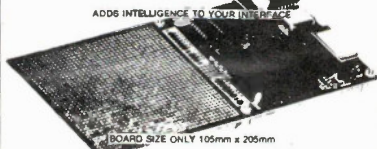

Micrologix
HS-80
ADDS INTELLIGENCE TO YOUR INTERFACE
BOARD SIZE ONLY 105mm x 205mm

SYSTEM FEATURES:

- Z80-CPU BASED
- Z80-PIO (TWO 8 BIT PROGRAMABLE PORTS)
- 8 DECODED INPUT PORT ENABLES
- 8 DECODED OUTPUT PORT STROBES
- FULLY BUFFERED DATA BUS
- 1 SETTABLE/RESETTABLE OUTPUT BIT
- CAPABILITY FOR NMI DRIVEN REAL TIME CLOCK (NMI DRIVEN BY SECOND ON BOARD CLOCK)
- CAPABILITY OF MULTI-TASKING USING THE MTHS-80 OPERATING SYSTEM
- EXPANDABLE TO 8K OF RAM AND 8K OF EPROM
- 5 VOLT OPERATION, PLENTY OF PROTO-TYPING SPACE, AND MORE!

PLEASE SEND ME THE FOLLOWING:

HS-80 BARE BOARD (\$21.95)	_____
HS-80 MANUAL (\$5.95)	_____
MTHS-80 OPERATING SYSTEM ON 2732A (\$30.00)	_____
MTHS-80 MANUAL (\$10.00)	_____
SUB-TOTAL	_____
ONTARIO RESIDENTS ADD 7% SALES TAX	_____
POSTAGE AND HANDLING (\$2.00 FIRST ITEM, \$1.50 EACH ADDITIONAL ITEM)	
TOTAL	_____

(PLEASE MAKE CHEQUE OR MONEY ORDER PAYABLE TO MICROLOGIX)

NAME _____
 ADDRESS _____
 CITY _____ PROV. _____
 POSTAL CODE _____ COMPANY _____

MAIL TO MICROLOGIX, P. O. BOX 976, STREETSVILLE, ONTARIO L5M 2C5

ALSO AVAILABLE AT
 EXCELTRONIX INC.
 319 COLLEGE STREET
 TORONTO, ONTARIO
 M5T 1S2

Circle No. 30 on Reader Service Card



There Are All Kinds Of Buttons For All Kinds Of Jobs ...

...from campaign to coat, from panic to push. When your product design calls for a single or multi-station, illuminated or non-illuminated push-button switch, you don't have to play "who's got the button?" Just specify Switchcraft. We're the hot button for one of the largest selections available, from IBS Miniature and Cord-Switches to Dual Visual Recognition switches and the LUS (Lighted Uni-Switch).

So whether your design is for a sophisticated lab instrument or a simple intercom, we've got what it takes to button up the job. That goes for consumer entertainment products, telecommunications, instrumentation, emergency lighting systems, AV, and medical electronics. And, you can be sure our Switchcraft quality and reliability will be right on the button.

Switchcraft®

A Raytheon Company



Represented in Canada, by—
Atlas Electronics Limited

50 Wingold Avenue, Toronto, Ontario M6B 1P7, Telephone 416-789-7761 Telex 069-69538

Branches: Quebec 514-337-5260 Ottawa 613-744-1212 Alberta 403-240-3838
 British Columbia 604-266-0682 Saskatchewan/Manitoba 204-889-0214

Circle No. 37 on Reader Service Card.

temperature.

Other items include proper safety grounding, bushings for conductors that pass through sheet metal, proper spacings of live parts, compliance with safety standards for high voltage probes and leads, proper labelling, and many more, all covered by the applicable manual of standards.

Here's a very important point once again: all components in your product which relate to the CSA investigation should be CSA-certified to begin with; otherwise uncertified components will have to be checked separately, slowing things down and raising the costs. You'll have to check the manual to determine which parts must be approved, but in general you should look for CSA-rated wire, power cords, switches, fuseholders, power transformers, etc. Incidentally, the American Underwriters Laboratories (UL) label on parts does not substitute for CSA certification.

Specifics

I asked Nick Maalouf, Manager of the Special Acceptance Program, what he thought were the most important things for an applicant to keep in mind.

"First, do your homework," he replied, "and second, CSA will go out of

its way to assist manufacturers in getting approval. Third, CSA realizes that time is important to manufacturers, and programs are tailored to suit the product. The Special Acceptance Program, in fact, is unique; there's nothing like it anywhere."

We can't do without technical standards. No one would argue the fact that products should be safe from fire and shock hazards, yet some manufacturers see CSA as just one more set of bureaucratic hurdles. Having been involved in various product submissions to CSA over the years, I can say that every single failure to get approval was due to our not reading the instructions, or not consulting CSA over doubtful points.

Here's the specific route to follow:

1. Obtain the current free CSA Service and Information catalogue from their nearest office.
2. Order the applicable publication covering standards for your product, plus any that you think might be relevant.
3. If you're stumped on ambiguous questions, consult CSA before beginning the applications procedure.
4. Obtain CSA's application form, which will ask for basic details (addresses, type of product and its uses, etc.) plus any helpful information such as operating in-

structions, schematics, wiring diagrams, and so on. A list of component parts showing maker's name, model numbers, ratings, and CSA file numbers will streamline things.

You're ready for the big moment. If you're applying under the Special Acceptance Program, or if your product is a bit large, a field visit can be arranged. Otherwise, you can now submit the application and one sample of your product (along with the deposit specified in the application).

After you receive approval and begin shipping your product, you may not make your million dollars in the first month, but you'll have the satisfaction of knowing that you built it right.

CSA offices are located in Moncton, Pointe Claire, Winnipeg, Edmonton and Richmond, BC, or contact the head office: 178 Rexdale Blvd., Ontario M9W 1R3, (416) 747-4007. ■

XT COMPATIBLE

- All major boards made in Japan
- Runs perfectly with Lotus 1-2-3, Flight Simulator, Auto Cad, etc.
- Compare our prices and quality
- All with 90 day warranty

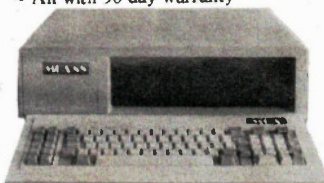

PACKAGE I\$1,250

- 256K 8088 XT mother board
- Colour graphic card
- Two 360K DS/DD disk drives
- Controller card
- Case, keyboard, 130 W power supply

PACKAGE II\$2,350

- 256K 8088 XT mother board
- Monochrome graphic and printer card
- One 360K DS/DD disk drive
- Controller card
- One 10MB Seagate hard disk drive with controller
- Case, keyboard, 130 W power supply
- Zenith TTL monochrome monitor

Dealer Inquiries Invited

XT PERIPHERAL

- Loaded 256K Japan made system board.....\$325.00
- Japan colour graphic card...\$159.00
- Japan monochrome graphic and parallel printer card.....\$239.00
- Japan controller card with cable.....\$99.00
- Loaded 384K multifunction card (clock, serial, parallel and game ports).....\$279.00
- Loaded 512K ram card.....\$199.00

DISK DRIVES

- Panasonic 360K DS/DD.....\$169.00
- Teac 360K DS/DD.....\$189.00
- Seagate 10M hard disk with controller and cables.....\$995.00
- Seagate 20M hard disk with controller and cables.....\$1,350

ACCESSORIES

- Hinged flip-top case (8 slot, for side switch).....\$75.00
- Japan keyboard.....\$120.00
- 130 W switching power supply.....\$149.00

ATTENTION! Hobbyist, Technician, Engineer: Compare Quality, Spec. & Price Before Buying Your Logic Probe!

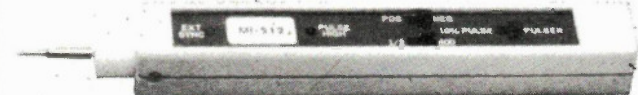

The MF504/MF505 Logic Probe is designed for quick servicing and checking of integrated logic systems. With its unique multi-lamp readouts, the logic probe visually displays the presence of correct logic levels by illumination of colored readouts. Incorrect logic levels are shown by the absence of colored readouts.

LOGIC PROBE	MF504	MF505
• Input Impedance:	3 Megohms	1 Megohms
• Minimum Detectable Pulse Width:	20ns	5ns
• Max. Input Frequency Displayed:	30MHz	100MHz
PRICE	\$32.50	\$37.50

LOGIC PULSER MF512 \$38.50

- Pulse Repetition Rate: 0.5pps/400 pps.
- Pulser: Normally high impedance (1 Meg ohms) output.
- Pulse Width in Pulser Mode: 10us typical
- Signal Delay from EXT SYNC to Output: 1.5us typical.
- Power Supply (Vcc): DC 5V 15V, 15mA 60mA

Mail orders: cheque, money order, Visa, MasterCard accepted. \$5.00 for shipping and handling. Ontario residents add 7% P.S.T.

SUNIX INC.

(Formerly Audiovision)

578 Marlee Ave. (at Glencairn subway)
Toronto, Ontario. M6B 3J5

Lots of free parking

TELEX: 06-217736 SUNIX TOR
TEL.: (416) 781-3263
In Dallas, U.S.A.: (214) 985-1842

The **BEST** is still "made in West Germany"

HAMEG model HM203-5

the 20MHz Oscilloscope that outsells all others in Western Europe

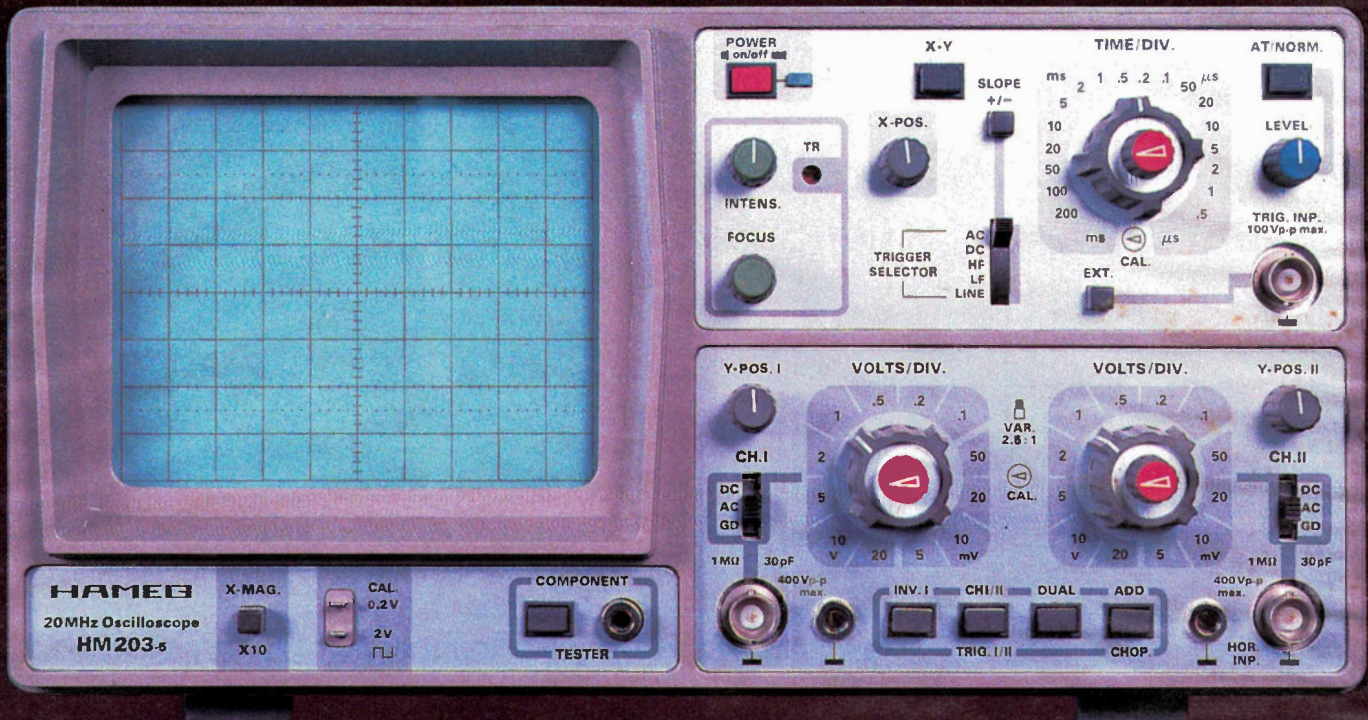

Until September 30, 1985

The model **HM203-5** will be available complete with probes at a special **HAMEG-BCS** price. This CSA approved Oscilloscope is complete with a **two year** parts and labour warranty; all for the special low price of

\$675⁰⁰*

FST Incl'd.

Immediate delivery from Stock
All major credit cards accepted.

Offer available only through



VISIT OUR EXHIBIT OCTOBER 7, 8, 9, 1985

Metro Toronto Convention Centre
Toronto, Canada

Booths 1618-1620-1622



980 Alness St. Unit 7,
Downsview, Ontario
M3J 2S2
(416) 661-5585
TELEX 065-28169

Mon-Fri. 8 am - 5 pm
Saturday: 10 am - 1 pm

*Price F.O.B. Downsview, Ont.

Circle No. 10 on Reader Service Card

Sinclair QL

The First 32-bit
Personal Computer for
under **\$800.00**



- 32-bit processor • 128K memory
- two built-in microdrives
- high resolution colour
- Includes software: word-processing, database management, spread sheet, graphics.

CALL 416-636-9415 TO ORDER...
Use your VISA or MASTERCARD

When you order your Sinclair QL from EDG Electronics, we'll ship it directly to your home or business, or now you can pick it up personally at an authorized Sinclair Customer Support Centre. Simply specify your choice of direct shipment or pick-up (the cost is the same) when you order. You get low direct pricing plus the benefit of personal service. When you pick-up your QL you will also be advised about the QL Consumer Education Programme (available at moderate extra cost) and the extended protection programme available beyond the ninety-day warranty period.

Personal pick-up available at AABEX locations in these cities:

Kitchener, Guelph, London, Windsor, Sudbury, Kingston, Ottawa, Montreal, Quebec, Trois-Rivieres, Chicoutimi, Edmonton, Winnipeg, Regina, Calgary, Victoria, Surrey, Vancouver.

The Sinclair QL revolutionizes the computer revolution. It offers the utmost in performance, speed and power at the remarkably low price of only \$799.95.

The QL is a full-size computer designed around the most powerful and advanced microprocessor yet created for the personal computer: the Motorola 68008. With 128K RAM, expandable to 640K. Two built-in Microdrives. Networking. A full-sized QWERTY keyboard. And its own operating system — QDOS — which accomodates windows and even multi-tasking. High resolution colour or black and white display, on either monitor or TV. Two RS-232C serial interfaces. Joystick cursor control.

That's just the hardware. The QL also comes with all the software you need to get started right away doing useful work. Word processing, Spreadsheet, Graphics, Database management. A powerful set of programs as sophisticated and as easy to use as any on the market.

Powerful software INCLUDED with your QL: Word Processor. Database Management. Spreadsheet. Graphics. These four programmes, supplied on microdrive cartridge, provide the most wanted features for home and business applications. These are fully INTERACTIVE programmes, meaning data from one programme can be transported to another (for example use figures from the spreadsheet to chart a graph in the graphics programme). All make use of the QL's colour capability. Help menus are provided. Multiple windows can be used. If sold separately these remarkable programmes would likely cost more than the price being charged for the entire QL package! Yet they are included with the QL at no additional charge.

Here are some of the incredible features of the Sinclair QL:

Two Powerful Processors: 32-bit main processor (68008), and Intel 8049 to control keyboard, sound, and RS232.

New Operating System: In addition to conventional DOS commands, the 32K ROM (expandable) provides single-user multi-tasking, allowing you to run several programmes individually and simultaneously. It also allows up to twenty independent windows to be viewed.

Fully expandable memory: The QL comes with 128K and is fully expandable up to 640K.

Professional keyboard: Full sized QWERTY keyboard with 64 keys including shift, function and four separate cursor control keys.

Two built-in microdrives: Sinclair's cartridge tape storage system provides high capacity data storage at a fraction the cost of floppy disk. Each stores up to 100K, easily and quickly accessible. Up to six more microdrives can be added externally.

Sinclair SuperBASIC: Adds new features to BASIC to allow the full power of the QL to be exploited. 'Procedure' facility allows code to be written in clearly-defined blocks. 'Extendability' allows new procedures to be added. 'Constant execution speed' allows long programmes to run much faster than other BASICS.

Your QL is supplied complete with everything you need to start computing immediately: cables, power supply, blank Microdrive cartridges, comprehensive instruction and programming manual, and complete guides to the software.

Make cheque payable and mail to:
EDG Electronics Distributors Inc.
3950 Chesswood Drive,
Downsview, Ontario. M3J 2W5

Please send	Each	Total
_____ Sinclair QL Computer	\$799.95	_____
_____ Shipping & Handling (per order)	15.00	_____
_____ Ont. res. add 7% PST	57.05	_____
	TOTAL	_____

Please ship to home/business address given OR

Please ship to AABEX location in _____ (name of city from above list). I understand they will notify me when the QL has arrived for pickup.

Enclosed is:
 Cheque Money Order Visa Mastercard
 Charge to:
 Number _____ Expiry _____
 Signature _____
 Name _____
 Address _____
 City _____ Prov. _____ Code _____
 Telephone _____

Tek's best-selling 60 MHz scopes: Now 25 ways better for not a penny more!

Now Tek has improved its 2213/2215 scopes with brighter displays. Greater accuracy. And more sensitive triggering. At no increase in price.

The 60 MHz 2213 and dual time base 2215 have been the most popular scopes in Tektronix history. Now, Tek introduces an "A" Series update with more than 25 specification and feature enhancements—things you have asked for such as single sweep—all included at no added cost.

A brighter display and new vertical amplifier design provides sharp, crisp traces.

That makes the 2213A/2215A a prime candidate for tasks like TV troubleshooting and testing, where fast sweeps are typical.

New features include 10 MHz bandwidth limit switch, separate A/B dual intensity controls (2215A only), and power-on light: additions customers have suggested for

giving these scopes the final measure of convenience.

Triggering, sweep accuracy, CMRR and many more major specifications are better than ever. Check the performance chart: not bad for scopes already considered the leaders in their class!

The Price: Still \$2033* for the 2213A and \$2456* for the 2215A. Or, step up to the 100 MHz 2235 for just \$2892*. Prices include two 10X probes, 15-day return policy, world-wide service back-up and comprehensive 3 year

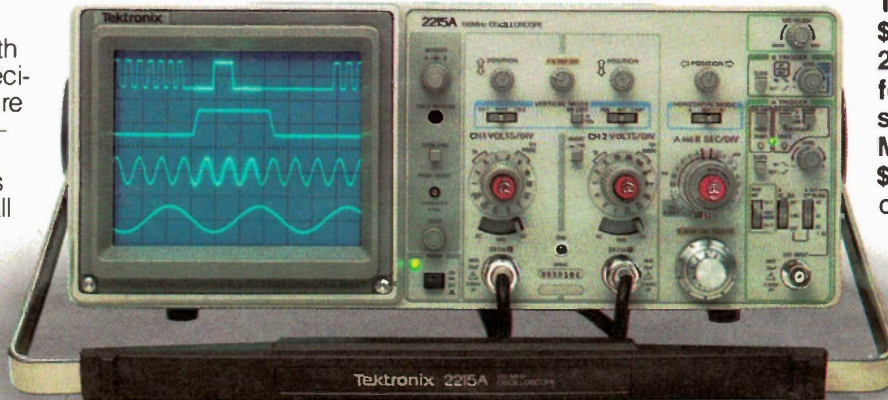

Specification enhancement	2213/2215 "A" Series	2213/2215
CRT brightness	14 kv accel. potential	10 kv accel. potential
Vertical accuracy	3%, 0° to 50°C	3%, +20° to 30°C
Chop rate	500 kHz	250 kHz
Input capacitance	20 pF	30 pF
CMRR	10 to 1 at 25 MHz	10 to 1 at 10 MHz
Channel isolation	100:1 at 25 MHz	Not specified
A Trigger sensitivity (int)	0.3 div at 5 MHz	0.4 div at 2 MHz
TV Triggering	1.0 div compos. sync	2.0 div compos. sync
Sweep accuracy (in 10X)	4%, 15° to 35°C	5%, 20° to 30°C
Delay jitter	20,000 to 1 (2215A) 10,000 to 1 (2213A)	10,000 to 1 (2215) 5,000 to 1 (2213)
Holdoff Range	10:1	4:1

warranty. Ask about our extended warranty.

Talk to our technical experts.

Vancouver	604-438-4321
Calgary	403-250-7583
Edmonton	403-434-9466
Winnipeg	204-632-4447
Toronto	416-675-3865
Ottawa	613-225-2850
Montreal	514-697-5340
Dartmouth	902-469-9476

Tektronix Canada Inc.
P.O. Box 6500
Barrie, Ontario
L4M 4V3

Tektronix
COMMITTED TO EXCELLENCE

*Duty and F.S.T. included.
Prices subject to change without notice.
All scopes are UL listed and CSA approved. 3-year warranty includes CRT and applies to 2000 family oscilloscopes purchased after 1/1/83

Quick... who makes the scopes that out-tech the competition?

NEW
100MHz
1590A

NEW
80MHz
1570A

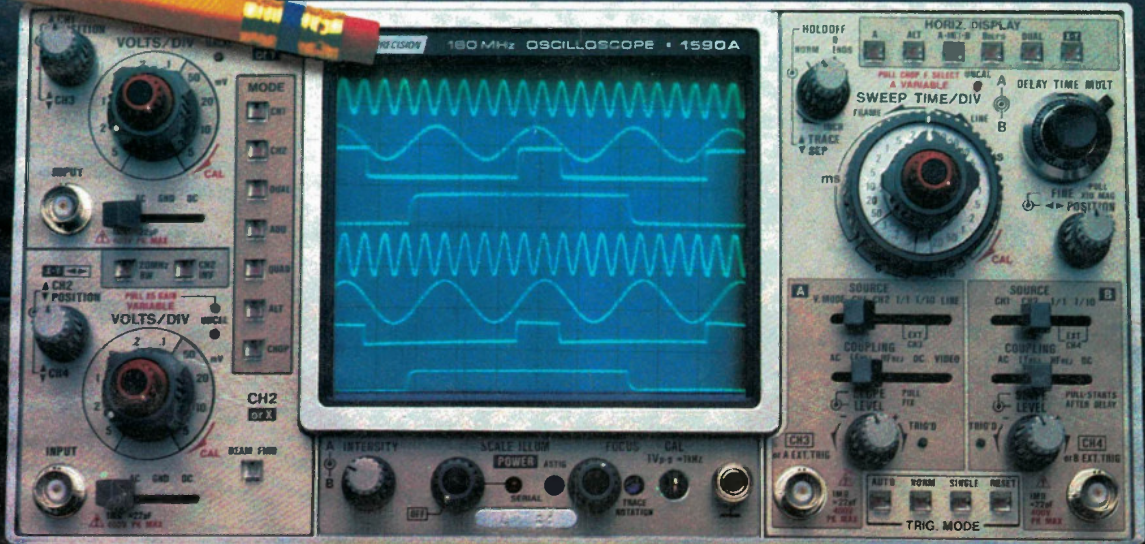

Compare these features and performance specifications.

Bright 20kV display
(12kV on 1570A)
with illuminated
graticule.

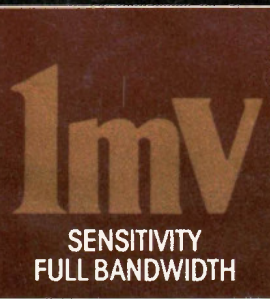
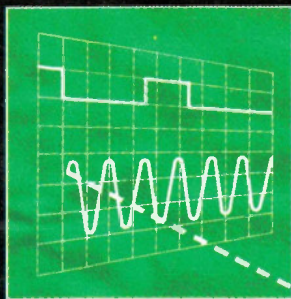

Dual timebase
with dual-
independent
timebase on
1590A



Four vertical inputs
with 8-trace display

- $\pm 2\%$ VERTICAL AND HORIZONTAL ACCURACY
- V-MODE DISPLAYS FOUR UNRELATED SIGNALS
- SOFT-TOUCH, LIT CONTROLS
- 500 μ V CASCADE SENSITIVITY
- CHANNEL 1 BUFFERED OUTPUT

Five times more
sensitive than
most competitors.

Compare all of the features and performance benefits
with any scopes in their price range. See your local
stocking distributor or phone: 416-789-7761

BK PRECISION DYNASCAN CORPORATION

is represented in Canada, by —
AE Atlas Electronics Limited
50 Wingold Avenue, Toronto, Ontario M6B 1P7
Telephone 416-789-7761 Telex 069-69538
Branches Quebec 514-337-5260 Ottawa 613-744-1212
 Albert 403-240-3838 British Columbia 604-266-0682
 Saskatchewan/Manitoba 204-889-0214
Prices/Specifications Subject to Change Without Notice.