

Electronics Today

\$3.25
MM70924

August 1985

Canada's Magazine for Electronics & Computing Enthusiasts

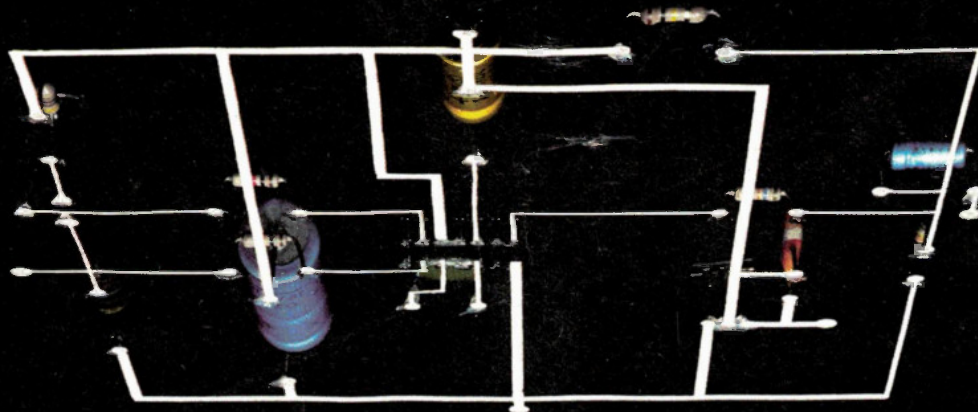

Circuit Special!

Our summer collection of analog and digital circuits

Commodore
RS232 Project
Add serial ports

Fundamentals
of Hearing
Hifi biology

Sound
Effects
Project
Simple but
versatile

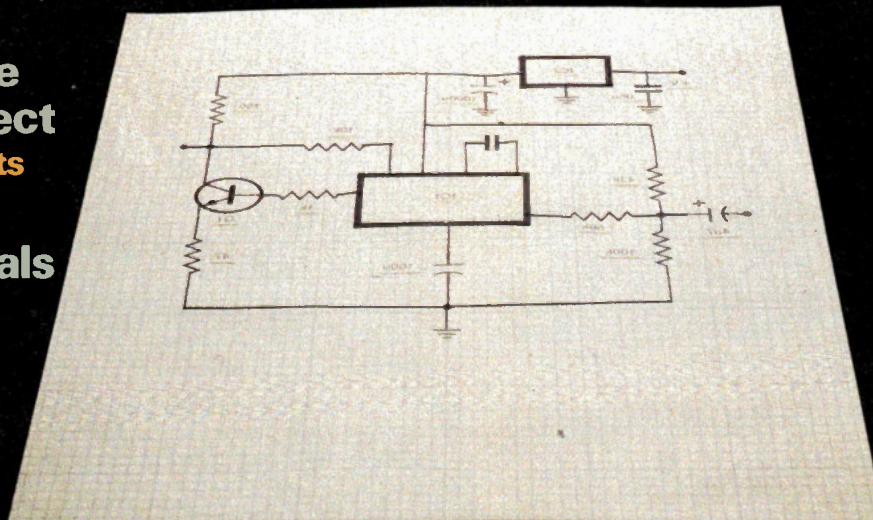

Time Domain
Analyze with

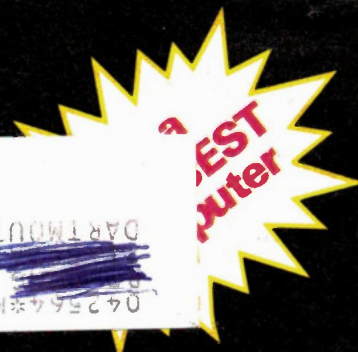
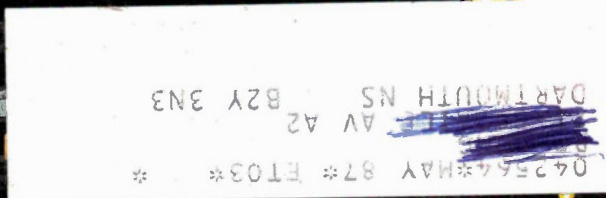

The BEST MK II Super PC and XT Compatibility

Look what you get as standard!

New Low Prices

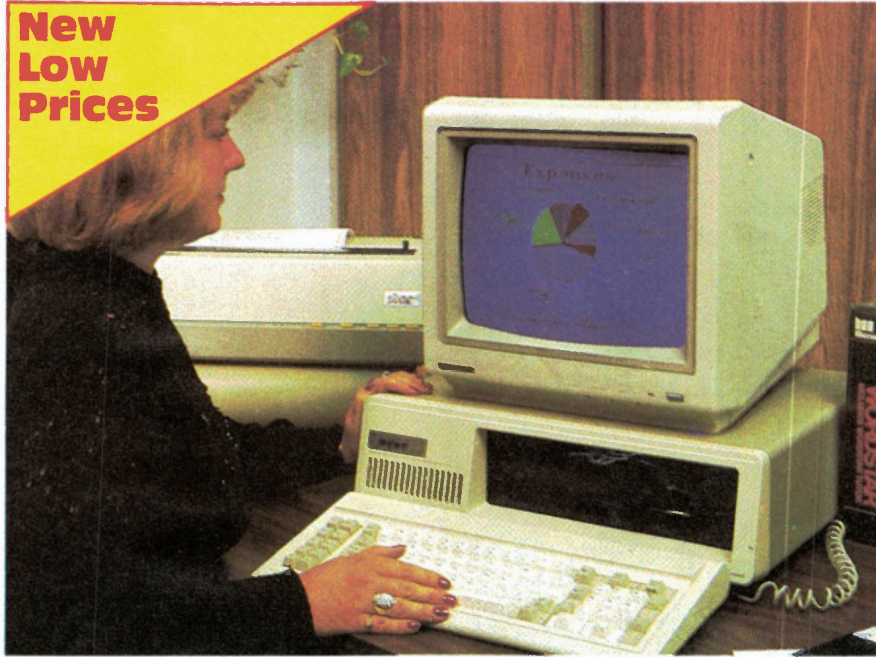

- Uses 8088 microprocessor.
- New Feature. 256K RAM as standard.
- New Feature. Comes with the latest 41256 RAM chips.
- Expandable up to 512K and more on main board using 41256 RAM chips.
- New Feature. 7 expansion slots, each being identical for the user to upgrade as required.
- New Feature. Fitted with 150W power supply so system can be upgraded to a hard disk without changing power supply.
- New Feature. Flip-Top case.
- DMA controller. Three of the DMA channels are available to the user.
- New Feature. Even most basic versions come with Parallel and Serial Ports and Real Time Clock.
- Half watt speaker.
- Pre-socketed for optional coprocessors such as the 8087 math processor.
- Keyboard Interface compatible with IBM compatible keyboards through a 5-pin DIN connector.
- Three ROM sockets are available to the user, one generally holding the Phoenix BIOS.
- New Feature. Reset switch.
- Timer/Counter used by the system for Real Time Clock, time base and for tone generation.
- Complete with the Phoenix BIOS, identical to that used by many of the large US companies manufacturing IBM compatible computers.
- Comes with two Slimline DS, DD 5 1/4" 360K Disk Drives.
- Colour Video (RGB and composite) and Disk Controller cards Included.
- 230V models available.
- 300 Day warranty.

Tape Drive option backup suitable for all systems \$Call

IBM is registered trademark of IBM Canada Ltd.

The BEST Mark II

As described above using 41256 RAM chips. Two 360K DS, DD disk drives, RS232 and parallel port, Real Time Clock, 7 slots, Phoenix BIOS, Colour Video and Disk Controller Cards, Keyboard and much, much more

With 256K \$1695

With 512K \$1795

The BEST 10 Meg Hard Drive

As the BEST Mark II but with 10 Meg Hard drive (supplied with one Floppy Drive. For second drive add \$200).

With 256K \$2695

With 512K \$2795

The BEST 20 Meg Hard Drive

As the BEST Mark II but with 20 Meg Hard drive (supplied with one Floppy Drive. For second drive add \$200).

With 256K \$2995

With 512K \$3095

Also the Basic BEST \$1595.00

As the BEST Mark II described above but without Parallel Port or Real Time Clock

The Best 256K PENTARAM BEST SELLER

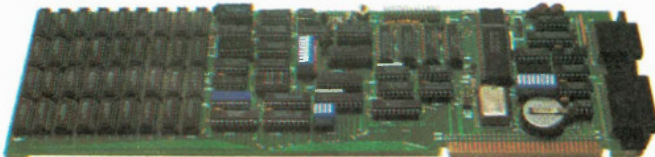

\$299.00 with 256K RAM, Real Time Clock Parallel, serial and Game Port.

New Multifunction Floppy Controller for your IBM or Compatible.

Includes: Floppy Controller (up to 4 DS, DD drives) Parallel Port, Real Time Clock/Calendar (with battery backup) and 2 Serial Ports (of which only one is installed, the second is an optional extra at \$29.00) **\$199.00**
(Real Time Clock software is Included — cables are extra)

Parallel/Game Port (For IBM or Compatible) **\$79.00** (cables extra)

Quanta Board with Parallel and Game Port, 2 Serial Ports and Real Time Clock **\$159.00** (cables extra)

EPROM Programmer \$99.00 (with ZIF Socket Adapter **\$159.00**)

BEST 512K RAM BOARD

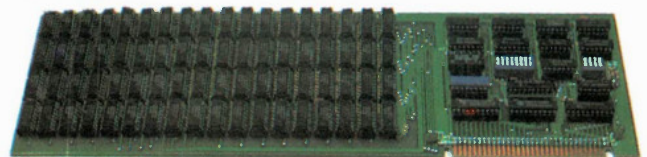

SPECIAL: \$229.00 with 512K. With 64K **\$149.00**

Colour Graphics Video Board \$179.00 (Composite and RGB Output)

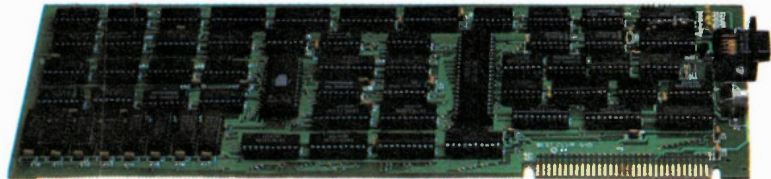

Quantity, Students and Teacher discount's available.

CHARGE X

master charge

Exceltronix Computer Division Computers at unbeatable prices! (416) 921-8941, 319 College St., Toronto, Ontario

EXCELTRONIX

No returns or exchanges after 7 days. 15% restocking charge.

Prices may change without notification

217 Bank Street, Ottawa (613) 230-9000

M5T 1S2

1-800-268-3798 —

Order line only

Circle No. 3 on Reader Service Card

319 College Street, Toronto, Ont, M5T 1S2 (416) 921-8941
217 Bank Street, Ottawa, (613) 230-9000 Mail Order Enquiries (416) 252-5285
We guarantee you the combination of BEST Prices & Service In Canada!

New from Star Micronics SG-10 Printer

- Dual Mode - NLQ/draft standard (NLQ = near letter quality) • 120 CPS and 20% faster throughput
- Bidirectional logic/seeking • 2K buffer (expandable to 6K with optional buffer interface) • 100% IBM PC or Star standard control codes-switch selected • Friction and tractor standard • full 1 year warranty • 10" wide carriage • Standard parallel interface (serial optional)

\$399.00

SG-15 same as SG-10

Except with 15" carriage and standard 16K buffer **\$599.00**

Radix — \$995.00 SR-15 \$995.00

Star Micronics Gemini 10X 1 year warranty

- 120 c.p.s., • 816 characters print buffer, option 4K or 8K • standard parallel optional RS232C • tractor & friction feed. **Super Special \$299.00**

(Time limited offer)

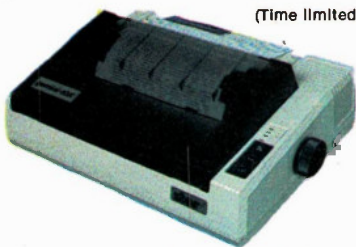

POWER TYPE LETTER QUALITY \$599.00

- 18 CPS bidirectional logic seeking.
- 96 Petal Wheel

IBM COMPATIBLE KEYBOARDS

Cherry **\$135.00**
Maxlswitch **\$135.00**

Super Special
Keytronics Programmable
Keyboard (no case) \$69.00

IBM Compatible Disk Drive SA455

(with warranty)

\$169



CASES FOR YOUR IBM Compatibles

- Hinged top cases allowing easy access by opening top half of the case. Can be supplied with plain back or for 5 or 8 slots. Please specify when ordering. **\$74.95**

- Above case with power supply and fan For Apple compatible 75 Watt **\$169.00**
- For IBM compatible 150 Watt **\$219.00**

Hinged Case with 90W (max.) Power Supply with fan **\$178.00**

As above with 175W (max.) Power Supply and fan **\$228.00**

APPLE COMPATIBLE DISK DRIVES

Now also available for Apple IIC

Famous
Multiflex
Disk
Drive



\$199.00

1 year full warranty.

Features:

- Apple compatible • Attractively packaged • Professionally built and tested • Canadian Made. We believe that Multiflex put out more drives in the last year than all other Canadian manufacturers combined.

Monitors Zenith Data Systems



BEST SELLER ZVM 122A • 12" diagonal screen • non-glare amber display • composite input • 25 lines x 4080 characters **\$135.00**

BEST SELLER ZVM 123A • 12" diagonal screen • non-glare green display • composite input • 25 lines x 4080 characters **\$125.00**

ZVM 133 • 13" diagonal screen • RGB input • 25 lines x 80 characters • 640 x 240 pixels green screen only switch • 16 colours including PC brown **\$749.00**

Peripherals for your Apple

Z80 **\$ 43.00**
80 x 24 Video Card with Soft Switch **\$ 67.00**
16K RAM Card **\$ 43.00**
128K RAM Card with 128K **\$ 99.00**
Parallel Card with Cable **\$ 59.00**
Serial Card **\$ 69.00**
Apple Programmer **\$ 65.00**

Multiflex 300 Baud Modem

For your Apple (Super compatibility) **\$159.00**

BEST IBM Compatible Modem

- Plugs into motherboard
- Excellent Hayes compatibility
- Auto Dial, Auto Answer, Directconnect

300 Baud **\$179** 300/1200 Baud **\$379**

Hard Disk Drives

Seagate (industry favoured)
10 MEG. slimline **\$889.00**
10 MEG Seagate, slimline drive and hard disk controller. This controller can handle up to two 10 MEG hard drives. **LOWEST PRICE OF \$1099.00**
Quantity Discounts Available
Seagate 20 MEG. slimline **\$1099.00**
Seg 20 MEG. with controller **\$1395.00**
Controller alone (for 10 or 20 MEG) **\$349.00**
Cables (for 10 or 20 MEG) **\$38.00**

MEMORY Untouchable Prices! Guaranteed Prime Stock Dynamic RAMs

4116 1x16k (150ns) **\$ 0.75**
4164 1x64k (150ns) **\$ 1.49**
4164's (150ns). Set of 9 **\$12.99**
41256 1x256k (150ns) **\$ 9.95**
41256 (150ns). Set of 9 **\$89.00**

Static RAM

2114L 4x1k 200ns **\$ 2.25**
6514 4x1k CMOS 450ns **\$ 1.20**
6116 8x2k 150ns **\$ 5.95**
2016 8x2k 150ns **\$ 4.99**
6164 8x8k 150ns **\$29.00**

EPROMS

2716 450ns 8x2k **\$ 5.50**
2716 300ns 8x2k **\$ 6.50**
2732 450ns 8x4k **\$ 4.89**
2732 250ns 8x4k **\$ 4.89**
2764 300ns 8x8k **\$ 5.89**
27128 350ns 8x16k **\$11.95**

EPROM Program **\$99.00**

(with ZIF Socket Adapter **\$159.00**)

Special Parts for your IBM & Apple Compatibles Intel Parts

8087-2 (High Speed) **\$259.00**
8087 **\$219.00**
8088 **\$14.50**
8237A-5 **\$14.50**
8250 **\$10.95**
8253A-5 **\$ 7.45**
8255A-5 **\$ 6.90**
8259A **\$ 6.95**
8284A **\$ 7.75**
8288 **\$14.95**
NEC765/8272 Equiv. **\$12.95**
74LS322 **\$ 5.95**
62 Pin Card Edge Connectors **\$ 2.19**
5 Pin Din Connector **\$ 0.99**
100ns Delay Line **\$ 5.89**
6502 CPU **\$ 5.45**
Z80A CPU **\$ 4.50**
68A45 CRT cont. **\$ 9.75**
TMS99532 FSK Modem **\$17.95**
Set of 8088, 8255A-5, 8237A-5, 8288, 8284, 8253A-5, 8259A **\$64.00**

High Quality AMP IC Sockets

8, 14, 16, 18, 20, 24, 28 and 40

1.5 cents per pin

Quantity discounts available

Bypass Capacitors

0.1 uF, 50V **.13¢**
100 pieces **\$9.00**

Fans

New 3in fan **\$12.95**
New 4in fan **\$13.95**

We have the best prices on 74LSXX TTL Series e.g:

74LS-00, 02, 04, 08, 10, 32 at **29¢ each**
74LS-138, 139, 158, 175 at **69¢ each**
74LS-244, 245, 273 at **\$1.19 each**

SURPLUSTRONICS

we will not be undersold

8088 Computer

The Price Barrier Smashed!
\$995



Includes:

- 8088 motherboard with 256K and all parts (except 8087)
- Phoenix Bios
- One 360K DS, DD disk drive and controller
- Power Supply with fan
- Flip-top case

All you need extra is a keyboard, video board and monitor.
8088 Motherboard only with 64K, fully assembled and tested, no Bios (one blank 2764). Expandable to 1Meg on-board memory. Flow soldered. Provision for 8087 **\$299.00**

6502 Systems

The Famous 6502 Board



- Assembled and fully tested (flow soldered)
- 64K, 80 x 24 video with soft-switch, floppy controller.
- System comes with blank EPROM'S on board, does not come with any proprietary software or Basic ... **\$249.00**

Complete System

- 6502 board (as illustrated above) with case, keyboard and power supply **\$399.00**

Complete System

- Using 6502 board above in IBM style flip-top case, using powerful 75 watt power supply with fan, programmable serial keyboard adaptor, IBM style keyboard ... **\$499.00**

- As above with one built in disk drive **\$749.00**
- As above with two drives **\$899.00**
- Switching Power Supplies. +5V 5A, +12V 2.8A, +12V 2.0 Amps - 12V 0.5A (open frame) **\$39.00**
- Panasonic Printers (open frame) **\$39.95**

PERIPHERAL CARDS FOR YOUR IBM AND COMPATIBLE COMPUTER

- Colour Video Board** **\$159.00**
Composite video or RGB Video
- Floppy Controller** **\$119.00**
- Floppy Controller with RS232** ... **\$149.00**
- Floppy Controller w. clock/RS232** **\$159.00**
- Parallel and Game Port Card** **\$59.00**
Cable and connector extra.
- Peripheral Interface Card** **\$139.00**
Includes two serial ports, parallel port, game port and provision for (but not including) real time clock.

- Clock/Calendar Option** **\$29.00**
With battery backup.

256K & Multifunction Board
Includes: Serial port, parallel port, game port, provision for optional real time clock/calendar and socketed for up to 256K RAM.

- With 64K RAM** **\$149.00**
- 512K Board.** Socketed for 512K including:

- 64K RAM** **\$119.00**

IBM Compatible Disk Drives **\$159.95**
Brand New, fresh from factory. Shugart SA455 40 track, double sided, double density Slimline. We have ordered 10,000 from Shugart - that is why we can pass the savings on to you.

IBM Compatible Keyboards

- Keytronics programmable (no case) **\$ 59.00**
- Maxiswitch **\$129.00**
- Cherry **\$ 99.00**

Cases - High Quality

Hinged for easy access, can be supplied with plain back or for 5 or 8 slots. Please specify **74.95**
Above case with power supply and fan.

- For Apple compatible (75W) **\$169.00**
- For IBM compatible (150W) **\$219.00**

PERIPHERAL CARDS FOR YOUR APPLE & COMPATIBLE

- Assembled, flow-soldered/cleaned and 100% tested
- 16K RAM Card **\$ 39.00**
 - 80x24 video card **\$ 59.95**
 - Z80A Card **\$ 39.00**
 - Parallel Printer Card (cables extra) **\$ 29.00**
 - 128K RAM Card with 128K **\$ 85.00**
 - EPROM Programmer with Software **\$ 63.00**
(programs 2716, 2732, 2732A, 2764)
 - 8" Floppy Controller **\$ 79.00**
 - Modem Autoanswer/autodial, touch tone or pulse dial. Plugs right into the system **\$ 69.00**
 - Apple Compatible Disk Drives (SA390) **\$175.00**
 - Case with numeric keyboard **\$129.00**
 - Power Supply (Hydro Approved) **\$ 69.00**

IBM is a registered Trade Mark of IBM Canada Limited Apple is a registered Trade Mark of Apple Canada Limited

Mail Orders add \$5.00 minimum for shipping & handling. Ontario residents add 7% P.S.T. Visa, Mastercard and American Express cards accepted: send card number, expiry date, name of bank and signature. Send certified cheque or money order, do not send cash. All prices on this page are final sale. No warranty, No returns, No refunds but HUGE savings. Warranties available at extra cost.

Surplustronics, 310 College Street, Toronto, Ontario, M5T 1S3

More lines to serve you better
(416) 960-1350



Our Cover

The Circuit Special contains lots of ideas for the experimenter, page 34; photo by Bill Markwick.



Audit Bureau of Circulations

Electronics Today is Published by:

Moorshead Publications Ltd. (12 times a year)
Suite 601, 25 Overlea Blvd.
Toronto, Ont. M4H 1B1
(416) 423-3262

Editor: **William Markwick**
Editorial Assistant: **Edward Zapletal**
Director of Production: **Erik Blomkwist**
Creative Manager: **Ann Rodrigues Maia**
Production: **Douglas Goddard**
Naznin Sunderji
Sandra Hemburrow

Circulation Manager: **Lisa Salvatori**
Account Manager: **Marlene Dempster**
Advertising (Que.) **John McGown & Associates**
(514) 735-5191
Advertising (B.C.) **(604) 688-5914**

Publisher: H.W. Moorshead; **Executive Vice-President:** V.K. Marskell; **Vice-President - Sales:** A. Wheeler; **General Manager:** S. Harrison; **Controller:** B. Shankman; **Accounts:** P. Dunphy; **Reader Services:** M. Greenan, H. Brooks, R. Cree, L. Robson, N. Jones; **Advertising Services:** A. LeBrocq.

Newsstand Distribution:
Master Media, Oakville, Ontario

Subscriptions:
\$19.95 (one year), \$34.95 (two years). Please specify if subscription is new or a renewal.

Outside Canada (US Dollars) U.S. add \$3.00 per year. Other countries add \$5.00 per year.

Postal Information:
Second Class Mail Registration No. 3955. Mailing address for subscription orders, undeliverable copies and change of address notice is: Electronics Today, Suite 601, 25 Overlea Blvd., Toronto, Ontario, M4H 1B1

Printed by Heritage Press Ltd., Mississauga
ISSN 07038984.

Moorshead Publications also publishes Computing Now!, Computers in Education, and Software Now!.

Advertisers' Index

Active Components Sales Corp.	59
Advance Interface Electronic Inc.	8
BCS Electronics Ltd.	31, 62
Computer Parts Galore	28, 29
Duncan Instruments Ltd.	30
EDG Electronics Distributors	30, 61
Exceltronix	2, 3
Information Unlimited	58
Kaientai Electronics Merchants Ltd.	59
McGraw-Hill	25
Orion Electronics	39
Patron Components Inc	36
Soltech Industries Inc.	40
Surplustronics	4
Tektronix Canada Inc.	64
The Software Link, Inc.	63
Varah Direct	7

Electronics Today

August 1985
Vol. 9 No. 8

Canada's Magazine for Electronics & Computing Enthusiasts

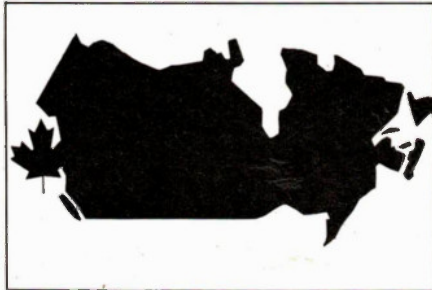

Electronics In Canada pg. 17

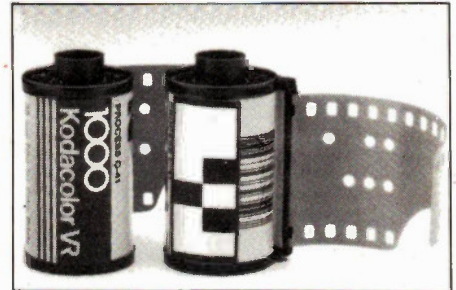

Kodak's DX Coding pg. 9

Features

Kodak's DX Coding	9
Time Domain Analysis	10
Circuit Special	34
Fundamentals of Hearing	44

Projects

RS232 For Commodores	23
Sound Effects Projects	32

Series

Electronics From The Start, Part 2	14
Electronics In Canada	17
Designer's Notebook: 7800 Regulators	26
Computing Today: Z80, Part 3	38
For Your Information	6

Columns and Information

Software	19	Order Form	51
Electronics Today Next Month	46	Subscriptions	52
Computing Now! This Month	47	Binders	55
Software Now! This Month	47	Product Mart	56

Copyright

All material is subject to worldwide copyright protection. All PCB patterns are copyright and no company can sell boards to our design without our permission.

Liability

While every effort has been made to ensure that all constructional projects referred to in this magazine will operate as indicated efficiently and properly and that all necessary components are available, no responsibility whatsoever is accepted in respect of the failure for any reason at all of the project to operate efficiently or at all whether due to any fault in the design or otherwise and no responsibility is accepted for the failure to obtain component parts in respect of any such project. Further no responsibility is accepted in respect of any injury or damage caused by any fault in design of any such project as aforesaid.

Editorial Queries

Written queries can only be answered when accompanied by a self-addressed, stamped envelope. These must relate to recent articles and not involve the staff in any research. Mark such letter Electronics TodayQuery. *We cannot answer telephone queries.*

Binders

Binders made especially for Electronics Today (ETI) are available for \$9.75 including postage and handling. Ontario residents please add provincial sales tax.

Back Issues and Photocopies

Previous issues of Electronics Today Canada are available direct from our office for \$4.00 each; please specify by month, not by feature you require. See order card for issue available.

We can supply photocopies of any article published in Electronics Today Canada; the charge is \$2.00 per article, regardless of length. Please specify both issue and article.

Component Notation and Units

We normally specify components using an international standard. Many readers will be unfamiliar with this but it's simple, less likely to lead to error and will be widely used everywhere sooner or later. Electronics Today has opted for sooner!

Firstly decimal points are dropped and substituted with the multiplier: thus 4.7uF is written 4u7. Capacitors also use the multiplier nano (one nanofarad is 1000pF). Thus 0.1 uF is 100nF, 5600pF is 5n6. Other examples are 5.6pF = 5p6 and 0.5pF = 0p5.

Resistors are treated similarly: 1.8Mohms is 1M8, 56kohms is the same, 4.7kohms is 4k7, 100ohms is 100R and 5.6ohms is 5R6.

PCB Suppliers

ETI magazine does NOT supply PCBs or kits but we do issue manufacturing permits for companies to manufacture boards and kits to our designs. Contact the following companies when ordering boards.

Please note we do not keep track of what is available from who so please don't contact us for information PCBs and kits. Similarly do not ask PCB suppliers for help with projects. K.S.K. Associates, P.O. Box 266, Milton, Ont. L9T 4N9.

B—C—D Electronics, P.O. Box 6326, Stn. F., Hamilton, Ont. L9C 6L9.

Wentworth Electronics, R.R. No. 1 Waterdown, Ont. LOR 2H0.

Danocinths Inc., P.O. Box 261, Westland MI 48185 USA.

Arkon Electronics Ltd., 409 Queen Street W., Toronto, Ont., M5V 2A5.

Spectrum Electronics, 14 Knightswood Crescent, Brantford, Ontario N3R 7E6.

For Your Information

WELCOME to our new expanded version of For Your Information. Surveys have shown it to be a very popular part of the magazine, and we'll be featuring more new products, more technology, and more news items. There'll be coverage of upcoming trade shows and speculations on trends in the electronics industry. Letters from readers will also figure prominently - let us know your views, good or bad, and we'll see that FYI becomes a forum for opinion.

What, no computer review? After some years of reviewing a new computer model each month, we've decided that the stabilizing computer market no longer warrants a regular feature. Reviews will still be seen on an occasional basis.

Headlining a press release from the Minister of State for Science and Technology: "Canada and Quebec Sign Agreement on Scientific and Technological Development". Canada and Quebec? Now, we know what they meant was the Federal Government and the Quebec provincial government, but headlines like that sure don't do much for unity, particularly if they're published.

However, they've redeemed themselves with the new incentives for stimulating Canadian research and development. Anyone involved in R&D should investigate the new budget's rulings on: eligibility of R&D expenditures for tax deductions (all R&D can be claimed), the 35 percent R&D tax credit is now fully refundable, and capital gains exemptions will be increased. There are also changes to investment rules to stimulate inflow of capital to firms, and more financial and technical help is available.

A booklet is available giving R&D budget highlights and further contact information. It's called "Research & Development and the Budget" and is available from the Communications Branch, Ministry of State for Science and Technology, Ottawa, Ontario, K1A 1A1, (613) 990-6142.

Statistics Canada and the Electrical and Electronic Manufacturers Association report that the electronics industry did well in the first quarter of this year, with shipments up about 18 percent over last year, and employment up slightly. Imports still exceed exports by about two to one; the top six categories for imports were semiconductors, tape machines, ICs, components, radio-phonosets and commercial communications equipment.

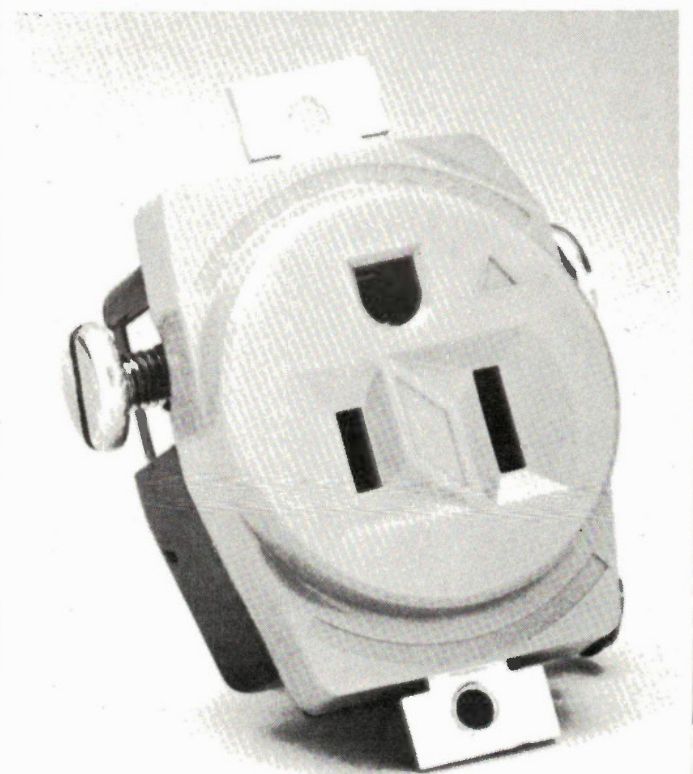
**Isolated Ground**

Arrow Hart, a division of Crouse-Hinds Canada, should get the Nobel Prize for this one. It's a 15 or 20 ampere power receptacle which is grounded via an isolated screw terminal. No ground connection is made to the mounting panel or wall box. This lets you isolate

sensitive test equipment from the noisy power ground and connect it to a water pipe or similar. It beats ripping off the third pin any day. Also available in 49 other types of power receptacles. Crouse-Hinds Arrow Hart, 1160 Birchmount Road, Scarborough, Ontario M1P 1B9, (416) 757-8781.

Circle No. 60 on Reader Service Card.

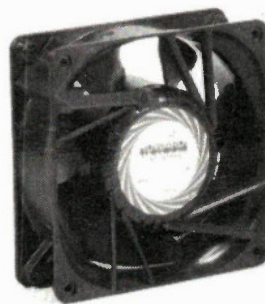
**DC Fans**

These brushless DC fans from Howard Industries feature 12 or 24 volt operation, an optional pulse output for speed monitoring, choice of 50, 75 or 100 CFM, and sleeve or ball bearings. There's also another smaller version for airflows of 13, 20 or 27 CFM. We

have no idea what a cubic foot per minute is in metric. An optional TTL-level logic control provides a means of controlling the operation. From Weber Division of DGW Electronics, 85 Spy Court, Markham, Ontario L3R 4Z4, (416) 475-8500.

Circle No. 59 on Reader Service Card.

New Fluke Meter

Fluke announces a variation on their excellent 70-series digital multimeters, the new Models 21 and 23. They have the digital plus analog display, auto-everything, and optional Touch Hold of the 70s, but are specifically designed for rugged use; they're said to provide exceptional operator safety in high-risk situations. The 23, for instance, is said to be "10 amp fused for protection to 100,000 amps". We aren't sure if anyone would want to be holding onto it while 100,000 amps went through it. At distributors across Canada, or contact Allan Crawford Associates Ltd., Test and Measurement Division, 5835 Coopers Ave., Mississauga, Ontario L4Z 1Y2, (416) 890-2010.



Circle No. 58 on Reader Service Card.

Representatives from Canada's computer industry met this June with a parliamentary subcommittee reviewing Canada's copyright law. John Reid, Chairman of the Canadian Business Equipment Manufacturers Association criticized government suggestions that would have limited software copyright to only five years. In other countries, software developers have the same protection as literary authors. In Canada, literary authors enjoy copyright protection for life, plus another 50 years for the estate.

Here's a question we should have come across for last month's Electricity Contest: who coined the computing word "bit"? The man's name was John Wilder Tukey, according to a release from Bell Labs. Retired in June from his position as Bell Lab's associate director of information sciences, Dr. Tukey was one of the world's leading statisticians and a pioneer in data analysis. He is said to have given the word to computer researchers at Bell Labs in 1946.

continued on page 50

Varah's direct

FINALLY!

A complete range of electronic components **DIRECT** from Varah's and leading manufacturers. Absolutely no surplus, no rejects, no old date codes, and all at **DIRECT** from the distributor prices!

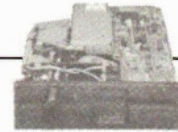

Improve Your Memory

Drives:

- best quality from Tandon
- fully pre-tested and guaranteed
- 500K Bytes

TM65-2 or TM100-2
1/2 ht. or full ht.

only \$199.95

NEW! 10 Meg Kit:

Upgrade your PC.

Includes:

- Tandon TM252 10 Meg hard disk.
- DTC controller card.
- and all necessary connects to get you going!
- fully covered by the Varah's Direct Guarantee.

Introductory Priced
\$949.95

Multimeter Special

HioKI 3200-50

Large 13mm LCD 3 1/2 Digit Display
Drop-proof and Dust-Proof

Auto and Manual Ranging
AC/DC to 10A
DC to 1000V.
AC to 750V
Ohms to 20M Ohms
Diode Tester
Reg. \$179.95
Now **\$129.95**



Quality Scopes from Meguro

Full 2 year warranty!

20 MHz 2-channel \$675.00
Contains Component Tester
35 MHz 2-channel \$895.00
Single sweep and trigger delay function

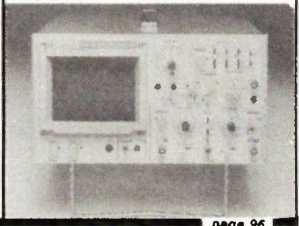

page 96

Static RAM Specials		6116-150ns (2K x 8)		\$5.49		4/\$19.95	
		6264-150ns (8K x 8)		\$16.49		4/\$59.95	
7400				LS			
Stk #	Qty	Price	Stk #	Qty	Price	Stk #	Qty
14000	4	1.95	14200	4	1.75	74LS00	4
14004	4	2.25	14202	4	1.75	74LS02	4
14006	4	3.00	14204	4	1.85	74LS04	4
14007	4	3.00	14206	4	1.85	74LS08	4
14010	4	2.20	14208	4	1.85	74LS10	4
14012	4	3.00	14220	4	1.85	74LS32	4
14014	4	3.00	14235	4	1.95	74LS74	4
14015	4	3.00	14241	4	2.25	74LS86	4
14022	4	2.20	14260	4	3.00	74LS138	4
14026	4	3.00	14261	4	3.00	74LS139	4
14035	4	2.20	14284	4	3.50	74LS174	4
14042	4	3.00	14285	4	3.50	74LS175	4
14062	4	3.00	14300	2	2.95	74LS240	2
14082	2	2.25	14304	2	2.95	74LS244	2
14110	4	4.15	14305	1	2.30	74LS245	1
14112	4	4.15	14340	1	1.80	74LS373	1
HCMOS				LINEAR			
Stk #	Qty	Price	Stk #	Qty	Price	Stk #	Qty
15000	4	2.25	16010	5	2.50	555	5
15002	4	2.40	16297	5	2.50	XRL555	5
15004	4	2.40	16015	2	1.75	556	2
15014	4	2.40	16160	2	1.35	339	2
15018	4	2.40	16130	2	1.35	324	2
15025	4	3.40	16115	5	2.50	741CP	5
15028	4	3.20	16210	4	2.75	4558	4
15042	2	2.80	16234	2	1.95	TL082	2
15055	2	3.05	16090	2	1.50	1488	2
15066	1	2.55	16092	2	1.50	1489	2
15072	1	4.25	16300	2	1.95	7805CT	2
15074	1	2.40	16310	2	2.15	7905CT	2
15075	1	3.80	16306	2	1.95	7812CT	2
15098	2	4.40	16314	2	2.15	7912CT	2
15099	2	4.40	16308	2	1.95	7815CT	2
15104	2	3.25	16318	2	2.15	7915CT	2

All of our semiconductors are protected with Varah's Direct exclusive static-free package and guaranteed perfect.

TAKE
A
PAGE
FROM
OUR BOOK

opto-electronics		ferrites		Electrolytic capacitors	
scopes	instrumentation	31410	100uF 16V radial	20/2.20	
hard crystals	data books	31420	1000uF 16V radial	5/2.20	
connectors	I/O modules	31480	10uF 35V radial	20/1.95	
heatsinks	transformers	31540	4.7uF 63V radial	20/2.20	
bridges	zeners	31545	10uF 63V radial	20/2.40	
SCR's		31580	1uF 100V radial	20/2.20	
signals	sockets	31610	10uF 16V axial	20/3.50	
cores		31625	470uF 16V axial	5/2.10	
rack & panel	BNC	31675	10uF 35V axial	20/3.70	
connectors		31720	1uF 63V axial	20/3.50	
testers	tools	Mini-toggle switches			
testers	tools	44047	SPDT on-off-on	1.95	
wire & cable	knobs	44049	DPDT on-off-on	2.95	
able ties	chemicals	44046	SPDT on-none-on	1.95	
bulbs	batteries	44048	DPDT on-none-on	2.95	
sockets	and jacks	PC mount slide switch			
accessors		44115	OPDT	6/1.95	
networks		44120	OPDT rt. angle	5/1.95	
controls					
mic					
testers					

The DIRECT Catalog

Our detailed catalog with full specs on over 2000 electronic components is now available! Reserve your free copy by circling the reader service number below, or by dialing (416) 842-8833, 8:30-5:00, Mon.-Fri., Eastern Standard Time.

The DIRECT Guarantee

We back our products **one hundred percent**. If you are not completely satisfied with an item, return it within thirty days for a full and prompt refund.

Order now and receive a complimentary jeweller's screwdriver kit (with any order over \$10).

416-842-8833



Member, Canadian Direct Marketing Association

Order now! All parts shipped from stock within 48 hours of receipt of payment and fully guaranteed. Orders under \$100 please add \$3.00 shipping and handling (+ \$1.00 insurance if desired). Ont. residents add 7% PST. Mastercard, Visa (incl. card no., cardholders name & expiry date), cheque, money order welcome.

Mail Orders & Oakville Store:
Varah's Direct Mail Order
504 Iroquois Shore Rd.
Oakville, Ont., L6H 3K4, 842-8833

Ottawa Store
35 Stafford Road
Ottawa (Nepean)
(613) 726-8884

Plus locations in:
Vancouver
Edmonton
Calgary Winnipeg

Circle No. 42 on Reader Service Card

SUMMER SALE !!

(For August Only)

IBM PC/XT COMPATIBLE ADD-ON CARDS

- *PC-001 Floppy Controller (Cable included) \$ 99.00
- *PC-002 Monochrome Graphic with Printer Port \$239.00
- *PC-003 Monochrome Display Card \$159.00
- *PC-011 Colour Graphic (Composite & RGB) \$159.00
- *PC-014 512K Memory Expansion (OK) \$129.00
with 512K \$199.00
- *PC-015 64K Printer Buffer with 64K Ram \$235.00
- *PC-017 Peripheral Interface Card
RS232, printer, clock, game \$149.00
- *PC-018 384K Multifunction (OK)
RS232, printer, clock, game \$225.00
with 384K Ram \$279.00
- *PC-019 12 Bit A/D & D/A Card \$295.00
- *PC-021 256K Multifunction (OK)
RS232, printer, clock \$175.00
with 256K Ram \$210.00
- *PC-030 Colour Graphic with Printer Port \$245.00
- *PC-045 Floppy Controller with Printer Port \$225.00
- *PC-046 Floppy Controller with RS232/P/G/C \$295.00
- *PC-062 High Resolution Monochrome (960Dx640L) .. \$790.00
- *PC-640 256K Installed XT System Board \$325.00
- *PC-1600 Mega Bare Board \$ 69.00
- *PC-2010 Parallel Printer Adaptor \$ 39.00
- *PC-2011 Dual RS232 Adaptor \$ 59.00

IBM PC/XT COMPATIBLE PERIPHERALS

- *SHUGART/PANASONIC/TOSHIBA
Slim Size, 5 1/4" DD/DS Floppy Drive \$169.00
- *IBM Compatible Keyboard \$115.00
- *ST-212 Slim size Seagate 10MB hard disk
with controller and cable \$995.00
- *ST-225 Slim size Seagate 20MB hard disk
with controller and cable \$1,350.00
- *CM-5412 Full Ht. CMI 10MB hard disk
with controller and cable \$995.00
- *CM-6426 Full Ht. CMI 20MB hard disk
(for both PC & AT) \$1,530.00
- *CM-6640 Full Ht. CMI 32MB hard disk
(for both PC & AT) \$2,100.00
- *ST-4026 Full Ht. Seagate 20MB hard disk
(for AT only) \$1,530.00
- *Flip-top Metal Case for XT System board \$ 75.00
- *Cipher-5210 32MB External Streaming Tape
Back-up Subsystem for PC/XT .. \$1,850.00
- *Memtec-420 20MB Internal Tape Back-up
with Controller for PC/XT/AT \$1,599.00
- *10MB, 20MB, 32MB External Hard disk Subsystem also
available, for informations, please call.

We also distribute large varieties of I.Cs. such as:

Part No.		Min. Order
4164-150ns	\$1.00	500
41256-150ns	\$8.00	100
4128 (128KRAM)	\$10.00	100
4116 (16KRAM)	\$0.80	100

MICROPROCESSOR

8088 Kit set (8088, 8253, 8237, 8284, 8288, 8259, 8255) \$51.00/set

MATH CO-PROCESSOR

C8087-3	\$169.00
C8087-2	\$249.00
C80287-3	\$349.00

EPROMS

2716 (3V)	\$14.00
2716-450	\$ 4.50
2716-300	\$ 8.80
27C16-450	\$24.00
2732-450	\$ 6.30
2732A-250	\$ 6.90
2532-450	\$ 8.50
2764-250	\$ 8.90
27C64-200	\$24.00
27128-450	\$18.50
27128-250	\$19.50
27256-300	\$88.00

T.T.L (74LS00 etc.) from 45¢
4000 CMOS from 37¢
6502 series, EPROM, clock chips, UARTS, FD controllers, Linears, etc., are also available, please call.

The above prices are all in Can. \$. FST included.
All parts are 100% fresh

*All prices and availabilities are subject to change without notice
* * * **Call us for quantity pricing & Free Catalogue** * * *

Dealers and OEM Enquiries are Welcome

Mail Orders add \$5.00 for shipping and handling. Ontario residents add 7% P.S.T. VISA, Mastercard, Money Order and Certified Cheque accepted.

ADVANCE—INTERFACE ELECTRONIC INC.

TELEX = 06-218660

FAX = 416-229-4943

232A Queen St. West, 2nd floor, Suite 1, Toronto, Ontario M5V 1Z6

TEL = 416-591-8433

Kodak's DX Coding



35mm films are now carrying information to set both processors and electronic cameras.

By Bill Markwick

AROUND the photo studio here at *Electronics Today*, we often go through several rolls of black-and-white and colour film per day. One of the biggest headaches is remembering to reset the ASA speed (now ISO speed) to match the film. Colour slides with a speed of 50 look a bit dark when shot at 400, and despite a warning sticker on the camera, we forget fairly often. Now that cameras contain miniature computers, you'd think it would be possible to automate the film speed setting.

Kodak has come to the rescue. Several of their lines of B&W and colour films are now being encoded with information using a number of different methods, making it possible for both the processing machinery and the camera to set themselves in accordance with the film type.

Outwardly

There are several things you'll see right away other than the letters "DX" on the package. First, the film cassette has the film type, speed, and number of exposures in tiny letters, allowing visual identification if the camera manufacturer fits a small window in the camera back. Secondly, there's a bar code similar to the supermarket UPC code next to the lip. It's an interleaved 2-5 code; scanning it yields

Electronics Today August 1985

a 6-digit number. The first digit is zero, digits two to five are product type, and six is the number of exposures. Reading this code allows the photofinishing machine to be set, not just to the general process, but to the optimum one for the specific film.

Next you'll see a series of alternating silver and black patches. These are actually two rows of six columns; the silver is the conductive body of the magazine, and the black is insulating paint. The twelve patches contact probes in the camera body, and the conduction or non-conduction yields a binary format which encodes speed (24 settings from 25 to 5000), number of exposures, and exposure range. The latter will make a considerable difference in automated photography; for instance, colour negatives have a wider latitude than transparencies, and the camera would be set to adjust exposure accordingly.

Lastly, you'll notice that the familiar leader, or tongue, is now 60mm instead of 100, and sports some extra holes. These form a 12-hole raster pattern which duplicates the information contained in the barcode and is for the benefit of photofinishers.

Inwardly

Once the film is processed, another barcode appears in the film itself, located

The new DX magazines with external conductive patterns, barcode, and a new leader. The inset shows the barcode in the film itself.

below the sprocket holes every half-frame. Photocells in the processor read the bars as Ones and spaces as Zeros; the result is an 11-bit binary number; bits 1-7 identify the manufacturer and family of film, and bits 8-11 specify the film type. There's even a parity bit for error checking.

When prints are made, the machinery can automatically be set to suit the film's density and colour balance, giving the customer better quality prints and minimizing the need for labs to do poor prints over again.

Is there a price to pay for all this? There's certainly no interference with the film itself; as compu-freaks say, it's user-transparent. However, you'll need one of the newer cameras with lots of bells and whistles to take advantage of the encoding at present; still, even without the gadgetry, your exposed film can benefit from optimum processing via the DX code. And, of course, advances in microprocessor technology mean that fancy features are now being fitted to even the most inexpensive models; you may not have to break the bank to get a DX-compatible camera. ■

Time Domain Analysis

Let your computer do the work with this introduction to circuit simulations using BASIC

By Andrew Armstrong

THERE have been complicated and expensive circuit analysis software packages available for some time. Time domain analysis, however, is a simple technique which can be used in BASIC programs on a home computer to analyze circuit performance. The simplicity is due to the fact that analysis is carried out in the time domain rather than the frequency domain.

Frequency domain analysis means calculating the frequency response, and perhaps the phase response, of a linear circuit. The problem is that, even for a very simple-looking circuit, the equations describing the frequency response may be very complicated. Usually, though, the DC behavior of the circuit can be calculated much more easily. What this time domain analysis technique does is to use DC equations for circuit performance, and to apply these equations repetitively at small increments of time. Any required input waveform can be specified as a function, or as a set of data points giving the input voltage of each increment of time.

During each time increment, it is assumed that currents and voltages are constant, while new values for these quantities are calculated. In the first part of the circuit in Fig. 1, for example, the charging current of C1 is assumed to be constant during the entire time increment. In reality, the current would decrease steadily as the capacitor charged, so the calculated increase in the charge on the capacitor is greater than the true value. Clearly, the greater the time period, the greater the error. For this reason, a very small time increment is used, and some circuit configurations are analyzed using several steps of calculation (i.e., several time increments) for each point plotted. In effect, time domain analysis involves the integration of equations by numerical approximation. Since they are DC equations, things are relatively simple.

There are a number of circumstances where time domain response is more meaningful than frequency response, of which one obvious example is video. For example, if a low pass filter produces rings and ripples in a square wave signal rather than rounding it off cleanly, those rings will show on the screen - yet the frequency response of the circuit producing the rings may be identical to that of one giving a clean rounding.

Of course, given that the computer time is available, there is no reason not to

carry out frequency response analysis by time domain methods. This transfers the burden of repetitive calculation to the computer rather than the programmer, so that the circuit designer can devote his or her time to thinking about circuit configurations rather than trying to solve equations using complex numbers, which require a piece of paper turned sideways just to write. (And that's only a second order low pass filter).

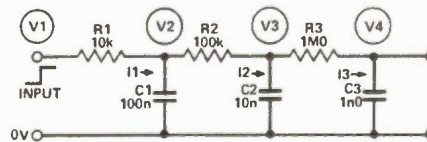

Fig 1. Low pass filter network.

Listing 1

```

1000 ' Analogue circuit analysis program - MAIN PROGRAM
1001 ' Andrew Armstrong 06 February 1985
1002
1003 DIMEN 3,0,0:CLS' Select and clear graphics screen
1004 ' Draw grid for graph
1005 FOR N=0 TO 470 STEP 50:LINE (N,0) - (N,63)...43690: NEXT N' Vertical lines
1006 LINE (0,0) - (0,63):LINE (0,63) - (473,63) ' Draw axes
1007 LINE (0,0) - (473,30)...34952:LINE (30,13) - (473,13)...61688' Horiz. lines
1008 GOTO 170
1009 FOR N=1 TO 8:R=(30+(N*50))*79/473:LOCATE N,8:PRINT N:NEXT N'Number scale
1010 LOCATE 2,2:PRINT "-1-":LOCATE 2,5:PRINT"0.5" ' Number scale
1011 IF INKEY$ <> "1" THEN 120' Do not print "OK" over the graph immediately
1012 END
1013
1014 ' Passive (PC) lowpass filter calculation
1015
1016 R1=10000:R2=100000:C1=.000001
1017 C2=1E-08:R3=1E+06:C3=1E-09:DT=.00002
1018 FOR N=0 TO 470
1019 IF N=0 THEN V1=0 ELSE V1=50
1020 I1=(V1-V2)/R1:V2=V2+DT*(I1-I2)/C1 ' First node
1021 I2=(V2-V3)/R2:V3=V3+DT*(I2-I3)/C2 ' Second node
1022 I3=(V3-V4)/R3:V4=V4+DT*(I3-I3)' Output
1023 PSET (N,63-V2):PSET (N,63-V3) ' Plot output and nodes on graph
1024 NEXT N:RETURN
    
```



Graph 1 Print-out of low pass filter network simulation.

DC Analysis

Taking the example of passive RC low pass filter as in Fig. 1, the method of writing the program is, first of all, to write a set of DC equations. These must be chosen so as to be able to be calculated sequentially.

Taking the circuit of Fig. 1 as the first example, the equations are:

$$I1 = (V1-V2)/R1$$

$$V2 = (I1-I2)*T/C1$$

and similiary for the second and the third parts of the circuit:

$$I2 = (V2-V3)/R2$$

$$V3 = (I2-I3)*T/C2$$

$$I4 = (V3-V4)/R3$$

$$V4 = I3-I4)*T/C3$$

The input waveform, V1, is any arbitrary function which is convenient to generate in software. In this case a simple step is used to demonstrate time delay.

A BASIC program to calculate this is shown in Listing 1, and its print out in Graph 1. The number of steps in the loop is set to be suitable given the response time of the circuit in question. Equally, the value used for V1 is set by the Y scale required, though it would be just as simple to use the value 1 and then scale the answer later on in the program.

The only formulae needed to generate these equations are Ohm's law, and the formula for the change in voltage on a capacitor subjected to a steady current for time T: $V = I*T/C$. In each small

time increment for computing purposes, the current is assumed to be constant, and the change in voltage is added to the previous total. The initial condition used in this program is that all currents and voltages are 0, which is the default condition of the dialect of BASIC in use here.

The shape of the graph showing the response to the input waveform is of interest in that it shows a distinct difference from the exponential charging characteristic of a single R and C. If many stages are added, the result will look like Graph 2 in which a single RC time constant is shown for comparison. In this graph, it is assumed that the current drawn from each RC stage by the succeeding one is negligible, or that they are separated by voltage followers, as in Fig. 2. The effect of ten cascaded time constants is plotted. The routine used is shown in Listing 2.

Overshoot

The technique can easily be applied to active circuits, such as the low pass filter shown in Fig. 3. The component values for this circuit are chosen so that it is under-damped. The results in an overshoot in the response to a step function, as shown in Graph 3.

Conventional wisdom also has it that there will be a peak in the frequency response, but more of this later. Listing 3 shows the equations used - the first part of the program, which draws the scale, is similar in all cases. Note (line 180) that the loop starts at 30 instead of at 0 as in

Listing 1. This eliminates the need for the IF statement (Listing 1, line 200), which was only there to illustrate the application of an input step function.

The inner loop of M (Listing 3, line 190 to line 230) allows the calculation of four points of each one plotted on the graphs, so that if high rates of change of any variable occur, a reasonable accuracy can be achieved. The size of this loop may be set as large as necessary to achieve good accuracy, but remember that each step of this inner loop is one time increment, so the step size DT should be scaled down appropriately to obtain the benefit from this. Otherwise, the time scale will simply be compressed, and the accuracy the same.

The only limitations on the size of the loop are how long you care to wait for an answer, and how long your computer is liable to be left undisturbed chonking away in peace while you do something else. In practice, I have found that the time taken to eat lunch is a reasonable limit but really fast machines may never need this long. Compiled Basic (or any compiled language) is to be preferred for complicated simulations.

The only significant difference between the active and the passive filter simulation is that the voltage across C1 is measured relative to the op-amp output instead of relative to 0V.

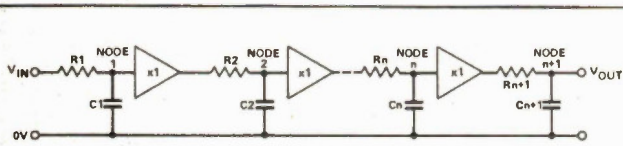
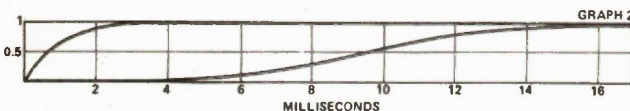

Fig. 2 Cascaded time constant circuit.

```

5 DIM V(10) ' Array to store node voltages
10 ' Analogue circuit analysis program - MAIN PROGRAM
20 ' Andrew Armstrong 06 February 1985
30 '
40 SCREEN 3,0,0:CLS: Select and clear graphics screen
50 ' Draw grid for graph
60 FOR N=80 TO 430 STEP 50:LINE (N,0)-(N,63)...43690:NEXT N:Vertical lines
70 LINE (30,0)-(30,63):LINE (0,63)-(473,63) ' Draw axes
80 LINE (30,38)-(473,38)...34952:LINE (30,13)-(473,13)...61680: Horiz. lines
90 GOSUB 170
100 FOR N=1 TO 9:M=(30+(N*50))*79/473:LOCATE M,8:PRINT N:NEXT N: Number scale
110 LOCATE 2,2:PRINT "-1-":LOCATE 2,5:PRINT"0.5" ' Number scale
120 IF INKEY#="" THEN 120: Do not print "OK" over the graph immediately
130 END
140 '
150 ' Cascaded time constant simulation
160 '
170 R1=10000:C1=.000001:DT=.00001:V(0)=50
190 FOR N=30 TO 474
200 FOR M=1 TO 4 ' Extra accuracy loop
210 FOR L=0 TO 9 ' Time constant cascading loop
220 I=(V(L)-V(L+1))/R1
230 V(L+1)=V(L+1)+I*DT/C1
240 NEXT L
250 NEXT M
260 PSET (N,63-V(11)):PSET (N,63-V(2))
270 NEXT N
280 RETURN
    
```

Listing 2



Graph 2 Print-out of cascaded time constant simulation.

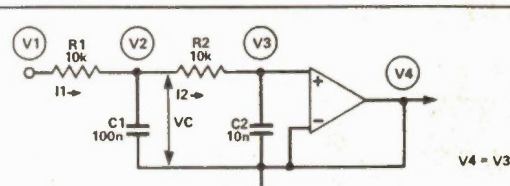

Fig. 3 Active low pass filter circuit.

```

10 ' Analogue circuit analysis program - MAIN PROGRAM
20 ' Andrew Armstrong 06 February 1985
30 '
40 SCREEN 3,0,0:CLS: Select and clear graphics screen
50 ' Draw grid for graph
60 FOR N=80 TO 430 STEP 50:LINE (N,0)-(N,63)...43690:NEXT N:Vertical lines
70 LINE (30,0)-(30,63):LINE (0,63)-(473,63) ' Draw axes
80 LINE (30,38)-(473,38)...34952:LINE (30,13)-(473,13)...61680: Horiz. lines
90 GOSUB 170
100 FOR N=1 TO 8:M=(30+(N*50))*79/473:LOCATE M,8:PRINT N:NEXT N: Number scale
110 LOCATE 2,2:PRINT "-1-":LOCATE 2,5:PRINT"0.5" ' Number scale
120 IF INKEY#="" THEN 120: Do not print "OK" over the graph immediately
130 END
140 '
150 ' Active lowpass filter simulation
160 '
170 R1=10000:R2=10000:C1=1.2E-07:C2=2.2E-08:DT=.00001:V1=50
190 FOR N=30 TO 474
200 FOR M=1 TO 4
210 VC=V3+(I1-I2)*DT/C1:V2=VC+V3
220 I2=(V2-V3)/R2:V3=V3+I2*DT/C2
230 NEXT M
240 PSET (N,63-V3)
250 NEXT N:RETURN
    
```

Listing 3



Graph 3 Print-out of active low pass filter simulation.

Lumped Constant

The same idea is applied to the voltage across the source resistor in the lumped constant transmission line simulation (Fig. 4, Listing 4 and Graph 4). The resistors chosen are of the nominal impedance of the line, L/C , so the output rings only a little. It is left to the reader to experiment with other values of R1 and R2. 50R give some entertaining rings!

In principle, this simulation could be applied to almost any linear circuit. If many similar stages were to be simulated, even though they had different values, it would be better to use a loop as in Listing 2, and to refer to component values stored in arrays.

Frequency Response

All the analysis shown so far gives only the time response of a circuit. There are at least two ways in which it can be adapted to provide a plot of frequency response.

COMMENTS ON LISTINGS

The computer for which the program were written, an Epson PX8, has available a graphics screen, on which the individual LCD points may be set. It is numbered from 0,0 in the top left hand corner to 479,63 in the bottom right hand corner. The screen contents can be copied to a suitable printer using the screen dump mode. Once the purpose of the graph plotting statements is understood, there should be little difficulty in performing the nearest equivalent operations on another machine.

As well as being able to set individual points, lines can be drawn. It is almost as fast to draw a line as to set a single point, so this is employed in lines 60, 70, and 80, as shown on Listing 1, to draw the framework of the graph. The line is drawn on the bit pattern of a repeating 16 bit binary number corresponding to the number specified after the three commas in the line statement, the default being a solid line.

Character positions may be specified in x, y co-ordinates, starting with 1,1 on the top left, and finishing with 80,8 on the bottom right. Only whole character positions

can be used, but the statement in line 100 LOCATEs the nearest position to the vertical scale lines, which are every 50 pixels for ease of calculation.

To avoid the message "OK" being printed over the graph, the INKEYS function is used in line 120 to keep the program twiddling its thumbs in a loop and allow time to press the screen dump button.

The calculation part of the programs is quite straightforward, and is detailed earlier on.

The only particular point of interest is that a smaller time increment is used in programs 2, 3 and 4 than in programs 1 and 5, and four steps of calculation are carried out for each point plotted. This reduces an otherwise unacceptable cumulative error in the cascading loop in program 2. In program 3 and 4 the same technique copes with the high rates of change or voltage in the circuits being simulated.

Listing 4 shows the use of an input waveform other than a step at time = 0. A sine wave is used, though any definable function may be used. R1 makes writing the equations convenient.

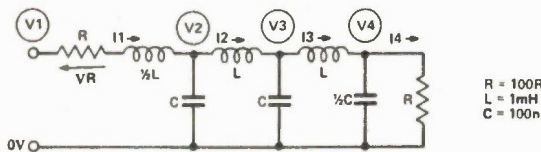

Fig. 4 Lumped constant transmission line equivalent circuit.

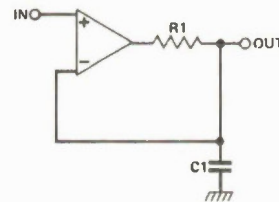
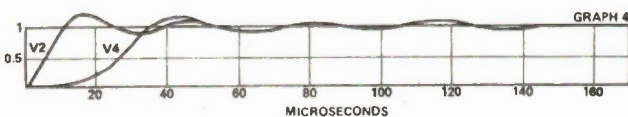

Fig. 5 A current limited op-amp configuration.

```

10 * Analogue circuit analysis program - MAIN PROGRAM
20 * Andrew Armstrong 06 February 1985
30 *
40 SCREEN 3,0,0:CLS: Select and clear graphics screen
50 * Draw grid for graph
60 FOR N=80 TO 430 STEP 50:LINE (N,0)-(N,63)...43690:NEXT N:Vertical lines
70 LINE (30,0)-(30,63):LINE (0,63)-(473,63) Draw axes
80 LINE (30,30)-(473,30)...34952:LINE (30,13)-(473,13)...61690:Horiz lines
90 GOSUB 170
100 FOR N=1 TO 8:M=(30+(N*50))*79/473:LOCATE M,0:PRINT 20*N:NEXT N
110 LOCATE 2,2:PRINT "-1-":LOCATE 2,5:PRINT20.5" Number scale
120 IF INKEY#="" THEN 120: Do not print "OK" over the graph immediately
130 END
140 * Lumped constant transmission line simulation
150 *
160 L=.001:C=.0000001:R1=100:R2=100:DT=.0000001:V1=100
170 FOR N=30 TO 474
180 FOR M=1 TO 4
190 I1=I1+DT*(V1-V2-VR)*2/L:VR=I1*R1:V2=V2+DT*(I1-I2)/C
200 I2=I2+(V2-V3)*DT/L:V3=V3+DT*(I2-I3)/C
210 I3=I3+(V3-V4)*DT/L:V4=V4+DT*(I3-I4) *2/C:I4=V4/R2
220 NEXT M
230 NEXT N
240 PSET (N,63-V2):LINE (N,63-V4)-(N,62-V4):Plot first node and output
250 NEXT N:RETURN
    
```

Listing 4



Graph 4 Print-out of lumped constant transmission line simulation.

```

10 * Analogue circuit analysis program - MAIN PROGRAM
20 * Andrew Armstrong 06 February 1985
30 *
40 SCREEN 3,0,0:CLS: Select and clear graphics screen
50 * Draw grid for graph
60 FOR N=80 TO 430 STEP 50:LINE (N,0)-(N,63)...43690:NEXT N:Vertical lines
70 LINE (30,0)-(30,63):LINE (0,31)-(473,31) Draw axes
80 GOSUB 160
90 FOR N=1 TO 8:M=(30+(N*50))*79/473:LOCATE M,4:PRINT N:NEXT N: Number Scale
100 LOCATE 2,4:PRINT "-0-": Number Scale
110 IF INKEY#="" THEN 110: Do not print "OK" over the graph immediately
120 END
130 *
140 * Current limited op-amp simulation
150 *
160 R1=470:C1=1.8E-07:DT=.00002:ANGLE=ATN(1)/25:GAIN=1000
170 FOR N=30 TO 474
180 V1=30*SIN(ANGLE*(N-30))
190 V0=GAIN*(V1-V2)+V1
200 IF V0>30 THEN V0=30
210 IF V0<-30 THEN V0=-30
220 I1=(V0-V2)/R1:IF I1>.006 THEN I1=.006
230 IF I1<-.006 THEN I1=-.006
240 V2=V2+I1*DT/C1
250 PSET (N,31-V1):PSET (N,31-V2)
260 NEXT N:RETURN
    
```

Listing 5

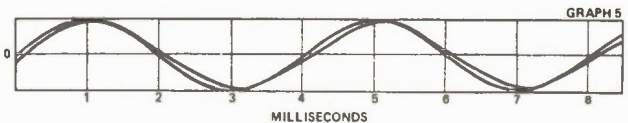

Graph 5 Print-out of current limited op-amp simulation.

There is another method, still under development, which should turn out more elegant and faster to execute. If the output signal from the circuit were to be spectrum analysed, perhaps by a Fourier transform, and compared with the frequency spectrum of the input, then the frequency transfer function of the simulated circuit could be determined. Phase information would be available as well.

This technique should work well, because the frequency spectrum of the input step function is continuous theoretically from zero to infinity (but only if the simulation is for an infinite period!). Any reasonable range of frequencies is liable to be able to be plotted with little difficulty, once the numerical spectrum analysis is working.

Further Applications

So far, only circuits have been considered. It is easy to add the effects of non-linearity anywhere in the circuit by using IF statements. For example, current limiting may be represented by: IF I $6E-3$ THEN I = $6E-3$: IF I $-6E-3$ THEN I = $-6E-3$

This limits the current to ± 6 milliamps, typical of the response of some small op-amps. The effect of a current limited opamp connected in the circuit shown in Fig. 5 is simulated by the program in Listing 5, which feeds a sine-wave into the circuit, and gives the output shown in Graph 5.

The circuit is a first approximation to a model for an op-amp. Equally, a conventional model may be used to simulate a transistor, with sets of values stored in arrays to enable a single transistor simulation subroutine to be used for a multi-transistor circuit.

The technique can be used for digital and control circuits. For example, Graph 6 shows the effects of PID (proportional, integral, and differential) control using a computer in conjunction with a heating system. In this case, the simulation can be very close to the truth, since the measurements would be sampled and the sampling period of the program can be made identical to that of the system to be used. The thick line of the graph represents heater power, the thin line represents temperature. At time 40 minutes, an extra kilowatt of cooling is introduced (to model, say, a window being opened). The graph shows the effect of such a disturbance to the system.

In this example, the maximum heater power is assumed to be 2.5 kW, the room to outside temperature insulation is 20°C per kW, and the outside temperature is 0°C . The thermal capacity of the room is assumed to be 100 kilojoules per degree, and the time constant of the heating element is about one minute.

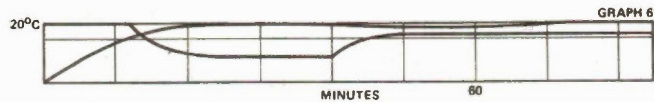

Graph 6 Print-out of heater control simulation.

THERMAL RESISTANCE TO OUTSIDE = R1 OUTSIDE TEMP = T0

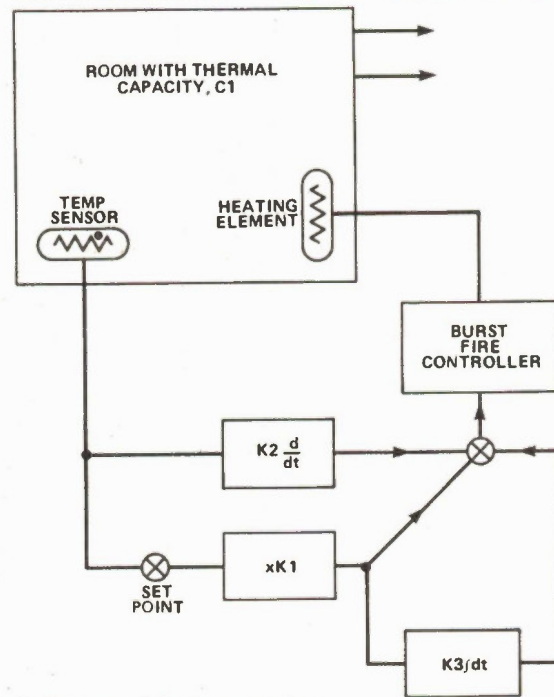

Fig. 6 Block diagram of heater control circuitry.

```

10 'Airconditioning simulation program A. Armstrong 4 Feb. 1985
20 SCREEN 3,0,0:CLS>Select and clear graphics screen
30 '
40 '
50 '
60 ' Draw grid for graph
60 FOR N=90 TO 450 STEP 50:LINE (N,0)-(N,63)...43690':NEXT N'Vertical lines
70 LINE (30,0)-(30,63):LINE (30,63)-(473,63)' Draw axes
80 LINE (30,13)-(473,13)...61600!' Aiming point
90 GOSUB 130' Call calculation routine
100 LOCATE 55,8:PRINT"60":LOCATE 1,2:PRINT"20°C" Scale number:0
110 IF INKEY$ <>" " THEN 110:TYPE 1 FOR A PRINTED COPY
120 COPY:END' THE END OF THE MAIN PROGRAM
130 C1=100:R1=20:T0=0:DAT=2:IAT=15:PB=5:SP=20:DT=.05:HTC=1'Times in minutes
140 X=DT*.36/HTC:Y=1-X'Heater time constant
150 K3=DT/IAT
160 DT=DT*60'convert to seconds
170 BAND=13*(PB*2.5)
180 LINE (30,BAND)-(473,BAND)...34952!' Draw proportional band lower limit
190 K1=1/PB
200 K2=1/(DAT+DT+PB)
210 ONE = DT'One kilowatt of cooling = 1st time increment
220 FOR N=30 TO 479
230 FOR LOOP=1 TO 4
240 HP=(SP-TEMP)*K1:HD=K2*TD
250 H=HP
260 IF HD>1 THEN H=1
270 YI=YI+HK3'INTEGRATE HEATING DEMAND (WITHOUT INTEGRAL TERM)
280 IF YI<0 THEN YI=0:IF YI>1 THEN YI=1'KEEP INTEGRAL WITHIN LIMITS
290 IF HD>.99 THEN YI=0:NO INTEGRATION OUTSIDE LINEAR CONTROL REGION
300 H=HP+YI-HD
310 IF H<0 THEN H=0:IF HD>1 THEN H=1
320 IF HD>1 THEN H=1
330 TPREV=TEMP
340 HEAT=DT+H*2.5*Y+HEAT*X'THERMAL MASS OF HEATER
350 LOSSES=(TEMP-T0)*DT/R1
360 IF N>229 THEN LOSSES = LOSSES+ONE'ADD 1 KW OF COOLING SUDDENLY
370 TEMP=TEMP+(HEAT-LOSSES)/C1
380 TD=.9*TD+.1*(TEMP-TPREV)'SIMPLE DIGITAL FILTERING ALGORITHM
390 NEXT LOOP
400 T1=2.5*TEMP
410 PSET (N,63-T1)
420 PSET (N,63-50*H):PSET (N,62-50*H)
430 NEXT N:RETURN

```

Listing 6

Electronics From The Start

Part 2

Getting acquainted with the multimeter, and prototyping with breadboards.

By Keith Brindley

This month, in our continuing series for beginners, we'll be giving you details of some fairly simple experiments designed to give you valuable practical experience. You'll need some basic components and a couple of new tools for following along with the examples. The components required are:

2 x 10K resistors
2 x 1K5 resistors
2 x 150R resistors

The power ratings and tolerances of the resistors are not important; buy the cheapest ones you can find. The tools you will need are a breadboard and multimeter; both should be of fairly good quality as you will be using these continuously for prototyping and circuit testing.

All Aboard

There are many varieties of breadboard. All of the better ones consist basically of a moulded plastic body which has a number of holes in the top surface, through which component leads may be easily inserted. Underneath each hole is a clip mechanism which holds the component lead securely. The clip forms a good electrical contact, yet allows the lead to be pulled out without damage.

Generally the clips are interconnected in groups so that by pushing leads of two different components into two holes of one group you have made an electrical contact between the two components. In this way the component leads don't have to physically touch above the surface of the breadboard to make electrical contact.

The differences in some breadboards are mainly in the spacings and positioning of the holes, and the number of holes in each group. The majority of breadboards have hole spacings of about 2.5mm (0.1

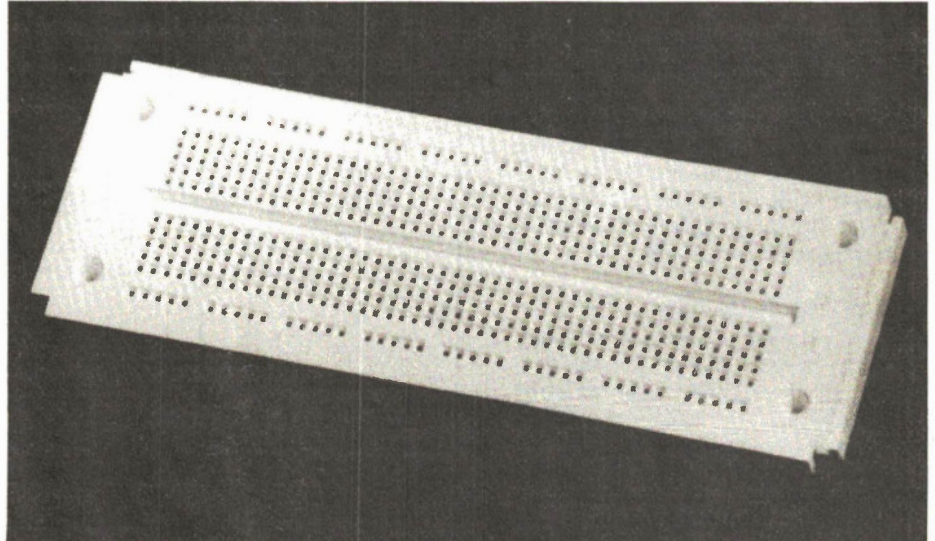

Fig. 1 A typical breadboard with holes linked by electrical contacts, and numbered in a grid pattern.

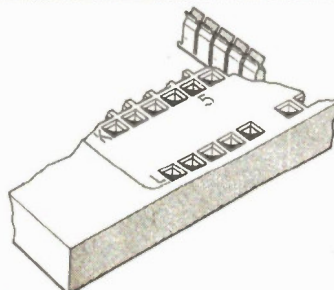
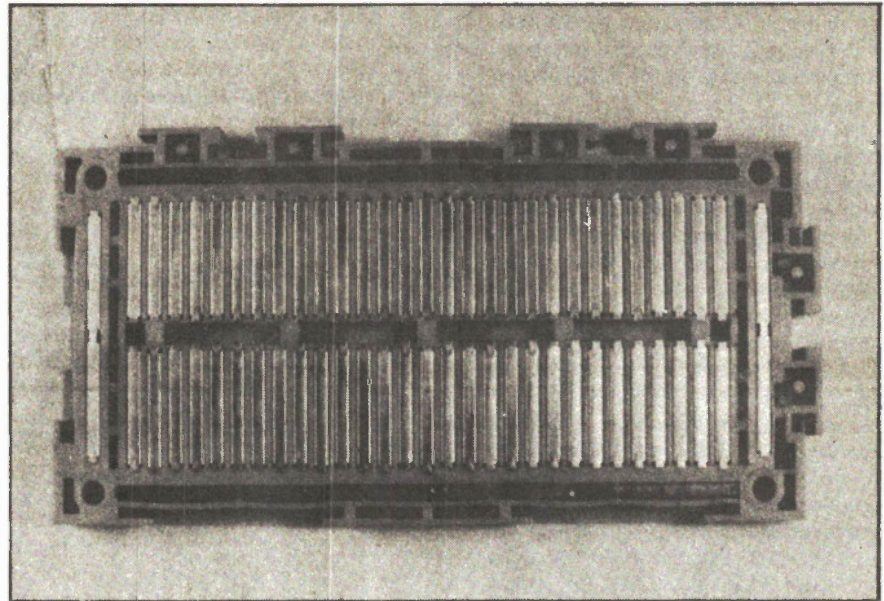

Fig. 2a and b. The interior of the breadboard showing the contacts.

in.) which is the exact spacing required by another electronic component: the dual-in-line (DIP) integrated circuit (IC). When choosing a breadboard you are mainly concerned with number of holes in the various groups, and the size of the board and its layout.

Fig. 1 shows a photograph of a typical breadboard, in which you can see the top surface with all the component holes. Fig. 2 shows the inside of the board with component lead clips interconnected into groups. The groups of clips are

organised as rows, the closest holes being 7.5mm (0.3 in.) apart. This is the distance between the rows of pins on a DIP integrated circuit.

ICs

Many types of ICs exist. The majority are in the DIP form, but other shapes do exist. Often DIP ICs have different numbers of pins, eg. 8, 14, 16, 18, 28 etc., but the pins are always in two rows. Some of the DIP ICs with large numbers of pins have rows spaced 0.6 in apart.

The circuits integrated inside the body of the ICs are not always the same, and so one IC can't do the job of another. They need to be exactly the same type to be able to perform the same functions.

Once the IC is in the breadboard, it's easy to make connections to it by pushing leads to the holes and clips of the same groups. Fig. 3 shows how two resistors may be joined by pushing their leads into the breadboard so that two leads are in the same group. This is an extremely simple example of creating a circuit on the breadboard.

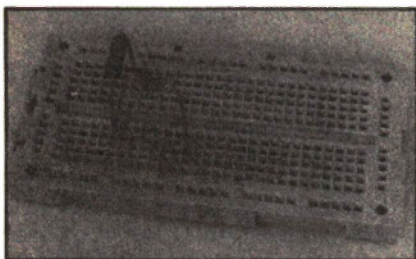

Fig. 3 Two resistors in parallel on the same breadboard. The two end leads of each resistor are joined by the internal contacts.

Down the edges of the breadboard, and along the top and bottom, are other groups of holes used for carrying power supply voltages from batteries, etc.

We can show all the various groups of holes in the breadboard by means of the Fig. 4, where the connected holes are joined by lines. This type of diagram will often be used to show how the experimental circuits we look at are built using the breadboard. Incidentally, any circuit can be built in a number of ways so you don't have to follow our diagrams of the following experiments to the letter.

The First Circuit

The experiments we'll be doing are all pretty simple: measuring the resistances of various resistors and their associated circuits. But to measure the resistances we need another essential tool: the meter. Strictly speaking, a meter isn't just a tool used in electronics; it's a complete piece of equipment. Apart from measuring resistances, it can also be used to measure voltage and current in a circuit. The meter

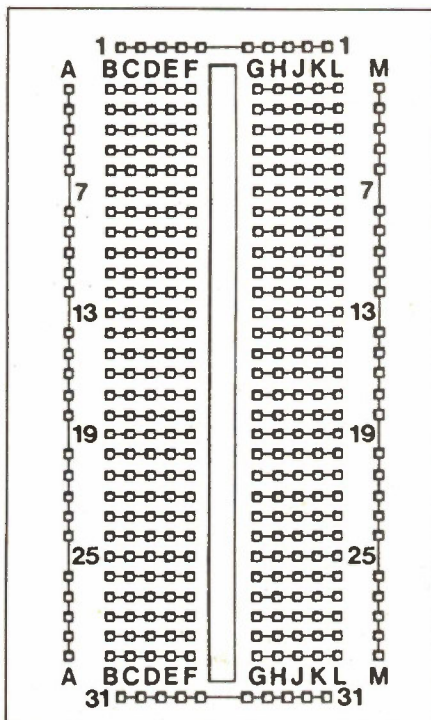

Fig. 4 A "breadboard pattern" showing graphically the internal contacts.

we're going to use is a good quality, general purpose multimeter. If you haven't yet acquired a meter, and are planning to do so, here are a few hints on what to look for:

- It should have a sensitivity of at least 20 ohms per volt on direct current (DC).
- It should be a moving coil movement.
- It should have an accuracy of no greater than 5%.

- Its smallest DC voltage range should be no greater than 1V.
- Its smallest current range should be no greater than 500uA.
- It should measure resistance in at least two or three ranges.

Using the meter is fairly simple. You can see from Fig. 7 that the meter has a rotary switch on the front which allows you to select the range of measurement you want. When the meter is connected to the circuit you wish to measure, the pointer moves and you can read-off the measured value on the scale.

Experiment

Our first experiment involves the measuring of a resistor's resistance and the simple circuit is shown built on the breadboard in Fig. 5. Before the meter can be used to measure resistance we have to adjust it so that the reading is accurate. The following steps will guide you through the procedure.

- 1) Turn the switch to point to the 1K range on the ohm scale.
- 2) Touch the meter probes together; the pointer should swing around to the right.
- 3) Read the resistance scale of the meter - the top one marked ohms. It should cross the scale exactly on the number 0.
- 4) If it doesn't cross at 0 (Fig. 6), adjust the meter using the zero adjust knob which is usually located just below the meter face.

What you've just done is a process known as zeroing the meter. It is important to perform this simple task every time you

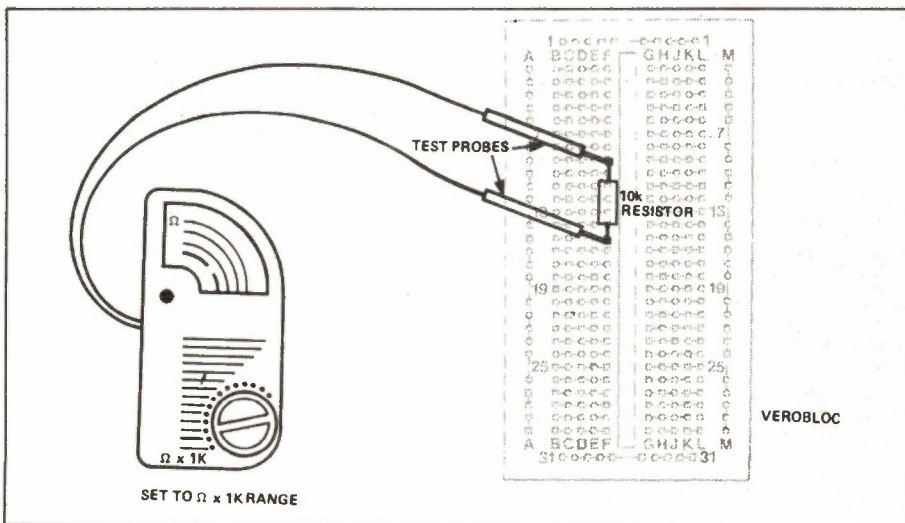

Fig. 5 Just about the simplest circuit you could have: a single resistor and a multimeter.



Fig. 6 If the meter pointer does not cross the scale exactly at zero, the meter needs adjusting with the Zero Adjust control.

use it to measure resistance. You may also have to do it if you change resistance ranges. However, it is not necessary to perform this function when measuring current or voltage. Measurement of resistance relies on the voltage of the cell inside the meter. When it's a new cell, the voltage it produces may be in the neighbourhood of 1.6V. But as it gets older and starts to run down, the voltage may fall to about 1.4V or even lower. The zero adjustment allows you take this change in cell voltage into account and therefore make sure your resistance measurement is correct.

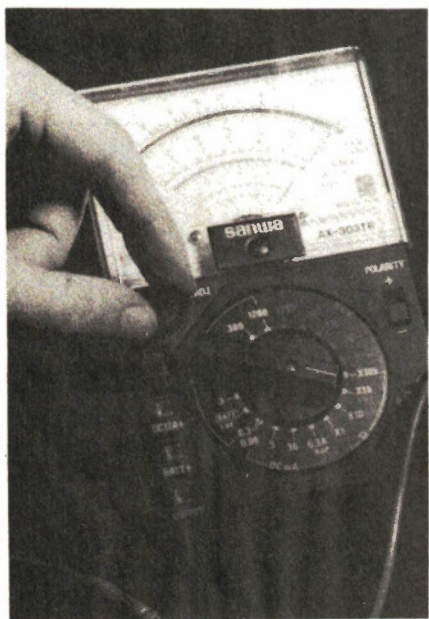

Fig. 7 The pointer crosses the scale at 10, but the meter is switched to the x1k, so multiply by 1000.

Measurement of current and voltage, on the other hand, doesn't rely on the internal cell at all, so no zero adjustment is necessary. Referring to Fig. 5, let's continue with our experiment.

- 1) Put a 10k resistor (brown, black, and orange bands) into the breadboard.
- 2) Touch the multimeter leads against the leads of the resistor. (It doesn't matter which way around the leads are.)
- 3) Read off the scale at the point where the pointer crosses it. It should read 10 (Fig. 7).

Now you may well be asking yourself why it's reading 10 when it should be reading 10000, right? Don't forget, you turned the multimeter switch to the x 1k range. This makes all resistance readings on this range greater by a factor of 1000. In practice, you may find that the pointer doesn't cross the resistance scale at exactly 10k. It may read anywhere from 9.5k to 10.5k. This is due to tolerance of the resistor. Both the resistor and the meter have a tolerance: it's indicated on the resistor by the last coloured band; and the meter's tolerance is approximately = 2%.

The Second Circuit

The aim of this experiment is to measure overall the resistance of two resistors connected in line, or in series as it is commonly known, and to see if we can devise a formula which allows us to calculate other series resistances without the need of measurement. Fig. 8 shows the breadboard representation of the experiment.

Fig. 9 shows the more usual way of representing a circuit in a drawing — the circuit diagram. What we've done is replace the actual resistor shapes with symbols. Resistors are commonly shown as zig-zag lines. The resistors in the circuit diagram are numbered R1 and R2, and their values are also given.

Meters in circuit diagrams are shown as a circular symbol with an arrow to indicate the pointer. To show it's a resistance meter (ohm-meter), the letter R is shown inside it.

Measure the resistance of the series circuit. The result should be 20k. But what does this prove? It suggests that there is a relationship between the separate resistors (each 10k) and the overall resistance. It looks very much as though the overall resistance (which we call R_{ov}) equals $R_1 + R_2$. Or put mathematically:

$$R_{ov} = R_1 +$$

The easiest way to test this relationship is to try resistors of different sizes. You'll find that the same is true: the overall

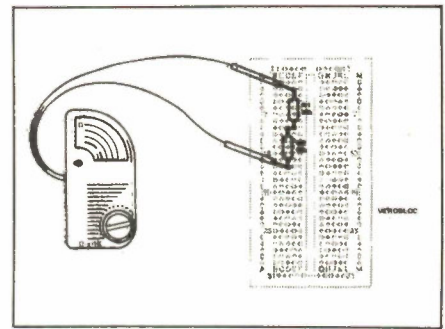

Fig. 8 Two resistors mounted on the breadboard in series.

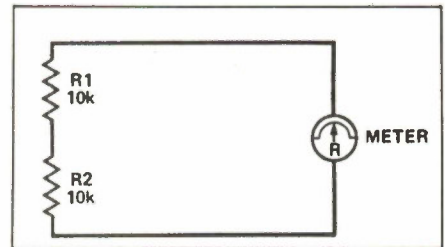

Fig. 9 A circuit diagram of two resistors in series. The meter is represented by a circular symbol.

resistance always equals the sum of the two separate resistances.

By experiment, we've just proved the law of series resistors. And it doesn't stop at two resistors in series. Any number of resistors may be in series — the overall resistance is the sum of the individual ones. This can be summarized mathematically as:

$$R_1 + R_2 + R_3 + \dots$$

The Next Circuit

There is another way two or more resistors may be joined. Not end-to-end as series resistors, but joined at each end. We say resistors joined together at each end are in parallel. Fig. 10 shows the circuit diagram of two resistors joined in parallel, and Fig. 11 shows the breadboard layout. Again, both these resistors are 10k. Measure this circuit with the meter.

continued on page 18

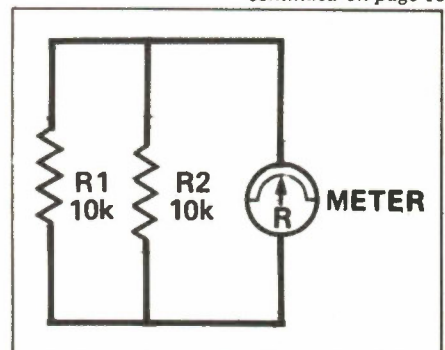
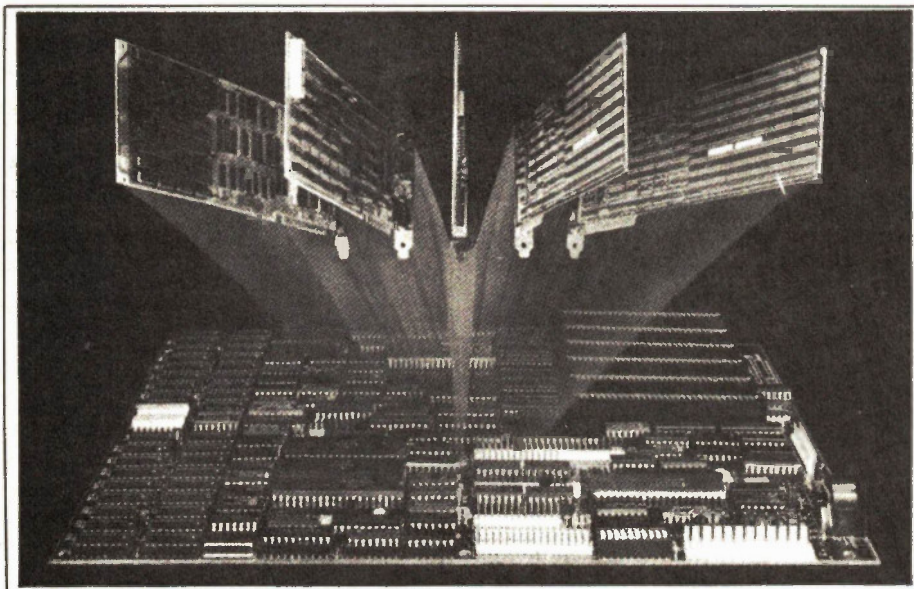

Fig. 10 The circuit diagram for two resistors in parallel.

Electronics in Canada



Soltech Industries Inc.

A new series, prepared by the staff of Electronics Today, looks at the companies who are providing Canada's leading edge in high technology.

ELECTRONICS IN CANADA will be featuring regular reporting on some of the country's hi-tech developers and manufacturers; we hope to include original research being done in Canada, innovative new products, aerospace development, or any similar subject that will demonstrate Canada's understated abilities in electronics technology.

Electronics Today August 1985

You may have come across our first subject, Soltech Industries of British Columbia, as we did: with the introduction early this year of their ACS-1000 motherboard, a printed circuit that allows you to build an IBM-compatible computer by simply adding a power supply and disk drives. The board's initial success was not only due to this convenience, but also to

the technical advancements added by Soltech; the design was not just a cloning of a work-alike system, but the development of a unique circuit with such features as a switchable 8MHz clock for high speed, one megabyte of RAM socketing, on-board floppy disk controller, and more. The board is now available completely packaged as a ready-to-run system.

The parent company, Solkan Enterprises, was incorporated in 1979 with the aim of manufacturing and distributing computer hardware, software, and accessories; other aims were the development of software and consultancy services for the installation of turnkey systems. The design of the motherboard compatible with the IBM PC/XT was begun during the early part of 1984 by Solkan Research Inc., an affiliate of Solkan which functions solely as the R&D arm, and passes developed products to affiliated companies for distribution. In this case, the motherboard and its graphics card, the Graphax 20-20, are manufactured by Soltech Industries, while the affiliated Kaltron Industries manufactures computer cables and accessories. The two companies distribute each other's products, and in the US, the products are handled by ACS International.

When the development began on the board, the company set high standards for itself: the product had to be software and hardware compatible as well as unique. The president of Soltech, Kamlesh Solanki, stated that "whatever you can connect to an IBM PC/XT you should also be able to connect to the IBM-compatible." It also had to offer significant features and performance as well as mere compatibility. The goal was achieved or exceeded with the successful completion

of a design offering high speed, a four-floppy controller card, two serial ports, a parallel port, a battery backed-up clock, one megabyte of expansion, and complete compatibility with IBM software.

The board normally functions at the standard speed of 4.7MHz but can easily be switched to the higher speed of 8MHz. This was done by using the 8088-2 CPU chip. Since this chip is an upgrade of the original 8088, there is greater compatibility, and hence more software will run at 8MHz on the ACS-1000 than on many of the 80286 high speed boards. The 80286 boards are often two or three times the price as the ACS-1000 as well. A more thorough description of the ACS-1000 board and its functions appeared in the May, 1985 *Electronics Today*.

The company has written their own BIOS, the Basic In/Out System which is in charge of file saving and loading, and really determines whether or not a computer deserves the title of "compatible". The ACS-BIOS is fully compatible with any software written for the IBM PC or PC/XT, including the Microsoft Flight Simulator, dBase III, Lotus 1-2-3, etc., and it also supports popular operating systems such as PC-DOS, MS-DOS, CP/M-86, Concurrent DOS and Xenix.

With positive response from the public, the media, and service people, the company is marketing a range of complete computers, Soltech I to Soltech VI, from a single floppy system without a hard drive to a two-floppy system with a 20M hard drive. We'll have a review of the complete computer in an upcoming issue.

Another product from Soltech is the remarkable Graphax 20-20 graphics card, certainly one of the brightest and sharpest of the many graphics cards that have been through our offices. It can expand the computer considerably for use with CAD/CAM, giving a 2000 by 2000 pixel drawing through a window of 1000 by 1000 pixels. At this resolution there are 5 planes, 32 colours, and a full alphanumeric overlay. It will shortly be available with software drivers for the popular AutoCAD software package.

Soltech has produced a unique computer designed and built in Canada; it's fully compatible with IBM hardware and software, with features that rival a fully-loaded IBM XT with higher performance and at about one-half the cost. Purchasers can expect good after-sales support; service companies have commented on the efficient layout and quality and the use of standard off-the-shelf

components, and have offered to service the product across Canada. Consequently, a Canada-wide service plan will soon be offered, both for the board and the complete computer.

Speaking from our personal experience, we found that Soltech was unusually cooperative and supportive in the matter of getting us hardware for review; you might think that large companies would bend over backward to supply the media with review equipment, but this isn't always the case. We've often received inoperative computers with no documentation or explanation, and occasionally without even a power cord. Kamlesh Solanki was always available if we needed anything, and even more important to the computer-buying public, the hardware performed exactly as it was supposed to.

With sales in the first half of the year growing at the remarkable rate of 75 percent and with sales of \$10 million last year, Soltech's staff of 100 people is moving into new larger premises. Future developments will include a high-resolution graphics terminal, enhancements, more add-on products, and the next model of compatible computer. ■

continued from page 16

You should find that the overall resistance is 5k. Odd, non? Replace the 10k resistors with two more of a different value, say 150 ohms (150R). You'll find the overall resistance to be 75R.

So we can see that if two equal resistors are in parallel, the overall resistance is *half* the value of one of them. Let's see what happens when the resistors are not of equal value.

Try the circuit with values of 10k and 1k5 (brown, green, red). You'll find the overall resistance to be about 1k3. So, what's the relationship?

Well, a clue to the relationship between parallel resistors comes from the fact that, in a roundabout way, parallel is the inverse of series. So if we inverted the formula for series resistors

$$R_{ov} = R1 + R2 + R3 + \dots$$

we would get:

$$\frac{1}{R_{ov}} = \frac{1}{R1} + \frac{1}{R2} + \frac{1}{R3} \dots$$

and this is the formula for parallel resistors. Let's try it out on the resistors of the last experiment. Substitute values of 10k and 1k5 in the formula:

$$\frac{1}{R_{ov}} = \frac{1}{10,000} + \frac{1}{1500}$$

which is:

$$= \frac{1500 + 10,000}{15,000,000}$$

$$= \frac{11,500}{15,000,000}$$

$$\frac{1}{R_{ov}}$$

$$= 0.00076$$

so:

$$R_{ov} = 1304R$$

which is about 1k3, the measured value.

This is the law of parallel resistors, every bit as important as that of series resistors. Remember it!

If there are only two resistors in parallel, you don't have to calculate it in the way we have just shown; there is a simpler expression given by:

Electronics from the Start

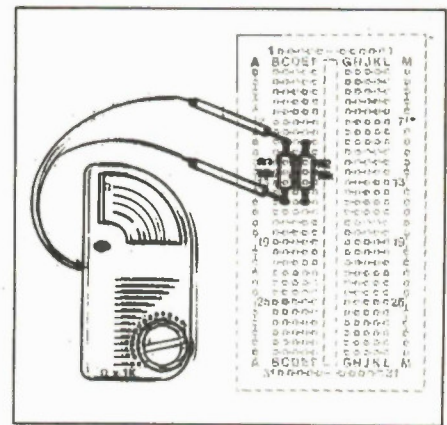

Fig. 11 The two parallel resistors shown in the breadboard connected to the meter.

$$R_{ov} =$$

$$\frac{R1 \times R2}{R1 + R2}$$

Moorhead Publications

Almost Free Software

Almost Free Software (CP/M) #1

Almost Free Software #1, #2 and #3 are for CP/M and are available in a variety of formats: Apple // + CP/M, 8 inch SSSD*, Access Matrix, Morrow Micro Decision, Superbrain, Xerox/Cromemco*, Epson QX-10VD, Sanyo MBC 1000, Nelma Persona, Kaypro II, Osborne and double densities, Teletideo, DEC VT-180, Casio FP-1000, Zorba.

Modem 7. Allows you to communicate with any CP/M based system and download files. Complete details were in Computing Now! November 1983.

PACMAN. You can actually play PACMAN without graphics, and it works pretty fast.

FORTH. A complete up-to-date version of FIG FORTH, complete with its own internal DOS.

DUU. The ultimate disk utility allowing you to recover accidentally erased disk files, fix garbled files, rebuild and modify your system. A real gem.

D. A sorted directory program that tells you how big your files are and how much space is left on the disk.

USQ/SQ. Lets you compress and uncompress files. You can pack about 40% more stuff on a disk with this system.

Finance. A fairly sophisticated financial package written in easily understandable, modifiable Microsoft BASIC.

BADLIM. Ever had to throw out a disk with a single bad sector? This isolates bad sectors into an invisible file, making the rest of the disk useable.

DISK. Allows you to move whole masses of files from disk to disk without having to do every one by hand, you can also view and erase files with little typing.

QUEST. A "Dungeons and Dragons" type game.

STOCKS. This is a complete stock management program in BASIC.

SEE. Also known as TYPE17, will TYPE any file, squeezed for not allowing you to keep documents in compressed form while still being able to read them.

Order as AFS #1, and specify system

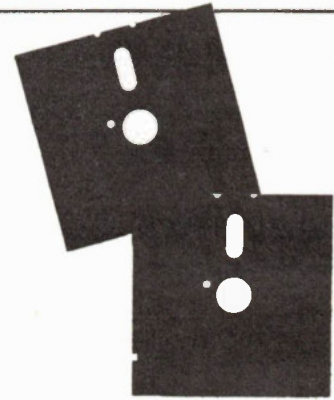

\$19.95 each

Except for 8" disks and those with two disks which are marked with an asterisk (*) above which are:

\$22.95

*single density formats require two disks. The package cost for these formats is \$22.95.

Almost Free Software (CP/M) #2



BISHOW The ultimate file typer, BISHOW version 3.1 will type squeezed or unsqueezed files and allow you to type files which are in libraries (see LU, below). However, it also pages in both directions, so if you miss something, you can back up and see it again.

LU Every CP/M file takes up unnecessary overhead. If you want to store lots of data in a small space, you'll want LU, the library utility. It permits any number of individual files to be stored in one big file and cracked apart again.

MORTGAGE This is a very fancy mortgage amortization program which will produce a variety of amortization tables.

NSBASIC Large disk BASIC packages, such as MBASIC, are great . . . and very expensive. This one, however, is free . . . and every bit as powerful as many commercial programs. It's compatible with North Star BASIC, so you'll have no problem finding a manual for it.

RACQUEL Everyone should have one printer picture in their disk collection.

Z80ASM This is a complete assembler package which uses true Zilog Z80 mnemonics. It has a rich vocabulary of pseudo-ops and will allow you to use the full power of your Z80 based machine . . . much of which can't be handled by ASM or MAC.

VFILE Easily the ultimate disk utility, VFILE shows you a full screen presentation of what's on your disk and allows you to mass move and delete files using a two dimensional cursor. It has heaps of features, a built-in help file and works extremely fast.

ROMAN This is a silly little program which figures out Roman numerals for you. However, silly programs are so much fun . . .

CATCHUM If you like the fast pace and incredible realism of Pacman, you'll go quietly insane over Catchum . . . which plays basically the same game using ASCII characters. Watch little "C"'s gobble periods while you try to avoid the delay "A"s" . . . it's a scream.

Order as AFS #2 and specify system

\$19.95 each

Except for 8" disks and those with two disks which are marked with an asterisk (*) above which are:

\$22.95

*single density formats require two disks. The package cost for these formats is \$22.95.

OIL. This is an interesting simulation of the workings of the oil industry. It can be approached as either a game or a fairly sophisticated model.

CHESS. This program really does play a mean game of chess. It has an on-screen display of the board, a choice of colours and selectable levels of look ahead.

DEBUG. The DDT debugger is good but this offers heaps of facilities that DDT can't and does symbolic debugging... it's almost like being able to step, trace and disassemble through your source listing.

DU87. The older DUU program does have some limitations. The version overcomes them all and adds some valuable capacities. It will adapt itself to any system. You can search map and dump disk sectors or files. It's invaluable in recovering damaged files too.

ELIZA. This classic program is a micro computer head shrinker... it runs under MBASIC, and with very little imagination, you will be able to believe that you are conversing with a real psychiatrist.

LADDER. This is... this program is weird. It's Donkey Kong in ASCII. It's fast, bizarre and good for hours of eye strain.

QUIKKEY. Programmable function keys allow you to hit one key to issue a multicharacter command. This tiny utility allows you to define as many functions as you want using infrequently used control codes and to change them at any time... even from within another program.

RESOURCE. While a debugger will allow you to disassemble small bits of code easily enough, only a true text based disassembler can take a COM file and make source out of it again. This is one of the best ones available.

**Order as AFS #3
and specify system**

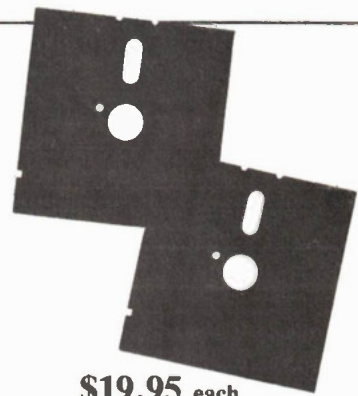

\$19.95 each

Except for 8" disks and those with two disks which are marked with an asterisk (*) above which are:

\$22.95

*single density formats require two disks. The package cost for these formats is \$22.95.

Almost Free Apple DOS Software

Almost Free Apple DOS Software ...#1

While CP/M is a wonderful thing in its own right, the Apple computer can also, and usually does, operate under DOS. For this reason, there's a multitude of programs available for it. Below, we offer a mini-multitude of our own.

The following programs will operate on any Apple //+, //e, //c, or true compatible operating under DOS 3.3. Apple users operating only under ProDOS may have to make alterations to some programs.

Picture Coder: All Apple HiRes pictures take up 36 sectors in their binary form. This program creates a textfile of a program in memory, squeezing out the zero bytes, that can later be EXECd into memory. The textfile often takes up less room on the disk.

DNA Tutorial: Operating under Integer BASIC, this program might appeal to 'clone' owners. In actuality, though, it's an interactive low-res graphics tutorial of DNA in its inherent forms. And you thought your Apple was only good for games...

Toad: Speaking of games, this program is an Applesoft BASIC implementation of 'Frogger' that can be controlled with either a joystick or the keyboard. The user's high scores are saved to disk.

Function Plotter: A fairly extensive Applesoft BASIC program that takes any inputted function and plots it on the HiRes Screen.

Data Disk Formatter: Apple DOS disks need not be bootable to be useful. This binary program formats a disk without setting DOS on the tracks, conserving useful disk space.

BASIC Trace: A program for the advanced Applesoft programmer, this file, when EXECd, displays the hexadecimal locations of each Applesoft line number of a program in memory.

Gemini Utility: A word processor pre-boot for Gemini printer users, this BASIC program initialises the printer's font or pitch before you boot your word processor.

Payments: This BASIC program allows you to keep track of payments and credits to and from up to 100 accounts on a single disk. A sample account is included.

Databox: A small but useful database program in Applesoft BASIC. Sample files are included to get you started.

Nullspace Invaders: A quick BASIC HiRes game testing coordination and judgement as you manipulate a monolith through mysterious gates.

Fine Print: The majority of this software has been obtained from on-line public access sources, and is therefore believed to be in the public domain. Any remaining programs were written in-house. The prices of the disks defer the cost of collecting the programs, debugging them, reproducing and mailing them, plus the cost of the media they're supplied on. The software itself is offered without charge.

Moorshead Publications warrants that the software is readable, and if there are any defects in the medium, we will replace it free of charge. While considerable efforts has been made to ensure that the programs have been thoroughly debugged, we are unable to assist you in adapting them for your own applications.

**Order as AFAD #1
and specify system**

Each disk is
\$19.95
or, as an introductory offer you
can order all three for
\$39.95

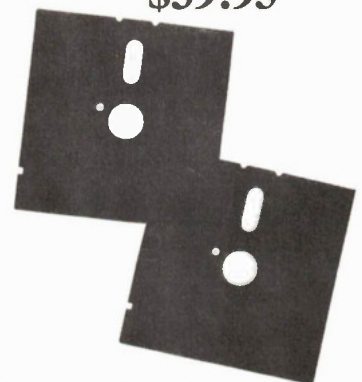
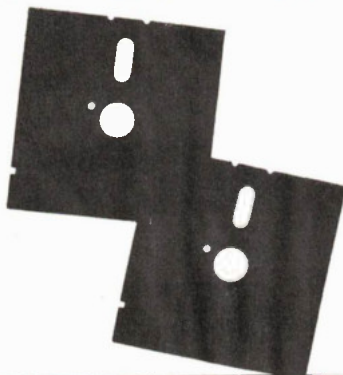

Software Services Moorshead Publications

25 Overlea Boulevard, Suite 601, Toronto, Ontario M4H 1B1

Electronics Today August 1985

Almost Free Apple DOS Software . . . #2

Amort: A monthly amortization program that calculates monthly payments to an inputted figure, calculates principle, interest on every balance, and prints out the resulting chart.

Voiceprint: An unusual program that uses the HiRes screen to sample sounds inputted through the cassette jacks at the back of your Apple. Sampling rate and other variables can be controlled, and two sounds may be compared side-by-side.

Calc NOW! Written in BASIC, this spreadsheet program is somewhat slower than VisiCalc, but still offers the power you expect from a spreadsheet. With sample files.

Cavern Crusader: A mix of BASIC and binary programming, winning this HiRes game is difficult, to say the least. For every wave of aliens shot in the cavern, there's always a meaner bunch in the wings.

Newcout: With source file. This binary program replaces the I/O hooks in the Apple with its own so you can operate your Apple through the HiRes screen. Comes with a character set.

Charset Editor: A utility to help you create your own character sets to use with Newcout.

Calendar: A BASIC utility useful for finding a particular day of any inputted month and year, or for printing out any given year.

LCLODR: With source. This binary utility BLOADs any given file into the 16K language card space at \$D000. The source is useful in showing how to use DOS commands through assembly language.

Cristo Rey: An animated HiRes BASIC program showing Cristo Rey by moonlight. For apartment-bound romantics.

ATOT: That's an acronym for 'Applesoft to Text'. EXEC this textfile to produce a textfile of your program.

Applesoft Deflator: This program takes a textfile made by ATOT and squeezes it, replacing PRINT statements with '?' and removing unnecessary spaces from the listing.

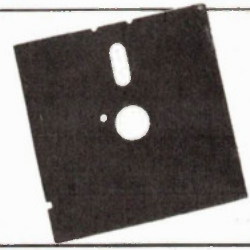

Order as AFAD #2 and specify system

Each disk is
\$19.95

or, as an introductory offer you can order all three for

\$39.95

Almost Free PC Software

Almost Free PC Software . . . #1

Our Almost Free Software disks, volumes one through three, for systems running CP/M have been so thunderingly popular that we have assembled a volume for IBM PC users. The considerably greater power of a sixteen bit system, coupled with its larger capacity disk drives, have enabled us to offer a collection of programs that will knock the socks off virtually any sentient life form booting the disk. Be warned... wear sandals when you unwrap this thing.

This software will run superbly on genuine IBM PC's and compatible systems.

PC-WRITE While not quite Wordstar for nothing, this package comes extremely close to equalling the power of commercial word processors costing five or six bills. It has full screen editing, cursor movement with the cursor mover keypad, help screens and all the features of the expensive trolls.

SOLFE This is a small BASIC program that plays baroque music. While it has little practical use, it's just a kick to toodle with. It's also a fabulous tutorial on how to use BASICA's sound statements.

PC-TALK Telecommunications packages for the IBM PC are typically intricate, powerful and huge. This one is no exception. It has menus for everything and allows full control of all its parameters, even the really silly ones. It does file transfers in both ASCII dump and MODEM7/XMODEM protocols and comes with... get this... 119424 bytes of documentation.

SD This sorted directory program produces displays which are a lot more readable than those spewed out by typing DIR. It's essential to the continued maintenance of civilization as we know it.

FORTH This is a small FORTH in Microsoft BASIC. It's good if you want to get used to the ideas and concepts of FORTH... you can build on the primitives integral with the language.

LIFE This is an implementation of the classic ecology game written in 8088 assembler. While you may grow tired of watching the cells chewing on each other, in time the source will provide you with a powerful example of how to write code.

MAGDALEN This is another BASIC music program. We couldn't decide which of the two we've included here was the best trip, so we wound up putting them both on the disk. Ah... the joys of double sided drives.

CASHACC This is a fairly sophisticated cash acquisition and limited accounting package written in BASIC. It isn't exactly BPI, but it's a lot less expensive and suitable for use in most small business applications.

DATAFILE This is a simple data base manager written in... yes, trusty Microsoft BASIC.

UNWS Wordstar has this unusual propensity for setting the high order bits on some of the characters in the files it creates. Looks pretty weird when you try to do something other than Wordstar the file, doesn't it... Here's a utility to strip the bits and "unWordstar" the text. The assembler source for this one is provided.

HOST2 This is a package including the BASIC source and a DOC file to allow users with SmartModems to access their PC's remotely. It's a hacker's delight.

The disk also includes various support and documentation files needed to run the software.

We can provide the Almost Free PC Software Disk volume one on either one standard double sided disk or on two single sided ones.

Order as AFPC #1 and specify system.

Only
\$19.95
or **\$22.95**

for two single sided disks.



Moorshead Publications warrants that the software will be readable. If defects in the medium prevent this, we will replace your disk at no cost. While we have made every effort to assure that these programs are completely debugged, we are unable to assist you in adapting them for your application.

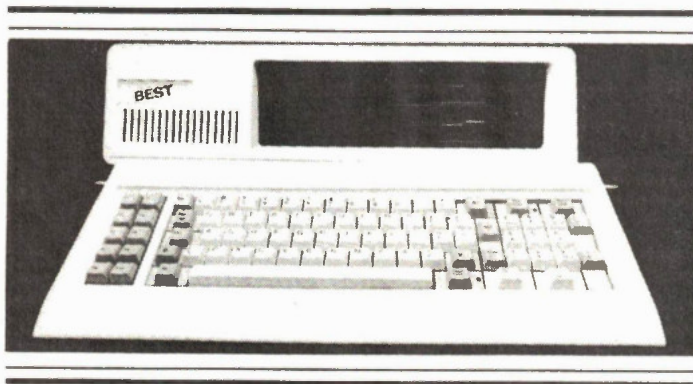

LAST CHANCE!

Win a 512K BEST computer from Exceltronix — 512K RAM, dual disk drives, IBM compatibility, colour graphics and more.

Enter now — contest closes August 15, 1985

Contest Rules

1. The decision of the judges is final.
2. The deadline for entries is Thursday, August 15th, 1985.
3. Any person associated with the contest, including employees (and their families) of Moorshead Publications and Exceltronix Inc., are precluded from entering.
4. The prize will be awarded as described. No correspondence will be entered into regarding this contest.
5. The winner will be notified by mail or telephone within seven

days of judging. The winner and the correct answers will be published in the October, 1985 issue of Electronics Today.

6. In case of multiple correct answers, the winner will be selected by drawing one of the correct entries at random.
7. In case that no totally correct entries are received, the winner will be the one with the most correct answers.

If you don't want to cut the magazine, please use a photocopy of the form, or readable facsimile.

The Electronics Today Electrivia Contest

Entries must be received by August 15, 1985. Results will be published in the October, 1985 issue; the winner will be notified by mail or telephone.

1. What law governs the relationship between distance and the intensity of a sound wave? _____
2. In a common-base transistor circuit, what is the equivalent of the common-emitter "beta" parameter? _____
3. The Wheatstone bridge was invented by Charles Wheatstone. True or False? _____
4. What is the name of the oscilloscope pattern resulting from the application of signals differing only in phase to the vertical and horizontal inputs? _____

5. In transformers, the turns ratio is equal to the square root of the impedance ratio. True or False? _____

6. What unit of measurement is named after Alexander Graham Bell? _____

7. In analog design, a buffer amplifier has a voltage gain of _____

8. In logic circuits, an asynchronous counter is also known as a _____ counter.

9. The algebra used in working with logic was named after _____

10. Maximum power is transferred when the source resistance equals the load resistance. True or False? _____

Mail your entries to:
Moorshead Publications,
Electronics Today Contest,
 25 Overlea Blvd.,
 Suite 601,
 Toronto, Ontario
 M4H 1B1

Name _____

Address _____

Town/City _____ Province _____ Postal Code _____

Telephone - Area Code _____ Number _____

Do you subscribe to Electronics Today? () yes () no

RS232 For Commodores

***A low cost serial RS232C interface
for your Commodore VIC20 and C64.***

By Ron D.C. Coles and Trevor Awalt

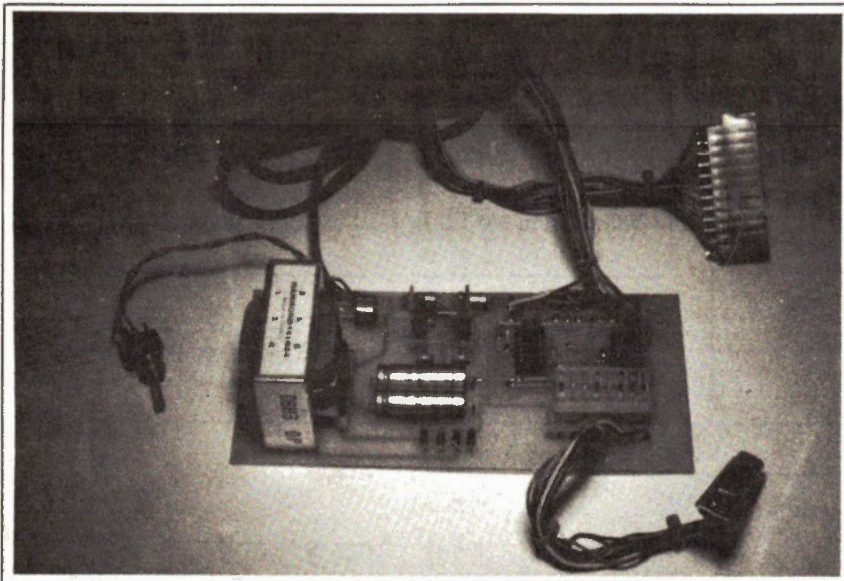

IF YOU bought a Commodore computer in the recent past and didn't buy a printer at the same time, you are probably now at the point where you would like to get your hands on an inexpensive printer. Unfortunately the inexpensive variety are usually surplus commercial units which have an RS232C interface. The Commodore VIC and C64 have a user I/O port which is claimed to be RS232C compatible. However, if you ever try to connect an RS232C device directly to this I/O port, you will soon find out that it doesn't work.

If you go to see your friendly neighbourhood computer salesman he will be very happy to sell you a brand name interface, but it will cost you the best part of \$100. This project will permit you to connect any serial RS232C device, printer, modem, etc. to your Vic or C64 for less than \$30, considerably less if you have a well stocked bits box. And with a little software you can take advantage of those surplus bargains that have eluded you before now.

Before we go into the reason why you need an interface, let's take a quick look at what an RS232C interface is. There is nothing magic about RS232C; this alpha — numeric designation is a specification issued by the Electronic Industries Association (EIA), and just specifies the standard method of connecting data devices so that the pin designations are always the same, and will therefore permit devices of different manufacturers to be connected together without grief.

The pinout connections on both the Vic and the C64 are shown in fig 2, and you can see from the table which pin connections correspond to the standard RS232C pin connections. By now you must be wondering what all the fuss is about, as the pin connections seem to agree. Unfortunately the logic levels to and from the Commodore user I/O port are TTL (0 to 5V), rather than the standard RS232C levels, which can be between -3V and -25V for a logic 1, and between +3V and +25V for a logic 0. Normally -12V and +12V are used, and this is where the Interface comes in.

Electronics Today August 1985

Commodore provided 9VAC on pins 10 and 11 of their user port, but unfortunately they didn't see fit to provide a centre tap in order to derive the +/- voltages required to power the MC1488 quad line driver; also the 9V wouldn't be enough signal voltage to drive a printer through a long cord. In most applications the printer or modem is situated several feet away from your computer, and therefore a separate power supply for the +/-12V has been provided in this design.

The Circuit

The power supply consists of a Hammond 161G24 transformer which has a 24V 420mA secondary winding with a centre tap. Radio Shack 273-1512 is a satisfactory substitute transformer, providing 22.5V at 2A, but it is physically larger than the Hammond. The output of the secondary is rectified through a full wave rectifier consisting of four 1N4001 diodes, and then fed to a 7812 +12V regulator and a 7912 -12V regulator with the appropriate smoothing capacitors. An LED is across the +/-12V to indicate that the power is on.

The actual interface consists of two 14 pin ICs and MC1488 Quad line driver to provide the correct logic levels from the computer to the RS232 port, and an MC1489 Quad line receiver to provide the correct logic levels from the RS232 port to the computer. The MC1488 requires both the +/-12V, and the MC1489 only requires the +5V, which is available from pin 2 on the user port up to a max. current of 100mA.

In the board shown, there are two Molex connectors which provide the ability to cross connect some of the pin connections. The reason for having this capability is to permit the interface to be used for not only connecting your computer to a printer but also to a modem.

When the computer is directly connected to the printer the cross connections are as shown in the diagram with a solid line, and when the computer is connected to a modem the cross connect is as shown with a dotted line. The cross connect

capability thereby eliminates the need for two separate connecting cables to be used.

The P.C. board layout shown is designed for the Hammond transformer. As indicated earlier, the Radio Shack alternative is physically larger, and therefore will not fit on this layout. Don't despair; the transformer can be mounted separately from the rest of the board, or if you feel up to it, you can modify the layout to accommodate the larger transformer.

Software

When your RS232C interface is assembled, you will be ready to put it to work for you. Before you can do this, you will have to provide the correct software instructions to your computer, as certain basic commands are required to open an RS232 channel. The basic syntax for opening the file is as follows:

OPEN lfn,2,0, (control reg) (command reg) (opt baud lo) (opt baud hi)

lfn. The logical file number, can be any number from 1 to 255, however if you choose a number greater than 127, then a line feed will follow all carriage returns.

(control register) This is a single byte character which determines the word length and baud rate.

The value of this byte (8 bits) is determined as shown in Table 1.

Table 1

Bit #	7	6	5	4	3	2	0
Binary value	128	64	32	16	8	4	2

bit 7 (128) (stop bits) 0 = 1 stop bit, 1 = 2 stop bits.
 bits 6&5 (64 & 32) (word length) 00, = 8 bits, 01, = 7 bits, 10, = 6 bits

bit 4 (16) unused.

bit 3,2,1 0	(8,4,2 0)	(baud rate)
0 0 0 0		user rate
0 0 0 1		50 baud
0 0 1 0		75 baud
0 0 1 1		110 baud
0 1 0 0		134.5 baud
0 1 0 1		150 baud
0 1 1 0		300 baud
0 1 1 1		600 baud
1 0 0 0		1200 baud
1 0 0 1		2400 baud

Values from 1 0 1 0 to 1 1 1 1 are not implemented.

A value of chrs\$(0) will provide one stop bit, an 8 bit word, and will determine the baud rate from the (opt baud lo) and (opt baud hi) values.

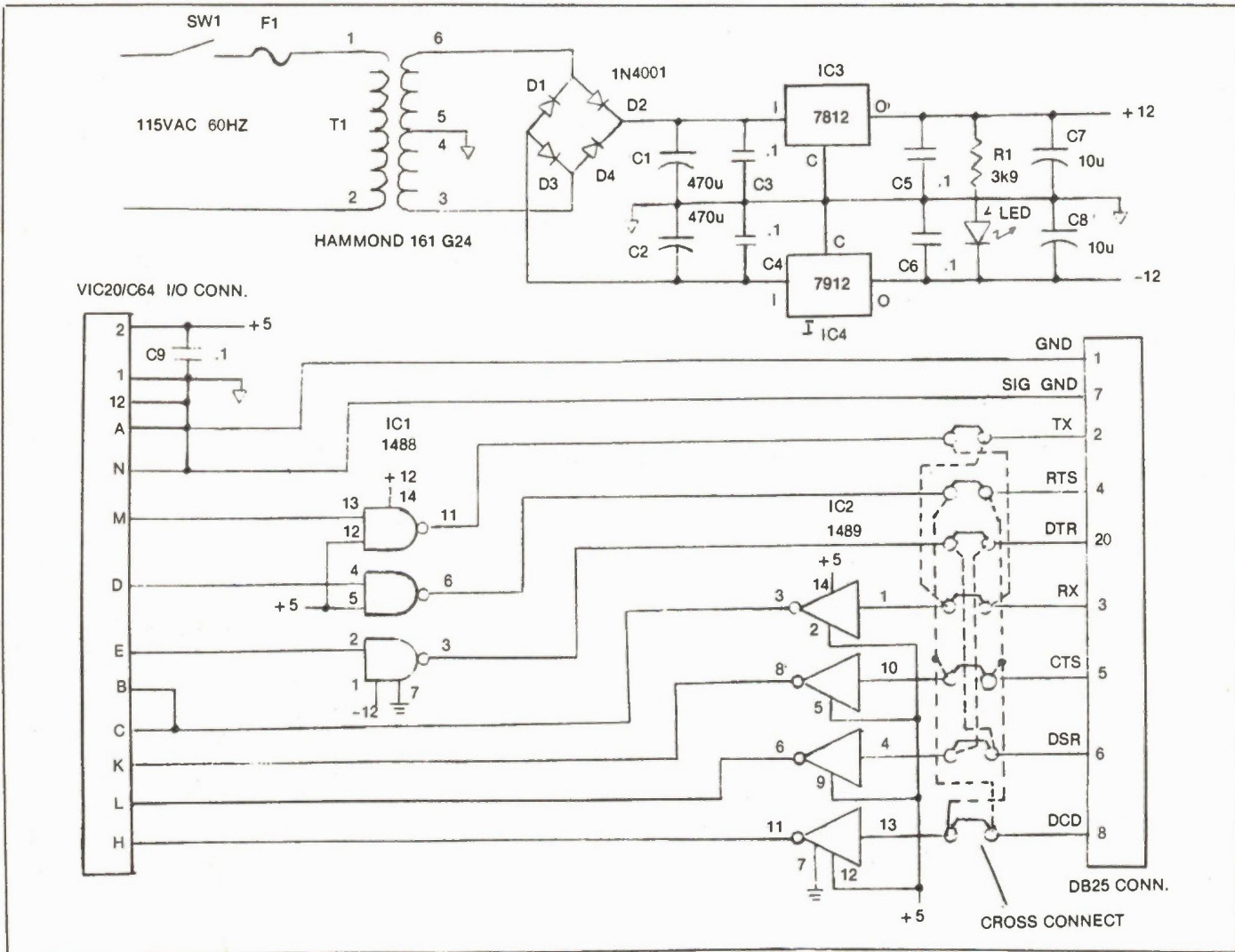

Fig. 1. The schematics of The RS232 project.

continued on page 54

Only NRI teaches you to service and repair all computers as you build your own 16-bit IBM-compatible micro

As computers move into offices and homes by the millions, the demand for trained computer service technicians surges forward. The Department of Labor estimates that computer service jobs will actually *double* in the next ten years—a faster growth than any other occupation.

Total System Training

As an NRI student, you'll get total hands-on training as you actually build your own Sanyo MBC-550-2 computer from the keyboard up. Only a person who knows *all* the underlying fundamentals can cope with *all* the significant brands of computers. And as an NRI graduate, you'll possess the up-to-the-minute combination of theory and practical experience that will lead you to success on the job.

You learn at your own convenience, in your own home, at your own comfortable pace. Without classroom pressures, without rigid night-school schedules, without wasted time. Your own personal NRI instructor and NRI's complete technical staff will answer your questions, give you guidance and special help whenever you may need it.

The Exciting Sanyo MBC-550-2—Yours To Keep

Critics hail the new Sanyo as the "most intriguing" of all the IBM-PC compatible computers. It uses the same 8088 microprocessor as the IBM-PC and the MS/DOS operating system. So, you'll be able to choose thousands of off-the-shelf software programs to run on your completed Sanyo.

As you build the Sanyo from the keyboard up, you'll perform demonstrations and experiments that will give you a total mastery of computer operations and servicing techniques. You'll do programming in BASIC language. You'll prepare interfaces for peripherals such as printers and joysticks. Using utility programs, you'll check out 8088 functioning. NRI's easy step-by-step directions will guide you all the way right into one of today's fastest growing fields as a computer service technician. And the entire



NRI is the only home study school that trains you as you assemble a top-brand micro-computer. After building your own logic probe, you'll assemble the "intelligent" keyboard...

Your NRI Course Includes a Sanyo MBC-550-2 Computer with 128K RAM, Monitor, Disk Drive, and "Intelligent" Keyboard; The NRI Discovery Lab®, Teaching Circuit Design and Operations; a Digital Multimeter; Bundled Spread Sheet and Word Processing Software Worth \$1500 at Retail—and More.

system, including all the bundled software and extensive data manuals, is yours to keep as part of your training.

100-Page Free Catalog Tells More

Send the postage-paid reply card today for NRI's big 100-page color catalog, which gives you all the facts about NRI training in Microcomputers, Robotics, Data Communications, TV/Video/Audio Servicing, and other growing high-tech career fields. If the card is missing write to NRI at the address below.

... then install the computer power supply, checking all the circuits and connections with NRI's Digital Multimeter. From there you'll move on to install the disk drive and monitor.

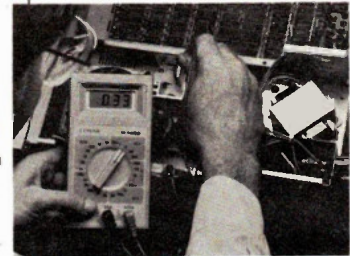

NRI SCHOOLS
McGraw-Hill Continuing Education Center

330 Progress Avenue
Scarborough, Ontario M1P 2Z5
or telephone 416-293-8787



We'll give you tomorrow.

IBM is a Registered Trademark of International Business Machine Corporation.

Designer's Notebook: Optimizing the 7800 Regulator

The 7800 and 7900 series voltage regulators have almost replaced discrete versions, but they're not without avoidable pitfalls.

By Bill Markwick

THE 7800 positive regulators, and their negative complement, the 7900 series, are so inexpensive, reliable, and multi-featured that they've almost eliminated the need to design small voltage stabilizers. In fact, at about one dollar each, it's often cheaper to use a regulator instead of multiple RC filtering of the rectifier output; only one main capacitor is needed.

The ICs are generally used with the plastic TO-220 case, and are available in fixed voltage ratings from 5 to 24 volts. The current available is in excess of one ampere, and they're almost crashproof with both heat sensing and current limiting. The designer is tempted to regard them as being close to perfect, and in fact they just about are for many applications. However, there are some circuit conditions that can make them appear to be failing their specifications.

The Protection Circuit

The circuitry that makes the IC almost completely self-protecting can also give the user a surprise when the current begins to fall off for no apparent reason. This is always due to one or both of two causes: excessive heat and excessive voltage across the IC.

In Fig. 1, Q2 and Q3 form the protection circuitry. First, let's take a look at the thermal sensing. Q1, D1 and the two associated resistors keep Q2 biased at about 400mV, or just a bit less than required to turn the transistor on. If the heat begins to rise, the base-emitter voltage of Q2 begins to fall; that is, the transistor effectively becomes more sensitive when heated. Eventually the rising temperature will cause Q2 to conduct heavily, shunting all the base current away from the output pair and shutting off the IC; this occurs at a chip temperature of about 175 degrees C. If the temperature problem is only borderline, the result will appear to be a loss of regulation as Q2 drifts in and out of conduction. For a permanent solution, see *Heatsinking* further on in the article.

26

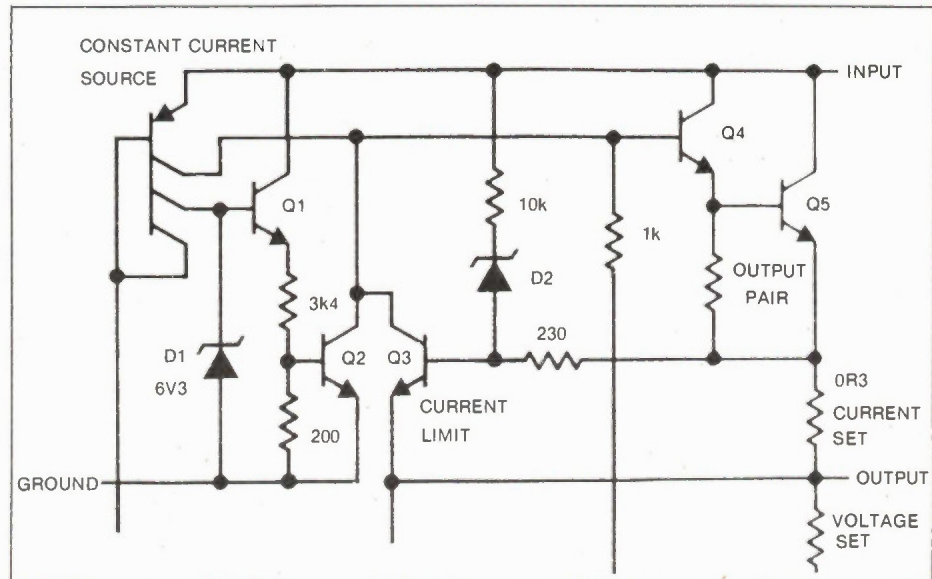

Fig. 1. The protection circuitry for the 7800 series regulators. The four circuit lines at the bottom are connected to the error amplifier.

Secondly, excessive voltage from the input to the output can limit the available output current. Still referring to Fig. 1, let's assume for the moment that the in/out voltage has no effect. The maximum current is now set by Q3 and the voltage developed across the 0R3 resistor by the output current. At room temperature, this is about .65/0.3, or 2.2 amperes. Naturally, the output current causes heating of the chip and a subsequent reduction in output as Q3's V_{be} falls. However, if you can keep it cooled, the IC should supply in excess of 1A. What usually happens, however, is that designers neglect the fact that there may be 10 volts or more across the input/output pins; it's easy enough to do this, since the regulator seems to be an ideal way to drop a high supply voltage to a lower one. Unfortunately, in/out voltage differentials in excess of about 6V at higher output currents soon exceed the chip's power dissipation rating, which is in the area of 8 watts. To allow for this, zener diode D2 is connected through a resistive network to the base of the current limiter Q3, and

when the in/out voltage exceeds about 6V, the zener conducts and extra bias is added to make the current limiting more sensitive.

Just how much the output current will fall when D2 conducts can be determined from the manufacturer's spec sheet; for instance, at room temperature the typical maximum current falls from 1.5A to .75A. If you don't have a spec sheet, or the graph is too small to interpret easily (aren't they always?), National Semiconductor has provided a handy equation in one of their excellent handbooks (*Linear Applications Handbook 2*), and it boils down to:

$$I_{max} = .077(37.2 - V_{diff})$$

where V_{diff} is the supply voltage less the regulator output voltage. The equation applies only at 25 degrees C; at higher temperatures both Q2 and Q3 act to reduce the current.

So far, the moral of the story is to keep the voltage differential low (2V is the minimum) and get rid of heat.

Electronics Today August 1985

Heatsinking

There's another tendency among designers, particularly those working on one-off projects, to stick the IC on a metal surface and hope it's enough. It very often is, and you can get away with it thanks to the excellent performance of the 7800 series. However, I once got caught; I had built a 1/2 ampere supply for a recording studio console, and had fastened the ICs to the steel box with mica washers and silicone grease. It *seemed* cool enough, even after hours at the rated current. However, the owner mounted the supply on top of other warm equipment in a rackmount cabinet with no cooling vents. Later, during a recording session, he phoned in a panic, saying that the console kept shutting itself off. When I tested the supply voltage, it was slowly falling as the chips heated up and activated their protection circuits. The cure was to mount them on properly calculated heatsinks and provide a bit of airflow for the cabinet.

It isn't difficult to determine the heatsink requirements. The rating of the heatsink sink-to-ambient in degrees C per watt can be estimated from:

$$\theta_{s-a} = (150 - T_a) / P_d - (6 - \theta_{c-s})$$

where 150 is the maximum chip temperature, T_a is the ambient temperature in degrees C, P_d is the chip power dissipation in watts, 6 is the thermal resistance from the junction to the case, and θ_{c-s} is the thermal resistance from the case to the sink. You can take 25 or 30 for the ambient temperature, or more if you think it necessary, and a mica insulator with silicone gives a case-to-sink resistance between .2 and .5. If you want an even easier shortcut, a general application will usually work out to about 8 or 9 degrees C per watt. This doesn't require much of a heatsink; for instance, a Wakefield 621 has a temperature rise of 4.5 degrees C per watt for convection cooling and measures only 1.5 by 4.4 inches.

No Heatsinking

If the circuit doesn't take too much current, it's often convenient to solder the regulator onto the PCB without a heat-sink. If you have multiple PCBs, each one can have its own regulator. The question becomes: how much current can you safely get out of the free-air application?

The TO-220 plastic package has a thermal resistance of 56 degrees C per watt from the chip to the ambient air (National's spec). Since the maximum chip temperature is 150 degrees C, and the ambient temperature can be taken as 25, you can run the IC at $125/56 = 2.2$ watts. However, this means that the thermal limiter will be on the verge of working; any slight increase in line voltage will cause the IC to shut down. The choice is

Electronics Today August 1985

up to the designer, but a wise move would be to run the IC at about 1 watt to allow some headroom. If the in/out voltage is 5V, then the output current is 200mA, usually more than enough for on-card regulation for small circuits. The 1W dissipation gives a chip temperature of about 80 degrees C and minimizes failures from extended thermal cycling of internal leads and soldering.

Adjustables

There are always those times when you need some voltage other than the rated one and you haven't time to obtain a proper adjustable regulator such as the LM317. The 7800 series can be easily adapted to other voltages; it's just a matter of having the ground pin sit on another voltage. This voltage adds to the rated voltage to give the desired output. The only catch is that the operating currents of the chip are all dumped through the ground pin; any change in these currents due to temperature or load variation will cause a variation in the voltage developed and thus a change in the desired output voltage. Fortunately, there's very little change in the IC quiescent current when the load changes; it's fairly constant at 7 to 10 mA, and changes by less than 1 mA

from no-load to full-load.

Figure 2 shows some of the many ways to make the IC output voltage adjustable. The first, 2(a), is the easiest, but suffers from a slight reduction in regulation as the load changes; this reduction isn't severe because of the small change in quiescent current, but it still may be as high as 1.5 percent. The current through the resistors should be 20mA or more. Better ripple and noise performance can be obtained by bypassing R_b with an electrolytic capacitor (but see *More Protection* below).

In 2(b), the zener diode voltage is selected to add the desired amount to the IC's output. This method gets you away from the quiescent current change problem, but it adds noise; a large electrolytic capacitor may be necessary across the zener diode. The zener current can be 10 to 30mA.

In 2(c), the 741 op amp absorbs any changes in quiescent current, buffers the current through the resistive divider, and allows a wide range of output voltage adjustment. The divider current can be as low as 1mA, but due to the construction of the 741, its output stage will not go down to zero volts; therefore, the minimum voltage at the bottom of the pot

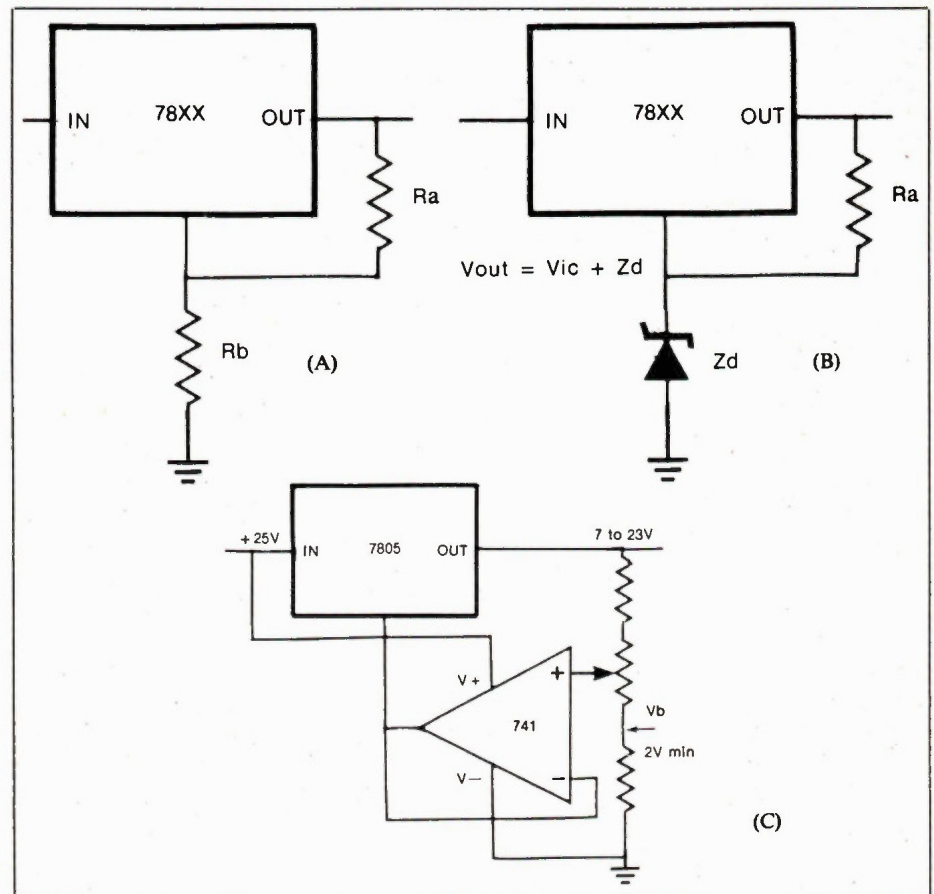
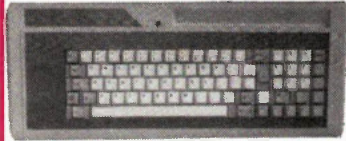

Fig. 2(a). Boosting the output voltage above the rated IC voltage: (a) the ground pin current should be taken into account when calculating the resistors; (b) a zener diode in place of R_b simplifies the design but may add noise; (c) an op amp solves most boosting method drawbacks.

PARTS GALORE INC.
316 College St.
Toronto, Ontario M5T 1S3

1-800-387-1385
Order Checking (416)925-8291
Technical Data (416)925-1105

**APPLE IIe®
DETACHED NUMERIC KEYBOARD
\$99.00**



For those of you who would like to put your IIe in another case we have a high quality 100% plug in compatible Matrix keyboard with all IIe keys plus the highly desirable numeric keypad for quick entry of numeric data **\$99.00**

ASCII KEYBOARDS



Now, we have a new keyboard, micro controlled with 3 levels of pre-coded functions for Basic, CPM etc. and at the same old price as before.

Function Keyboard, Numeric **\$89.95**
Function Keyboard, Standard **\$73.95**

**SOLID ABS
CASE
NUMERIC
\$59.95**

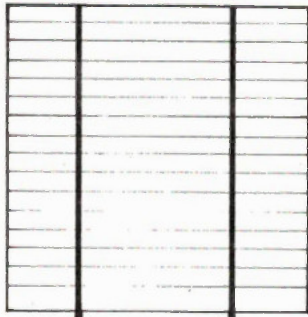

**SOLAR
CELLS**

SOLAR CELLS. These square polycrystalline silicon solar photo-voltaic cells have many uses from car top battery chargers, sony walkman power supplies, calculators, radios, nicads, etc. Each cell has an open circuit potential of 0.5 volts that is area independent, and a short circuit current that is area dependent, see list. We

have been playing with them here and they are lots of fun, we are going to make up a few large banks of cells as an emergency lighting system. Note can also be used for the ETI solar powered night light. Each order comes with a data sheet and instructions on how best to use the cells.

- High Efficiency
- Polycrystalline
- Antireflective Coating
- Fine Collector Grid
- High Area Factor Square Cells

- (a) 1" x 4", 1/2 Amp. **\$3.95**
- (b) 2" x 2", 1/2 Amp. **\$3.95**
- (c) 2" x 4", 1 Amp. **\$6.95**
- (d) 4" x 4", 2 Amp. **\$8.95**

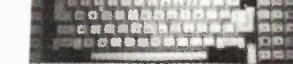

This is a high quality Hall Effect keyboard made by Microswitch of Canada for AES data and now bought by us for 10% of the \$169.00 that AES paid for them in 10,000 lots. They are a very good word processing keyboard with both serial and parallel data outputs for use with APPLE and IBM type systems and come complete with a ribbon cable connector and complete pin-out. **\$24.95**

WIRED CARDS

- | | | | |
|------------------|----------|---------------------|----------|
| 16K | \$ 45.00 | Applext 128K | \$140.00 |
| 128K no IC | \$ 34.95 | Sprite gr. | \$ 69.95 |
| 128K OK | \$ 55.00 | TM:S9918A IC | \$ 18.95 |
| 128 64K | \$ 99.00 | DISC SHMRCK | \$ 45.00 |
| 128K 128K | \$150.00 | 80 Column | \$ 65.00 |
| MC3242 IC | \$ 12.00 | 80 Col. Sofsw. | \$ 69.00 |
| DISC | \$ 45.00 | Gripper | \$ 50.00 |
| Z-80 | \$ 45.00 | Grip cable | \$ 19.95 |
| Applicard | \$150.00 | | |

**NEW LOW BARE
PCB PRICES***

- Real time clock
- Rana 4 drive
- 9 V Music
- Disc Controller
- Disc Controller (Shamrock)
- Gripper
- 80 Column
- 80 Column Soft Switch
- Z-80
- PIA card
- EPROM
- WILD CARD
- SAM TALKS
- COMMUNICATIONS

GROUP 2 \$9.00 each

- RGB
- Sprite graphics
- APPLICARD 128K ADD ON

GROUP 3 \$11.00 each

- SSM MODEM
- APPLICARD
- APARAT EPROM PROG
- 16K
- 128K

All boards come with a parts list and placement diagram. We have all the parts of the PCB's just ask for them.

*Prices so low we require payment with order

MEMORY FLASH

- 256K-150Ns DRAM **\$7.95**
 - 64K-150Ns DRAM **\$1.00**
 - 64K-200Ns DRAM **\$1.25**
- Prime stock, limited quantity.

PROGRAMMABLE KEYBOARD
An excellent ASCII Keyboard. Fully Apple Compatible. Full size with numeric pad, fully programmable key switches with full data. **\$9.95**

**POWER
SUPPLY
CSA APPROVED**

Our Famous "BLACK BEAUTY" power supply, now reduced in price but not in quality. Our ratings are 5V 5A; 12V 2.5A; 5A 1/2 A; -12V -1/2A for real **\$79.95**

OUR 6502 BOARD

Now only \$29.95 still with all the versatility of the original and a full 8 slots.



**APPLE® DETACHED
KEYBOARD \$159.00**



The excellent MAKII Apple detached keyboard using serial data (IBM) format. Plugs directly into Apple PCB

**GREAT
DEAL**

THE GREAT DEAL CARRIES ON FOREVER AND GETS BETTER

Our proven 6502 motherboard plus a numeric case plus a black beauty power supply plus a numeric function keyboard plus any 4 bare pcb for **\$225.00**

CONNECTORS



DB SERIES

- DB-25 M solder **\$1.95**
- DB-25 F solder **\$1.95**
- DB-25 M IDC, Flat cable **\$5.95**
- DB-25 F IDC, Flat cable **\$5.95**
- DB-25 M Right angle PCB **\$4.95**
- DB-25 F Right angle PCB **\$4.95**
- DB-25 Shell **\$1.00**
- DB-15 M solder **\$1.95**
- DB-15 F solder **\$1.95**
- DB-15 M IDC, Flat cable **\$3.95**
- DB-15 F IDC, Flat cable **\$2.95**
- DB-15 F right angle PCB **\$2.95**
- DB-15 Shell **\$1.00**
- DB-9 M solder **\$1.75**
- DB-9 F solder **\$1.75**
- DB-9 M right angle PCB **\$2.50**
- DB-9 F right angle PCB **\$2.50**
- DB-9 Shell **\$0.75**

DRIVE CONNECTORS

- 50 Pin Edge C, 8" drive **\$5.95**
- 40 Pin Edge C **\$4.95**
- 34 Pin Edge C, 5-1/4" drive **\$5.95**
- 20 Pin Edge C, Hard drive **\$4.95**
- 34 Pin Fem header 17 x 2 **\$3.50**
- 26 Pin Fem header 13 x 2 **\$3.00**
- 20 Pin Fem header 10 x 2 **\$2.00**

**ASSORTED SEMI-
CONDUCTORS AND
OTHER STUFF**

- (A) RED LED S/M/L **10/\$1.00**
- (B) GREEN LED S/M/L **8/\$1.00**
- (C) AMBER LED S/M/L **8/\$1.00**
- (D) PIN PHOTODIODES, INFRA-RED **2/\$1.00**
- (E) PHOTO TRANSISTOR, NPN VISIBLE **2/\$1.00**
- (F) LDR (LIGHT DEP RESISTOR) **\$1.00**

**MOTHER
BOARD**

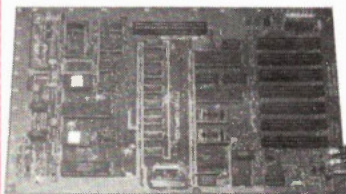

100% IIe® Compatible, for those of you who wish to build a clone of the very popular APPLE IIe®. This board is a reverse engineered copy of the IIe® and is 100% compatible. We have the motherboard and the custom ICs only. All other parts are widely sold. The custom ICs are workalike chips that do not infringe any copyrights. The software for operating the board must be obtained elsewhere as we do not have it for sale. When we say 100% we mean it.

- A very good buy at **\$49.95**
- Custom IC set(2) **\$49.95**
- Keyboard encoder (AY3-3600) **\$14.95**
- Character generator, U/I/C **\$14.95**

**IIe® ABS PLASTIC CASE
\$49.95**

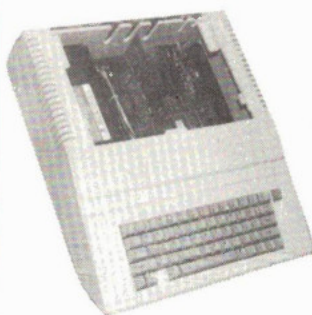

This case is made to fit the Mother Board listed here for making IIe® clones and it makes a very nice looking copy. There is just enough difference to avoid design infringement. The case also has no brand names or other marks on it. **\$49.95**

**IBM POWER
SUPPLY**

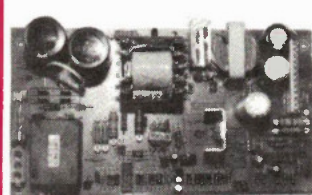

One of the nicest open frame IBM type switching power supplies we have ever seen. Came from the defunct NCR IBM compatible. runs the whole thing, has +5V-7A, +12V-3A, -5, -12-1/4A. A very good unit for starter system. Will not run hard disc system. A real Steal at: **\$49.95**



**IIe® MATRIX
KEYBOARD
\$69.95**

This keyboard fits the above case and has 100% clone compatibility. It will allow operation of all IIe® commands. Another bargain at **\$79.95**

**SWITCHING
POWER SUPPLY**



Another great bargain from PARTS GALORE, A small power supply switching style that give +5v -4A; ±12v 1A and -5v (adjustable) on a compact 4x8" open frame PCB. Cost Northern Telecom \$50.00 when they bought 5000 pieces. We got em when a subcontractor went belly up for 10% of that price and we are selling em for

\$18.95 NEW IN BOX TESTED

AC power cable (3 Wire) for above **\$2.50**

Toll Free Orders Only
1-800-387-1385
Order Checking (416)925-8291
Technical Data (416)925-1105

MAIL ORDERS: We accept VISA, MC, AMEX, credit cards. Money orders, cheques (2 week wait) are also OK. Minimum packing and handling fee \$5.00 or 5%, whichever is larger. The only COD we use is via CANPAR (Add \$4.00 COD fee) or motor freight. We do not use postal COD at all. All Ont. res. add 7%. All prices are subject to change without notice. Returns are subject to a 20% restocking charge.

**CHERRY IBM® \$99.00
STYLE KEYBOARD**

At last a good low cost keyboard for the IBM PC, XT or compatible machine. Uses capacitive keys, has a very good feel, and has TYPEWRITER LAYOUT for easy word processing at the very low price of \$99.00

**MBE-XT
AN IBM®
XT Compatible
8 Slot Motherboard**
MBE-XT BARE PCB WITH
MANUAL AND SCHEMATICS.
\$49.95
LAZY BOARD

What is your time worth? We have had a bunch of MBE-XT boards stilled and wave soldered so you can save all that time soldering them up. All you need are the IC's memory and BIOS and you are set to go 149.00

**FULLY WIRED AND TESTED WITH
64K ON BOARD WITH MEGABIOS
AND MANUAL**
\$365.00

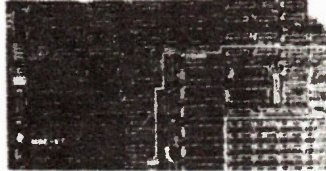

- 8086 16 Bit Microprocessor
- 8087 Math Processor, Optional
- Up to 256K Dram on Board
- Has Digital Delay Line for Error Free Memory Refresh
- 8 IBM Compatible Expansion Slots
- 4 DMA and Timer Channels
- 64K/128K Eproms Jumper Selectable
- Will run any compatible BASIC
- IBM Power Plug Compatible
- Same PCB size as IBM XT
- Runs PC-DOS and CPM-86
- Compatible BIOS in stock

DTC DISPLAY TECHNOLOGIES CORPORATION **new!**

MEGA-BOARD

IBM and IBM PC are trademarks of International Business Machines.

Eight Compatible I/O Interface Connectors
Full PC compatible. Compatible with all IBM PC plug-in cards.

Special J1 Interface
(Allows expansion mounting of compatible expansion cards for extra bus expansion and custom configuration. Board has full on card parallel control connector)

Extended ROM Capability
Runs all compatible PC ROMs. Complete expansion to accommodate all popular 80, 128, 256 and 512K ROM chips and NEV or E ROMs. VPP power on board. Available for EPCROM burning. E-EPROM voltage regulated.

Board Size
10 1/2" x 13 1/2"

Full Mega-Byte Ram Capacity! On board!
128K capacity.
Other BIOS using 256K chips.
Mega-Byte using 512K chips.

ONLY! \$99.95 Evaluation Board Kit

Standard Keyboard Interface
Full PC compatible

Hardware Reset
Control reset fan (PC)

Power Connector
Full PC compatible

8088 Processor
Same as PC

8087 Numeric Processor
Same as PC

Peripheral Support Circuits
Same as PC

Configuration Switches
Same as PC

Speaker/Audio Port
Same as PC

Wire Wrap Area
Application specific

ORDER NOW!!!

Evaluation Board with full quality, multi-line, and parts list.
Includes regional guide, PC board with quality wiring, and 40 track 8" drive.

MEGA BIOS
The amazing MEGABIOS® from DTC of Dallas. A fully rewritten BIOS that allows you to make a fully compatible legal system. Note they do not ask MEGABUS® for it, only \$29.95

TAIWAN BIOS, not as good or 100% compatible but it will get you running and save you bucks \$19.95
TAIWAN BASIC, in 4 2764 EPROMS \$49.95

IBM BARE PCB

(A) Color Graphics (Pcrsys)	\$27.95	(N) 256K short card	\$19.95
(B) Monochrome graphics	\$24.95	(O) IBM 6" extender for service	\$19.95
(C) Disc controller	\$17.95	(P) WW Proto, full sized with DB9 & DB25 footprint	\$24.95
(D) Disc controller + Printer	\$24.95	(Q) WW Memory proto, full sized with 256K (1Meg) memory laid out on one and with DB9, DB25 footprint	\$29.95
(E) Disc controller + Game	\$24.95	(R) 512K Mapping PROM	\$12.95
(F) IO + 2 I/O clock etc.	\$24.95	(S) Multifunction PROM(S)2	\$24.95
(G) Multifunction card 11 function	\$24.95	(T) 2732 for color graphic	\$10.00
(H) AST SIXPACK COPY	\$24.95		
(I) Parallel printer	\$17.95		
(J) RS-232 card	\$17.95		
(K) Simple modem card	\$17.95		
(L) Disc for above	\$ 8.00		
(M) 512K card	\$24.95		

All cards come with a detailed parts list and placement drawing, we also have all parts needed for them.

MBE-XT

MBE-XT Motherboard, wave soldered with no IC's at all with manual and schematics \$149.00
As above with 64K, BIOS, tested with all IC's and fully burned in, 8 Slots \$325.00
BASIC SYSTEM, MBE-XT, A & T with 256K with one 360K drive & controller with power supply, hinged lid case and MEGA-BIOS \$895.00
MBE-XT SYSTEM +, The fully loaded MBE-XT system with 256K on board, BIOS, Cherry keyboard, color graphics, 2-360K OSDD Drives with controller and serial, parallel ports, calendar, clock and many more small features, fully tested, ready to go \$1395.00

MEGABOARD

MEGABOARD Motherboard, Wave soldered with no IC's at all with parts list and schematics \$195.00
MEGABOARD Motherboard, Wave soldered with all IC's and 64K on board, with schematics and test data, no BIOS but fully burned in and tested with one \$399.00
BASIC SYSTEM, MEGABOARD, A & T with 256K (256K DRAMS) with one 360K OSDD Drive & controller with power supply and hinged lid case, and megabios \$995.00
MEGABOARD SYSTEM +, The fully loaded MEGABOARD with 640K on board (256K & 64K DRAM) with 2-360K OSDD drives and controller, color graphics board, with serial, parallel, clock, calendar, and many small features fully tested and ready to go \$1999.00

IBM CASE

We have the nicest case of all the various competing cases, ask any friend who has bought someone else's case and then has seen ours. The lid is hinged with pushbutton access. The back is cut for 8 XT slots and it comes with all the case back inserts for cards, card guides, blind disc filler plates, standoffs, feet, screws, all for \$79.95
Please specify back or side cutout for power supply.

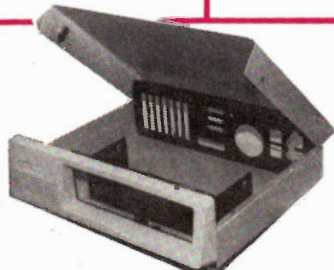

MEGABOARD CASE, similar to the above, but no pushbuttons or hardware, from DTC in Dallas Texas. A stronger US made case, but less finishing parts. Fits the MEGABOARD exactly with side cut extender, for back power supply \$99.00

We also have an IBM 8 Slot/6502 Board dual duty case for making IBM look-a-like 6502 systems \$79.95

SWITCHING POWER SUPPLY

110V, 60Hz with Fan and two rear switched outlets.

These power supplies fit our cases.

100 WATT	+5v-10A; +12v-3.5A; ±12v-1/2A	\$139.00
130 WATT	+5v-14A; +12v-4.2A; ±12v-1/2A	\$149.00



Please specify, side or back switch

8" DRIVE SWITCHING POWER SUPPLY

\$39.95

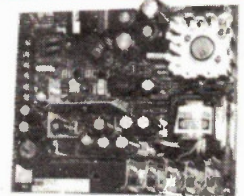

The greatest 8" Drive supply we have ever found. Has 24V-2.2A 5V-3A and -12V-1.7A. All you need for a dual 8" Drive system. A switching power supply by ASTEC \$39.95

PARTS, PARTS, PARTS, PARTS, PARTS

Hard to get parts for your IBM compatible (8088) systems and peripherals

8088 CPU	\$7.95
8087 Math Processor	\$219.00
8237A-5 Prog. DMA Cntrl.	\$8.95
8250 Serial Port	\$9.95
8253A-5 Prog. Interval timer	\$5.95
8255A-5 P.I.A.	\$4.95
8259A Prog. Interrupt Cntrl.	\$4.95
8284A ADC clock gen & driver	\$5.95
8288 Bus Controller	\$9.95
8272 Floppy Disk Controller	\$9.95
NEC 765 Floppy Disk Controller (equivalent to 8272)	\$9.95
Set of 8088, 8255A-5, 8237A-5, 8288, 8284, 8253A-5 and 8259A	\$55.00
2716	\$3.49
2732	\$3.95
2764	\$4.95

LS for IBM Systems

00	\$0.39
02	\$0.39
04	\$0.39
08	\$0.39
10	\$0.45
20	\$0.45
27	\$0.45
30	\$0.45
37	\$0.80
42	\$0.50
138	\$0.70
158	\$0.75
175	\$0.80
243	\$1.20
244	\$1.25
245	\$1.50
273	\$1.90
322A	\$6.00
373	\$3.50
374	\$1.40
377	\$1.40
378	\$1.25
870	\$1.75
7407 TTL	\$1.00

S SERIES

S00	\$0.75
S02	\$0.75
S04	\$0.75
S08	\$0.75
S74	\$0.85
S138	\$1.75
S157	\$1.85
S158	\$1.85
S374	\$3.25

MISC

75477	\$1.25
-------------	--------

Hard to get parts for your 6502 Systems and Apple Compatible Peripherals.

6502 CPU	\$ 5.50
6845 CRT controller	\$ 9.50
68A45 CRT controller	\$ 9.95
280A CPU (4 MHz)	\$11.95
MC3242	\$ 62
74LS259	\$ 1.39
74LS161	\$ 99
74S74	\$ 82
74S174	\$ 1.70
74LS323	\$ 4.55
Card edge connector (50 pin)	\$ 2.49
RCA jack PC mount	\$ 69
6 pin power square connector	\$ 99
Phono jack (small)	\$ 99
MPSA 13 trans	\$ 55
2N3904 trans	\$ 19
2N3906 trans	\$ 27
MPSU51 trans	\$ 79
2N4258 transistor or equiv	\$ 69
1K SIP 10 pin	\$ 69
1K SIP 8 pin	\$ 69
10K SIP 10 pin	\$ 75
4 pos dip sw	\$ 95
20 pin female header for disk drive	\$ 1.79
20 pin male	\$ 1.69
50 pf trim cap	\$ 69
220 ohm trimpot	\$ 69
20 conductor ribbon cable	\$ 89/ft.

MONOLITHIC CAPS

MONOLITHIC CERAMIC CAPS
We bought 100,000 of em dirt cheap, they are very good quality, 63V, 0.2" lead spacing. Now only 10¢ ea.
50 pcs. \$ 5.00
100 pcs. \$ 9.00
1000 pcs. \$85.00
more? ask!

WE'VE GOT EM!

**5-1/4" HALF SIZE DRIVES!
For IBM PC, TI PC,
XEROX 820**

Shugart/Panasonic 1/2 size SA455-3AEC \$179.00
TEAC (A Cadillac Drive) 1/2 size FD55B \$179.00

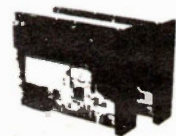

CANON 1/2 HEIGHT

Canon entered the 1/2 height drive market with the nicest drive we have seen for a while. Fully IBM compatible. 40 Track. Very quiet. With all hookup data \$149.95

- 40 Track per side 48 TPI
- Double-sided, double density
- Same as SA455
- Latest head & drive technology
- Fast access time

TEAC

TEAC the nicest drive FD55F \$219.00 with free DOS patch for 80 track.

- 80 Track per side 96 TPI
- Double sided, quad density
- Same as SA465
- Latest head & drive technology
- Fast access time

should be about 2V. The input voltage can be about 25V, giving an adjustment range of 7 to 23 volts. You'll also have to keep in mind that at the lower voltage settings, the high in/out differential will reduce the available current to about 1A or less (with a good heatsink).

Higher Voltages

The maximum input voltage that can be applied between the input and ground pins is 35V (40V for the 24V output version). This can come up a bit if you raise the ground pin above zero volts using one of the methods in Fig. 2. The major drawback is that the IC is now vulnerable to damage if the output is short-circuited. For instance, if you've jiggered the resistor values of 2(a) for an input of 60 volts and an output of 40, a short circuit to ground will put 60 volts across the IC's output pair. It might survive, but it's more likely to go to that great Junkbox in the Sky. Most manufacturer's application notes include circuits for safely raising the input and output voltages; their books are well worth the price if you work with regulators much.

Starting Latches

I can't say I've ever had this happen to me, but a manufacturer's application note

points out that the 7800 series regulators will latch in the zero-output mode if they are started into an overload condition; for instance, tungsten pilot lights may draw up to ten times their normal current when cold, and this may be enough to activate D2 and the current sensing on power-up, and this will latch the IC off. The cure, if this happens, is to put a large resistor from input to output to ensure some starting current; the resistor will be swamped out once the regulator starts. This problem does not occur with newer regulators such as the LM317.

Higher Currents

The ICs are inexpensive enough that you can use on-card regulation rather than one massive regulator, but if you just have to beef it up, the circuit in Fig. 3 will work. With currents below 1A, Q1 (which is an MJ2955 or similar) is held off by the 0R5 resistor and the IC functions normally. When the current rises to 1A or more, Q1 begins to conduct, boosting the current available from the IC; 5A or more is possible if Q1 has a good heatsink. Unfortunately, the short circuit and thermal limiting function of the IC isn't of much use here; the current through the IC will be enough to saturate Q1 and damage it if the output is shorted. If you start adding

current limiting transistors and so forth, you're making the circuit complicated enough to justify using one of the more versatile ICs such as the 723; they have provision for boosting, current limiting, etc. Also, 3-pin regulators with output currents in excess of 5 amps are getting cheaper all the time; the external pass transistor is just about obsolete these days, at least in lower current circuits.

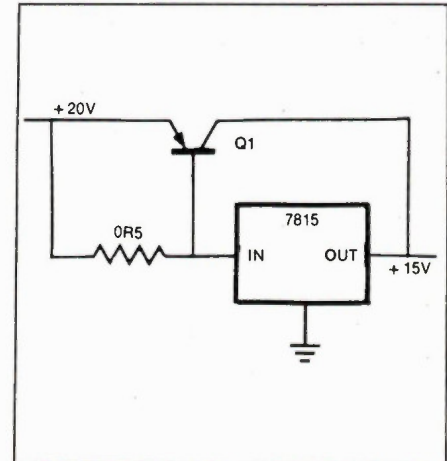

Fig. 3 Q1 will boost the available current considerably; the above method has no overload protection.

WAREHOUSE CLEARANCE

SALE

50% - 80% OFF!

***COMPUTER Products**

Software & Hardware for ZX81
Cables, Accessories, Cleaners
VIC20, C64, Atari Software

- ACORN ATOM Computers \$49.95
- MOVIT Hobby Robot Kits
- TEST EQUIPMENT - Demonstrators
- 64K Chips 4164 - Set of 8 on Circuit Board \$19.95

PLUS OTHER SURPRISES!! SHOP EARLY!!
LIMITED QUANTITIES!!

Sale runs for month of August only.
Hours - Monday - Friday 10 am - 5 pm
This is a ONE TIME offer only and cannot be repeated.
All sales final. No warranty on any sale item. Call (416) 636-9415 for sale price list.

EDG ELECTRONICS, 3950 Chesswood Drive,
Downsview, Ontario, M3J 2W6

DUNCAN INSTRUMENTS LTD.

ELECTRONIC INSTRUMENT SPECIALISTS

121 MILVAN DRIVE, TORONTO, ONTARIO M9L 1Z8

TEL. (416) 742-4448 - TELEX: 065-27271

OSCILLOSCOPE

MODEL 6022 20 MHz DUAL TRACE

The model 6022 oscilloscope meets the needs of the modern technician at a most realistic price. A built-in component tester enables problem components to be eliminated, thus saving valuable service time.

FEATURES

- DC - 20 MHz (-3 dB)
- 5 mV vertical sensitivity
- built-in component tester
- 140mm PDA tube with internal graticule
- X-Y-Z operation
- dual 1:1, 10:1 probes supplied

\$635.00 FST incl. Ontario residents add 7% PST.

Circle No. 29 on Reader Service Card

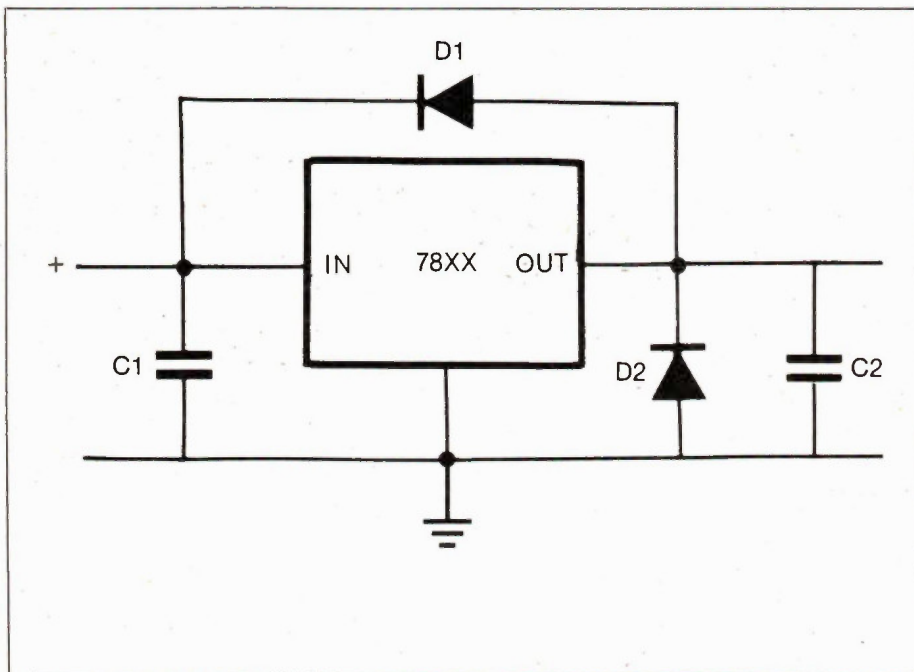

Fig. 4. Some of the methods for ensuring reliable operation; the choice of component values is explained in the text.

More Protection

While the IC is well protected against overcurrent and inadequate heatsinking, there are some circuit conditions that can make it expire without a sigh. One of these is reverse conduction with high currents, almost always fatal with any semiconductor. This can happen to your regulator if the main power supply should short out; the capacitance in the load circuitry will now discharge back through the IC, usually destroying it at the same time. Picture a large control or computer console with lots of on-card regulators and a remote main power supply. Somebody steps on the console's power cable and the connector shorts internally (it happens). The result is a whole lot of instantly dead regulators inside the console.

In Fig. 4, D1 is a reversed power diode such as a 1A, 200V silicon type (1N4002 or equivalent). Normally, it has no effect on the circuit, but should the input become shorted, it will forward-bias and safely drain off any charge in the circuitry capacitance. D2 is another of the same type, and it drains away any negative voltages that might be generated by the load circuit or something attached to it.

If the circuit of Fig. 2(a) is used with a noise-bypassing capacitor across Rb, it's particularly important to install D2 from the output pin to the ground pin (not circuit ground). Otherwise, a shorted output could cause the noise capacitor to discharge through the ground pin and possibly damage the IC.

C1 is a 0.1 or 0.2 μ F film capacitor, and is particularly important for stability

if the main supply is far from the regulator. C2 is almost always specified by the manufacturers as a 10 μ F solid tantalum to prevent oscillation of the IC; I've always used a cheap, readily available electrolytic without the slightest stability problems.

When it comes to reliability versus operating temperature, cooler is always better for any component. Although the thermal limiting seems like the ideal answer to overheating, it lets the chip approach its operating limit of 200 degrees C, and if the IC gets overloaded much (as it might in a testbench supply), thermal cycling may cause internal metal fatigue. So, although the IC can run on-card without a heatsink as mentioned previously, keeping it as cool as possible extends its life and reliability.

You may have noticed that some component supplier catalogs list the 7800 series as being one amp regulators. No doubt this is due to the fact that many users overdo the heat and voltage specs, causing the chip to current limit and the manufacturers to play it safe. However, if you follow the maker's application notes summarized above, you can easily get your regulators to reliably meet full specifications. ■

PROBES FOR SALE

FROM THE BEST SOURCE FOR OSCILLOSCOPE PROBES AND DMM/VOM TEST LEAD SETS.

- Low cost
- High Quality
- Excellent Performance
- Slender, Flexible Cable

- Wide Range of Choice
- Switchable X1 and X10 Attenuation Factor
- 100 MHz Bandwidth

MODEL SP100
\$25.00

Please add \$2.00 for shipping

Your Probe Specialists

BCS
ELECTRONICS LIMITED

980 Ainess St. Unit 7,
Downsview, Ontario,
M3J 2S2
(416) 661-5585
TELEX 065-28169

Coline Canadian Sales & Stocking Source
Store Hours: Monday to Friday 8:00 am to 5:00 pm

Sound Effects Project

A miniature but versatile sound effects unit for recording or just driving the cat crazy.

WITH experimentation the unit described is capable of producing an almost infinite variety of sound effects. Sci-fi, animal, musical, engine and mechanical sounds can be generated by adjusting the four control oscillators. Each control has a calibrated scale which allows the settings to be repeated. However, a very small adjustment of the controls can cause major changes in the nature of the sound produced, and with this in mind it is better to record your effect on tape for future use.

The Circuit

Figure 1 shows the circuit of the unit. Four separate collector-coupled free-running multivibrators are the source of the tones. Each multivibrator is individually adjustable over a different band of audio frequencies, as shown in the following table:

- Q1,2..... .3Hz-5Hz
- Q3,4..... 80Hz-300Hz
- Q5,6..... 1KHz-3KHz
- Q7,8..... 2KHz-7.5KHz

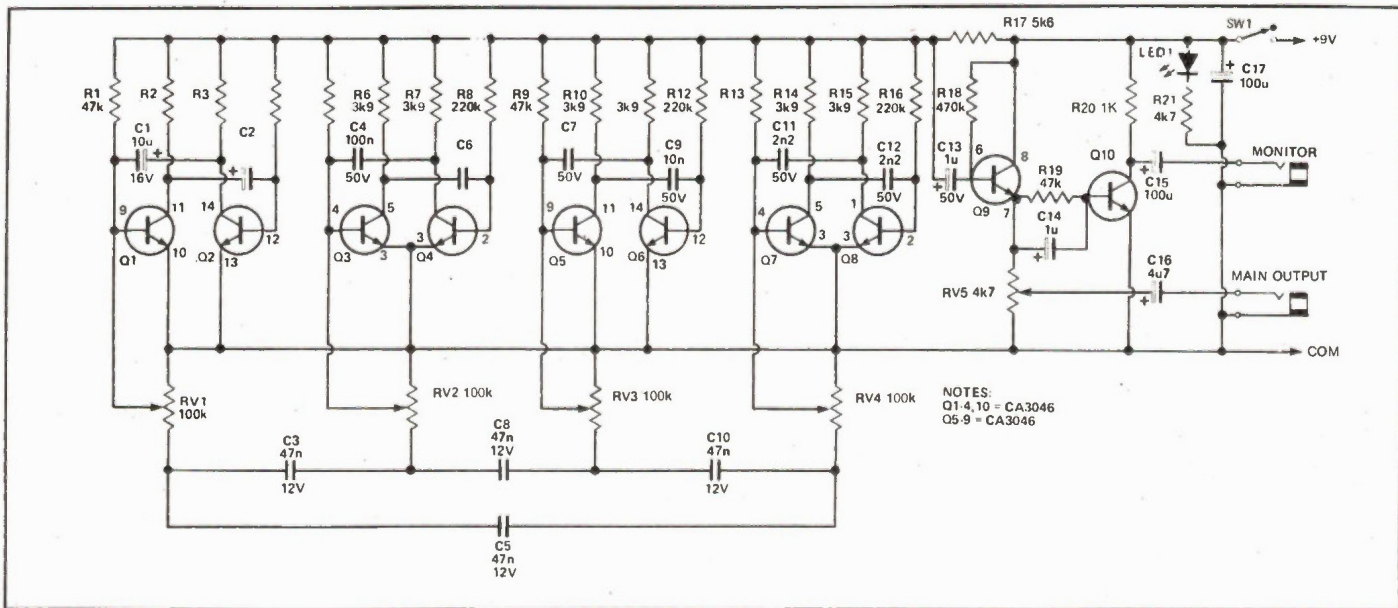

Fig. 1. The schematic of the sound effects circuits.

Each oscillator shares a common load resistor, R17. This causes the multivibrators to mix and synchronize according to their respective frequencies. RV1-4 set the frequency. Further effects are achieved by coupling the oscillator bases via C3, C5, C8 and C10 at the counterclockwise low frequency end of the controls. Individual oscillators can be muted by setting the controls fully clockwise.

The combined output is fed through C13 to Q5 to act as a buffer stage. RV5 enables the 100mV peak to peak signal to be set up before emerging through C16 to the 3.5mm output jack. Q10 amplifies the signal sufficiently to drive an earpiece or headphones, allowing monitoring via the other jack.

The unit is powered from an internal 9V battery, drawing a steady 5mA of current switched by SW1.

Two CA3046 transistor arrays are used to provide the ten transistors used in the circuit.

Construction

The prototype was built in an ordinary experimenter box which was 13 x 6.7 x 4 cm. A single Veroboard, 22 strips by 37 holes long contains most of the circuit, and the balance is to be found on the aluminum front panel.

The CA3046 transistor arrays are connected through 14-pin DIP sockets. This is advisable if easy replacement is necessary in the event of, say, one transistor failing. If you wish to reconfigure the array, be sure to connect the substrate to the chassis common (the substrate is connected to IC pin 13, one of the transistor emitters).

Two spacers support the Veroboard off the front panel. A piece of insulating

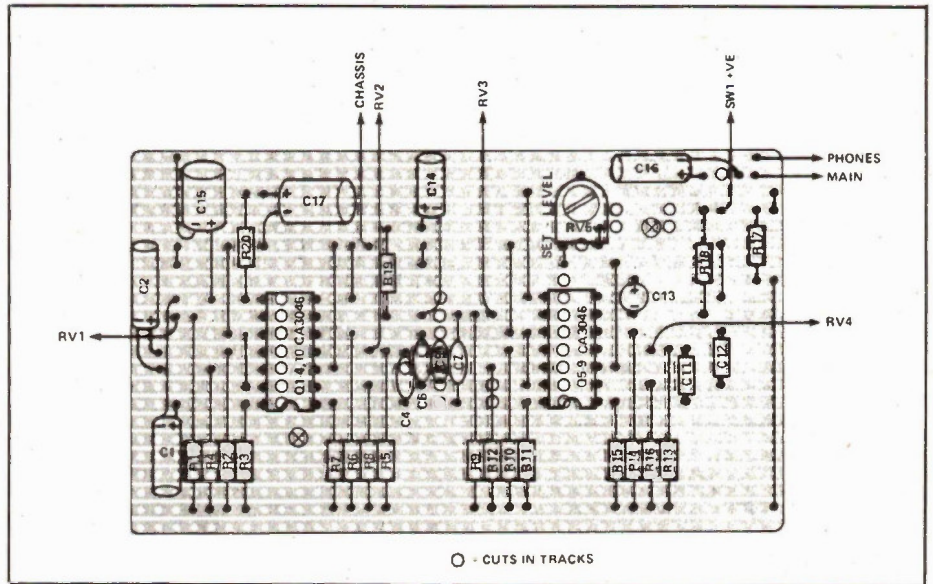

Fig. 2. The parts location on the Veroboard.

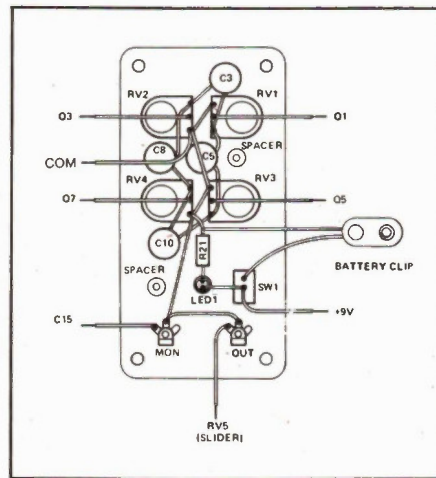

Fig. 3. Front panel wiring.

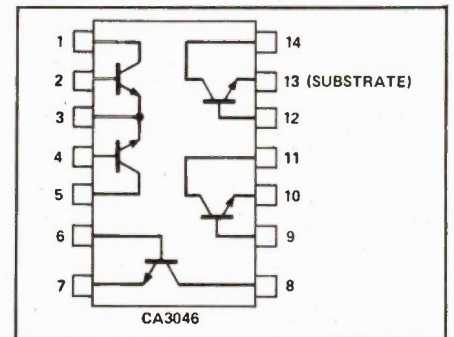

Fig. 4. Diagram of the CA3046.

card or similar should be positioned between the circuit board and the metal body of the battery to prevent shorts. This can be attached via the mounting screw holding the Vero to the spacer.

No calibration is required aside from positioning the knobs to read across the same range of numbers. RV5 can be set by trial and error depending on the type of equipment it is required to feed.

Operation

The large variety of sounds available from the box makes it difficult to be precise as to the settings of the controls. It is best to have the four controls turned fully clockwise (off) to begin with. Rotate one control at a time, listening through the monitor jack to get the range, and then return to the off position. Try mixing the same single tones with RV1. Notice the cyclic sounds produced. Finally, gradually introduce several combinations, taking note of the effects.

After a little experience, it is possible to create animal and human cries by swinging the tones against one another so that a library of sounds can be created. ■

PARTS LIST

Resistors

(All 1/4W 2% unless stated)

R1,5,9,13,19	47k
R2,3,6,7,10,11,14,15	3k9
R4,5,9,13,19	220k
R17	5k6
R18	470k
R20	1k0
R21	4k7

Potentiometers

RV1,2,3,4	100k linear
RV5	4k7 horiz preset

Capacitors

C1,2	10uf 16V radial electro
C3,5,8,10	47nf 12V disc
C4,6	0.01uf 50V mylar
C7,9	10n 50V

C11,12	2n2 50V mylar
C13,14	1u 50V mylar
C15,17	100u 10V axial electro
C16	4u7 35V axial electro

Semiconductors

Q1-10	two CA3046 transistor array
-------	-----------------------------

Miscellaneous

LED1	red LED
SW1	SPST toggle switch
SK1	3.5mm jack socket

Knobs; LED mounting clip; 9V battery connector; experimenter box 8R earpiece or headphones with 3.5mm jack; Veroboard 23 tracks by 37 holes wide; wire, solder, etc.

Circuit Special

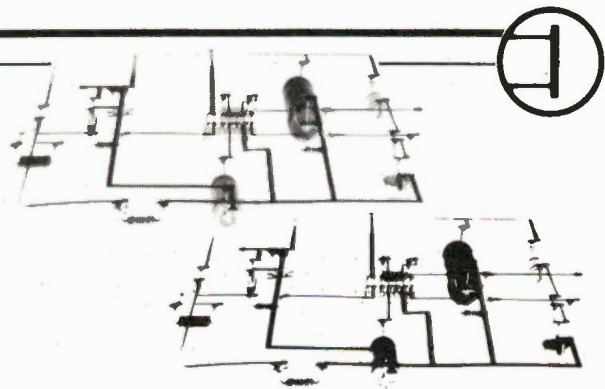

A collection of circuits for the enthusiastic builder, or for some summer electronics reading.

VU Meter

By J. Green

THE CIRCUIT uses three or more green LEDs and one red LED to indicate the level of a varying input signal. Each LED is connected to a different point on a chain of diodes and will only light up when the applied voltage exceeds the combined conduction threshold of all the diodes connected between its cathode and the negative rail.

About 5.2V is needed to light all the LEDs in the chain, and this is achieved by using an op-amp arranged to give a gain of 3.5. This is sufficient to light the red LED from a standard 0dB signal input. RV1 sets the gain of the op-amp and is adjusted so that the red LED just lights at the required level.

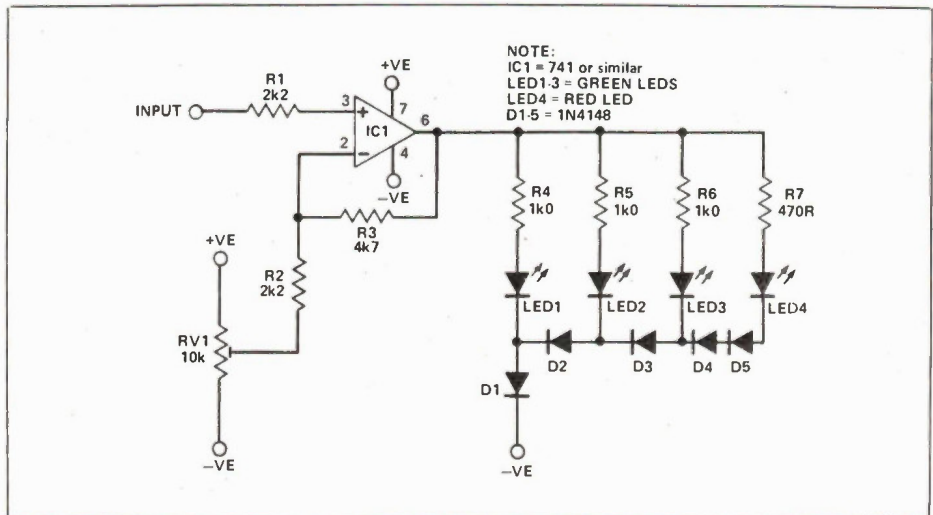

The circuit works well with a supply of plus or minus 5V, but if you plan to use more LEDs in the chain, the supply voltage will have to be increased and the

value of R3 raised to increase the gain of the op-amp. An op-amp with a higher current rating may also be required.

Signal Tracer

By R.A. Penfold

THIS SIMPLE CIRCUIT is a sensitive RF signal tracer that operates well over the medium wave and long wave bands as well as the popular broadcast receiver intermediate frequencies around 455 to 470kHz. It also works well at SW frequencies up to several megahertz. The circuit is built around IC1, the ZN414 (Ferranti) AM RF, IF, detector, and AGC chip. This would normally have a tuned circuit at the input to provide frequency selectivity, but in this application it is used as broadband amplifier with C1 being used to couple the input signal to the input terminal of the device. Resistor R1 biases IC1, while R2, D1, and D2 provide it with a stabilized supply potential of about 1.3V. R3 and C2 are the load resistor and RF filter capacitor respectively for the detector and AGC stages of IC1.

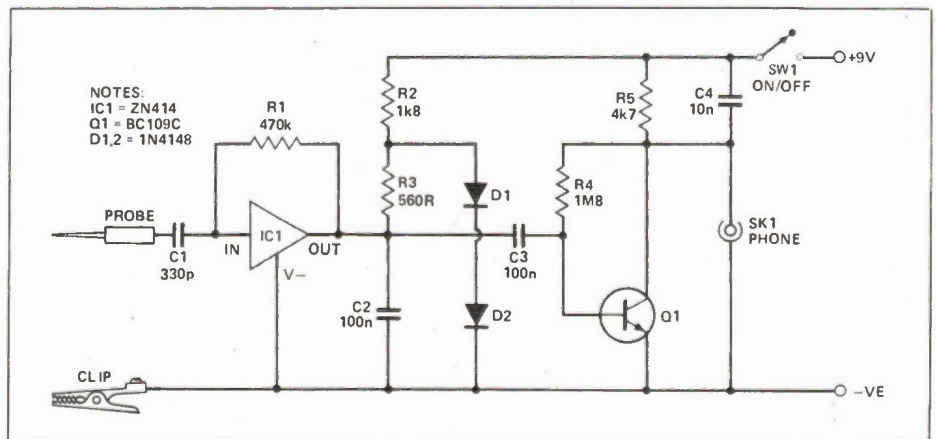

C3 couples the demodulated audio signal at the output of IC1 to the input of a high gain common emitter amplifier formed by Q1. C4 provides RF filtering at the output of this stage and helps to avoid instability due to stray high frequency feedback. The output is taken to a crystal earphone, and other types are not suitable for use with this unit. The current con-

sumption of the circuit is only about 5mA or so.

The circuit has extremely high sensitivity and it is advisable to house the circuit in a small metal case which is grounded to the negative supply so that the circuitry is protected from RF signals within the broad passband of the unit.

Three State TTL Logic Probe

By L. Heaney.

THIS IS a TTL three-state logic probe which can be built into a small piece of tubing with a minimum of components, providing a low cost, reliable piece of test gear.

A low input is inverted by gate *a* and again by gate *b* to illuminate LED1. At the same time the low output of gate *b* is applied to gate *d* which switches off LED2. Q1 will remain non-conducting for this input, so the output of gate *c* and condition of LED3 remains unchanged.

For a high input, Q1 will conduct and switch on LED3 via gate *c*; thus switching off LED2. The twice-inverted high from gates *a* and *b* also mean that LED1 will be off.

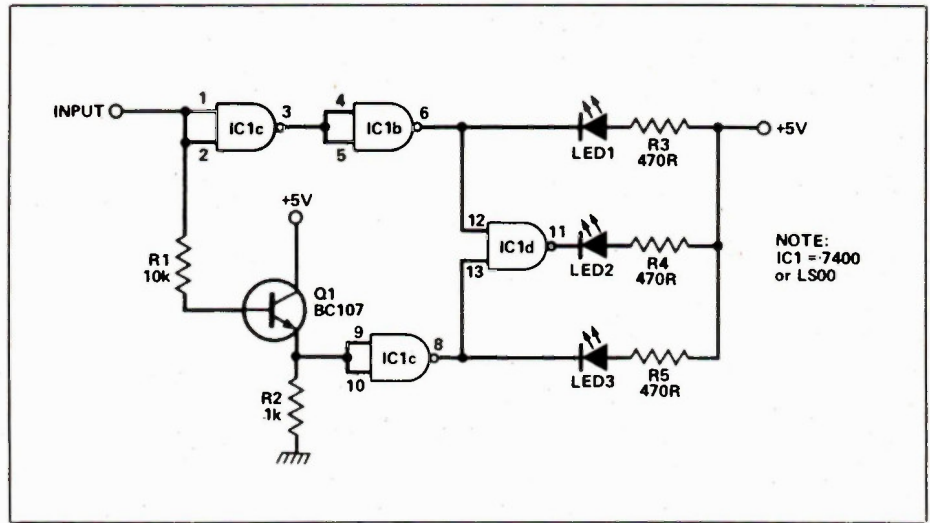

A disconnected input sees a high input at gate *a* which is connected via gate *b* to gate *d* along with a high output from

gate *c*. With both inputs of gate *d* at a high level, its low output will light up LED2.

Door Chime Controller

By L. Heaney

THIS CIRCUIT provides electronic control for an ordinary door chime. The chime sounds only for one *ding dong* at a preset rate regardless of how often the chime button is pushed. After twenty seconds or so the chimes are ready to operate again.

Operation of the circuit is straightforward. Bell-push 1 (front door) will trigger monostable 1 (gates 1a + 1b).

This in turn will trigger monostable 3 (gates 2c and 2d) whose output will switch the chime relay (RLA) on and off again at a rate determined by C5 and R11. Monostable 3 will then remain inhibited for the duration of the remaining output pulse from monostable 1, which is approximately 20 seconds and depends on the values of C3 and R5. The output of monostable 1 is also taken to Q1 and will illuminate LED1.

Bell-push 2 (back door) triggers monostable 2 (gates 1c and 1d) which

operates in a similar manner to monostable 1. The LEDs are fitted to the side of the chime unit and indicate whether the caller is at the front door or the back door. Diodes D1 to D4, resistors R1 to R4 and capacitors C1 to C4 are included to protect the circuit from any transients which may be induced, particularly on the lengthy leads to the door bells. The low current requirements mean that battery operation is practical.

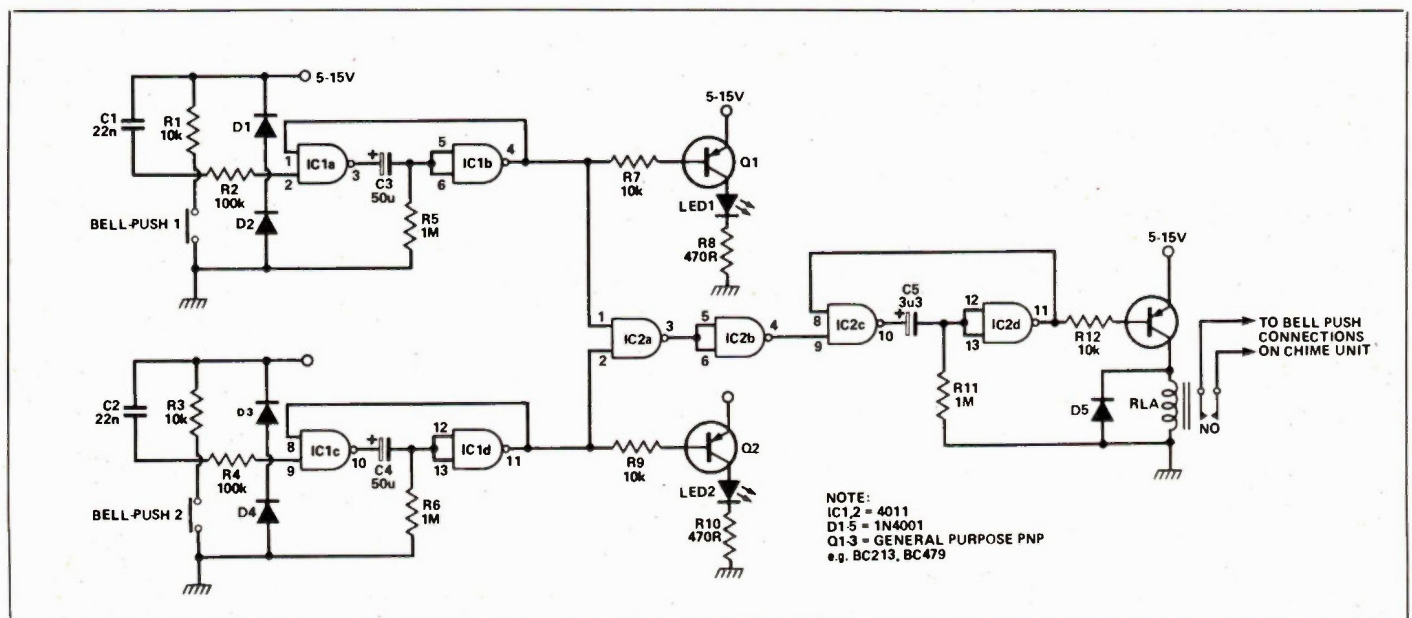



Radio Control Mixer

By G. Foote

THIS MIXER was designed to be fitted to a radio control transmitter to allow a tracked vehicle (toy tank) to be controlled from a resistive joystick controller.

Potentiometer RV1 controls the forward/reverse speed, while RV2 controls the direction. The voltages from the two pots are buffered by IC1a and IC1b, and the outputs are fed to another pair of op-amps.

IC1c is connected as an inverting amplifier, while IC1d is connected as a differential amplifier. The buffered voltage from RV1 is fed to both IC1c and IC1d, and the voltage from RV2 is added to it at IC1c and subtracted at IC1d producing the outputs necessary to steer a tracked vehicle.

The gain of ICs 1c and 1d are set by resistors R1-R7. For most applications $R2/R1 = R5/R4$; $R3/R1 = R6/R7$, with $R3/R1$ less than $R2/R1$.

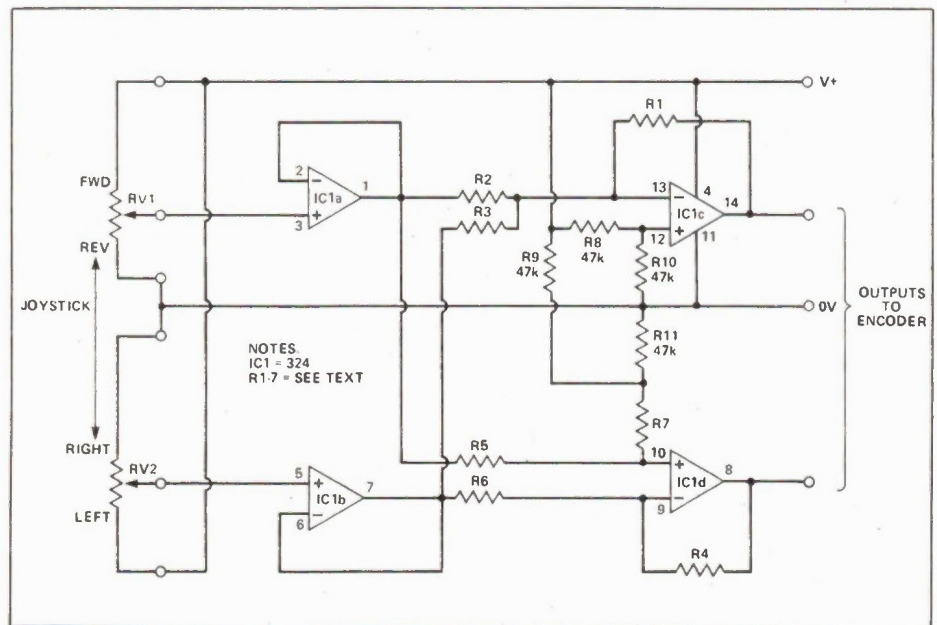

PATRON COMPONENTS INC.

4002 Sheppard Ave. E, Suite 506, Agincourt Comm. Centre, Scarborough, Ontario M1S 1S6 Canada
Tel: (416) 299-7731 FAX: 416-298-4569
Telex: 065-25256

Stock Distributor of Memories I.C. (U.S.A./JAPAN), All New Parts.

Min. 1000 pcs. Price in USD. (Canadian Currency please add 39% extra.)

RAM/EPROM:

- 16k DRAM (4116) from USD \$0.35/EPROM (2716) \$1.75 • 64k DRAM (4164) from USD. \$0.78/EPROM (2764) \$2.25
- 128k DRAM (4128) from USD. \$5.8/EPROM (27128) \$2.85 • 256k DRAM (41256) from USD. \$3.9/EPROM (27256) \$8.50
- 16k SRAM (6116, 2016) from USD. \$1.50 • 64k SRAM (6264, 5565) from USD. \$4.80

T.T.L.:

(74LS00 etc.) from USD.\$0.12

LINEAR:

(LM324 etc.) from USD. \$0.15

4000 CMOS:

(CD4001 etc.) from USD. \$0.12

MICROPROCESSOR:

8088 Kit set (8088, 8253, 8237, 8284, 8288, 8259, 8255) from USD. \$23.80 per set.

Please call for other 8000 series MPU/O.E.M. price and delivery.

MAIL ORDERS: For quantities under 1000 pcs, please add 25% extra from above price plus postage and provincial tax. We can ship C.O.D. freight collect for larger quantities. Price subject to final confirmation.

We also deal with other Computer Peripherals. Please call for details. U.S.A. customers welcome.

Pick-up Preamplifier

By Jeff Macaulay

THE CIRCUIT may be considered in two parts, each built around one of the two op-amps. IC1 functions as an RIAA equalizer with R2, R3, C2, and C3 in the feedback loop providing the correct response; R4 sets the midrange gain at 10 while C4 prevents the stage amplifying DC. The input overload is greater than 40dB and this, combined with a signal to noise ratio of 70dB, gives the circuit a dynamic range of 110dB.

IC2 has a flat frequency response and provides extra gain for the equalizer stage or for an auxiliary input selected by SW1. Both op-amps should be low noise, low distortion, audio quality devices such as the TL071, LF351, etc, and either single or dual types would be suitable. A quad op-amp could be used if two of the preamps were to be combined in a stereo

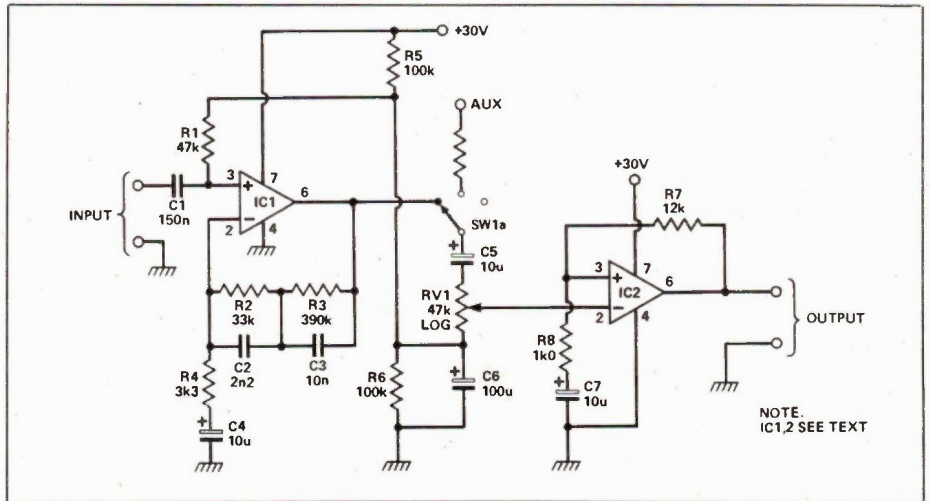

arrangement. The pin numbers given are correct for a 741-type single-package op-amp but it's advisable to check carefully the pinouts of the device you plan to use. The arrangement will also be different if dual or quad devices are used.

Thyristor Tester

By R.A. Penfold

THYRISTORS, or SCRs as they're also known, can be rather difficult to test as they have rather unusual characteristics. However, they are easily checked using this very simple and inexpensive tester which is very useful when sorting through untested packs of thyristors.

In normal use a thyristor has its cathode connected to the negative supply and its anode to the positive supply via the load. In this circuit, the load is formed by LED1, R2, and R3. With no signal applied to the gate terminal the thyristor should be in the *off* state and only a minute leakage current should flow between the anode and cathode terminals. LED1 should therefore not light up at this stage. A thyristor can be switched on by an input current of about 20 to 30 mA to the gate terminal, and such an input current can be produced here by operating PB1. With the device switched on, LED1 will of course light up. Thyristors have a sort of built in latching action so that once triggered they remain on, provided the anode and cathode current does not fall below some threshold level (normally 10 to 30mA). The load impedance in this circuit has been made sufficiently low to ensure that the latching action is produced, and LED1 should remain switched on when PB1 is released.

If PB2 is briefly operated, the current that formerly passed through the thyristor will be diverted through PB2, reducing the current through the thyristor to almost zero so that it switches off and extinguishes LED1.

The test procedure is as follows:

1. Connect the test device, LED1 should not light. If LED1 lights, the device is short circuit.
2. Operate PB1, LED1 will switch on and remain on if the device under test is functioning properly.
3. Operate PB2, LED1 should switch off as PB2 is released if test device is fully operational.

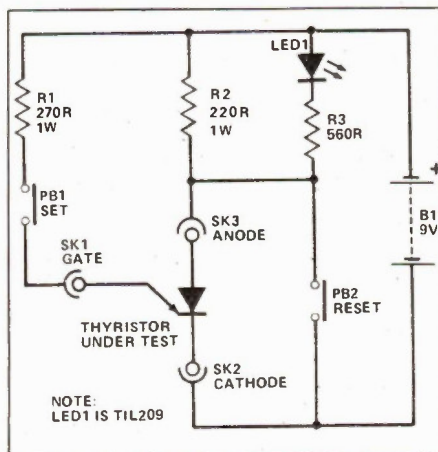

OEM Sales Representatives

Do you wish to add a very successful, proven product to your line? We require sales representatives with a proven track record to sell IBM compatibles—Motherboards—Peripherals and accessories. To cover Manitoba, Ontario, Quebec and Atlantic provinces.

Reply in confidence to:

Box 64
c/o Moorshead Publications
25 Overlea Boulevard,
Toronto, Ontario
M4H 1B1

No phone calls please!

Computing Today

Designing with the Z80. Part 3

In this part, we add input and output ports to the circuit.

IN ORDER to interface the Z80 CPU to the real world, input and output ports are needed. The Z80 PIO provides the CPU with 16 lines of input/output and interfaces directly to the CPU without the need for additional logic. The PIO can be programmed to operate in different modes and can be programmed to interrupt the CPU under certain I/O conditions.

The pinout of the Z80 PIO is shown in Figure 1. The PIO is housed in a 40 pin DIP package. Two ports, port A and port B, provide a total of 16 lines of I/O; provided with each port are two handshaking lines, ASTB and ARDY, which are used to communicate with external devices such as printers, and keyboards.

The data bus, DO-D7, is a standard data bus and can be connected directly to the Z80 CPU data bus. The CE, C/D, and A/B signals are used to describe the data on the data bus. Table 1 shows the truth table for these signals. Since these three lines address a certain location inside the PIO, these signals are connected to the Z80 address bus.

The four remaining signals to be connected to the CPU are the control lines. The control bus consists of RD, IORQ, MI and CLK. All of these lines are compatible with the Z80 CPU counterpart and therefore should be directly connected to the CPU. Figure 2 shows the entire interface to the CPU.

Connecting more PIOs

Without additional decoding logic, 6 more PIO or other I/O devices can be connected to the CPU. In Figure 2 the CE input of the PIO is connected to address

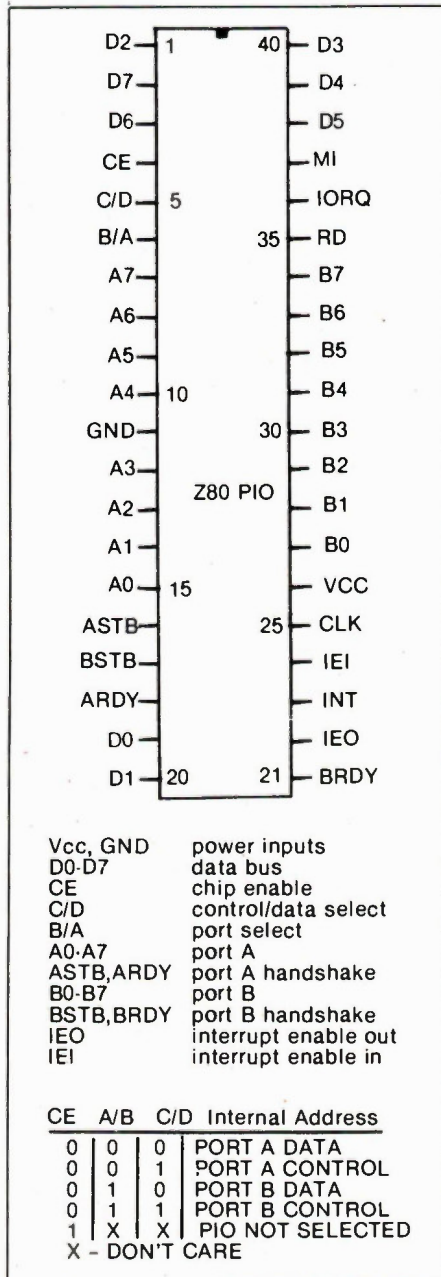

Fig. 1. The pinout of the Z80 PIO. The table gives the logic states for the internal address selection.

line 2. Whenever this address line is low or zero the PIO is activated. By connecting the CE input of other PIOs to address lines 3-7 no more decoding logic is needed. Table 2 illustrates the different address locations for the different PIOs.

In small projects the number of PIOs or I/O devices is defined and usually there is no room for upgrading. However, if the project has an extension bus or a PIO is to be connected to an existing computer, further address decoding is necessary. A simple decoding circuit can be implemented with two 74LS42 devices that will allow the PIO to be placed at any address.

Figure 3 shows the schematic of the decoding circuit. The first 74LS42 device decodes the upper 3 bits of the address bus. A jumper is placed between one of the outputs of the decoder and the D input of the next decoder. When the output that is selected goes low it will enable the second decoder; the second decoder selects the next lower 3 bits of the address bus. A second jumper is placed between the outputs of this decoder and the CE input of the I/O device. In this example the address range 5C to 5F is selected.

Minimum Z80 computer

Using all the information presented so far in this series, a small Z80 computer can be built. Figure 4 shows the schematic of the Z80 computer using a minimum of support logic. With just 5 ICs this circuit has 16 I/O lines and 2K of programmable memory. Notice that there is no RAM connected to the Z80 CPU. Since the Z80 CPU has quite a number of internal registers, these registers can be used to store temporary data.

The 74LS04 inverter is used to provide the CPU and the PIO with all the necessary clocking. Notice the 330 ohm resistor at the clock input of the CPU. This pull up resistor is necessary to match the logic levels of the inverter with the CPU. Also take note how the inverters are connected so that the PIO and CPU clock are in phase. This is very important.

The 74LS04 inverter is used to provide the CPU and the PIO with all the

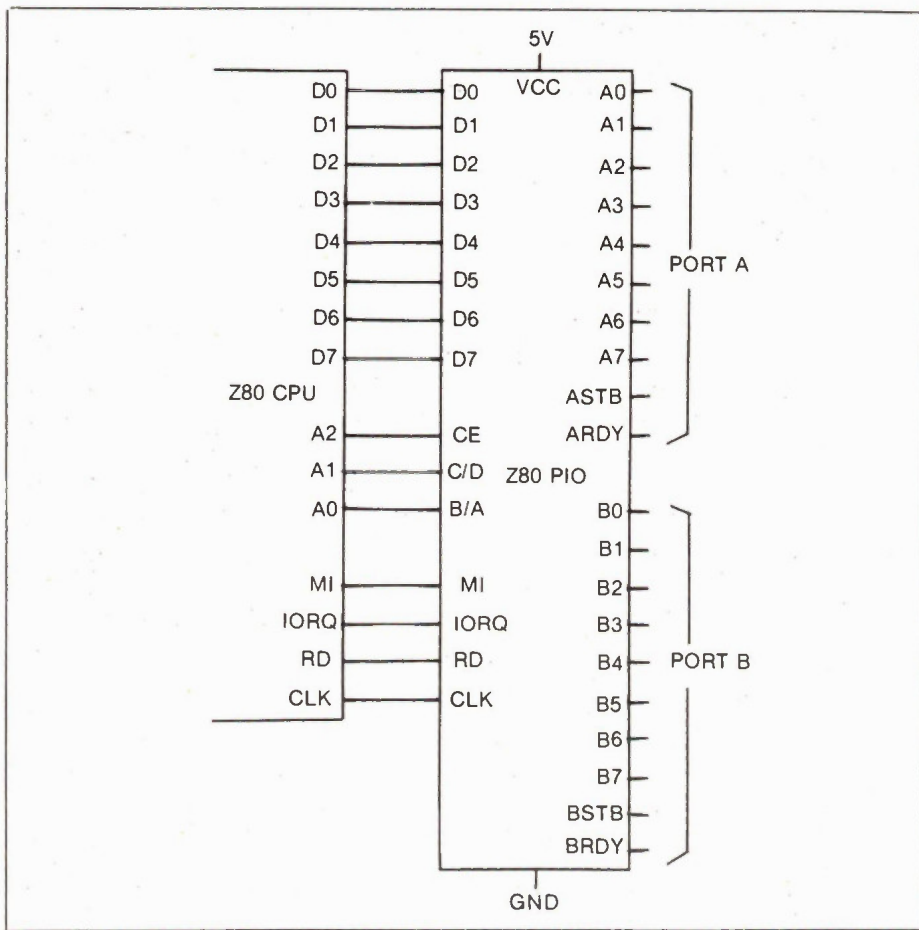

Fig. 2. A simple interface between the CPU and the PIO.

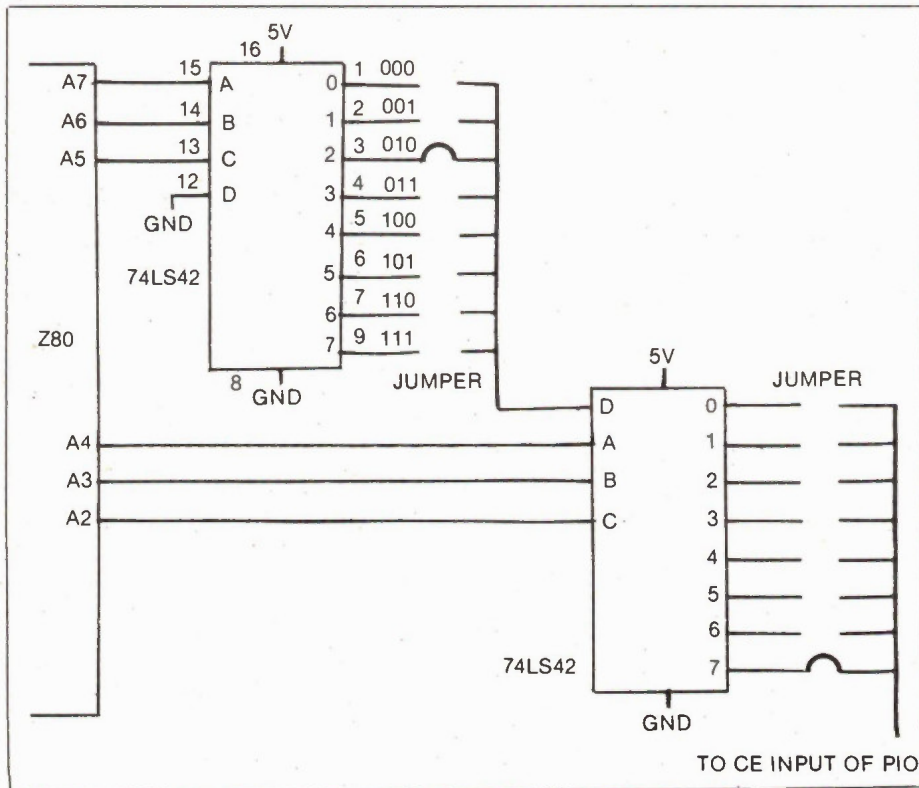
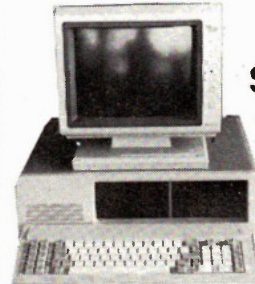

Fig. 3 A simple decoder circuit.

\$29.95

TIMEX 2040 PRINTER \$49.95
All Software \$2.50 to \$7.50 ea.

ORION 5XT
IBM XT COMPATIBLE



\$1495.00

Includes:

- 256K Memory
 - 8 Expansion Slots
 - One 360K DS/DD Disk Drive
 - Parallel Port
 - 135 Watt Power Supply
 - Choice of Colour or Monochrome
 - Card
 - Serial Port
 - Game Port
 - Clock
- Lotus 1-23™ Flight Simulator, dBase II™ Super Calc, Visi Calc and others.

IBM Compatible Boards

- 1F01 256K Multifunction (S/P/C) - OK \$175.00
- 1F02 384K Multifunction (S/P/C/G) - OK ... \$249.00
- 1F03 256K RAM Ver 11 - OK \$ 89.00
- 1F03 512K RAM Ver II - OK \$135.00
- 1F05 Color Graphic (2-Layers) \$159.00
- 1F06 Monochrome \$159.00
- 1F07 Mono-Graphic with printer port \$239.00
- 1F08 Multi I/O (S/P/C/G/FDC) \$245.00
- 1F09 I/O 11 + (S/P/C/G) \$149.00
- 1F11 Parallel Printer (Cable extra) \$ 39.00
- 1F12 Serial - RS232C \$ 59.00
- 1F13 Game \$ 35.00
- 1F14 Floppy Drive Controller + Cable \$ 99.00

IBM Hard Disk Drives

- 10M External w/power supply \$ 995.00
- 10M Internal \$ 995.00
- 20M Internal \$1495.00

Diskettes (Box of 10)
Lifetime Warranty

- Datatech SS/DD \$15.95
- Datatech DS/DD \$19.95
- Verbatim (Bonus) SS/DD \$15.95
- Package of 11 for \$19.95
- *No Name Box of 10 \$12.50

Complete System for \$699.00

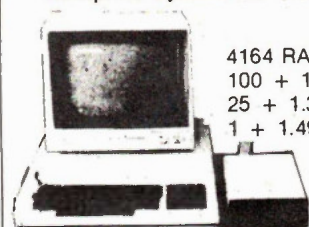

4164 RAM 150Ns
100 + 1.25 ea.
25 + 1.35 ea.
1 + 1.49 ea.

- 6502 Micro processor • 48K memory • Disk drive
- Disk controller card • Upper/lower case • Hi-res Amber monitor • Colour graphics • Numeric Function Key • 90 day warranty.

Orion Electronic Supplies Inc.
40 Lancaster Street West
Kitchener, Ont. N2H 4S9
(519) 576-9902

Circle No. 21 on Reader Service Card

Protected PSU

BY P. Mulvey

THE PROTECTED PSU is conventional in design, using Q1 with its base tied to each of the zener voltages to provide the regulated outputs of 6 and 9 volts. The circuit differs in respect to the short circuit protection components consisting of SCR1, R1, and C1.

When a short circuit occurs, the current passing through R1 increases to such a point that the gate turn on voltage of the thyristor is exceeded. Once this point has been exceeded the thyristor turns on and pulls the base of Q1 to ground, effectively turning the transistor off. With the transistor turned off, the external short circuit is effectively removed from the regulating circuit. However, because the thyristor is still turned on the current from the unregulated supply will still flow through it via R2, hence the need for a large power rating for this resistor. Because the regulating transistor is now turned off, there will be no supply to the LED, which of course goes out. This provides the user with an indication that a short circuit has occurred and must be rectified immediately.

Once the short has been removed, the circuit may be reset by pressing SW1. This puts a short across the thyristor which in turn cuts out. With the thyristor turned off the circuit returns to normal operation.

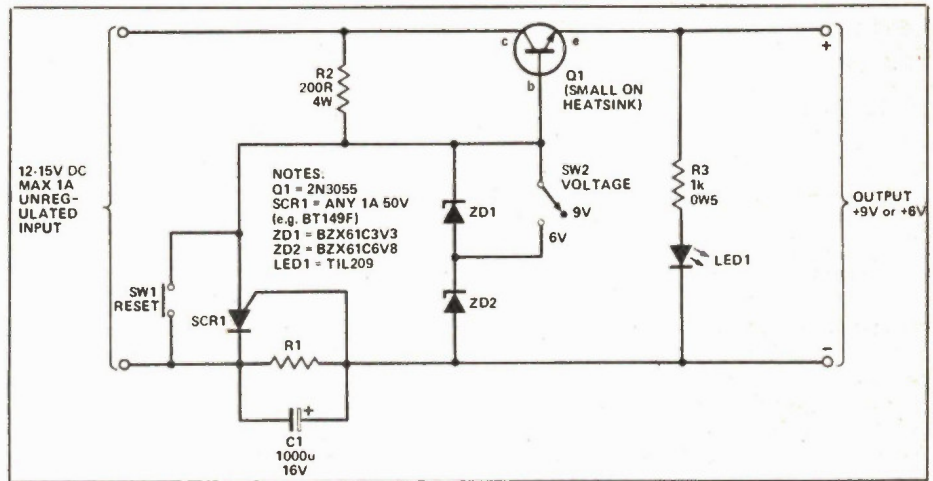

tion. The large value capacitor, C1, is included to prevent spurious operation of the thyristor in the case of the large (but short) surge currents that may occur when the power supply is connected to circuits with a large capacitance across its own supply lines.

The value of R1 is calculated from the equation:

$$\text{Value of } R1 = \frac{\text{gate trigger voltage (VG)}}{\text{required cut-out current}}$$

The value of VG can be found from the data sheet of the particular device you are using. So for example, if you are using the following values in the circuit then the calculation is:

$$\begin{aligned} \text{Value of } R1 &= \\ &= \frac{0V8}{800mA} \\ &= 1 \text{ ohm} \end{aligned}$$

Note that, for this particular circuit, the maximum cut-out current is one amp, although any current value smaller than this is quite safe. It is not possible to use a variable potentiometer instead of R1 as the values encountered are very small, and in most cases the value of R1 needs to be made up from lengths of enamelled copper wire.

In Circuit Junction Tester

BY M. Howes

THIS circuit will check any semiconductor junction while it is still in circuit, even if shunted by 330R and 100u. It works as follows.

IC1a and IC1b form a low frequency oscillator of about 1Hz with two out of phase outputs. With IC1a output high, Q1 and Q4 are turned on taking the inputs of IC1c and IC1d high and low respectively. This is turn lights LED1 via Q5, but not LED2. When the oscillator changes state, Q2 and Q3 are turned on which lights LED2 only. Therefore, when test points A and B are open-circuit the two LEDs flash alternatively.

If a diode is connected to A and B, with its cathode on A, then with Q1 and Q4 turned on the diode will be reverse biased and LED1 will light. With Q2 and Q3 turned on the diode will be forward biased, but the voltage drop across the diode and Q3 will be insufficient to switch

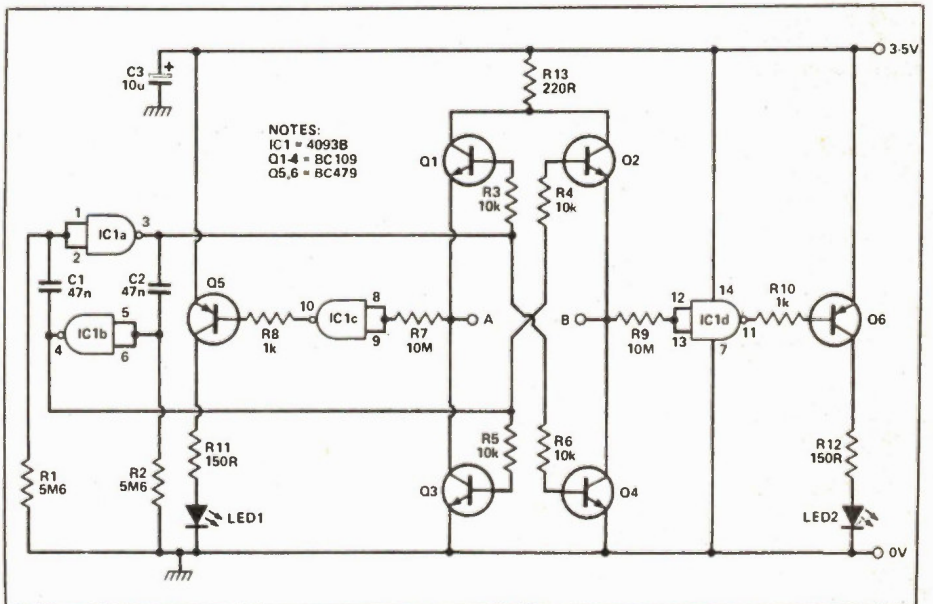

IC1d so neither LED lights. In this case, LED1 indicates that the cathode of the diode is connected to A.

With a short circuit or a low im-

pedance shunt path across A and B, then neither LED lights because the voltage drop from A or B to ground is not enough to switch IC1c or IC1d.



Computer/Synth Keyboard Interface

By Philip Jones

THIS INTERFACE circuit was designed to connect a 61-note music keyboard to a microcomputer for music synthesis applications. The facility for touch sensitivity is included by using changeover contacts for keys and two multiplexer ICs (74LS151). Complete control from the computer is possible using one input/output port.

The computer sets the port so that the lower six bits are outputs and the two top bits are inputs. A six-bit code on the output bits will select one key of 64 (only 61 used). The top two port lines feed back the status of the selected key to the computer. This status can then be further processed by the software to give many different keyboard responses, for example monophonic, polyphonic, or touch sensitive.

The resistors R1 and R2 protect against the danger of setting all the port lines to be outputs and thus shorting two outputs together.

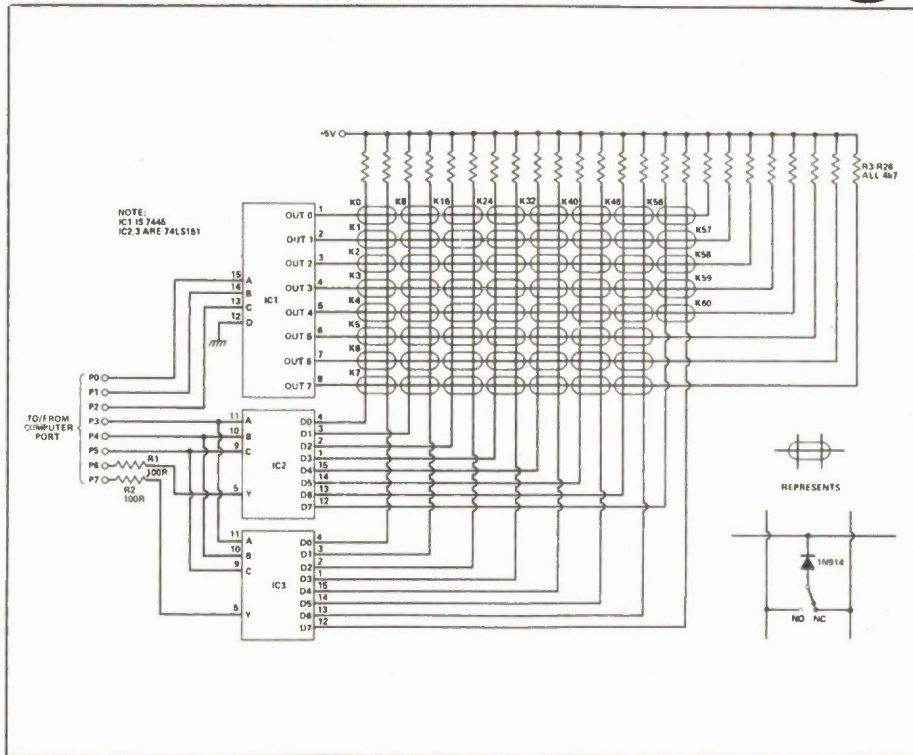

Pulse Group Generator

By P. Cuthbertson

THE IDEA for this circuit came from the need to modulate a transmitter with a burst of 1kHz about 100ms long every second. It is very inexpensive and has the following advantages:

- a) less complex than the usual two 555s in series;
- b) low power consumption at about 800uA (not including output stage);

- c) guaranteed known number of pulses in each group or burst, all the same width (no glitches due to non synchronized gating);
- d) extremely flexible, with pulse grouping depending only on diode configuration. (The only restriction on this is that each burst or bursts contains 2 to the power of n pulses where n is a whole number between 1 and 12);
- e) duty cycles and pulse arrangements do not vary with frequency;
- f) frequency is easily varied by altering the resistors on pin 10 or by chopping an existing pulse train injected at pin 11;
- g) maximum attainable frequency typically 8MHz, minimum operating voltage theoretically 1V, but not at the same time.

The circuit works by dividing the square wave on pin 9. Various counter outputs are available to do the gating. In the example shown, only when 8, 9, and 10 are all high will pulses be output. R1, R2, and C1 set the operating frequency using the 4060's internal clock circuitry. R3 prevents the O outputs from conflicting with pin 9. There are residual pulses remaining when the O outputs are low, and R4 and R5 form a divider which prevents the output transistor, Q1, from turning on with these 0.7V pulses. (A forward-biased diode in the base of the transistor often serves the same purpose.)

- On a more speculative note:
- a) use the 4040 or 4020s which have different sets of outputs available (but no built in clock circuitry);
 - b) turn (all) the diodes around to get a disabled high with different patterns;
 - c) some of these chips have Schmitt inputs — inject a sine wave;
 - d) use another transistor to invert a set of diode outputs, adding the result of this back into the system to get bursts of pulses other than 2 to the power of n in number;
 - e) feed one of the Qs back to the reset input;
 - f) use a series of changeover/centre off switches to switch diodes out of the circuit, or to an inverter or the normal matrix;
 - g) use the gate signal itself as an output giving precise control over duty cycle at varying frequencies of input.

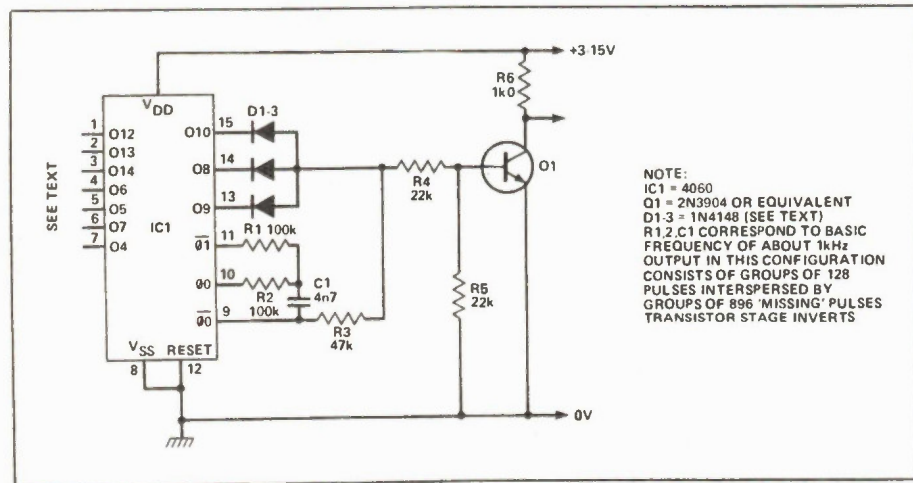

MOORSHEAD PUBLICATIONS READER OFFER

ZX81 & TS1000 EXPANSION 50% OFF

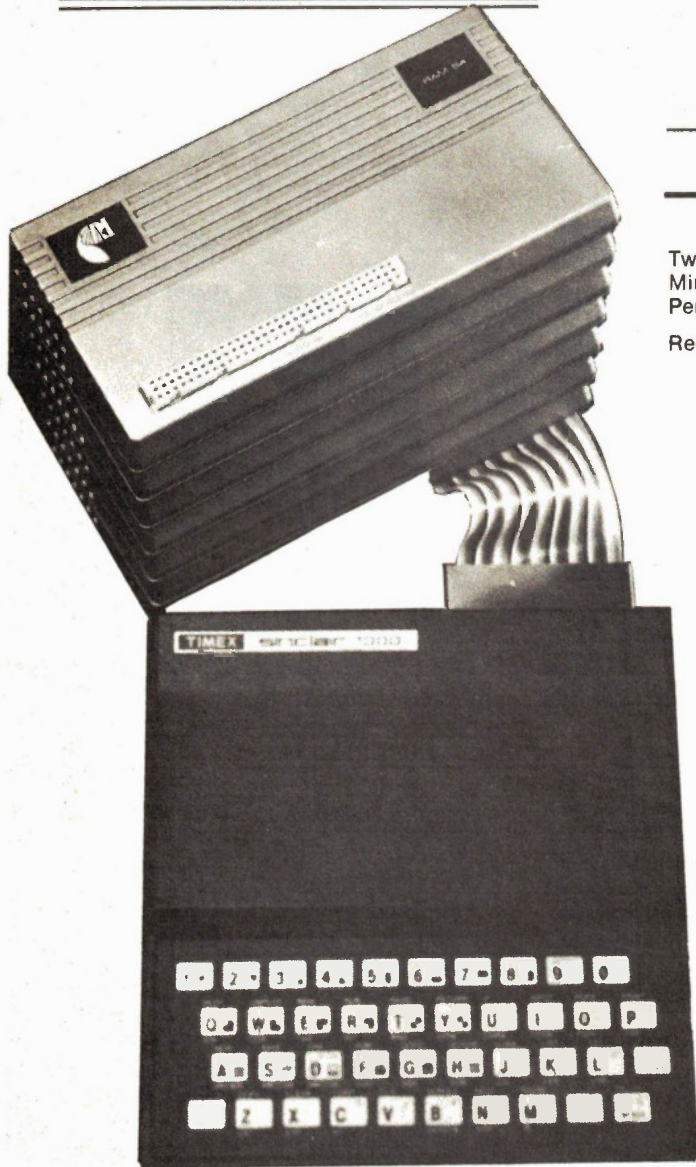

SYSTEM #1

32K — includes

Two 16K RAM Modules
Minimap Bank switching module
Persona Interface module

Reg. \$300.00

\$149.95

SYSTEM #2

128K — includes

Two 64K RAM Modules
Minimap Bank switching module
Persona Interface module

Reg \$540.00

\$269.95

These systems can be further expanded by the addition of any of the following modules:

SONUS: Three voice music & sound synthesizer with independent envelope control under BASIC commands. Reg. \$79.95

READER OFFER \$39.95

2K DROM: Ultra-low-power memory backed by a rechargeable battery for non-volatile storage of programmes and data. Use it, for example, to "instant start" any short routine in regular use. Reg. \$99.95

READER OFFER \$49.95.

PERICON B: Peripheral controller device provides 24 lines of heavy duty output to access and control the outside world. For example: robotics, motor switching, relays etc. Reg. \$69.95

READER OFFER \$34.95

PERICON C: Peripheral controller to drive an 80 column printer with standard Centronics type parallel interface. Reg. \$89.95

READER OFFER \$44.95



Take advantage of this time/limited quantity **SPECIAL READER OFFER!**

BASICare modules are what is required to turn any Timex Sinclair into a serious computer for business, education, industrial, and hobby applications. In order to open the door to this exciting new world of expansions you require a Persona module. It simply (and firmly) plugs into your computer. No soldering. No modifications of any sort!

BASICare uses a unique 64 way Organic Bus. This bus is the pathway to all modules. You have **INSTANT** access to all modules simply and easily through the PEEK and POKE commands.

Memory can be added **AS REQUIRED** in blocks of 16K or 64K up to one MEGABYTE. This is memory that is **INSTANTLY AVAILABLE**. This is unlike any other system available for home computer and compares in capability to multi-tasking systems costing thousands of dollars!

MAIL TO:

MOORSHEAD PUBLICATIONS

25 Overlea Boulevard, Suite 601,
Toronto, Ontario M4H 1B1
(416) 423-3262

Name _____

Address _____

City _____

Province _____

Post Code _____

Telephone _____

Please send:

System # 1

\$149.95

System # 2

\$269.95

Sonus Music & Sound Synth

\$ 39.95

2K DROM

\$ 49.95

Pericon B

\$ 34.95

Pericon C

\$ 44.95

Add \$5.00 per order shipping. Ontario residents add 7% p.s.t.

Fundamentals of Hearing

***Loudspeakers are not
the final link in the
listening chain, nor is
the room.***

By Vivian Capel

THE human ear makes all other links in the hifi chain seem crude in construction and design. An understanding of these fascinating instruments with which we have been endowed can help us identify the important characteristics of the sounds that we hear. This in turn can shed light on the art of sound reproduction and hifi.

The ear is divided into three sections: the outer, middle, and inner ear; each section has its own specific function.

The Outer

The outer ear consists of the appendage known as the *pinna* and the ear-canal terminating in a diaphragm stretched across it, the eardrum. The pinna is provided not merely for decoration or protection, though it does both to some extent. Its convolutions produce reflections which follow the direct sound into the canal with minute delays, hence with phase differences.

The reflections differ according to the angle of incidence of the sound, so the resulting phase differences serve as a code to identify direction. The auditory section of the brain decodes this information instantaneously to locate the position of a sound source.

It is commonly believed that source location is entirely due to volume and phase differences existing between the two

ears. If this were so, our sound location would be limited to the front horizontal plane, as it is with conventional stereo systems. However, as we have the facility for all-around location with vertical identification as well, there is evidently more involved. This can be demonstrated by plugging one ear and trying to identify the direction of a sound source. It is still possible, though the sense of direction is reduced.

The amount of phase difference generated by there being a path difference between direct and reflected sound depends on two things: the path difference itself and the wavelength of the sound concerned. The first of these will depend on the dimensions of the pinna convolutions, and if these are small in comparison to the wavelength, the phase difference will be quite small and probably undetectable. So, logically, we will get the best sense of sound location with higher frequencies.

At mid-to-low frequencies, the wavelength of the sound becomes comparable to the head's size, so comparison of phase between the two ears may help location here. At lower frequencies, it would take pinnas (or possibly heads) of literally elephantine proportions to give good directional sense. However, this is not a major problem, as the majority of low frequency sounds have higher fre-

quency components that we can locate satisfactorily.

The Middle Ear

The directionally-encoded sound travels down the ear canal to the eardrum, or *timpanum* as it is also called, which vibrates in response. The next section, the middle ear, has the function of impedance matching and dynamic range compression. The well-known rule which applies in electronics as well as mechanics is that to transmit the maximum amount of energy from one system to another, the impedances must be similar. Electrical impedances can be matched through transformers, and the mechanical impedance offered by the road wheels of a car is matched to the engine torque by the gearbox.

In the case of the ear, minute air pressure variations acting on the eardrum make this a low impedance member, whereas the fluid-filled inner ear which converts the vibrations to neural signals is of a higher impedance. Matching is accomplished by three interjoined bones termed the *hammer*, *anvil*, and *stirrup*. The first two of these are a pair of pivoted levers that produce a leverage ratio of nominally 3:1, and the stirrup, or *stapes* as it is also called, communicates the motion of the second lever to the window of the inner ear.

Electronics Today August 1985

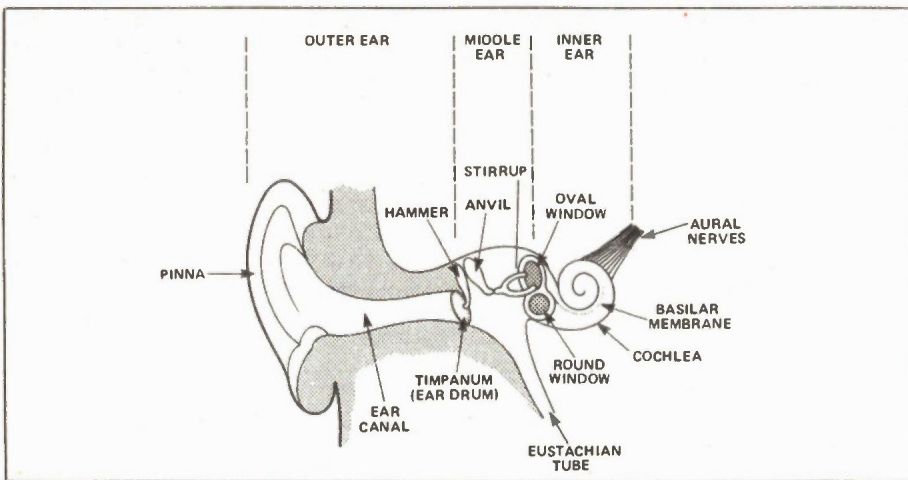

Fig. 1 Our hearing system showing the three main sections: the outer, middle and inner ear.

The three bones are held in position by tiny muscles. These can cause the pivot position to change, and they can also stiffen to cause a decrease in the amount of movement. Hence these can reduce the sensitivity of the whole ear progressively as the sound level increases. This enables the ear to handle an enormous range of sound levels, the loudest being one trillion times the faintest, or 120dB. We can accommodate all the natural sounds we are ever likely to encounter, from the rustling of leaves to a thunderclap, but we have problems with man-made sounds such as explosions, jet engines and machine tools, to name but a few.

If the middle ear were a completely sealed cavity, differences of atmospheric pressure would cause the eardrum to be stretched inward or outward, depending on the atmospheric pressure. This would displace the three connecting bones and upset the sound comprehension. The *Eustachian tube* connects the middle ear to the back of the throat, and so maintains atmospheric pressure on the inner surface of the eardrum.

The Inner Ear

The final bone of the trio, the stirrup, transmits the sound vibration to the window of the inner ear. This is shaped like a snail's shell; hence it's name, the *cochlea*. It is really a long tube rolled up in a spiral. To understand what it does, we will imagine that it is unrolled. A horizontal membrane divides the tube into an upper and lower compartment, except at its end where there is a short gap. The membrane is termed the *basilar membrane*, the upper compartment the *scala vestibuli*, the lower one the *scala tympani*, and the end gap the *helicotrema*.

The whole tube is filled with fluid and is sealed at the far end so that a complete path is formed along one half, through the helicotrema and back along the other half. The top half has at its en-

trance a diaphragm termed the *oval window*, while the bottom one terminates at the *round window*.

When pressure variations are communicated to the upper oval window by the stirrup, they travel along through the fluid to the far end, down through the helicotrema gap and back along the lower chamber to the round window. As fluid is incompressible, the round window serves to absorb the pressure variations and dissipate them to the air in the middle ear.

Now as those vibrations travel along the upper chamber they pass through thousands of very sensitive hair cells on the upper surface of the dividing membrane. These are linked to the nerve fibres that are connected to the auditory part of the brain, and their movements produce the neural signals along the fibres.

Total length of the membrane average 31mm, and frequency response is distributed along its length; the region near the entrance is sensitive to the high frequencies and the region near the end to the low frequencies. The audio spectrum is divided into 24 bands with 1/3 octave spacing, each with its own nerve path to the brain. Centre frequencies of each

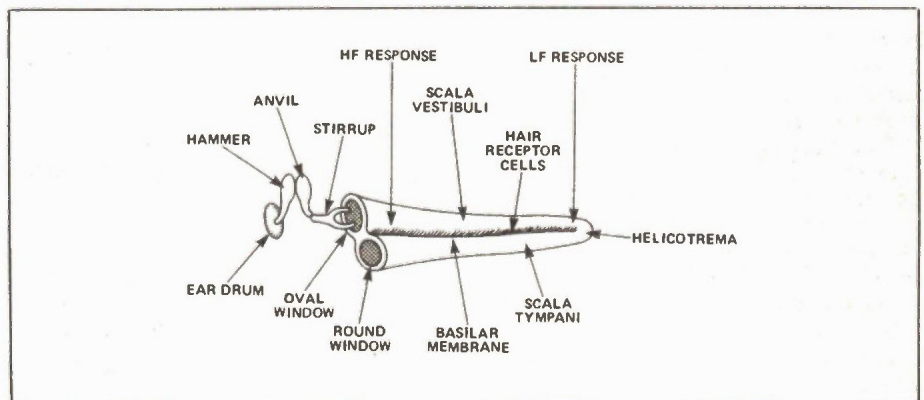

Fig. 2 Diagram of basic components with cochlea straightened out to show various features.

band start at 50Hz for band 1 up to 13.5kHz for band 24.

Cutoff outside each band is not sharp but gradual, especially on the high side, although it is steeper on the low. Thus there is some overlap which fills in, should any band become inoperative for some reason. Each band occupies a definite position along the basilar membrane with physical spacings of 1.3mm; spacings are termed *barks*, one bark being the space from one band to the next.

Frequency Response

The frequency response of the "typical" ear is shown in Figure 3. As can be seen, the response is by no means levels, and varies considerably with absolute sound intensity.

The figure shows the levels at which pure tones of given frequency appear to equal the loudness of a 1KHz reference tone, averaged over a large group of people in the 18 to 25 age range; these curves are now accepted as an international standard.

The most sensitive region at all sound levels is around 4kHz, with lifts in response at around 400Hz (for higher sound levels) and 12kHz. The response at very low levels to bass and treble is comparatively much lower than at the higher levels, in particular at the bass end. This explains why some amplifiers have loudness controls to lift the bass response at low levels. The better amplifiers will have loudness contours dependent on the volume control setting.

As with most other abilities, there is a decline in the sensitivity of hearing with age. Over the age of 30, the high frequency response falls off at an increasing rate, and at age 60, the response is some 15dB down at 3kHz as compared to the age of 20. At 6kHz the response is even lower, at around 25dB down. Thus progressive loss is known as *presbycusis*.

Warning Rock Fans...

Permanent damage can be inflicted on your ears by overexposure to loud sounds. Short periods of overindulgence produces a temporary loss of sensitivity, after which your hearing will recover. However, if you listen to such a sound for a long enough time, permanent damage will occur, and the safe time depends on the level of the sound.

There are maximum permitted times for which workers can be exposed to industrial noise; these vary internationally. For example, eight hours of exposure might be permitted for a level of 90dB, with a halving of the time for each 3dB increase in level.

Damage can be greater if the noise contains impulsive components caused by percussive sources. However, irrespective of the frequency or nature of the noise which produced the damage, the effect is always the same: a reduction in sensitivity centred around 4kHz, the frequency region for speech. Lower and higher frequencies are less affected, if at all. As the damage increases with further exposure, the band of affected frequencies broadens until it sometimes reaches down to 1kHz.

The effect of listening to loud rock music can now be appreciated. Unlike

classical music where loud peaks are interspersed with quiet passages, rock music is usually reproduced at a continuously high level, often at well over 100dB. Furthermore, the percussive beat adds its toll.

Listening Levels

At what volume should orchestral music be reproduced? If it is too quiet, it lacks colour and interest, while if too loud, as is more often the case, it sounds unnatural. One reason for this, even if the amplifier can handle the peaks, is those aural response curves. The frequency balance is distorted a very high levels just as much as at the low ones. For optimum fidelity, the sound pressure level at the ears should be about what it would be in the concert hall.

What sort of levels could we expect there? A lot depends on the acoustics, the size of hall and the position of the listener. In a typical concert hall, from a centre position in the 11th row, peaks of 86dB were measured during an orchestral concert. On another occasion, in the 9th row, 90dB was clocked. From a similar position, during a large scale orchestral and choral work, a peak of 94dB was recorded.

Those peaks were rare and momentary. The quietest passages were

pianissimo strings which measured 45dB and were just audible. Woodwind solos were in the 60dB range, while most of the orchestral playing was in the 60-80dB region. Thus a dynamic range of some 45dB was called for, which is well within the range of hifi producers; in fact, many exceed this.

If you are keen on getting the level right, a sound level meter should be used. Not all are expensive; some are available without the sophistication of professional instruments. However, if you feel inclined to shell out for one of these, a few common sound pressure levels might help to get things into perspective: a soft whisper at 1 metre is 45dB, a vacuum cleaner at 1 metre 75dB, inside a cruising bus 70dB, a whistling kettle at 1 metre 85dB, and a pneumatic drill at 1 metre 110dB.

Decibels

The decibel, or dB, expresses a logarithmic ratio between two numbers. In sound pressure levels, it is the ratio between the sound being measured and a reference standard which is the accepted threshold of hearing, 20 microPascals, or 200 microdynes per square centimetre. Being logarithmic, it more closely expresses

NEXT MONTH IN Electronics Today

Cellular Telephones

A look at mobile telephones now that the system is operational in Ontario and Quebec.

CSA Certification

How the Canadian Standards Association certifies electronic equipment and how to get your design approved.

Power Supply Noise

Will a series 10 ohm resistor and a 100u capacitor eliminate high frequency PSU noise? If not, why? We look at ways to optimize the design of the power supply rails for high performance.



For Advertising Information Call (416) 423-3262
For Subscription Information Call (416) 423-3262

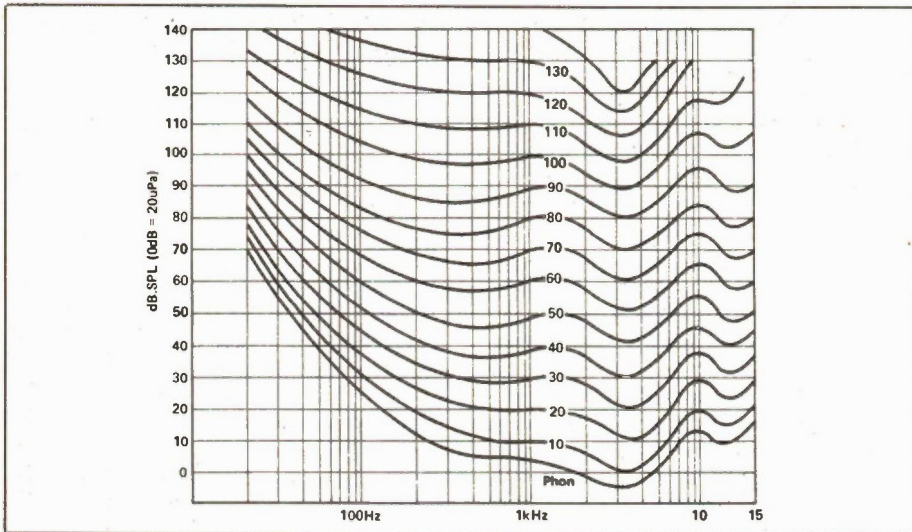

Fig. 3 Equal loudness contours. These show the amount of sound pressure required to produce sensations of equal loudness at various frequencies and volume levels. They are therefore the inverse of a frequency response curve.

the ear's perceived sound levels because of the ear's sound level compression. A difference of 1dB is said to be the absolute minimum that can be detected, though some people can detect less in the midrange; a level of 3dB is a more usual

level before a difference is detected. Doubling the sound pressure produces a 6dB increase in the log scale, but a subjective doubling of the loudness requires an increase of some 10dB, or about three times the SPL.

Identifying Sounds

How is it that we can identify sounds, especially musical instruments that are playing the same note? The standard explanation is that we do it by means of harmonics and overtones.

When a string or column of air in an instrument vibrates, in addition to the fundamental vibration there are harmonics at twice, three times, four times the fundamental frequency and so on. As well, the various parts of the instrument vibrate at resonant frequencies which may be harmonically unrelated to the note being played. All these harmonics and overtones produce a characteristic pattern or *formant* which is different for each instrument and gives it its special tone.

Harmonic analysis reveals that the pattern changes considerably with some instruments between their lower, middle and upper registers. The flute, for example, has few if any harmonics in its upper register, being perhaps one of the purest of instruments, yet in its lower range it can have up to ten. The bassoon has an upper register that is fairly conventional, with a strong fundamental and a series of harmonics of diminishing amplitude, but its middle compass has a weak fundamental and a second harmonic that is usually

This Month in

Computing! Now!

Software Now!

Local Area Networks

How to easily hook terminals to your microcomputer and have them communicate with each other. What's available in software and hardware.

MSX

The new operating system standard for Z80 micros, developed in Japan, may mean compatibility at last. Also, a look at the CX5M, the first MSX computer available in Canada.

Dialog On The PC

Multiple windows let you see various aspects of software operation all at once without using up operating overhead. We show you how it works.

Local Area Networks

An examination of various systems and applications with a focus on new products from Novel, Corvus and The Software Link.

Keyboard Enhancement Software

Programs that let you integrate and streamline your applications with timesaving macro commands: a comparison of the newest versions of ProKey, Smartkey and Superkey.

Graphics

Reviews of graphics software for the Apple, IBM, C64 and Atari computers, including 3 Design-3, Blazing Paddles, Graphics Magician and Pixelwerks.

For Subscription or Advertising Information Call (416) 423-3262

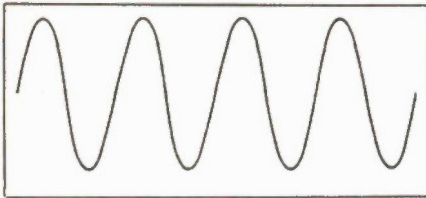

Fig. 4 Format of glockenspiel: a pure tone with low harmonic content; very difficult to identify without starting transients.

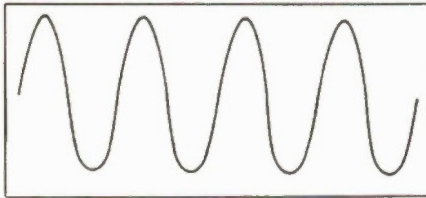

Fig. 5 Piano played *pp*: mainly second harmonic with fundamental as seen from broader negative half-cycles.

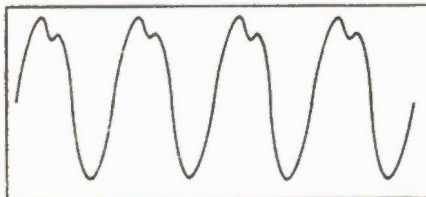

Fig. 6 Piano played *mf*: stronger second harmonic with others, mainly even.

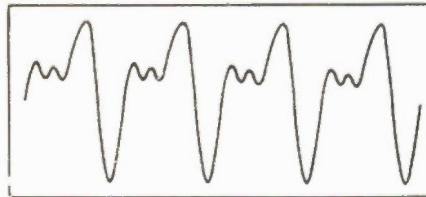

Fig. 7 Trumpet: stronger harmonic content than piano note but not dissimilar, when starting and finishing sections removed. Harder sound than piano.

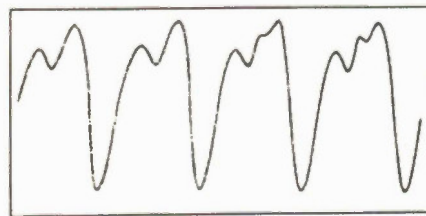

Fig. 8 French horn: mellower tone than trumpet, but similarity in waveform can be seen.

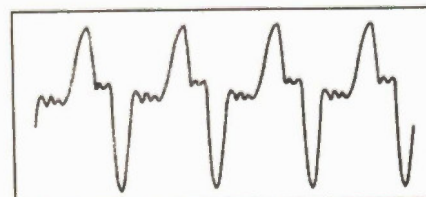

Fig. 9 Clarinet: distinctive pattern consisting of strong fundamental with strong odd harmonics in large number.

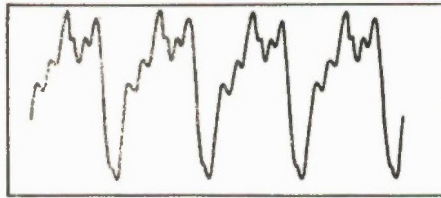

Fig. 10 Violin: large number of harmonics both odd and even gives rounder, less incisive tone than clarinet. Yet without starting and finishing portions, it is difficult to distinguish them.

stronger, with the following ones irregular in strength. The low register is different again with a weak fundamental and harmonics increasing in amplitude as high as the fifth.

Also, many instruments have quite a different harmonic pattern when played loudly to when played softly; the piano is an example. Yet with all this, we can still recognize the instruments whatever their register and level.

Clearly, something else must be responsible for giving the characteristic sound in addition to harmonic content. Another factor which has been suggested is the "shape" of the sound; that is, the way it starts, decays and finishes. Percussive instruments produce very steep starting transients, but quickly decay to inaudibility. The attack of the bow on stringed instruments is quite different, and the notes can be sustained or increased in volume at the will of the player, and the cessation is abrupt as the bow is lifted. Further complications are vibrato, whereby the performer makes small and rapid changes in pitch, and tremolo, which is mainly amplitude variations.

Experiment

To test the validity of this theory, I set up an experiment with the cooperation of a small amateur orchestra. Six instruments were chosen that were all unlike in tone: trumpet, French horn, glockenspiel, B-flat clarinet, violin, and piano. Each instrument played in turn an ascending scale of C major starting at middle C. Each note was played deliberately and slowly, with no vibrato or tremolo, and was duly recorded on a reel-to-reel tape recorder.

Next, each note was edited; the start and finish were edited out, leaving only the middle portion, and the order of the instruments was rearranged.

Finally, members of the orchestra, members of a choir that performed with it, and some hifi enthusiasts were asked to try and identify the instruments from the doctored recording. In view of the knowledge and familiarity with the sound of the instrument, only 25 percent got it right.

The editing gave the glockenspiel a pure clear tone very much like the flute. Horns were the easiest to identify, and the piano turned out to have a strange tone rather like a brass instrument.

So, the conclusion is that stating transients in particular, and the decay and

termination in addition, play an important part in the recognition of musical sounds. This emphasizes the need for good transient response and avoidance of transient distortion in sound systems.

Listening Fatigue

After a spell of listening to music, various symptoms may arise. These can range from a mild feeling of having heard enough to feelings of unease and actual irritation. It may not be associated with the sounds actually heard, but these nevertheless are the cause.

What causes listening fatigue? Distortion is one problem. Even harmonics can be tolerated in quite large doses, because they are harmonious with the fundamentals. Odd harmonics are dissonant, and small amounts can be unpleasant. Crossover distortion associated with Class-B amplifiers consists mostly of third harmonics. Although reduced to very low levels by sophisticated design, it can still have an effect, though to a lesser extent.

Another case is intermodulation distortion. Here, harmonically unrelated spurious frequencies are generated by the interaction of two signal frequencies. Complex waveforms consisting of many frequencies can generate an abundance of spurious ones, nearly all discordant. This too can result in fatigue.

A further cause is excessive high frequency response. Peaks in the treble can over-emphasize the natural harmonics of the musical instruments. The effect may be an apparent brilliance which is not unpleasant, but even stimulating to start with, yet can soon produce fatigue symptoms.

An interesting fact is that female voices are less likely to produce listening fatigue than male ones. A possible explanation for this is the harmonic content of the female voice. Although the female voice is pitched higher than the male, it has less harmonics and thus a purer tone.

We do not know all the mechanisms and psychological effects that are involved between the outer ear and the sensations of sound produced in the brain, but the outline presented here should help us appreciate the equipment with which we have been endowed and how it relates to reproduced sound. ■

Special Reader Offer

ZX81/TS1000 Products at Genuine 50%-80% Savings!



1. Memotech Memory Expansion



16K Mempak Stackable Add-on Memory: can be used to extend capacity of existing 16K ZX81 or TS1000 to 32K

Originally \$99.00	64K Memopak Originally \$200.00
\$49.95	\$99.95

When we started offering ZX81 some months ago, no one could have predicted the enormous demand. The prices were incredible but the demand more so.

So, what do you when you have a winner? You come up with another. ET has made special arrangements for the supply to readers of a wide variety of ZX81 and TS1000 software and hardware. But order quickly — many of the originally offered products sold out completely in a short time; we expect the same thing to happen and it is first come, first served.

2. BASIC LEARNING COURSE



With 2 software cassettes. Complete comprehensive learning guide and reference text. Covers every command and function. Actual programme samples are provided in text and on accompanying tapes. Supplied in a 3 - ring vinyl binder.

\$19.95

3. Hobbyist Keyboard



Designed for ZX81/TS1000. 47 keys with proper keycap, legends, full space bar and life estimated at 20 million cycles! Simple plug-in connection.

Originally \$145.00	\$59.95
---------------------	----------------

4. 64K RAM



The ICs alone are worth more than the cost of this complete cased 64K memory expansion (8 x MK 4564). Plugs in directly to ZX81 or TS1000. Expands the Z80A CPU to its addressable maximum.

Originally \$159.95	\$69.95
---------------------	----------------

5. Software Assortment



Eight software packages (our choice) of games utilities, etc. Works out at less than \$4.00 each!

\$29.95

6. Speech Pak \$99.95



Let you, ZX81/TS1000 do the talking! Synthesizes all the letters of the alphabet, numbers to a million plus many complete words. Operated under keyboard control. Built in speaker with volume control.

7. Health and Fitness

Weight Control program. A medically designed diet control program for the ZX81/TS1000. Complete with guide.

Originally \$39.95	\$9.95
--------------------	---------------

8. ZX FORTH Programming language

FORTH is an Inter-active compiled language with the simplicity of BASIC at ten times the speed. ZX-FORTH is a full implementation, with 250 commands. It works on 18-bit numbers, has some 32 bit routines, includes a 60-page user/programmer manual.

Regular \$39.95	\$14.95
-----------------	----------------

9. HOME & BUSINESS MANAGEMENT

VU-CALC. Financial Spreadsheet. Turns ZX81 into a powerful tool to generate and calculate large tables for budgets, financial analyses and projects.

VU-FILE. Data Storage and Filing System. Ideal for name/address files, lists, catalogue of items, etc. You can enter, list, search for print records.

Originally \$39.90	\$14.95
--------------------	----------------

Send to: ZX81/TS1000 Offer, Moorshead Publications, 25 Overlea Boulevard, Suite 601 Toronto, Ontario, M4H 1B1

Please send me the following. I enclose payment (cheque or money order) made out to Moorshead Publications.

- #1a. 16K Memotech memory expansion at \$49.95 _____
- #1b. 64K Memotech expansion at \$99.95 _____
- #2. Basic Learning Course at \$19.95 _____
- #3. Hobbyist Keyboard at \$59.95 _____
- #4. 64K RAM at \$69.95 _____
- #5. 8-Pack Software Assortment at \$29.95 _____
- #6. Speech Pak at \$99.95 _____
- #7. Health and Fitness at \$9.95 _____
- #8. ZX Forth at \$14.95 _____
- #9. Home and Business Management at \$14.95 _____

Sub-Total _____

Ontario Residents add 7% _____

Shipping. \$1.50 1st item, \$1.00 for each extra _____

Total _____

Name _____

Address _____

City _____ Province _____

Postal Code _____

Items are ex-stock, but please allow reasonable time for delivery

Please use this coupon or a photocopy to place your order

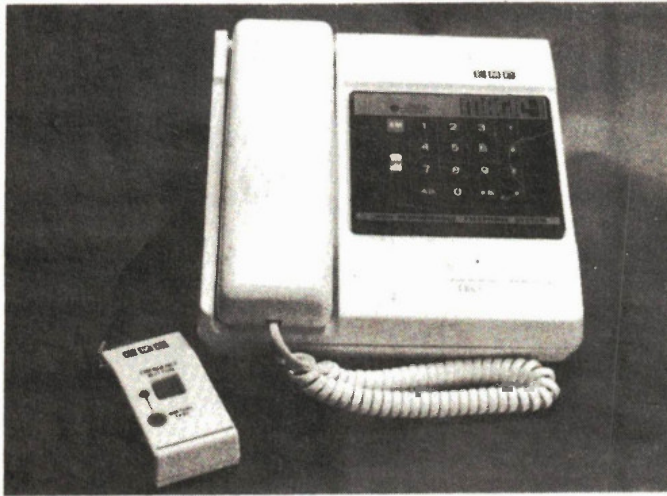

Mini-Review: Magic-1 Emergency Telephone

The EMP Magic-1 Emergency Telephone is not just a gadget, but a remote signaller that's ideal both for the elderly or handicapped and for those who want a home security device. With the telephone comes a tiny box with a push-button; when the button is pressed, 45nW worth of a 310MHz signal activates the CPU in the main set. The CPU then dials up to four previously-entered numbers and a voice synthesizer says 'Emergency. Help needed at...' and then says your phone number. It repeats this for about one minute and then steps to the next number.

The telephone itself features storage of up to 31 numbers, auto-dialing, auto-redialing of the last number called, and a volume control. Standby batteries give about ten minutes of backup power in case of an AC failure (it runs from a 9V plugpack). It will also tell you vocally what numbers are stored in what location.

We tried the gadget by programming it to call our receptionist Heather, who suffers through lots of pranks from the Editorial department. The "voice" has a stilted computer sound (at least it

didn't say "Seen-tax err. Or") but it's adequate for comprehension. Judging from Heather's puzzled reaction, you should clue in anybody who's likely to receive the emergency message or they may not take it seriously ("Hello, police? I just had a phone call from a robot...").

The tiny button has a line-of-sight range of about 150 feet, adequate for domestic use, and extra ones can be purchased. There's also another emergency button on the phone itself. The user has to allow for the fact that both the remote and the phone button are easily pressed by children or visiting editors. The distributor also points out that security devices such as door switches and window foil can be wired into the phone to activate the emergency feature. It's too bad that the emergency feature is preprogrammed; if you could put in your own message it would be the world's easiest way of ordering a pizza when you just can't make it up off the couch.

The Magic-1 phone lists at \$299. If you can't locate one, contact Mark Gee Enterprises Ltd., 2250 Midland Ave., Unit 26, Scarborough, Ontario M1P 4R9 (416) 298-9388. Circle No. 54

Big Little Disks: Memorex Corporation is shipping evaluation samples of a 1 Megabyte 3 1/2 inch microfloppy disk. The micro flex disk is double-sided, and holds the equivalent of about 240 typewritten pages. Though no commercial release date was mentioned, the new format is expected to be a serious challenge to the 5 1/4 inch disk.

We've heard from other sources that the little plastic microfloppies are so durable that they (and their data) can survive a trip through a clothes washer. Well, we don't have any evidence that they can't, but if a washer can eat socks it can eat disks.

Richard Andersen of Fulford Harbour, BC, writes: "...the Designer's Notebook in the May issue (Complex Numbers) is so good I had just had to write a note of thanks. Your article is the first place I've ever seen that explains why imaginary numbers are used in AC theory. Everybody else just uses them; the why is ignored. Keep up the good work and convey my thanks to author John Linsley Hood."

Those who also feel that the "why is ignored" will be pleased to know that we have an article in the works explaining the origins of the most often used electronics formulas.

Elastomer Keypanels

The Advanced Input Devices line of elastomer keyboards are represented in Canada by Haltronics. They can be provided in a wide variety of formats, from calculator-style to full keyboards, featuring options such as electronic displays, LEDs, back-

lighting, various legends, custom overlays, etc. They have a tactical and reliable life in excess of a million cycles. Contact Haltronics, 1085 North Service Road East, Oakville, Ontario L6H 1A6 (416) 844-2121; there are offices in BC, Alberta, Saskatchewan, Manitoba, and the Atlantic provinces. Circle No. 55 on Reader Service Card

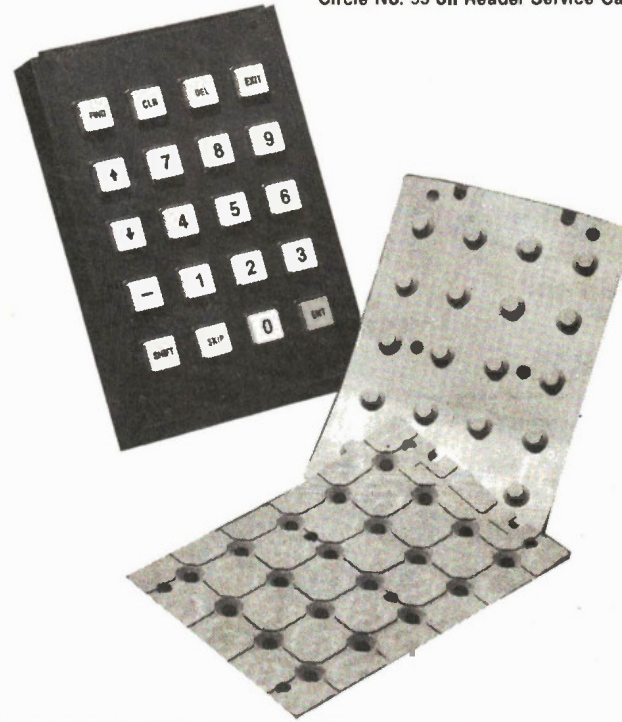

Flat Colour TV

Remember all those predictions that someday we'd have TVs that you could hang on the wall like a picture? We're almost there. Matsushita has demonstrated a TV only 9.9cm in depth, featuring a 10-inch diagonal screen. We know what that is in metric; it's 25.4mm.

Oops, no, it isn't. The TV uses electron beams with multiple control electrodes to achieve minimum depth and elimination of the usual shadow mask. A microprocessor controls beam diameter and position. There's no word yet as to when you can pick one up from your local dealer.

Order Form

Subscriptions:

Please complete reverse side of order form to start or renew a subscription.

Back Issues: \$4.00 each; Ontario residents add 7% sales tax.
Please circle issues desired.

1977	February					July
1978	April	May	September	November	December	
1979	February	March	April	May	July	
	August	September	October	November		
1980	January	February	May	June	November	December
1981	January	February	March	April	June	July
	August	September	October	November	December	
1982	January	March	April	May	June	
	July	August	September	October	November	December
1983	January	February	March	April	May	June
	August	September	October	November	December	
1984	January	February	March	April	May	June
	July	August	October	November	December	
1985	January	February	March	April	May	June

On the following items please add \$1.00 for postage and handling plus 7% Ontario provincial sales tax.

Special Publications:

ITEM	QTY	AMOUNT
Hobby Projects \$3.95	\$
Electronic Circuit Design \$3.95	\$
Projects Book No. 2 \$3.95	\$
Personal Computer Guide \$3.95	\$
50 Top Projects \$4.95	\$
Your First Computer \$3.95	\$
Computers in Small Business \$3.95	\$

Binders: Electronics Today; Computing Now!
 Moorshead Publications
\$9.75 each plus 7% P.S.T.

BOOKSHELF ORDER FORM

Code (e.g. BP12)	Title (Short-form is O.K.)	Price
.....	\$
.....	\$
.....	\$
.....	\$
.....	\$

SOFTWARE ORDER FORM

.....	\$
.....	\$
.....	\$
Sub Total \$	
Tax (Ontario Residents) \$	
Postage \$	
Total Enclosed \$	

Orders from the Bookshelf are tax exempt. Please add \$1.00 for postage. Remember to put your name and address on reverse side. See over for mailing details.

Do you currently subscribe to Electronics Today Yes No Computing Now! Yes No Computers in Education Yes No Software Now Yes No

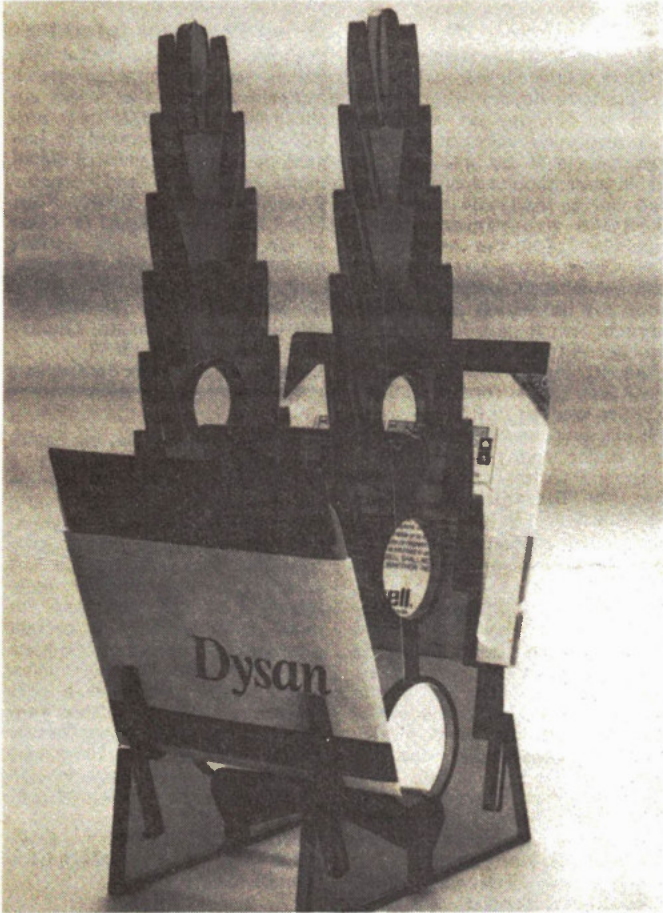

Disk Tree

And you wondered where disks came from. The Disk Tree is an inexpensive alternative to other disk filing systems, and it allows at-a-glance perusal of your video

game disks when you should be working. It holds 20 disks, each in its own slot, or more if you double them up. At local computer dealers.

Letters: Patrick McDonald of Saint Joh, NB, writes: "(Bill Markwick's) articles are informative and easy to understand... the humour puts the fun into the electronics... I'm sure many others feel the same. I may start the Bill Markwick fan club."

Bill replies: "Splut, splut! What??? Are you sure you have the right magazine? Seriously, though, Patrick's profuse compliments are an incentive to make the magazine as good as we can get it; as a thank-you to readers who might feel as Patrick does, I'll add some more to my efforts. As to the fan club, I'm incredibly flattered, but I won't have time to sign all those glossy photos."

Patrick also asked if Electronics Today T-shirts are still available. The last of them were sold, and the design has to be redone. We'll keep you posted.

A less flattering letter from John E. Stephenson of Willowdale: "...over the last year or so I notice an increasing tendency to add

more self-advertising either in editorial or in advertisements. You have promoted the Psion and ZX81 recently and then have the insult to add pages of editorial material to promote it. Now I receive May's issue and find 15-plus pages of ads for your magazine or associated companies..."

First and most important: the editorial department never promotes reader offers. It was an unfortunate coincidence that the Psion computer review was in the same issue as the reader offer; the ZX81 editorial is there because of many reader requests and is unrelated to the advertising. Honest.

Occasionally there are a large number of "house ads". We'll try to keep these from ever interfering with the number of editorial pages, but the Editorial Department doesn't determine ad content.

Lastly, there are no "associated companies". Some advertisers have been with us since the start of Electronics Today, and often bring us products that would be of interest to readers.



BOOKS, BACK ISSUES, SPECIAL PUBLICATIONS, BINDERS — SEE OVER

Moorshead Publications

Suite 601, Overlea Blvd., Toronto, Ontario M4H 1B1.

- MERCHANDISE ORDER** Please fill out, form overleaf
- SUBSCRIPTIONS:** NEW SUBSCRIPTION RENEWAL
- Electronics Today**
 One year (12 Issues) \$19.95 Two years (24 issues) \$34.95.
- Computing Now!**
 One year (12 issues) \$22.95 Two years (24 issues) \$37.95
- Computers in Education**
 One year (10 issues) \$25.00 Two years (20 issues) \$45.00
- Software Now!**
 One year (12 issues) \$19.95 Two years (24 issues) \$34.95
- For U.S. please add \$3.00 per year other countries add \$5 per year

NAME _____

ADDRESS _____

TOWN/CITY _____ PROVINCE/STATE _____

CODE _____ DATE _____

POSTAL CODE _____

Cheque enclosed DO NOT send cash

Mastercard Account No. _____

Visa Account No. _____

American Express Account No. _____

Expiry Date _____

Signature _____

Cross-Assembler

The Cross-8 cross-assembler is a flexible, table-based assembler designed for anyone who doesn't wish to purchase an expensive dedicated microprocessor development system. It can produce a hex file in three popular 8-bit formats, and can be used with most EA/EPROM programmers and emulators. You can even create your own cross-assembler for almost any 8-bit processor, write your own instruction set, combine opcodes, etc. It's available by mail for \$99.95 (until Aug. 31) for the IBM-PC, Apple II with Z80, or the 8 inch CP/M format (Z80 only). See their ad in ET July, page 55; a review copy should be on its way to Electronics Today shortly. Universal Cross-Assemblers, PO Box 384, Bedford, Nova Scotia, B4A 2X3.

Circle No. 52 on Reader Service Card.

China-Watcher Dept.: ComputerLand Inc. and the Millard Foundation have begun opening a series of computer training institutes in China, the first one in Beijing with others to follow this year. The institute is in a high school, with seven labs and two lecture rooms. No mention was made of computer types. Odd to think that someone's first contact with English might be "Syntax Error" or "File Not Found".

Northern Telecom's president, Robert Ferchat, said in an address that the Chinese are increasingly looking to technology transfers and joint ventures as a way of doing business with bi-tech firms. China's enormous telecommunications needs require it to import technology, but they want to become independent of foreign suppliers, making them a vast market for assistance in manufacturing, marketing, sales and service.

Earthquake-Watcher Dept.: How do you predict an earthquake? Well, just before a quake, the earth's crust stretches by an amount equivalent to a change of 0.5mm in the distance from LA to NY City, so all you have to do is keep an eye on the crust. Nothing to it. To facilitate this measurement, Corning Glass of NY has supplied fibre optic cables to Los Alamos National Laboratory. A 200 metre cable is cemented into a borehole drilled in the earth, and a second one is suspended beside it, but isolated from the earth; both carry the output of a laser. The fixed cable will change dimensions if the earth changes, and the slight difference in the light path can be detected by comparing the output of the two cables with an interferometer. It's said to be the most sensitive seismic device.

Signal Processor Interface

Designed for use in digital telephone, speech synthesis, speech recognition and other voice applications, the PD32HC01 provides an optimized interface between the TMS320 family of digital signal processors and external RAM, ROM or filters. Uses ISO-CMOS technology in either 40-pin DIP or 44-pin surface mount. From Pacific Microcircuits, 1645 140th St., White Rock, BC V4A 4H1 (604) 536-1886, or 360 Legget Dr., Kanata, Ontario K2K 1X3, (613) 592-5630.

Circle No. 53 on Reader Service Card

In San Antonio, Texas, the Zenith Corporation has tried out a pay-per-view cable TV system called Phonevision. When you'd like to watch a particular program, you dial a code on your regular telephone. This code uses the ANI network, or All Number Identification, which bypasses the usual phone network to prevent overloading. Your number is passed to the cable operator's computer, which then sends a code down the cable to enable your decoder unit. Zenith hopes that the system will appeal to those who feel that they don't watch enough TV to justify the flat-rate system.

MEASURING ANTENNA FACTOR OF ELECTRICALLY SMALL ANTENNAS

In the United States, National Bureau of Standards engineers have developed a compact, simple, and inexpensive method of measuring the antenna factor of electrically small antennas. Antenna factor is a transfer function that converts received signal level to field strength. The method uses a loop cell capable of generating known fields, over a physically small antenna aperture, that are accurate to within plus or minus 2 dB in the frequency range from 0.25 MHz to 1000 MHz. The loop cell uses two intersecting metal sheets joined at a 36 degree angle.

A section of loop is placed between two coaxial panel jacks which are mounted on each metal sheet at a distance equal to the loop radius from the intersection. A known current passed through this section of loop produces calculable electric and magnetic fields between the sheets in the plane of the loop. These known fields are used to determine the antenna factor of small electric and magnetic antennas placed in the field. It is expected further refinement should improve the accuracy within plus or minus 1 dB.

For those who are interested in exploring this further, a paper is available from R.G. Fitzgerald, Division 723.04, National Bureau of Standards, Boulder, Colorado 80303.

-David Dempster

continued on page 58

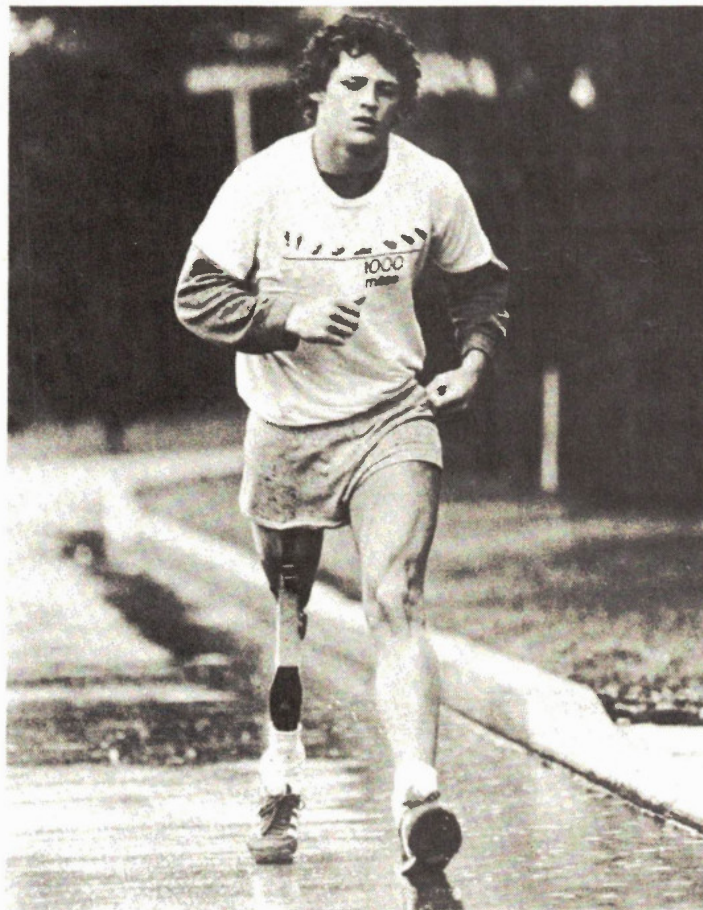

MAKE THIS YEAR'S RUN TWICE THE SUCCESS. BRING A FRIEND.

Every day brings us closer to Terry's dream. To beat cancer.

And until his dream becomes a reality, The Terry Fox Run continues.

The great thing about *this* Run is that it's not just for runners. Everyone can participate and get involved in helping to stop this disease.

You can walk it. You can bike it. Wheel it. Jog it. Whatever you wish.

You can cover as much of the course as you want and you do it at your own pace. It's up to you.

The thing is to come out, participate, have an enjoyable time while making a contribution in Terry's memory.

And when you join us this year, bring along a friend. You'll make Terry's Run twice the success.

Just imagine. If all participants bring a partner, we can more than double our contribution to cancer

5th Annual TERRY FOX RUN

Walk it. Jog it. Bike it. Run it. Wheel it.

Make it Sun. Sept. 15

research. It's really that simple.

And it's simple to get involved. You just call or write your local Canadian Cancer Society for the Terry Fox run site nearest you.

They'll tell you more about how you can spend an enjoyable, personally rewarding Sun. Sept. 15th.

Pledge sheets are available at these locations: Canadian Cancer Society, Canada Post Offices, Collegiate Sports, Four Seasons Hotels, Kentucky Fried Chicken, Shoppers Drug Mart and Kmart.

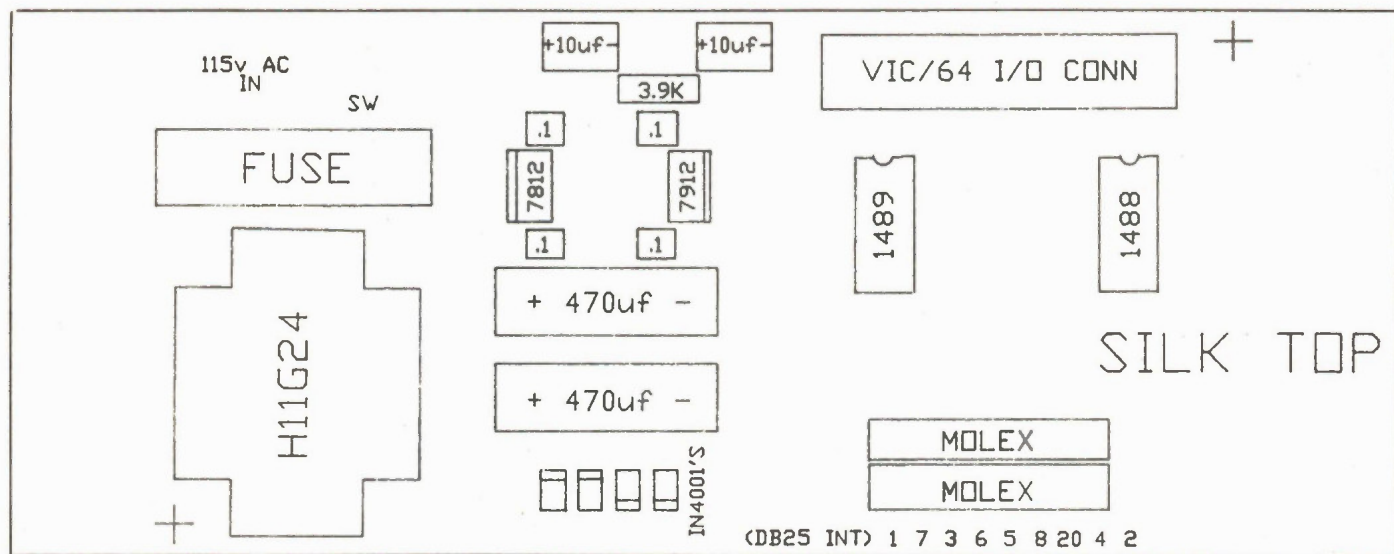

Fig. 2. The parts overlay, showing the placement of the components.

(command register) This is a single byte character which is not used unless there is a need to specify parity. If parity is required then the value of this byte is as follows:

Bits 7 6 5 PARITY

- 0 0 0 Parity disabled.
- 0 0 1 Odd parity transmitted / received
- 0 1 1 Even parity transmitted / received
- 1 0 1 Mark Transmitted / parity check disabled
- 1 1 1 Space Transmitted / parity check disabled

Bit 4 DUPLEX

- 0 Full Duplex
- 1 Half Duplex

Bits 3, 2 & 1 NOT USED

Bit 0 Handshake

- 0 3 Line (data in, data out and ground)
- 1 X Line (CTS Protocol.)

(opt baud lo) = (system frequency/baud rate/2-100)-(opt baud hi) *256

(opt baud hi) = INT (system frequency/baud rate/2-100) /256

When (system frequency) = 1.02273E6 (North American NTSC TV. Standard and = 0.98525E6 (UK. PAL TV. Standard.

If all this seems to be a bit complicated, it is mainly to provide the flexibility to accommodate a range of printer and modem options. In practice you will not be required to input all of the above. Example, for a simple 3 line interface running at 300 baud, the open statement would be: OPEN 1,2,0 CHR\$(8)

Note: An automatic CLR is performed when an RS232 channel is OPENED (due to 512 bytes being allocated at the top of memory), so remember to open the channel before you create any variables or arrays.

Once the channel is open, then control must be transferred from the computer to the printer. This is done by issuing the CMD command. This is as follows:-

CMD lfn (use the same lfn as in the open syntax)

Next, in order to send information to the printer, the PRINT command is used as follows:

PRINT# lfn, "data"

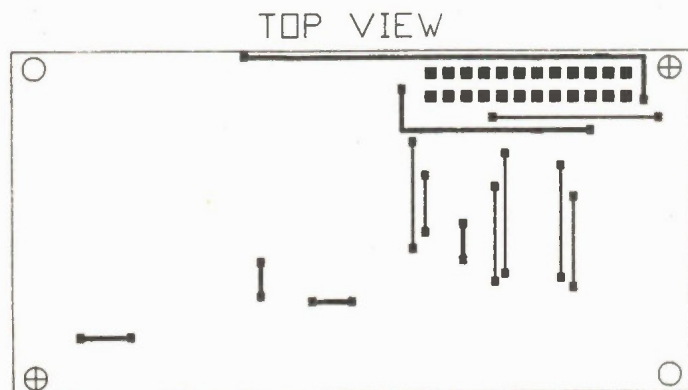

Fig. 3. A parts overlay, showing the placement of the jumper wires.

COMMODORE PIN	RS 232C FUNCTION	DB25
A	GROUND (GND)	1
B		3
C	RECEIVED DATA (SIN)	3
D	REQUEST TO SEND (RTS)	4
E	DATA TERMINAL READY(DTR)	20
H	CARRIER DETECT (DCD)	8
K	CLEAR TO SEND (CTS)	5
L	DATA SET READY (DSR)	6
M	TRANSMITTED DATA (SOUT)	2
N	SIGNAL GROUND (GND)	7
1	GROUND (GND)	1
2	+5V 100mA max	
12	GROUND (GND)	

The Commodore-to-DB25 pin functions.

Finally at the end of your basic program the RS232 channel must be closed, this is done by typing:-

CLOSE lfn

Remember when the file is closed it automatically discards all data in the buffers, so care should be taken to ensure all data is transmitted before closing the channel.

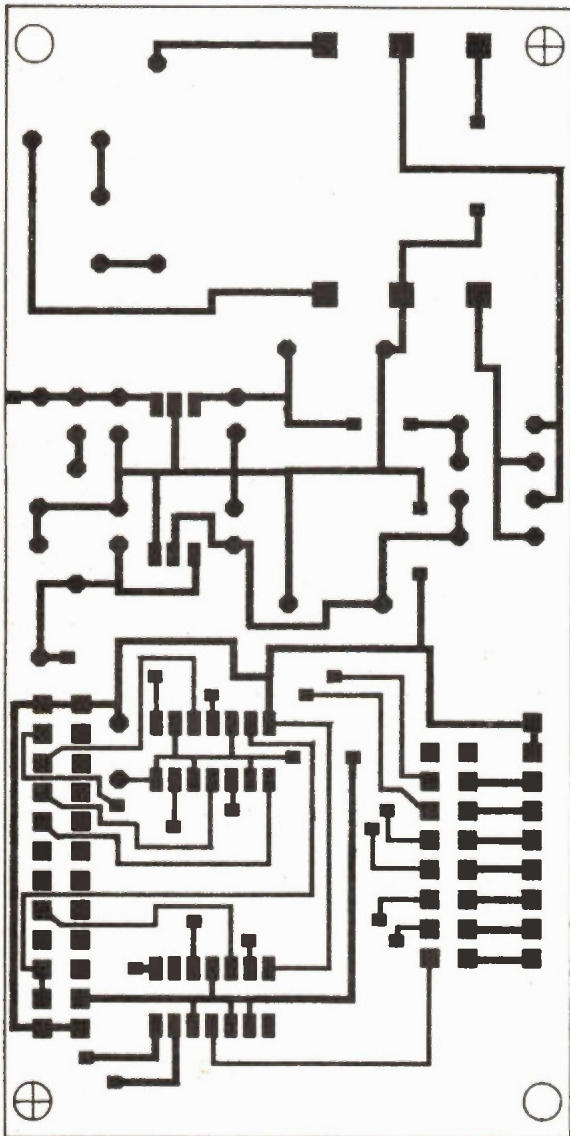

Fig. 4. The printed circuit foil side.

PARTS LIST

Capacitors:
 C1, C2470u.
 C3, C4, C5, C6, C90.1u.
 C7, C810u.

Resistors:
 R13k9

Semiconductors:
 IC.1MC1488
 IC.2MC1489
 IC.37812
 IC.47912
 D1, D2, D3, D41N4001

Miscellaneous
 T1. . . .Hammond 161G24 / RS. #273-1512
 Connector. 1 12/24 .156" spacing
 (Wire wrap)
 Connector. 2 . .DB25 Male (RS. #276-1547)
 SW 1SPST Toggle switch
 Fuse1/4 Amp.
 Fuse holder RS. #270-1270
 P.C. BoardG10 Double sided
 Cross connect Molex part #09-52-3083



**ELECTRONICS TODAY
 YAK COVER/MAGAZINE BINDER**

If you're heading up a mountaineering expedition, the last thing you need is a wet yak and nothing to read. You can solve both problems with the Electronics Today Yak Cover/Magazine Binder that holds 12 issues without cutting or punching; also available with Computing Now! or Moorhead Publications printed on the spine (please specify).

Make your yak a happy one.

Binders are \$9.75 each; Ontario residents must add 7% sales tax. Send to:

Moorshead Publication Binders
 Suite 601, 25 Overlea Blvd.
 Toronto, Ontario M4H 1B1

Product Mart *Where Buyers Find Sellers*

Computers In Small Business

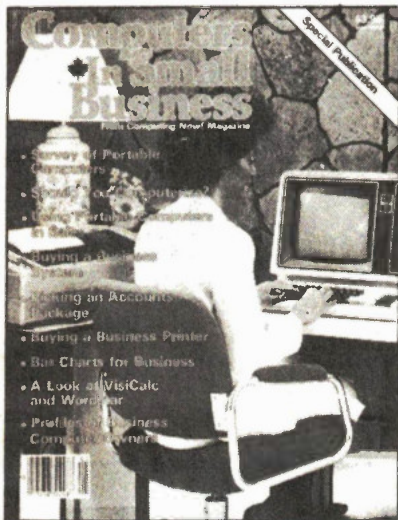

Small companies across Canada are hungry for knowledge about the microcomputer revolution. Many of them believe that they alone are ignorant about what is going on and what equipment is available.

This Special publication is addressed exclusively to this market. The articles comprise reprints of the very best material already published in *Computing Now!* magazine together with several specially commissioned features to form a well balanced publication. We believe this Special is of real use to the hundreds of thousands of small companies on the verge of buying a microcomputer.

**First Published
March 1984**

\$3.95 plus \$1.00 postage and handling For a copy call (416) 423-3262 or write:

**Moorshead Publications
25 Overlea Boulevard,
suite 601,
Toronto, Ontario, M4H 1B1**

DIGITAL Organ and Drum Kits from \$475.00, Demo LP \$8.00 (Plus \$2.00 P/H), Professional 4 to 16 channel Mixer Kit from \$675.00. Free Information from **SELTRON INSTRUMENTS**, 35 Southbridge St., Leamington, Ont. N8H 4N4.

"DISK Drives aligned and repaired, all makes. Most home and personal computers repaired. Reasonable rates. Fast turnaround. Call evenings: **FM COMPUTERS**, Toronto 281-2151."

FOR \$10 per kit \$2 handling, receive free flyer and any of the following. #1: 1000 asst'd pcs, choke — capacitor — resistor — transistor — hardware — etc. Capacitor specials: #2: 200 asst'd ceramic — #3: 100 asst'd silver mica — #4: 100 asst'd mylar — #5: 50 asst'd tantalum — #6: 50 asst'd electrolytic — #7: 50 asst'd feed-through — #8: 50 asst'd metallic silver mica (Elmenco) #9: 25 asst'd variable. All new material. Unconditional guarantee. Repco Module for portable radio available at special price. **SURPLUS ELECTRO QUEBEC**, 2264 Montee Gagnon, Blainville, Quebec J7E 4H5.

APPLE Software Rental. The Pacific Apple Computer Club lists over 600 Apple programs. Most rentals only \$6.00. You keep the disk. For catalog write **P.A.C.C.** Box 25, Point Roberts WA., 98281.

MPF III Apple IIe Compatible \$1395.00 64K Slim Drive, Z80, Printer Card, 80 Columns Amber or Green Monitor, Shipping \$10.00. Send SASS for catalog. **RAITRONIC'S**, 6650 Ross St., Vancouver, B.C. V5X 4B2.

NOTCH Filters, Jerrold SB3 compatible, Hamlin MLD 1200 compatible. \$15.00 each plan, all 3 for \$30.00 (Postal money orders only) **G.C. INDUSTRIES** P.O. Box 4958, St-Laurent Station, Montreal (Quebec) H4L 4Z6.

TS2068 OWNERS. We now carry a large selection of excellent software for the unmodified TS2068. Write for brochure to: **E. MCGHEE**, suite 557-21 10405 Jasper Avenue Edmonton, Alberta.

HOBBIT ÉLECTRONIQUE

**WE DON'T SELL COMPUTERS.
WE JUST SELL THE PARTS!**

Send your name and address along with \$1.00 to: 7454 Langelier, St. Leonard Montreal, Que. H1S 3A7.
Tel: (514) 259-5581.

EXCITING Scientific and Electronic Devices you can build! Affordable Technologies! Catalogue \$2.00. Mail order only. **DUKER ENTERPRISES** 8307-160 Street Edmonton, Alberta T5R 2H2.

SAVE your Computer or Stereo from the most common cause of failure. Top quality power bar \$45.00 or wool mounted \$35.00. Both have 6 outlets with built in surge protection. A must for all computers or expensive stereos. **APPLIED COMPUTING**, P.O. Box 1566, Peterborough, Ontario K9J 7H7. For information on other products send S.A.E.

AUDIO KITS: (1) The Brute 300W AMP. P.C. Board \$9.50, Semiconductors Package \$40.00, Resistors Package \$7.00 (2) Hafler 100W MOSFET AMP.: P.C. Board \$6.50, Semiconductors Package \$59.50 (3) E.T.I. 150W MOSFET AMP.: Semiconductors Package \$59.50. **SUNIX INC.** 578 Marlee Ave., Toronto, Ontario M6B 3J5 (416) 781-3263.

CANADIANS; Smashing values; Surplus, closeouts, buyouts; Video, Computer, Cable TV, Telephone, Scanners, Radar Detectors, Wireless Microphones, Parts & Accessories, 60 miles from Montreal. Set of catalogs \$2.00 **ETCO**, Box 777, Champlain, N.Y. 12919.

CONSTRUCT your own Satellite TV Antenna for under \$100.00. Easy to follow plans \$24.95 or send \$2.00 for information, refundable on purchase. To: **SOTHIS SATELLITE SYSTEMS**, Box 6637, Station "A", Saint John, N.B. E2L 4S1.

J&J ELECTRONICS Ltd., Box 1437E, Winnipeg, Manitoba R3C 2Z4. Surplus and Semiconductor Specialists. Do you get our bargain flyer? Send \$1.00 to receive the current literature and specials and to be placed on the mailing list for future publications.

CERESIST, the guaranteed line of dry transfers for direct etching of PCBs (also for layouts on mylar film etc.) comes in over 65 patterns, including 1:1 and Symbols too. 1-of-a-kind and assortment packages available. Send stamp for free catalog w/sample, or \$3 for our SP-6 Hobby Pak with 100s of symbols. Mailing address only: **CERES**, 866 Bloor St. W., Toronto, M6G 1M5.

BRIDGE Game Software. 1 to 4 players . . . \$39.95, IBM colour and Monochrome, Apple, Adam, T199/4A/16K TRS80-1/3/4/CoCo/CoCo2, Commodore 64/C16/+ 4/VIC-20. **ALLAN'S MICROCOMPUTING**, Box 313, Azilda, Ontario, P0M 1B0, (705) 983-4341.

TECHNICAL BOOKS. Metalworking, woodworking, electronics, plans, science. Large catalogue \$1.00. **ERIC KEATS & COMPANY**, P.O. Box 796, Station A, Scarborough, Ontario, M1K 5C8.

EXCITING scientific and electronic plans and kits you can build. Long range FM Micro Transmitter Kit only \$29.95. Plus many more facinating devices. Catalogue \$2.00. Mail order only. Send cheque or money order to **DUKER ENTERPRISES** 8307-160 Street, Edmonton, Alberta T5R 2H2.

**DO SMALL
ADVERTISEMENTS
ATTRACT ATTENTION?
WELL, THIS ONE DID!**

PRODUCT MART
Insertions Contact:
Alison LeBrocq
or use Order Form
on next page.

ZX81, 2068 Disk Drive Controller Card. Use Shugart SA 455 or Comaptible drive. 160 KB per disk, 2K DOS on EPROM \$119.95. **LARKEN ELECTRONICS**, RR #2 Navan, Ontario K4B 1H9.

VARAH'S, Edmonton, Alta., 1-800-661-7223 437-2755, Electronics for Industry. We have it all . . . Motorola, TI, RCA, Zilog, Hammond . . . and many more!

Product Mart

CLASSIFIED ADVERTISING FORM

Rates: The basic one time insertion rate is \$1.50 per word (Minimum 25 words). The rate of \$3.50 per word allows your advertisement to run in all four publications. (Software Now!, Computing Now!, Electronics Today, and Computers in Education). Headings, logos and reverse advertisements are available for an additional \$30.00.

Special discount rates are available for multiple insertions. They are as follows:

- 25% for 12 consecutive insertions
- 15% for 6 consecutive insertions
- 10% for 3 consecutive insertions

These rates apply only to the prepayment of the entire sum.

Send a cheque (deduct applicable discounts) along with this order form.

Classification:

Copy:

1.	2.	3.	4.	5.
6.	7.	8.	9.	10.
11.	12.	13.	14.	15.
16.	17.	18.	19.	20.
21.	22.	23.	24.	25.
26.	27.	28.	29.	30.
31.	32.	33.	34.	35.
36.	37.	38.	39.	40.
41.	42.	43.	44.	45.
46.	47.	48.	49.	50.

Name: _____
 Address: _____

 Postal Code: _____
 Phone: _____
 Mastercard Visa American Express Card Number: _____ Expiry Date: _____
 Signature: _____



Please contact: **Moorshead Publications**
 25 Overlea Boulevard, Suite 601, Toronto, Ontario M4H 1B1
(416) 423-3262

Transformer Catalogue

L.H. Frost Limited has introduced a 32 page catalogue of small transformers and chokes, and a fine catalogue it is too. It contains low profile transformers, power transformers specifically made for the voltage needs of popular microprocessors, chokes, ferrite cores, audio and control transformers and more. You'll even find charts to help you select voltage and current ratings for your power supply design. For a free copy, contact L.H. Frost Ltd., 1130 Eighth Line, Oakville, Ontario L6H 2R4 (416) 844-6681.

Circle No. 61 on Reader Service Card.

Steve Demler of Toronto commented that a US magazine is printing printed circuit layouts so that they can be easily removed chemically and used as a mask for photo-etching. Electronics Today did a similar printing in the past, but the cost was excessive. Our US counterparts have a much larger circulation to support printing costs, and right now we can't see an economic way around it.



Desoldering Station

If you do PCB repair, or if you really make a lot of mistakes when you're building your Electronics Today project, Len Finkler and Co. is offering an extra-power variable temperature desoldering station from OK industries. Two

models are available with 45 or 60 watts. The built-in pump provides a vacuum of 17 inches of mercury. We've no idea what that is in metric. Contact them at 80 Alex-don Road, Downsview, Ontario M3J 2B4 (416) 630-9103.

Circle No. 62 on Reader Service Card.

Readers of the January issue may recall our enthusiastic review of ACNAP, the AC circuit analysis software from BV Engineering. They have a new program out called LOCIPRO, a computer aided design program designed to enable system, control, and electronic engineers to model complex control systems and determine closed loop system stability before the actual system is built. It's compatible with other BVE products, which adds transient analysis and hi-res graphics. It's available in PC/MS-DOS, CP/M and TRS-DOS in 121 disk formats. A review copy is on its way to us, but until then, you can contact them at 2200 Business Way, Suite 207, Riverside, CA 92501, (714) 781-0252.

Circle No. 64 on Reader Service Card.

Looking for a source for Hewlett-Packard discrete components? Zentronics has just sent us a packet of releases detailing their stock of HP optocouplers, LEDs, Schottky diodes, displays, and others. They're also offering a new catalogue of all Mitel Semiconductor product lines. Contact them at 8 Tilbury Court, Brampton, Ontario L6T 3T4, (416) 451-8445.

Circle No. 65 on Reader Service Card.

AMAZING SCIENTIFIC and ELECTRONIC DEVICES

LASER DEVICES

- LC5 BURNING CUTTING CO2 LASER\$15.00
- RUB3 RUBY LASER RAY PISTOL 15.00
- LRG3 IR LASER RIFLE/PISTOL 10.00
- LGU3 VISIBLE RED LASER RIFLE 10.00
- LHP/LLD LASER LIGHT XMTR/RCVR SYS 10.00
- LHC2 BEGINNER simulated VISIBLE LASER 5.00

SCIENTIFIC & ELECT

- TCL3 SOLID STATE TESLA COIL 35KV 6.00
- BTC3 250 THOUSAND VOLT TESLA COIL 9.00
- BTC5 1.5 MILLION VOLT TESLA COIL 15.00
- HVM3 125 THOUSAND VOLT DC SUPPLY 8.00
- IOG3 ION RAY FORCE FIELD GUN 8.00
- HEG1 MILLION WATT 500 JOULE SOURCE 10.00

ULTRASONIC ACCOUSTICAL

- PPF1 PHASOR PAIN FIELD GENERATOR 15.00
- PSP3 PHASOR SHOCK WAVE PISTOL 7.00
- IPG5 POCKET PAIN FIELD GENERATOR 7.00
- RAT2 RAT AND PEST ELIMINATOR 6.00
- HT9 HIGH FREQ. LISTENING DEVICE 8.00

SECURITY & PROTECTION

- DEVI DEVASTATING DEVICES 10.00
- PPG1 PHASOR PROPERTY GUARD 15.00
- MFT1 MINI VOICE XMTR 2-3 MILE 7.00
- INF1 INFINITY TRANSMITTER 15.00
- PSW3 PHASOR BURNING STUN WAND 7.00
- ITMI INTIMIDATOR PLASMA GUN 10.00

WE STOCK ALL PARTS NECESSARY FOR CONSTRUCTION OF THE ABOVE PROJECTS

• CATALOG CONTAINING HUNDREDS MORE OF ALL NEW AMAZING and FASCINATING PLANS. EASY TO BUILD KITS AND ASSEMBLED ITEMS \$1.00. CATALOG INCLUDED FREE WITH ANY OF THE ABOVE PROJECT PLANS. SEND CASH, CHECK, MO, VISA, MC IN US FUNDS.

INFORMATION UNLIMITED

P.O. Box 716, DEPT. ET, AMHERST, NH 03031

Circle No. 32 on Reader Service Card

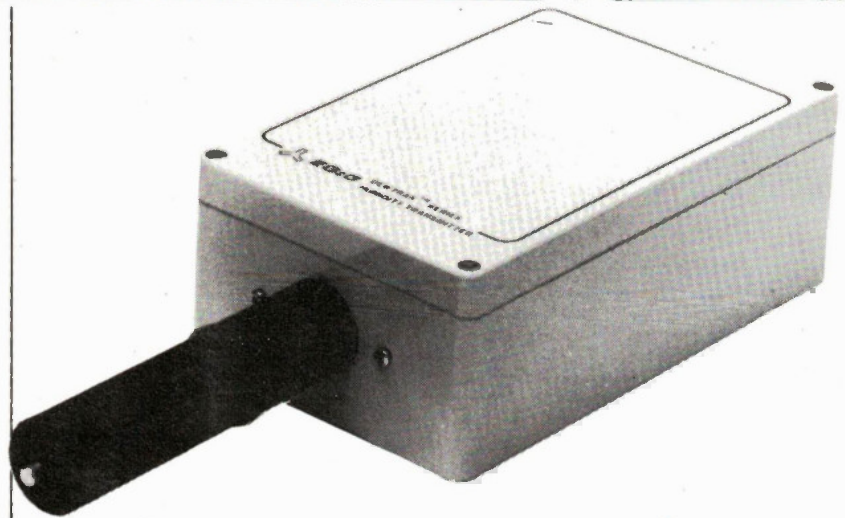

Humidity Transmitter

A humidity transmitter? So is a garden hose, non? Actually, until recently humidity sensors have been difficult to locate. The new DewTrak Series is suitable for mounting in or on ducts, pipes, walls, etc. It will operate from 24VDC, 24VAC, or standard power lines. The

output is 4-20mA over a dew point range of -40 to +140 degrees F. It uses a mirror system, and diagnostic circuitry indicates locally and remotely whether the mirror needs to be cleaned. From PID Instruments, a division of R.H. Nichols Co. Ltd., 80 Vinyl Court, Woodbridge, Ontario L4L 4A3, (416) 851-8871.

Circle No. 63 on Reader Service Card.

Update

Commodore computers is bringing out a new model, the Amiga, which is said to be "the greatest single advance for the microcomputer today". A US publisher has already announced plans to publish a user magazine, Amigaworld. All this from a computer that's not unveiled as yet. Hope it lives up to all the calculated press leaks.

Update

Varah's of Edmonton, suppliers of components for the electronics industry, appeared in our classifieds last month without an address because they were moving. They're now at 9525-41st Avenue, Edmonton, Alberta T6E 5X7, and the phone number remains the same: 1-800-661-7223 for long distance, or 437-2755 for local calls.

AutoCAD Tutor

Heath/Zenith announce a tutorial course dedicated to the fundamentals of computer-aided drafting and design, and introduces the powerful and popular AutoCAD system. It's a self-learning program which includes text and tutorial software, and is available

for either the Heath H/Z-100 computer, or the HS-151, IBM PC, or IBM-compatibles. They didn't mention AutoCAD's really dumb text editor. Heath Company, 1020 Islington Ave., Toronto, Ontario M8Z 5Z3, (416) 232-2686.

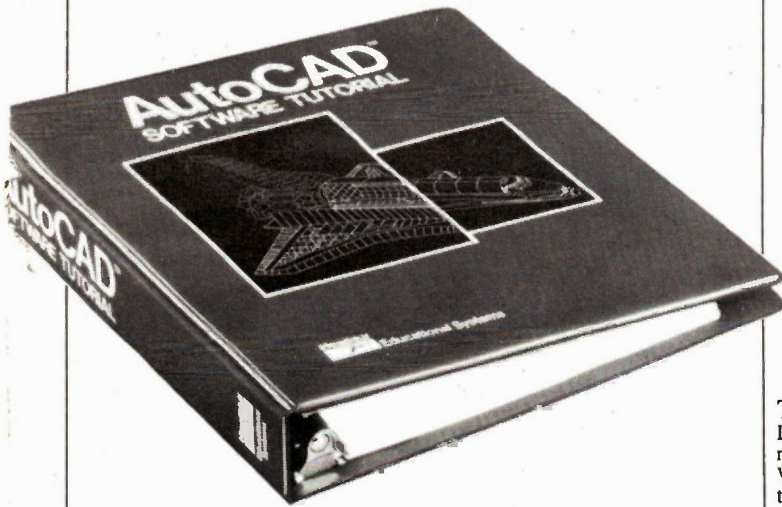

Timer Relay

Looking for a precision time delay relay? Have we got a deal for you. Well, actually, Lenbrook Electronics, Unit 1, Esna Park Drive, Markham, Ontario L3R 1H2, (416) 477-7722, have just the

thing. The National Controls Model TMM relay has two range switches and a 3-digit thumbwheel, giving delays from 50ms to 16 hours with 0.1 percent repeatability. Contacts are 10A, 120/240VAC.

K.E.M. COMPUTER AND ELECTRONICS

NEW MODEL

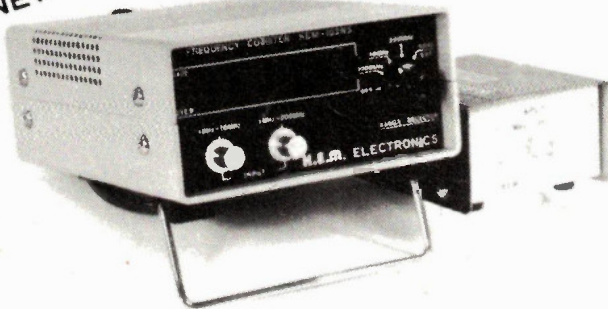

FREQUENCY COUNTER MODEL KEM-102NS \$199.00

THE BEST! Cost PERFORMANCE. 200MHz, 6 DIGIT DISPLAY
30mVRMS HIGH SENSITIVITY. HIGH QUALITY METAL CASE MOUNTED.
TIME BASE ACCURACY 1PPM.

OPTION

1GHz (1000MHz) PRE-SCALER
30mVRMS. \$99.00

Plus \$5.00 for shipping charge.
Plus provincial sales tax.
Please send CHEQUE or MONEY
ORDER. Plus Canada Post COD
fee when COD shipping required.

6-DIGIT PRESETTABLE UP/DOWN COUNTER UNIT...\$149.00

4-DIGIT UP/DOWN COUNTER UNIT \$59.00

FOR SCHOOL ONLY
INTRODUCTORY OFFER FREQ. COUNTER \$125 (1ST SET ONLY)

KAIENTAI ELECTRONICS MERCHANTS LTD

879 E. HASTINGS ST. VANCOUVER, B.C. V6A 1R8
MAIL TO: P.O. BOX 69126 STATION 'K'
VANCOUVER, B.C., CANADA V5K4W4
PHONE: (604) 251-1514

FREE 1985 CATALOG

JUST CLIP AND RETURN THIS COUPON

THIS MONTH'S SPECIALS

Memories	4116	16K	150ns	1.95
	4164	64K	150ns	2.75
D-RAMS	41256	256K	150ns	12.45
	2708	1K x 8	350ns 8K	9.35
MICROPROCESSORS	2716	2K x 8	450ns 16K	5.65
	2732A	4K x 8	300ns 32K	7.65
MICROPROCESSORS	2764	8K x 8	300ns 64K	7.75
	27128	16K x 8	300ns 128K	12.45
MICROPROCESSORS	27256	32K x 8	250ns 256K	27.95
	27512	64K x 8	250ns 512K	133.95

WE ALSO STOCK...

- Books • Breadboard & Accessories
- Capacitors • Chemicals • Connectors
- Crystals • Plugs & Jacks • Fans
- Enclosures • Filters • Fuses • Heat Shrink Tubing • Heat Sinks • Kits
- Knobs • Peripherals • Probes • Opto
- PCB Products • Potentiometers
- Power Supplies • Relays • Resistors
- Cable Assemblies Sockets...

USA
P.O. BOX 9100
WESTBOROUGH, MASS
1-800-343-0874

Active

CANADA
5651 FERRIER ST.
MONTREAL, QUEBEC
1-800-361-5884

MAIL ORDERS
PROCESSED WITHIN
24 HOURS

YOUR ELECTRONIC
COMPONENTS
CENTER

CURRENT DATE
CODE PRODUCTS
VOLUME DISCOUNTS

SELF SERVE STORES LOCATED NEAR YOU. JUST CALL...

WESTBOROUGH
366-9684
BELLEVUE
881-8191
MONTREAL
731-7441

OTTAWA
728-7900
TORONTO
977-7692
DOWNSVIEW
630-0400

EDMONTON
438-5888
CALGARY
235-5300
VANCOUVER 8 E1
438-3321

The **BEST** is still "made in West Germany"

HAMEG model HM203-5

the 20MHz Oscilloscope that outsells all others in Western Europe

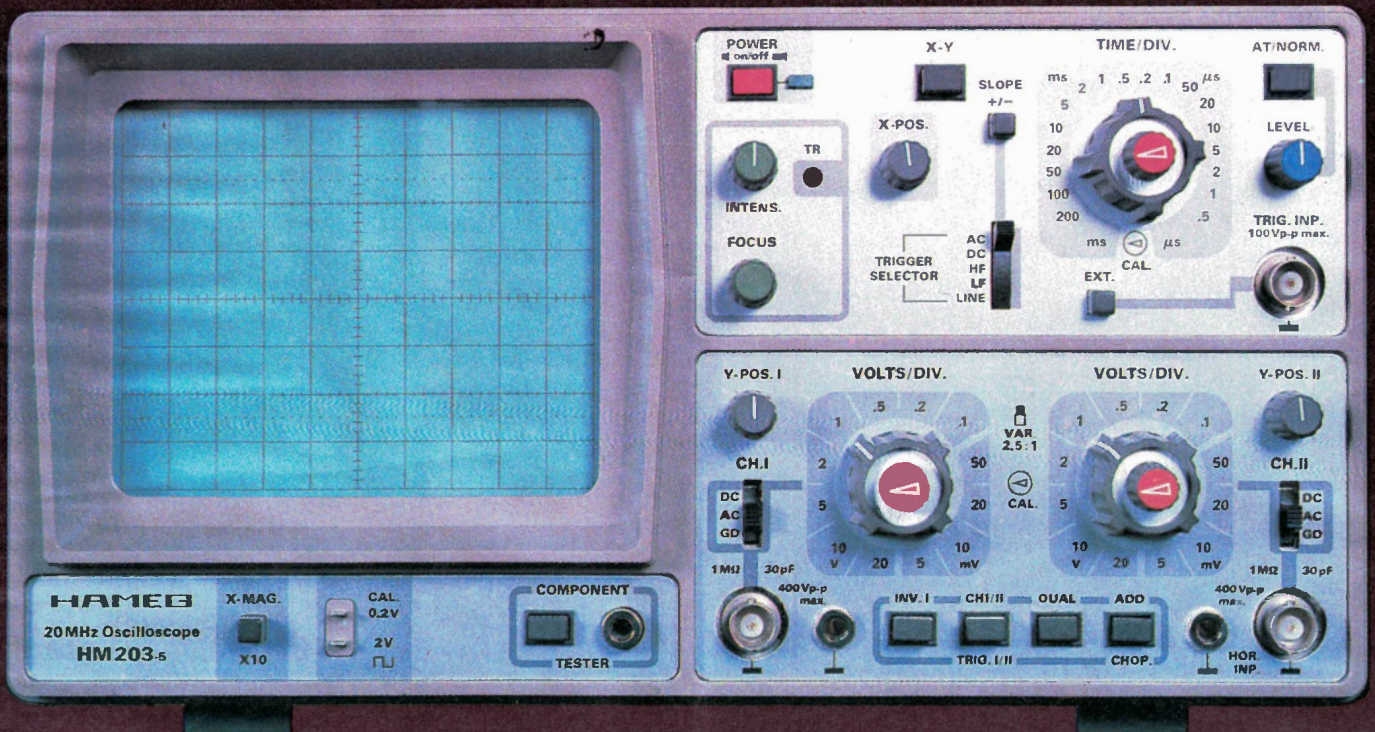

Until September 30, 1985

The model **HM203-5** will be available complete with probes at a special **HAMEG-BCS** price. This CSA approved Oscilloscope is complete with a **two year** parts and labour warranty; all for the special low price of

\$675⁰⁰*

FST Incl'd.

Immediate delivery from Stock
All major credit cards accepted.

Offer available only through



VISIT OUR EXHIBIT OCTOBER 7, 8, 9, 1985

Metro Toronto Convention Centre
Toronto, Canada

Booths 1618-1620-1622



980 Alness St. Unit 7,
Downsview, Ontario
M3J 2S2
(416) 661-5585
TELEX 065-28169
Mon-Fri 8-5 pm

*Price F.O.B. Downsview, Ont.

Circle No. 10 on Reader Service Card

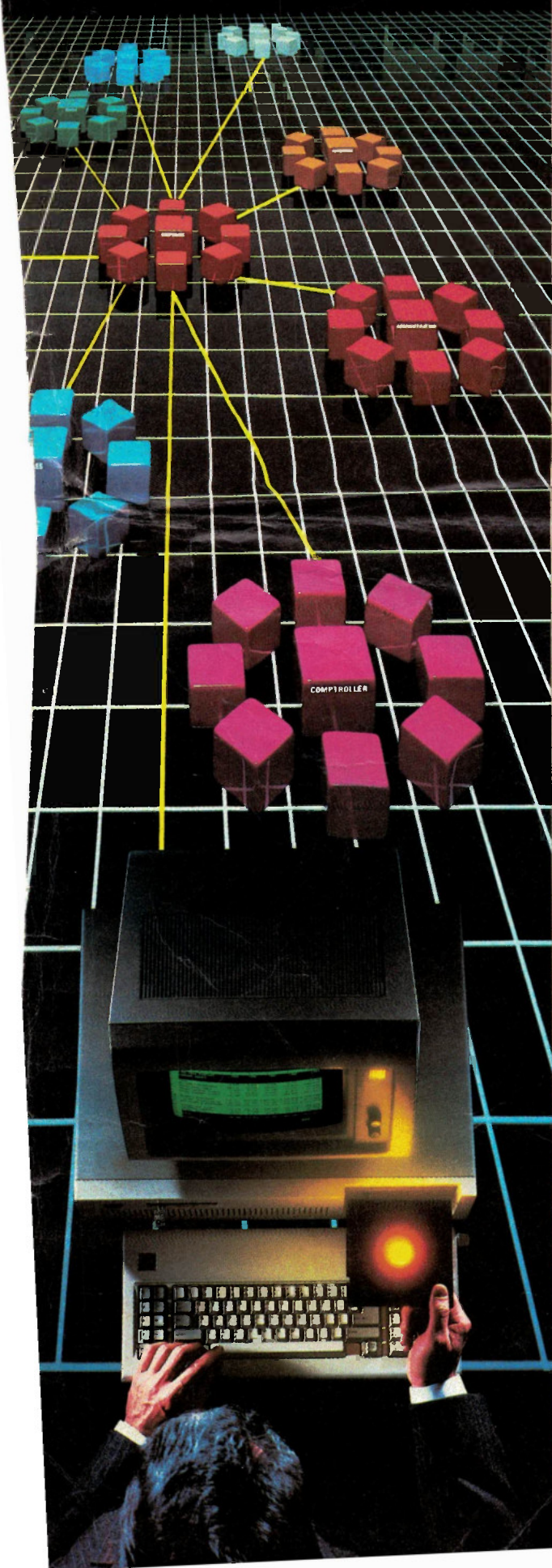

We've Put a Local Area Network on a Disk

Corporate Information Sharing. It's been described as the key to increasing a company's productivity. It's also why large networks of PC's are becoming more and more common in the workplace...in spite of the fact that they're costly, difficult to install, and incompatible with much existing software.

Finally, there's a solution to this corporate dilemma. Its name is LANLink™

A Software-Driven LAN That Uses Standard, RS-232 Ports. A major breakthrough in local area networks, LANLink™ uses your computers' existing serial ports and runs under PC-DOS.

Because all of the intelligence the network requires is on the server and satellite diskettes, expensive network interface boards aren't required.

A Powerful Network That's Cost-Conscious. If you've been pricing board-driven LAN's, you already know that they can cost over \$1,000 per workstation.

LANLink™ is different.

Boasting a data transfer rate in excess of 100,000 BPS, LANLink™ is compatible with a wide range of programs. And because special boards aren't required, installation costs are one-third that of a traditional network.

A Network Designed the Way Business Works. With LANLink™ you're able to customize your network along departmental lines using a data-sharing hierarchy and password-protected access.

Get Started With LANLink™ TODAY. Call The Software Link TODAY for complete details and the authorized dealer nearest you. The LANLink™ Starter Kit, priced at \$745, comes complete with network software for both a server and a satellite computer. For a limited time, 50 feet of RS-232 cable will be included free of charge.

LANLink™ is immediately available and comes with a money-back guarantee. VISA, MC, AMEX accepted.

Circle No. 19 on Reader Service Card.

LANLink™



THE SOFTWARE LINK, INC.

Developers of MultiLink™ and MultiLink Advanced™

400 Esna Park Drive, Suite 18, Toronto (Markham), Ont. L3R 3K2

CALL: 416/477-5480

Dealer Inquiries Invited

MultiLink, MultiLink Advanced & LANLink are trademarks of The Software Link, Inc. PC-DOS is a trademark of IBM Corp.

High performance portable scopes. One name says it all!

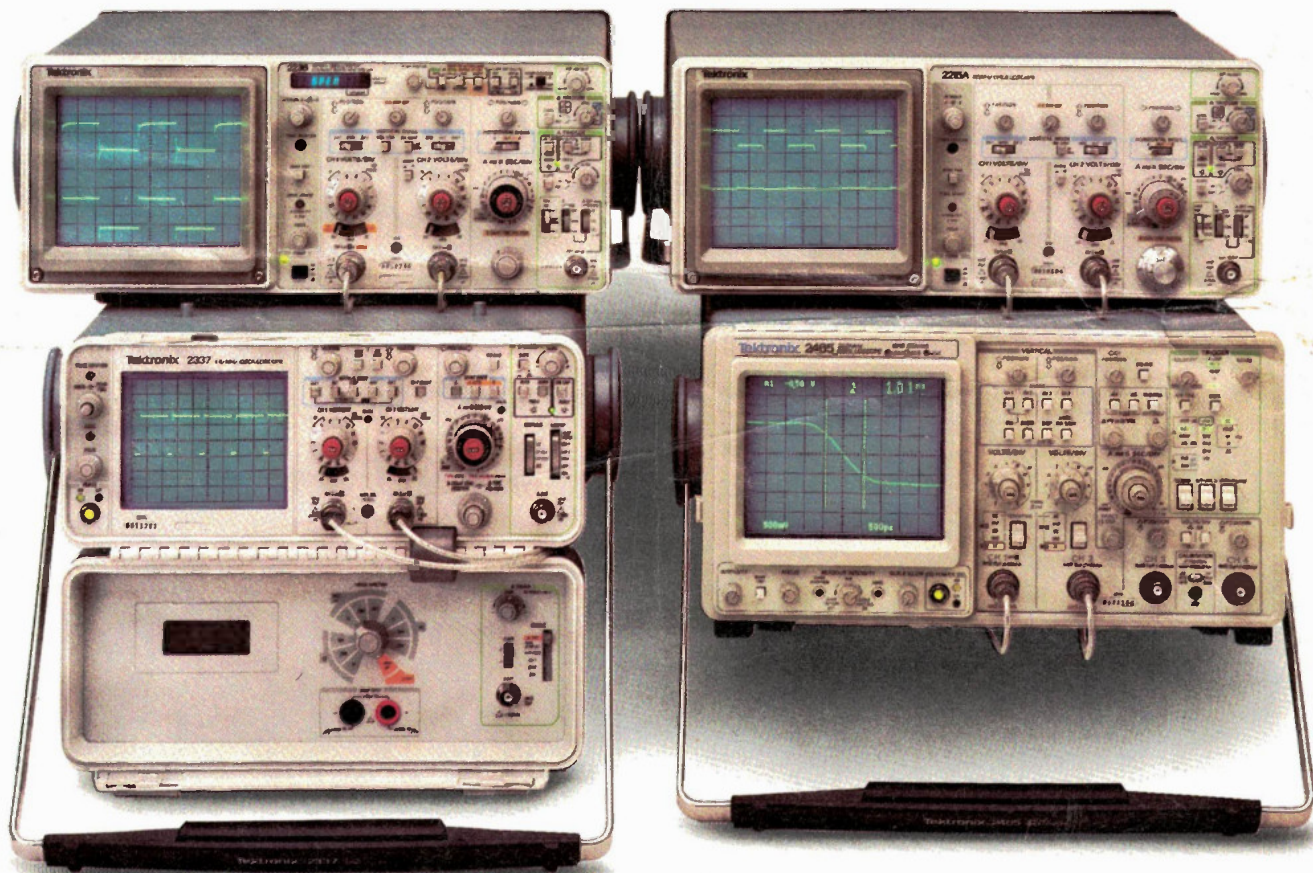

A world standard in performance plus value: the Tek 2000 family of portable scopes. Each one has different characteristics but they have plenty in common: quality that's unmistakably Tektronix. In our 30 years of oscilloscope leadership, no other scopes have recorded such immediate popular appeal.

Even compared to Tek's own previous industry standards, these scopes are easier to use, more portable, more precise. You get better measurements faster, more performance for the money.

There's a full family of scopes to fit demanding portable needs. At 60 MHz, choose the 2213A or dual time base 2215A. At 100 MHz, the 2235 or 2236 with its bright fluorescent readout and integrated counter/timer/DMM. For field service environments, the ultra-durable, 100 MHz 2335, 2336 or 2337, built to be rugged and reliable beyond all previous standards.

Finally, there are the 150 MHz 2445 and 300 MHz 2465: the leading edge in portable scope performance. Now you can specify either

with built-in GPIB interface for automated measurements and a powerful TV option for precise video measurements.

Contact the Tektronix office or sales representative nearest you for complete details. Each scope is backed by a 3-year warranty, excellent documentation, training programs, plus applications and service support worldwide. All part of the high standard of excellence to expect when you work with Tektronix, the world's largest and most respected scope manufacturer.

Vancouver 604-438-4321
Calgary 403-250-1583
Edmonton 403-434-9466
Winnipeg 204-632-4447

Toronto 416-675-3865
Ottawa 613-225-2850
Montreal 514-697-5340
Dartmouth 902-469-9476

Tektronix
COMMITTED TO EXCELLENCE