

ETI for Electronics & Computing Enthusiasts

\$2.75
MM70924
CGA SPRITE EDITOR

Electronics Today

INTERNATIONAL

April 1984

Zener Diode Primer Zener Diode Tester

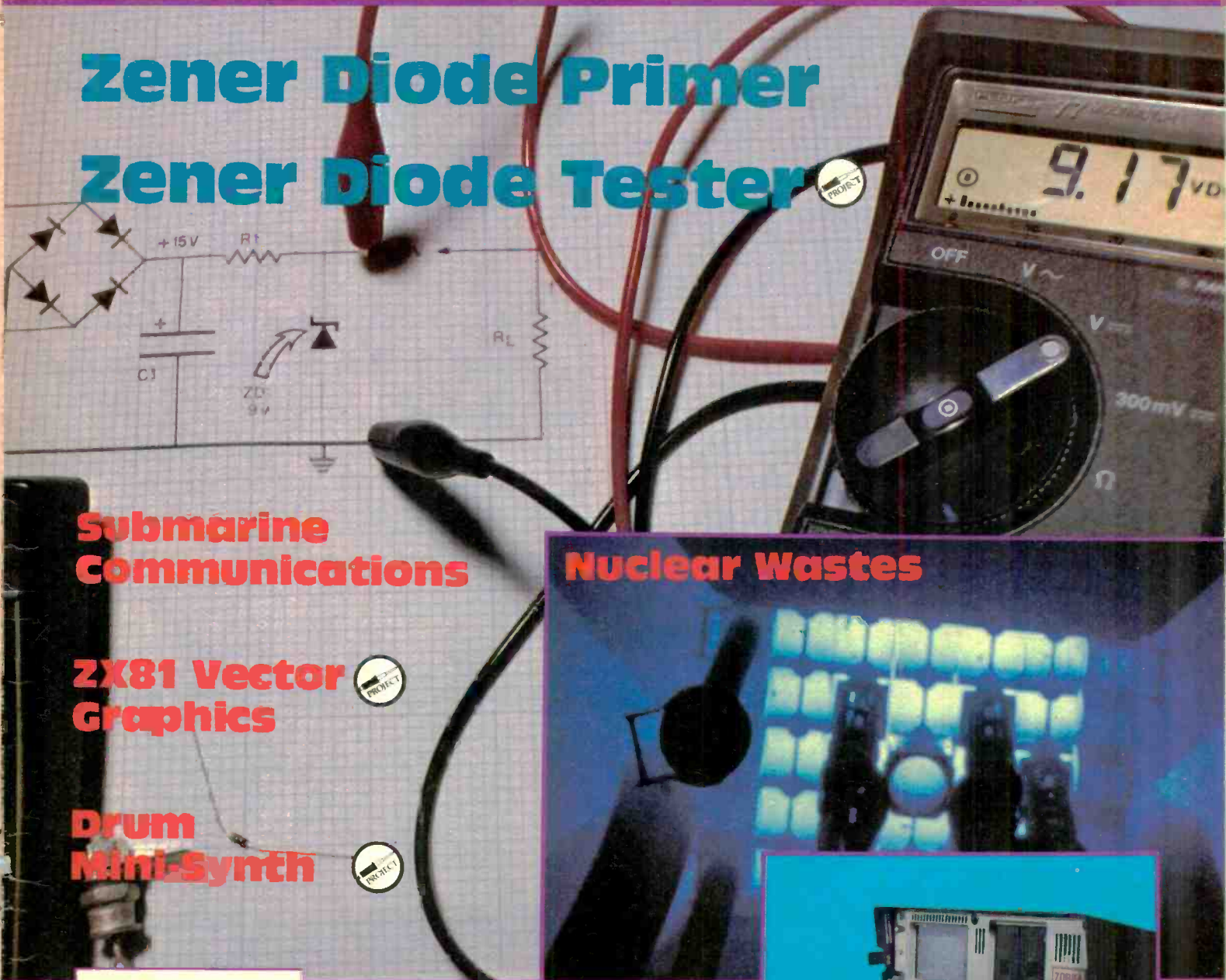

Submarine Communications

ZX81 Vector Graphics

Drum Mini-Synth

Nuclear Wastes

Computer Review
The Zorba



EXCELTRONIX (416) 921-8941

Bulletin Bd. (416) 921-4013 Telex 065-24218

319 College St., Toronto, Ont. M5T 1S2

Toll-Free Number:

1-800-268-3798

The "BEST"

IBM Compatible Microcomputer

See the Review
In March 1984
Computing Now!

\$1995

Not a kit — a complete system

This price includes:

- 64K of RAM with pre-socketed provision for 256K
- One disk drive. SA455. Double Sided. Double Density
- Colour Video Board
- Floppy controller capable of handling up to four DS. DD 5¼" disk drives and socketed for optional serial port and real time clock
- Monitor not included

Warranty:
Full 120 day
Warranty

Prices does NOT include
IBM (Microsoft) BASIC

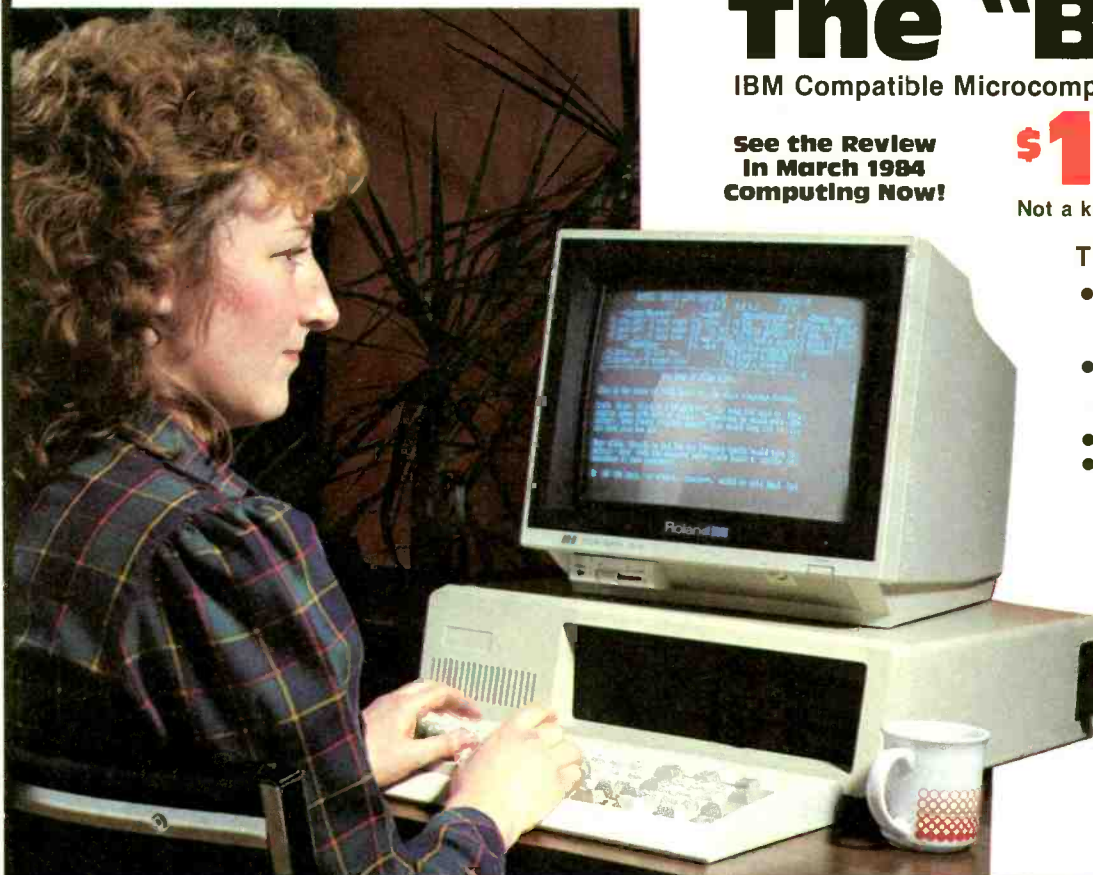

OR The Loaded "BEST"

Everything in our \$1995 System plus:

- Two DS. DD 5¼" Disk Drives
- On-board 256K of RAM
- RS232 Port

\$2595

OR 10 Meg Hard Disk Version

Everything in our \$1995 system plus:

- 10 Meg Hard Disk Drive & Controller
- On-board 256K of RAM
- RS232 Port

\$3995

SOFTWARE FOR YOUR IBM

- Lotus 1, 2, 3 \$439
- Wordstar \$399
- Multiplan \$219
- dBASE II \$479
- Flight Simulator \$62.95

Great Selection of other software for your IBM available.

IBM is a Trade Mark of IBM Canada Limited

Mail Order: Call for shipping costs. Rate will depend on methods chosen and distance.

Call our TOLL-FREE number for more information.
1-800 268-3798

(Toronto area call 921-8941)

Call in and let us demonstrate the "BEST" to you at 319 College Street, Toronto. Store hours 9:30 to 6:00 Monday-Saturday; to 9:00 p.m. Thursday and Friday.

PERIPHERALS FOR YOUR IBM

- Color Video Board \$339
- Floppy Controller Board \$299
Has provision optional RS232 port and real time clock.
- Parallel and Game Port Card \$149
Will also drive parallel printer
- 256K Memory Expansion Card and real time clock. Allows you to add a further 256K to your IBM's existing 256K capacity for 1/2 Megabyte of total memory.
With 64K RAM on board \$289
With 128K RAM on board \$369
With full 256K RAM on board \$530
- EPROM Programmer \$149
For 2732, 2769 and 27128.
- Disk Drive - SA4555 \$299
- IBM Compatible Case \$ 99
- IBM Compatible Keyboard \$189
- Super Heavy Duty Power Supply \$ 69

See our other ads for monitors, printers etc.,

EXCELTRONIX (416) 921-8941 1-800-268-3798

Bulletin Bd. (416) 921-4013 Telex 065-24218

319 College St., Toronto, Ont. M5T 1S2

Catalogue shipping rates are incorrect. Please call us for correct charges. Prices in catalogue are fluctuating. Use as guideline.

Multiflex Intelligent Terminal
 (As Reviewed in Oct. '82 ETI)
 An excellent low cost terminal kit from **\$195**
 Assembled & Tested with case and P/S
\$350

We're Doing It!

April Specials

Others try to compete with the best — Exceltronix. But will they be here tomorrow? Celebrate our 5th year in business.

PRINTERS

Star Gemini 10X	\$359
Gemini 15X	\$599
Delta 10 (160 cps)	\$739
Epson MX100	\$995
Epson RX80 (Replaces MX80)	\$495
Epson FX80 (New)	\$798
Epson FX100 (New)	\$1069
TTX (Daisy Wheel)	\$649
Microtek	\$139

APPLE CARDS

16K card - Multiflex	\$58.00
128K card	\$210.00
Proto Board	\$15.00
80-Column Card	\$84.00
Z80 Card	\$59.00
EPROM Programmer	from \$69.00
(for 2716, 2732, 2732A, 2764, with software) Parallel Printer Card with cable	\$69.00
Wizard Parallel Card	\$95.00

Joysticks

Economodel	\$19.95
Wico Red Ball	\$42.95
Self-Centering with two adjustable controls	
Super offer	\$64.00
Kraft Joystick (Apple, PC)	\$64.95
Kraft Paddles	\$48.95
TG Joystick	
Deluxe Model	\$75.00
TG Paddles Deluxe Model	\$64.95
Hayes Mach III	\$58.95
Model Deluxe Table Top	\$59.00
Hayes Mach II	\$48.95

MONITORS

Zenith ZVM-122 Amber	\$165
Amdek Amber-300A	\$259
Zenith ZVM-123 Green	\$129
Amdek Colour 1	\$445
Roll and DG	\$419

Apple //e™ Package Includes: 80 x 24 Card, Multiflex IPI, Z80 Card, Multiflex Disk Drive and Controller \$1599

Apple //e™ Package Includes: Apple //e, ZVM 123 Monitor, Apple Drive & controller card & DOS software, 80 x 24 Multiflex card, Apple manuals \$2099

NEW Macintosh, based on 68000 with 3" Disk Drive (smaller version of Lisa™), 3" Diskette Software now available \$3595

MODEMS

EPM 310	\$99
Smart Modem (300 Baud, IBM Comp)	\$359
Apple a la Modem (300 Baud)	\$215
Micromodem (Apple Comp)	\$475
Signalman (300 & 1200 Baud)	\$495
Smart Modem 1200 Baud	\$899

FAMOUS MULTIFLEX Z80 STARTER KIT: SPECIAL \$349.00
 Ideal Learning Tool, with EPROM programmer
 see page 18 of catalogue

Multiflex Super "Z" Package

Similar features to Xerox™ computer for a fraction of the price A&T \$1,695.00

Includes: Economy Video Board, Floppy Disk Controller, capable of handling up to four 5¼" or 8" Disk Drives, one 5¼" SA 455 DS/DD Floppy Disk Drive, CPU card in attractive packaging, which can accommodate up to two Disk Drives, and powerful, high quality power supply.

Memory Chips

4164-150ns (1x64K single + 5V)	
Motorola	\$9.95
T.I.	\$7.95
4116-200ns (1x16K)	\$1.74
4116-150ns (1x16K)	\$1.99
2114L-200 ns (1Kx4 static)	\$2.49
6116-150 ns (2Kx8 static RAM)	\$8.94
(Pin compatible with 2716 uses negligible amount of power)	
2016-150 ns (2Kx8 static)	\$8.74
2102L-200 ns (1Kx1 static)	\$1.94
5101-CMOS RAM	\$3.84
2708-(1Kx8 EPROM)	\$6.74
2716-(2Kx8 EPROM single + 5V)	\$5.50
2732-(4Kx8 EPROM single + 5V)	\$8.95
2532-(4Kx8 EPROM single 5V)	\$8.74
2764-(8Kx8 EPROM single 5V)	\$12.95

HUGE STOCK OF LS

UNIVERSITY OF TORONTO/MULTIFLEX 6809 Board, great for learning about 6809 and computing in general with A & T \$499.00
 Economy Terminal A&T \$369.00
 Package Deal A&T \$349.00

Featuring the Multiflex Apple™ Compatible Drive only \$249

Package Deals:	
A1 Drive & Controller	\$310
B2 Drives & Controller	\$549
Controller only	\$69
with software	\$119
VISTA DRIVE	\$299
QUENTIN DRIVE	\$299

1 year warranty

Special!



Controller \$89
With Apple™ Software \$119

Paper \$10.45

For your printer
 Control Data, 9½" x 11" plain 500 sheets.
 Other sizes available.
 1500 Sheets of Paper in carrying case.
\$29.00

New Ottawa Location
 217 Bank Street
 (613) 225-0029

Coming Soon:

COMMODORE PERIPHERALS!

Multiflex Users Group
 P.O. Box 4059 Station 'E'
 Ottawa, Ont. K1C 5B1

Diskettes

5¼" Diskettes. Boxes of 10

Maxell MD1	\$34.00
Maxell MD2	\$52.95
Verbatim	\$34.00
CDC	\$26.95
3M	\$32.95
Accutrak	\$26.95
2 Ectype Diskettes in a plastic binder sheet	\$5.89
Flip N File 50	\$44.95
Diskminder (75)	\$33.95
Dysan	\$39.00
BASF	\$34.00
BASF with case	\$35.00

PRICE POLICY

Remember that at Exceltronix all prices are negotiable for quantity purchases. If you cannot afford large quantities on your own how about starting a Co-op.

CHARGE X

MAIL ORDERS

Send a certified cheque or money order (do not send cash). Minimum order is \$10 plus \$3 minimum for shipping. Ontario residents must add 7% provincial sales tax. Visa Mastercard and American Express accepted: send card No., signature, expiry date and name of bank.



Head Office: 319 COLLEGE STREET, TORONTO, ONTARIO, CANADA. M5T 1S2 (416) 921-8941

Circle No. 27 on Reader Service Card.

SURPLUSTRONICS

we will not be undersold



Canadian Made

As Reviewed
in ETI
May 1983:
Send for a
FREE COPY

OUR FAMOUS 6502 BOARD

NOW NEW & IMPROVED VIDEO SECTION

This 6502 board is a vast improvement on others available:

- 64K RAM (8-4164 chips)
- 80 x 24 video included on board
- Floppy Disk Controller included
- FIVE additional slots
- Z80 blank PCB included
- Powerful power supply (5V 5A, +12V 2 up to 3A peak, -5V 0.5A, -12V 0.5A)
- Hydro-approved whereas many others are not!
- Superb quality plastic case
- Excellent keyboard including numeric keypad
- EPROMS (blank) included
- Available preassembled by special order only.
- Ideal for educational applications.

\$689

Our prices are low due to our mass production assembly, which makes it hard for others to compete.

NOW you receive a **FREE** Z80 PC BOARD **AND** **FREE** 128K RAM DISK PC BOARD when you order the complete package (either Kit or A&T) (BLANK

Our boards are professionally made, flow soldering & cleaned & use only high quality prime parts.



Peripheral Boards for your IBM PC

IBM, IBM PC are registered trademarks
IBM Canada Ltd.

The following boards now available A&T

- Prototyping Card
- Floppy controller card with serial port on board: \$289.00
- Colour Video Card: \$299.00
- 256K Memory Board expandable to 1 Meg with real time clock & serial ports: Call for prices
- Case to house the above: \$99.00 (Made in Canada)
- Parallel Card and Game Port Card: \$149.00
- Compatible keyboard: \$189.00 Superb quality
- Our own 8088 Board, enhanced and compatible 64K RAM
- Power supplies from \$69.00 to \$250.00

8088 BOARD

Best Prices in Canada

COLOUR GRAPHICS 256K RAM or 1 MEG. using new 256K RAM Chips.

- Floppy controller
- I/O
- And much more
- Sold with all parts including blank EPROMS
- Compatible with ??? Yes you guessed it. At a price so low you won't believe it. Please call for ordering & pricing. Demand is overwhelming. Orders will be filled (On a first come first served basis).

Systems are in stock now, but due to the high demand, delivery may be delayed slightly.

SYSTEM INCLUDES: Case, superb keyboard, good power supply, fan, one SA 455, DS DD DISK DRIVE, Colour Video Board (works as Black and White also). Main 8088 Board with 64K of memory, expandable to 256K by adding 4164 or you can expand to 1 meg. using 41256IC's, floppy controller which can handle up to four 5 1/4" disk drives & has optionally available serial port and real time clock.

Note: We do not sell any proprietary software



Call for best prices

Complete A&T System,
Introductory Offer,

Now only
\$1,989

6502/8088 Board

All prices subject
to change

EPS Keyboard \$399.00
Apple Compatible. IBM Module
available. Distributor for Ogivar

Apple Peripherals Assembled and Tested

Z80 Card	\$ 58.00
80 x 24	\$ 84.00
16K RAM	\$ 58.00
Prototyping Board	\$ 14.50
Parallel Printer Card	\$ 59.00
... with cable & connector	\$ 69.00
128K Board (No IC's)	\$ 49.00
...with IC's & 64K RAM	\$129.00
...with IC's & 128K RAM	\$210.00
Crazy Card	\$ 58.00

Disk Drives

Apple Compatible	\$249.00
Controller	\$ 89.00
... w/software	\$119.00

One year warranty

Monitors

ZVM-122 Amber	\$165.00
ZVM-123 Green	\$129.00
Roland Colour 1	\$395.00

Printers

A. Gemini 10x	\$359.00
B. Special Multiflex parallel card with cable. Shop and compare	\$ 69.00
Package price of A and B	\$415.00
Gemini 15x	\$598.00

5" Green Screen Monitors. \$59

Telex No.
065-24218

Mail Orders add \$5.00 minimum for shipping & handling. Ontario residents add 7% P.S.T. Visa, Mastercard and American Express cards accepted: send card number, expiry data, name of bank and signature. Send certified cheque or money order, do not send cash.

Circle No. 29 on Reader Service Card.
More lines to serve you better
(416) 960-1350

Huge variety of Surplus stock at low, low prices. New shipments arriving. No reasonable offers refused. Prices subject to change without notice!

Surplustronics, 310 College Street, Toronto, Ontario, M5T 1S3

for your information

New VCRs

The VHS Hi-Fi stereo system and a unique all-in-one video recorder and camera highlight the all-new video cassette recorder (VCR) line from Zenith. Zenith unveiled three low-profile, front-loading VCR decks, a compact portable/deck, a color video camera and the Video Movie system (a combination VCR-camera).

Zenith's new video recorders feature a precision-engineered four-head tape scanning system for improved picture performance. A new dual-function infrared remote control transmitter operates the functions of each of the new VCRs and any Zenith remote control color TV set built since 1981.



ETI Magazine is Published by:

Moorshead Publications

Editorial and Advertising Offices
Suite 601, 25 Overlea Boulevard,
Toronto, Ontario, M4H 1B1
Telephone (416) 423-3262

Editor: William Markwick
Editorial Assistant: Edward Zapletal
Director of Production: Erik Blomkwist
Creative Manager: Ann Rodrigues
Production: Doug Goddard
Neville Williams
Naznin Sunderji
Circulation Manager: Lisa Salvatori
Advertising: Omar Vogt
Rick May
Advertising (Que.): John McGowan
& Associates
(514) 735-5191

Publisher: H.W. Moorshead; **Executive Vice-President:** V.K. Marskell; **General Manager:** Senga Harrison; **Controller:** Bernie Shankman; **Accounts:** Pirjo Dunphy; **Reader Services:** Carolyn Wyatt, Shannon Haladay, Megan Rimmer, Heather Brooks, Ken Adams; **Advertising Services:** Claire Zylvitski.

COPYRIGHT

All material is subject to worldwide copyright protection. All PCB patterns are copyright and no company can sell boards to our design without our permission.

LIABILITY

While every effort has been made to ensure that all constructional projects referred to in this magazine will operate as indicated efficiently and properly and that all necessary components are available, no responsibility whatsoever is accepted in respect of the failure for any reason at all of the project to operate efficiently or at all whether due to any fault in the design or otherwise and no responsibility is accepted for the failure to obtain component parts in respect of any such project. Further no responsibility is accepted in respect of any injury or damage caused by any fault in design of any such project as aforesaid.

Editorial Queries

Written queries can only be answered when accompanied by a self-addressed, stamped envelope. These must relate to recent articles and not involve the staff in any research. Mark such letters ETI-Query. We cannot answer telephone queries.

PCB Supports

Non-conductive, nylon printed circuit board supports, produced by W.H. Brady Inc. are now available in three different styles. New, self-locking, releaseable style offers secure assembly, and is not affected by vibration or ambient temperatures. Design permits easy removal when necessary. The new supports feature a molded guide to permit sure centering on the circuit board holes. The construction of the support shaft and locks assures the same sturdy support and rigid mounting found in the tension-retaining and double-locking styles already in the Brady line. Made of natural nylon, the supports are available in 12 spacing heights from 4.76 — 34.83mm. For additional information, contact John Standish, W.H. Brady Inc., 10 Marmar Drive, Rexdale, Ontario M9W 1E6. (416) 675-2112.

LOOSE ENDS

In our January, 1984 issue we published a project for a ZX81 A-to-D converter using the 7581 chip. This chip is made by Analog Devices and Beckman, and is available from Tracan Electronics Corporation, Units 3 and 4, 1200 Aerowood Drive, Mississauga, Ontario L4W 2S7 (416) 625-7752. The price turned out to be much higher than we expected: about \$30 in single quantities.

The Designer's Notebook on Optocouplers promised for this issue had to be delayed due to space restrictions. It will appear in the May issue.

The Miscellaneous section was missing from the Frequency Counter project last month. It was:

XTAL1 5.000 MHz crystal —
Displays IEE 2678R or FND500 —
XFRMR1 10 to 12 V 500 mA —
Bezel IEE 24036R — Cabinet Hammond 9H CH BU. The bezel, displays, and 16 pin connectors are available from the source listed in the March parts list.

Apple Spectrum Analyzer

A wide range of biomedical, audio and industrial analysis functions can now be performed easily and economically with a new FFT Spectrum Analyzer in conjunction with an Apple personal computer. The IQS Series 401 analyzer is available in Canada exclusively from the Test & Measurement Division of Allan Crawford Associates Ltd., located in most major Canadian cities. The IQS 401 provides all the hardware and software required to acquire and analyze arbitrary analog signals or perform impulse testing of electronic, electroacoustic, electromechanical or mechanical systems. Typical applications include performing numerous biomedical measurement and analysis functions, development

and production testing of high-performance audio products, and production and QC testing of products as varied as electronic circuits or rocket components. The 401 can even be used in systems to measure microparticles in ultra-pure water and to test the crispness of food products.

IQS Series 401 analyzers are available as add-ons to existing Apple computers, as part of turnkey packages, and as systems which address specific industrial, medical, educational or audio requirements. The 401 comes complete with signal acquisition and processing hardware, software on diskette and in firmware, and user manual. Canadian prices are from \$1275 for an Apple add-on unit, FST extra.

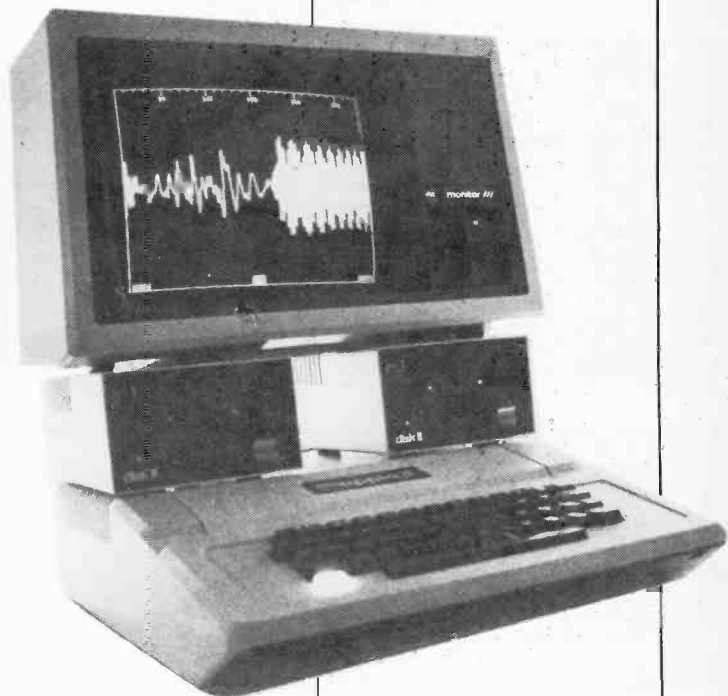

for your information

New Buying Guide

Detailed listings on communications cable are featured in a new catalog and buying guide just announced by Consolidated Electronic Wire & Cable. This new 80-page guide features a greatly expanded product line and has been custom designed for ease of use. Divided into ten major sections, the book covers more than 7,000 standard wire types, with full descriptions of their characteristics. Products described include a broad range of coaxial and multi-conductor cables for broadcast, CATV, satellite, two-way radio as well as other commercial and military communications systems. Specialty coaxial cables include low-loss large diameter types, CATV drop cable, video camera cables and high temperature cables. Many cables are 100% sweep tested. In addition product listings, the guide also includes a number of handy cable reference charts. Three separate competitive cross reference sections are also provided. To receive a free copy of the new publication, write or call Doug Pettifer, Lenbrook Electronics, 111 Esna Park Drive, Unit 1, Markham, Ontario. L3R 1H2 — 477-7722.

DATES ANNOUNCED FOR CANADA'S LARGEST MICROCOMPUTER SHOW

Toronto. . . . **COMPUTER FAIR** is earlier this year. Hunter Nichols Inc., producers of this enormously successful microcomputer show have announced the dates for the 1984 Show.

This year the 2nd Annual Computer Fair will take place Thursday, May 10th to Sunday, May 13th at the International Centre on Airport Road.

The first Computer Fair in 1983 had displays, exhibits, special features, and a very popular seminar programme. With attendance of over 40,000 and more than 150 exhibiting companies covering an area of 100,000 square feet, the 1983 Show proved to be the largest microcomputer show in Canada.

Show Management promises an even more intriguing and educational seminar programme with expert guest speakers providing information in an entertaining and enlightening fashion, for 1984 attendees, and already the size of the Show has

been enlarged over last year.

Computer Fair, which is open to the public will offer a "Special Educational Package" this year for advance student group bookings. The special package with discounted admission rates will encourage instructors to inquire and make early arrangements for student groups. For information call (416) 439-4140.

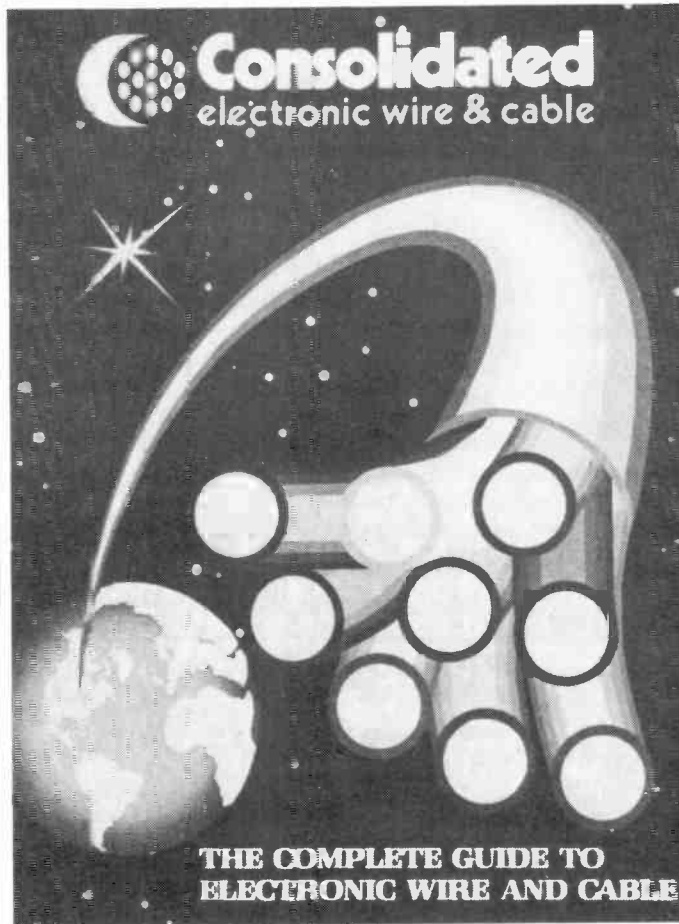

TORONTO — The Electrical and Electronic Manufacturers Association of Canada stated today that the recently released budget does not contain enough encouragement or help for industry to provide much needed jobs. Instead, it appears to be an extension of the April 1983 budget in which substantial concessions were made to industry.

David Armour, president and chief operating officer of EEMAC pointed out that the capital cost allowance changes introduced in the April 1982 budget should have been recinded this year to further stimulate the industry. Armour also expressed further disappointment in the failure by government to introduce tax measures to promote industrial modernization despite government's previous concern for the development of technology.

Armour added that the Minister of Finance should be commended for his initiative in restraints towards public sector wages but the promise of government not to play 'catchup' with private sector wages and salaries is an easy commitment especially because government is already paying about 20 per cent higher than the private sector.

Among the budget measures that were welcomed was a reference to the amendment of the Competition Act which will open the way for export consortia — a move which would improve our export competitiveness. The simplification of the tax system for small business was also welcomed by the association as a positive step for industry.

EEMAC is an association of 200 Canadian manufacturers of electrical and electronic components, systems, apparatus and components. The industry serves a domestic market of \$15 billion and an export market of \$3 billion and employs 135,000 Canadians in the manufacturing sector.

MICRO HOUSE

72 STEELES AVE. W., (AT YONGE), SUITE 208, TORONTO, ONTARIO L4J 1A1, TEL: (416) 731-1058 (416) 731-4146

QUALITY MICRO PRODUCTS AT WAREHOUSE SALE PRICE!!!

UNBEATABLE PRICE \$368

SYSTEM 48

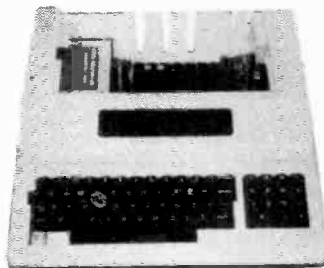

48K ASSEMBLED & TESTED MOTHER BOARD (W/BLANK EPROM), HEAVY DUTY 5A POWER SUPPLY, NUMERIC, UPPER & LOWER CASE KEYBOARD, CASE EXTRA.

PACKAGE SPECIAL SYSTEM 48 & DISC CONTROLLER & DISC DRIVE & RF MODULATOR \$638.00

Z80 COMPUTER BARGAIN!!! STD BUS, 48 PIO, RS232 (300-19-2 BAUD) UP TO 32K EPROM OR RAM, 8 A/D, 3 TIMER, BLANK BOARDS & DOCUMENTATION \$29.00

BOARD & ACCESSORIES

48K MOTHER BOARD (A + T) (w/blank EPROM) \$228
16K RAM \$43
DISC CONTROLLER \$43
SELF CENTERING JOYSTICK \$29
128K RAM BOARD (w/no software, w/64K) \$119
Z80 BOARD \$48
COMPUTER CASE (numeric) \$59
DISC DRIVES \$CALL
FREE EPROM programming (max 6 EPROMS) with any purchases.

IC
4164 \$7.90
Parts for IBM Boards \$CALL
2764 \$CALL

DISKETTES
For Apple 10/\$23

SPECIALS

HEAVY DUTY 5A POWER SUPPLY \$73
This quality heavy duty power supply can easily beat all other prices. REG. \$99

NUMERIC KEYBOARD \$89
this keyboard is packed with features: numeric upper/lower case. Quality built at low low price. REG \$109

QUANTITY DISCOUNT AVAILABLE DEALER ENQUIRY WELCOME

Price subject to change without notice. Mail orders add 3% for shipping (min. \$3.) Ontario residents add 7% PST. Visa, MC accepted, send card no. expiry data, name of bank and signature. Send certified cheque or money order, do not send cash.

WINNER: Ultra-modern! Super-efficient! Fully Apple compatible

Please note the distinct features
Winner offers:

- *Dual microprocessors 6502 & Z-80A
- *RS-232 built in
- *Disk drive interface card built in
- *40/80 column text display and auto change video output port by soft switch
- *76K RAM with 4 expansion slots
- *16K ROM
- *DOS 3.2 & DOS 3.3 capability
- *Apple & CP/M compatible
- *ASCII keyboard with function keys and a numeric keypad

\$995

- *Upper/lower case
- *Streamline case
- *OS could be changed when desired without affecting other memory RAM



"ADD VISION TO YOUR COMPUTER WITH THE MICRON EYE"
- solid state - programs included - hardware, software & optics included, **\$380.00**

Roland CB-141 COLOR B



\$395.00

Composite System Colour Display

- Composite system, 14-inch display.
- With its built-in amplifier and speaker, it accommodates games, video monitor, etc.
- Low cost but provides high performance with sound circuit & headphone jack.
- Protected from an erroneous operation of a floppy disk drive unit and dealt with a shield treatment against other electronic units.

Electrohome Monitors & Accessories

EDM1226/B&W 12" Black & White Monitor	\$149.00
EDM1226/P31 12" P31 Green Monitor	\$159.00
ECM1302-1 13" Color RGB Monitor	\$349.00
ECM1302-2 13" Color RGB Monitor Hi Rez.	\$450.00
I-1302 NTSC Interface for ECM1302 for Apple II Computers (1 year warranty from Electrohome)	\$69.50
Zenith 12" Green	\$139.00
12" Amber	\$169.00
Roland Colour Monitor	\$449.00
MACKINTOSH 12" Amber	\$169.00
MACKINTOSH Colour & Green	\$425.00
GM 1201 Green 12"	\$149.95
GM 1201 Amber 12"	\$159.95

DIRECT COUPLED MINI MODEM
\$99.00

TTX™ 1014 RELIABLE DAISY WHEEL RO PRINTER \$749

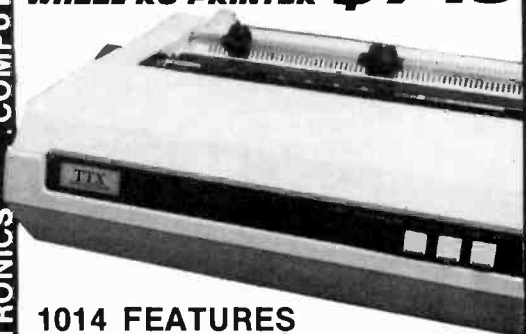

1014 FEATURES

- SERIAL AND PARALLEL INTERFACE
- WORD STAR* COMPATIBLE
- QUIET OPERATION
- PROGRAMMABLE PITCH AND LINE SPACING
- COMPACT AND DURABLE
- MICRO, MINI, MAINFRAME COMPATIBLE
- INTEGRAL PIN FEED GUIDE (ADJUSTABLE)
- RIBBON CARTRIDGES AND PRINTWHEELS READILY AVAILABLE

CP80 DOT MATRIX PRINTER

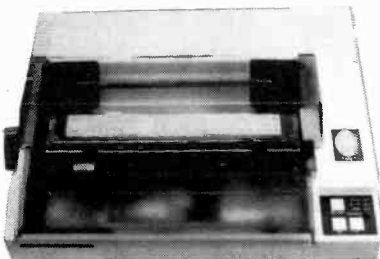

7X8 DOT MATRIX
80 CPS, 640 dots/line per second
Bidirectional
80 Column normal
142 Compressed
Friction & Tracktor Feed
Standard Centronics Parallel
Same as EPSON 80

\$495.00

Assembled \$45.00
ZX81 Printer \$109.00
16K Sinclair Memory \$45.00



Books Hardware

COMPLETE ZX81 BASIC COURSE - Inc. 2 tapes	39.95	ZX81 Ass. Sinclair Printer	45.00
NOT ONLY 30 PROGRAMS: 1K MACHINE LANGUAGE MADE SIMPLE	19.95	Times Printer	125.00
ZX81 ROM DISASSEMBLY PART A & PART B	24.95	64K RAM (Mamotech)	199.00
UNDERSTANDING ZX81 ROM	19.95	ORION 64K 32K RAM (Mamotech)	149.00
T/S 1000: PROGRAMS, GAMES and GRAPHICS	18.95	16K RAM (Sinclair)	119.00
LEARNING T/S BASIC THE BASIC HANDBOOK	18.95	500MA	48.95
48 EXPLODING GAMES	29.95	Power Supply (850 M.A.)	14.95
COMPUTER FOR KITS SINCLAIR EDITION	18.95	Power Supply (1 AMP)	19.95
MASTERING MACHINE CODE ON YOUR ZX81	18.95	Keyboard (unboxed) 47 Keys, Assembled no soldering req.	119.95
T/S 1000 USERS GUIDE (Vol 1)	18.95	Metal Case for above	29.95
EXPLORERS GUIDE TO THE ZX81	18.95	Memopak Centronics Type Parallel Printer Interface	119.00
ZX81 POCKET BOOK	18.95	Memopak ZX81 Keyboard	129.00
GETAWAY GUIDE	18.95	Memo Cyclic	79.95
GETTING ACQUAINTED WITH YOUR ZX81	18.95	* Interface for any serial printer & 4 cassette recorders; includes plugs, cords and a detailed manual.	

Additional Hardware & Software for the SINCLAIR ZX81 AVAILABLE ON REQUEST.

THE ORION II 64K COLOUR COMPUTER \$549.00



APPLE COMPATIBLE COMPUTERS

- 48K Color Computer with standard keyboard** **\$498.95**
- 48K Color Computer with numeric keys & function keys** **\$549.95**
- 64K Color Computer with standard keyboard** **\$549.95**
- 64K Color Computer with numeric and function keys** **\$598.95**
- 64K Color Computer (Dual-6502 & Z80A, CP/M), Numeric & function keys** **\$649.95**

*** Smith-Corona Correct III Messenger & Typewriter ***

- Portable typewriter • Optional serial or parallel interface for letter quality printer!
- One touch memory • 3 different type sizes • 10 different styles • With interface \$950.00

\$750.00

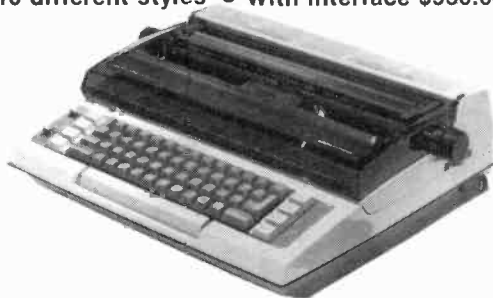

"Universal Monitor Swivell"

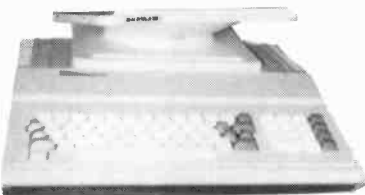

\$39.00!

COPAM PC301 IBM™ COMPATIBLE

The COPAM PC 301 is a 16 BIT computer system designed specifically to be compatible with the popular IBM personal computer. The COPAM computer consists of system unit, 2 disk drives & keyboard.

SYSTEM UNIT: 16 BIT computer * RAM 128K expandable to 256K * Multi function card -2 channels serial asynchronous communications port (RS232 interface) - one parallel printer port - calendar/clock function, powered by rechargeable battery * disc controller card handles up to 4 disk drives * colour display card * test mode 40 col x 25 row, 80 col x 25 row * graphic mode 320 dots x 200 lines, 640 dots x 200 lines * high wattage power supply * five expansion slots.

Keyboard: fully detachable keyboard, function compatability with IBM PC keyboard * transmit : serial 1/P * 95 keys * 10 function keys * 15 numerical keys * 57 alpha/num keys * 8 cursor control * 5 other keys.

Disk Drive: The PC301 comes with 2, 5 1/4 double sided, double density disk drives * unformatted -media 500K bytes track 6520 bytes * formatted (16 sector, IBM format) media 327K bytes, track 4096 bytes.



Operating System: * provides you with microsoft MS DOS, allowing purchase of prewritten and designing of software packages. MS DOS 2.0 & 1.1 can run on COPAM PC 301.

CALL FOR MORE INFORMATION & PRICING.

CALL FOR MORE DETAILS

WOWIE! LOOK AT THIS! 6502 BOARDS & ACCESSORIES

AMB-1	\$325.00	ALC-1	\$69.00
Mother Board, APPLE II Compatible, Assembled & Tested c/w Basic ROMS, 64K RAM, Made in Japan, Integer & Reg Basic.		16K RAM (Language) Card	
ABB-1	\$ 39.00	AKB-2	\$99.00
APPLE II Compatible, Motherboard (no components)		Keyboard; Numeric key pad with function keys, replacement for APPLE II	
6502 Board Kit	\$275.00	AC-2	\$99.00
Includes all parts, less ROMS		Beige APPLE II Case (for above keyboard)	
AEB-1	\$99.00	Case & Keyboard numeric	\$175.00
EPROM Burner Card		APS-2	\$99.00
AIC-1	\$89.00	Switching Power Supply for APPLE II; +5V @ 5 amps, +12V @ 3 amps, -5V @ 1/2 amp, -12V @ 1/2 amp; c/w on-off switch & connecting wires	
Integer Card		AAA-2	\$299.00
AEC-1	\$89.00	Disc Drive, 5 1/4", APPLE II Compatible, Excluding Controller Card	\$365.00
80 Column Card		with controller	\$69.00
AZC-1	\$79.00	ADC-1	\$69.00
Z80A (CPM) Card		Disc Drive Controller Card for two drives; Apple II Compatible	
APC-1	\$89.00	APPLE II is a registered trade mark of Apple Computer Inc.	
Parallel Printer Card			
ASC-1	\$89.00		
Serial Printer Card			

Orlon Electronic Supplies Inc.

40 Lancaster Street West
Kitchener, Ontario N2H 4S9
(519) 576-9902

Master Charge & Visa, COD, Cheque, Money Orders accepted. COD's, shipping & insurance extra. Write for our **FREE FLYER.**

Prices subject to change without notice.

Circle No. 6 on Reader Service Card.

COMPUTER ROOM ORION ELECTRONICS COMPUTER ROOM ORION ELECTRONICS COMPUTER ROOM

Directional Broadcast Towers

Establishing a two element array radio station in Nova Scotia proved to be more involved than simply garnering space on an already crowded wave band. James W. Essex tells the story.

THE SIGHT of today's ubiquitous broadcast towers arranged in multiple arrays might leave you wondering why more than a single tower is needed to get your favourite program onto the air. For example, CBL's signal manages to get on the air with a single (although giant) tower that is located just west of Toronto by the 401 Expressway. The CBC outlet is an exception, though, as it enjoys a "clear channel" (no other radio station shares the same wavelength), whereas most broadcast stations today share their frequency with another station and are required to protect a common channel even if it is a thousand miles distant. Because of this requirement, setting up a directional broadcast installation sometimes proves to be a greater problem than obtaining the necessary permission to operate the station.

Radio station CKBW, a two element array located in rural Nova Scotia, is a good example of the problems that can be encountered. While it was true that obtaining the license required a great deal of preparation and planning, getting the towers to work as they were designed was difficult, and a faulty pattern held up the anticipated opening for a long time.

CKBW was originally planned for 1000 watts at 1000 kHz, although it has now increased its power to 10,000 watts with a three-tower array on the same frequency. The site of the station was chosen, the land purchased and the equipment was ordered. The final assembly of the studios and transmitter was completed, and all items checked and rechecked for proper adjustment.



For daytime transmission only, the left tower is used; for night-time, the right tower is energised 90 degrees out-of-phase to create a cardioid pattern.

The station used a two tower antenna system operating with a 90° phase difference and a null area west of the line of towers, which ran due east and west. These specifications were laid down in the brief submitted to the licensing authority that had granted the license. CKBW could not contribute any interference on the 1000 MHz channel in a westerly direction after sundown because of a possible conflict with WCFL in Chicago, which was some 1200 air-miles distant. The Nova Scotia station would be operated non-directionally by day and directionally by night. Because the site chosen for the installation did not allow the transmitter house to be set directly in line with the towers, it was built to the south-west and connected with a transmission line. This location created dire complications for the system in due course.

Null Makes Void

After setting up the phasing units at the base of each tower to obtain the 90° displacement, we prepared to make our first check of the resulting radiated field.

Using a loop receiver with an output circuit driving a meter calibrated in microvolts per metre, we made a trip by automobile, and completely circled the

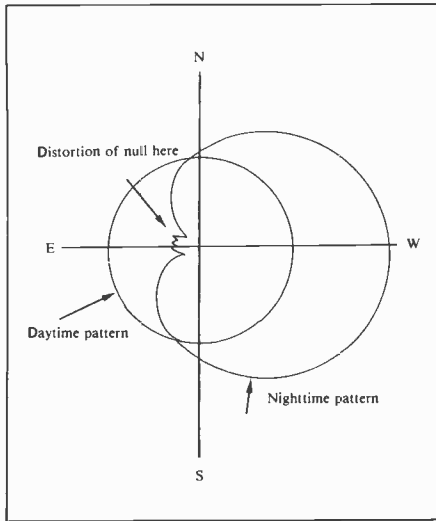

Distortion at the null point was the start of all the trouble ...

two towers. We stopped every 9° where such radials intersected an accessible road at a distance greater than one mile from the station. The run completed, all microvolts per metre reading were calculated into ratios, resulting in a set of numerical values. These figures, plotted on a polar graph, revealed a directional pattern similar to that shown in the il-

lustration. The distortion that appeared was a clear indication of trouble.

Because of strict adherence to the Department of Communication's regulations, the distortion or "blip" indicated in the null area was not acceptable. A long struggle was initiated to rid the pattern of distortion. The date for going on the air was shelved, and the sleuthing began.

Believing the problem was because of incorrect phasing between the towers, we shifted the phase slightly above and below the mean of 90°. With each shift in phase, a sweep through the area where the null was supposed to appear just west of the towers was necessary. At the conclusion of each run, as already described, the values obtained were plotted.

The car consumed large quantities of gasoline and the transmitter room became a litter of graph paper, but each run failed to bring use any closer to a solution. The blip was determined to remain.

The search continued from the end of November to mid-December, and hopes for a desired Christmas opening rapidly evaporated. Snow began to fall and we had to abandon the car for a Jeep in order to negotiate difficult roads well into the null area. In farmer's fields even the Jeep became useless, but with the aid of skis,

continued on page 17

WHY SPEND A FORTUNE ON A DIGITAL CAPACITANCE METER?

As a matter of fact you don't have to pay \$200 to \$500 and up anymore for a Digital Capacitance Meter that is both dependable and rugged with good accuracy. The MC100A comes completely assembled and calibrated and at \$89.95 is an outstanding value. The extensive range of 30 pF to 9,999 uF (no external meters required) and true hand held portable size (only 4 7/8" x 2 1/2" x 1 1/2") make the MC100A an extremely practical and easy to use instrument for the hobbyist technician or engineer.

CHECK THESE OTHER FEATURES

- * Basic accuracy 2% (± one count) on pF, nF ranges, 5% (± one count) on uF range.
- * Uses single 9V battery (not included).
- * Decimal points light up when battery is low or when capacitor is overrange.
- * Full 4 digit high efficiency LED display uses special circuitry to save on batteries.
- * Maximum conversion time for 9,999 uF is less than 6 seconds.
- * Constructed with a tough impact resistant plastic case.
- * 90 day parts and labour warranty.



DAETRON
935 THE QUEENSWAY, BOX 641
TORONTO, ONTARIO M8Z 5Y9
(416) 499-7221
DEALER ENQUIRIES INVITED

PLEASE SEND ME

(Quantity) MC100A(s) @ \$89.95 \$ _____

Ontario residents add 7% PST \$ _____

Postage — \$1.85 (per instrument) (C.O.D. orders add \$1.59) \$ _____

I ENCLOSE CHEQUE MONEY ORDER BILL MY VISA TOTAL \$ _____

VISA CARD NO. _____

EXPIRY DATE _____ SIGNATURE _____

Immediate shipping on orders with money orders, VISA or certified cheque

Personal cheques please allow 2 to 3 weeks for clearance

NAME _____

ADDRESS _____

CITY _____ PROV. _____ POSTAL CODE _____

MAIL TO DAETRON 935 THE QUEENSWAY BOX 641 TORONTO ONTARIO M8Z 5Y9

Circle No. 30 on Reader Service Card.

Complete System +



for
\$995.00

- Fully Apple™// compatible
- 48K memory
- Disk drive
- Disk controller card
- Upper/lower case
- Hi-res Amber monitor
- Color graphics
- 90 days warranty

I.B.M. Compatible

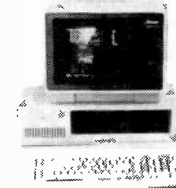

ECS1
\$2600.00

- 8088 processor
- optional Intel 8087 numeric coprocessor
- two RS232 interface
- parallel interface
- 64K memory exp. to 256K on board
- double sided double density disk drive
- detachable keyboard
- colour-graphic board
- amber monitor
- support IBM® software
- 90 day warranty

Complete System Model 2200

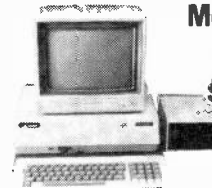

for
\$1199.00

- Fully Apple // compatible
- dual processor 6502 and Z80
- 64K RAM
- 24K ROM
- 80 or 40 column soft switch
- controller card
- disk drive
- Hi-res amber monitor
- colour graphics
- detachable keyboard
- 90 days warranty

ECS2 Systems



\$1395.00

- Fully Apple // compatible
- dual processor 6502 and Z80
- 64K RAM
- 24K ROM
- controller card
- disk drive
- Hi-res lit amber monitor
- colour graphics
- detachable keyboard with special function
- 90 days warranty

ELECTRONIC CONTROL SYSTEMS

1890 Meyerside Drive, Mississauga, Ontario L5T 1B4
(416)673-1302
Hours — Mon. to Fri. 10-7, Sat. 10-2

Circle No. 16 on Reader Service Card.

Product Review

Border Logic Trainer Model 100

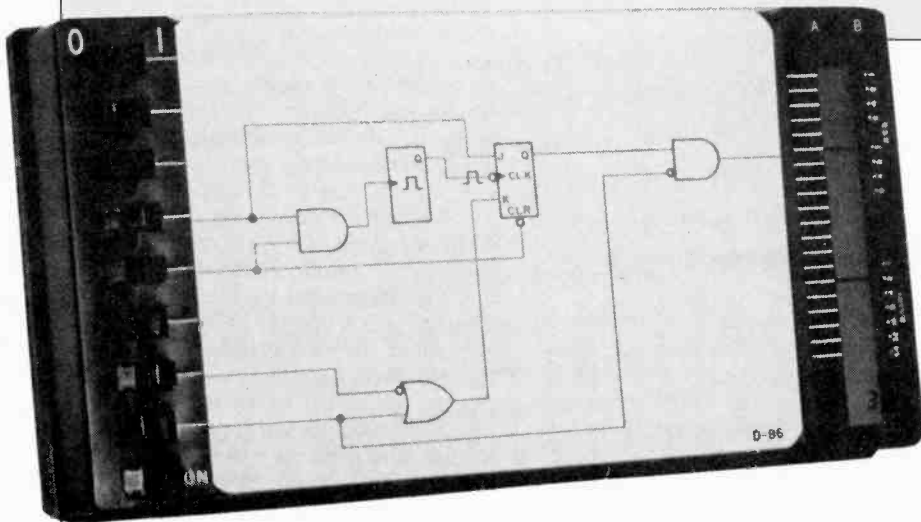

Learning logic functions and circuitry on a miniature simulator.

By Bill Markwick

The Broder Logic Trainer Model 1000 is distributed in Canada by Sterling Enterprises, 14 Randy Avenue, Orangeville, Ont. L9W 2A1, (519) 941-5375.

THERE ARE two ways to learn and confirm the operation of a logic or electronic circuit. The first way is to actually build a working model of the circuit, and probe it to death with measuring instruments. This is the best way, of course, because you discover all sorts of practical problems that you might not have thought of before. The drawback is the cost, complexity, and time required to actually build the thing and debug your errors.

The second way is the Broder Logic Trainer. It lets you choose from 52 standard logic circuits, choose what you think are the correct input conditions, and see if you get the proper output. This certainly beats seeing an IC go up in smoke after three hours of soldering.

The unit itself consists of a black plastic box about 11 by 23 by 4 cm, with a row of slide switches at one end and a liquid crystal display at the other. In between is a space for holding one of the 26 double-sided cards with the logic circuit drawn on it.

You'll also find a manual, a plastic overlay for pencilling in your thoughts, and a supplementary book with 20 single-sided cards covering the discrete logic series.

Operation

To increase the flexibility of the unit, there's a slide switch marked A-B; this is set to match the card in use: A series on one side, B on the other. Turn on the power, which comes from an internal 9 volt battery, and you'll see a zero appear

on the display. This is an incremental counter which will keep track of the number of times you move the switches.

Insert the first card, and AND gate. This one's easy; both inputs must be high to toggle the output. Follow the input lines to the appropriate slide switches and set them to "1". A line will appear on the display at the circuit output to let you know that you've been successful.

A few other lines may appear, too. This is the result of trying to extract all sorts of useful combinations from the input/output possibilities; without some sort of mechanical connection to tell the box which card has been inserted, it's inevitable that there'll be leftovers. They aren't distracting, and can be ignored.

All the usual logic gates follow, by themselves and in various combinations. Since I've always had trouble with latches, I was pleased to have them nicely explained by the manual and demonstrated by the trainer.

The A series of cards will take you as far as multiplexers and two-bit adders. The manual is clear and concise, though it isn't meant to be a comprehensive course on everything there is to know about logic circuitry; it should be a supplement to a larger text.

The B Series

Once you get the hang of basic gates and their hookups, set the selector switch to B and turn the cards over. The B series begins with an introduction to flip-flops

and their use as one-shots, dividers, and shift registers. This is where things begin to get really interesting; the IC in the trainer can keep track of past switch states; it isn't just an on-off situation. A flip-flop or latch may have to be Set or Reset before the signal can be clocked through the rest of the circuit. In another instance, a ripple counter (card B16) requires four pulses of one of its inputs to set up the shift registers, and then a "1" on the clock line to toggle the output.

The B series also includes various other counters and latches, and lets you set up the various states of the circuit's truth table. You can certainly wring out the functions in a far more convenient way than actually breadboarding the chips.

Also, you can't beat the video game appeal of the thing. It was immensely rewarding to work through the logic states and then have the little bar appear with the minimum number of switch movements.

Binary Counting

Having trouble getting your mind to work in binary instead of good old decimal? The trainer has provision for that, too. All the switches but the first are set to "1", and the A-B can be in either position. The first switch is now used to clock in the equivalent of a pulse train; each pulse (i.e., each change to a "0" or "1") cause the display bars to appear at the appropriate front-panel number. The display simultaneously displays binary

continued on page 65

COMPUTERS ARE CREATING JOBS FOR NRI-TRAINED PEOPLE.

IF YOU'RE SERIOUS ABOUT MAKING MONEY IN MICROCOMPUTERS, NRI IS SERIOUS ABOUT SHOWING YOU HOW.

The U.S. Department of Labor projects job openings for qualified computer technicians will soon double. International Resource Development, Inc., estimates a 600% increase in these jobs in a decade. And most of these will be new jobs, created by the expanding role of computers.

NEVER HAS THERE BEEN A FASTER-GROWING FIELD OF TECHNOLOGY.

Many people are afraid of losing their jobs to computers, but thousands of jobs will be created for those who are prepared to meet the challenge.

With NRI training, you'll be prepared. You can have a profitable, exciting future as an expert



who can handle the operational, programming and technical aspects of all kinds of microcomputers and microprocessors.

LEARN IN YOUR SPARE TIME.

NRI trains you in your own home, at your convenience...no classroom schedules to meet, no need to quit your job. As a class of one with complete course materials and the backing of a staff of professional electronics instructors, you'll get extraordinary hands-on training on the latest, most popular microcomputer: the new TRS-80™ Model 4 with Disk Drive. Designed to perform diverse personal and business functions and accept more software, the TRS-80 is yours to keep.

LEARN HOW TO USE, PROGRAM AND SERVICE STATE-OF-THE-ART MICROCOMPUTERS.

Through your carefully designed NRI course, you'll get a wealth of practical experience. You'll build circuits...from the simplest to the most advanced...with your NRI Discovery Lab.® You'll use a professional 4-function LCD digital multimeter for analysis and troubleshooting.

With NRI training you'll explore your computer's registers, memory and input-output ports. You'll even write programs to control the circuits you've designed and built. You'll perform hundreds of challenging experiments, always backed by a full-time faculty ready to help you personally.

When your NRI training is complete, you'll be a computer technician, ready for your first job — servicing, testing or programming all types of microcomputers — in a rewarding and challenging new career.

THE CATALOG IS FREE, THE TRAINING IS PRICELESS.

Send the postpaid card today for your FREE 104-page catalog.

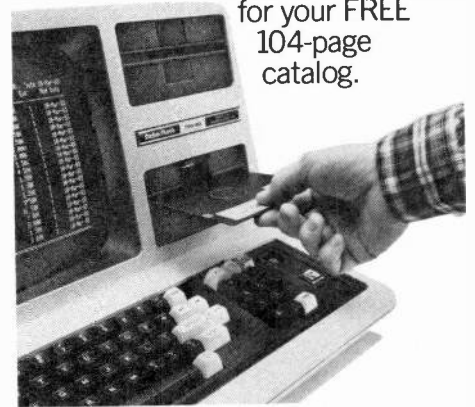

For greater computer memory capacity, a double density disk drive is included.

It's a valuable guide to opportunities and training in the high-tech revolution. You'll see how easily you become part of the growing high-tech world of microcomputers.

If the card has been removed, please write to us today.



NRI School of Electronics
McGraw-Hill Continuing
Education Center
330 Progress Avenue
Scarborough, Ontario M1P 2Z5
or telephone 416-293-1911

We'll give you tomorrow.



Your NRI course will include the new TRS-80 Model 4 with Disk Drive or the TRS-80 Color Computer with NRI Computer Access Card...plus a professional LCD multimeter, NRI Discovery Lab and hundreds of demonstrations and experiments. It's all yours to keep.

TRS-80 is a trademark of the Radio Shack division of Tandy Corp.

Here's a nifty little circuit that should be of universal applicability, wherever there are lightbulbs that get switched on and off a fair amount.
Circuit by Kevin Jones.

INCANDESCENT LAMPS almost invariably 'blow' when they are first switched on. The reason for this is that the cold resistance of the filament is much lower than the hot resistance, with the result that a very large current can flow at switch on while the filament is heating up.

Filaments are, obviously, designed to withstand this surge, otherwise incandescent lights would not exist. However, part of the art of the manufacturer is not to 'over-engineer' a project (or, to the cynical, not to make products that last too long). This means that the average domestic light bulb can stand this sort of treatment for only so long before succumbing.

There is a way of reducing the stress on the filament, however, and this is by implementing zero-crossing switching. In this, the initial current into the filament is allowed to flow only when the instantaneous voltage of the AC mains is well away from the peak voltage. In the circuit given here, the maximum voltage at turn-on will be 40 volts.

Looking at Fig. 1, we can see the effects of this. In the worst case, the light switch might close at or just before point B or B', with the result that the filament will have 40 volts applied to it immediately, and the voltage will then rise steadily to the peak voltage of 70 volts; this worstcase example is rather better than the normal possible worst case of the filament having 170 volts applied to it when it is cold.

However, most of the time, the switch-on will occur somewhere between B and A' or B' and A, with the result that no current will flow until A' or A. The lamp will then be subject to an extra warm-up period of A' to X' or A to X before commencing the first full half-cycle at zero volts.

Construction and Testing

Firstly, and most importantly, we must point out that this circuit deals with mains voltages and should be treated with all due respect — we want to keep our readers. In particular, it should either be mounted in a plastic box using nylon screws or in an grounded metal box. The terminals specified are not designed to take a mechanical pull from the leads, so you must arrange for the cable or flex connecting to the unit to be firmly anchored by some other means.

With regard to assembling the PCB itself, note that the centre leads of the SCRs should be cut; the metal tab should be secured to the PCB using a metal screw to complete the circuit, as the tabs are joined to the SCR anodes. If you use alternative SCRs to the type specified, check the pin-out.

If you want to check the action of the lightsaver, then you can use the circuit shown in Fig. 4, in which a dimmer is used to pick out those sections of the waveform in which the Lightsaver should be operating. The bulb attached to the Lightsaver should be on for very low and very high settings of the dimmer and should have approximately the same brightness as the other bulb (if the two wattages are the same).

Some flickering in the transition regions between on and off as the dimmer is varied is normal, and is due to (inevitable) discrepancies in the turn-on point for the two polarities of the mains waveform. With some dimmers the bulb controlled by the Lightsaver may not come on for one of either the low or high settings (possibly even both), and this will probably be due to a rather limited range of phase-angle being available from the dimmer.

continued on page 67

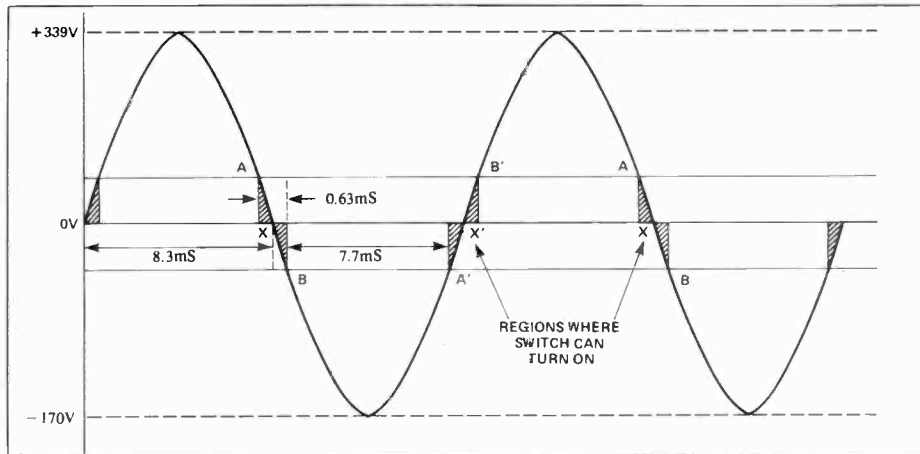

Fig. 1 Switching waveforms for 'zero crossing' switching.

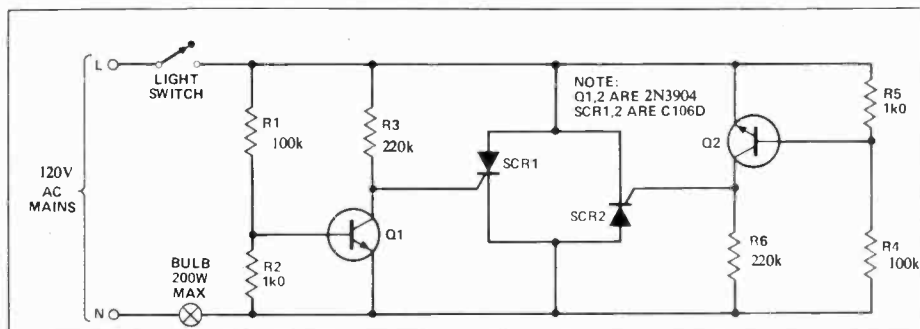
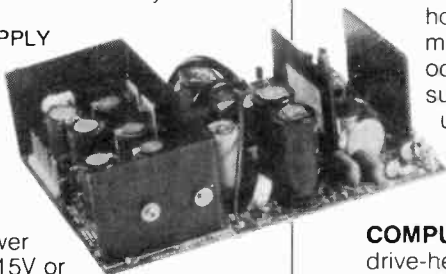

Fig. 2 Circuit diagram of the Lightsaver.

One-Stop Electronics Shopping

First-time shoppers at Arkon are often amazed at the sheer volume of items and services we offer. We can provide the best in price, quality and selection to the professional and hobbyist alike.

POWER SUPPLY SPECIAL
\$59.95



SIERRACIN

Switching power supply with 115V or 230V input and taps at 0V, -5V @ 5A, +5 @ 4A, ±12V @ 5V, and +15V @ 1A. Threaded standoffs make for easy mounting in one of our many Hammond cases.

A FULL SELECTION OF COMPONENTS is one of the things we're noted for. Semiconductors, (TTL, CMOS, Linear, CPU, memory, transistors, rectifiers, SCRs, triacs), capacitors, (tantalum, film, electrolytic, ceramic), connectors, (telephone, audio, video, RF, edge, ribbon, etc.), potentiometers, trimmers, fixed resistors, cases, surplus parts. Everything you need for your project including tools, manuals and test equipment.

CUSTOM CABLES

are available from our in-house factory. You can now make full use of those oddball peripherals you got such a great deal on. If you're unsure of which pin goes where, we also have the manuals and expertise to help you out.

COMPUTER CORNER - We have drive-head cleaning kits, power supplies, ribbons, and drafting aids for designing PCBs. Also the best selection of software, books, and magazines around. Various computers on sale too.

KITS

CODE OSCILLATOR	\$2.00
LED BLINKER	2.00
FM WIRELESS TRANSMITTER	3.00
VIDEO MODULATOR	3.00
SIREN	3.50
UNIVERSAL TIMER	3.00
UNPOPULATED BOARDS	
COLOUR ORGAN	1.50
SHUTTER TIMER	2.00
300 WATT AMPLIFIER	3.50
CASSETTE INTERFACE	2.00
GUITAR EFFECTS	1.00
STROBE	1.00
GRAPHIC EQUALIZER	2.00
DIGITAL THERMOMETER	2.00

MAIL ORDERING is encouraged. Call or write for our catalogue (indicate your interests). Computer shopping is also available through Networks Canada (416) 593-7460. VISA, Mastercharge, and American Express are welcome. Call the store at (416) 593-9653, or write to Arkon Electronics, 409 Queen Street West, Toronto, Ontario, M5V 2A5.

arkon

ARKON ELECTRONICS LTD. 409 QUEEN ST. W. TORONTO, ONTARIO

computing today



A joystick-operated 'sprite' editor for the Commodore 64

THE UNIQUE FEATURE about this sprite editor is that it uses the joystick to do everything: save, load, change colour etc. When you run the program you will see a large grid on the left and several small grids on the right of the screen with the cursor in the large grid. You move the cursor by moving the joystick.

When you have located the point where you want to begin the graphic, be it a space ship or cartoon character, then press the fire button. If there is no dot, pressing the button puts one there. If there is one, then pressing the button removes it.

The boxes on the right hand side of the screen comprise the control section. Placing the cursor in any of these boxes followed by a press of the button does various jobs.

They are:

- The top box is for identifying page number (you can save several sprites on different pages and recall them at will). You can change the page number by placing the cursor in the top box. To get there you have to move the cursor out of the sprite editor grid through the gap in its right hand wall.
- To select a page number push the joystick left or right and the page is displayed in the box. When the desired page has been reached press the button again.
- The second box is for selecting high resolution and multicolour: When the button is pressed while the cursor is in this box it will toggle (switch) the sprite between high-res and multicolour.
- The third to sixth boxes are for colour selection: Pressing the fire button while the cursor is in these boxes will

Here is a sprite editor for the Commodore 64 that simplifies the otherwise laborious job of designing animated characters or graphics for games.

by Mark Lingane

change the colours. If the sprite is in multicolour mode then the colour one will change. The same happens for the next two boxes. The sixth box is the screen colour, it operates as all the other do.

- The seventh box: X expand, Y expand, Save sprites, Load sprites: Pressing the button while on the Z to expand or contract. The Y has the same function but expands and contracts on the Y axis.

Saving and loading are also achieved by joystick control. Move the cursor to either S or L (Save or Load) and then simply press the button.

Pressing the button on either of these letters (S or L) will cause the cursor to jump to the line of characters on the bottom line. The computer will ask a few questions which you answer by moving the cursor along the line and pressing the button on the chosen characters.

If you make a mistake, cursor along to the second last character (the back arrow) and press the button. When the input is complete cursor along to the last character on the end (the reverse M) and press the button. You will know it is right

because it will say "loading sprites" or "saving sprites".

- The bottom box: Clear, Reverse, Quit: pressing the button on C will cause the sprite grid you are working on to be erased. Reverse will cause the sprite grid to be reversed. Q will quit the programme.



That's all there is to it! It is a lot harder to explain than actually do.

This program saves hours of work once you can get the hang of using the joystick — and it's cheaper than a light pen!

continued on page 65

Perseverance Pays Off

But we persevered. When phase shifting didn't bring the desired result, it was suggested that perhaps some reflecting object — other than the second tower — might be adding a third signal to the array and producing the blip in the area where the null was supposed to be. The seriousness of the situation led to a prankster offering some comic relief. Posted in the transmitter house one morning was the following sign: "All metal-band wristwatch straps and clothes that have hung on metal coat hangers must be removed because they are re-radiating the signal and causing the blip."

The reflecting-object theory was examined thoroughly; we even had the telegraph company temporarily remove copper wires which traversed the tower array directly behind the east tower. This however, did not remove the distortion in the pattern, and the search continued.

The approach of milder weather caused spirits to lighten somewhat and a final all-out effort was mounted to solve the riddle.

"Setting up a directional installation sometimes proves a greater problem than obtaining permission to operate the station."

A complete re-examination of all past investigations and experiments was made, and one fact became apparent. The transmission line path to the west tower was determined with a magnetic compass, and the figures carefully recorded and compared with our previous findings relative to the position of the blip. Knowing that the type of transmission line used was an "open-wire" system, as opposed to a closed gas-filled shielded co-axial line, we concluded that a standing wave existed on this line which, re-radiating, could be causing the distortion in the null.

Armed with this possibility, we investigated the tuning and phasing units in the west tower more closely. The search disclosed an inductance that was not properly shielded. When on directional transmission, it contributed a mismatch in the line, inadvertently creating a standing wave. This, of course, did not occur when only the west tower was used in an omni-directional mode during the daytime.

Standing Wave Remedy

The problem was remedied by shorting the coil out automatically by a relay. The parasitic inductance effect of this coil, which detuned the circuit and caused the line mismatch, was thus corrected, leaving the line properly loaded and eliminating any chance of a standing wave.

Our efforts were rewarded at last. Another run through the null area proved that the troublesome blip had been eliminated, and another radio station made it to the air waves.

ETI

UNLEASH THE POWER OF ATOM

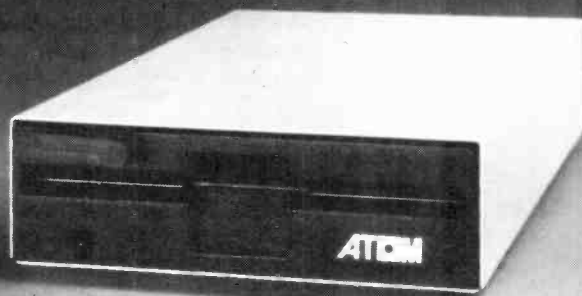

ATOM Model: AT-1 Disk Drive

MORE THAN JUST ANOTHER APPLE® COMPATIBLE DISK DRIVE

HIGH PERFORMANCE FEATURES

- High precision Ball Bearing Head Carriage, almost **NO NOISE**;
- **DIRECT DRIVE** Brushless Spindle Motor;
- 163 K Bytes, 40 Track capability;
- Half Track Capability;
- Fast Access Time (6ms track to track);
- Enhanced Read/Write Circuitry;
- Simplified High Technology Board for Lower MTBF
- **One Year Labour & Parts Warranty**

**THE ATOM AT-1 WILL READ MANY
MARGINAL DISKETTES OTHER
DISK DRIVES CANNOT ACCESS ...**

APPLE is a Registered Trade Mark of
Apple Computer Inc.
ATOM is a Trade Mark of Budgetron Inc.

We are signing up Dealers across
Canada. Call us now for
FREE DEALER DISK DRIVE PROGRAM
(Offer expires May 31, 1984)

ATOM

is a Trademark of

Budgetron Inc.

1601 Matheson Blvd., Unit 3
Mississauga, Ontario, Canada L4W 1H9
Tel.: (416) 624-7323 Telex: 06-960172 Budgetron MSGA

Mini Drum Synth



Why beat around the bush when you could be beating upon our latest up-beat offering? Design by A.G. Atkins; development by Phil Walker.

modulation envelopes. With SW1 open, the pitch remains constant throughout the drum beat, while with SW1 closed, the pitch falls sharply as the beat decays. With short decay times this latter effect produces a very natural sound, while with longer decay times the sound becomes less drum-like but if anything more interesting, opening up lots of possibilities for off-beat effects.

Construction

Construction is pretty straightforward since everything except the potentiometers, the switch, the input sensor, the battery, and the output connector is mounted on the PCB. The IC can, if desired, be fitted into a socket, but however you do it make sure it's the right way round. The same goes for the electrolytic capacitors (C1, 2, 3, and 6) the two diodes, and of course all the transistors. No case has been described since there are no real layout problems and almost anything you can come up with should be suitable. One possibility, however, is to mount all the bits in a drum-shaped container with the sensor held against the underside of the upper surface. The instrument can then be 'played' by tapping on this surface with a pencil, or your fingers, or even a drum-stick! If preferred, the electronics can be mounted in a more conventional case and the sensor connected via a suitable length of wire. Ordinary twisted flex should be fine; since the sensor has a very low impedance there should be no problems with noise

SINCE COMMERCIAL drum machines first appeared in the late '70s there have been numerous designs published for the home constructor. Some of them were very good, some were not too bad, and some appeared in magazines other than ETI, but almost without exception they were comparatively complex and cost quite a lot to build. Whilst the little unit described here cannot claim as many facilities as some of its illustrious forebears, it does offer good performance at a very low price, and it is very easy to build.

The circuit is that of a manually operated, single channel drum synthesiser. The input sensor consists of a small loudspeaker operating as a microphone, the circuit being arranged so that a light tap on the loudspeaker will cause the synthesiser to produce a drum beat. The circuit includes controls for the adjustment of pitch, decay time and output level and features two basic pitch

PARTS LIST

RESISTORS (all 1/4W, 5%)

R1, 9, 10	47k
R2	4k7
R3	3k9
R4	120R
R5	2k2
R6	38k
R7	270R
R8, 11	100k
RV1	2M2 linear
RV2	47k log
RV3	220k linear

CAPACITORS (10v working min)

C1, 3	10u electrolytic
C2	100u electrolytic
C4	220n polyester
C5	100n polyester
C6	1000u electrolytic

SEMICONDUCTORS

IC1	555
Q1, 3, 5	2N3904
Q2, 4	2N3905
D1, 2	1N4148

MISCELLANEOUS

SW1 single pole switch PCB; 9V battery; small loudspeaker of between 8 and 80 ohms; battery connector; output connector; case; on-off switch, IC socket, knobs, etc. as desired.

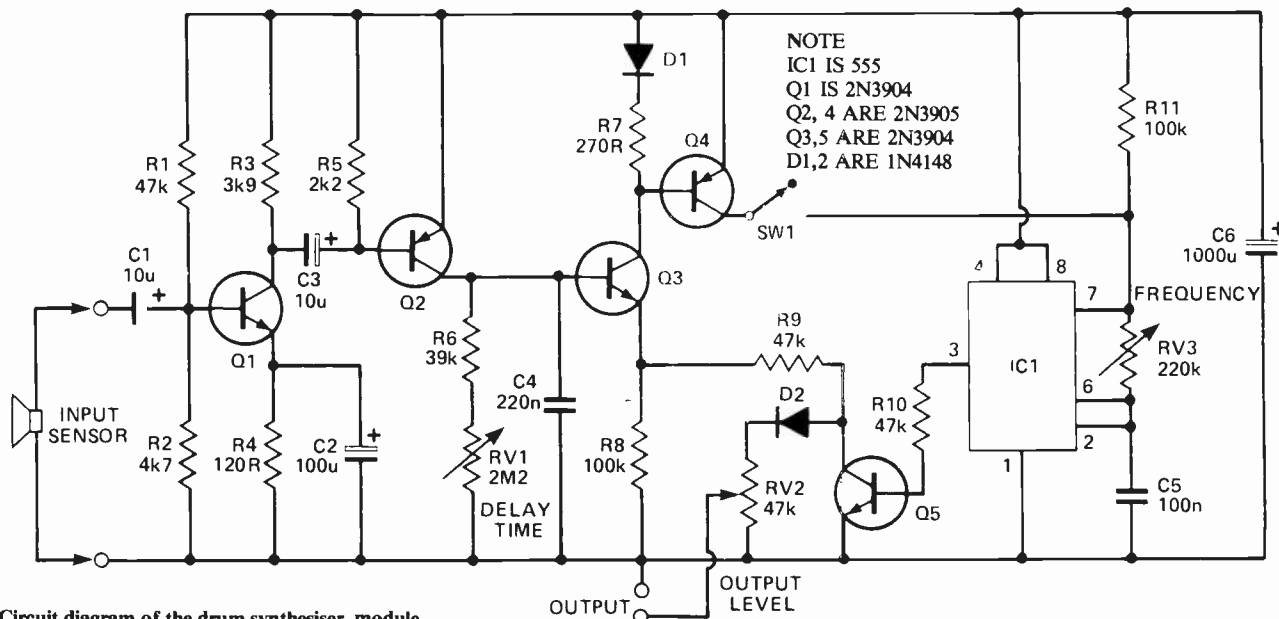

Fig. 1 Circuit diagram of the drum synthesiser module.

pick-up. SW1 can be any single pole switch, and if the battery is to be permanently installed in the case you may wish to include an on-off switch.

Going Modular

For the ambitious constructor, this simple circuit offers plenty of scope for development. Several units could be built and set to produce different sounds, allowing a comprehensive mini drum kit to be built up. Taking the idea a stage further, some of our more experienced readers might feel able and inclined to produce a multichannel drum synthesiser to their own requirements. By dispensing with the input sensor and modifying the input amplifier, the circuit could be adapted to trigger from logic pulses, whereupon any number of units might be controlled from a fairly simple digital timing circuit. From there on, the sky's the limit.

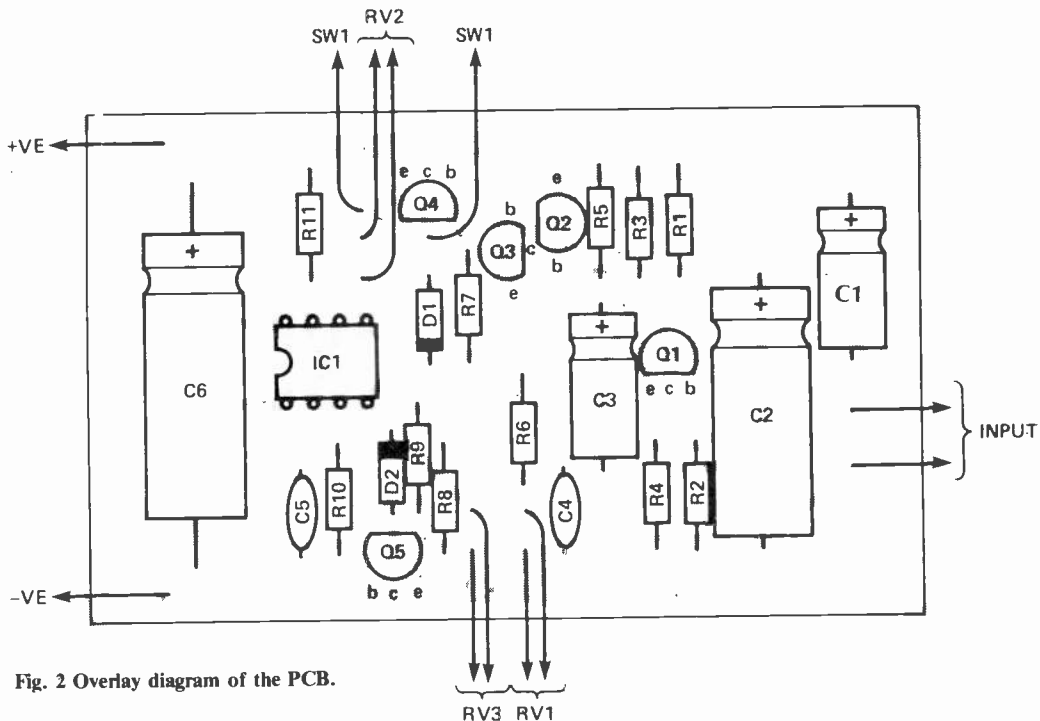
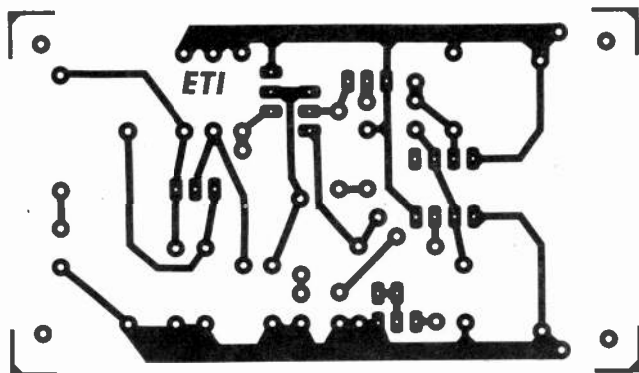

Fig. 2 Overlay diagram of the PCB.

ETI



HOW IT WORKS

The input sensor can be almost any small loudspeaker. Its output is fed to the amplifier formed by Q1 and its associated components. The amplified signal is converted into pulses by Q2 which then charge up C4. This charge leaks away via R6 and RV1, the latter setting the decay time. Q3 acts as a buffer, passing the voltage on C4 to Q5 via R9. IC1, the 555 timer is connected to form a free-running oscillator whose frequency is controlled by RV3. The oscillator output is fed via R10 to the base of Q5. Q5 acts as a crude modulator, the output from its collector taking the form of a series of pulses whose amplitude is determined by the voltage on C4. These pulses are then fed to the output via D2 and RV2.

If SW1 is closed, current flows from the collector of Q4 into the oscillator circuit. The magnitude of this current is roughly proportional to the voltage on C4, and causes the oscillator frequency to increase as C4's voltage increases and to decrease when it falls. Thus, as the charge on C4 leaks away after each trigger pulse, the oscillator frequency will drop from its initial value.

BRUNELLE presents THE Commander SERIES Model 4060 Digital

ALL THAT THE NAME IMPLIES

The Multimeter you've been waiting for...
at the price you've been hoping for!

\$99.00

- Handheld 7-function, 35 ranges with 200 uA AC and DC. Hi-low ohms diode check.
- Built-in transistor test function.
- Overload protection. 2 amp fuse protects all meter ranges.
- Safety designed input jacks and test leads, tilt stand for bench use. Easy external battery access.
- Calibration certificate traceable to NRC supplied with meter.
- 1 year parts/labor guarantee.

SEE IT, TEST IT, COMPARE IT!

**BRUNELLE
INSTRUMENTS INC.**

826 Belvedere St., Sherbrooke,
Quebec. J1H 4B8
1-819-569-1335 Telex 05-836266

Mail Orders accepted: Send certified cheque
or money order. Quebec residents add
9% P.S.T. add \$3.00 for shipping.

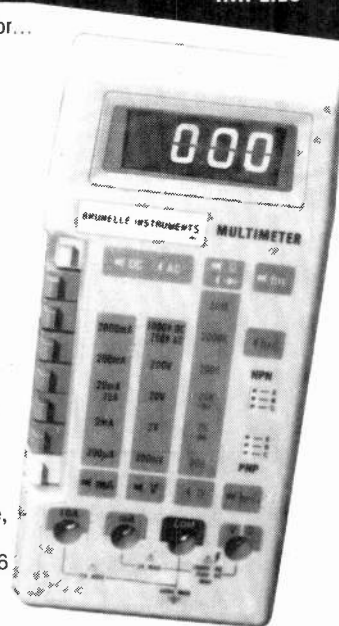

Circle No. 17 on Reader Service Card.

THERE ARE essentially three types of radioactive wastes: high level, transuranic and low level. Transuranic wastes (TRU) are those containing isotopes above uranium in the periodic table of chemical elements. They are the by-products of fuel assembly and weapons fabrication and of reprocessing operations. Customarily, while their radioactivity is greater than 10 nanocuries per gram (1 nanocurie = 37 disintegrations/second), they give off very little heat. As such, they can customarily be handled by ordinary methods not requiring remote control. For many years they were disposed by burying in shallow trenches, but since 1970 have been placed in retrievable storage. Low level wastes (LLW) contain relatively little radioactivity and require little or no shielding. These wastes customarily come from medical applications, university laboratories and such mundane items as household smoke detectors which use the heavy artificial isotope americium-241 (half life: 432 years).

High level wastes are those resulting from the reprocessing of spent fuel from a reactor, either defense or commercial. Within a year or so of removal of spent fuel from a reactor, most of the short lived isotopes have decayed away, the cesium-137 and strontium-90 that remain providing most of the heat and radiation of the wastes. At the beginning of 1982 there were about 9,000 tons of spent fuel assemblies from commercial nuclear power plants in temporary storage. These spent fuel assemblies occupy 104,000 cubic feet of space — about the equivalent of one football field covered two feet deep. Each nuclear power generating plant generating a million kilowatts of electricity produces about 33 tons (390 cubic feet) of spent fuel assemblies each year. By the year 2000, the accumulation of spent fuel from commercial nuclear power reactors is projected to total about 950,000 cubic feet.

The spent fuel taken from a reactor after it has operated for a year is highly radioactive, with a surface radiation dosage in the millions of rems per hour (400 rem/hour being lethal to a human being). Most of the heat and radiation decays away after about five years of storage, but spent fuel remains potentially dangerous for much longer periods of time. This danger exists because exposure to even low levels of radiation over sufficiently long periods of time could cause harmful health effects. Also, some of the waste products could be chemically poisonous if ingested. However, spent fuel is not explosive from either a chemical or nuclear standpoint.

Customarily, the spent fuel rods are stored in facilities at the reactor sites in pools flooded to a depth of thirteen feet with ion-free water. The water provides a medium for dissipating the heat generated by the spent fuel rods, with its depth designed to prevent contamination to reactor workers.

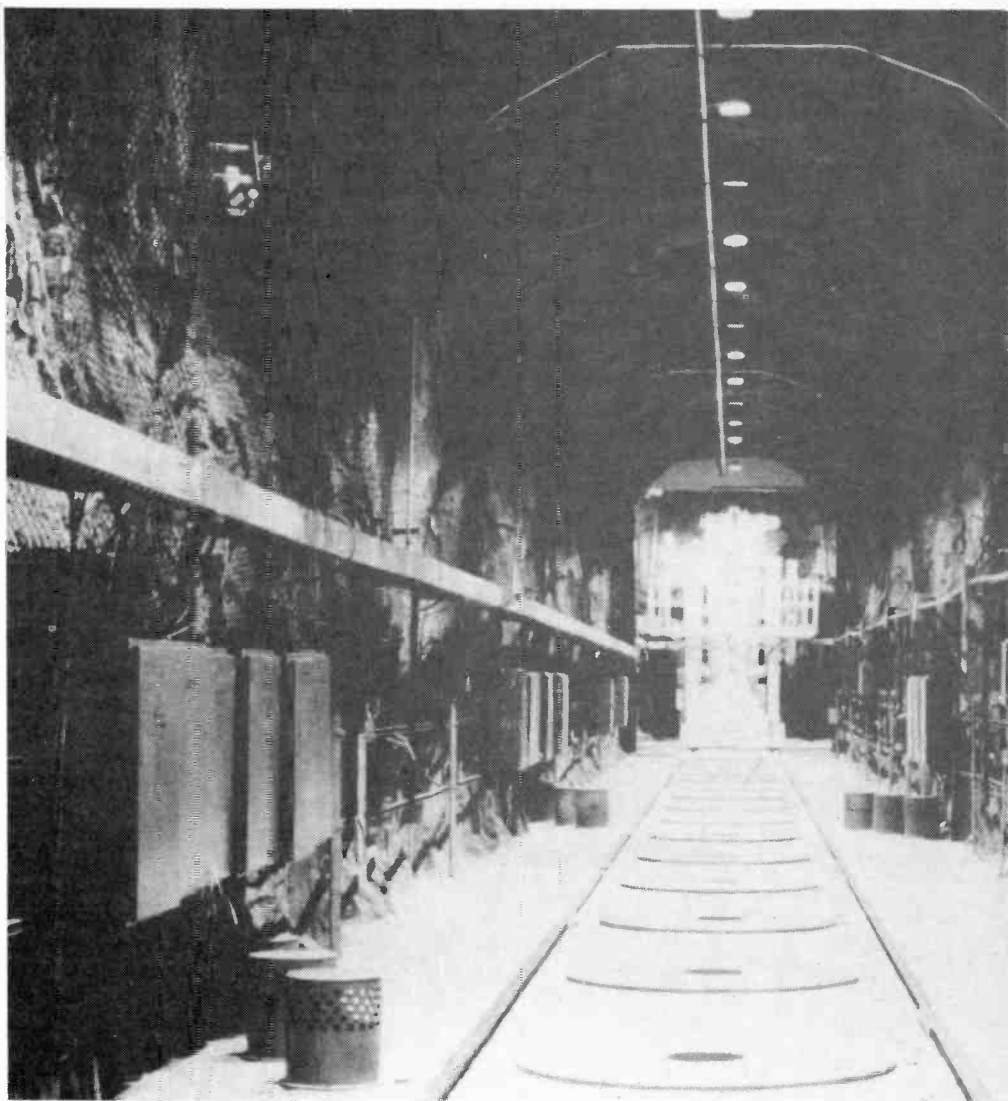

Actual spent fuel assemblies have been placed 1400 feet below the surface at the Nevada test site to evaluate granite's response to heat and radiation (All illustrations, courtesy of U.S. Department of Energy).

Nuclear Wastes

Roger Allan finds some hot things in the nation's garbage can

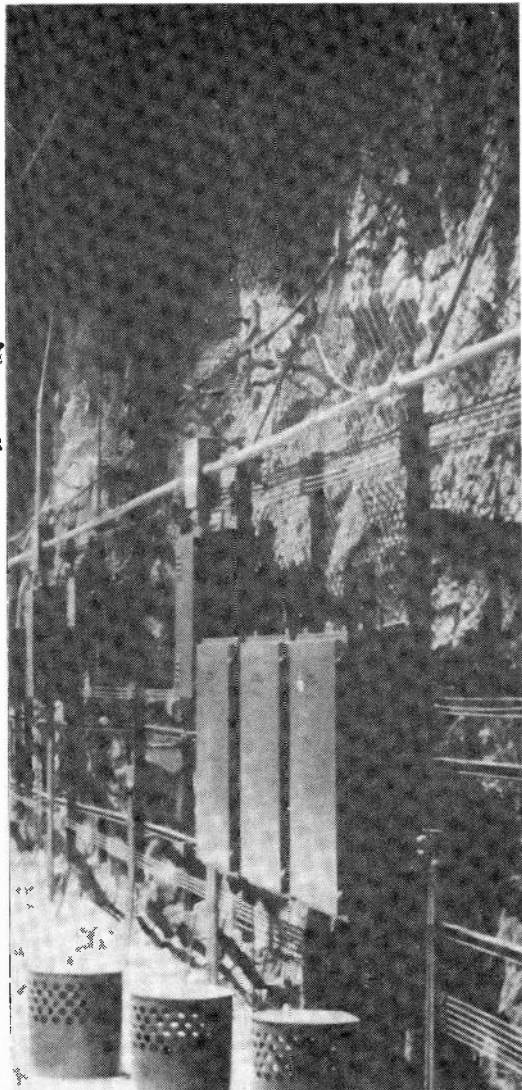

The difficulty with all this is the amount of spent fuel produced (number of bundles), the half-life of the isotopes, and the lack of a permanent storage program. All the designers of reactors built in the late 50s, 60s and early 70s expected that the water pool storage facilities to be built on site would only be a temporary stop-gap measure, pending the construction of a permanent long term storage or reprocessing facility. And in fact, a facility, the Barnwell Nuclear Fuels Plant, was constructed in South Carolina for this purpose. However, for political and economic reasons, the Carter Administration in 1976 closed the facility, believing that in so doing it might urge other countries to do likewise, thereby decreasing the world's production of military grade plutonium, a by-product of the process.

As such, the nuclear power facilities were caught in a bind; they were producing spent fuel rods at the rate of 60-180 per reactor per year (depending on the design), and when it is remembered that the US and Canada combined have 82 operating reactors, with another 104 either on order or

under construction, they rapidly started to run out of space to put them. Their first attempt at dealing with this problem was to decrease the distance between spent fuel rods in the retaining pools from 20 inches to 12 inches. While this increased the number of rods that could be held by a pool, it also increased the amount of heat generated, reaching the design maximums for the pools, a bit like putting a quart in a pint pot. The second method of dealing with the rods was to ship them to the retaining pools of nuclear facilities still under construction, in the hopes that by the time the facility was finished someone would come up with a better idea. Needless to say, a process for the long term (centuries, 500-1000 years minimum) storage, isolation or disposal of HLW was increasingly become a matter of concern, and while it would be wrong to suggest that the nuclear industry is currently choking on its own waste products, the time is drawing nearer when such a reality will occur.

There are, broadly speaking, three ways that HLW can be dealt with: holding them for decay, diluting and dispersing them, or concentrating and containing them. Holding them for decay is relatively simple: one merely shrouds the material with adequate protective layers, sits back and waits. It is fine for such things as iodine-131 which has a half-life of 8 days, after which the radioactive components have reduced to the level where one can virtually flush it down the toilet without there being any danger to the public or the environment. An example of diluting is the controlled release of krypton-85 gas into the atmosphere, it being a side product of the chemical processing of spent fuel. The gas has practically no chemical or biological action, and the volume of the atmosphere is so huge that the krypton concentration rapidly falls to unreadably low levels.

But neither of these methods are useful for those high-level wastes which are solid or liquid and toxic for long periods of time such as tritium (half life: 12.3 years), carbon-14 (half life 5730 years), plutonium-239 (half life: 24,131 years), or the two big ones in volume, strontium-90 (half life 28.8 years) and cesium-137 (half life: 30.2 years). These two dominate the radioactive components of spent fuels for the better part of a millenia. Customarily, protection from them is considered to require a time span of at least 500 years, preferably 1000 years.

The first question that must be addressed in dealing with this matter is whether these types of high-level wastes should be either stored or disposed. Arguments in favour of storage are that handling is safer after decay has taken place, that further research and development may lead to better ways of getting rid of these wastes, and that some new important use for the radioisotopes may be found by future generations. An argument against storage is that there

may be an accidental release of radioactivity, contaminating the biosphere. Arguments in support of disposal (that is, the final action, with no intent to recover or transfer the material at a later date) are invariably based on the idea that disposal is final and requires no further action. Arguments against disposal are predicated on the question of whether or not the disposal process is safe. Over the years, a number of proposals have been forthcoming, with one, deep bed incarceration, seemingly becoming the only truly viable alternative, and the subject of much research in Canada and the United States.

Basic Methods

An overview of some of the methods: The first is underground storage in tanks. This is useful if the wastes (particularly defense wastes dating back to the primitive methods employed during the Manhattan Project) are liquid or sludge. There are a number of such facilities scattered around North America. While the original tanks developed leaks, contaminating the surrounding area, modern tanks are made of steel and sit inside metal lined concrete boxes that have a monitored and filtered air flow through them. Cooling water passes through coils in the tank to prevent boiling, and a condenser returns water evaporated from the wastes. Measuring devices include liquid level gauges, thermocouples for sensing temperature, and detectors for determining radioactivity in the air. The main advantage of such a system is that with careful attention leaks can be detected and fixed. The main disadvantage is that the instrumentation must be extremely accurate, the cost of maintaining the facility over hundreds of years is prohibitive, and in the event of an earthquake the tanks would rupture. It is considered "long term" temporary storage, i.e. storage for decades until something better becomes available.

A second approach is surface storage, of which there are three types. The first is water bed storage, used by nuclear power facilities as outlined above. The second is an air cooled vault placed just below the ground. Air is forced through the spaces in the concrete and cools the containers of solidified waste. The third type consists of an above-ground silo, with air flowing by natural convection up through the space between the container and a concrete biological shield. Canada uses the first method for spent fuel rods from power reactors, and the third method for more dangerous radioactive wastes. The advantages of these systems is that they are retrievable and relatively easily monitored. Their disadvantage is that they are prone to human and mechanical error, and are very expensive to maintain. All three methods are considered to be "long term" temporary storage.

A third generic approach involves seabed disposal, and consists of dumping

wastes into the ocean either as a liquid or contained in concrete canisters. While it has been used from time to time over the years, particularly for the disposing of liquids, it currently is considered non-viable for environmental reasons. This system is predicated on the belief that the vast volume of water in the oceans will dilute the toxic radioactive particles to below dangerous levels. There are two adjunctive seabed disposal methods. The first consists of drilling large holes in areas that are free from water currents and seismic disturbances. Into these holes a machine would place canisters of wastes followed by plugs of inert materials. In a variation of this idea, canisters mounted with fins (a bit like bombs) would be dropped into areas that had deep beds of sedimentary material. The canister would "plow" into the sediment and be buried. While there are still partisans of this approach, it is now customarily considered to be a last ditch method due to the inability of locating the canisters, and the lack of knowledge as to how the radioactive material would flow through sediment if one of the canisters fractured. However, research continues in this vein, research in which Canada takes part.

Fractionation, while not in itself a method of disposal, is a way in which the volume of material can be reduced. Essen-

tially, spent fuel is reprocessed, and most of the uranium and plutonium removed for further use. Further, the other fission products, such as strontium-90 and cesium-137, can be removed. The net effect is to reduce the volume of fission products by some 90%. While the remaining 10% is very highly radioactive, composed of products with very long half-lives, it helps in that one doesn't have as much of it to deal with.

Transmutation is an esoteric process, akin to the medieval alchemist's desire to change one substance into another, preferably gold, albeit brought up to date. It is now theoretically possible through neutron bombardment, but at a prohibitive cost. As applied to nuclear wastes, transmutation would involve irradiation of wastes by neutrons as in a fission reactor or in some future fusion reactor. The neutrons are absorbed to produce new isotopes that may have very short half-lives or be stable. The process thus supplements natural radioactive decay as a way to eliminate the isotope by shortening its half life. Although studies show that transmutation is feasible, it seems to be a more expensive choice than any of the others. If fission reactors are used to produce neutrons to transmute wastes, new wastes would be continually generated, analogous to a puppy chasing its own tail. It might be better to use charged particle bom-

bardment as in high-energy particle accelerators. Also, fusion reactors, possibly available in the next century, might supply enough neutrons to transmute wastes. However, for the time being, it has no practical advantage.

Another somewhat off the wall disposal method involves ice-sheets. It is based on the belief that the further away from habitation such toxic radioactive wastes are placed the better, analogous to the old adage of "out of sight, out of mind". There are three versions of ice-sheet disposal. The first would be to place waste-filled containers on racks sitting on the top of the ice itself. A second would fix the canisters in the ice, suspended by cables, with markers to show the waste location. The third, and oddest, proposal involves the canisters melting their own way down through the ice-sheet by the heat produced by the wastes themselves, eventually settling on the bedrock. Water would freeze above them, forming a plug. There are many reasons why these methods are not being actively investigated. The only place for them to occur would be in the Antarctic (the Arctic is floating); there are international legal problems as to who owns the Antarctic; there is only a short period of the year when access to the region is possible, and transportation would be difficult. Further, there is some thought that the ice

CATCH UP WITH ELECTRONICS TODAY

COMPLETE YOUR COLLECTION OF ELECTRONICS TODAY NOW. FILL OUT THE HANDY COUPON AND MAIL WITH YOUR PAYMENT TODAY. See order form in this issue for full complete list of available back issues.

ELECTRONICS TODAY

Back Issues

Moorshead Publications,
Suite 601, 25 Overlea Blvd.,
Toronto, Ontario M4H 1B1.

List desired issues below.

Cheque or Money Order for \$4.00 per issue. (Postage and handling included.) Payment must accompany order.

Total amount enclosed

\$ _____

Name _____

Address _____

City _____ Province _____ Postal Code _____

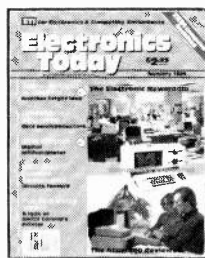

JANUARY '83



FEBRUARY '83



MARCH '83

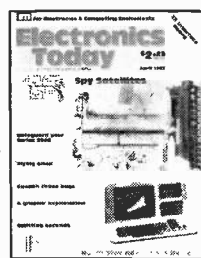

APRIL '83

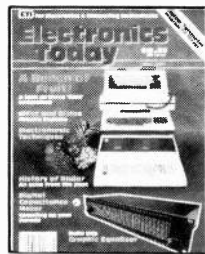

MAY '83

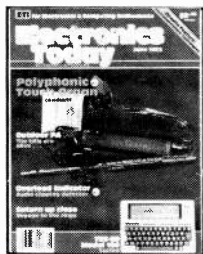

JUNE '83

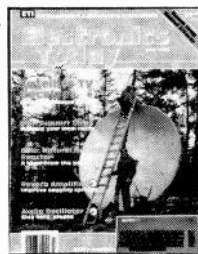

JULY '83



AUGUST '83

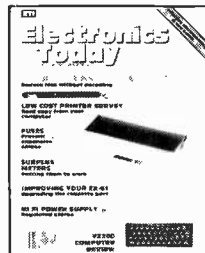

SEPTEMBER '83

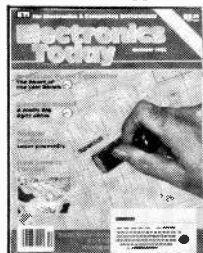

OCTOBER '83

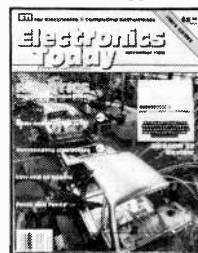

NOVEMBER '83

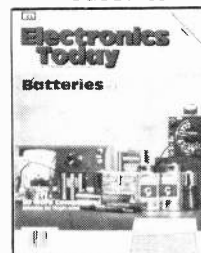

DECEMBER '83

024

IBM PERSONAL COMPUTER & XT *The Software Guide*

By Gerald VanDiver



IBM PERSONAL COMPUTER & XT: THE SOFTWARE GUIDE

By Gerald VanDiver

This unusually comprehensive guide to the IBM PC software is massive, over 1000 pages — 43mm thick! Not only is it massive, it also is very up-to-date. Software is broken down into 37 major and 150 sub-categories ranging from games to highly sophisticated business and engineering software. This is more than just a listing; not only are specifications given but a very detailed (some of them two pages long) write up. Over 3,000 products are covered in this volume. A real "bible" for the IBM PC user. \$30.95 plus \$1.00 shipping.

Available from:
Book Service
Moorshead Publications,
25 Overlea Blvd. Suite 601
Toronto, Ontario
M4H 1B1

NAME _____

ADDRESS _____

TOWN/CITY _____ PROVINCE _____

CODE _____ DATE _____

Cheque enclosed. DO NOT send cash.

Mastercard Acct. No. _____

Visa Acct. No. _____

American Express Acct. No. _____

Signature _____

Expiry Date _____

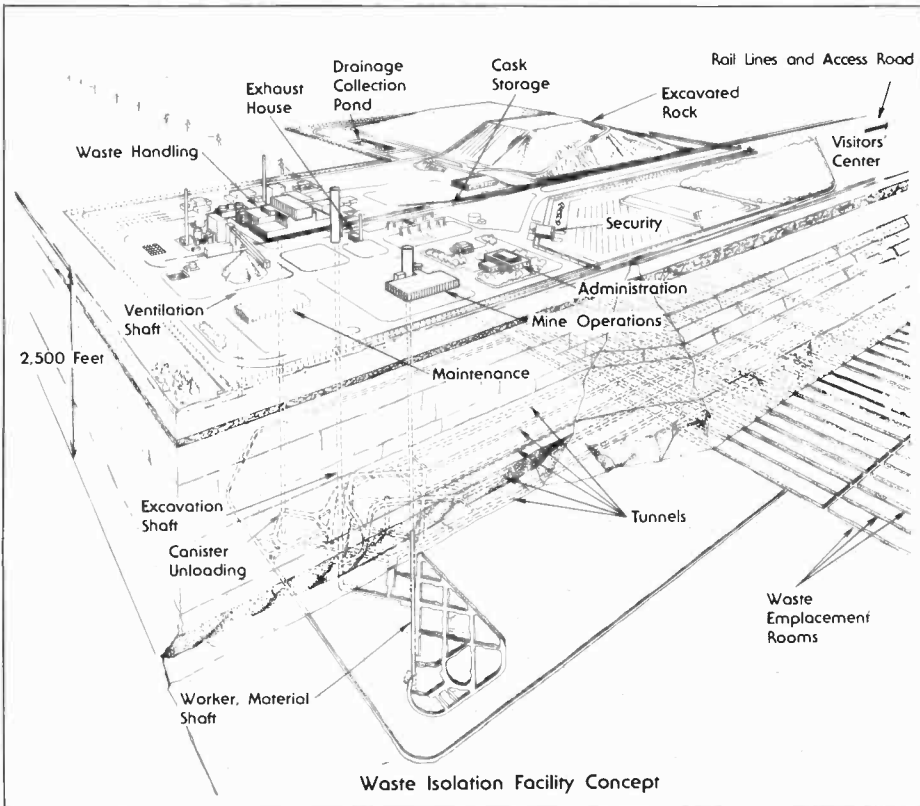

Waste Isolation Facility Concept

The storage of wastes in deep shafts would be an elaborate undertaking.

sheets and bedrock are separated by a water layer produced by the great weight of the ice-sheet itself (analogous to the water layer produced under an ice-skaters skate). As such, the canister would be exposed to water that is directly connected to the sea, and hence provides a possible means of contaminating the biosphere. While this process looks pretty on paper, no one is taking it seriously.

Another esoteric process for disposal is in space — essentially either just bunging it out of earth orbit into the black void, placing it on the moon, or putting it into orbit around the sun or even plunging it into the sun. The difficulties are tremendous. For a start, the shielding of the wastes adds a tremendous weight penalty, enormously increasing the launch costs. Further, there is the danger that a mission might have to be aborted, involving the dispersal of the wastes over the earth as the rocket disintegrated. Legally, who owns the moon? And as for plunging them into deep space, what if it should bump into another life form? The only serious studies of this method involve the space disposal of isolated special nucleotides, thereby decreasing the volume of high level toxic nuclear wastes.

Geologic Disposal

The final generic method of disposal

AUDIOVISION

COMPUTING/ELECTRONICS

MAIL ORDER: Certified cheque, money order, VISA or Master Card plus 5% delivery charge. Ontario residents add 7% P.S.T. We send Canada Post, or Purolator collect.

8502 COMPUTER SPECIAL SALE THIS MONTH ONLY!

A. 48K \$450.
B. 64K \$510.

Each Includes:

- Assembled and tested mother board (w/blank Eproms).
- Keyboard w/numeric keypad, upper and lower case.
- Plastic case.
- Heavy duty switching power supply.

C. 48K System \$948.
D. 64K System \$999.

Each system includes:

- Assembled and tested computer.
- Disk drive (Quentin).
- Disk controller card.
- Zenith 12" green monitor.

We repair 8502 boards at reasonable charges.

PERIPHERAL CARDS

- Disk Controller Card . . . \$55.00
- Z80 Card \$65.00
- 80 Column Card \$79.00
- 16K (Language) Card . . \$65.00
- EPROM Writer Card . . . \$79.00
- Wizard IPI Card \$95.00
- Parallel Card w/cable . . \$69.00
- Speech synthesis card . \$65.00

ACCESSORIES

- R.F. Modulator \$15.00
- Joystick (self centered) \$20.00
- Delux self centered joystick w/quick fire button on stick handle \$62.00
- Disk drive (Quentin) . . \$319.00
- Zenith 12" green monitor \$137.00
- Light pen system \$225.00
- Graphic tablet \$119.00
- Verbatim diskettes, S.S.D.D. (Box of 10) \$35.00
- Sentinel diskettes, S.S.D.D. (Box of 10) \$33.00
- 40-80 column switch . . \$7.50
- Printer \$CALL
- Colour monitor \$CALL

AUDIO KITS

400W Mono/260W Stereo Power Amp.

- Built-In Selectable Switch for High Power Mono Amp. or High Quality Stereo Amp. On-board Power Supply and Delay-on, speaker protector
- All Parts Including Power Trs. and Heatsinks are Mounted on-board
- Required Power Transformer 46VCT.72VCT. 5-10A #7777A Kit \$99.50 A&T \$129.50

10 BAND EQUALIZER PREAMP.

- Combination of a Stereo Preamp and A 10 Band Slide Control Graphic Equalizer in a 19" Low Profile Pre-drilled Rack Mount Cabinet with Speed Control
- Transformer, Instruction and all Electronic Parts included.
- #TA-2500 Kit \$129.50 A&T \$179.50

SOLID STATE STEREO REVERBERATION AMP.

- Adds Depth and Exciting "Hall Effect" to your system — "Bucket Brigade Device" Utilized as Delay Element
- LED Reverberation Level Display
- Triple Reverb, Control-Depth, Delay and Effect — Compatible with any Preamp and Power Amp. — Complete with all Electronic Parts, Transformer and Pre-drilled Rack Mount Cabinet.
- #TA-2400 Kit \$139.50 A&T \$189.50

LED Bar Graph or DOT Display with Response to Freq. from 30HZ — 16 KHZ

- Direct Connects to Preamp. or Power Amp.
- Output
- Left or Right Ch. Display Selection
- Input Level Control
- Complete with all Electronic Parts, Transformer and Pre-drilled Rack Mount Cabinet.
- #TA2900 Kit \$155.50 A&T \$205.50

BAR DOT AUDIO LEVEL DISPLAY

- 20 Step BAR/DOT Mode Audio Level Display
- Range from -57DB to 0 DB
- Compatible with any Power Amp.
- Ideal for Power Output Indication and adds Exciting Sight to your System
- On-board Power Supply
- Operates also on 12V DC Car Battery
- #TY-45 Kit \$42.50 A&T \$57.50

COLOUR LIGHT CONTROLLER

- Features Light Chaser and Colour Organ Functions
- Light Chaser in 3 Different Flashing Sequence with Speed Control
- 3 Channels (Treble, Midrange & Bass) Colour Organ each with individual input Level Controls
- Ideal for Disco, Amusement Park, Commercial Signs and Special Light Effect — Handles up to 1,000W Light Power
- #TY239 Kit \$79.50 A&T \$99.50

RACK MOUNT CABINETS

Black Anodized Aluminum Front Panel with Steel Box, Hardware, Ventilation Slots and Instruction.

Panel size (inch)	Box size (inch)	Price
19 x 7	17 x 6.5 x 20	67.50
19 x 6	17 x 5.5 x 14	45.50
19 x 7	17 x 6.5 x 12	43.50
19 x 6	17 x 5.5 x 12	42.50
19 x 5	17 x 4.5 x 12	39.50
19 x 4	17 x 3.5 x 12	36.50
19 x 3	17 x 2.5 x 10	33.50
19 x 2.5	17 x 2 x 10	32.50
17 x 6	15.5 x 5.5 x 9	37.50
17 x 4	15.5 x 3.5 x 9	32.50
17 x 2	15.5 x 1.5 x 9	30.50
12 x 6	11.5 x 4.5 x 7	26.50
12 x 4	11.5 x 3.5 x 7	22.50
12 x 2	11.5 x 1.75 x 7	21.50

White Audiolwords for Cabinets \$2.50

INTRODUCING

PROFESSIONAL TYPE PRO-2000 SERIES

SEMI ASSEMBLED KITS

(Very little wiring needed)

Tuner \$179.00
 Pre-Amp \$149.00
 Power Amp \$479.00

- Dynamic Bias Class A Amplifier.
- LED Display peak and average power.
- Continuous output power 100 w/ch (8 ohm).
- THD = 0.05%
- Frequency response = 10 Hz - 100 kHz -0.1 dB
- IM = 0.03%

COMPLETE PACKAGE SPECIAL \$750.00

New 1984 Catalogue \$1.00

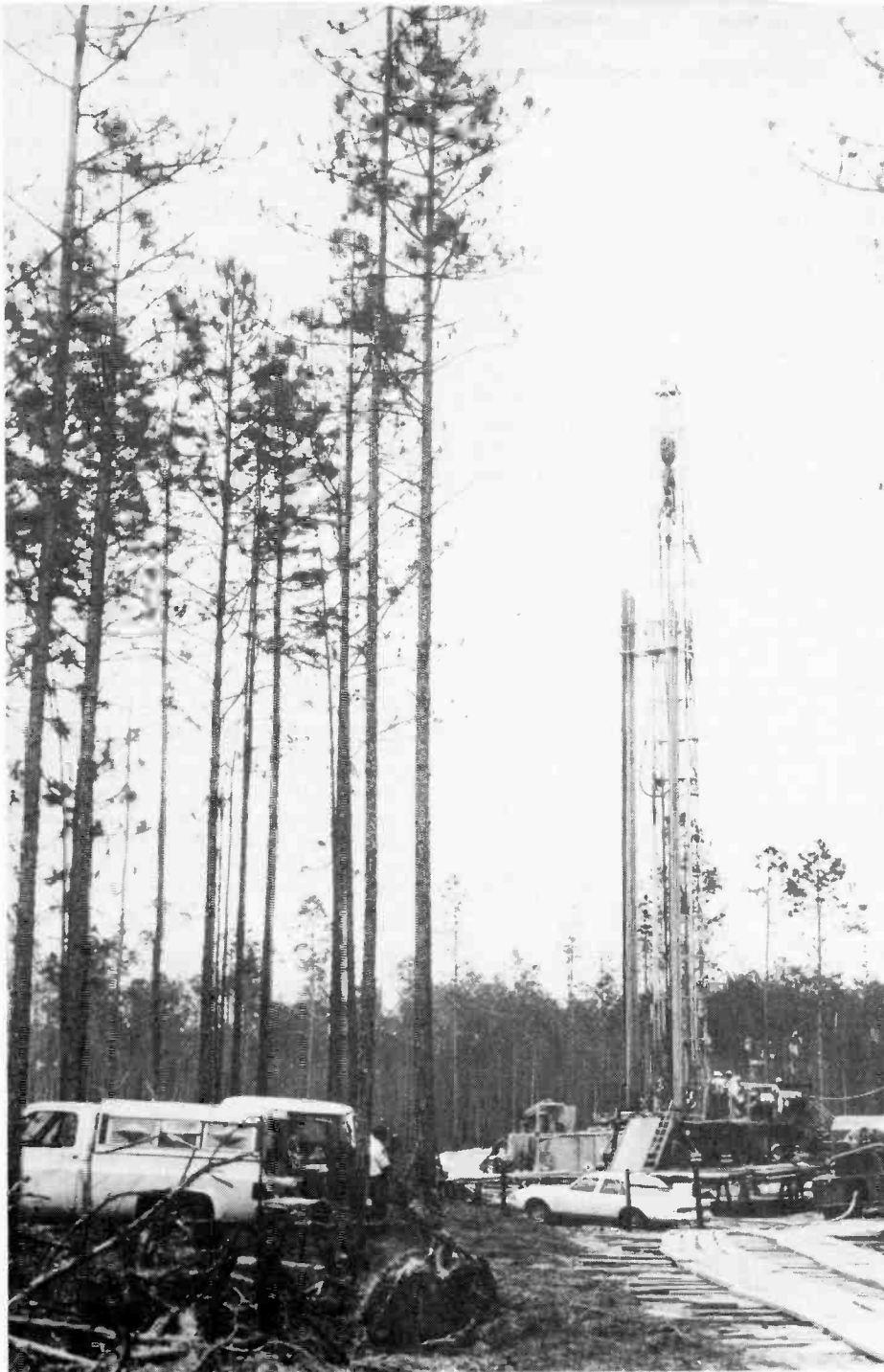

Drilling in the American south to evaluate salt domes as potential repository sites.

comes in a number of forms, under the general heading of geologic disposal. They are six in number.

Firstly, the placement of solid wastes in very deeply drilled holes, say 6 or 10 miles deep. Canisters would be lowered into the hole and stacked in a column several miles high, the hole then being plugged. Its apparent advantage is the waste's remoteness from water and the biosphere. Its advantage is that holes of that diameter have not been drilled to date to that depth, and the geology of rock at that depth is unknown.

Second is a variation of ice-sheet melting process, though in this case it involves rock melting. Solid or liquid wastes are poured down a hole, say 3000 metres deep.

The heat from the radioactive decay melts the rock, the wastes mixes with the rock and any liquid present boils away; escaped vapour is caught and treated. The mass of rock would eventually cool after about a thousand years, and the resulting rock would be resistant to further change. It is not being seriously considered.

Thirdly, there is a process which involves the pumping of liquid wastes into geologic structures causing hydrofracture along fault lines in rock such as shale, similar to the process sometimes used for getting oil out of rocks. This system has been used on occasion by both the US and USSR to dispose of liquid defense wastes. It is not considered very good as it is not

suitable for all types of wastes, as the geology of the area must be very carefully known, as the area could never be mined or drilled, and as there is always the risk that the liquids would percolate through the ground water to the surface, contaminating the biosphere.

Fourthly, double walled tunnels could be mined transversely through mountains. Remotely controlled conveyors would fill the tunnels with canisters of radioactive wastes, and remotely monitor them. An air flow through the tunnels would dissipate the heat. This method appears good for storage, but not adequate for permanent disposal due to high cost and the threats of earthquakes and landslides.

Fifthly, island isolation. No one is taking this method seriously, other than pie-in-the sky types. Essentially, it consists of finding a remote island and dumping the stuff there, posting a "Keep-Out!" sign, and sailing away.

Sixthly, and most promisingly, is the placement of waste canisters in a mined cavity, not in transverse shafts as in method four above, but in transverse drifts at depth. This method being studied by at least fifteen countries, including Canada and the United States.

The first step is the determination of which type of rock is most suitable, and have included studies of granite, crystalline rocks, volcanic rocks such as basalt and tuff, salt, shale and various types of clay. Initially, in laboratory tests over the past twenty odd years, several of the above types of rock were viewed as acceptable for geologic waste isolation. In the US, various types of salt domes (in Louisiana and Mississippi), salt beds (in Texas and Utah), basalt (in Washington) and tuff (in Nevada) have proven the most promising. In Canada, research is centring around the utilization of plutons. Plutons are large homogeneous formations of hard rock many kilometres across and found in great number throughout the Canadian Shield. They are believed to have remained essentially unchanged since the molten rock welled up through the earth's crust and solidified billions of years ago. They contain no valuable minerals, and are unlikely to be used for anything, ever.

The repository which would be built into either a pluton in Canada, or probably a salt dome in the US, would resemble a large mining complex. It would combine two types of industrial facilities — a waste handling facility at the surface and a large mine constructed 2,000 to 4,000 feet below the surface. A central area of about 400 surface acres (in the US design, not much different from the Canadian) will contain buildings and other repository facilities during the 30 to 40 year operating period. The waste handling facility will contain the equipment to handle high-level waste or spent fuel. Canisters of solidified high-level waste would be unloaded from shipping

Nuclear Wastes

casks and transferred to a shielded cell. The integrity of the cask would be inspected, and then the canister would be lowered through the waste shaft to the emplacement level and moved to the final location by a shielded transport vehicle.

The underground area of the repository, in the US design, would cover approximately 2000 acres. Separate shafts with elevators will lead below ground for personnel and equipment and for lowering nuclear waste canisters. Other shafts will provide ventilation. Tunnels will spread out into the underground area. Canisters of solidified high-level waste will be lowered to the repository emplacement area where a transport vehicle will carry them into a tunnel for emplacement by lowering them into holes drilled into the tunnel floor.

In addition to the geologic barriers that surround the repository, various types of engineered barriers would be used to contain the waste, i.e. the canister, liner and absorbent packing material. As each storage zone is filled, the holes, tunnels and shafts would be backfilled and sealed. However, provisions in the US design would be made to provide for retrievability of the waste canisters for up to fifty years. Following closure, attempts to alert future generations of the existence, importance and danger of the repositories would be made, including

surface symbols, records in public libraries, and computerized information.

As an experiment to determine the feasibility of this waste disposal system, the US National Waste Terminal Storage Program (part of the Department of Energy) in conjunction with the Lawrence Livermore National Laboratory undertook to build a small facility on part of the Nevada Test Site (primarily used for the testing of weapons). Commencing in 1978 with conclusion expected later this year, the project, code named **Climax**, was designed to see if the computer models of how high-level radioactive wastes would react underground were in fact accurate. While the final report has not yet been written, it is believed that the theoretical calculations match the experimental data as to the effect of heat, water movement and such like.

In Canada, an Underground Research Laboratory (URL) is being constructed near Lac du Bonnet, Manitoba, 300-500 meters deep in the crystalline rock formation known as the Lac du Bonnet batholith, on a site leased for 21 years from the Manitoba government. Its purpose is similar to the **Climax** project, but more suited for Canadian Shield conditions. Excavation for the URL began in 1983, with 1986 being the date of commencement for the underground experiments. In the year 2000 the shaft and

boreholes will be sealed and an evaluation of whether this is a practical method of waste disposal will be made. If the report is favourable, then an enlarged, permanent centre will be built in one of the plutons, probably in Ontario.

But until then, the high-level wastes just remain in temporary water pools year after year after year.....

In the future it is expected that more and more spent fuel will be transferred between reactor sites, central fuel storage sites and reprocessing plants. Since accidents are inevitable, safety considerations require that the containers be designed to withstand impact, fire and immersion. The shipping cask is specifically designed to withstand a series of conceivable events: a 30-foot fall onto a flat, hard surface (as if the cask were dropped from an overpass onto a concrete highway), a 40-inch fall onto a metal pin 6 inches in diameter (as if the cask hit a sharp corner of a bridge abutment), a 30-minute exposure to a fire at a temperature of 1475°F (as if a tank of gasoline ruptured in an accident and a fire ensued) and complete immersion in water for 8 hours (as if the cask rolled off into a creek). Such a cask has been designed and tested. Shown here is part of the testing procedure in which a cask was mounted on a rail car and crashed into a concrete wall at 80 miles per hour. The cask survived with only light scratches on its outer surface.

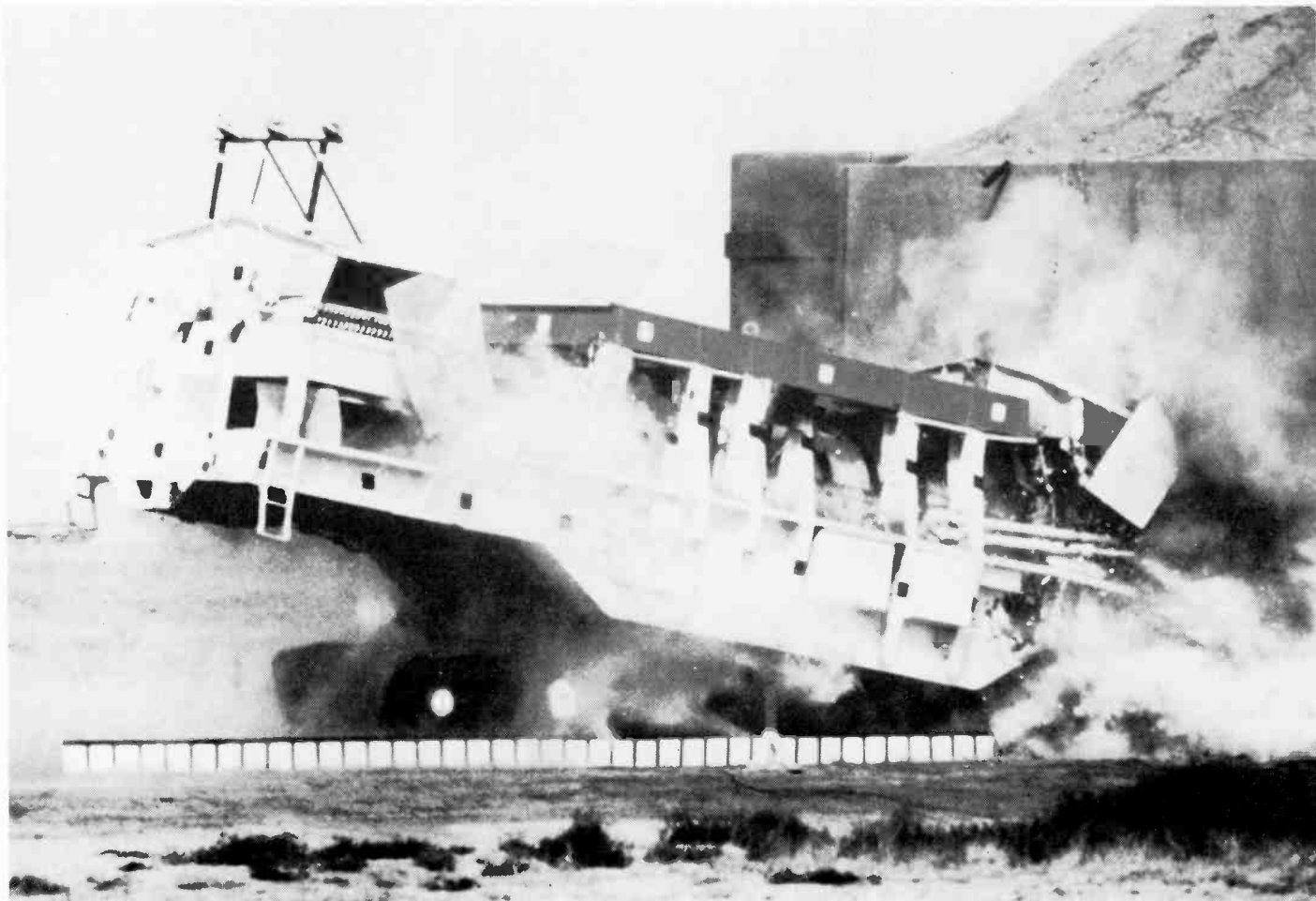

ETI

Vector Graphics



4,294,967,296 vectors should take over a year to draw, even at 100 per second. However if you want to try — the ETI Graf-vec will do it.

THIS PROJECT takes us away from the familiar world of the TV display and shows us instead the other principal means of producing a picture. The ordinary TV set produces a picture by moving an electron beam backwards and forwards across a phosphor coated screen so that it traces a fixed number of parallel horizontal lines. The actual picture is produced by turning the beam on to display a bright dot at the right time and turning it off where no light is required. This method works very well for broadcast pictures, but is sometimes not so good for pictures generated electronically. For a home computer to generate a picture, it must generate a pattern of bits which determine when the electron beam in the display tube is to be on and off. Since the transitions can only occur at discrete time intervals, the

picture produced does not always appear as smooth as we might wish. This effect is usually most noticeable on diagonal lines where there are marked contrast changes.

While we cannot pretend that this project will replace a TV type of display for home computer applications, it does provide an interesting alternative output device for graphics.

The method employed by the Graf-vec in producing a picture is to define the start and finish of a line and cause an electron beam to traverse the intervening space relatively slowly. Drawing many such lines in a short space of time allows us to build up a picture. The main disadvantage of this method is that if too many lines are drawn the whole display will appear to flicker. This can be reduced by the use of long persistence phosphors if available.

As described, the Graf-vec will draw lines between any two points on a 256x256 grid. The relatively simple circuitry used does not compensate for differing line lengths changing the brightness but still gives an interesting result.

The Circuit

The circuit consists of a power supply, digital input and control section, and two linear scan generators. The basic mode of

operation requires a data source — probably your trusty home computer — to put two bytes of data into the device to represent the co-ordinates to which a vector is to be drawn (The starting point is assumed to be where you are now). The Graf-vec will draw the vector and then wait for the next set of data and indicate that it is ready. The digital input circuitry of the Graf-vec is designed so that one byte of the next vector can be input at any time as it is stored in a latch, but the second byte should only be put in after the status bit is detected as high as this will start the next scan.

When the second byte of a new vector is written in, the logic section generates a 400 uS enable pulse for the linear scan generators. This allows them to generate the linear voltage ramps which eventually move the spot around on the oscilloscope or other display device.

Once the 400 uS pulse has finished, the linear scan generators are set up ready for the next vector and the display enable or blank output will go low. If you have the facility available, this can be used to blank the display between vector scans or, by means of the internal latch accessible by writing to two further addresses, the display can be turned on and off to allow you to move position without drawing a line.

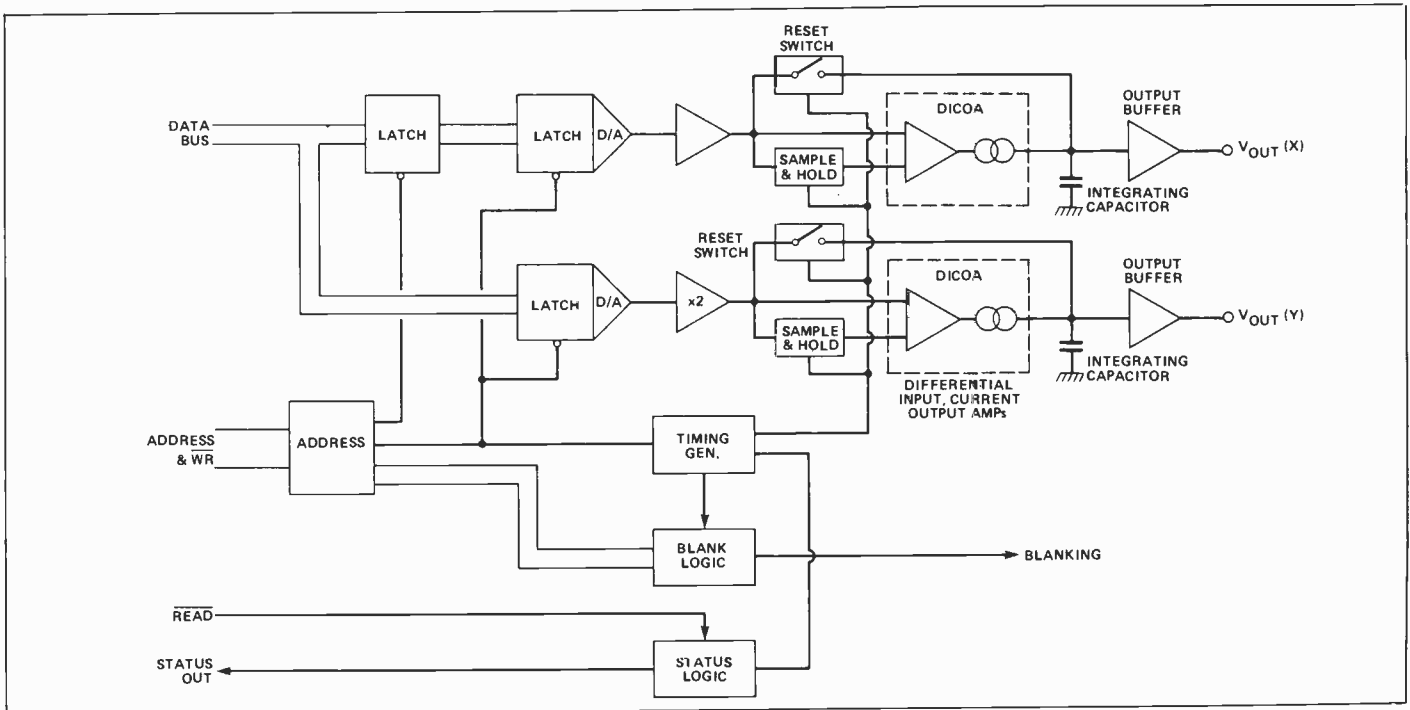

Fig. 1 Block diagram of the Graf-vec.

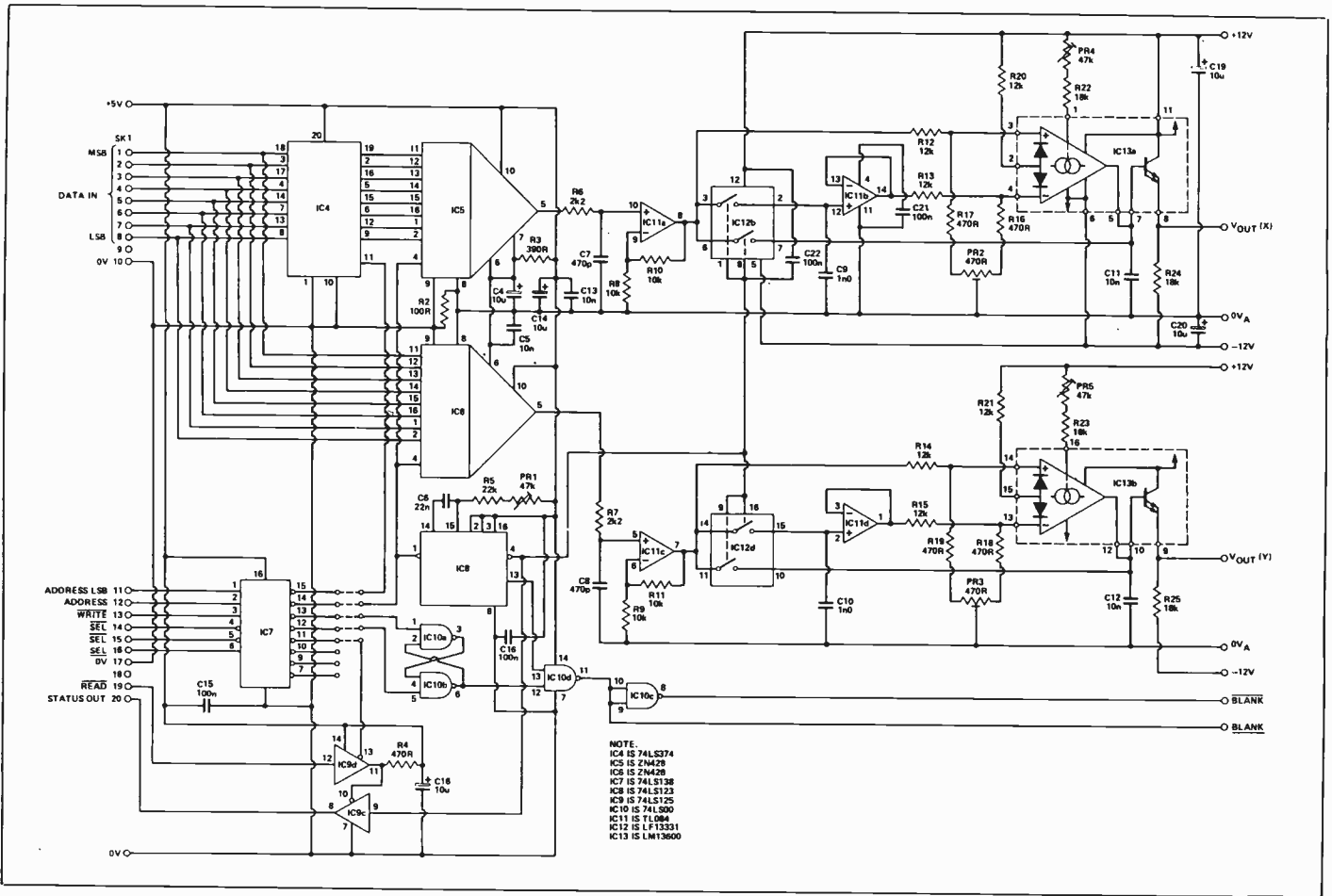

Fig. 2 Circuit diagram of the Graf-vec.

The Linear Scan Generator

This is the heart of the whole system and is basically an integrator. Before each scan starts, the output voltage and the voltage stored on a sample and hold circuit are clamped to the current output from the D to A circuits. When a scan starts, the sample and hold circuit changes to its hold function and the output is unclamped. Since the output is closely associated with the integrator capacitor it does not change immediately.

The D to A circuit now changes its output voltage to the new value and a current is generated which is proportional to the difference between the old and new input voltages. This current is used to charge the integrator capacitor and will do so at a constant rate. This gives a linear voltage ramp between the old output voltage and (if set up properly) the new one.

At the end of the scan pulse the sample and hold circuit and the output voltages are again clamped in readiness for the next scan. Note that while in the clamped state there is ideally no current flowing in the output circuit of the current generator as its input voltages are equal.

Semi-Solid Section

This is about the interface between the hardware described in this project so far and the

software needed to make it do anything interesting. Fig. 6 shows in flow chart switch the actions needed to form the display. In order to prevent a lot of flicker, the routine scans all the points in the display many times each time it is called. The main cause of any residual flicker is the relatively slow response of the BASIC program which calls it. If this too were in machine code a very smooth display could result.

Table 1 shows how the flow chart is implemented in Z80 code while Table 2 (up to line 45) is the ZX81 basic program which is used to control it. Lines 50 onward are a simple program which allows hexa-decimal codes to be typed into the machine which are then held in the REM statement in line 10.

For initial entry of the machine code, alter line 50 to read:—

50FOR K = 16514 TO 16543 Then you can run the program from line 50 and input the program code. Changing line 50 back again will let you type in the data for the picture. The format for typing hex numbers in is two characters 0 to 9, A to F followed by newline. Wrong characters or wrong number of characters will require re-entry of the correct ones. To abort this entry mode type a single space and newline. When first entered, line 10 can be REM with at least 64 characters after it.

While the development work for the project was done on a Z80 system, there is no reason why any other processor could not be used. The only differences would be in the actual interface hardware and the machine code realization of our flow chart.

There are 8 data lines, 7 control lines and one status output to the project. Normally the data lines will be connected to the controller's data bus. The status output line is from a three state buffer and can be connected to the data bus (we used bit 7). One of the remaining control lines is devoted to reading the status bit and must go low when a read operation is required (on a 6502 system it could be tied low permanently as the read and write are controlled by the same line). Of the remaining 6 control lines, one must be high and two must be low before anything happens. These would normally be used as select lines. The last three lines are used to select the operation to be carried out. One of these should be the R/W or similar function while the others will be simple address lines to select the particular operation to be performed. Exactly how these various lines are connected will depend on your particular requirements but Table 3 shows how we did it for a ZX81.

Construction

This should cause no headaches as it is quite

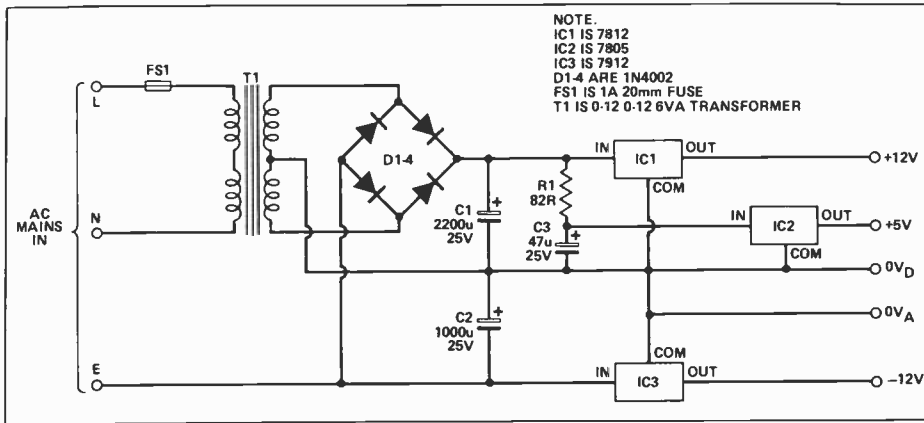

Fig. 3 Circuit diagram of the PSU.

straightforward. First of all, decide whether you want to use the PCB as it is or to split it into two parts (it might be tricky to cut it once the parts are assembled!). Note that there are eighteen links on the main board and five on the power supply, and begin by inserting these, the resistors, and the IC sockets. We recommend the use of sockets if only because some of the devices are expensive and therefore worth protecting... Next, fit the smaller capacitors, potentiometers, and sockets, followed by the power supply diodes, resistor R1 (mounted 6 mm above the board), larger capacitors, fuse, and power connector. Finally, fit the transfor-

mer and insert the ICs into their sockets. Check that the ICs and capacitors are mounted the right way round.

Test the power supply section fully before connecting it to the other board and BE CAREFUL, there is HIGH VOLTAGE present. If all is well, all that remains is to wire the PCB connectors to suit your micro-computer or whatever and then connect up.

Setting Up

If you have an oscilloscope at hand — you need one for the display — set up the sample driver program or something similar on your

computer and check that you get negative going pulses on the outputs of IC7 pins 15, 14 and 11. (this could change if you use a different jumper pattern for a different computer interface.) Set VR1 to give a low pulse period of 400 us at pin 4 of IC8.

Check the outputs from IC13 with the oscilloscope. These should consist of straight line segments with no sudden jumps. If this is not the case, adjust VR2 and VR4 for the X channel and VR3 and VR5 for the Y channel. VR2 and VR4 are effectively offset controls which tend to have the effect of shifting the lines in one direction whereas VR3 and VR5 are gain controls which increase the slope of the lines in whichever direction they happen to be going. The proper setting of these controls is vital to the production of a good display. If you have difficulty setting them, set up the data in the display table to be 00,00,FF,FF etc. This will give a repeating full scale display.

When the controls have been set up reasonably, run the demonstration program and set the 'scope to X-Y mode. You should now have a moving display. Final trimming of the pots may be made to clear up any visible defects. If you do not have an oscilloscope, connect up the device to whatever you are using for a display, set all pots to mid travel and run the demo program and tweak for best results.

QUALITY APPLE™ & IBM™ COMPATIBLE PRODUCTS

16 BIT PERSONAL COMPUTER (IBM™ COMPATIBLE)

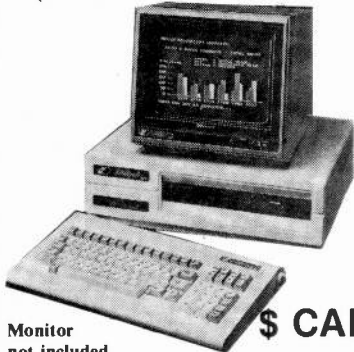

Monitor not included

IBM is a Trademark of IBM Corp.

\$ CALL ...

RX-8800 A NEW BORN STAR \$575.00

- Featuring:
- *Dual CPU 6502 & Z-80
 - *64K RAM
 - *188 Function Key
 - *10 User Programmable key
 - *Self Repeatable Key
 - *Auto Line Feed
 - *Cursor Control
 - *Upper/Lower Case Cap Lock

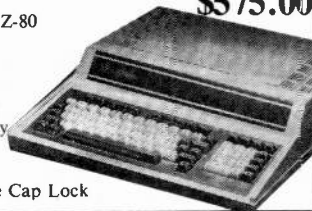

NEW 64K COMPACT SYSTEM

- FEATURING:
- 6502 CPU
 - 64K RAM
 - 16K ROM
 - DETECHABLE KEYBOARD
 - BUILT-IN FUNCTION KEYS
 - USER DEFINE KEYS
 - NUMERIC KEYS



ONLY \$625.00

New 6502 Mark IV 64K RAM plus built-in

- *Z-80, *Disk Controller Card, Micro Modem Card, *80 Column Card, ***8088 Card, *New EPROM Programmer Card, ***6809 Card, *New RAM Card, **A/D/D/A Card, SCS System **Communication Card, **6522 Via Card, **Clock Card, Telephone Dialer, Video Telex System, Light Pen, **Music Card, ***RGB Card, **Speech Card, Superior Serial Card, ***128K RAM Disk Drive, ***Buffer Printer Card

Price for above PCB *\$10.00 ea., **\$15.00 ea., ***\$25.00 ea., kits also available.

- JOYSTICK • MINI FAN • 3M DISKETTE
- DISKETTE STORAGE BOX • HEAD CLEANING DISKETTE • ZENITH MONITOR • AMBER MONITOR

NEW PRINTER BUFFER CARD

- * High Res. Graphic Dump
- *Expandable Buffer (16K-64K)

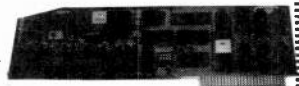

Terms: Send cheque or money order (allow 2 weeks for personal cheques). Credit cards welcome. No C.O.D., Quebec Res. add 9% sales tax. Min. order \$10.00. Add 5% for shipping and handling, except Case & Power Supply. 20% restocking fee for returned merchandise. Prices and availability subject to change without notice. Do not send cash.

Dealers Inquiry Welcome



SLIM LINE DISK DRIVE

100% MADE IN JAPAN

**Teac MF-525-22
326K Bytes 80, Tracks

\$375.00



*MF525-12
163 Bytes
40 Tracks

SPECIAL \$265.00

**Special interface card required.

Teac Bare Drive FD-50F \$200.00 ea.

NEW AUTO MODEM II

INTRODUCTORY OFFER \$250.00

Fully compatible with Hayes Micromodem IITM

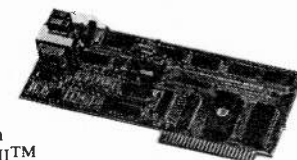

128K RAM CARD

Soft-ware not included. \$210.00



FUJICOMP INC.

6420 Victoria Ave., Suite 3,
Montreal, Quebec. H3W 2S7
Tel. (514) 733-5612

16514	11 10 00	LD DE,0010	:Scan counter = 256
17	PICOUT 06 0E	LD B, 0E	:Points/scan = 14
19	21 A0 40	LD HL,40A0	:Start of data table = 16544
22	POINTOUT 7E	LD A,(HL)	:Get "X" data
23	D3 1F	OUT (1F),A	:Output "X" data
25	23	INC HL	:Move data pointer
26	TESTIT DB 1F	IN A,(1F)	:Input status indicator
28	CB 7F	BIT A.7	:Isolate status bit
30	28 FA	JRZ (TESTIT)	: Jump back if not ready (low)
32	7E	LD A,(HL)	:Get "Y" data
33	D3 3F	OUT (3F),A	:Output "Y" data
35	23	INC HL	:Move data pointer
36	10 F0	DJNZ (POINTOUT)	:Repeat for all points
38	1B	DEC DE	:Decrement scan counter
39	7A	LD A,D	:Get scan count high byte
40	B3	OR A,E	:OR with scan count low byte
41	20 E6	JRNZ (PICOUT)	: Repeat if not zero
43	C9	RTS	:Return to calling program

DATA LIST	
16544	00 80 40 C0 7F 80 AE C0
	FE 80 7F 80 97 68 7F 50
	68 68 7F 80 7F 30 7F 80
	40 80 00 00

Table 1. Z80 machine code demo program.

```

10 REM ) ( # :S:RNDACS C IF .?
4 NEW TAN XXXXXXXXXXXXXXXXXXXXXXXX
XXXXXXXX
15 FAST
17 LET X=10
18 LET Y=X
30 POKE 16545,X
35 POKE 16553,X
40 LET X=X+Y
41 IF X>235 OR X<15 THEN LET Y
=(-1)*Y
45 GOTO 20
50 FOR K=16514 TO 16575
60 PRINT K,
70 INPUT A$
75 IF A$="" THEN STOP
80 IF LEN A$<>2 THEN GOTO 70
90 LET A=CODE (A$(1 TO 1))
100 LET B=CODE (A$(2 TO 2))
110 LET C=CODE "F"
120 LET D=CODE "0"
130 IF A>C OR A<D OR B>C OR B<D
THEN GOTO 70
140 POKE K,16*(A-D)+B-D
150 PRINT CHR$ A;CHR$ B
160 NEXT K
    
```

Table 2. ZX81 BASIC program. Note that you must go to line 50 to enter data and RUN to display.

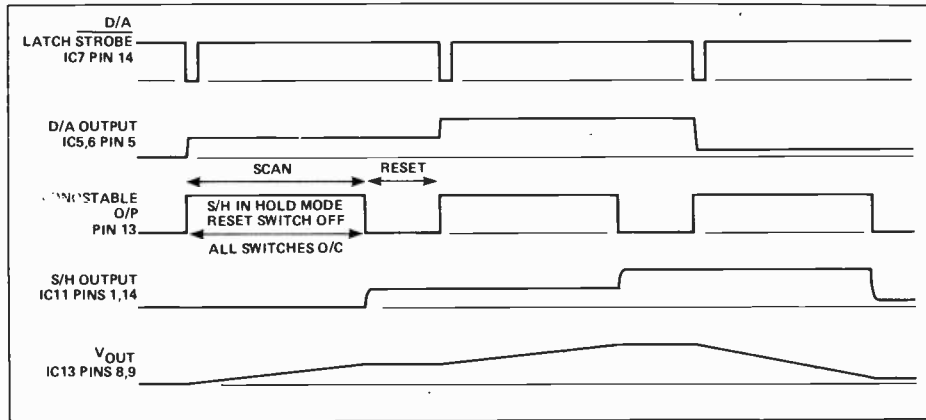

Fig. 4 Timing diagram of the Graf-vec.

Graf-vec, socket 1	ZX81
pins 1 - 8 (data in)	D0 - D7
pins 10, 17 (OV)	OV
pin 11 (address LSB)	A5
pin 12 (address)	A6
pin 13 (WRITE)	WR
pin 14 (SEL)	A7
pin 15 (SEL)	IORQ
pin 19 (READ)	RD
pin 20 (status out)	D7

Table 3 Connections to the ZX81.

PARTS LIST			
Resistors (1/4 W Carbon film unless otherwise stated)	C4,14,18,19,20	10uF 25 V tant. bead	
R1	82R 1W	C5,13	10nF ceramic disc
R2	100R	C6	22nF polycarbonate
R3	390R	C7,8	470 pF ceramic 1 nF poly-carbonate
R4,16,17,18,19	470R	C11,12	10 nF polycarbonate
R5	22K	C15,16,17,21,22	100 nF ceramic
R6,7	2K2		
R8,9,10,11	10K	Semiconductors	
R12,13,14,15,20,21	12K	IC1	1N4002
R22,23,24,25	18K	IC2	7805
VR1,4,5	47K min. horizontal preset	IC3	7915
VR2,3	470R min. horizontal preset	IC4	74LS374
		IC5,6	ZN428
Capacitors		IC7	74LS138
C1	2,200 uF 25 V axial electrolytic	IC8	74LS123
C2	1,000 uF 25 V axial electrolytic	IC9	74LS125
C3	47 uF 25 V axial electrolytic	IC10	74LS00
		IC11	TL084
		IC12	LF13331
		IC13	LM13600
		D1,2,3,4	1N4002
		Miscellaneous	
		T1	0-12, 0-12 V 6 VA PCB mount transformer
		FS1	1 A, 20 mm fuse + PCB mount holder
		SK1	2 off, 10 way 0.1 in pitch PCB connector PCB; Small heatsink for IC2; 23 way double sided edge connector 0.1 in pitch; 16 way(min) or 20 way ribbon cable. (Ferrenti, distributed by Zentronics)

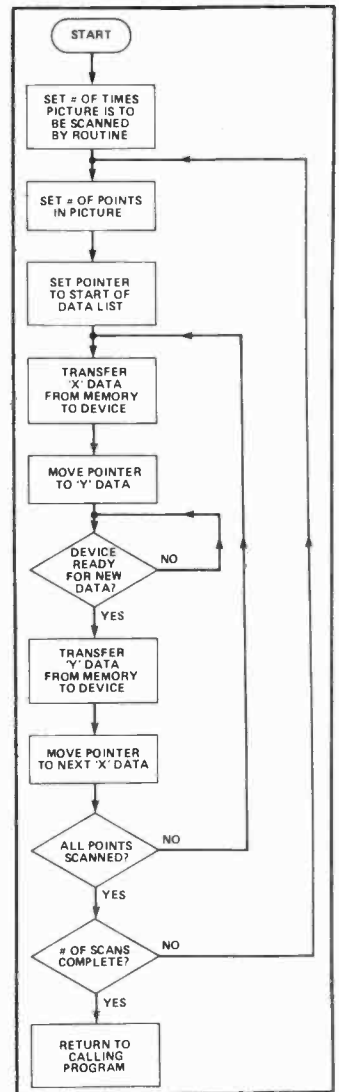
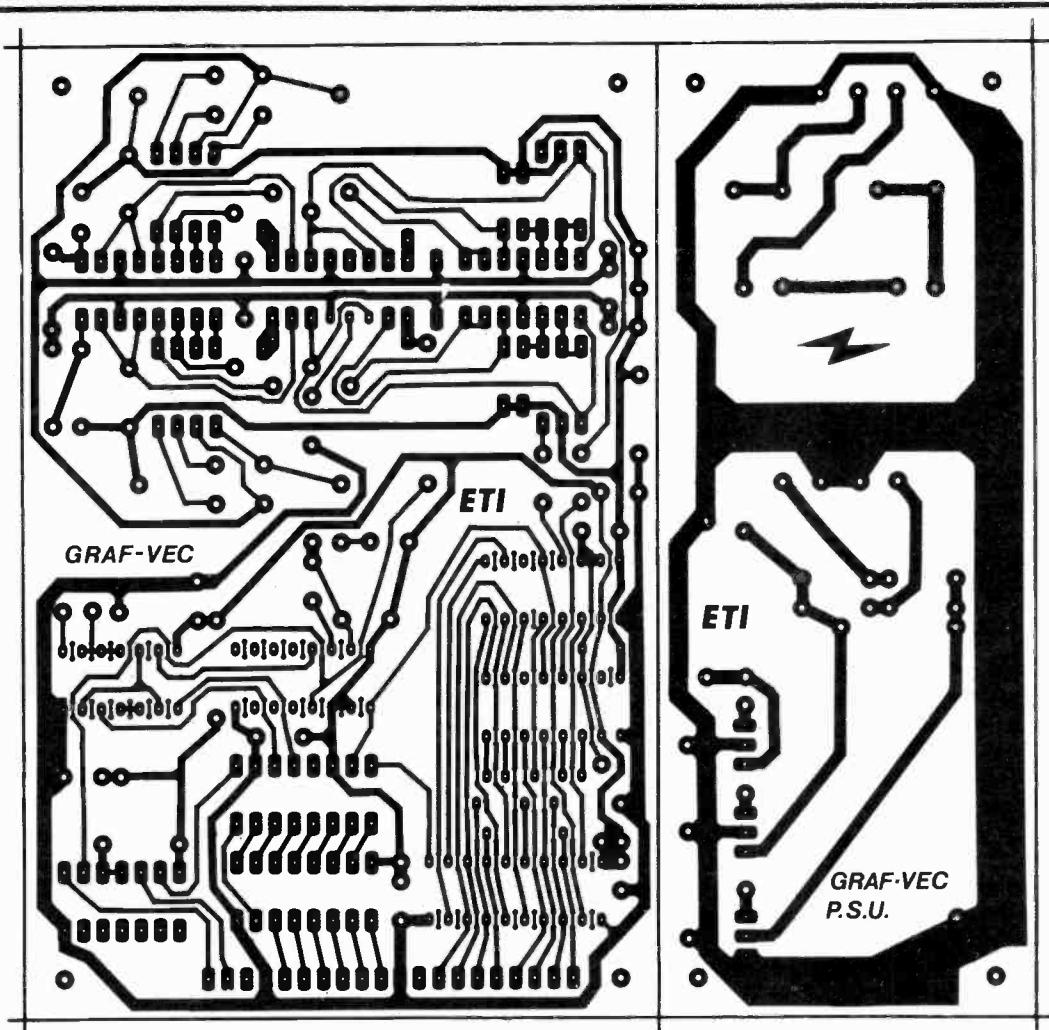

Fig. 6 The algorithm.

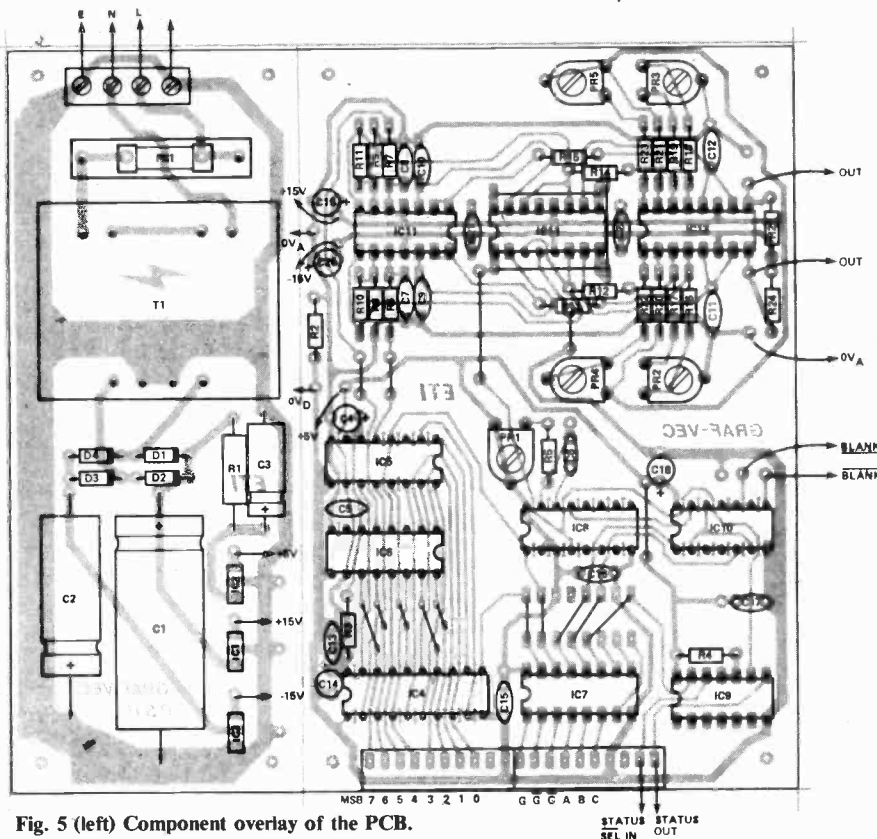

Fig. 5 (left) Component overlay of the PCB.

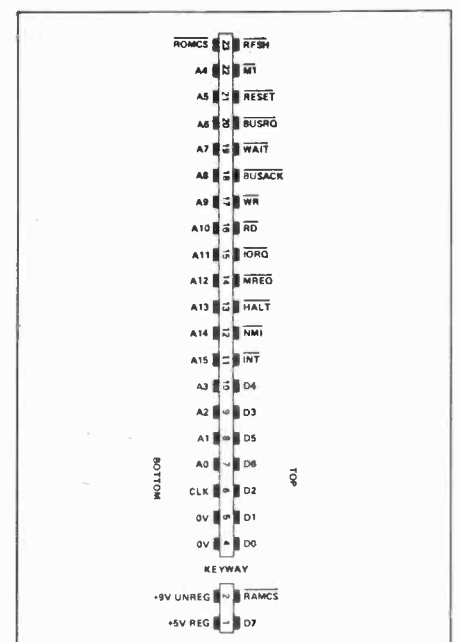

Fig. 7 The ZX81 edge connector.

HOW IT WORKS

The Graf-vec consists of three major parts. The first of these is a straightforward stabilized power supply giving ± 12 V and $+5$ V at about 100 mA each. Only one transformer is used, to save on cost and space. The output is regulated by three IC stabilizers which often need no heatsink in normal operation. However, R1 is provided to dissipate some of the excess power in the $+5$ V regulator, and a small piece of aluminum would not go amiss.

The second major part consists of the logic, timing and digital to analogue conversion. IC7 is a 74LS138, 1 of 8 decoder whose inputs are available at the input connector. This enables simple interfacing to some computers systems without additional circuitry. The outputs from this device are all available on the board via links and are used to enable the other logic functions. The first output drives the strobe input of a 74LS374 (IC4), which is an octal latch with three-state outputs. The outputs from the device are permanently on in this circuit and it is used to store the data corresponding to the X vector before it is loaded into the DAC (IC5).

The next output from IC4 has two uses. It drives the data input enable pins on the DACs (IC5 & 6) and it also drives the trigger input on IC8. ICs 5 & 6 are ZN428 monolithic digital to analogue converters which accept data from the inputs when the enable pin is low and store it while the pin is high. They convert the digital data to a corresponding analogue output voltage in the range 0 to 2.55 V. Note that IC6 gets its data from the input data bus whereas IC5 gets it from the output of IC4.

IC8 is a dual monostable device only one part of which is used in this circuit. Its purpose

is to provide the timing signals for the sweep generator, a display enable signal, and status indication back to the controller.

The next two outputs from IC7 are used to set or reset a simple latch made from two parts of IC10. An output from this latch is gated with the output from IC8 and enables or disables the display (if this facility is used.).

The final output from IC7 enables part of IC9 which is a 74LS125 quad three state buffer. This transfers the logic level at SK1 pin 19 onto the enable pin of another section of IC9. If this is low, the logic state of IC8 Q output is impressed on SK1 pin 20. This indicates that the unit is ready to start display when the pin is high.

The final part of the Graf-vec is made up of two identical circuits. Each of these takes the output from a DAC (IC5 or 6) and processes it to give the required output. We shall only explain one of these circuits as the other is exactly the same.

The output from the DAC comes via R6 and C7 which remove glitches and high frequency noise from the signal. It is then amplified by a factor of 2 by IC11a. This also provides a low impedance drive to the rest of the circuit.

Consider firstly the case when the Q output from IC8 is high (i.e. not triggered). The output from IC11a is connected via two of the four FET switches in IC12, an LF13331, to C9 and C11. This ensures that these capacitors are charged to a defined voltage before each sweep. Nothing further happens to this part of the circuit until the DACs are loaded with new information and IC8 is triggered. When this happens all the switches in IC12 are turned off. This isolates C9 which will hold its previ-

ous voltage for some time, and also removes the clamp on C11. The voltage on C9 is buffered by IC11b and applied via R13 to the inverting input of IC13. A new voltage now appears on the output of IC11a as the DAC has been updated. This is applied via R12 to the non-inverting input of IC13, an LM13600, which contains two transconductance amplifiers and two buffers. The transconductance amplifiers provide an output current which is proportional to the difference of the two input currents, modified by currents into two other inputs.

In this circuit, one amplifier and buffer combination is used for each channel. The currents through R12 and R13 are subtracted and a current proportional to their difference flows into C11. Currents flowing through R20 and VR4, R22 determine what the actual gain will be. As the voltage on IC11a output is constant after its initial change and that on IC11b output is also constant, the resulting current flowing into C11 will be constant. The result of this is that C11 will charge linearly and will also tend to go in the direction of the voltage on IC11a output. In fact, when everything is set up correctly, the voltage on C11 will just reach the voltage on IC11a output as the monostable pulse ends. At this time the capacitor voltage will be clamped by the FET switches being turned on again. The capacitor voltage is buffered by buffers in the LM13600 before being sent out.

Finally it should be mentioned that R16, 17 and VR2 form a balancing network and DC return path for the input currents and one of the control currents.

ETI

PLEASE MENTION ETI WHEN REPLYING TO ADVERTISEMENTS.

SELF-SUFFICIENT EPROM COPIER/PRO-GRAMMER

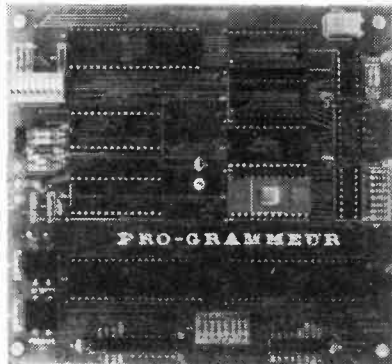

- Includes its own Z80-A processor
- Needs no personality module
- Copies: 1, 2, 4 & 8K bytes single supply EPROMs
- Comes with a powerful 4K bytes-monitor

ONLY \$99.00* (kit)

FREE

Call or write for your free copy of the products catalogue we manufacture

With this KBH interface, you can modify your EPROM content or load a new code in the PRO-GRAMMER's RAM before transferring on EPROM. You can also access several operation modes such as:

- Memory and register examine and change
- Insert/delete one or many bytes anywhere in a program
- Break point execution mode
- Block transfer mode
- and much, much more

ONLY \$59.00 kit

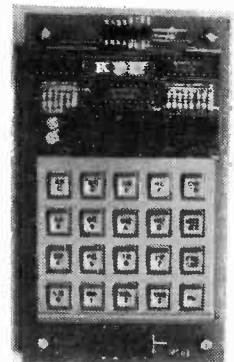

PROTEC MICROSYSTEMS INC.
725 Decarie Suite 202, St. Laurent, Que. H4L 3L4
(514) 744-3363

*Add 3% shipping and handling. Quebec residents: add 9% P.S.T. Cheque, money order, visa accepted. Please print your name, visa no. expiration date & signature.

Viewing Hoods

HZ47 \$12.00

For HM203, HM204, HM605, HM705, HM808, HM312, HM412, HM512, and HM812

Scope Tester

HZ60 \$63.75

The HZ60 provides a fast-rising (≤ 5 ns) switchable 1kHz/1MHz square-wave generator for checking wide-band measuring amplifier systems and for probe compensation. Three BNC-outputs provide signals of 20mV_{pp}, 0.2V_{pp} and 2V_{pp} \pm 1%.

4-Channel Switch

HZ64 \$585.00

Enables the simultaneous display of 4 individual signals or 2 sums or 2 differences of signal voltages on an oscilloscope. Channel switching can be selected for chopped or alternate mode. Each channel comprises a 12-step frequency-compensated input attenuator with 1 M ohm || 30pF input impedance. Sensitivity range 5mV — 20V/div.in 1-2-5 sequence. Bandwidth 4xDC-60MHz. Triggering (DC — 100MHz) is possible for each channel.

As an additional advantage, the input sensitivity of the oscilloscope can be increased by the 10x gain of the HZ64.

Component Tester

HZ65 SPECIAL \$60.00

Indispensable for trouble-shooting in electronic circuits. Single component and in-circuit tests are both possible. The HZ65 operates with all scopes, which can be switched to X-Y operation (ext. horizontal deflection). Non-destructive tests can be carried out on almost all semiconductors, resistors, capacitors, and coils. Two sockets provide for quick testing of the 3 junction areas in any small power transistor. Other components are connected by using 2 banana jacks. Test leads supplied.

Examples of Test Displays:

Shortcircuit



Capacitor 33μF



Junction E-C



Z-diode <8V



Carrying Cases

For HM203-1 and HM203-3	HZ42	\$66.00
For HM312, HM412, HM512, and HM705	HZ43	\$48.00
For HM307, HZ62, and HZ64	HZ44	\$39.00
For HM103	HZ45	\$39.00
For HM203-4, HM204, and HM605	HZ46	\$73.50

All prices are List. To order, send Certified Cheque or Money Order. Minimum order for post or C.O.D. is \$25.00. All shipments are F.O.B. Downsview. Orders shipped within Ontario must include 7% Provincial Sales Tax. We accept VISA. Send card number, signature, expiry date along with name of bank.

STORE HOURS

Prices subject to change.

Mon. to Fri. 8 AM to 5 PM
Saturday 10 AM to 1 PM



The already **excellent price/performance ratio** of the **HM203-4** has been improved even further. Both vertical amplifiers now incorporate **variable gain controls** and maximum input sensitivity is **2mv/cm** over the full bandwidth of the oscilloscope. Another new feature permits display of the **sum and difference** of two signals.

Triggering facilities have also been expanded. In addition to **line** and **TV** triggering, **HF** and **DC** triggering are now possible. The HM203-4 will **trigger** stably with a 5mm display height up to at least **40 MHz**. Using the manual level control, even relatively complex signals can be stably triggered. An 8x10cm **internal graticule** permits **parallax-free viewing** over a wide angle. The effect of the earth's magnetic field upon horizontal trace position can be compensated for, externally, with a **trace rotation** control.

The **HM203-4** has a built-in **component tester**, which is especially useful in maintenance and servicing work. Among other applications, this device enables rapid, **in-circuit testing** of semiconductors. Test voltage and current are rated so that normal semiconductors or other components cannot be damaged. Test **results** are **displayed on the scope screen**.

The **HM203-4** was designed for **general purpose applications** in industry and service. Its many operating modes, front panel layout, and **ease of operation** also make it an ideal oscilloscope for use in training engineers and technicians.



980 Ainess St. Unit 7,
Downsview, Ontario.
M3J 2S2
(416) 661-5585
TELEX 065-28169

The Zorba

Remember Maxwell Smart's telephone in a shoe? Well, now there's a computer in a suitcase. A very respectable computer in a suitcase, too. Anthony DeBoer takes a look.

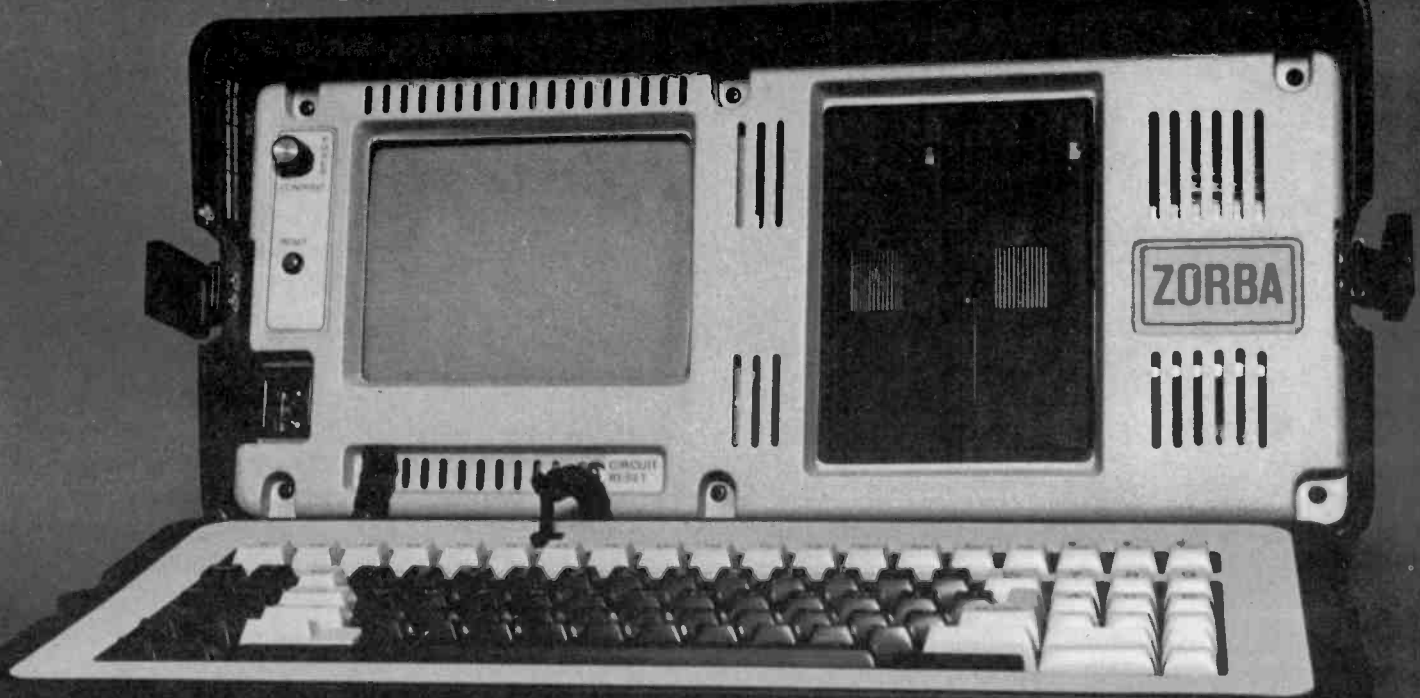

ONCE UPON a time, there was a medium-sized brown suitcase. Or at least it looked like a suitcase. It had a handle at the top and little feet at the bottom, and it looked much like brown leather until one got close enough to see that it was actually brown plastic. At this point, it ceased to look so much like the sort of thing you throw your towel in and drag along to Florida, for few suitcases have connectors marked Serial Printer, Parallel Port, Comm. Port, and IEEE next to the handle, nor do they have power company approval stickers.

Further investigation reveals that two little black clasps on the side of the case allow the bottom to come off. The inside of the bottom reveals itself to be a keyboard with lots of extra keys, and the inside of the rest of the case contains the screen, two disk drives, controls for power, contrast, reset, and circuit reset, and connections for the keyboard and the power cord. Once a pair of feet are swung out, the main unit can sit behind the keyboard and the system is ready to compute. Actually, it takes less time to set it up than it does to tell about it.

What we have here is the Telcon Zorba, a complete CP/M computer system in a suitcase. With drives that can store 400K per disk and read dozens of different disk formats, at a price of less than three grand, this is definitely a computer to be reckoned with.

Diskussion

The disk drives on the Zorba look like something special right away. The drives on the majority of microcomputers in use today are essentially the same, but the Zorba's are different. Instead of a square latch in the middle of the slot to hold the disk in, a door covers the whole disk. The drive-in-use LED peeks out through a little window instead of being mounted right out in the open.

Once you start using these drives, you find them to actually be something special soon enough. They are of the double-sided, double density persuasion, holding about twice as much data as a single-sided double density disk, or four times as much as a single-sided single density disk. That adds up to 400K per disk. No longer do you need a shoehorn to get lots of files on

a disk. Well, maybe I shouldn't say that. Somewhere among the Laws of Computing, right along with 'Always PEEK before you POKE', it says 'Data multiplies to fill the available disk space.' In other words, you'll still fill disks, but nowhere near as often.

The really unique trick that the Zorba can do with its drives is read other disk formats. You may have noticed that an Osborne can't read a Xerox disk, and neither can read a KayPro or a Heath disk, even though they all use the same CP/M operating system. The differences involve things like the number of tracks on a disk, the number of sectors per track, the order in which the sectors are read, the size of the disk blocks, and enough other things to confuse any normal human being (or any normal computer, for that matter).

The Zorba comes with a program called COMPAT. You run this and it will offer you a choice of 30 disk formats, ranging from Osborne single sided/single density to IBM PC CP/M 86 format. You can set the second drive to any one of these formats (the first stays in Zorba for-

mat) and read from or write to an appropriate disk. The FORMAT program offers similar options, so you can format disks for other computers too.

The practical implication of all this is that you can obtain software or data files in any one of a variety of formats and copy it to Zorba format, or copy it onto any one of these formats and send it to someone who has one of the other machines. It's great if you're into software distribution — you don't need twelve computers to generate software in twelve formats, for example. Also, you no longer have to worry about buying software in the exact format for your computer if you have a Zorba, because you can use disks set up for any one of this range of other computers.

Yet another big plus of these disk drives is their speed. They're noticeably faster than most other drives. WordStar becomes almost hasty on the Zorba. This is really helpful if you're planning to work with a lot of files. Since most CP/M applications involve working with files, this is definitely an asset.

Keying In

The keyboard on the Zorba is quite acceptable, although not the greatest thing that fingers have ever touched. On

the negative side, the keys are a bit stiff (although they probably improve with use), and the CTRL key is lost in the middle of a group of keys to the left of the keyboard. Also, on our review model, the bottom of the keyboard case wasn't quite flat (nothing we couldn't fix with a package of disk labels under one of the rubber feet).

On the positive side, there are no less than 95 keys. Besides the usual keyboard, numeric pad, and so on, there are 19 programmable function keys, four direction keys, and a few others. The keyboard will generate all but one ASCII character, the exception being the reversed quote.

The computer comes with a program called SETUP that, among other things, lets you set up the function keys. The 19 function keys and the four arrow keys can be programmed with whole commands, control key sequences, and so on. Also, both the function keys and the keys in the numeric keypad can be redefined to do one thing normally and another when you use CTRL with them, giving you a total of 55 different definitions you can set up. You can edit a whole file in WordStar without once going near the CTRL key, believe it or not.

Hardware

The screen, while awfully small, is still

quite sharp and readable. Prolonged use might give you a case of Osborne Eye, but then you can get it from full-sized screens too. If you badly want a bigger display, you can connect a larger monitor quite easily. But for such a small screen, resolution is excellent.

The video section can do some graphics characters, and also seems to be able to do half-intensity (or dim) video, but no explanation is given in the manual for this latter phenomenon. WordStar is set up without the half-intensity for its menus.

Unlike just about anything else that plugs into a wall outlet, the power cord comes out of the front of the unit instead of the back. This makes sense when you consider the suitcase design (it puts the plug on the inside when the unit is closed up, out of harm's way), and it doesn't get in your way when the machine is in use, since it is at the extreme left of the computer, next to the screen.

The case itself, to be quite honest about it, is of a rather flexible plastic. It will probably take more abuse than a rigid case, but it doesn't make the unit look very professional or expensive.

But Softly...

Like just about all CP/M systems, the Zorba comes with a collection of soft-

continued on page 38

MEMORY SPECIAL

4116 150nS NEC	\$1.99
4864 1x64K Hitachi 150NS	\$8.99
2708 1Kx8	\$5.55
2716 2Kx8 Hitachi, NEC	\$4.99
2732 4Kx8 Hitachi, NEC	8.25
2764 8Kx8 Mitsubishi	\$11.75
6532	\$7.99
2532	\$7.65
2114 200nS (Hitachi)	\$2.25
2128-2	\$7.99

4164 1x64K OKI 200NS	\$ 8.50
2016 150 NS	\$ 8.25
6116 150 NS Hitachi	\$ 8.75
27128	\$37.95

Call for quantity price.
OEM Enquiries Invited.

5¼ Mitac Disk Drive with Controller Card	\$339
5¼ double head Panasonic slim Direct Drive with controller card	\$379
Numeric Case	\$59

Japanese Parts Specialists PARTS 100% GUARANTEED

CPU		TTL	
Z80	\$ 5.99	LS323	\$4.99
Z80A NEC	\$ 6.75	LS11	.65
6502A 2MHz	\$ 6.99	LS132	.80
6502	\$ 6.50	LS107	.65
6845 CRT Controller (Hitachi)	\$10.99	LS257	.90
6522	\$ 6.99	LS151	.65
6850	\$ 4.99	LS194	.90
8088	\$32.95	LS283	.95
Peripherals		LS367	.80
UPD 7220D	\$59.95	LS166	1.79
8748D NEC	\$24.50	LS377	1.30
8741 NEC	\$32.50	LS368	.69
8251 NEC	\$ 5.99	LS86	.75
8253-5 NEC	\$12.00		
8257-5 NEC	\$12.00		
8086	\$19.95		

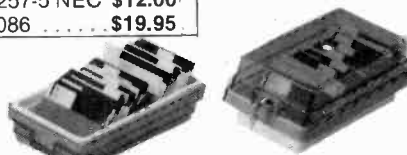

5¼ Floppy Disk Case (storage up to 150 diskettes)	\$39.95
1. YJE High Res non-glare Amber Monitor	\$169.00
2. 52 function numeric keyboard (electronic touch upper/lower case)	\$129.00

1. 40-80 Column Switch	\$ 5.00
2. Colour R.F. Modulator	\$15.00
3. Joystick (Self-centering) two adjustable controls	\$39.00
a) 128K RAM Card	\$225.00
b) 16K RAM Card	\$ 59.00
c) 80 Column Card	\$ 79.00
d) Disk Controller Card	\$ 59.00
e) Z80 Card	\$ 60.00
f) Communication Card	\$ 79.00
g) 40/80 Col. soft switch	\$ 19.95

Toll Free Orders Only
1-800 268-5619
General Inquiries
(416) 298-3280

Compatible with Shurgart SA455
Introduction Offer \$289.00

Panasonic Drive for Apple™ \$329.00

Teac Drive for Apple™ \$299.00

IBM Compatible keyboard & case \$CALL

Service Centre and Retail Outlet, 4051 Sheppard Avenue East (at Kennedy), Agincourt, Ontario M1S 1S8 (416) 298-3280

Kitstronic

INTERNATIONAL LTD.

(416) 298-3280
Telex - 065-26150

Mail Orders: Send a certified cheque or money order plus \$3.00 for shipping and handling. For Special Delivery, please add \$1.00 extra. Ontario residents add 7% P.S.T. Visa & Mastercard accepted.

COMPUTER PARTS GALORE INC.
316 College St.
Toronto, Ontario M5T 1S3

Toll Free Orders Only
1-800-387-1385
Order Checking (416)925-8291
Technical Data (416)925-1105

DTC™ DISPLAY TELECOMMUNICATIONS CORPORATION

Come In And See Our New Parts Array

new!

MEGA-BOARD™

IBM is a registered trademark of International Business Machines

COMMENTS ON THE MEGA-BOARD

We have looked long and hard for the very best of the 8088, IBM* compatible PCB's and we are happy to say that the "Mega-Board" looks like a winner. It has one of the best manuals I have ever seen, with a complete explanation of board operation and a minutely detailed schematic set in easily readable format. The ROM-BIOS is an original composition that is fully IBM* compatible, and non-infringing. The main board is very well laid out, epoxy coated, and fully and readably screened for exact component identification. The spaces and traces are well and properly spaced to make soldering easy and discourage shorts and bridges. These mechanical features along with the impressive electrical features detailed on the picture at right make the "Mega-Board" our choice for the home builder of an IBM* compatible machine.

Eight Compatible I/O Interface Connectors
(Full PC compatible)
(compatible with all IBM-PC* plug-in cards)

Special J1 Interface
(Allows horizontal mounting of compatible expansion cards for easy bus expansion and custom configuring) (Board has 62 pin gold plated compatible connector)

Extended ROM Capability
(Runs all compatible PC ROMS) (Jumper programmable to accommodate all popular 8K, 16K, 32K and 64K ROM chips and NEW EE ROMS! VPP power pin available for EP ROM burning!) (External VPP voltage required)

Full Mega-Byte Ram Capacity! On board!
(With parity)
 256K Bytes using 64K chips
 1 Mega Bytes using 256K chips

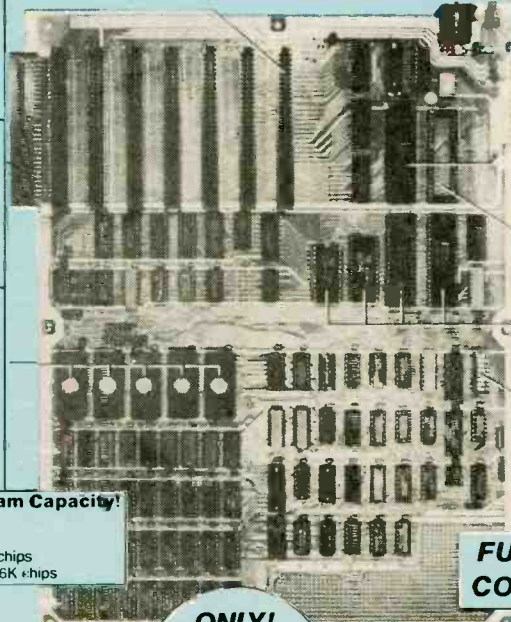

Standard Keyboard Interface
(Full PC compatible)

Hardware Reset
(Overcomes reset flaw in PC)

Power Connector
(Full IBM* pinout compatible)

8088 Processor
(Same as PC)

8087 Numeric Processor
(Same as PC)

Peripheral Support Circuits
(Same as PC)

Configuration Switches
(Same as PC)

Speaker/Audio Port
(Same as PC)

Wire Wrap Area
To facilitate special custom applications!

FULL IBM - PC* COMPATIBILITY!

DEALERS AND OEM MANUFACTURERS QUANTITY DISCOUNTS AVAILABLE

Ideal for

- COMPUTERISTS
- OEM MANUFACTURERS
- DEVELOPMENT LABS
- UNIVERSITIES
- INDUSTRIAL APPLICATIONS

THE ULTIMATE OEM/PC COMPATIBLE SINGLE BOARD COMPUTER

- MEGA-BOARD™ with full assembly instructions \$99.95
- USERS MANUAL with theory of operation, schematics, block diagram, application notes \$19.95
- MEGA-BIOS™ fully compatible MS-DOS/PC-DOS BIOS \$29.95

ORDER NOW!!

ONLY!
\$99.95
Evaluation Board Kit

MEGA-BOARD™ Evaluation Board Kit!
(Blank board with full assembly instructions and parts list.)

Includes highest quality PC board with gold plating, silk screen, solder mask

Bare Boards Bare Boards Bare Boards

- (A) REAL-TIME-CLOCK CARD. Like the TIME II, has all clock features with disc driven system.
Bare PCB with layout data \$14.95
- (B) QUAD DRIVE CARD. Like a RANA drive card, lets you run up to 4 drives on your Apple system.
Bare PCB with layout data \$24.95
- (C) 9 VOICE MUSIC CARD. An excellent card for tuncraft, uses 3 GI 3 voice chips, the best single card music board.
Bare PCB with layout data \$14.95
- (D) BUFFERED PRINTER CARD. 64K on board allows the CPU on your system to keep on going while the intelligent printer buffer card loads 64K of data in an instant and prints it at leisure.
Bare PCB and layout data \$19.95
- (E) GRAPHICS PRINTER CARD. A full feature bit-image graphics card, has all picture and screen dump features.
Bare PCB and layout data \$14.95
- (F) Cable for above two cards, please specify type \$24.95
- (G) 80 COLUMN CARD. A new improved VIDEX style card with softswitch on board and new 6116 CMOS RAM \$14.95
- (H) DISC CONTROLLER CARD. Standard 2 drive type Apple compatible \$12.95
- (I) Z-80 CARD. The CPM card runs all Z-80 CPM programs. Needs 16K card. Makes 1000's of excellent programs available \$12.95
- (J) MODEM CARD. A copy of the popular SSM Modem with full features, direct connect, auto-answer, etc. 300 Baud \$24.95
- (K) MULTIFUNCTION CARD. 80 Column, serial I/O and Parallel I/O. All on one card, a must for serious users \$24.95
- (L) 128K MEMORY CARD. Much like the popular Saturn card. Takes 64K or 128K.
Bare PCB and layout data \$24.95

- (M) RGB CARD. A software driven colour card, much like the ELECTROHOME RGB card, has far more colours than the standard Apple provides \$24.95
- (N) EPROM PROGRAMMER. A stand-alone unit that does not need a disc drive for operation. Does 2716, 2732, 2764 5V versions. Bare PCB and layout data.
- (O) PROGRAMMABLE INTERFACE ADAPTOR (PIA). An interface card that has prototype area and also has spaces for the 8255 and the 6821 I/O chips \$14.95
- (P) WILD CARD. The best program copy card money can buy \$12.95
- (Q) SEMI-AUTOMATIC-MOUTH (SAM) CARD. A very good speech card that allows very life-like speech to be programmed. Types in letters and software speaks.
Bare PCB and layout data \$14.95
- (R) RS-232 SERIAL CARD (PRINTER). The standard card for SERIAL PRINTERS \$12.95
- (S) RS-232 SERIAL CARD (MODEM). Also called COMMUNICATIONS CARD. For phone data transfer \$12.95
- (T) RS-232 ASYNCHRONOUS DATA CARD. For non-synchronous data transfer \$12.95
- (U) SPRITE GRAPHICS CARD. Made to use the TI SPRITE GAME VIDEO CHIP. For advanced SPRITE OVERLAY MOVEMENT. Has full colour.
Bare PCB and parts layout \$17.95

IBM™ Parts

- | | |
|------------------------------------|----------------------------------|
| 5 pin DIN connector \$3.95 | 1.8432 MHz Xtal \$6.95 |
| 8 position DIP switch \$2.95 | DIP relay, cassette \$6.95 |
| EDGE conn. 62-pin \$3.75 | Power connector male \$1.49 |
| 4.7K 8-pin SIP \$.75 | Power conn. female \$1.49 |
| 8088 \$34.95 | 8255A-5 \$16.95 |
| 8237A-5 \$34.95 | 8259 \$14.95 |
| 8250 \$29.95 | 74LS280 \$ 4.75 |
| 8253-5 \$19.95 | 74S157 \$ 2.50 |
| 74LS85 \$ 2.50 | 74LS125 \$ 2.50 |

Software

Some of the cards advertised require software in the form of an EPROM or a program disc. These are available as follows:

- (A) Real-time-clock (Diskette) \$ 8.00
- (B) Quad drive card (PROM set) \$16.00
+ (EPROM) \$ 8.00
- (C) 9 Voice music (3 Diskettes) \$15.00
- (D) Buffered printer card (Diskettes) \$ 8.00
- (E) Graphic printer card (EPROM) \$ 8.00
- (G) 80 Column card (3 EPROMS) \$20.00
- (H) Disc controller (PROM set) \$16.00
- (J) Modem card (EPROM) \$ 8.00
- (K) Multifunction card (EPROM) \$ 8.00
- (L) 128K memory card (3 Diskettes) \$20.00
- (M) RGB card (Diskette) \$ 8.00
- (N) EPROM programmer (EPROM) \$ 8.00
- (P) Wild card (Diskette) \$ 8.00
- (Q) SAM card (Diskette) \$ 8.00
- (R) RS-232 (PROM set) \$16.00
- (S) Communication card (EPROM) \$ 8.00
- (T) Asynchronous card (EPROM) \$ 8.00
- (U) Sprite card (Diskette) \$ 8.00

Hard To Get Parts

- 14.318 MHz Apple crystal \$2.95
- 17.43 MHz Videx crystal \$4.95
- MPSA13 Transistor (1 on 6502 PCB) \$.75
- 2N3904 Transistor (3 on 6502 PCB) \$.35
- 2N4258 Transistor (2 on 6502 PCB) \$.90
- 1K 9-pin SIP resistor (3 on our 6502 PCB) \$.75
- 1K 8-pin SIP resistor (3 on some 6502 PCB) \$.75
- 10K 10-pin SIP resistor (2 on Z-80 PCB) \$.75
- 4 position DIP switch (1 on Z-80) \$1.75
- 20-pin male right angle header (2 on drive PCB) \$2.95
- 20-pin female cable header (on disc drive) \$2.95
- 6-pin male power connector inline (for 6502 PCB) \$1.29
- RCA jack, right angle (for 6502 PCB) \$1.00
- 10 0.025" header pin set (1 set on 6502 PCB) \$0.50
- 50 Pf variable capacitor (2 on 6502 PCB) \$1.00
- 220 Videp trimpot (1 on 6502 PCB) \$.75
- 68A45 (80 col.) \$16.00
- MC3242 (128K) \$16.00

IBM™ STUFF

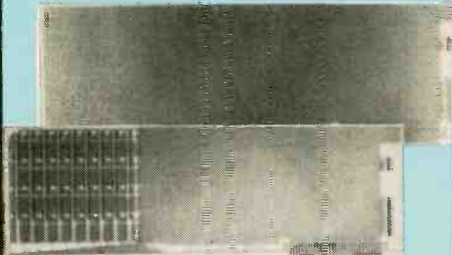

PROTOTYPING CARDS

(A) WIRE WRAP ONLY CARD. An ideal card for high density wire wrap work. There are WW holes everywhere with a DB-25 and a DB-15 footprint at one end . . . \$34.95
 (B) MEMORY AND WIRE WRAP. A very good prototyping card for those doing video, memory, etc. cards. This card has the pads for a 256K 9 bit memory already laid out. All power and grounds runs are in, pads for 0.1uf bypass caps on each 4164 are in, all control functions are gridded and brought out to WW pads, upward compatible to 41256, 256K memory chips. The rest of the PCB is WW on .1 centres with a DB-25 and a DB-15 footprint at one end for I/O . . . \$49.95

HAL, JLS BOARDS, ETC.

- (A) Mother Board, JLS, HAL . . . \$64.95
- (B) Memory Board, JLS, HAL . . . \$39.95
- (C) Disk Controller Board . . . \$34.95
- (D) Video Board, mono . . . \$34.95
- (E) Color Graphics Board . . . \$49.95
- (F) IBM connectors, 62 pin (5) . . . \$ 3.50 ea.

The HAL JLS boards work well and have no errors, unlike some IBM clones that have more jumpers than Wall Street in 1929. We have a working demo in the store. The boards are well laid out and have lots of space between parts for easy assembly.

IBM PC™ LOOK-A-LIKE CASE



Make your Apple™ or 6502 machine look like an IBM PC™. This attractive metal case with ABS front bezel looks just like you-know-who, but is punched internally to take all the 6502 Mother boards, power supplies etc that are now sold. . . . \$135.00
 • Keyboard Case . . . \$ 19.95

SYSTEM SAVIOUR



2 grounded 3 wire switched sockets, pilot light, surge protector and on-off switch to turn off your system and two plugged in items . . . \$55.95

POWER SUPPLY



Our Famous "BLACK BEAUTY" power supply, now reduced in price but not in quality. Our ratings are 5V-5A; 12V-2.5A; 5A-1/2A; 12V-1/2A for real. . . . \$99.95

SOLID ABS CASE NUMERIC \$59.95



Parts ELECTRONIC COMPUTER Galore

316 College St., Toronto. M5T 1S3
 (416) 925-1105 (416) 925-8291

OUR 6502 BOARD
 Now only \$29.95 still with all the versatility of the original and a full 8 slots.



NOTE: The great deal offering our 6502 PCB and any 4 peripherals for \$57.00 is still in effect. (Excludes the 128K card and wildcard)

NEW FROM MAXISWITCH™



The finest most cost effective keyboard for the IBM™PC or the APPLE™ that we have ever seen. The IBM model has all of the standard features of the IBM KB plus an improved return key for true typewriter emulation (For word-processing) Full N key roll-over, auto-repeat and more. The APPLE version has a lot more than the run of the mill APPLE keyboard, 10 function keys, cursor pad, numeric pad, and 21 preprogrammed commands to save a lot of typing. Just like the picture and just as pretty ONLY \$189.00

Please specify APPLE, or IBM PC, XT
 NOTE: Complements our IBM look-alike case exactly.

PROJECT BOARD

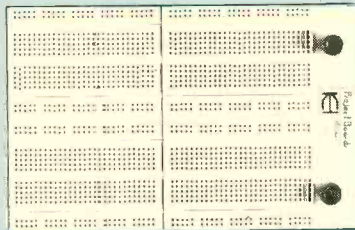

Have you ever tried to get an economical protoboard and had a shock? Well look at this, a good quality protoboard at a 30-40% saving. The KH-408 has 1560 holes on a std 0.1" grid for IC's and a sturdy plastic base with two binding posts for power, an excellent buy for the student.

\$38.00

PERIPHERAL CARDS



New low prices.

- A) Z-80 Wired n tested . . . \$58.00 . . . Bare PCB . . . \$12.95
- B) 80 Col. Wired n tested . . . \$72.00 . . . Bare PCB . . . \$12.95
- C) 16K Wired n tested . . . \$58.00 . . . Bare PCB . . . \$12.95
- D) Disc Wired n tested . . . \$59.00 . . . Bare PCB . . . \$12.95
- E) Shamrock 13/16 sector disk Wired n tested . . . \$79.95
- F) Apple™ Prototype card, all WW holes . . . \$12.95
- G) Apple™ Prototype card, power bussed . . . \$14.95
- H) Wildcard™, Wired n tested \$55.00 Bare PCB \$12.95
- I) 128K Wired n tested, no IC's \$39.95 With 64K \$129.00, 128K . . . \$210.00, PCB . . . \$24.95

GREAT DEAL



THE GREAT DEAL CARRIES ON FOREVER AND GETS BETTER
 Our proven 6502 motherboard plus a numeric case plus a black beauty power supply plus a numeric keyboard plus any 4 bare pcb (except 128K and tamecard) for \$275.00.

DIGITAL MULTI-METER

AMAZINE QUALITY AT LOW COST \$69.96

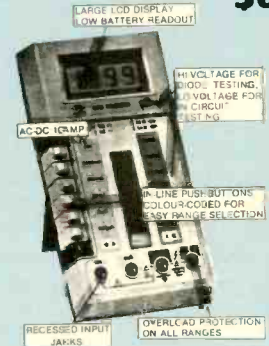

EXTRA FEATURE

- Diode test circuit • Lo voltage ohms, 0.5v • Lo battery Indicator • Auto-Zero • Auto polarity • Overload protection, all ranges • ABS case (will not crack) • One hand push buttons.

ASCII KEYBOARDS



Our ASCII keyboards are by ALPS, a famous Japanese switchmaker and feature high quality debounced switches. Full upper and lower case capability. Direct plug in compatible with all 6502 boards and 'SURF' board. Available in numeric and std style.

- (a) Standard KB . . . \$89.00
- (b) Numeric KB . . . \$99.00

MAIL ORDERS

We accept; Personal Cheques, Postal Money Orders, Certified Cheques, Travelers Cheques, Visa, American Express, Mastercard, Bank Draft. We ship C.O.D. only by CANPAR and Truck. We do not use Canada Post C.O.D. We will send your goods via CANPAR or Canada Post unless you say otherwise. You will be charged a min \$3.00 for delivery and handling or more if your goods are heavier than the \$3.00 weight or if you specify another delivery service that charges more. All Ont res + 7% sales tax. We sell wholesale to any retail store or other reseller with a sales tax exemption #, as long as a realistic quantity is bought. We ship within a week if in stock and we will cancel any backorders over 4 weeks unless otherwise instructed. 20% Restocking Charge

ware. Besides the usual CP/M stuff (ASM, LOAD, DDT, ED, MOVCPM, PIP, STAT, SUBMIT, and so on), you get WordStar, MailMerge, CalcStar, CBASIC, the M80 assembler, and a few useful utilities from the makers of the Zorba. These include SETUP and COMPAT, mentioned earlier, and a few miscellaneous items.

WordStar ran quite well on the Zorba. As mentioned before, it ran with beautiful speed. The menus come out the same as the text, but that's no major complaint.

No applications programs (accounting packages, etc.) are included with the Zorba. According to one of the manuals, this is because the manufacturers feel it would be 'unreasonable' to choose applications for the user. Rather, they want to give good value. They're in the hardware business, not the software business. Besides, this lets you choose your hardware and your software separately. If you do want an accounting package, any CP/M based package should run on the Zorba, or if you want to write it yourself, WordStar and CBASIC will go a long way towards getting you going.

As a business system, the Zorba looks good. Considering the price, the disk capacity, and the software that comes with it, it is good value. On the other hand, businesses that want to avoid a fly-by-night image might want to avoid so portable-looking a computer system, and few data entry clerks would really want to sit hunched over the tiny screen for a whole eight-hour work day. But then, the line between 'fly-by-night' and 'upwardly mobile' is fairly thin, and the Zorba would probably be quite a fashionable executive system.

As a personal system, the Zorba is highly suited to that part of the population that considers 'hacker' a compliment. It's not an Atari or a '64 that you can play games on (the graphics are very limited), and not a system to learn BASIC on either. CBASIC, which comes with the machine, differs wildly from standard BASIC in several areas, most notably in that you don't need a line number on every line. The line numbers don't even need to be in order. You have to type in your program using WordStar and then feed it through CBASIC's compiler before you can run it. Compiled BASICs like this one run your programs faster, but interactive BASICs like you find on most other machines are much easier to learn with.

As a system for a programmer, the Zorba stands up very well. The CBASIC compiler lets you write fast BASIC programs, and the M80 assembler is probably the state of the art as far as assemblers for CP/M systems go. The disk space allows lots of room for code files and listing files,

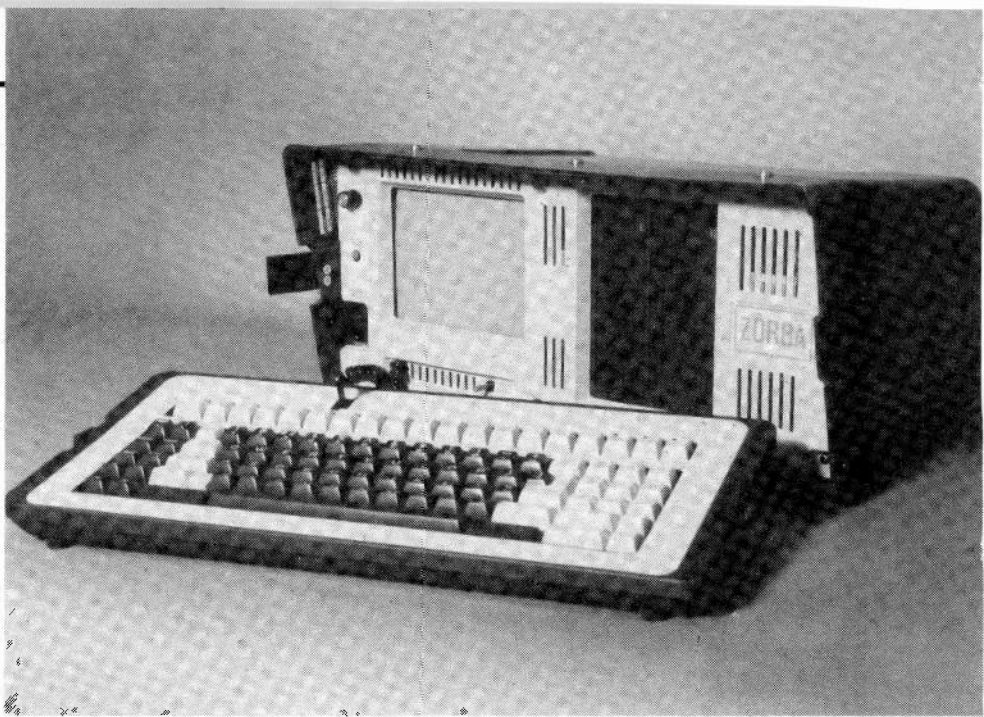

and with the disk compatibility system programs can go to or from other systems easily. CP/M on the Zorba is standard from the point of view of software running on it, so programs written on it can be taken to other CP/M machines.

Internally, the Zorba's CP/M has a number of nice extra features. When a disk error occurs (a rare event), it tells you which track and sector of which disk died. Most systems just say 'Bad sector' and leave you to figure out where. Also, the disk compatibility and programmable function key systems live inside the CP/M BIOS module. An optional patch lets the system automatically search both disks for command files. If you're logged onto the B disk, you don't have to use A: before a command name if the command is on the A disk. This may seem minor, but it's a big step towards making CP/M more user-friendly.

The system comes with source code for the BIOS and the read-only memory chips. This is wonderful if you're curious about what goes into these parts of the system, and allows you to make changes to the BIOS if you're a really ambitious programmer. Few manufacturers include these files, perhaps because they regard them as trade secrets or perhaps because they figure that nobody would be interested anyway.

Manually

The system comes with the usual small library of manuals. The first, entitled 'First Steps: Introductory User's Guide', comes in a really unique three-ring binder that stands up on its own beside the computer so that you can read it as you try out the examples. It's written in that over-friendly style found in some beginner's publications that makes you somehow glad the author isn't there in person. It

takes you through setting up the computer, backing up your disks, using the more common CP/M utilities, setting up the function keys, using WordStar (with the function keys), MailMerge, CBASIC, and CalcStar. It's a good place to start for the first-time user who finds himself with a Zorba in front of him.

Next in line is the User's Reference Guide. It covers the CP/M utilities again, this time including ASM, LOAD, DDT, and the other utilities that first-time users don't usually use. It gives details of the system, the I/O ports, the video system, the disk layout, and various other technical details, along with a tutorial on computer number systems. Manuals for M80, CBASIC, WordStar and CalcStar are also included for those who need them.

Conclusions

The Zorba is a very respectable computer, with an excellent set of internals. The disks and the CP/M system are first-class, and the software included is top quality. It's decent value for the dollar, too. Over against this, however, you have the plastic case and the mini-monitor. On the whole, though, it's an excellent machine.

Quick Reference

Telcon Zorba	
Mfg:	Telcon Inc.
CPU:	Z-80
RAM:	64K
Operating System:	CP/M
I/O:	Serial, parallel, and IEEE
Disk drives:	2 DSDD 400K
Screen:	80 x 25
Suggested Retail:	\$2995

ETI

A Zener Diode Primer

How to get a stabilized voltage source from a simple diode and optimize power supply circuits to suit the conditions. By Tony Bailey.

THOSE WHO ADMIT to being around for a few years may remember the days when stabilized voltages of any highish value were dependent on that healthy purple glow which emanated from the vacuum tube stabilizer, such as the VR90/105/150 series. As with many vacuum tubes, they were not particularly reliable, consumed lots of wasted power, generating lots of heat as a result, and were quite large. Today, the evolution of the semiconductor replacement now enables voltages in excess of 200V to be stabilized with one diode, obtainable in power ratings from a few hundred milliwatts in small glass encapsulated devices to 50 watts in stud mounted versions.

The purpose of this article is to run through the basic facts concerning the Zener diode, mainly for the benefit of those unfamiliar with them, using the minimum maths possible.

Basics

How do you design your Zener circuits? Shove in a suitable value of diode, with a few hundred ohms in series and hope for the best? Or do you get out the calculator and actually do some maths? For any sort of reliable results you need the latter approach, and it isn't difficult if attacked from first principles.

The discovery of the this diode phenomenon fell to Dr. Carl Zener, who found that, beside the ability of the diode to rectify, it could also stabilize a low voltage if biased correctly. As you are no doubt

aware, an ordinary rectifier diode such as the 1N4001, if forward biased to ground (Figure 1a), will have the ability to maintain a stabilized voltage of around 700mV, for a current variation from a few milliamps to 1 amp or more. This is not, unfortunately, of much practical use in power supplies as a large number of diodes in series would be required to achieve any worthwhile voltage. However, this characteristic can be used to limit the voltage on a line to 0V7 maximum, or more if several are used in series. RF users will be familiar with this technique.

Reverse Biased Diodes

If a diode is connected so that it is reverse biased, with the current drawn limited by a suitable value of resistor in series (Figure 1b), and the voltage is slowly increased from zero, a point will be reached at which the voltage stabilizes and does not increase further (Figure 2). This voltage at which the diode stabilizes, or conducts, is known by a number of terms — reverse breakdown voltage, avalanche voltage, knee voltage; all refer to the same thing.

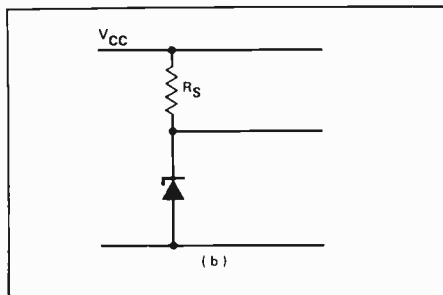

Figure 1b. Basic reverse biased Zener regulator.

The true Zener effect only occurs at voltages up to about 5V; above this the control is by avalanche breakdown, but the terms tend to be mixed in practice. Again, a simple diode exhibits a reverse breakdown voltage, and it is possible to use these as Zener diodes. The problems arising from the fact that they have not been specifically designed as avalanche diodes are that the actual stabilized voltage can vary between any two samples of the same diode by a factor of two or more, and the effect of temperature on the stabilized voltage is more than would be expected from a diode designed for that purpose. Also, the current which can be drawn from the stabilized circuit is severely limited by the current which can be allowed to be drawn by the diode itself, in the range of only a few milliamps. However, in the absence of a suitable Zener diode, the junk

box could yield suitable diodes to get you out of a jam.

The Series Resistor

In the diagram of reverse voltage versus reverse current (Figure 2), you will see that as the voltage increases from zero, the current rises slowly at first until the knee voltage is reached, and then suddenly soars upwards. Without any means of limiting the current taken by the diode, the device will self-destruct fairly soon, and hence a series limiting resistor is required to maintain the current within a safe boundary.

In designing a simple Zener regulated power supply, we will assume that the initial supply voltage is higher than that of the stabilized voltage required (otherwise the diode cannot be provided with a working current), and that both the input voltage and the current drawn by the load only vary a little: possibly an oscillator circuit.

The usual minimum diode current for correct regulation is normally between 5 and 10mA, and the maximum will be limited by the stated maximum dissipation of the Zener diode. A typical BZY88 series device is rated at 400mW, so for the purposes of illustration, let us assume that our unregulated voltage is nominally 20V, and that we wish to stabilize this to 8V. Also, that the current drawn by the load is around 15mA (Figure 1c). Firstly, a suitable value of diode has to be selected, and these come in similar steps to resistors, the E12 series being the easiest to find, so the nearest that can be used will be 8V2. All Zener diodes have tolerances, often plus or minus 5%, so in this case you would expect your output voltage to be within 0V4 of the nominal figure.

We will allow a nominal 10mA to pass through the actual Zener diode as its minimum current, and hence the total current drawn by the circuit will be 25mA (Zener current plus load current). So we need to drop the difference between the supply voltage (20V) and the regulated voltage

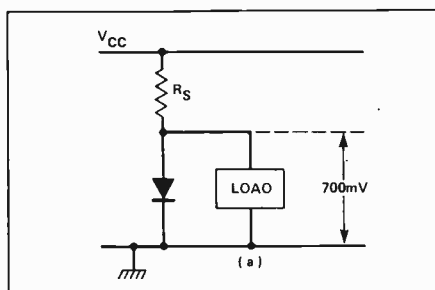

Figure 1a. Forward biased diode regulator.

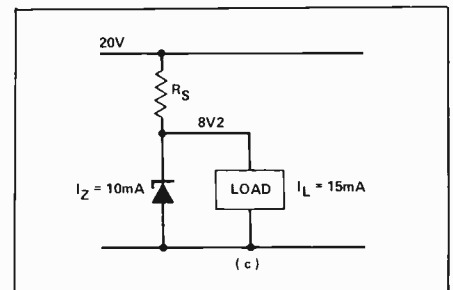

Figure 1c. Example Values.

(8V2) across our series resistor. To maintain the current, Ohms Law comes to the rescue for the value of the resistor:

$$R = \text{Source voltage} - \text{regulated voltage}$$

$$\frac{\text{Load current} + \text{Zener current}}{20 - 8V2} = \frac{.015 + 010}{+ 472 \text{ ohms}}$$

We have defined our load as stable and supply voltage as reasonably stable; the power dissipated by the diode will be 8V2 at 10mA or 82mW, which is within the diode's rating.

Varying Loads

The problems start to come when the current taken by the load varies, as the resistor value then has to be such that it will limit the current taken by the diode to a safe value under all conditions, possibly even if the load is open circuit, leaving all the current passing through the diode. The only way here, is to do the calculations and see what happens.

If the load in question is longer stable, but varies between say 15 and 45mA, then the value of the resistor should first be calculated at the maximum load current, to ensure that the 10mA Zener current is still available. Dropping the new figures into the formula gives an answer of 204 ohms — in practice we would pick the next lowest resistor value at 180 ohms. The next problem to face is what happens to the Zener when the load current drops to 15mA.

The voltage drop across the 180 ohm resistor is still 11V2, so the current passing is 11V2/180R = 62mA. Of this, 15mA is drawn by the load, so the rest is passed by the diode, or 47mA, which at 8V2 represents 384mW — just inside the maximum dissipation. For long life, and reduced heating of the junction, we would need to pick a higher rated Zener of at least 1W, or preferably higher. Don't forget that the series resistor is also dissipating heat, in this case 11V2 at 62mA = 694mW, so don't use a 1/4W resistor! If you want, you can now work out what happens when the load fails to draw any current at all.

Varying Input Voltages

More problems arise when the unregulated input voltage varies, with possibly the load current also varying. If the input voltage is only just a little above the Zener stabilizing voltage, it may not be possible to design a suitable circuit which will maintain sufficient voltage differential across the series resistor under varying load conditions to ensure stabilization at all times.

The same calculations as before apply when the load current and input voltage both vary. Take the previous case of a load

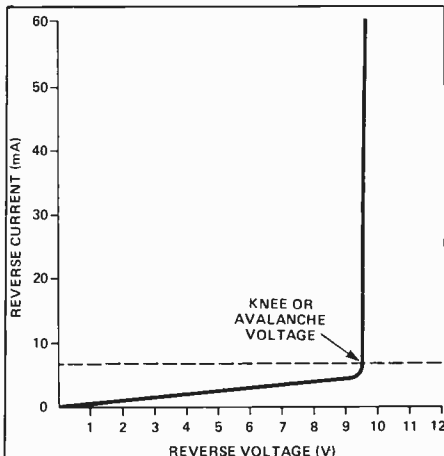

Figure 2. Graph of reverse current vs. reverse voltage for a Zener.

current varying between 15 and 45mA, but additionally the input voltage also varying between 15V and 25V. The formula for the series resistor will now use the minimum voltage input, again so that the minimum Zener current is maintained at maximum load current. The calculation now becomes:

$$\frac{\text{Min. output voltage} - \text{Zener voltage}}{\text{Max. Load current} + \text{Zener current}} = \frac{15 - 8V2}{.045 + 010} = 124 \text{ ohms, or use 120 ohms}$$

Continuing as before, maximum current passed by the 120R resistor is 25 - 8.2/120 = 140mA. Minimum load current is 15mA so the maximum Zener current is 125mA, or equivalent to 1W025 dissipation. In this case we would have to move up to an even higher rated diode of at least 5W rating, or reduce the variation in the maximum load current drawn, or maximum excursion of the input voltage.

It should already be apparent that as variations in load current and input voltage

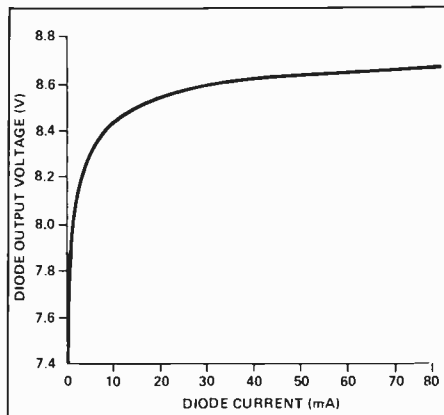

Figure 3. Typical current/voltage curve for a 400mW 8V2 Zener diode.

increase, the efficiency of the Zener stabilizer becomes less, with much of the power drawn being lost as heat. The series resistor in the last example would not be dissipating just under 2W5 maximum.

Regulation

Throughout the above, we have ignored the effect of the varying load current through the Zener on the value of the stabilized output voltage. There are no real problems when the input voltage and load current are stable, but as you might expect, varying the current through the Zener will have some effect on the voltage stabilization. The question is, how much?

Figure 3 shows an actual plot of a nominal 8V2 Zener diode output voltage, against the current drawn by the diode. If you remember our example where the load current varied from 15 to 45mA, the actual Zener current varied from 47 to 10mA as a result. Looking at the graph shows that the output voltage will vary by 200mV. Depending on the circuit, this may or may not be acceptable, representing a variation of plus or minus 2%. This variation in output voltage is caused by the effective resistance of the diode, or its output impedance, changing as the current varies through it — hence the voltage drop across the diode varies. This variation is lowest, and will therefore give the best regulation, for diodes with nominal voltages around the 6V8 region.

You will observe from the graph that as the current increases, the voltage output also increases, fairly rapidly at first, but then levels off somewhat. A way of improving the stability of the output with varying load current is to allow the diode to take higher current at all times, moving the variations to the flatter part of the curve, in the example shown this could improve the regulation to about 1%. The penalties are more power dissipation in the series resistor, and if an inadequately rated diode is used, more heating of its junction.

Thermal Effects

As the junction temperature varies with load, some drift in the output voltage will be experienced. This is not so serious as the effects of load current itself, and depending on the diode, will be of the order of .01 to .1% per degree C of the nominal Zener voltage. Also, the direction of the drift varies with the zener nominal voltages. Below about 6V it is a negative coefficient, and above, positive. Nevertheless, in the case of a Zener stabilized supply feeding an oscillator, where the load current is stable, the effects of temperature need to be minimized, as for the oscillator circuit proper.

You will have noticed that the temperature coefficient is lowest at around 6V, for the same reason that regulation is best at around this voltage and the choice of a 6V2 or 6V8 Zener will provide the lowest drift.

Zener Diode Primer

As Zeners can be cascaded quite happily (and do not need any form of voltage equalization across them) a nominal 12V stabilized line would be better off using two 6V2 diodes in series, rather than a single 12V diode.

Another useful fact is that a normal rectifier diode when forward biased exhibits a negative temperature coefficient. This can be useful to counteract the positive coefficient of Zeners above 6V, by inserting one or more forward biased diodes in series with the reverse biased Zener diode. Also, a non standard value of stabilized voltage can be achieved by using additional rectifier diodes to bump up the Zener voltage in 0V7 increments. 1N4148s are often used for this purpose. However, watch out that they can handle the likely current peaks through the diode chain.

Reference Diodes

A special class of Zener diodes are those which have actually had additional forward biased diodes built in during manufacture. These very low temperature drift diodes are known as reference diodes, and are very useful as precision voltage references only — you should not take any power directly from the device. Such a diode is normally fed from a constant current, or high impedance source, at only a few milliamps of bias current.

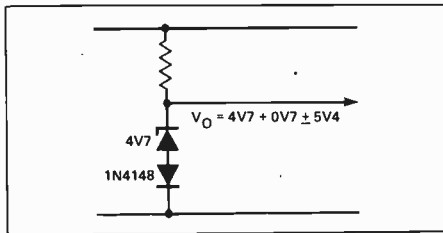

Figure 4. Increasing Zener voltage by 0V6/0V7. Also a temperature stabilizing technique.

A typical example is the 1N821, which is a nominal 6V2 plus or minus 5%, with a temperature coefficient of .01% per degree C. Or the 1N8127, having a similar voltage but improved temperature coefficient of .001% per degree C. Both require around 8mA of bias current. The 1N3499 at the same voltage will maintain stabilization to within .0005% per degree C.

Improving The Regulation

You should now be aware of some of the limitations of the Zener diode as a source of regulated volts, and can see that the best results for the least effort occur when the load current is not more than about 100mA, preferably less, and the source voltage/load current are reasonably stable, or the load voltage regulation is not very critical. If greater currents are required, the better way is to use a Zener as a reference at low current, with the majority of the current passing through an additional series pass transis-

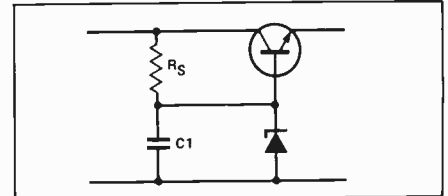

Figure 5. Using a Zener as a reference diode, allowing the transistor to pass the majority of the current. C1 can be added to improve ripple characteristics.

really the subject of power supply design, we will not discuss this further.

Other Uses Of Zener Diodes

Besides their obvious use already described, Zeners lend themselves to a number of other applications. One which you may already be aware of is not to limit the maximum voltage on a line to some predetermined safe value. Placing a high current rated 15V Zener diode across the power leads to a mobile rig will safeguard the rig — if the voltage exceeds 15V, the Zener will conduct and blow the protective fuse, or if the over-voltage is transient in nature, at least limit it to 15V for the duration of the transient.

Stabilization of valve heater supplies is another application which can easily be undertaken using a combination of a 5V6 zener and one silicon diode to bring the voltage up to 6V3.

Transistor PA stages are susceptible to damage if the peak collector voltage exceeds

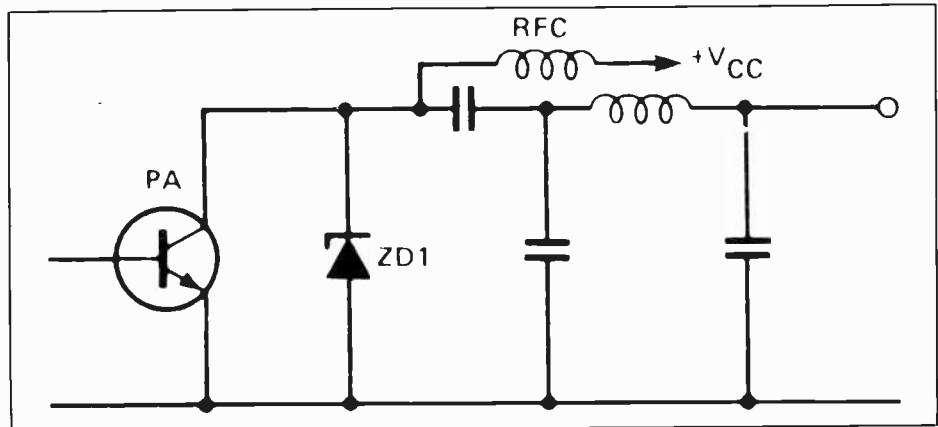

Figure 6. Protecting PA transistor against over-voltage, parasitic oscillations etc. ZD1 is chosen to suit circuit conditions.

tor (Figure 5). Several advantages accrue from this technique — the output ripple is lower, and as the load resistance seen by the Zener is increased by a factor of Hfe (current gain) of the pass transistor, the regulation is improved by a similar factor.

There are a number of limitations of this circuit, but as we are concerned with Zener diodes, and these latest limitations are the ratings for the device. This can occur if the load inadvertently goes open circuit, or parasitic oscillations occur. The addition of

a Zener diode between collector and chassis with a rating sufficient to protect the device under such circumstances would be a sensible addition.

At audio frequencies, Zeners can be used in the back to back configuration to clip AF waveforms at some predetermined value. Bear in mind that the clipping voltage of either the +ve or -ve cycle of the waveform will be that of one Zener's nominal voltage PLUS 0V7 (as one diode is forward, and the other reverse, biased). **ETI**

K.E.M.

ELECTRONICS KITS

- FM Wireless Mike ----- \$18.95
- Music Synthesizer for Alarm, etc. ----- 19.95
- Motion Alarm Sensor ----- 24.95
- Sensor Training Kit ----- 16.95
- Mini Audio Amplifiers
 - 5 Watts RMS Output ----- 8.95
 - Ultra Sonic Remote Controller 1ch ----- 29.95
 - 4ch ----- 49.95
- 4 Digit Resettable UP/DOWN Counter ----- 49.00
- Digital Frequency Counters ----- 69.95
 - 6-digit LED, 1Hz - 10MHz
 - BCD Code Digital Read-Out (OPTION)
 - High Sensitivity 30mV rms Typical
- Pre-scaler for Frequency Counter
 - +10, +100, 200MHz ----- 19.95
 - 550MHz -- Coming Soon ----- ?
- Stepping Motor & Driver Controlled By Computer, APPLE II etc. with Program -- 65.00

ASSEMBLED & TESTED P.C. BOARD UNITS

- ICL8038 Function Generator ----- 36.95
- Digital Capacitance Meter
 - 10pF-999uF ----- 42.95
- LCD Digital Panel Meter ±199.9mV FS. -- 49.95
 - Voltage Divider ----- 21.95
 - Ohm-Volt Converter ----- 24.95
 - Temp-Volt Converter ----- 19.95
- 6-Digit Presettable UP/DOWN Counter -- 99.00
- Data Presetting Unit ----- 49.00

Plus \$3.00 each item for postage & handling charge. Plus provincial sales tax. C.O.D. mail order accepted. Ask for catalog. Dealer inquiries welcome.

KAIENTAI ELECTRONICS

P.O. BOX 69126 STATION 'K'
VANCOUVER, B.C., CANADA V5K4W4

PHONE: (604) 435-9697

Circle No. 9 on Reader Service Card.

Steel Tubes and Water Droplets

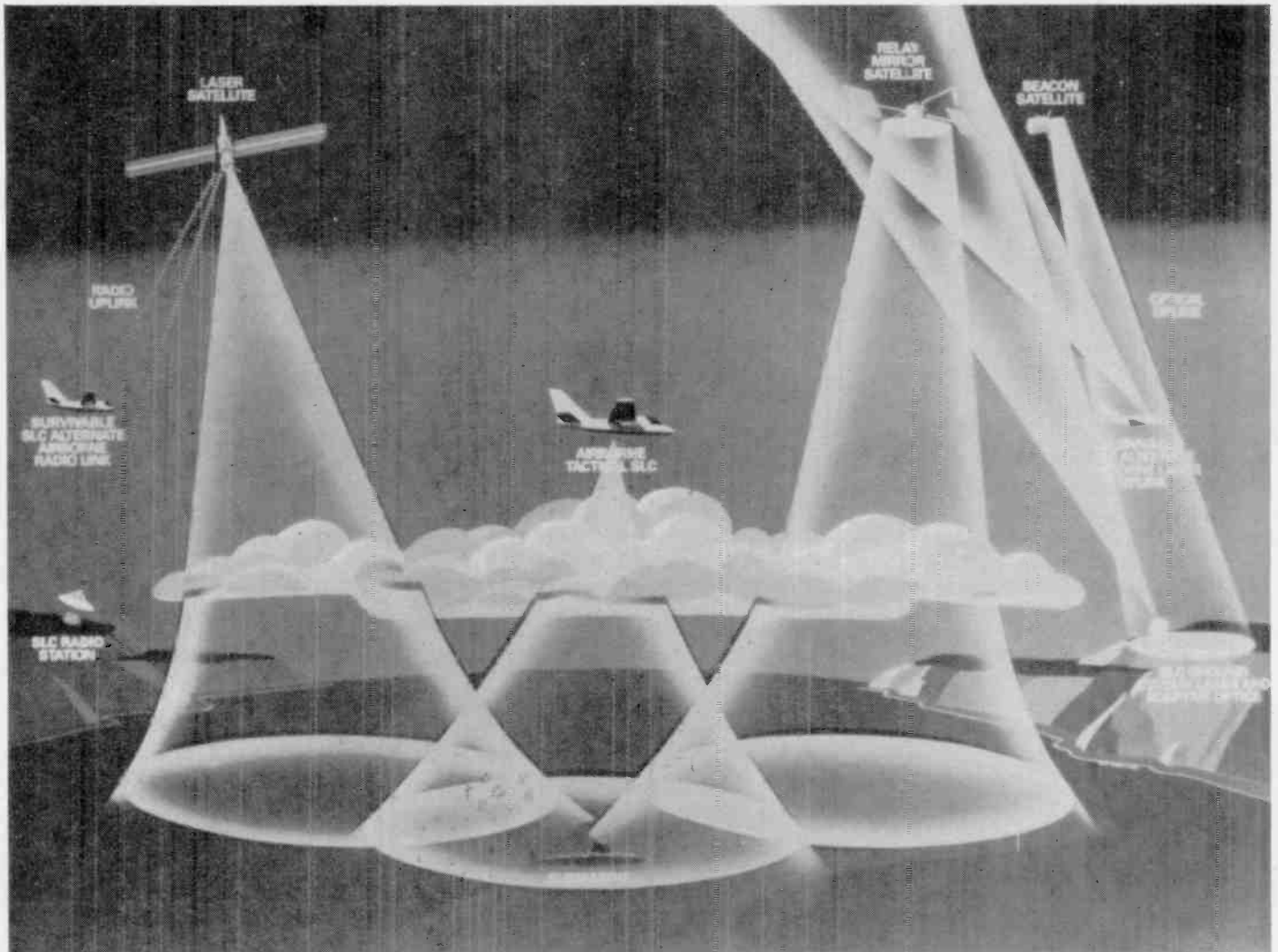

If you have trouble telephoning your neighbour, imagine being under-water and 1000 miles away.

by Roger Allan

THE WORLD IS in a major political crisis.

You are three or four hundred feet underwater commanding enough fire power to take out central Canada.

You are unable to communicate with your headquarters.

Life can be a bit tense.

You can come to the surface, thereby giving away your position, running the risk of being thumped by the other side before you get a chance to thump them, or you can sit tight and do nothing. Needless to say, the powers that walk the Pentagon's corridors don't much fancy either scenario — hence the need to beef up the U.S. Navy's command, control and communication (C³) capability.

To communicate through water is a nuisance, for it strongly absorbs all electromagnetic waves except blue-green light and extremely low frequency (ELF) radio waves. To date, there are two ways to communicate with a submerged submarine — have it come close enough to the surface to send up a whip antenna and communicate via normal radio waves, or

have a Lockheed C-130 Tacamo aircraft fly overhead trailing an eleven mile long antenna broadcasting at very low frequency (VLF). Whip antennas give away positions, and VLFs only penetrate a short distance into the ocean.

In an attempt to overcome the C³ problem, the U.S. Navy is developing two generically alternate systems: one based on ELF's and one on lasers.

ELF's have extremely long wavelengths — some 2500 miles — and as such require extremely long transmitting antennas. A prototype has been built in Wisconsin and Michigan — with a 28 mile long overhead antenna — but despite continued funding by the U.S. Congress, the U.S. Navy is not all that happy with the system. It works fine, but can be so easily destroyed by someone with a pair of wire

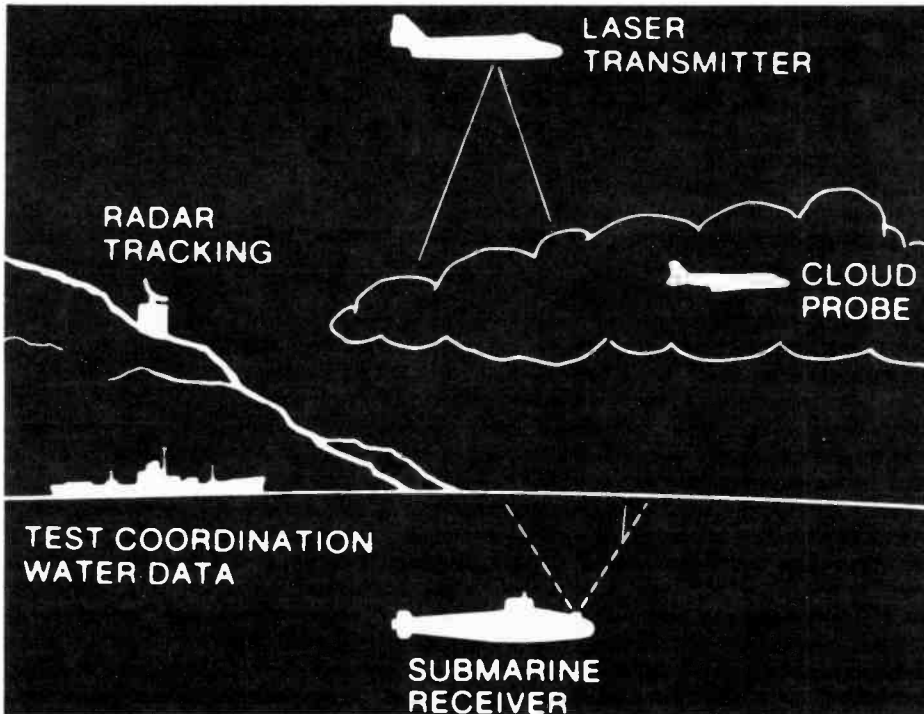

The components of a submarine communications system.

cutters, much less by a bomb or missile warhead. Hence the U.S. Navy's increasing desire for a system based on the only alternate — blue-green light waves.

But to generate enough power to penetrate water requires a laser, and lasers in turn require a good deal of power to get them going with an appreciable strength with regards to sea water penetration. Thus the first difficulty: building a powerful enough generator, small enough and light enough to be carried on an aircraft or satellite (see "Particle Weapons", ETI, March '84).

But where there's a will there's a way and the Defence Advanced Research Projects Agency (DARPA) commenced working on the problem about five years ago. And they've had some success. In May of 1981, DARPA and the U.S. Navy successfully demonstrated a blue-green strategic laser communications system, known as Submarine Laser Communications (SLC), off the coast of California.

It utilized a frequency-doubled neodymium-YAG eximer laser excited by long-lived gallium-arsenide diode arrays (instead of the customary "flash lamp" system). The laser, built by GTE Sylvania, generated 1 w of pulsed power at 0.53 microns. A novel element in the system was the use of a crystal to obtain the high efficiency necessary when passing the laser beam from infrared wavelength to the blue-green required to penetrate the sea water. Customarily, a filter would have been used.

The transmission system was mounted on a Rockwell International T-39 Sabreliner, with the receiver mounted on the submarine USS Dolphin,

submerged to a depth of 100 feet. Transmission times were very slow, taking several minutes to transmit a short message. While in itself too slow to be of any practicable use, it did demonstrate that the physics worked. Of a total of 16 tests conducted, 15 are reported to have been successful, though which one failed no one will say.

GTE Sylvania, having thereby demonstrated its ability with lasers, was then selected to develop a 10 w frequency doubled laser for a new series of tests

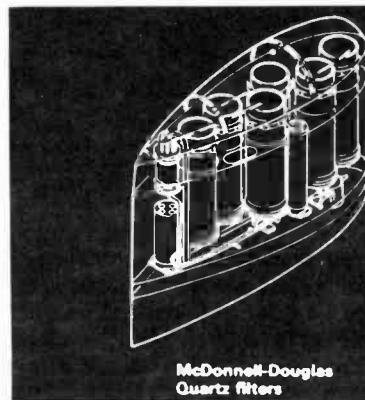

McDonnell-Douglas Quartz filters

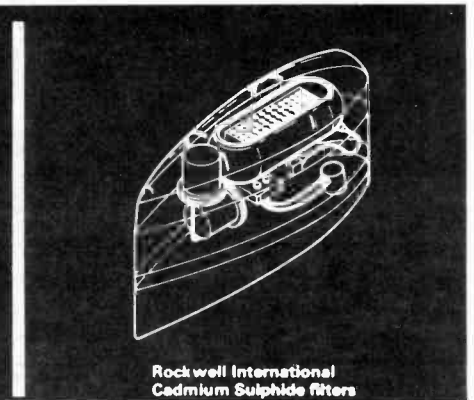

Rockwell International Cadmium Sulphide filters

Experimental submarine-laser communications receivers can be installed on submarines for tests.

under more challenging conditions, expected to begin early in 1984. The new laser will also be able to operate a somewhat higher pulse repetition rates than the 10 pulses/sec of the earlier model.

Acting in a competitive fashion, DARPA simultaneously contracted Avco Everett Research Laboratory to develop a xenon-fluoride rare gas halogen eximer

laser. The ultraviolet beam from this device will provide, it is hoped, ten times the single-pulse energy required. After propagation, the laser light will be Raman-shifted to the blue-green wavelength. In this system, electron beams are pumped into opposing sides of the laser cavity, powered by a pulse forming electrical network, rather than the customary continuous light stream.

The new series of tests will also be conducted under more difficult conditions, such as heavy cloud cover, higher altitudes, and in more turbid water.

Another problem that will have to be overcome is bioluminescence — the faint light emitted by some marine organisms that provides unwanted background noise, which in turn obscures the faint laser signals at any sort of depth. To overcome this problem, Lockheed Missiles and Space Co., working under DARPA contract, is developing filters with a bandwidth of only two angstroms and with a 15 degree wide signal acceptance angle. Such filters should be useful in excluding, or at least minimizing, bioluminescence.

Two competitive companies, McDonnell-Douglas and Rockwell International, working on the same problem, have taken Lockheed's quartz birefringent filter system and refined it — McDonnell-Douglas experimenting with pure quartz filters and Rockwell with cadmium sulphide filters. But whichever system is finally selected, they will have to be extremely accurate. At a depth of 100 feet, the pulsed power of the laser reaching the submarine will only have the directed strength of a single star on a moonless night to a person standing on

the sea shore.

Should everything work out according to plan — and the U.S. Navy is confident it will, even going so far as to scale down the ELF research in favour of a \$40 million a year SLC research and development program — then a practicable demonstration should be possible by the end of this decade, and a strategic system in place by the early 1990s. **ETI**

Electronic Bookshelf

ELECTRONICS BEGINNERS

PH255: COMPLETE GUIDE TO READING SCHEMATIC DIAGRAMS, 2nd Edition
J. DOUGLAS-YOUNG \$9.95

Packed with scores of easy-to-understand diagrams and invaluable troubleshooting tips as well as a circuit finder chart and a new section on logic circuits.

PH251: BEGINNER'S HANDBOOK OF IC PROJECTS
D. HEISERMAN \$16.95

Welcome to the world of integrated circuit (IC) electronic projects. This book contains over 100 projects (each including a schematic diagram, parts list, and descriptive notes.)

PH252: DIGITAL ICs: HOW THEY WORK AND HOW TO USE THEM
A. BARBER \$10.95

The dozens of illustrations included in this essential reference book will help explain time-saving test procedures, interpreting values, performing voltage measurements, and much more!

PH249: THE BEGINNER'S HANDBOOK OF ELECTRONICS
G. OLSEN & M. MIMS, III \$10.95

In this basic book, the authors cover the entire spectrum of modern electronics, including the use of such components as integrated circuits and semiconductor devices in record players, radio receivers, airplane guidance systems, and many others.

THE BEGINNER'S HANDBOOK OF ELECTRONICS
AB003 \$10.95

An excellent textbook for those interested in the fundamentals of Electronics. This book covers all major aspects of power supplies, amplifiers, oscillators, radio, television and more.

ELECTRONIC THEORY

ELEMENTS OF ELECTRONICS — AN ON-GOING SERIES

F.A. WILSON, C.G.I.A., C.Eng.,
BP62: BOOK 1. The Simple Electronic Circuit and Components \$8.45

BP63: BOOK 2. Alternating Current Theory \$8.45

BP64: BOOK 3. Semiconductor Technology \$8.45

BP77: BOOK 4. Microprocessing Systems And Circuits \$11.70

BP89: BOOK 5. Communication \$11.70

The aim of this series of books can be stated quite simply — it is to provide an inexpensive introduction to modern electronics so that the reader will start on the right road by thoroughly understanding the fundamental principles involved.

Although written especially for readers with no more than ordinary arithmetical skills, the use of mathematics is not avoided, and all the mathematics required is taught as the reader progresses.

Each book is a complete treatise of a particular branch of the subject and, therefore, can be used on its own with one proviso, that the later books do not duplicate material from their predecessors, thus a working knowledge of the subjects covered by the earlier books is assumed.

BOOK 1: This book contains all the fundamental theory necessary to lead to a full understanding of the simple electronic circuit and its main components

BOOK 2: This book continues with alternating current theory without which there can be no comprehension of speech, music, radio, television or even the electricity utilities.

BOOK 3: Follows on semiconductor technology, leading up to transistors and integrated circuits

BOOK 4: A complete description of the internal workings of microprocessor.

BOOK 5: A book covering the whole communication scene.

PH241: DC ELECTRONICS \$16.95
Covers everything from voltage current, and resistance relationships to more advanced studies of electrical measurements, circuits, resistors, capacitors, and inductors

PH242: AC ELECTRONICS \$16.95
Covers AC fundamentals and theory. Includes discussions and experiments in resonance and reactance; RC, RL, and RLC circuits; and how to work with formulas to analyze the operations of AC circuitry

PH243: ELECTRONICS CIRCUITS \$16.95
Covers all of the most popular electronic circuits, with emphasis on integrated circuits

PH244: SEMICONDUCTOR DEVICES \$16.95
Covers semi-conductor fundamentals, diodes, zeners, bipolar transistor operation and characteristics, FETs, thyristors, ICs, and optoelectronics

PH247: DIGITAL TECHNIQUES \$19.95
Covers logic circuits, Boolean Algebra, flip-flops, registers, combinational logic circuitry, and digital design

Tab1531: CONCEPTS OF DIGITAL ELECTRONICS \$21.95
This book erases the mysteries surrounding digital electronics theory. Understand and use low-cost 7400 series IC's to produce working digital devices including a power supply and a breadboard experimenter.

PROJECTS

BP48: ELECTRONIC PROJECTS FOR BEGINNERS \$5.40

F.G. RAYER, T.Eng.(CEI), Assoc.IERE
Another book written by the very experienced author — Mr. F.G. Rayer — and in it the newcomer to electronics, will find a wide range of easily made projects. Also, there are a considerable number of actual component and wiring layouts, to aid the beginner

Furthermore, a number of projects have been arranged so that they can be constructed without any need for soldering and, thus, avoid the need for a soldering iron.

Also, many of the later projects can be built along the lines as those in the 'No Soldering' section so this may considerably increase the scope of projects which the newcomer can build and use.

221: 28 TESTED TRANSISTOR PROJECTS \$5.00

R.TORRENS
Mr. Richard Torrens is a well experienced electronics development engineer and has designed, developed, built and tested the many useful and interesting circuits included in this book. The projects themselves can be split down into simpler building blocks, which are shown separated by boxes in the circuits for ease of description, and also to enable any reader who wishes to combine boxes from different projects to realise ideas of his own.

BP49: POPULAR ELECTRONIC PROJECTS \$5.75

R.A. PENFOLD
Includes a collection of the most popular types of circuits and projects which, we feel sure, will provide a number of designs to interest most electronics constructors. The projects selected cover a very wide range and are divided into four basic types. Radio Projects, Audio Projects, Household Projects and Test Equipment.

EXPERIMENTER'S GUIDE TO SOLID STATE ELECTRONIC PROJECTS

AB007 \$9.95
An ideal sourcebook of Solid State circuits and techniques with many practical circuits. Also included are many useful types of experimenter gear.

BP71: ELECTRONIC HOUSEHOLD PROJECTS \$7.20

R. A. PENFOLD
Some of the most useful and popular electronic construction projects are those that can be used in or around the home. The circuits range from such things as '2 Tone Door Buzzer', Intercom, through Smoke or Gas Detectors to Baby and Freezer Alarms.

BP94: ELECTRONIC PROJECTS FOR CARS AND BOATS \$8.10

R.A. PENFOLD \$7.60
Projects, fifteen in all, which use a 12V supply are the basis of this book. Included are projects on Windscreen Wiper Control, Courtesy Light Delay, Battery Monitor, Cassette Power Supply, Lights Timer, Vehicle Immobiliser, Gas and Smoke Alarm, Depth Warning and Shaver Inverter.

BP69: ELECTRONIC GAMES \$7.05

R.A. PENFOLD
In this book Mr. R. A. Penfold has designed and developed a number of interesting electronic game projects using modern integrated circuits. The text is divided into two sections, the first dealing with simple games and the latter dealing with more complex circuits.

BP95: MODEL RAILWAY PROJECTS \$7.60

Electronic projects for model railways are fairly recent and have made possible an amazing degree of realism. The projects covered include controllers, signals and sound effects: stribroad layouts are provided for each project.

BP93: ELECTRONIC TIMER PROJECTS \$7.60

F.G. RAYER
Windscreen wiper delay, darkroom timer and metronome projects are included. Some of the more complex circuits are made up from simpler sub-circuits which are dealt with individually

110 OP-AMP PROJECTS

MARSTON \$12.95
HB24
This handbook outlines the characteristics of the op-amp and present 110 highly useful projects—ranging from simple amplifiers to sophisticated instrumentation circuits.

110 IC TIMER PROJECTS

GILDER \$10.95
HB25
This sourcebook maps out applications for the 555 timer IC. It covers the operation of the IC itself to aid you in learning how to design your own circuits with the IC. There are application chapters for timer-based instruments, automotive applications, alarm and control circuits, and power supply and converter applications.

BP110: HOW TO GET YOUR ELECTRONIC PROJECTS WORKING \$7.60

R.A. PENFOLD
We have all built circuits from magazines and books only to find that they did not work correctly, or at all, when first switched on. The aim of this book is to help the reader overcome just these problems by indicating how and where to start looking for many of the common faults that can occur when building up projects.

PH250: EXPERIMENTER'S GUIDE TO SOLID STATE ELECTRONICS PROJECTS \$9.95

A. BARBER
This book takes the mystery out of solid state electronics and enables the reader to build such useful devices as series regulated power supplies, light dimmers, solar cell operated radios, hi-fi amplifiers, light indicators for battery operated equipment and much more.

110 THYRISTOR PROJECTS USING SCRs AND TRIACS

MARSTON \$12.95
HB22
A grab bag of challenging and useful semiconductor projects for the hobbyist, experimenter, and student. The projects range from simple burglar, fire, and water level alarms to sophisticated power control devices for electric tools and trains. Integrated circuits are incorporated wherever their use reduces project costs.

110 CMOS DIGITAL IC PROJECTS

MARSTON \$11.25
HB23
Outlines the operating characteristics of CMOS digital ICs and then presents and discusses 110 CMOS digital IC circuits ranging from inverter gate and logic circuits to electronic alarm circuits. Ideal for amateurs, students and professional engineers.

BP76: POWER SUPPLY PROJECTS \$6.80

R.A. PENFOLD
Line power supplies are an essential part of many electronics projects. The purpose of this book is to give a number of power supply designs, including simple unregulated types, fixed voltage regulated types, and variable voltage stabilised designs, the latter being primarily intended for use as bench supplies for the electronics workshop. The designs provided are all low voltage types for semiconductor circuits.

There are other types of power supply and a number of these are dealt with in the final chapter, including a cassette power supply, Ni-Cd battery charger, voltage step up circuit and a simple inverter.

BP84: DIGITAL IC PROJECTS \$7.60

F.G. RAYER, T.Eng.(CEI), Assoc.IERE
This book contains both simple and more advanced projects and it is hoped that these will be found of help to the reader developing a knowledge of the workings of digital circuits. To help the newcomer to the hobby the author has included a number of board layouts and wiring diagrams. Also, the more ambitious projects can be built and tested section by section and this should help avoid or correct faults that could otherwise be troublesome. An ideal book for both beginner and more advanced enthusiast alike.

BP67: COUNTER DRIVER AND NUMERAL DISPLAY PROJECTS \$7.05

F.G. RAYER, T.Eng.(CEI), Assoc. IERE
Numeral indicating devices have come very much to the forefront in recent years and will, undoubtedly, find increasing applications in all sorts of equipment. With present day integrated circuits, it is easy to count, divide and display numerically the electrical pulses obtained from a great range of driver circuits.

In this book many applications and projects using various types of numeral displays, popular counter and driver IC's etc. are considered.

BP73: REMOTE CONTROL PROJECTS \$8.10

OWEN BISHOP
This book is aimed primarily at the electronics enthusiast who wishes to experiment with remote control. Full explanations have been given so that the reader can fully understand how the circuits work and can more easily see how to modify them for other purposes, depending on personal requirements. Not only are radio control systems considered but also infra-red, visible light and ultrasonic systems as are the use of Logic ICs and Pulse position modulation etc

BP99: MINI — MATRIX BOARD PROJECTS \$7.60

R.A. PENFOLD
Twenty useful projects which can all be built on a 24 x 10 hole matrix board with copper strips. Includes Doorbuzzer, Low-voltage Alarm, AM Radio, Signal Generator, Projector Timer, Guitar Headphone Amp, Transistor Checker and more.

BP103: MULTI-CIRCUIT BOARD PROJECTS \$7.60

R.A. PENFOLD
This book allows the reader to build 21 fairly simple electronic projects, all of which may be constructed on the same printed circuit board. Wherever possible, the same components have been used in each design so that with a relatively small number of components and hence low cost, it is possible to make any one of the projects or by re-using the components and P.C.B. all of the projects.

Tab1431: DIGITAL ELECTRONIC PROJECTS \$20.95

Build a deluxe code oscillator, a digital game called Climb-the-Mountain, a clock with alarm, a metric measuring wheel, a modular decade counter, even a 14-note music generator. 17 projects in all.

BP107: 30 SOLDERLESS BREADBOARD PROJECTS — BOOK 1 \$8.85

R.A. PENFOLD
A "Solderless Breadboard" is simply a special board on which electronic circuits can be built and tested. The components used are just plugged in and unplugged as desired. The 30 projects featured in this book have been specially designed to be built on a "Verobloc" breadboard. Wherever possible the components used are common to several projects, hence with only a modest number of reasonably inexpensive components it is possible to build, in turn, every project shown.

BP106: MODERN OP-AMP PROJECTS
R.A. PENFOLD \$7.60
 Features a wide range of constructional projects which make use of op-amps including low-noise, low distortion, ultra-high input impedance, high slew-rate and high output current types

CIRCUITS

BP80: POPULAR ELECTRONIC CIRCUITS — BOOK 1
R.A. PENFOLD \$7.75
 Another book by the very popular author, Mr. R.A. Penfold, who has designed and developed a large number of various circuits. These are grouped under the following general headings, Audio Circuits, Radio Circuits, Test Gear Circuits, Music Project Circuits, Household Project Circuits and Miscellaneous Circuits.

BP98: POPULAR ELECTRONIC CIRCUITS, BOOK 2
R.A. PENFOLD \$8.85
 70 plus circuits based on modern components aimed at those with some experience.

The GIANT HANDBOOK OF ELECTRONIC CIRCUITS
TAB No.1300 \$27.95
 About as twice as thick as the Webster's dictionary, and having many more circuit diagrams, this book is ideal for any experimenter who wants to keep amused for several centuries. If there isn't a circuit for it in here, you should have no difficulty convincing yourself you don't really want to build it.

BP39: 50 (FET) FIELD EFFECT TRANSISTOR PROJECTS
F.G. RAYER, T.Eng.(CEI),Assoc.IERE \$5.00
 Field effect transistors (FETs), find application in a wide variety of circuits. The projects described here include radio frequency amplifiers and converters, test equipment and receiver aids, tuners, receivers, mixers and tone controls, as well as various miscellaneous devices which are useful in the home.

This book contains something of particular interest for every class of enthusiast — short wave listener, radio amateur, experimenter or audio devotee

BP87: SIMPLE L.E.D. CIRCUITS
R.N. SOAR \$5.40
 Since it first appeared in 1977, Mr. R.N. Soar's book has proved very popular. The author has developed a further range of circuits and these are included in Book 2. Projects include a Transistor Tester, Various Voltage Regulators, Testers and so on.

BP42: 50 SIMPLE L.E.D. CIRCUITS
R.N. SOAR \$3.05
 The author of this book, Mr. R.N. Soar, has compiled 50 interesting and useful circuits and applications, covering many different branches of electronics, using one of the most inexpensive and freely available components — the Light Emitting Diode (L.E.D.) A useful book for the library of both beginner and more advanced enthusiast alike

BP82: ELECTRONIC PROJECTS USING SOLAR CELLS
OWEN BISHOP \$7.60
 The book contains simple circuits, almost all of which operate at low voltage and low currents, making them suitable for being powered by a small array of silicon cells. The projects cover a wide range from a bicycle speedometer to a novelty 'Duck Shoot', a number of power supply circuits are included

BP37: 50 PROJECTS USING RELAYS, SCR'S & TRIACS
F.G. RAYER, T.Eng.(CEI),Assoc.IERE \$5.00
 Relays, silicon controlled rectifiers (SCR's) and bi-directional triodes (TRIACs) have a wide range of applications in electronics today. This book gives tried and practical working circuits which should present the minimum of difficulty for the enthusiast to construct. In most of the circuits there is a wide latitude in component values and types, allowing easy modification of circuits or ready adaptation of them to individual needs

BP24: 50 PROJECTS USING IC741
RUDI & UWE REDMER \$3.75
 This book, originally published in Germany by TOPP, has achieved phenomenal sales on the Continent and Babani decided, in view of the fact that the integrated circuit used in this book is inexpensive to buy, to make this unique book available to the English speaking reader. Translated from the original German with copious notes, data and circuitry, a "must" for everyone whatever their interest in electronics

BP83: VMOS PROJECTS
R.A. PENFOLD \$7.70
 Although modern bipolar power transistors give excellent results in a wide range of applications, they are not without their drawbacks or limitations. This book will primarily be concerned with VMOS power FETs although power MOSFETs will be dealt with in the chapter on audio circuits. A number of varied and interesting projects are covered under the main headings of: Audio Circuits, Sound Generator Circuits, DC Control Circuits and Signal Control Circuits

BP44: IC 555 PROJECTS
E.A. PARR, B.Sc.,C.Eng., M.I.E.E. \$7.05
 Every so often a device appears that is so useful that one wonders how life went on before without it. The 555 timer is such a device. Included in this book are Basic and General Circuits, Motor Car and Model Railway Circuits, Alarms and Noise Makers as well as a section on the 556, 558 and 559 timers.

BP65: SINGLE IC PROJECTS
R.A. PENFOLD \$6.05
 There is now a vast range of ICs available to the amateur market, the majority of which are not necessarily designed for use in a single application and can offer unlimited possibilities. All the projects contained in this book are simple to construct and are based on a single IC. A few projects employ one or two transistors in addition to an IC but in most cases the IC is the only active device used.

BP97: IC PROJECTS FOR BEGINNERS
F.G. RAYER \$7.60
 Covers power supplies, radio, audio, oscillators, timers and switches. Aimed at the less experienced reader, the components used are popular and inexpensive

BP88: HOW TO USE OP AMPS
E.A. PARR \$8.85
 A designer's guide covering several op amps, serving as a source book of circuits and a reference book for design calculations. The approach has been made as non-mathematical as possible.

IC ARRAY COOKBOOK
JUNG
H826 \$13.75
 A practical handbook aimed at solving electronic circuit application problems by using IC arrays. An IC array, unlike specific-purpose ICs, is made up of uncommitted IC active devices, such as transistors, resistors, etc. This book covers the basic types of such ICs and illustrates with examples how to design with them. Circuit examples are included, as well as general design information useful in applying arrays

BP50: IC LM3900 PROJECTS
H.KYBETT, B.Sc., C.Eng. \$5.40
 The purpose of this book is to introduce the LM3900 to the Technician, Experimenter and the Hobbyist. It provides the groundwork for both simple and more advanced uses, and is more than just a collection of simple circuits or projects. Simple basic working circuits are used to introduce this IC. The LM3900 can do much more than is shown here, this is just an introduction. Imagination is the only limitation with this useful and versatile device. But first the reader must know the basics and that is what this book is all about

223: 50 PROJECTS USING IC CA3130
R.A. PENFOLD \$5.00
 In this book, the author has designed and developed a number of interesting and useful projects which are divided into five general categories: I — Audio Projects II — R.F. Projects III — Test Equipment IV — Household Projects V — Miscellaneous Projects.

224: 50 CMOS IC PROJECTS
R.A. PENFOLD \$3.75
 CMOS IC's are probably the most versatile range of digital devices for use by the amateur enthusiast. They are suitable for an extraordinary wide range of applications and are also some of the most inexpensive and easily available types of IC.
 Mr. R.A. Penfold has designed and developed a number of interesting and useful projects which are divided into four general categories: I — Multivibrators II — Amplifiers and Oscillators III — Trigger Devices IV — Special Devices.

THE ACTIVE FILTER HANDBOOK
TAB No.1133 \$13.95
 Whatever your field — computing, communications, audio, electronic music or whatever — you will find this book the ideal reference for active filter design.
 The book introduces filters and their uses. The basic math is discussed so that the reader can tell where all design equations come from. The book also presents many practical circuits including a graphic equalizer, computer tape interface and more.

DIGITAL ICs — HOW THEY WORK AND HOW TO USE THEM
AB004 \$10.95
 An excellent primer on the fundamentals of digital electronics. This book discusses the nature of gates and related concepts and also deals with the problems inherent to practical digital circuits.

MASTER HANDBOOK OF 1001 PRACTICAL CIRCUITS
TAB No.800 \$19.95
MASTER HANDBOOK OF 1001 MORE PRACTICAL CIRCUITS
TAB No.804 \$23.95
 Here are transistor and IC circuits for just about any application you might have. An ideal source book for the engineer, technician or hobbyist. Circuits are classified according to function, and all sections appear in alphabetical order.

THE MASTER IC COOKBOOK
TAB No.1199 \$17.95
 If you've ever tried to find specs for a so called 'standard' chip, then you'll appreciate this book. C.L. Hallmark has compiled specs and pinout for most types of ICs that you'd ever want to use.

ELECTRONIC DESIGN WITH OFF THE SHELF INTEGRATED CIRCUITS
AB016 \$12.95
 This practical handbook enables you to take advantage of the vast range of applications made possible by integrated circuits. The book tells how, in step by step fashion, to select components and how to combine them into functional electronic systems. If you want to stop being a "cookbook hobbyist", then this is the book for you

BP117: PRACTICAL ELECTRONIC BUILDING BLOCKS
BOOK 1 \$7.60
 Virtually any electronic circuit will be found to consist of a number of distinct stages when analysed. Some circuits inevitably have unusual stages using specialised circuitry, but in most cases circuits are built up from building blocks of standard types.

This book is designed to aid electronics enthusiasts who like to experiment with circuits and produce their own projects rather than simply follow published project designs.
 The circuits for a number of useful building blocks are included in this book. Where relevant, details of how to change the parameters of each circuit are given so that they can easily be modified to suit individual requirements.

PH253: ELECTRONIC DESIGN WITH OFF-THE-SHELF INTEGRATED CIRCUITS
Z. MEIKEN & P. TACKRAY \$12.95
 A real help for do-it-yourselfers, this handy guide tells professionals and hobbyists alike, how to take components off the shelves, arrange them into circuitry, and make any system perform its desired function

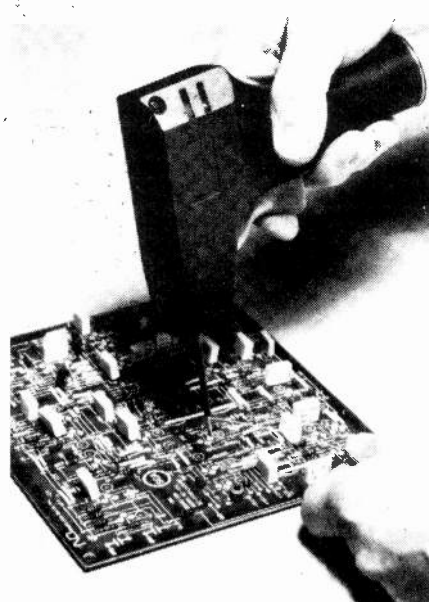

RADIO AND COMMUNICATIONS

BP79: RADIO CONTROL FOR BEGINNERS \$6.80
F.G. RAYER, T.Eng.(CEI), Assoc.IERE.

The aim of this book is to act as an introduction to Radio Control for beginners to the hobby. The book will commence by dealing with the conditions that are allowable for such things as frequency and power of transmission. This is followed by a "block" explanation of how control-device and transmitter operate and receiver and actuator(s) produce motion in a model.

Details are then given of actual solid state transmitting equipment which the reader can build. Plain and loaded aerials are then discussed and so is the field-strength meter to help with proper setting up.

The radio receiving equipment is then dealt with which includes a simple receiver and also a crystal controlled superhet. The book ends with the electro-mechanical means of obtaining movement of the controls of the model.

BP96: CB PROJECTS \$7.60
R.A. PENFOLD

Projects include speech processor, aerial booster, cordless mike, aerial and harmonic filters, field strength meter, power supply, CB receiver and more.

222: SOLID STATE SHORT WAVE RECEIVERS FOR BEGINNERS \$4.70
R.A. PENFOLD

In this book, R.A. Penfold has designed and developed several modern solid state short wave receiver circuits that will give a fairly high level of performance, despite the fact that they use only relatively few and inexpensive components.

BP91: AN INTRODUCTION TO RADIO DXing \$7.60

This book is divided into two main sections one to amateur band reception, the other to broadcast bands. Advice is given to suitable equipment and techniques. A number of related constructional projects are described.

BP105: AERIAL PROJECTS \$7.60
R.A. PENFOLD

The subject of aerials is vast but in this book the author has considered practical designs including active, loop and ferrite aerials, which give good performances and are reasonably simple and inexpensive to build. The complex theory and math of aerial design are avoided.

BP46: RADIO CIRCUITS USING IC'S \$5.40
J.B. DANCE, M.Sc.

This book describes integrated circuits and how they can be employed in receivers for the reception of either amplitude or frequency modulated signals. The chapter on amplitude modulated (a.m.) receivers will be of most interest to those who wish to receive distant stations at only moderate audio quality, while the chapter on frequency modulation (f.m.) receivers will appeal to those who desire high fidelity reception.

BP92: ELECTRONICS SIMPLIFIED - CRYSTAL SET CONSTRUCTION \$6.80
F.A. WILSON

Aimed at those who want to get into construction without much theoretical study. Homewound coils are used and all projects are very inexpensive to build.

PH245: ELECTRONIC COMMUNICATIONS \$16.95

Covers amplitude modulation, AM and FM transmitters, pulse modulation, and antennas. Includes discussions of applications.

BP70: TRANSISTOR RADIO FAULT-FINDING CHART \$1.90
CHAS. E. MILLER

Across the top of the chart will be found four rectangles containing brief descriptions of various faults, viz - sound weak but undistorted, set dead, sound low or distorted and background noises. One then selects the most appropriate of these and following the arrows, carries out the suggested checks in sequence until the fault is cleared.

MOORSHEAD PUBLICATIONS

Return Policy

If, within 10 days of receiving a book from our Book Service, you decide that the title is not suitable or what you expected, you may return it, in marketable condition, for a refund or credit (your choice). We would appreciate a reason for the return but even if this is not given, refunds will be made promptly and cheerfully.

AUDIO

BP90: AUDIO PROJECTS \$7.60
F.G. RAYER

Covers in detail the construction of a wide range of audio projects. The text has been divided into preamplifiers and mixers, power amplifiers, tone controls and matching and miscellaneous projects.

205: FIRST BOOK OF HI-FI LOUDSPEAKER ENCLOSURES \$3.05
B.B. BABANI

This book gives data for building most types of loudspeaker enclosure. Includes corner reflex, bass reflex, exponential horn, folded horn, tuned port, klipschorn labyrinth, tuned column, loaded port and multi speaker panoramic. Many clear diagrams for every construction showing the dimensions necessary.

BP47: MOBILE DISCOTHEQUE HANDBOOK \$5.40
COLIN CARSON

The vast majority of people who start up "Mobile Discos" know very little about their equipment or even what to buy. Many people have wasted a "small fortune" on poor, unnecessary or badly matched apparatus.

The aim of this book is to give you enough information to enable you to have a better understanding of many aspects of "disco" gear.

HOW TO BUILD A SMALL BUDGET RECORDING STUDIO FROM SCRATCH \$15.95
TAB No.1166

The author, F. Alton Everest, has gotten studios together several times, and presents twelve complete, tested designs for a wide variety of applications. If all you own is a mono cassette recorder, you don't need this book. If you don't want your new four track to wind up sounding like one, though, you shouldn't be without it.

BP51: ELECTRONIC MUSIC AND CREATIVE TAPE RECORDING \$5.00
M.K. BERRY

Electronic music is the new music of the Twentieth Century. It plays a large part in "pop" and "rock" music and, in fact, there is scarcely a group without some sort of synthesiser or other effects generator.

This book sets out to show how electronic music can be made at home with the simplest and most inexpensive of equipment. It then describes how the sounds are generated and how these may be recorded to build up the final composition.

BP74: ELECTRONIC MUSIC PROJECTS \$7.20
R.A. PENFOLD

Although one of the more recent branches of amateur electronics, electronic music has now become extremely popular and there are many projects which fall into this category. The purpose of this book is to provide the constructor with a number of practical circuits for the less complex items of electronic music equipment, including such things as a Fuzz Box, Waa-Waa Pedal, Sustain Unit, Reverberation and Phaser-Units, Tremelo Generator etc.

BP81: ELECTRONIC SYNTHESISER PROJECTS \$6.80
M.K. BERRY

One of the most fascinating and rewarding applications of electronics is in electronic music and there is hardly a group today without some sort of synthesiser or effects generator. Although an electronic synthesiser is quite a complex piece of electronic equipment, it can be broken down into much simpler units which may be built individually and these can then be used or assembled together to make a complete instrument.

ELECTRONIC MUSIC SYNTHESIZERS \$10.95
TAB No.1167

If you're fascinated by the potential of electronics in the field of music, then this is the book for you. Included is data on synthesizers in general as well as particular models. There is also a chapter on the various accessories that are available.

Tab1364: DESIGNING, BUILDING AND TESTING YOUR OWN SPEAKER SYSTEM ... WITH PROJECTS \$13.95

Covers the theory of speaker construction and describes a variety of plans for speaker system projects ranging from simple setups to complex multi-driver systems. Enclosure design is covered in very good detail.

BP68: CHOOSING AND USING YOUR HI-FI \$6.75
MAURICE L. JAY

The main aim of this book is to provide the reader with the fundamental information necessary to enable him to make a satisfactory choice from the extensive range of hi-fi equipment now on the market.

Help is given to the reader in understanding the equipment he is interested in buying and the author also gives his own opinion of the minimum standards and specifications one should look for. The book also offers helpful advice on how to use your hi-fi properly so as to realise its potential. A Glossary of terms is also included.

TEST EQUIPMENT

BP75: ELECTRONIC TEST EQUIPMENT CONSTRUCTION \$6.80
F.G. RAYER, T.Eng. (CEI), Assoc. IERE

This book covers in detail the construction of a wide range of test equipment for both the Electronics Hobbyists and Radio Amateur. Included are projects ranging from an f.f.t. Amplified Voltmeter and Resistance Bridge to a Field Strength Indicator and Heterodyne Frequency Meter. Not only can the home constructor enjoy building the equipment but the finished projects can also be usefully utilised in the furtherance of his hobby.

99 TEST EQUIPMENT PROJECTS YOU CAN BUILD \$15.95
TAB No.805

An excellent source book for the hobbyist who wants to build up his work bench inexpensively. Projects range from a simple signal tracer to a 50MHz frequency counter. There are circuits to measure just about any electrical quantity: voltage, current, capacitance, impedance and more. The variety is endless and includes just about anything you could wish for!

HOW TO GET THE MOST OUT OF LOW COST TEST EQUIPMENT \$9.95
AB017

Whether you want to get your vintage 1960 TestRite signal generator working, or you've got something to measure with nothing to measure it with, this is the book for you. The author discusses how to maximize the usefulness of cheap test gear, how to upgrade old equipment, and effective test set ups.

THE POWER SUPPLY HANDBOOK \$15.95
TAB No.806

A complete one stop reference for hobbyists and engineers. Contains high and low voltage power supplies of every conceivable type as well mobile and portable units.

PH246: ELECTRONIC TEST EQUIPMENT \$19.95

Covers analog and digital meters, oscilloscopes, frequency generation and measurement, and special measuring instruments.

Tab1532: THE COMPLETE BOOK OF OSCILLOSCOPES \$19.95

This totally up-to-date handbook is both an in-depth reference source and a practical applications guide. Information is included on both ordinary service and laboratory scopes, waveform analysis, vectors, vectorscopes, high and low frequency analysis, sampling, storage, digital scopes, and signature analysis. The author, Stan Prentiss is one of the leading technical writers in the U.S.

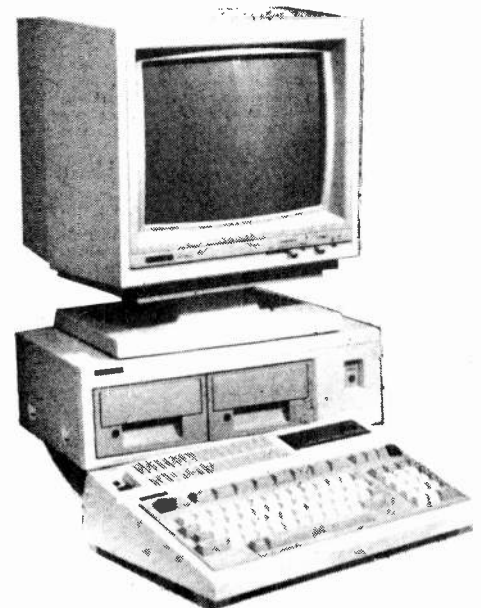

Our Notebook continues with the second and final part of Switched Power Supplies

SWITCHING POWER supplies can use capacitive elements as the energy transfer medium, rather than magnetic components which have been considered so far. Generally, capacitive circuits are limited to use at high frequency (greater than 10 kHz) and relatively lower power levels. Figure 4 shows a capacitive voltage multiplier and a voltage inverting circuit. An example of such a circuit, which is available in integrated form, is the ICL7660 from Intersil Inc.

Operation of the circuit in Figure 4a is as follows. Initially, SW2 is closed and SW1 'off'. Capacitor C1 is charged to V_{IN} through rectifier D2 and SW2. SW2 then opens and SW1 is closed. This causes the voltage seen at the anode of rectifier D1 to rise from V_{IN} to a value determined by the relative sizes of capacitors C1, C2. When $C1 = C2$, the voltage at the output of the supply will rise toward $2V_{IN}$. SW1 is then opened and SW2 closed to repeat the cycle.

The circuit in Figure 4b operates on the same principle. SW1 charges capacitor C1 to V_{IN} . SW2 is then closed, taking the cathode of rectifier D1 negative to a value determined by C1, C2. Capacitor C1 is then recharged through SW1 and D2.

What Semiconductor?

As is inferred by the name 'switching mode' the semiconductor devices required for this application are primarily switching devices. The requirements for the switches are:

- Low conduction losses.
- Fast switching times.
- Voltage rating to match the circuit configuration and input supply voltage.
- Ability to withstand an overload.
- Good safe operating area (SOA) when used in an inductive load switching circuit.

These requirements can be met largely by a wide variety of bipolar transistors, thyristors and SCRs. More recently, power MOSFETS have been introduced with voltage and current ratings suitable for use in switching power supplies (current ratings to 40 A and voltage ratings to 500 V). These devices offer substantial advantages over bipolar transistors in the following areas:

DESIGNER'S Notebook

Switched Power Supplies Part 2

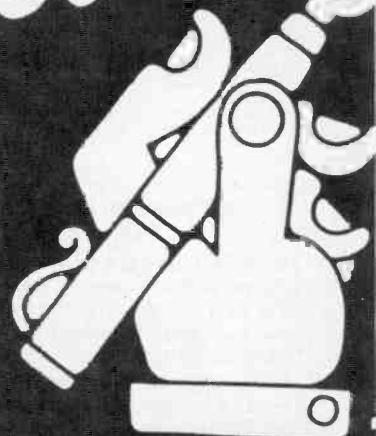

- Low gate drive power — simplifying the driver stage.
- Fast switching times which are largely temperature insensitive — allowing operation at frequencies greater than 50 kHz.
- Good overload capability — the device is not limited by gain or second break-down. Power dissipation is the limiting factor.
- The positive temperature coefficient of 'on' resistance assists current sharing when devices are parallel-connected to achieve higher current ratings.

Rectifiers for switching power supplies have similar requirements to the switching devices. The type of rectifier used is governed by the circuit application as indicated in Table 1.

Monolithic switching regulator circuits of limited output power capability are available (Fairchild uA78S40, Texas TL497A), and the trend toward integrated power functions can be expected to accelerate. There are a number of integrated control circuits for switching mode power supplies available, allowing the control circuit board complexity to be reduced. The functions available in these circuits include: an oscillator, a voltage reference, a regulator, a current limit function, and a driver stage. Some of the more common devices are: Philips TDA1060 which is pin-for-pin compatible with the Signetics NE5560; the Silicon General SG3524 which is multi-sourced; the Texas Instruments TL494 which is also available from Motorola; Fairchild and Fujitsu (as MB3759); and the Motorola MC3420.

Magnetic Component Design

Magnetic components are used in the majority of switching mode power supplies. It is, generally, only at low power and high frequency that capacitive circuits can be used. Magnetic components are used not only as high frequency transformers and DC inductors, but also as drive transformers, providing isolation between the control circuit and the power switching elements, and as current sensing elements.

Some of the criteria for the selection of a magnetic component as a high frequency transformer core are:

- Operating frequency range.
- Maximum magnetic flux density.
- Loss coefficient at the operating frequency.
- Available winding area.
- Primary to secondary coupling factor, and isolation.

Ferrite cores in a variety of shapes and materials are available. Metal power cores, laminated and tape wound cores are also available for specialist applications.

Transformer Design

As an example, consider the design of a switching mode transformer to operate at 50 kHz in a half bridge circuit (refer to Fig. 3d). The input voltage is 310 V + 5%, - 10% and the output required is 5 V at 40 A.

Step 1. Select a core material suitable for operation at 50 kHz and a core size commensurate with the power loading. Example: Mullard FX3740 core, A16 material; Philips EC52/24/14 core, 3C8 material.

Step 2. Calculate the number of primary turns required to avoid saturation of the transformer core under worst case loading. Check that the worst case core losses do not cause excessive core operating temperature. Check that the winding area is adequate. Check that the magnetizing current is less than 10% of the load current for efficient operation. Example: Worst case loading will occur with maximum input supply voltage and maximum duty cycle for the switches.

$$V_{IN} \max \frac{\delta \max}{f_o} = \widehat{B} \cdot Ae \cdot n$$

where $V_{IN} \max$ is the maximum voltage applied to the transformer = (310 + 5% V)/2
 F_o is the operating frequency = 50 kHz
 B is the peak working flux density of the core, at elevated temperature = 200 mT
 Ae is the magnetic cross-sectional area of the core = 180 mm²
 n is the minimum required number of turns

Hence $n_{min} = 40.7$ turns

Working at a peak flux of 200 mT, at 50 kHz, core losses are approximately 1W8. This corresponds to a rise in core temperature above ambient of approximately 20°C. Assuming a conversion efficiency of 70%, the input power requirement is 286 W. The lowest input voltage, applied across the transformer primary is (310-10%)/2V = 139 V. This gives a primary winding current, assuming 0.9 duty cycle, of approximately 2A3.

Assuming a current density in the

TABLE 1

Application	Rectifier Type
High Frequency Switching	Schottky Epitaxial Fast recovery, diffused
High Current, Low Voltage Switching	Schottky Epitaxial Germanium
High Voltage Switching	Silicon diffused Rectifier stack

transformer winding of 4 A/mm², the cross-sectional area of wire used for the primary winding should be 0.57 mm², corresponding to a wire of diameter 0.85 mm. Assuming a packing factor of two (because a circular cross-section conductor is used) the winding area consumed by the primary winding will be $2n \times 0.57 \text{ mm}^2 = 46.7 \text{ mm}^2$. The available winding area on the core, after making an allowance for isolation is 304 mm². The primary winding will take only 1/6th of the available area.

The magnetizing inductance of the winding is determined by:

$$L_m = \frac{\mu_o \mu_a n^2 Ae}{l_e}$$

where L_m is the magnetizing inductance in Henries

μ_o is the permeability of free space = $4 \times 10^{-7} \text{ H/m}$

μ_a is the amplitude permeability of the core = 10^3

l_e is the magnetic path length in the core = 105 mm

$$L_m = 3.62 \text{ mH}$$

The peak magnetizing current is given by the equation:

$$\frac{V_{in} \min}{2} = \frac{2 \cdot L_m \cdot I_m \cdot f_o}{\delta \max}$$

$$\text{So } I_m = \frac{V_{in} \min \cdot \delta \max}{4 \cdot L_m \cdot f_o} = 86 \text{ mA}$$

The peak magnetizing current represents 4% of the load current, which is acceptable.

Step 3. Establish the transformer turns ratio. Example: The voltage required at

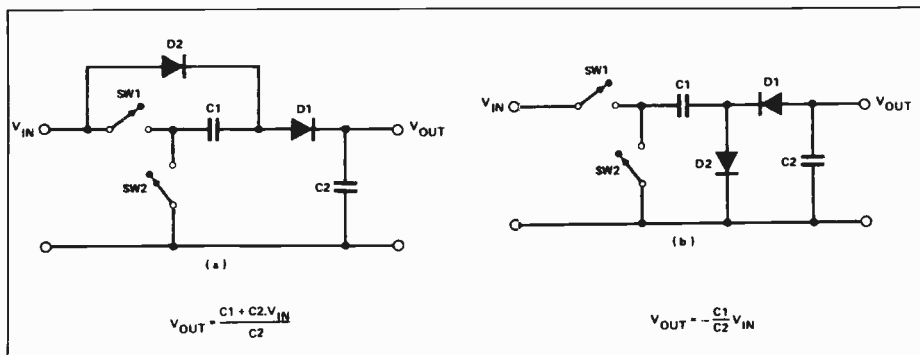

Fig. 4. Capacitive converter circuits. (a) Capacitive voltage multiplier. (b) Capacitive voltage inverter.

the secondary winding of the transformer is a function of the power supply output voltage (5 V), the duty cycle of the switches SW1, SW2, and the voltage dropped across the rectifiers and resistance of the output inductor L1. Disregarding the circuit losses initially, the transformer output voltage can be found by balancing the volt-second products for the output inductor in the minimum input supply condition, when the duty cycle is 0.9.

$$(V_x - V_o) = (V_o + V_f) (1 - \delta)$$

where V_x is the transformer output voltage.

V_o is the supply output voltage = 5 V
 δ is the duty cycle = 0.9
 V_f is the rectifier forward drop = 1 V

$$V_x = 5V7$$

To this figure must be added the circuit losses, $V_f + I_o.R_L$, where I_o is the rated output current, and R_L is the series resistance of L1 and the circuit wiring.

A minimum output voltage of 7 V can be used. The minimum input voltage is 139 V, so the transformer turns ratio is 20:1. Assuming a primary winding of 40 turns (marginally below the minimum, resulting in a slightly higher peak flux density, B, which can be tolerated in this example), each secondary winding comprises two turns.

Step 4. Transformer winding design. The correct design of the transformer windings will result in a reproducible and efficient transformer design. The conductor size and placement can have a significant effect on winding losses in a high frequency design. Example: The primary winding consists of 40 turns of 0.85 mm diameter wire, which can be wound in two layers each comprising 20 turns. The available winding breadth on the transformer core is approximately 20 mm after an allowance of 4 mm at either end for isolation. The secondary consists of two windings, each of two turns. The conductor for these windings is in strip form, being 8 mm in width and 0.625 mm thick. The windings are wound side by side on the former. Electrostatic screens and isolation are wound between primary and secondary windings. Worst case windings losses arise at maximum loading. Primary winding loss is 3W4 maximum, and the secondary winding loss 1W25 watts maximum. When added to the transformer core losses of 1W8, the worst case transformer loss is 6W45 at a core temperature of 100°C. The transformer is capable of operating in ambient temperatures up to 35°C without additional heatsinking. (Core data and ratings are drawn from the manufacturer's literature).

Inductor Design

The operating conditions of the magnetic core in the inductor are significantly different from those of the switching mode transformer. The core must withstand a DC magnetizing field, without saturation. For this reason, an air gap is commonly introduced into a magnetic circuit. This can be either in the form of a single gap introduced, say, in the centre pole of an 'E' core, or can be a distributed gap throughout the core material. The distributed gap solution presents a lower radiated magnetic field. When a gapped core is used, the magnetic flux is sorted mainly in the gap. There are small flux excursions as the load current ramps up and down. As an example, consider the design of an output filter inductor to be used with the 50 kHz transformer previously designed. The operating frequency will be 100 kHz. The maximum output current is 40 A and the minimum output current for continuous current flow in the inductor is 4A.

Step 1. Calculate inductance value required, and the energy storage capability required. Example: The minimum voltage applied to the inductor by the transformer secondary winding is 5V7 with a 0.9 duty cycle. The current in the inductor can be allowed to rise by 8 A maximum during this time, if the current flow is to remain continuous when the output loading is minimum, i.e. 4A.

$$(V_{in\ min} - V_o) = L\ min.\ \frac{I_L\ fo}{\delta\ max}$$

where $V_{in\ min}$ is the voltage applied to the inductor = 5V7
 V_o is the output supply voltage = 5V
 $L\ min$ is the minimum inductance value
 I_L is the peak to peak inductor current = 8 A
 fo is the operating frequency = 100 kHz
 \max is the switch duty cycle = 0.9
 $l\ min = 1.6$ microhenries

The energy storage capability is $L.I_m^2$ where I_m is the peak current flowing in the inductor = 44 A, so $L.I_m^2 = 3.1$ mJ.

Step 2. Select a suitable inductor core and determine the air gap required (if it is not a distributed gap material). The majority of magnetic core manufacturers provide selection charts/guides for this purpose. Example: Philips core EC35/17/10 with a 0.9 mm air gap will meet the energy storage requirement (equivalent to the Mullard FX3720).

Step 3. Calculate the number of turns required and determine the inductor losses. The core data gives an effective permeability or an A_L value (inductance per turn of the coil) for gapped cores, which enables the number of turns to be calculated and rounded up to the nearest half turn. The inductor losses are primarily

ly in the winding and these can be determined using a similar method to that used to calculate the transformer winding losses. Example: For the Philips EC35/17/10 core with a minimum air gap of 0.9 mm, 4 turns are required to give an inductance of 1.6 microhenries. The winding losses can be written as $I_{eff}^2.F_R.R_{DC}$ where:

I_{eff} is the RMS current flowing in the inductor winding.

F_R is a resistance multiplier to account for high frequency operation.

R_{DC} is the DC resistance of the winding.

The high frequency impedance of the winding is a minimum for a conductor of thickness 0.57 mm. Making the winding with copper strip of thickness 0.5 mm and width 20 mm gives a 100°C AC winding resistance of 0.58 mR. The winding loss is 0W93, resulting in an inductor temperature rise above ambient of 18°C when fully loaded.

Drive Transformer Design

Various approaches to the design can be made, though the choice is frequently restricted by the operating conditions and the drive requirements of the semiconductor switch. Thyristors and power MOSFETS can be driven by pulse transformers. The length of the trigger pulse and the circuit impedance are designed to comprehend the drive requirements of the worst case drive. Bipolar transistors require a continuous base current supply which often results in a larger transformer core being needed. The need for a wide variation in switch duty cycle often results in the drive supplied to the switching device being compromised; the forward base current supplied during long duty-cycle operation may be the bare minimum to maintain the transistor in saturation. At short duty-cycles, the base current supplied can be far in excess of the device requirements, compromising its switching performance. This effect is less severe when power MOSFETS are used as the switches, since they do not exhibit storage time effects.

As an example, consider the design of drive transformers for power MOSFETS when used as the switches in the 50 kHz switching mode power supply. A single transformer with two primary and two isolated secondary windings could be used. A disadvantage of this approach, however, is the absence of negative gate bias to turn off the MOSFETS at any duty cycle other than the maximum of 0.5, which would give poor noise immunity in normal operation. Instead, separate transformers are used and the magnetizing energy stored in the transformer core during the conduction phases is used to assist turn-off. The transformer design is similar to that required for a single-ended for-

ward converter (Fig. 3b).

Step 1. Select a suitable magnetic material and core size. Example: The operating frequency is 50 kHz and the average current flow in the windings will be low. A core material with a high permeability is desirable to maintain a low level of magnetizing current. Winding area is a significant factor in determining the core size and will depend on the isolation voltage rating desired. For this application consider the Philips core P1418 in 3B7 material, with an A_L value of 2,200 nH/1000 turns and a total winding area of 9.4 mm².

Step 2. Calculate the number of turns required for the primary winding and the magnetizing inductance and current. Example: To avoid core saturation when operating at maximum duty cycle, with a supply voltage of 15 V, the minimum number of turns required in the primary winding is given by:

$$V_{IN} \cdot \frac{\delta \max}{f_o} = \widehat{B} \cdot A_e \cdot n_{min}$$

where V_{IN} is the supply voltage = 15V
 $\delta \max$ is the maximum duty cycle = 0.45
 f_o is the operating frequency = 50 kHz
 \widehat{B} is the peak magnetic flux density in the core = 180 mT
 A_e is the magnetic cross sectional area of

the core = 25.1 mm²
 n_{min} is the minimum number of primary turns
Hence $n_{min} = 30$ turns

The magnetizing inductance, with n , the number of turns equal to n_{min} is given by:

$$L_M = 10^3 \sqrt{\frac{L_M}{A_L}}$$

where:

L_M is the magnetizing inductance in millihenries

A_L is the inductance factor in nanohenries/1000 turns = 2,200

Hence $L_M = 2.0$ mH

The magnetizing current at maximum duty cycle is:

$$I_M = \frac{V_{IN} \cdot \delta \max}{L_M f_o} = 67.5 \text{ mA}$$

Step 3. Check that the winding area on the ferrite core is adequate. Example: To calculate the winding area required for the primary winding, we must first estimate the average current flow. The current required to drive the power MOSFET IRF720, which would be used in this application, at 50 kHz, is low compared to the magnetizing current (1.7 mA averaged over a switching cycle). So, the average magnetizing current level can be assumed. A suitable wire gauge is 0.1 mm diameter.

Because of handling difficulties, a 0.2 mm wire may be preferred. The winding area consumed is approximately 20% of the total winding area of the transformer. Assuming that the drive transformer has a 1:1 turns ratio, giving a ± 15 V gate drive to the power MOSFET, the winding area is adequate, after an allowance for isolation spacing has been made.

Step 4. Calculate the minimum permitted drive pulse for safe turn-off. Example: Because this design relies on the transformer magnetizing energy to switch off the power MOSFET, a minimum drive pulse must be defined whereby the magnetizing energy equals the worst case turn-off energy for the MOSFET. Turn-off energy requirements for the MOSFET = $Q_G \cdot \Delta V$ where Q_G is the maximum gate charge figure.

$$\Delta V \text{ is the gate voltage swing} = 30 \text{ V}$$

$$\text{Magnetizing energy in the transformer} = (V_{IN} \cdot t_{onmin})^2 / L_M$$

where t_{onmin} is the duration of the minimum drive pulse. Equating these figures, assuming $Q_G = 17$ nC for the IRF720 device, gives a minimum drive pulse of $t_{onmin} = 2.15$ microseconds, which represents a minimum duty cycle, at 50 kHz, of 0.22. **ETI**

Kitron

COMPONENTS INC.
 (416) 298-3280
 Telex-065-26150

PANASONIC MATSUSHITA
 I.B.M.™ Compatible
 5 1/4" Disk Drive
 Model JA551-2

NEC MEMORY
 64K, 16K

PANASONIC MATSUSHITA
 Apple™ Compatible
 5 1/4" Disk Drive
 Model JA 551-2

MATSUSHITA
 T.T.L.

TEAC SUPER 5
 Apple™ Compatible
 5 1/4" Disk Drive
 Model FD-55A

HITACHI
 Memory
 Static Ram

OK1
 Memory

Hugestock of Japanese 64K Ram and TTL

OEM & IBM Dealer Enquiries Invited

Circle No. 19 on Reader Service Card.

PERFECT ELECTRONICS INC.

315 Queen St. W., Toronto, Ontario, M5V 2A4 Tel: (416) 598-2831

COMPUTER

48K 6502 Computer • 188
 Function Key • 10 User
 Defined Key • Self Repeat
 Key • Auto Line Feed •
 U/L Case • Assembled &
 Tested • \$495

MONITORS

Amdek Amber 300A \$235
 Zenith ZVM-123 \$129
 YJE Amber \$159
 YJE Green \$150

Intelligent Keyboard &
 Case \$150
 5 AMP Power Supply \$95

PRINTERS

Star Gemini 10X \$359
 TTX 1014 \$629
 Epson Call

PERIPHERALS

16K Ram Card \$55
 Controller Card \$55
 Z-80 Card \$55
 80 Column Card \$80
 Graphic Parallel Printer
 Card W/Cable \$90
 128K Ram Card \$199
 Eprom Writer Card \$69
 Pure Data Card \$115

MISCELLANEOUS

Quentin Disk Drive \$299
 RF Modulator \$14
 Flip N File 50 \$25
 Dysan SSDD \$29.95
 Self Centre Joystick \$18.00
 IBM Compatible
 Detachable Keyboard \$189
 IBM Look-A-Like
 Case \$135

NEW 3 INCH COMPACT FLOPPY DISK DRIVE FOR APPLE COMING SOON.

DEALER ENQUIRIES INVITED.

Mail Order: Send Certified Cheque, Money Order, VISA or MASTER CARD Plus 5% Delivery Charge. Ontario Residents Add 7% P.S.T.

Circle No. 10 on Reader Service Card.

Zener Diode Tester



This handy little adjunct for your multimeter allows you to read out the actual zener voltage of any zener diode up to 60 volts and will also test LEDs.

EVER DUG INTO a tray of components looking for a zener diode only to find that the markings have worn off? Even a brand new zener is usually marked with a code number giving little indication of the thing you want to know — the actual zener voltage rating. This simple tester will save you thumbing through the data books looking for a 1N4XXX, and allows easy identification of those unmarked diodes.

Most multimeters have a diode check position, but few can test LEDs, let alone zeners. This handy little adjunct for your multimeter allows you to test zeners up to about 60 volts, and can drive enough current through an LED to light it (and give you a reading of its forward voltage drop).

The tester simply plugs into your multimeter (a digital meter is ideal) and gives a direct reading of zener voltage. The circuit uses an inverter to provide a current-limited output of up to 70 volts dc from a nine volt battery. Table 1 shows the output characteristics of the prototype.

The leads on diodes are designated *anode* and *cathode*, the latter being marked by a band. When connected to the tester with the cathode to the black or negative terminal, the multimeter will indicate the diode forward voltage. For a silicon diode this will be about 650 mV while a germanium diode will read around 300 mV. Zener diodes are normally operated in reverse bias and are therefore tested with the cathode (banded end) connected to the red or positive terminal so that the zener voltage is displayed on the meter.

Zener characteristics

The zener voltage rating of a diode is only a nominal figure and should be considered with other parameters when designing circuitry. The first thing to realize is that the zener voltage is rounded to the *nearest preferred value*. Secondly, the voltage rating is dependent on the current passing through the diode. The diode manufacturers usually

quote zener voltages at a current of 5 mA for voltages up to 30 volts and at 2 mA above this.

Low voltage zeners will not develop their nominal voltage until the current reaches a few milliamperes. As the diode current is increased the voltage drop will also increase, representing a dynamic resistance which varies from tens of ohms for zeners between six and ten volts, to hundreds of ohms outside these limits.

Lastly, the zener exhibits a temperature sensitivity that varies with zener voltage as shown in Figure 2. A detailed explanation of the temperature characteristic may be found in any solid state physics textbook, the essential features being a negative temperature coefficient associated with true zener breakdown below six volts and a positive temperature coefficient associated with avalanche breakdown above six volts.

It is possible to combine zener diodes with opposing temperature coefficients in order to obtain a near temperature-independent reference, or to use a normal diode (with a negative coefficient) and a zener with the same result.

Construction

I built the zener tester into a plastic box with metal lid measuring about 30 x 50 x 80 mm. This is the smallest common low cost box that will accommodate the electronics and battery.

The pushbutton switch is mounted centrally in the lid about 10 mm from one end with the two banana plugs in the box underneath the switch. The spring terminals

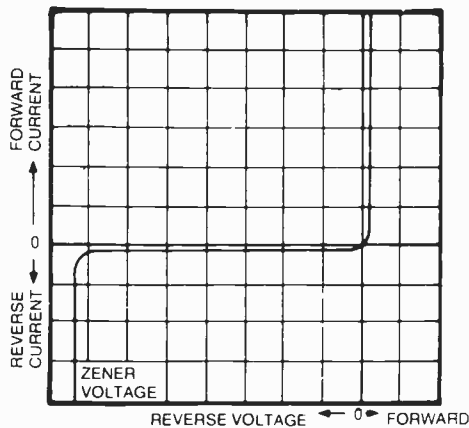
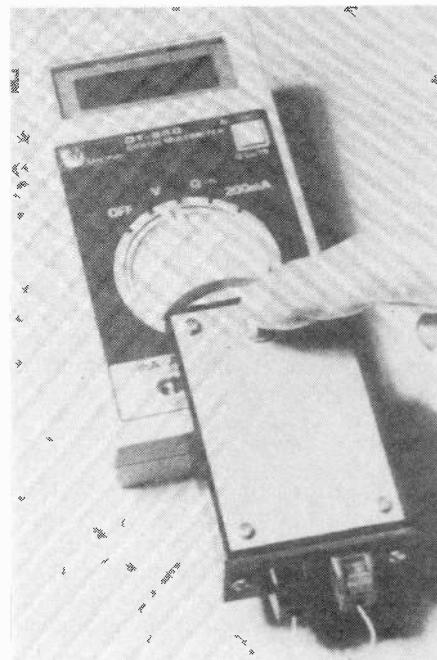

Figure 1. The fundamental characteristics of a zener diode. Little reverse current flows until a certain voltage — the zener voltage — is reached. This voltage is almost constant.



Push-to-read. The tester is housed in a box with banana plugs protruding from the rear spaced to suit the multimeter input sockets spacing.

mount on the other end of the box, as shown in the photographs. You may wish to vary construction to suit the components on hand, but check that the bits all fit together before chopping up your box.

The banana plugs are mounted at a spacing of 0.75", or about 19 mm, which allows the tester to plug straight into a stan-

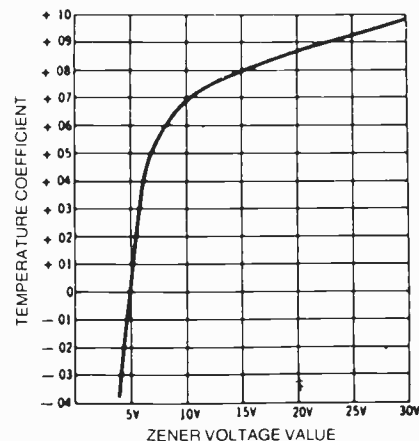

Figure 2. Temperature characteristics of zener diodes depend on the zener voltage value.

standard multimeter with 'GR' inputs.

To mount the plugs, first remove the plastic handles and cut them down to 20 mm so they can be fitted inside the box. Solder about 100 mm of insulated wire to each plug and feed the end through the holes in the box. Grab each plug with pliers and push them through the holes from the bottom. Now slip the handles over the wires and tighten up the plugs.

If all that seems too much, you may want to simply bring a couple of wires out to the multimeter with the banana plugs soldered to the ends.

The spring terminals I used had mounting holes about 45 mm apart which allowed

screws to tap into the plastic pillars in the corners of the box. You may also mount the terminals on the long side of the box. In any case, a couple of holes will be necessary under the spring terminals to allow the solder lugs to pass through.

The pc board is straightforward to assemble, watch the orientation of the electrolytic capacitors, the two diodes (note: D1 is the smaller) and the transistor. There are several types of transformer available and some may require R1 to be mounted on the copper side of the board in order to fit properly. The pc board may slot into a groove inside the box, or simply lay alongside the battery as in our prototype.

TABLE 1 Performance of prototype.

OUTPUT VOLTAGE volts	OUTPUT CURRENT mA	BATTERY DRAIN mA
0	5	140
5	8	160
15	9	190
24	9	190
48	5	160
60	1.5	130
72	0	120

PARTS LIST

Resistor 1/4 W, 5%
R1 4k7

Capacitors

C1 100u/25 V (or 16 V) electro
C2 3n3 ceramic
C3 2u2/50 V electro (see text).

Semiconductors

D1 1N914
D2 1N4001, 1N4002, etc.
Q1 MPS A06

Miscellaneous

PB1 momentary action pushbutton
T1 transistor audio transformer, '1k CT to 8 ohm', Hammond 146K or equiv.
pc board; box spring terminals; wire etc.

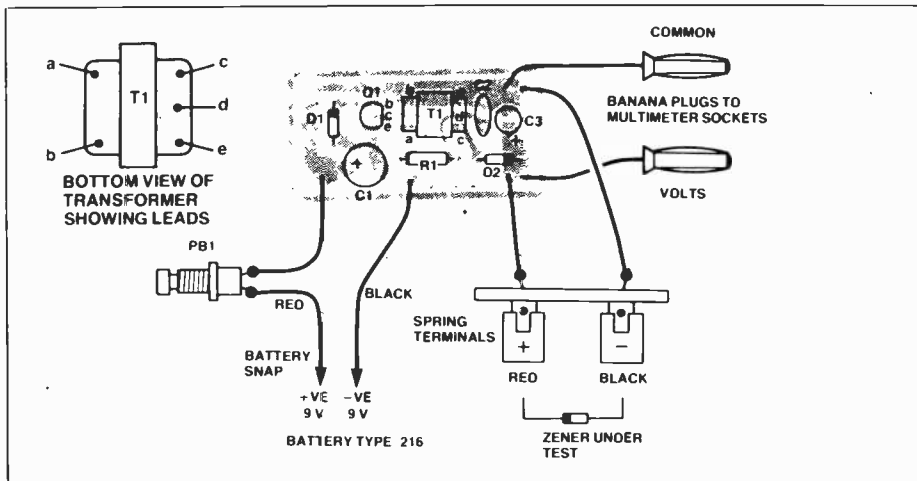
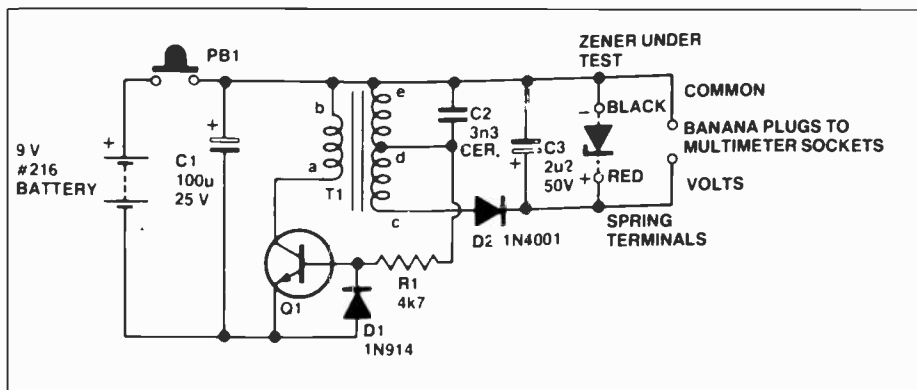

Diode-LED test. When testing diodes and LEDs, the anode goes to the red terminal, the opposite way to zeners.

HOW IT WORKS

The operation of apparently simple inverter circuits is usually exceedingly complex, so the following is a simplified explanation.

After PB1 is closed, current flows through terminals 'e' and 'd' of the transformer (and C2) to the base of Q1 starts to conduct and causes current flow through transformer terminals 'b' and 'a' (the primary winding) which causes the magnetic field to build up in the transformer. This field increases the base current to Q1 because of the phasing of the windings.

The magnetic field increases until the

transformer core saturates, when the transistor base current reverses, turning the transistor off.

Diode D1 protects the base-emitter junction against excessive reverse bias voltage.

The energy in the transformer's magnetic field is dissipated via several mechanisms, one being to charge C3 via D2.

The whole cycle repeats at a rate of a few kilohertz.

Capacitor C1 provides a low impedance source to ac signals and improves operation with a battery supply.

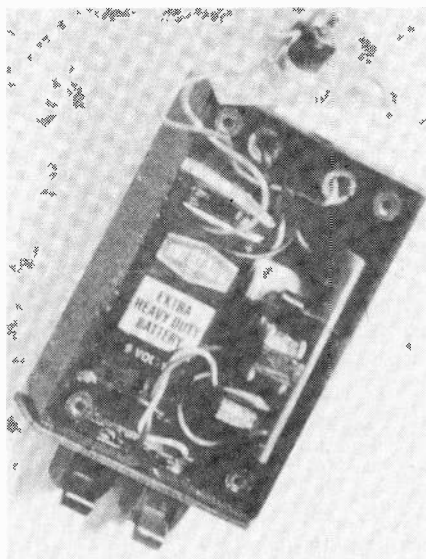

Inside story. Internal view of the zener tester. Note the cut-down banana plug handles at the top of the box.

Designing Micro Systems

Part 8

Last month we began looking at various computer interfaces, but we ran out of space. We continue with more on graphics, serial and parallel ports.

THE VARIETY IN methods of producing textual displays is exceeded by the variety of techniques used for producing graphics. A few micros (e.g. ZX-81 and PET) use the character generator to produce geometric shapes and other designs and symbols. These can be combined on the screen to produce designs of almost infinite complexity. This technique exploits one of the useful features of character generators; they can be programmed to produce any or all of the possible patterns on a 5 x 7 (or larger) matrix. For example, we can have them programmed for different styles of letter or for special letters for different languages. There are 2³⁵ permutations of dots, far more than can be accommodated within a single IC, so the snag of this method is that the user is limited to the range of symbols selected by the manufacturer. If you are writing programs for playing Bridge or Blackjack, the hearts and clubs symbols will be useful, but if our interest lies in cash account programs, they are a waste of space on the chip.

Many computers use graphics blocks (Fig. 10) as a means of constructing displays. A block may consist of six sub-blocks (or *pixels*, which is the name used for picture elements). Designing displays by this method involves interpreting your picture six blocks at a time and programming the computer with the corresponding code. The codes are stored in video RAM, as with text. Separate circuits are used in place of the character generator to convert the code to the corresponding set of video signals and feed them to the shift register. If the designs required are regular (such as decorative borders), programming is simple, but it becomes very time-consuming if you want to draw complicated pictures.

A third approach to graphics is to deal with each pixel separately, and allocate one bit in video RAM to each pixel. If the value of the bit is '0', the corresponding pixel is 'off' (black screen). If

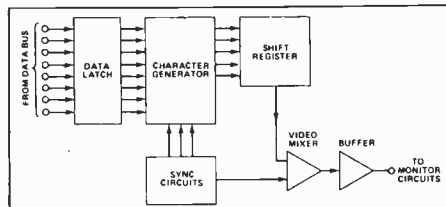

Fig. 9. Block diagram of the circuit for displaying text.

is '1', the pixel is 'on' (white screen). Colour can be obtained by allowing two bits per pixel for four colours, or four bits per pixel for 16 colours. A 256 by 192 pixel display, with 49152 pixels, will need 6K of RAM in black and white, 12K in four colours, or 24K in 16.

It can be seen that high resolution graphics, and particularly high resolution colour graphics, require a very extensive video RAM. The cost of RAM has fallen in recent years, making it feasible to provide micros with good high-resolution colour graphics at relatively low cost. But, unless special 'paging' address circuitry is introduced, a micro with a 16-bit address bus is limited to 64K of memory, into which ROM, program RAM, and the video RAM must be fitted. Consequently, an increase in the size of the video RAM means a decrease in the address space left for program RAM. If video RAM is physically a section of RAM itself, instead of being a separate entity as in some micros (see above), this section of RAM can be used for video when a program is to have plenty of graphics in colour, but can be turned over to program or data storage when graphics are not required. This is the system generally adopted in micros with high resolution graphics.

A Colourful Computer

The output from a computer to an RGB colour monitor consists of four signals on separate lines. The 'sync' signal provides

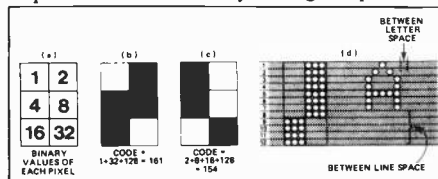

Fig. 10. Graphics blocks, as used in the TRS-80 Model I. (a) Each pixel has the binary value shown. (b) and (c) The sum of values of 'on' blocks plus 128 gives the code. (d) How a block is displayed by scanning (letter A for comparison of sizes). The blocks are displayed on a 6x12 matrix, leaving no space between adjacent blocks.

the pulses needed for synchronizing scanning with the reading of video RAM. The other three signals (R,G and B) control the three electron guns of the colour tube. Whenever there is a pulse on R, a red dot is produced on the screen. Whenever there is a pulse on G, we obtain a green dot. In either case, only one kind of phosphor (red or green) is made to glow. If there are pulses on R and G at the same time, both electron guns are activated. A red dot and a green dot are produced in the same region of the screen. From the normal viewing distance, it appears that there is a yellow dot on the screen. All colours are produced by mixing red, green and blue in various combinations and proportions.

The availability of separate signals for the red, green and blue guns means that excellent colour rendering with full saturation may be readily obtained on an RGB monitor. For those who wish to use a domestic colour TV, micros with colour graphics usually have a TV output. In the video mixer circuit, the RGB signals are combined with the luminance signal before modulation and the composite signal is sent to the TV set. As with monochrome TVs, losses of signal quality occurring during demodulation and decoding mean that resolution and colour rendering is not as good as with a monitor.

High resolution colour graphics can give an intricate picture, but with so many pixels to be individually dealt with, one might think that programming would be too laborious for the average user. In fact, high resolution graphics may be easier to handle than the graphics blocks or generated characters described earlier. Since there is only one shape (a dot) instead of dozens or hundreds, we avoid the need to specify which shape is to be displayed. Since each pixel can be specified solely by its X and Y coordinates on the screen, the basis of pixel graphics is mathematical and it lends itself readily to mathematical treatment. It is easy to write routines for drawing lines, circles, or triangles, and for filling in areas with solid colour. The high-level language may include commands such as DRAW, PLOT, and CIRCLE, which perform these functions automatically, leaving the user to supply only the parameters. Graphs, bar charts, clock faces and all kinds of designs which are composed of reasonably simple geometrical shapes can be programmed in a few lines.

Getting Into Print

Controlling a printer is very different from controlling a monitor or TV. When controlling a monitor, the computer is responsible for all the timing and signal generation. The monitor merely transfers this signal to the screen as a raster of lines, varying in brightness along their length. Once the data has been transmitted, there are no further problems for the computer, for the monitor is able to work fast. The signals it receives are almost immediately translated into a pattern on the screen.

A printer takes a much larger share of the work on itself. The computer simply tells the printer which letter is to be printed next. Then the printer works out how and where to print the letter, or when to feed the paper on to print the next line. It can even organize itself to save time by printing alternate lines from right to left! In order to do this, the printer needs an elaborate logic circuit. This may often include a microprocessor specially devoted to managing its activities. If the printer is of the dot matrix type, it also needs a character generator to tell it which combinations of printing needles to fire at the ribbon (Fig. 11).

The main disadvantage of a printer compared with a screen is that it deals with data much more slowly. There is a physical limit on how rapidly we can accelerate and then decelerate the appreciable mass of the print head (be it a matrix of needles or a daisywheel) and the rollers or sprockets which feed the paper to it. By contrast, the beam of electrons in a CRT is virtually massless and can be directed and modulated almost instantly.

There are two main ways in which a computer and printer may be connected. The parallel transfer of data is illustrated in Figure 12. An example of this system is the Centronics interface, originally devised by manufacturers of Centronics printers, but now adopted by many other manufacturers. The first point to note is that there is two-way communication, in contrast with the one-way communication

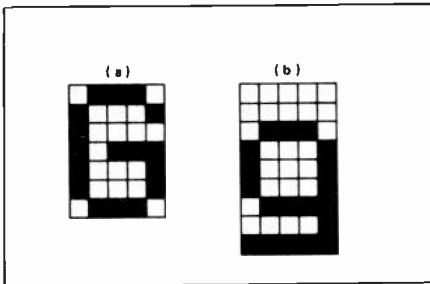

Fig. 11. Dot-matrix printers use a matrix of printing needles. If a needle is fired, it hits the ribbon and makes a dot on the paper. In (a) a capital G is produced on a 5x7 matrix. In (b) a lower-case g is produced with a tail beneath it using a 5x9 matrix. In general, printers with few rows are not able to offer descenders like this.

between computer and monitor. This is a consequence of the relatively slow speed of a printer. A computer can instruct a printer far faster than the printer can print. Rather than have the computer waste its valuable time waiting for the printer to operate letter by letter, we let the computer send a long string of commands to the printer in rapid succession. Since there are eight data lines, the computer can send a byte at a time. This is normally the ASCII code for the letter required. The printer can also interpret ASCII control characters for operations such as line feed (LF) and carriage return (CR). Whenever the computer is outputting data, it makes the **DATA STROBE** line low. This has the same function as the \overline{WR} control line used internally, and is derived almost directly from it. Similarly, the data lines are separated from the data bus of the computer only by latches, which hold the data long enough for the printer to be able to receive it. In some micros, a general-purpose I/O device is used for this purpose

(see *Designing Micro Systems*, ETI, February, 1984).

The I/O device or the buffers leading to the printer data lines need only one decoding circuit to enable them. Thus a printer needs to have only one address in RAM allocated to it. In comparison with the video screen, the printer makes minimal demands!

Printer Buffer

When data is received by the printer, it is stored in a small RAM called the *holder buffer*. This holds the codes for about 80 characters (maybe more), which is enough to print one line of text. It stores codes as they come in, then reads out codes previously stored and prints the characters they represent. When the computer sends a long string of codes, the buffer is likely to become full. Also, the printer has to occasionally stop printing to move on the paper to the next line. Again, codes will accumulate in the buffer. At this stage, the printer puts a signal on the **BUSY** line. The effect of this is to interrupt the com-

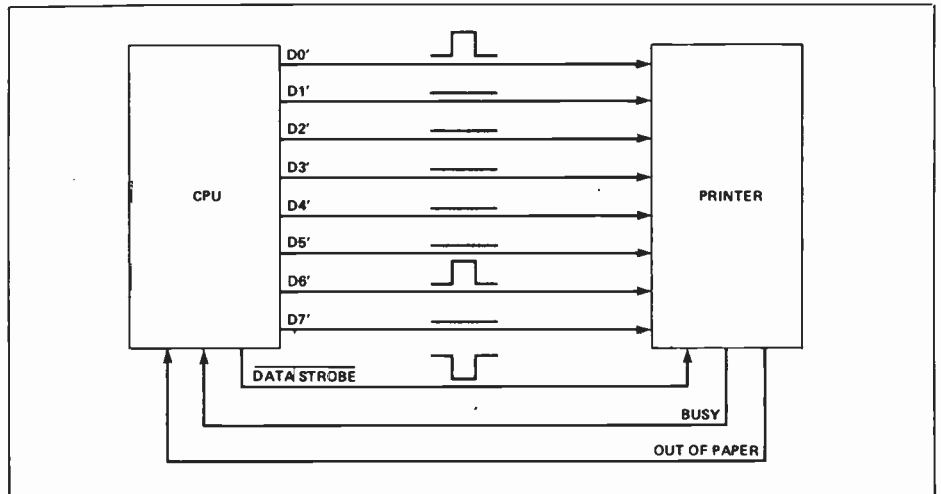

Fig. 12. Parallel data transfer between computer and printer.

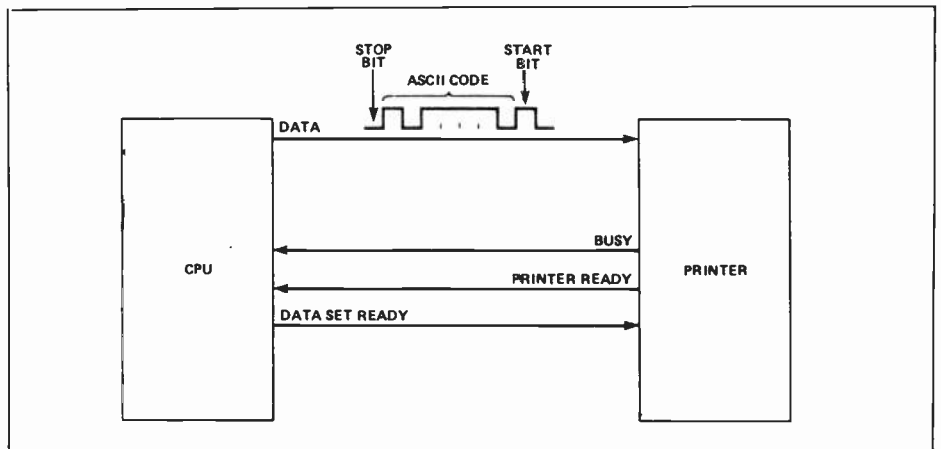

Fig. 13. Serial transfer of data between computer and printer.

puter and make it stop sending any more data. When the printer has printed all that it has stored and its buffer is empty, the BUSY signal is taken off the line and the computer is free to send the next batch of data. On some interfaces there is also an acknowledge line (\overline{ACK}), a handshaking line by which the printer informs the computer that it has done whatever it was told to do and is awaiting fresh instructions. There may be an OUT OF PAPER line for signalling this fact to the computer. The level on this line is usually controlled by a micro-switch connected to a lever which is in contact with the paper. An OUT OF PAPER signal causes the computer to send no more data until the normal level is restored.

Are You Being Serialized?

The alternative way of sending data to a printer is to transmit a series of pulses along a single line. This has obvious advantages in that only a single data line is required instead of eight. The most frequently used system of serial data transfer is known as the RS232C standard. The standard specifies voltage levels and rates of data transfer, and the system to be used for coding the data. The standard also

covers the types of connector to be used so that any pair of devices employing RS232C may be coupled together and expected to communicate reliably.

In Figure 12, the pulses drawn above the parallel data lines indicate that the computer is sending 0100 0001 (or 65 decimal, the ASCII code for 'A'). In Figure 13, the same ASCII code is being sent serially along one data line. Sending eight bits one after another is obviously slower than sending them in parallel, a byte at a time, as in Figure 12, but since printers are relatively slow, this is not a great disadvantage.

There are various ICs available for converting parallel data to serial data. A simple parallel-in-serial-out (PISO) shift register, such as the 74LS166, will do the job, but ICs specially designed for computers do it better. A universal asynchronous receiver transmitter (UART) is an example of such an IC. This provides two-way communication, being able to receive parallel data from the CPU and transmit it as serial data, and to receive serial data from a peripheral and pass it to the CPU as parallel data. The latter function is not required for use with a printer, but would be used, for example, when two

computers are required to communicate with each other. Not only does the UART convert from parallel to serial (or the other way about), but it takes the parallel data, makes it into a train of eight pulses, and adds a 'start' pulse and 'stop' pulse to the beginning and end of the train.

Correcting The Errors

Since it requires only one data line, serial data transmission is suited for long distance. Parallel data transmission is rarely used under such circumstances. The longer the line, the greater the chance of stray electromagnetic interference finding its way onto the line and into the data receiving circuit. This is why the train of pulses often includes an extra pulse known as the *parity bit*. The idea of this is to allow the receiving device to check that no spurious pulse has been added as a result of interference during transmission. The parity bit is calculated by the UART before the data is transmitted, and is added to the end of the train of data pulses, then followed by the stop bit or bits. The value to be given to the parity bit is found by counting how many 1s are present in the data. If the number is even, the parity bit is made 1, so the total number of 1s

continued on page 63





20% off all Sam's & Tab Books

B.T.W. Electronic Parts

4164 150 ns 8.99	5.5 LB. 60/40 resin core
4164 200 ns 8.85	solder 1mm \$59.00
4116 200 ns 1.70	1350K UNGAR SOLDERING
4116 150 ns 1.90	IRON \$19.80
6502A 6.99	7365 UNGAR SOLDERING
6522A 6.99	IRON \$ 7.79
Z80A-CPU 6.75	7874A UNGAR DESOLDERING
MC6800 3.95	PUMP \$19.49
MC6809EP 11.90	STOCKING DISTRIBUTOR
MC68A45 7.50	FOR THE FOLLOWING:
6116 120 ns 8.85	CHEMTRONICS chemicals
HM4315P 7.10	GLOBAL SPECIALTIES bread
2708 5.20	boarding
2732A 9.25	OK TOOL wire wrap
27128 35.00	MINIFUS fuses
MCM68764 25.90	MODE plugs, jacks, adapters
TMS2564 22.50	BUG BOX IC storage, protection,
MM76EL 11.00	and retrieval systems
TMS9927 8.00	EDUKIT educational kits
LM1889N 2.50	INTEGRATED PLASTICS plastic
	drawers
	DAETRON digital capacitance
	meter
	MICRO INSTRUCTIONAL audio
	tutorial tapes
	SAM's books
	TAB books
	UNGAR Soldering and
	De-Soldering Equipment

Mail orders minimum \$10.00, add 7% PST for Ontario, \$3.00 minimum shipping, VISA accepted.

1542 WARDEN AVENUE - SCARBOROUGH, ONTARIO M1R 2S8 - (416) 441-1733

NEXT MONTH

At the time of going to press, the articles mentioned are in an advanced stage of preparation. However, circumstances may result in changes to the final contents of the magazine.

Auto-Answer Add-on

Does your modem talk and talk and never hear from anyone? Add this simple project and it can answer as well as originate

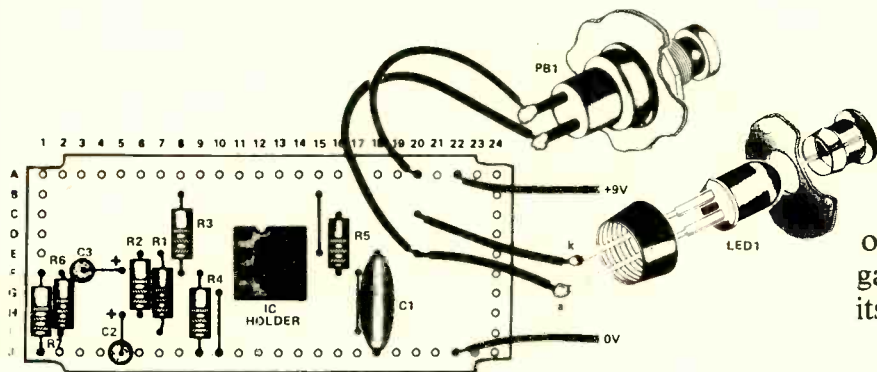

Op Amp Checker

Test out those junkbox op amps with this inexpensive gadget. All you'll need to read its output is a Cray high-speed 32-bit mainframe.

Plus!!!

**Test Gear Special! Taking a look at equipment for your testbench.
ZX81 Burglar Alarm! Monitor up to eight devices.**

Subscribe Now To CANADA'S PERSONAL COMPUTING MAGAZINE.

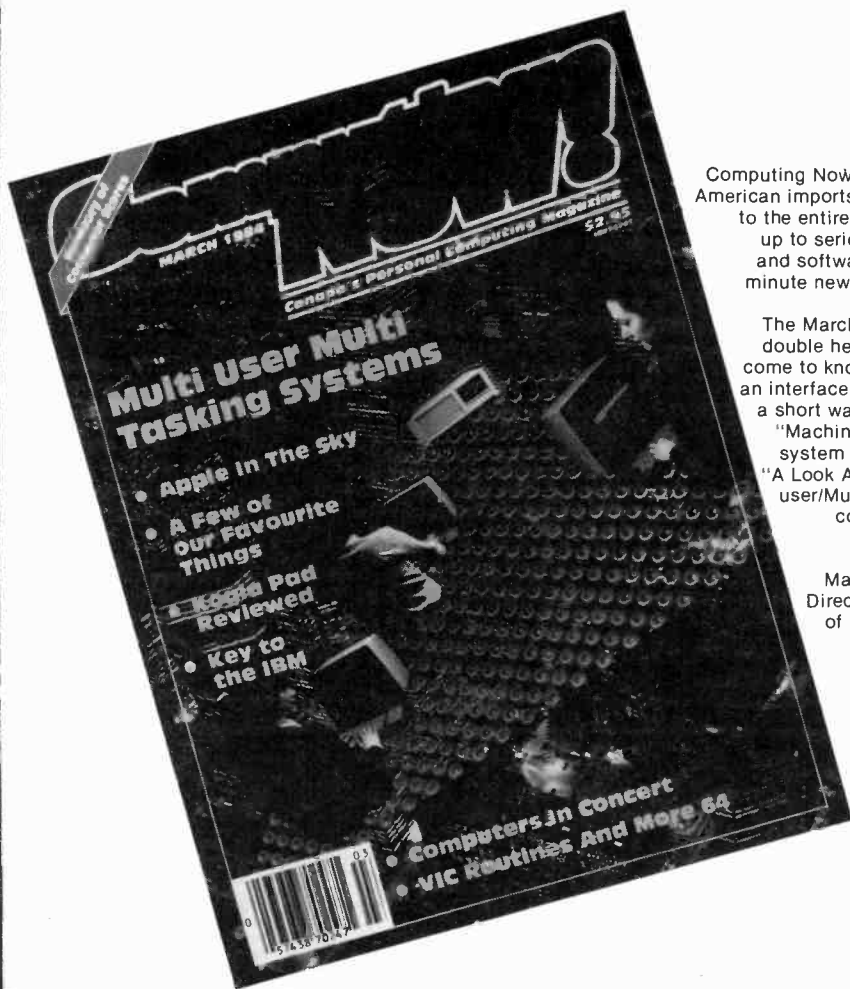

Computing Now! is Canada's only serious computer magazine. Unlike American imports and specialist publications, Computing Now! speaks to the entire field of personal computer users from beginners right up to serious business users. It contains applications, hardware and software reviews, background, market surveys and up to the minute news about the rapidly changing micro-computer industry.

The March issue of CN! for example, will be featuring the usual double helping of articles and features that CN!'s readers have come to know, including "Receiving Radio Teletype on an Apple", an interface to allow one to pick up news wire transmissions from a short wave radio and decode them into text. There will also be "Machine Language on VIC-20's and 64's" to help Commodore system users to explore the inner workings of their machines. "A Look At Dedicated Terminals" and "An Introduction to Multi-user/Multi-tasking Systems" will dispell a lot of the myth and confusion that's built up around this aspect of high end business micros.

March will also bring our valuable reference feature "The Directory of Computer Stores". It will be a complete listing of the computer retailers across Canada ... invaluable for you for months after the magazine has been released.

Computing Now!

Canada's Personal Computing Magazine

Special Bonus

Save up to 50% on Newsstand price
AND
receive a FREE copy of Your First Computer.

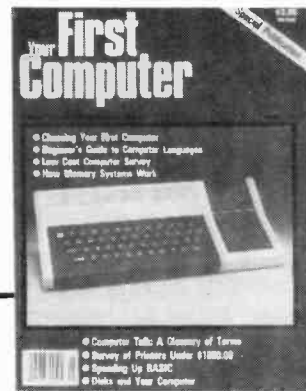

Please enter my name as a Subscriber to Computing Now! I understand that I may cancel my subscription at any time and receive a refund on the unexpired portion.

- One year (12 issues) \$19.95 Two years (24 issues) \$34.95.

(For US add \$3.00 per year, other countries add \$5.00 per year).

Cheque enclosed

Bill Me

Please Charge

Visa

Mastercard

Amex

Name

School (if applicable)

Address

City:

Province:

Postal Code

Date

No.

Expiry Date

MAIL TO: Moorshead Publications, Suite 601, 25 Overlea Blvd., Toronto, Ontario M4H 1B1.

The Fun of Electronics



"This computer has really been making a fool out of me. Not only does it beat me at chess, but now I find out it's been dating my wife."

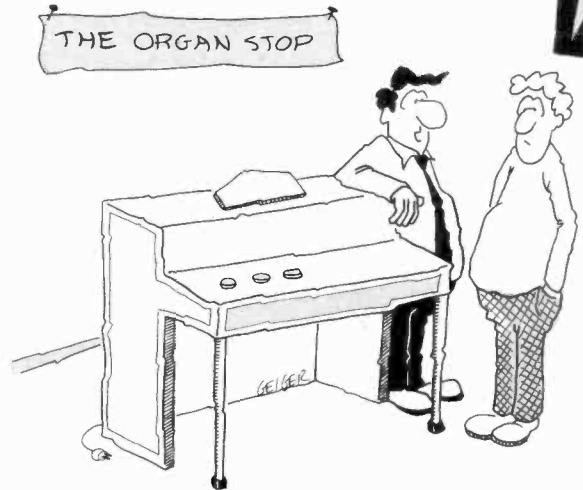

"Automatic rhythm, melody, and harmony. We even got rid of all those confusing keys that just serve to complicate things."

THE COMPUTER CAVE



"The software is a little slow, but you can still play exciting games like 'snail race 2000' and 'Tortoise Attack'."



"This is the last time I'll ever play poker with a cheater!"

TEST AREA



"None of them ever pass this test, but boy, it's a lot of fun!"



"Why would you spend thirty bucks on a rain alarm kit, when you can achieve the same results by drilling a hole in the roof?"

From Computers in Education



Moorshead Publications, publisher of Electronics Today and Computing Now! magazines, is proud to announce the first issue of Computers In Education, a merge of two other successful magazines: Computers In The Classroom, and Teaching Electronics and Computing.

We're bringing the strengths of both to the new edition. There are news articles on the latest events and products, beginner's guides to using computers and languages, book and software reviews, a build-it-yourself project, technical tips, and more.

In future issues we'll be looking at how people use computers effectively in the classroom, how administrative policies affect computer use, and reports on how the educational system is meeting the challenges of high technology.



YES, I want to subscribe!

Send me 10 issues of Computers in Education
 Payment of \$25 is enclosed ; I prefer 20 issues at \$45 ; Bill me . I understand that if I am not completely satisfied I may cancel my subscription at any time and receive a refund.

Please indicate occupation and level at which you teach: (if applicable)

Principal Librarian Teacher/Lecturer Consultant Other _____

Elementary Jr. High School High School Community College

University Bd. of Education Government Other _____

Name _____

Name of School (if applicable) _____

Address _____

City _____

Province _____ Postal Code _____

Be sure you have your copy of Computers in EDUCATION in your classroom every month.

Subscribe TODAY!

MAIL TO:
 Moorshead Publications,
 Suite 601, 25 Overlea Blvd.,
 Toronto, Ontario M4H 1B1.

becomes odd. If the number of 1s in the data is already odd, the parity bit is made 0, so retaining the odd number of 1s. At the receiving end, the UART simply has to count the number of 1s in the train. If it is odd, all is well and it then sends on the train (minus the parity bit) to be decoded. If the number of 1s is even, a transmission error has occurred and the device or its operator can be alerted. This system is not absolutely error-proof, for two errors could occur which would be self-cancelling. However, if the average rate of error is, say 1 in 100,000 bits on any occasion, the chance of two errors occurring on that occasion is 1 in 10,000,000,000 bits, which can be fairly safely disregarded.

The system described above is known as *odd parity*. It is also possible to work with *even parity*, in which the parity bit makes up the 1s to an even number. Most UARTs can be programmed to deal with either type of parity.

It's Your Timing That's Crucial

Figure 10 shows the train of pulses required to transmit the ASCII code for 'A' serially. It includes an even parity bit. The voltage level specified for signalling 0 is +3 V or more, while the level for 1 is any voltage lower than -3 V. The interval between successive groups of pulses can be as long as necessary. The receiver waits until a start bit arrives, and then decodes the nine or so bits which follow. There is no interval between successive pulses. The sequence of five 0s, for example, is received as one long high pulse. It follows that the transmitter and receiver must both have a method of timing the duration of pulses. Both circuits have oscillators or clocks built into them to fix the rate at which they work. When two devices are coupled, both clocks must operate at the same frequency. To assist standardization, a number of frequencies have been selected for use with RS232C interfaces.

The rate of transmission of data is expressed in *baud*. This unit, named after the French engineer, J.M.E. Baudot, is equal to the number of bits transmitted per second. Standard rates are 110, 150, 300, 600, 1200, 2400, 4800, 9600 and 19200 baud, though the higher ones are not included in the RS232C standard. To simplify circuit design, there are baud rate generator ICs. These are driven by a high frequency crystal oscillator circuit; the high frequency is divided by internal counter circuits to produce a range of output frequencies at standard baud rates. A UART may be connected to one or other of these outputs, depending on which baud rate is to be used. An interface usually has the facility for switching the UART to any one of the generator out-

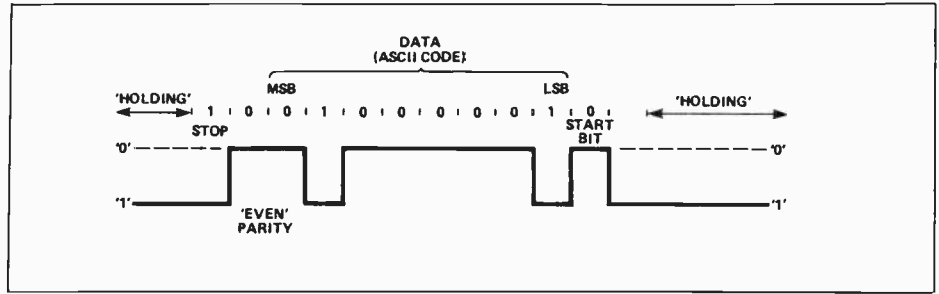

Fig. 14. The waveform of a serial signal (see text). There may be one or two 'stop' bits. The holding period between successive signals may be any length, which is why the system is called asynchronous.

puts so that the rates on transmitter and receiver may be matched.

Since this is an asynchronous system, matching of timing does not have to be of high precision. Timing at the receiver begins when a start bit is received. The clock at the receiver has to remain in phase with the transmitting clock only for the duration of 10 to 11 pulses. The receiving clock probably runs slightly slower or faster than the transmitting clock, but this does not matter. It can get

only a fraction of a pulse out of phase in such a short time, and this is not enough to cause errors in decoding. When the next train of pulses arrives, timing begins all over again from the arrival of the start pulse. Any discrepancies of timing which might have accumulated between trains are eliminated.

Next month, Owen Bishop concludes the series with a look at the most popular methods for storing and retrieving information. ETI

SUBSCRIBER SERVICE

MOVING? RENEWING? NEW SUBSCRIPTIONS?

Moving? Renewing? Affix your present mailing label(s) here. Mail entire form to address shown below.

- I'm moving, please change my address as indicated below.
- Please extend my subscription for one year at \$19.95 for 12 issues.
- I'd like to become a subscriber for one year (12 issues) at \$19.95.
- My cheque is enclosed Bill me
- Bill my/Mastercard/Visa/Amex
- Card No. _____
- Expiry Date _____

Name (please print) _____

Address _____

City _____

Province/Postal Code _____

Subscription to: Electronics Today and/or Computing Now!

Mail to: Moorshead Publications, Subscriptions Department, Suite 601, 25 Overlea Blvd., Toronto, Ontario M4H 1B1

Moorshead Publications

If you are enjoying this issue, why not try some of our highly successful special publications.

Available from your favourite newsstand, electronics store, or direct from Moorshead Publications at suite 601, 25 Overlea Boulevard, Toronto, Ontario M4H 1B1. Please add \$1.00 for postage and handling.



•Projects Book No. 2
100 pages
Contains 25 of the best projects from recent issues including the High Performance Series 4000 Amplifier (including Preamps and Power Supply), Rumble Filter, Dynamic Noise Filter, Logic Probe, Cable Tester, Function Generator, Rain Alarm, Digital Tacho, Two Octave Organ, Light Chaser, Shutter Speed Timer, Ni-Cad Charger, and more. First published January 1981.

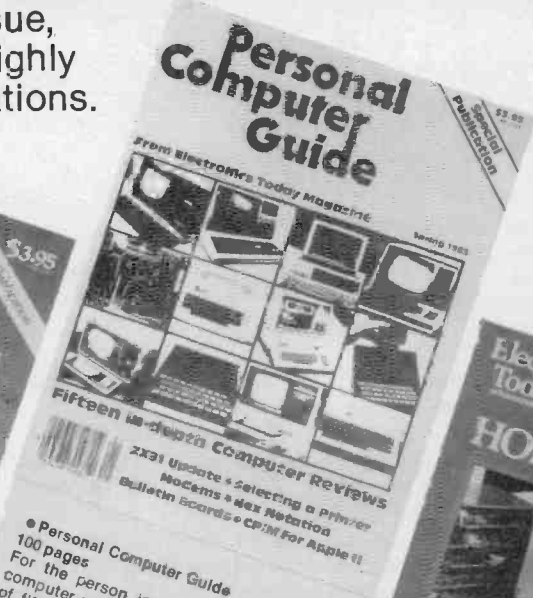

• Personal Computer Guide
100 pages
For the person interested in choosing a computer system of their own. A collection of fifteen in-depth computer reviews from ETI magazine, as composed by Steve Rimmer. Also included are articles on how to buy a printer, the intricacies of hexadecimal notation, and an appraisal of the current boom in modems and bulletin boards.

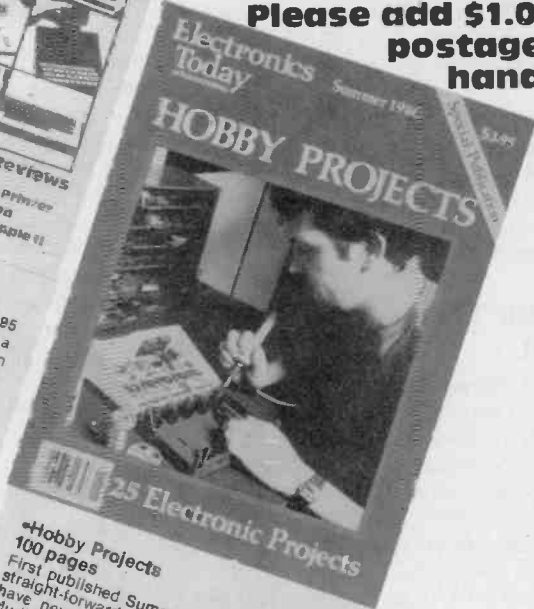

•Hobby Projects
100 pages
First published Summer 1980. Contains 25 straight-forward projects most of which have never appeared in the magazine including: Stereo Amp, Audio Mixer, Scratch and Rumble Filter, Constant Mixer, Scratch Graphic Equaliser, Envelope Volume Amp, White Noise Effects, Envelope Generator, Ohmmeter, Intercom, Drill Speed Controller, LED Tacho, Parking Meter Timer, Electronic Organ, Touch Switch, Electronic Dice, Siren, Simple Receivers.



•50 Top Projects
156 pages
Fifty all-time best projects from ETI magazine packed into one giant 156 page special. There are projects for the beginner to the more advanced builder, including: Semiconductor Tester, Universal Counter, LED Level Meter, AM radio, and much, much more.



•Electronic Circuit Design
92 pages
A collection of major articles on various aspects of circuit design including CMOS, Audio Amplifiers, Power Supplies, SCR's, Op-Amps, Using the 3080 and Temperature Control. A large number of useful circuits are given but the emphasis is on guidance and how to design for yourself.



•Your First Computer
100 pages
Your First Computer is a special guide from Computing Now! magazine for people who would like to get into computers but don't know where to begin. The publication includes articles on buying your first computer, buying a computer secondhand, a section on computer languages for beginners, surveys of computers and printers under \$1000.00, and a complete glossary of computer terms.

```

10 PK=1065164+53281:VC+53248:DIMCOL*(15):PG=200:SI=VC+39:CI=PEEK(S1)AND15
20 S2=VC+39:CE=PEEK(S2)AND15:CI=PEEK(S4)AND15:S3=S2-1:CS=PEEK(S3)AND15
30 PRINT"  " " :FOR I=1TO11
32 PRINT"  " " :NEXT
33 PRINT"  " " :FOR I=1TO9
34 PRINT"  " " :NEXT
35 PRINT"  " "
40 DN$=" " :
42 LI=13:COL=5:ST$="ONE MOMENT PLEASE":GOSUB2000
45 FOR I=0TO39:POKE55296+I,1:NEXT
50 LI=1:CO=29:ST$=" " :PAGE: " :GOSUB2000
51 LI=4:CO=29:ST$=" " :PAGE: " :GOSUB2000
52 LI=7:CO=29:ST$=" " :PAGE: " :GOSUB2000
53 LI=10:CO=29:ST$=" " :PAGE: " :GOSUB2000
54 LI=13:CO=29:ST$=" " :PAGE: " :GOSUB2000
55 LI=16:CO=29:ST$=" " :PAGE: " :GOSUB2000
56 FOR I=1TO26:POKE1383+I,1:NEXT:FOR I=0TO9:POKE2018+I,1+48:NEXT:POKE2020,31
57 NC=12+4096:POKE2021,141
58 REA0A:IFA=-1THEN60
59 POKE NC,A:NC=NC+1:GOTO56
60 FOR I=0TO15:REACOL*(I):NEXT
61 LI=5:CO=29:ST$="HIGH-RES":IFPEEK(VC+28)AND21CSTHENST$="MULTICOL"
62 GOSUB2000
70 GOSUB500:GOSUB75:GOSUB80:GOTO100
75 FOR E2040,FG:POKEVC+16,21CS:POKEVC+CS*2,20:POKEVC+1+CS*2,200:POKEVC+21,21CS
76 GOSUB2010:RETURN
80 LI=8:CO=29:ST$=COL*(C1):GOSUB2000
82 LI=8:CO=34:ST$=COL*(C2):GOSUB2000
84 LI=11:CO=29:ST$=COL*(C3):GOSUB2000
86 LI=11:CO=34:ST$=COL*(C4):GOSUB2000
89 RETURN
100 V=PEEK(PK+PX+FY)*40:POKEPK+PX+PY*40,1280RV
101 IFPEEK(56320)<127THEN120
110 GETH$:IFA$=""THEN101
120 J=PEEK(56320):POKEPK+PX+PY*40,V
122 IFA$="0"OR(JAND2)=0)THENFY=PY+1
125 IFA$="1"OR(JAND1)=0)THENFY=PY-1
130 IFA$="2"OR(JAND3)=0)THENPX=PX+1
135 IFA$="3"OR(JAND4)=0)THENPX=PX-1
140 IFPEEK(PK+PX+FY)*40>160THEN150
142 IFPX=-1THENPX=23
144 IFPX=24THENPX=0
146 IFPY=21THENPY=0
149 IFPY=-1THENPY=20
150 IF(JAND16)=0ORA$="" THENGOSUB400
152 IFPX>37THENPX=37
153 IFPY>21THENPY=21
154 IFPY<0THENPY=0
200 GOTO100
400 IFPX>24THEN450
402 PF=PG*64+INT(PK/8)+PY*3
405 IFPEEK(PK+PX+PY*40)=32THENPOKEPK+PX+PY*40,81:GOTO410
407 IFPEEK(PK+PX+PY*40)=81THENPOKEPK+PX+PY*40,32:GOTO415
410 POKEPP,PEEK(PP)OR(2*(7-(PK-INT(PK/8)*8))) :GOTO420
415 POKEPP,PEEK(PP)AND255-(2*(7-(PK-INT(PK/8)*8)))
420 RETURN
450 IF(PX>27ANDPX<36)ANDPY=0THENGOSUB1000:RETURN
455 IF(PX>27ANDPX<36)ANDPY=3THENQ0=28:GOSUB600:LI=5:CO=29:ST$="MULTICOL"
456 IF(PX>27ANDPX<36)ANDPY=3ANDTG=1THENST$="HIGH-RES"
457 IF(PX>27ANDPX<36)ANDPY=3THENGOSUB2000:RETURN
460 IFPX=28ANDPY=12THENQ0=29:GOSUB600
462 IFPX=30ANDPY=12THENQ0=29:GOSUB600
464 IF(PX>27ANDPX<31)ANDPY=6THENC1=(C1+1)AND15:POKE S1,C1:GOSUB80
466 IF(PX>32ANDPX<36)ANDPY=6THENC2=(C2+1)AND15:POKE S2,C2:GOSUB80
468 IF(PX>27ANDPX<31)ANDPY=9THENC3=(C3+1)AND15:POKE S3,C3:GOSUB80
469 IF(PX>32ANDPX<36)ANDPY=9THENC4=(C4+1)AND15:POKE S4,C4:GOSUB80
470 IFPX=29ANDPY=15THENFOR I=PG*64TOPG*64+64:POKE I,0:NEXT:GOSUB500:RETURN
472 IFPX=33ANDPY=15THENPOKEVC+21,0:PRINT" " :END
475 IFPX=31ANDPY=15THENFOR I=PG*64TOPG*64+64:POKE I,255-PEEK(I):NEXT:GOSUB500:RETURN
490 IFPX=32ANDPY=12THEN1200
485 IFPX=34ANDPY=12GOTO1500
499 RETURN
500 PRINT"  " :FOR I=0TO20:PRINT"  " :FOR J=0TO2:POKE820,PEEK(PG*64+I*3+J):SYS12*40
96
510 NEXT:PRINT:NEXT:RETURN
600 TG=0:IF(PEEK(VC+Q0)AND21CS)THEN620
610 POKEVC+Q0,PEEK(VC+Q0)OR21CS:RETURN
620 POKEVC+Q0,PEEK(VC+Q0)AND255-21CS:TG=1:RETURN
1000 J=PEEK(56320):IFJ=127THEN1000
1010 IF(JAND4)=0THENFG=PG-1:GOSUB75
1020 IF(JAND8)=0THENFG=PG+1:GOSUB75
1030 IF(JAND16)=0THENGOSUB500:RETURN
1040 GOTO1000
1200 LI=24:CO=0:ST$="FROM PAGE:":GOSUB2000:GOSUB3000:PA=VAL(IN$):IFPA=0THEN100
1210 LI=24:CO=0:ST$=" " :GOSUB2000
1220 LI=24:CO=0:ST$="TO PAGE:":GOSUB2000:GOSUB3000:PH=VAL(IN$):IFPH=0THEN1200
1230 LI=24:CO=0:ST$=" " :GOSUB2000

```

continued on page 66

and binary-coded decimal.

The B series ends with a short discussion on the actual characteristics of the hardware that you'd use to implement the demonstrated circuits, and covers logic voltages, noise immunity, clock frequencies, and so forth.

More Cards

There are lots of logic applications that don't use integrated circuits. A heavy-duty power control device with very simple logic requirements would probably use relays and switches. The R series of cards and the supplementary manual start you off on relays. A seemingly simple circuit may not operate because a circuit breaker hasn't been closed, or an over-temperature protector has opened. All these can be investigated; successful completion of the circuit cause the "relay" to operate and the "load" to be energized in the same way as the gate displays.

Diodes and Transistors

Diode-to-diode logic is still used; it's a simple way to implement basic functions. These are shown in the DIO cards, with the diode polarities selected by the input switches. The concept of reverse- and forward-biasing will lead you into the section on transistors. The transistors are hooked up as saturated switches, and this section will give a good grounding in transistor theory for later tours through the innards of TTL chips.

Summary

In conclusion, I haven't come across a better way to learn basic logic and its circuitry. As I mentioned, the fun appeal of solving the problems with a sort of game eases a lot of the tedious "if this is high, then that is low" business. In fact, I doodled with this thing for hours.

The unit is very well made, and since the cards don't actually operate any little toggles or catches, they should stand up to a fair amount of handling. There didn't seem to be any mention of battery life, though liquid-crystal displays are notoriously stingy with current; I suspect you could leave it on for thousands of hours before needing a new 9-volter.

It's a tad expensive at \$240.62, but it has the advantages of being comprehensive, easy to use, portable and a whole bunch of fun.

ETI

Computers in Small Business

From Computing Now! Magazine

Special Publication

- Survey of Portable Computers
- Should You Computerize?
- Using Portable Computers in Sales
- Buying a Business System
- Picking an Accounts Package
- Buying a Business Printer
- Bar Charts for Business
- A Look at VisiCalc and Wordstar
- Profiles of Business Computer Owners

Computers for Small Businesses

Small companies across Canada are hungry for knowledge about the microcomputer revolution. Many of them believe that they alone are ignorant about what is going on and what equipment is available.

This Special publication is addressed exclusively to this market. The articles will comprise reprints of the very best material already published in *Computing Now!* magazine together with several specially commissioned features to form a well balanced publication. We believe this Special will be of real use to the hundreds of thousands of small companies on the verge of buying a microcomputer.

To Be Published

For Circulation Call (416) 423-3262

**Moorshead Publications,
25 Overlea Boulevard, Suite 601,
Toronto, Ontario, M4H 1B1**

Computing Today continued from page 65

DEALERS WANTED

Reputable wholesaler looking for active dealers to distribute its quality products.

- Monitors color, green & amber
- IBM compatible computers
- Apple compatible computers
- Peripheral boards
- disk drives
- supplies and more...

All products are fully guaranteed at very competitive prices. Mail orders welcome. Why not give us a call today.

KCE

Wholesale & Distribution Ltd.
(416) 499-6261

P.O. Box 284, Station "J",
Toronto, Ontario M4J 4Y1

Mail orders accepted: 10 day money-back guarantee. Send certified cheque or money order. Ont. residents add 7% P.S.T. Add \$10.00 for shipping and handling.

DEALER ENQUIRIES INVITED

```

1240 BE=PA*64:EN=PH*64*64:HB=INT(BE/256):LB=BE-HB*256:HE=INT(EN/256)
1350 LE=EN-HE*256:LI=24:CO=0:ST$="FILENAME":GOSUB2000:FL$=IN$
1360 LI=24:CO=0:ST$=" "GOSUB2000
1370 LI=24:CO=0:ST$="TAPE OR DISK":GOSUB2000:GOSUB3000:D=ASC(IN$)
1375 DEV=1
1380 IFD=68THEN FL$="0":FL$+PRG,WRITE:DEV=8
1400 GOTO1600
1500 LI=24:CO=0:ST$="FILENAME":GOSUB2000:GOSUB3000:FL$=IN$
1510 LI=24:CO=0:ST$=" "GOSUB2000
1520 LI=24:CO=0:ST$="TAPE OR DISK":GOSUB2000:GOSUB3000:D=ASC(IN$)
1530 PRINT":DEV=1
1540 IFD=68THENFL$="0":FL$+DEV=8
1550 PRINT "LOADING"FL$
1560 PRINT"LOAD"CHR$(34)FL$CHR$(34),"DEV",1:RUN:POKE631,19:POKE632,13:POKE198,2:END
1600 PRINT "SAVING"FL$:POKE646,PEEK(53281)AND15
1605 PRINT"SP43","LB":PF44,"HB":PF45,"LE":PF46,"HE":PF47:CHR$(34)FL$CHR$(34)
1610 PRINT","DEV",1
1620 PRINT"SP43",1:PF44,8:PF45,136:PF46,26:RUN
1630 POKE631,19:FORI=632TO640:POKEI,13:NEXT:POKE198,10
1999 END
2000 PRINTLEFT$(DN$,LI)TAB(CO)ST$:RETURN
2010 LI=2:COL=34:ST$=MID$(STR$(PG),2):IFPG<100THENST$=ST$+" "
2011 GOSUB2000:RETURN
3000 PS=1984:TB=1:IN$=" "
3005 X=PEEK(PS):POKEPS,1280RX
3010 J=PEEK(56320):IFJ=127THEN3010
3020 POKEPS,X
3030 IF(JAND4)=0THENPS=PS-1:IFPS<1984THENPS=2021
3040 IF(JAND8)=0THENPS=PS+1:IFPS>2021THENPS=1984
3050 IF(JAND16)=0THEN3070
3060 GOTO3005
3070 IFX<31AND(TB)1THENIN$=LEFT$(IN$,TB-1):TB=TB-1:PRINT" ":GOTO3005
3072 IFX=31THEN3005
3075 IFX=141THEN3100
3080 IFX>0ANDX<27THENX=X+64
3090 IN$=IN$+CHR$(X):PRINTCHR$(X):TB=TB+1:GOTO3005
3100 IN$=MID$(IN$,2):RETURN
63990 DATA173,60,3,41,128,32,65,192,173,60,3,41,64,32,65,192,173,60,3,41
63992 DATA32,32,65,192,173,60,3,41,16,32,65,192,173,60,3,41,8,32,65,192
63994 DATA173,60,3,41,4,32,65,192,173,60,3,41,2,32,65,192,173,60,3,41
63996 DATA1,32,65,192,96,208,5,169,32,76,74,192,169,209,32,210,255,86,-1
63998 DATABLEK,WHT,RED,CYN,PUR,GRN,BLU,YEL,ORG,BRN,LTR,GR1,GR2,LTR,LTB,GR3

```

READY.

ETI

Circle No. 5 on Reader Service Card.

HOW IT WORKS

Up to about 40V, R1 and R2 cause there to be less than 0.4V between the base and emitter of Q1. This is too small to switch the transistor on, so the current flowing through R3 is directed to SCR1.

Above 40V or so, Q1 conducts and the gate of the thyristor is held low. This prevents it from switching on; if the lamp switch is flicked on at this moment, the circuit will wait for the mains voltage to fall again before switching the SCR on.

It was considered that the easiest way of maintaining operation during the negative half-cycle was to duplicate the circuit the other way around; hence R4-6, Q2 and SCR2.

R1 and R2 must be selected so that the voltage across R2 never exceeds the maximum V_{EBO} of the transistor, and the value of R3 must be sufficiently high for it to be able to cope with the power it will dissipate when Q1 is conducting and the resistor is effectively clamped across the mains.

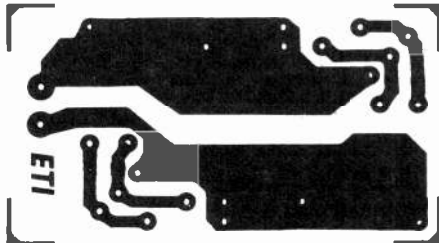

PARTS LIST

RESISTORS

- R1,4 100k, 1/2 W
- R2,5 1k0, 1/4 W
- R3,6 220k, 1/2 W

SEMICONDUCTORS

- Q1,2 2N3904
- SCR1,2 C106D or similar (400V 3 A)

MISCELLANEOUS

PCB; PCB mounting screw connector, (suitable for mains voltage); short bolts & nuts; case to choice.

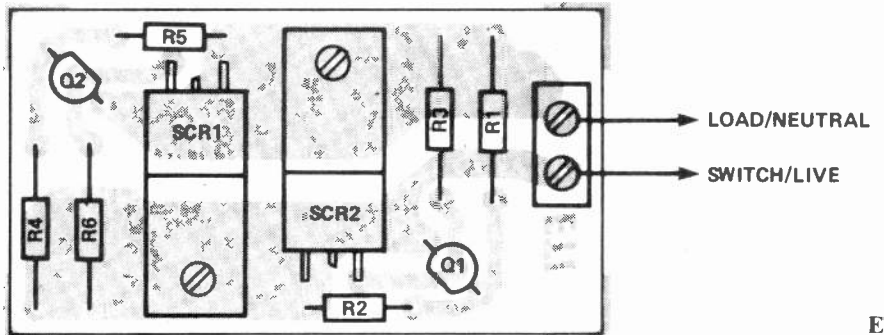
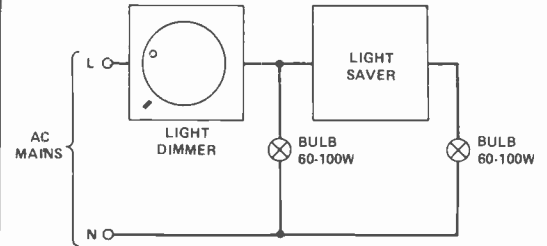

ETI

ETI Arc de Triomphe Set

History buffs who happen to also be into electronics and computing are hereby offered the deal of a lifetime: the ETI Arc de Triomphe Set. Just think, you too can set up a scale model of Paris in your own living room. (Good luck with the Eiffel Tower.)

The Arc de Triomphe set needs to be weighted down, or else it will blow over easily. This is best done with a year's supply of ETI magazine, which can be installed into the 'ETI' pillar without cutting or punching. The other two can be ballasted with a year's supply of Computing Now!, our sister magazine, and a collection of Moorshead Publications' special publications ('50 Top Projects', 'Your First Computer', etc.), respectively.

In what we think is the really brilliant part of the design, the pillars are hinged so they open on the same side as the magazines. You can read them without having to disassemble the whole works, and they stay safe and organized. You wouldn't believe how many cups of coffee we drank before thinking of that.

Pillars are available for \$9.25 each — don't forget to specify which ones you need — from: ETI Binders, 25 Overlea Blvd., Suite 601, Toronto, Ontario, M4H 1B1. Ontario residents please add 7% PST.



TECH TIPS

CMOS monostable

Geoff Nichols

This circuit was adapted from the familiar RS flip-flop by adding R and C.

Two gates, (a) and (b) from a 4093

quad Schmitt NAND gate, form a useful monostable multivibrator.

On power up, C ensures that the mono is in the reset state, and is charged up to the rail by R. If the pushbutton is

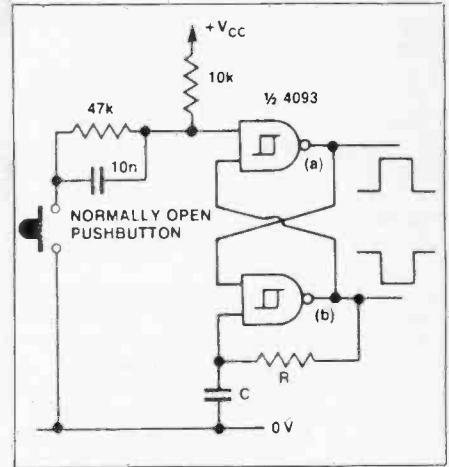

operated, gate (a) goes high and (b) goes low. R then discharges C to the switching point when the monostable resets, thus charging C back up ready for the next period.

The recharging may be speeded up by adding a diode across R, with the cathode to the capacitor side. The timing period, with R = 1M and C = 100n, was 100 ms.

LED bracket

David Sambrosky

An LED display with irregularities in the alignment and unevenness in the spacing between LEDs can make a project look very unprofessional.

Overcome this problem with a simple and effective method for mounting the LEDs in an array for display typically for the ETI-438 audio level meter.

A piece of matrix board with standard spacing between the pre-punched holes was used. The pre-punched holes can be drilled slightly smaller than the diameter of the LEDs being used, so that the LEDs will fit securely into the holes drilled, without falling out.

The precise nature of spacing between the pre-punched holes in the matrix board makes it an ideal mounting bracket for a display using an array of LEDs as shown below.

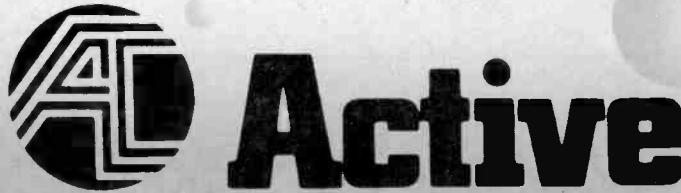

Active



1984 Mail Order Catalog

**The One Stop Shop For All
Your Electronic Needs!**

Conveniently located across Canada

Montréal

5651 Rue Ferrier
Montréal, Québec
H4P 1N1
(514) 731-7441

Ottawa

1023 Merivale Road
Ottawa, Ontario
K1Z 6A6
(613) 728-7900

Toronto

14 Carlton Street
Toronto, Ontario
M5B 1K5
(416) 977-7692

Calgary

3220-5th Ave. N.E.
Bay 2
Calgary, Alberta
T2A 5N1
(403) 235-5300

Downsview

86 St. Regis Cr. N.
Downsview, Ontario
M3J 1Y8
(416) 630-0400

Vancouver

3070 Kingsway
Vancouver, B.C.
V5R 5J7
(604) 438-3321

* Mail Orders to Montreal Address.

Visit your nearest Active store, call, write or circle
the Reader Service Card for your copy of Active's new catalog.

Circle No. 25 on Reader Service Card.

Amazing
Grace

A time to love

Support the new Salvation Army
Grace Hospital

The Salvation Army
Grace Hospital
\$11 million Building Fund
3 Heintzman Street
Toronto, Ontario M6P 2J7

Product Mart *Where Buyers Find Sellers*

Advertising in the **Product Mart** section allows you to reach over 30,000 Canadian readers nation wide for \$1.00 per word (minimum 25 words). Please contact us for further details on the various sizes and styles available.

WHAT DO YOU DO?

Send us your typewritten or clearly printed words, your permanent address and telephone number and your money (no cash please). Make your cheque or money order payable to Moorshead Publications. We're at Suite 601, 25 Overlea Blvd., Toronto, Ontario, M4H 1B1.

WHAT DO WE DO?

We typeset your words (and put the first word and your company name in **BOLD** capital letters). If we get your message by the 14th of the month, it will appear 1½ months later. For example if we receive it by October 14th you and our readers will see it in the December issue.

CMOS Sale. MC14023, MC14040, MC14049, MC14070, 74S00, 7490, 74S74, 74LS273, 74S374 and lots more. **FREE FLYER. M.O. Enterprises, Box 2066E, Bramalea, Ontario L6T 3S3.**

APPLE™ BUILDERS NEED "APPLE-SEED" 1-Motherboard Assembly Manual, \$9.95: Self-directing, simple-to-follow guide to building the 6502.

2-Peripheral Card Assembly Manual, \$9.95: Parts list, component placement, condensed instructions for building THIRTY-FIVE cards. A NEW REFERENCE for Apple enthusiasts & hobbyists.

Both 1 & 2 Manuals: \$18.00. Send cheque (includes P&H) to **NuScope Associates, P.O. Box 742, Stn. B, Willowdale, Ont, M2K 2R1.**

FOR \$10 per kit \$2 handling, receive free flyer and any of the following. #1: 1000 asst'd pcs, choke - capacitor - resistor - transistor - hardware - etc. Capacitor specials: #2: 200 asst'd ceramic - #3: 100 asst'd silver mica - #4: 100 asst'd mylar ! #5: 50 asst'd tantalum - #6: 50 asst'd electrolytic - #7: 50 asst'd feed-through - #8: 50 asst'd metallic silver mica (Elmenco) - #9: 25 asst'd variable. All new material. Unconditional guarantee. **SURPLUS ELECTRO QUEBEC, 2264 Montee Gagnon, Blainville, Quebec J7E 4H5.**

ACTIVE COMPONENTS 5651 Ferrier Street, Montreal, Que., H4P 1N1 (514) 731-7441. Canada's first and foremost leader in ICS, computer products, peripherals and micro-computers. All new 1984 product catalogue is now available.

PLANS to build your own backyard satellite dish and pay-TV decoders. Send a S.A.S.E. to: **J.C. SYSTEMS INTERNATIONAL, Dept. 306, 7305 Woodbine Ave., Markham, Ont. L3R 3V7** for free information.

CORONET ELECTRONICS, 649A Notre Dame W., Montreal, Que. H3C 1H8, Catalogue IC's, Semi's, Parts, send \$1.00 to cover postage. Monthly specials at crazy prices.

TIMEX-SINCLAIR Software and Hardware. Brand name products at incredible prices! Send for **FREE** catalogue - pricelist. **TORONTO SOFTWARE WORLD, Box 84, Dept. CN, Agincourt, Ontario M1S 3B4.**

ACTIVE COMPONENTS 14 Carlton Street, Toronto, Ontario M5B 1K5 (416) 977-7692 **ACTIVE** has largest electronics inventory — all at truly wholesale prices affordable to your budget. All new 1984 product catalogue now available.

NEW — just released, descriptive catalogue and directory of over 2400 books on computers, electricity and electronics. Send \$5.00 to **ELECTECH BOOK SERVICE, 3223 Broadwater Rd., Dept. ETI, Castlegar, B.C., V1M 3H3.**

DIGITAL Organ and Digital Drum Kits. Prices starting from \$495.00. Demo LP \$8.00 and free information available from **SELTRON INSTRUMENTS, 35 South-bridge St., Leamington, Ont. N8H 4N4.**

NEW! Build these easy, fascinating IC projects. Combination lock controls computers, stereos, etc! Programmable light show controller! Intelligent auto alarm. Logic probe! Vocal blander. Digital dice! Most cost under \$20.00. \$10.95 for complete, full-size glossy manual. Schematics, theory, trouble-shooting, operation, sources, etc. Extra details \$1.00 (order credited). **STARK ELECTRONICS, Box 11963, Edmonton, Alberta, T5J 3L1.**

ATARI owners, with 48K RAM minimum backup any 8K or 16K cartridges on disk or tape. As many as 15 cartridges on 1 disk, DOS transferable. Send \$125 cheque, money order to **LO-COST COMPUTERS LTD. 619B Corydon Ave., Winnipeg, Man. R3L 0P3. 204-482-1737** Visa accepted.

We will not be undersold. If you find identical pcbs (glass epoxy) being sold for less elsewhere (within 30 days) — show us and we'll refund the difference. Send 32¢ for pricelist: **SPECTRUM ELECTRONICS 14** Knightswood Cres., Brantford, Ontario, N3R 7E6.

ACTIVE COMPONENTS — 3070 Kingsway, Vancouver, B.C. V5R 5J7 (604) 438-3321. Increase the memory capacity of your present system or add peripherals such as a disk drive, printer terminal, keyboard or controller board — **ACTIVE** has all the top names at prices you can afford. All new product catalogue 1984 is now available.

Software evaluation club. No membership fee. Apple™ games, utilities & CP/M™ programs. Send \$8.00 per disk and your program request (almost all available) to: **J.A. Box 83, Station "E", Montreal, P.Q. H2T 3A5.**

MODEM one card plugs in any Apple™ slot, 110-300 baud, auto dial/answer, on board firmware, direct phone connect //e compatible and terminal softwares. Certified Cheque or M.O. \$275. **CRIS P.O. Box 21, Oakville, Ontario, L6J 4Z5.**

BRIDGE is our computer game. Adjustable skill. Point count bidding. 1 to 4 players. T199/4A, APPLE2 +, 2E, 3 TRS80-1, 3, 4 IBM-PC/PCjr. \$29.95. **JOHN & LYNDIA ALLAN, 93 Laurier St., Dept. ETI, Box 313, Azilda, Ont. P0M 1B0, 705-983-4341**

ACTIVE COMPONENTS — 4800 Dufferin Street, Downsview, Ont. M3H 5S8 (416) 661-1115. Thousands of electronic students, professionals and hobbyists make **ACTIVE** their No.1 choice for electronic projects needs. All new 1984 product catalogue is now available.

1984 WORLD RADIO-TV HANDBOOKS \$23 + \$2 S&H, WSI 1984 Catalogue \$2.00, WSI RADIO, Box 400, Kitchener, Ontario N2G 3Y9.

SHURE V15V stereo cartridge only \$260.00 Retail \$400.00 for info write **DRAGON SOUND P.O. Box 151, Prince George B.C. V2L 4S1.**

Visit your **HEATHKIT ELECTRONIC CENTRE** for computers, robots software and peripherals. Also wide range of courses including Robotics and Electronic Kits. 3058 Kingsway, Vancouver, B.C. V5R 5J7 (604) 437-7626.

Product Mart *Where Buyers Find Sellers*

continued from page 68

UNUSUAL BOOKS: Intelligence & Investigative electronics and other covert technologies, (the real James Bond stuff.) Fascinating, hard-to-find technical information on many subjects. Free brochures: **MENTOR PUBLICATIONS**, Dept. CIA, 135-53 No. Blvd., Flushing, New York, 11354.

TIMEX/SINCLAIR software. 2K to 48K programs. T/S 1000/1500 and 2068. Free catalogue. **JDC** 5-14 Sentinel Rd., Downsview, Ont. M3M 2Y5.

ACTIVE COMPONENTS Bay 2, 3220 5th Ave., N.E. Calgary, Alta., T2A 5N1 (403) 235-5300 discover why thousands of electronics enthusiasts who think electronics, think **ACTIVE** — Canada's Electronics Stores. All new 1984 product catalogue is now available.

EDJ ELECTRONICS catalog now available. Send \$1 for best prices and selection on components and replacement parts. P.O. Box 1122, Saint John, N.B., E2L 4E6.

COMMODORE 64 Owners. We offer a fine selection of Programs. Send for our new free catalogue. **SANDISON SOFTWARE**, Box 1403, Chatham, Ontario N7M 5W8.

**DO SMALL ADS
ATTRACT ATTENTION?
WELL, THIS ONE DID!**

PRODUCT MART

Insertions Contact:
Claire Zyvitski

Moorshead Publications
Suite 601, 25 Overlea Blvd.
Toronto, Ontario M4H 1B1
Telephone (416) 423-3262

ACTIVE COMPONENTS, Baxter Centre 1050 Baxter Rd., Ottawa, Ont. K2C 3P2. (613) 820-9471.

ACTIVE — one stop shop for all your electronic components and micro-computer needs at wholesale prices. All new 1984 product catalogue is now available.

LASERS-Surplus units and parts. Infra-Red Night vision equipment. Best prices anywhere. Free listing. **MEREDITH INSTRUMENTS** 6517 W. Eva Glendale, Az. 85302 U.S.A.

PRINTED CIRCUIT BOARDS for ETI and Ham Radio projects. NDFL Amplifier - \$6.70; ZX81 A/D Converter - \$4.50; NiCad - \$3.50; Precision Pulse Generator - \$9.50. Full list free. Boards from **ARRL Handbook 1983** available. Post and pack \$1.00, Ontario tax 7%. **B-C-D ELECTRONICS**, P.O. Box 6326 Station F, Hamilton Ontario. L9C 6L9.

AMAZING Projects and plans for the hobbyist. Enter the fascinating world of Lasers, Ultrasonics, Surveillance, High Voltage Plasma, Unique Electronics and many more space age devices. Catalogue \$1.00. Mail order only. **DUKER ENTERPRISES** 8932 - 155 Street, Edmonton, Alberta T5R 1W4.

VIC20 Battery Powered RAM Kits from \$34.95. Complete 8K cartridge \$69.95. C64 RS232 interface coming soon. Free info **Canadian Micro Peripherals, Box 123, Waterloo, Ont. N2J 3Z9.**

J&J ELECTRONICS Ltd., P.O. Box 1437E, Winnipeg, Manitoba R3C 2Z4. Surplus and Semiconductor Specialists. Do you get our bargain flyer? Send \$1.00 to receive the current literature and specials and to be placed on the mailing list for future publications. **ETI**

Product Mart *Where Buyers Find Sellers*

NAME _____ COMPANY _____

ADDRESS _____

CITY _____ PROVINCE _____

POSTAL CODE _____ TELEPHONE _____

NO. OF WORDS _____ AMOUNT ENCLOSED _____

Please print the following in the next available issue of **ELECTRONICS TODAY**, **COMPUTING NOW**,
or **BOTH**. My cheque is enclosed. SIGNATURE _____

NOTE: A 3 line heading can be added to your advertisement for \$30. Also, the whole advertisement can be reversed for effective presentation also for \$30.

OSCILLOSCOPES!

The Best Buys Available

Model 65810
100 MHz Bench/Portable Scope

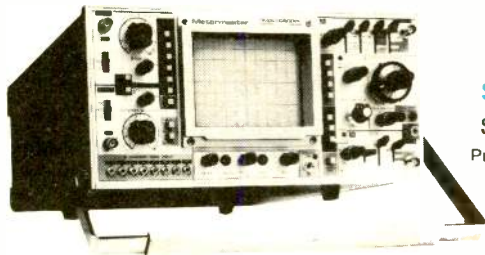

NOW
\$2595.00!
~~\$2695.00~~
Probes & FST
included

A HYBRID COMBINING ANALOG AND
LOGIC FUNCTIONS

VERSATILITY +

- Will Display 4 Analog Traces (independently adjustable) or 8 Logic Channels, or 3 Analog and 8 Logic
- 2ns/Div. Sweep Speed
- 16 kV CRT Potential for A Bright Clear Display
- Scale Illumination
- Delayed Triggered Sweep

Model 65601
Dual Trace Bench/Portable Scope

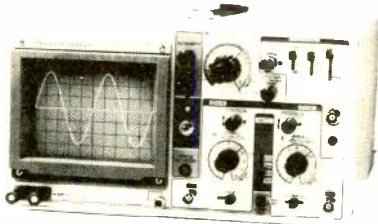

\$795.00
Probes & FST
included

- Featuring at no extra cost 'The Component Tester'
- 20 MHz (-3dB) Bandwidth
 - Trace Rotator
 - 6" CRT Display
 - 5 mV Vertical Sensitivity
 - Fully Automatic Triggering
 - HF Rejection

Model 65635
Dual Trace Bench/Portable Scope

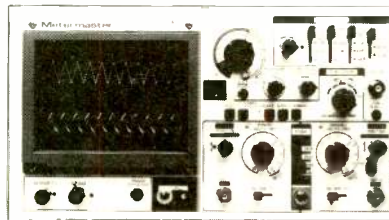

\$995.00
Probes & FST
included

- 35 MHz (-3dB) Bandwidth
- Delayed Sweep (selectable)
- Single Sweep (selectable)
- 6" CRT Display
- 1 mV Optimal Sensitivity
- X-Y or X-Y-Z Operation
- 120V AC Line Operation
- x5 Sweep Magnifier

MULTIMETERS!

Go for Quality --- Go for The Best Value

REDUCED PRICES... INCREASES YOUR VALUE

Models 78020, 78021, 78022

- AUTO ZERO
- AUTO POLARITY
- 3½ DIGIT LCD
- FULL OVERLOAD PROTECTION ON ALL RANGES
- RECESSED - SAFETY DESIGNED INPUT TERMINALS

- Supplied with:
- 28 Page Operating and Maintenance Manual
 - Calibration Certificate Traceable to NRC
 - Schematic with complete Parts Listing
 - Safety Test Leads
 - One-year Warranty

"Students 10% discount with Student Card!"

Circle No. 26 on Reader Service Card.

Metermaster

A Div. of R.H. NICHOLS CO. LTD.



\$139.00*

- ◆ ±0.1% DC
- ◆ 2000 hrs Bat. life

\$99.00*

- ◆ ±0.25% DC
- ◆ 10 Amps AC+DC
- ◆ 200 hrs Bat. life

\$89.00*

- ◆ ±0.25% DC
- ◆ 200 hrs Bat. life

* FST Included



5% Discount for Cash,
Certified Cheque, or Money Order
DEALER INQUIRIES INVITED

All prices F.O.B.
Downsview, Ontario
subject to change with-
out notice. P.S.T. extra
where applicable.

Head Office: 214 Dolomite Drive, Downsview, Ontario M3J 2P8

TORONTO (416) 661-3190 MONTREAL (514) 337-0425 EDMONTON (403) 432-7746 OTTAWA (613) 238-7007

Imagine that there was a single source for all your Interconnection needs.

There is. A P PRODUCTS has the most complete line of Interconnection products and accessories. DIP, Socket and Card-Edge connectors, all styles and sizes of Headers, and D-Submin in both IDC and solder versions. A P PRODUCTS offers flat cable in both gray and rainbow, in a wide variety of widths. And, our new low cost IDC assembly tool can help put everything together without putting a crimp in your budget.

Imagine that you could find high quality IDC products at affordable prices.

You can. A P PRODUCTS understands your prototyping needs. Our IDC products are manufactured to give you the accurate, dependable connections you must

have. They are designed to save you time. And, they are priced to save you money.

Imagine that there's an easy way to find the AP PRODUCTS you need.

There is. The A P PRODUCTS Interconnection rack at your electronics dealer has the complete line of connectors, cable, tooling, and accessories. Over one hundred and sixty products in all. You'll be able to find what you need fast. So you can get back to your project in a hurry.

Imagine that you need more information.

No problem. Just call toll free 800-321-9668 for the name of the distributor nearest you. (In Ohio, call collect (216) 354-2101.)



IMAGINE THAT

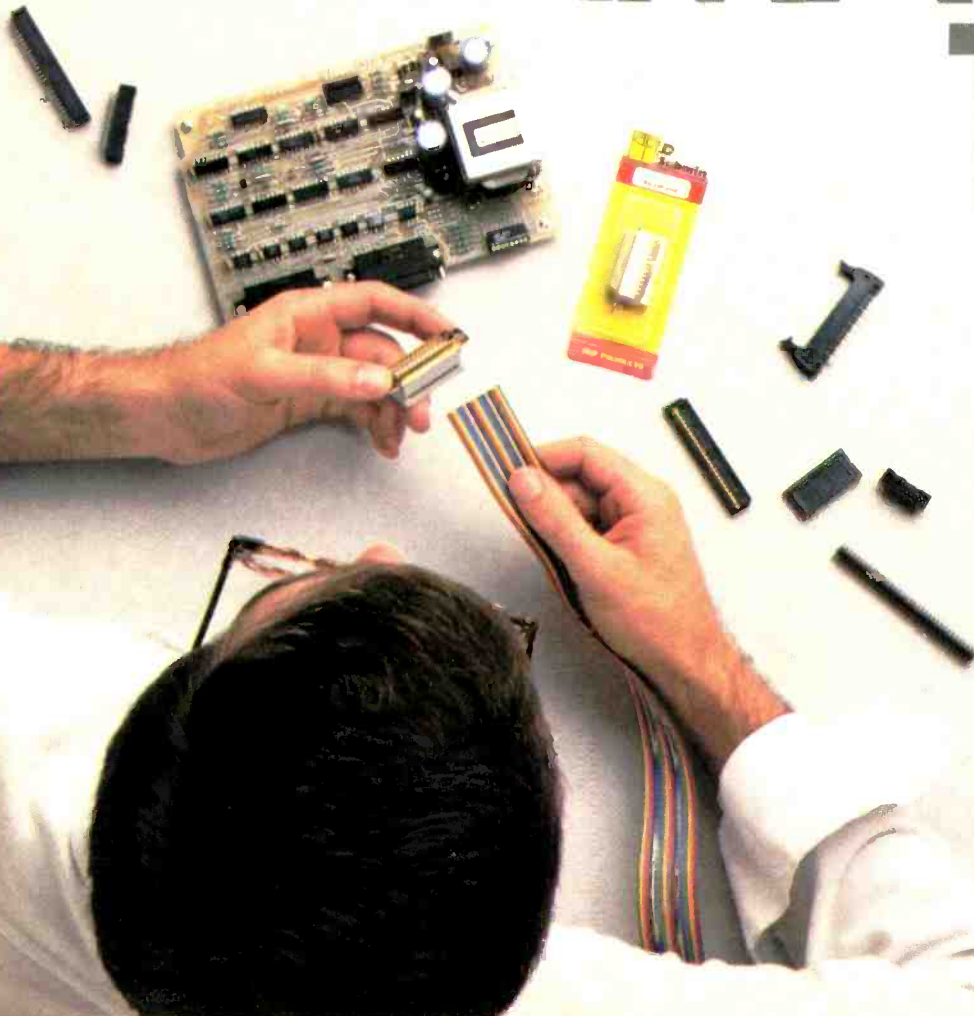

AP PRODUCTS INCORPORATED
9450 Pineneedle Dr. • Box 540
Mentor, Ohio 44061-0540
(216) 354-2101
TWX: 810-425-2250

In Canada, call Lenbrook Electronics
111 Esna Park Dr., Unit 1

Markham, Ontario, L3R1H2
(416) 477-7722, TWX: 610-492-3102

Circle No. 14 on Reader Service Card.