

ETI for Electronics & Computing Enthusiasts

Electronics Today

INTERNATIONAL

\$2.25
MM70924

January 1983

ZX81 Computer
Revisited

**Sound-to-Light
Modulator**
Another bright idea



**Josephson
Junctions**
Cool semiconductors

DVM Project
Digital
millivoltmeter



**Constant
Current
Generators**
Circuits feature

**The SCM Daisy
Wheel**
A look at
Smith Corona's
Printer

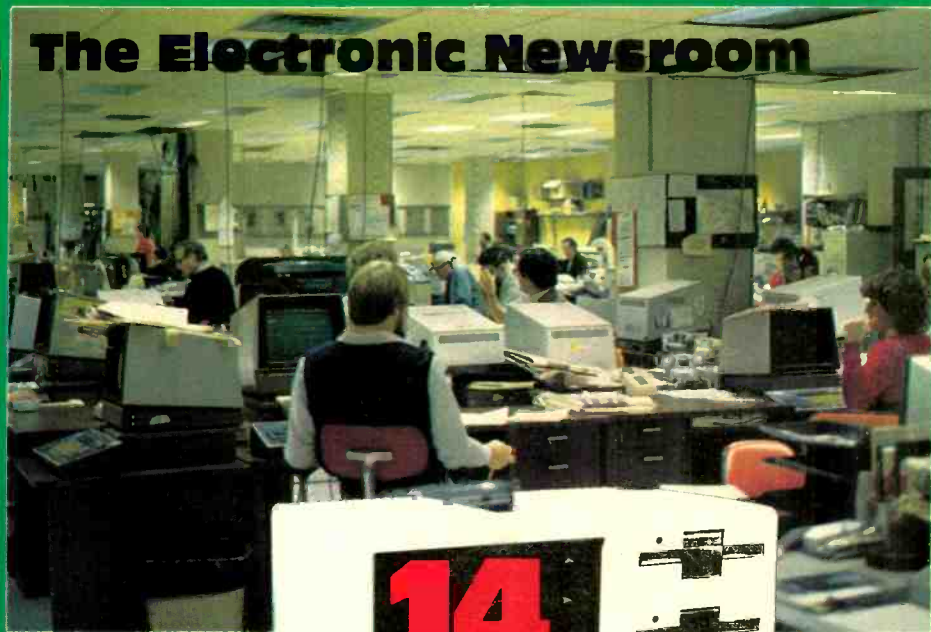

The Electronic Newsroom

**14
Computers Evaluated**



The Atari 800 Reviewed



SURPLUSTRONICS

we will not be undersold

We accept Visa, Mastercard and American Express

We buy, trade and sell

ABS '6502' Cases

High Quality

\$99.00

Beautiful ASCII encoded KEYBOARD, fits above exactly and plugs directly into 6502 board

\$109

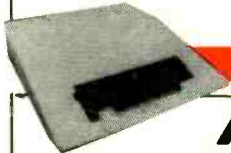

Aluminum '6502' Cases

Beige colour, similar to ABS case, with all hardware.

\$69

Super value ASCII encoded KEYBOARD in Kit form with all parts; ideal for 6502 board.

\$89

6502 Power Supplies



5V, 5A; 12V 1A; - 5V, 0.5A;
- 12V, 0.5A **\$95.00**

5V, 3A; 12V, 2A; - 5V, 0.5A;
- 12V, 0.5A **\$115.00**

Special

16K RAM Card (PCB only)
Apple compatible \$18.95
80x24 Video Board (PCB only)
Apple compatible \$18.95
Z80 Card, Apple compatible \$19.95
Wire Wrap Card, Apple
compatible \$18.95
Parts Kits available for the above
Apple is a registered trade mark of Apple Computers Inc.

NEW 6502 BOARD COMING SOON!

Has on-board provision for: 64K RAM, 80x24 Video, Floppy Controller and 6 slots for some of the above boards.

\$57.95

PARTS ON SALE

2114 (450nS) 95c
4116 (150nS) \$1.70
Special: 24 of above \$39.00
2716 \$4.95
Special: 6 of above \$25.95
2732 \$8.95
Special 3 of above \$21.95
6502 \$6.89
All sockets. Super quality 1c per pin
(Quantity discounts available)

112K Memory Boards

Containing (56 pieces) 4116, in sockets and control circuitry with schematics.

\$79

128K Memory Boards containing (64 pieces) 4116 (in sockets) and control circuitry. Schematics included.

New Shugart SA400L Disk Drives

5 1/4" Single Sided, Single or Double Density. Limited time offer. **\$265**

300 Baud Acoustic Modems

(No case or PSU) while they last **\$24**

128K Memory Boards + Parity

Containing 4116 200nS and control circuitry (Multilayer board). Great for prototyping. Works out at about 65c per 4116!

\$49

Mail Orders

Send a certified cheque or money order (do not send cash). Minimum order is \$10 plus \$3 for shipping. Ontario residents must add 7% provincial sales tax. Visa and Mastercard accepted: send card No., signature, expiry date and name of bank. All sales final.

You can't beat the best!

Exceltronix

Components & Computing Inc.

Don't hesitate to contact us on our price hotline 921-4114 for the most competitive prices in Canada!



Check out our new
Multiflex 68000/8086 Kit
 Complete with memory, floppy controller, video and much more right on board. Check with us for pricing on options. See catalogue page 25.
Basic Kit Starting Price \$695

U of T 6809 Board
 Perfect as a starter
KIT PRICE \$375
 Requires RS232 Terminal
 Includes 6809, 2 (6522) parallel ports, 2 (6551) serial ports, 48K of dynamic RAM, 4K of monitor.
 Optional 8K of U of T Assembler and Editor available at \$160 extra.
 Read May 1982 ETI for review of this 6809 Board.

SPECIAL MEMORY SUPER SPECIALS

very good stock



- 4164—150ns \$9.95
 - (1 x 64K single (+5V) supply) \$2.50
 - 4116-150ns (1x16k) \$1.95
 - 4116-200ns (1x16k) \$1.75
 - 4116-300ns (1x16k) \$1.95
 - 2114L-200ns low power \$1.95
 - TMM 2016 (2k x 8 static RAM) \$9.00
- NOTE: 1 of these can do the job of 4 2114's but uses only one 24 pin socket
- 6116 (2k x8) \$11.00
 - (same as above but CMOS) \$1.80
 - 2102 CFPC \$3.85
 - 5101 CMOS \$5.95
 - 2708 EPROM (1k) \$5.50
 - 2716 EPROM (2k) \$8.95
 - 2732 EPROM (4k) \$9.95
 - 2532 EPROM (4k) \$9.95
 - 2764 EPROM (8K)300ns \$17.95

DISK DRIVES SPECIAL
 This Month Only!

- SA400L \$289
(5 1/4" SS Shugart)
- SA200 \$285
(5 1/4" Slimline SS Shugart)
- SA801 \$669
(8" SS Shugart)
- SA851 \$895
(8" DS Shugart)

CONTROL DATA

- CDC 9409 \$399
(5 1/4" DS DD)
- CDC 9406 \$595
(8" DS DD)

Best Prices on Hameg, Hitachi and Leader 'Scopes. See pages 34-37 in our catalogue.

FOR QUANTITY PRICES CONTACT US FOR UNBEATABLE PRICES



New Improved Multiflex
 Great for beginners or pros
\$369

Comes with a motherboard and a S100 CPU card. Standard features:

- Motherboard**
 Includes 32 keypad with 16 HEX and 16 control keys; HEX display; Cassette Interface; EPROM Programmer for 2708, 2716, 2732, 2532, 2764, 27128; Wire-Wrap area (space for about fifty 14-pin chips); Parallel Port (8255); S100 Connector (with space for three more).
- CPU card includes**
 Z80A CPU, 2732 (EPROM with our monitor), 6116 (2K x 8 RAM) and all the circuitry. The CPU card has provision (but kit does not include the parts for) 64K of RAM, 4 sockets for EPROM/RAM (2732, 2764, 6116, 8255), parallel port and 8253 timer. Also piggyback board is available for this CPU with 2 serial ports, real time clock and much more.

PRICE POLICY

Remember that at Exceltronix, all prices are negotiable for quantity purchases. If you cannot afford large quantities on your own, how about starting a Co-op.

NEW MULTIFLEX PRODUCTS

Intelligent Terminal Kit

Comes with keyboard and 4K of RAM, 80x24 character composite video display and RS232 output (uses Z80 as control chip). See ETI Oct. and Nov. '82 issues.

- Kit \$269
- Case \$45.00
- TV Option \$39.00
- Power Supply \$45.00
- Extra 4K RAM \$19.00

Ass. & Tested \$369 (plus options)

Intelligent Terminal Kit & Zenith 12" Green Screen Monitor. \$379

This Month Only
 (This is an unbeatable combination)

Multiflex Terminal & 6809 Board

Includes Multiflex Intelligent Terminal (options extra) and U of T 6809 Board Kit with monitor program and 16K of RAM.

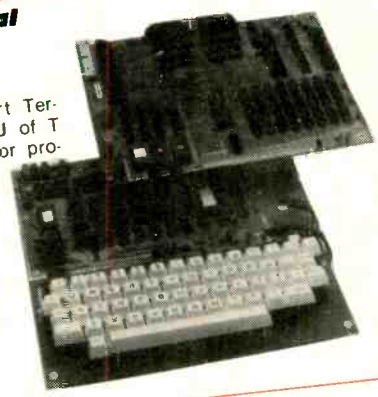

- \$495 Kit
- \$647 with Zenith 12" Monitor
- \$645 A&T \$797 with Zenith 12" Monitor

Multiflex Keyboard (55 key)

With connector wired in for external keypad. This keyboard uses 2716 to store the ASCII characters, therefore can be customised to suit your needs (all drawings and codes supplied in kit).

Optional case \$35

Static 5-100 RAM Card Kit

Using 6116 (150ns). See catalogue page 20.

Special on 16K version \$295

Multiflex Modem Kit

(See catalogue page 30)

\$149

New Multiflex Single Board Z80 system

See catalogue page 23. On board memory, floppy controller, video and much more.

Special with 64K RAM \$579

Optionally expandable to 256K RAM at \$289 extra. For limited time only you can buy this kit (with 64K RAM) with a Zenith 12" Green Screen monitor for only \$729. CPM 2.2 and BIOS \$169 extra.

Logic State Analyser Kit

(See catalogue page 24)

Special. Kit with case \$289
Assembled and Tested \$379

MAIL ORDERS

Send a certified cheque or money order (do not send cash). Minimum order is \$10 plus \$3 for shipping. Ontario residents must add 7% provincial sales tax. Visa, Mastercard and American Express accepted: send card No., signature, expiry date and name of bank.



319 COLLEGE STREET, TORONTO, ONTARIO, CANADA, M5T 1S2 (416) 921-5295
ALL PRICES ARE IN CANADIAN FUNDS, 9% FEDERAL SALES TAX INCLUDED

You can't beat the best!

Exceltronix

Components & Computing Inc.

The Multiflex Super Package



1. Multiflex Kit

Consisting CPU and Motherboard. CPU has Z80A, 2732 (EPROM with out monitor) and all the circuitry. Has 4 sockets for EPROM/RAM (2732, 2764, 6116) 8255 parallel port and 8253 timer. Also piggyback board is available for this CPU with 2 serial ports, real time clock and much more.

2. 64K RAM (4164)

On CPU Board.

The basic package includes:

3. Video Board Kit

Featuring 80x24 screen with programmable attributes (using its own Z80A, 8275 CRT Controller and 8257 memory manager and 8K of static RAM). On board ASCII keyboard interface.

4. Floppy Disk Controller

Based on the 1793, can handle up to four 8" or 5 1/4", SS or DS, SD or DD disks. Shugart compatible. Provision for DMA.

5. SA400L Shugart Disk

5 1/4" single sided, single or double density.

6. Motherboard

Holds all the above boards (with space for one more). Plus EPROM programmer, HEX control keypad, 6 digit 7-segment display (drives Multiflex monitor). Parallel and Serial ports, Wirewrap area.

7. CP/M 2.2

and custom BIOS on 5 1/4" disk

All this for an incredible \$1195!*

At last an S-100 computer at an affordable price — and a system with real power at that! Don't be misled by the price — check out the specs and compare with systems costing at least twice the price.

If you've had some experience with less powerful computers, step up now to a full featured system running CP/M.

The Multiflex Super Package includes CP/M as an operating system — just add your own CP/M software (in suitable 5 1/4" format) and you've got a powerful word processor, spread-sheet or communication terminal. (Remember there's more software for CP/M than just about any other operating system).

+ BASIC EXTRA OPTIONS

Multiflex Keyboard	\$120
(with duplicated numeric keypad)	
Keyboard	\$99
(without numeric keypad)	
Keyboard Case	\$35
(for either of above)	
Power Supply	\$99
(5V 5A, +12V 1A, -12V 0.5A) (Power supplies with higher currents for more drives and options available)	
Zenith 12" Green Monitor	\$165
(10% off this price if purchased with system)	

Huge Selection of Options Available

See our catalogue for full specifications

Hardware

1. Piggyback board with 2 serial ports and real time clock (kit)\$120.00
2. Economy RS232 expansion board (kit)\$35.00
3. DMA (kit)\$29.00
4. High resolution graphics board. Data is on request
5. DC-DC converter for programming EPROMs\$19.95

Plus Many More — Runs Virtually all S-100 Cards.

Software

1. EASIC (running under CP/M)
 2. WORDSTAR (Word Processor)
 3. SUPERCALC (Spread Sheet)
- Plus Many More.

PRICE POLICY

Remember that at Exceltronix, all prices are negotiable for quantity purchases. If you cannot afford large quantities on your own, how about starting a Co-op.



MAIL ORDERS

Send a certified cheque or money order (do not send cash). Minimum order is \$10 plus \$3 for shipping. Ontario residents must add 7% provincial sales tax. Visa, Mastercard and American Express accepted; send card No., signature, expiry date and name of bank.



319 COLLEGE STREET, TORONTO, ONTARIO, CANADA, M5T 1S2 (416) 921-5295
ALL PRICES ARE IN CANADIAN FUNDS. 9% FEDERAL SALES TAX INCLUDED

Circle No. 5 on Reader Service Card.

Features

Electronics in the Newsroom 13

You don't have to hold the presses anymore. Now you can hold the VDT's, which are a lot lighter.

Constant Current Generators 21

This month's circuit feature.

14 Computers Evaluated 24

An overview of some of the most popular systems.

Atari 800 Review 38

An audience with the lord imperious emperor of home video game computers.

Radio Astronomy Part 2 43

Further into the void.

Smith Corona TP-1 Review . . 48

Can you buy a daisywheel printer for under a thousand dollars and not have to worry about treadmill power? Actually, yes.

ZX-81 Revisited 53

A further look at this diminutive machine

Josephson Junctions 68

A semiconductor popsicle for overheated electrons.

Projects

Sound To Light Modulator . . 28

With this project and a liquor licence you can turn your basement into a bar. What fun!

Digital Millivoltmeter 31

Accurate, low cost and green if you spray paint it.

Series 5000 Preamp Part 2 . . 62

Concluding with the construction details.

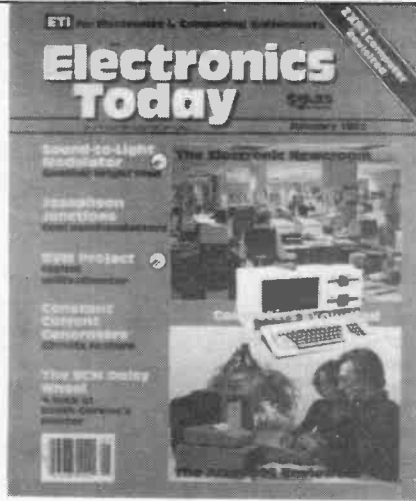

Our cover: The newsroom has recently lost its clattering typewriters and foam flecked copy boys in favour of VDTs and computer composition, as you'll see on page 13. Photo by Steve Rimmer, courtesy of the Globe and Mail. Also, the Atari 800 reviewed, on page 38.

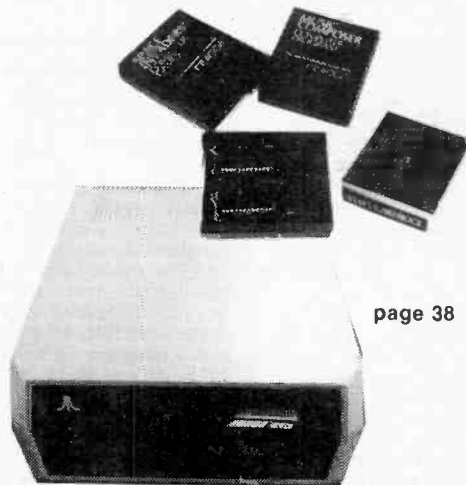

page 38

Columns, News and Information

News	6
Next Month	19
ETI Specials	20
Computing Today	57
Into Digital	59
Order Form	69
Subscriptions	70
ETI Bookself	71
Classifieds	75
Fun of Electronics	76
Software Exchange	80
Tech Tips	82

ADVERTISERS' INDEX

Arkon Electronics	8,9
Audiovision	84
BCS Electronics	52
Classified	75
Daetron	77
Electronic Packaging Systems	78
Exceltronix	3,4,81
F&T Associates	83
General Electronics	83
Gladstone Electronics	86,87,88
Imperial Tobacco	85
Kitstronic International	77
Lanpar Limited	7
McGraw-Hill	37
Metermaster	12
Nu-West Video Systems Ltd.	78
Omni Micro Inc.	42
Oriontronix	77
Orion Electronic Supplies	46,47
Parts Galore	49
H. Rogers Electronic Instruments ..	85
Smith Corona	11
Surplustronics	2
Tektronix	40,41
Torch International Computers Ltd ..	51
Trigid Communications	78

NEWSSTAND DISTRIBUTION:

Master Media, Oakville, Ontario

SUBSCRIPTIONS

\$18.95 (one year), \$33.95 (two years). For US add \$3/yr., other countries add \$5/yr. Please specify if subscription is new or a renewal.

BINDERS

Binders made especially for ETI are available for \$8.00 including postage and handling. Ontario residents please add provincial sales tax.

BACK ISSUES AND PHOTOCOPIES

Previous issues of ETI Canada are available direct from our offices for \$3.00 each; please specify by month, not by feature you require. See order card for issues available.

We can supply photocopies of any article published in ETI Canada; the charge is \$2.00 per article, regardless of length. Please specify both issue and article.

COMPONENT NOTATION AND UNITS

We normally specify components using an international standard. Many readers will be unfamiliar with this but it's simple, less likely to lead to error and will be widely used everywhere sooner or later. ETI has opted for sooner!

Firstly decimal points are dropped and substituted with the multiplier; thus 4.7uF is written 4u7. Capacitors also use the multiplier nano (one nanofarad is 1000pF). Thus 0.1uF is 100nF, 5600pF is 5n6. Other examples are 5.6pF = 5p6 and 0.5pF = 0p5.

Resistors are treated similarly: 1.8Mohms is 1M8, 56kohms is the same, 4.7kohms is 4k7, 100ohms is 100R and 5.6ohms is 5R6.

PCB SUPPLIERS

ETI magazine does NOT supply PCBs or kits but we do issue manufacturing permits for companies to manufacture boards and kits to our designs. Contact the following companies when ordering boards.

Please note we do not keep track of what is available from who so please don't contact us for information on PCBs and kits. Similarly do not ask PCB suppliers for help with projects.

- K.S.K. Associates, P.O. Box 54, Morriston, Ont. N0B 2X0
- B-C-D Electronics, P.O. Box 6326F, Hamilton, Ont., L9C 6L9.
- Wentworth Electronics, R.R.No.1, Waterdown, Ont., L0R 2H0.
- Danocinths Inc., P.O. Box 261, Westland MI 48185, USA.
- Arkon Electronics Ltd., 409 Queen Street W., Toronto, Ont., M5V 2A5.
- Bayer & Martin Electronic Ltd., 2 Jodi Ave., Unit C, Downsview, Ontario M3N 1H1.
- Spectrum Electronics, Box 4166, Stn 'D', Hamilton, Ontario L8V 4L5.
- Dacor Limited, P.O. Box 683, Station Q, Toronto, M4T 2N5.

POSTAL INFORMATION

Second Class Mail Registration No.3955. Mailing address for subscription orders, undeliverable copies and change of address notice is: Electronics Today International, Unit 6, 25 Overlea Blvd., Toronto, Ontario, M4H 1B1.

News

Digital Audio

Sony, Philips, CBS/Sony and Polygram have jointly announced the release of the Compact Disc Digital Audio System. Market introduction, of both the players and records, commenced October 1st, 1982 in Japan, with the introduction in Europe scheduled for March 1983.

The Compact Disc (CD) players are produced by Sony and Philips, along with an additional thirty-six manufacturers, now licensed to produce equipment for this new international record standard.

The records are currently being produced and distributed by CBS/Sony and Polygram to coincide with the availability of the CD players. Within 1982, CBS/Sony will release a total of 112 titles in classical, jazz and rock selections while Polygram have committed

an additional 50 titles. The combined effort of both companies is expected to push the total to over 500 titles by March, 1983.

All units, both players and records are fully compatible and can be directly connected to any Hi-Fi/Stereo system now in the market. With full international acceptance of the new standard now assured, it is expected to eventually replace the LP in the same manner the 78 RPM shellac discs were superseded in the 1950's.

Offering significant advantages over the existing LP format, the new records are only 12cm (4.7 inches) in diameter and contain 60 minutes of music on one side. Surface scratches and fingerprints will not effect the sound quality. Utilizing new high density digital encoding technology, the music signal is transferred from the disc to the playback circuits by a solid state optical laser with no physical contact on the disc surface. The discs remain untouched during playback and therefore will not deteriorate with use, no matter how many times they are played.

The sound quality is substantially superior, to any disc or tape format presently in use, with a totally flat frequency response, ab-



solute channel separation, undetectable wow and flutter, no distortion and a dynamic range/signal to noise ratio over 90 dB.

For complete information on

Sony CD players contact Mr. Mel Hinde, Professional Audio Division, Sony of Canada Ltd., 411 Gordon Baker Road, Willowdale, Ontario, M2H 2S6, Telephone (416) 499-1414.

ETI Magazine is Published by:

Electronics Today International
Editorial and Advertising Offices
Unit 6, 25 Overlea Boulevard,
Toronto, Ontario, M4H 1B1
Telephone (416) 423-3262

Publisher and Editor: Halvor W. Moorshead
Assistant Editor: Steve Rimmer
Production Manager: Ann Rodrigues
Production: Cindy Baker
Liz Longwill
Subscription Department: Bebe Lall
Diane Neill
Accounts Department: Pirjo Dunphy
Advertising Manager: Senga Harrison
Advertising Representative: Omar Vogt
Advertising Services: Carolyn Wyatt

COPYRIGHT
All material is subject to worldwide copyright protection. All PCB patterns are copyright and no company can sell boards to our design without our permission.

LIABILITY
While every effort has been made to ensure that all constructional projects referred to in this magazine will operate as indicated efficiently and properly and that all necessary components are available, no responsibility whatsoever is accepted in respect of the failure for any reason at all of the project to operate efficiently or at all whether due to any fault in the design or otherwise and no responsibility is accepted for the failure to obtain component parts in respect of any such project. Further no responsibility is accepted in respect of any injury or damage caused by any fault in design of any such project as aforesaid.

EDITORIAL QUERIES
Written queries can only be answered when accompanied by a self-addressed, stamped envelope. These must relate to recent articles and not involve the staff in any research. Mark such letters ETI-Query. We cannot answer telephone queries.

Radio Beacon

A new type of life-saver for ships at sea, a radio beacon that automatically beams its message via satellite to shore, is expected to emerge from tests nearing completion in Spain. Several nations are working towards development of the device, known as a satellite Emergency Position-Indicating Radio Beacon (EPIRB), which would be built to internationally agreed specifications.

Experimenters from the USSR, US, UK, Norway and Federal Republic of Germany have developed satellite EPIRB systems in their own countries which they are now comparing and evaluating in a demanding series of tests, using a channel simulator developed by the German Aerospace Research Establishment, at the European Space Agency (ESA) tracking station at Villafranca del Castillo, 30 km west of Madrid.

Under requirements of the Future Global Maritime Distress and Safety System, now being developed by the International Maritime Organization (IMO), most countries are expected to make it mandatory for all ocean-going vessels to carry such satellite EPIRBs in the 1990s.

The radio beacon would send a distress message to the appropriate rescue authorities indicating where the signal originated, the ship involved and the nature of the distress. Within a few minutes, rescue authorities

would have the message processed so that they could direct other ships or aircraft to the vessel in distress.

The nations involved are using capacity provided free of charge by the International Maritime Satellite Organization (INMARSAT) on the MARECS A satellite, positioned over the Atlantic Ocean. INMARSAT's geostationary satellites give almost total global coverage within latitudes of 70° north and south. The London-based organization's 37 member-nations account for 85 per cent of the world's shipping. The tests are being carried out at ESA's tracking station in Villafranca under the control of the European Space Operation Centre (ESOC) and are being co-ordinated by the International Radio Consultative Committee (CCIR) of the International Telecommunication Union.

For further information, contact David Wright, Press Officer, INMARSAT, London, Telephone: 387-9089.

Darlington Power

A series of three new Darlington Power transistors, specifically designed for motor-control and power supply applications in the 25KVA category, have been introduced by Motorola.

Capable of dissipating up to 250 watts of power, with current ratings as high as 100 amperes, the devices are encapsulated in a new

medium-current "Energy Management" plastic package that's a smaller version of a previously introduced high-current 50KVA package. The new Darlingtons,

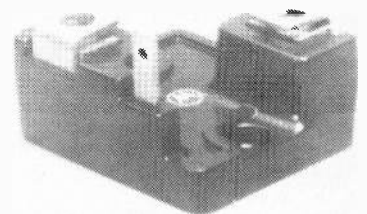

therefore, have all the attributes of the high power devices at half the cost.

The first group of devices to be introduced will be power Darlington transistors intended for variable voltage, variable frequency, six step ac motor controls.

The following are the initial devices and their respective ratings and prices:

Device	Rated I _C (amperes)	V _{CEO} (voltage)
MJ10042	25 A	850 V
MJ10045	50 A	450 V
MJ10048	100 A	250 V

Samples of these 25KVA devices will be available now, with production quantities during the first quarter, 1983.

For more information, contact your local Motorola distributor.

Continued on page 10

LANPAR announces The most important Price Breakthrough in Personal Computing this year.

Osborne 1 Personal, Portable Professional Computer

And Printer!

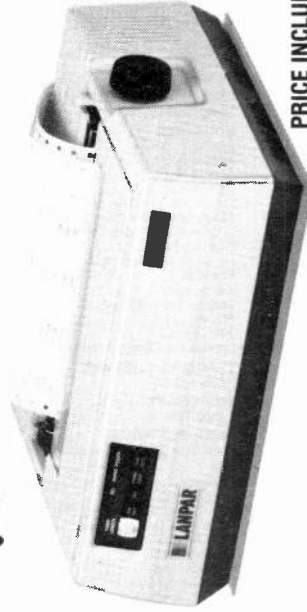
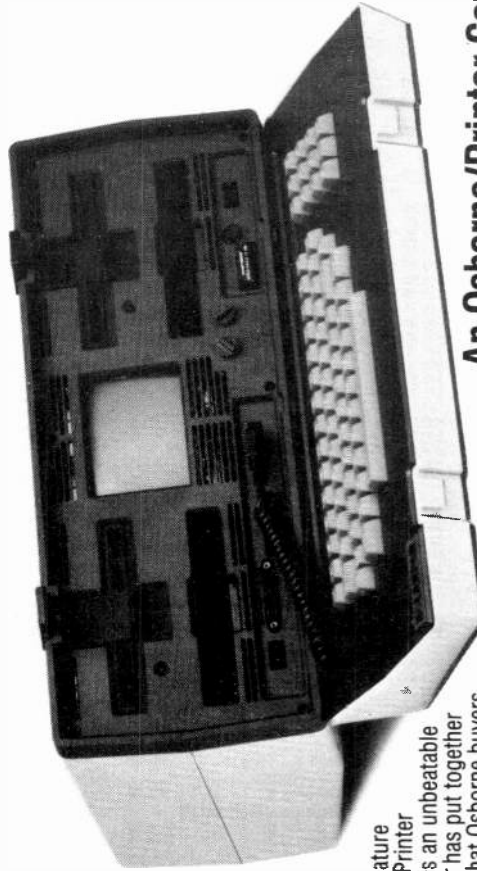

Feature for feature our Osborne/Printer combination is an unbeatable value. Lanpar has put together the package that Osborne buyers have been demanding. And at \$2973, you can't afford to pass it up!

FULL FUNCTION PRINTER

A high-performance, 120 character per second printer ideal for personal computer systems. Using a 9 x 9 matrix to produce crisp upper and lower-case characters, the printer delivers up to 132 columns on plain or pin-fed paper. Sophisticated users will appreciate the full graphics ability for preparing charts, graphics and illustrations. Includes interface and cable.

An Osborne/Printer Combination

Only \$2973*

*Manufacturers Suggested Retail price \$3673.

A \$700 savings!

PRICE INCLUDES SOFTWARE
This remarkable price includes the widely-used CP/M[®] operating system, with FIVE ready-to-use software packages including WORDSTAR[™] (word processing) with MAILMERGE[™], SUPERCALC[™] (a spreadsheet planning tool), CBASIC[™], and MBASIC[™].

OPTIONAL EXTRAS

And there's more! A 12-inch video monitor, letter quality printers, modems, and many CP/M compatible software packages. You can add DATASTAR[™], DBASE 11[™], MILESTONE[™], MAILMAN or PERSONAL DATEBOOK[™], to name but a few.

RENTALS AND FLEXIBLE FINANCING

Lanpar offers flexible rental and lease plans to suit your needs.

LANPAR OFFICES
Quebec City: (418) 653-1345
Vancouver: (604) 321-5777
Winnipeg: (204) 632-4345
Edmonton: (403) 483-1133
Burlington: (416) 681-2442
Calgary: (403) 253-8866
Toronto: (416) 475-9123
Ottawa: (613) 238-3966
Toronto W: (416) 492-0515
Montreal: (514) 731-7421
London: (519) 685-6030

Registered trademark of Digital Research, Word Star[™], Mailmerge[™]. Trademarks of Micro Pro Corp. International, Super Calc[™]. Trademark of Sorcom Inc. MBasic[™]. Trademark of Micro Soft. CBASIC[™]. Trademark of Computer Systems. Z80-A[™]. Trademark of Zilog. Service Power[™]. Registered trademark of Lanpar.



Canada's largest independent distributor of Computer Terminals.

Circle No. 21 on Reader Service Card.

arkon electronics ltd

409 Queen St. West
Toronto, Ont. M5V 2A5
593-6502/03/04 — Computer Dept.
593-9653/54/55 — Electronic Dept.



GAMES

ADVENTURE INTERNATIONAL	
Adventure #10-11-12	\$54.95
Adventure #7-8-9	\$54.95
Eliminator (new version)	\$41.95
S.A.G.A. #1	\$41.95
S.A.G.A. #2	\$41.95
S.A.G.A. #3	\$41.95
Stone of Sisyphus	\$41.95
The Curse of Crowley Manor	\$41.95
AUTOMATED SIMULATIONS	
Crush, Crumble & Champ (48K)	\$39.95
Curse of Ra (48K)	\$26.95
Danger In Drindist (48K)	\$26.95
Invasion Orion (48K)	\$32.95
Jabbertalky (48K)	\$39.95
Rescue At Rigel (48K)	\$39.95
Richocheat (48K)	\$26.95
Sorcerer Of Siva (48K)	\$39.95
Temple Of Apsah (48K)	\$53.95
The Datesones Of Ryn (48K)	\$26.95
Upper Reaches Of Apsah (48K)	\$26.95
BLUECHIP SOFTWARE	
Millionaire	\$112.95
BRODERBUND SOFTWARE	
Apple Panic	\$41.95
Chop Lifter	\$47.95
David's Midnight Magic	\$47.95
Dueling Digits	\$41.95
Labyrinth	\$41.95
Seafox	\$41.95
Serpentine	\$47.95
Star Blazer	\$42.95
Track Attack	\$41.95
CALIFORNIA PACIFIC	
Both Barrels	\$54.95
Fender Bender	\$34.95
CONTINENTAL SOFTWARE	
3-D Skiing	\$32.95
Guardian	\$39.95
Hyperspace Wars	\$39.95
Torpedo Terror	\$32.95
AVANT GARDE	
Death Race '82"	\$42.95
CAVALIER	
Star Thief	\$42.95
Asteroid Field	\$42.95
Microwave	\$49.95
Teleport	\$42.95
Bug Attack	\$42.95
DATAMOST	
Aztec Adventure	\$54.95
County Fair	\$41.95
Crazy Maze	\$41.95
Gin Rummy	\$41.95
Mars Cars	\$41.95
Missing Ring	\$41.95
Money Munchers	\$41.95
Pig Pen	\$41.95
Snack Attack	\$41.95
Swashbuckler	\$47.95
Thief	\$41.95
Tubeway II	\$47.95
World Series Baseball	\$41.95
DATASOFT	
Tumble Bugs (Dung Beetles)	\$41.95
EDU-WARE	
Empire I: World Builders	\$44.95
Rendezvous	\$54.95
The Prisoner 2	\$44.95
GEBELLI SOFTWARE	
Firebird	\$41.95
Horizon V	\$47.95
Nephtun	\$41.95
Phazer Fire	\$41.95
Zenith	\$47.95
HAYDEN SOFTWARE	
Final Conflict	\$48.95
Kamikaze	\$48.95
Reversal	\$48.95
Sargon II	\$48.95
Shuttle Intercept	\$48.95
HIGHLANDS	
Goblins	\$38.95
Mummy's Curse	\$42.95
I.D.S.I. (Innovative Design Software Inc.)	
Juggler	\$41.95
Pool 1.5	\$47.95
Shuffleboard	\$41.95
Trick Shots	\$54.95
INFOCOM	
Deadline	\$68.95
Starcross	\$54.95
Zork I	\$54.95
Zork II	\$54.95
Zork III	\$54.95
INTELLIGENT STATEMENTS	
Ken Ulston's Pro Black Jack	\$126.95
MICROFUN	
Dogfight II	\$42.95
Ming's Challenge	\$49.95
Peeping Tom	\$49.95
Roach Hotel	\$49.95
MICROSOFT	
Adventure	\$41.50
Dlympic Decathlon	\$35.50
MUSE SOFTWARE	
AMB	\$34.95
Castle Wolfenstein	\$41.95
Firebug	\$34.95
Frazzle	\$34.95
Robot War	\$54.95
The Cube Solution	\$34.95
Three Mile Island	\$54.95
OMEGA MICROWARE	
Night Falls	\$47.95
ON-LINE SYSTEMS	
Canonball Blitz	\$47.95
Crossfire	\$41.95
Frogger	\$47.95
Hires Adv. #2 Wizard & The Princess	\$45.95
Hires Adv. #3 Cranston Manor	\$47.95
Hires Adv. #4 Ulysses	\$47.95
Hires Adv. #5 Time Zone	\$137.95
Hires Adventure Adv. #1 Mystery House	\$34.95
Jawbreaker	\$41.95
Laf Pak	\$47.95
Marauder	\$47.95
Mouskattack	\$45.95
Softpop Adventure	\$41.95
Threshold	\$54.95
Ultima II	\$75.95
SABRE SOFTWARE	
Demon's Forge	\$39.95
SENSIBLE SOFTWARE	
Cyclotron	\$41.95
Quadrant 6112	\$48.95
SIR-TECH SOFTWARE	
Wizardry: Knight of Diamonds	\$47.95
Wizardry: Proving Grounds Of The Mad Overlord (Part 1 Of Wizardry)	\$68.95
SIRIUS SOFTWARE	
Bandits	\$45.95
Beer Run	\$45.95
Borg	\$39.95
Computer Football	\$39.95
Cyclod	\$39.95
Epoch	\$45.95
Escape From Rungistan	\$39.95
Fly Wars	\$39.95
Free Fall	\$39.95
Gorgon	\$52.95
Hadron	\$45.95
Jelly Fish	\$39.95
Kabul Spy	\$45.95
Minotaur	\$45.95
Outpost	\$39.95
Snake Byte	\$39.95
Sneakers	\$39.95
Space Eggs	\$39.95
Twerp	\$39.95
Wayout	\$52.95
SOFTAPE/ARTSCI	
Gomoku	\$27.95
Photar	\$41.95
Reversi	\$41.95
Roulette	\$41.95
Starmites	\$41.95
SOUTHWESTERN DATA SYSTEMS	
Norad	\$49.95
Alien	\$49.95
STRATEGIC SIMULATIONS	
Battle of Normandy	\$54.95
Computer Baseball	\$54.95
Computer Quarterback	\$54.95
Cosmic Balance	\$54.95
Cytron Masters	\$54.95
Napoleon's Campaigns	\$82.95
Pursuit Of Gratspee	\$82.95
Road To Gettysburg	\$82.95
Galactic Gladiators	\$54.95
SUBLOGIC	
Flight Simulator	\$49.95
Night Mission	\$49.95
Space Vikings	\$69.95
SYNERGISTIC SOFTWARE	
Adventure To Atlantis	\$54.95
Nightmare Gallery	\$47.95
Crisis Mountain	\$47.95
Spotlight	\$65.00
Mix & Match	\$65.00
Instant Zoo	\$65.00
COMPUTER COURSEWARE	
Speed Reading Courseware	\$249.95
EDU-WARE	
Algebra II	\$54.95
Algebra III	\$54.95
Algebra III	\$54.95
Compu-Read 3.0	\$41.95
Compu-Spell (No Data Disk Incl.)	\$41.95
Compu-Spell Data Disks (Specify Level 4-8, or Adult/Sec.)	\$26.95
Counting Bee	\$41.95
Edu-Ware Decimals (New Ver.)	\$67.95
Edu-Ware Fractions (New Ver.)	\$67.95
Perception 3.0	\$34.95
Spelling Bee (with Reading Primer)	\$54.95
Statistics 3.0	\$41.95
Uni-Solve (Electronics Designer)	\$34.95
LEARNING COMPANY	
Rocky's Boot	\$104.95
MICROSOFT	
Typing Tutor II	\$34.50
MUSE SOFTWARE	
Know Your Apple	\$47.95
PDI	
Analogies	\$32.95
Astro Quotes	\$32.95
Astro Word Search: Geography	\$32.95
Astro Word Search: French	\$32.95
Code Breaker	\$32.95
Memory Builder	\$32.95
Minicrossword	\$32.95
New Step By Step (Incl. Audio Cassette)	\$109.95
Number Series	\$32.95
Preschool IQ Builder	\$32.95
Reading Comp: What's Different	\$32.95
Spelling Builder (Incl. Audio Cassette)	\$36.95
Story Builder/Word Master	\$32.95
Vocabulary Builder I	\$32.95
Vocabulary Builder 2	\$32.95
SPINNAKER	
Facemaker	\$49.95
Disappearing Dolphin (Case #2)	\$63.95
Granite Ghost (Case #1)	\$63.95
SYNERGISTIC SOFTWARE	
The Linguist	\$54.95
LANGUAGE	
APPLE COMPUTER	
Fortran II	\$255.00
Pascal II	\$319.00
Pascal III	\$319.00
Pilot II	\$129.00
Logo (Apple)	\$235.00
APPLE COMPUTER	
Access III	\$199.00
Apple Graphics	\$95.00
Apple Writer III	\$289.00
Apple Writer II	\$195.00
ARROW MICRO SOFTWARE	
DFX (Dos File Exchange)	\$55.95
BEAGLE BROTHERS	
Alpha Plot (+Tr Book #4)	\$54.95
Apple Mechanic	\$39.95
Oos Boss (Doss Command Editor)	\$34.95
Tip Disk #1	\$27.95
Utility City (+Tr Book #3)	\$39.95
BRODERBUND SOFTWARE	
Arcade Machine	\$82.95
DATASOFT	
Micropainter	\$47.95
Refill Album #1 (X-rated)	\$27.95
Refill Album #2 (cars)	\$27.95
HIGHLANDS	
Crae	\$56.95
MICRO	
Micro I	\$32.95
Micro II	\$32.95
Micro III	\$32.95
MICRO-WARE	
Nibbles Away II	\$94.95
MICROCOMM SOFTWARE	
Microterminal II	\$114.95
Microterminal III	\$134.95
MICROSOFT	
A.L.D.S. (Assembly Language Development System)	\$172.50
MUSE SOFTWARE	
The Voice	\$54.95
NIKROM TECH. PRODUCTS	
Master Diag. Software	\$78.95
OMEGA MICROWARE	
Consolidator	\$79.95
Locksmith	\$189.95
The Inspector	\$91.95
The Inspector On Rom	\$91.95
The Manager	\$54.95
Watson	\$79.95
Watson On Rom	\$79.95
ON-LINE SYSTEMS	
Expditer II Plus (Comiler)	\$186.95
Speed/ASM	\$54.95
PHOENIX SOFTWARE	
Zoom Graphix	\$54.95
QUALITY SOFTWARE	
Bag Of Tricks	\$54.95
SENSIBLE SOFTWARE	
Back-It-Up "Copy All"	\$82.95
Disk Organizer II	\$41.95
Dos Plus	\$34.95
Multi Disk Catalog	\$34.95
Super Disk Copy II	\$41.95
The Sensible Speller — DOS 3.3	\$179.95
SIRIUS SOFTWARE	
Audex	\$39.95
E-Z Draw 3.3	\$66.95
SOUTHWESTERN DATA SYSTEMS	
ASCII Express II	\$84.95
Z-Term (Z-80)	\$141.00
SSM MICROCOMPUTER	
Transend I (Data Communications)	\$124.95
Transend II (Data Communications)	\$208.95
SUBLOGIC	
Graphics Package	\$174.95
SYNERGISTIC SOFTWARE	
Higher Fonts I	\$19.95
Higher Graphics II	\$47.95
Higher Text II	\$54.95
VIDEX	
Appewriter Videx	
Pre-Boot Disk	\$27.95
Utilities Disk With Font Editor	\$54.95
Visicalc: 80 Column Pre-Boot Disk	\$68.95
BUSINESS	
APPLE COMPUTER	
Apple Post II	\$65.00
Business Basic III	\$159.00
Business Graphics III	\$245.00
CONTINENTAL SOFTWARE	
Accounts Payable	\$345.00
Accounts Receivable	\$345.00
The Home Accountant	\$99.95
DATAMOST	
Write-On	\$179.95
Write-On (Apple III)	\$179.95
HAYDEN SOFTWARE	
Pie Writer (40 Col)	\$209.95
Pie Writer (80 Col)	\$209.95
MICROPRO	
Calstar (Z-80)	\$215.00
Dastar (Z-80)	\$315.00
Mailmerge Option (Z-80)	\$135.00
Spellstar 1.2 Option (Z-80)	\$215.00
Supersoft (Z-80)	\$235.00
Wordmaster (Z-80)	\$210.00
Wordstar 3.01P (Z-80)	\$395.00
MUSE SOFTWARE	
Form Letter Module	\$139.95
Super Text 40/50/70	\$174.95
Super Text 40/80	\$240.00
ON-LINE SYSTEMS	
Screenwriter II	\$179.95
The Dictionary	\$137.95
The General Manager Ver. 1.5	\$206.95
SILICON VALLEY SYSTEMS	
The List Handler	\$94.95
The Word Handler	\$274.95
SOFTAPE/ARTSCI	
Magic Mailer	\$96.95
Magic Window	\$137.95
Magic Words	\$96.95
SOFTWARE PUBLISHING CORP.	
PFS3: The Personal Filing System (Apple III)	\$242.95
PFS: Graph	\$172.95
PFS: Report	\$129.95
PFS: Report (Prodisk Compatible Apple III)	\$172.95
PFS: The Personal Filing System	\$172.95
SYNERGISTIC SOFTWARE	
Data Reporter	
(Mod. Data Base + +)	\$300.00
Modifiable Data Base	\$109.95
ZIRCON INTERNATIONAL INC.	
Desk Top Plan II	\$360.00
Desk Top Plan III	\$435.00
Visicalc	\$360.00
Visicalc Advanced Version III	\$580.00
Visicalc Business	
Forecasting Model	\$145.00
Visidex	\$360.00
Visifile	\$360.00
Visiplot	\$290.00
Visisschedule	\$435.00
Visisschedule III	\$435.00
Visiterm	\$145.00
Visitrend/Visiplot	\$435.00
Visitrend/Visiplot (Apple III)	\$435.00
HARDWARE	
ALPHA PRODUCTS	
Stick 80 (TRS-80 Model I)	\$69.95
Stick 80 (TRS-80 Model III)	\$69.95
DATASOFT	
Atari Le Stick	\$54.95
HAYES MICROCOMPUTER	
Micromodem II (Apple II)	\$599.95
Micromodem II/Terminal Pkg	\$649.95
Micromodem 100	\$639.95
Smartmodem 300	\$459.95
Smartmodem 1200	\$1109.95
Chronograph	\$399.95
KRAFT SYSTEMS	
Apple Joystick	\$97.95
IBM P.C. Joystick	\$105.95
TRS-80 Colour Joystick	\$97.95
M & W COMPUTERS	
Lower Case Chip (Apple II)	\$24.95
MICROSOFT	
Z80 Softcard (Apple II)	\$592.00
MOUNTAIN COMPUTER	
CPS Multifunction Card (Apple II)	\$360.00
A/D + D/A (Apple II)	\$525.00
Romwriter (Apple II)	\$265.00
ORANGE COMPUTER	
16K Ram Card (Apple II)	\$139.00
ORANGE MICRO INC.	
Grappier + : Parallel Graphics Interface Card (Apple II)	\$249.00
VIDEX	
PRACTICAL PERIPHERALS (Apple II Printer Interface Cards)	
Microbuffer II 16K Epson Parallel	\$389.95
Microbuffer II 32K Epson Parallel	\$449.95
Microbuffer II 16K Serial (For Daisy Wheel Printers & Modems)	\$359.95
Microbuffer II 32K Serial (Same As Above But 32K)	\$449.95
(Epson Printer Interfaces) Parallel 16K	
Buffer (For All Epson Printers Any Computer's Parallel Port)	\$239.95
Epson Serial 8K Buffer RS232 Interface With X On/X Off	\$239.95
RANA SYSTEMS	
Elite One Minifloppy Disk Drive (Apple II)	\$635.00
Controller Card (13 or 16 Sectorboot)	\$195.00
R.H. ELECTRONICS	
Super Fan II (Apple II)	\$114.95
SIRIUS SOFTWARE	
Joyport/With Football (Apple II)	\$100.00
SSM MICROCOMPUTER	
Four Function Serial & Parallel Apple Interface	\$349.95
Serial Apple Interface & Cable	\$229.95
Parallel Apple Interface & Cable	\$167.95
IEEE-488 Apple Controller Interface And Cable	\$719.95
T.G. PRODUCTS	
Apple II Game Controllers (Paddles, Pair)	\$54.95
Apple II Joystick	\$79.95
Apple II Select-A-Port	\$79.95
IBM PC Joystick	\$87.95
Apple III Joystick	\$87.95
VERSA COMPUTING INC.	
(Apple II) Versawriter	\$449.95
Expansion Pac-1	\$54.95
Expansion Pac-II	\$54.95
E-Z Port	\$37.95
(Atari 400/800) Versawriter	\$449.95

CANADA'S LARGEST SOFTWARE SUPPLIER!

HERE'S HOW TO ORDER

Send Certified cheque, money order, Visa, Master Card, American Express number. Include expiry date and signature. (We also accept government purchase orders.) Add \$1.50 shipping & handling. Ontario residents and 7% sales tax. Phone orders accepted or pick it up now!! All products and more on display.

Address:
ARKON ELECTRONICS
 (M & W COMPUTER STORES INC.)
 409 Queen St. West, Toronto,
 Ontario M5V 2A5 (416) 593-6502/03/04



TRS-80

GAMES

ADVENTURE INTERNATIONAL

Adventure #	Disk	Cass
Adventure #10-11-12	\$54.95 1/3	
Adventure #7-8-9	\$54.95	
Adventure #1 thru 12	\$179.95 2	
Adventure #10		\$27.95 1/3
Adventure #11		\$27.95 1/3
Adventure #12		\$27.95 1/3
Adventure #7		\$27.95 1/3
Adventure #8		\$27.95 1/3
Adventure #9		\$27.95 1/3
Amazing Black Jack Mach		\$27.95 1/3
Armored Patrol	\$34.95 1/3	\$27.95 1/3
Balrog	\$41.95 1/3	
Combat	\$29.95 1/3	\$27.95 1/3
Conquest Of Chesterwood	\$29.95 1/3	\$27.95 1/3
Earthquake-San Francisco	1906	\$29.95 1/3
\$27.95 1/3		
Eliminator	\$34.95 1/3	\$27.95 1/3
Frog	\$	\$20.95 1/3
Galactic Empire	\$27.95 1/3	\$20.95 1/3
Galactic Revolution	\$20.95 1/3 D.	
Galactic Trader	\$20.95 1/3 D.	
Galactic Trilogy	\$54.95 1/3	
Games #1		
(Computer Mouse)		\$27.95
Colour		
Lunar Lander	\$29.95 1/3	\$20.95 1/3
Mean Craps	\$	\$27.95 Col.
Missile Attack	\$29.95 1/3	\$20.95 1/3
Morton's Fork	\$41.95 1/3	
Planets	\$29.95 1/3	\$27.95 1/3
Sea Dragon	\$34.95 1/3	\$27.95 1/3
Shutdown	\$29.95 1/3	\$20.95 1/3
Sky Warrior	\$29.95 1/3	\$20.95 1/3
Star Scout	\$29.95 1/3	\$20.95 1/3
Star Trek 3.5		
(Star File)	\$27.95 1/3	\$20.95 1/3
Stone Of Sisypus	\$41.95 1/3	
The Curse Of		
Crowley Manor	\$29.95 1/3	\$27.95 1/3

Automated Simulations	Disk	Cass
Crush, Crumble & Champ	\$39.95 1/3	\$39.95 1/3
Curse Of Ra	\$26.95 1/3	\$26.95 1/3
Danger In Drindisti	\$26.95 1/3	\$26.95 1/3
Helifire Warrior	\$32.95 1/3	\$51.95 1/3
Invasion Orion	\$32.95 1/3	\$32.95 1/3
Jabbertalky	\$39.95 1/3	
Monster Maze	\$39.95 1/3	\$39.95 1/3
Morloc's Tower	\$26.95 1/3	\$26.95 1/3
Rescue At Rigel	\$39.95 1/3	\$39.95 1/3
Ricochet	\$26.95 1/3	\$26.95 1/3
Sorcerer Of Siva	\$39.95 1/3	\$39.95 1/3
Temple Of Apschai	\$53.95 1/3	\$53.95 1/3
The Datestones		
DI RYN	\$26.95 1/3	\$26.95 1/3
The Keys Of Acheron	\$26.95 1/3	\$26.95 1/3
Tuesday Morning		
Quarterback	\$39.95 1/3	
Upper Reaches Of Apschai	\$26.95 1/3	\$26.95 1/3

Big Five	Disk	Cass
Attack Force	\$27.95 1/3	\$21.95 1/3
Cosmic Fighter	\$27.95 1/3	\$21.95 1/3
Defense Command	\$27.95 1/3	\$21.95 1/3
Galaxy Invasion	\$27.95 1/3	\$21.95 1/3
Meteor Mission II	\$27.95 1/3	\$21.95 1/3
Robot Attack	\$27.95 1/3	\$21.95 1/3
Stellar Escort	\$27.95 1/3	\$21.95 1/3
Super Nova	\$27.95 1/3	\$21.95 1/3

Cornsoft	Disk	Cass
Crazy Painter	\$26.95 1/3	\$21.95 1/3
Bounceoids	\$26.95 1/3	\$21.95 1/3
Scarfman	\$26.95 1/3	\$21.95 1/3

Fantastic	Disk	Cass
Panik	\$33.95 1/3	\$26.95 1/3

Hayden	Disk	Cass
Sargon II	\$48.95 1	\$42.95 1/3
Starclash		\$23.95 1/3

Med Systems	Disk	Cass
Laser Defense	\$33.95 1/3	\$26.95 1/3

Melbourne House	Disk	Cass
Penetrator	\$33.95 1/3	\$33.95 1/3
Strike Force	\$26.95 1/3	\$21.95 1/3

Softsector Marketing	Disk	Cass
Caterpillar	\$26.95 1/3	\$21.95 1/3
Outhouse	\$26.95 1/3	\$21.95 1/3

Strategic Simulations	Disk	Cass
Battle For Normandy	\$54.95 1/3	
Computer Bismark		\$68.95 1/3
The Battle Of Shiloh		\$34.95 1/3
Tigers In The Snow		\$34.95 1/3

Sublogic	Disk	Cass
Flight Simulator	\$49.95 1	\$37.95 1
Flight Simulator	\$49.95 3	\$37.95 3
Forest Fire Dispatcher	\$46.95 3	\$35.95 3
Forest Fire Dispatcher	\$46.95 1	\$35.95 1

Utilities & Business	Disk	Cass
APPARAT		
Chextext	\$84.95 1/3	
Flextext I	\$52.95 1/3	
Flextext II	\$42.95 2	
Flextext Plus	\$49.95 1/3	
Microclinic I	\$35.95 1	
Microclinic III	\$42.95 3	
Newdos/80 Version 2	\$210.00 1&3	
Terminal/80	\$70.95 3	
Uniterm/80	\$125.00 1/3	

J.J.G.	Disk	Cass
Basic Faster & Better	\$27.95 1/3	
Disk #1 Programs		
Basic Faster & Better	\$27.95 1/3	
Disk #2 Library Functions		
Electric Pencil 2.0 Word	\$124.95 1/3	



GAMES

ADVENTURE INTERNATIONAL

Adventure #	Disk	Cass
Adventure #10 (24K)	\$27.95 1/3 D.	
Adventure #10-11-12	\$54.95	
Adventure #11 (24K)	\$27.95 1/3 D.	
Adventure #12 (24K)	\$27.95 1/3 D.	
Adventure #7 (24K)	\$27.95 1/3 D.	
Adventure #7-8-9	\$54.95	
Adventure #8 (24K)	\$27.95 1/3 D.	
Adventure #9 (24K)	\$27.95 1/3 D.	
Deflection (8K)		\$20.95
Lunar Lander (24K)		\$29.95
Mountain Shoot (16K)		\$20.95
Preppie (16K)		\$34.95
Pre-Pic (24K)		\$27.95
Rear Guard (16K)		\$34.95
Star Trek 3.5 (32K)		\$27.95
Stone Of Sisypus		\$47.95

Automated Simulations	Disk	Cass
Crush, Crumble & Champ (32K)	\$39.95	\$39.95
Dragon's Eye (40K)	\$39.95	
Invasion Orion (32K) (24K)	\$32.95	\$32.95
Rescue At Rigel (32K)	\$39.95	\$39.95
Ricochet (32K)	\$26.95	\$26.95
Star Warrior (32K)	\$53.95	\$53.95
Temple Of Apschai (32K)	\$53.95	\$53.95
The Datestones Of Ryn (24K)	\$26.95	\$26.95

Broderbund Software	Disk	Cass
Apple Panic (32K)	\$41.95	
Chopflipper (48K)	\$47.95	
Seafox (48K)	\$41.95	
Stellar Shuttle (32K) (16K)	\$34.95	\$34.95
Track Attack (32K)	\$41.95	

DataSoft	Disk	Cass
Bishop's Square	\$41.95	
Canyon Climber (16K)	\$41.95	\$41.95
Clowns + Balloons (16K)	\$41.95	\$41.95
Pacific Coast Hwy (16K)	\$41.95	\$41.95
Shooting Arcade (16K)	\$41.95	\$41.95
Tumble Bugs	\$41.95	

GameStar	Disk	Cass
Baja Buggies	\$39.95	\$39.95

Gebelli Software	Disk	Cass
Matchtracer (16K)	\$41.95	\$41.95
Pathfinder (32K)	\$47.95	

I.D.S.I.	Disk	Cass
Pool 1.5	\$47.95	
Pool 400		\$59.95
Speedway Blast		\$59.95

Infocom	Disk	Cass
Deadline (32K)	\$68.95	
Starcross (32K)	\$54.95	
Zork I (32K)	\$54.95	
Zork II (32K)	\$54.95	
Zork III (32K)	\$54.95	

JV Software	Disk	Cass
Action Quest (16K)	\$39.95	\$39.95
Ghost Encounters (16K)	\$39.95	\$39.95

On-Line Systems	Disk	Cass
Crossfire		\$67.95
Crossfire	\$41.95	\$41.95
Frogger	\$47.95	\$47.95
Hires Adv. #0 Mission		
Asteroid	\$34.95	
Hires Adv. #2 Wizard & The Princess	\$45.95	
Hires Adv. #4 Ulysses	\$47.95	
Lawbreaker	\$41.95	\$41.95
Mousetack	\$47.95	
Softporn Adventure	\$41.95	
Threshold	\$54.95	

P.D.I.	Disk	Cass
Astro Quotes (16K)		\$23.95
Bowling (16K)		\$23.95
Captivity (24K)		\$34.95
Code Breaker (16K)		\$23.95
Krusk'n Quole (16K)		\$23.95
Minicrossword (24K)		\$23.95
Moon Base 10 (16K)	\$41.95	\$41.95
Sammy The Sea Serpent (16K)		\$23.95
Time Bomb (16K)		\$23.95

Sirius Software	Disk	Cass
Bandits (48K)	\$45.95	
Cycolot (48K)	\$39.95	
Snake Byte (48K)	\$39.95	
Sneakers (48K)	\$39.95	
Space Eggs (48K)	\$39.95	
SOFTAPE/ARTSCI		
Gomoku (16K)	\$41.95	\$27.95

Poker Solitaire (16K)	\$27.95	\$20.95
Reversi (16K)	\$41.95	\$27.95
STRATEGIC SIMULATIONS		
Cytron Masters (48K)	\$54.95	
The Cosmic Balance (48K)	\$54.95	
SUBLOGIC		
Adventure On A Boat	\$35.95	\$28.95
Black Forest	\$35.95	\$28.95
Ghoshly Manor	\$35.95	\$28.95
Robby The Robot		
Catcher	\$35.95	\$26.95
Sky Rescue	\$35.95	\$28.95
SYNAPSE		
Protector II	\$49.95	\$49.95
Claim Jumper	\$49.95	\$49.95
Picnic Paranoia	\$49.95	\$49.95
CAVALIER		
Rug Attack	\$42.95	\$42.95

EDUCATIONAL

EDU-WARE

Compu-Math: Decimals (32K)	Disk	Cass
Compu-Math: Decimals (32K)	\$41.95	\$26.95
Compu-Math: Fractions (32K)	\$41.95	\$26.95
Compu-Read 3.0 (32K)	\$41.95	\$26.95
LIGHTNING SOFTWARE		
Master Type	\$54.95	
P. D. I.		
Addition With Carrying (8K)		\$23.95
Analogies (8K)		\$23.95
Cash Register (16K)		\$23.95
Do It Yourself Spelling (8K)		\$23.95
Let's Spell (8K)		\$23.95
Memory Builder (16K)		\$23.95
Number Series (8K)		\$23.95
Pre-School IQ Builder (8K)		\$23.95
Pre-School IQ Builder 2 (8K)		\$23.95
Quantitative Comparisons (8K)		\$23.95
Reading Comp: What's Different Bk		\$23.95
Spelling Builder (16K)		\$23.95
Story Builder: Word Master (16K)		\$23.95
Vocabulary Builder 1: Beg. (8K)		\$23.95
Vocabulary Builder 2: Adv. (8K)		\$23.95
Word Search: French (16K)		\$23.95

UTILITIES & BUSINESS

DATASOFT	Disk	Cass
Graphics Master	\$54.95	
Micropainter	\$47.95	
VISICORP		
Visicalc	\$360.00	

DISK

Automated Simulations	Disk	Cass
Jabbertalky (64K)	\$39.95	\$39.95
Upper Reaches Of Apschai		\$26.95
Curse Of Ra		\$26.95
Oil Barons		\$134.95
BLUE CHIP SOFTWARE		
Millionaire		\$140.95
CONTINENTAL SOFTWARE		
Home Accountant Plus		\$199.95
DATAMOST		
Space Strike	\$41.95	
Pig Pen	\$41.95	
Write-On	\$179.95	

Infocom	Disk	Cass
Starcross	\$54.95	
Zork III (48K)	\$54.95	
Zork II (48K)	\$54.95	
Deadline (48K)	\$68.95	
Zork I (48K)	\$54.95	

Micropro	Disk	Cass
Maimerge Option		\$195.00
Spellstar Option		\$285.00
Wordstar 3.0 Manual Only		\$80.00
Maimerge Manual Only		\$35.00
Wordstar 3.0		\$575.00

Sirius Software	Disk	Cass
Call To Arms		\$39.95
STRATEGIC SIMULATIONS		
Wario Factor	\$54.95	
VISICORP		
Desk Top Plan	\$435.00	
Visitex	\$360.00	
Visitile	\$435.00	
Visicalc	\$360.00	
Vitrend/Visiplot	\$435.00	
INTELLIGENT STATEMENTS		
Ken Uston's Black Jack	\$126.95	

CP/M

8 DISK

BLUE CHIP SOFTWARE		
Millionaire	\$140.95	
INFOCOM		
Zork III	\$68.95	
Starcross	\$68.95	
Zork I	\$68.95	

Zork II		\$68.95
Deadline		\$82.95
MICROPRO		
Wordstar 3.0		\$575.00
Maimerge Option		\$175.00
Spellstar Option		\$285.00
Calstar		\$315.00
Datatar		\$375.00
Supersort		\$285.00

OSBORNE

Small Technical Computer

A compact, low-priced personal technical computer, the HP Series 200 Model 16, is Hewlett-Packard's first 16-bit personal computer offered through dealer channels.

The new Model 16 will be available through direct sales and retail computer stores.

Occupying about as much desk surface area as a three-ring notebook, the Model 16 is based on the Motorola MC68000 microprocessor, a 16-bit "computer on a chip" with 32-bit internal architecture that has become an industry standard for computation-intensive applications.

The Model 16 consists of a 9-inch (229 mm) CRT, a detached ASCII keyboard and a choice of

floppy also is available with a 4.6-Mbyte Winchester hard disc.

A standard 128 kilobytes of main memory can be increased to 768 kilobytes, and with an external expander can be as much as 4.6 Mbytes. The Model 16 has built-in graphics, and the CRT features an 80-character by 25-line display and a resolution of 300 by 400 pixels.

The Model 16 is available with three language systems — BASIC, HPL and Pascal. Hewlett-Packard BASIC includes enhancements characteristic of more powerful languages such as Fortran or ALGOL, including subprograms, multi-dimensional arrays, unified I/O and mass storage, labeled COMMON blocks and external program control.

Current delivery estimates for the Model 16 and peripheral devices are four to 10 weeks after receipt of order.



new 3 1/2-inch micro-flexible disc drives. Available are single or dual "micro-floppy" disc units providing 270 kilobytes of storage per disc. A single 3 1/2-inch micro-

For more information contact Inquiries Manager, Hewlett-Packard (Canada) Ltd., 6877 Goreway Drive, Mississauga, Ontario L4V 1M8.

Oscilloscope

A new full featured, low priced, 35 MHz Oscilloscope with 1mV/div vertical sensitivity and delayed triggered sweep has been added to the Metermaster line.

The Model 65635 is a dual trace scope with a bright, large 6" CRT for easy viewing. It offers a

seconds in 5 steps. It may also be operated with delayed intensity for the delayed part of the sweep. Other features include a vertical deflection factor of 5mV/div to 10V/div over 11 ranges; X5 vertical gain switch; 5X sweep magnification; trace rotator; and X-Y or X-Y-Z operation.

The convenient location and clear legible marking of all front

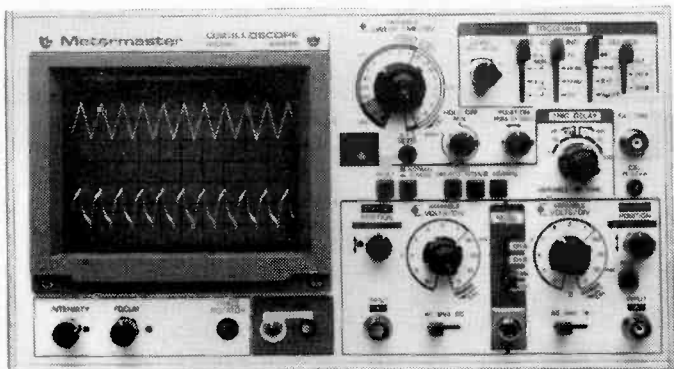

full 35 MHz bandwidth at -3dB. Sweep modes are selectable as either Normal-Auto-Single or Delay. In the delay mode, the delayed trigger time is adjustable from 1 micro second to 100 milli

panel controls make this scope a very easy to use instrument.

For more information contact Metermaster, 214 Dolomite Drive, Downsview, Ontario, M3J 2P8.

Driver IC's

Teledyne Semiconductor announces the TSC700A — a four digit, seven segment light emitting diode (LED) decoder/driver integrated circuit. The all CMOS TSC700A drives common anode LED displays with 28 high current, open drain N channel output transistors. Four seven segment LED digits may be driven. An 11 mA minimum segment drive current is guaranteed. This represents over a 100% percent increase over comparable, pin-compatible products. The TSC7212A and ICM7212A, for example, specify 5 mA minimum LED segment drive current.

The increased driver current results in increased LED luminous intensity, an advantage when large character height displays are designed into systems. Along with greater character heights an increase in a system's ambient light environment calls for increased driver currents. For a desired given brightness level, LED luminous intensity must be increased for larger character heights and higher ambient light environments. The TSC700A 11 mA minimum segment drive current is needed in high ambient light environments where viewing distance and readability considerations demand larger character height LEDs.

The TSC700A directly drives four seven segment LED digits. The non-multiplexed outputs eliminate multiplexing clock noise that may degrade precision analog measurements. Four data and four digit select inputs allow the TSC700A to receive data from multiplexed output devices such as the TSC7135 and TSC14433 analog-to-digital converters. Connection to micro-processor peripheral chips such as the 6520 and 6522 is straight forward.



An on-chip ROM decodes the BCD or binary input word to the seven segment alphanumeric "CODE B" format. A 0 to 9, —, E, H, L, P, or "blank" reading may be displayed. A brightness control input allows the user to adjust the LED segment drive current. This input also serves as a digital display enable. The TSC700A is available in 40 pin CerDip packages. The -25° to +85°C industrial temperature range TSC700A1JL is available for \$3.90 in hundreds. The -55°C to +125°C military temperature range TSC700AMJL lists for \$14.65. The MIL-STD-883 processed TSC700AMJL/883 is available for \$17.60. All devices are available for immediate delivery and sampling.

For further information contact David Gillooly, Product Marketing Manager, (415) 968-9241.

ETI/Omnitronix Contest Winner

The winner of this contest in the October issue is Serge Bilodean of Dorval, P.Q. who receives a Leader LBO-514A scope worth \$919 from Omnitronix.

The answers were a i) a capacitor from A to B, ii) a diode from B to C, iii) a connection from C to D with a diode to 0V and iv) a capacitor from D to E.

Also...

Thomson—CSF Central Research Laboratory in France have developed the world's fastest IC for room temperature operation. It is an eleven stage ring oscillator with a gate delay time of 22 picoseconds (10⁻¹² seconds). It has a GaAlAs/GaAs structure which confines electrons at its hetero-junctions. Circuits built with this new technology are expected to compete with Josephson effect devices for speed (see article in this issue).

CBM recently claimed that the VIC-20 now the most common microcomputer in the world at a press conference held in Toronto. Asked by ETI to give numbers to substantiate this, they refused. The same claim is made by Sinclair for the ZX81, they however are not so shy about numbers. Including the Timex version (TS1000) 900,000 have been sold. For good measure Apple also claim to be No.1 with 500,000 units!

Directly and indirectly, \$192 is spent on computers in Canada for every man, woman and child. The total dollar value has topped \$5 billion. This compares to spending of \$15 billion on new cars.

Adam Osborne, founder of Osborne Computer Corp. said in Toronto recently that he welcomed the 25-odd imitators of his computer; he doesn't believe that they'll get more than 15% of a given market. He added that he thought Apple Computer Inc. would be better off making its specs available to imitators rather than engaging in costly legal battles. Well, imitation is the sincerest form of flattery!

A Telidon Graphics System interface card developed by Norpak for the Apple II is now available. Cost is \$795.

Hewlett Packard are using a 32-bit chip inside their HP9000. The chip is only being used by HP: it's not for sale. It contains 450,000 transistors.

The HP 9000, despite this power a desktop computer, will sell here in Canada for \$41,000.

Smith-Corona introduces the first printer with real character at the unreal price of \$1095.*



The Smith-Corona Daisy Wheel Printer

Until now, if you wanted to include a reasonably-priced printer as part of your computer or word processing system, you had to use a dot matrix printer. Daisy wheel printers were just too expensive.

Not anymore. Now Smith-Corona* offers a daisy wheel printer at such an incredibly low price, you can't afford *not* to include it. That means that even the smallest installation or business can now have letter quality printing capabilities at every work station.

The Smith-Corona printer operates with micro-processor-controlled daisy wheel technology, and is available with industry standard serial or parallel data interfaces.

Best of all, it produces results identical to those of our very finest office typewriters – printing with real character. So it can be used to create letters or documents that have to look perfect. As well as financial statements, inventory reports, direct mail campaigns – anything that requires quality printing.

And it's easy to use – just turn on the power, load the paper and away it goes. (It works equally beautifully with letterhead bond or fanfold paper.) There are drop-in ribbon

cassettes and a choice of easy-to-change, snap-on daisy print wheels for a variety of fonts.

So why not get your hands on a real bargain: letter-perfect printing at an amazingly low price. Because, thanks to Smith-Corona, a printer with real character is no longer expensive.

Ask for it by name. **Smith-Corona**

DIVISION OF **SCM**® (CANADA) LIMITED

*suggested retail price

Please send me more information on the Smith-Corona daisy wheel printer.

Name _____

Title _____

Company Name _____

Business Address _____

City _____ Prov. _____ Postal Code _____

Type of Business _____

Mail coupon or call:
Education Director,
Smith-Corona

29 Gervais Drive, Don Mills, Ontario M3C 1Z1
(416) 449-0164

ETI

Circle No. 24 on Reader Service Card.

OSCILLOSCOPES!

The Best Buys Available

Model 65310

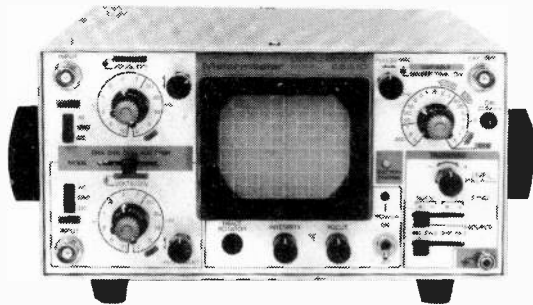

Dual Trace Portable Scope

\$795.00

Probes and F.S.T. included

- 15 MHz (-3dB) Bandwidth
- X5 Sweep Magnifier
- Battery, 12 VDC & AC Operation
- 2 mV Vertical Sensitivity
- Trace Rotator

Model 65601

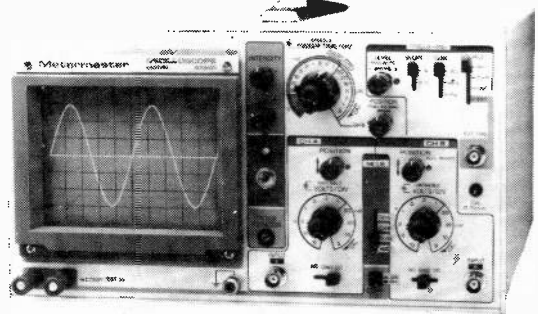

Dual Trace Bench/Portable Scope

\$795.00

Probes and F.S.T. included

- Featuring At No Extra Cost 'The Component Tester'
- 20 MHz (-3dB) Bandwidth
 - 6" CRT Display
 - Fully Automatic Triggering
 - Trace Rotator
 - 2 mV Vertical Sensitivity
 - HF Rejection

Model 65625

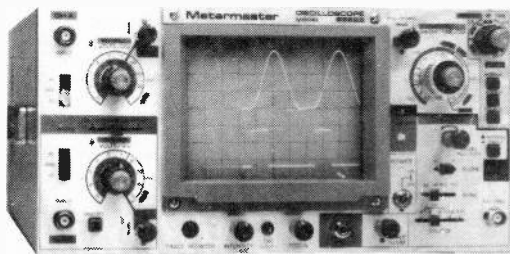

Dual Trace Bench/Portable Scope

\$1385.00

Probes and F.S.T. included

- 45 MHz (-3dB) Bandwidth
- Delayed Sweep (selectable)
- Single Sweep (selectable)
- Extremely Bright 5" CRT
- Illuminated Internal Graticule
- Optimal Sensitivity of 1 mV
- X-Y or X-Y-Z Operation
- 120 VAC Line Operation

Model 65635

NEW!

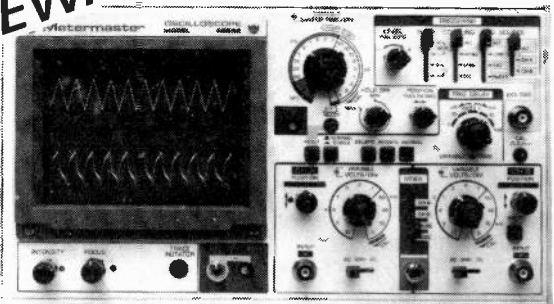

Dual Trace Bench/Portable Scope

\$995.00

Probes and F.S.T. included

- 35 MHz (-3dB) Bandwidth
- Delayed Sweep (selectable)
- Single Sweep (selectable)
- 6" CRT Display
- Optimal Sensitivity of 1 mV
- X-Y or X-Y-Z Operation
- 120 VAC Line Operation
- X5 Sweep Magnifier

Metermaster

R. H. NICHOLS



5% Discount for Cash,
Certified Check, or Money Order

All prices F.O.B.
Downsview, Ontario
subject to change with-
out notice, P.S.T. extra
where applicable.

Head Office: 214 Dolomite Drive, Downsview, Ontario M3J 2P8

Circle no. 11 on Reader Service Card.

TORONTO (416) 661-3190 MONTREAL (514) 337-0425 EDMONTON (403) 432-7746 OTTAWA (613) 238-7007

watch for our "NEW" 100 MHz feature packed Scope ... SOON!

Electronics in the Newsroom

Eric McMillan reports.

IF YOUR IDEA of journalism comes from late-night movies, you likely picture a city newsroom as a noisy confusion of reporters banging away at their Remingtons, copy boys darting about with paper in hand, and editors shouting for rewrites. Occasionally an editor screams, "Get this down to typesetting and fast!" and you imagine the dim composing room where black-smudged craftsmen manipulate blocks of type under twisting lamps.

This may have been the reality as recently as ten years ago but it has gone the way of the pound and gallon—clung to by romantic diehards but widely superseded by a more efficient system.

Walking into a newsroom today you'll find few indications you're not in a stockbroker's office or any other modern white-collar environment. Rows of desks are dominated by softly glowing video screens, silently keyed by intent operators who turn out to be today's journalists and editors.

As you tour the rest of the building you realize the video terminals are not just an isolated innovation restricted to the newsroom but an integral part of the overall computerization of newspaper production. From the gathering of news around the world to the printing and distribution of news, as well as supplementary departments like libraries and advertising, electronics is transforming the newspaper business.

Backgrounder To The News

The transformation began in the late 1960s, progressed rapidly through the 1970s and hasn't finished yet. When the silicon chips settle sometime before the end of this century, the result will be either a streamlined newspaper operation or the relegation of newspapers to history along with stone tablets and parchment scrolls.

Ironically, the impetus propelling newspapers into the electronic age may be the stiffening competition with the electronic media—TV, radio

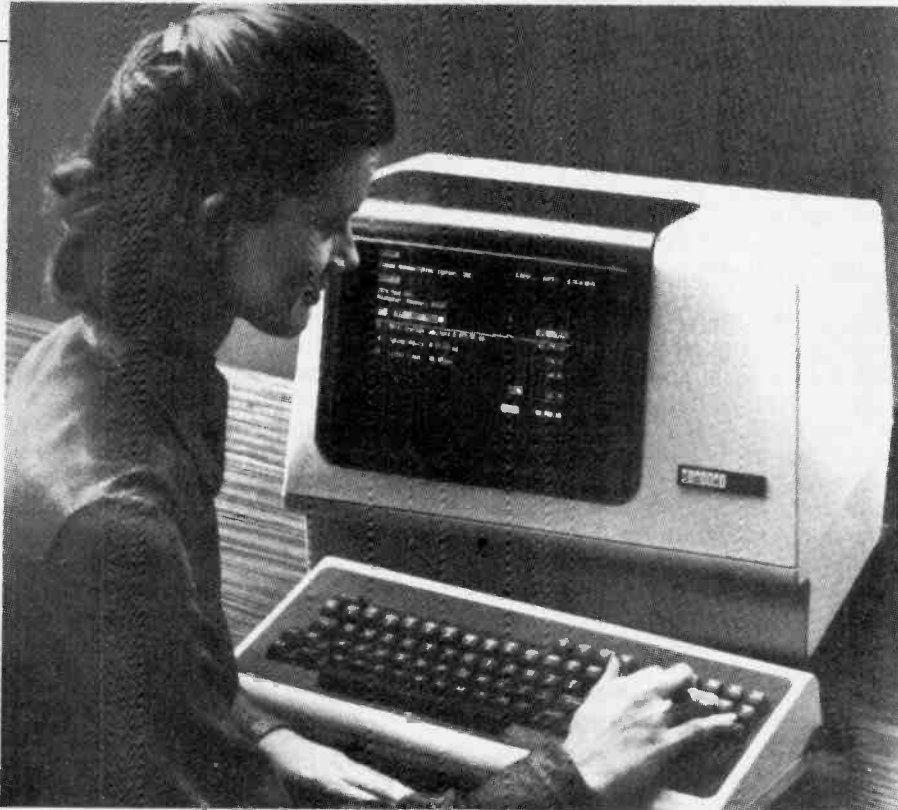

VDTs for newspapers and news agencies are similar to those in other office settings. the VT100 from Digital Equipment Corp. is only 49 cm deep, accepts up to 32 characters per line, offers split-screen capability and can be customized for newsroom use.

and on-line information systems — for audiences and advertising revenues.

In Canada the Royal Commission on Newspapers found that the advertising dollars that went to newspapers fell from 36.1 percent of the total spent in 1972 to 31.4 percent in 1980. Television and radio over the same period increased their share from 23.8 to 28 percent.

Newspaper publishers have looked to computerization and other technological upgrading as a means of cutting costs and speeding up production. The economization should allow better rates for advertisers while more up-to-date news should appeal to subscribers.

Of course, the changes don't come cheap. The American Newspaper Publishers Association has estimated a small fully-automated system with 20 video display terminals (VDTs) costs approximately \$200,000. To convert an

entire operation from the old hot-metal system to computer production could set a newspaper back over \$8 million.

Apparently publishers think it's worth it, for virtually all North American city newspapers have made the switch.

The Change-Over

In a research study for the Royal Commission in 1981, journalist George Bain wrote, "In most newsrooms of the country, the typewriter has gone to join the quill pen, and the waste-baskets ... are left to soft drink cans and discarded newspapers ... Today's reporter doesn't write on paper, nor does the editor edit on paper or write his heads on paper; both punch keys, like so many airline clerks making out tickets, and characters, words and sentences are made to appear—and

Electronics in the Newsroom

disappear—on a screen which produces no mess."

One detects a note of wistfulness for a bygone era. But, in general, writers are adapting quickly to VDTs which they use as "deluxe typewriters" on which they can make corrections without having to crumple copy and start over.

The effect of VDTs however has been more profound than simply giving reporters a new tool to work up their articles—otherwise word processors would have been even more efficient. As used by newspapers, VDTs connected to computers have brought together three previously distinct operations—writing, editing and typesetting—and promise to encompass even more in the near future.

At one time the newsroom was linked to the composing room, where stories are set in type and laid out, only by the flow of copy and instructions from the former to the latter.

The change began in the composing room. Hand-set type gave way to linotype machines which punched out words on metal strips. This hot-metal system yielded in turn to phototypesetting by which operators typed at computer terminals to produce either a coded paper tape which could be converted to film by computer or the film negative itself. When processed, the positive images were pasted upon boards in the design of the newspaper pages.

Greater technological sophistication however made typesetting redundant. In the 1970s reporters learned to enter their stories directly into the computer via VDTs. Editors simply call up the stories to their own screens for revision. Special keys and codes allow them to assign the articles to specific sections and pages of the paper. All the information necessary for typesetting can be input from the newsroom by the editors. At the *Globe and Mail*, for example, they have the choice of 50 type styles in various sizes at their finger tips. Headlines can be inserted in distinct type faces at the top of articles or an editor may choose to split his screen down the middle and keep tentative headlines off to one side. A key releases the finished article with heads and all into the composing room computer. All that remains at that point is the touch of another button and the typeset columns emerge ready for pasting up.

A VDT station consists of a keyboard and monitor connected to the main computer. The keyboard in newsrooms is similar to that of most computer terminals except for a few

extra keys for paragraphing and other journalism-related functions. Depending upon the sophistication of the programming, VDTs can also enter rules of varying widths, borders, logos, crossword puzzles and some graphics, thus eliminating further functions of the composing room.

The VDT Blues

Although reporters have taken readily to VDTs, editors have been known to grumble about the editing process being slowed down. Some editors who were whizzes with pencil on paper have not been able to maintain their pace at terminals. Another problem has been slow response time when the computer is being overused close to deadlines. Ten seconds may not seem very long to wait for an article to appear on-screen, but try telling that to an editor pumped full of caffeine and trying to beat the clock. The compensation for editorial drag is the overall speeding up of production and the lower rate of typographical errors.

Eyestrain is also a touchy issue with editors who, unlike reporters, are

votes for a blue field with yellow characters.

Since VDTs emit a low level of radiation, maladies from headaches to miscarriages have been blamed on working with VDTs, sometimes even on working in the same room as VDTs. In a well-publicized case, the *Toronto Star* has carried out tests on their equipment after four women reported defects in babies born while the women were employed by the paper.

The issue is of concern to everyone because VDTs seem to be becoming a ubiquitous part of our work environment. An estimated 1.6 million VDTs were in operation in the U.S. by 1979 and researchers at International Data Corporation expect the figure to reach 5.3 million by 1984. Newspapers account for one percent of these, the numbers having increased an average of 50 percent a year since the late 1960s.

VDT, Call Home

Telephone hook-ups between VDTs and central computers have enabled



The Hewlett-Packard computers used by the *Globe and Mail* are similar to Model 65, shown above with optional peripherals. This top-of-the-line model is a high-performance disc-based system with 256K to 2M bytes of memory. The *Globe* employs eight such units interlinked to provide access to the entire database from any VDT.

stuck in front of the screens for up to eight hours a day. Screens can be adjusted for brightness but rarely for colour. Green characters on a black background is the most prevalent combination and easier on the eyes than white on black but users haven't developed a consensus yet on their preference. At least one journalist

reporters to file stories efficiently over long distances. Two ways of doing this is through stationary VDTs with their own modems, usually in news bureaus, or through portable VDTs which send their codes over regular phones wherever they can be found.

The *Globe and Mail* operates 15



The newsroom of the *Globe and Mail* looks more like a stockbrokers office than the traditional movie image. Journalists now input their copy through VDTs into a computer. (Photo courtesy *Globe and Mail*).

VDT-equipped bureaus in North American centres and is planning to upgrade similarly their offices in South America and England. Each of the VDTs has disc storage in order that distant correspondents have their own record of information transmitted.

In the field *Globe* reporters can use one of 18 portable units. The newer models are about 7 kg in weight and the size of a portable typewriter, except for the tiny video screen attached to it. They are ideal for covering sporting events and other news away from a permanent office. Their main drawback is the longer time it takes to transmit over regular phones.

Fed via phone links into the main computers, stories from bureaus around the world or from portable VDTs can be called up to an editor's screen as easily as reports filed from across the aisle in the same office. Exactly the same procedure is followed for editing and typesetting.

The information can flow both ways. Portable VDTs can have access to information from the computerized library or other sources at the central office. Security reasons however can prevent newspapers from allowing a full release of information out of the mail computer to journalists in the field. *Globe and Mail* bureaus can retrieve items from the *Info Globe* service which includes articles up to the

ELECTRONIC PRODUCTION OF NEWSPAPERS

News gathering

Processing

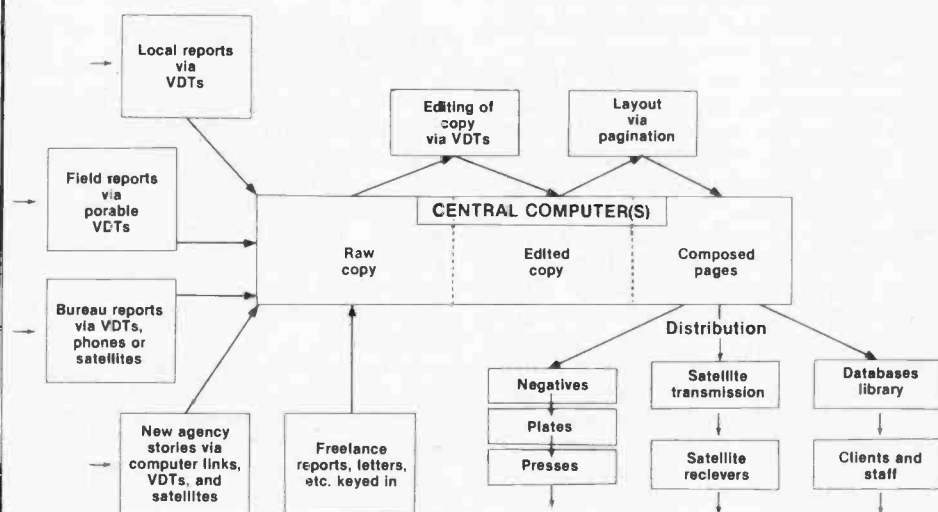

From the sources of news at large, through computerized processing, to public distribution — the chart shows the flow of news in a newspaper operation utilizing all the automated methods currently available. Further advances are expected to computerize making plates and running presses as well as performing standard layout. Note however that humans are still very necessary to feed reports to the computer, edit the articles and, of course, to read the newspaper.

Electronics In the Newsroom

latest edition but not as-yet-unpublished material.

A future refinement in this area may eliminate portable VDTs altogether. Experiments have been carried out on voice identification and word recognition by computers. The goal is to have correspondents phone their articles directly into the computer. Voice identification, which must be perfected to protect news security, has reached a success rate of 98 to 99 percent in one project. Another experiment has shown computers potentially can recognize an unlimited number of words although actual vocabularies are still limited.

In the meantime improvements seem to be going in the direction of lighter, yet more sophisticated, portable VDTs.

Wire Services—Without Wires

Economy dictates that most foreign, and even national, news is provided to newspapers by news agencies. Journalists still refer to stories coming in "over the wire" in reference to the days when the agencies were known as wire services.

Wire is still used but in different ways. At this point a number of methods exist to deliver stories from the agencies to the newspapers. Telegraph is the lowest and oldest form, involving a teletypewriter which sends coded signals to teleprinters in the newspaper offices. The international agency Reuters retains this system for financial news to businesses in Canada and Canadian Press (CP) needs it for smaller papers which have not been computerized.

Computer to computer links however have largely taken over. Just as a newspaper receives reports from its own correspondents, it can accept input from agency computers through phone hook-ups. Complete, edited news copy is transmitted along with the typesetting codes applicable to the receiving newspaper. The newspaper editors can call them up to their screens to revise or pass them on, as is, into the composing room computer banks. Already coded, they can be immediately released as typeset articles to be pasted up.

Since news agencies rely on the co-operation of member papers, their computers can also receive data for compilation and editing into articles by agency staffs.

Satellite transmission represents the delivery system of the future and is already in place in some parts of the world. Reuters, United Press International and Associated

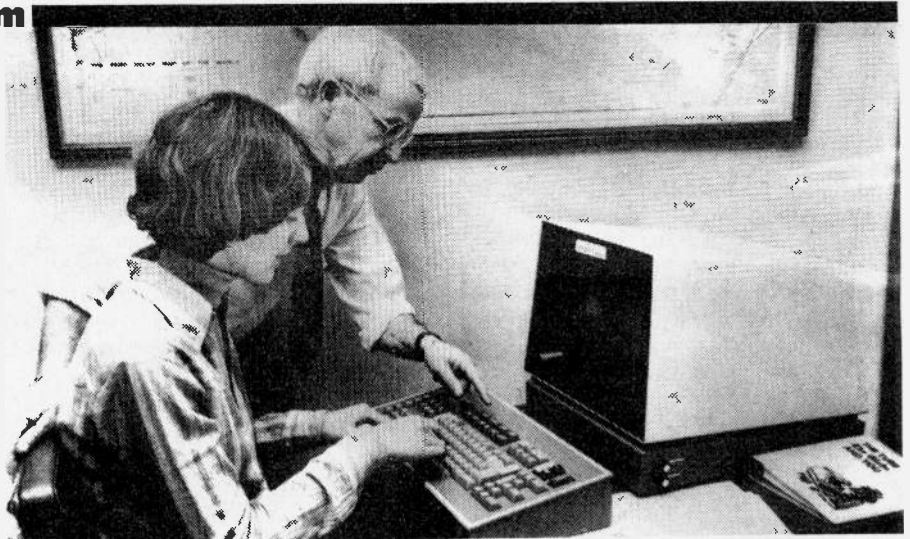

Journalists, used to typewriters and editing pencils, have had to learn how to use VDTs. Once they made the adjustment however, most have come to prefer the new tools of the trade for eliminating time-consuming rewrites. (Photo courtesy Globe and Mail).

Press all are developing satellite systems with some receiving dishes being provided free of charge to newspapers. CP also has a "firm plan" to introduce this kind of transmission, particularly in light of the continuing drop in dish prices.

Agencies, of course, require staffs of their own to collect and edit the news before they forward it. Their tools are similar to those of newspapers, including VDTs and computers in the office as well as portables in the field. CP, for example, uses 45 portable VDTs, each with a screen and cassette storage. Figures for the international services run into the thousands in the United States alone. Reuters estimates they operate 35,000 VDTs in 50 countries.

A Page From The Future

At the opposite end of newspaper production, the next obvious step is the full-page layout of papers on VDT screens. "Pagination" (rhymes with imagination) has been predicted for years but only a handful of newspapers have the capability. Most have plans however for introducing it for laying out ads or news or both by the 1990s.

Pagination would eliminate the last hands-on work before the platemaking stage. Instead of an editor drawing a plan of the issue with pencil, paper, rulers and reduction wheel, he would design each page on the VDT screen. The computer would set the type and place it on the page with headlines and graphics, as instructed without manual paste-up.

The process could be automated further to reduce the workload of the layout editor at his screen. Some magazine-format publications are

already employing computer programs which fit all contents to a standard design. The editor need only decide on the size and positioning of pictures. Although this may sound as though it would result in dull layout, programs can be flexible enough to take into account the human need for visual variety. Such programs can also be overridden in the cases where editors want a particularly creative treatment.

Some feel pagination is better suited to magazines with their departmentalized formats than to daily newspapers with their unpredictable content. Pagination, they say, will be useful—and is being used now in some places—for making up full-page and half-page advertisements as well as standard sections of the paper such as classifieds, stock market reports and sports scores.

Even with complete computerization, the composing room may not be discarded altogether. A remnant army have to remain to enter via VDTs typed or handwritten letters to the editor and the articles that come in from freelancers without access to terminals. But this would effectively reduce what was once an arcane craft to the level of typist.

News From Outer Space

The *Globe and Mail* has long billed itself as "Canada's national newspaper" and since 1980 satellite communications have made it possible to print the paper simultaneously across the country.

Each composed page of the National Edition is scanned in Toronto by a helium-neon laser beam which translates the print into "bits" for transmission as an electrical pulse.

An average page becomes 369,640,000 bits—a comma could contain 100 bits. A satellite transmitter behind the *Globe* building amplifies and modulates the pulse to a radio signal of 400 watts and directs the signal to the Anik A-3 satellite 35,680 km from earth. From there it's relayed back to receiving dishes in Vancouver, Calgary, Ottawa and Moncton. This may seem a roundabout route between Canadian cities but it's traversed in one quarter of a second.

At the receiving end another laser beam reproduces a negative of the page composed in Toronto. Plates made from the negatives are fitted to the presses in each city and identical editions are printed.

The only other paper to transmit clones across the continent is the *New York Times* which also considers itself a national newspaper.

Both these papers are centralized in their head offices and send out the same editions to all parts of their respective countries. Theoretically,

two-way satellite or computer communications should enable national papers to produce versions with regional slants—a prospect which has prompted fears for the demise of local newspapers who would be unable to compete. The present *Globe and Mail* system however consists of a send-only station in Toronto and a receive-only dish in the other four cities.

Libraries Into Databases

It's been said that in the future power will reside with those who have access to information. Along with teletext, videotex, and entrepreneurs of all hues, newspapers have realized they can make money by selling information. The nature of their operation means they have a ready-made network for the gathering of data, not to mention newspaper morgues—their own reference libraries—full of news, facts and speculation going back to their founding. And the spread of computer technology means a lot of potential customers have the means of access to these databanks.

Large newspapers have begun the transformation of their libraries, back issues and other news sources into databases. Clients can retrieve nearly the same amount of information as do newspaper staff members—though for a fee.

The *New York Times* offers an information service which includes a choice of databases. "Deadline Data on World Affairs" contains information on every country and major international organization in the world. If you want to know the name of the foreign minister of Upper Volta or labour statistics in Illinois, this database has the answer. The "Middle East Database" goes into even greater detail on the area of the world. Other databases provide information specifically for businessmen, abstracts from 50 English-language newspapers and periodicals, and the *New York Times* on-line going back to the June 1, 1980 issue.

Any telephone-compatible computer or word processor can access the *New York Times* service for display or print-out. Off-line printers can be made available by the service. The databases are made accessible to Canadians through local dial-up facilities.

The *Globe and Mail* started converting its library into a database in 1979 and markets it through a subsidiary *Info Globe*. Each day the information is updated with the latest issue of the newspaper. Clients can

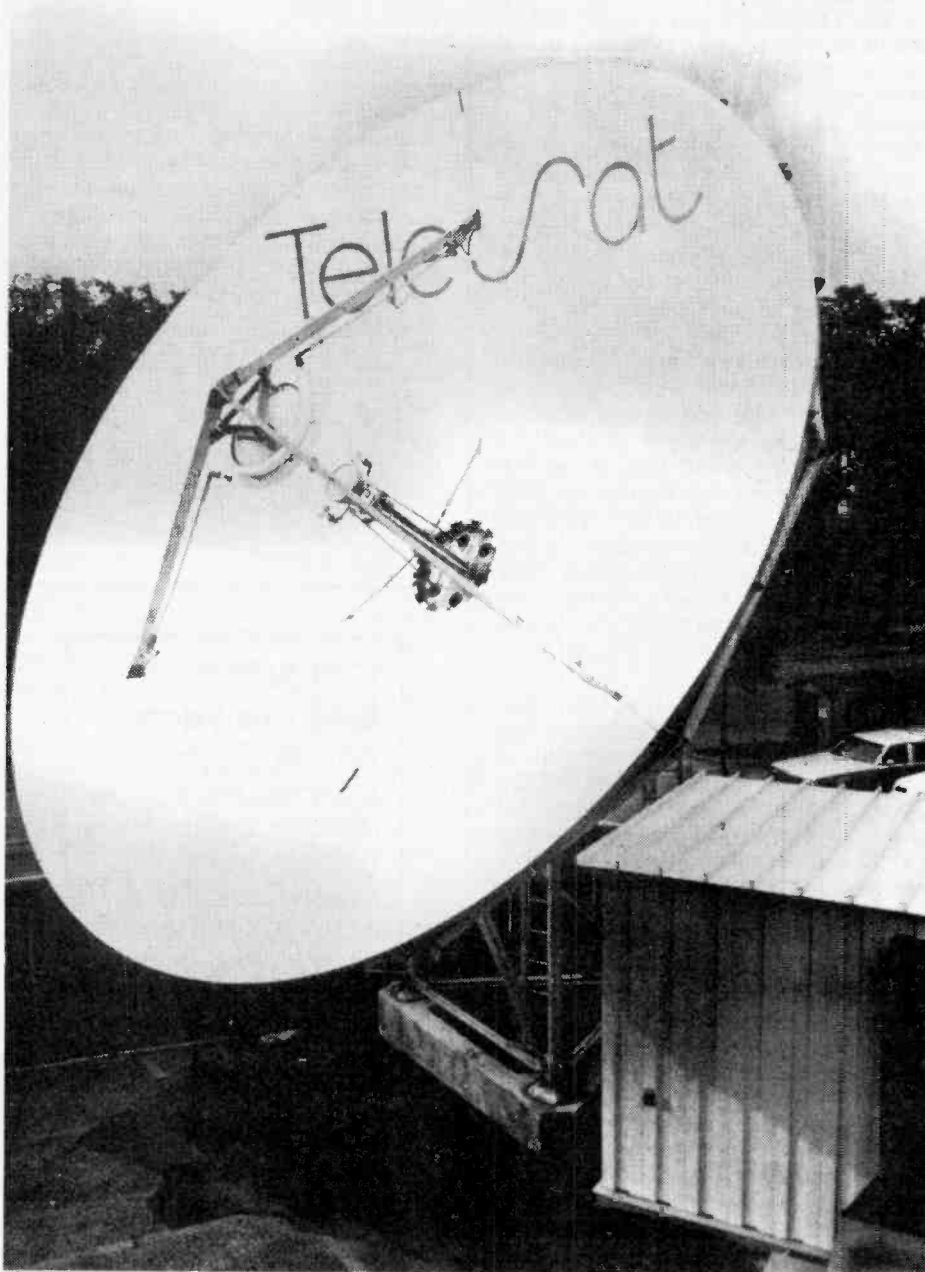

Our only national newspaper, the *Globe and Mail*, is originated in Toronto. A digitized version of each page is then transmitted to the Anik A-3 satellite using the dish shown here for receiving stations in Vancouver, Ottawa, Calgary and Moncton. (Photo courtesy *Globe and Mail*).

Electronics In the Newsroom

read each morning's news on VDTs or on print-outs in their own office and can turn back to items that appeared in the *Globe* as long ago as November 14, 1977 or in the *Globe's* Report on Business since the beginning of 1978.

Since the *Globe and Mail* is known as a paper geared to the business community, it is not surprising that *Info Globe* appeals to people in marketing, sales, research and public relations. Its literature stresses typical questions that customers can have answered such as "What is the competition doing?" and "What has public reaction been to a new government proposal?" As with the *New York Times* service *Info Globe* is accessible through almost any computer-phone link. The current charge is \$2.50 per minute plus \$5.00 per thousand lines for high-speed off-line print facilities. To save expenses, clients are urged to search the material before getting a read-out, although custom searches themselves cost \$80 an hour. *Info Globe* also offers an on-line stock market service called *marketscan* which provides daily quotations, comparison of individual stocks, focussing on particular days and other services.

News agencies are also involved in marketing databases. The firm that set up the *Globe* system went on to do the same for Canadian Press. The database, called *Newstext*, consists solely of CP reports going back to 1974. A quarter of a million words are added every day. Non-news outfits have got into the business as well by buying data from newspapers and news agencies for sale to their own clients.

Is There A Newspaper In Our Future?

Newspapers have not just been trying to compete with the electronic media but in many cases have tried to join the electronic media. As we have seen with the use of electronic storage systems to produce marketable data and as we have yet to see with some of the papers dabbling in videotex systems, newspapers have strayed far from their centuries-old traditions. The question to be settled before the end of this century is whether the newspaper that subscribers hold in their hands at the breakfast table will go the way of the copy paper on which reporters used to type and editors edit.

Futurist Earl Joseph writes in *The Bulletin of the American Society of Newspaper Editors*, "If electronic dissemination comes now, it would likely substitute for only parts of the paper." He expects the electronic

delivery systems to specialize in the "many sophisticated features that are difficult or impossible via newsprint" and points out the greater expense of electronic delivery over newsprint delivery.

Publishers may take heart from such prognostications, especially as they see the electronic transformation continuing inside their enterprises. Among innovations considered for the next few years are the following:

- Laser plate-making—After pagination you might expect the next step in creeping computerization to be automatic production of the printing plates. You would be right but not in the way you might expect. Lasers would not just extend present phototypesetting but replace it. Journalists would type their reports via VDT directly onto the printing plates. Editors could make revisions directly on the plate. Type faces, headline sizes, placement—everything would be etched and adjusted by lasers directly on the plate as easily as editors now adjust VDT images.

- Computerized press-runs—Subscribers lists, invoices, newsstand sales and accounting are already entered in computers and so it seems like a small step to let the computer decide how many copies of each issue to run off. In fact, the computer could take over as soon as the plates are fitted to the presses. This is another one of those advances that have been predicted for years but are running into practical obstacles.

- Automatic spelling correction—Computers to check spelling have been tested out with failure rates of only one mistake per 100,000 words. Programs could be integrated within existing computer programs to catch errors automatically as they are typed in by journalists.

- Portable phones—Hardly a new product, since they are already used in other capacities, but portable phones would be handy in tandem with portable VDTs or for those future voice reports we've discussed.

Since first walking into the modern newsroom, it may seem we've wandered quite a ways. But one effect of the electronic transformation of newspaper operation may be to extend the range of the individual sitting at a terminal in an office from events occurring everywhere in the world to the final product coming off the presses and heading back into the world.

ETI



Sanu Rawat: Seven years old. Only toys are mud and stones. Home is shared with family's goats and chickens. Too little food, no hope.

Who cares about Sanu's life?



pay off. Foster Parents Plan of Canada offers you a way to give that hope to a child and family overseas. Your monthly contribution can provide education, medical care and counselling—all the stepping stones to self-sufficiency. Clean water, schools and more are made possible too, through your support. PLAN's guidance and the people's own hard work. And all the time, you can watch their progress through letters, pictures and reports.

By now, Sanu will have her Foster Parent, but so many children still wait. Show them who cares. Complete the coupon below, or call toll-free: 1-800-268-7174.

We at Foster Parents Plan are proud of the handling of our funds. 88.5% of all contributions go directly overseas, with 7.5% used for administration costs, and 4% for promotion. We are non-profit, non-sectarian and non-political, and are officially registered as a Canadian Charitable Organization by the Federal Government (Reg. No. 0249896-09-13). Complete financial statements are available on request.

Sanu knows a lot about being poor. In her country children learn fast about life's harshness, about hunger and hopelessness—and about questions with no answers. If you were Sanu's hardworking parents, what would you say when she asked you why nobody cared, why people who could help don't get involved? Imagine thinking that no one cares about you or your family. Imagine how much harder it makes poverty to bear.

Almost anything can be faced if there's some hope of it ending, some assurance that your hard work will

CALL TOLL FREE ANYTIME 1-(800)-268-7174
Information will be sent immediately (In British Columbia, 112-(800)-268-7174)

PLAN FOSTER PARENTS PLAN OF CANADA
153 ST. CLAIR AVENUE WEST TORONTO CANADA M4V 1P8

I want to be a Foster Parent of a boy girl age _____
country _____ or where the need is greatest

I enclose my first payment of \$23.00 Monthly \$69.00 Quarterly
\$138.00 Semi-Annually \$276.00 Annually I enclose my contribution of \$ _____

I can't become a Foster Parent right now, however I enclose my contribution of \$ _____ Please send me more information Tel. No. _____

Name _____
Address _____
City _____ Prov. _____ Code _____
I wish communication with PLAN to be in English French

PLAN operates in Bolivia, Colombia, Ecuador, Egypt, Guatemala, Haiti, Honduras, India, Indonesia, Mali, Nicaragua, the Philippines, Sierra Leone, the Sudan and Upper Volta. Foster Parents Plan of Canada is officially registered as a Canadian Charitable Organization by the Federal Government. Contributions are tax deductible.

Got Arthritis? Get The Facts!

Arthritis is Canada's number one chronic disease. It affects more than three million Canadians. 30,000 of them are children under 15, and nearly a million are between 30 and 45. Get the facts about arthritis! Contact the office of The Arthritis Society nearest you.



THE ARTHRITIS SOCIETY



Torch Computer Review

From out of the East . . . Wales, actually . . . comes a new computer with improved CP/M, dual processors, BBC Basic, three voice music, the highest resolution graphics of any currently available micro and, most important, *three colours of keys on the keyboard!* Three of them. Too bad it has such a silly name.

Plastic Foam Cutter Project

Of course you can just get some of those pieces of wook from out behind the garage and a few nails, zip down to Canadian tire for a couple of six by nines and have at the whole mess with a chain saw and the glue gun. However, it isn't very scientific and it will probably sound like a cat with asthma. Next month, the better way.



- Membrane Switches I have known
- My exploits among the wild ZX-81 interfaces
- Searching the wild Amazon for High Definition TV
- How I slew a mad elephant with two 555 timers and a kazoo

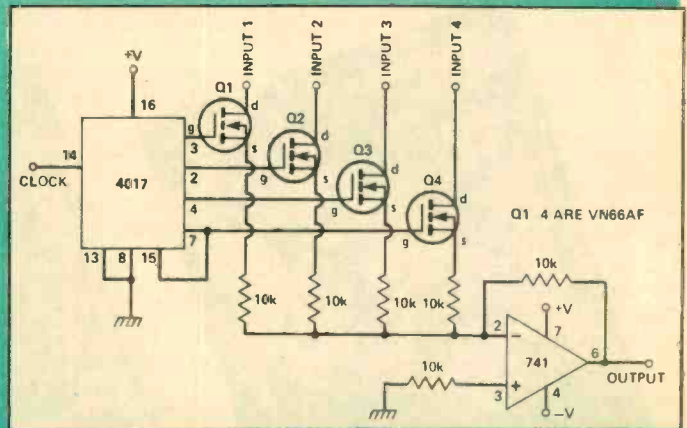

Designing with MOSFETs

Of course MOSFETs are mysterious. They were designed that way by a three foot high partially deaf mutant troll that they keep chained up in the basement of Motorola to write unfathomable application notes. Last week we snuck in and liberated him and he has gratefully given us the truth about these complicated little devices.

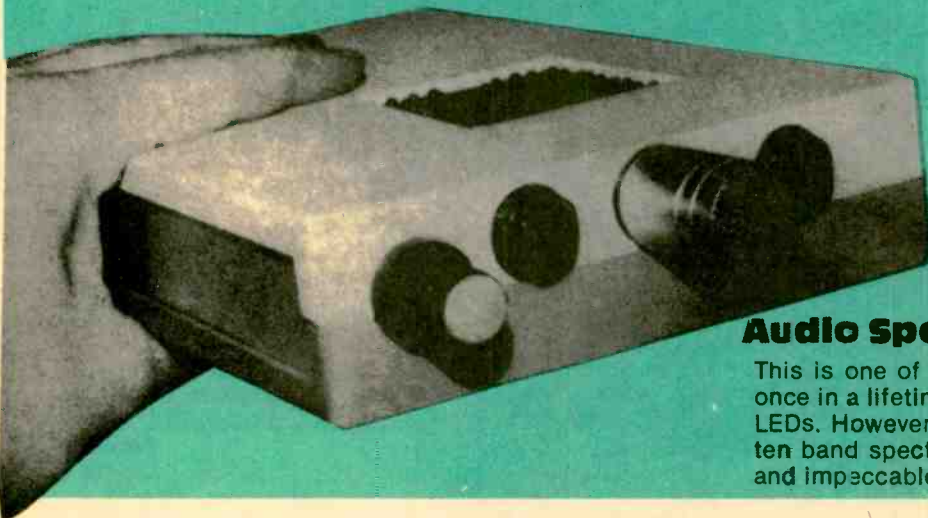

Audio Spectrum Analyser Project

This is one of those projects that only comes around once in a lifetime. It'll take you that long to find enough LEDs. However, once you do you'll be ready to built a ten band spectrum analyser with a bar graph readout and impeccible specifications to tune up your sound.

ETI Special Publications

If you enjoy ETI, why not try some of our highly successful special publications.



•Projects Book No. 2
100 pages
\$3.95
Contains 25 of the best projects from recent issues. Including the High Performance Series 4000 Amplifier (including Preamps and Power Supply), Rumble Filter, Dynamic Noise Filter, Logic Probe, Cable Tester, Function Generator, Rain Alarm, Digital Tacho, Two Octave Organ, Light Chaser, Shutter Speed Timer, Ni-Cad Charger and more. First published January 1981.

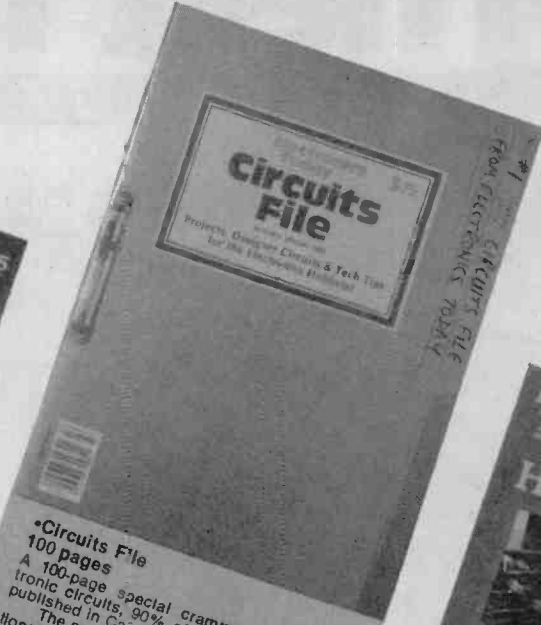

•Circuits File
100 pages
\$3.95
A 100-page special crammed with electronic circuits, 90% of them never before published in Canada.
The publication is divided in three sections: short-form projects; designer-circuits which are normally self standing designs but with no building details; Tech—Tips which are circuit ideas. About 125 circuits in all.



•Hobby Projects
100 pages
\$3.95
First published Summer 1980. Contains 25 straight-forward projects most of which have never appeared in the magazine including: Stereo Amp, Audio Mixer, Scratch and Rumble Filter, Constant Volume Amp, Graphic Equalizer, Envelope Generator, White Noise Effects Unit, Linear Scale Ohmmeter, Intercom, Drill Speed Controller, LED Tacho, Parking Meter Control, Electronic Organ, Touch Switch, Electronic Dice, Siren, Simple Receivers.



•More Circuits
108 pages
\$4.50
Over 150 circuits plus articles on Circuit Construction, Test Gear, a project on a Digital Panel Meter, Design notes on Speaker Crossovers, TTL pin-outs, Design notes on Crystal Oscillators.



•Electronic Circuit Design
92 pages
\$3.95
A collection of major articles on various aspects of circuit design including CMOS, Audio Amplifiers, Power Supplies, SCR's, Op-Amps, Using the 3080 and Temperature Control. A large number of useful circuits are given but the emphasis is on guidance and how to design for yourself.

Available from your local electronic parts store or direct from ETI please add 45c each to cover postage. Send money to: Electronics Today Magazine, Unit 6, 25 Overlea Blvd., Toronto, Ont., M4H 1B1

Constant Current Generators

Ray Marston takes an in-depth look at constant current generator applications and circuits.

A CONSTANT CURRENT generator circuit can be simply described as being electrically equivalent to a voltage generator with such a high output impedance that the current fed to an external load is virtually constant, irrespective of wide variations in the load resistance value. Figure 1a illustrates this description by showing the simple equivalent of a 1 mA constant current generator, with a basic source voltage of 100V and an output impedance of 100k; as you can see, varying the load impedance from zero to 1k Ω causes the load current to change by a mere 1%. In practice, of course, a true constant current generator can use electronic techniques to simulate these high source voltage and high output impedance characteristics. Figure 1b shows the circuit symbol that is used to represent a practical constant current generator.

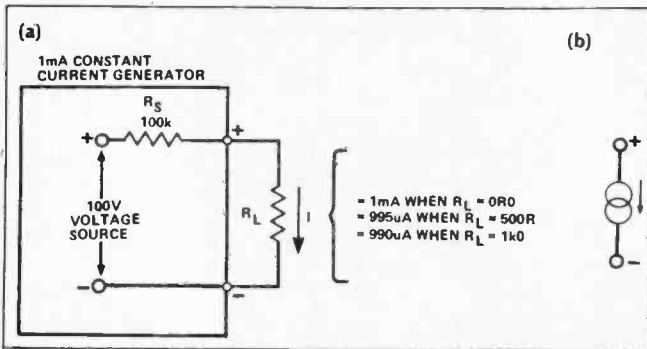

Fig. 1. Simple equivalent circuit of a 1 mA constant current generator (1), and the circuit symbol for a constant current generator (b).

Figure 2 shows some useful basic applications of constant current generators. Figure 2a is the basic circuit of a linear-scale ohmmeter, in which the R_x value is read off on a voltmeter; if I is 1 mA, the output voltage will be 1 mV per ohm of R_x value, if I is 10 μ A the output voltage will be 10 μ V/R, and so on.

In Fig. 2b, the generator is used to provide linear charging of a capacitor; this circuit is useful in linear timebase generators, for example.

In Fig. 2c, the constant current generator is used as the emitter load of a common collector amplifier or emitter follower, where the high dynamic impedance of the generator gives the follower excellent linearity and a near perfect unity gain.

In Fig. 2d the generator is used as the collector load of a common emitter amplifier, where its high dynamic impedance causes the amplifier to operate with high voltage gain (typically about 70 dB).

In Fig. 2e, the generator is used as the emitter load

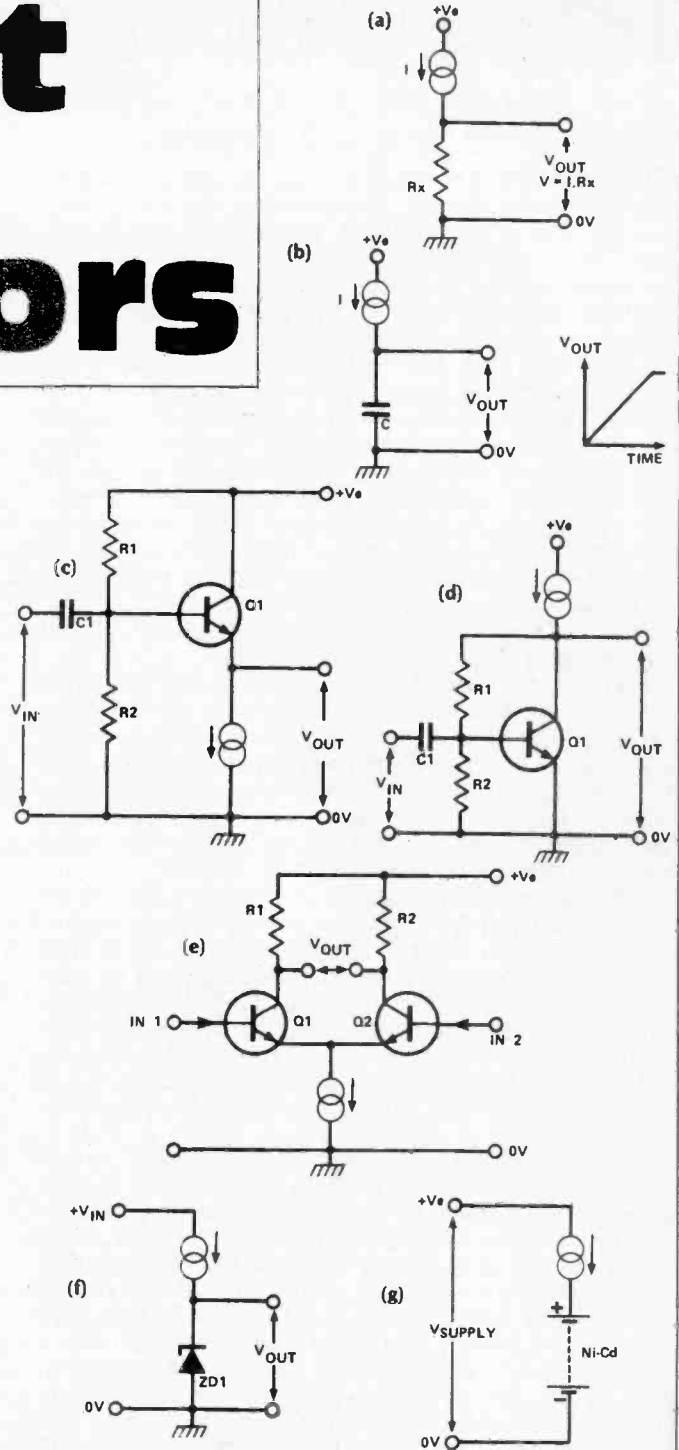

Fig. 2. Typical applications of constant current generator circuits; (a) linear scale ohmmeter; (b) linear charging of a capacitor; (c) unity-gain, highly-linear emitter follower; (d) high-gain common emitter amplifier; (e) high performance differential amplifier; (f) precision voltage source; (g) Ni-Cd charger.

of a differential amplifier, where its high dynamic impedance causes the amplifier to operate with high gain, excellent linearity and a high CMR ratio.

Figure 2f shows a typical power supply application, in which the generator is used to apply a fixed bias current to a zener diode, irrespective of wide variations of input voltage, and thus enables the zener to generate an ultra-stable output reference voltage.

Finally, Fig. 2g shows how the generator can be used as a Ni-Cd charger, in which the charger current is

Constant Current Generators

constant, irrespective of the number of cells that are used in the Ni-Cd stack.

Transistor Circuits

Bipolar transistors can easily be configured to act as efficient constant current generators. Figure 3 illustrates an easy way to use an NPN transistor in this mode. Here, R1 and ZD1 are used to apply a fixed 5V6 reference voltage to the base of common emitter amplifier Q1, which uses R2 as its emitter load and its collector as the constant current source. Because of the inherent 600 mV (approximately) base-emitter voltage drop of the transistor, 5V is developed across emitter resistor R2, so a fixed current of 5 mA passes through this resistor via Q1 emitter. Since the emitter and collector currents of a bipolar transistor are inherently almost identical, a 5 mA current also flows in any load that is connected between the collector of Q1 and the positive supply rail of the circuit, almost irrespective of the load's resistance value (providing that the value is not so large that Q1 is driven into saturation), so these two points serve as constant current source terminals.

From this description, you can see that the constant current magnitude is determined by the values of the base reference voltage and the emitter load resistor (R2), so the current value can be varied either of these values. Figure 4, for example, shows how the basic circuit of Fig. 3 can be 'inverted' to give a ground-referenced constant current output that can be varied from approximately 1 mA to 10 mA using RV1.

In most practical applications of constant current generators, the most important feature of the circuit is its high dynamic output impedance (see Fig.2). The precise magnitude of the constant current is of only modest importance: in such cases, the basic circuits of Figs. 3 and 4 will satisfy most practical needs. If greater precision is needed, the characteristics of the reference voltage of these circuits must be improved, to eliminate the effects of supply line and temperature variations.

One simple modification to improve the Fig. 3 and 4 circuits is to replace R1 with a 5 mA constant current generator, as shown in Fig. 5, so that the zener voltage (and thus the zener current) is independent of variations in the supply line voltage. If really high precision is needed, the zener reference should have a temperature coefficient of $-2 \text{ mV}/^\circ\text{C}$, to match the base-emitter coefficient of Q1; an easy way round this problem is to use a forward biased LED in place of the zener, as shown in Fig.6. In this case the LED voltage is roughly 2 V, so only about 1V4 appears across emitter resistor R1, which has its value reduced to about 270R to maintain the constant current output level at 5 mA. An even better way of obtaining high precision is to use an op-amp version of the constant current generator circuit.

Op-amp Circuits

Op-amp constant current generators are very easy to implement, as illustrated by the 1 mA to 10 mA precision generator of Fig. 7. Here, IC1 is used as a voltage follower with a variable reference voltage of 560 mV to 5V6 applied to its non-inverting terminal via RV1, but has the base-emitter junction of Q1 included in its negative feedback loop. Thus the R2 voltage precisely follows the reference voltage, but has its current supplied via the emitter of Q1. Consequently, remembering that the collector and emitter currents of the bipolar

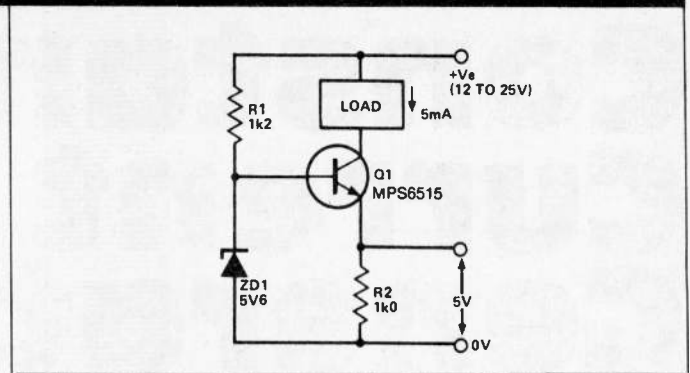

Fig. 3. A simple transistor 5 mA current generator.

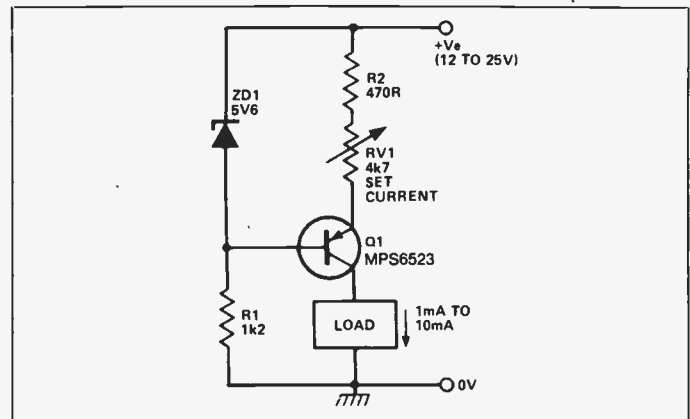

Fig. 4. A simple variable ground-referenced constant current generator (1 mA — 10 mA).

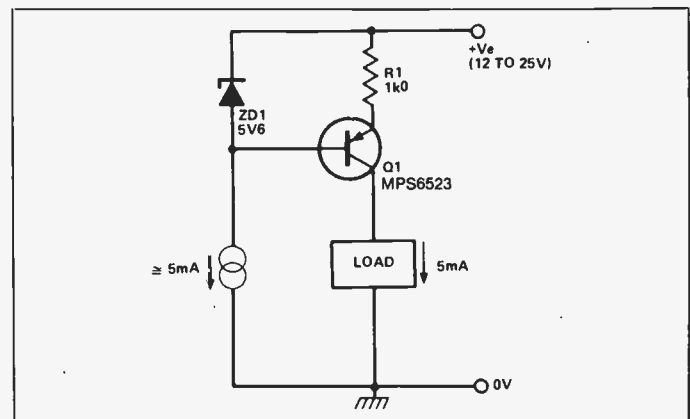

Fig. 5. A precision constant current generator, with precision voltage reference.

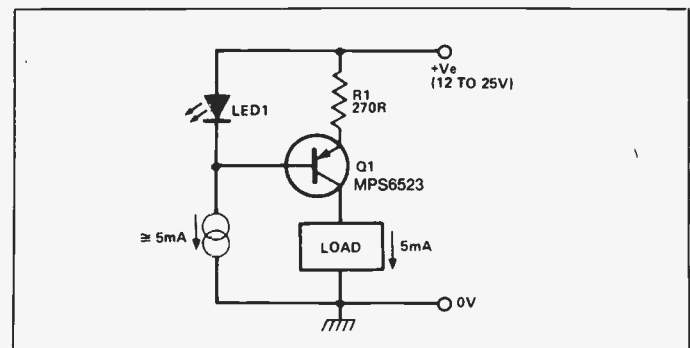

Fig. 6. A thermally-stabilised constant current generator, using a LED as a voltage reference.

transistor are virtually equal, the collector (external load) current of the circuit is almost identical to the R2 current, irrespective of the resistance value of the external load, and can be varied from 1 mA to 10 mA by RV1.

The Fig. 7 circuit, like the circuits of Figs. 3 to 6, acts as a unidirectional fixed-current generator, in

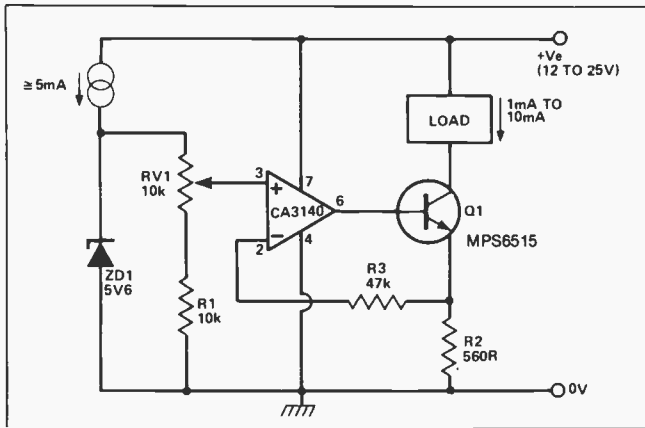

Fig. 7. A precision 1 mA — 10 mA op-amp constant current generator.

which the load current is fixed and can flow only in a single direction. A totally different type of constant current generator is the voltage-controlled bilateral circuit, which can be used to convert an AC input voltage into an AC load current that is virtually independent of the value of load resistance.

A simple example of a bilateral constant current generator is shown in Fig. 8. Here, the op-amp is wired in the inverting configuration, but uses the load as its feedback resistor. The inherent action of this circuit is such that the feedback current (through the load) automatically adjusts to a value equal to that through R1 (ie $V_{IN}/R1$), irrespective of the load value, so bilateral constant current generation is automatically obtained. Note that the output voltage of this circuit is directly proportional to the load impedance.

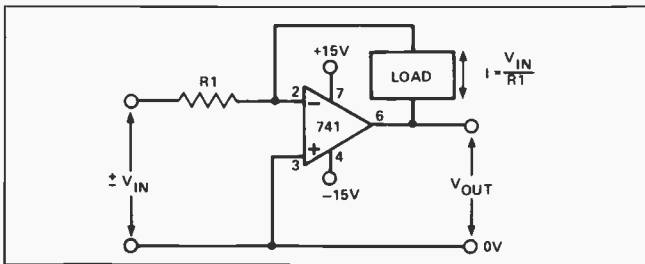

Fig. 8. A precision 1 mA — 10 mA op-amp constant current generator.

The Fig. 8 bilateral circuit is useful in applications where the load is fully floating; if the load is not floating, but has one end tied to ground, the alternative circuit of Fig. 9 can be used as a bilateral constant current generator. Here, when the R1 to R4 resistor networks are given the indicated ratios, circuit feedback causes the output load current to be determined entirely by the values of R5 and V_{IN} , irrespective of the value of the load impedance. With the component values shown, the output current has a value of 1 mA per volt of input and the output current is in phase with the input voltage: if the value of R5 is doubled, to 1k0, the output current value will halve, to 0.5 mA/V. Note that, since the AC load current of the above circuit is effectively constant, the load voltage is directly proportional to the load

impedance: the circuit can thus readily be adapted for use as an impedance-measuring piece of test gear.

High-current Generators

All of the circuits that we've looked at so far are designed to provide maximum currents of only a few milliamps, which is easily adequate for the majority of applications shown in Fig. 2. If desired, all of the circuits of Figs. 3 to 9 can be fairly easily modified to provide greatly increased current levels. The levels of the Fig. 3 to 7 circuits, for example, can be boosted by simply replacing Q1 with a Darlington power transistor and suitably altering the emitter resistor values. Similarly, the levels of the Fig. 8 and 9 circuits can be boosted by replacing the 741 device with a high-power op-amp and, in the case of Fig. 9, suitably altering the R5 value.

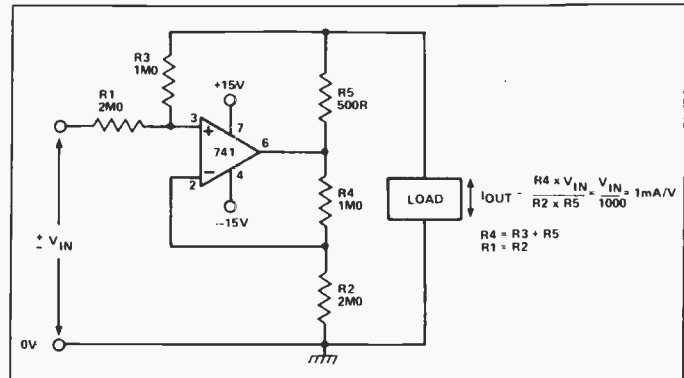

Fig. 9. This bilateral constant current generator has a grounded load. Note that the component values shown do satisfy the equations when component tolerances are taken into account.

If you need an ultra-simple precision high-value fixed-current generator, e.g. for charging Ni-Cds, an easy solution is to use an LM317 three-terminal regulator IC in the configuration shown in Fig. 10. The basic action of this chip is such that the output terminal automatically adjusts to a value 1V2 greater than the voltage set on the adjust terminal; consequently, when the IC is used in the Fig. 10 configuration in which the

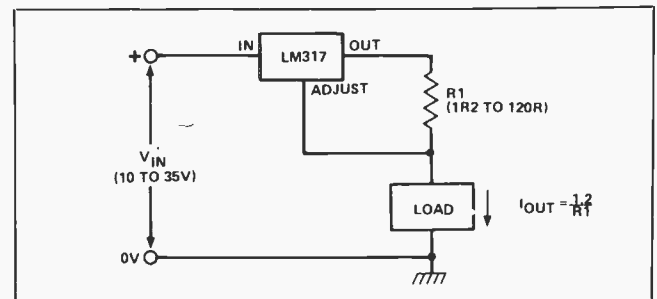

Fig. 10. A precision high-value (10 mA — 1 A) constant current generator.

output current flows to an external load via sensing resistor R1, the circuit acts as a constant current generator with a current value of $1.2/R1$. When R1 has a value of 1R2 the circuit acts as a 1 A generator, and when R1 has a value of 120R it acts as a 10 mA generator. The circuit can be used with any input (supply) voltage in the range 10 to 35V.

Computer Review

The year in computers: a buyer's guide to the popular computer systems as seen in the pages of recent issues of ETI. By Steve Rimmer.

BUYING A COMPUTER is a bit of a catch 22. In order to really be able to decide if a system is good, both from a design and manufacturing standpoint... is it well thought out and put together... and in terms of its application... is it right for you... it really helps to already have a computer. No amount of research is as useful as actually knowing what you're doing. However, as in all of these cases, if you do find yourself in this position the exercise becomes necessarily academic.

The next best thing, in choosing a system, is to have an impartial second opinion around. That's where magazine reviews and surveys come in. They tell you an awful lot more about systems than salesmen ever will... because there is no salesman yet born that isn't dead sure that whatever computer he's flogging is absolutely perfect for you even if you really just stumbled in by mistake while looking for a food processor. Magazine articles tell you about what's wrong with the computers they look at, but, more important, they'll help you decide whether the computer you're considering will do what you want it to.

The following is an overview of fourteen ETI reviews, a summary of some of the most popular contemporary systems. However, unlike traditional magazine surveys these have been compiled from actual hands-on experience with the systems in question, not just manufacturer's literature. If you want more information on particular ones of these machines, consult back issues of ETI.

Finally, before you choose a system, have a good lengthy play with it. Try to find other users of the computer you have in mind and talk to them. Find out what they are happy about and what you can expect to gripe about and decide whether this suits your expectations. It is particularly important to realize that every system will throw some errors and turn up some bugs. Peaceful co-existence with your computer involves being forewarned of them and understanding how to minimize their effect.

Acorn ATOM



Manufacturer	Acorn Computers
Area of interest	Home
Processor	6502
Screen size	16 lines of 32 characters
Graphics	High resolution with sufficient RAM
Sound	One channel through internal speaker
Display	External monitor
Mass Storage	Cassette (disk optional)
RAM	12K
Printer included	No
Software included	BASIC in ROM
ROM pack facility	No
RS-232 Port	Optional
Printer Interface	Optional
DOS	Optional
Number of units	3
Documentation	Large fairly complex BASIC and ML manual
Price	\$525.00 (\$599.00 colour)

- Mechanical construction ●●●●
- Overall ease of use ●●●●
- Speed of operation ●●●●
- Software ●●●●
- Graphics capability ●●●●
- Suitability for beginners ●●●●
- Suitability for business ●●●●
- Manuals and instructions ●●●●

Information available from:

Gladstone Electronics
1736 Avenue Rd.,
Toronto, Ontario
M5M 3Y7

Apple II



Manufacturer	Apple Computers
Area of interest	Home and business
Processor	6502
Screen size	up to 280 x 192 high resolution
Graphics	one channel
Sound	External monitor
Display	cassette or 5 1/4 inch disk drives
Mass Storage	48K
RAM	48K
Printer included	No
Software included	Applesoft BASIC and monitor in ROM
ROM pack facility	No
RS-232 Port	Optional
Parallel Port	Optional
Printer Interface	Optional
DOS	Optional
Number of units	1 (plus monitor & drives(s))
Documentation	Excellent manuals
Price	\$2499.

- Mechanical construction ●●●●●●
- Overall ease of use ●●●●●●
- Speed of operation ●●●●●●
- Software ●●●●●●
- Graphics capability ●●●●●●
- Suitability for beginners ●●●●●●
- Suitability for business ●●●●●●
- Manuals and instructions ●●●●●●

Information available from:

Apple Canada Ltd
875 Don Mills Rd.
Don Mills, Ont
M3C 1V9

Apple III



Manufacturer	Apple Computers
Area of interest	Business
Processor	6502B
Screen size	24 lines of 40 characters, 80 characters under "Business BASIC"
Graphics	High resolution
Sound	
Display	External monitor
Mass Storage	One built in 5¼ inch disk drive
RAM	128K
Printer included	No
Software included	SOS
ROM pack facility	No
RS-232 Port	Yes
Printer Interface	Yes
DOS	SOS (Sophisticated Operating System)
Number of units	2
Documentation	Extensive Manuals
Price	\$6475 + BASIC (\$250) + Monitor (\$375)

Mechanical construction	● ● ● ●
Overall ease of use	● ● ● ●
Speed of operation	● ● ● ●
Software	● ● ● ● ● ● ● ●
Graphics capability	● ● ● ● ● ● ● ●
Suitability for beginners	● ● ● ● ● ● ● ●
Suitability for business	● ● ● ● ● ● ● ●
Manuals and instructions	● ● ● ● ● ● ● ●

Information available from:

Apple Canada
875 Don Mills Rd.,
Don Mills, Ontario
M5C 1V9

Atari 800



Manufacturer	Atari (Division of Warner)
Area of interest	Home
Processor	6502
Screen size	
Graphics	Up to 280 x 192 high resolution
Sound	Four voices
Display	External TV set
Mass Storage	Cassette or 5¼ inch disk drive
RAM	8K expandable
Printer included	No
Software included	BASIC in ROM pack
ROM pack facility	Yes
RS-232 Port	Optional
Printer Interface	Optional
DOS	Atari DOS
Number of units	1 (plus TV and any peripherals)
Price	\$1099.00

Mechanical construction	● ● ● ●
Overall ease of use	● ● ● ●
Speed of operation	● ● ● ●
Software	● ● ● ● ● ● ● ●
Graphics capability	● ● ● ● ● ● ● ●
Suitability for beginners	● ● ● ● ● ● ● ●
Suitability for business	● ● ● ● ● ● ● ●
Manuals and instructions	● ● ● ● ● ● ● ●

Information available from:

Irwin Electronics
165 North Queen Street,
Etobicoke, Ontario
M9C 1A7

IBM Personal Computer

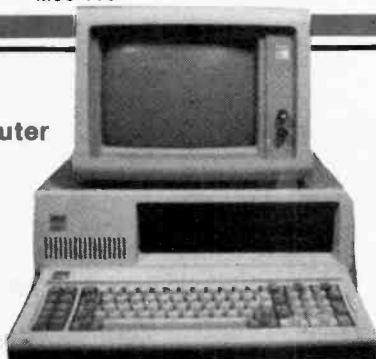

Manufacturer	IBM
Area of interest	Home and Business
Processor	8088
Screen size	24 lines of 80 characters
Graphics	High resolution
Sound	1 channel programmable
Display	External monitor
Mass Storage	One or two 5¼ inch disks (cassette version also available)
RAM	64K
Printer included	Yes
Software included	DOS
ROM pack facility	No
RS-232 Port	Optional
Printer Interface	Yes
DOS	PC DOS
Number of units	3
Documentation	Excellent manuals
Price	\$5900 (depending upon options)

Mechanical construction	● ● ● ●
Overall ease of use	● ● ● ● ● ● ● ●
Speed of operation	● ● ● ● ● ● ● ●
Software	● ● ● ● ● ● ● ●
Graphics capability	● ● ● ● ● ● ● ●
Suitability for beginners	● ● ● ● ● ● ● ●
Suitability for business	● ● ● ● ● ● ● ●
Manuals and instructions	● ● ● ● ● ● ● ●

Information available from:

IBM Canada Ltd.,

IF 800



Manufacturer	Oki Computers (Japan)
Area of interest	Home and business
Processor	Z 80
Screen size	24 lines of 80 characters
Graphics	High resolution
Sound	Internal speaker
Display	Internal monitor
Mass Storage	2 5¼ inch disks
RAM	64K
Printer included	Yes
Software included	CP/M, BASIC
ROM pack facility	Yes
RS-232 Port	Yes
Printer Interface	Yes
DOS	CP/M
Number of units	1 (actually 2 plugged together)
Documentation	Extensive manuals
Price	\$7995.00

Mechanical construction	● ● ● ●
Overall ease of use	● ● ● ● ● ● ● ●
Speed of operation	● ● ● ● ● ● ● ●
Software	● ● ● ● ● ● ● ●
Graphics capability	● ● ● ● ● ● ● ●
Suitability for beginners	● ● ● ● ● ● ● ●
Suitability for business	● ● ● ● ● ● ● ●
Manuals and instructions	● ● ● ● ● ● ● ●

Information available from:

Canada Computer
1285 Britannia Road East,
Mississauga, Ontario
L4W 1C7

Multiflex "Super Package"



Manufacturer	Multiflex Computers
Area of interest	Home
Processor	Z-80
Screen size	24 lines of 80 characters
Graphics	Block characters (high resolution board optional)
Sound	
Display	External monitor
Mass Storage	1 5/4 inch disk
RAM	64K
Printer included	No
Software included	CP/M
ROM pack facility	No
RS-232 Port	Yes
Printer Interface	Optional
DOS	CP/M
Number of units	4
Documentation	Manual plus CP/M books
Price	\$995 without power supply, keyboard, case or monitor.

- Mechanical construction ● ● ●
- Overall ease of use ● ● ● ●
- Speed of operation ● ● ● ●
- Software ● ● ● ●
- Graphics capability ●
- Suitability for beginners ●
- Suitability for business ● ● ●
- Manuals and instructions ● ● ●

Information available from:

*Exceltronix Components
And Computing
319 College Street,
Toronto, Ontario
M5T 1S2*

Osborne



Manufacturer	Osborne
Area of interest	Home
Processor	Z-80
Screen size	24 lines of 52 characters scrollable
Graphics	Block characters
Sound	
Display	Internal 5 inch CRT, provision for external monitor
Mass Storage	2 internal 5 1/4 inch disks
RAM	64K
Printer included	No
Software included	CP/M, BASIC, WORDSTAR, SUPERCALC
ROM pack facility	No
RS-232 Port	Yes
Printer Interface	No
DOS	CP/M
Number of units	1
Documentation	Ring bound manual
Price	\$2395.00

- Mechanical construction ● ● ●
- Overall ease of use ● ● ● ●
- Speed of operation ● ● ● ●
- Software ● ● ● ●
- Graphics capability ●
- Suitability for beginners ●
- Suitability for business ● ● ●
- Manuals and instructions ● ● ●

Information available from:

*Lanpar
85 Torbay Road,
Markham, Ontario
L3R 1G7*

TRS 80 Model II

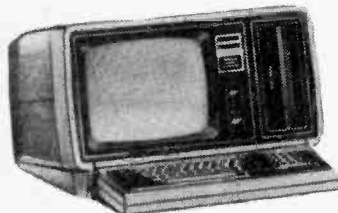

Manufacturer	Radio Shack
Area of interest	Business
Processor	Z 80
Screen size	24 lines of 80 characters
Graphics	Block character
Sound	
Display	Internal monitor
Mass Storage	1 8 inch disk
RAM	64K
Printer included	No
Software included	TRSDOS, BASIC
ROM pack facility	No
RS-232 Port	Yes (2)
Printer Interface	Yes
DOS	TRSDOS
Number of units	2
Documentation	Extensive manual
Price	\$5399.00

- Mechanical construction ● ● ●
- Overall ease of use ● ● ● ●
- Speed of operation ● ● ● ●
- Software ● ● ● ●
- Graphics capability ●
- Suitability for beginners ●
- Suitability for business ● ● ● ●
- Manuals and instructions ● ● ● ●

Information available from:

*Local Radio Shack
Computer Centres*

TRS-80 Model III

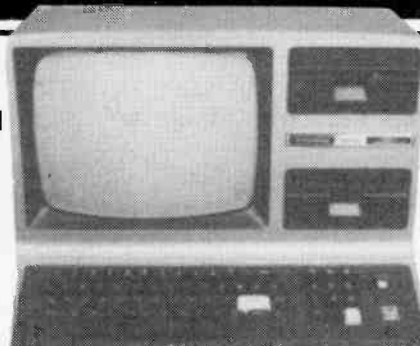

Manufacturer	Radio Shack
Area of interest	Home and Business
Processor	Z-80
Screen size	16 lines of 64 characters
Graphics	Large block character set
Sound	
Display	Internal monitor
Mass Storage	Cassette or up to 2 5 1/4 inch disks
RAM	4K expandable
Printer included	No
Software included	BASIC (TRSDOS with disk systems)
ROM pack facility	No
RS-232 Port	Optional
Printer Interface	Optional
DOS	TRSDOS
Number of units	1
Documentation	Extensive manual
Price	\$999.00 (4K, cassette system)

- Mechanical construction ● ● ●
- Overall ease of use ● ● ● ●
- Speed of operation ● ● ● ●
- Software ● ● ● ●
- Graphics capability ●
- Suitability for beginners ● ● ● ●
- Suitability for business ● ● ● ●
- Manuals and instructions ● ● ● ●

Information available from:

Local Radio Shack stores

University of Toronto Board

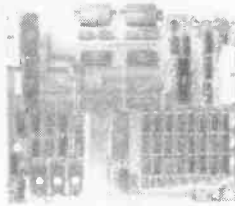

Manufacturer	Exceltronix
Area of interest	Home
Processor	6809
Screen size	
Graphics	
Sound	
Display	External terminal
Mass Storage	Cassette
RAM	48K
Printer included	
Software included	Sophisticated "TEACH" assembler in ROM
ROM pack facility	
RS-232 Port	Yes (2)
Printer Interface	
DOS	
Number of units	Manual
Documentation	
Price	\$369 (16K kit) \$499 (48K Assembled and tested) + \$169 for the editor/assembler

Mechanical construction	● ● ● ●
Overall ease of use	● ● ● ●
Speed of operation	● ● ● ●
Software	● ● ● ●
Graphics capability	● ● ● ●
Suitability for beginners	● ● ● ●
Suitability for business	● ● ● ●
Manuals and instructions	● ● ● ●

Information available from:

**Exceltronix Components
And Computing**
319 College Street,
Toronto, Ontario
M5T 1S2

Vic-20



Manufacturer	Commodore Business Machines
Area of interest	Home
Processor	6502
Screen size	20 lines of 22 characters
Graphics	Optional high resolution
Sound	3 Channels of tone + 1 of noise
Display	External monitor
Mass Storage	Cassette (disk optional)
RAM	3.5K
Printer included	No
Software included	BASIC in ROM
ROM pack facility	Yes
RS-232 Port	Optional
Printer Interface	Optional
DOS	
Number of units	4
Documentation	Very good beginner's BASIC manual
Price	\$399.00

Mechanical construction	● ● ● ●
Overall ease of use	● ● ● ●
Speed of operation	● ● ● ●
Software	● ● ● ●
Graphics capability	● ● ● ●
Suitability for beginners	● ● ● ●
Suitability for business	● ● ● ●
Manuals and instructions	● ● ● ●

Information available from:

Commodore Business Machines
3370 Pharmacy Avenue
Agincourt, Ontario
M1W 2K4

Zenith H-89



Manufacturer	Zenith/Heath
Area of interest	Home and business
Processor	8080
Screen size	24 lines of 80 characters
Graphics	
Sound	Internal speaker
Display	Internal monitor
Mass Storage	One 5 1/4 inch disk
RAM	48K
Printer included	No
Software included	DOS, BASIC (Compiler)
ROM pack facility	No
RS-232 Port	Yes (3)
Printer Interface	
DOS	DOS or CP/M
Number of units	1
Documentation	Extensive manual
Price	\$3995.00

Mechanical construction	● ● ● ●
Overall ease of use	● ● ● ●
Speed of operation	● ● ● ●
Software	● ● ● ●
Graphics capability	● ● ● ●
Suitability for beginners	● ● ● ●
Suitability for business	● ● ● ●
Manuals and instructions	● ● ● ●

Information available from:

Heath Company
1480 Dundas Street East,
Mississauga, Ontario
L4X 2R7

ZX-81



Manufacturer	Sinclair
Area of interest	Home
Processor	Z-80
Screen size	16 lines of 32 characters
Graphics	Block characters
Sound	
Display	External monitor
Mass Storage	Cassette
RAM	1K
Printer included	No
Software included	BASIC in ROM
ROM pack facility	No
RS-232 Port	No
Printer Interface	Optional
DOS	
Number of units	2
Documentation	164 page manual, many other books available
Price	\$129.95

Mechanical construction	● ● ● ●
Overall ease of use	● ● ● ●
Speed of operation	● ● ● ●
Software	● ● ● ●
Graphics capability	● ● ● ●
Suitability for beginners	● ● ● ●
Suitability for business	● ● ● ●
Manuals and instructions	● ● ● ●

Information available from:

Gladstone Electronics
1736 Avenue Rd.,
Toronto, Ontario
M5M 3Y7

Sound-Light Modulator

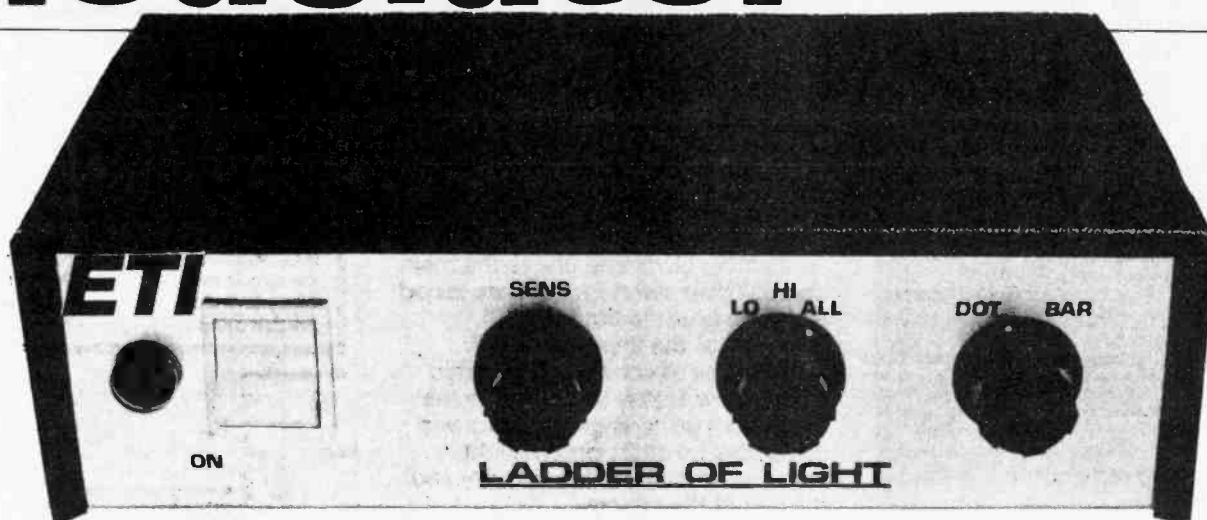

No ordinary sound-into-light display this: by creating a pulsating, rising-and-falling light show it will transform your party or disco.

OH NO, NOT another boring old sound-into-light converter — well yes and no. Yes, it is a sound-into-light converter but no, it certainly is not boring, in either appearance or design. By constructing the ETI Ladder-of-Light as a modular design you will be the owner of a very versatile project. The module (as shown here) will drive ten 100W bulbs either in bar mode (in a line increasing from one end) or dot mode (one bulb at a time) according to the volume of music. All that's required is to connect the Ladder-of-Light to your amplifier or speakers.

By filtering the audio signal through a low-pass, a high-pass or an all-pass filter, the converter is controlled by bass, treble or middle frequencies allowing the display to pulsate in time with music or vocal etc. An adjustable sensitivity level means that most amplifiers regardless of output power, can be used with the project.

The display of bulbs is triac-controlled with zero-cross detection and triggering to prevent radio frequency interference (RFI), and with no heatsinking ten 100 W bulbs can be used without the triacs overheating. If you wish, the triacs can be fitted

with heatsinks thus taking power handling up to the triacs maximum of 1k2 W per bulb, but it is outside the scope of this article to show how this can be done. If you want to increase power handling, remember that the total current consumption of the converter and display must not exceed that available from line (i.e. 20 A). Style of the display is largely a matter of personal choice and so we only give suggestions for its constructional details, but designs could be in the form of a line of bulbs, a circle, a spiral etc.

More intricate and eye dazzling displays can obviously be built if more than one module is used so that different coloured bulbs can be used, for bass and treble for example, adding a new dimension.

Construction

Unlike most AC powered projects (especially those which control AC voltages via triacs and thyristors etc) we have not used a PCB for constructional purposes, but Veroboard. The main reason for this is that the only AC connection to the board is a neutral connection. However, we must stress that while we have taken every precaution in the wiring of the project, if the wiring of the particular application is incorrect (i.e. the live and neutral connections are reversed), then the line and triac board will be potentially live — and prying fingers might pry no more. So

take care!

Construction starts with the Veroboard — a larger-than-usual piece — 26 strip by 50 holes, 0.1" matrix. We are assuming that builders of this project are not beginners so we need not explain all stages of build-up of the board; just remember to make the breaks in the tracks first. Use pins in the board for all external connections — in this way the board can be fixed in position into the case using plastic mounting bushes (for insulation) before wiring-up starts.

Drill the case for all switches, the pot, neon, cable holder, triac and main board mounting holes, transformers, connector blocks and a rectangular slot in the back panel to allow the cables from all lamps to enter the case. Grommet strips should be put around the slot to prevent chaffing of the cables. Your project can now start to go together as in the connection diagram of Fig. 5 which should provide you with details of the full project minus only the triac board. This is a piece of phenolic board on which the ten triacs, 10 fuseholders and the 12-way connecting block fit as you can see in the photograph. These must all be firmly mounted on the phenolic. Solder all 10 triac MT1 terminals together, using a suitable length of single-core, tinned wire and insulate this adequately with sleeving. Each MT2 terminal of the triacs goes to the corresponding fuseholder (again insulated). The final

triac connections — the 10 gate terminals — should be taken to the corresponding output of the LM3914 on the main board. Figure 1 connection diagram shows their order.

The other sides of the fuseholders go to the first 10 terminals on the connecting block. The final two terminals of the block are neutral connections, one to the AC input connecting block and one to the main board. These two terminals are joined and then taken to the ten MT1 terminals of the triacs. Figure 1, summarises all connections on this board. Now fasten this board to the back panel using angle brackets and make sure no short circuit might occur between the triac circuitry and the rest of the project.

A second phenolic panel should be used over the triac board to prevent the lid from shorting out the connections underneath, if for instance, the case is accidentally damaged.

The project is ready for testing now, with ten bulbs and an audio source. The live connection for each bulb is taken from the AC terminal block and connected to the bulbs in turn.

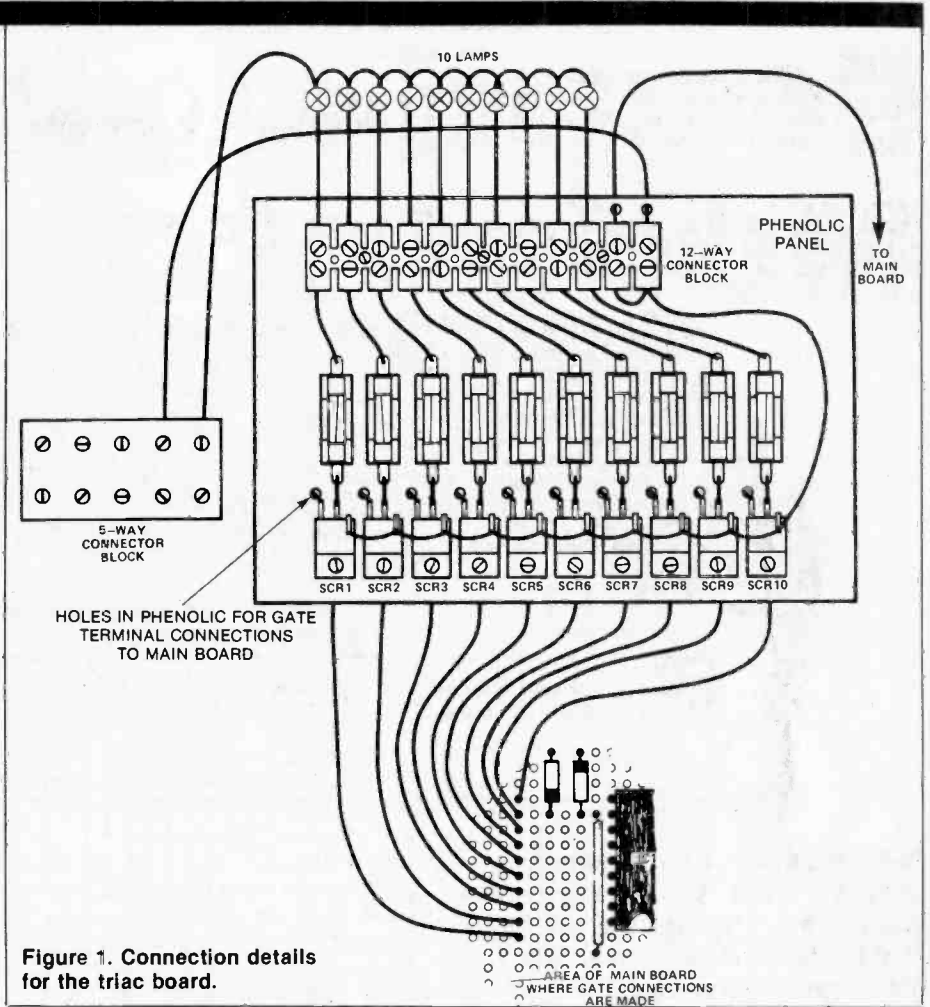
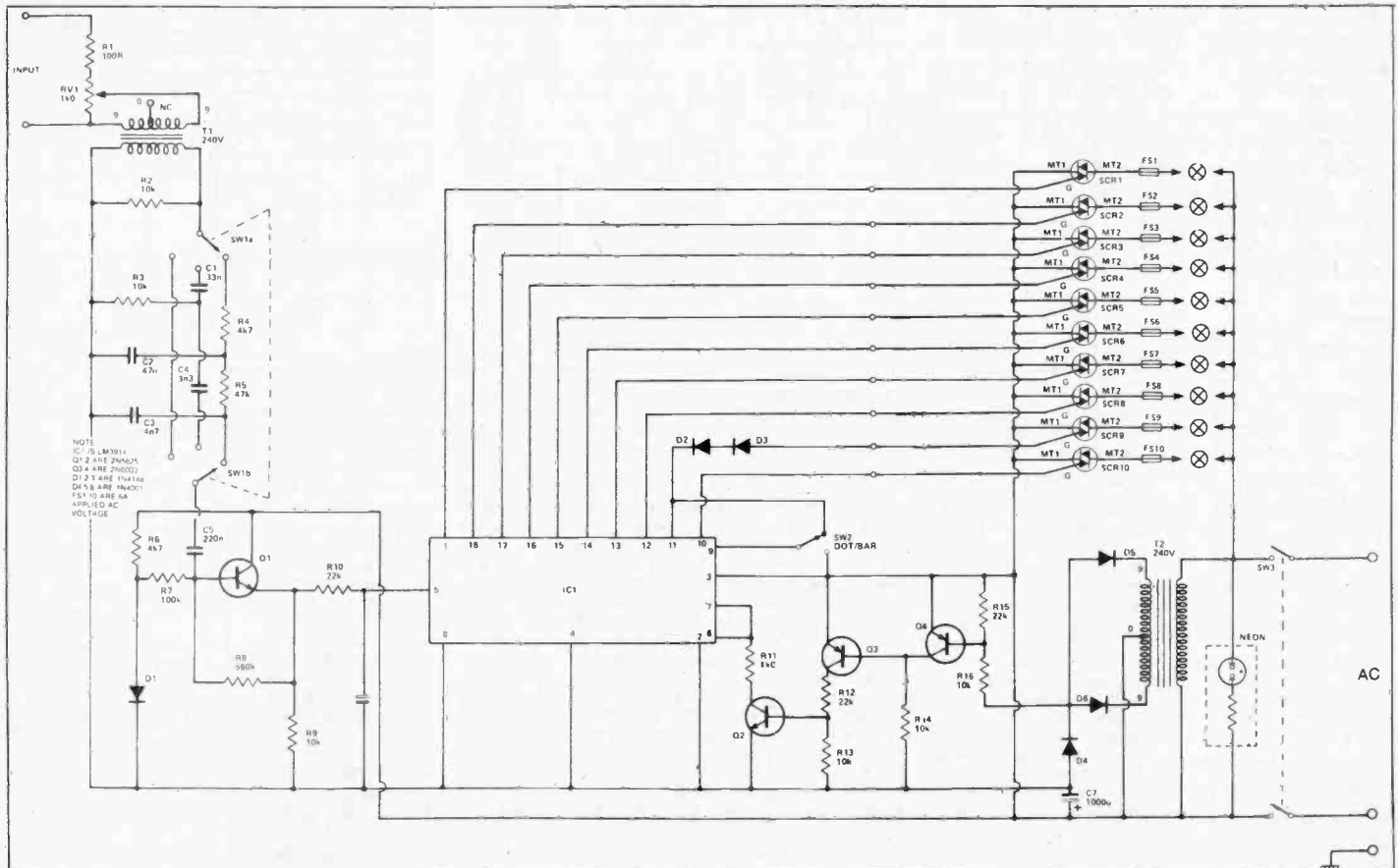

Figure 1. Connection details for the triac board.



Sound-Light Modulator

The Ladder-of-Light

The Ladder-of-Light controls each bulb in the display, according to the amplitude of the applied audio signal. The 10 bulbs are turned on and off by triacs SCR 1 to 10 in Fig. 2. These triacs can be considered as being electronic switches which are operated by pulses at their gates. The block diagram shown in Fig. 3 shows such a switch capable of turning on one bulb. Although we have only shown one triac, there are ten in the project.

The gate pulse to operate the triac comes from the dot/bar vohm meter IC1, an LM3914, which as our 'regulars' will know (we have used it once or twice before) drives either a bargraph or dot display, where the number of 'dots' illuminated depends on the applied DC voltage at its input. The LM3914 is most often associated with a 'line of LEDs' display, but this application sees it driving a line of triacs directly.

The DC voltage at the input of the LM3914 vohm meter is derived from the audio input, taken directly from your amplifier output. Transformer T1 is used as an isolating transformer to electrically separate the amplifier circuit from the

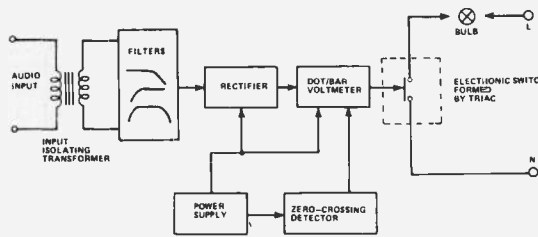

Figure 3. Block diagram of Ladder-of-Light.

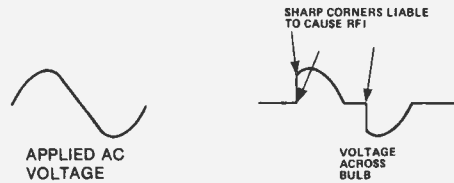

Figure 4. Input and output voltages to an ordinary triac power controller.

Ladder-of-Light circuit (only magnetic coupling takes place). From here the signal is switched through a bank of filters (low-pass, high-pass or all-pass) by SW1, which means that various frequency bands — either bass, treble or middle — are used to control the light.

As the audio signal is AC and the required control voltage at the LM3914 is DC, the signal must be rectified and Q1 with its associated components performs this function. The resultant DC voltage of 0V to 1.2V is stored by capacitor C6.

Now, if a triac is turned on half-way through an AC cycle, radio frequency interference (RFI) can occur, because of the sharp edge on the wave — Fig. 4 shows such a waveform. The obvious way to prevent RFI from occurring therefore, is to switch on the triac at the beginning of the cycle. The block diagram shows a section dedicated to detecting when the AC voltage crosses 0V, the zero-crossing detector formed by Q2,3,4 along with associated components. Whenever this 0V state occurs the LM3914 is allowed (given the right control voltage) to turn on the triacs.

Figure 5. Veroboard layout and underside view showing track breaks.

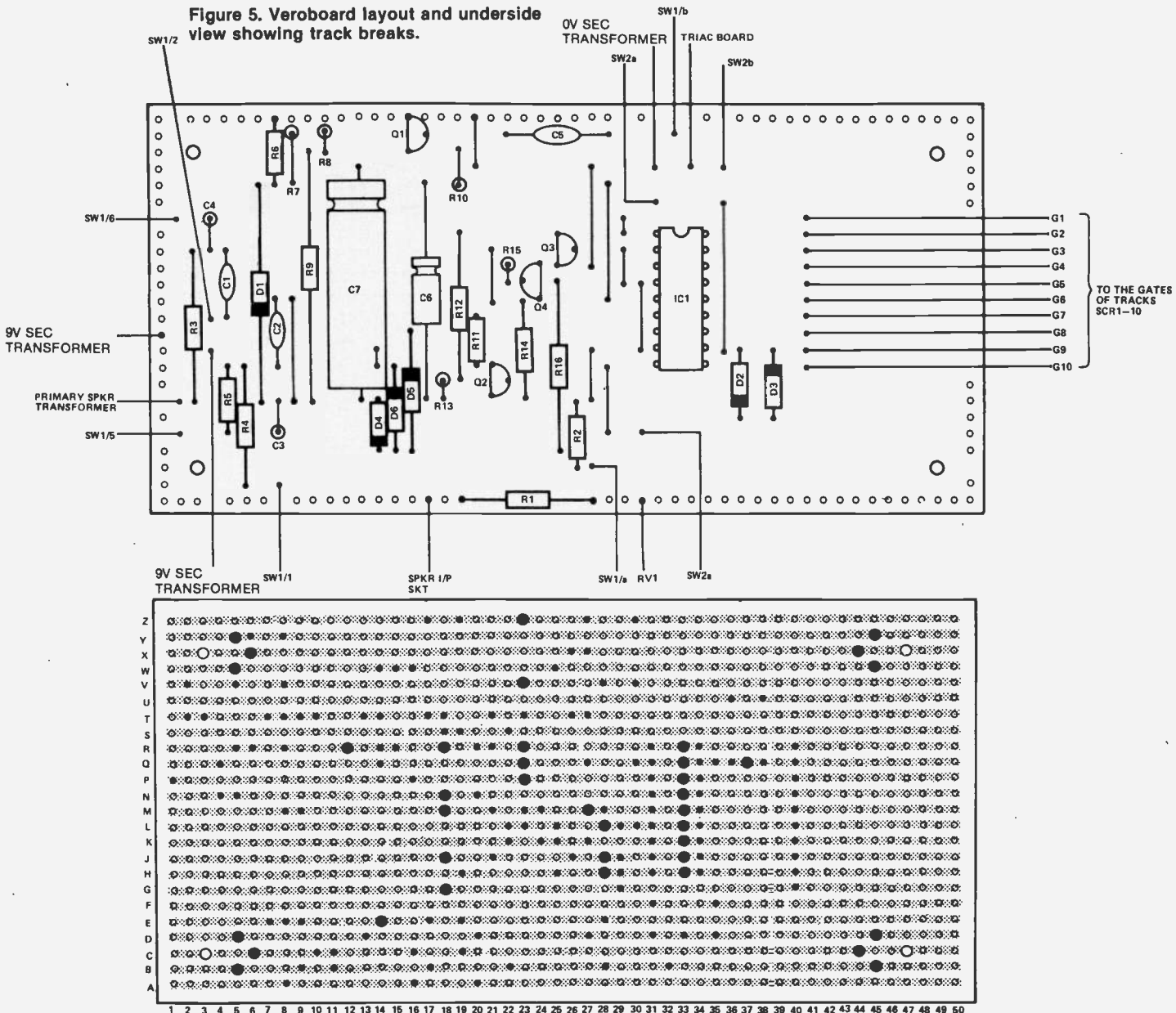

Digital Millivoltmeter

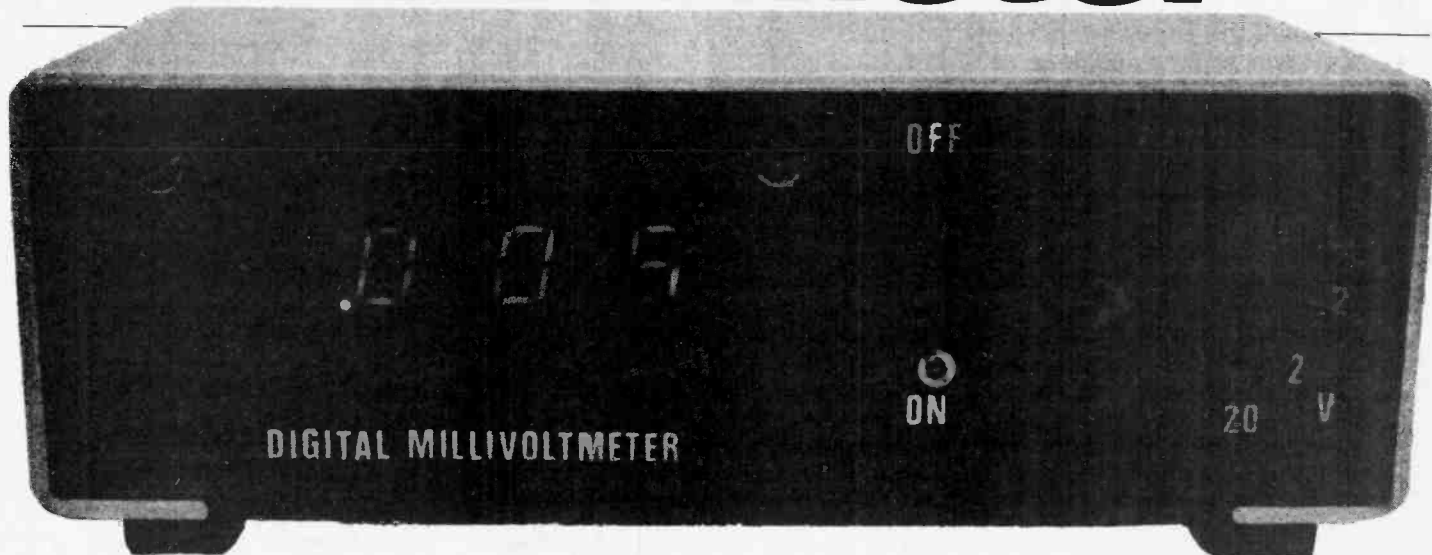

A high precision bench instrument based on a single VLSI chip.

THIS IS an item of precision test equipment which will be in constant use on the electronics work-bench, as well as being frequently called on for jobs around the home. It is battery-powered, to give it portability, and its compact layout makes it almost pocket-sized. In spite of the fact that it is built from only two ICs, its detailed specification (see box) includes most of the features found in an instrument costing appreciably more to buy ready-made.

Compared with its analogue counterpart, a digital voltmeter is an instrument of considerable complexity. To assemble an analogue voltmeter, you need only a milliammeter, a set of precision resistors and a rotary switch. An essential part of a digital voltmeter is the ingeniously designed circuit which converts the analogue voltage input into its digital equivalent. This, in itself, is a fairly complex operation if it is to be performed with precision (see *How It Works*). The final stage of conversion consists of the output from a series of decimal counters, one for each digit. The next step is to convert the counter output to a decimal number to be shown on a set of 7-segment displays. When the number of digits in the display is 3 or greater, it is more

economical to use a multiplexed display, where the digits are each illuminated, in turn, for a very short period. The rate of turning the digits on and off is so high that, to the eye, it appears that they are continuously lit. As each digit is illuminated, the output from the corresponding counter is decoded to produce the correct figure for that display. Only one decoder IC is needed to serve all the digits, instead of one for each digit. This saves expense on decoder ICs but the multiplexing circuit requires a pulse generator (or clock) to time its operations, plus the switches required to connect each counter, in turn, to the decoder.

To build such a circuit using MSI (Medium Scale Integration) ICs requires 2 dual counters, a decoder, a clock IC, another IC for the multiplexing counter and 2 or more for the multiplex switches, making a total of 7 ICs — as a modest estimate! The complexity of the wiring, and the difficulties of setting up and testing each stage, make the assembly of a circuit of this kind a daunting project for the inexperienced constructor. Fortunately, VLSI (Very Large Scale Integration) has made it possible to put all of the above (and more) on to a single slice of silicon!

Although it costs only as much as the total cost of the individual ICs listed above, the 7107 chip carries a complete digital millivoltmeter, including the analogue-to-digital con-

verter, the counter, and all the circuitry required to multiplex and drive the display. All the constructor needs to do is to provide the circuits which cater for the various ranges of input voltage, to add the few external components which the 7107 requires, and to assemble the display digits on a panel. This is still plenty enough to do, so VLSI does not rob the constructor of the interest and satisfaction of building a useful and attractive instrument.

DVM Specification

Four switched DC ranges with 0.05% counting precision on all ranges:

- 0 — 20.00 mV
- 0 — 200.0 mV
- 0 — 2.000 V
- 0 — 20.00 V

High-impedance input: Over $2 \times 10^{11} \Omega$ on 200 mV range, over 10M on 2 V and 20 V ranges, over 2M on 20 mV range.

Conversion rate: display refreshed 3 times per second.

Automatic polarity indication.
Over-range indication.
Auto-zero.

Battery-powered allowing measurement of differential voltage levels.

Digital Millivoltmeter

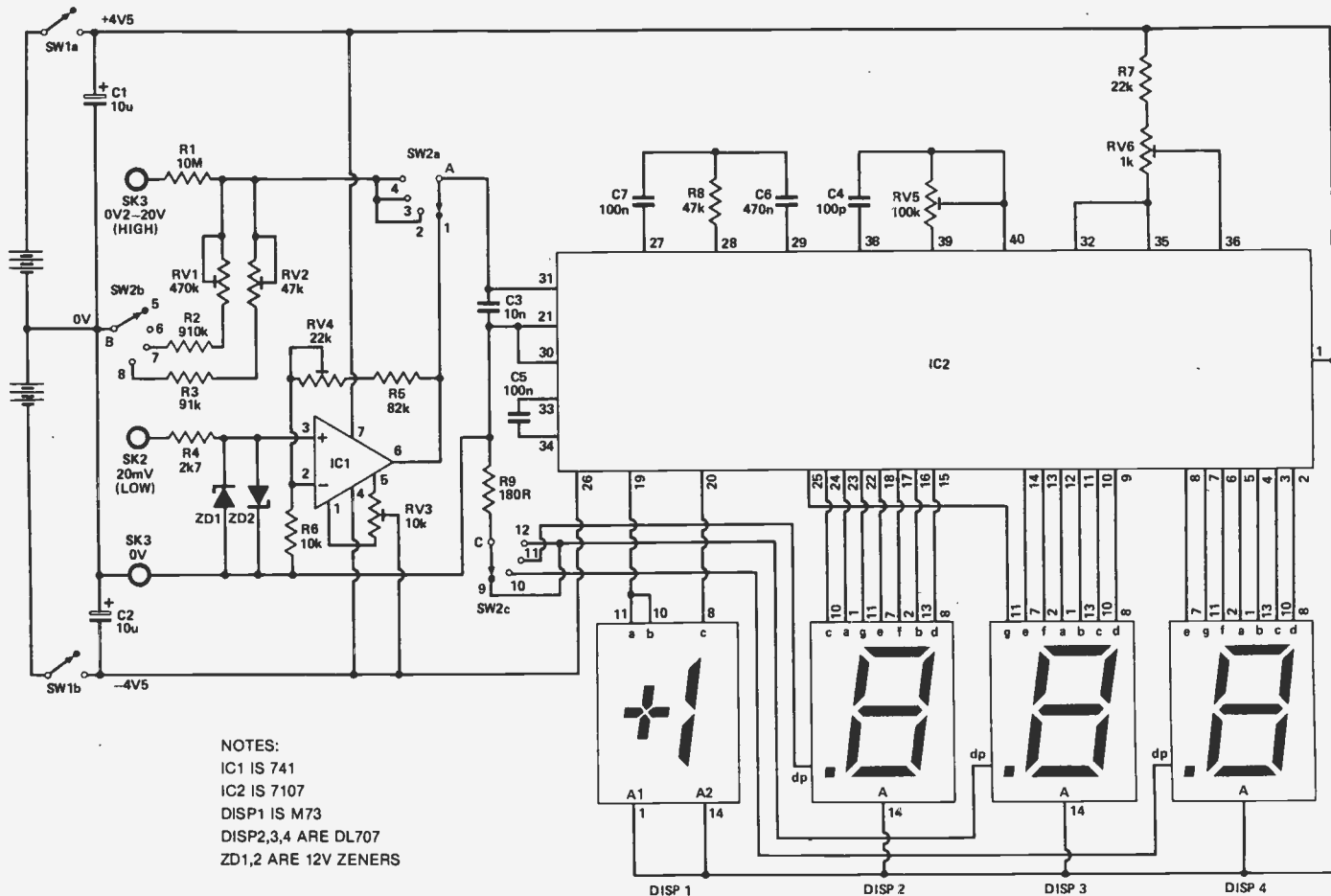

NOTES:
 IC1 IS 741
 IC2 IS 7107
 DISP1 IS M73
 DISP2,3,4 ARE DL707
 ZD1,2 ARE 12V ZENERS

Figure 1. Almost all the circuitry is within IC1.

HOW IT WORKS

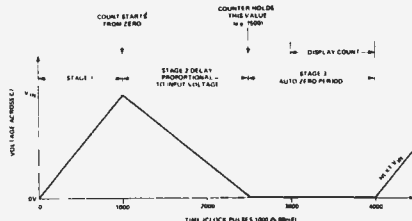

The DVM IC requires an input of 200 mV to give a full-scale reading of 2000 counts. The attenuator stages of the circuit produce an input to the IC of up to 200 mV for each of the input ranges except on the 20 mV range, where there is a x10 operational amplifier. On the 200 mV range, the input goes direct to the IC; on the 2 V and 20 V ranges, potential dividers reduce the input to 200 mV, maximum.

The IC converts an input voltage in the range 0 to 200 mV to a digital count in the range 0 to 2000 counts. The operating principle is known as the 'dual ramp technique'. The IC goes through three stages of operation automatically, three times a second; at the first stage, the input is connected to an integrator circuit, charging a capacitor for a fixed period of time, determined by the internal clock of the IC. The voltage to which this capacitor is charged depends on the input voltage and it is charged positively or negatively, depending on the polarity of the input.

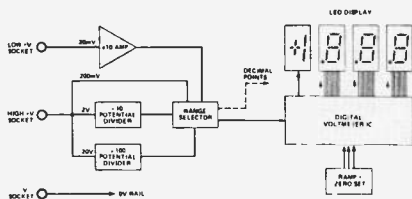

In the second stage of operation, the capacitor is discharged by connecting it to a reference voltage. There are two reference voltages; +REF, which is used when the polarity of the input is negative and -REF, which is used when the polarity is positive. While discharging is occurring, a counter operates at a fixed rate, determined by the internal clock. Discharge is terminated when the charge on the capacitor has reached zero, at which point (the beginning of the third stage of operation) the number of counts registered is a measure of the original input voltage. This count is then decoded and sent to the LED display.

In the third stage, the +ve and -ve input lines are connected together and a special auto-zero capacitor is charged with a small voltage, to compensate for differential voltages appearing at the amplifier outputs; any drift in the output is reflected as a change in the charge on this capacitor. At the next stage-one operation, this charge is used to correct the reading; should there be

no input voltage, the charge compensation gives an all-zero reading, but should there be an input voltage, a small value is added to or subtracted from the result, compensating for amplifier drift.

The dual ramp technique gives a precise result yet does not require many high-precision or high-stability components. For example, charging and discharging both involve the same capacitor (C7) and resistor (R8), so that their exact values do not matter and there are no problems if these should alter with temperature or with age. In addition, each stage begins and ends at the same voltage, thus cancelling out errors and the effects of drift in the comparator amplifier.

Nor must the frequency of the clock be exact or stable; if the clock is running slow, charging proceeds for longer, and a higher voltage is reached, but during the longer discharge stage, the counter counts more slowly because it is triggered by the same clock. The clocking error cancels out completely, leaving the final count entirely unaffected!

Precision circuits are required only in setting the voltage levels and holding the discharge current constant. Circuits of this kind are relatively easy to incorporate into an IC, making it possible to produce a precise instrument for relatively low cost.

PARTS LIST

RESISTORS (All 1/4 watt 5% metal film unless noted)

R1	10M (1%)
R2	910k
R3	91k
R4	2k7 (1%)
R5	82k
R6	10k (1%)
R7	22k
R8	47k
R9	180R

POTENTIOMETERS (All cermet min. horizontal presets)

RV1	470k
RV2	47k
RV3	10k
RV4	22k
RV5	100k
RV6	1k

CAPACITORS

C1,2	10u 6V radial electrolytic
C3	10n metallised polycarbonate
C4	100p siver mica
C5,7	100n metallised polycarbonate
C6	470n metallised polycarbonate

SEMICONDUCTORS

ZD1,2	12V zener diode
DISP1	M73 common anode \pm 1 LED display
DISP2,3,4	DL707 common anode seven segment display
IC1	741 op-amp
IC2	7107 digital panel meter IC

MISCELLANEOUS

SW1	DPDT miniature slide switch
SW2	3P4W rotary switch
SK1,2,3	4mm terminal post
20-way jumper or ribbon cable; 40 pin DIL socket; small knob, case 9V x 'AA' battery holder; 9V clip; nuts, bolts, wire, solder etc.	

Circuit Details

The input potential dividers consist of R1, together with RV1 and R2 (2 V range) or RV2 and R3 (20 V range). These are set to divide the input voltage by 10 and 100 respectively. The dividers are brought into action by grounding the lower resistor of each, using switch SW2b. The voltage from the potential dividers is selected and passed to the IC by SW2a. For the 200 mV range, neither potential divider is grounded, so only the 10M resistor (R1) comes between the input socket and the IC. It might be thought that such a high resistance would seriously reduce the voltage reaching the IC, however, the current needed by the +ve or -ve inputs for a full-scale reading is only 1 pA (a millionth of a millionth of an amp). With so little current, the maximum voltage drop across R1 is only 0.05 mV, which

can certainly be ignored.

The high resistance of R1 also serves to protect the IC from a high voltage, accidentally applied. If, by chance, the +ve socket is connected to 1000 V, say, the current flowing through R1 will be only 100 uA. Since the input can take up to this current without damage, R1 gives full voltage protection against \pm 1000 V on the three upper ranges. On the 2 V and 20 V ranges, R1 and one of the potential dividers are connected across the input lines. The input impedance on these ranges is therefore a little over 10M. On the 200 mV range, the input impedance is that of the input of IC2 itself, equivalent to 2×10^{11} ohms.

The operational amplifier (IC1) used on the 20 mV range is connected in a non-inverting configuration. There is a potential-divider (R5, RV4, R6) connected to the output (pin 6), so that one tenth of the output voltage is fed back to the inverting input. The offset null compensation is provided by setting RV3. Input protection is a little more elaborate on this range; R4 provides part of the protection, the remainder being provided by the zener diodes ZD1 and . The diodes are connected with opposite polarity, so that protection is independent of the polarity of the input. The input of IC2 can withstand up to 15 V but before this voltage is reached one of the

diodes begins to conduct. The resistor, R4, serves to reduce the current through the zeners when an excessively high voltage is applied. With 100 V on the input, the voltage drop across R4 is 88 V, giving a current of 33 mA, which is well within the rating of the zeners. In normal use, R4 presents only a small addition resistance, in series with the input impedance of IC1, so its effect on input voltage may be ignored.

DVM Circuits

The oscillator in IC2 uses the external components RV5 and C4. RV5 is adjusted to give a clock frequency of approximately 48 kHz, which is divided down by internal logic to give a display renewal rate of 3 times per second. RV6 and R7 set the reference voltages; to give 200 mV full-scale reading, RV6 is adjusted until the voltage at its wiper is 100 mV. C7 is the capacitor used in the integrator, while C6 stores the correcting charge required for the auto-zero function. R8 links the input buffer amplifier to the integrator, and is the resistor through which C6 and C7 are charged and discharged during ramp and auto-zero operations.

One of the advantages of the 7107 is that it drives the segments of

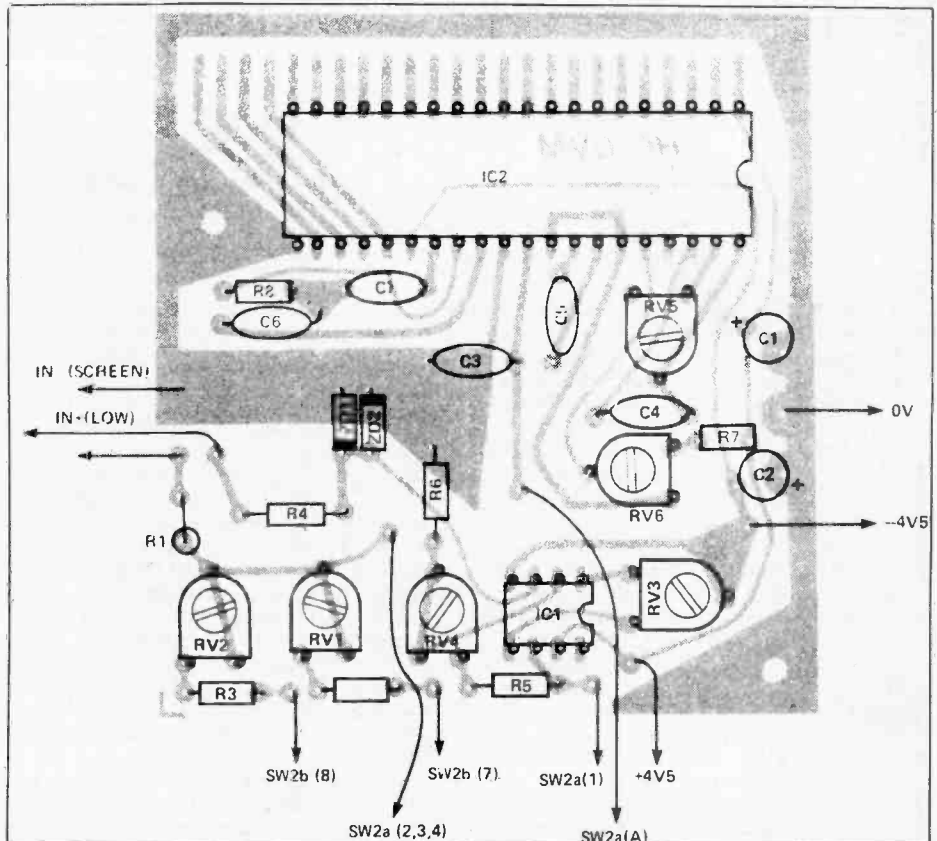

Figure 2. The component layout is straightforward, but care is needed when wiring the jumper leads to the display board (see Figure 4).

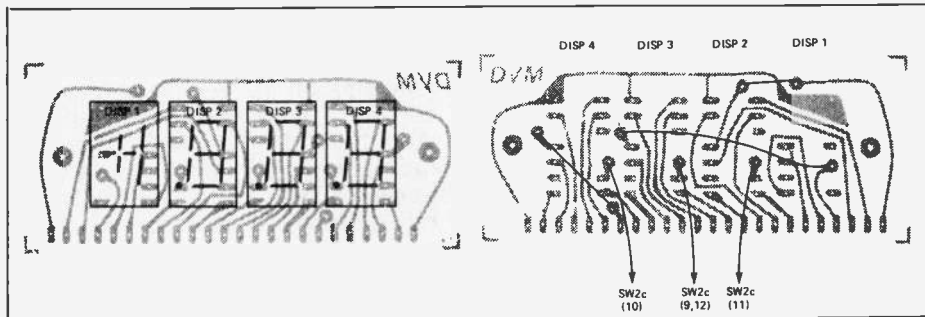

Figure 3. The display board; top, the view from the component side; bottom, the foil side, showing the wire links which must be soldered in place.

the displays directly eliminating the need for 23 current-limiting resistors. The displays are of the common anode type, the cathodes of the individual segments being wired to the corresponding pins of IC2. Each of these sinks the right amount of current, to illuminate the segment. The decimal points are switched by the range-change switch SW2c. A single current-limiting resistor (R9) is required in the return connection of the 0V line.

Construction

The LED board (Figure 3a,b) is simple to assemble. Insert the terminal pins before soldering the displays in position; they are placed with their heads flush with the display side, with the pins projecting out on the track side of the board. The displays are then pushed into position. Solder the pins of the displays and the terminal pins, then make the wire links as shown in

Figure 3b — except for the connections to the decimal-point pins, which are best left until later. Connections between the LED board and the main board are by 24 wires. The 20-way jumper cables suggested for this purpose make it very easy to insert the ends of the wires in the row of holes and solder them in position. The standard 20-way jumper cable is only 85 mm long so the relative positions of the boards, as shown in the internal photograph, Figure 4, must be closely adhered to. If you wish to mount the boards further apart, use 20-way ribbon cable instead, or even 24 separate wires, though either will take a lot longer to solder, with increased possibility of short-circuits between adjacent wires. Now solder the jumper cables to the LED board; use one complete 20-way cable and split a 5-way or 20-way cable to make the 4-way cable needed for the remaining 4 connections.

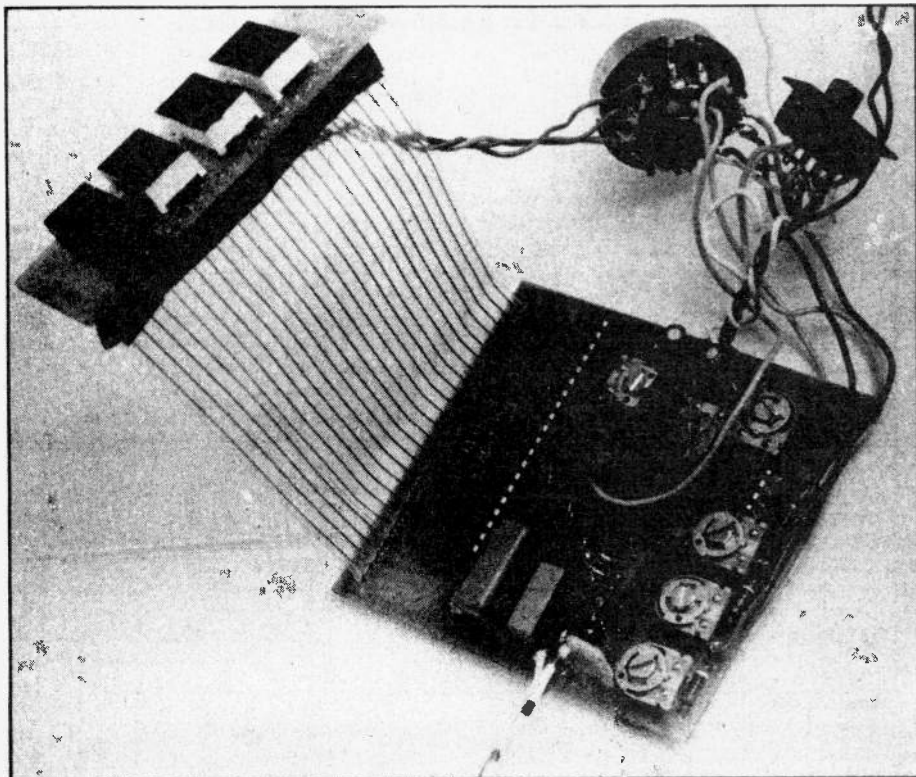

Figure 4. An 'exploded' view of the Millivoltmeter, before final assembly.

To test the board, connect the +4V5 line to a 4V5 or 6 V battery, through a 180R resistor. Then touch a wire, connected to the 0 V terminal of the battery, to each of the other wires of the cable, in turn. Check that each segment lights correctly and, if it does not, inspect the soldering and tracks. In the +1 digit, both segments 'a' and 'b' of the '1' light together. Only segment c of the '+' sign is used, giving '-' sign to indicate reversed polarity. When polarity is normal, the '+' sign is not lit.

It is highly advisable to use a socket for IC2, but it is not worth while for IC1. Mount the socket and other components, but do not insert IC2 until the whole board has been assembled and tested as far as possible. Solder leads to the power supply pins, the input terminal pins and the leads to the rotary switch, SW2 (Figure 5), taking care that these are long enough to run from the board to the intended position of SW2, but not so long that they will take up an undue amount of room in the enclosure. Finally, solder the jumper cable to the board.

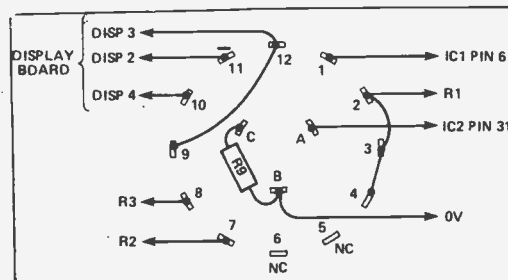

Figure 5. Wiring diagram for the range switch (SW2).

Testing The Main Board

To test the input circuits, temporarily connect the power supply and connect a 6 V battery to the +ve and -ve input pins. With SW2 switched to the appropriate range and using a borrowed meter, measure the voltage at its wiper. All voltages are measured with respect to the 0 V line, which is common with the -ve input terminal. Unless your test instrument has very high input impedance, the voltage you find at SW2 will be very much lower than expected. For example, if your test meter has 2MΩ input impedance then, since it is in series with R1, five-sixths of the voltage is dropped across R1 and the voltage at SW2a will be only one sixth of the expected value. At this stage, though, the point is simply to check that some sort of signal gets through, showing that none of the soldered joints are 'dry' and that no tracks are

incomplete. This is also a check against unintended high voltages (from the power supply) appearing, due to short-circuits between tracks.

To adjust the offset null of IC1, first connect the 20 mV input pin to the -ve input pin. Adjust RV3 until the output of IC1 (read at pin 6 or at the wiper of SW2a) is 0 V. Next, make up a low-voltage source (Figure 6a) for testing the 20 mV input circuit. Connect this to the 20 mV and -ve input pins and adjust RV4 until the reading on the test meter is approximately 150 mV, indicating an input voltage of 15 mV. Exact setting can be left until later, but it is worth while getting it approximately correct at this stage. Now position the wipers of RV5 and RV6 to the middle of their tracks.

After a thorough check to see that all components directly connected to IC2 have been correctly mounted and properly soldered, and that there are no broken tracks or short-circuits, plug IC2 into its socket. This is a CMOS IC and the usual precautions, to avoid static charges, must be taken when handling it.

Power Supplies

The specified supply is a battery-pack consisting of six AA cells, wired to produce $\pm 4V5$. The 7107 is actually designed to operate at $\pm 5V$ so, if you are a TTL enthusiast or frequent builder of microprocessing systems and already have a bench power supply delivering 5 V DC, it is quite in order to use this instead. You will need a -5 V supply too, a point which is discussed later.

The maximum supply rating for the IC is +6 V and -9 V, so it is also feasible to use an 8-cell split supply, giving $\pm 6V$. The main effect of this is to brighten the display, which could be a useful feature under bright ambient light. You will need a larger case to accommodate the extra cells though, so while you are about it, you might as well adopt 'C' size or 'D' size cells, for longer life.

The negative supply does not need to have exactly the same voltage as the positive supply. The current required on the negative side is much smaller too, since it is from the positive side, only, that the current for the display is drawn. This makes it possible to adopt a different method of providing the negative supply, in which the positive supply comes from a battery (or a line power-pack), but the negative supply is generated by diode level shifting. This, in fact, was the method used for

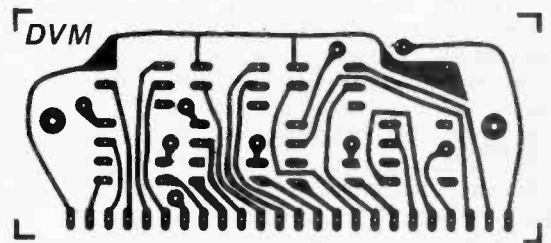
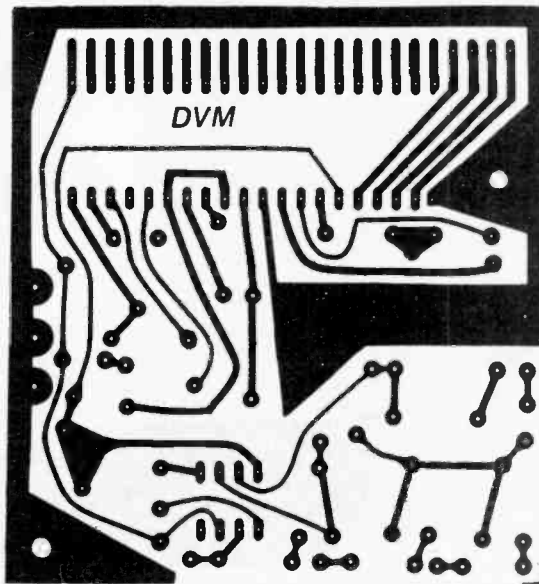

The two foilside PCB patterns for the Digital Millivoltmeter. Both boards must be cut exactly to fit the case.

the prototype of the DVM, in which three 'C' cells and an inverter gave entirely satisfactory results.

Calibration

The following instructions are for a preliminary calibration, which serves also to check the operation of the circuits and the IC; it is best carried out before mounting the boards in the case. If the circuit fails to respond correctly, switch off the power and check it. This procedure should also be repeated for the final calibration, after the board has been mounted in the enclosure.

On applying power, the display should light and, after flashing one or two random figures, should settle down and display figures close to '000' and '-000'. For accurate calibration it is best to use a precision voltage reference, with a potential divider (Figure 7). This IC is relatively expensive and most readers will probably be content with the less accurate alternative, a single dry cell (Figure 6b).

Connect the 0 V rail of the reference source to the -ve input, turn SW2 to the 200 mV range and connect the +ve input to the 136.4 mV point. As the reading settles, the display should change about 3 times a second; adjust RV5 so that this rate

is obtained, approximately. Alternatively, monitor pin 40 with an oscilloscope and adjust RV5 to obtain a frequency of 48 kHz. You may see the display flash (the last 3 digits extinguished and the '1' flashing); this is the over-range indication — but don't worry about it at this stage.

Adjust RV6 until the display reads '1364', (no decimal points, yet), occasionally showing close values between about '1360' and '1370'. Now

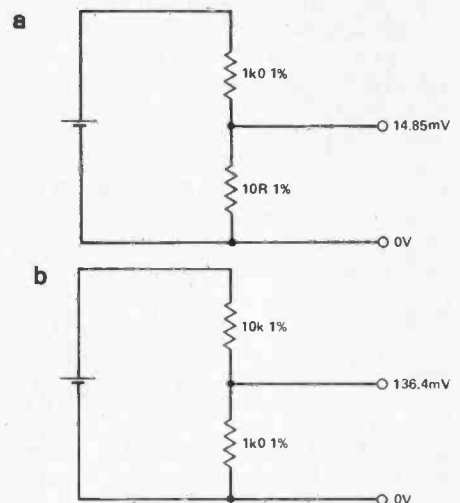
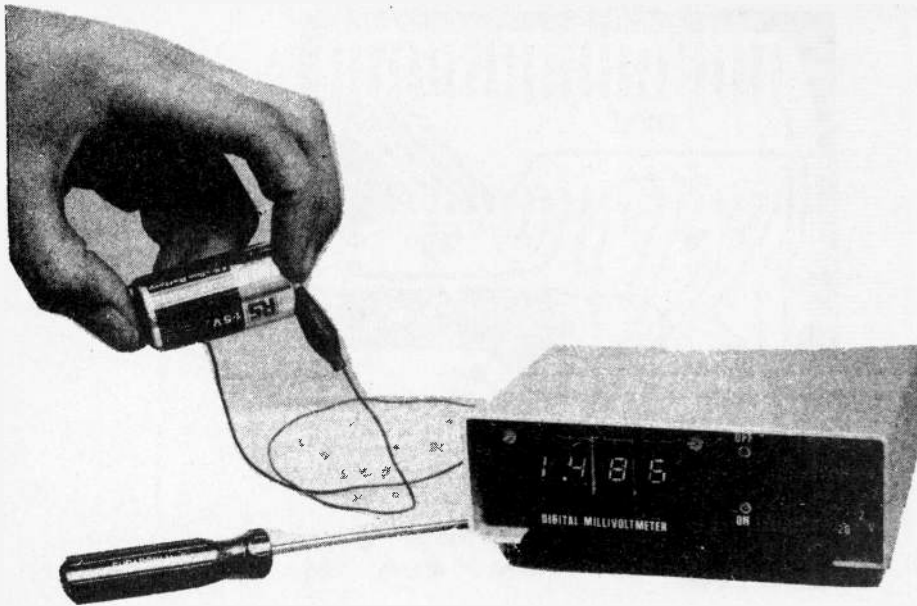

Figure 6. (a) a low voltage source for testing the 20mV input; (b) a battery-based voltage reference.



worth running through the calibration procedure once again to check that nothing has been altered during assembly. At this stage, the display is still suspended on the end of the jumper cable allowing access to the presets. Before closing up, run a strip of insulating tape across both sides of both ends of the jumper to guard against short circuits.

When all is working correctly, gently bend the jumper so that the display board comes to its correct location. Fix it to the front panel by its bolts — you may need to use insulating washers to avoid short-circuiting the tracks. Check that nothing is protruding from the top or sides of the case, then slide the cover into position. The digital millivoltmeter is now complete and ready for action!

change the range switch to 2 V and use the 1V5 cell direct. Adjust RV1 until the reading '1500' is obtained, then change to the 20 V range and adjust RV2 until a reading of '0150' is obtained. Change to the 20 mV range and connect the 14.85 mV source to the + 20 mV input; adjust RV4 to obtain a reading of '1485'.

It must be stressed that although this is a high-precision instrument, giving a reading to 1 in 2000 counts (0.05% of full scale), its accuracy depends on the care with which it is calibrated and the accuracy of the sources used. If you have access to a meter of similar high precision and input impedance, it is worth while checking your instrument against this. If you are unable to do this, do not rely on the fourth figure of your reading as an absolute indicator of voltage. Even the third figure is suspect when 2% resistors are used in the calibration procedure. However, if you measure two voltages and merely want to know by how much they differ, subtraction of one reading from another, made on the same range, removes many of the inaccuracies of calibration and you can be reasonably confident of the result to the nearest millivolt.

Final Assembly

The first step is to cut and drill the front and rear panels, and to add the legends. Also, cut a notch in the cover of the case, to allow for one of the bolts holding the main board. There is not much room to spare inside the case but, provided that you tackle assembly in the right order, everything will slip smoothly into

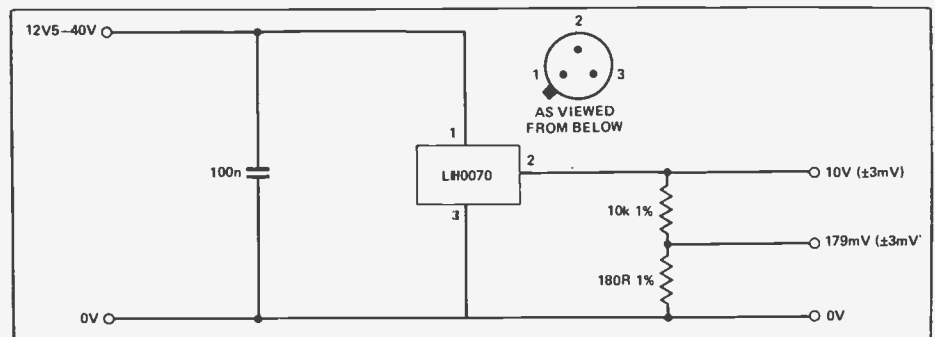

Figure 7. A precision voltage reference is preferable.

ETI

position. First, mount the main board on its two bolts; take care that the tracks do not contact any metal parts of the case beneath the board. The case has bosses, to which the cover of the case is bolted; one of these projects upward, beneath the board, and may make contact. To guard against this, stick a square of insulating tape on the track side of the board in this region. Next, mount the rotary switch, which is already wired to the board.

The input sockets project from the back panel and come close to IC2. You may find it more convenient to remove the back panel from the case before fitting the sockets to it. Note the V-shaped notches cut in the mounting holes. These align the sockets so that wires may be inserted in a vertical direction. When the sockets are in place, connect them to the main board, remembering that the jumper cable lies across the top of the board, eventually, so make these connections long enough to go around the cable.

Next wire up the power supply and connect it to the board. At this stage, the circuit is complete and it is

Do You Think You Have Arthritis?

If you think you do, you're in good company. More than three million other Canadians have it too. For the facts about arthritis, arthritis research and treatment programs, contact the office of The Arthritis Society nearest you. It's listed in your phone book.



THE ARTHRITIS SOCIETY

New from NRI!

The first at-home training in videocassette recorder repair with exclusive videotaped lessons.

Learn Video/Audio Servicing... includes RCA state-of-the-art VCR, NRI Action Video lessons, plus full training in color TV and audio repair.

Now, you can learn the hottest, most wanted skill in home entertainment electronics... servicing and repairing videocassette recorders and video disc players. Well over 2 million units have already been sold and the demand is just starting! Already, qualified VCR technicians are in short supply... people are waiting up to a month for VCR repair. Good jobs at good pay are going begging. And NRI can get you in on the action with convenient and effective at-home training.

Choice of Specialized Training

NRI offers you three Master Courses in Video/Audio Servicing, each complete, each with equipment and training for the specialty you want. Each course thoroughly prepares you for color TV plus audio and video equipment. Then, you take the specialized hands-on training on the equipment you select.



Learn as you work with equipment you keep.

You can get specialized audio experience as you build your own AM/FM stereo system complete with speakers. Or gain real bench experience with hands-on TV training as you build a 25" (diagonal) fully-computerized, programmable color TV and professional test instruments. Or train with your own RCA videocassette recorder and NRI's exclusive Action Video servicing lessons on videotape.

State-of-the-Art VCR

This modern VCR features high-technology design with electronic pushbutton tuning, remote control, three recording speeds with up to 6-hour capacity, high-speed visual search, built-in clock/timer, memory rewind and audio dubbing capability. Direct drive motors and azimuth recording give outstanding picture reproduction.

It's yours to keep, as part of your training. You'll not only use it to learn operation and servicing techniques, but to play the absorbing NRI Action Video lessons that come as part of your specialized training. In word and picture, you'll learn theory, construction, and service procedures, see them explained in graphic closeups. And you get this unique training only with NRI!

Learn at Home at Your Convenience

No need to quit your job or tie up your evenings at night school. No time away from your family or expensive travel. NRI comes to you. You are a class of one, getting both theory and practical hands-on training backed up by our staff of experienced educators.

NRI the Pros' Choice

More than 65 years and a million and a half students later, NRI is still the first choice in home-study schools. A national survey of successful TV repairmen



shows that more than half have had home-study training, and among them, it's NRI 3 to 1 over any other school.

That's because you can't beat the training and you can't beat the value. Only NRI combines exclusive fast-track training techniques with modern state-of-the-art equipment to give you the skills you need for success quickly and easily. Only NRI offers such complete training with so many timely options for specialized bench experience. Send for our free catalog and get all the facts on these exciting Master Courses in Video/Audio servicing.

Rush Card for Free Catalog

Mail the postage-paid card today for your free copy of our 100-page look into tomorrow. It shows all the equipment you get, describes each lesson in detail. And it tells you about other important career opportunities in Microcomputers and Microprocessors, Digital and Communications Electronics, Electronic Design Technology, and more. Send today and get started on a big new future for yourself. If card has been removed, please write to us.



NRI SCHOOLS

McGraw-Hill Continuing
Education Center
330 Progress Avenue
Scarborough, Ontario M1P 2Z5
or telephone 416-293-1911

We'll give you tomorrow.

Atari Review

Ataris are usually regarded as game playing computers but their 800 looks more like a personal computer. How good is it? Steve Rimmer investigates.

NOTHING MUCH TO DO tonight . . . let's go kill some aliens. Yes, yes, I know, the man at the store said computers were supposed to be educational but who really cares about getting smarter. The skies over Earth need defending!

The Atari 800 is the first system we've looked at that is primarily an arcade computer. It is an outgrowth of Atari's dedicated home video game computers. However, it does have a keyboard and can do some limited computing things if you have a mind to. Should you be into both playing games and fooling with BASIC it might be the ideal system.

The Atari is similar to the VIC in many ways. Differences include a larger screen, fewer separate parts and almost no firmware on board. However, the firmware *off* board is quite something.

Plug In The Paddles

The most obvious application of this system is in playing games and using other pre-packaged software. Unlike in the case of most of the other home systems, almost all of this is supplied in firmware, on ROM packs. Albeit there are some ROM packs available for other systems, such as the VIC, but a big part of the trip for the Atari is the incredible variety of these things immediately extant. Not only are there games by the handful (huge hairy three fingered hands from across the limitless void) but you can get things like a music composer, bio-rhythm calculator and a semi-smart terminals package all on these little boxes. A bit hard doing patches, to be sure, but these may be the ultimate in convenient booting.

Plug it in, turn it on and let it rip.

The Atari 800 consists of a plastic case with a keyboard in the expected position and a wire snaking out the back to attach to a TV set. The wire is extremely long, presumably so that the thing can be used with a floor type TV while the user sits at a comfortable distance away. The top of the computer hinges open to reveal two gaping openings which will accept



the aforementioned ROM packs. There is an interlock switch which disempowers the system whenever this trap door is sprung for pack changing, thus preventing all the grisley things that are supposed to happen if you change chips with the juice on.

The system is powered by a huge potted power pack halfway in the middle of a line cord. Actually, everything to do with the Atari system gets its own one of these things, and they soon look like they've been getting friendly during the night and reproducing. When you buy your system don't forget the cube tapes.

This may be the quickest system to set up. Having prised it away from its mammoth titanium and concrete packaging, one needs only hook the switch box to the set, plug in the power pack and the paddle, stick in a ROM pack and there it is, Asteroids in all its glory. After this you can read the instruction manual and see what you were supposed to have done.

Despite its fairly low level of admittance . . . you've gotta be pretty vacant to be confused by this one . . . there is a surprising level of sophisticated hardware available for the 800, including a disk drive, a modem and a printer. Atari maintains dial up BBS's in some major cities, and there's a user's newsletter available. There are also little add-on bits such as game controllers of several types and a numeric pad for entering data. All the stuff that George Plimpton sneers at on the tube can be had for this system.

I want to see a game where you get to shoot at George Plimpton.

We got three games with our review system, to wit, Asteroids and Space Invaders, which are pack based, and Caverns of Mars, which came on a disk. We didn't get Pac-Man due to the epistemological and social contexts involved and also because I hate it.

Power corrupts, I know.

The first thing you realize, upon powering up an Atari game is that phrases like "home version of the arcade game" are quite meaningful. The horizontal resolution of the Atari is only half that of most arcade games, and it shows in the detail available to the system's graphics. This is not cheapness on the manufacturer's part, however; you can't get much more into the bandwidth of a broadcast TV. Colour monitors, on the other hand, are very, very expensive. It is a drag, though, that there is no apparent way to get a raw video out of the Atari for use with a monitor for situations where one is to be had.

The detail on games may not be quite so good as that of an arcade, but the colour is first rate and the action is pretty swift. The space invaders graphics were a bit sinister looking . . . I like it when the martians laugh and jump up and down when they take over Earth, which these don't do . . . and the sound effects were really heavy. However, the software itself was easily among the best. It requires a paddle to operate, as do pretty well all of the games . . .

it might have been better to have had the option of using buttons on the keyboard for those users who aren't going to be able to afford the paddles 'til next payday.

The paddles themselves are quite rugged . . . they have to be; you beat the stuffing out of them swarming around the far beyond . . . although they are not joysticks, but, rather, quadrant switching deals which aren't quite so nice feeling. However, they do sort of impart that space pilot feeling if you turn off the lights and crank the volume up.

Asteroids, the other pack based game, was probably the better of the two. It isn't particularly fast, but there seems to be a lot of thinking going on regarding the trajectory of the Asteroids, which behave much more like rocks in space than shapes on a screen. The graphics for the ship are a bit awful, actually, but this is a limitation imposed by the resolution of the CRT. It takes a while to get used to the paddle, as its switches control the rotation and engines of the ship, depending upon which way you push the stick.

There is, of course, a limit to what can be put on a ROM pack, and the disk based games are several orders of magnitude better. *Caverns of Mars* is extremely well thought out . . . you descend into the caverns shooting up things sitting on ledges and, later on, flying ships of various types . . . all hostile, of course . . . everything's hostile with video games. The paddle acts a bit oddly, but you get used to it in time. The graphics, however, are superb, and, if you are a total games freak it might well be worth while going for a disk for the added capability it gives you.

This, of course, is easy for me to say when it isn't my pay check I'm cheerfully squandering.

Rolling Your Own

If the video games on the Atari are unimpeachable, some of its other functions can be quite easily peached, or whatever. Applied, maybe. If you buy the BASIC cartridge, just another ROM pack that plugs in, you will have a real live computer that you can program . . . just like the big ones? Well . . .

The Atari BASIC cartridge is not exactly a full rich language. Whereas it will provide a decent introduction to programming, it's a bit like an original ROM Pet . . . you can get into it, but you can't take it very far before running out of its capability. Unlike an old PET it is not remarkably user friendly or scathingly fast.

On the other hand, the BASIC does have some first rate bells and whistles. Included are sound and high resolution graphics commands, and these work rather well. The sound has a feature not found in most audio commands. It lets you control the waveshape of the tones it produces from sinusoidal to square, giving the programmer some hand in what the noises will sound like. There are four voices available.

The BASIC also supports PEEK and POKE, and lets you jump to machine language routines, so if you really want to get heavily into stretching the system you can.

As in the case of the video games, the BASIC is limited by what you can put on one of these little ROM packs, and, in fact, there isn't a great deal that will fit on a couple of chips. In opening up the BASIC pack we found two twenty four pin chips (and a small green diode) which suggests that the BASIC lives in 8K or less.

Atari also sells something called "Invitation to Programming". This is a sort of introduction to BASIC, concentrating heavy on the fancy bits of the system like the sound and graphics. Far from being frivolous, this is actually a fairly good way of getting into computers, and is certainly ideal for those individuals who are still almost certain they'd just as soon stay in the caverns of Mars.

As in the case of the games, there is a better BASIC, Microsoft's, actually, available for the Atari. It comes on a disk, which, of course, requires that one have a drive available. While we did not have a serious look at it, it appears to be as powerful as many contemporary Microsoft BASIC

disassembler, such as those found in the machine code monitor in the Apple II. The disk version, however, is a moderately sophisticated compiling assembler with supported labels, conditional assembly and all the good bits. This is extremely impressive, actually, for a game machine, although one might come to wonder how many of them Atari is likely to actually sell.

You can also get PILOT for the Atari, a LOGO-like kid's language with turtle graphics and actually a fairly high degree of sophistication in terms of its I/O capabilities. It can drive either a cassette recorder or a disk drive and the Atari printer. Probably not the thing to write the next version of TRON in, but a good introductory trip for the ankle biters.

Where's the FORTRAN compiler?

Other Software

As mentioned earlier, there is quite a lot of very clever software available for the Atari, and this is certainly a major attraction to the system. You can have a lot of fun with it even if you give the BASIC pack to the cat and never write a single line of programming.

One of the most impressive aspects of the 800 is something called "Telelink II", a communications package. It includes a sort of smart terminal on a ROM pack and an hour of connect time on the Source, CompuServe and Dow Jones. To use it you have to buy an amazingly large box which interfaces the computer to the outside world plus a modem. Atari offers an acoustic coupled modem . . . which actually appears to be a Novation in sheep's clothing.



packages, with lots of fancy bits.

In addition to the BASICs available for the 800, there are, rather surprisingly, two machine code development packages, one in a ROM pack and one on disk. The ROM pack one is more of a sophisticated monitor with an assembler and

Being ROM pack based, the terminal is immediately available as soon as the lid of the machine is closed. It sets the protocol for you, and, in fact, is about as turnkey as something like this can hope to be. The terminal has a number of selectable options, such as a buffer to

Continued on page 41

Tek's most successful scope series ever: At \$1815-\$2175, it's easy to see why!

Wide-range vertical sensitivity:
Scale factors from 100 V/div (10X probe) to 2 mV/div (1X probe). Accurate to $\pm 3\%$. Ac or dc coupling.

Two high-sensitivity channels: dc to 60 MHz bandwidth from 10 V/div to 20 mV/div; extended sensitivity of 2 mV/div at $\gt 50$ MHz.

Sweep speeds:
from 0.5 s to 50 ns. To 5 ns/div with X10 magnification.

Delayed sweep measurements:
Accurate to $\pm 3\%$ with single time-base 2213; to $\pm 1.5\%$ with dual time-base 2215.

Complete trigger system. Includes TV field, normal, vertical mode, and automatic; internal, external and line sources; variable holdoff.

Probes included. High-performance, positive attachment 10-14 pF and 60 MHz at the probe tip.

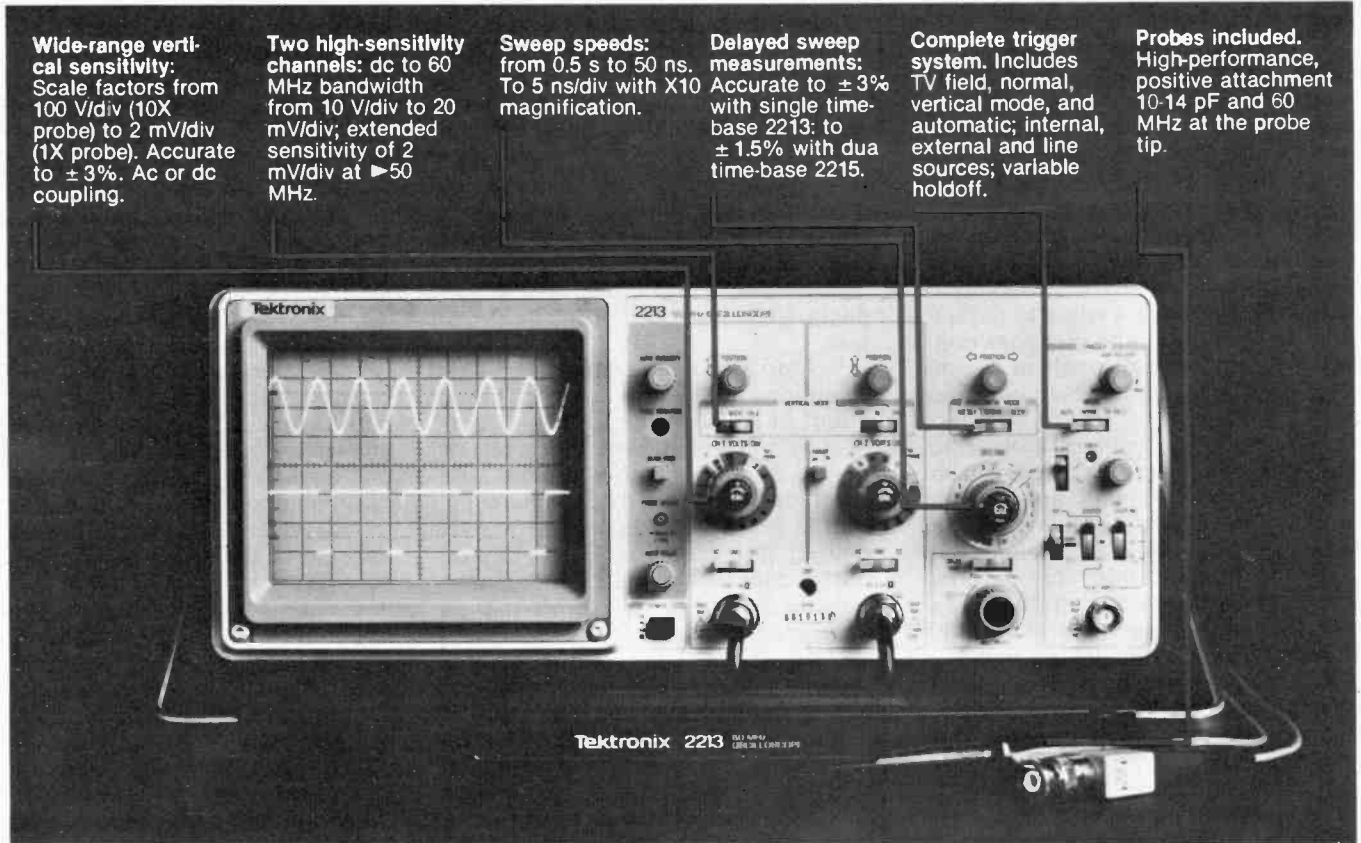

In 30 years of Tektronix oscilloscope leadership, no other scopes have recorded the immediate popular appeal of the Tek 2200 Series. The Tek 2213 and 2215 are unapproached for the performance and reliability they offer at a surprisingly affordable price.

There's no compromise with Tektronix quality: The low cost is the result of a new design concept that cut mechanical parts by 65%. Cut cabling by 90%. Virtually eliminated board electrical connectors. And obviated the usual cooling fan.

Yet performance is written all over the front panels. There's the bandwidth for digital and analog circuits. The sensitivity for low signal measurements. The sweep speeds for fast logic families. And delayed sweep for fast, accurate timing measurements.

The cost: \$1815 for the 2213. \$2175 for the dual time base 2215. Mail order direct from our national 2200 distribution centre and take advantage of a special Christmas discount for readers of Electronics Today International. See opposite page for details.

For further information contact your nearest Tektronix field office or write:

Tektronix Canada Inc.
P.O. Box 6500
Barrie, Ontario L4M 4V3

Toronto (416) 675-3865
Montreal (514) 697-5340
Ottawa (613) 225-2850
Vancouver (604) 438-4321
Calgary (403) 230-1836
Edmonton (403) 434-9466
Winnipeg (204) 632-4447
Dartmouth (902) 469-9476

Circle No. 9 on Reader Service Card.

Tektronix
COMMITTED TO EXCELLENCE

Atari Review

Continued from page 39

store text in and a line wrap feature which can do automatic line ending with incoming text. This is a bit disconcerting to watch at first, but you do get used to it.

Unfortunately, the terminal does seem to lack the facility of storing its buffer on tape or disk, which is a decided limitation. It will, however, echo to the printer.

What I think I find disturbing about small computers is when they try to be big computers. Atari's TV ads suggest that when you are finished playing with your Atari you can work with it. This is true, to an extent. If your job is reviewing video games, it's an ideal tool. However, this not being the case you may find yourself attracted to some of the "large system" style software offered for the system, such as the financial packages or the word processor. Don't be.

The Atari word processor, which is the higher level package we got, was, in fact, not a bad little system. It does most of the things a fairly simple package should do, automatic line ending, insertion and deletion and various forms of nifty text manipulation. It has block moving that works quite quickly, and several gimmicks, like single character case toggling and the like. However, it can

only deal with documents as single buffer segments. That is, you type your brains out until the buffer is full and then send it to the disk. The alternative, which is found in more sophisticated systems is for the software to treat the disk as its buffer, inhaling bits of it depending upon the cursor movement on the screen. It is doubtful whether you could actually do something like this with Atari's DOS.

The thing is, for all of these sophisticated software packages, is that it's extremely hard to use them with a TV set. The contrast level is low, there aren't that many lines on the screen and the resolution can be pretty fuzzy unless the convergence on your set has been done recently. As such, doing something like word processing will gradually remove your eyeballs, requiring, as it does, intensive staring at the screen. The 800's keyboard is also no great shakes for something like this.

These heavy software things probably aren't a bad trip if you want to fool around with serious computer applications. They can also be looked on as a good introduction to these areas. However, I wouldn't count on writing your novel or running your business with an Atari.

In addition to the software we

played with intensively, there is quite a lot of stuff in the current catalog which we just peered at and wondered how it worked. It varied from the very clever to the fairly mindless. Everything associated with TV sets seems to go this way. Examples are:

—SCRAM A very simplified model of a nuclear power plant lets you learn how to run one better than the government currently does. Adjust the parameters and try to avoid meltdown. If I have any kids I don't know about I don't think I want them playing with this one.

—MUSIC COMPOSER The phrase "close enough for rock and roll" comes quickly to mind in using this package. There are about six tones that aren't either sharp or flat. However, it has good graphics, displaying the notes "composed" on a staff, and is probably a good introduction to sight reading.

—CONVERSATIONAL FRENCH (Or German, Spanish or Italian). This package points out that you can synthesize voice on the Atari, which it does in the languages mentioned. This is probably a good thing for kids, as it's colourful and weird.

—STOCK CHARTING This is one of those sophisticated programs for the grownups to play with after the kids

Continued on page 82

Tektronix
COMMITTED TO EXCELLENCE

Humbug

Save \$100* on the 2215, off the regular price of \$2175.
Save \$75† on the 2213, off the regular price of \$1815.
Simply mail back the completed order form along with a cheque or money order. (Please allow 4 to 6 weeks for delivery.)

Offer good till January 31, 1983.

Limit of one unit per order form.

15 day return privilege!

If you are not satisfied with the product, return it within 15 days and we will give you a full refund.

Both Models in Stock (Barrie).

Name

Company
(if applicable)

Ship To Address

P.O. or Ref. No.
(if applicable)

Postal Code

Phone

Enclosed is my cheque or money order for:

* \$2075, plus PST for one only, model 2215

† \$1740, plus PST for one only, model 2213

*Dear Santa,
I'm sorry to have to tell
you this, but you blew it
again this year.
I'll no more Mr. Nice Guy!
This treat is on me...
Tektronix, send me a brand
new 2200 series portable
60 MHz oscilloscope.*

Signature

Mail To: Tektronix Canada Inc., P.O. Box 6500
Barrie, Ontario L4M 4V3
Phone: 705-737-2700

THE GOLDEN II MICROCOMPUTER SYSTEM IS HERE!

PRICE
\$999.00
(Canadian)



You don't have to send money to far away places to get it!

Software and Hardware compatible with that well known micro that has the name of a fruit (in case you miss that, here is another hint: its name starts with the first letter of the alphabet).
(48K RAM, Color Graphics, and Sound)

If you want to order, please fill out this form and send a certified cheque or money order payable to OMNI MICRO INC. to the address shown.

Omni Micro Inc. P.O. Box 451, Station B, Montreal, P.Q.
Canada H3B 3J7 Tel. (514) 676-2088



Quantity is limited, so hurry!		Price	Qty	Amount	Price	Qty	Amount
Name: _____							
Street Address: _____		GOLDEN — II		\$999.00	MX80-III		\$700.00
City: _____ Prov: _____		12" Green		\$230.00	MX80-III		\$850.00
Postal Code: _____ Tel.: _____		Monitor			F/T		
Residents of Quebec Province please add		MITAC Disk		\$385.00	MX100-III		\$1050.00
9% sales tax.		Drv w/o Controlr					
90 day Warranty		Prices FOB Montreal			TOTAL		

Radio Astronomy

Part 2

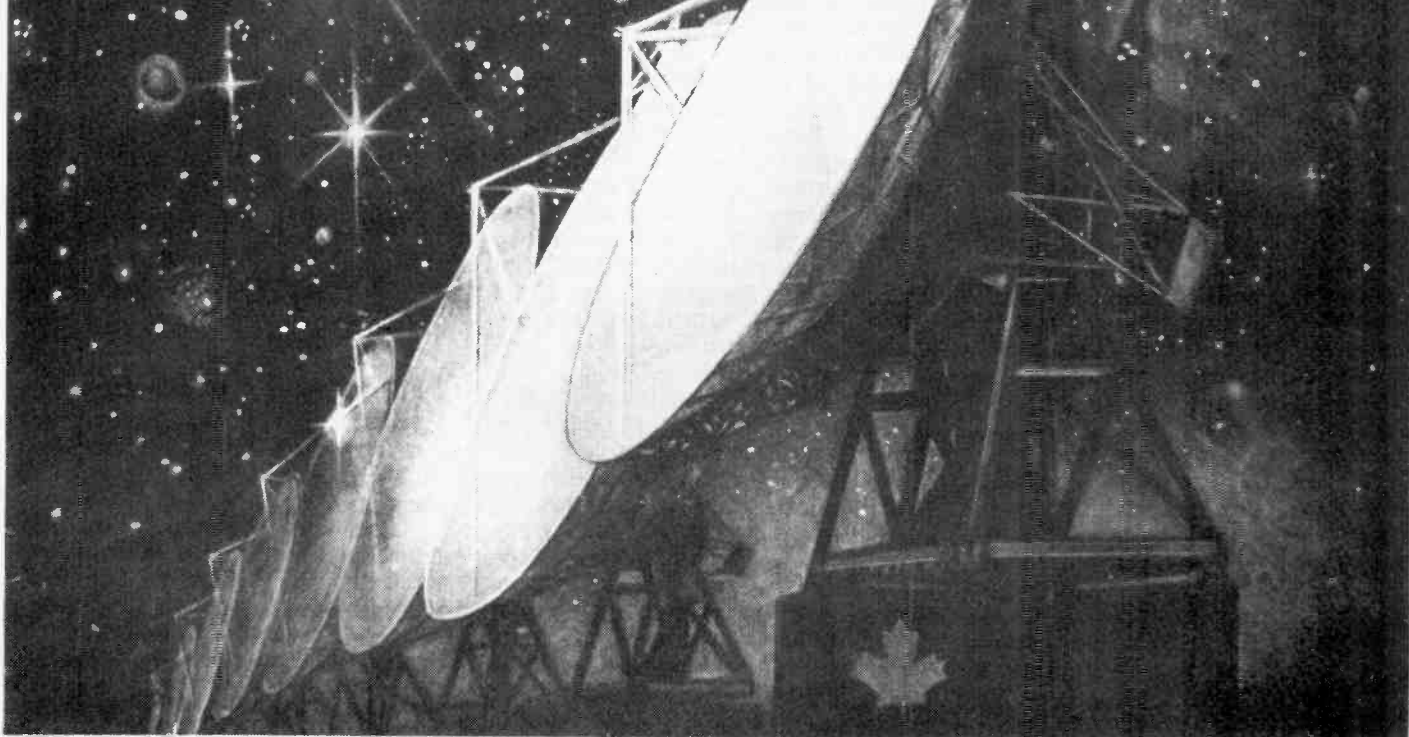

In this second part, Roger Allan looks at the resolution available with modern radio telescopes, what has been discovered and Canada's contribution.

Resolution

IN ORDER TO achieve a resolution substantially better than one arc-second, it is necessary to have telescopes hundreds or thousands of kilometers apart. Such instruments cannot simply be connected by cables. This is a major problem, or at least was a major problem, because the signals from the two telescopes comprising an interferometer must be synchronized to within a fraction of a microsecond before being added together. The advent of accurate atomic clocks in the late 1960's made it unnecessary to link the two telescopes physically. The signals could be separately recorded with microsecond accuracy at the two sites on the same kind of magnetic tape used for recording television images. The tapes are then shipped to a central correlator where they are synchronized and the signals combined. However, phase variations due to the atmosphere and the ionosphere are not easily eliminated by calibration,

even when the telescopes are only a short distance apart, much less thousands of kilometers. Further, random jumps and drifts in the atomic clocks and by ignorance of the precise distance between the focii of the two telescopes cause the fringes to jitter back and forth in position 'corrupting' the phase measurements.

The difficulty in overcoming the phase variations came in 1953 when a graduate student at the Jodrell Bank Radio Observatory in England, Roger C. Jennison, recognized that radio waves have many of the same characteristics as optical waves and could be treated similarly. Jennison recognized that if the fringe phases around a closed loop of three or more interferometers are added together, all the spurious contributions due to the propagational effects and instrument errors would precisely cancel each other out. The sum of the phases would therefore only contain information about the structure of the object being observed.

To explain, imagine a group of three telescopes numbered 1, 2, and 3, linked in a triangular system each of whose legs is an interferometer. Thus there are three interferometers consisting of telescopes number 1-2, 1-3, and 2-3. Each of these interferometers generates its own pattern of interference fringes. If the atmosphere delays the wave arriving at telescope 2, this does not effect the fringes on interferometer 1-3. The fringes on interferometer 1-3 and 2-3, however, are each shifted by an equal but opposite amount. If the phases around the closed loop are summed, the phase shifts cancel each other exactly. Shortly after Jennison's work, but before he published, the American Alan E. E. Rogers at the Haystack Observatory determined the same fact, calling the sum of the phases around a closed loop *the closure phase* a name which has received common currency.

In somewhat more contemporary VLBI, such as the one proposed to be built by Canada, the Communications

Radio Astronomy

Technology Satellite, *Hermes*, is to be used to link together ground based receiving stations in 'real' time. This new technique, pioneered by Canada, will eliminate the tape recorders and most of the post-observational data processing required in conventional long base line interferometry.

But what have they found?

Discoveries

The initial studies of the universe using radio astronomy were efforts consisting of the mapping of the Milky Way. Such maps have been made with increasing sensitivity and angular resolution: the latter property enables astronomers to determine the position of the radio sources accurately. Knowing the position, they can refer to optical photographs of the sky and establish precisely which object is emitting radio waves. This procedure has led to the identification of radio sources with many bright galaxies and even with the most distant objects in the universe. Of all the radio sources mapped, about one fifth cannot be subsequently spotted using optical telescopes. Hence, it appears that radio astronomy provides a more complete sampling of objects in the universe than does optical astronomy.

Galaxies and radio galaxies: The morphological structure of most galaxies resembles either a spiral or an ellipse. Spiral galaxies, such as the Milky Way, are seen laced with gas, dust and newly formed stars. Elliptical galaxies consist of older

stars and show no evidence of gas and dust and are not customarily radio sources. However, those elliptical galaxies which are radio sources present the biggest and most powerful radio sources in the sky. The radio emission from spiral galaxies is usually confined to a small nuclear region supplemented by a much weaker extended emission from the disk of the galaxy. In elliptical radio galaxies the radio emission emanates from small radio sources within the galaxy, from the whole volume of the galaxy and in some cases from a huge volume of the galaxy. Sometimes, there are two large regions on opposite sides of the galaxy which emanate most of the radio energy. An example is the galaxy Fortax A, in which the two emitting lobes are some 500,000 light years apart. Radio emission from galaxies is almost certainly generated by the electron synchrotron process.

Quasars: Quasi-stellar objects (quasars) are perhaps the most interesting objects in the universe. They are generally indistinguishable from radio galaxies in regard to both their spectrum and apparent radio flux. However, measurement of the red shift of the quasars demonstrates that they are receding from earth at velocities approaching that of light. They have been determined to be the most distant objects in the universe. VLBI observations have demonstrated that the size of the radio-emitting region in quasars is very small compared with the size of the radiating regions in radio galaxies (approximately 1/1000 as large).

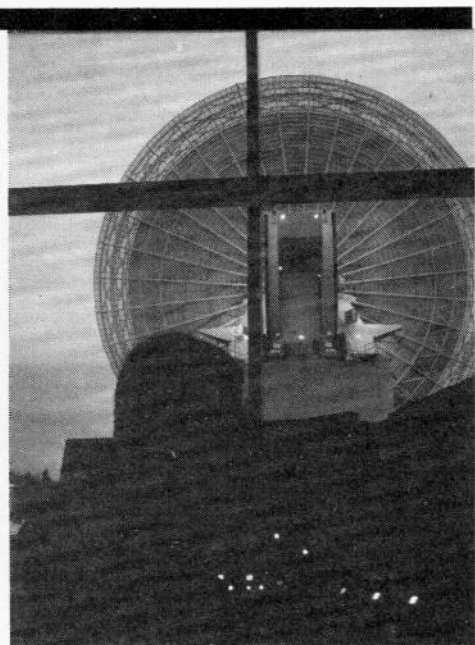

How such small regions can emit such large amounts of energy from such a small volume is not yet understood.

Big Bang: Perhaps the most significant achievement of radio astronomy to date is the support it has generated for the Big Bang Theory of the creation of the universe. In 1965 Penzias and Wilson at the Bell Telephone Laboratories demonstrated that the radio temperature of the universe was about 3°K. They further demonstrated that the universe is uniformly permeated by an electromagnetic flux at this temperature. This radiation is the relic of the initial evolutionary phase of the universe. When the universe was a small fraction of its present size, the 'heat' of its formation was contained in sub-nuclear particles and electromagnetic waves. As time passed, the particles coalesced into atoms and ultimately into galaxies and stars, whereas the radiation simply cooled by the expansion of the universe to its present temperature of 3°K. The detection of this residual radiation by radio astronomy 'confirmed' the Big Bang Theory.

Pulsars: In 1968 radio astronomy found a new type of radio source which instead of emitting energy continuously, emits bursts of energy in extremely regular intervals. Precise measurements show that these pulses have periods which are constant (1 part in 10¹²), but the pulse intensity varies unpredictably. In all pulsars the pulses are stronger at the longer wavelengths. The length of individual pulses range from 1 to 20 mS.

MASER AMPLIFIERS

In 1953 J. Weber (University of Maryland) suggested that if the population of a quantum mechanical energy-level system in some material could be unbalanced so that a higher energy level contained more atoms of the material than a lower level, then a new type of amplification might be available.

Gordon Zeiger and Nobel Prize winner Townes at Columbia University, NY, in the following year put the notion into practice using ammonia gas, and obtained amplification at the characteristic frequency of ammonia, 23 870 MHz. They called the device a MASER—the word is an acronym:

Microwave (because of the radio band where it occurred)
Amplification by
Stimulated (because the natural equilibrium has to be upset)
Emission of
Radiation

Later the more famous acronym LASER came along, in which this type of amplification was produced at the frequencies or wavelength of visible light.

The maser amplifier is of particular interest to radio astronomers because of its extremely high sensitivity. The price one has to pay for this characteristic is that the amplifier must be cooled to 4.5 K (−268.5°C) for it to operate. This environment is provided in the CSIRO Division of Radiophysics' masers by a closed-cycle helium refrigeration unit.

The Division has constructed two maser amplifiers, one operating at 22 GHz and the other at 43 GHz. The physical layout of the

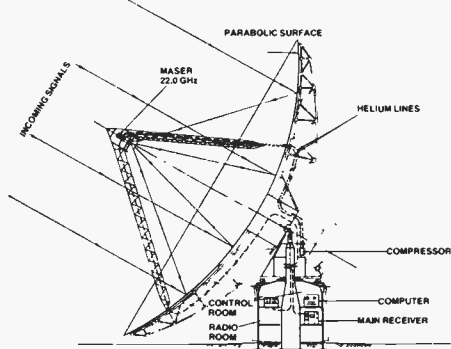
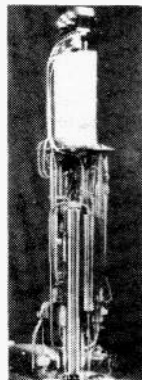

Figure 1. The maser amplifier will be located behind the prime focus feed of the Parkes dish.

maser amplifiers when mounted on the Parkes 64 metre radiotelescope is shown in Figure 1. The maser amplifier is situated at the focus of the telescope and is mounted on the cold station of the refrigeration system. High-pressure helium gas is supplied to the focus from a helium compressor located in the main structure. The low pressure gas from the cold station is returned to the input side of the compressor, thus forming a closed-cycle system.

Another interesting point about the Division's maser amplifiers is the use of a superconducting magnet to provide the

necessary magnetic field for the maser. As the wire used in the electromagnet becomes superconducting (i.e. has no resistance) at low temperature (less than 10 K), once the field is established in the magnet the external source of energy (for example, a power supply) may be removed with very little effect on the magnetic field. It has been estimated that it would take approximately 500 years till the field in the magnet decayed to about 0.7 of its original value.

J.W. Brooks
CSIRO Division of Radiophysics

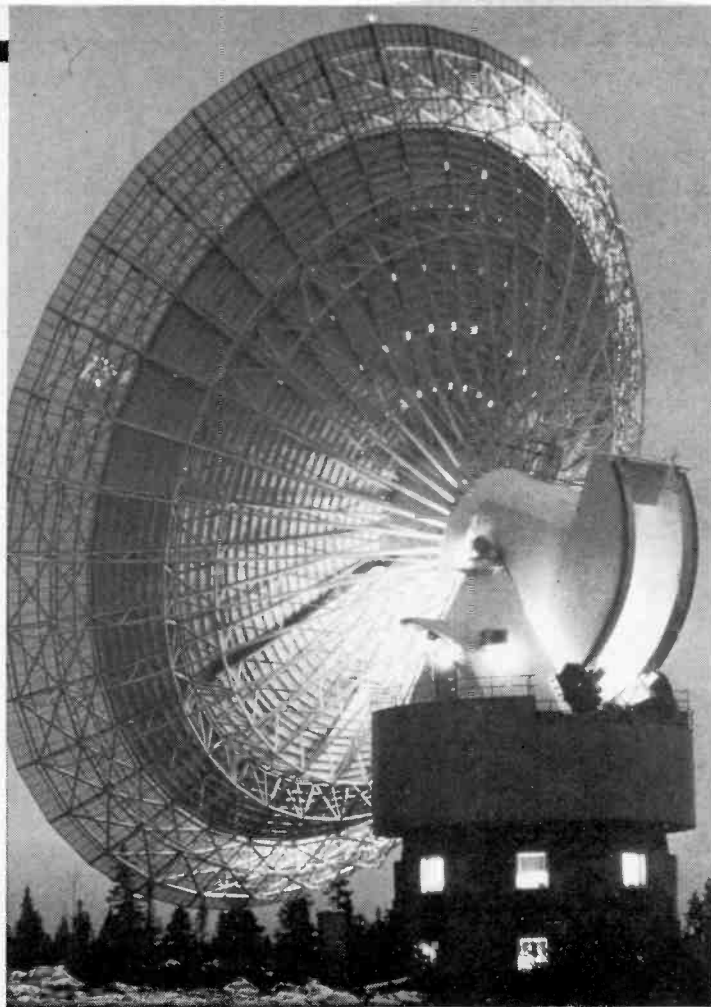

A large observatory telescope.

Pulsars appear to be very highly evolved stars that have exhausted their inner energy sources and are slowly collapsing. The size inferred for these stars (10 km) and their masses (10^{23} grams per cubic centimetre) means that they are so dense that individual protons and electrons cannot exist as separate entities. Rather, the extreme pressure inside the pulsars will cause the protons and electrons to 'coalesce' into neutrons. Pulsars are neutron stars rotating at enormous speeds with enormous magnetic fields which emit radio radiation by synchrotron radiation from electrons moving in these intense magnetic fields.

Supernova remnants: The final neutron star phase of stellar evolution is thought to be preceded by a phase of catastrophic stellar instability in which the core of the star suddenly collapses, causing the outer envelope of the star to be explosively ejected. During this process, the luminosity of the star increases briefly by a factor of 10_{12} or more, and the star is said to be a *supernova*. The atmospheric envelope of the star that is ejected in this process becomes a rapidly expanding cloud of fast moving par-

ticles, magnetic fields and filaments of ionized gas. These conditions are precisely those necessary for the generation of radio emission through electron synchrotron radiation, and very intense radio sources exist at the positions of old supernovae chronicled by ancient astronomers such as the Crab Nebula which first appeared in AD 1054 and was chronicled by Chinese and Japanese astronomers.

H 11 regions: An H 11 region (being a region of ionized hydrogen) is a large cloud of interstellar gas that has been ionized and heated by one or more bright hot stars located within. These nebula are sources of both continuum and line energy at radio and optical wavelengths. Since cosmic matter consists mostly of hydrogen, the ionized gas consists mostly of protons and electrons that emit continuum energy; the gas also emits recombination line radiation. In the radio region these lines arise from transitions between two high quantum levels in the hydrogen atom. Since many such levels exist, many lines at different wavelengths appear. Similar transitions exist for elements other than hydrogen, comparison of the intensities of lines from two

elements thereby yielding a direct measure of their abundance.

Molecular lines: It was long believed that simple molecules could not exist in the tenuous gas regions between stars, because starlight radiation would be sufficiently intense to break apart even the simplest of molecular species. However, in 1968, radio astronomers had found rotational transitions of three simple molecules OH, H₂O and NH₃. These molecules were found in dark clouds of gas and dust usually associated with H 11 regions — such dark clouds are believed to be the sites of recent and continuing star formation. VLBI studies have shown that the individual line components of these, and the fifty other organic molecules found (up to 1981) show that each component arises in a discrete region spatially separated from the others, and moreover, that the diameter of each of these discrete regions is quite small, usually only a few astronomical units (the distance between the Sun and the Earth, 1.5×10^8 km). The great intensity of these sources combined with their small sizes leads one to infer that the equivalent temperatures of the emitting gas is unreasonably high, in the order of 10^{13} degrees K. Since this cannot represent a real temperature, the line emission must be amplified in the source, that is, microwave amplification by stimulated emission of the OH and H₂O lines is being directly observed. These lines are interstellar masers (the precursor to lasers). The ultimate energy source which energizes or 'pumps' the masers may be collisional processes with H₂ or free electrons, or it may be intense infrared, optical or ultraviolet radiation. Observations of the molecules may make it possible to establish the chemistry and thermodynamics in the interstellar clouds from which, ultimately, stars, planets and life itself must form.

Canadians Contribution

Canadians entry into the study of radio astronomy commenced after the war via the National Research Council curtailing its large wartime effort and requesting from the staff members in the Radio Branch of the Division of Physics for suggestions as to replacement studies. The discovery of radio waves from the sun at metre wavelengths during the war prompted continuation studies to be proposed which were eventually accepted and implemented. Plans were made for the immediate construction

Continued on page 79

ORION

Electronic Supplies Inc.

ELECTRONIC DISTRIBUTOR
INDUSTRIAL — EDUCATIONAL — COMMERCIAL — HOBBYIST

Circle No.6 on Reader Service Card.



Sinclair ZX81 Computer ASSEMBLED \$129.95

The ZX81's advanced capability. The ZX81 uses the same fast microprocessor (Z80A), but incorporates a new, more powerful 8K BASIC ROM — the "trained intelligence" of the computer. This chip works in decimals, handles logs and trig, allows you to plot graphs, and builds up animated displays. And the ZX81 incorporates other operation refinements — the facility to load and save named programs on cassette, or to select a program off a cassette through the keyboard.

New, improved specification.
*Unique "one-touch" key word entry: eliminates a great deal of tiresome typing. Key words (PRINT, LIST, RUN, etc.) have their own single-key entry.
*Unique syntax-check and report codes identify programming errors immediately. *Full range of mathematical and scientific functions accurate

to eight decimal places. *Graph-drawing and animated-display facilities. *Multi-dimensional string and numeric arrays. *Up to 26 FOR/NEXT loops. *Randomize function. *Programmable in machine code. *Cassette LOAD and SAVE with named programs. *1K-byte RAM expandable to 16K. *Full editing facilities. *Able to drive the new Sinclair ZX Printer (to be available shortly).

If you own a ZX80...
The new 8K BASIC ROM as used in the ZX81 is available as a drop-in replacement chip. (Complete with new keyboard template and operation manual). With the exception of animated graphics, all the advanced features of the ZX81 are now available on your ZX80 — including the ability to drive the Sinclair ZX Printer.

16K Memory Expansion Kit (No P.C. Board) \$69.95

Sinclair's new 8K Extended Basic offers features found only on computers costing three or four times as much. *Continuous display, including moving graphics. *Multi-dimensional string and numerical arrays. *Math and scientific functions accurate to 8 decimals. *Unique one touch entry of "key words" (i.e. basic and system commands). *Automatic syntax error detection. *Randomize function. *Built-in interface for ZX Printer. *Connects to standard TV and cassette recorder. *164 page manual included. *Power supply (9V at 650 ma) optional for \$14.95. *1K of memory is included.

ZX81 Printer \$169.95

Designed exclusively for use with the ZX81 (and ZX80 with 8K basic ROM), the printer offers full alphanumeric and highly sophisticated graphics. COPY command prints out exactly what is on screen. At last you can have a hard copy of your program listing and results. Printing speed is 50 characters per second, with 32 characters per line and 9 lines per vertical inch. Connects to rear of ZX81 — using a stackable connector so you can use a RAM pack as well. A 65 ft paper roll, instructions included. Requires 9 volts, 1.2 amp power supply (option extra).

64K \$249.95

MEMOTECH 64K MEMOPAK

The Memopak is a 64K RAM pack which extends the memory of the ZX81 by a further 56K. Designed to be in the price range expected by Sinclair owners. Plugs directly into the back of the ZX81 and does not inhibit the use of the printer or other add-on boards. There is no need for additional power supply or cables. The Memopak together with the ZX81 gives a full 64K, which is neither switched nor paged, and is directly addressable. The unit is user transparent and accepts such basic commands such as 10DIM A(9000). With the Memopak extension the ZX81 is transformed into a powerful computer, suitable for business, leisure and educational use, at a fraction of the cost of comparable systems.

Machine Language Software

ZXAS Machine Code Assembler. A full specification Z80 assembler. Standard mnemonics are written directly into your BASIC program. **\$13.95**
ZXDB Disassembler/Debugger. Perfect complement to ZXAS, also provides single step, string search, block transfer, hex loader. **\$13.95**



Hardware	
ZX81 Assembled	\$129.95
ZX Printer	169.95
64 K-RAM	249.95
16K RAM	99.95
16K RAM Kit	69.95
Power Supply (for ZX81 + 16k memory)	14.95
Software	
Multifile Data Storage System	\$39.95
Dictator	19.95
Constellation	19.95
ZX Chess	29.95
Star Trek	13.95
Vu-Calc	29.95
Viewtext	19.95
Books	
Not only 30 programs for the ZX81 — \$16.95	
Understanding your ZX81 ROM — 23.95	
Getting acquainted with your ZX81 — 16.95	
The explorers guide to the ZX81 — 16.95	
The gateway guide for the ZX81 & ZX80 — 16.95	
Mastering machine code on your ZX81 — 24.95	
The ZX81 pocketbook — 16.95	

Orion Electronic Supplies Inc.
40 Lancaster Street West
Kitchener, Ontario N2H 4S9
(519) 576-9902

Master Charge & Visa, COD, Cheque, Money Orders accepted. COD's, shipping & insurance extra. Write for our FREE FLYER.

Prices subject to change without notice.



Electrohome Monitors

EDM926/B&W 9" Black & White monitor	\$159.50	ECM1302-2 13" Color RGB Monitor Hi Rez.	\$850.50
EDM926/P31 9" P31 Green Monitor	\$169.50	I-1302 NTSC Interface for ECM1302 for Apple II Computers	\$ 69.50
EDM1226/B&W 12" Black & White Monitor	\$179.50	I-1302/IBM Cable for ECM1302-3 and IBM Computer	\$ 27.50
EDM1226/P31 12" P31 Green Monitor	\$189.50	I-1302/Apple Cable for ECM1302 and Apple III Computer	\$ 27.50
ECM1302-1 13" Color RGB Monitor	\$499.50		



MP-1302-APL **\$249.50**
 RGB Card for Apple II or Franklin 100

Special: Orders placed before Jan. 1st 1983 deduct \$5.00 from any orders over \$100!

What can you honestly expect from an interactive data terminal that costs only \$475.95



Well, to begin with, color graphics. RCA's VP-3301 has unique color-locking circuitry that gives you sharp, jitter-free color graphics and rainbow-free characters.

Plus much more: Microprocessor control. Resident and programmable character set. Reverse video. State-of-the-art LSI video control. 20 and 40 character formats. RS232C and 20 mA current loop. Six baud rates. Eight data formats. ASCII encoding. Light-touch flexible-membrane key switches for reliability and long life. CMOS circuitry and a spill-proof, dust-proof keyboard for hostile environments.

The VP-3301 can be used with a 525-line color or monochrome monitor or a standard TV set through an RF modulator.** It serves a wide variety of industrial, educational, business and individual applications including communication with time sharing and data base networks such as those provided by Dow Jones News/Retrieval Service, CompuServe and Source.

All this—for the low price of \$475.95. And it's made by RCA.

VP-3501 Videotex Data Terminal
 For time sharing applications via telephone. Connects to standard TV set for display. Built-in 300 baud direct connect modem, includes: numeric keypad, color graphics, tone and noise generator, RF and video/audio outputs, expansion interface, resident and user-definable character sets, cursor control, reverse video, plus many other features. (Includes connecting cables.)

VP-3303 Interactive Data Terminal (RF & Video/Audio)
 General purpose terminal. Similar to the VP-3501. Does not include modem or numeric keypad. Six switch selectable baud rates to 19.2k. RS-232C and 20 mA current loop interfaces.

RCA PRICE LIST

58-Key Typewriter Format for Alphanumeric Entry	
VP-611 - 8-bit parallel output	\$109.75
VP-606 - Asynchronous serial output	139.75
58-Key Typewriter Format Plus Separate 16-Key Calculator-Type Keypad for Fast Numeric Entry	
VP-611 - 8-bit parallel output	\$149.75
VP-616 - Asynchronous serial output	159.87
VP-3301 - Video output & built in audio	475.95
VP-3303 - Connects directly to TV set	498.95
VP-3501 - With built in modem & RF modulator	549.95

ASCII Keyboard Fully encoded, 128-character ASCII alphanumeric keyboard. 58 light touch keys (2 user defined). Selectable "Upper-Case-Only"	\$109.75
VP-601 ASCII/Manual Keyboard ASCII Keyboard identical to VP-601 plus 16 key numeric entry keyboard for easier entry of numbers	\$149.75
VP-611 ASCII Keyboard Flat ribbon cable, 24 in. length, for connecting VP-601 or VP-611 and VP-711. Includes matching connector on both ends	\$27.50
VP-620 ASCII Keyboard Flat ribbon cable, 36 in. length with mating connector for VP-601 or VP-611 keyboards. Other end is unterminated	\$27.50

START WITH ORION FOR A NEW ERA IN THE WORLD OF ELECTRONICS

We have the most complete selection of electronic components.

Full line of TTL, CMOS, Linear, ICs, Computer Interface, Support Chips and CPUs.

ORION
Electronic Supplies Inc.
 ELECTRONIC DISTRIBUTOR
 INDUSTRIAL — EDUCATIONAL — COMMERCIAL — HOBBYIST

Circle No.6 on Reader Service Card.

6502 BOARDS & ACCESSORIES

AMB-1 Mother Board, APPLE II Compatible, Assembled & Tested c/w Basic ROMS, 48K RAM, Made in Japan	\$449.00
ABB-1 APPLE II Compatible, Motherboard (no components)	\$ 59.00
PDA-232C Serial interface RS232C Card for APPLE II c/w Cable & Manual, Three Operating Modes: I/O, Terminal, Remote	\$169.00
VCB-1 Versatile Communication Board for APPLE II	\$249.00
VVC-1 Videotape, Video Disc, Controller Board for APPLE II c/w Demo & Interface Software	\$499.00
AKB-1 Keyboard; replacement for APPLE II	\$139.00
KBC-1 Plastic 2-tone Beige & Brown Case for Apple-type keyboard	\$ 29.00
AC-1 Beige APPLE II Case (No keyboard)	\$145.00
APS-1 Switching Power Supply for APPLE II; +5V @ 5 amps, +12V @ 1 amp, -5V @ 1 amp, -12V @ 1 amp	\$ 99.00
APS-2 Switching Power Supply for APPLE II; +5V @ 3 amps, +12V @ 2 amps, -5V @ 1/2 amp, -12V @ 1/2 amp; c/w on-off switch & connecting wires	\$139.00
AAA-2 Low Profile Disc Drive, 5 1/4", APPLE II Compatible, Excluding Controller Card	\$599.00
AAA-1 Low Profile Disc Drive, 5 1/4", APPLE II compatible c/w Controller Card, Single Side, Single Density, Automatic Select DDS 3.2 & 3.3	\$649.00
PC-1 Printer Interface Card for APPLE II, Parallel Output	\$169.00
ZVM-121 12" Green Phosphor Data Monitor Zenith	\$189.00
ADC-1 Disc Drive Controller Card for two drives; Apple II Compatible	\$129.00
AXT 14.31818 MHz Crystal for APPLE II; HC-18/U package	\$ 5.50

APPLE II is a registered trade mark of Apple Computer Inc.

Memory Special

RAM		
4116-20	16K	\$ 1.85
4164-15	64K	\$15.00
4164-20		\$12.50
6116P	200nS 2Kx8 Static CMOS	\$12.50
2016	NMOS 2Kx8	\$ 9.75
EPROM		
2708		\$ 5.95
2716		\$ 5.95
2732		\$ 8.75
2532		\$ 9.75
2764-45		\$17.50

Smith Corona Review

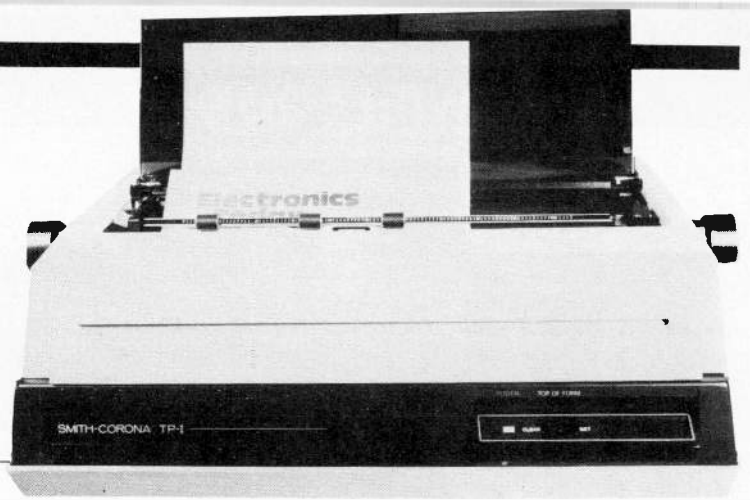

Cheap hard copy used to involve old teletypes. Now it can be achieved rather more elegantly. By Steve Rimmer

THERE ARE A number of different grades of printers available to the home computer user. Cheapest are the various surplus deals going ... teletypes, logging printers and ancient line printers ... but all of these little wonders suffer from some drawbacks. They're huge, slow, upper case only or require complicated and/or unreliable interfaces.

Next, there are the dot matrix deals, which are plummeting in cost of late. These printers have much to commend them, including speed, small size and relative ease of use. However, their print looks very, uhm, how can one put it, uhm ... ginchy. It's readable, but, in terms of doing up manuscripts or printing out letters it leaves something to be desired.

Daisy wheels are really where it's at. They produce typewriter quality type at a reasonable speed and some are really fancy. However, as of a little while ago, the daisy wheel printer was a very expensive little brute as well as being both huge and heavy. It was very much still the province of the office and few private souls could ever hope of acquiring one through legitimate means (hey, bub, you wanna buy a hot peripheral?).

All that has somewhat changed. Daisywheels aren't free, but they've come down a lot. The least expensive, and, potentially, most interesting is made by Smith Corona, and is called the TP-1. It is the first daisywheel printer available for under a thousand dollars.

Flower Power

The TP-1 has been called the first low cost American daisy wheel, a bit of a misnomer as, while SCM is local, the box itself is built in the mysterious

East. However, it is built very well, with a heavy die cast aluminum chassis, lots of fierce looking steel bits and an ABS plastic case that is certainly not a toy-like product. However, in spite of all this rigor and beefiness, it is quite small (6.5 x 19.5 x 12.5 inches), and not at all heavy (20 pounds), being similar to a typewriter sans the keyboard.

There are four permutations of the printer available. It can come with either a Centronics type parallel interface or a programmable RS-232 serial port, and can print in either 10 pitch, with 105 characters to a line, or 12 pitch, with 126. The case matches the decor of most computer rooms providing they're off-white, and the complex operating controls, these being the power switch and a second switch to decide whether or not to print in pages, will confuse most orangutans but a very few humans.

The printer uses detented print wheels, which are fairly commonly available in a number of type fonts. It can also handle niceties, like automatic underlining, tabs and programmable margins. Other usual printer features, like line spacing are done mechanically, which is crude and primitive, of course, but certainly accounts for the TP-1's lower price (and it doesn't make any difference in using the thing). There are a number of different types of ribbons available for it, including those one-shot mylar deals which print really clean type.

The printer has a 128 character set, with 88 printable. The rest are control codes to set modes like the auto underline. There is a microprocessor in there to handle all the logic.

Using It

We got a 12 pitch TP-1 with an RS-232

serial port. The port connections are reversed from those usually found on terminals ... this is an aspect of the "standard" that isn't. After a bit of torture with the soldering iron, the connectors behaved and we started getting characters through. Garbage at first, of course, but then, you'd expect that.

The RS-232 port on the printer is, as it turns out, programmable. It can be set at any baud rate from 50 to 19,200, 7 or 8 bit characters and odd, even or no parity via a single seven section dip switch inside. This, of course, entails removing the top of the case, which is a minor pain. Once inside, the dip switches can be set with a pen, paper clip or hand carved Norwegian toe pick if you've got one handy. The dip switches work in exactly the opposite way in which they seem like they should so it's important to read the setup instructions all the way through.

The port utilizes pin 20 as a busy line, which, when flagged, tells the sending device that the printer is involved in something meaningful and does not wish to be further disturbed with any more characters for a while. This may cause some trouble with certain driving software, as really simple implementations of the RS-232 may not use this pin. This will result in quite a seething mess very early on, as the printer will start jumping characters and will become hopelessly confused. One way around this, if you become faced with this problem, is simply to slow down the baud rate to the point where the machine has lots of time to think. The actual print speed of the printer is a maximum of 14 characters a second, so the baud rate setting won't affect the speed at which the unit prints, just how much of the time involved in sending a

Continued on page 50

6502 MOTHER BOARD(BARE)



This beautifully made G-10 epoxy PCB runs the ever popular 6502 CPU. Fully and clearly screened to give the precise identification and location of all parts from resistors to the CPU This board will operate with software in these formats

- (a) 6-2718's (b) 3-2732's
(c) 6-Masked ROM's (d) 3-2532's
- giving you the maximum latitude possible. Upper and lower case character set is available and 3 separate prototype areas are on the board. Each board is pretested for shorts and opens and it has both color trim and crystal trim variable capacitors. (never buy a board without both of these) This board will run all 6502 software, fully compatible with Apple™ products and other peripheral boards.

6502 BOARD.....\$60.00

PARTS KITS

For those in need we have these parts kits.

- (a) Tin IC sockets, 8,14,16,20,24,40.....\$13.00
(b) Gold IC Sks 8,14,16,20,24,40.....\$26.00
(c) 1/2-1/2 IC Sks, gold, 40,24 rest tin.....\$18.00
(d) Edge connectors, set of 8.....\$25.00
(e) Resistors, all the 1/4W resistors.....\$1.00
(f) SIP resistors, 3-0.1w 1KΩ.....\$2.00
(g) Capacitors all the 1 + others.....\$7.00
(h) Transistors & diodes.....\$2.00
(i) Crystal, trimcaps, trimpot, RCA jack audio jacks, header pins, coll.....\$6.00
(j) All TTL parts.....\$34.95
(k) All linear parts.....\$4.00
(l) 6502 CPU.....\$7.00
(m) RAMS 24 4116's.....\$42.00
(n) 2718's 6 pcs.....\$27.00
(o) 2716 character gen programmed.....\$8.00
(p) 2732's 3 pcs.....\$25.00
(q) 2532's 3 pcs.....\$25.00
(r) Complete kit, no IC's.....\$57.00
(s) Complete kit, all IC's.....\$160.00
(t) Complete kit, all IC's, gold.....\$170.00
(u) Wired and tested motherboard with all parts, including blank 2732's.....\$395.00
(v) Wired motherboard, with all IC's packed separately ready to stuff.....\$325.00
(w) Wired motherboard, no IC's.....\$185.00

MODULATORS

Those of you who have no monitor can use the following modulators to interface to a std TV set

- (a) El cheapo, a TV game modulator, OK for 40 column print in black & white but not recommended for colour.....\$6.95
(b) Medium quality unit, good for almost any use but lacks a SAW filter for top grade colour.....\$19.95
(c) High quality unit good for all uses, has integral SAW filter for top grade colour reception.....\$29.95

ASCII KEYBOARDS



Some of you will get your PC boards running with surplus keyboards but some will not and if you want the 'original' look try one of these two keyboards. Both are ASCII and can implement all the 'original' keyboard functions.

Light grey, suitable for our Ivory enclosure. With header cable.....\$130.00
We also have a small ABS keyboard (only) box suitable for those who build their own PCB enclosure.....\$19.95

SMALL PARTS

- 16 Pin header.....\$2.00
50P trimcap.....\$0.75
250-ohm trimpot.....\$0.50
RCA Jack.....\$0.75
Header pins (10).....\$0.35
1K by 8 SIP.....\$0.75
1K by 9 SIP.....\$0.75
1K by 7 SIP.....\$0.75
10K by 9 SIP.....\$0.75
14-318Khz xtal.....\$3.00
17-430Khz xtal.....\$5.00
27UH coil.....\$0.75
Audio jack.....\$0.75
Header (5 pin).....\$0.50
Power, male.....\$0.75
Power, female.....\$0.75
Speaker, 3", 8ohm.....\$1.50
Ribbon cable 8'.....\$3.00

PARTS

An assortment of parts at really good prices so that your budget will go a long long way.

- (a) NPN Transistors, general purpose.....100/\$6.00
(b) PNP Transistors, gen purpose.....100/\$8.00
(c) NPN Transistors, 2N2222 style.....100/\$10.00
(d) Zeners, Asstd 400 mw.....100/\$5.00
(e) 1N4003 diodes, 1A, 200V.....100/\$8.00
(f) 1N4007 diodes, 1A 1000V.....100/\$10.00
(g) MR502 diodes, 3A, 200V.....100/\$18.00
(h) Shottky, 3A, 20V switching.....100/\$50.00
(i) Power cords, 2 wire, 18g, 6'.....100/\$22.00
(j) 4 digit 1" MUX Ilttronix LED.....10/\$10.00
(k) PL-259, pliers crimpable, 58.....10/\$6.00
(l) SPDT mini toggle switch.....10/\$15.00
(m) S-100 connector, solder tail.....10/\$25.00
(n) S-100 connector, wire wrap.....10/\$40.00
(o) 1000uf 25V Radial lytc.....100/\$30.00
(p) Modem transformer, 600,600.....10/\$20.00
(q) Infra red LEDs.....100/\$18.00
(r) Standard jumbo red LED's.....100/\$12.00
(s) Calculator keyboard, from a TI scientific 32 Key calc, matched.....10/\$18.00

IC SOCKETS

8 PIN LPTIN.....\$1.00	8 PIN LFG.....\$4.00
14PIN LPTIN.....\$7.00	14 PIN LFG.....\$31.00
16PIN LPTIN.....\$6.00	16 PIN LFG.....\$31.00
18PIN LPTIN.....\$4.00	18 PIN LFG.....\$21.00
20PIN LPTIN.....\$4.00	20 PIN LFG.....\$21.00
22PIN LPTIN.....\$4.00	22 PIN LFG.....\$21.00
24PIN LPTIN.....\$4.00	24 PIN LFG.....\$21.00
28PIN LPTIN.....\$4.00	28 PIN LFG.....\$1.00ea.
40PIN LPTIN.....\$21.00	40 PIN LFG.....\$1.40ea.

Augat 24 and 28 pin machined contact IC sockets, the best kind.....\$1.30ea.
Loose Augat machined contact pins 20/1.00

PERIPHERAL DEVICES

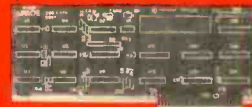

These PC boards lack parts and need to be built up for use. All boards come with a parts layout and list but after that you're on your own.

- (a) Z-80 Bare board. This board allows you to run CP/M™ on a 6502 board. You must purchase a copy of CP/M™.....\$20.00
(b) 80 Character bare board, enables the user to display 80 characters on video screen. Also has light pen input.....\$25.00
(c) 16K bare board, allows for a full 64K of memory in your system.....\$20.00
(d) Floppy disc bare card, allows operation of a floppy disc drive, user must buy a DOS from dealer.....\$20.00
(e) EPROM programmer bare board, this board allows the user to program 2708, 2716, 2732, 2532, 2764 EPROMs, has its own software and is not dependent on disc.....\$25.00
(f) ROM bare board, allows an extra 16K of ROM to be switched in & out of memory in place of on-board ROM's.....\$20.00
(g) RS-232 bare board, allows serial communication to peripheral devices.....\$20.00
(h) Printer bare board, allows interface to EPSON and other printers.....\$20.00
(i) Centronics parallel interface card, lets you use a Centronics printer.....\$20.00
(j) Prototype card, all wire wrap holes no annoying power busses all over the active board area.....\$20.00
(k) Music bare board, this board allows a wide range of musical effects to be performed with a 6502 board.....\$25.00
(l) Special deal, order 10 boards from the above with a maximum of 3 of any one kind for a total price of.....\$150.00
Save \$50 to \$100, get a group together.

MODEM

Well here we have an acoustically coupled originate only novation MODEM for the hobbyist. A real buy.....\$29.95

ABS CASES



For those who wish to copy the 'original' as closely as possible we have the following enclosures, both fit the PCB's, power supplies, and keyboards exactly.
(a) Beige case, ABS, all hardware, close colour match to the real thing.....\$150.00
(b) Ivory case, ABS, all hardware, to many a nicer colour for the home.....\$150.00

MUFFIN FANS



These fans are tested units taken out of use equipment, 1000's of hours of life in 'em yet.

- (a) Standard, 4 1/4 x 4 1/4.....\$9.50
(b) Sprite, 3 1/4 x 3 1/4, fits inside Apple (m).....\$9.95

POWER TRANSFORMERS

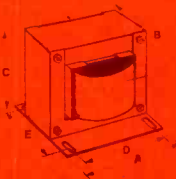

We have had some transformers wound for the 6502 board and other projects.

- (a) 6502 board transformer, provides 3V at 5A plus 25V CT at 1.1A, this unit will run two drives and a full set of peripherals.....\$18.00
(b) S-100 board transformer, provides 8V at 8A plus 25V CT at 1.8A plus 22V at 2.5A Runs any size S-100 system with up to 4 8" disc drives.....\$30.00
(c) General purpose 5V power supply transformer, gives 8V at 5A for a good bench supply or what have you.....\$9.50
(d) General purpose 12V power supply transformer, gives 15V at 2.5A for a good bench supply etc.....\$8.50
(e) General purpose 24V power supply transformer, gives 25V CT at 2.5A deal for 24V at 2A or 12V at 4A.....\$12.00

BANK KEYBOARD



What a deal, this keyboard was originally made for a bank terminal but the standard was changed. It has an Intel 8048 CPU with 2K masked ROM on board that runs it as a serial data terminal, or you can have the 8048 address an external 2716 and run it anyway you like. There is a 6MHz crystal on board, a numeric pad, 28 keys with LEDs that can hold a written legend and a bunch of standard CMOS and 74LS IC's, an ideal low cost keyboard for classroom use
BANK KEYBOARD.....\$10.00

AMAZING QUALITY

At last, a high quality, 3 1/2 digit, LCD, DMM with all the features of the higher priced American brands at an affordable price. Check these specs.

- Voltage, DC
0.2, 2.0, 20.0, 200.0, 1000.0
Voltage, AC
0.2, 2.0, 20.0, 200.0, 750.0
Current, DC
200ua, 2ma, 20ma, 200ma, 2000ma, 10A
Current AC
200ua, 2ma, 20ma, 200ma, 2000ma, 10A
RESISTANCE
200, 2K, 20K, 200K, 2000K, 20M Ohms
ACCURACY 0.25% ± 1 DIGIT

LARGE LCD DISPLAY
LOW BATTERY READOUT



HI-VOLTAGE FOR
DIODE TESTING.
LO-VOLTAGE FOR
IN CIRCUIT
TESTING

ON-LINE PUSHBUTTONS
COLOUR-CODED FOR
EASY RANGE SELECTION

RECESSED INPUT
JACKS

OVERLOAD PROTECTION
ON ALL RANGES

EXTRA FEATURES

- Diode test circuit
- Lo voltage ohms, 0.5v
- Lo battery indicator
- Auto-Zero
- Auto polarity
- Overload protection, all ranges
- ABS case (will not crack)
- One hand push buttons. ONLY \$99.00

SWITCHING POWER SUPPLIES



We have 4 power supplies that can power the 6502 PCB. They differ mainly in the total wattage available.

- (a) A small open frame supply giving enough power for the main PCB and some peripherals.
+ 5v - 3A; + 12v - 1/2 A; - 5v - 1/2 A;
- 12v - 1/2 A.....\$85.00
(b) A bit bigger, runs more peripherals and a low power disc drive.
+ 5v - 3A; + 12v - 1A; - 5v - 1/2 A;
- 12v - 1/2 A.....\$99.00
(c) Larger still, runs lots of peripherals and std disc drives.
+ 5c - 3A; + 12v - 1 1/2 A; - 5v - 1/2 A;
- 12v - 1/2 A.....\$120.00
(d) The largest, runs 2-drives and lots of peripherals.
+ 5v - 3A; + 12v - 2A; - 5v - 1/2 A;
- 12v - 1/2 A.....\$130.00

PROJECT BOARD

Have you ever tried to get an economical protoboard and had a shock? Well look at this, a good quality protoboard at a 30-40% saving. The KH-408 has 1560 holes on a std 0.1" grid for IC's and a sturdy plastic base with two binding posts for power, an excellent buy for the student.

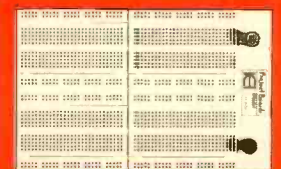

- KH-408 (as pictured).....\$38.00
KH-204 1/2 the size of KH-408.....\$20.00

PARTS ELECTRONIC COMPUTER GALORE

316 COLLEGE ST., TORONTO. M5T 1S3 (416) 925-8291

Min Order \$15.00 Visa, MC, American Express,

All Ont. Residents add 7% Sales Tax. Add 5% delivery charge; we ship Canpar or Canada Post, or Purolator

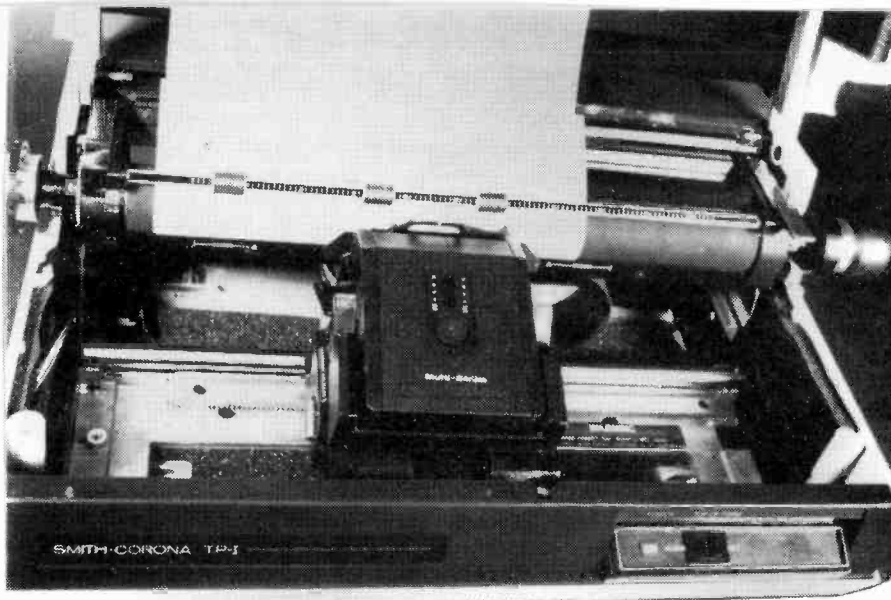

Continued from page 48

character is data, and how much is waiting.

In time, of course, our printer did begin typing properly, and very nicely indeed. The type it produced was ultra crisp and clean. It could be put into the auto underline mode by transmitting an EM control code, hex 19, which caused it to backspace after each character was printed and print an underscore. A second EM toggled it out of this mode. Other nifties included DC1, which positions the left margin, DC3 which set the right and CSN, which clears them. DC2 sets a tab and DC4 clears it. These latter bits won't be remarkably useful with most word processors, as the text usually goes to the printer preformatted.

The TOF, top of form, control is the front panel rocker. When it is in its set position, the machine will look for form feed characters, hex FF, and, upon getting one, will advance one form (58 lines).

The print head is adjustable for different amounts of stroke force. The darkest position is quite hard, and will do several carbons. The maximum paper thickness for the printer is specified at .022 inches.

Wither Daisywheel

Costing a third to a quarter of the price of many daisywheel printers, you might be wondering if there could be a few differences between the TP-1 and those more expensive machines. Well, actually, there are. What is more important is to ask whether they mean anything to you.

The TP-1 is definitely a home printer. It's designed to interface to fairly low cost systems and do good work. However, it does have some

drawbacks which will limit its applications in more demanding situations. Well it should, too . . . people with twelve thousand dollar computers can darn well afford four thousand dollar printers.

First off, the TP-1 is slow. Glacially. Fourteen characters a second is an eternity if you're going to whip off a copy of your revised version of War and Peace. Toggled into the automatic underline mode its slowness approaches a rapid state of stop. However, this really isn't a concern if you're using the thing for your own stuff in most cases. For letters,

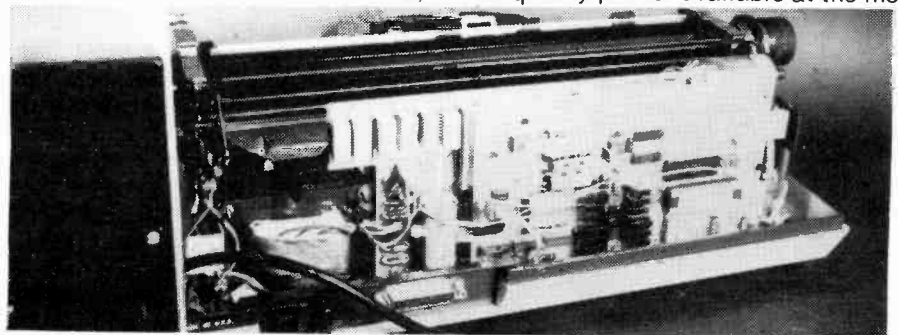

manuscripts and so on, quality is vastly more useful than volume, and most aspiring authors would rather wait for a daisywheel than try to explain a dot matrix. In an office environment it would probably be a supreme drag.

The TP-1 is also a strictly friction feed machine. While one could use continuous paper, minor crookedness of the form can manifest itself in quite a bit of travelling over a few yards of paper, creating a profound mess. Thus, the printer must be attended when it's printing.

The TP-1 also lacks proportional spacing. This means that every character takes up the same amount

of space on a line no matter how wide it is. This reduces the number of characters that can be gotten on a line, and makes the type a bit less pretty. However, the logic and mechanicals required to do proportional spacing are formidable, and, to be sure, its absence is largely responsible for the financial accessibility of the TP-1. Proportional spacing does not actually add that much to the overall attractiveness of a page.

The only really nice thing about proportional spacing printers is that they tend to eliminate the "river of white" effect caused by having all the characters lining up vertically. However, in playing with the TP-1 and our word processor we found that the right margin justification done by the word processing software did a pretty decent job of this . . . the text looked real cool.

The printer is fairly noisy, producing over seventy dB of raspy, buzzing sound when it's typing. The best way to deal with this is to clamp headphone's on your head and listen to Jethro Tull 'til it's finished. It should be said, however, that it isn't that much louder than our dot matrix TRS-80 Line Printer VI, and its clattering is less irritating than the whine of a dot matrix.

Type Cast

All told, the TP-1 is likely the best letter quality printer available at the mo-

ment for the average dude with an average Visa limit. It's small, rugged, high quality and, most important, reasonably cheap. It is certainly a viable alternative to that other way of producing letter quality print on a budget . . . ahem, interfacing filthy Selectric typewriters. It's backed up by a first rate reputable company, which cannot be said of every imported printer, and the proud owner of one of these things can be assured of a long and happy life for his or her new toy.

Now. Just let me see them try to pry the review sample away from me!

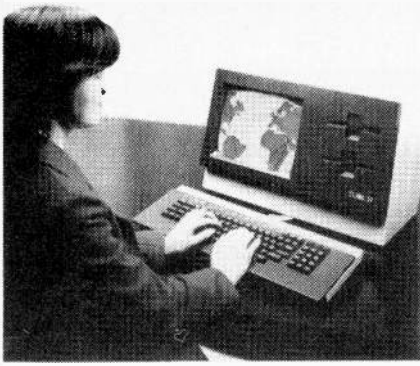

\$7995

Torch Computers are limited only by your imagination.

High Level Communications

The range of communications capabilities include: Torch to telex using Tele Torch emulation software; Torch to Torch internally via Torchnet; Torch to any other computer using Torch-talk software; Torch to mainframe including IBM and DEC® terminal emulation using Torchterm; and Torch to viewdata systems using Torchtel.

But this is not all. The 6502 peripheral controller enables communications to be handled automatically without interrupting the applications programs the user happens to be running on the Z80. This applies to both incoming and outgoing communications.

Dialing is automatic and messages can be scheduled to be sent at whatever times you like, even when there is no one in the office. And Torch will keep dialing until messages are successfully transmitted.

DEC® is a registered trademark of Digital Equipment Corporation.

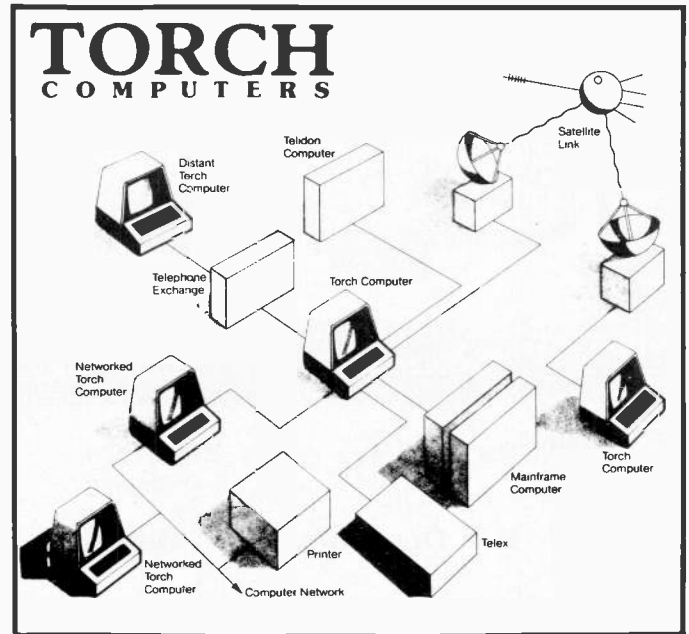

Technical Specifications

Twin processor and memory.

Main processor: Z80A 6MHz with 64K bytes RAM and 4K 'Shadow ROM' for bootstrap. TUBE interface to 6502 peripheral processor.

Peripheral processor: 6502 2MHz with 32K bytes RAM and 48K ROM for machine operating system, and BBC Basic interpreter.

Display: 12-inch colour monitor. Software selectable modes include:

- 80 x 25 two-colour text (standard).
- 80 x 30 text and 640 x 256 two-coloured graphics.
- 320 x 256 four-colour graphics.
- 160 x 256 16-colour graphics.
- 40 x 25 teletext compatible text and graphics.

Scrolling and general screen handling are performed by the peripheral controller. Graphic display operations such as DRAW LINE and FILL AREA are also handled by the peripheral processor.

Power supply: Switch-mode power supply. 240/110V input, 50 or 60Hz.

- Interfaces:
- parallel printer port to Centronics specification.
 - RS232 serial port with nine software selectable baud rates.
 - Four 12-bit analogue to digital converter channels.
 - RGB output.
 - UHF output.
 - CUTS cassette interface.

Communications: Torchnet interface for local networking with other TORCH computers. Modem for connection to telephone and telex lines, software selectable baud rate (normally 1,200 Baud to CCITT standards).

Internal units: Sound generator and loud speaker capable of producing four independent channels of sound over a three octave range, with level control and envelope shaping.

Real-time clock with 10ms resolution and 100 year range.

Advanced speech synthesis unit, using phoneme encoding to produce realistic speech under program control.



TORCH

COMPUTERS

Cambridge • Toronto • Boston

Let Torch Show You The Way

Circle No. 3 on Reader Service Card.



Torch International Computers
(Canada) Ltd.
7240 Woodbine Ave. Ste. 207
Markham, Ont. L3R 1A4
(416) 475-8622

- Please send me more information.
- Please have salesman call.
- Please send me dealer information.

Name

Title

Company

Address

Postal Code

Telephone ()

HM 203-4 GENERAL-PURPOSE SCOPE

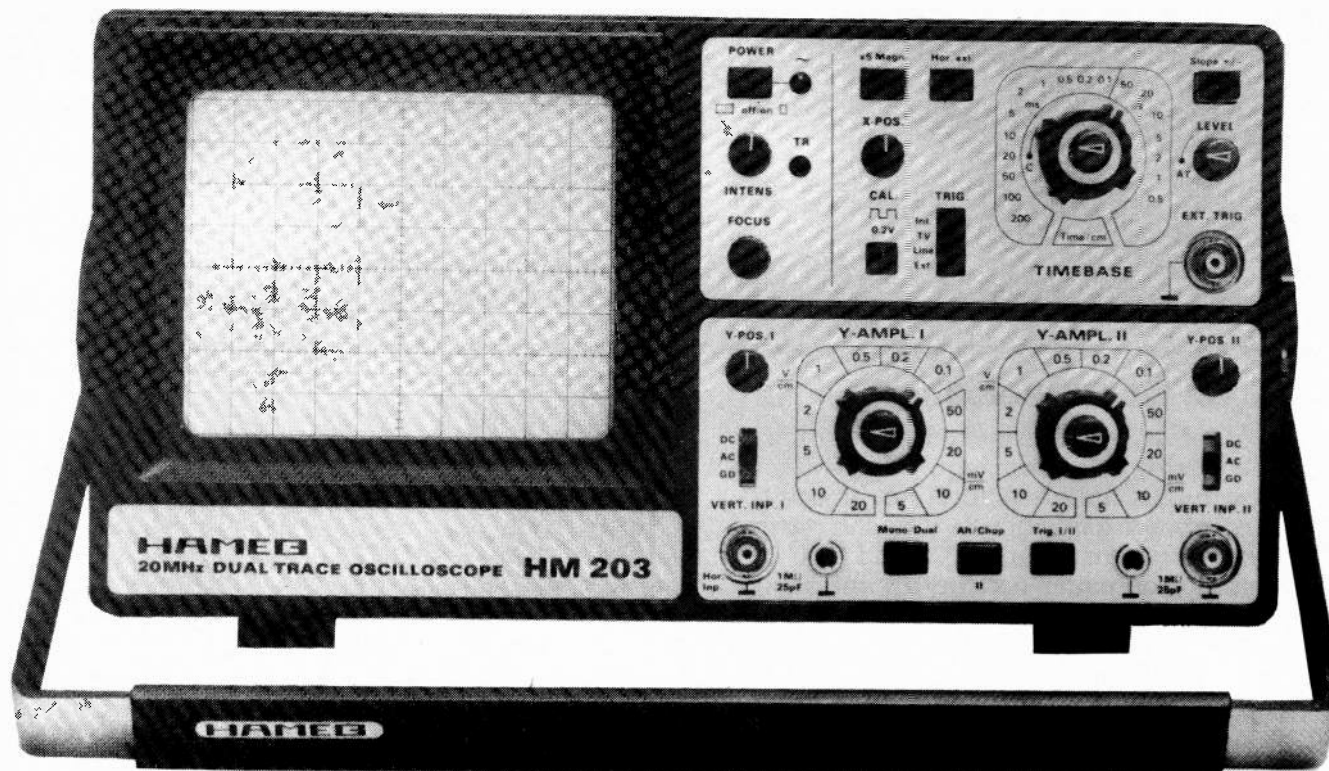

■ **2x 20MHz, max. 2mV/cm**
max. 1% Overshoot

■ **X-Y Operation, (1:1 Ratio)**

■ **8x10cm, Rectangular CRT**
with Internal Graticule

■ **Timebase 40ns — 0.2s/cm**
incl. Magnification x5

■ **Trigger Bandwidth 30MHz**
internal at 5mm

■ **TV-Filter, Line-Triggering**

The new HM203 is a general-purpose **20MHz Dual Trace Oscilloscope**, representing outstanding value for money. Its stable sweep triggering and measuring accuracy are particularly impressive. The **rectangular CRT with internal graticule** provides excellent brightness and display definition. The **electronic regulation** of all internal supply voltages including HV and the favourable thermal arrangement of drift-sensitive components ensure **exceptional display stability**.

The HM203 can be used for **single or dual trace** operation. Two signals are displayed either consecutively in the **alternate mode** or by multiple switching of the channels within one sweep period in the **chop mode**.

HAMEG's new LPS trigger technique permits **perfect triggering up to 30MHz** even on small signals. TV- and Line-Triggering are just as much standard features as are the built-in **square-wave calibrator** for probe compensation or calibration and the trace rotation.

A particular feature of the HM203 is its simplicity of operation. Clearly arranged front panels and controls facilitate **easy handling of the instrument**, even for newcomers and non-professionals.

Inside the instrument, **two large printed circuit boards** accommodate the entire circuitry, enabling **quick access to all components** for better serviceability.

The high performance and competitive price of the HM203 have been achieved by the optimum use of both discrete semiconductor and integrated circuit technology. Only readily available high quality components and semiconductors are selected for the instrument in order to ensure **long-time reliability**.

Each instrument is supplied with a **comprehensive manual** containing operating and servicing instructions, circuit diagrams, PCB-layouts, and test instructions for checking the most important functions by relatively simple means.



980 Alness St.,
Unit 7,
Downsview, Ontario
M3J 2S2
(416) 661-5585

LIST **\$835.00**

ZX81 Update

This remarkable value computer has caught the imagination of readers. Igor Nowikow of International Publishing and Software Inc. of Toronto spends his working life with the ZX81: who better to comment on developments!

THE SINCLAIR ZX81 is a machine that has totally surprised many experts, the computer market — and myself. In a world where sophisticated computers have revolutionized our lifestyles, shrunk the universe around us and presented the realization that our minds and capabilities are truly infinite, I found myself, of all places, employed programming the "little fellow" of computers, the ZX81. To my surprise, the computer offered a formidable amount of programming capability as well as a truly incredible, large and ever increasing user market.

In a survey done recently by ETI it was found that nearly 20% of the readers of this journal already own one of these "mighty midgets". Surprisingly a good percentage of the readers own the ZX81 as a *second* computer.

Cumulative sales of the ZX81 now surpass 500,000 units and in each of the last three months 50,000 units have been sold. Never wanting to be left out, the Japanese, through Mitsui, a large trading company, have been licensed to sell the ZX81.

As well, Sinclair has formed a happy marriage with Timex in the US, which has been licensed to use the Sinclair technology and name in producing an enhanced 2K version of the ZX81. The unit is called the TS1000 (Timex-Sinclair 1000). Timex is also working on the TS2000, the North American version of the Sinclair Spectrum computer. This is a colour graphics version, with audio, that has just been developed by Sinclair (more said about the Spectrum tantalizingly later). Having seen such impressive advances in the computer technological field and computer market, I dug around to find out who or what Sinclair is.

Clive Sinclair is the founder and driving force behind Sinclair computers. He's a 41 year old, mild-mannered electronics and computer genius, who seems to produce a never ending stream of new ideas. Ten years ago he introduced the first pocket sized calculator, then developed the first pocket T.V. The enterprise was short of cash and was eventually subsidized by the British NEB (National Enterprise Board),

nevertheless it went under. NEB, \$17 million poorer and Sinclair, a lot wiser, parted company in the summer of 1979. Losing nary a breath and returning to the electronics field with even more vigour, Sinclair produced a prototype, small and cheap, home computer in just seven months. It sold for \$200.00, was called the ZX80 and 100,000 units were produced in the first year. The new improved ZX81 replaced this model in early 1981 and has dominated the home computer industry ever since.

Some Add-on's Available

Along the way, many hardware peripherals made by independent companies have sprung up in support of the ZX81. An expansion bus exists at the back of the computer, which by edge connectors brings out all lines (address and data included) and thus allows for easy expansion of the computer.

Several companies supply memory packs, including Sinclair themselves, Memotech and Jigsaw. All produce 16K, 32K and 64K RAM packs that plug into the back of the computer, thus expanding the accessible memory. The prices of these packs may seem hefty in comparison to the price of the computer itself (computer costs about \$100, whereas the 16K pack about \$60, the 32K pack \$100 and the 65K pack about \$180) however most games on the market as well as computer aids (programs which add extra functions to the computer) require at least 16K extra RAM. For those who require large data bases, the 64K RAM pack brings the ZX81 up to par with many business computers, especially if coupled with a normal keyboard (\$50 and up), a printer interface (\$140 from Memotech) and a lower/upper case word processor package (Oasis Software in England offers such a package). The printer interface will allow one to print on plain sheet paper with any commercially available serial printer that uses the ASCII character code.

The Sinclair printer available for the ZX81 uses a silver coloured paper about 4 inches wide on a 64 ft. roll. Personally I feel that the quality of

the hard copy is poor and the printer speed slow. However for occasionally producing copies of program listings, the printer is adequate and cheap.

For myself, I find the touch sensitive, membrane keyboard (standard with the computer) an aggravation to program with, and so the positive action keyboard with optional cover was a great addition to the computer setup. The keyboard I use costs about \$50, is easy to setup and contains the same 40 keys as the computer. Anyone who is a speed typist will notice that the keys require a "hearty" tap to ensure a key read which tends to be rather frustrating.

Better keyboards are available at substantially higher prices and can be bought from companies such as Synergistic Design in Chicago (P.O. Box 411023, zip code 60641). This company as well as others also distribute non-standard keyboards (contain extra function keys).

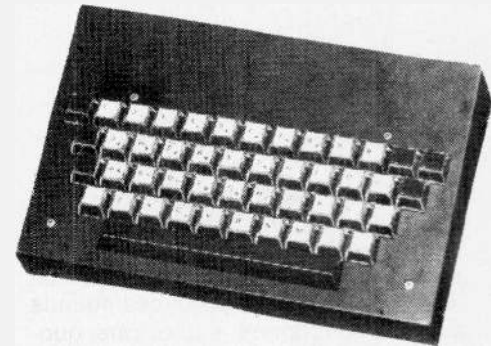

Because of the unpopularity of the ZX81 keyboard, a number of companies offer more conventional types. The one shown here costs about \$150 including the case.

There are also hi-resolution graphics packs that allow you to create better quality, more detailed graphics. Southern Computer Systems in Kentucky boasts a package that has a resolution of 256 by 192 pixels and comes with a 48K memory expansion pack. Units such as these will be available from Gladstone (Toronto) in the near future.

There is another option now available from Gladstone that I'm very eager to try. This is a pack that allows the user to add sound to ones

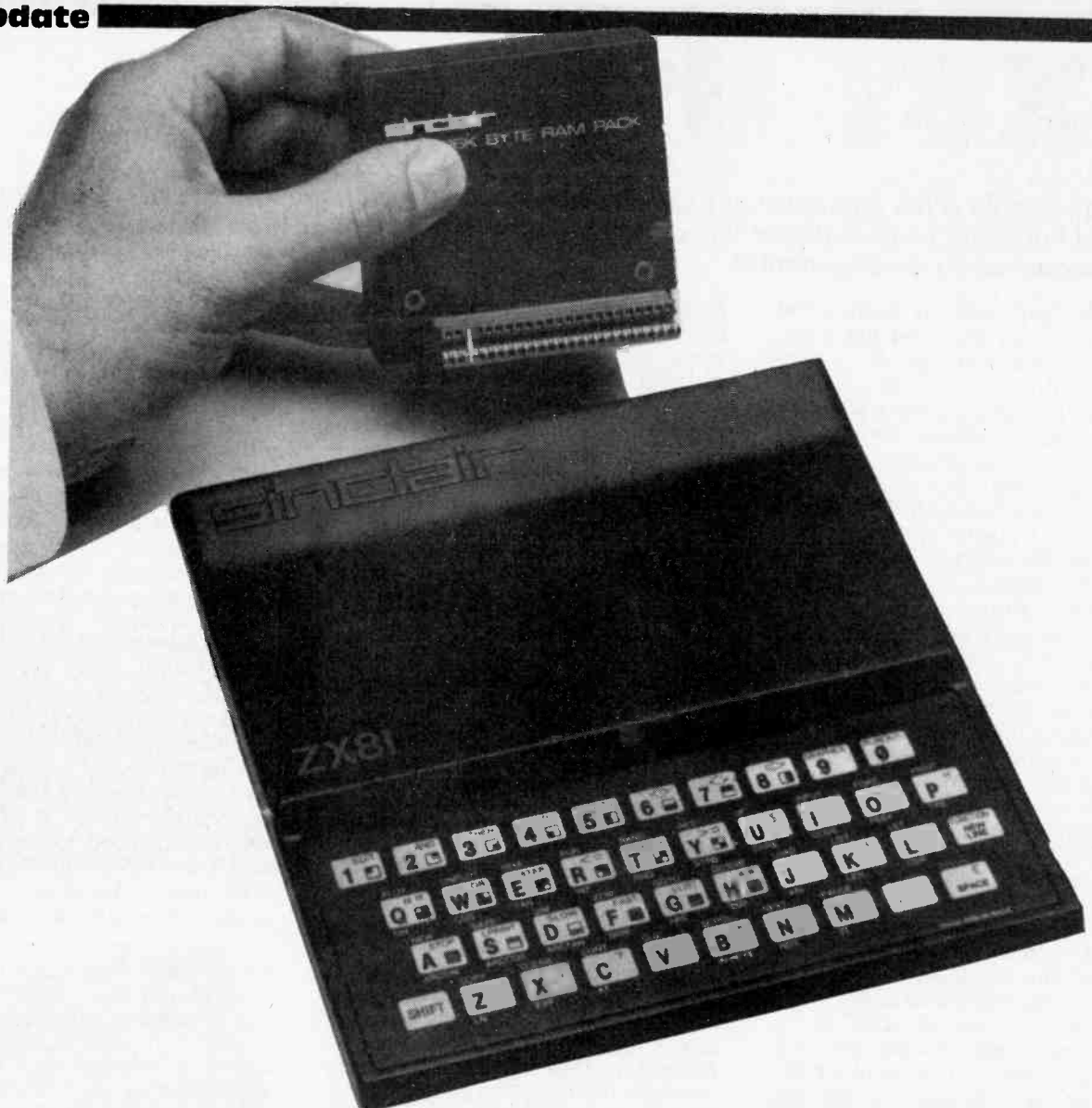

programs. BIPAK in England manufactures this peripheral which comes complete with a loudspeaker and variable volume control. The Zon X-81, as it's known, produces sounds such as helicopters, explosions, gunshots, drums, bells or whatever you devise. To incorporate the sounds into your programs one just uses a few simple BASIC lines. The package comes complete with detailed instructions and examples. The first thing I aim to produce is a video game complete with explosions, gun blasts and rocket fire. And who knows; if enough people buy these units we may have to start producing commercial programs with sound! The unit is reasonably priced at about \$50.

A handy little unit to have is the Jigsaw T.L.I (Tape Loading Interface). This unit plugs in between the computer and the tape recorder using the standard connecting cables you used before to connect your set up. Once connected it will allow you to obtain

reliable loads of programs from cassette to computer. If you do a lot of programming then this unit can be a real time saver. It has easy to see red and green LED's to indicate whether or not the computer will load the program. As well, the unit is a filter, which removes frequencies outside the computer's bandwidth thereby removing unwanted noise and hum. Thus you now have a more reliable load/save system which certainly removes the frustrations of losing programs because of corrupted saves (available from Gladstone).

The list of hardware peripherals available for the ZX81 is an incredibly long one and continues to grow as the machine gains popularity. SYNC magazine is a publication specifically printed for the Sinclair user. It's an excellent source of information on the ZX81 and it's peripherals. The magazine is printed bi-monthly and costs \$19.00 per year. For those who require more information on peripherals I suggest you have a look

at this journal. (SYNC, 39 Hanover Ave., Morris Plains NJ 07950).

Software

As for software products, the market has an ever expanding line of games education packages, business and entertainment programs. There is a take-off on virtually every famous (and not so famous) arcade game around. These are fast-action games which are programmed in machine code to allow for instantaneous response times from the keyboard, and produce fast movements across the screen.

One of the most popular games on the market, and one of my personal favourites is Mazogs. The game involves a large maze with monsters and treasures waiting around various corners. The clever part of the program is that you only see a part of the maze at a time! It's not easy to win and the graphics used in the program are of high quality.

Another couple of games, distributed by I.P.S. in North America and Orwin in Great Britain are Galaxy Invaders and ZX Scramble. These two games are extremely fast (programmed in machine code) with real arcade type graphics. In fact these two games seem to come closest to giving you a real "arcade" type feeling. Everyone at the I.P.S. office became rapidly hooked on these products in the testing stages thus slowing our production down as we battled the invading alien hordes! In fact Orwin games in general are of high quality.

In terms of impressive visual graphics the game Shootout produced by one of my colleagues at I.P.S. stands as one of the best on the market. It's a fast draw game, programmed in BASIC but in such a manner that it's not easy to beat the computer. You can also play a friend. I found this to be a great party game, especially with the excellent and humorous visual effects.

One certainly can't say I'm a great chess player, so when I tried ZX Chess II I didn't expect to dominate the game. However the ease at which the computer beat me, even at the lowest levels bruised my poor ego so much that I actually read up on strategies and played the machine as often as I could. I'm happy to announce that I've reached the third level out of seven, but it may be a while before I progress further. The program offers a clear display of the board, an analyse feature, and a quick response time for moves if you are using the first few levels (the ZX81 responds in seconds to a few minutes). The upper levels are suitable for correspondence chess or to those of you who have a day or so to kill (moves may take well in excess of 5 minutes, depending on the situation).

There is a rather unique package just produced by a friend in I.P.S. working in conjunction with a research doctor in the nutritional field. This is a weight control program designed to analyse your diet and help you set up nutritional, balanced meals in order to reach a certain weight goal. It's very easy to use, and is a useful guide to dieting and eating properly.

A BASIC Program

For those who wish to try programming a short game for themselves and enjoy puzzles, the following is a BASIC program version of the game Reverse. The program prints ten digits in a random order and you must find a way of putting them in ascen-

ding order using the least number of moves. The program will ask you how many digits you wish to reverse. If you select 5 then the 5 digits on the left will reverse their order.

i.e., select 5: 0392165487 will become 1293065487

select 3: 1293065487 will become 9213065487

select 8: 9213065487 will become 4560312987

Once you've arranged all 10 digits in proper order a message will be printed out.

```

10 PRINT AT 1,10; "REVERSE"
20 DIM N$(10)
30 LET S$="0123456789"
40 FOR I=1 TO 10
50 LET A=INT (AND*LEN S$+1)
55 LET N$(I)=S$(A)
60 LET L=LEN S$
70 IF A=1 THEN LET S$=S$(2 TO
L)
80 IF A=L THEN LET S$=S$(1 TO
L-1)
90 IF A<>1 AND A<>L THEN LET
S$=S$(1 TO A-1)+S$(A+1 TO L)
100 NEXT I
110 PRINT AT 10,10;N$;AT 19,6;
"HOW MANY DIGITS";AT 21,4;"DO YOU
WANT REVERSED?"
120 IF N$="0123456789" THEN
GOTO 220
130 INPUT A
140 LET C=A
150 FOR I=1 TO INT A/2
160 LET X$=N$(C)
170 LET N$(C)=N$(I)
180 LET N$(I)=X$
190 LET C=C-1
200 NEXT I
210 GOTO 110
220 PRINT AT 19,6;"YOU WIN ";AT
21,4;"

```

A Word About Spectrum

In April of this year Sinclair launched a colour, graphics computer called the ZX Spectrum. Initially the Spectrum computer is being sold by mail-order, and only in England. By middle to end of 1983 it should be available in North America. There are two versions of the Spectrum, one has a 16K RAM memory capacity and the other 48K RAM memory capacity. The two computers presently sell for 125 pounds and 175 pounds respectively. Those who purchase the 16K version

will be able to upgrade to 48K. Programs are still loaded by cassette, except load times are 6 times faster than the standard ZX81 load time. The colours available for use with the Spectrum are black, blue, red, magenta, cyan, green, yellow, and white. The screen supports 24 32-character lines of text. The graphics display is divided into 256 by 176 pixels accessed by various BASIC commands. Timex, who will manufacture the machine in North America will call the model the TS2000. The computer features new functions such as REPEAT, DRAW and CIRCLE and has upper and lower case letters.

Having tried the computer I found the keyboard very responsive but a bit cluttered (the keys have extra commands now). The model I tried went on the blink after about an hours

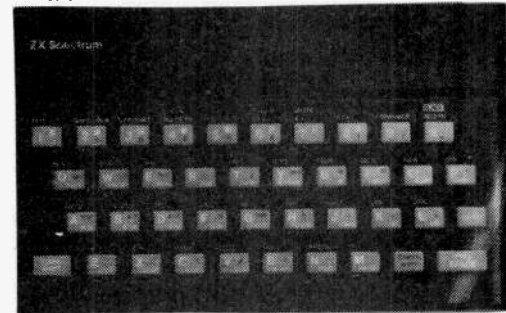

The Sinclair ZX Spectrum.

worth of programming, the problem was diagnosed as a logic chip overheating. This apparently was a problem with the earlier models but has since been corrected. The speed of BASIC is also quite a bit faster than that of the ZX81 and thus readily lends itself to fast action games programming. From the short programming session I had on the machine, I found it to be a pleasure to use.

Krakit — A New Adventure!

Around Christmas time one seems to always be looking for that one gift that's fun and unusual. KRAKIT meets both these requirements, and has the added bonus of having a prize of at least \$20,000! KRAKIT is a program that takes the user on a treasure hunt around the world. There are 12 clues to solve, each revealing a country, a city and a number. Once you think you have solved all 12 clues, just fill out the KRAKIT form and mail in the answers. The first correct entry will win the prize. This prize grows with time, since for every KRAKIT tape sold I.P.S. throws in another dollar. A sample clue is: WHERE IT ALL BEGAN, WHERE THE TORCH WAS FIRST LIT, WHERE MUSCLES AND SINEWS STRAIN,

WHERE OUR HEROES WIN ACCLAIM, WHERE THE SYMBOLS HOLD THE KEY. Now you must find a country, a city and a number in those clues (this is just a sample clue to give you a flavour of the hunt). From whispers in the wind, it seems that KRAKIT 2 is waiting in the wings.

Fastload

In recent weeks, a new phenomenon has entered the ZX81 scene—Fast Loading tapes. These are programs that increase the baud rate of the computer.

Mindware had advertised programs which load 6 times faster than the normal rate and has a LOAD VERIFY feature. The programs sell from \$9.95 to \$24.95 and should already be available in stores.

Personal Software Services offers a program called QSAVE which allows the user to create their own fast loading programs. This package has a VERIFY function as well (checks for corrupted saves of program). It comes with a hardware attachment that must be used along with the program. Drawbacks to this system are that you cannot name your program nor can you create a fast loading version of an auto-start program.

I.P.S. has a dual speed Load/Save Program package that will allow the user to create programs that load either 4 times or 6 times as fast as a normal Load/Save. The program has a built in VERIFY function as well as a CATALOG function. This function scans a data tape and prints out on the screen a list of programs on the tape (by name), the program length in bytes, the speed used to save the program and if the Save was an uncorrupted one. Included with this package is a Bootstrap loader which will allow for the creation of self contained fast loading programs initiated by a normal LOAD command. (With fast loading programs one normally has to load the Fast Load/Save Monitor and keep it in memory. The bootstrap loader does away with this need). This package requires no special hardware and can be used for all types of programs. As well, I.P.S. is converting all lengthy loading tapes to fastloading ones (user does not require any special hardware or program to run these programs).

The advent of these programs allow the user to store far more information on tape (1 megabyte on a C90 cassette), and take some of that aggravation out of sitting, waiting for 6½ minute programs to save or load.

DEC	HEX	MNEMONICS
42	2A	LD HL, (16396)
12	0C	
64	40	
6	06	LD B, 23
23	17	
30	1E	ROW: LD E, 0
0	00	
35	23	COL: INC HL
126	7E	LD A, (HL)
254	FE	CP A, 118
118	76	
40	28	JR Z, END
4	04	
115	73	LD (HL), E
95	5F	LD E, A
24	18	JR COL
246	F6	
16	10	END: DJNZ ROW
242	F2	
201	C9	RET

To scroll right to left the program is slightly different.

DEC	HEX	MNEMONICS
42	2A	LD HL, (16400)
16	10	
64	40	
6	6	LD B, 25
25	19	
30	1E	ROW: LD E, 0
0	0	
43	2B	COL: DEC HL
126	7E	LD A, (HL)
254	FE	CPA, 118
118	76	
40	28	JR Z, END
4	4	
115	73	LD (HL), E
95	5F	LD E, A
24	18	JR COL
246	F6	
16	10	END: DJNZ ROW
242	F2	
201	C9	RET

Remember, all these programs require at least 16K of memory.

Machine Code Programming

For the more advanced programming enthusiast the following is a standard machine code method of scrolling everything on the screen left to right. How do these routines work? Well, the left to right scroll begins by loading the HL register pair with the starting address of the display file and the B register with the number of rows to be scrolled plus one. A bubble sort is performed for each row, moving each character along a row until a new-line character is found. The new-line character signifies the end of a

row. The start of each line is padded with a blank on the left hand side. After all the rows are scrolled, the computer returns to the BASIC program.

The right to left scroll works in a similar way, but it starts at the end of the display file and works backwards.

To enter either one of these routines you:

1. Add these lines to your BASIC program.

```
1 REM 01234567901234567890
10 For I = 16514 TO 16533
20 INPUT A
30 POKE I, A
40 NEXT I
```
2. Run this section and enter the 20 decimal codes given previously.
3. Delete lines 10, 20, 30 and 40.

The routine is stored in the REM statement at the start of the program. The statement USR 16514 can now be used anywhere in the BASIC program to scroll the screen.

And finally some tips:

1. Always keep your tape recorder heads clean and demagnetized. Use a standard tape recorder head cleaning cassette every 10 to 15 hours. This will cut down greatly on the number of unsuccessful LOADS and corrupted SAVES.
2. Sometimes you may encounter problems in LOADING a friends program, saved on another tape recorder. This could be due to differently aligned heads on the tape recorders. If the output level of the recording was too high, this may also cause problems in LOADING. Experiment by trying other tape recorders (if available).
3. If a VU meter is available to you, an optimum output setting for recording seems to be at about -6db.
4. Look for an easy-to-use games programming book to come out early in the new year. The authors are Bob Fraser and Mike McGuire and the book is a good guide to programming in machine code. In the meantime "Understanding Your ZX81 ROM" by Dr. Ian Logan is one of the better Machine Code programming books around.

If you have any suggestions, comments or debugging problems please feel free to write to this journal, attention: ZX81 THOUGHTS.

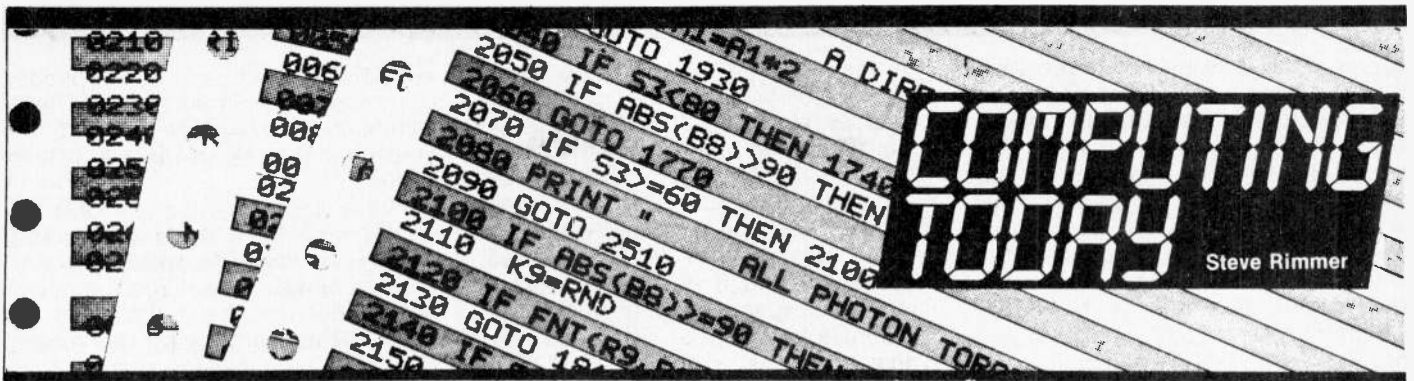

OUR TALE OF nasty fake Apple type computers last month has brought about a severe interest in these things . . . the companies involved are doing up dozens of these boards a week and Applesoft BASIC, the language of the midnight ROM copies, is becoming a rather common tongue. It is similar to regular Microsoft BASIC in most respects, but there are a few differences which will confuse the uninitiated. For those not about to fork over for the Applesoft manual . . . it's getting pretty hard to come by at any price these days . . . here's a brief introduction to the mysteries of this dialect.

The Verbage

If you build up a fake Apple board one of the first things you will probably try is the FRE(s) command to see how much RAM you have. If you're a bit cautious, you'll probably put in the first bank of chips and enter? FRE(x). If everything's working you'll get about fifteen K, which is the total minus what Applesoft reserves for its personal consumption. Okay, stick in the next set of chips and you'll get thirty one K, which is fairly reasonable. However, when you go for the last bank, you will get a FRE value that's negative! Ah, yes, negative memory . . . it forgets more than it retains, right? This is a very useful point to realize about Applesoft. It likes to represent numbers bigger than 32768 in a rather weird way sometimes. You have to add 65536 to the result to get the true value.

Once you have all the RAM working, you will be able to start doing some programming. There are, first off, no lower case characters available, so the inability of your system to produce them should come as no shock. And, although it is a little buried, there is an editing feature available for the Apple's screen. It involves the first four letters of the alphabet plus the ESCape character from the keyboard.

If your Apple copy is running with a duplicate Apple keyboard, using this mode shouldn't be too dif-

ficult. However, on systems using standard teletype style keyboards, implementing it may be a bit tricky. When you type the ESC character from the keyboard, a flag is set by Applesoft to interpret the next character that comes down the line as a cursor movement command instead of a printable character. Type an ESC followed by an "A" and the cursor will move right one space. "B" is left, "C" is down and "D" is up. "D" is the useful one, actually, as it lets you cursor up to a previously listed line and make changes on it. The right arrow key can be used to move along the line, modifying any characters

by NOTRACE. When the TRACE mode is on Applesoft displays the line numbers of the statements it's executing as it does 'em, allowing the programmer to follow the action.

CALL is similar to the SYS command found in other operating systems. It hands control over to a machine code subroutine at a specified address. It deals with this address in something like the way FRE printed up the available memory. The address specified can range from -65535 to +65535, although the negative values have corresponding positive ones. -936, for instance, is the same as 64600 . . . you just add



that want changing along the way.

On a teletype style keyboard, the ESC character is usually a CTRL code. It may take a while to get used to this system.

Another useful control character for editing on an Apple is CTRL X, which causes Applesoft to disregard the line being edited and leap to a fresh line.

When actually running programs, such as:

```
10 PRINT "HELP . . . I AM IN A LOOP!!!"
20 GOTO 10
```

it will also be useful to know that CTRL C is the break command. This is not the same as pushing the RESET button, which will keep the program intact but will, sadly enough, trash most of the pointers and data.

TRACE is a utility often found on moderately complex computers as TRON and TROFF. Here it's shut off

65535.

Applesoft programs make a lot of fuss over two variables, HIMEM and LOMEM. These, after some decoding, are simply the pointer values for the beginning and end of the buffer in which BASIC text can go. You might want to move HIMEM down, for example, to protect some machine code that lives up near the top of memory. The current value of HIMEM is kept in two registers in zero page, and can be read by PRINTING PEEK(115) + 256*PEEK(116). Likewise, LOMEM is PEEK(105) + 256*PEEK(106). These values can be changed by doing HIMEM (x) or LOMEM (x) where x is the value you want to set them to.

Applesoft doesn't deal with cursor movements on the screen in the same way as, say, a PET does. While you could do something like POKEing the cursor position registers, it's a lot

easier to use two functions provided for the purpose, HTAB and VTAB, the H and V being Horizontal and Vertical respectively. If you try to move the cursor beyond the margins of the screen using these things you'll get an illegal quantity error.

There are three video attributes which can be associated with text on the screen. The first is NORMAL, which is there anyway. The other two are FLASH and INVERSE, which can be invoked by using these words. There is also a command called SPEED ... which does not cause drugs to pop out of peripheral slot seven ... but rather sets the rate at which characters are transferred to the screen. Usually this is defaulted to 255, but it can be less if you want to simulate a terminal or annoy people.

Into The Numbers

One of the features which is quite useful about Applesoft is its ability to get whole arrays onto and off of its mass storage medium. This trip is gotten into by the commands STORE and RECALL. You can STORE and RECALL any array by putting the letter which it is dimensioned under after whichever of these commands is appropriate. However, these things are a bit tricky as the name of the array is not stored along with its contents, and a stored array can be read back into an array of a different name ... throwing an error message if it isn't big enough.

IN# and PR# tell Applesoft where to look for input and output respectively when you want to have it communicate with the peripheral slots. They are followed by a number from one to seven ... you can't talk with slot zero, and if you specify it you'll be returned to the keyboard or screen, as the case may be. The system tends to freak over numbers larger than 7 and hang when directed towards empty slots.

Grunt

Now for the important stuff ... the graphics commands.

The screen is usually in the TEXT mode, and, if you should manage to get it into some other mode you can return it to this one by typing TEXT. Note that, if you're in a graphics mode you might not see the letters come up on the screen until after you're back in TEXT.

Low resolution graphics on the Apple consist of a forty by forty matrix of boxes that can be any colour the machine can generate (there are sixteen, of which we shall speak momentarily). You can put the system

in this mode with the command GR.

At this point, we also encounter another interesting feature of the Apple. When you're in one of the usual graphics modes you can still display some text at the bottom of the screen in what is called the "text window". While useful, this is not always necessary, and, if you'd rather have a bit more space to play with your graphics in, you can close this window altogether with POKE 49234,0 after the GR.

The low resolution screen on the Apple can be plotted in any of the aforementioned sixteen colours, and you can set these from a program using the COLOR command. Don't try to spell it correctly: it doesn't work. You type COLOR = x, where x is one of:
0 Black 1 Magenta 2 Dark Blue
3 Purple 4 Dark Green 5 Grey
6 Medium Blue 7 Light Blue 8 Brown
9 Orange 10 Grey 11 Pink 12 Green
13 Yellow 14 Aqua 15 White

Plotting is done with PLOT x,y. When called forth from the depths of the ROM, this command will lay a box in the colour defined above at the location specified by x and y. Once again, if x or y are out of range the system will throw an error message.

HLIN and VLIN are also low resolution commands, and draw lines instead of just points. HLIN x,y AT z draws a line from x,z to y,z. VLIN works the same way, but for vertical lines.

You can also read the screen when it's in low resolution mode with SCRN (x,y). It returns the colour of the box at the point defined by x,y.

HGR sets the high resolution graphics mode. It reserves 8K of RAM for the use of the screen. The same POKE command given for the low resolution graphics command can be used to close the text window with HGR. In this case, the screen can plot

2B0 by 192 pixels.

There are not as many colours available in the high resolution mode. They are set by HCOLOR, and can be
0 Black 1 Green
2 Blue 3 White

The dots are placed using HPLLOT, a versatile little fellow if there ever was one. HPLLOT x,y will put a dot in the colour set by HCOLOR at point x,y on the screen. HPLLOT TO x,y causes a line to be drawn from the last dot to x,y. HPLLOT x,y TO j,k causes a line to be drawn from x,y to j,k. However, it is useful to note that you can add "TO" and another set of co-ordinates onto the end of this, and get another line after the first one has been plotted. In fact, you can add as many "TO"s as you have room for.

There is also a second page of high resolution graphics plotting available on the Apple, set by HGR2, but its use and function gets a bit complicated, and should probably be gone into at a later time.

Down to the Core

Despite its age and fairly crude hardware design, the Apple II ... and, of course, all those demi-Apples which have sprung from the electronics shops of Canada ... is possessed of an amazingly profound design, and is still versatile and powerful six years or so after its inception. If you have created one on the cheap, this should get you started into using the language in ROM. Although it has never really been priced as one before now, the Apple II makes a very good beginner's system, and, armed with a BASIC manual and these minor uniquenesses you should have no hassle learning to write programs on this very neat system.

Just don't fall out of the tree in the process.

ETI

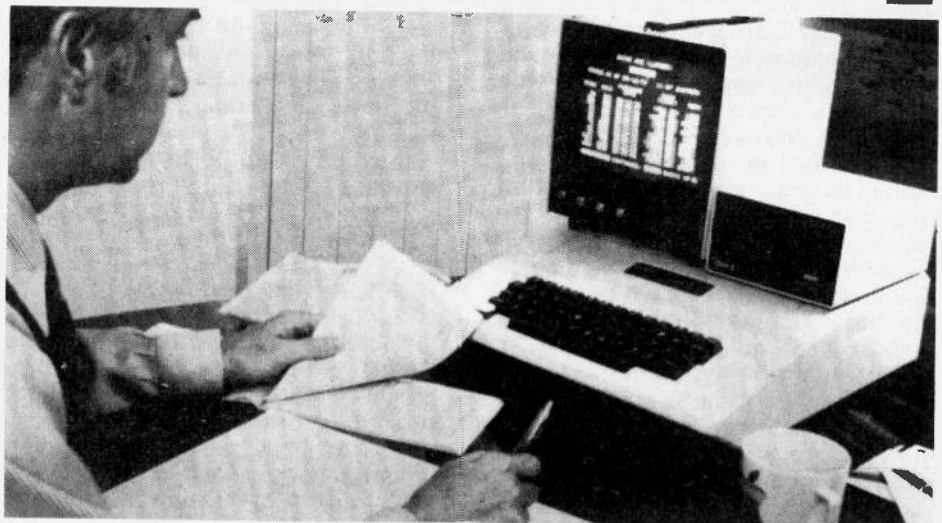

Into Digital Electronics Part 5

Dust off your breadboard, we have some practical circuits for you to try out using the theory we covered last month.
by Ian Sinclair.

USEFUL THINGS, gate circuits. In case you've forgotten last month's work, we can make any sort of gate circuit which has a 1 at the output for whatever pattern of 1s we want at the inputs. Even if these were the only kind of digital circuits we could make, they would still be useful, but NAND gates can be used to make an even more useful type of circuit, called a sequential circuit or flip-flop.

Practice before theory, this time. Build the circuit which is shown in Fig. 1. The breadboard switches and LEDs are in their usual places, and the quad NAND gate 74132 has been inserted with its pin 1 in line 19A and its pin 14 in line 19B. The connections are as shown on the diagram. Looks familiar? Yes, if you've built multivibrators with transistors you should recognise this as one of the great multivibrator family. There are no capacitors, though, so this is a form of bistable; and all the resistors are inside the ICs. What makes this important is that it is a simple example of a circuit which, although it's made out of gates, doesn't behave like any of the gate circuits you've built so far.

Figure 2 is a blank truth table for this circuit. Make sure you go through this table in the order which is given, otherwise you may miss the important feature of this circuit. There's nothing accidental about the fact that we have two lines in the truth table for which the inputs, R and S, are both at logic 1.

See the difference? With $R=1$, $S=1$, the output which is monitored by the LED can be 1 or 0. What does it depend on? Look at the table again. What decides the value of the output Q is the value it had before the inputs changed to $R=1$, $S=1$. Now this is quite different from the circuit which we used earlier. In these 'combinational' circuits, the output from

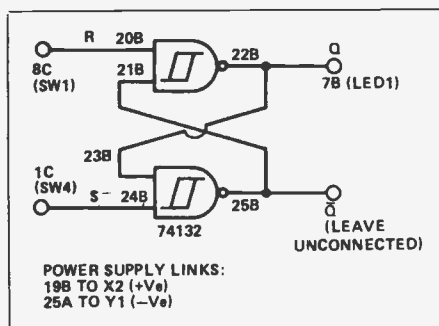

Fig. 1 The circuit for the R-S flip-flop, showing the breadboard link numbers.

the gate circuit was decided completely by the combination of inputs. If we had a gate circuit with two inputs and one output, the output would always be the same when the inputs were both 1s. The circuit we're looking at now doesn't do this. What counts here is the *sequence* of signals at the inputs, and the output for $R=1$, $S=1$ depends on this sequence — the signals which were there at the inputs just before this state. If we had $R=1$, $S=0$ before $R=1$, $S=1$, then Q is 0. If we had $R=0$, $S=1$ before $R=1$, $S=1$, then Q is 1. Sequence, not combination, is what matters, so that circuits of this type are called *sequential* logic circuits.

R (SW1)	S (SW2)	Q
1	0	
1	1	
0	1	
1	1	

Fig. 2 Blank truth table for the R-S flip-flop. Make sure that you go through the truth table in the order which is shown.

The R-S Flip Flop

This particular one is called the R-S flip-flop, with R and S meaning Reset (putting Q to 0) and Set (putting Q to 1). It's the simplest type of sequential circuit, but it's not used very much because of two problems. Problem 1 is that we have to leave out $R=0$, $S=0$ on the truth table. Why? Well, with that output, the Q output is 1,

and the other output, marked Q is also 1. Now if we used only Q, this might not be too serious, although it's still a nuisance, having another state which causes $Q=1$. For a lot of flip-flop applications, however, we use Q to provide the inverse of Q (so if $Q=1$, $\bar{Q}=0$ and if $Q=0$, $\bar{Q}=1$), saving another inverter. With $R=0$, $S=0$, \bar{Q} is not the inverse of Q, so our logic goes bananas. Problem number 2 is that the output changes almost instantly when either input is taken to logic 0. For a number of reasons which we'll look at later, we'd like some control over this.

When the R-S flip-flop is used, it's used as a latch. A latch is our name for a circuit which will hold a bit (binary digit) unchanged for a time, a sort of temporary memory. We can set the R-S latch by making $R=0$, $S=1$ and reset it by making $R=1$, $S=0$, and we can store the result by keeping both R and S at logic 1. The outputs Q and \bar{Q} will stay as they are as long as power is applied and $R=1$, $S=1$; this is the latching condition.

How about an example? Imagine the R-S latch is connected to operate a burglar alarm (Fig. 3). The reset button has been pressed, making $S=0$, $R=1$ momentarily, so that the output Q is at logic 0. When the button is released, $R=1$, $S=1$ for as long as the door and window switches remain intact. Breaking contact on any one of these switches, even momentarily, will cause the input $R=0$ because of the 'pull-down' resistor R1. This makes $Q=1$, and this condition will remain latched even when $R=1$, causing the alarm to sound until the switches are all closed and the reset button pressed. The 'pull-down' resistor is needed because without it a TTL input will remain at logic 1 if the connections to it are broken. Another way in which the R-S flip-flop is used is to control a gate in a counting circuit — the gate can be 'opened' by a push button which sets the output of the flip-flop, and closed by an 'end-of-count' pulse. The important point is that the R-S flip-flop can be changed over by a very brief pulse at one input, and the output can then be held in its new state.

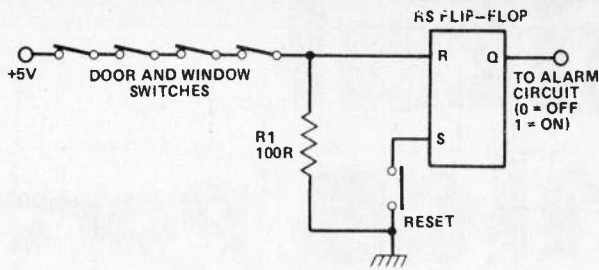

Fig. 3 Using an R-S latch in a burglar alarm circuit.

D-lightful D-ifference

So much for the R-S flip-flop. Incidentally, there seems to be no particular rhyme or reason about how the inputs are labelled. Some texts show the R input to the gate whose output is Q (the scheme we've used here), others show the R input to the gate whose output is \bar{Q} . It doesn't really matter which way round it is, so long as you know the action — a zero at one input will cause a change at the output, and when the inputs are both at logic 1, the output is held latched. An R-S made from NOR gates, by the way, has just the opposite action, latching when R=0, S=0 and changing when either input goes to logic 1. Just as well we don't make much use of them!

We make a lot more use of the next chip, a D-type flip-flop. The example we have is a 7474, and it involves us in a lot of new ideas, one of which is clocking. Start by setting up the circuit in Fig. 4. We have removed the connections between the 74132 and the switches, and substituted the 560R feedback resistor, and 470uF capacitor. Please note, you can't use this circuit with just any old gates. Only the 74132 NAND gate, the 7413 (also NAND) and the 7414 (hex inverter) can be used this way, because they are all of a type called Schmitt gates — more of the later.

Now switch on, and see what LED 1 is doing. If you are so lucky as to get a quick flash at intervals, that's it! The output of this circuit is a pulse, a change from logic 0 — to 1 — to 0 which recurs at regular intervals. Because it ticks away so regularly, we call it a clock pulse.

For any sort of sequential circuit beyond the simple R-S type, a clock pulse is essential. The reason is that the clock pulse can be made to control each step in the sequence, so that any changes which take place will always take place at some particular part of the clock pulse, either the leading edge (the start of the pulse) or the trailing edge (the end of

the pulse). This avoids a lot of problems which can arise because of time delays in gate circuits. A single NAND gate will usually manage to respond to an input in about 30 nanoseconds (that's 0.03uS). That's fast, but suppose you have a circuit which uses two signals, one of which has come from one single NAND gate and the other of which has passed through about ten NAND gates. No prizes for guessing which signal gets to the circuit first, but suppose we need to wait until both of them are present? A circuit which operates from clock pulses (a clocked circuit) has a built-in time delay, the time between the clock pulses. We could arrange the circuit so that the signals were held in latches until both were present, and then gate them into our circuit by a clock pulse. The next clock pulse then resets the latches, ready for the next lot of signals. Circuits which make use of clock pulses avoid all the problems which time delays can cause in simple gate circuits, and also give us an automatic method of resetting latches. Clock pulses put the sequence into sequential circuits, and allow us to carry out very complicated actions in a surprisingly simple way, because we do only one step at a time. This idea is the germ from which the microprocessor has grown.

Going back to the board, you now have a clock pulse generator ticking away merrily at a nice slow

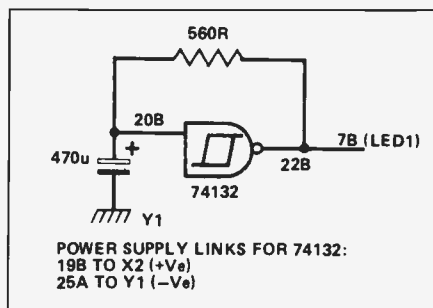

Fig. 4 A pulse generator which makes use of the 74LS132 IC. Don't be tempted to use larger resistance values.

pace. This pace isn't typical, most clock pulses go a lot faster, 100 kHz or more, but by slowing it down we can see what is going on by watching the LEDs. Switch off now, keep the clock pulse generator in place and put a 7475 on the board, with its pin 1 on line 11A and its pin 14 on line 11B. The power supply connections are shown in Fig. 5 with line 17A connected to line Y1 and line 11B connected to line X1. This also shows the symbol for a D-type flip-flop; there are two such flip-flops in the 7475.

Now for your actual flip-flop. Connect up as shown in Fig. 5. The clock input of one D-type flip-flop is connected to the output of our clock pulse generator. The clock pulse generator circuit hasn't been shown here, only the connections. The D-type input (D for datum — one bit is datum, two or more is data) is obtained from one switch, SW1, and the Q output is connected to LED 1. We can now use SW1 to switch the D input to 0 or 1, and watch the output LED change — but when does it change? Does it change at the exact instant when you change over the switch?

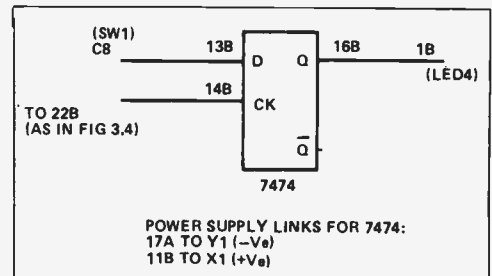

Fig. 5 Using the D-type flip-flop 74LS74. The 74LS132 which is already on the board provides the clock pulses.

That's the action. It might not seem very spectacular, but watch this space. What happens is that whatever logic level (0 or 1) is present at the D input when the leading edge of the clock pulse occurs is latched into the output (Fig. 6). Notice that it's latched — if you stop the clock pulses, the Q output will remain as it is, no matter how the voltage at the D input changes. The other important point is that the leading edge of the clock pulse starts the latching — and this leading edge takes very little time, a few nanoseconds. The \bar{Q} output is, as its symbol suggests, always the inverse of the Q output.

Now the interesting point about the D-type is that we can actually make use of the time delay between the leading edge of the clock and the appearance of the output. The clock pulse has its effect only while the

voltage is rising, not at 0 nor at 1, and the output reaches its final state some time after the clock pulse voltage has reached 1. We can therefore connect up the crazy-looking circuit of Fig. 7. Try it, and watch the two LEDs. LED 4 is operated by the Q output of the 7474, and LED 1 is operated by the clock pulse. Notice anything about the flashing rate of LED 4?

It is indeed half of the flashing rate of LED 1, so that the output is a set of pulses at half the frequency of the clock pulses. The circuit is

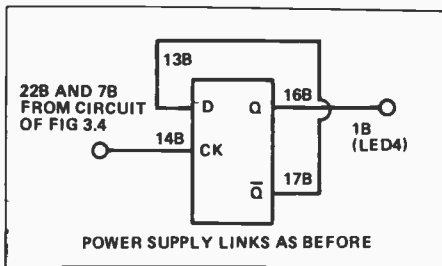

Fig. 7 Toggling a D-type flip-flop. This connection makes the D-type give one output pulse for each two in, but only if the clock pulses have very fast rising leading edges.

variously known as a toggle circuit, divide-by-two, scale-of-two, binary divider or bistable. The sixty-four thousand dollar question is, how does it work? The key to it is this business of time delays.

Imagine that the output of Q is logic 1, so that the output at \bar{Q} is logic 0. Because \bar{Q} is connected to D, the D input is also at logic 0, but this doesn't have any effect until a clock pulse comes along. When the clock pulse appears, its leading edge starts the changeover action, but the clock voltage has reached logic 1 before Q has had time to change from 1 to 0. That's the important point, because when the change takes place, it's too late to have any effect on D until the

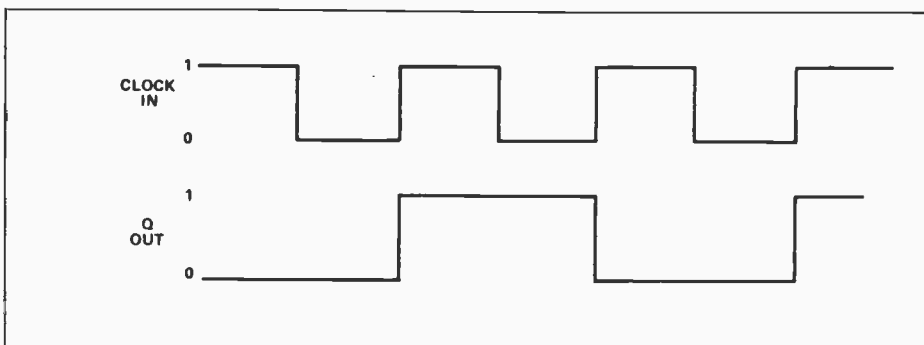

Fig. 9 The divide-by-two action of a toggling circuit.

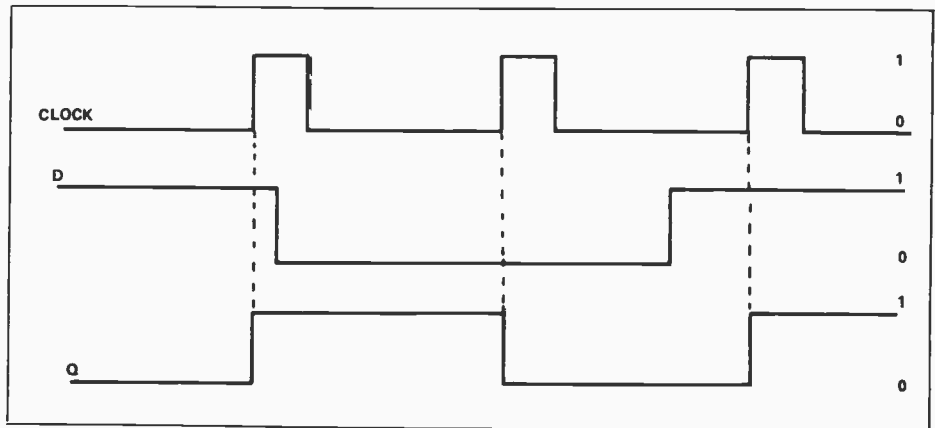

Fig. 6 D-type action. The Q-output switches over at the leading edge of each clock pulses to a value equal to the logic level at the D-input.

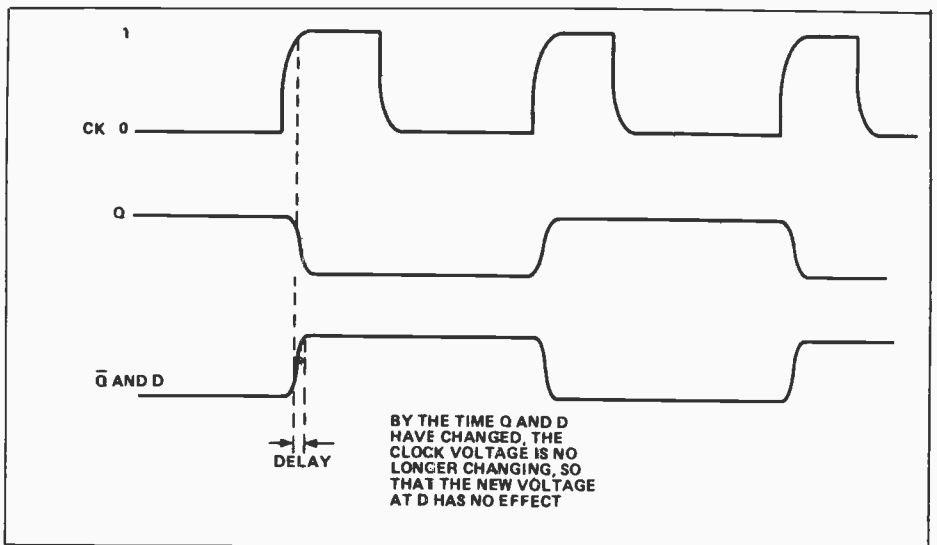

Fig. 8 The time delays which cause the toggling action of the D-type.

next clock pulse arrives. A timing diagram will make this a bit clearer. Fig. 8 shows the times, not to scale. You can see that by the time Q and \bar{Q} change, the D input is 'locked out' — because the leading edge of the clock pulse has passed, the voltage at the D input has no effect on the output.

The result is the toggling action, with the voltage at Q changing at each clock pulse leading edge, causing an output pulse at half the rate of the input (Fig. 9). This toggling action is important because it is the method that a lot of counting circuits use but more of that next month. **ETI**

Blood is meant



**Be a
RED CROSS
Blood Donor**

Series 5000 Part 2

Pre-amp

This second part describes the construction of our very high quality audio preamplifier.

COMMENCE THE construction by assembling the LED level meters and the MM and MC input stages. Full construction details for these boards have been given in earlier articles.

In this project the LED level meters are mounted with their track sides closest to the top of the preamp. In this way the LEDs run from left to right. This has the disadvantage, however, that calibration of the level meters must be done before mounting. Alternatively drill holes through the level meter pc boards, large enough to take a small screwdriver, immediately behind the three preset pots on each board. In this way adjustment of the level meters can be done after mounting, which is considerably easier. A second modification which must be done to the LED level meters is to increase their input impedance. This is done by removing the 22k parallel input resistor, R1 on the level meter circuit diagram, and replacing it with a 470k. These additional resistors are included on the main pc board parts list.

Next assemble the main pc board; a component overlay has been included to simplify this stage of construction. First make a visual inspection of the circuit board, checking for open circuits or short circuits between adjacent tracks. This is a reasonably complex board and any faults are best found at this stage. Check also that the holes are drilled to convenient sizes. I prefer to enlarge holes intended to take the shields from the shielded cables, and the three holes for the preset RV4 must also be large enough to accommodate the fairly wide pins. There are five mounting holes for the circuit board itself; these should be approx. 3 mm. The LED level meters mount on their own pillars, two of which pass through the main pc board. These holes (see overlay) should be large enough to allow a bolt without interference from the main pc board.

If all is correct mount the wire links, resistors and nonpolarised

capacitors such as mylars and ceramics. Next mount the transistors and diodes, ensuring that they are inserted the correct way around. Note that in the row of diodes near the power switch, diodes D3 and D4 are mounted in the reverse direction to the other diodes. Mount the integrated circuits, again making sure the orientation is correct. The voltage regulator ICs are best mounted by bending the leads with a pair of side cutters first, then inserting the pins through the pc board and securing the regulators with nuts and bolts. Pass the bolts through the pc board from the underside (i.e., nut on top). Finally solder the pins. The regulator IC3 runs the warmest of these regulators since it supplies the positive rail to the LED level meters. Mount the preset RV4. The last components to be mounted on the main pc board are the electrolytic and tantalum capacitors. Once again be careful of the orientation of these components.

The final stage in the construction of the main board is to solder the connecting cables. These are left as 'flying leads' at this stage but with sufficient length to allow them to run to their respective positions within the preamp. If the main board is positioned roughly on the bottom panel an estimate of the necessary lengths is easily made.

The connections marked +VA, -VA, +VB, -VB and the two 0V connections at the extreme right edge of the pc board supply power to the MC and MM input stages. These leads are already soldered to the MC and MM pc boards, so leave them empty at this stage. The power supply leads to the LED level meters, however, should be soldered to the main board and left flying for the time being. Notice that all signal-carrying leads are shielded cable, and provision has been made on the pc board to accommodate the shields. The connections to the mute lines and the 400 Hz oscillator are done with conventional hookup wire (see overlay and relevant photographs).

Next construct the rear panel assembly. All inputs and outputs are done with RCA-type sockets, with the

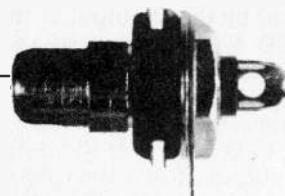

The RCA sockets mount through the hole of nibber grommets fixed to the rear panel, electrically isolating them from the panel.

exception of the two three-pin DINs. The RCA sockets must be insulated from the chassis. This is done by first fitting rubber grommets to the drilled holes in the rear panel and then mounting the sockets through the grommets. Ensure that the ground lug points toward the top of the rear panel.

Once all the RCA sockets have been mounted, fit the two three-pin DIN sockets. All the leads to the rear panel come from either the main board or the front panel assembly so no leads need to be soldered to the rear panel at this stage. Instead solder all the resistors and capacitors as shown in the rear panel assembly drawing. Note that all the sockets with the exception of the four tape outputs have parallel resistors and/or capacitors. The overlay drawing included shows the position of these components.

The next stage is the assembly of the front panel. Once again start by disassembling this part of the chassis; the wiring is fairly complicated and is much easier to do with the sub-panel separate. Start by cutting the shafts of the potentiometers and switches to the correct lengths to suit the knobs used. Be sure to allow for the depth of the sub-panel and the thickness of the front panel. Mount the three pots with their pins pointing toward the top of the sub-panel, i.e. closest to the lid of the preamp. Be careful not to confuse the two 10k pots.

Next mount the rotary switches to the four switch pc boards. Once again start by inspecting the boards carefully. The rows of pads at the top edge of these boards are intended to take the shields of the shielded cable, so enlarge them if necessary.

To be continued next month

COMPONENT OVERLAY FOR THE MOTHERBOARD ETI-478 MB

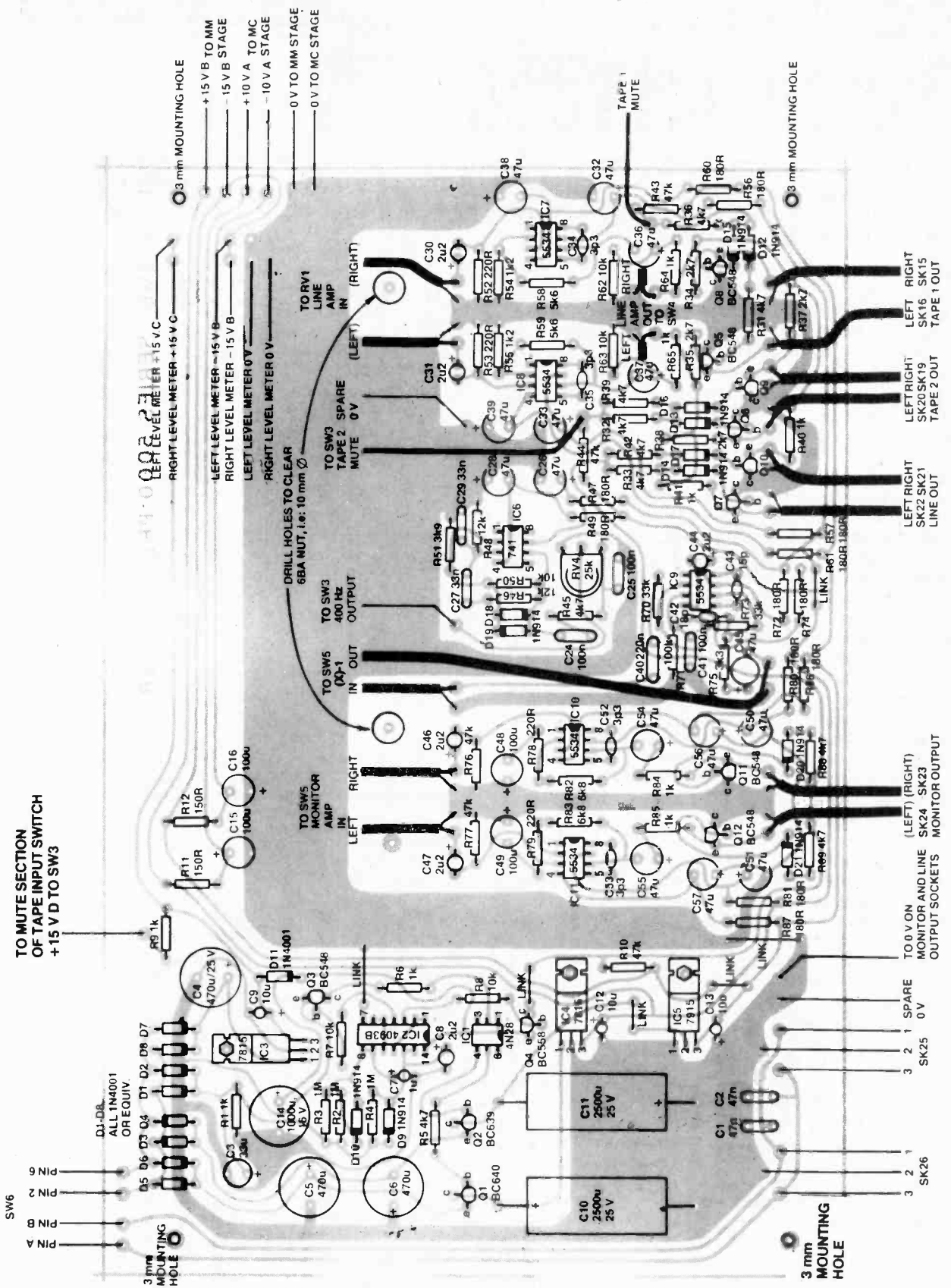

TO MUTE SECTION
OF TAPE INPUT SWITCH
+15 V D TO SW3

SW6

9 PIN
2 PIN
B PIN
A PIN

DJ-D8
ALL 1N4001
OR EQUIV

D5 D6 D3 D4 D1 D2 D8 D7

3 mm
MOUNTING
HOLE

3 mm MOUNTING HOLE

TO RV1
LINE
AMP
IN (RIGHT)

TO SW3
TAPE 2
MUTE 0V

TO SW3
400 Hz
IN OUT

TO SW5
00-1
IN OUT

TO SW5
MONITOR
AMP
IN LEFT

TO SW5
MONITOR
AMP
IN RIGHT

TO SW3
TAPE 2
MUTE 0V

TO RV1
LINE
AMP
IN (LEFT)

TO SW3
TAPE 2
MUTE 0V

TO SW3
400 Hz
IN OUT

TO SW5
00-1
IN OUT

TO SW5
MONITOR
AMP
IN LEFT

TO SW5
MONITOR
AMP
IN RIGHT

TO SW3
TAPE 2
MUTE 0V

TO RV1
LINE
AMP
IN (RIGHT)

DRILL HOLES TO CLEAR
6BA NUT, i.e. 10 mm Ø

+15 V B TO MM
-15 V B STAGE
+10 V A TO MC
-10 V A STAGE
0 V TO MM STAGE
0 V TO MC STAGE

3 mm
MOUNTING
HOLE

Series 5000 Preamp

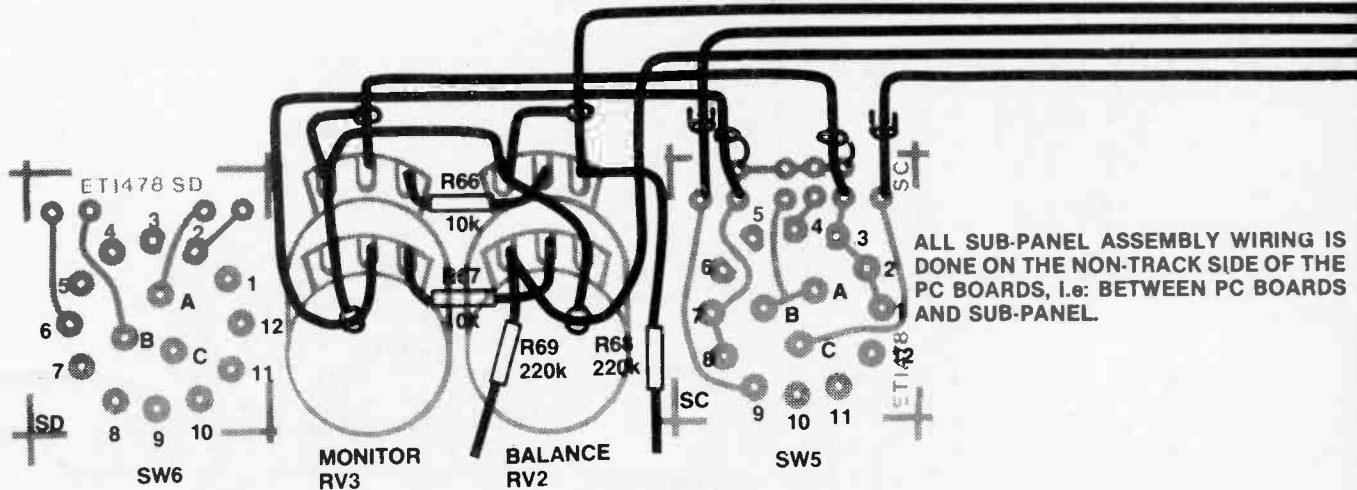

ALL SUB-PANEL ASSEMBLY WIRING IS DONE ON THE NON-TRACK SIDE OF THE PC BOARDS, I.e: BETWEEN PC BOARDS AND SUB-PANEL.

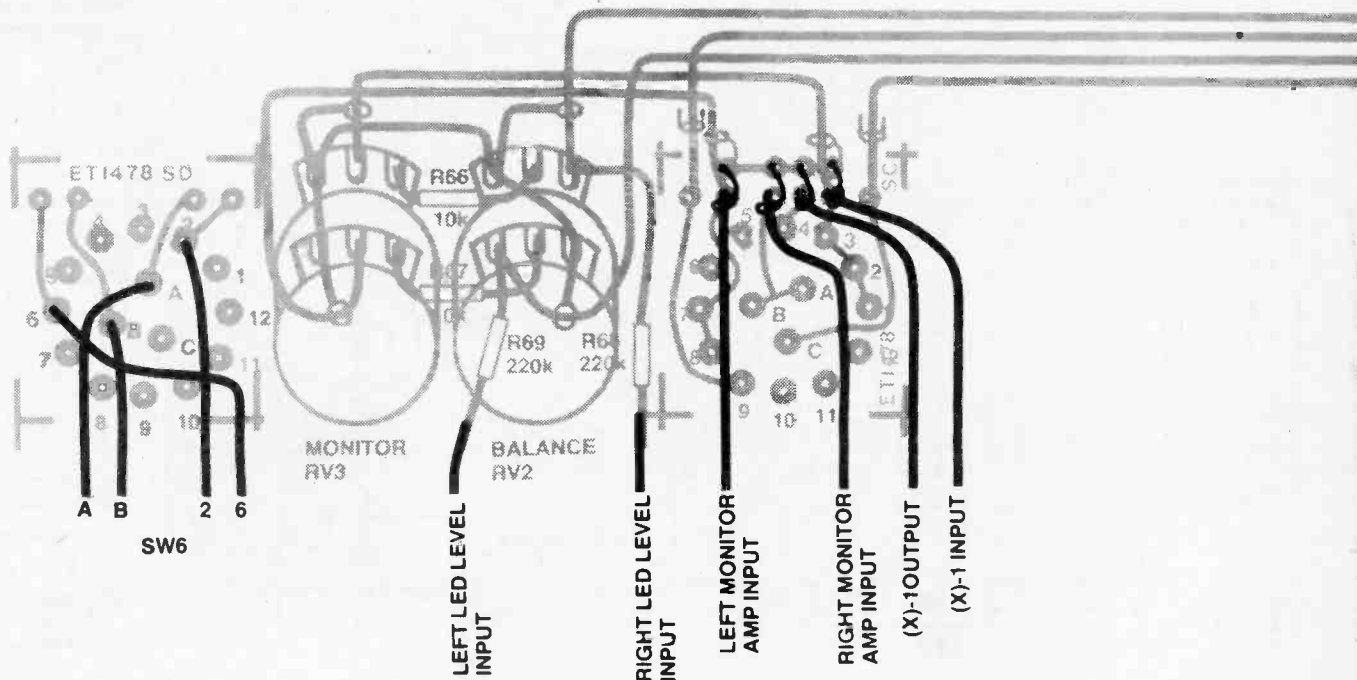
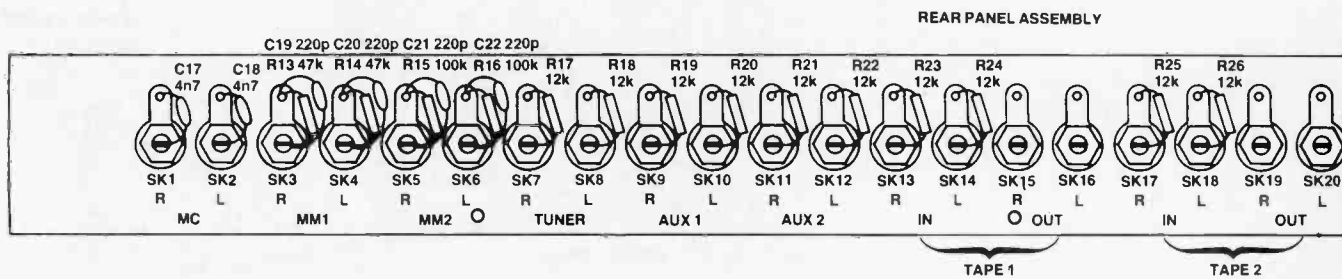

FIRST STAGE OF SUB-PANEL ASSEMBLY WIRING Note that all this wiring is done from the non-track side of the pc boards - cables between the pc boards and the sub-panel

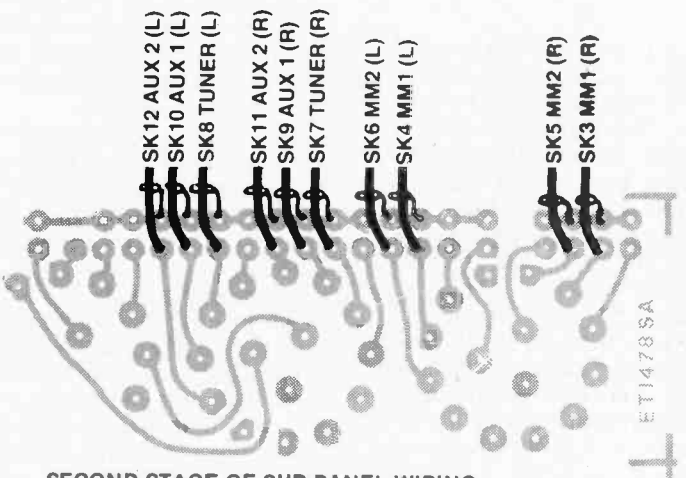
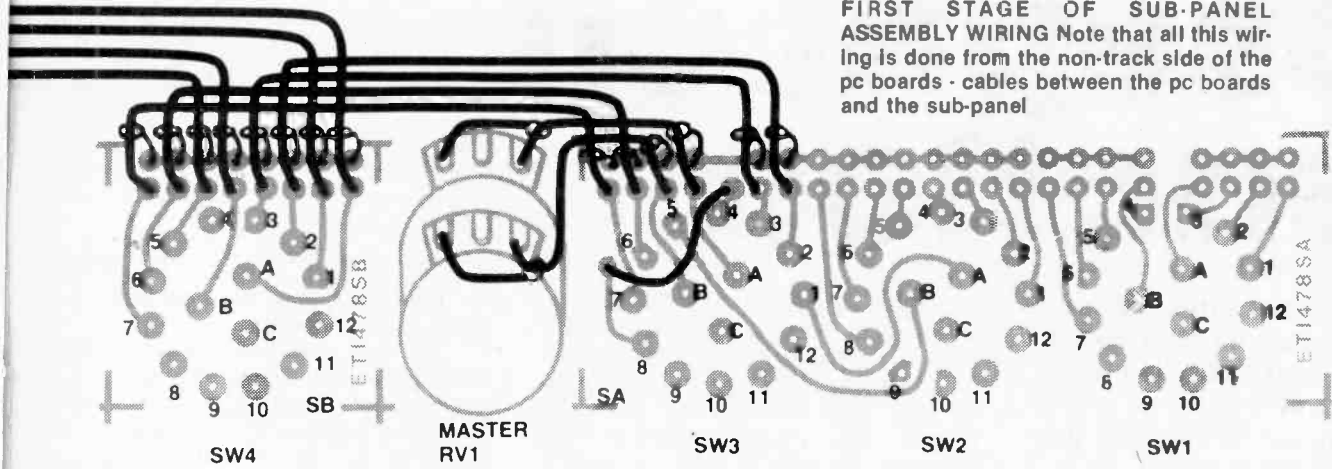

SECOND STAGE OF SUB-PANEL WIRING
This too is done from the non-track side of the board.

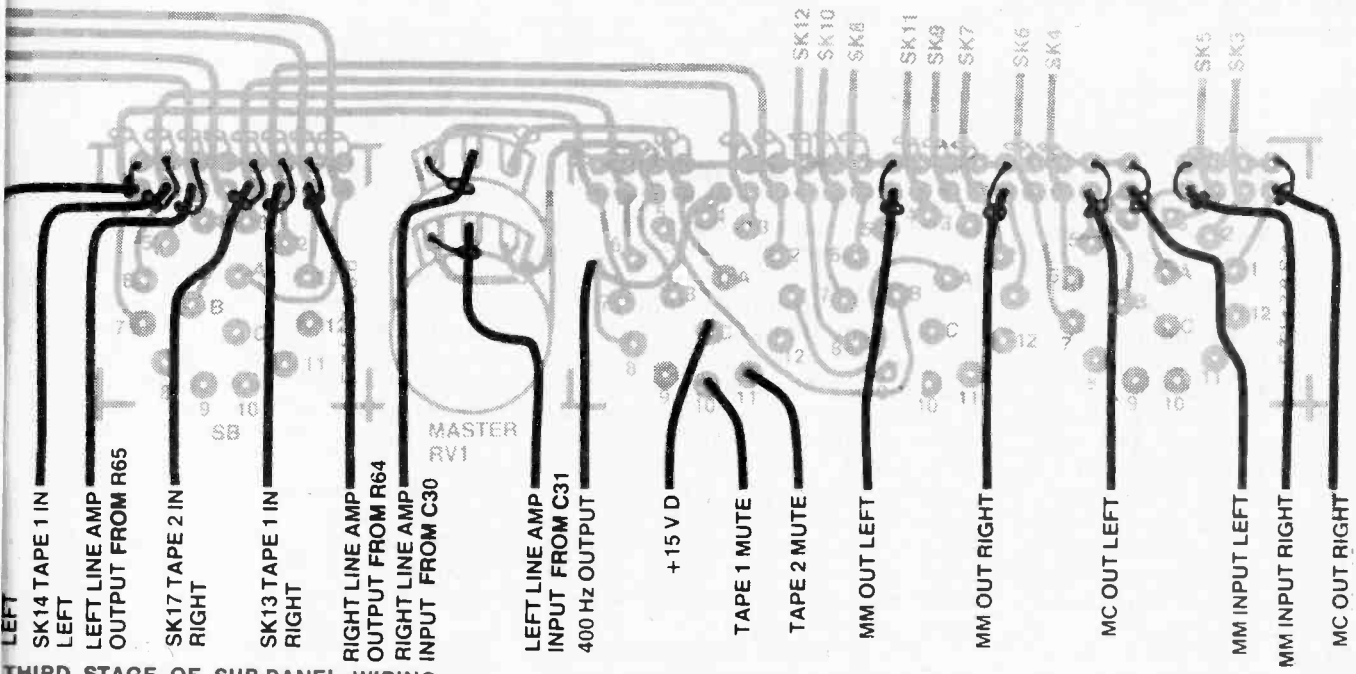
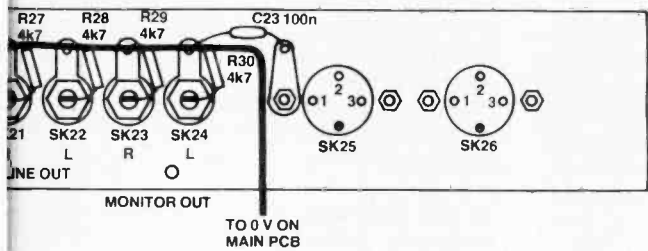

THIRD STAGE OF SUB-PANEL WIRING
This is done from the track side of the pc boards.

Josephson Junction

By 1990, most of the space in your micro may be filled with a helium refrigerator. The important part will occupy a cubic inch or so, but will do the job of one of today's mainframes. Jim McCartney explains.

IT ISN'T EASY to see how the present TTL and NMOS logic of the current generation of micros can be pushed much further. The next few years will probably make 16 and 32 bit CPU chips common enough, as well as 64K bit memory chips, but there are two barriers to progress. The first is the speed of operation, and the second is the heat dissipation.

On the Z80 chip, for example, the clock pulse rise time is 30 ns, and most other functions, which are more complex, take 100 ns (the propagation time) to change state. The limit of machine performance is therefore about one machine cycle every 250 ns. This allows for rises, falls, and a bit of time between. From this, it follows that the clock frequency is 4 MHz at the maximum.

Frying Chips

Furthermore, the Z80 can use up to a watt of energy. This is a lot of power over the area of the chip itself; about 3-4W per square centimetre. If we extended the area of the chip, or layered a lot of them on top of each other, this assembly would get very hot. As a useful comparison, the bar of an electric heater radiates about 6W per square centimetre. The chip is of course kept cool by conduction away through the connectors and the package, otherwise it might tend to glow dull red. Because of this high power dissipation, it is not possible with current electronic technology to make large scale integration more than about an order of magnitude larger than at present.

We can get faster junctions — TTL will give a propagation time of 5 ns at the best for a simple device, but it uses a lot more power; whereas CMOS, which uses less power, can't

manage much better than 100 ns for a simple gate. In any case, CMOS power requirements increase according to speed. CPU chips are far from simple, and propagation time is longer the more complex the systems, so NMOS gives a pretty good compromise between overheating and speed. The newer gallium arsenide technology promises that speeds can be increased by a great deal, but power dissipation is still likely to be a problem.

The design of a large CPU chip is not therefore just a matter of putting n times as many components on the chip to produce n times the result. While it would be wrong to suggest that byte size will not increase beyond, say 64 bits (and there isn't much reason why it should) it would clearly be a difficult job to design and even more difficult to manufacture in a reliable way, and might well require a pretty massive heatsink. In any case, it would be practically impossible to accommodate any useful amount of RAM on the same chip.

Beyond The Limits

The Josephson junction is of interest because it gets round the difficulties of power dissipation and of speed. It isn't really a transistor at all, nor is it a FET. It was discovered by Brian D Josephson at Cambridge in 1962. It operates on millivolts instead of volts and with perhaps one tenth of the usual sort of current, so that, for equivalent circuitry, the power dissipation is about one tenthousandth of that of present technology. Furthermore it is incredibly fast; propagation times as short as 10 ps (10^{-11} s) have been recorded. It isn't easy to measure times as short as this: it is the time it takes light to travel 3mm. If 10 ps were scaled to 1s, 1s would become over 3000 years. The speed of light itself will then become the limiting feature in LSI design.

The principal disadvantage of the Josephson junction is that it only works at a few degrees above absolute zero; in order to do this it must be immersed in liquid helium. This is

because it depends on superconductivity for its properties.

As you probably know, many conductors lose all resistance as absolute zero is approached. Because of various quantum effects, a state is reached in which the normal mechanism of conductivity is changed, and instead of current being carried by single electrons loosely attached to the atoms of the conductor, it is carried by pairs of electrons which are weakly bound only to each other. They drift along with very little relation to the conductor except that they remain in it, and once moving, they will continue to move indefinitely. A current induced in a closed loop will therefore keep on circulating forever, unless it is interrupted. Such interruptions can be caused by:

- Warming the superconductor — a temperature of 7 or 8K is usually enough.
- The presence of a magnetic field. Magnetic fields are absolutely excluded from superconductors, but a moderate field will break in and stop the superconduction.
- An electric field. A potential gradient across a superconductor has a similar effect.

The Tunnel Effect

Another consequence of quantum mechanics is that you cannot say exactly where an electron is or how it is moving. This is the famous Heisenberg uncertainty principle. The possible position of an electron can't be described by its wave function, which extends over an appreciable distance, especially when the electron is not bound to an atom. This means that instead of saying that an electron is at a given point, all you can really say is that the probability of finding the electron at such and such a point is proportional to its wave function, which is centred at a given point.

Now suppose that we have two conductors separated by a very thin layer of insulator. The conductor at the left is negatively charged (it has spare electrons) while the conductor at the right of the insulator is neutral.

Consider an electron hard up against the insulation. Its wave function, which is quite independent of any material, extends all round it, and through the insulator. The wave function is therefore present to a small extent to the right of the insulator, and this means, as we have seen, that there is a distinct possibility of the electron being found on the right of the insulator, without having actually passed through it.

This is a bit like saying that although you have put the car in the garage for the night, and locked it up, there is a possibility that it will be found in the morning on the drive outside, or on the roof, or maybe in the kitchen, without having passed through the doors or walls. Fortunately, wave functions associated with motor vehicles or anything much heavier than elementary particles can be ignored for practical purposes.

Nevertheless, this means that the insulator does in effect pass electrons: although it is not a resistive material because its resistance is not proportional to thickness, but instead increases exponentially. Tunnelling can be distinguished from normal current flow in this way. It is also clear that the layer has got to be very thin; about 10^{-6} cm gives satisfactory results. However, this is very large compared to the size of the electron.

Now the tunnel effect takes place at any or all temperatures at which the materials are stable. What happens if we cool a tunnel junction, as described above, down to superconducting temperatures?

Weak Superconductors

It was this question that Josephson set out to answer. He found that under these conditions, tunnel barriers also became superconducting: the insulator turned into a perfect conductor! This sort of superconductor turned out to be a lot more susceptible to the influence of electrical or magnetic fields than a normal superconductor — it could be 'switched off' a lot more easily. The picture is not, in fact, quite as simple as that; arcane quantum mechanical effects produce peculiar oscillations both in space and in time, and for practical purposes it is helpful to have two or more junctions in parallel. This need not concern us for the moment.

The Josephson junction switch is made up as shown in Fig. 1. Current flows from superconductor B to superconductor C through the thin insulator, which is a weak superconductor A, it will generate a field which

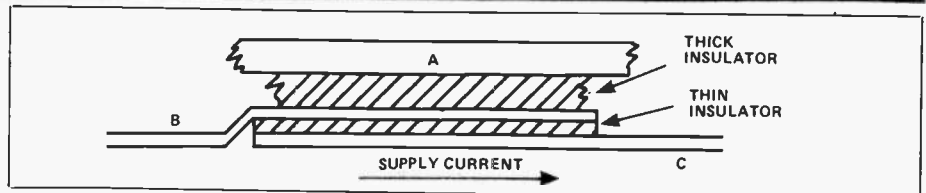

Fig. 1 Construction of the basic Josephson junction.

interests the weak superconductor, and destroys its superconductivity. It then reverts to being an insulator, and although the tunnel effect is still there, the resistance of the junction has jumped from zero to several hundred ohms. A potential difference now exists between B and C, and this gives quite a strong electrical field, which maintains the junction in its high resistance state even after the magnetic field is removed. What we have got is a latching switch. A latching switch appears to be of little use; in a computer built with latching switches everything hangs up after the first machine cycle. Therefore we have to reset all the switches, but this can only be done by returning all the supply voltages to zero. This, you may object, is not only tiresome in practice, but will wipe out all memory as well. Not so; there are convenient techniques for getting round these snags.

The AC Computer

You may have noted that nothing has been said so far about polarity. The main characteristic of conventional semiconductor devices is that they are polar and will not work if the supply voltage is connected the wrong way round; indeed they are generally destroyed for good. The Josephson junction, on the other hand, will work equally well with the voltage applied in either direction through the same junction, unlike a bridge rectifier or a triac. So all that is necessary to unlatch the switches is to reverse the current. The weak superconductor resumes its function when the electrical field across it approaches zero, and it starts conducting again. All we need to do is to run the thing on alternating current this also provides an infallible clock system.

It is no use trying to build a memory out of components which have zero voltage on them at any time in the cycle: we need something quite different. Here we make use of the best-known characteristic of superconductors, that of maintaining the current in a closed loop. In principle this is like the system where a charge is stored in a TTL dynamic memory cell, except that we substitute current for voltage, and in theory we never

need a refresh cycle.

Junctions, Field And Gates

You can see at once that the circuit elements are going to be quite unlike anything we are used to. It is interesting to see how they are made up and utilised.

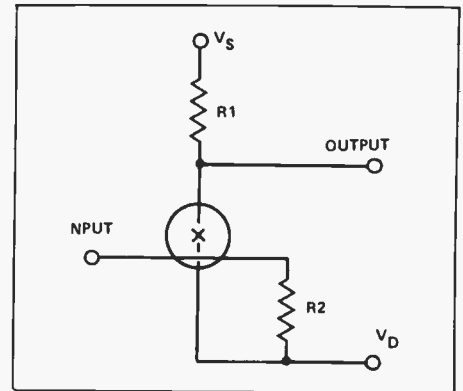

Fig. 2 The Josephson version of a buffer or switch.

A single buffer or switch is shown in Fig. 2. The junction is symbolised by the 'X'; in practice, as mentioned above, it will consist of two or more parallel junctions but this does not affect the argument. V_s is the source voltage, which may be either positive or negative, and V_D is the drain voltage, zero. R_1 limits the current through the junction (which otherwise provides a short circuit when conducting) and R_2 is an input impedance. Now if there is no input current, the junction is conducting and the voltage of the output must be zero. This happens when the input voltage is also zero. Suppose we apply some voltage on the input; the resulting current creates a magnetic field round the junction, and the junction resistance jumps to several hundred ohms. The output voltage will then jump from zero to a value determined by this latter resistance and R_1 . This gives us a non-inverting buffer: an inverter can be made simply by reversing the gate and the resistor (Fig. 3), and an OR gate by having two inputs (Fig. 4).

The AND gate uses a rather different and more complex system: this depends on the fact that too large a current flowing through a supercon-

Josephson Junctions

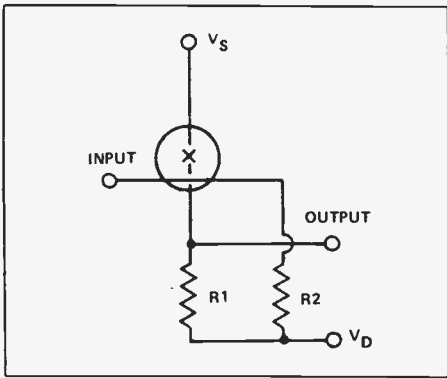

Fig. 3 Implementation of an inverter.

ductor will itself switch the superconductor off. Two input currents are arranged to pass through a pair of junctions: if these add to give a sufficient current, the junctions are triggered to the off state.

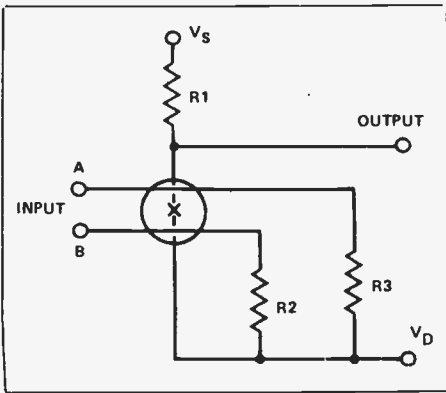

Fig. 4 With two inputs the junction becomes an OR gate.

In practice, each logic device will be followed by a non-inverting buffer. One circuit element can in theory trigger an infinite number of others: all that is necessary is to pass the output current through the necessary inputs in series (Fig. 5). In practice there is a sufficiently high fan-out for any conceivable purpose.

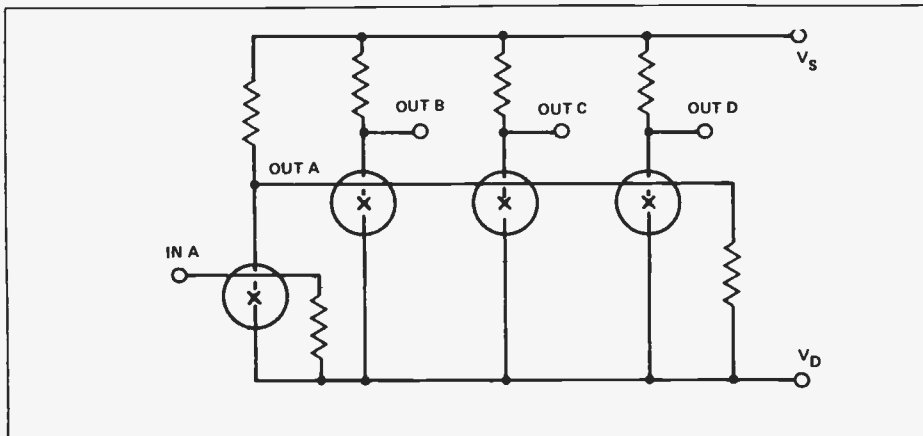

Fig. 5 One buffer driving three others.

Memory cells bear more resemblance to the old-fashioned core store than to any semiconductor device. Their operation is shown in Fig. 6. This system is very fast and non-volatile; it would probably be used for immediate access memory. A slower system which is erased by reading can be used for back-up.

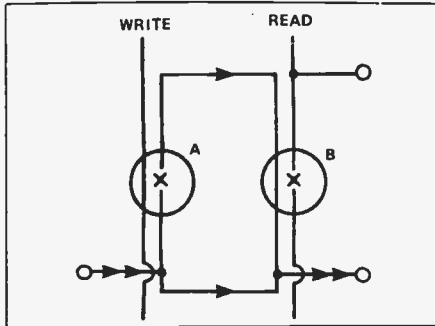

Fig. 6a A superconducting memory element. A current is passed through the memory loop and divides between the two branches.

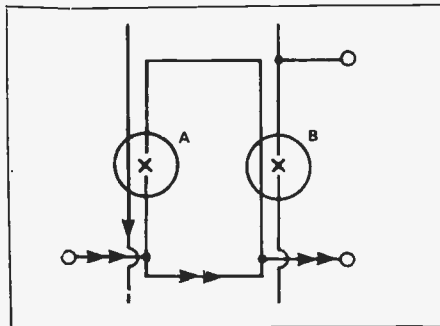

Fig. 6b A 'Write' current is passed, opening junction A. The loop current passes through the other arm.

High Velocity, Low Volume

Light travels about a foot in 1 ns; electric current in a conductor is propagated at perhaps a third of this speed, depending on capacitance

and inductance. It is estimated that a Josephson junction computer might

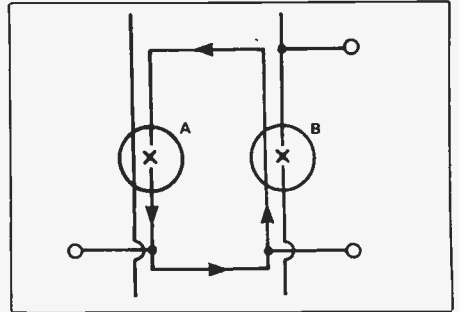

Fig. 6c. Both supply currents are turned off. Junction A becomes superconductive again and the current which flowed in the lower arm now continues around the upper arm.

have a machine cycle time of 3 ns at the best: this corresponds to an AC cycle of 6 ns or a frequency of 167 MHz. To keep all components in good synchronisation the maximum size of a computer should be an order of magnitude less than the distance which light can travel in 3 ns, since all routes are not direct in the circuit and some will be more affected by capacitance and inductance problems than others. This gives a requirement for a computer and memory a few centimetres along each side.

This can be constructed by using a micro-motherboard system, in which several chips are made on a microcard, which is slotted into the motherboard. The cards and motherboard are made by the same techniques as the chip itself, using a silicon base. The whole assembly is then put

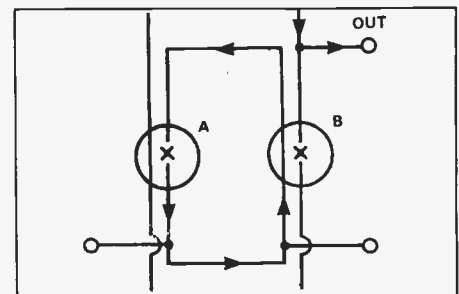

Fig. 6d. This disables junction B so that any subsequent 'read' current is diverted to the output.

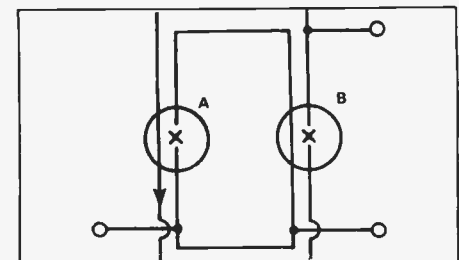

Fig. 6e A 'write' current without an applied loop current will open junction A again and stop the circulating current. This enables B again.

ETI Staff Vacancies

We are looking for one, possibly two, people to join the editorial side of ETI and associated publications. The positions will involve subbing (preparing articles for publication), proof reading and a considerable degree of researching (mostly by mail, telephone and reading).

Essential requirements are a fair degree of technical literacy and an ability to spell. An understanding of electronics and computing (though not necessarily to an advanced degree) is also necessary. We expect to have to train the successful candidates in areas other than these requirements. We do not maintain a large staff and therefore flexibility and willingness to tackle a wide variety of tasks is needed. Both are new, full-time positions. Initial salary will be \$13,000 — \$15,000 p.a. (depending on skills and experience) plus an excellent benefits package. **There are unusually good chances of promotion associated with these positions.** Final date for applications is January 14th, 1983. Contact:

The Editor
ETI Magazine
Unit 6, 25 Overlea Blvd.,
Toronto, Ont.
M4H 1B1

\$50,000 Reward

That is how much we have budgetted for payment to free-lance editorial contributors during 1983 for ETI and our sister publications.

We are looking for additional writers to add to our regular team, few of who have had previous journalistic experience. We do however need people who are well informed in specific technical areas and/or are good at research.

If you are interested in finding out more send a stamped, self-addressed envelope to the Editor at ETI. We will send you: a) our guideline notes for authors and b) a list of specific articles we are looking for.

ARE YOU IN THE DARK?



Thirty eight years of relentless struggle with his home made television. The 12AX7s finally deliver. The picture is 3" by 4" and bright green!

SUBSCRIBE TODAY!

The progress of electronics these days is truly astonishing. What's commonplace today, would have been miraculous ten years ago. Today's dreams will be tomorrow's reality.

Electronics Today focuses on the current electronics scene in Canada. You can buy ETI on the newsstand every month, or you can take out a subscription.

12 ETI's (one year) will cost you \$18.95, \$33.95 for two years. Use the convenient order form or send cheque of Money Order to:

**Electronics Today International
Unit 6, 25 Overlea Blvd.
Toronto, Ontario, M4H 1B1**

COMPUTERS (HARDWARE)

THE ESSENTIAL COMPUTER DICTIONARY AND SPELLER AB011 10.45

A must for anyone just starting out in the field of computing, be they a businessman, hobbyist or budding computerist. The book presents and defines over 15,000 computer terms and acronyms and makes for great browsing.

A BEGINNER'S GUIDE TO COMPUTERS AND MICROPROCESSORS — WITH PROJECTS TAB No.1015 \$13.45

Here's a plain English introduction to the world of microcomputers — it's capabilities, parts and functions — and how you can use one. Numerous projects demonstrate operating principles and lead to the construction of an actual working computer capable of performing many useful functions.

BP66: BEGINNERS GUIDE TO MICROPROCESSORS AND COMPUTING E.F. SCOTT, M.Sc., C.Eng. \$7.55

As indicated by the title, this book is intended as an introduction to the basic theory and concepts of binary arithmetic, microprocessor operation and machine language programming.

There are occasions in the text where some background information might be helpful and a Glossary is included at the end of the book.

BP72: A MICROPROCESSOR PRIMER E.A. PARR, B.Sc., C.Eng., M.I.E.E. \$7.70

A newcomer to electronics tends to be overwhelmed when first confronted with articles or books on microprocessors. In an attempt to give a painless approach to computing, this small book will start by designing a simple computer and because of its simplicity and logical structure, the language is hopefully easy to learn and understand. In this way, such ideas as Relative Addressing, Index Registers etc. will be developed and it is hoped that these will be seen as logical progressions rather than arbitrary things to be accepted but not understood.

BEGINNERS GUIDE TO MICROPROCESSORS TAB No.995 \$10.45

If you aren't sure exactly what a microprocessor is, then this is the book for you. The book takes the beginner from the basic theories and history of these essential devices, right up to some real world hardware applications.

HOW TO BUILD YOUR OWN WORKING MICROCOMPUTER TAB No.1200 \$16.45

An excellent reference or how-to manual on building your own microcomputer. All aspects of hardware and software are developed as well as many practical circuits.

BP78: PRACTICAL COMPUTER EXPERIMENTS E.A. PARR, B.Sc., C.Eng., M.I.E.E. \$7.30

Curiously most published material on the microprocessor tends to be of two sorts, the first treats the microprocessor as a black box and deals at length with programming and using the "beast". The second type of book deals with the social impact. None of these books deal with the background to the chip, and this is a shame as the basic ideas are both interesting and simple.

This book aims to fill in the background to the microprocessor by constructing typical computer circuits in discrete logic and it is hoped that this will form a useful introduction to devices such as adders, memories, etc. as well as a general source book of logic circuits.

HANDBOOK OF MICROPROCESSOR APPLICATIONS TAB No.1203 \$14.45

Highly recommended reading for those who are interested in microprocessors as a means of accomplishing a specific task. The author discusses two individual microprocessors, the 1802 and the 6800, and how they can be put to use in real world applications.

MICROPROCESSOR/MICROPROGRAMMING HANDBOOK TAB No.785 \$14.45

A comprehensive guide to microprocessor hardware and programming. Techniques discussed include subroutines, handling interrupts and program loops.

BP102: THE 6809 COMPANION M. JAMES \$8.10

The 6809 microprocessor's history, architecture, addressing modes and the instruction set (fully commented) are covered. In addition there are chapters on converting programs from the 6800, programming style, interrupt handling and about the 6809 hardware and software available.

AN INTRODUCTION TO MICROPROCESSORS EXPERIMENTS IN DIGITAL TECHNOLOGY HB07: \$15.85 SMITH

A "learn by doing" guide to the use of integrated circuits provides a foundation for the underlying hardware actions of programming statements. Emphasis is placed on how digital circuitry compares with analog circuitry. Begins with the simplest gates and timers, then introduces the fundamental parts of ICs, detailing the benefits and pitfalls of major IC families, and continues with coverage of the ultimate in integrated complexity — the microprocessor.

DESIGNING MICROCOMPUTER SYSTEMS HB18: \$15.85

POOCH AND CHATTERGY
This book provides both hobbyists and electronic engineers with the background information necessary to build microcomputer systems. It discusses the hardware aspects of microcomputer systems. Timing devices are provided to explain sequences of operations in detail. Then, the book goes on to describe three of the most popular microcomputer families: the Intel 8080, Zilog Z-80, and Motorola 6800. Also covered are designs of interfaces for peripheral devices, and information on building microcomputer systems from kits.

S-100 BUS HANDBOOK HB19: \$22.75 BURSLEY

Here is a comprehensive book that exclusively discusses S-100 bus computer systems and how they are organized. The book covers computer fundamentals, basic electronics, and the parts of the computer. Individual chapters discuss the CPU, memory, input/output, bulk-memory devices, and specialized peripheral controllers. It explains all the operating details of commonly available S-100 systems. Schematic drawings.

BASIC MICROPROCESSORS AND THE 6800 HB06: \$21.45

Provides two books in one: a basic guide to microprocessors for the beginner, and a complete description of the M6800 system for the engineer.

Each chapter is followed by a problem section.

DIGITAL INTERFACING WITH AN ANALOG WORLD TAB No.1070 \$14.45

You've bought a computer, but now you can't make it do anything useful. This book will tell you how to convert real world quantities such as temperature, pressure, force and so on into binary representation.

MICROPROCESSOR INTERFACING HANDBOOK: AID & DIA TAB No.1271 \$14.45

A useful handbook for computerists interested in using their machines in linear applications. Topics discussed include voltage references, op-amps for data conversion, analogue switching and multiplexing and more.

COMPUTER TECHNICIAN'S HANDBOOK TAB No.554 \$17.45

Whether you're looking for a career, or you are a service technician, computer repair is an opportunity you should be looking at. The author covers all aspects of digital and computer electronics as well as the mathematical and logical concepts involved.

HOW TO TROUBLESHOOT AND REPAIR MICROCOMPUTERS AB013 \$13.45

Learn how to find the cause of a problem or malfunction in the central or peripheral unit of any microcomputer and then repair it. The tips and techniques in this guide can be applied to any equipment that uses the microprocessor as the primary control element.

TROUBLESHOOTING MICROPROCESSORS AND DIGITAL LOGIC TAB No.1183 \$13.45

The influence of digital techniques on commercial and home equipment is enormous and increasing yearly. This book discusses digital theory and looks at how to service Video Cassette Recorders, microprocessors and more.

HOW TO DEBUG YOUR PERSONAL COMPUTER AB012 \$13.45

When you feel like reaching for a sledge hammer to reduce your computer to fiberglass and epoxy dust, don't. Reach for this book instead and learn all about program bug tracking, recognition and elimination techniques.

COMPUTERS (SOFTWARE)

BP109: THE ART OF PROGRAMMING THE 1K ZX81 M. JAMES and S.M. GEE \$8.10

This book shows you how to use the features of the ZX81 in programs that fit into the 1K machine and are still fun to use. Chapter Two explains the random number generator and uses it to simulate coin tossing and dice throwing and to play pon-toon. Chapter Three shows the patterns you can display using the ZX81's graphics. Its animated graphics capabilities, explored in Chapter Four, have lots of potential for use in games of skill, such as Lunar Lander and Cannon-ball which are given as complete programs. Chapter Five explains PEEK and POKE and uses them to display large characters. The ZX81's timer is explained in Chapter Six and used for a digital clock, a chess clock and a reaction time game. Chapter Seven is about handling character strings and includes three more ready-to-run programs—Hangman, Coded Messages and a number guessing game. In Chapter Eight there are extra programming hints to help you get even more out of your 1K ZX81.

BEGINNER'S GUIDE TO COMPUTER PROGRAMMING TAB No.574 \$16.45

Computer programming is an increasingly attractive field to the individual, however many people seem to overlook it as a career. The material in this book has been developed in a logical sequence, from the basic steps to machine language.

HOW TO PROFIT FROM YOUR PERSONAL COMPUTER: PROFESSIONAL, BUSINESS, AND HOME APPLICATIONS LEWIS HB01 \$17.00

Describes the uses of personal computers in common business applications, such as accounting, managing, inventory, sorting mailing lists, and many others. The discussion in-

cludes terms, notations, and techniques commonly used by programmers. A full glossary of terms.

PROGRAMS FOR BEGINNERS ON THE TRS-80 BLECHMAN HB02 \$13.05

A valuable book of practical and interesting programs for home use that can be understood and used immediately by the beginner in personal computer programming. You'll learn step-by-step how 21 sample TRS-80 programs work. Program techniques are described line-by-line within the program, and a unique Martri-Dex™ matrix index will enable you to locate other programs using the same BASIC commands and statements.

THE JOY OF MINIS AND MICROS: DATA PROCESSING WITH SMALL COMPUTERS STEIN AND SHAPIRO HB03 \$15.85

A collection of pieces covering technical and management aspects of the use of small computers for business or science. It emphasizes the use of common sense and good systems design for every computer project. Because a strong technical background is not necessary, the book is easy to read and understand. Considerable material is devoted to the question of what size computer should be used for a particular job, and how to choose the right machine for you.

USING MICROCOMPUTERS IN BUSINESS VEIT HB04 \$14.45

An essential background briefing for any purchaser of microcomputer systems or software. In a fast-moving style, without the usual buzz words and technical jargon, Veit answers the most often asked questions.

BASIC FROM THE GROUND UP SIMON HB15 \$17.00

Here's a BASIC text for high school students and hobbyists that explores computers and the BASIC language in a simple direct way, without relying on a heavy mathematical background on the reader's part. All the features of BASIC are included as well as some of the inside workings of a computer. The book covers one version of each of the BASIC statements and points out some of the variations, leaving readers well prepared to write programs in any version they encounter. A selection of exercises and six worked out problems round out the reader's experience. A glossary and a summary of BASIC statements are included at the end of the book for quick reference.

BASIC COMPUTER PROGRAMS FOR BUSINESS: STERNBERG (Vol. 1) HB13 \$15.85

A must for small businesses utilizing micros as well as for entrepreneurs, volume provides a wealth of practical business applications. Each program is documented with a description of its functions and operation, a listing in BASIC, a symbol table, sample data, and one or more samples.

BP86: AN INTRODUCTION TO BASIC PROGRAMMING TECHNIQUES S. DALY \$8.25

This book is based on the author's own experience in learning BASIC and in helping others, mostly beginners, to program and understand the language. Also included are a program library containing various programs, that the author has actually written and run. These are for biorhythms, plotting a graph of Y against X, standard deviation, regression, generating a musical note sequence and a card game. The book is complemented by a number of appendices which include test questions and answers on each chapter and a glossary.

THE BASIC COOKBOOK TAB No.1055 \$9.45

BASIC is a surprisingly powerful language... if you understand it completely. This book, picks up where most manufacturers' documentation gives up. With it, any computer owner can develop programs to make the most out of his or her machine.

FET BASIC — TRAINING YOUR PET COMPUTER AB014 \$17.45

Officially approved by Commodore, this is the ideal reference book for long time PET owners or novices. In an easy to read and humorous style, this book describes techniques and experiments, all designed to provide a strong understanding of this versatile machine.

PROGRAMMING IN BASIC FOR PERSONAL COMPUTERS AB015 \$13.45

This book emphasizes the sort of analytical thinking that lets you use a specific tool — the BASIC language — to transform your own ideas into workable programs. The text is designed to help you to intelligently analyse and design a wide diversity of useful and interesting programs.

COMPUTER PROGRAMS IN BASIC AB001 \$15.45

A catalogue of over 1,600 fully indexed BASIC computer programs with applications in Business, Math, Games and more. This book lists available software, what it does, where to get it, and how to adapt it to your machine.

FET GAMES AND RECREATION AB002 \$17.45

A variety of interesting games designed to amuse and educate. Games include such names as Capture, Tic Tac Toe, Watchperson, Motie, Sinners, Martian Hunt and more.

BRAIN TICKLERS AB005 \$9.00

If the usual games such as Bug Stomp and Invaders From the Time Warp are starting to pale, then this is the book for you. The authors have put together dozens of stimulating puzzles to show you just how challenging computing can be.

PASCAL
TAB No.1205 \$16.45
 Aimed specifically at TRS-80 users, this book discusses how to load, use and write PASCAL programs. Graphic techniques are discussed and numerous programs are presented.

PASCAL PROGRAMMING FOR THE APPLE
AB008 \$17.45
 A great book to upgrade your programming skills to the UCSD Pascal as implemented on the Apple II. Statements and techniques are discussed and there are many practical and ready to run programs.

APPLE MACHINE LANGUAGE PROGRAMMING
AB009 \$20.45
 The best way to learn machine language programming the Apple II in no time at all. The book combines colour, graphics, and sound generation together with clear cut demonstrations to help the user learn quickly and effectively.

Z80 USERS MANUAL
AB010 \$21.45
 The Z80 MPU can be found in many machines and is generally acknowledged to be one of the most powerful 8 bit chips around. This book provides an excellent 'right hand' for anyone involved in the application of this popular processor.

HOW TO PROGRAM YOUR PROGRAMMABLE CALCULATOR
AB006 \$12.45
 Calculator programming, by its very nature, often is an obstacle to effective use. This book endeavours to show how to use a programmable calculator to its full capabilities. The TI 57 and the HP 33E calculators are discussed although the principles extend to similar models.

Z-80 AND 8080 ASSEMBLY LANGUAGE PROGRAMMING
SPRACKLEN
HB05 \$14.25
 Provides just about everything the applications programmer needs to know for Z-80 and 8080 processors. Programming techniques are presented along with the instructions. Exercises and answers included with each chapter.

BASIC COMPUTER PROGRAMS IN SCIENCE AND ENGINEERING
GILDER
HB08 \$15.85
 Save time and money with this collection of 114 ready-to-run BASIC programs for the hobbyist and engineer. There are programs to do such statistical operations as means, standard deviation averages, curve-fitting, and interpolation. There are programs that design antennas, filters, attenuators, matching networks, plotting, and histogram programs.

GAME PLAYING WITH COMPUTERS SECOND EDITION
SPENCER
HB11 \$31.25
 Now you can sharpen programming skills through a relaxed approach. Completely devoted to computerized game playing, this volume presents over 70 games, puzzles, and mathematical recreations for a digital computer. It's fully illustrated and includes more than 25 game-playing programs in FORTRAN or BASIC complete with descriptions, flowcharts, and output.

MICROCOMPUTERS AND THE 3 R'S
DOERR
HB09 \$14.25
 This book educates educators on the various ways computers, especially microcomputers, can be used in the classroom. It describes microcomputers, how to organize a computer-based program, the five instructional application types (with examples from subjects such as the hard sciences, life sciences, English, history, and government), and resources listings of today's products. The book includes preprogrammed examples to start up a microcomputer program; while chapters on resources and products direct the reader to useful additional information. All programs are written in the BASIC language.

GAME PLAYING WITH BASIC
SPENCER
HB10 \$15.25
 The writing is nontechnical, allowing almost anyone to understand computerized game playing. The book includes the rules of each game, how each game works, illustrative flowcharts, diagrams, and the output produced by each program. The last chapter contains 26 games for reader solution.

SARGON: A COMPUTER CHESS PROGRAM
SPRACKLEN
HB12 \$25.00
 "I must rate this chess program an excellent buy for anyone who loves the game." Kilobaud.
 Here is the computer chess program that won first place in the first chess tournament at the 1978 West Coast Computer Faire. It is written in Z-80 assembly language, using the TDL macro assembler. It comes complete with block diagram and sample printouts.

A CONSUMER'S GUIDE TO PERSONAL COMPUTING AND MICROCOMPUTERS, SECOND EDITION
FREIBERGER AND CHEW
HB14 \$14.45
 The first edition was chosen by Library Journal as one of the 100 outstanding sci-tech books of 1978. Now, there's an updated second edition!
 Besides offering an introduction to the principles of microcomputers that assumes no previous knowledge on the reader's part, this second edition updates prices, the latest developments in microcomputer technology, and a review of over 100 microcomputer products from over 60 manufacturers.

THE BASIC CONVERSIONS HANDBOOK FOR APPLE, TRS-80, AND PET USERS
BRAIN BANK
HB17 \$11.75
 Convert a BASIC program for the TRS-80, Apple II, or PET to the form of BASIC used by any other one of those machines. This is a complete guide to converting Apple II and PET programs to TRS-80, TRS-80 and PET programs to Apple II, TRS-80 and Apple II programs to PET. Equivalent commands are listed for TRS-80 BASIC (Model I, Level II), Applesoft BASIC and PET BASIC, as well as variations for the TRS-80 Model III and Apple Integer BASIC.

SPEAKING PASCAL
BOWEN
HB16 \$17.25
 An excellent introduction to programming in the Pascal language! Written in clear, concise, non-mathematical language, the text requires no technical background or previous programming experience on the reader's behalf. Top-down structured analysis and key examples illustrate each new idea and the reader is encouraged to construct programs in an organized manner.

BP33: ELECTRONIC CALCULATOR USERS HANDBOOK \$4.25
M.H. BABANI, B.Sc.(Eng.)
 An invaluable book for all calculator users whatever their age or occupation, or whether they have the simplest or most sophisticated of calculators. Presents formulae, data, methods of calculation, conversion factors, etc., with the calculator user especially in mind; often illustrated with simple examples. Includes the way to calculate using only a simple four function calculator: Trigonometric Functions (Sin, Cos, Tan) Hyperbolic Functions (Sinh, Cosh, Tanh) Logarithms, Square Roots and Powers.

THE MOST POPULAR SUBROUTINES IN BASIC
TAB No.1050 \$10.45
 An understandable guide to BASIC subroutines which enables the reader to avoid tedium, economise on computer time and makes programs run faster. It is a practical rather than a theoretical manual.

PROJECTS

BP48: ELECTRONIC PROJECTS FOR BEGINNERS \$5.90
F.G. RAYER, T.Eng.(CEI), Assoc.IERE
 Another book written by the very experienced author — Mr. F.G. Rayer — and in it the newcomer to electronics, will find a wide range of easily made projects. Also, there are a considerable number of actual component and wiring layouts, to aid the beginner.

Furthermore, a number of projects have been arranged so that they can be constructed without any need for soldering and, thus, avoid the need for a soldering iron.
 Also, many of the later projects can be built along the lines as those in the 'No Soldering' section so this may considerably increase the scope of projects which the newcomer can build and use.

221: 28 TESTED TRANSISTOR PROJECTS \$5.50
R.TORRENS
 Mr. Richard Torrens is a well experienced electronics development engineer and has designed, developed, built and tested the many useful and interesting circuits included in this book. The projects themselves can be split down into simpler building blocks, which are shown separated by boxes in the circuits for ease of description, and also to enable any reader who wishes to combine boxes from different projects to realise ideas of his own.

BP49: POPULAR ELECTRONIC PROJECTS \$6.25
R.A. PENFOLD
 Includes a collection of the most popular types of circuits and projects which, we feel sure, will provide a number of designs to interest most electronics constructors. The projects selected cover a very wide range and are divided into four basic types: Radio Projects, Audio Projects, Household Projects and Test Equipment.

EXPERIMENTER'S GUIDE TO SOLID STATE ELECTRONIC PROJECTS
AB007 \$10.45
 An ideal sourcebook of Solid State circuits and techniques with many practical circuits. Also included are many useful types of experimenter gear.

BP71: ELECTRONIC HOUSEHOLD PROJECTS \$7.70
R. A. PENFOLD
 Some of the most useful and popular electronic construction projects are those that can be used in or around the home. The circuits range from such things as '2 Tone Door Buzzer', Intercom, through Smoke or Gas Detectors to Baby and Freezer Alarms.

BP94: ELECTRONIC PROJECTS FOR CARS AND BOATS \$8.10
R.A. PENFOLD
 Projects, fifteen in all, which use a 12V supply are the basis of this book. Included are projects on Windscreen Wiper Control, Courtesy Light Delay, Battery Monitor, Cassette Power Supply, Lights Timer, Vehicle Immobiliser, Gas and Smoke Alarm, Depth Warning and Shaver Inverter.

BP69: ELECTRONIC GAMES \$7.55
R.A. PENFOLD
 In this book Mr. R. A. Penfold has designed and developed a number of interesting electronic game projects using modern integrated circuits. The text is divided into two sections, the first dealing with simple games and the latter dealing with more complex circuits.

BP95: MODEL RAILWAY PROJECTS \$8.10
 Electronic projects for model railways are fairly recent and have made possible an amazing degree of realism. The projects covered include controllers, signals and sound effects: stiboard layouts are provided for each project.

BP93: ELECTRONIC TIMER PROJECTS \$8.10
F.G. RAYER
 Windscreen wiper delay, darkroom timer and metronome projects are included. Some of the more complex circuits are made up from simpler sub-circuits which are dealt with individually.

110 OP-AMP PROJECTS
MARSTON
HB24 \$11.75
 This handbook outlines the characteristics of the op-amp and present 110 highly useful projects—ranging from simple amplifiers to sophisticated instrumentation circuits.

110 IC TIMER PROJECTS
GILDER
HB25 \$10.25
 This sourcebook maps out applications for the 555 timer IC. It covers the operation of the IC itself to aid you in learning how to design your own circuits with the IC. There are application chapters for timer-based instruments, automotive applications, alarm and control circuits, and power supply and converter applications.

110 THYRISTOR PROJECTS USING SCRs AND TRIACS
MARSTON
HB22 \$12.05
 A grab bag of challenging and useful semiconductor projects for the hobbyist, experimenter, and student. The projects range from simple burglar, fire, and water level alarms to sophisticated power control devices for electric tools and trains. Integrated circuits are incorporated wherever their use reduces project costs.

110 CMOS DIGITAL IC PROJECTS
MARSTON
HB23 \$11.75
 Outlines the operating characteristics of CMOS digital ICs and then presents and discusses 110 CMOS digital IC circuits ranging from inverter gate and logic circuits to electronic alarm circuits. Ideal for amateurs, students and professional engineers.

BP76: POWER SUPPLY PROJECTS \$7.30
R.A. PENFOLD
 Line power supplies are an essential part of many electronics projects. The purpose of this book is to give a number of power supply designs, including simple unregulated types, fixed voltage regulated types, and variable voltage stabilised designs, the latter being primarily intended for use as bench supplies for the electronics workshop. The designs provided are all low voltage types for semiconductor circuits.

There are other types of power supply and a number of these are dealt with in the final chapter, including a cassette power supply, Ni-Cad battery charger, voltage step up circuit and a simple inverter.

BP84: DIGITAL IC PROJECTS \$8.10
F.G. RAYER, T.Eng.(CEI), Assoc.IERE
 This book contains both simple and more advanced projects and it is hoped that these will be found of help to the reader developing a knowledge of the workings of digital circuits. To help the newcomer to the hobby the author has included a number of board layouts and wiring diagrams. Also the more ambitious projects can be built and tested section by section and this should help avoid or correct faults that could otherwise be troublesome. An ideal book for both beginner and more advanced enthusiast alike.

BP67: COUNTER DRIVER AND NUMERAL DISPLAY PROJECTS \$7.55
F.G. RAYER, T.Eng.(CEI), Assoc. IERE
 Numerical indicating devices have come very much to the forefront in recent years and will, undoubtedly, find increasing applications in all sorts of equipment. With present day integrated circuits, it is easy to count, divide and display numerically the electrical pulses obtained from a great range of driver circuits.

In this book many applications and projects using various types of numeral displays, popular counter and driver IC's etc. are considered.

BP73: REMOTE CONTROL PROJECTS \$8.60
OWEN BISHOP
 This book is aimed primarily at the electronics enthusiast who wishes to experiment with remote control. Full explanations have been given so that the reader can fully understand how the circuits work and can more easily see how to modify them for other purposes, depending on personal requirements. Not only are radio control systems considered but also infra-red, visible light and ultrasonic systems as are the use of Logic ICs and Pulse position modulation etc..

BP99: MINI — MATRIX BOARD PROJECTS \$8.10
R.A. PENFOLD
 Twenty useful projects which can all be built on a 24 x 10 hole matrix board with copper strips. Includes Doorbuzzer, Low-voltage Alarm, AM Radio, Signal Generator, Projector Timer, Guitar Headphone Amp, Transistor Checker and more.

BP103: MULTI-CIRCUIT BOARD PROJECTS \$8.10
R.A. PENFOLD
 This book allows the reader to build 21 fairly simple electronic projects, all of which may be constructed on the same printed circuit board. Wherever possible, the same components have been used in each design so that with a relatively small number of components and hence low cost, it is possible to make any one of the projects or by re-using the components and P.C.B. all of the projects.

BP107: 30 SOLDERLESS BREADBOARD PROJECTS — BOOK 1 \$9.35
R.A. PENFOLD
 A "Solderless Breadboard" is simply a special board on which electronic circuits can be built and tested. The components used are just plugged in and unplugged as desired. The 30 projects featured in this book have been specially designed to be built on a "Verobloc" breadboard. Wherever possible the components used are common to several projects, hence with only a modest number of reasonably inexpensive components it is possible to build, in turn, every project shown.

BP110: HOW TO GET YOUR ELECTRONIC PROJECTS WORKING R.A. PENFOLD \$8.10
We have all built circuits from magazines and books only to find that they did not work correctly, or at all, when first switched on. The aim of this book is to help the reader overcome just these problems by indicating how and where to start looking for many of the common faults that can occur when building up projects.

CIRCUITS

BP80: POPULAR ELECTRONIC CIRCUITS — BOOK 1 R.A. PENFOLD \$8.25
Another book by the very popular author, Mr. R.A. Penfold, who has designed and developed a large number of various circuits. These are grouped under the following general headings: Audio Circuits, Radio Circuits, Test Gear Circuits, Music Project Circuits, Household Project Circuits and Miscellaneous Circuits.

BP98: POPULAR ELECTRONIC CIRCUITS, BOOK 2 R.A. PENFOLD \$9.35
70 plus circuits based on modern components aimed at those with some experience.

The GIANT HANDBOOK OF ELECTRONIC CIRCUITS TAB No.1300 \$24.45
About as twice as thick as the Webster's dictionary, and having many more circuit diagrams, this book is ideal for any experimenter who wants to keep amused for several centuries. If there isn't a circuit for it in here, you should have no difficulty convincing yourself you don't really want to build it.

BP39: 50 (FET) FIELD EFFECT TRANSISTOR PROJECTS F.G. RAYER, T.Eng.(CEI), Assoc.IERE \$5.50
Field effect transistors (FETs) find application in a wide variety of circuits. The projects described here include radio frequency amplifiers and converters, test equipment and receiver aids, tuners, receivers, mixers and tone controls, as well as various miscellaneous devices which are useful in the home.
This book contains something of particular interest for every class of enthusiast — short wave listener, radio amateur, experimenter or audio devotee.

BP87: SIMPLE L.E.D. CIRCUITS R.N. SOAR \$5.90
Since it first appeared in 1977, Mr. R.N. Soar's book has proved very popular. The author has developed a further range of circuits and these are included in Book 2. Projects include a Transistor Tester, Various Voltage Regulators, Testers and so on.

BP42: 50 SIMPLE L.E.D. CIRCUITS R.N. SOAR \$3.55
The author of this book, Mr. R.N. Soar, has compiled 50 interesting and useful circuits and applications, covering many different branches of electronics, using one of the most inexpensive and freely available components — the Light Emitting Diode (L.E.D.). A useful book for the library of both beginner and more advanced enthusiast alike.

BP82: ELECTRONIC PROJECTS USING SOLAR CELLS OWEN BISHOP \$8.10
The book contains simple circuits, almost all of which operate at low voltage and low currents, making them suitable for being powered by a small array of silicon cells. The projects cover a wide range from a bicycle speedometer to a novelty 'Duck Shoot'; a number of power supply circuits are included.

BP37: 50 PROJECTS USING RELAYS, SCR's & TRIACS F.G. RAYER, T.Eng.(CEI), Assoc.IERE \$5.50
Relays, silicon controlled rectifiers (SCR's) and bi-directional triodes (TRIACS) have a wide range of applications in electronics today. This book gives tried and practical working circuits which should present the minimum of difficulty for the enthusiast to construct. In most of the circuits there is a wide latitude in component values and types, allowing easy modification of circuits or ready adaptation of them to individual needs.

BP44: IC 555 PROJECTS E.A. PARR, B.Sc., C.Eng., M.I.E.E. \$7.55
Every so often a device appears that is so useful that one wonders how life went on before without it. The 555 timer is such a device. Included in this book are Basic and General Circuits, Motor Car and Model Railway Circuits, Alarms and Noise Makers as well as a section on the 556, 558 and 559 timers.

BP24: 50 PROJECTS USING IC741 RUDI & UWE REDMER \$4.25
This book, originally published in Germany by TOPP, has achieved phenomenal sales on the Continent and Babani decided, in view of the fact that the integrated circuit used in this book is inexpensive to buy, to make this unique book available to the English speaking reader. Translated from the original German with copious notes, data and circuitry, a "must" for everyone whatever their interest in electronics.

BP83: VMOS PROJECTS R.A. PENFOLD \$8.20
Although modern bipolar power transistors give excellent results in a wide range of applications, they are not without their drawbacks or limitations. This book will primarily be concerned with VMOS power FETs although power MOSFETs will be dealt with in the chapter on audio circuits. A number of varied and interesting projects are covered under the main headings of: Audio Circuits, Sound Generator Circuits, DC Control Circuits and Signal Control Circuits.

BP65: SINGLE IC PROJECTS R.A. PENFOLD \$6.55
There is now a vast range of ICs available to the amateur market, the majority of which are not necessarily designed for use in a single application and can offer unlimited possibilities. All the projects contained in this book are simple to construct and are based on a single IC. A few projects employ one or two transistors in addition to an IC but in most cases the IC is the only active device used.

BP97: IC PROJECTS FOR BEGINNERS F.G. RAYER \$8.10
Covers power supplies, radio, audio, oscillators, timers and switches. Aimed at the less experienced reader, the components used are popular and inexpensive.

BP88: HOW TO USE OP AMPS E.A. PARR \$9.35
A designer's guide covering several op amps, serving as a source book of circuits and a reference book for design calculations. The approach has been made as non-mathematical as possible.

IC ARRAY COOKBOOK JUNG HB26 \$14.25
A practical handbook aimed at solving electronic circuit application problems by using IC arrays. An IC array, unlike specific-purpose ICs, is made up of uncommitted IC active devices, such as transistors, resistors, etc. This book covers the basic types of such ICs and illustrates with examples how to design with them. Circuit examples are included, as well as general design information useful in applying arrays.

BP50: IC LM3900 PROJECTS H.KYBETT, B.Sc., C.Eng. \$5.90
The purpose of this book is to introduce the LM3900 to the Technician, Experimenter and the Hobbyist. It provides the groundwork for both simple and more advanced uses, and is more than just a collection of simple circuits or projects.
Simple basic working circuits are used to introduce this IC. The LM3900 can do much more than is shown here, this is just an introduction. Imagination is the only limitation with this useful and versatile device. But first the reader must know the basics and that is what this book is all about.

223: 50 PROJECTS USING IC CA3130 R.A. PENFOLD \$5.50
In this book, the author has designed and developed a number of interesting and useful projects which are divided into five general categories: I — Audio Projects II — R.F. Projects III — Test Equipment IV — Household Projects V — Miscellaneous Projects.

224: 50 CMOS IC PROJECTS R.A. PENFOLD \$4.25
CMOS IC's are probably the most versatile range of digital devices for use by the amateur enthusiast. They are suitable for an extraordinary wide range of applications and are also some of the most inexpensive and easily available types of IC.

Mr. R.A. Penfold has designed and developed a number of interesting and useful projects which are divided into four general categories: I — Multivibrators II — Amplifiers and Oscillators III — Trigger Devices IV — Special Devices.

THE ACTIVE FILTER HANDBOOK TAB No.1133 \$11.45
Whatever your field — computing, communications, audio, electronic music or whatever — you will find this book the ideal reference for active filter design.
The book introduces filters and their uses. The basic math is discussed so that the reader can tell where all design equations come from. The book also presents many practical circuits including a graphic equalizer, computer tape interface and more.

DIGITAL ICs — HOW THEY WORK AND HOW TO USE THEM AB004 \$11.45
An excellent primer on the fundamentals of digital electronics. This book discusses the nature of gates and related concepts and also deals with the problems inherent to practical digital circuits.

MASTER HANDBOOK OF 1001 PRACTICAL CIRCUITS TAB No.800 \$20.45
MASTER HANDBOOK OF 1001 MORE PRACTICAL CIRCUITS TAB No.804 \$19.45
Here are transistor and IC circuits for just about any application you might have. An ideal source book for the engineer, technician or hobbyist. Circuits are classified according to function, and all sections appear in alphabetical order.

THE MASTER IC COOKBOOK TAB No.1199 \$16.45
If you've ever tried to find specs for a so called 'standard' chip, then you'll appreciate this book. C.I. Hallmark has compiled specs and pinout for most types of ICs that you'd ever want to use.

ELECTRONIC DESIGN WITH OFF THE SHELF INTEGRATED CIRCUITS AB016 \$13.45
This practical handbook enables you to take advantage of the vast range of applications made possible by integrated circuits. The book tells how, in step by step fashion, to select components and how to combine them into functional electronic systems. If you want to stop being a "cookbook hobbyist", then this is the book for you.

AUDIO

BP90: AUDIO PROJECTS F.G. RAYER \$8.10
Covers in detail the construction of a wide range of audio projects. The text has been divided into preamplifiers and mixers, power amplifiers, tone controls and matching and miscellaneous projects.

HOW TO DESIGN, BUILD, AND TEST SPEAKER SYSTEMS. TAB No.1000 \$1.45
OUT OF PRINT
This book covers a variety of speakers as well as instructions on how to design your own.

205: FIRST BOOK OF HI-FI LOUDSPEAKER ENCLOSURES B.B. BABANI \$3.55
This book gives data for building most types of loudspeaker enclosure. Includes corner reflex, bass reflex, exponential horn, folded horn, tuned port, klipschorn labyrinth, tuned column, loaded port and multi speaker panoramic. Many clear diagrams for every construction showing the dimensions necessary.

BP35: HANDBOOK OF IC AUDIO PRE-AMPLIFIER AND POWER AMPLIFIER CONSTRUCTION F.G. RAYER, T.Eng.(CEI), Assoc.IERE \$5.50
This book is divided into three parts: Part I, understanding audio IC's, Part II, Pre-amplifiers, Mixers and Tone Controls Part III Power Amplifiers and Supplies. Includes practical constructional details of pure IC and Hybrid IC and Transistor designs from about 250mW to 100W output. Out of stock until December 1982.

BP74: MOBILE DISCOTHEQUE HANDBOOK COLIN CARSON \$5.90
The vast majority of people who start up "Mobile Discos" know very little about their equipment or even what to buy. Many people have wasted a "small fortune" on poor, unnecessary or badly matched apparatus.
The aim of this book is to give you enough information to enable you to have a better understanding of many aspects of "disco" gear.

HOW TO BUILD A SMALL BUDGET RECORDING STUDIO FROM SCRATCH. TAB No.1166 \$16.45
The author, F. Alton Everest, has gotten studios together several times, and presents twelve complete, tested designs for a wide variety of applications. If all you own is a mono cassette recorder, you don't need this book. If you don't want your new four track to wind up sounding like one, though, you shouldn't be without it.

BP51: ELECTRONIC MUSIC AND CREATIVE TAPE RECORDING M.K. BERRY \$5.50
Electronic music is the new music of the Twentieth Century. It plays a large part in "pop" and "rock" music and, in fact, there is scarcely a group without some sort of synthesiser or other effects generator.
This book sets out to show how electronic music can be made at home with the simplest and most inexpensive of equipment. It then describes how the sounds are generated and how these may be recorded to build up the final composition.

BP74: ELECTRONIC MUSIC PROJECTS R.A. PENFOLD \$7.70
Although one of the more recent branches of amateur electronics, electronic music has now become extremely popular and there are many projects which fall into this category. The purpose of this book is to provide the constructor with a number of practical circuits for the less complex items of electronic music equipment, including such things as a Fuzz Box, Waa-Waa Pedal, Sustain Unit, Reverberation and Phaser-Units, Tremelo Generator etc.

BP81: ELECTRONIC SYNTHESIZER PROJECTS M.K. BERRY \$7.30
One of the most fascinating and rewarding applications of electronics is in electronic music and there is hardly a group today without some sort of synthesiser or effects generator. Although an electronic synthesiser is quite a complex piece of electronic equipment, it can be broken down into much simpler units which may be built individually and these can then be used or assembled together to make a complete instrument.

ELECTRONIC MUSIC SYNTHESIZERS TAB No.1167 \$10.45
If you're fascinated by the potential of electronics in the field of music, then this is the book for you. Included is data on synthesizers in general as well as particular models. There is also a chapter on the various accessories that are available.

TEST EQUIPMENT

BP75: ELECTRONIC TEST EQUIPMENT CONSTRUCTION \$7.30
F.G. RAYER, T.Eng. (CEI), Assoc. IERE
 This book covers in detail the construction of a wide range of test equipment for both the Electronics Hobbyists and Radio Amateur. Included are projects ranging from an FET Amplified Voltmeter and Resistance Bridge to a Field Strength Indicator and Heterodyne Frequency Meter. Not only can the home constructor enjoy building the equipment but the finished projects can also be usefully utilised in the furtherance of his hobby.

99 TEST EQUIPMENT PROJECTS YOU CAN BUILD \$14.45
TAB No. 805
 An excellent source book for the hobbyist who wants to build up his work bench inexpensively. Projects range from a simple signal tracer to a 50MHz frequency counter. There are circuits to measure just about any electrical quantity: voltage, current, capacitance, impedance and more. The variety is endless and includes just about anything you could wish for!

HOW TO GET THE MOST OUT OF LOW COST TEST EQUIPMENT \$9.45
AB017
 Whether you want to get your vintage 1960 TestRite signal generator working, or you've got something to measure with nothing to measure it with, this is the book for you. The author discusses how to maximize the usefulness of cheap test gear, how to upgrade old equipment, and effective test set ups.

THE POWER SUPPLY HANDBOOK \$16.45
TAB No. 806
 A complete one stop reference for hobbyists and engineers. Contains high and low voltage power supplies of every conceivable type as well mobile and portable units.

BP70: TRANSISTOR RADIO FAULT-FINDING CHART \$2.40
CHAS. E. MILLER
 Across the top of the chart will be found four rectangles containing brief descriptions of various faults, viz. — sound weak but undistorted; set dead; sound low or distorted and background noises. One then selects the most appropriate of these and following the arrows, carries out the suggested checks in sequence until the fault is cleared.

ELECTRONIC TROUBLESHOOTING HANDBOOK \$12.45
AB019
 This workbench guide can show you how to pinpoint circuit troubles in minutes, how to test anything electronic, and how to get the most out of low cost test equipment. You can use any and all of the time-saving shortcuts to rapidly locate and repair all types of electronic equipment malfunctions.

COMPLETE GUIDE TO READING SCHEMATIC DIAGRAMS \$10.45
AB018
 A complete guide on how to read and understand schematic diagrams. The book teaches how to recognize basic circuits and identify component functions. Useful for technicians and hobbyists who want to avoid a lot of headscratching.

RADIO AND COMMUNICATIONS

BP79: RADIO CONTROL FOR BEGINNERS \$7.30
F.G. RAYER, T.Eng. (CEI), Assoc. IERE.
 The aim of this book is to act as an introduction to Radio Control for beginners to the hobby. The book will commence by dealing with the conditions that are allowable for such things as frequency and power of transmission. This is followed by a "block" explanation of how control-device and transmitter operate and receiver and actuator(s) produce motion in a model.

Details are then given of actual solid state transmitting equipment which the reader can build. Plain and loaded aerials are then discussed and so is the field-strength meter to help with proper setting up.

The radio receiving equipment is then dealt with which includes a simple receiver and also a crystal controlled superhet. The book ends with the electro-mechanical means of obtaining movement of the controls of the model.

BP96: CB PROJECTS \$8.10
R.A. PENFOLD
 Projects include speech processor, aerial booster, cordless mike, aerial and harmonic filters, field strength meter, power supply, CB receiver and more.

222: SOLID STATE SHORT WAVE RECEIVERS FOR BEGINNERS \$5.20
R.A. PENFOLD
 In this book, R.A. Penfold has designed and developed several modern solid state short wave receiver circuits that will give a fairly high level of performance, despite the fact that they use only relatively few and inexpensive components.

BP91: AN INTRODUCTION TO RADIO DXing \$8.10
 This book is divided into two main sections one to amateur band reception, the other to broadcast bands. Advice is given to suitable equipment and techniques. A number of related constructional projects are described.

BP105: AERIAL PROJECTS \$8.10
R.A. PENFOLD
 The subject of aerials is vast but in this book the author has considered practical designs including active, loop and ferrite aerials, which give good performances and are reasonably simple and inexpensive to build. The complex theory and math of aerial design are avoided.

BP46: RADIO CIRCUITS USING IC'S \$5.90
J.B. DANCE, M.Sc.
 This book describes integrated circuits and how they can be employed in receivers for the reception of either amplitude or frequency modulated signals. The chapter on amplitude modulated (a.m.) receivers will be of most interest to those who wish to receive distant stations at only moderate audio quality, while the chapter on frequency modulation (f.m.) receivers will appeal to those who desire high fidelity reception.

BP92: ELECTRONICS SIMPLIFIED—CRYSTAL SET CONSTRUCTION \$7.30
F.A. WILSON
 Aimed at those who want to get into construction without much theoretical study. Homewound coils are used and all projects are very inexpensive to build.

REFERENCE

THE BEGINNER'S HANDBOOK OF ELECTRONICS \$10.45
AB003
 An excellent textbook for those interested in the fundamentals of Electronics. This book covers all major aspects of power supplies, amplifiers, oscillators, radio, television and more.

ELEMENTS OF ELECTRONICS — AN ON-GOING SERIES

F.A. WILSON, C.G.I.A., C.Eng.
BP62: BOOK 1. The Simple Electronic Circuit and Components \$8.95

BP63: BOOK 2. Alternating Current Theory \$8.95

BP64: BOOK 3. Semiconductor Technology \$8.95

BP77: BOOK 4. Microprocessing Systems And Circuits \$12.30

BP89: BOOK 5. Communication \$12.30

The aim of this series of books can be stated quite simply — it is to provide an inexpensive introduction to modern electronics so that the reader will start on the right road by thoroughly understanding the fundamental principles involved.

Although written especially for readers with no more than ordinary arithmetical skills, the use of mathematics is not avoided, and all the mathematics required is taught as the reader progresses.

Each book is a complete treatise of a particular branch of the subject and, therefore, can be used on its own with one proviso, that the later books do not duplicate material from their predecessors, thus a working knowledge of the subjects covered by the earlier books is assumed.

BOOK 1: This book contains all the fundamental theory necessary to lead to a full understanding of the simple electronic circuit and its main components.

BOOK 2: This book continues with alternating current theory without which there can be no comprehension of speech, music, radio, television or even the electricity utilities.

BOOK 3: Follows on semiconductor technology, leading up to transistors and integrated circuits.

BOOK 4: A complete description of the internal workings of microprocessor.

BOOK 5: A book covering the whole communication scene.

BP85: INTERNATIONAL TRANSISTOR EQUIVALENTS GUIDE \$12.25

ADRIAN MICHAELS
 This book will help the reader to find possible substitutes for a popular user-orientated selection of modern transistors. Also shown are the material type, polarity, manufacturer selection of modern transistors. Also shown are the material type, polarity, manufacturer and use. The Equivalents are sub-divided into European, American and Japanese. The products of over 100 manufacturers are included. An essential addition to the library of all those interested in electronics, be they technicians, designers, engineers or hobbyists. Fantastic value for the amount of information it contains.

BP108: INTERNATIONAL DIODE EQUIVALENTS GUIDE \$8.35

ADRIAN MICHAELS
 This book is designed to help the user in finding possible substitutes for a large user orientated selection of the many different types of semiconductor diodes that are available today. Besides simple rectifier diodes also included are Zener diodes, LEDs, Diacs Triacs, Thyristors, Photo diodes and Display diodes.

BP1: FIRST BOOK OF TRANSISTOR EQUIVALENTS AND SUBSTITUTES \$2.80

B.B. BABANI
 This guide covers many thousands of transistors showing possible alternatives and equivalents. Covers transistors made in Great Britain, USA, Japan, Germany, France, Europe, Hong Kong, and includes types produced by more than 120 different manufacturers.

BP14: SECOND BOOK OF TRANSISTOR EQUIVALENTS AND SUBSTITUTES \$4.80

B.B. BABANI
 The "First Book of Transistor Equivalents" has had to be reprinted 15 times. The "Second Book" produced in the same style as the first book, in no way duplicates any of the data presented in it. The "Second Book" contains only additional material and the two books complement each other and make available some of the most complete and extensive information in this field. The interchangeability data covers semiconductor manufacturers in Great Britain, USA, Germany, France, Poland, Italy, East Germany, Belgium, Austria, Netherlands and many other countries.

TOWER'S INTERNATIONAL OP-AMP LINEAR IC SELECTOR \$13.45

TAB No. 1216
 This book contains a wealth of useful data on over 5,000 Op-amps and linear ICs — both pinouts and essential characteristics. A comprehensive series of appendices contain information on specs, manufacturers, case outlines and so on.

CMOS DATABASE \$14.45

TAB No. 984
 There are several books around with this title, but most are just collections of manufacturers' data sheets. This one, by Bill Hunter, explains all the intricacies of this useful family of logic devices. The missing link in getting your own designs working properly. Highly recommended to anyone working with digital circuits.

MISCELLANEOUS

BP68: CHOOSING AND USING YOUR HI-FI \$7.25

MAURICE L. JAY
 The main aim of this book is to provide the reader with the fundamental information necessary to enable him to make a satisfactory choice from the extensive range of hi-fi equipment now on the market.

Help is given to the reader in understanding the equipment he is interested in buying and the author also gives his own opinion of the minimum standards and specifications one should look for. The book also offers helpful advice on how to use your hi-fi properly so as to realise its potential. A Glossary of terms is also included.

BP101: HOW TO IDENTIFY UNMARKED IC'S \$2.70

K.H. RECORR
 Originally published as a feature in 'Radio Electronics', this chart shows how to record the particular signature of an unmarked IC using a test meter, this information can then be used with manufacturer's data to establish the application.

SIMPLIFIED TRANSISTOR THEORY TRAINING SYSTEMS, INC. AND LEVINE

HB20 \$10.25

This book is designed to provide the reader with a knowledge of the physical theory and how transistors and transistors are used in a series of brief, concise sections — over 400 in all. A complete reference source for future use.

AUDIO AND VIDEO INTERFERENCE CURES \$9.05
KAHANER

HB21
 A practical work about interference causes and cures that affect TV, radio, hi-fi, CB, and other devices. Provides all the information needed to stop interference. Schematic wiring diagrams of filters for all types of receivers and transmitters are included. Also, it supplies simple filter diagrams to eliminate radio and TV interference caused by noisy home appliances, neon lights, motors, etc.

BASIC TELEPHONE SWITCHING SYSTEMS \$15.25

TALLEY
HB27
 The Revised Second Edition of this book, for trainee and engineer alike, includes updated statistical data on telephone stations, and new and improved signaling methods and switching techniques. It also includes E & M signaling interface for electronic central offices and automatic number identification methods used in step-by-step, panel and crossbar central offices.

INTERRELATED INTEGRATED ELECTRONICS CIRCUITS FOR THE RADIO AMATEUR, TECHNICIAN, HOBBYIST AND CB'ER \$11.35

MEDELSON
HB29
 This book provides a variety of appealing projects that can be constructed by anyone from the hobbyist to the engineer. Construction details, layouts, and photographs are provided to simplify duplication. While most of the circuits are shown on printed circuit boards, every one can be duplicated on hand-wired, perforated boards. Each project is related to another projects so that several may be combined into a single package. The projects, divided into five major groups, include CMOS audio modules, passive devices to help in benchwork, test instruments, and games.

BASIC CARRIER TELEPHONY, THIRD EDITION \$14.45

TALLEY
HB28
 A basic course in the principles and applications of carrier telephony and its place in the overall communications picture. It is abundantly illustrated, with questions and problems throughout, and requires a minimum of mathematics.

ROBOTICS

THE COMPLETE HANDBOOK OF ROBOTICS \$13.45

TAB No. 1071
 All the information you need to build a walking, talking mechanical friend appears in this book. Your robot can take many forms and various options — light, sound, and proximity sensors — are covered in depth.

HOW TO BUILD YOUR OWN SELF PROGRAMMING ROBOT \$13.45

TAB No. 1241
 A practical guide on how to build a robot capable of learning how to adapt to a changing environment. The creature developed in the book, Rodney, is fully self programming, can develop theories to deal with situations and apply those theories in future circumstances.

BUILD YOUR OWN WORKING ROBOT \$11.45

TAB No. 841
 Contains complete plans — mechanical, schematics, logic diagrams and wiring diagrams — for building Buster. Buster is a sophisticated experiment in cybernetics you can build in stages. There are two phases involved: first Buster is leashed, dependent on his creator for guidance; the second phase makes Buster more independent and able to get out of tough situations.

NEW

CLASSIFIED ADVERTISING

ETI's classified advertising section allows you to reach about 30,000 Canadian readers nation-wide for \$1.00 per word. For as little as \$20 per insertion (there's a 20 word minimum) you can promote your business from coast-to-coast.

WHAT DO YOU DO?

Send us your typewritten or clearly printed words, your permanent address and telephone number and your money (no cash please). Make your

cheque or money order payable to 'ETI Magazine'. We're at Unit 6, 25 Overlea Blvd., Toronto, Ontario, M4H 1B1.

WHAT DO WE DO?

We typeset your words (and put the first word and your company name in BOLD capital letters). If we get your message by the 14th of the month, it will appear in ETI 1½ months later. For example if we receive it by October 14th you (and thousands more) will see it in the December issue.

FOR \$10 per kit + \$2 handling, receive free flyer and any of the following. #1: 1000 asst'd pcs, choke - capacitor - resistor - transistor - hardware - etc. Capacitor specials: #2: 200 asst'd ceramic - #3: 100 asst'd silver mica - #4: 100 asst'd mylar - #5: 50 asst'd tantalum - #6: 50 asst'd electrolytic - #7: 50 asst'd feed-through - #8: 50 asst'd metallic silver mica (Elmenco) - #9: 25 asst'd variable. All new material. Unconditional guarantee. **SURPLUS ELECTRO QUEBEC**, 2264 Montee Gagnon, Blainville, Quebec J7E 4H5.

FOCAL High Tech, European L/S units now, first time in Canada. High efficiency, excellent power handling, with the newly developed, superior neoflex cones, utilising dual concentric voice coils. Build your own high quality systems. Kit designs and filter networks available. Enclose \$1.00 for literature. Sole distributors **BRITISH ACOUSTICS**, 1011 Meyerside Drive, Mississauga, Ontario L5T 1K8.

PRE-PROGRAMMED one-chip microcomputers for simple effective projects. Versatile Lamp Controller for 4-channel computerized colour organ. Video Display Controller to add video to your one-board microcomputer. \$39.95 each. Write for information. **FIRELIGHT ELECTRONICS**, P.O. Box 729, Station La Cite, Montreal, Quebec, H2W 2P3.

HYDROGEN GAS GENERATOR plans and starter kit, \$12. **PRAIRIE POWER RESEARCH AND DEVELOPMENT**, P.O. Box 8291, Edmonton, Alberta. T6H 0L0.

CORONET ELECTRONICS, 649A Notre Dame W., Montreal, Que. H3C 1H8, Catalogue IC's, Semi's, Parts, send \$1.00 to cover postage. Monthly specials at crazy prices.

PRINTED Circuit Boards for ETI Projects. Synthesizer #I 6.25; #II 4.25; #III 4.40; #499 9.30; Nicad Charger 2.15; Solid state reverb. 7.55; RPM Meter 1.50. We also have boards for Summer '80 Projects and Special Projects Book 2. All boards since 1977 still available. Full list free. Post & Pack \$1.00 Ontario tax 7%. Send cheque or money order to **B-C-D ELECTRONICS**, P.O. Box 6326 Sta. F, Hamilton, Ont. L9C 6L9.

AVAILABLE Now LNA's Microwave associates 120° 50 db noise 4 GHz amplifiers for satellite TV \$699.00. **DRYDEN COMMUNITY T.V. LTD.**, 61A King St., Dryden, Ont. P8N 1B7. Phone (807) 223-5525.

DISK drives for Apple™ Computers. 5¼" high quality Siemens™ technology in a handsome beige cabinet. Front panel "write protect" lock feature. Ready to install. 180 day warranty. Disk drive \$349.00, disk drive with controller \$429.00. Quebec residents add 9% PST. All orders shipped freight collect. Send certified cheque or money order. **ADV MICRO PERIPHERALS**, 763 Lajoie, Dorval, Quebec H9P 1G7. (514) 631-7672.

ION POKER for Timex-Sinclair-1000 ZX81. 16K req'd. 2 copies on cassette with instructions. \$15.95 Canadian. **ION ELECTRONIC**, P.O. Box 6187, Fort McMurray, Alberta, Canada.

ZX81 Video Monitor Amp. Composite output. Installs easily inside case, instructions included \$9.95; **JDC**, 5-14 Sentinel Rd., Downsview, Ont. M3M 2Y5.

APPLE™ fully compatible computer boards. Mother board — \$60.00. Peripheral boards — Z80, 80 column, disk controller, 16K — \$20.00 each. All boards of high quality glass — solder — masked, silk-screened. Parts kits also available to allow you to build a fully Apple compatible and supported computer at a fraction of the original's price. Special prices for quantity and school buyers. Listed prices include shipping. B.C. residents add 6% P.S.T. Stamp brings further details. **K-K ENTERPRISES**, P.O. Box 65368, Station F, Vancouver, B.C. V5N 5P3.

SOFTWARE tapes for Apple, PET, TRS 80, Atari. All games under \$16.00. Surprise game pack: 6-tapes \$50.00. Send computer type & model. New C-10 cassettes 10/\$13.00. Add 10% shipping. Ontario residents add 7% tax. Mail order only. **GRACIE INTERNATIONAL COMPUTER & ELECTRONICS**, 489 Glenlake Ave., Toronto, Ontario M6P 1G9.

UNBELIEVABLE Buys on Prime LED's, IC's, Semi's, Resistors, Capacitors, Switches, Surplus Equipment and S-100 Boards. Send stamp for latest flyer. **ELECTRONICS**, Box 68, Whitecourt, Alberta, T0E 2L0.

WSI RADIO — SWL Radios — Ham radios 18 Sheldon Avenue North, Kitchener, Ontario N2H 3M2. Tel. (519) 579-0536. Write for 1983 catalogue, \$2.00 (VE3EHC).

ZX81 owners! Internal memory for your Sinclair. 2K Kit - \$20, 4K - \$35. Radio Shack Colour Computer memory: 16K Kit - \$40, 32K - \$75. Full instructions. (P.S.T. extra) **CANADIAN MICRO PERIPHERALS**, Box 123, Waterloo, Ont. N2J 3Z9.

FREE catalogue, newsletter. Video cartridges. Dealer prices. Home business books. Avant-Garde Computer software. New products. **OPPORTUNITIES**, Box 381, Brampton, Ontario L6V 2L3.

J&J ELECTRONICS Ltd., P.O. Box 1437E, Winnipeg, Manitoba R3C 2Z4. Surplus and Semiconductor Specialists. Do you get our bargain flyer? Send \$1.00 to receive the current literature and specials and to be placed on the mailing list for future publications.

RECEIVING tubes. Brand new & boxed. RCA, CBS, etc. Liquidating distributors stock. Hundreds of older types. All \$2 each. Send long S.A.S.E. for list. **WOLVERTON ENTERPRISES**, 5, South Hythe, Burnaby, BC, V5B 3H6.

DISCOUNT prices on game disks and tapes. Apple; TRS-80 Model I/III, Atari 400/800. Inquiries: **A-K SOFTWARE**, Dept. E, 480 Balsam Ave., Penticton B.C., V2A 6J7.

ATOM and **VIC 20** owners! If you have written high quality programs in the categories of games, education, business and utilities, etc., and would like a monetary return for your time and effort, please call us at (416) 686-2889, or write to **OAK MICROWARE**, 23 Brock St., Ajax, Ont., L1S 1S9.

IMAGINATION is all you need. Our growing inventory includes anything we can fit into the store. Bargain prices on all kinds of manufacturers surplus just waiting for your ideas! **FOREST CITY SURPLUS**, London, Ontario. 519-438-0233, open Mon.—Sat.

16k computer \$220; Timex Sinclair 2K \$160; 16K Module \$75; 64K module \$215; Modem \$260; Stabilizer pad \$10; All items add P.S.T. Post paid. All accessories fit ZX81 **STREAM COMPUTERS**, P.O. Box 113, Ajax, Ontario L1S 3C5 (416) 839-0323

The Fun of Electronics

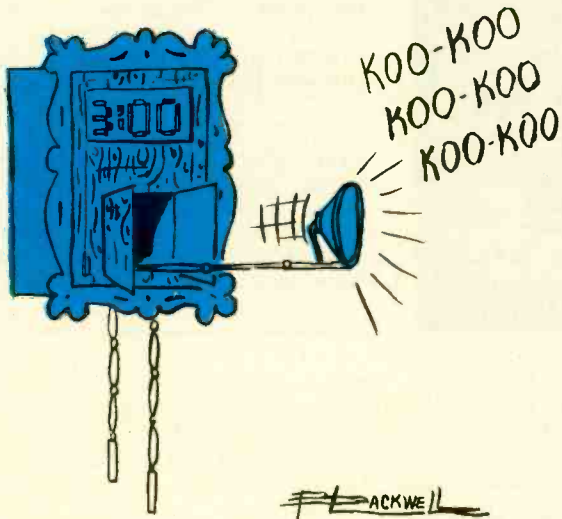

You're right. They don't bounce at all.

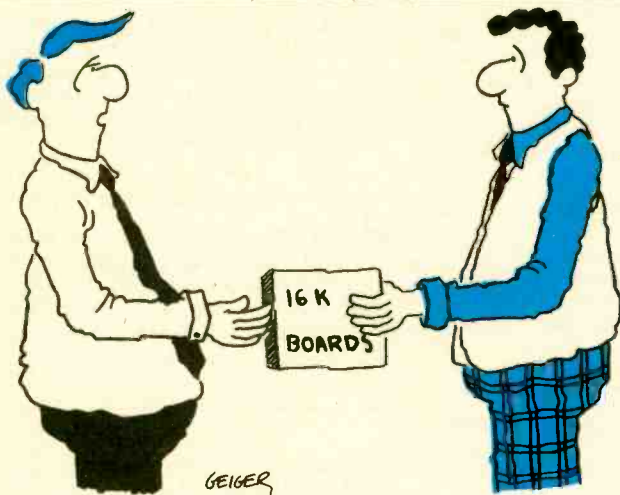

Thanks for the memories.

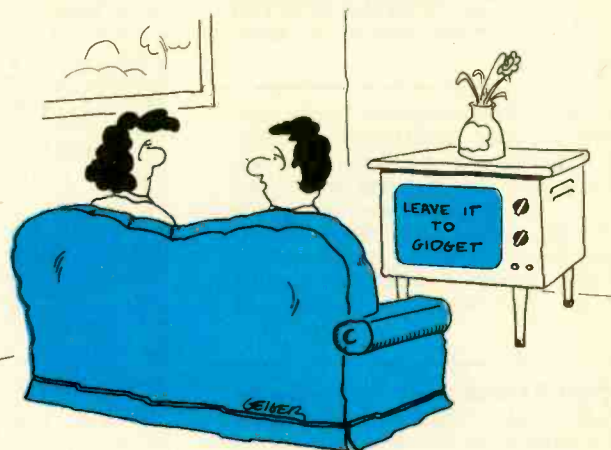

With that new satellite disk antenna, we can get terrible programs from thousands of miles away.



We save you money by eliminating the frills - like PC boards.



WHY SPEND A FORTUNE ON A DIGITAL CAPACITANCE METER?

As a matter of fact you don't have to pay \$250 to \$700 and up, anymore, for a Digital Capacitance Meter that is both dependable and rugged, with good accuracy.

The Model MC100 is manufactured by DAETRON and is sold directly to you, eliminating costly mark ups by the middle man and distributors.

Check these features:

- Portable (only 4 3/4" x 2 1/2" x 1 1/2")
- Extensive range - 50 pF to 9,999 uF
- Completely assembled (no kit to assemble)
- Basic accuracy 2% (\pm one count) on pF and nF ranges, 5% (\pm one count) on uF range
- Decimal points light up when battery is low or when capacitor is over range.
- Uses special circuitry to save on batteries (batteries not included)
- 90 Day parts and labour warranty

The meter is also well suited for the hobbyist, technician or engineer who wants to quickly sort and check out many different type capacitors, especially those that have lost their markings.

DAETRON

935 THE QUEENSWAY, BOX 641, TORONTO, ONTARIO M8Z 5Y9



\$89.95

PLEASE SEND ME

—(QUANTITY) MC 100(s) @ \$89.95

ONTARIO RESIDENTS ADD 7% PST

SHIPPING AND HANDLING @ \$1.00 per instrument

TOTAL \$

I ENCLOSE CHEQUE MONEY ORDER BILL MY VISA

VISA CARD NO. EXPIRY DATE

SIGNATURE

Immediate shipping on orders with Certified cheque, money order or Visa. Personal cheques, please allow 2 to 3 weeks for clearance.

NAME

ADDRESS

CITY PROV. POSTAL CODE

ETI 0183

THE Scope surprise of the year!

Capability and Economy combined like you've never seen!

1st CHOICE FOR CAPABILITY & ECONOMY

SEE FOR YOURSELF...

The advantages of Leader's unbeatable value combination!

Meets ALL your needs—price too! BANDWIDTH plus! SENSITIVITY plus!

A test-trial (at your dealers) does it! Beginners and pros in 80 countries are convinced Leader is the best buy anywhere. A Leader scope gives everything they want (plus) with terrific Savings.

- Reliable—2-year parts/labour guarantee.
- Prompt delivery.
- Large bright display.
- Wide range of applications — education, professional and hobbyist.
- Rock-solid triggering 1 mV/div. sensitivity.
- Wide 15 MHz bandwidth.

LEADER leads the cost-effective quality instrument field for 26 years.

TRY IT at your dealer or write IPhone:

Omnitronix LTD.

6295 Shawson Drive, Unit 7, Mississauga, Ont. L5T 1H4 Phone (416) 678-7170
2056 South Service Rd., Trans-Canada Hwy., Dorval, P.Q. H9P 2N4 Phone (514) 683-6993

Leader

TRY ALL 4 SUPER-SENSITIVE MODELS

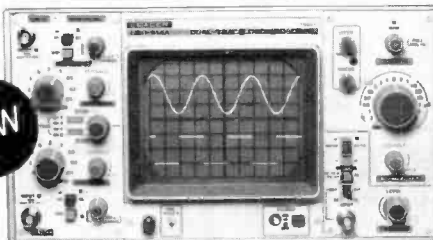

We can supply the following components for your 6502 project.

1. Computer Keyboard (Apple compatible) \$129.00



2. Switching Power Supply
A. A large open frame supply that will run the main PCB and a low current Disc drive (3 LB)
+5V 4 AMP, +12V 1.0 AMP
-5V 0.5 AMP, -12V 1.0 AMP **\$85.00**

B. The ORIGINAL, runs 2 Disc drives plus several peripherals.
+5V 3 AMP, +12V 2 AMP
-5V 0.5 AMP, -12V 0.5 AMP **\$119.00**

3. 6502 Motherboard (bare) \$55.00

4. ABS Case (steel base) \$129.00

5. Motherboard Components (All IC sockets, TTLs, RAMs, CPU, Transistors, Capacitors, Crystal and Peripheral Connectors) \$189.00

6. 5 1/4" MITAC Floppy Disk Drives with controller card (100% Apple compatible, much quieter than the SHUGART DRIVES). **\$489.00**

7. SPECIAL THIS MONTH

6502 — \$6.50 each

4116 — \$1.65 each

2716 — \$4.99 each

Distributor for "FUJITECH BRAND" Audio Kits. (made by Luxman, Japan).

FREIGHT AND INSURANCE INCLUDED. Send cheque or money order. Ontario residents please add 7% P.S.T. VISA & Mastercard accepted. DEALER INQUIRIES INVITED

KITSTRONIC INTERNATIONAL

Box 577, Stn. J. Toronto
Ontario. M4K 4Z2 (416) 667-8807

Circle No. 8 on Reader Service Card.

Circle No. 17 on Reader Service Card.

ETI—JANUARY—1983—77

SATELLITE TV

SATELLITE HANDBOOK — \$5.00

COMPLETE SATELLITE SYSTEM

\$2,995

MINI—SAT II



- 24 CHANNEL RECEIVER
- 120° LNA
- RF MODULATOR
- 2 METER DISH
- TRUE POLAR MOUNT
- 100 FEET OF CABLES

Computer Printout — for your location for all Satellites \$19.95

BRANCH OFFICES: Montreal, Toronto, Winnipeg, Edmonton, Seattle

SOME DEALER AREAS STILL AVAILABLE



604 324 3343 Nu. West Video Systems Ltd.

6590 VICTORIA DRIVE, VANCOUVER B.C. V5P 3X9

Circle No. 18 on Reader Service Card.

AS ADVERTISED AT THE TORONTO COMPUTER SHOW

\$169.00

The Grenadier manual mini modemMM102



Modem Phone Features:

- * FCC Approved
- * CSA Approved AC Adaptor
- * Asynchronous interface compatible with RS-232C
- * 300 bps full duplex
- * Bell 103 Compatible
- * Direct Connection between Microcomputer and Telephone
- * Easy Manual Originate and Answer Mode
- * Power On Indicator
- * Carrier Detector Indicator
- * Low Cost Compact Construction
- * Complete Instructions in Owners Manual

RS-232C — 6' Connector Cable Assembled \$24.95

Ontario Residents add 7% PST. Please add \$5.00 Shipping and Handling. Send only certified cheque or money order, COD accepted. VISA/MC accepted - Send card No., Expiry Date & Signature to:

DEALER ENQUIRES INVITED

TRIGILD

1631 The Queensway #6
Toronto, Ont. M8Z 5Y4
(416) 259-7801
Telex: 06-989235

COMMUNICATIONS

Circle No. 20 on Reader Service Card.

Vero
has countless reasons to celebrate 20 years of Veroboard.



BICC vero

That's how Vero began and many of you started.

Twenty years ago Vero introduced Veroboard to the designer and hobbyist market.

It was then unique in its concept and is still one of the basic boards for the electronics industry. Such is the influence that Veroboard has had, and is still having, that the very name has become part of general vocabulary. Twenty years is a long time in a new industry and Vero have been in the forefront with their standards, quality control and customer service throughout that time.

From Veroboard through Card Frames to Vero Cases, we are proud to be of service and hope that you will agree that sales of millions of Veroboards is a suitable cause to celebrate our twentieth birthday.

Electronic Packaging Systems Ltd.
P.O. BOX 481, KINGSTON, ONTARIO, K7L 4W5
PHONE (613) 384-1142 TELEX 066-3243



Circle No. 1 on Reader Service Card.



New ETI Loose Leaf Binder Punch

We here at ETI realize that money is scarce, and that there are plenty of our readers who would rather not spring for binders to preserve their copies of this precious publication. Well, that's cool, and there is always the time worn solution of digging out those filthy loose leaf binders you used in high school, the ones with the smeared anatomical renderings etched into the vinyl in greasy ball point pen, and giving over to their tender embraces your clean, shiny issues of Electronics Today. The only hassle is getting the holes punched.

Well, that need not be a problem any more, not if you use the ETI loose leaf magazine punch illustrated above. Complete with enough supplies to punch two issues, the ETI punch is guaranteed to get through even the real fat issues with the catalogs in the middle. Try that with a regular hand punch!

In addition, the ETI punch can serve as a handy vermin killing device, fly swatter, attention getter at parties, robbery implement or murder weapon. What could be more useful?

The ETI magazine punch is available to all ETI readers for the amazing low price of just \$9.45. **All orders must be postmarked before July 1, 1981.** Supplies are limited, so order now. (Note: if you'd prefer to use our regular ETI binders, they will, of course, still be available for \$8.00 each. . . . postmarked anytime.)

ETI Binder Punch/Funny Old Gun
25 Overlea Boulevard, Unit 6
Toronto, Ontario
M4H 1B1

Radio Astronomy

Continued from page 45

from readily available radar components of a polar-mounted four foot paraboloidal reflector for operation at 10.7cm wavelength and for the design study of a large 30 foot reflector after the manner of Reber, but for operation at the wavelength of 3.2 cm.

This small radio telescope was completed in July 1946, being located on the roof of one of the buildings at the Radio Field Station south of Ottawa. In 1947, it was relocated at Goth Hill, South Gloucester, near Ottawa, in order to minimize the interference from nearby radar sets. By July 1946 solar radiation emission was detected as soon as the antenna was pointed towards the sun, which at that time displayed a large sun-spot group. Soon after making these observations, the radio telescope was aimed at Sagittarius, but no radio signals were found. Further tests on the moon and Mars also proved negative. A solar patrol system, involving daily sweeps of the sun was implemented and by 1949 it was possible to establish the salient characteristics of the 10.7cm solar noise. Essentially the daily levels of flux showed a pronounced 27 day variation of intensity associated with the presence of sun spots, a steady emission from the undisturbed sun, and intense bursts of noise in association with optical solar flares.

In 1948, it was decided to construct a small Yagi antenna and radiometer to obtain first hand experience with bursts of solar noise at a wavelength of 1.5 metres. The experiments were a success.

A large reflector is one of the essential instruments for radio astronomy as detailed above. When a large reflector (30 feet) was being considered in 1949, the Americans were constructing a 50 foot reflector at the Naval Research Laboratory in Washington. Canadian design plans changed, and it was decided to construct a 100 foot reflector telescope. Cost and design difficulties proved insurmountable, so a partial compromise was made in the construction of an array of slots in the board side of a standard 3 by 1½ inch waveguide. It was made as long as possible, 150 feet, and placed in the bottom of a small trough. When the sun drifted through the narrow beam, the recorded variation of radio emission or drift curve showed immediately the quiet sun as a broad radio source while radio spots appeared as peaks superimposed upon this curve.

The gradual growth of radio interference from the nearby airport and the limitation in land suitable for the construction of another large

antenna made the Goth Hill site inadequate for continuing studies in radio astronomy. By 1957, when approval had been obtained for the establishment of a radio observatory by the Dominion Observatory, a search was undertaken for a suitable site. During the summer of 1957 interference levels were measured at a number of sites in BC, Ontario and Quebec. A site was selected for the Dominion Radio Astrophysical Observatory in a secluded valley near Penticton, BC, and a site near Lake Traverse in Algonquin Park was selected for the National Radio Astronomy Observatory.

At the Dominion Observatory, a telescope and associated receiver for studies of the 21cm line of hydrogen was completed in June 1960. The telescope is an equatorially mounted paraboloidal reflector 25.6 metres in diameter. The surface of the reflector is aluminum mesh and sufficiently accurate to permit operation at wavelengths as short as 10cm. As originally designed, the receiver had a crystal mixer front end and a tunable local oscillator which permitted scanning of the Doppler broadened hydrogen line with a narrow band filter. Later an electron beam parametric pre-amplifier was installed which reduced the noise contributed by the radiometers. With this instrument, studies were made of the distribution of neutral hydrogen in the galactic anti-centre region.

Preliminary results at 22MHz were encouraging, and the discovery of quasars emphasized the importance of extending measurements to still lower frequencies. Thus in late 1963 it was decided to build a second array for 10MHz as a joint project with Cambridge University. This array was erected quickly to take advantage of the optimum observing conditions which were then prevailing due to a sun-spot minimum. Extensive surveys were undertaken, all successfully.

At the National Radio Astronomy Observatory a 10 metre paraboloid telescope and a parabolic horn reflector telescope were constructed. This equatorially mounted paraboloid has a surface which is sufficiently accurate to permit observation at wavelengths as short as 8mm! Much of the observing time on this telescope has been spent on a survey of the galactic spaces at wavelengths of 10cm and 4.5cm. A survey has been completed of the Cygnus X region and the Cassiopeia and Cepheus regions. Many individual sources were observed, imbedded in the general emission from these regions.

were surrounding hot young stars, while a few are believed to be remnants of supernova explosions. Observations at the two frequencies enables the two types of sources to be distinguished since they have different spectra. In these regions where the optical picture is obscured by absorbing clouds (dark nebula) the radio observations provide important data for studies of stellar evolution.

In 1966 a further 46 metre telescope was completed. Over the inner 120 foot diameter the reflector source consists of steel plates with a manufacturing tolerance of about 0.4mm and beyond this surface mesh panels. The telescope may be used either as a prime focus instrument or the radio frequency equivalent of a Gregorian optical telescope. Over the years, the telescope has been used on a number of observing programs. The studies have detailed the structure of galactic H 11 regions for which the telescope provides excellent resolution of 3 minutes of arc at a wavelength of 3cm. Further studies have accurately determined the fluxes of a large number of radio sources at centimetre wavelengths. Observations of the planets, supernova remnants, planetary nebulae and the existence of chemical molecules have all been completed.

In 1967 the Canadian Very Long Baseline Interferometer was designed and operated using Canada's two radio observatories giving the interferometer a base line of 3074km. It was used to study quasars, and at the operating wavelength of 67cm gave it a resolution of 0.02 seconds of arc. Much was learned.

In early 1975, the Herzberg Institute of Astrophysics was created to serve as a focal point for radio astronomical research in Canada. It was named in honour of Dr. Gerhard Herzberg, an NRC scientist who had won the Nobel Prize in Chemistry in 1971. A range of astrophysics oriented programs from several NRC and university laboratories were brought together with Dr. Herzberg's internationally known spectroscopy group. Today, the Institute includes laboratory spectroscopists thinking on the same 'wavelengths' as are optical and radio astronomers, as well as specialists in many other branches of science. This promotes a catalyst gained from workers rubbing elbows and freely exchanging their ideas, helping to keep Canada in the forefront of radio astronomical research.

ETI

Sound-Light Modulator

Continued from page 30

PARTS LIST

RESISTORS (All 1/4 W, 5%)

R1	100R
R2,3,9,13, 14,16	10k
R4,6	4k7
R5	47k
R7	100k
R8	560k
R10,12,15	22k
R11	1k0

POTENTIOMETER

RV1	1k0 linear
-----	------------

CAPACITORS

C1	33n polyester
C2	47n polyester
C3	4n7 polystyrene
C4	3n3 polystyrene
C5	220n polyester
C6	2u2, 16V electrolytic
C7	1000u, 16V electrolytic

SEMICONDUCTORS

IC1	LM3914 dot/bar display driver
Q1,2	2N5825 NPN transistor
Q3,4	2N6003 PNP transistor
D1,2,3	1N4148 diode
D4,5,6	1N4001, 1A diode
SCR1-10	300V 10A TRIAC

MISCELLANEOUS

SW1	two-pole, three-way rotary switch
SW2	one-pole, two-way rotary switch
SW3	single-pole, single-throw rocker switch
T1,2	9-0-9 V transformer
FS1-10	6 A fuse + fuseholders
neon with integral resistor, cable grip, 12-way connecting block (2A), 5-way connecting block (10A), speaker DIN socket, IC socket (18 pin), knobs to suit, case to suit, 2 x angle brackets, 26 strip x 50 hole 0.1" Veroboard, 2 x phenolic panels of suitable size.	

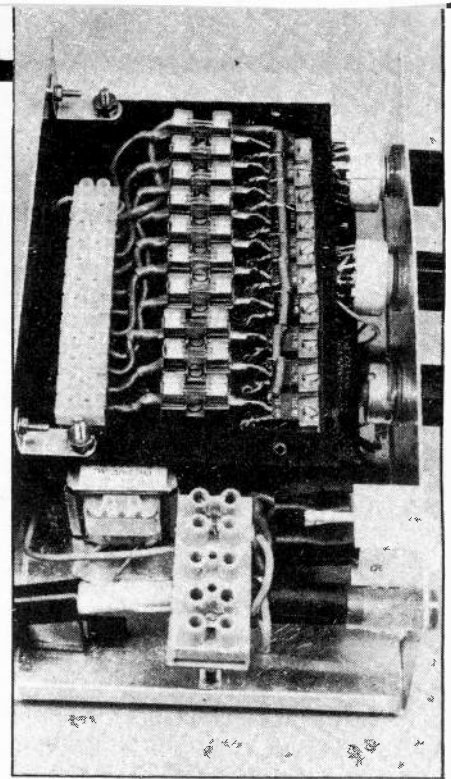

ETI

ETI SOFTWARE EXCHANGE

ZX81 GAME. and educational programs. Each package contains 10 programs, to amuse, challenge, and entertain. Play Blackjack, Mines, Slots, Catch-the-word, or try Spell, Math, or Count. Each \$10.00 package includes cassette, listings, and documentation.

Northstar wordprocessor fantastic bargain at \$29.96! Just look at all the options: search and/or replace, copy, inline editing, screen mode, move, multiple insertions and deletions, plus much more. **INTEGRATED COMPUTER ENTERPRISES**, 25 Ritchie Street Box 190, Toronto, Ontario M6R 3A5, 416-532-9986.

"MACHINE-TO-APPLESOFT" utility program. Converts binary to BASIC files. For Apple II+ with 16-sect disk. Only DE-compiler on the market. Send \$20.00 to A. TULOD, 8671 Darlington Crescent, Windsor, Ont. (Supplied on disk.)

TRS-80 Couleur 4K machine a sous Las-Vegas, plus JEU GENRE Mastermind. ET JEU GENRE Simon. Instructions en Francais. \$10. Pour les trois. S. LAVERGNE PARC CAROUSSEL, Box 80 Bromont, JOE ILO, P.Q.

STOCK ticker (the fashionable board game) and inventory (for all your stock needs). Now available from SINCLAIR USERS GROUP, Box 777, Swan River MB. R0L 1Z0.

I WOULD like other people in Canada with the APF IM1 Computer to get in touch with me. 8K or 16K, KEN C. PASSAILAIGUE, 76 Brimwood Blvd., Agincourt, Ontario M1V 1C1.

"ANTI-CHOPLIFTER" on Apple disk, just like the popular game but this time you play sub-commander. With hi-res, colour, sound effects! Send \$14.95 to A. TULOD, 251-2 Valhalla Rd., Toronto, Ont M9B 6C3.

PLAY "Doctor" in hi-res Apple graphics. You diagnose and treat patients; advance from intern to hospital-chief in this educational game. \$12.95 for 48K (3.3) disk. RON SALVADOR, Box 62, Islington, Ont. M9A 4X2.

A FREE Advertising Service! If you've got a home computer there's a pretty good chance that you've written a piece of software of which you are proud. If you are in this category and want to swap or sell this for a nominal sum, ETI will run your message FREE OF CHARGE in SOFTWARE EXCHANGE.

There are conditions: sums requested must not exceed \$10 (\$20 where material is offered on a disk); the message must not exceed 35 words including name and address and you must sign the warranty that the material is your copyright or in public domain.

Readers may offer listings, tapes or disks or make specific requests. Exchanges where no money changes hands are acceptable.

If you wish to charge more than the sums given you may still use this service but then there is a charge of 50¢ per word (which must be prepaid). Minimum payment is \$15 but there is no maximum word length.

VIC 20 users — we have loads of software to trade including recent expanded memory programs. RANDY HOLMES, 24 Regent St., Ottawa, Ontario K1S 2R5. 233-4453.

SUPERNOVA software, friends of the friendly computer. Unexpanded VIC-20 games for under \$10. send. 75¢ for programme guide. SUPERNOVA SOFTWARE, 92 Langarth Street West, London, Ontario, N6J 1P4.

ETI Software Exchange, ETI Magazine, Unit 6, 25 Overlea Blvd., Toronto, Ont. M4H 1B1. Please publish the following message FREE in ETI. Any material offered is my own copyright or in public domain

Signed

Please Write Clearly			



DISK DRIVE II W/DOS 3.3

\$795

DISK DRIVE II

\$739

Also check out our Multiflex drives

We provide our own 120 day warranty

New Multiflex Products for the Apple™

Special Limited Time Offer

16K RAM CARD \$75

Allows you to expand your 48K Apple to 64K.

Assembled & Tested with 90 day guarantee

Multiflex Video Card

(80 x 24)

\$169

Based on 6845

Assembled & Tested with 90 day guarantee

Multiflex Wire-Wrap card for Apple \$17.95

Multiflex Disk Drives for your Apple™

SA400L Disk Drive attractively packaged, ready to plug into an Apple Drive Controller Card (Compatible to Apple Drive). This month only

\$389

SA400L Packaged with Controller, DOS and Book. Special

\$549

Apple is a registered trade mark of Apple Computers Inc.

Multiflex Z80 Card

for the Apple

\$150.00

Software at extra cost

Multiflex EPROM Programmer

for the Apple

Programs 2716, 2732, 2764 \$150

with ZIF socket

Assembled and tested with 90 day warranty

MAIL ORDERS

Send a certified cheque or money order (do not send cash). Minimum order is \$10 plus \$3 for shipping. Ontario residents must add 7% provincial sales tax. Visa, Mastercard and American Express accepted; send card No., signature, expiry date and name of bank.



Monitors

Zenith Monitors complete with housing and power supply ready-to-use with any composite video signal 12" green phosphorus screen switch selectable for 40 or 80 characters. 90 day warranty; quantity discounts available.



ONLY \$165

AMDEK

COLOUR 1 MONITOR

13" Colour Monitor 90 day warranty.

\$569

OSBORNE 1

The Osborne 1 computer is one of the most exciting developments in the field of small systems in the recent times. Its low prices, combined with its small size and large features make it in high demand all over the world. The hardware features include: * a Z80A CPU with 64K RAM * dual floppy disk drives with 90K storage * 5" CRT * RS232 interface * IEEE 488 interface * business keyboard. The software included is: * CP/M operating system * WORDSTAR word processor (c/w MAILMERGE) * SUPERCALC spreadsheet * CBASIC * MBASIC.

\$2495

includes 12" Zenith Green Screen Monitor

\$2395

without extra Monitor

Multiflex Speech Board Kit
with 32 useful words

Special \$149
Read about on page 23 in our catalogue.



PRINTERS OKI DATA

EPSON

- MX80 type III \$759
- MX80FT type III \$869
- MX82 type III \$825
- MX82FT type III \$959
- MX100 type III \$1069

Note: All type III printers include graphics. All printers come with 90 day warranty.

Apple Interface card and cable for Epson printers \$149

- Okidata u82A. 80 column, pin or friction feed, 120 c.p.s., parallel or serial \$795
- Okidata u83A. 132 column, friction or tractor feed, 120 c.p.s. parallel or serial \$1250
- Daisywriter-100. 132 column, serial, daisy-wheel letter quantity \$1795

TEC

- Tec-Writer I. 80 column, tractor & friction feed, parallel and serial \$645
- Tec-Writer II. 120 c.p.s., 132 column tractor & friction feed, parallel & serial \$1250
- Tec-Writer III. Daisy-wheel, 40 c.p.s., 2K buffer \$2450

Quantity Discounts Available. Please call.

PRICE POLICY

Remember that at Exceltronix, all prices are negotiable for quantity purchases. If you cannot afford large quantities on your own, how about starting a Co-op.



TECH TIPS

Enriching Synthesiser Sounds

H. Duncan

When working with synthesisers I have found that a much richer sound can be obtained if a second VCO is tuned to a fifth above the first. This can cause problems if quick patch changes are required since the second VCO will have to be retuned. The circuit given here overcomes this problem cheaply, leaves the second VCO free and also lends itself to other interesting applications.

IC1 is wired as a standard phase-locked loop, with R1, C1 setting the maximum operating frequency and R2, R3, C2 feeding the error voltage to the 4046 VCO. The output of the 4046 is used to clock IC2, a top octave divider, which divides the input by a

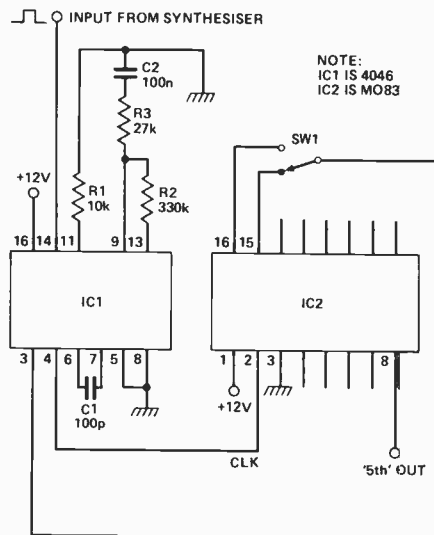

series of integers to produce semitones. One of the two 'C' outputs is sent back to the PLL via SW1.

The circuit will now track accurately any square pulse of suitable level and produce any semitone in an octave starting from the input frequency or the one above. The output is, of course, only a square wave, but by suitable shaping any waveform may be derived. Clearly the circuit is open to many modifications; for example, if the top octave divider is replaced by a 4024 divider, with suitable decoding and filtering harmonics could be obtained, making any sound possible!

Continued on page 84

Atari Review

Continued from page 41

are asleep. It's a kind of mini data analyst deal which produces a graphic readout. I think after the kids went to sleep I'd want to play with the games.

—BASKETBALL This is one of the games the competition insults on TV, but it's actually quite cool, with a three dimensional representation of a basketball court and little high res players. A bit gimpy, but any video game without aliens seems like a bit of an exercise to me.

—VIDEO EASEL This is a very lovely program that creates abstract coloured pictures on the screen of your own TV. Suitable for kids of all ages, it should keep the user enthralled for as long as five minutes.

—PAC MAN What can I say. I think it's a turkey, but nobody else does. Compared to the arcade version of this game, the Atari implementation is extremely good, and PAC MAN freaks will appreciate not having to feed the thing with loose change.

The Hardware

Compared to its software, the hardware on the Atari is quite mundane. The computer itself seems to have a really cruel looking aluminum frame inside all that plastic, and is unquestionably able to take a lot of abuse. The keyboard is okay for doodling... it's about on a par with that of the VIC-20. There is a caps lock feature

which takes a bit of time to figure out.

The Atari disk drive is a single 5¼ inch floppy deal, and, besides being among the loudest drives going, seems to be a first rate trip. It, like the machine itself, is rugged and fairly idiot proof. The DOS is rudimentary and slow, but I am inclined to feel that this is an advantage for it. With fewer options one has fewer things to go wrong, and errors on a disk operating system can be fatal to great swarming herds of data.

The Atari printer is sort of cool. It's definitely a "home" device, with a lot of plastic where other machines use metal. However, it has eighty column lines, several character sizes and reasonable print quality for a low cost dot matrix deal. While I'd be a bit loath to receive manuscripts for articles done on one, as a hard copy device for programming it's more than adequate. It has a few niceties, like actual proportional spacing, underlining and some limited character control codes. The documentation for it is surprisingly complete.

Plug In

If I were considering a computer for "the whole family", especially one that young children could use unsupervised and have some fun with, the Atari 800 would probably be my

first choice. It has a wide scope of user levels, and while its only real forte is in playing games, it allows one to dabble in a variety of other areas of computer use... and this is as much as many users really want to do. It's not grossly expensive as a first system, and, when it is outgrown the user has the option of either getting something larger or making it into something larger... the latter option not being available to owners of most of the other introductory computers.

Once you get attached to one of these things it's nice to be able to hang onto it.

If you are going to get a machine primarily for playing games you should get a game machine... the more sophisticated dedicated computing computers running games are not half as good at them as one that's been designed for the task. If you have aspirations to computer phreakdom, the Atari is probably not for you.

Mr. Plimpton aside, I am impressed with the versatility of the system and the balance it strikes between fooling around and serious work.

And arrrgh, Billy, we can sell the dead aliens to the tourists from Alabama...

Josephson Junctions

Continued from page 68

together using tiny droplets of mercury as a solder — mercury is of course solid at the working temperature.

The high density of packing is possible because of the very low power consumption and the excellent cooling system: the assembly is actually immersed in liquid helium. This liquid also has the property of being superfluid because of quantum effects: it has zero viscosity and flow is restrained only by inertia. Circulation of the cooling fluid is therefore even better than for a normal liquid cooling system.

If I Could Talk To The Micros . . .

What can we do with a microcomputer running 50 to 100 times faster than present systems, and with at least 10 times the computing capacity? Certainly most of today's mainframes could be replaced by much more compact assemblies of such micros, but space is not usually at such a premium nowadays. On the other hand today's desk-top computer can be replaced by something perhaps a thousand times as powerful and (we hope) at not too much greater expense. We could expect to

have practical verbal and video recognition systems from such systems, and super-high level interactive languages.

This new technology is still in its infancy, but if you cast your mind back to the state of the art in 1971, it is reasonable to expect that I might be able to dictate an article of this sort to a voice-controlled word processor by 1991, no larger and no more expensive than today's micros.

ETI

★★★★★ ★★★★★ ★★★★★ ★★★★★ ★★★★★

AP II 6502 PROJECT

<ul style="list-style-type: none"> * ABS LOOK-A-LIKE CASE \$139.95 * GOLD SWITCHING POWER SUPPLY . \$115.00 (Will run 2 drives plus peripheral cards) * BEAUTIFUL MATCHING ASCII KEYBOARD \$129.95 * 6502 PROJECT BOARD \$59.95 * DISC DRIVE LOOK-A-LIKE WITH INTERFACE \$495.00 	<ul style="list-style-type: none"> * ALL SMALL PARTS, C's Capacitors, Crystals, Trim Caps, Resistors, Sockets, Choke, etc. LOW PRICES * IN CASE YOUR PROJECT HAS PROBLEMS WE HAVE A REPAIR SERVICE LOW PRICES * PERIPHERAL BOARD KITS Z80, Floppy Disc, 80 character, 16K expansion and more coming LOW PRICES
---	--

SABTRONICS • HAMEG SCOPES • PARTS, KITS • SURPLUS



general electronics

5511 YONGE ST., WILLOWDALE, ONT., M2N 5S3 221-6174



★★★★★ ★★★★★ ★★★★★ ★★★★★ ★★★★★

Circle No. 16 on Reader Service Card.

P.O. BOX 513
LASALLE, QUE.
H8P 3J4

F & T SOFTWARE

INQUIRIES & ORDERS
CALL (514) 365-5392
BETWEEN 1 & 7 P.M.
(E.S.T.)

ATARI 400/800 32K RAM EXPANSION BOARD

At the unbeatable price of \$135.00 (reg. \$150) Canadian—made and 100% compatible with both 400 and 800. Carries DOUBLE — GUARANTEE of manufacturer and F & T Ass. **\$135.00**

INVASION ORION—EPYX

You are fleet admiral. You alone can stop the alien forces. SUPERB GRAPHICS & SOUND Create your own fleet! 10 different scenarios. Design your own ships! Ages 12 through adult. Requires 32K. Disk or cassette **\$30.00**

TRS COLOR MADNESS & THE MINOTAUR

Adventure game with over 200 rooms — played in real time. Treasures, spells and creatures that attack you even if you sit still! 16K Cassette. **\$27.50**

SPACE WAR!

Command only remaining combat VIPER & break through enemy fighters & defenses of the DEATH STAR. Beware of BLACK HOLE as you maneuver — its gravity pull is strong and can suck you into it. DEATH STAR has 1 weak spot! Req. joystick, 16K Cass. **\$29.50**

CATALOGUES

For any of the following catalogues send \$1.00 (refundable on first order).

**APPLE—ATARI—PET
NORTHSTAR—TRS 80
TRS COLOR
OSBORNE 1**

ORDERS

PERSONAL CHEQUES O.K. QUE. RES. ADD 9% SALES TAX. C.O.D. ORDERS UNDER \$100.00 ADD \$1.50. PLEASE SEND FULL ADDRESS AND COMPUTER MAKE & MODEL.

FREE SHIPPING & HANDLING — FREE INSURANCE — NO HIDDEN CHARGES

Circle No. 19 on Reader Service Card.

Four Bit Analogue-to-Digital Converter
P.A. Barber

This converter was designed to be a cheap and relatively simple alternative to ADCs made from counters/ramps. It uses standard op-amps as voltage comparators, one for each bit. Each comparator is fed with the input signal and a reference voltage that depends on the states of the more significant bits. For example the threshold of bit D2 will be either 1/4 or 3/4 of the input range (in this case 5V) depending on whether the MSB (D2) is set to a 1 or a 0; similarly the reference voltage for the D1 comparator will be set to 7/8, 5/8, 3/8, or 1/8 of 5V for the values of D3 and D2 set to 11, 10, 01, 00 respectively.

In order for the D-to-A parts of the circuit (all the resistors) to supply these voltages, the outputs of the comparators must swing from 0V to 5V which few op-amp packages can manage. In the prototype I used ordinary 3140 op-amps with an extra supply rail of a few volts above 5V.

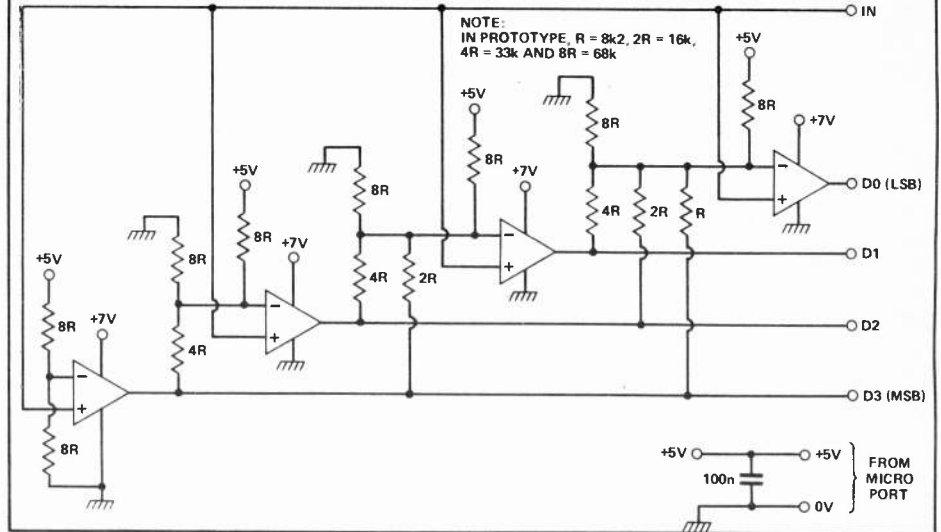

The current consumption was of the order of a few milliamps. The frequency response was difficult to measure on the limited equipment available but a reasonable trace was produced by reading the unit with a machine code routine on a ZX81 with an expansion port while music from a tape recorder was played into the converter.

Although the unit was made as a four bit converter any number of bits could be connected giving better resolution at the expense of operating speed and greater cost (the number of resistors required varies as $2b + b(b - 1)/2$ where b is the number of bits).

MICROCOMPUTER PARTS (6502)

1. PACKAGE I\$23.00
(Includes all resistors, capacitors, transistors, diodes, crystal, coil and jacks).
2. PACKAGE II\$120.00
(Includes all IC's RAMS and 6502)
3. PACKAGE III\$38.00
(Includes all IC sockets and 8 pcs (25 x 2) pin gold inlaid edge connectors)
4. ABS case\$145.00
5. Aluminium case\$89.50
6. Keyboard case (aluminium)\$44.50
7. Disc Drive case (aluminium)\$32.50
8. Keyboard\$165.00
9. Switching Power Supply\$94.50
(+ 5V5A, - 5V 1/2 A, + 12V1A, - 12V 1/2 A)
10. Linear Power Supply Kit\$29.50
(+ 5V6A, - 5V 1/2 A, + 12V1.5A, - 12V 1/2 A)
11. Disk Drive with controller card. \$500.00

SPECIAL PACKAGE SALE

- PACKAGE A: (1) + (2)\$136.00
 PACKAGE B: (1) + (2) + (3)\$172.00
 PACKAGE C: (1) + (2) + (3) + (4) + (8) + (9)\$555.00
 PACKAGE D: (1) + (2) + (3) + (5) + (8) + (9)\$500.00

Store Hours : Weekdays 1 p.m - 7 p.m.
 Saturdays 10 a.m. - 1 p.m.

Lots of free parking, front and rear.

Send cheque, money order plus 5% for postage and handling (no charge on orders over \$250.00). Ontario residents add 7% P.S.T. Visa and Master Card accepted : Send card No., expiry date and signature to:

AUDIOVISION

**578 Marlee Avenue
 Toronto, Ontario M6B 3J5
 Tel: (416) 781-3263**

(Just one block West of Glencairn subway)

Computer TV Sound Modulator
J. Wike

When a computer that generates a square wave type audio signal is used with a domestic TV receiver, this simple circuit can be used to transfer the sound onto the TV. All 525 line transmissions use a frequency-modulated sound carrier spaced at 4.5 MHz from the vision carrier. In the receiver the two carriers are mixed to give a 4.5 MHz sound 'sub-carrier' superimposed on the vision signal. This is known as the inter-carrier system. It is possible to insert an ex-

ternal sound sub-carrier onto the video signal and this will be correctly detected by the receiver.

The circuit shown is a very simple frequency modulator which will switch between two frequencies depending on the level at the TTL input. The output is mixed into the video input to the computer's modulator via the resistor-capacitor network. Quite a high level of sound carrier (approximately 500 mV pk-pk) has been found necessary to overcome video buzz on the audio output, but on the other hand too high a sound carrier produces interference on the picture. Some experimentation with the resistor value is therefore required to get the best compromise.

When the circuit is connected up the frequency of the variable oscillator should be adjusted to give the loudest undistorted output from the TV loudspeaker.

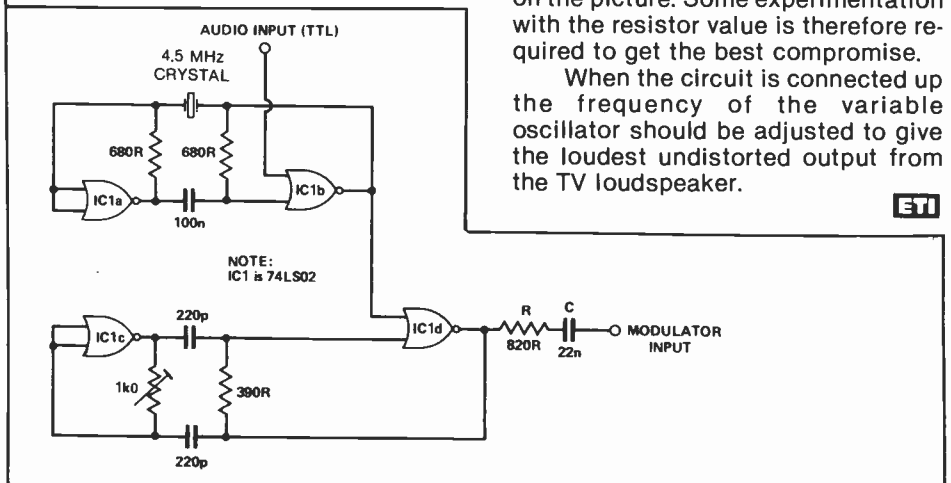



LX304 digital multimeter with automatic decimal point, built in low battery indicator and transistor testing capability. **\$138.00**

LX303 digital multimeter with easy-to-read LCD display. Only **\$110.00**

Model 216 Transistor Tester with fast, automatic switching for instant good-bad analysis of NPN's, PNP's, FET's, diodes and SCR's in or out of circuit. **\$172.00**

Model 240 Video Generator with 10 step gray scale staircase for VTR, CCTV monitor and TV applications. **\$230.00**

HICKOK
the value innovator

HROGERS electronic Instruments Ltd.

P.O. Box 310, 595 Mackenzie Ave. Units 1&2
Ajax, Ontario L1S 3C5. Tel. (416) 683-4211

Duty and FST included. Chargex (Visa) accepted.
Ontario residents add 7% sales tax. Shipping extra.

**FOR THOSE
ON THE GO
FROM...**

HICKOK
the value innovator

HROGERS electronic Instruments Ltd.

Your Toolbox Test Bench

Circle No. 4 on Reader Service Card.

GIVE ME A GOOD CIGAR ANY TIME.

OLD PORT

Give yourself a break.

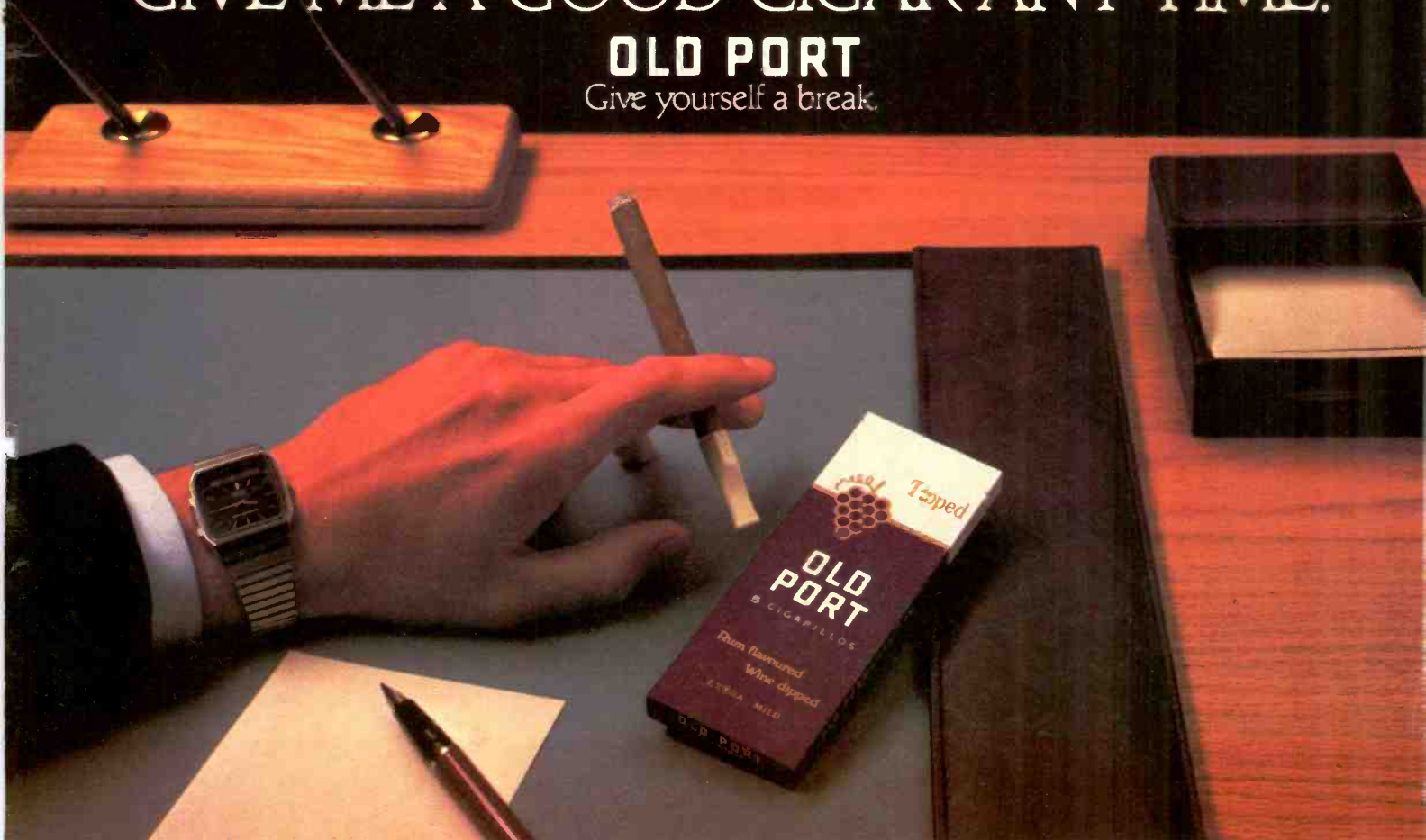

ZX PROGRAMMERS TOOLS

TOOLKIT

9 Powerful New Functions! \$17.95

RENUMBER. This routine rennumbers a program in any step and from any line up to 9999
DELETE. This command deletes a group of lines in a program.
MEMORY. Prints how much spare memory is available.
DUMP. Displays current values of string and numerical values, except arrays.
FIND. Will find any string of up to 255 characters and list each line containing that string.
REPLACE. Replaces any string of up to 255 characters by any other string.
SAVE. Transfers program in computer to below RAM-TOP.
APPEND. Allows two programs to be joined.
REMKILL. Removes all REM statements from a program, otherwise leaving it unchanged, preserving memory.

ZX FORTH \$39.95
Simplicity of BASIC with the Speed of Machine Code

A complete implementation of the FORTH language for the ZX81 and TS1000 computer. FORTH's most distinctive feature is its flexibility. The basic unit is the word — the programmer uses existing words to define his own which can then be used in further definitions. FORTH is a compiled language so programs run very fast (typically five times faster than BASIC).

ZX-FORTH is supplied on cassette and is accompanied by extensive documentation:
 56-page Users Manual
 8-page Editor Manual

ZXAS Assembler \$12.95

Now you can use the full power of the Z80 microprocessor without having to laboriously POKE in instruction codes. This full specification Z80 assembler assembles all the standard Zilog mnemonics, which are simply written into REM statements (more than one per line is allowed) within your BASIC program. When assembled, the assembly listings, together with assembled codes and addresses, are displayed on the screen. The assembled code is executed byUSR. The program occupies 5K, is situated at the top of the memory, and is protected from overwriting. This means that ZXAS may be used in conjunction with ZXDB (see below), providing an extremely powerful machine code system normally only found on very expensive computers.

The program is available for both the ZX81 and the 8K ROM ZX80, and in both cases, the 16K RAM pack is required. Despite the low price, ZXAS is a FULL-SPECIFICATION assembler, and is a must for all serious ZX users. Full documentation on how to use the assembler (including a list of the mnemonics) is supplied.

ZXDB Disassembler/Debugger \$12.95

The perfect complement to the ZXAS assembler, ZXDB is a complete combined machine code disassembler and debugging program. Like ZXAS, it is itself written in machine code for compactness, and may be used in conjunction with ZXAS, still leaving about 9K of memory for your own program.

Apart from the DIASSEMBLER, the program has features including SINGLE STEP, BLOCK SEARCH, TRANSFER AND FILL, HEX LOADER, REGISTER DISPLAY and more, all of which are executed by simple one key commands from the keyboard. All in all, an extremely powerful programming aid, well worth the money for the disassembler alone!

Z-AID 1.0 \$19.95

A machine language programming aid on cassette. Includes the following routines:

VERIFY confirms whether a program has been recorded properly on tape. The program in memory is unaffected, and a further "save" can be made if necessary.
Mload/Msave enables a specified block of memory to be saved. **VPTR** can be used within a BASIC program to eliminate many tedious POKES and PEEKs in finding the addresses where variable values are stored.
CHAIN allows the second part of a BASIC program to be loaded and tacked onto the end of the first part.
Z.AID 1.0 is convenient to use, being loaded from tape, and residing at the top of 16K memory. The user accesses the various routines with USR calls while loading, running, editing and saving BASIC programs normally.



\$24.95

- ★ Allows you to LOAD and SAVE ZX81 programs up to 6 TIMES FASTER!
- ★ Easy-to-use in your own programs.
- ★ User-transparent when incorporated into programs.
- ★ Verifies proper loading.
- ★ Catalogue feature lists program names and memory usage.
- ★ LOADER occupies less than 500 bytes (½ K) of RAM.
- ★ Consists of 2 separate programs — KEYBOARD MONITOR and FAST LOADER.
- ★ Supplied on cassette with extensive documentation.

KEYBOARD MONITOR is a user-friendly BASIC program which gives such information as the speed at which the tape was recorded, file name, file type, number of bytes in file, and whether a read error occurred. If desired, the user-friendly portion of the program can be removed for direct access to Machine Code Monitor. Both parts reside at RAMTOP and are user transparent. Full details are given in the manual for fast saving of your program.

FAST LOADER also resides above RAMTOP and can be used in front of any fast-saved program to enable it to be fast-loaded. This removes the need to load the monitor for each load.

Reliability and compatability: Fast-Load is an exceptionally reliable system. In one 3 hour test, over 1,300,000 bytes of data were recorded and then read without error, using a low cost cassette player. Compatible with all ZX81 systems, at your choice of two operating speeds: Medium Speed (4 times faster) suitable for use with any tape recorder that works with ZX81; Fast speed (6 times faster) for most higher quality tape recorders.



STRIKE FORCE is the ultimate challenge in arcade action- bent on destroying your concepts about game software!

Skill, cunning, lightning fast response and a keen sense of strategy are not just important—they're imperative to your life and the lives of millions of city dwellers! **STRIKE FORCE**, stretching your skills and imagination beyond this planet, is undoubtedly the fastest and most complex game you will ever see!

16K TRS Model I/III cassette \$21.95
 32K TRS Model I/III diskette \$29.95

PENETRATOR

THE FASTEST & MOST EXCITING GAME EVER DEVELOPED FOR THE TRS80*

- ★ Amazingly Fast Firing Action ★ Arcade Type Graphics & Sound ★ Includes Training Simulation Mode and ★ Unique Customising Feature ★ Free 16 Page Booklet ★ Compatible with Alpha Joystick

16K TRS Model I/III cassette \$21.95
 32K TRS Model I/III disk \$29.95

ZX81



WIN \$20,000 or more

KRAKIT™ is an adventure and a treasure hunt for the ZX81 and TS1000 computers. The bank account and prize money actually exist. Be the first to crack the puzzle and the prize is yours. Only one prize will be awarded.

SOLVE 12 CLUES LIKE THIS! \$24.95

Where it all began. Where the torch was first lit. Where muscles and sinews strain. Where our heroes will acclaim. Where the symbols hold the key.

ZX81 GAMES

MAZOGS MAZE ADVENTURE \$12.95

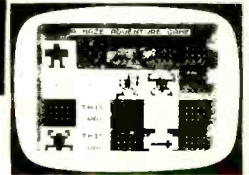

A new standard in ZX81 programming. MAZOGS presents the best use of ZX81 graphics to date. Written in machine code, MAZOGS is fast, exciting, and challenging!

ZX SCRAMBLE \$17.95



Pilot your space craft through a fast moving, complex space maze. Watch out for missiles being fired from all directions. You can shoot back or evade them. Written in machine code for fast-paced excitement.

GALAXY INVADERS \$17.95

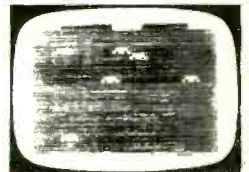

An excellent version of the classic space game. Protect your seven lives against fleets of hostile invaders, who swoop down and attack quickly. This version is an excellent demonstration of the capabilities of the ZX81 or TS1000 to entertain and excite for hours.

As an added bonus, there is a version of Invaders included on this tape!

ZX CHESS (Enhanced) \$15.95

Full graphic display of chess board. Six levels of play, two of which play within competitive time limits. You choose black or white. Plays all legal moves including castling and en-passant.

ZX CHESS II (Chess Master) 7 levels \$29.95
 1K ZX CHESS \$15.95

OTHER ZX81 SOFTWARE (16K)
 VUCALC Financial Spreadsheet \$29.95
 VUFILE Data storage/retrieval (16K) \$29.95
 MULTIFILE + Data storage system (64K) \$44.95
 Flight Simulation \$19.95

ZX81 Astronomy:
 Constellation (Computer telescope) \$19.95
 Solar System File (Databank) \$15.95
 Biorhythms with book \$15.95
 Book of Days — Historical databank \$15.95

Business Pack #1:
 Breakeven analysis, Cash flow, Payback, Internal rate of return, Depreciation \$39.95

Business Pack #2:
 Project Scheduler, Proposal Sheet \$19.95
 Personal Weight Control Program \$39.95

PLUS MANY OTHER NEW PROGRAMS IN STOCK

GLADSTONE ELECTRONICS

(416) 787-1448

1736 Avenue Rd., Toronto, Ont., M5M 3Y7
 Telephone (416) 787-1448 Telex 06-986782

Personal orders with VISA, Mastercard, American Express welcomed.

Use order form on inside back cover.

Circle No. 12 on Reader Service Card.

The \$129.95 Computer!

A personal computer that grows with you.



JAN 04 1983

ZX81 Assembled
\$129.95

Now includes Heavy-duty AC Adaptor

Sinclair ZX81. . . .World's most popular personal computer. . . .more than 500,000 sold. . . .owned by 20% of ETI's readers!

Uses standard TV & cassette.

Your ZX81 connects directly to colour or black & white television for a 32 character x 24 line display. You can store programs on a standard cassette recorder. All the connecting cables you require for TV and cassette are provided.

Sinclair 16K RAM PACK 99.95

Provides massive add-on memory in a compact plug-in module via an edge connector. Can be used for program storage or as database. Yet it costs as little as half the price of competitive memory.

Sinclair ZX Printer . . . 169.95

Designed exclusively for use with the ZX81 (and ZX80 with 8K basic ROM), the printer offers full alphanumeric and highly sophisticated graphics. COPY command prints out exactly what is on screen. At last you can have a hard copy of your program listing and results. Printing speed is 50 characters per second, with 32 characters per line and 9 lines per vertical inch. Connects to rear of ZX81 — using a stackable connector so you can use a RAM pack as well. A 65 ft paper roll, instructions included.

Lower price: higher capability.

Sinclair's new ZX81 personal computer is a tremendous advance over the highly successful ZX80. It offers far more computer capability, yet Gladstone Electronics is able to offer the ZX81 at less than half the ZX80 price!

How is it possible? Quite simply, by design. The ZX81 uses only 4 chips (as opposed to 21 in the original ZX80). The secret lies in the totally new Master chip. Designed by and custom-manufactured for Sinclair, this unique chip replaces 18 chips from the ZX80.

The ZX81's advanced capability.

The ZX81 uses the same fast microprocessor (Z80A), but incorporates a new, more powerful 8K BASIC ROM — the "trained intelligence" of the computer. This chip works in decimals, handles logs and trig, allows you to plot graphs, and builds up animated displays. And the ZX81 incorporates other operation refinements — the facility to load and save named programs on cassette, or to select a program off a cassette through the keyboard.

New, improved specification.

- * Unique 'one-touch' key word entry: the ZX81 eliminates a great deal of tiresome typing. Key words (PRINT, LIST, RUN, etc.) have their own single-key entry
- * Unique syntax-check and report codes identify programming errors immediately.
- * Full range of mathematical and scientific functions accurate to eight decimal places.
- * Graph-drawing and animated-display facilities.
- * Multi-dimensional string and numeric arrays.
- * Up to 26 FOR/NEXT loops.
- * Randomize function.
- * Programmable in machine code.
- * Cassette LOAD and SAVE with named programs.
- * 1K-byte RAM expandable
- * Full editing facilities.
- * Able to drive the new Sinclair ZX Printer

ZX81 Professional Keyboard and Case

A full-sized professional keyboard for the ZX81. Features 47 keys and a full-sized space bar. Connects to the ZX81 with no soldering required, via a plug-in flexible connector. You can purchase the keyboard only, or the optional metal case that holds both keyboard and ZX81. Expansion devices (i.e. RAM packs, etc) connect to the ZX81 edge-connector which extends from the rear of the cabinet.

A professional keyboard makes program entry easier and less error-prone.

Keyboard (KB-1) \$119.95
Metal case for keyboard and ZX81 (MC-1) \$29.95



NEW 32K RAM MEMOTECH

"May be used with Sinclair 16K RAM to give a total system memory of 48K RAM! Unit simply plugs into back of ZX81 and existing 16K RAM "piggy backs" on. May also be used instead of 16K. Greatly extends the capacity of the ZX81 to store masses of data and longer programmes.

Memotech Memopak 32K \$179.95

64K RAM.

The maximum the ZX81 can address. With 64K your ZX81 is transformed into an extremely powerful computer for business, leisure, and educational use, at a fraction of the cost of comparable systems.

Memotech Memopak 64K \$259.95

High Resolution Graphics. Memopak HRG \$239.95

RS232 Printer Interface. Memopak IF \$199.95

GLADSTONE ELECTRONICS

(416) 787-1448

Telephone (416) 787-1448. Use VISA, Mastercard, AMEX to order.

Circle No. 12 on Reader Service Card.

1736 Avenue Rd.,
Toronto, Ont., M5M 3Y7