

Projects, Audio, Video, Computers, Radio, Servicing, Education \$1.50

electronics today

DECEMBER 1979

MM70924

ETI Checks Out **POLICE RADAR:**

*How It Works
When it Doesn't
Can You Beat It?*

LM10 Super Op-Amp
ETI Index 1979

Build:

Ultra-Fi Preamp

Logic Trigger

Novel Development Timer

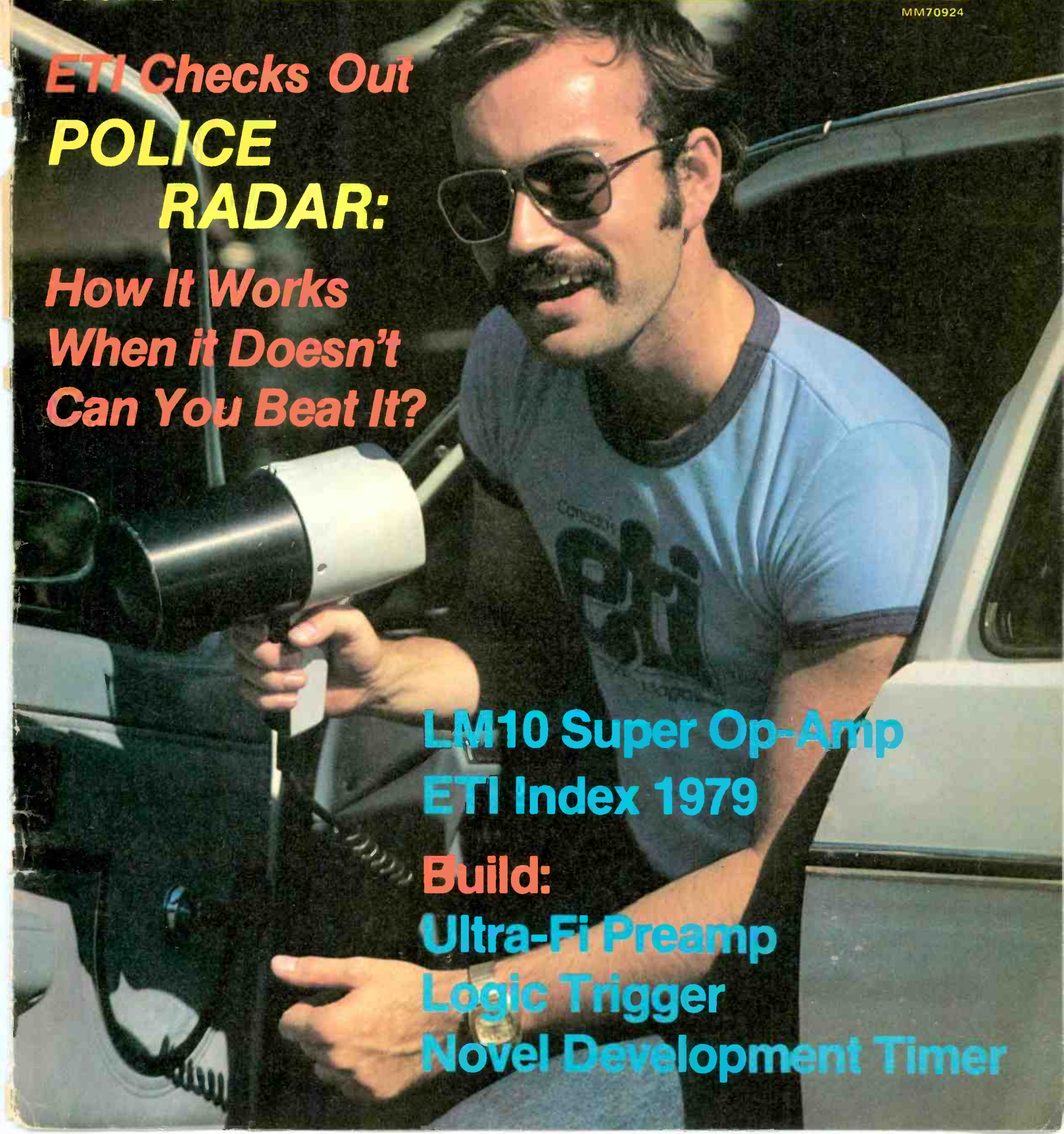

He-Ne LASER KIT

\$149.95

At last a safe (1mW) Helium-Neon laser kit at an affordable price. Kit of all parts and instructions. Ideal for optical experiments, holography, ranging, etc.

ULTRALINEAR POWER AMPLIFIER MODULE KIT

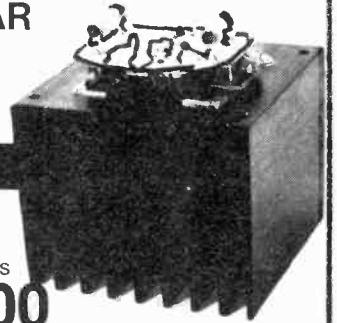

POWER OUTPUT — 100 watts RMS into 8 or 4 ohms
 FREQUENCY RESPONSE — 20 Hz - 20 KHz ± 1db
 HARMONIC DISTORTION — 0.15% at 1 KHz at 100 watts
 IM DISTORTION — 0.1%

AE100

INPUT IMPEDANCE — 100K ohms
 LOAD IMPEDANCE — 4 ohms Min
 SENSITIVITY — 1.0 V for 100 watts

\$44.95

AE50

The AE-50 is a little brother to the AE-100, same great specs but only 50 watts.

\$29.95

ARKON KITS

01 5 Transistor 1 W. amp	\$ 8.95	14 3 Self Blinking LED's	\$ 2.95
02 0-24V 1 Amp Power Supply	\$18.95	15 Video Modulator	\$ 8.95
03 Strobelight	\$15.95	16 RS232— TTL Converter	\$ 9.95
04 Light Chaser	\$19.95	17 IC Amp (LM380)	\$ 5.95
05 Light Organ 500w/ch	\$18.95	18 Crystal Radio	\$ 4.95
06 Light Organ 1500w/ch	\$39.95	19 Photo Electric Nightlight	\$ 5.95
07 FM Mike	\$ 3.95	20 1 Channel Light Organ	\$ 5.95
08 FM Mike, with preamp	\$ 4.95	21 Shimmer Strobe	\$ 7.95
09 Tone Decoder 567	6.95	22 Whisper Light	\$ 8.95
10 Timer board 555	\$ 3.95	23 MA1003 Car Clock	\$24.95
11 Code Oscillator 555	\$ 3.95	24 Decision Maker	\$ 3.95
12 Code Key, brass WWII	\$ 3.95	25 Hi-Power 12V Flasher	\$ 5.95
13 LED Blinky	\$ 2.95	26 AM-FM Freq. Readout	\$49.95

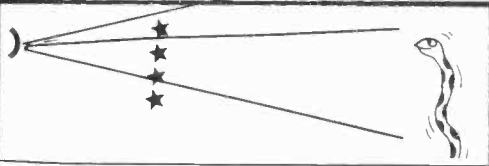

TELEPHONE CURLY CORDS

A great item for audio, Ham, CB, etc. 6 foot curled cord as used by MA BELL. Black, Brown, Red, Orange, Yellow, Green, White.

3/\$5.00

OHIO SCIENTIFIC

SUPERBOARD \$417⁰⁰

You've seen all the ads, at last this great item is in stock. What more can we say.

FORT//80

FORT//80[®] is here at an affordable price. A fast, resident Fortran compiler. Produces directly executable, highly condensed machine code for the 8080, (will run on Z80 and 8085). Runs on any CPM[®] system.

- Direct IO to 8080 ports
- Accepts embedded in-line code
- Fortran Interrupt control
- ANSI FORTRAN IV subset
- Single, double precision
- Custom IO drivers
- Memory mapped IO
- Made in Canada

Send now for a full data sheet and sample program.

Copyright Arkon Electronics, Digital Research of Cal.

FORT//80	\$99.00
MANUAL ONLY [APPLIES TO BUY]	\$20.00
DATA SHEET AND SAMPLE PGM	NC

LED BAR GRAPH AND ANALOG METER DRIVER
 New from National Semi. #LM3914. Drives 10 LED directly for making bar graphs, audio power meters, analog meters, LED oscilloscopes, etc. Units can be stacked for more LED's. A super versatile and truly remarkable IC. Just out!
SPECIAL PRICE: \$4.95 INCLUDES 12 Page Spec. Sheet

10 Mini bar LED's \$2.00

ARKON CP-IO-1

The ARKON CP-IO-1 is an S-100 card that has all the CPU, Disc control and IO capability needed to construct a disc based microprocessor system for business, hobby or scientific system. Features are:

- 2 Mhz 8080-A, fully buffered S-100.
- EIA-RS232 port, 110 to 76,000 baud.
- Fully vectored interrupt (TMS-5501).
- 5 Interrupt controlled timers.
- EIA port for printer up to 9600 baud.
- Disc controller on board (1771).
- Shugart 400, 800, Memorex 550, plus.
- On board digital data separator.
- 2K bytes EPROM.
- 24 fully handshaked IO lines.
- Dual mapped IO.
- MWRITE generation on board.
- Software driven cassette interface.

ARKON CP-IO \$495.00

MAGNECRAFT 12V

3PDT Relay, \$3.95 DC
 SPDT Co-Axial RF Relay for antenna use, 1-450 MHz \$6.95

PARTS

7805 +5V	\$01.40
7812 +12V	\$01.40
7905 -5V	\$ 1.95
7912 -12V	\$01.90
100V-25A bridge	\$03.50
Red LED S,M,L	5/1.00
Green LED S,M,L	4/1.00
Yellow LED S,M,L	4/1.00
Bi-polar LED	\$0.75
2114 4Kx1	\$11.95
4116 16Kx1	\$13.95
741	3/1.00

ARKON ELECTRONICS
409 QUEEN ST W
TORONTO ONT.
(416) 868-1315

SD SYSTEMS EXPANDORAM

Z-80 STARTER KIT . . .	\$325.00	16K . . .	\$325.00
SBC 100 KIT	\$399.00	32K . . .	\$425.00
VERSAFLOPPY KIT . . .	\$199.00	48K . . .	\$525.00
		64K . . .	\$599.00

VIDEO TERMINAL KIT

DISPLAY: 64 char per line x 16 line per frame of 5x7 dot matrix, 64 ASCII char

VERT SYNC: 60 Hz XTAL controlled

HDR SYNC: 15.840 KHz XTAL controlled

VIDEO O/P: 1V P-P composite video

I/O: Parallel port to ASCII keyboard + 20ma current loop + RS232 IO

BAUD RATE: 110 to 9600 Baud remote sel
 POWER: 5v 1A DC + +12VDC for RS232

RE6416 \$169.95

LOWER CASE POWER SUPPLY
 OPTION . . . \$16.95 OPTION . . . \$16.95
 WIRED and TESTED \$239.00

MEMOREX 550

Now you can buy a full sized 8" disc drive fully IBM compatible at a reasonable price in Canada. Ask for a data sheet as there is not enough space here to do justice to this high quality unit

MEMOREX 550 DRIVE \$650.00

All orders processed promptly, add 5% for shipping. Excess refunded. Make sure you include complete Master Charge or ChargeX numbers and expiry date, minimum order \$5.00 Ont. Res. add 7%.



GRAHAM WIDEMAN BAsC
Assistant Editor
JOHN VAN LIERDE

ADVERTISING

Advertising Manager

MARK CZERWINSKI BAsC

Advertising Services

CHERYL MAY

Advertising Representatives

JIM O'BRIEN

Eastern Canada JEAN SEGUIN &
ASSOCIATES INC. 601 Cote Vertu,
St. Laurent, Quebec H4L 1X8.
Telephone (514) 748-6561.

Subscription Department

BEBE LALL

Accounts Department

SENGA HARRISON

Layout and Assembly

SARAH-JANE NEWMAN

Contributing Editors

WALLACE PARSONS (Audio)

BILL JOHNSON (Amateur Radio)

JOHN GARNER (ShortWave Listening)

DICK CARTWRIGHT (Servicing)

STEVE RIMMER (Video)

EDITORIAL AND ADVERTISING

OFFICES

Unit 6, 25 Overlea Boulevard,
Toronto, Ontario, M4H 1B1
Telephone (416) 423-3262

Published by Electronics Today
International (Canada) Ltd.

Printed by Livingstone Printing Ltd
Delta Web Graphics

News Stand Distribution

Master Media, Oakville.

COPYRIGHT

All material is subject to worldwide
copyright protection. All reasonable
care is taken to ensure the accuracy
of the information.

All ETI PCB Patterns are copyright .

No company may sell boards to our
designs without our permission.

INTERNATIONAL EDITIONS

Electronics Today International,
145 Charing Cross Road,
London WC2H 8DEE, UK.

Electronics Today International

Ryrie House, 15 Boundary St.,
Rushcutters Bay, Sydney, Australia.
Managing Editor Collyn Rivers.
Acting Editor Roger Harrison

Elrad

Kommanditgesellschaft, Bissendorfer
Strasse 8, 3000 Hannover 61 Germany
Editor Udo Wittig

Postal Information

Second Class Mail registration number
3955. Return postage guaranteed. Post
office returns to Unit 6, 25 Overlea
Blvd., Toronto, Ontario. M4H 1B1

electronics today

international

INCORPORATING ELECTRONIC WORKSHOP

PROJECTS

HIGH PERFORMANCE STEREO PREAMPLIFIER	14
<i>High quality high fidelity project that's easy to build.</i>	
DEVELOPMENT TIMER	20
<i>Check it out! A new way to do prints.</i>	
LOGIC TRIGGER.....	24
<i>Homebuilt MPU got you down? This could help.</i>	

FEATURES

LM10 THE BASICS	29
<i>A new op-amp? It's worth a look.</i>	
POLICE RADAR SPEED METERS	34
<i>Tool of justice? Bane of the common motorist?</i>	
WHAT'S ALL THIS 'EAR.....	52
<i>How music turns you on.</i>	
PRACTICAL GUIDE TO TRIACS	68
<i>First of a three part series.</i>	
FLUORESCENT DISPLAYS	75
<i>Movementless meters.</i>	
ETI EDITORIAL INDEX	81
<i>Last year's articles together for you.</i>	

NEWS & COLUMNS

NEWS DIGEST	4
AUDIO TODAY	9
<i>Wally Parsons time warps into the future and looks at vacuum tubes.</i>	
SERVICE NEWS.....	55
<i>Thinking of a job as a service tech? Dick Cartwright says why you should.</i>	
SHORTWAVE WORLD	58
<i>John Garner tells what you can do in 24 hours with your rig.</i>	
QRM	60
<i>Bill Johnson muses on the implications of radar detector legislation.</i>	
WHAT'S ON	71
<i>Is there a flat TV in your future? Steve Rimmer reports.</i>	
TEACHERS' TOPICS	76
<i>How to draw good schematics.</i>	
THE FUN OF ELECTRONICS.....	78
<i>Looks like Geiger has been doodling on our pages again.</i>	

INFO & MISCELLANEOUS

Next Month In ETI	18	Reader Service Card.....	62
Sam's Books.....	64,65,66	Subscriptions	62
Classified Ads.....	79	ETI Project File	80
Babani Electronic Books.....	12,63	General Reader Information	82
ETI Market Place.....	13	Advertiser's Index	82
TAB Books	67		

NEWS DIGEST

Jobs For Professionals Still At Record Levels

Job vacancies for accountants, engineers, scientists and other professionals reached record levels at the end of September. The Technical Service Council's quarterly survey of openings with 1,600 firms showed demand increased 3% since June 1979, and 34% in the last 12 months.

"Canadian employers still have confidence in the economy, as evidenced by their active recruiting," according to N.A. Macdougall, general manager and director of the Technical Service Council/Le Conseil de Placement Professionnel. "Although there is concern about the effects of the downturn in the American economy, employers are equally concerned about their inability to hire experienced professionals."

Shortages of specialized engineers, data processing staff and accountants have intensified during the last year. Employers in every region of the country report problems filling openings for experienced professionals.

A survey of 17 major consulting and resource firms in Alberta showed shortages of senior engineers; planners, schedulers, systems specialists and auditors. These employers expected recruiting problems to worsen during the next six to twelve months.

The TSC's national survey showed systems analysts and computer programmers were in greater demand than any other group.



Who says university grads don't get jobs? Professional occupations offer job satisfaction and security in a changing economy. (photo courtesy of Apple Computer Inc.)

Large university graduating classes provide a good supply of trainees. However, companies who failed to recruit in universities in the Spring report difficulty hiring 1979 graduates in commerce and most engineering courses. A few civil engineers are still unplaced. Arts, general science, physics and life science graduates have had difficulty finding responsible positions.

A strong demand was reported for electronics technicians and technologists, instrument engineers, petroleum engineers, chemical process engineers, personnel managers, plant super-

intendents, mechanical draftsmen and accountants.

The TSC is financed by some 650 companies. There is no charge to job hunters. The TSC has put on free "how to job hunt" courses and financed three major studies of the supply of and demand for university graduates and accountants.

Bryce, Haultain personnel consultants, a TSC division, undertakes relocation counselling, executive search, employment interviewing courses and personnel consulting.

APF'S IMAGINATION MACHINE

APF Electronics Inc. believes their new computer: The Imagination Machine is the first user programmable and expandable computer (retailed as low as \$500 US) which will be educational, entertaining, fun and easy to operate by consumers.

APF marketing representatives feel The Imagination Machine is the solution to the personal computer problem in that the consumer was previously afraid to operate a computer.

APF offers a preliminary cartridge which will instruct the new user in programming the computer through directions on the screen in front of them. This program also eliminates the confusing, head turning of learning from a manual beside you and instead, gives commands to easily teach the

various computer capabilities on the screen as you perform them.

The Imagination Machine will offer color graphics, music synthesizer plus a detailed software program covering education, home management and games. Hand held joysticks and key pads are part of the attractive unit which has 9K RAM expandable to 32K and 10K ROM.

Write to APF Electronics Inc., 444, Madison Ave., New York, NY 10022.



SOLAR CELL FUTURE

Dr. Raj Singh, former member of a sizeable team of University of Waterloo solar cell researchers (now at Colorado), has some reservations about the extent to which some utility producers have locked themselves into nuclear power. He is extremely optimistic about the fairly short-term future of solar cells. He notes that in the past four years the price of these cells has been reduced by a factor of 10 and predicts the day of the truly cheap cell is a good deal closer than many people realize. The three keys to the solution of the problem: (1) cheaper materials; (2) less of them; (3) automated production. On campus, he was working with metal insulator semiconductor cells.



THUMB WHEEL

Wherever limited space prevents the use of conventional wrenches, this new "Thumb Wheel" Ratchet Set comes to the rescue. Lets the user reach the tight places behind the dash, under the hood, in the trunk with good leverage and maneuverability. Ideal for installing and servicing radios, CB's, etc.; working inside TV sets; assembling cabinets and electronic gear.

Made in the U.S. to the highest standards and is Warranted for life, the complete 8-piece Thumb Wheel Ratchet Set, with pouch, is \$14.95 US plus \$1.00 for postage and handling. Satisfaction fully guaranteed. From: Howard Products Company, P.O. Box 57246, Dallas, Texas 75207.

TO 220 DARLINGS

Motorola now has three new high-voltage, Darlington power transistors, available in the industry-standard TO-220 outline for plastic packages. These devices, designated the MJE5740, MJE5741 and MJE5742, have $V_{ce0(sus)}$ ratings of 300, 350 and 400 volts respectively. All devices have maximum collector current I_C ratings of 8 amperes. They are designed for high-voltage power switching in inductive circuits. The TO-220 package provides a maximum power dissipation of 80 watts at 25°C case temperature.

These TO-220 power darlington transistors are particularly suited for operating switch-mode applications such as Small engine ignition, Inverters, Switching regulators, Solenoid and relay drivers, Motor controls.

The Darlington power transistors are priced, in 100-999 quantities, at

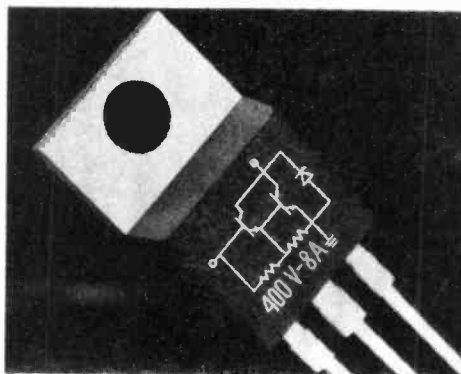

around a dollar. Delivery is from OEM and authorized Motorola distributor stocks.

NEW WIRE WRAP SYSTEM

O.K. Machine and Tool Corporation (New York) has announced "Just Wrap" a revolutionary wiring process and a series of tools that produce wire wrapped connections without prior stripping or slitting of the wire insulation. Designed to wrap on .025 in. (0.63 mm) sq. posts, each tool carries a 50 ft. (15m) spool of 30 AWG (0.25mm) wire. The tool will wire continuously through any number of pins (daisy chain). It is equipped with a built-in wire cutoff, and is equally suited for point-to-point wiring. Wire is available in 4 colors: blue, white, red and yellow.

For further information Len Finkler Limited, 25 Toro Road, Downsview, Ontario, M3J 2A6.

ETCO CAT

One of North America's most unique electronics parts and equipment catalogues has just been released by Ectco Electronics.

Labeled issue "H" this catalog is the largest yet to be issued by Ectco and contains many new items not in their previous issues.

The book consists of 80 pages filled with unusual and hard-to-find parts, choice factory "termination" material and hundreds of bargain priced items.

This catalog is available from Ectco Electronics, Dept. 113, Box 796. Plattsburg, N.Y. 12901.

A CAT NAMED BRYAN

Bryan Electronics has a catalogue out featuring a wide selection of LEDs, TTL, CMOS, plugs, cables, capacitors and more. In addition there is no minimum order and \$2.00 flat fee (\$5.00 Yukon and NWT) on any goods they sell. Write to Bryan Electronics, P.O. Box 2068 Bramalea, Ontario L6T 3S3.

DIGITAL C. METER

The CSC Model 3001 Digital Capacitance Meter is a high-precision 3½-digit instrument designed for measuring, testing, selecting and matching capacitance. But here its resemblance to other cap meters ends. It is designed for high-volume, heavy-duty tasks in production and quality control, as well as critical applications in laboratories and servicing.

The 3001's unique dual-threshold measuring technique delivers 0.1% accuracy — that's 0.1% of *reading*, not of full scale. This technique also eliminates errors resulting from dielectric absorption in capacitors.

CSC instruments are available from Len Finkler Ltd.

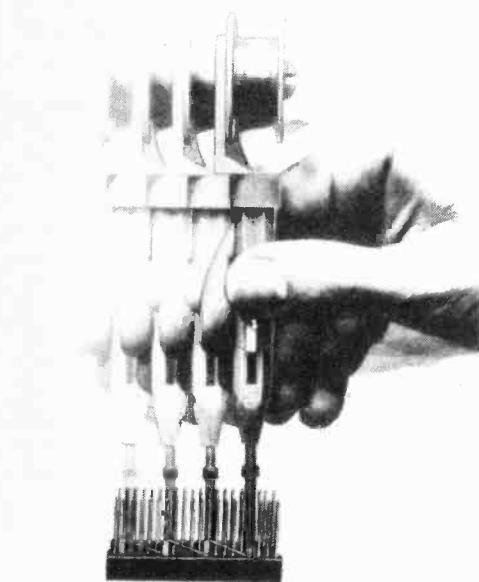
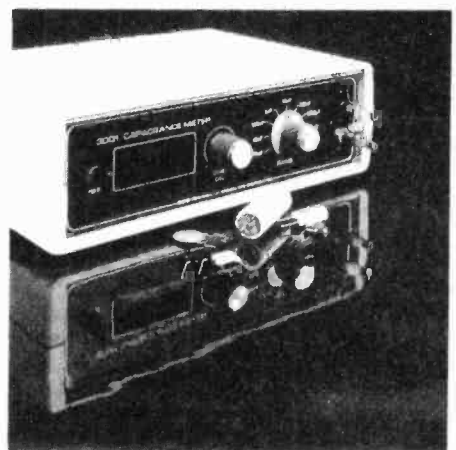

THE 68000, IT'S HERE

In Motorola's product line, the MC68000 is the most advanced of the many MPU/MCUs that they have introduced over the past years. It doesn't obsolete the other types, however. Rather, it satisfies an applications void that currently exists between the upper capabilities of 8-bit processors and the more sophisticated functions of the minicomputer. And — the 16-bit architecture and its unique high-level-language orientation offers Original Equipment Manufacturers a pervasive basic component with which to implement proprietary machines with mini-computer capabilities.

A variety of MC68000-complementary peripheral chips are in design and will start becoming available early in 1980. But in the meantime MC68000 system implementation can be accomplished with the standard series of M6800 peripheral chips with which the new processor is compatible. This compatibility of components in Motorola's MPU/MCU family is one of the desirable features of the Motorola processor line, in that it permits hardware developed for one processor to be used with more powerful, upgraded systems.

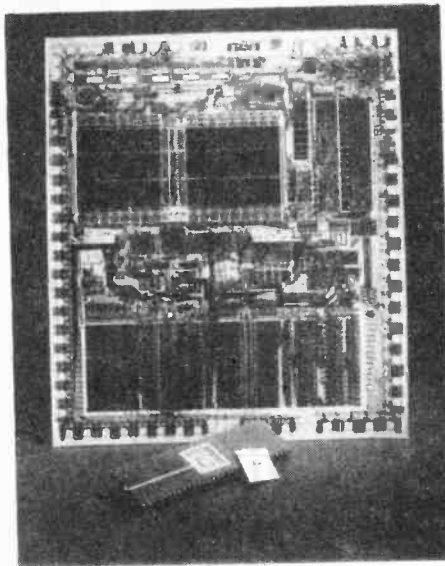

Production of the MC68000 is being expanded. It is expected that all sampling requirements will be filled on an "as required" basis before the end of 1979, with production quantities becoming available during 1980. Introductory prices for MC68000 products are MC68000 \$249.00 US and the MEX68KDM Design Module \$1795.00 US.

APPLE EDITORS

Apple Computer, Inc., announces the Apple Writer a powerful text editor for the Apple II personal computer. Available now the Apple Writer offers a low-cost way to edit and print text, letters and documents.

With the attachment of a dot matrix- or impact-type printer and a television screen, the Apple II and Apple Writer become a time-saving tool for producing and revising documents. The Apple Writer allows anyone to reduce the amount of time and effort spent on paperwork.

A document needs to be typed into the computer only once; revisions or changes can be accomplished easily and quickly. Additional documents or documents segments (e.g., paragraphs) can be merged into any location within the previously typed document.

The Apple Writer — as well as the Apple II personal computer — is made by Apple Computer, Inc., a leading personal computer manufacturer located in Cupertino, California.

The Apple Writer, available as of November nationwide at all authorized Apple dealers, will retail for \$75 US.

PET PORT

TNW Corporation of San Diego now offers the TNW-2000 Serial Interface, an inexpensive unit that adds a bidirectional RS-232 port to the Commodore PET and other IEEE-488 computers. Users of these computers can now interface them to standard RS-232 printers, terminals, and modems, and to other computers.

Other devices can be used on the IEEE bus with the TNW-2000, and it can be used with other IEEE-488 capable computers as well as the Commodore PET. A meter IEEE bus cable provides a daisy chaining capability with both the PET style edgeboard connector and the IEEE-488 Standard ribbon connector.

Priced at \$229 US, the TNW-2000 is delivered as a fully assembled and tested unit with cabinet, IEEE bus



cable, built-in female EIA (RS-232) connector, and full documentation. Contact TNW Corporation, 3351 Hancock Street, San Diego, CA 92110.

LOW POWER MEMORIES

Three memory microboards, new additions to RCA's expanding line of microprocessor-based milliwatt-powered Microboard computer systems are now available immediately.

The three new Microboard memories include the CDP18S621V1 16-kilobyte RAM, the CDP18S623 8-kilobyte RAM, and the CDP18S624 4-kilobyte battery-backup RAM. Each module features static CMOS components with low-power and high noise immunity advantages and operates from a 5-volt supply. Typical current requirements are 11 mA for the CDP18S621V1, 8 mA for the CDP18S623, and 13 mA for the CDP18S624. The CDP18S624 battery-backup RAM, with its rechargeable Ni-Cad batteries on board, has a 96-hour memory-retention capability with external power off.

In quantities of 1 to 9, the CDP18S621V1 16-kilobyte RAM is priced at \$1195.00 US, the CDP18S623 8-kilobyte RAM is priced at \$650.00 US

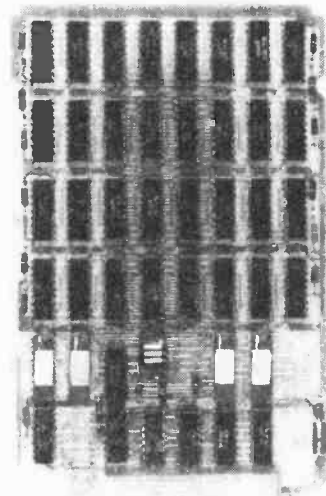

and the CDP18S624 4-kilobyte battery-backup RAM is priced at \$515.00 US. These prices are U.S. only. RCA COSMAC Microband Computer System products are available from RCA Solid State distributors.

Further information may be obtained from RCA Solid State Division, Box 3200, Somerville, New Jersey 08876.

Light up a Party!

for exactly 1/1000 sec. (366 times a second)
with **Jana's Xenon Strobe**

The whole world will look fantastic!
When room light is by Jana Xenon
Strobe, your party will become magical
... as if the guests included Tolkien's
hobbits, C.S. Lewis's lion, and a Cabell
witch.

When it's off, the secret of the
powerful little Xenon tube will be seen by
everybody. Turn the Jana case over and
let them marvel at the intricacies inside.
That might be as much of a show for
them as the light that goes

ONOFFONOFFONOFFONOFFONOFFONOFFON

All this you can accomplish for your friends and
yourself. Jana makes it possible for you with an
illustrated plan that is easy to follow, and a clever
selection of parts that do the job ... all of it. Even
the case is included.

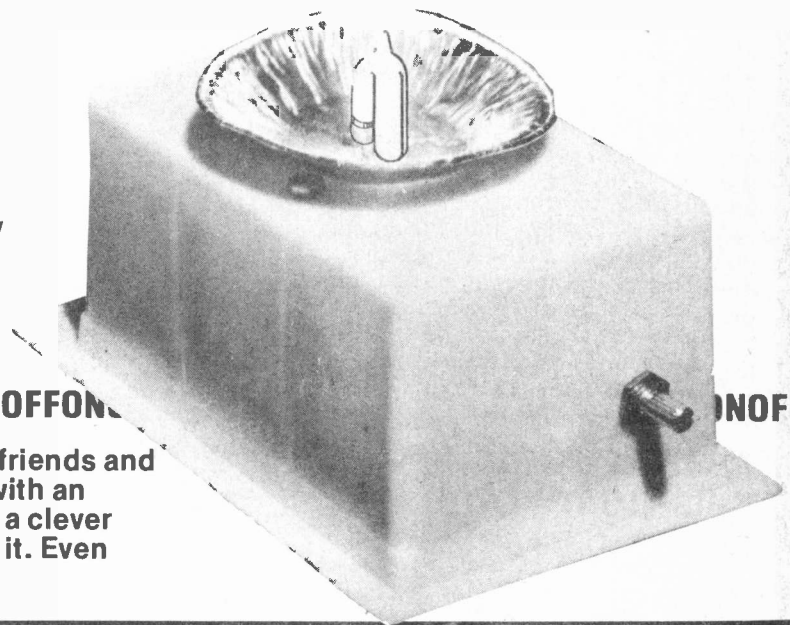

ONOFFONO

Check the list of Jana kits for many that are useful
as well as those that make parties exciting.

JANA KITS

- | | | |
|---|---------------------------------------|-----------------------------|
| #1. Automatic Headlight
Reminder | #12. Photo Electric Night
Light | #23. 3 Channel Color Organ |
| #2. Battery Operated
Fluorescent Light | #15. 0-20V Power Supply | #24. Loudmouth Siren |
| #3. Bug Shoo | #16. Single Channel Color
Organ | #25. Roulette Wheel |
| #4. Code Oscillator | #17. Electronic Siren | #26. Electronic Skeet Game |
| #5. Crystal Radio | #18. Shimmer Strobe Light | #27. Electronic Dice |
| #7. Curiosity Box II | #19. Tone Generator | #28. Super Roulette |
| #8. Dally Lighter | #20. 5 Transistor 1 Watt
Amplifier | #29. FM Mini Broadcaster |
| #9. Decision Maker | #22. Xenon Strobe | #31. Shoot Out |
| #10. Fish Caller | | #32. Road Runner |
| #11. Hi Power 12V DC Flasher | | #33. Love-O-Meter |
| | | #34. Soldering Iron Kit |
| | | #35. Audio Power Watt Meter |

Jana kits are available from dealers across
Canada, including

Atwater Electronics Limited
886 Dundas Highway East
Mississauga, Ontario
L4Y 2B8

Circle No. 7 on Reader Service Card.

INDUSTRIAL ELECTRONICS

1777 Elllice Avenue, Winnipeg, Manitoba R3H 0W5

A SOUND IDEA

Ever wonder how much noise you're exposed to during an average day? Well, now there's a handy, easy-to-read chart that illustrates the noise levels in a variety of environments with a colorful "noise thermometer".

The chart, available free from Bruel & Kjaer Canada Limited, a company specializing in noise measurement, shows how much harmful noise you may be exposed to in typical daily situations, measured in both decibels and equivalent uPa units.

The examples illustrated range from the threshold of hearing at 0 decibels to the point where noise becomes painful at 140 dB. Since each 3 dB increase means the volume of sound has about doubled, the changes become increasingly significant at higher levels.

Forexample a secluded wooded area registers a very quiet 15 dB, much lower than normal conversational speech at about 60 dB. The noise level in the living room of a well-behaved family is usually a relatively quiet 40 dB, about equal to that in a public library, while a bedroom at 25 dB is nice and quiet for sleeping.

Copies of the chart can be obtained by writing Bruel & Kjaer Canada Limited, 90 Leacock Road, Pointe Claire, Quebec, H9R 1H1.

BLOOD FROM STONE, OIL FROM WOOD

Turning the Pacific Northwest's abundant supply of wood and other wastes to oil is a possible method for easing the regional energy shortage. Cellulose conversion to oil is one of the alternative energy sources researchers are studying at the Department of Energy's Pacific Northwest Laboratory. Battelle Memorial Institute operates PNL for DOE.

Cellulose is the fibrous portion of a plant's structure and is indigestible to humans. Cellulose as an alternative energy source is present in renewable biomass — any residue from living organisms, including wood wastes, agricultural residues (stalks, stems, shells, husks, cobs), algae, kelp and manure. Included in the list are crops grown on "energy farms" specifically for use as fuel in biomass conversion projects.

Cellulose in its pure form looks like powdered sugar, and can be converted to a thick black liquid using alkaline digestion with a catalyst under high temperatures (300°C) and high pressures (1,000 psi). So far, over 100 of the most prevalent chemical compounds in

JAPANESE THREAT TO NORTH AMERICA

North America is in peril of losing its position as the world's leader in the field of technology, according to John Fluke Sr., speaking in Toronto to a gathering of top officials from Canada's electronics industry. John Fluke Sr., the founder and chairman of John Fluke Mfg Co., Inc., the world's largest manufacturer of digital multimeters and associates electronic instrumentation, was the keynote speaker at a technical seminar sponsored by Allan Crawford Associates Ltd.

In his speech Fluke attacked Canadian and US educational systems which stress arts and crafts rather than teaching technology. "If we want to live in a world of crappy pottery and funny looking leather objects we can keep doing what we're doing. But I don't want to," he said.

The biggest threat to North American technology comes from Japan, accord-



ing to Fluke. "Their (Japan's) avowed purpose now is to go after computers (and) supremacy in the computer business means supremacy in the entire spectrum of electronics."

LOOKING BACK

Some months you can't do anything right ...

On page 38 of the November issue the picture of TDS-M68 microcomputer was pasted down upside down. I don't know how it got through, and I don't want to know.

Also, Jerry Skye says he carries Moonlighter Electronics Kits. Gosh, Jerry you should have told us sooner. In addition he also has Arkon, Jana and many more. Talk to him at General Electronics, 5511 Yonge St, Willowdale, Ontario M2N 5S3.

The remark in the Heathkit blurb "The instructions are designed for people *with* previous experience in electronics. . . I should read *without*. I'd send in my resignation if I was sure I wouldn't screw it up."

Expose Yourself

News digest is a regular feature of ETI Magazine. Manufacturers, dealers, clubs and government agencies are invited to submit news releases for possible inclusion. Submissions, or questions about material, should be sent to: News Digest, c/o ETI Magazine Unit 6, 25 Overlea Blvd., Toronto, Ontario, M4H 1B1.

Audio products news will be directed to Audio Today's product department, and similarly Shortwave news will appear in Shortwave World. Sorry, submissions cannot be returned.

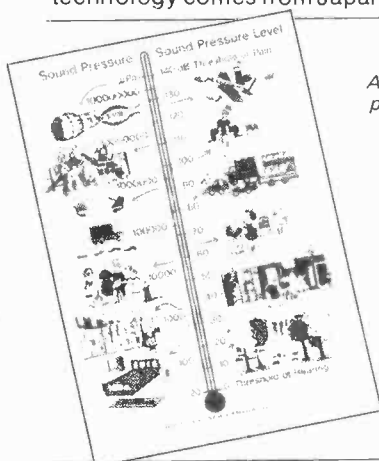

A noisy poster?

liquefied cellulose have been identified.

Cellulose is the major component of wood. Battelle researchers will study the other two components (lignin and hemicellulose) after completing the chemical characterization of cellulose oils.

The product obtained from biomass liquefaction is not directly usable as a fuel oil, as many expected it would be. With further refinements, such as distillation, the "offensive smelling tar" could be converted to a heating oil and an extender for asphalt, another petrochemical product. Furthermore, the cellulose converted to oil could also be used as a chemical feedstock to make phenol or phenol compounds, chemical intermediates for making plastics, cosmetics and a range of other products dependent upon the continued availability of petroleum.



Audio Today

Wally Parsons reviews latest developments in audio.

THROUGHOUT MOST of the history of high fidelity audio as we know it, the principal active device for amplification has been the vacuum tube. Although the transistor was first patented in 1926, it did not become a manufactured device until it was re-invented in the late '40's. Even so, these early germanium devices were so unreliable, performance so poor and so variable from one device sample to another that their application was limited to portable radios. There was simply no way that these devices could compete with advanced tube technology in any area except size, weight, and heat, none of which were considered of importance by any serious audiophile.

But along about 1962 it was discovered that silicon was good for more than implants, and so the silicon transistor was born, and along with it a massive move towards solid state circuitry in audio technology. Naturally, a great deal of controversy arose as to the relative merits of tubes and transistors, but much of the dispute proved to be nothing more than the difference in the relative state of the two arts, and improved transistors and circuits gradually led to the supremacy of transistors and their subsequent dominance.

It might, therefore, appear strange to be discussing tubes in audio applications today, and yet as recently as March 1977, the AES Journal published communications under the heading "Transistors Can Sound Better Than Tubes", complete with a microphone preamp circuit claiming to possess the virtues of tube circuitry. Not too long ago a Japanese manufacturer, yet, introduced a tube amplifier using circuitry very similar to the McIntosh MC60, and in England interest in tube equipment and "tube sound" has awakened, complete with typical British sound and fury. Much of it signifies nothing, of course, because so

many proponents and opponents don't seem aware of the difference between "sound" and distortion.

Accordingly, I thought it might be an opportune time to look at the operation of vacuum tubes and some applications, perhaps spread irregularly over several months.

For a comparison of tubes, bi-polar transistors, and FET's, readers are referred to ETI for October and November, 1977 under "V-Fets for Everyone"

THERMIONIC EMISSION

All matter is composed of molecules, which in turn are composed of atoms, which are made up of many sub-atomic particles, including electrons. These electrons have some mobility, the exact amount dependent on the particular molecular structure, and its temperature. With some materials, particularly certain metals, heat can increase electron mobility to the point where electrons are thrown from the surface, much like molecules are thrown from the surface of boiling water to form steam. Of course, these electrons don't usually get very far, because their departure leaves a positive charge on the material which attracts them back again. But if the material is connected to a supply of electrons, such as ground, an electron cloud forms around like steam. At this point, the electrons still aren't going anywhere, but if we place in the cloud's vicinity an electrode connected to a positive supply, electrons will be attracted to it. If they have to pass through air, operation will not be too efficient, but if the whole structure is enclosed in a vacuum, we now have a vacuum tube diode. The heated emitter of electrons, called the cathode may be either a filament similar to that of a light bulb, and through which an electric current is passed, or it may be a sleeve electrically insulated from, fitted over, and heated by the

filament. This cathode normally operates at a temperature which causes it to glow a dull red to a bright amber. The anode, or plate is of a suitable conducting material which encircles the cathode. If the plate is connected to a positive supply and the cathode to a negative supply, current will flow through the diode, while if polarity is reversed, there is no current flow. Thus, the device may be used for rectification. Notice too, that because of the mechanism of operation, it is best to consider its operation in terms of *electron* flow, rather than conventional current flow as we do with transistors. Fig 1.

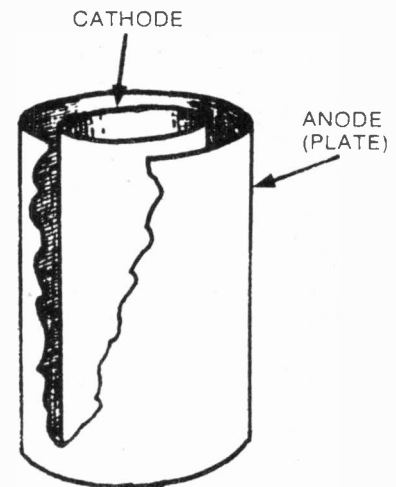

Fig. 1 Physical configuration of a diode (AKA the 'Fleming Valve'.)

CONTROL VALVE

Our diode can be likened to a water pipe which allows water to flow in one direction only. By installing a valve in the pipe we can control the rate of flow from fully on to fully off, and continuously between. To accomplish this with our diode, we install a wire grid

between the plate and cathode. If a negative voltage is applied to this grid, the resulting charge will oppose electron flow, forcing them back to the cathode. We now have two forces acting on the electrons, an attractive force due to a high voltage on the plate, and a repulsive force due to the lower voltage on the grid. The relative balance of the two will determine the final electron flow, yet the spacing between grid wires allows flow. By placing the control grid, as it's called, relatively close to the cathode, a low voltage can counteract the plate's high voltage. Thus, a small change in control voltage produces a large change in electron flow. If this changing grid voltage corresponds to a signal, then the resulting changes in electron flow will also correspond to that signal, provided it is allowed to operate only over a range in which control is linear. Fig 2 shows a typical transfer characteristic.

Biasing

Notice that the vacuum tube is a "normally on" device, unlike the bipolar transistor and Enhancement type MOSFET, which are normally off. Notice, too, that electron flow can only occur in one direction and that input and output are completely separate. Thus the output circuitry will not affect the input characteristics unless other circuit components are so arranged as to bring this about.

If an alternating polarity signal is applied to the grid, on positive half-cycles electrons would flow through the grid. Although there are some circuits which actually drive the grid this way, usually in audio applications this is not desired, so a negative bias voltage is applied to the grid sufficient to prevent a signal from driving it positive. Thus, the grid is made more negative, or less negative by the driving signal. For single ended linear applications bias is usually set at some point which will allow maximum swing while remaining within the linear region of the transfer curve. As in transistor operation, this is described as "Class A" operation, which is defined as that bias condition in which current will flow during 360° of a cycle, and no grid current flows. Class B operation is possible, in which current flows only during 180° of a cycle. This is accomplished by biasing the tube to its cut-off. This is comparable to pinch-off operation of a J-FET, or zero-bias operation of a bi-polar device.

Operation may also be Class AB, in which current flows for less than 360° but more than 180°, and is accomplished by biasing somewhere between Class A and Class B, usually where the transfer characteristic begins to curve

at the toe. Class AB may be further subdivided into AB¹ and AB². The numerical suffix signifies, respectively, that grid current may or may not be allowed to flow during positive half-cycles. In this case, input signal is allowed to exceed the bias value, and the signal source must be capable of supplying power. Audio applications are usually limited to high level modulation of AM transmitters.

Biasing beyond cut-off results in Class C operation and is limited to RF transmitters.

BASIC CIRCUITS

Fig 3 shows the basic circuit for the triode tube we've been discussing. RL is a load resistor between B+ supply and the plate, and Rk is a biasing resistor. Rg is a grid leak resistor, and establishes the DC ground reference for the grid. When current flows through the tube a voltage drop occurs across RL and across Rk. Because the negative supply is ground referenced, the cathode is at a positive potential with respect to ground. Since the grid is at ground potential, it is, therefore, negative with respect to the cathode. Current flow through RL results in a voltage drop here, so that the plate is less positive than the B+ supply. If a negative going signal is applied to the grid, current is reduced, causing less voltage drop across each of the resistors; consequently, plate voltage increases, or becomes more positive. The reduced voltage drop across Rk results in the cathode moving closer to ground potential, that is, less positive (or more negative). A positive going signal produces the opposite results. Thus, we see that the output at the plate is in reverse phase to the grid input, while the signal on the cathode is in phase. Notice, too, that since the instantaneous voltage on the grid and cathode are changing in phase, the grid-cathode voltage is less than the grid-ground voltage. Since the cathode is common to both the input and output circuits, the cathode resistor introduces negative feedback. The cathode resistor can be bypassed with a capacitor to bring the cathode to AC ground potential, but this introduces a low frequency phase shift which may not be desirable. Another method of biasing connects the cathode to ground, and the low end of the grid resistor to negative supply of the desired value.

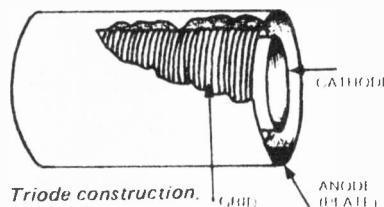

Triode construction.

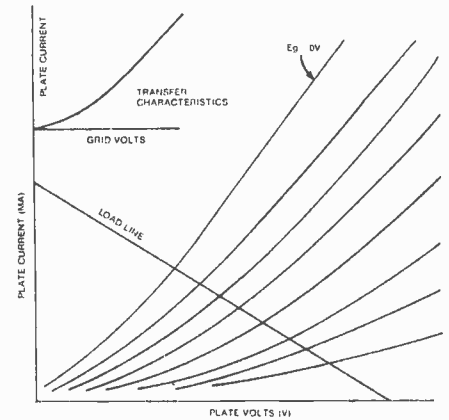

Fig. 2 Typical transfer characteristics of a triode.

PENTODES

Fig 4 shows another type of tube which contains a couple more grids. The first grid is the control grid already described. The function of the second grid, called the screen grid is to accelerate electron flow to the plate. Because it is closer to the cathode, it has greater effect on electron flow than the plate, but because of its open structure, most of the electrons shoot past the grid to the plate. As a result, plate current is practically independent of plate voltage. The supply to the screen is normally fixed at some value below that of the plate, so only the control grid controls current.

Unfortunately, at signal swings large enough to cause large current flows, plate voltage can drop below that of the screen. Electrons striking the plate at high velocities dislodge electrons from

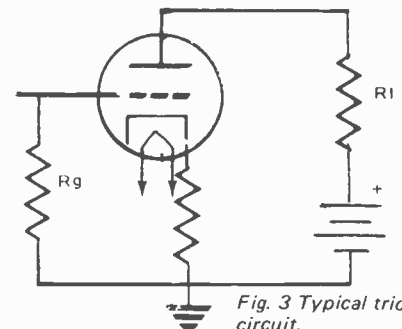

Fig. 3 Typical triode circuit.

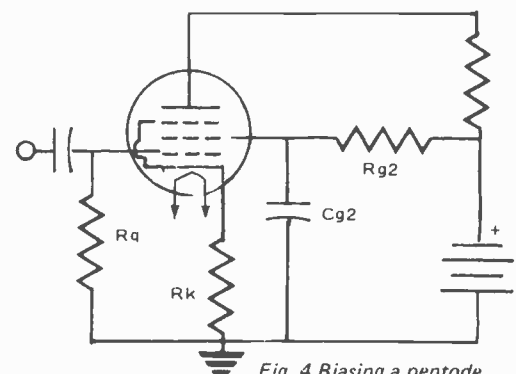

Fig. 4 Biasing a pentode.

the plate, producing secondary emission. If the plate is at a lower voltage level than the screen, these electrons will be attracted to the screen, resulting in a reduction in plate current. To overcome this, a suppressor grid is placed between the plate and the screen and the plate, and connected to the cathode. Because it is at cathode potential, it forces secondary electrons back to the plate. To prevent screen voltage from varying with the signal, the screen resistor, R_{g2} is normally bypassed to ground with a capacitor. As with cathode bypassing, this introduces a phase shift which may be undesirable. The alternative is to leave out the capacitor and allow feedback to develop across the resistor, or to supply the screen from a separate regulated

supply. This latter course is often used in output stages designed for maximum output.

Other types of tubes are sometimes in use, but these are the most common for audio applications.

Next month, a look at some circuits you can use.

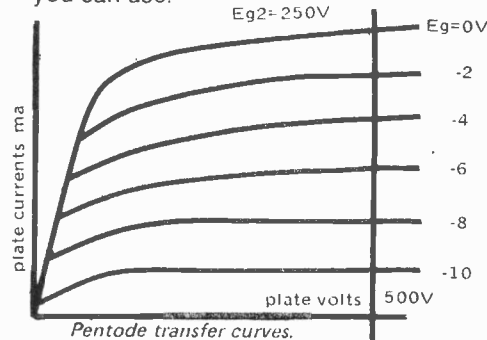

Pentode transfer curves.

Audio Today Letters

Want to express your views or report on news? Write to Audio Today, ETI Magazine, Unit Six, 25 Overlea Blvd., Toronto, Ont. M4H 1B1.

Thanks for your circuit on how to make LEDs random flicker. They look good in the miniature fireplace. I have some other questions for you that I hope you do not mind answering for me. Your magazine is the only contact I have with up-to-date audio and electronics.

I have read in articles that to hear stereo the proper way in relation to live audio that there is supposed to be a third speaker connected to the amplifier. This speaker is placed between the Left and Right speakers. Could you please tell me how this speaker is connected and what are the advantages of having it. Does it play sound from both left and right, or???

Also, I have noticed a lot of digital tuning and digital VU meters coming on

the market. Could you tell me some of the advantages of these. I have noticed that big brand names such as Technics and Akai are coming out with more mechanical tuners, etc. Will there be a complete change over to digital or will both be marketed for a while.

Finally, I noticed or heard of a Dolby Test Tape. Is there such a tape for testing your Dolby and do you know where I could get one and the approximate price. I have a cassette deck here with Dolby, but it seems to cut out a lot of highs and ends up leaving hiss. Are there different types of Dolby circuits in respect to price or are they all standard?

I appreciate any time you give me in answering my questions.

A.J.B. Agassiz B.C.

My crystal ball is not very reliable, which is why I don't play the horses and I let my wife buy the lottery tickets. However, I've never called an election wrong yet, so I'll try a little crystal gazing with regard to digital tuning and meters.

The main advantage of digital readout is precision of reading. That is, you know exactly what the reading is. Resolution is determined by the number of decimal places available, and accuracy is generally better than a slide rule dial or a d'Arsonval meter movement. The cost of such devices usually makes them inappropriate for use on inexpensive equipment, but I should imagine that in time the cost will come down relative to the other components, making them suitable for use in medium quality components. With regard to digital tuning, part of the cost lies in the conversion of frequency to voltage and from analog to digital. A true digital tuner, on the other hand, utilizes digital frequency synthesis for tuning, and digital readout is a natural. However, at the present time, frequency synthesis is a more expensive technique than coils and variable capacitors, although this may change in the future.

Off-setting the increased cost, at least with the true digital tuner, is the vastly improved front end performance, particularly in regard to stability and improved capture ratio. I suspect that the cheapest tuners and receivers will feature a simple rotary knob directly mounted to a tuning shaft, along with an over-sized dial face, like many AM sets.

Digital VU meters, when used for monitoring programme levels strike me as having an alien feel to them. What is needed here is the ability to sense what the level is. Nobody really reads a meter in terms of how many VU above or below the zero mark the instantaneous signal actually reaches, but rather how far from the magic position it goes. This is why scales are not subject to change from one manufacturer to another. The eye cannot follow the changing numbers rapidly enough for them to be useful unless the response can be slowed down or peak readings held, in which case LED readouts would be more useful.

As a regular reader, you will by now have read the June issue in which reference is made to a centre channel speaker as well as derived ambience. Briefly, the simplest method of hook-up involves lifting the return (ground) leads of each speaker and connecting them to each other. They are now in series across the left and right outputs.

Jensen Triaxial® 3-Way Speakers

Quite simply, the most advanced car stereo speaker ever.

For the best sound ever in your car. The first car stereo speaker with a woofer, a tweeter and a midrange.

Identical in principle to the best home stereo speakers. Jensen's midrange picks up a whole range of tones lost to any other car speaker.

Write today for Free catalogues and the name of your nearest Jensen Dealer —

len finkler limited
25 Toro Road, Downsview, Ontario M3J 2A6
Telephone (416) 630-9103 Telex 065-24010



Circle No. 9 on Reader Service Card.

Audio Today

Then connect the centre speaker from the junction of the side speaker return leads to the ground terminal(s) of the amplifier. If all speakers are phased such that the plus lead is the one to which, if the positive terminal of a battery is connected, the cone will be made to move out, then the plus lead should be connected to this junction.

Strictly speaking, there's no such thing as a Dolby circuit, at least in the sense that we usually use the term. "Dolby" really refers to the system of dynamic range expansion-compression with specified frequency parameters. Most recorder manufacturers can supply a suitable test tape for use with their own products, and I would suggest that you contact the manufacturer of your machine, his distributor, or dealer for such a tape.

In my search for new stereo speakers, several questions have arisen in my mind with respect to the different kinds and combinations of drivers used in speaker systems. (Seeing as a good pair of speakers is a fair investment, I figured it would be better to have these answered by someone other than a fast-talking salesman).

First of all, many of the larger systems now employ two mid-ranges, and some two tweeters as well. I have even heard of some that employ four of each. Other than increased power handling capabilities, what are the reasons and advantages to this, in these systems, and are they that much better to warrant spending the extra money? (I am quite a serious listener, and want a good system).

Secondly, there are many other systems that employ passive radiators. Again, what are the advantages of these, and do they have that much of an effect on sound?

Finally, I would like to know something about piezo-electric tweeters, and how they compare with one or dome type tweeters.

(I realize now that I have asked almost enough for you to write a complete column, however there are probably lots of other readers who would be interested in hearing about all this, and it would really help me in my search. Besides, I can't find a book that would answer these).

P.D. Willowdale, Ont.

You're not likely to find a salesman competent to advise on such matters; if he were, he wouldn't be a salesman. Either fast or slow talking.

There are several reasons for employing multiple drivers within a given

pass band. One of them is to impress the uninformed buyer. In some cases, though, the designer meant well, but was no more knowledgeable than the customer. Thus, if one driver worked, two or more worked even better. Often, too, multiple drivers are used in the mistaken belief that four junky tweeters will out-perform one good one. Then, of course, there is the belief that eight or more little speakers are the equal of one larger unit with the same radiating area. No matter how many times the fallacy of this notion is demonstrated, it continues to pop up. Four junky tweeters do not sound like an Electro-Voice T350; they just sound like four junky tweeters. Which is why most such speaker systems sound so bad.

There are, however, legitimate reasons for using multiple drivers within a pass band. One of them is increased power handling, which also allows a lower cross-over or more gradual slope. Another is impedance control at driver resonance. The most useful is control of dispersion pattern. One of the reasons for the outstanding performance of the larger Infinity speakers above the lower mid-range is the arrangement of upper mid-range and tweeters in line arrays, resulting in wide horizontal dispersion, and narrow vertical dispersion. By tailoring the response of each driver in an array a well-controlled and uniform dispersion can be achieved. You'll notice that such speakers are not cheap.

The passive radiator is the same as a port in a reflex system. It has the advantage of a radiating area equal to or greater than that of the driver, while not requiring either a very large enclosure or a very long duct. Like all reflex speakers, some exhibit spectacular performance, while others are nothing more than boom boxes.

I plan a column on piezo tweeters at a later date, with special emphasis on the Motorola KSN 1025 horn and KSN 1033A driver. Briefly, though, the horn units are not too suitable where wide dispersion is desired, but they can handle lots of power, are very efficient, very smooth, can be made to exhibit a smooth characteristic, and are almost indestructible.

What, only one complete column?

Correction

An embarrassing typographical error slipped by us last month. The Audiovision amp being reviewed was reported to have an output power of 18W. This should have read 18V, giving an output power of about 40WRMS into 8 ohms. Our apologies to readers and to Audiovision.

COLOR LED POWER LEVEL INDICATOR

The latest advanced way of measuring audio power output

- Works as a pair of VU meters, and adds exciting sights to your sound system.
- 3 color LED display, each channel.
- Enjoy the "dancing color light" show while you enjoy your music.
- Responds to musical signals at much faster speed than conventional mechanical VU meters.
- Applicable to most power amplifiers.
- Very easy to build, and just hook up with the speaker output without affecting the sound.
- Operates on battery or AC adaptor.
- Display panel, plated fiberglass p.c. board and all electronic parts included.

SAD-02

18 step display

Front Panel

size 8-1/4" x 2-1/2"

- 36 LED (4 colors) with peak, floating and gradual display.
- Suitable for 30W-200W/Ch max. power output amplifiers.
- Operates on DC 6-9V.

KIT: \$56.00 Assembled: \$66.00

10 step display also available. Write for details.

Send cheque or money order. Add 10% for shipping and handling. Ont. residents please add 7% sales tax.

MONEY BACK GUARANTEE.
FREE REPAIR SERVICE.

For free audio kits catalogue, write to:
AUDIOVISION SERVICE
P.O. Box 955, Stn. B,
Willowdale, Ont.
M2K 2T6

HIGH-TECH jewelry

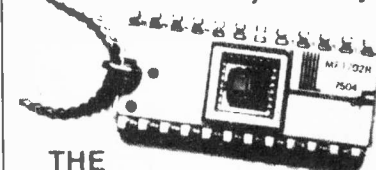

THE COMPUTER MEMORY PENDANT

A unique conversation piece

and great way of letting your interests be known. Ten years ago such a jewel was unimaginable. Today, this technology is transforming our lives and the lives of others.

The white ceramic and quartz package attracts attention, while a closer look reveals the intricacy and precision of the silicon circuit.

This high-tech symbol of the seventies is a genuine product of the micro-electronic revolution.

Pendant available on:
gold plated chain \$18.95, gold filled chain \$21.95,
10k gold chain \$32.00 or as a stick pin \$16.95

Send check or money order
plus \$1.00 postage and handling to

HIGH-TECH Jewelry
3 Canterbury Road
Islington, Ontario, M9A-5B2

Please find enclosed cheque or money order
for pendant on, GP , GF , 10kG
or SP

Name _____

Address _____

City _____ Prov _____ Post Code _____

ETI MARKET PLACE

FREE PERSONAL ADVERTISING!

We will allow up to thirty-five words to advertise items you want to buy or sell, or to publicise meetings of clubs, etc. Advertising will be accepted at our discretion—we will not accept commercial or any form of company advertising. For more insertions, mail again.

ATTENTION 1802 USERS! A CANADIAN 1802 MONTHLY SOFTWARE BULLETIN IS AVAILABLE. FOR INFORMATION WRITE TO: BRIAN MATTHEW 19 FRENCH CRES. REGINA, SASK. S4R 6N3

MEASUREMENTS 82 & HICKOK 295X LAB. SIGNAL GENs. W/MANUALS. GUARANTEED GOOD. R.H. FRANSEN, 227 COTTONWOOD AVE., SHERWOOD PARK, ALTA T8A 1Y3 467-5802.

FOR SALE: TWO 8K RAM BARE BOARD, S-100, NOT EVEN TAKEN OUT OF PACKAGE \$30.00 EACH. BRIAN MATTHEW 19 FRENCH CRES. REGINA, SASK. S4R 6N3

WANTED: STRIP CHART OR FLAT BED RECORDER, TUBE OR TRANSISTOR. WILL BUY MECHANICALLY COMPLETE BUT NON-OPERATING INSTRUMENT IF PRICE RIGHT. J. COCHRANE, 2815 RONALD RD. VICTORIA B.C. 478-6538.

FOR SALE: IMSAI MICROCOMPUTER, 22 BOARD POWER SUPPLY, 11 SOCKETS INSTALLED, 4K STATIC RAM BOARD, FULL DOCUMENTATION \$750.00 OR BEST OFFER. (416) 576-4839 OSHAWA.

IF YOU LIKE TO HELP DESIGN AN ELECTRONIC CIRCUIT FOR MY ELECTRICAL INVENTION, I'LL SEND THE COMPLETE DESCRIPTION. YOU CAN TAKE IT FROM THERE. ERNEST MALTAIS, 100 TAMARACK STREET, TIMMINS, ONTARIO P4N 6P6

WANTED: ETI'S IN VERY GOOD CONDITION, THE OLDER THE BETTER. MICHAEL WEISS 16 ROSEMARY AVE. LAKE WILCOX, ONTARIO. L0G 1X0 1-416-773-4367

RARE TUBES—ORIGINAL CARTONS—VALUES \$20.00 AND UP—IC7G—2A3—1B4P—34, ETC.—\$10.00 EACH—RUSH. CASH SALE, OR C.O.D. SERGE BEAUDOIN BOX 328, ST-JOSEPH, BEAUCE P.Q. G0S 2V0 PHONE: 418-397-5323, 418-397-5225

FOR SALE: PLANS FOR BUG SHOO (SCARES AWAY AND ATTRACTED BUGS) \$2.00 PLANS FOR THE ELECTRONIC SHELL GAME- PLAYED SEVERAL DIFFERENT WAYS (NOT EXPENSIVE) AND FUN \$2.00 FOR PLANS. GARY KUPKEE 114 MADDISON AVE. FREDERICTON N.B. E3A 2N4.

WANTED: SCHEMATIC FOR EICO ELECTRONIC VOLT-METER, MODEL 221. RON HO, BOX 13, CROWELL, (SHEROSE ISLE.) NOVA SCOTIA B0W 1S0

FOR SALE: BOWERS & WILKINS PM--70 ES SPKRS. (1PR) EXCELLENT CONDITION. \$800.00 OR B.O. TEL. (416) 688-6524 12:00 PM. - 4:00 PM. OR AFTER 1:00 AM. 35 WILEY ST., ST. CATHARINES, ONTARIO, L2K 4E8

WANTED: CORRESPONDENCE WITH SERIOUS ELECTRONICS BUG OR NUT; TO EXCHANGE IDEAS, ETC. WRITE STEPHEN KAWAMOTO BOX 165 ALDERGROVE, B.C. V0X 1A0

SHORT WAVE RECEIVER FOR SALE EXCELLENT HAMM-ARLUND HQ--180A RECEIVER \$275.00 M. POWELL JR. BOX 500 CARBONEAR, NFLD. A0A 1T0

SELLING COMBINED SWEEP AND MARKER GENERATOR AND MARKER ADDER—RCA—WR514A. Brand NEW CONDITION. SUITABLE FOR ALIGNMENT OF ALL TV RECEIVERS. STAN PARRY, 92 BESSBOROUGH AVE; MONCTON, N.B. E1E 1P7

U OF C STUDENTS WILL DO CUSTOM PROGRAMMING FOR COMMODORE PETS WITH OR WITHOUT PRINTER OR WITH OTHER IEEE-488 PERIPHERALS, SEND REQUIREMENTS FOR QUOTE. STEPHEN VERMEULEN 3635 UTAH DRIVE, N.W., CALGARY, ALBERTA, T2N 4A6. 284-3490.

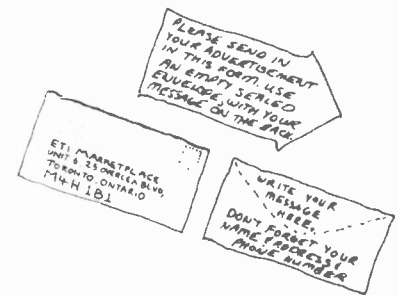

Get more!

... information about the things that interest you. Use ETI's handy Reader Service Cards. Page 62 has all the details. Individual numbers can be found under many of the ads in this issue.

Circle the numbers for those ads that interest you, mail it to us and more information will be on its way.

'Look, Jasmin, TTL and CMOS ICs, transformers, cabinets and more! I want to find out more about these guys.'

'Oh Graham ...'

High Performance Stereo Preamplifier

This project is designed to complement our 60 watt low distortion amplifier module and forms part of a complete stereo system, our "Series 4000" project—to be described in a forthcoming issue.

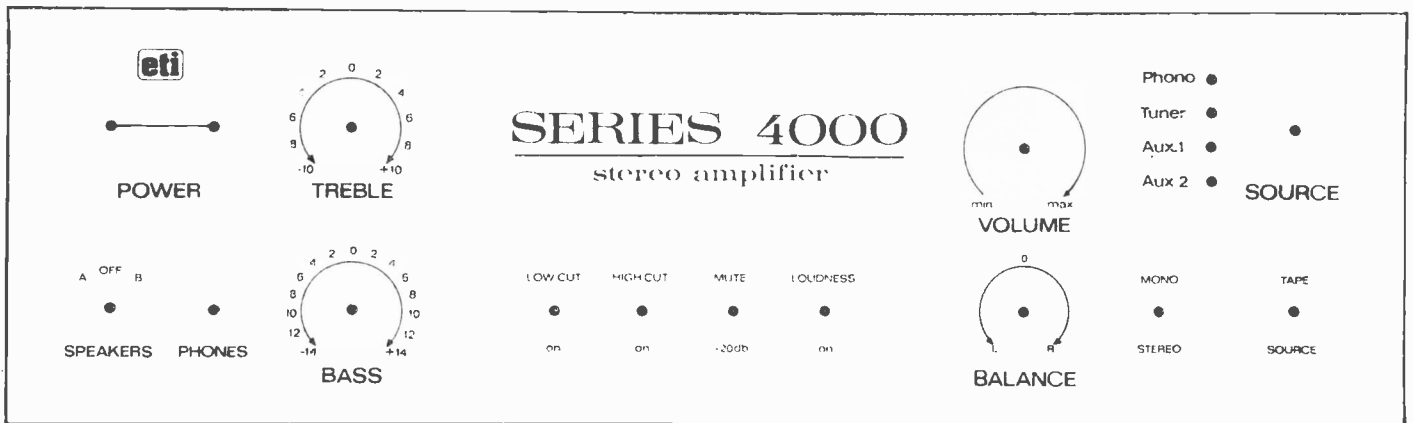

THIS stereo preamplifier is designed to drive two 60 watt, low distortion amplifier modules (ETI 470), described last month.

The requirements for this preamp/ amplifier/control unit were set down after many hours of office discussion. In fact it would be fair to say that the final design was evolved, rather than conceived.

Amongst the first requirements were low hum and noise and low distortion — much lower distortion than the amplifier modules it would be required to drive. Low distortion in a preamplifier is relatively easy to achieve and makes the subsequent addition of a high quality class A headphone amplifier worthwhile.

In the final design, we feel we have achieved performance figures well up front amongst commercial equipment.

Features considered essential included loudness, high cut and low cut filters. These are common in commercial preamp/control units but lacking on most kit designs. The low cut filter incorporated in our design will effectively reduce bass rumble while the high cut filter is useful for reducing tape hiss or 'monkey chatter' and heterodynes from an AM tuner.

The disc amplifier stage of a preamp must be capable of handling very high input signals before clipping to preserve

dynamic range, especially as moving coil cartridges with voltage boosting transformers and/or amplifiers are finding increasing popularity. The disc input of this design can handle 400 mV peak-to-peak before clipping, giving it a dynamic range in excess of 100 dB!

Finally, and by far the most difficult of our requirements to implement, was the idea that all switches and potentiometers be mounted directly onto the pc board, with as few links and external leads as possible. All this, while preserving an attractive and stylish front panel layout! The advantage of this is that assembly is easy, and straightforward and there is less room for wiring errors to creep in and, should it be necessary, the board can be removed for servicing in its complete, functional form. All interconnections to and from the board are via RCA sockets using standard audio 'jumper' leads.

The 60 watt power amplifier module and this preamp/control unit project form the basis of our "Series 4000" high performance stereo amplifier project, complete details of which we plan to present next issue.

CONSTRUCTION

All the components, including the pots, switches and LEDs, are mounted onto the pc board. The board is then fixed,

component side forward, behind the mounting panel of the case using standard 25 mm spacers and countersunk screws. A dummy fascia — with the control markings etc on it, is subsequently held in place by the switch nuts.

If all directions are followed, then construction is quite straightforward — it's easier to do than describe!

Firstly, the mounting panel and fascia must be cut and drilled to the dimensions shown on the drawing (or, you can mount everything off board, as shown at the end of this article). The drilled pc board may be used as a template. Dimensions shown in brackets refer to the fascia panel which must be cut slightly smaller if you wish to use the same case for your stereo as we have.

The holes for the pot shafts are only 7 mm in diameter on the fascia panel to ensure correct knob alignment. Countersunk holes are drilled in the mounting panel, but not in the fascia, for the bolts securing the pc board through the spacers.

Once the mounting panel and fascia are drilled, carefully check the alignment of all holes with the corresponding holes in the pc board. The drilling must be reasonably accurate.

High Performance Stereo Preamplifier

ETI 471 – STEREO PREAMPLIFIER SPECIFICATIONS (Measured on prototype)

Distortion0015% at 1 kHz .0015% at 10 kHz (For all inputs, with 500 mV RMS output – distortion is mainly 2nd harmonic).	Output7 V p-p before clipping
Hum and Noise83 dB unweighted (With respect to 10 mV phono input).	Tape output	150 mV RMS
Frequency Response	Phono: Within 0.5 dB of RIAA from 20 Hz to 20 kHz (Follows new IEC curve). Other inputs: 20 Hz to 20 kHz \pm 0.5 dB Subsonic rolloff: 6 dB/octave below 20 Hz	Sensitivity	For 500 mV RMS output phono: 3 mV RMS other: 150 mV RMS (Phono overload level is 400 mV p-p).
		Tone controls	Bass: \pm 13 dB at 50 Hz Treble: \pm 11 dB at 10 kHz
		Filters	High: 6 dB/octave, –3 dB at 5 kHz Low: 6 dB/octave, –3 dB at 100 Hz
		Loudness8 dB boost at 15 kHz and 10 kHz.
		Mute switch20 dB attenuation

Once this mechanical work is completed the components may be mounted on the pc board. Start with the RCA sockets. Take care not to use too much force on the nuts and check that electrical contact has been made to the ground plane of the pcb using an ohm-meter. Join the centre pin of the RCA sockets to the pc board pads using lengths of tinned copper wire – refer to the overlay.

Mount the potentiometers next so that their terminals are directly above the pads on the pc board. The lower pot terminals can be cut, bent down and soldered directly onto the pads. Connect the upper pot terminals to the pc board, as shown in the overlay, using tinned copper wire.

All switches are mounted on the board using pig tail leads. The rotary is a

type commonly available almost anywhere. When mounting switches on the pcb, make sure all switch and pot bushings are in the same plane.

Once the major parts are assembled onto the pc board, all the minor components may be loaded and soldered in place. Make sure that any large components (electrolytics particularly) are less than 25 mm high, otherwise they will foul the front panel. Check that all transistors, tantalums and electrolytics are correctly oriented. Refer to the overlay as you proceed.

The switches and LEDs must be mounted and spaced correctly off the pc board. Solder 50 mm lengths of tinned copper wire onto each of the switch terminals and LED leads (see illustration). Pass the wires through the

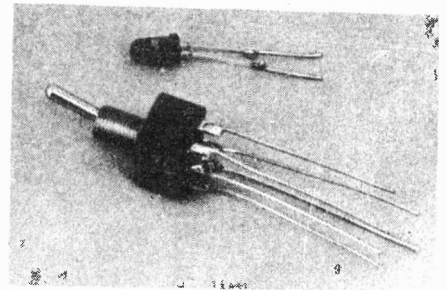

Above: The switches and LEDs have lengths of wire soldered on to them so that they can be inserted into the pcb before being attached to the front panel. They can then be soldered in place. This procedure ensures that there is no strain on the joints. Below: the completed unit. Full details of metalwork will be given in a later article, in which we will describe how to use this preamp with two of the ETI 470 60W units to build a high-performance, low cost stereo amplifier.

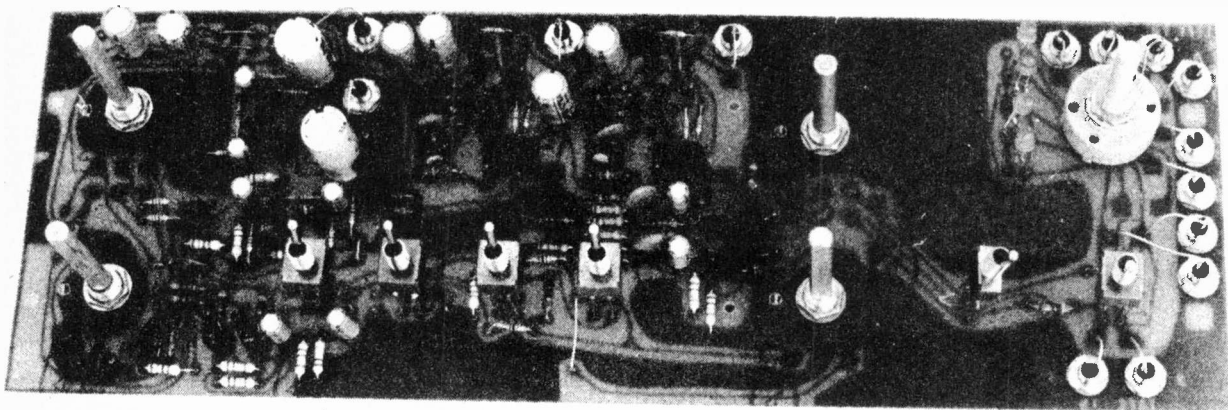

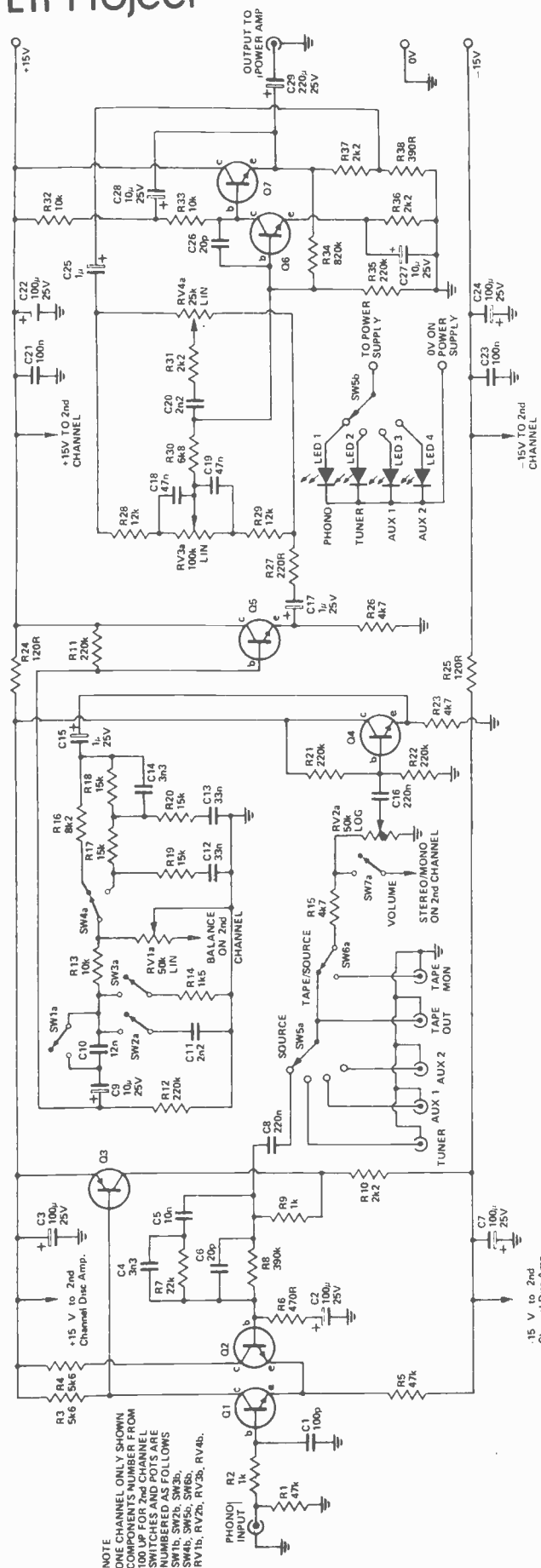

Fig. 1. Preamplifier circuit diagram. Only one channel has been shown for clarity. The component numbering of the other channel begins at 101.

The signal from a magnetic cartridge is fed to the base of Q1 via a low pass filter, (R2 and C1) for attenuation of radio frequencies. Q1 and Q2 form a differential pair, each half operating at low collector current to minimise noise. The output of the differential pair is taken from the collector of Q1 and further amplified by Q3. Feedback is taken to the base of Q2, the negative input of the differential pair, through the RIAA equalisation network. Overall gain of the phono stage is set by the ratio of the feedback network impedance to the value of R6.

Subsonic bass roll-off of 6 dB/octave, to conform to the new IEC 65 specification, is achieved by a high pass filter consisting of C8 and RV2.

Output from the disc preamplifier is then fed via the Source Switch (SW5), Tape-Source switch (SW6), R15 and the volume control (RV2), to an emitter follower, Q4. This emitter follower presents a high impedance for the aux inputs and a constant impedance for driving the filters.

When switched in, the loudness network boosts the high and low frequencies with respect to the midrange. In actual fact, all frequencies are attenuated but the midrange is attenuated more. When the loudness is switched out, R16 approximates the impedance of the network.

Muting is achieved by switching R14 to earth. The ratio of R14 to R13 sets the attenuation to 20 dB. C11 shunts high frequencies to earth for high cut, while C10 reduces low frequency content when switched in, providing low cut.

A second emitter follower, Q5, presents a constant impedance to the filters and acts as a low impedance source to the tone control stage.

A Baxandall tone stage is used here, a common circuit in many designs. Q6 is a gain stage with a bootstrapped collector load, via C28, to the output. Bootstrapping increases the gain by increasing the effective collection load impedance. Q7 is an emitter follower connected directly to the collector of Q6. This provides a very low output impedance. DC bias for Q6 is

taken from the output.

Some of the output signal is fed back to the tone controls and split into high and low frequencies by RV3 and RV4. By adjusting the controls the percentage of the input to the negative feedback signal appearing at the base of Q6 can be varied, thereby varying the overall gain of the amplifier at either high or low frequencies. The gain of the tone stage is set by the ratio of R37 to R38. As R38 is reduced in value the negative feedback is reduced and therefore the overall gain is increased.

To preserve the very low output impedance of the pre-amplifier the balance control is placed ahead of, rather than after, the tone stage.

Power supply filtering and decoupling is provided by 100 μ F capacitors and resistors in each rail.

Source indication is by LEDs from the spare section of the source switch. No current limiting resistor is on the pc board for the LEDs as one will be included in the power supply. (To be described).

HOW IT WORKS

corresponding pc board holes for these components but do not solder them in place yet. Check that the LED leads are the right way round.

Assemble the pc board onto the case mounting panel (using the 25 mm spacers and countersunk screws). Place the fascia over the front panel, securing it in place with the switch nuts (three hands and a prehensile nose might help! ... a little sticky tape and deft juggling is all that's really necessary). Once you've got it all together the protruding wires may be soldered to the pc board. Ensure that no short circuits have occurred.

That completes the assembly. For servicing purposes the pc board and all switches, LEDs and pots — all the operating controls — may be removed simply by undoing several nuts, removing the fascia and the countersunk screws beneath.

High Performance Stereo Preamplifier

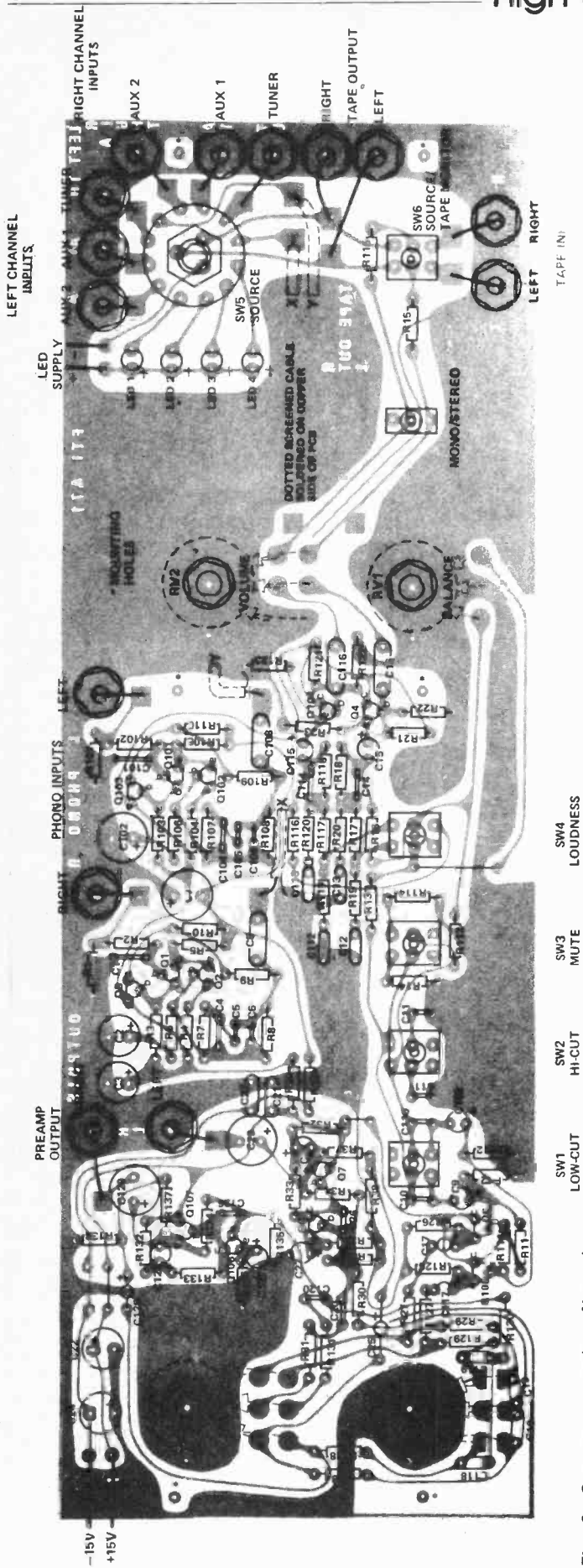

Fig. 2. Component overlay. Note that lengths of shielded cable are used to connect the outputs of the disc preamplifier to the selector switch.

PARTS LIST

Resistors	all 1/4W 5%
R1, R101	47k
R2, R102	1k
R3, R4, R103,	10k
R104	5k6
R5, R105	47k
R6, R106	470R
R7, R107	22k
R8, R108	390k
R9, R109	1k
R10, R110	2k2
R11, R12,	220k
R111, R112	10k
R13, R113	1k5
R14, R114	4k7
R15, R115	8k2
R16, R116	15k
R17 - R20,	15k
R117, R120	15k
R21, R22,	220k
R121, R122	4k7
R23, R123	4k7
R24, R25	120R
R26, R126	4k7

R27, R127	220R
R28, R29,	220R
R128, R129	12k
R30, R130	6k8
R31, R131	2k2
R32, R33,	10k
R132, R133	10k
R34, R134	820k
R35, R135	220k
R36, R37,	2k2
R136, R137	2k2
R38, R138	390R

Potentiometers

RV1	50k single linear
RV2	50k dual log
RV3	100k dual linear
RV4	25k dual linear

Capacitors

C1, C101	100p ceramic
C2, C3, C102	100µ 25V electro
C4, C104	3n3 mylar
C5, C105	10n mylar

C6, C106	20p ceramic
C7	100µ 25V electro
C8, C108	220n greencap
C9, C109	10µ 25V electro
C10, C110	12n mylar
C11, C111	2n2 mylar
C12, C13,	33n mylar
C12, C113	33n mylar
C14, C114	3n3 mylar
C15, C115	1µ 25V tantalum
C16, C116	220n mylar
C17, C117	1µ 25V tantalum
C18, C19,	47n mylar
C18, C119	47n mylar
C20, C120	2n2 mylar
C21	100n mylar
C22	100µ 25V electro
C23	100n mylar
G24	100µ 25V electro
G25, C125	1µ 25V tantalum
C26, C126	20p ceramic
C27, C28,	10µ 25V electro
C127, C128	10µ 25V electro
C29, C129	220µ 25V electro

Semiconductors

Q1, Q2	MP5 6515
Q101, Q102	MP5 6515
Q3, Q103	2N5086
Q4-Q7, Q104	MPS 6515
-Q107	MPS 6515

LED1-LED4 red LED

Switches (see text)

SW1-SW4	DpDT min toggle switch
SW5	3 pole 4 pos rotary switch
SW6	DpDT min toggle switch
SW7	spdt min toggle switch

Miscellaneous

14 RCA panel mounting single hole sockets, ETI 471 pcb, tinned copper wire, length shielded cable, 25 mm spacers, 30 mm screws, nuts, mounting panel and fascia plate.

NEXT MONTH...

JANUARY 1980 ISSUE . . . THE FIRST ETI OF THE 80s!

“Series 4000” stereo amp

Combine the 470 and 471 amplifier modules into one high quality unit.

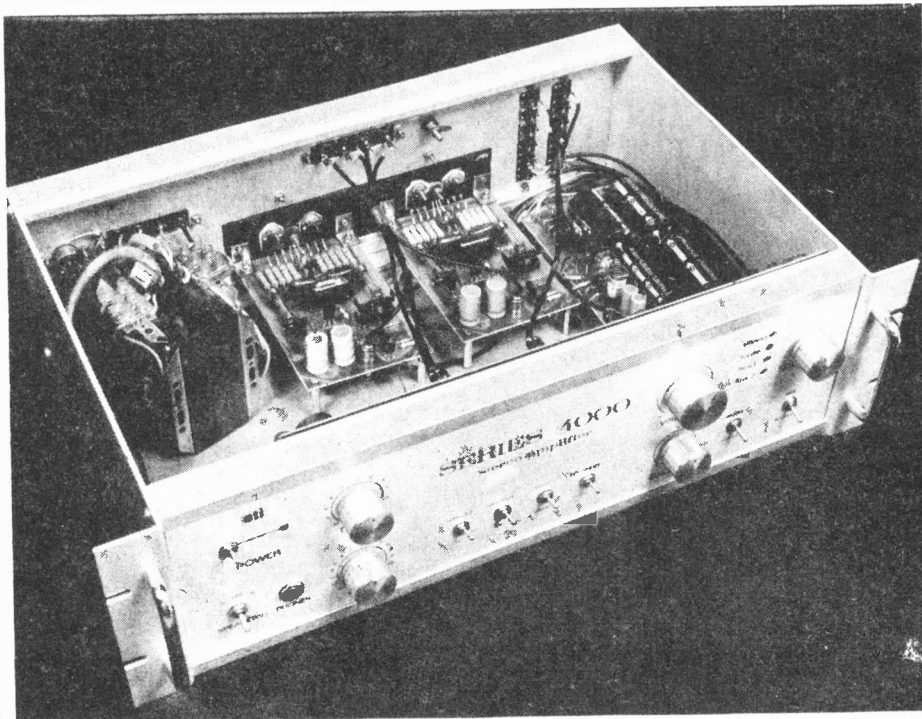

The completed stereo amplifier is shown here mounted in a handsome rack-mounting case.

Versatile logic probe

A truly low cost and versatile unit that can detect pulses as fast as 500 ns.

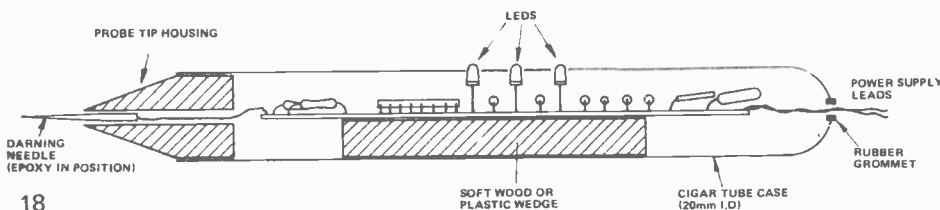

18

HISTORY OF IGNITION SYSTEMS IN AUTOMOBILES

Just when the &t*?!\$ beast won't start, maybe you can find some solace in knowing how it works.

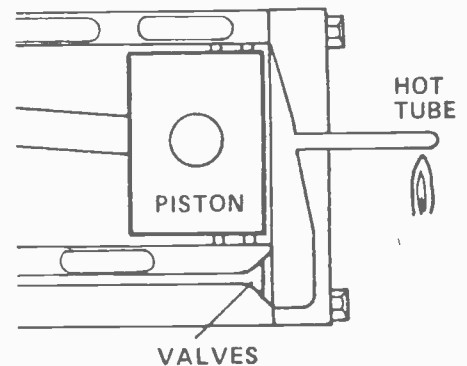

MORE ON THE LM 10 . . .
Some exciting applications for a unique device.

PLUS, all our monthly columns on Audio, Video, Servicing, Education, Amateur Radio, and Shortwave Listening.

The articles mentioned here are in an advanced stage of preparation. Circumstances may dictate changes in the final contents.

High Performance Stereo Preamplifier



If you wish a more streamlined amplifier, you can mount the pc board horizontally, and make all connections via shielded cable.

Unfortunately, the pcb pattern for the preamp was much too large to print. A copy of the layout is available from us. Send cheque or money order for \$1.00 to Series 4000 Preamplifier, Unit 6, 25 Overlea Blvd., Toronto, Ont. M4H 1B1. Be sure to enclose a self stamped business envelope. Note, we will not process orders without an SASE.

Next month, we will publish a power supply suitable for use with this preamplifier and 60W power amplifiers from November.

For pcbs for this project please contact: Spectrum Electronics, P. O. Box 4166D, Hamilton Ontario L8V 4L5, or B & R Electronics, P. O. Box 6326F, Hamilton Ontario L9C 6L9.

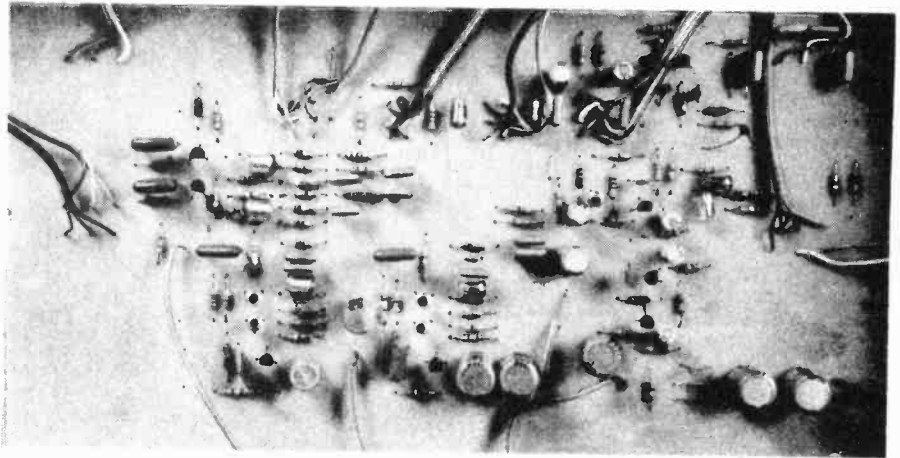

Rear view of the assembled preamp, showing how the potentiometers and shielded cables are mounted. Note the use

of pc mounting phono sockets for ease of assembly.

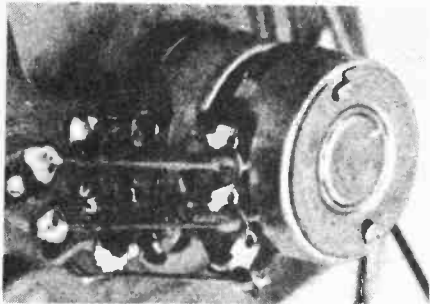

Potentiometer connections to the pcb are made via lengths of tinned copper wire.

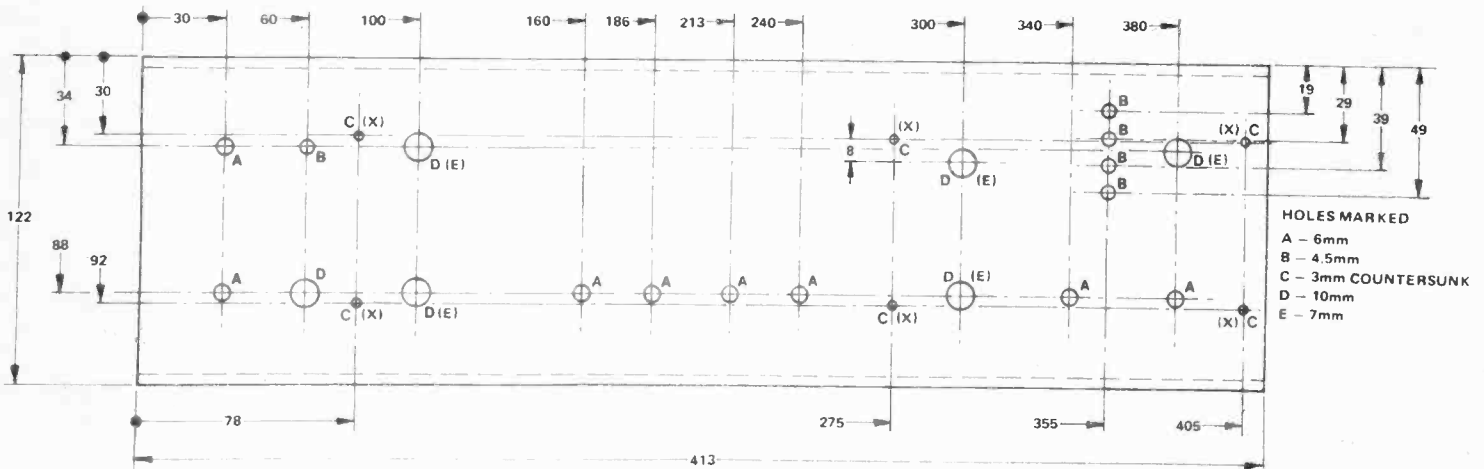
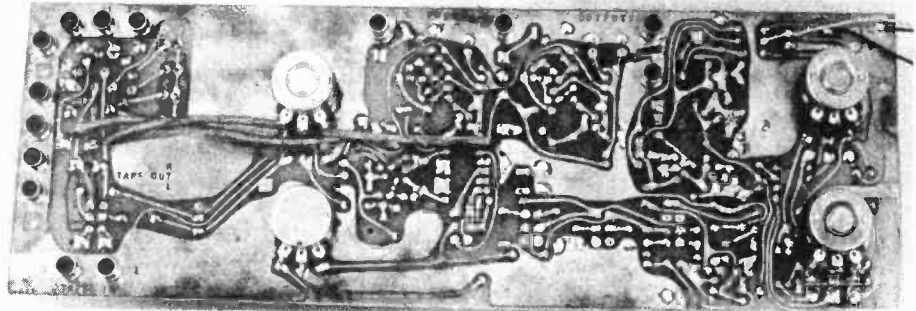

HOLE SIZES IN BRACKETS ARE FOR FACIA PANEL ONLY
FOR HEIGHT OF FACIA PANEL TRIM 4mm FROM TOP AND
BOTTOM OF FRONT PANEL DIMENSION. (AS INDICATED

BY DOTTED LINE.)
ALL DIMENSIONS ARE IN MILLIMETRES
DO NOT SCALE DRAWING

Development

Timer

The Watkins Factor method of development is little known and at present almost unused – is this due to the lack of a proper timer? Phil Cohen has designed one.

IN 1893, a photographer called Alfred Watkins noticed that the time taken for an image to appear during the development of a photographic plate was a fixed fraction of the total development time.

The Watkins Factor

The phenomenon that Watkins noticed was that the total development time was a fixed number (called the Watkins Factor) times the period taken for the plate to be seen to darken initially. Now, whereas development time varies with temperature, concentration and 'age' of the developer, the Watkins Factor does not. If you develop a film for a *fixed* period, you *must* keep these three factors constant. If, however, you develop it using the Watkins Factor you can (within reasonable limits) *forget* the age, concentration and temperature.

This is all very well, but you would have to be able to see the film as it develops. This is not feasible with modern high-speed panchromatic film, which has to be developed in complete darkness. For this reason the Watkins Factor has been all but forgotten, hardly rating a mention in modern textbooks.

This print was developed in fresh, normally diluted developer. The print darkened after 15 seconds and total development time was 45 seconds. The Watkins Factor was thus 3.

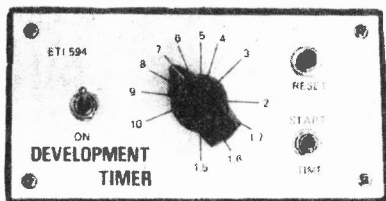

Theory

In the process of developing a print, developer slowly diffuses into the paper, reacting as soon as it reaches the photosensitized areas. The reaction is *diffusion controlled*. The reason why nothing appears for the first few seconds of development (called the 'induction period') is that the developer is still working its way into the paper.

With film you can't watch it develop, with paper you can so the Watkins method of development timing should be extremely useful to the amateur who can't afford a constant-temperature bath for his developer.

The Timer

It works like this: you set the appropriate Watkins Factor (which is specific to a particular developer and paper) on the front panel control. When you put the paper into the developer, you push the switch to 'START'. As soon as the first image starts to appear, you flick it back to 'TIME'. At the end of the development period the buzzer will sound. Then pull the paper out of the dish, wash it and fix it . . . viola!, beautiful prints.

With the developer diluted to half its strength this print was developed for 45 seconds. Clearly, it is underdeveloped.



It may take a bit of experiment to find the correct Watkins Factor. Once you have it, though, you need not bother too much about developer temperature and (within limits) its age and concentration.

Building It

Construction should begin with the pc board. Make sure all of the capacitors, diodes, transistors and ICs are inserted the right way round. RV2 and RV3 are 'upright' preset pots bent over to fit flat against the pc board.

Mount C4 directly onto SW1, this keeps the batteries in place. The buzzer mounts on the end of the case with its leads passed through a hole. Note that the red lead goes to the '+' buzzer connection on the board.

Make sure that you use the correct tags of RV1. Refer to the wiring diagram. It is a log characteristic pot. A linear one will not have the same calibration scale.

This print was developed in the diluted developer using the timer set for a Watkins Factor of 3. The result is very little different to the first print indicating that the Watkins Factor method is useful for 'old' developer.

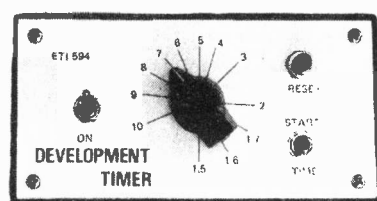

Setting Up

After finishing the unit, disconnect the 'TIME' and 'START' wires from SW2. Solder them together and put the most sensitive current meter you have between this joint and 0V (most medium-priced multimeters will do). Disconnect the wire which goes to the middle contact of SW2 and connect it to the + end of C4. Set RV1 to '2'. Switch on and adjust RV2 for a zero meter reading.

What you have just done is to ensure that when the resistance of RV1 is at the '2' value, the current through Q1 is the same as that through Q2 (see 'How It Works'). This is to correct for differences between the two FETs which seldom have the same characteristic.

Now adjust RV3. Turn it fully clockwise and then slowly rotate it until the buzzer sounds (if it doesn't — there's something wrong). After this happens, turn it back about one-eighth turn. The timer is now fully set up.

Re-connect the unit as shown in the

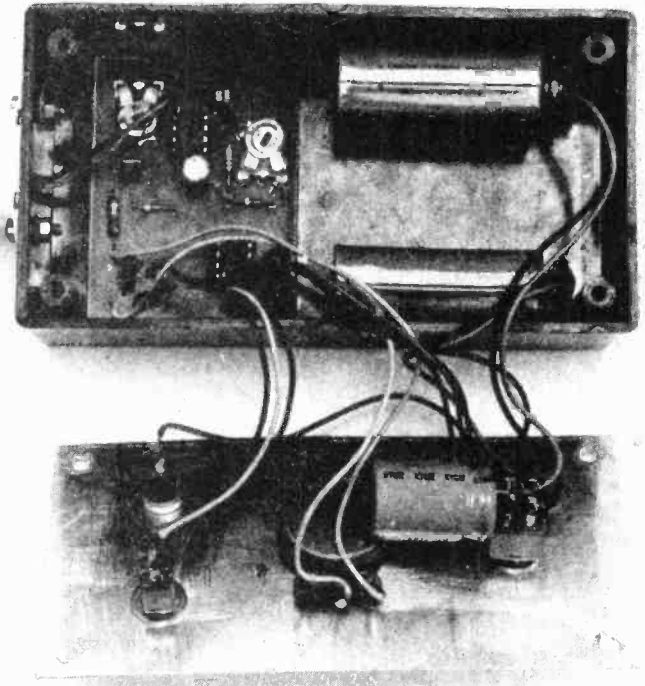

An interior view of the Timer. Note how the batteries are arranged. C4 can be seen mounted on the switch. This keeps the batteries in place when the box is closed.

REAR VIEW OF FRONT PANEL

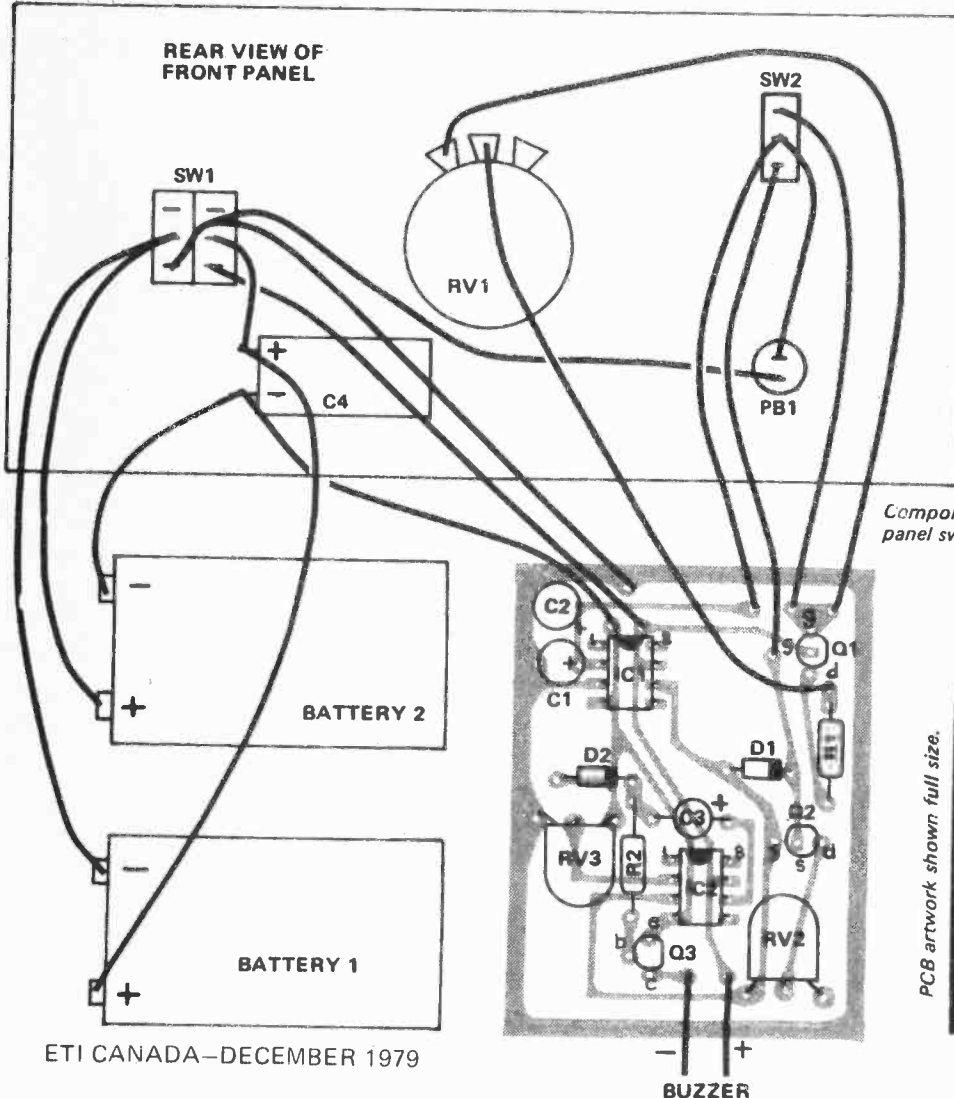

diagrams. Switch on and set SW2 to 'TIME'. Short out C1 temporarily to remove the charge put on it during the setting-up. With RV1 set to 2, switch SW2 to 'START' for five seconds and then push it back to 'TIME'. Five seconds later, the buzzer should sound.

Summary

The theory behind the use of this unit needs development. It should make a fascinating study for any photographer, amateur or professional. This device will make an interesting addition to any darkroom.

Component overlay, including the front panel switch and potentiometer arrangements

For PCBs for this project please contact: Spectrum Electronics, P. O. Box 4166D, Hamilton Ontario L8V 4L5, or B & R Electronics, P. O. Box 6326F, Hamilton Ontario L9C 6L9.

PCB artwork shown full size.

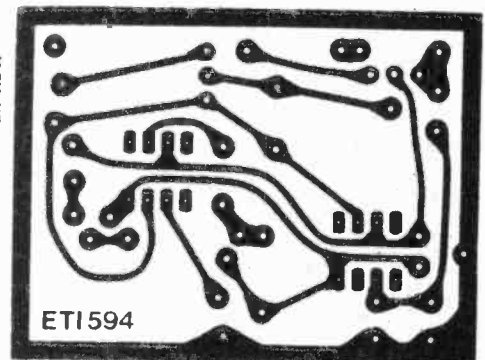

HOW IT WORKS

The Watkins Factor is the ratio of two time periods. A timing circuit having one variable period, which you set, and one fixed period is arranged to indicate when the correct ratio of time periods has been reached.

This is achieved by charging and then discharging a capacitor. The time taken to charge the capacitor is varied while the discharge time is fixed. The control used to vary the charging time is calibrated in terms of the Watkins Factor.

When a capacitor is charged at a constant current, the voltage across it will rise linearly with time - or 'ramp' upwards. Similarly, when it is discharged at a constant current, the voltage across it will 'ramp' downwards. This technique allows good accuracy to be obtained in timing applications.

In this circuit, the current at which the timing capacitance is charged is varied by means of a potentiometer control.

Q1 is connected as a 'constant current' source; that is, it will only allow a constant current to pass, the amount being determined by R1 and RV1. The potentiometer RV1 sets the Watkins Factor.

When SW2 is set to START, C1/C2 will charge via Q1/R1/RV1, the voltage across it ramping upwards at a linear rate. The lower the resistance of RV1, the higher the charging current causing C1/C2 to charge at a faster rate. The converse is also true.

Q2 is connected as a 'constant current' sink - when SW2 is set to TIME, C1/C2 will discharge via Q2/RV2, these components 'sinking' the current. The discharge current will be constant and the voltage across C1/C2 will ramp down at a linear rate.

A Watkins Factor of '2' requires equal charge/discharge times for C1/C2. So that the currents through Q1 and Q2 will be equal when RV1 is set for a Watkins Factor of 2, RV2 (a trimpot) is provided to set the current through Q2. This is used to calibrate the timer.

When the timer is switched on initially, with SW2 in the TIME position, any positive voltage on C1/C2 will cause the output of IC1 to go negative, drawing current through Q2/RV2, discharging the capacitors. Any negative voltage that may appear on C1/C2 will cause the output of IC1 to go positive. This will forward-bias D1 and 'pull up' the voltage across the capacitors. The combined action of these processes ensures that the voltage across C1/C2 stabilises at zero volts.

When the timing period is commenced at the start of developing a print, SW2 is set to START. As C1/C2 charge, the output of IC1 will go negative. When the image first appears on the paper, SW2 is set to TIME. C1/C2 will then discharge, as previously explained, and the voltage across the capacitors will go to zero. At this time, the buzzer will sound.

IC2 is arranged as a 'trigger'. When C1/C2 first begin to charge, the output of IC1 goes negative. When this negative voltage passes the value of the negative voltage applied to the inverting input of IC2, set by RV3, the output of IC2 will go very rapidly to about -7 V. At the end of the timing period, the output of IC1 goes to zero volts. As this drives the non-inverting input of IC2, the output will swing rapidly from about -7 V to +7V.

This will force a pulse of current through C3/R2, forward-biasing the base of Q3. When Q3 turns on the buzzer will sound.

C3 will take about one second to charge, Q3 will not receive sufficient base current and the buzzer will cease its cacophony. It sounds not unlike the wheeze from expiring bagpipes! This project was designed by a homesick scotsman.

D2 discharges C3 when the output of IC2 goes low when next you turn SW2 to START.

A pushbutton, PB1, allows you to abort a timing sequence by shorting C1/C2.

Note that the buzzer will sound whenever the unit is turned on. IC2 will trigger as the output of IC1 will initially be zero and the output of IC2 will thus jump to about +7 V, setting off the buzzer.

PARTS LIST

RESISTORS

- R1 27k
- R2 12k

POTENTIOMETERS

- RV1 1M log
- RV2 1M trim
- RV3 250k trim

CAPACITORS

- C1, 2 33μ 10V tantalum
- C3 10μ 25V electrolytic
- C4 470μ 25V electrolytic

SEMICONDUCTORS

- IC1, 2 741
- Q1, 2 2N5484
- Q3 2N5831
- D1, 2 1N914

MISCELLANEOUS

- pcb ETI 594
- SW1 miniature dpdt toggle
- SW2 miniature spdt toggle
- 2 of 9V batteries with clips; case to suit;
- 9V dc buzzer and mounting bolts; knob with pointer.

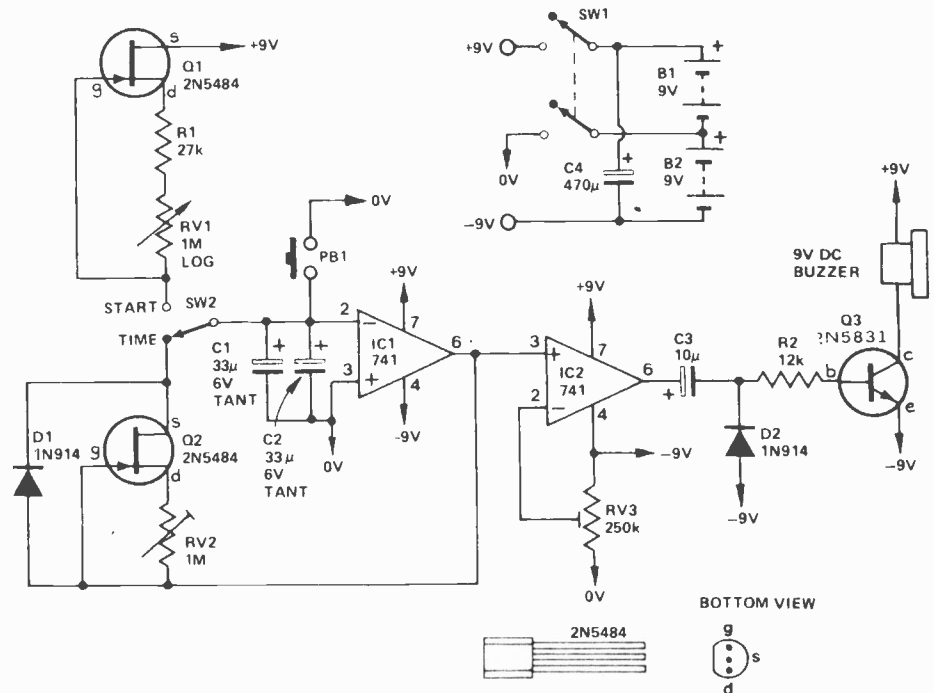

The circuit diagram. C1 and C2 are in parallel to achieve the required total capacitance and voltage rating.

New from NRI! ^{DIAGONAL} 25" color TV that tunes by computer, programs an entire evening's entertainment.

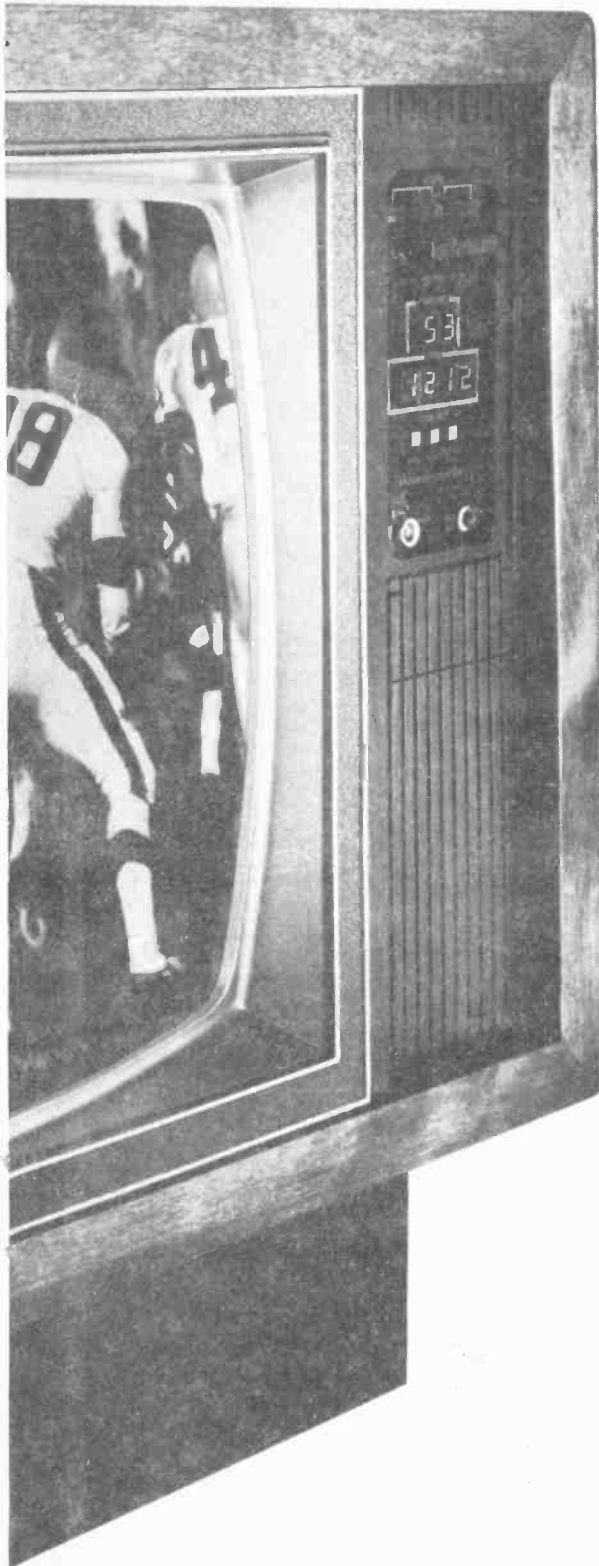

Just part of NRI's training in servicing TV, stereo systems, video tape and disc players, car and portable radios.

Only NRI home training prepares you so thoroughly for the next great leap forward in TV and audio... digital systems. Already, top-of-the-line TVs feature digital tuning, computer programming is appearing, and new digital audio recording equipment is about to go on the market.

NRI is the only home study school to give you the actual "hands-on" training you need to handle servicing problems on tomorrow's electronic equipment. Because only NRI includes this designed-for-learning, 25" diagonal color TV with electronic tuning, built-in digital clock, and computer programmer as part of your training. With this advanced feature, you can pre-program an entire evening's entertainment... even key lock it in to control children's viewing.

Exclusive Designed-for-learning Concept

The color TV you build as part of NRI's Master Course looks, operates, and performs like the very finest commercial sets. But behind that pretty picture is a unique designed-for-learning chassis. As you assemble it, you perform meaningful experiments. You even introduce defects, troubleshoot and correct them as you would in actual practice. And you end up with a magnificent, big-picture TV with advanced features.

Also Build Stereo, Test Instruments

That's just a start. You demonstrate basic principles on the unique NRI Discovery Lab,[®] then apply them as you assemble a fine AM/FM stereo, complete with speakers. You also learn as you build your own test instruments, including a 5" triggered sweep oscilloscope, CMOS digital frequency counter, color bar generator, and transistorized volt-ohm meter. Use them for learning, use them for earning as a full- or part-time TV, audio, and video systems technician.

Complete, Effective Training Includes Video Systems

You need no previous experience of any kind. Starting with the basics, exclusive "bite-size" lessons cover subjects thoroughly, clearly, and concisely. "Hands-on" experiments reinforce theory for better comprehension and retention. And your personal NRI instructor is always available for advice and help. You'll be prepared to work with stereo systems, car radios, record and tape players, transistor



radios, short-wave receivers, PA systems, musical instrument amplifiers, electronic TV games, even video tape recorders and tape or disc video playbacks.

Send for Free Detailed Catalog

Mail the postage-paid card today for our free 100-page catalog with color photos of all kits and equipment, complete lesson plans, convenient time payment plans, and information on other electronics courses. You'll also find out about NRI's new Computer Technology Course that includes your personal microcomputer. Or Complete Communications with 2-meter transceiver. If card has been removed, write to:



NRI Schools
McGraw-Hill Continuing
Education Center
330 Progress Avenue
Scarborough, Ontario M1P 2Z5
or telephone 416-293-1911

Logic Trigger

Debug complex logic circuitry with this unit.

WHEN USING AN oscilloscope to examine or fault find digital circuitry, it is often desirable to see what happens just before a pulse or edge occurs. An example of this is when measuring the propagation delay in a ripple counter. Here it is easy to trigger on the last output but the edge of the counter input which initiated the change in the output may have occurred over 100 ns earlier. Even with the delay line built into modern oscilloscopes the edge is too early to see.

Triggering on the input waveform allows this edge to be seen but if the output pulse occurs only once every thousand or so pulses it will not be seen. With this unit, the output of all the stages in the divider can be examined and a pulse can be generated anywhere in the cycle. By selecting a pulse very close to, but before, the edge in question and using it to trigger the oscilloscope (use ext trigger) both the clock waveform and output waveform can be seen.

With the advent of microprocessors it has become increasingly difficult to fault find as things happen (e.g. the CE input to a memory may go low) only when a particular address is given. As the address bus is always in motion it is almost impossible to trigger the scope on any one address. Again with this unit the address bus is interrogated along with the necessary write or read lines, and its output can be used to trigger the oscilloscope only when the correct sequencer is received.

SPECIFICATIONS

Modes	Asynchronous or synchronous
No. of inputs	12 address, 1 clock
Loading address clock	0.4 UL (TTL) 0.4 UL (TTL)
Pulse extension mono	10 ms
Pulse indication	LED
Minimum pulse detectable	<40 ns
Propagation delay	<45 ns
Trigger (synchronous)	positive or negative edge of clock input
Set up time (synchronous) address to clock	<40 ns
Output	logical "1" when input agrees with switch setting and/or clock (synchronous only)
Power requirement	+5V @ 50 mA

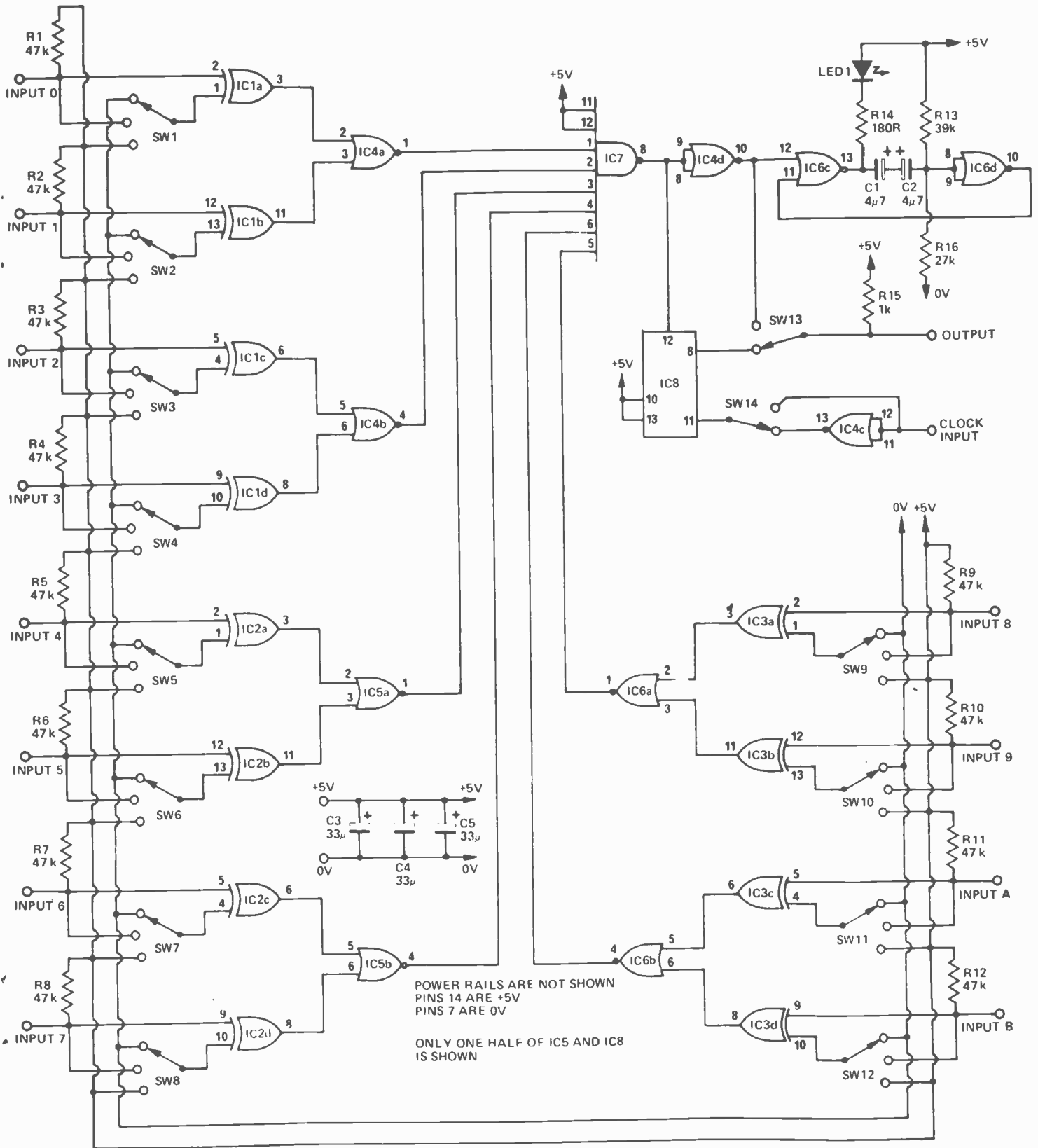

Fig. 1. Circuit diagram of the Logic Trigger.

MICROPROCESSORS

6800	8 bit cpu	\$ 9.95
8080A	8 bit cpu	\$ 6.49
1802	8 bit cpu	\$13.99
Z80A	8 bit cpu (4-Mhz)	\$19.95

6800 SUPPORT DEVICES

6810P	128x8 static ram (450ns)	\$4.19
6820P	peripheral interface adapter	\$4.99
6850P	asynchronous adapter	\$4.99

8080A SUPPORT DEVICES

8214	priority interrupt controller	\$4.99
8216	bi-directional bus driver	\$2.59
8224	2mhz clock & driver	\$4.00
8226	inverting bi-dir. bus driver	\$2.59
8228	system controller & bus driver	\$4.99
8238	system controller & bus driver	\$4.99
8251	programmable comm. interface	\$5.99
8255	programmable peripheral int.	\$5.99

1802 SUPPORT DEVICES (unlisted, but we have in stock)

LINEAR IC

555	Timer Ic	.70
556	dual 555 timer	\$1.65
565	phase lock loop	\$2.50
567	tone decoder	\$2.50
741	op. Amp	.50
LM381	dual preamp	\$1.95
LM380	audio amp	\$2.50
LM339	quad comp. etc.	\$1.35

VOLTAGE REGULATORS

78L12	.55	7905	1.95
7805	1.45	7912	1.95
7808	1.45	7915	1.95
7812	1.45	723	.75
7815	1.45	78MG	2.00
7818	1.45		
7824	1.60	78H05	7.95

MEMORY DEVICES

21L02 (350ns)	\$1.85
MK4116 (300ns)	\$14.50
P5101-45L (HM435101P-1)	\$5.75
2708 EPROM	\$14.95

HAVE YOU HEARD OF 'US' YET ?

NEW!

Exceltronix
COMPONENTS & COMPUTING INC.

319 College St.
Toronto, Ont. M5T 1S2
Tel. (416)921-5295

* WE ARE NEW ELECTRONIC STORE LOCATED IN DOWNTOWN TORONTO TO SERVE AND MEET ALL YOUR DESIGN NEEDS FROM A SINGLE RESISTOR TO A COMPUTER THAT DRAWS DAZZLING GRAPHICS.

* WE HAVE KNOWLEDGEABLE STAFF TO PROVIDE YOU WITH EXCELLENT SERVICE AND HELP YOU TO SOLVE ANY TECHNICAL PROBLEM YOU MIGHT HAVE. JUST ASK !!

LS AND CMOS SHORTAGES? HERE IS SOME GOOD NEWS!

IF you are stuck with some digital projects because you couldn't find the parts, especially TTL LS chips try us! Chances are we have the ICs that you are desperately hunting for. A few examples:

74LS00... 65¢	74LS02... 65¢	74LS04... 65¢
74LS08... 65¢	74LS74... \$1.19	etc..

and many more! (We have most of the series in stock)

10% OFF OUR REGULAR PRICES.

IF YOU show us this ad. when you are in our store, or just tell us what page you saw this ad., WE will give you a 10% DISCOUNT COUPON. HURRY!

AUDIO VISION KITS

- FOR DISCO EFFECTS
- LED VU DISPLAY
- CHASER LIGHT
- STARBURST
- COLOR ORGAN etc.

OTHER ELECTRONIC PROJECTS

- BRITISH/AMERICAN SIREN KITS
- FLUID LEVEL DETECTOR KIT
- SOUND-ACTIVATED SWITCH and many more interesting Kits.

WE HANDLE MAIL ORDER!

Send cert. cheque/money order (NO CASH). Minimum \$5.00 +\$1. handling. Ont. Res. add 7% PST. M.Charge/Chargex accepted. Send A/C No., signature, expiry date.

TEST EQUIPMENT

- .DMM & MULTIMETERS
- .SIGNAL GENERATOR
- .FREQ. COUNTER
- .OSCILLOSCOPE
- .LOGIC ANALYSER

'PLAYMASTER' AUDIO AMP KIT

- 25W+25W \$139.95
 - 40W+40W \$149.95
- complete with encl. & front panel. Instructions incl.

WRITE FOR FREE CATALOG

To get our FREE catalogue, circle No. 6 on Reader Service Card

SPECIAL LIMITED TIME OFFER—SAVE \$100.00 ON LOW COST INTERACT MICROCOMPUTER!

Still in time for Christmas, this powerful microcomputer, costing several hundred dollars less than other similar microcomputers, is now available for a limited time at substantial savings. The Interact is a full function microcomputer with "Advanced BASIC"

programming capability. Simply attach to your home television and you are on your way to becoming a computer programmer. Write your own programs or take advantage of the many Interact programs available from us on cassette. Future options will include floppy disk and printer attachments.

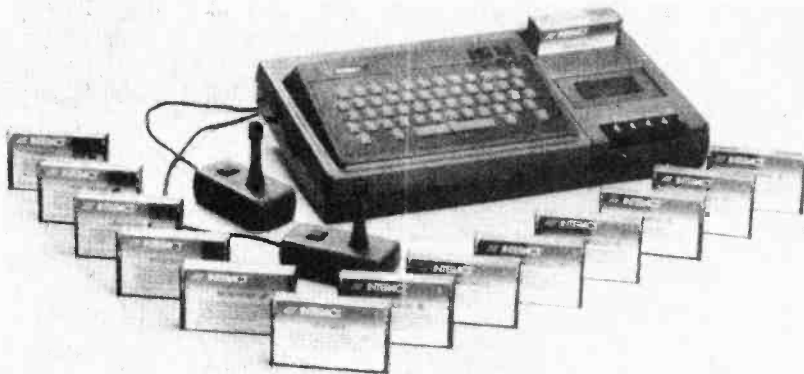

POWERFUL 16K RAM

Features include: full colour; sound; full size keyboard; built-in cassette drive; 16K RAM - 2K ROM; includes RF connector and two joysticks. Weighs only 12 pounds.

NOW ONLY \$695.00

BONUS OFFER

For a limited time only receive 13 program tapes (\$300 value) including EDU-BASIC, for only \$50.00. Optional Level II BASIC \$39.95, Micro Chess \$29.95; plus many more programs available — complete list available upon request. Available at our store or by mail order.

Mail to:

MARKETRON CORP. LTD.
1240 Bay Street Mall
Toronto, Ont. M5R 2A7
Phone 416/923-1917

Dealer inquiries invited!
Dealership information available to qualified retailers. Please request on company letterhead.

Please send: Cheque Money Order Chargex Master Charge American Express

ORDER INFORMATION

Interact Microcomputer	\$695.00
Bonus Programs(\$300 value)	50.00
	\$745.00
Ontario Res. add 7% sales tax	52.15
Shipping charges	5.00
Total enclosed	\$802.15

Card No. _____ Expires _____

Signature _____

Name _____

Street _____

Town _____ Province _____

Postal Code _____ Phone _____

Delivery guaranteed for Christmas if payment is received by Dec. 14; shipment made by courier during business hours almost anywhere in Canada.

PARTS LIST

RESISTORS all 1/2 W, 5%
 R1-R12 47k
 R13 39k
 R14 180R
 R15 1k
 R16 27k

CAPACITORS
 C1,2 4µ7 25V electro
 C3-C5 33µ 16V tantalum

SEMICONDUCTORS
 IC1-IC3 74LS86
 IC4-IC6 74LS02
 IC7 74LS30
 IC8 74LS74
 LED 1 Red LED

MISCELLANEOUS
 PC board ET1 141
 Twelve 3 position slide switches
 Two 2 position slide switches
 Front panel
 Box to suit

HOW IT WORKS

The twelve inputs are compared to the levels set on the slide switches SW1-SW12 by the exclusive OR gates IC1-IC3. These ICs have a high output only if the two inputs differ. If they are the same, either both low or both high, the output will be low. If the two inputs are joined together, as when the switches are in the don't care position, the output will always be low.

The outputs from the exclusive OR gates are combined in pairs by the NOR gates IC4-IC6. If the 12 input signals match the preset selection, the output of all 6 NOR gates will be high. If any one is not in agreement with the selection one or more of the NOR gates will have a low output.

These NOR gate outputs are combined by IC7 which is an eight input NAND gate. The output of this gate will low only if all 12 inputs match. The output of this IC is inverted by IC4/d to provide the asynchronous output.

This output also triggers the monostable formed by IC6/c and IC6/d. This gives a 10 ms long pulse to light the LED indicating a pulse was received. If it is a steady state signal the LED will stay on.

The output of the NAND gate, IC7, also joins the data input of IC8 (D type flip flop). This IC is toggled on the positive edge of the clock waveform transferring the data to the output. This is the synchronous output. To allow for either positive or negative synchronization an inverter is used on the clock input and either polarity can be selected by SW13.

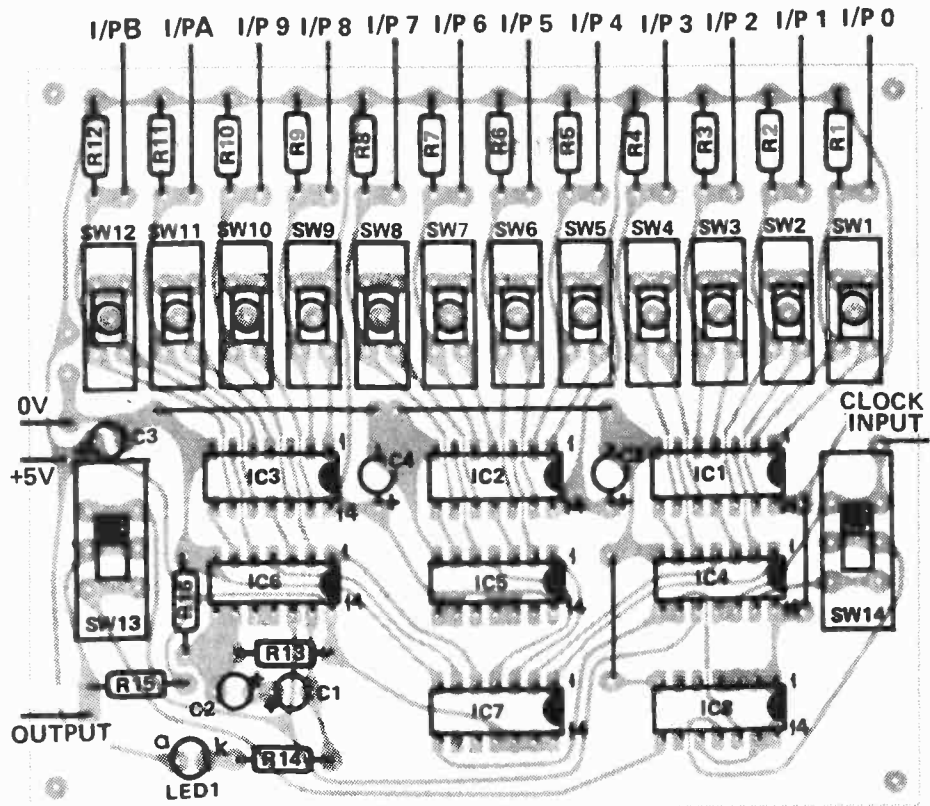

Fig. 2 Overlay of the PCB

For pcbs for this project please contact:
 Spectrum Electronics, P. O. Box 4166D,
 Hamilton Ontario L8V 4L5, or B & R
 Electronics, P. O. Box 6326F, Hamilton
 Ontario L9C 6L9.

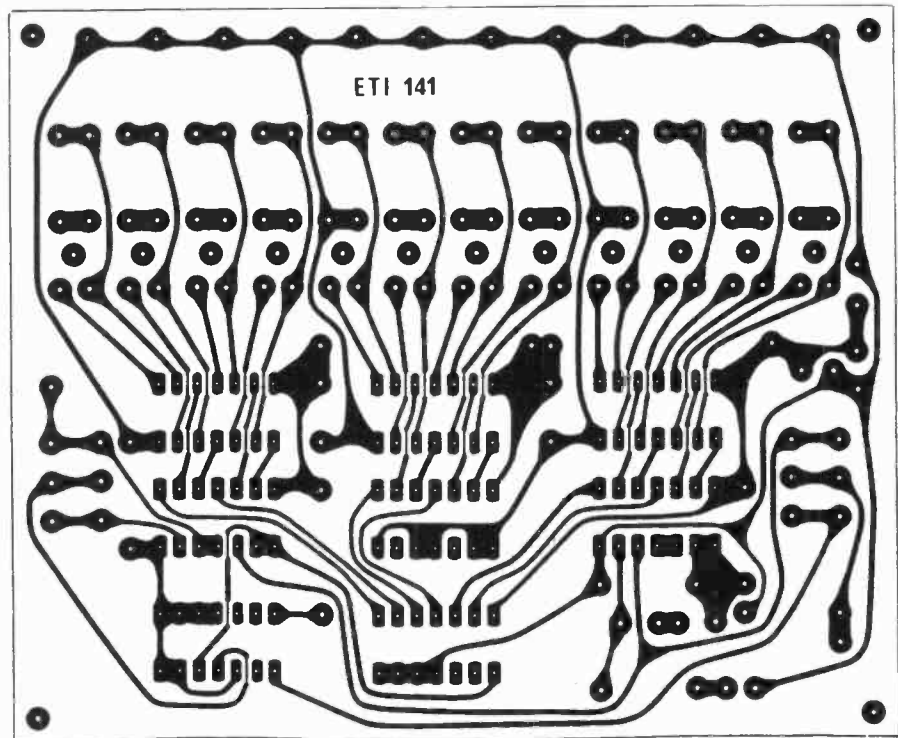

Fig. 3 PCB pattern shown full size.

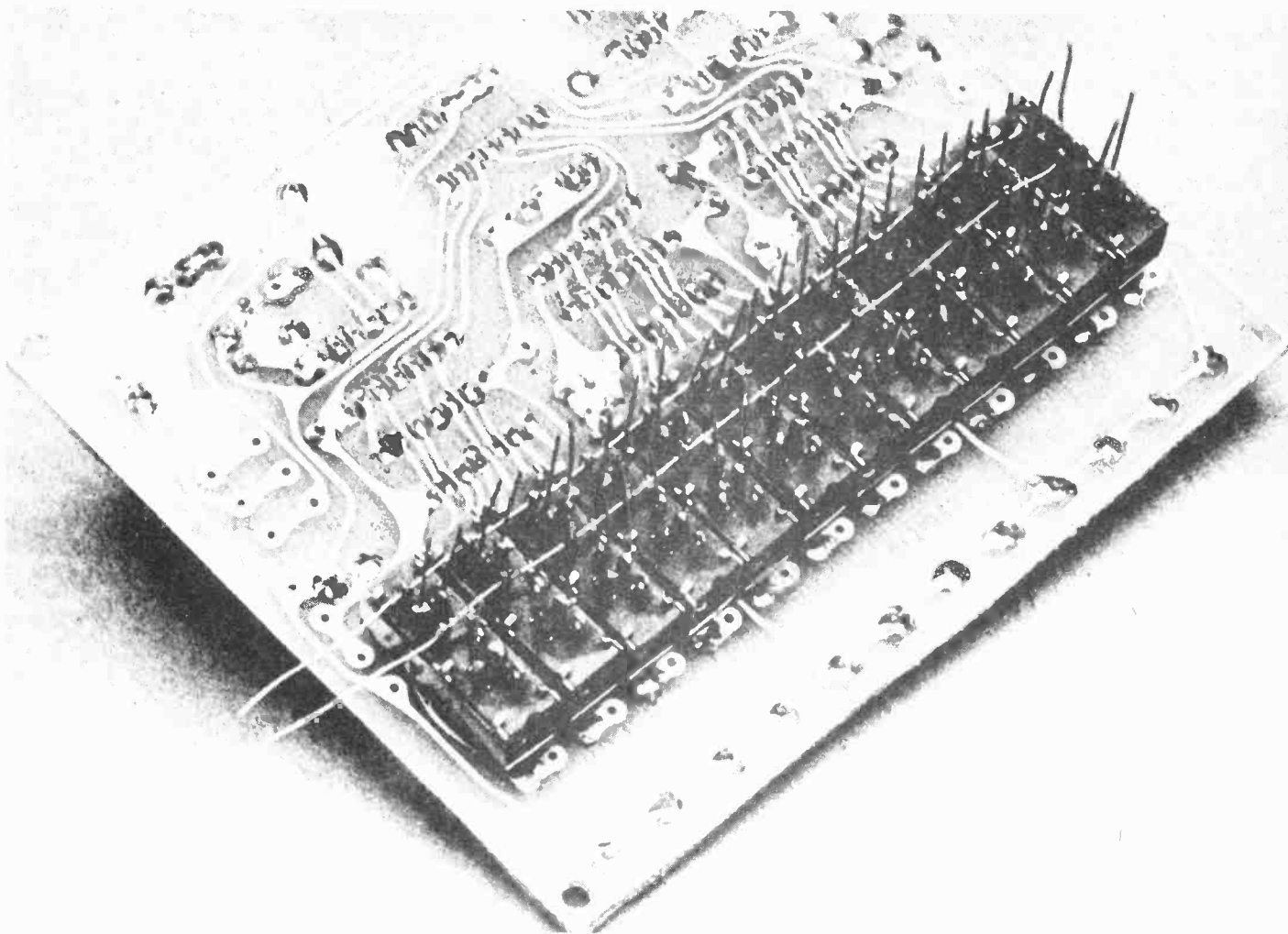

Photo showing how the slide switches are wired prior to installation. While our photo shows them on an assembled pc board it is best if they are wired before the board is assembled.

CONSTRUCTION

We mounted all the components on the pc board including the switches. The only difficult (fiddly) bit is the wiring of the three position slide switches which have to be preassembled before fitting to the pcb. The wiring is shown in fig.3.

To aid this we have provided 12 holes in the pcb the size of the toggle of the switches; if the switches are initially placed upside down in these holes the board will act as a template to provide the correct spacing. We have also used two wires of the second pole of the switch to provide mechanical support.

The switches can now be mated to the pc board with the two longitudinal wires being terminated in the holes provided at the end of the switch bank.

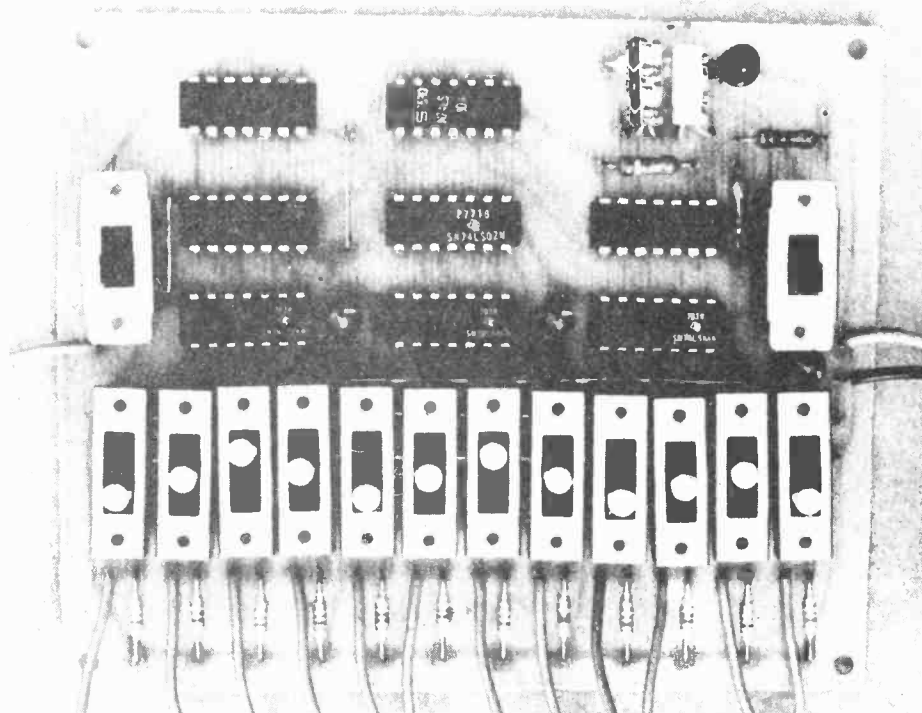

LM10 The Basics

Not another Op-amp, ANOTHER Op-amp.

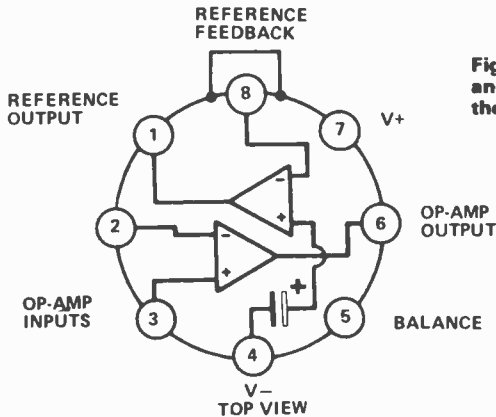
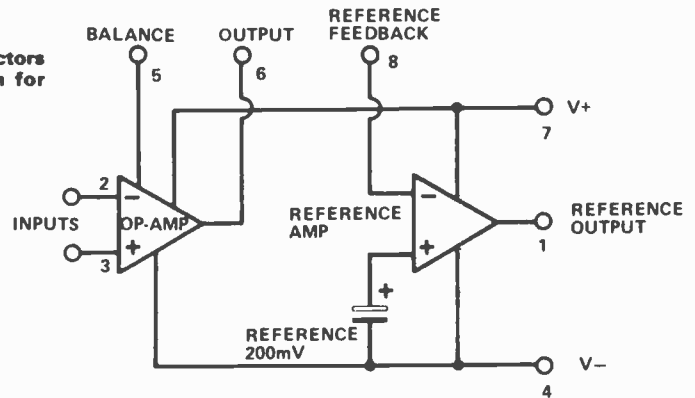

Fig 1. TO-5 can connectors and schematic diagram for the LM 10.



THE LM10 IS THE FIRST of a brand new and very exciting generation of highly versatile op-amp devices. It has been specifically designed to have a capability of working from single-ended supplies with voltages as low as 1V1 to as high as 40 V while giving a performance that is vastly superior to that of most of today's 'conventional' dual-supply op-amps.

The LM10 has been designed by Robert J. Widlar, the acknowledged 'Father of the op-amp' (he also designed the μ A709, 710, 711, LM101, LM108, etc), and incorporates some brilliant design innovations. The device is being manufactured by National Semiconductors.

Parting With It

When we at ETI first heard about the device we reckoned it sounded pretty good, so we decided to run a one-part feature on the LM10. Since then, however, we've received actual samples of the IC!

In this month's part of the series we tell you what the device is, and describe some basic ways of using it. In next month's concluding part we'll show you a whole stack of practical applications.

The LM10; An Introduction

THE LM10 is a brand new and revolutionary type of monolithic op-amp. It draws a total quiescent current of only 270 μ A over the entire voltage range, is capable of delivering tens of milliamps output current, and can operate from either fixed or fully-floating power supplies.

The op-amp has a PNP differential input stage that can accept input signals down to zero volts, and has a complementary class-B output stage that can swing within 50 mV of the supplies at 50 μ A load current, or within 400 mV at 20 mA load current. The input is well protected via integrated current-limiting resistors against damage from excessive voltages and the output is protected by thermal overload and short-circuit detection circuitry.

The LM10 actually comprises three circuits, all housed in a single TO-5 8-pin package (see Fig. 1). The circuits comprise the op-amp, a 200 mV band-gap voltage reference and a reference amplifier. The reference is an ultra-precision device, with a temperature coefficient better than 0.002%/°C, and is externally available at the amplifier output. The reference output value can be adjusted over a wide range (200 mV to 39 volts) by trimming the amplifier feedback.

The LM10 Family

There are five members of the LM10 family. All the characteristics except the unity gain bandwidth (0.3 MHz) and the slew rate (0.15 V/ μ S) are exceptionally good (the device is clearly not designed for high frequency operation). The five devices in the range are categorised by their operating temperature ranges (LM10, LM10B, or LM10C) and also by their maximum supply voltage ranges of either 7 volts ('L' suffix) or 40 volts. The LM10C is a relaxed-specification 'commercial' version of the 40 volt unit.

The device is moderately complex (it incorporates 88 transistors, 81 resistors, and 16 capacitors), is fairly pricey, and is initially likely to be used only in unique (and until now 'impossible') applications for which no alternative solution is possible.

Several manufacturers are considering second-sourcing the LM10, however, and when they do the price of the device can be expected to drop significantly. This factor, combined with the certainty of spin-off devices based on the new circuit design techniques of the brilliant Bob Widlar, must mean that the LM10 and its derivatives will become classic IC devices, just like the 741 op-amp and the 555 timer, in the next couple of years. We at ETI vote the LM10 as IC of the year and Robert J. Widlar as design Superman of the decade.

NEW LOW COST LX303 DMM

\$99.95

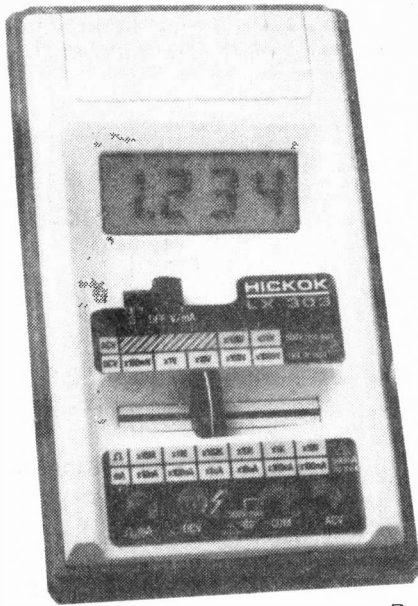

Less 10% for orders placed in the month of December.

Operates up to 200 hours on a single 9 volt battery. 100 mV DC f.s. sensitivity. Features auto zero, polarity, overrange indication. Nineteen ranges and functions. With easy-to-read 1/2" LCD display for convenient use in any kind of light. Removeable cover stores test lead set furnished as part of the unit. Excellent overload protection. Colour coded panel. Carries a full one year warranty. Available accessories include 10 kV probe/adaptor, 40 kV probe, 10 amp DC shunt, AC adapter and deluxe padded vinyl carrying case.

HICKOK
the value innovator

Duty and FST included.
Chargex (Visa) accepted.
Ont. res. add 7% sales tax
F.O.B. Ajax.

SPECIFICATIONS:

DC VOLTS (5 RANGES): 0.1 mV to 1000V; Accuracy $\pm 0.5\%$ rdg $\pm 0.5\%$ f.s.; Input imped: 10M ohm; Max. input 1kV except 500V on 200mV range. AC VOLTS (40Hz to 5kHz): 0.1V to 600V; Accuracy: $\pm 1.0\%$ rdg $\pm 0.5\%$ f.s. (-2db max. at 5kHz); Max. input: 600V.

RESISTANCE (6 LOW POWER RANGES): 0.1 ohm to 20M ohm; Accuracy: $\pm 0.5\%$ rdg $\pm 0.5\%$ f.s. ($\pm 1.5\%$ rdg on 20M ohm range); input protected to 120 VAC all ranges.

DC CURRENT (6 RANGES): .01nA to 100mA; Accuracy: $\pm 1.0\%$ rdg $\pm 0.5\%$ f.s.

DIMENSIONS AND WEIGHT: 5-7/8" x 3-3/8" x 1-3/4", 8 oz.; POWER: 9V battery (not included) or Hickok AC adapter; READ RATE: 3/sec.

ROGERS electronic instruments Ltd.
P.O. Box 310, 595 Mackenzie Avenue Units 1 & 2.
Ajax, Ontario L1S 3C5. Tel. (416) 683-4211

Circle No. 15 on Reader Service Card.

Now Available!

OUR ALL NEW
LENLINE
ELECTRONIC
COMPONENTS
CATALOGUE.

60 pages contain-
ing more than
400 items, all
fully illustrated
and described.

SEND FOR
YOUR FREE
COPY TODAY!



Please send me your LENLINE Electronic Components Catalogue and the name of my nearest LENLINE Dealer.

NAME _____

ADDRESS _____

CITY _____

PROV. _____ CODE _____

len finkler ltd

25 Toro Road, Downsview, Ontario M3J 2A6 • 630-9103



Circle No. 10 on Reader Service Card.

FREE "More Circuits"
— See Page 62

NOW AVAILABLE

\$419*

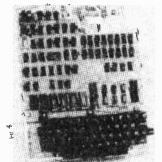

OSI SUPERBOARD II

- . 8K Microsoft BASIC - in - ROM
 - . 4K RAM on board expandable to 8K
 - . Full 53 - Key keyboard with upper/lower case and user programmability
 - . Audio cassette interface
 - . Graphics and gaming characters
- Fully assembled and tested. Requires +5V at 3 amps and a video monitor or modified TV set.

C4P color graphic computer. \$999.00

* These prices include import duties, federal sales tax & 90 day full warranty service by D.C.B. ELECTRONICS. Ontario residents add 7% Sales Tax. Prices subject to change without notice. Master-charge or Visa accepted. 4% handling charge (does not apply to cash or certified cheque orders). Shipped collect by any method you specify.

D.C.B. ELECTRONICS
333 Denison St. Unit 3, Markham,
Ontario L3R 2Z4 (416) 495-1599

Using The LM10; Power Supplies

The LM10 is a remarkably easy device to use. It can be powered from either fixed or floating single ended or dual supplies, and can use total voltages anywhere in the range 1V1 to 40 V. Figures 2 to 6 show a few ways of powering the device.

Figs. 2 and 3 show methods of powering the unit from dual supplies, for 'conventional' applications in which the inputs are referenced to the zero volts rail and the outputs can swing between the positive and negative supply line voltages. The Fig. 2 circuit uses two independent supply rails and the Fig. 3 circuit uses two rails derived from a single source.

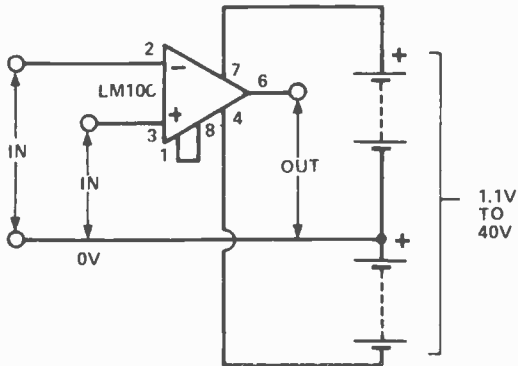

Fig 2 (above). Method of powering the LM 10 for conventional split-supply operation.

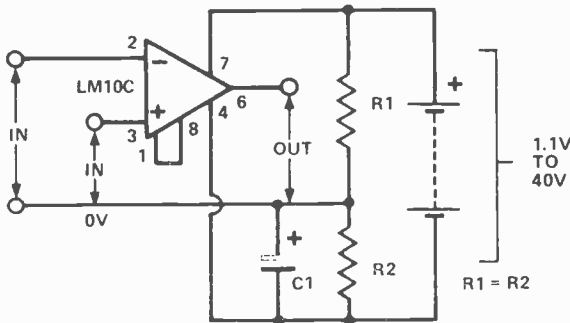

Fig 3. Method of powering the LM 10 for split-supply operation using a single supply source.

The Fig. 2 and 3 supply connections enable the LM10 to be used in all of the standard op-amp configurations, but with the quite remarkable advantages of using total supply voltages down to a mere 1V1 at total quiescent currents of only 270 μ A and of having outputs that can swing within a few tens of millivolts of the supply rail voltages.

Fig. 4 shows the standard and self-evident method of powering the LM10 from a single pair of supply rails. The supply can again have any value in the range 1V1 to 40

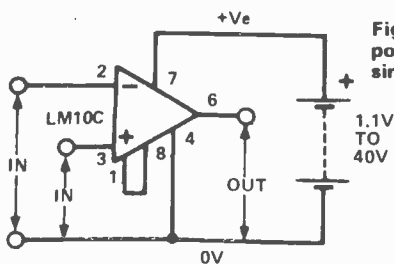

Fig 4. Standard method of powering the LM 10 from a single pair of supply rails.

V, and the op-amp output can again swing within a few millivolts of the zero and positive supply rails. An additional and rather pleasant surprise is that the op-amp can handle input signals right down to zero volts when used with a single power supply.

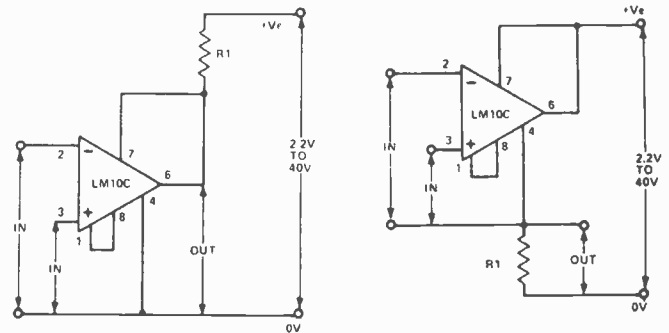

Fig 5 and Fig 6 (above). Two alternative methods of 'shunt' supplying the LM 10.

Finally, Figs. 5 and 6 show two quite unique and mind blowing ways of powering the LM10 from a single pair of supply rails. In these configurations the op-amp output terminals are shorted directly to the positive supply terminal of the LM10, so that the output 'shunts' the devices supply and a limiting resistor is wired in series with one of the supply leads.

The LM10 op-amp has an output drive current capability that is a couple of orders of magnitude greater than the device's normal quiescent current. This factor, combined with the device's excellent supply-voltage rejection figure of 96 dB and wide operating voltage range, enables it to operate quite happily in either the linear or the switching mode while at the same time using its own output to modulate its own supply voltage and current!

Thus, this 'shunt' method of operation can be used in two-wire remote-sensor applications, in which the two wires carry both the supply current and the resulting signal information. Note that the minimum supply voltage used in this application must be significantly greater than the normal 1V1 figure, to enable reasonable data amplitudes to be developed across R1 without reducing the LM10 voltage below its minimum working value.

Using The LM10; The Reference Amplifier

If you don't want to use the reference facility in a particular application, or wish to use it simply as a 200 mV reference, strap pins 1 and 8 of the IC together as shown in Fig. 7. That gives the reference amplifier

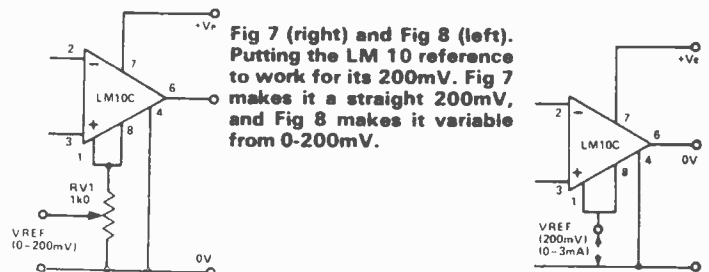

Fig 7 (right) and Fig 8 (left). Putting the LM 10 reference to work for its 200mV. Fig 7 makes it a straight 200mV, and Fig 8 makes it variable from 0-200mV.

something useful to do and makes a 200 mV 0-to-3 mA reference available between pins 1 and 4.

If you want a precision reference in the range 0 to 200 mV, wire a fixed or variable potential divider between pins 1 and 4, strap pins 1 and 8 together and take the output from the potential divider junction or slider, as shown in Fig. 8.

If you want a precision reference in the range 200 mV to 39 volts, use the connections shown in Fig. 9. In this configuration the reference amplifier is used as a non-inverting amplifier with an input of 200 mV and a voltage gain of $(R1 + R2) / R2$.

A useful point to note about the reference amplifier is that it has a typical unity gain bandwidth of about 500 kHz and can be gainfully employed in some special applications as an AC amplifier, if you use a little ingenuity in your circuit design.

A final point to note is that the reference amplifier can also be used as a simple voltage comparator that can be quite useful in some special applications (an ETI discovery). Fig. 10 shows the basic connections.

Using The LM10; The Op-Amp

The op-amp section can be used in a wide variety of basic configurations in the single-supply mode. Some of these configurations are shown in Figs. 11 to 24.

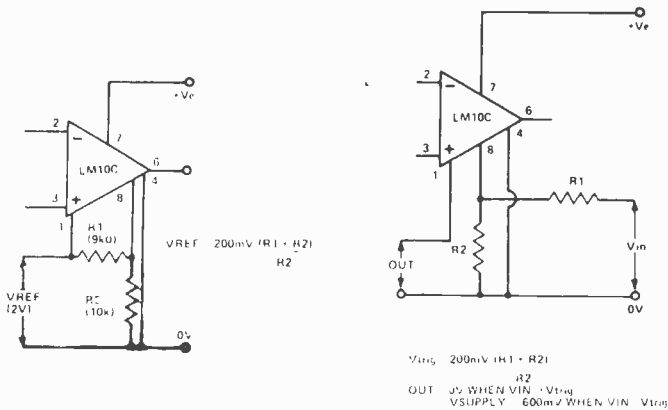

Fig 9 (left) and Fig 10 (right) give a circuit for getting the reference to behave as a 200mV-39V precision output and using the reference as a simple voltage comparator respectively.

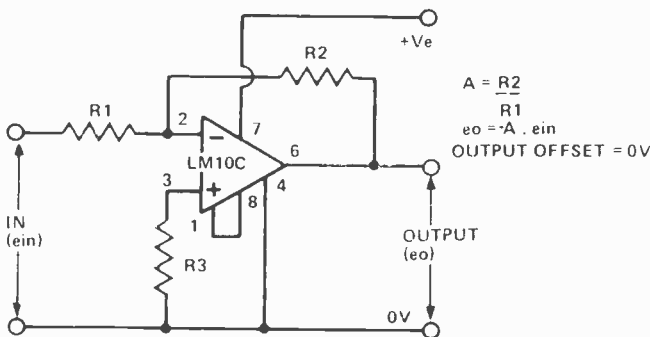

Fig. 11 shows the basic connections for using the op-amp as an inverting DC amplifier. Note here that the circuit can usefully accept input signals that are negative with respect to the 'zero' volts rail only.

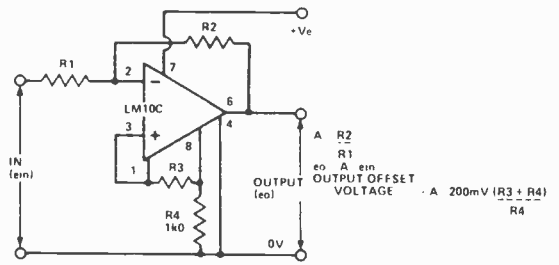

Fig. 12. If you want the circuit to accept positive DC input signals, you can do so by feeding an offset biasing voltage to the non-inverting terminal of the op-amp from the built-in reference amplifier.

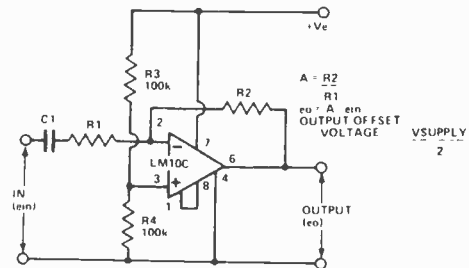

Fig. 13 shows the connections for making an inverting AC amplifier. The output is biased at half-supply volts, for maximum signal swing, by the R3-R4 potential divider.

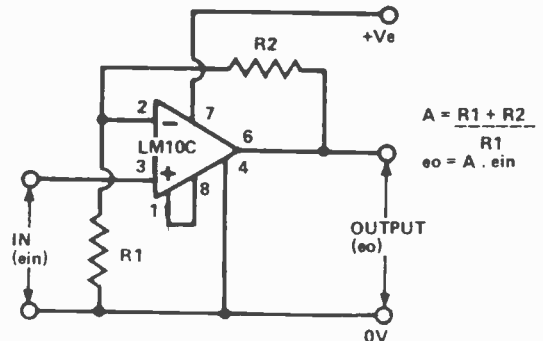
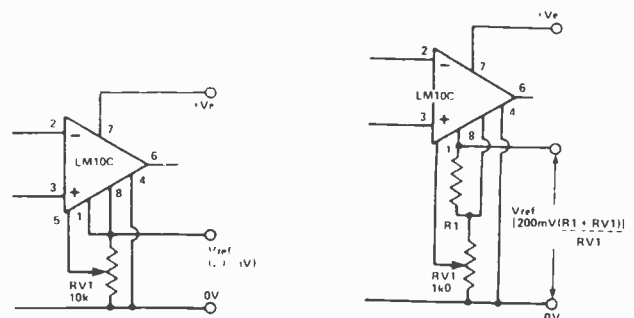

Fig. 14 shows how to use the LM10 as a non-inverting DC amplifier that will accept input signals down to zero volts. The circuit can be used as a unity-gain voltage follower by removing R1 and replacing R2 with a short circuit. The circuit can be used, in conjunction with the built-in voltage reference and amplifier, as a precision voltage regulator in this mode.

Figs. 15 and 16 show standard methods of applying offset adjustment or compensation to the op-amp, using the IC's built-in reference amplifier.



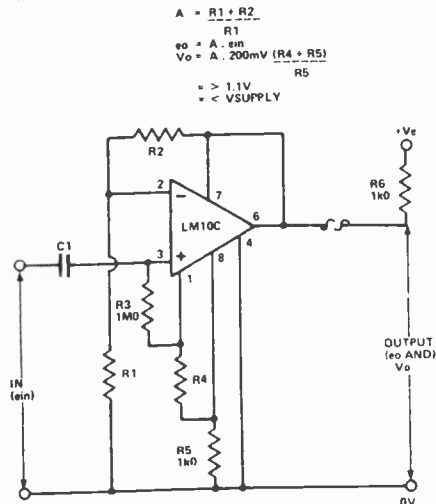

Fig. 17 shows how the LM10 can be used in a 'shunt' mode when connected as a non-inverting AC amplifier. Note that the output must be biased so that the quiescent output voltage (V_o) is part way between the positive supply value and the 1V1 minimum operating potential of the IC. Both the IC supply and signal currents flow through R_6 in this mode of operation, thus enabling the IC to be used as a 2-wire (or single-wire if a common earth return is used) sensor or data transmitter.

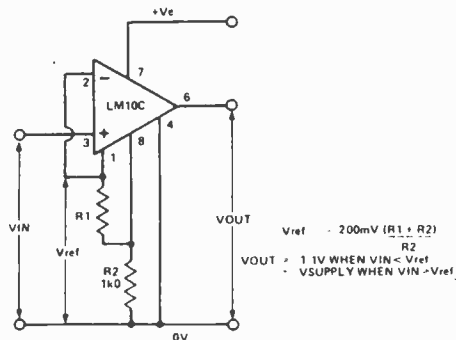

Fig. 18 shows how to use the LM10 as a precision voltage comparator, using the IC's built-in voltage reference and amplifier. The action of the circuit can be reversed, so that the output goes high when V_{in} falls below V_{ref} by transposing the op-amp pin 2 and pin 3 connections.

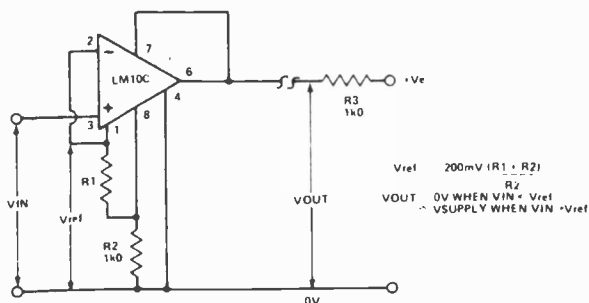

Fig. 19 shows how the voltage comparator can be used in the shunt mode.

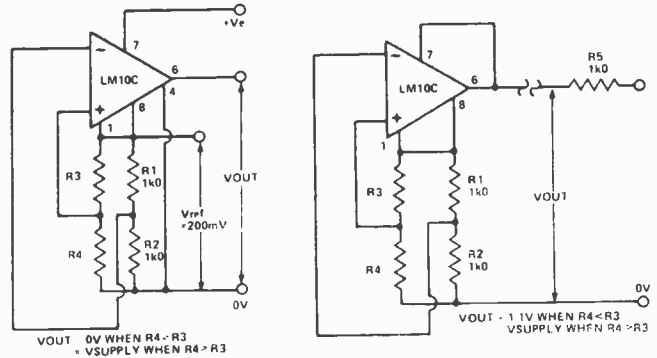
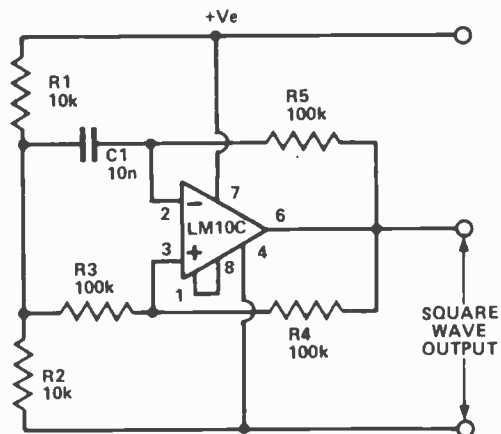

Fig. 20 (left) shows how the LM10 can be used as a resistance comparator, using the IC's built-in reference to power the test and reference resistors. The sensitivity of the circuit can be improved by raising the reference voltage above the basic 200 mV value. Note that the total output current of the reference must not be allowed to exceed 3 mA.

Fig. 21 (right) shows how the resistance comparator can be connected in the shunt mode. Note in this case that the reference voltage value should not exceed 1 V.



PERIOD = 2.6mS
RISE TIME = 80uS @ 6V PEAK

Fig. 22 is the basic astable circuit and is a fairly simple development of the standard 'dual supply' op-amp astable, with R_1 and R_2 acting as a potential divider that sets the 'common' point of the R_3 - R_4 and C_1 - R_5 networks at half-supply volts. Because of the poor slew-rate characteristics of the LM10, the circuit gives a pretty lousy square wave output, with typical rise and fall times of about 80 μ S when used with a 6 V supply. The circuit is, nevertheless, very useful in low frequency applications (up to a couple of kHz) as a simple alarm-tone generator or LED flasher, etc.

Coming Soon

We'll show you a whole stack of practical applications in the final part of this series next month. All of these applications will be based on the LM10C version of the device.

Police Radar Speed Meters

This ETI Special Report covers all aspects of Radar Speed Meters, from the State of the Art to the Art of the State.

IF YOU'RE READING this magazine, then it's a sure bet that you've been in an automobile. And if you've been in a car it's also a sure bet that you've seen, or worse yet been stopped by, a police radar speed "trap". Well, so have we, and being curious sorts, we decided to look into the subject further, and find out how these speed meters work. (and whether we really *did* deserve those tickets!). Naturally, we were also interested to find out whether these meters can perhaps be fooled, and to see what kind of a chance you have if you are caught by the men in blue.

Very fortunately for us, one of the world's leading companies in radar speed meters, Tribar Industries, is located right here in Toronto, and we were able to make the very pleasant acquaintance of their Service Manager, Mr. Ross Brimbecom. He assisted us greatly in the preparation of this article, and lent us a Tribar T3 Radar "Gun" (Fig.1.) to try out. Let's get into the subject by first describing how one uses the T3 Radar unit, a good example of the way most radar meters would be used.

THE TRIBAR T3

To put it conservatively, the T3 is incredibly easy to operate. As can be seen in Fig.1, it has 2 switches, 2 push-buttons, a digital display, and a trigger switch. All you have to do is to plug the cord into the car cigarette lighter socket, (or portable battery pack), switch on, and point the thing at a moving object, such as a car (what imagination!). The speed is registered on the digital display. Both kph and mph models are available. Pull the trigger and that number is remembered, and the display flashes the number on and off to show that you are in



Fig. 1. The Tribar T3 hand-held radar gun.
(Photo courtesy of Tribar.)

"remember" mode. Pull the trigger again and you're back in "measuring" mode.

The toggle switch on the left gives you high or low distance ranges, which are 1500 to 5000 feet for the high range, and about one third that for the low one, which is more suited to city traffic situations.

The two push buttons allow you to test, producing readouts of 25 or 100.

An additional feature is that in "flashing" mode, (ie: trigger pulled once) the radar transmitter is not operating. When the trigger is pulled again the transmitter starts operating again and a reading is taken. This is of course useful in catching those dastardly types who have radar detectors ("fuzzbusters") mounted in their Firenzas.

And that's all there is to it! There is no mystique or trickery, it's simply a measuring instrument. As such, of course, it's readings are subject to interpretation. Just as you would not expect a police officer to vaguely wave a ruler at your car and claim that you had parked too close to a fire hydrant, you would also expect him to be knowledgeable about the techniques necessary to obtain a meaningful reading from the meter. More on this later.

So the T3 is a nice portable speed measuring device, but you can't use it from a moving vehicle. Let's take a look at Tribar's most sophisticated model, a microprocessor controlled unit which has this capability.

TRIBAR MDR-1 "TRACK RADAR"

Pictured in Fig.2 is probably the most sophisticated speed radar available today. As can be seen it is composed of a dash-board mounted control and display box, and remote antenna, mounted externally on the car.

As a stationary unit, operation is similar to that of the T3, although with more sophisticated signal processing.

Used in a moving vehicle it really comes into it's own. It functions as two radar meters, one measuring "patrol" vehicle speed, the other measuring relative speed between patrol car and "Target" vehicle. The microprocessor makes the addition or subtraction and displays both patrol speed and target speed. Switches allow operator to "remember" a reading, to put radar transmitter on standby, to observe vehicles in same or opposite direction, and to look only for vehicles traveling at speeds above that preset on the front panel. Range is up to 2 miles when used in stationary mode, and ¾ to 1¼ miles when moving.

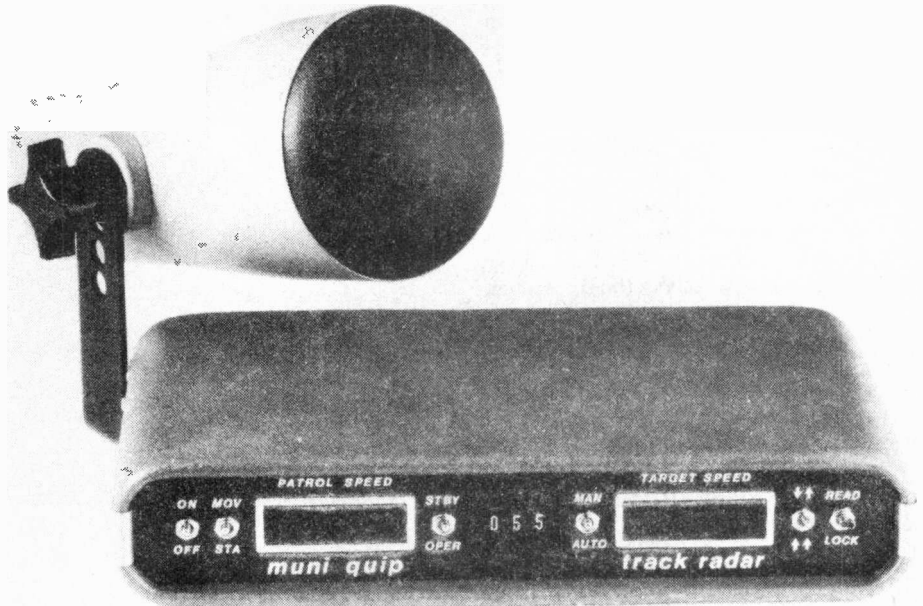

Fig. 2. "Track Radar", the Tribar MDR-1. (Photo courtesy of Tribar.)

BASIC PRINCIPLES BEHIND SPEED METERS

The central part of any radar speed meter, is a transmitter and a receiver, using a common, and fairly directive, antenna arrangement.

The transmitter directs a beam of radio waves toward the target, and the target reflects them back to the receiver. If the target is moving towards the radar unit, the returning waves will be compressed, this is known as the Doppler effect. The radar receiver will

ILP Amplifier Modules — so reliable they carry 5 Year warranty*

Built-in heatsink for cool reliable operation

Amplifier circuitry encapsulated in epoxy for excellent thermal stability

MODEL HY200
120 watts into 8 ohms
\$79.⁵⁰

TRUE HIGH FIDELITY SPECIFICATIONS:
Typical distortion-0.05% at 1kHz
Frequency response-10-45 kHz
Signal/noise ratio-up to 96 db

Only 5 simple connections

ILP is the original line of audio amplifier modules, and the only ones with a five-year warranty. Choose from 4 models, conservatively rated 30 - 60 - 120 and 200 watts. Matching preamp module also available. Fully short/open circuit protected. ILP alone offers performance, value, reliability backed up by a five year warranty. In short, ILP is the only choice for the discerning audiophile

*to original owner when used with recommended power supply.

ILP MODULES ARE AVAILABLE IN: MONTREAL- Addison TV Parts. TORONTO: Dominion Radio, General Electronics, Gladstone Electronics. MISSISSAUGA: Atwater Electronics. OTTAWA: Kris Electronics. KITCHENER: Orion Electronics. LONDON: Provincial Electronics. NOVA SCOTIA: F. Rhodenizer (Bridgeport)

Dealer/distributor enquiries welcome.

audiex ELECTRONICS

1736 Avenue Rd., Suite B,
Toronto, Ont. (416)787-7367

Circle No. 13 on Reader Service Card.

thus pick up a signal of higher frequency than that which was transmitted. Similarly for a receding target, the returning waves will be "stretched out", seen at the receiver as a signal of slightly lower frequency.

The "front end" of the radar receiver mixes the reflected signal with a portion of the transmitter signal. This has the effect of "demodulating" a low frequency signal which is the difference between transmitted and received frequencies. The frequency of this low frequency signal is proportional to the absolute speed of the target. (Speed meters can't tell the difference between advancing or receding vehicles, except by antenna aim.)

The frequency of this "speed signal" is dependant also on the transmitter frequency, and is:

$$F_{\text{speed}}(\text{Hz}) = 2 \times \text{Speed}(\text{mph}) \times F_{\text{trans}}(\text{Hz}) / C$$

$$C = \text{speed of radio waves} = 6.696 \times 10^8 \text{ mph}$$

$$F_{\text{speed}} = 2.986 \times \text{Speed}(\text{mph}) \times F_{\text{trans}}(\text{GHz})$$

The two commonly used radar bands today are centred at 10.525 GHz ("X band") and 24.150 GHz ("K band") which, plugging into the above formula gives 31.4Hz per mph for X Band, and 72.1Hz per mph for K Band.

This speed signal is amplified and filtered, then fed to a frequency counter, scaled for either mph or kph, giving a digital readout of speed.

In order for a display to appear, a number of consecutive readings are taken and compared. If they are reasonably constant the display is activated indicating that the speed meter considers the reading valid.

MDR-1 SOPHISTICATIONS

The "Track Radar" has to have some additional sophistication, since it has to be able to distinguish between the signal returned from the road and that from the target.

For this purpose the low frequency signal is treated somewhat differently. Referring to Fig.4. the circuitry is faced with interpreting a number of different frequency components. The tricky part of the MDR-1 is its programmable band pass filter. Under control of the microprocessor, this filter may be made to select the frequency bands corresponding to each mph or kph up to 256.

To look at it another way, imagine that there are 256 frequency "windows", from one to 256 mph.

The microprocessor can "look" in each one to see if there is any signal there. If there is, the microprocessor knows that something is moving with respect to the patrol car, at a speed corresponding to the number of the window.

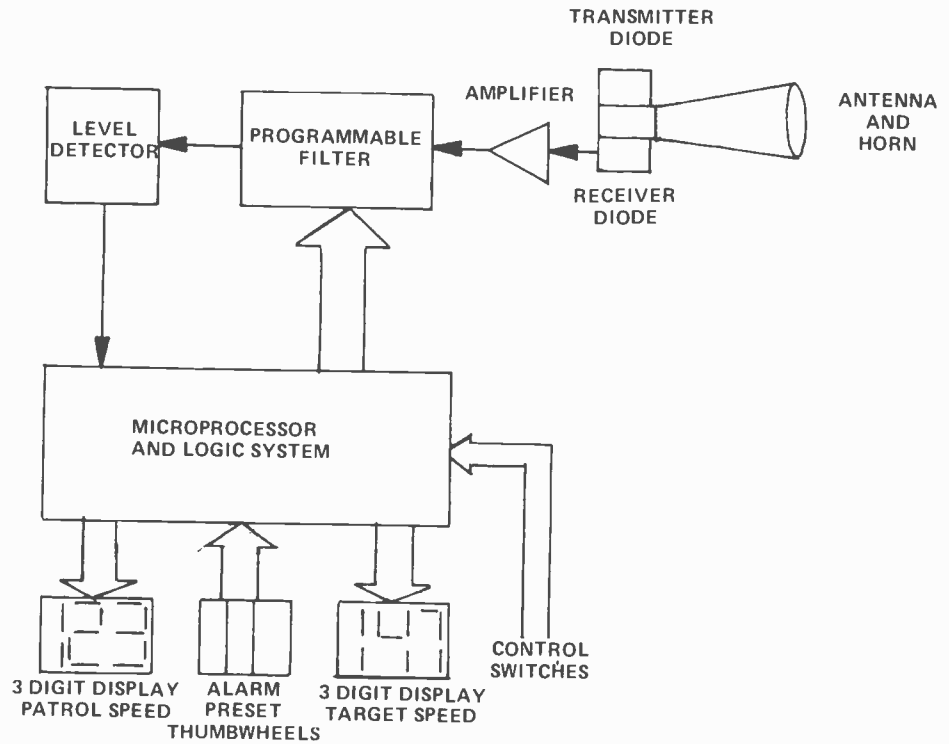

Fig. 3. Inside the MDR-1 is a microprocessor system, and programmable filter which together are able to find and track speed signals with great selectivity.

OPPOSITE DIRECTION

As an example, suppose the patrol car is moving at 50 mph (see Fig.4.) and the MDR-1 is switched to "opposite direction" operation. The mpu looks in all the windows and finds the biggest signal in the 50 mph slot. Then it scans from there to find signal C. Subtracting A from C it finds the speed of the vehicle.

This is considered to be the "standard mode" of operation, with antenna aimed forward to observe oncoming vehicles. In this case, the scanning for a target starts at the top

Fig. 4. Example of signals demodulated by radar in moving application.

A: Reflection from road gives patrol car speed.
 B: Signal reflected from car going same direction, at speed A+B or A-B relative to road.
 C: Signal reflected from car going opposite direction at speed C-A relative to road. It could also be from a car going at A+C, but this is pretty quick!

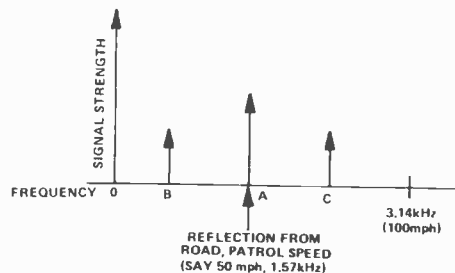

and proceeds downwards until a target is found, or the patrol speed (A) is reached, in which case the scan starts again. In this way the highest speed target is found.

SAME DIRECTION

If the MDR-1 is used to track cars going in the same direction the antenna may be faced behind or in front, and reads the speed of cars approaching from behind, or passing respectively. In other words referring to Fig.4, after finding the patrol speed it scans down to find the highest frequency below that, adds the two (A+B) for the resulting target speed.

TRACKING

In each case, once the patrol and target "windows" have been found, the MDR-1 keeps track of each one by repeatedly looking in these and adjacent windows to follow the two speeds as they vary up or down.

ALARM AND PRESET

Using thumbwheel switches on the front panel, the operator can select a target speed above which the display will be activated and an alarm sound.

CHECKING TUNING

All speed meters we have seen are tuned in the same way, with a tuning fork! The units are supplied with a tuning fork designed to vibrate at the

frequency corresponding to, say 100 kph. All the operator does is to bang the fork against a piece of wood or hard rubber (metal is unsuitable since it has a tendency to cause oscillations in the fork other than the fundamental) and then hold it in front of the speed meter. 100 kph pops up on the display showing correct calibration.

How does this work? The vibrating fork prongs frequency modulate the radar beam, which produces strong "sidebands" offset from the transmitter frequency by the fork frequency (see Fig.5).

Because this is frequency modulation there will be other sidebands, but these are of lower amplitude so are ignored by the meter.

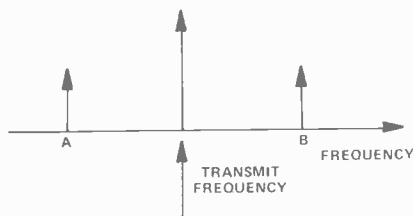

Fig. 5. Calibrating a radar speed meter. These are the signals reflected from the tuning fork:
A and B : Reflected components at "100kph" offsets, for example.

Do Speed Meters Make Mistakes?

As we mentioned before, this is like asking does a ruler make a mistake? We will look at some of the possible sources for error in using a speed meter. These can briefly be broken down to: Calibration error, Angle error, Wrong vehicle error, "Operator Interference" Mechanical Interference, and Electrical Interference.

CALIBRATION ERROR

In the meters we looked at there appeared to be little room for calibration error, either the thing would work or it wouldn't. The only way that an *incorrect* reading could occur would be if the transmitter frequency drifted miles from its intended value, or the crystal timebase for the frequency counter drifted off. The first is quite unlikely since it is the resonant cavity which determines resonant frequency, and the oscillator would only be able to function at very limited output at other frequencies. The second is also pretty unlikely, but possible.

These are pretty easy to check however. If you are stopped, you are quite entitled to look at what the radar

is reading (your speed should be "locked on") and to challenge the calibration. Ask the officer to test the unit with his tuning fork and show that the display is correct, as marked on the tuning fork. (Calibration forks are marked with speed reading, not frequency!) This is a useful exercise anyway: we have heard of cases which were thrown out because the officer did not have his tuning fork with him, and this could not have checked the calibration of his unit before and after use, as he is supposed to!

It has been claimed that rough usage could throw off these tuning forks, which would be a problem if the particular radar meter concerned is actually recalibrated against the fork. (This could not really be done with the units we saw, but may be possible in other cases, if there is a calibration adjustment) In this case, perhaps you should carry your own tuning fork of known accuracy, a musical one will do, and you can work out what reading should result, according to its note.

MECHANICAL AND ELECTRICAL INTERFERENCE

First—mechanical. Obviously, any moving, reflective (to radio waves) object is capable of giving a reading on the meter. This includes metal fans, swinging advertising signs etc. However, these do not add to, and are almost always less than the speed of your vehicle. At most, they will activate whatever automatic level control the meter has, making it less sensitive.

Remember, even 20 mph corresponds to 628Hz (for X Band), or over 37,000 rpm for a fan for example! But then it's hard to predict exactly what effect a fan will have. But suffice it to say that mechanical interference, even vibration of the police car upon which the radar meter is mounted are very unlikely to get you into trouble.

It has been reported that whistling loudly into the radar antenna can cause a false reading. We could not do this, and find it hard to believe. We can only hypothesize that such a result could occur if the sound waves were so strong as to vibrate some part of the receiving apparatus, or the whistler's gold fillings.

Electrical interference is another story, however. Referring to Fig.7, circuit diagram for the receiver front end, anything that will cause a high audio frequency to appear at the "output to counter" will do you in.



The Sinclair PFM200 digital frequency meter.

The new SINCLAIR PFM200 brings digital frequency measurements within the range of affordability, for the first time! It is ideal for use with audio, video and radio systems, and all electronic and digital circuitry. It is directly comparable in performance with the very best bench-top instruments, but it's packaged in a compact case which is rugged, lightweight and ready for use anywhere.

Features:

- 20 Hz - 200 MHz guaranteed range (typically better)
- Frequency resolution down to 0.1Hz
- High sensitivity (10mV typical)
- High-accuracy crystal timebase
- Built-in attenuator
- Variable sampling rate
- Battery or plug-in operation
- Truly portable- weighs 6oz.
- One year warranty.

Also from Sinclair:
4 digital multimeters
priced \$89.95 to \$339.50



ONLY
\$149.95
BUILT, TESTED,
READY TO GO!

Write or call for your nearest distributor!

audiex ELECTRONICS 1736 Avenue Rd., Suite B,
Toronto, Ont. (416) 787-7367

Circle No. 12 on Reader Service Card.

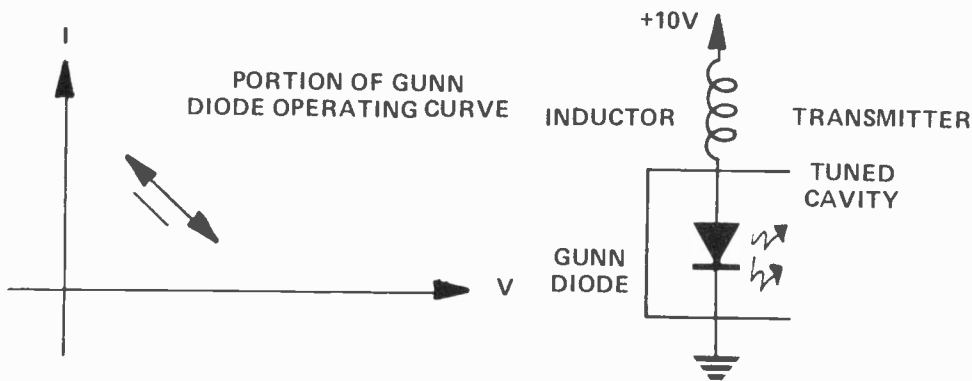

Fig. 6. The "Gunn Diode", used in most microwave transmitters of this type, is a "negative resistance" component. That is to say, over a part of its characteristics, as current increases voltage decreases, and vice versa. So all you have to do is get it into that part of the curve and it'll oscillate! But at what frequency? The diode is mounted in a "resonant cavity", tuned to the appropriate frequency. This cavity acts very much like a square bathroom with hard tiles. If you sing a certain note you hit a resonance and the sound is much stronger. Technically, in both cases this is due to the ability for the particular size of space to accommodate standing waves of sound, or electromagnetic energy at that frequency. In any case, the resonant cavity encourages oscillation at one particular frequency, and discourages others.

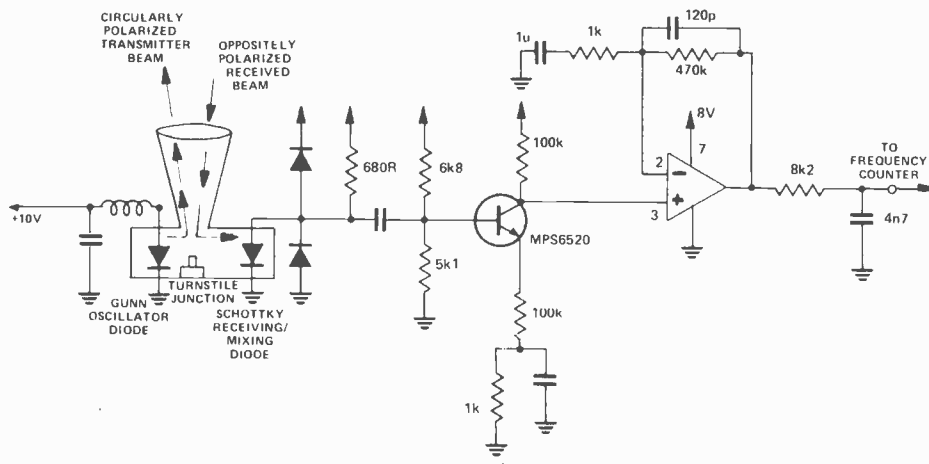

Fig. 7. The resonant cavity feeds through a "turnstile junction" to fire out through the horn. The final output is 100mW concentrated in a 16 degree cone. It is circularly polarized in one orientation, and when reflected is returned oppositely polarized. Hence it feeds down the horn and through the turnstile junction the opposite way to the receiver diode. The receiving antenna pattern is the same as the transmitter's, and the combination of patterns means that the overall pattern quoted for the instrument (angle of "half effectiveness") is 8 degrees. The remainder of the receiver "front end" is a fairly standard amplifying arrangement using transistor and op-amp. Combined in the op-amp circuitry is a filtering feedback loop, the overall effect being to roll off low and high audio frequencies.

Fig. 8. The cosine error in action. Suppose A was 10 degrees, $\cos(10) = .985$, thus the reading would be 49.2mph. Even at 30 degrees, reading would be 43.3mph.

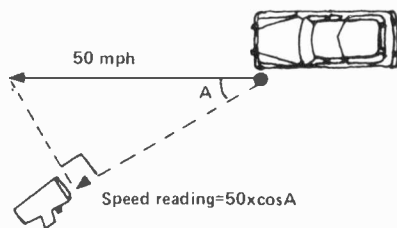
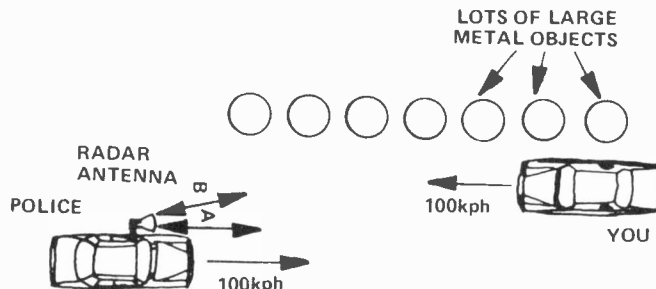

Fig. 9. Cosine error in moving radar situation.

A: Looks at you, at 0 degrees to direction of travel, reads your speed as coming toward police car at 200 kph (relative to police car!)
 B: Supposed to look at road but is distracted by metal objects at side of road, reads police car speed as $100 \text{ kph} \times \cos(8 \text{ degrees at worst}) = 99 \text{ kph}$.
 Subtracting, your speed looks like 101 kph instead of 100 kph. Oh dear.



(This is how the tuning fork works after all).

An improperly grounded or connected set with separate antenna could possibly manage to end up with noise on this line, 60Hz, or from the automobile electrical system. The Tribar set appeared very unlikely to have this problem, though this has been mentioned in connection with older sets of other makes.

Flashing neon or fluorescent lights have reportedly caused false readings on some sets. The plasma reflects the radar waves variably as it is ionized and de-ionized. The T3 we tested has no such problem, but its sensitivity appeared markedly reduced inside ETI's office under fluorescent lights.

What about nearby CB sets or other transmitters? We couldn't make our CB do it, but referring again to Fig.7, we'll explain how radar sets with insufficient RF rejection might respond.

Normally the Schottky receiving diode acts in such a way as to mix the received signals direct from transmitter and reflected from target. As such it is dealing with very small signals. However, if a very powerful AM signal was to arrive, got through the tuned cavity and landed on poor defenseless receiver diode, the high amplitude of said signal would cause the diode to rectify and detect the modulating signal. (Like crystal radio!) So, you stand near victim radar unit, switch on CB, whistle a 100 mph sine wave into the mike, and your unsuspecting neighbour is nabbed. Since 27 MHz is pretty far removed from 10.525GHz, we feel that you'll have to be pretty darn close to have much effect.

The Tribar sets are fairly well protected against this sort of thing, and at worst will simply not give a reading. Tribar's "Operational Notes--Muni Quip T3" do caution officers against using AM transmitters while taking a reading for this reason.

More on this subject later.

ANGLE ERROR

Suppose that the radar is aimed at an angle to the roadway, it will still register a speed reading when you come along, but it only sees the component of your speed in it's direction (Fig.8). As you can see, the error is in your favour.

There is one case where it's not in your favour. Suppose a moving radar is being used in the "opposite direction" mode, looking at oncoming cars. Then it's possible to have a cosine error on the patrol speed. With a typical radar beam width of 8 degrees, Fig.9, shows the worst case error, with the antenna aimed 4 degrees off straight ahead. Unfortunately for you the error against you is only 1%, unlikely to get you off the hook as an excuse.

WRONG VEHICLE ERROR

Many speed meters respond to the strongest signal received, the T3 included, as you might guess from the diagram of it's front-end. (There is also some low frequency rejection.) Assuming yours is the only vehicle in range, the reading the operator sees is for your vehicle. Generally the strongest reading is for the closest vehicle, and thus you can really only be stopped if you are the only car, or the "lead vehicle", if a number of cars are involved. However, suppose you are cruising along at 80 kph in your Austin Mini, and a transport truck is hustling along at 100 kph about 200 yards behind as you enter a speed trap. It's very likely that the meter is going to read 100, and you just might wind up with the truck's ticket. And remember, the hypothetical truck could have been a vehicle going in the *other direction*! As we said, the speed meter does not distinguish between coming or going. On the other hand, with a beam width of 8 degrees it is possible to be fairly selective of lanes.

This type of error is even more important when dealing with the radar units which are less dependant on signal amplitude, such as the MDR-1 or Kustom Signals KR11.

In otherwords, you are very much dependent on the training and experience of the operator in making sure your speed was properly measured. Unfortunately, speeding ticket cases deal only very cursorily with this aspect.

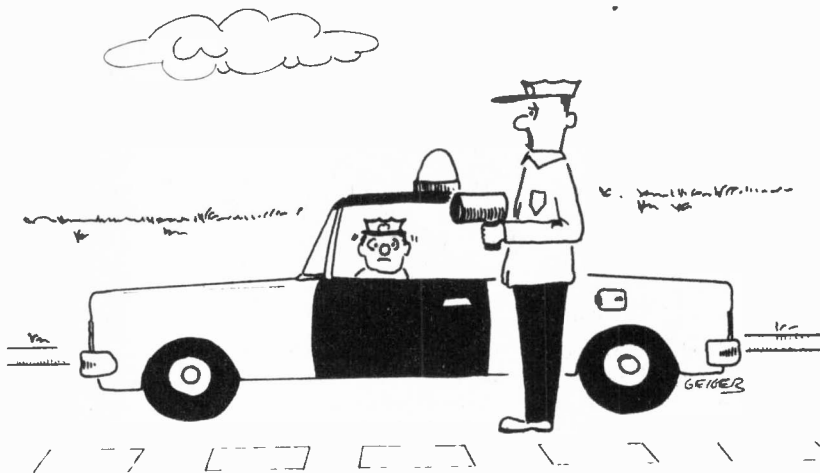

Y'KNOW, THERE MAY BE SOME TRUTH TO THE RUMOUR THAT THESE RADAR SPEED DETECTORS ARE INACCURATE; I JUST CLOCKED A '63 CHEVY AT WARP FACTOR SEVEN.

If the officer says the meter read X, and he says it was your car, and he says he calibrated his set, then this is almost always accepted. After all, how many traffic court judges, or even defendants know the above facts? How many defendants checked the radar meters calibration when they were stopped? Etc. etc.

To top this off, police officers are not required to take a course in using the speed meter. Tribar recommends

that they do, and even run such a course, complete with written material to educate the officers in proper usage. Tribar's Brimbecom says that police officers are supposed to be able to estimate speeds by eye, and Tribar's equipment is to be used to accurately verify that a suspected speeder is indeed breaking the law. In other words, it's not intended to simply be a fishing rod, dangled at the roadside awaiting a nibble.

GLADSTONE ELECTRONICS

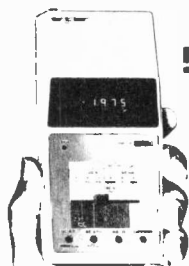

sinclair

PDM35 3 1/2 digit multimeter

\$89.50

- * 6 functions, 26 ranges
- * operates from 9V battery
- * 10 day money-back trial offer

SINCLAIR TEST EQUIPMENT IN STOCK:

DM235. 3 1/2 digit multimeter	. \$149.95
DM350. 3 1/2 digit multimeter, accuracy 0.1%, 34 ranges 239.95
DM450. 4 1/2 digit multimeter, accuracy 0.05%, 34 ranges 339.95
PFM200 digital frequency meter	. \$149.95



ILP

Audio Amplifiers
*5-year warranty.

HY50 30 watts RMS \$28.95
HY120 60 watts RMS \$57.50
HY200 120 watts RMS \$79.50
HY400 240 watts RMS (4ohms)	. \$99.50
HY5 mono preamplifier \$21.95

Just arrived! ACE AUDIO SUBWOOFER CROSSOVER KIT. 100 Hz, 18 db/octave, Model 5000K. Only \$141.00
NEW GLADSTONE STORE now open at 2936 EGLINTON AVE.E., Scarborough, Ont. Telephone 438-3999.



PHILIPS DeFOREST

Quality Loudspeakers

AD15240/W8 15" Woofer (150W)	\$74.95
AD12240/W8 12" Woofer (120W)	\$74.95
AD10240/W8 10" Woofer (120W)	\$69.95
AD0211/SQ8 (or 4) 5" dome mid	\$32.95
AD5060/SQ8 (or 8) 5" cone mid	\$21.95
AD0162/63/T4,8, or 15. dome tweeter	\$14.95
AD3WXSP. 200 watt 3 way xover	\$42.50
AD3WXA 60 watt 3-way crossover	\$17.95
AD2WXA 60 watt 2-way crossover	\$10.25

FREE CABINET PLANS



PAIA
\$117.00
GNOME

Electronic music mini-synthesizer. Gladstone's carry the complete PAIA line of synthesizers and computer products.

MAIL ORDER ADDRESS and MAIN STORE:

1736 Avenue Rd., Toronto, Ont., M5M 3Y7
Phone order line: (416)787 1448.

Use your Chargex Visa or Mastercharge. Ont. residents add 7% P.S.T. Both locations open Tues-Sat 9:30-6, till 9 Thurs and Fri.

Circle No. 11 on Reader Service Card.

OPERATOR INTERFERENCE

We now turn to the somewhat unpleasant topic of deliberate misuse to cause a false reading. While we don't like to think of our police officers as dishonest, the very fact that "quotas" of tickets are in some cases expected, might be enough to tempt those less than perfect humans on the force to some trickery. The public should at least be aware of the possibilities.

The most obvious way to create a false reading would be to take a reading

off someone who is speeding, "remember" that reading on the radar unit and then await the next car to stick with a ticket. A high reading could also be made on the T3 for example, by the patrol vehicle driving at a high speed with the T3 aimed at the ground to get the high reading.

Then there are the test buttons giving readings of 25 or 100. (that would look a bit suspicious though!) Or there's the tuning fork, (but this too would be suspicious.)

At ETI we were able to generate any reading we wanted with a simple battery powered signal generator feeding a 3 inch speaker with household aluminum foil glued to its cone. Held in front of the radar unit, the T3 cooperatively showed anything we chose to dial up.

Maybe we should vote the police a raise to make sure they stay honest.

Evading A Radar Speeding Ticket

First, why are we going to look at ways of evading speeding tickets in the first place? There are several reasons: We think there are strong arguments that lowering speed limits to save gas is a very makeshift measure, and a very heavy handed one. For example, in the interests of gas conservation one should be allowed to speed downhill, to build up speed to go up the next incline. Yet where does one find speed traps? Right. Lower speed limits mean higher transportation costs for the goods we consume. Lower speed limits do *not* encourage the design of more energy efficient vehicles.

A very interesting article appeared in the Feb. 79 issue of "Car and Driver", entitled "The Cost of Going 55" written by Charles A. Lave, chairman of the economics department, and member of the Institute of Transportation Studies at the University of California-Irvine. (The article was apparently reprinted from Newsweek) He details the almost insignificant effects of the reduced speed limits in gasoline saving, and strongly supports an incentive scheme to get people into smaller and more fuel efficient cars. He says why not reward those driving more efficient cars by allowing them to drive faster? If this sort of scheme could be practicalized, it seems to be a much more civilized way of dealing with the problem.

We also object to the absolute faith the courts appear to place in radar evidence, in spite of the fact that the radar operator is not required to have any training. We also do not like the outlawing in some provinces of radar detectors--more on this later. So we'd like "the other side" ie: us, to have some more support.

Don't get us wrong however, we are not condoning fast driving where it may be dangerous. We believe that speed limits should guide the driver as to what is a safe speed. To make the limit less than that is to reduce the driver's respect for the limit, and cause him eventually to ignore all limits. This situation occurs already on certain express-

Guess who builds this great \$39⁹⁵ Logic Probe.

You. With this easy-to-build Logic Probe Kit from CSC and just a few hours of easy assembly—thanks to our very descriptive step-by-step manual—you have a full performance logic probe. With it, the logic level in a digital circuit translates into light from the Hi or Lo LED; pulses as narrow as 300 nanoseconds are stretched into blinks of the Pulse LED, triggered from either leading edge. You'll be able to probe deeper into logic with the LPK-1, one of the smarter tools from CSC.

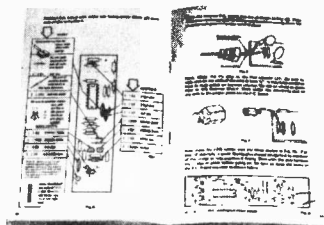

Complete, easy-to-follow instructions help make this a one-night project.

CONTINENTAL SPECIALTIES CORPORATION



len finkler ltd

25 Toro Road, Downsview
Ontario M3J 2A6 Tel (416) 630-9103
Telex O65-24010

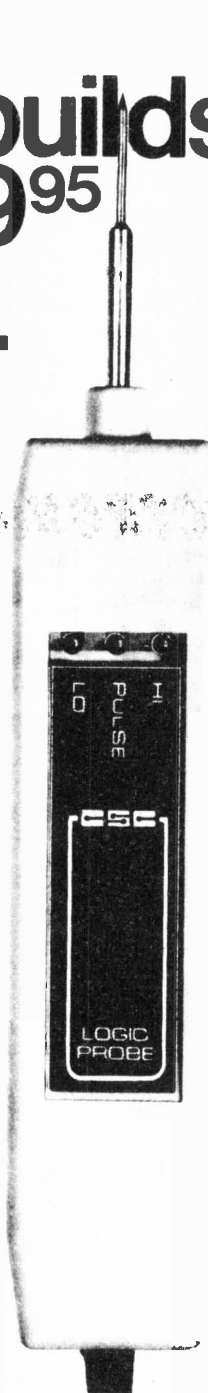

Write for free CSC catalogue and the name of your nearest distributor.

Circle No. 8 on Reader Service Card.

A-1 ELECTRONICS MAIL ORDER CATALOGUE

LEADER TEST EQUIPMENT

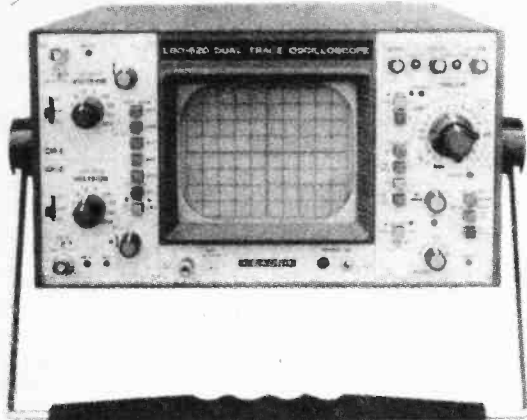

LBO 520

LSG16-RF Signal Generator	\$189.00
LAG26-Audio Generator	\$212.00
LBO520-30 MHz Dual Trace Oscilloscope	\$1555.00
LBO508A 20MHz scope	\$988.00
LBO310 4MHz scope	\$290.00
LTC906 Transistor Checker	\$260.00

OSI SUPERBOARD II COMPUTER

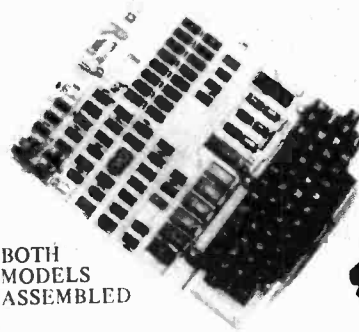

SEE
REVIEW
IN
SEPTEMBER
ETC.

BOTH
MODELS
ASSEMBLED

\$409.00!

- . 8K Microsoft BASIC - in - ROM
 - . 4K RAM on board expandable to 8K
 - . Full 53 - Key keyboard with upper/lower case and user programmability
 - . Audio cassette interface
 - . Graphics and gaming characters
- Fully assembled and tested. Requires +5V at 3 amps and a video monitor or modified TV set.

Challenger 1P also available. Includes case and power supply. READY TO GO! \$509.00

YOUR No. 1 ELECTRONICS PARTS PLACE

JANA KITS

KIT No.

1 Auto Headlight Reminder	\$ 4.49 ea	18 Shimmer Light Kit	\$ 9.95 ea
2 Battery Operated Fluorescent Light Kit	\$15.95 ea	19 Tone Generator	\$ 6.69 ea
3 "Bug Shoo"	\$ 5.49 ea	20 5 Transistor Amp Kit 1W RMS	\$13.75 ea
4 Code Oscillator	\$ 7.49 ea	21 Tube & Continuity Checker	\$ 3.89 ea
5 Crystal Radio	\$ 5.99 ea	22 Xenon Strobe	\$19.95 ea
7 Curiosity Box II	\$ 8.49 ea	23 3 Channel Color Organ	\$24.95 ea
8 Dally Lighter	\$ 6.59 ea	24 Loudmouth Siren	\$13.75 ea
9 Decision Maker	\$ 5.49 ea	25 Roulette Wheel	\$15.95 ea
10 Fish Caller	\$ 6.49 ea	26 Electronic Skeet	\$37.95 ea
11 12V Hi Power Flasher	\$ 8.49 ea	27 Electronic Dice	\$33.95 ea
12 Solid State Night Light	\$ 7.95 ea	28 Super Roulette	\$28.95 ea
13 6V Power Supply	\$13.79 ea	29 FM Mini Broadcaster	\$29.95 ea
14 9V Power Supply	\$13.79 ea	31 Electronic Shoot-out	\$13.75 ea
15 0-24V 1A Power Supply	\$29.95 ea	32 Road Runner Sound Effects Generator	\$13.75 ea
16 Single Channel Color Organ 300 Watts	\$ 8.49 ea	33 Love-O-Meter	\$18.95 ea
17 Electronic Siren	\$ 5.89 ea	34 30W Soldering Iron Kit	\$ 9.95 ea
		35 Audio Power Watt Meter	\$21.95 ea

Order before December 25th, 1979. and receive 10% off. 2 or more Kits ordered additional 5% off.

burglar alarms

ADEMCO PROFESSIONAL EQUIPMENT

No.39	Magnetic door contacts . . .	\$4.50 pair
No.383	Lead tape for windows (large roll)	\$9.80
	Take off blocks for lead tape	38¢ea.
No.612	Electronic telephone dialer. Dials police - fire, plays message . .	\$320.00
No.1000	Alarm panel controls 100s of devices	\$86.00
No.1026	Alarm panel controls 100s of devices with delay for enter and leaving Comes with rechargeable battery pack	\$149.00
	Bell 8"	\$22.50
No. 246	Outdoor remote control station	\$24.50

Circle No. 1 on Reader Service Card for more information on alarms.

BELL



No. 39

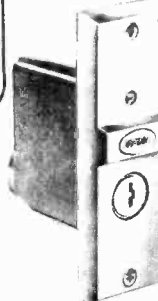



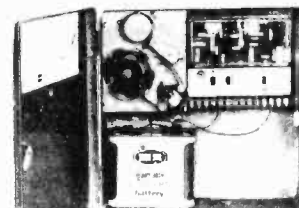

No. 246



No. 612

A-1 ELECTRONICS MAIL ORDER CATALOGUE

MINIATURE SWITCHES

 SPST 1.88 DJ4030 6A	 SPDT 2.01 DJ4031 10A	 DPDT 2.81 DJ4034 10A	 SPDT CENTRE OFF 2.31 DJ4032 10A
--	---	---	--

DPDT CENTRE OFF
DJ4033 10Amp

3.02

SURPLUS

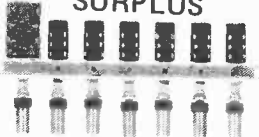

PUSHBUTTON SWITCH
5, 6 or 7 Buttons **1.85**

ELECTROLYTIC CAPS

uF	WV	PRICE	uF	WV	PRICE	uF	WV	PRICE
1.0	63	20¢	220	63	55¢	22	35	35¢
2.2	63	20¢	330	16	35¢	33	35	35¢
3.3	63	20¢	330	25	45¢	47	35	35¢
4.7	63	20¢	330	63	60¢	68	35	35¢
10	16	20¢	470	16	40¢	10	35	35¢
10	25	20¢	470	25	30¢	1.5	35	35¢
10	63	25¢	470	63	40¢	2.2	35	35¢
22	16	25¢	1090	16	30¢	3.3	35	35¢
22	25	25¢	1000	25	65¢	4.7	35	35¢
22	63	30¢	1000	63	90¢	4.7	16	35¢
33	16	25¢	2200	16	65¢	6.8	35	40¢
33	25	30¢	2200	25	90¢	6.8	16	35¢
33	63	30¢	2200	63	90¢	10	35	40¢
47	16	30¢	3300	16	90¢	10	16	45¢
47	25	30¢	3300	25	\$1.25	15	35	55¢
47	63	30¢	3300	63	\$5.30	15	16	50¢
100	16	30¢	4700	16	\$4.50	15	35	90¢
100	25	35¢	4700	25	\$1.43	22	16	55¢
100	63	45¢	4700	63	\$1.70	22	35	\$1.45
220	16	30¢	6800	63	\$6.40	33	16	65¢
220	25	35¢	10000	63	\$8.40	33	35	\$2.20
				63	\$12.50	47	16	\$1.40

COMPARE AND YOU'LL SAVE MONEY!

30 WATT STEREO AMPLIFIER

Has Bass + Treble + Volume + Balance controls. Very low distortion. 8 ohms. Comes with heatsink. Assembled Amp/preamp, 30W/channel, stereo, with schematic requires 32V, 2A power supply. . . . \$29.00
Assembled Power supply for above \$9.00

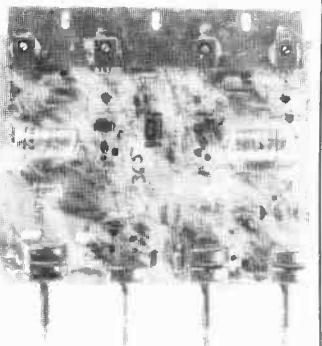

AUTOMOTIVE CLOCK MODULE

- Ideal for automotive applications
- Operates from 12 VDC supply
- Internal crystal timebase
- ± 0.5 second/day accuracy
- Complete—just add switches
- Low standby power consumption

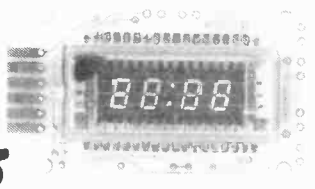

A-1 PRICE 23.95

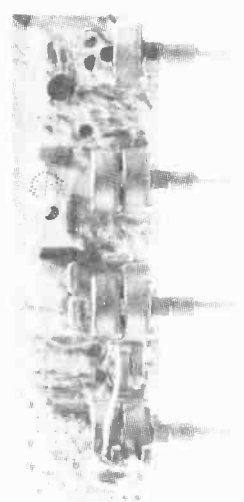

PREAMPLIFIER

Preamp with Bass, Treble Volume, and Balance controls. Very low distortion. Requires 12V DC. Will work with ILP AMPS and other amplifier modules. Assembled \$26.95
Kit \$19.95

ILP POWER MODULES

HY5 - Preamp	\$19.95
HY50 - 25 Watts	\$24.95
HY120 - 60 Watts	\$50.25
HY200 - 120 Watts	\$70.50
HY400 - 240 Watts	\$89.75

HIGH POWER, ULTRA LOW DISTORTION AMPLIFIER MODULES

SINCLAIR DMMs

PDM35	\$75.00
DM235	\$135.00

FUSIS (FAST BLOW) . 10¢
RESISTORS—1/4w 5% or 1/2w 3¢ ea.
DISC CAPACITORS . 5¢ ea.
VARIABLE ROTARY CONTROL 49¢
VARIABLE SLIDE CONTROL . . . \$2.65
TRIMPOTS 39¢
PC BOARD ETCHANT
16OZ \$2.10
32OZ \$3.95

ALL INJECTORALL PRODUCTS 10% OFF OUR REGULAR PRICES.

CERESIST (ALL PATTERNS) \$1.89

AV ELECTRONICS MAIL ORDER CATALOGUE

Popular ICs! Canadian prices!

CMOS

CD4000	.44	CD4030	.98
CD4001	.48	CD4035	1.98
CD4002	.48	CD4040	2.38
CD4006	1.95	CD4040	2.38
CD4007	.45	CD4041	2.50
CD4009	.98	CD4042	1.97
CD4010	.98	CD4043	1.84
CD4011	.46	CD4044	1.84
CD4012	.54	CD4046	3.60
CD4013	.78	CD4047	4.95
CD4014	2.78	CD4048	2.70
CD4015	2.18	CD4049	.99
CD4016	.65	CD4050	.99
CD4017	1.38	CD4051	2.37
CD4018	1.99	CD4053	2.42
CD4019	.98	CD4060	3.02
CD4020	2.33	CD4066	1.60
CD4021	2.80	CD4068	.83
CD4022	2.34	CD4069	.92
CD4023	.46	CD4070	1.10
CD4024	1.60	CD4071	.46
CD4025	.46	CD4072	1.00
CD4026	2.54	CD4076	2.90
CD4027	1.41	CD4081	.46
CD4028	1.87	CD4082	.46
CD4029	2.38	CD4093	2.05



ALL IC's
100%
PRIME

TTL IC'S

SN7400	.32	SN7476	.70
SN7401	.39	SN7485	1.58
SN7402	.38	SN7486	.70
SN7403	.39	SN7490	.92
SN7404	.38	SN7490	.93
SN7405	.40	SN7491	.88
SN7406	.59	SN7492	.86
SN7407	.40	SN7493	.86
SN7409	.40	SN74100	1.78
SN7410	.39	SN74121	.70
SN7411	.50	SN74122	.78
SN7412	.50	SN74123	1.04
SN7413	.82	SN74125	1.03
SN7414	1.39	SN74141	1.58
SN7420	.41	SN74145	1.58
SN7423	.50	SN74150	1.78
SN7425	.59	SN74151	1.18
SN7426	.59	SN74154	2.06
SN7427	.50	SN74155	1.60
SN7430	.40	SN74150	1.48
SN7442	.99	SN74164	1.48
SN7445	1.51	SN74177	1.78
SN7446	1.40	SN74190	2.50
SN7447	1.18	SN74191	2.50
SN7448	1.49	SN74192	1.60
SN7460	.40	SN74193	1.40
SN7472	.59	SN74366	1.39
SN7473	.70	SN74367	1.39
SN7474	.70	SN74368	1.39
SN7475	.98	SN74390	3.90
		SN74393	3.90

BEST PRICES IN CANADA!

LS PARTS

74LS00 TTL

74LS00	.49	74LS74	.90
74LS01	.51	74LS75	1.20
74LS02	.51	74LS76	.93
74LS03	.51	74LS85	2.50
74LS04	.70	74LS86	.97
74LS05	.70	74LS90	1.18
74LS08	.49	74LS92	1.51
74LS11	1.50	74LS93	1.51
74LS13	1.20	74LS96	2.30
74LS14	2.50	74LS123	2.50
74LS20	.48	74LS190	2.30
74LS26	.70	74LS191	2.30
74LS27	.70	74LS192	2.30
74LS28	.70	74LS193	2.30
74LS30	.62	74LS367	2.50
74LS73	.90	74LS368	2.50

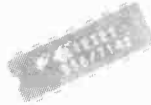

ALL IC's
100%
PRIME

LINEAR

LM301	.70
LM308	2.00
LM309	2.20
LM311	1.80
LM324	3.60
LM339	1.98
LM555	.69
LM556	1.70
LM723	1.10
LM741	.73
LM567	1.98
LM3900	.98
LM1458	1.18

ZENER DIODES

All voltages . . . 34¢ ea.
C106 B SCR . . . 79¢
TRIAC 12 amp, 200V
TIC 236 B . . . \$2.40

BRIDGES:

1.5 Amp 200 V . . . 59¢
6.0 amp 200V . . . \$1.65
25.0 amp 200 V . . . \$3.25

JUMBO LEDS

RED . . . 24¢
GREEN . . . 32¢
YELLOW . . . 32¢

DIODES

1N4001	7¢
1N4002	8¢
1N4003	9¢
1N4004	10¢
1N4005	11¢
1N4006	12¢
1N4007	14¢
1N914	6¢

We reserve the right to limit quantities on these items.

A-1 ELECTRONICS MAIL ORDER CATALOGUE

SURPLUS

Regulated Computer Power Supply (with schematic) (+12V, -12V, +5V)	\$55.00
Complete Video Terminal with keyboard (ASCII display). With manual	\$295.00
6.3 Volt Sec. 2 Amp Transformer	\$1.95
240V, 2A Sec	\$6.00
12V 1/2 Amp sec.	\$1.95
2 wire power cords with plug attached (approx. 8')	29¢
3 wire power cords with plug attached (approx. 6')	\$1.50
Magnet wire (22 to 40 gauge)	1¢ per ft.
Hookup wire (20 gauge solid; white only)	1¢ per ft.
Heat shrinkable tubing 3/32 diameter (red or black)	10¢ per ft.
Really loud 9V horns (from smoke alarms)	\$1.50
0 to 30 minute mechanical timers (120VAC motor)	\$5.00
Resistance photo cell	\$1.00
TV Tuner	\$4.95
3 or 4 or 6 Position Rotary Switch	\$0.50
Video Monitor (with schematic)	\$75.00

CLOCK:
120 VAC; motor driven; digital/mechanical;
built-in light; includes microswitch to control 120V
appliance; plus sleep switch \$9.00

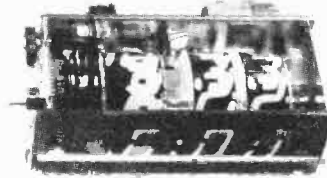

ORDERING INFORMATION

All orders shipped within 24 hours (we'll ship via CANPAR where possible so we can serve you quickly & avoid the Christmas Post Office crush).
Write out your order Ont. residents add 7% to total. Please add 5% for shipping (shipping is free for orders over \$75.00). Any excess refunded. We accept Chargex (Visa) & Master Charge. Please send us your card number and expiry date (with your signature).
If you want to send us a cheque, you must certify it. Otherwise we have to wait two weeks for it to clear the bank.
All prices subject to change without notice.
A-1 ELECTRONICS, 5062 DUNDAS ST. WEST, ISLINGTON, ONTARIO, M9A 1B9 (416) 231-4331

WE MAKE YOUR DOLLAR GO FURTHER!

A-1 KITS

3 CHANNEL COLOUR ORGAN	
500 WATT	\$13.95
1500 WATT	\$25.95
MAKE IT COMPLETE!	
BUY IT WITH A CASE	\$3.50 extra
VIDEO RF MODULATOR	\$7.95
LED WATTMETER	\$21.50

MAXELL TAPES



UD - XL I C-60	\$5.00
UD - XL I C-90	\$6.40
UD - XL II C-60	\$5.00
UD - XL II C-90	\$6.40
UD C-46	\$3.60
UD C-60	\$4.30
UD C-90	\$4.95
UD C-120	\$6.40

SPEAKERS

Pioneer - Mid range	\$14.95
Tweeter	\$10.95
Crossover 75W RMS	\$14.95

LASER AUDIO

12" 60W RMS Air suspension	\$39.95
10" 60W RMS Bass	\$24.50
15" 100W RMS Air suspension	\$39.95
18" 300W RMS Bass	\$199.95

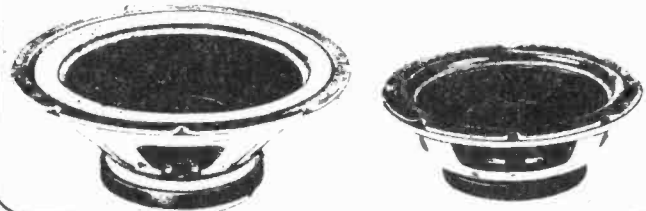

OTHER THINGS WE SELL

SAM'S Books - 10% off suggested retail.
Circle No. 4 on Reader Service Card for catalogue.
Receiving Tubes - many different types.
Circle No. 2 on Reader Service Card for list.
AM-FM - Stereo cassette car radio \$99.00
Jerrold Cable TV converter (30 channel) . . . \$89.00
IC Bimboard Breadboard 5 7/8" x 2" . . . \$14.95
FULL ASCII Professional Quality Keyboard
53 keys encoded (NOT surplus) Kit only \$85.00
Case . . . \$19.95
Shure Magnetic Cartridge with needle (M70 B)
SALE price \$14.95
Ungar, Hammond, etc.

ways in Toronto, and no doubt in your town as well.

OK, so let's get down to how the speed meter can be evaded.

VARIOUS METHODS

There are various classes of evasion, which can be summarized as: Radar detectors; Make your car invisible; Passive methods of radar interference; Active methods of interference. Some of these are more or less illegal, and as we shall see, under Ontario's legislation all are illegal.

RADAR DETECTORS

Basically radar band receivers with a buzzer and light attached, these devices have been bought by the millions of drivers sufficiently interested in slowing down for radar traps. The "Fuzzbuster" (this is actually a brand name) is widely disliked by police forces for this reason, although certain forces reportedly consider them an asset, feeling they tend to make drivers go slower. Some areas have gone to the extreme of placing decoy radar transmitters along highways to set off motorists detectors, causing them to either slow down, or ignore their detectors.

Anyhow, detectors are considered by many motorists as great highway buddies, but if you're in the market for one, be aware that there are big variations in their effectiveness.

The most complete review of radar detectors we have seen was done by Car and Driver, again in their February 79 issue. They appear to have thoroughly tested, on both X and K band, all the detectors they could find. The report makes interesting reading. All we can add is why one design is better than others.

TO HET OR NOT TO HET

The major difference exists between so called "passive" detectors, and those employing superheterodyne circuitry. These two types are outlined in Figs. 10. and 11.

The other differences between detectors are principally in the sensitivity of the horn-receiving diode combination, and the ability of the signal processing circuitry to distinguishing between a radar signal and false alarms. Effectiveness of the warning light or buzzer, in other words, ease of use also enter the picture.

It appears that ultimately most radar detectors will be of the superhet variety, as it makes the difference between a detector that tells you in enough time to slow down, and one which tells you you're about to get caught.

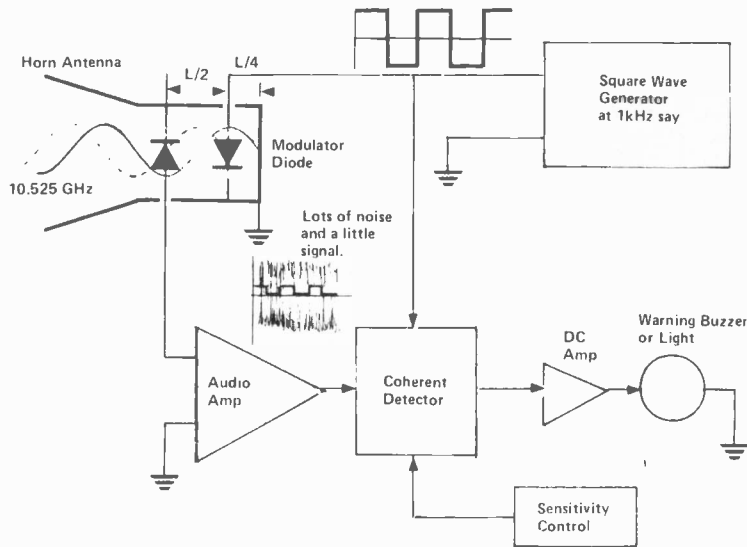

Fig. 10. "Passive" Radar Detector. In this design, a modulator diode is used to create a "false back" in the resonant cavity. When radar waves enter the antenna, standing waves occur in the cavity. If the modulator diode is switched off, the receiving diode is at a maximum. If the modulator diode is switched on, the receiving diode is at a minimum. The remainder of the circuitry detects this change in signal level occurring at the square wave generator frequency, which is only present if radar signals are picked up.

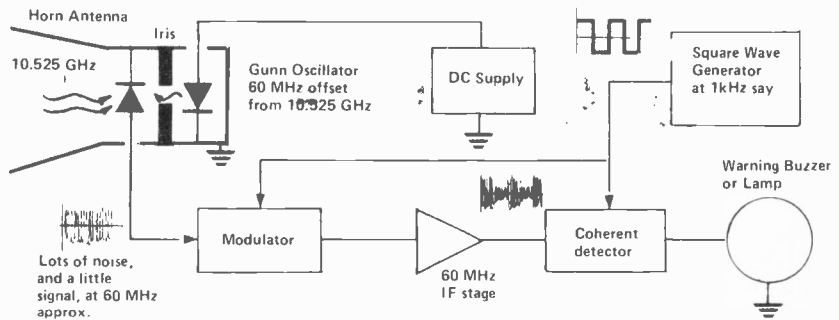

Fig. 11. "Superheterodyne" Radar Detector. This is as the name implies simply a version of the trusty old superhet principle. The Gunn diode provides a "local oscillator" signal which is mixed with the received signal at the receiver/mixing diode. This mixing, or multiplying, results in a much easier-to-handle signal at 60MHz. The rest of the circuitry detects whether there is any signal present at this 60 MHz intermediate frequency.

In both this and the "passive" detector arrangement, K band detection can be added with a second horn, cavity and diode(s) assembly.

OH YEAH?!!! WELL, LET'S SEE YOU CATCH ME SPEEDING ONCE I'VE INSTALLED THIS ANTI ANTI RADAR DETECTOR DETECTOR...



WHO'S WINNING

There are apparently new radar meters coming up whose beams are pulsed, and of course we already have those units which can be switched on instantly with trigger or pushbutton. Both are claimed to completely foil radar detectors, which of course they do if consistently used in these ways. Then there are the dummy radar transmitters. It appears that the deck is stacked on the side of the police's equipment.

Yet many people are using radar detectors, even in Ontario where they are illegal. We were quite amused to be able to slow down groups of cars by firing our borrowed T3 at them from a concealed location!

THE INVISIBLE CAR

For the radar to operate it is of course necessary for your car to reflect some of the radar beam, back towards the radar unit. So you could travel around in an all-plastic car, or one very low to the ground. Or you could try attaching metal surfaces to your vehicle at a very acute angle to the direction of travel, thereby deflecting the radar waves largely away from the radar unit. This approach definitely reduces your reflectivity somewhat, but how much we don't know. It *does* make your car more streamlined so you'll probably save gas though!

On the other hand, it is possible to obtain radar absorbing material, it's used by the airforce, and also by research establishments in making microwave "dark rooms". (Like an anechoic chamber, but for microwaves.) It looks like foam rubber, and it is impregnated with a conductive substance such as carbon particles. The impregnation varies from sparse to dense from the front to the back of the material, matching it electrically to the air. It's available in sheets and you can stick it all over the front of your car. Trouble is you can't stick it over the windshield, headlights, wheels etc, and it's murder in the car wash. But it does cut down your radar visibility. A good job might reduce your readable range to say half or quarter the distance.

You can also reduce the reflectivity by creating a surface such as that in Fig. 12. Sets of equal area reflective surfaces are placed so that one set is a half wavelength behind the other. Waves reflected from each of these will cancel. This is quite a practical idea, except you need one set of spacings for X Band (14.2 mm) and another for K Band (6.2 mm), however this may be arranged, with more levels of surface.

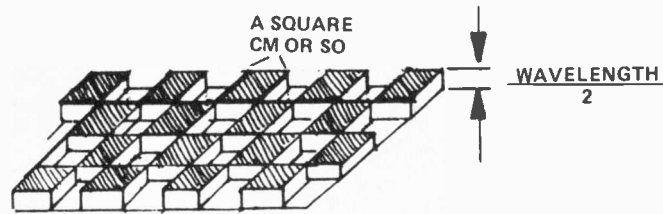
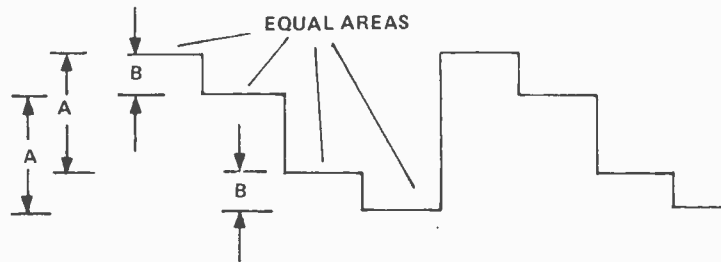

Fig. 12. Wave cancelling surface for one frequency (above). For multi-frequency operation arrange one pair of planes for each. (Lower) A is Wavelength "a" / 2, and B is Wavelength "b" / 2.



OK so you're cruising down the highway in your Alfa ZK 3000, loaded to the hilt with carbon sponge and radar absorbing surfaces, doing 120 kph, and behind you there's a Ford LTD at 140 kph. The radar can't see you, but the police sure can, and they'll assume the reading they're getting is from you, unless they take a real close look, and are also radar experts. You see the problem.

PASSIVE INTERFERENCE

A radar beam is heading for your car. Quick, how are you going to interfere with the reflection so as to give either no reading, or a ludicrously high reading on the meter?

The giant fan fixed on the roof is quickly ruled out. How about a surface of variable reflectance? This could be achieved in a couple of ways: mount hundreds of tiny dipoles, of length suitable for radar frequency, and alternately switch the centre load in and out, at a rate corresponding to say 100 kph. (This will add to your real speed). They just won't believe your 63 Valiant could be doing 197! Trouble is, you need two sets of dipoles, for X and K bands, and you're dealing with microwaves, so ordinary resistors, transistors and diodes just won't work. But it's a possibility.

The other reflecting method is by a plasma screen, alternately ionized and de-ionized at sufficient high rate. Whole bunches of neon or fluorescent tubes

might do the trick, but we unfortunately could not try this since we couldn't find a 2kHz power supply for them.

What about turning your car into a giant tuning fork? This looked like a possible, so we tried it. Twenty ten inch speakers were obtained and mounted in a 4' by 5' frame; suitable for mounting on the front of a VW van. (VW van was chosen since 40% of the ETI fleet are these, and they represent 100% of those vehicles capable of exceeding the speed limit).

Next special styrofoam blocks were cut and glued to the speakers to turn the vibrating cones into vibrating flat surfaces. Finally, aluminum foil was glued to the front of the styrofoam.

This monster was tested on the ground, and we were able to get a "dial-your-own-speed" range of about 300 feet with a 50 watt amplifier driving it. (Fig.13) We decided that this was not sufficiently encouraging to go on with the "mobile" tests.

The major drawback with reflection modulators is that there will still be a large true speed component -- see Fig. 14. It is theoretically possible with a vibrating surface (analogous to FM) to completely eliminate the true speed component. However, this requires a relatively large surface deflection, not practical with loudspeakers, and very, very loud! Conclusion: reflection modulators are impractical. One thing is for sure though: with several hundred dollars worth of speakers on the front of their car, who's going to speed?

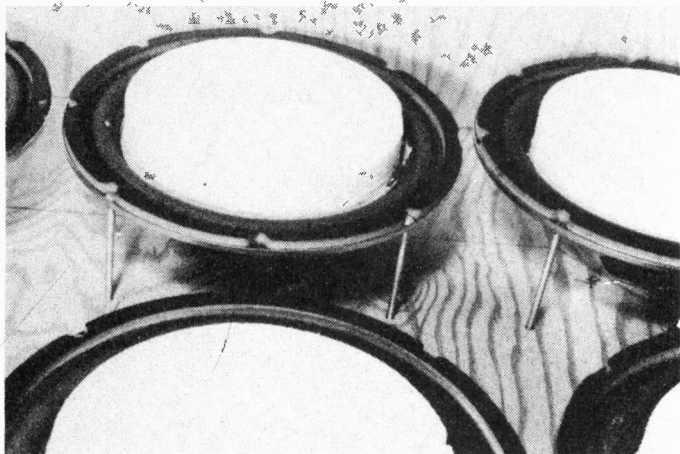

Close-up view of individual speaker mounting.

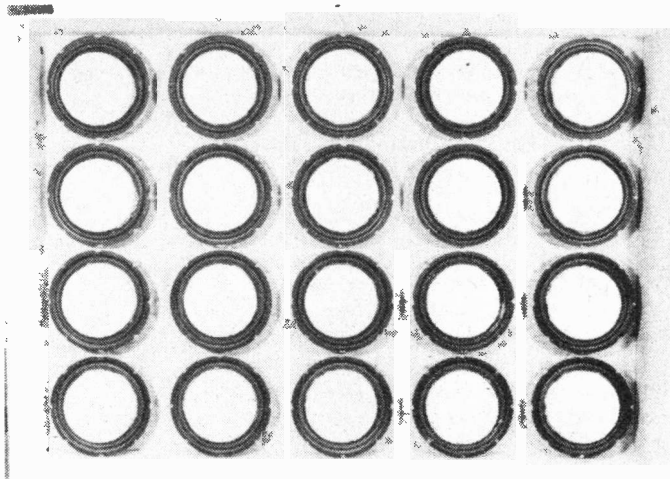

How it looked with all the speakers in place.



Speakers with styrofoam "cone-to-flat" adapters. Aluminum foil covers the front.

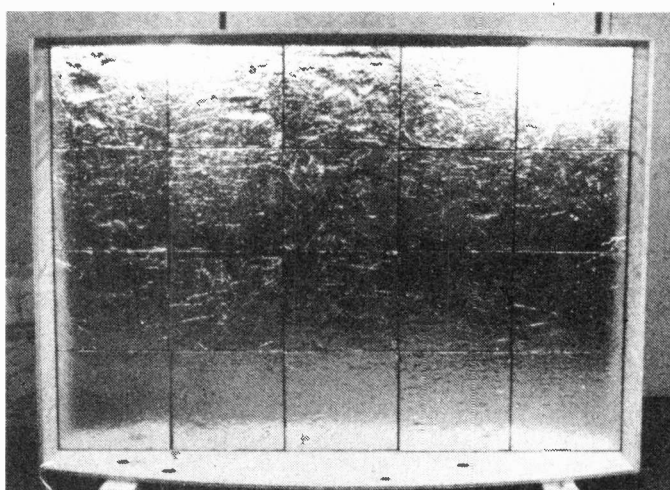

The final product. Specs: 50 kph at 1.73 kHz, 50 WRMS and 500ft.

Fig. 13. ETI speaker project? Wally wouldn't have approved. Twenty hefty ten inch speakers were bolted to a plywood frame, destined ultimately (we hoped) for the front of a VW van. It was a great idea while it lasted, unfortunately static results were not sufficiently encouraging to go all the way. We never did figure out how to hold the back wheels down . . .

ACTIVE INTERFERENCE

We are of course talking about transmitters. These are of course relatively illegal. They have of course been built. We have heard such a unit is "commercially" available, but haven't seen it, though the principle is pretty straightforward.

The first thought would be to make an unmodulated transmitter which operates at an offset from 10.525 GHz representing whatever speed you like. This notion can quickly be discarded since we are talking about an offset of only a kHz or so, that is 0.000001GHz. Needless to say the radar unit is not going to be that dead on 10.525!

We've already seen how a CB radio could cause an erroneous reading. But it has to be very close since the signal is greatly attenuated going through the horn and resonant cavity system. So what about a transmitter operating at approximately 10.525 GHz, modulated by the speed signal of your choice. (See Fig.15) Being powerful it marches right into the radar receiver front end where the receiver diode demodulates the nice tone and out sprouts your legal speed reading. For added sophistication, couple your speedometer to the modulating signal generator to subtract a constant 20 or 30 mph from your actual speed. Be sure to turn off when parked. You'll also need one for X and one for K band.

Fig. 14. The problem with most reflection modulating schemes is that there will still be a dominant component from the actual speed.

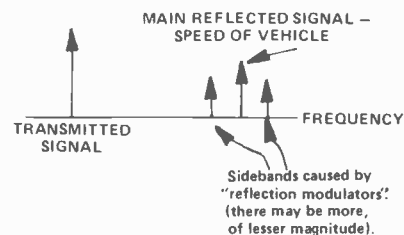

Fig. 15. 55 MPH FOR EVERYONE! This diagram shows the relevant parts of a microwave transmitter, pulse modulated at whatever frequency you like, up to several tens of kHz.

Adjusting VR1 so that the pulse frequency is 1.73 kHz, and an X band speed radar in the vicinity will read 55 mph. Or set it as you desire. You could even link it up to your speedometer to subtract 20 mph from your speed, or ??? Carrier frequency is not critical, for this purpose the radar meter receiver front end tuning, the cavity, is quite broadband.

Sophisticated moving radar speed meters however can be set to ignore legal speeds, and look only for illegal ones. We figure that if it picked up this signal it could ignore it, but the front end would be so overwhelmed that detection of other signals (your real speed) would be fairly unlikely.

The MA parts are made by Microwave Associates, available in Canada from M A Electronics Canada Ltd., 3135 Universal Drive Mississauga Ontario L4X 2E7.

This transmitter is of course illegal as a transmitter, which is why we've deliberately left off some of the component values. If you fill them in you have only yourself to blame for getting in trouble with the DOC.

If you'd rather have a commercial version

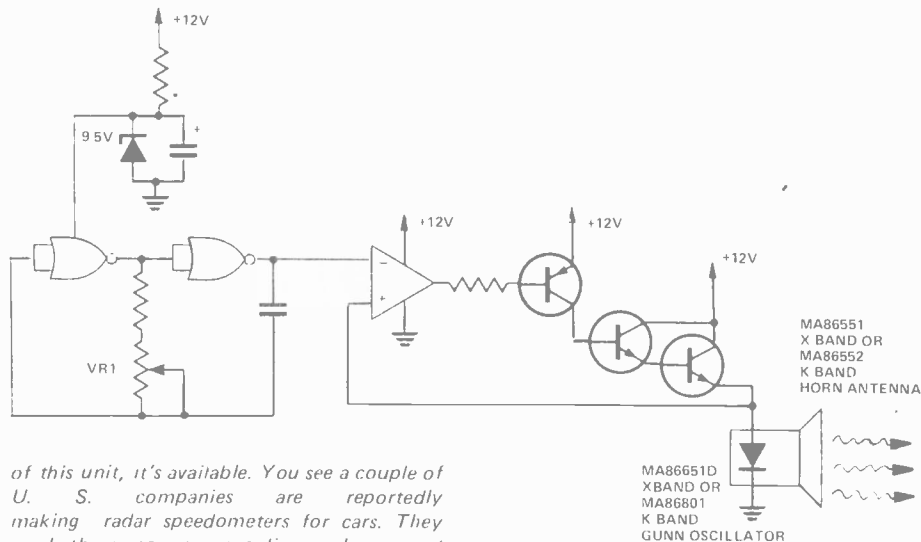

of this unit, it's available. You see a couple of U. S. companies are reportedly making radar speedometers for cars. They work the same way as police radar, except they look at the road, and the readout gives you your speed. There's a test button, which pulses the transmitter beam, so that the returning beam is modulated, and (when you're stationary) gives a readout that should be the one preset by the factory, thus verifying the operation of the system. And gee whiz, if one of those test speeds isn't 55 mph!

The do-it-yourself approach may be more attractive in the long run however, since you can select the transmitter power specs to suit your requirements.

NOTE: IF YOU ARE GOING TO PLAY WITH MICROWAVES, PLEASE BE AWARE OF THE CAUTIONS MENTIONED UNDER "MICROWAVE RADAR: IS IT SAFE?"

The Last Word: Rimmer's "Retaliator"

We asked Steve Rimmer what he thought, and he said...

RADAR DETECTORS are, by and large, a passive, spineless sort of defense against the onslaught of the law. Radar "confusers" are better, but what is really called for here is a weapon of at least as much cunning as traffic radar itself. Outlined here is the REU, or Radar Evaporation Unit.

The REU is comprised of two units, these being the detector unit and the retaliatory unit. The detector is of the standard type, with which we are all familiar. The retaliatory system is really what makes the concept unique.

The system is built around the 2D21 klystron. While basically a low power tube, it can produce outputs of up to 55 KW at very short pulse durations with slow repetition rates. If directed in a relatively narrow beam, this power level is quite sufficient to completely evaporate any of the commonly used microwave detectors, as found in police radar sets, not to mention peeling the paint off the police car and melting its tires. God help anyone or anything that gets between the cops and your car when the thing lets loose.

The REU system is usually trunk mounted. It begins with a capacitor bank, which is used to provide the high energy pulses that power the klystron. The exact number of capacitors used

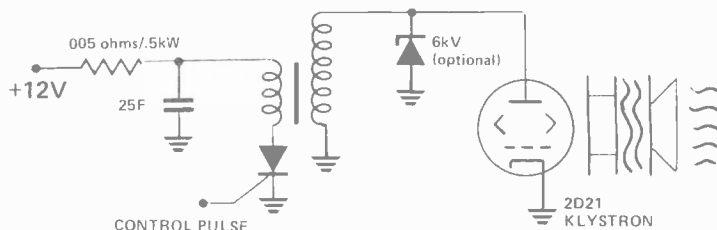

will be determined largely by available space. About twenty five farads is the nominal value. These of course, are charged by the automobile's electrical system. A resistor may have to be inserted in the supply line to keep the charging current down below thirty amps so that the headlights don't dim out every time the thing fires a blast. Usually this is made by wrapping thirty feet of number three insulated bridge cable around a baseball bat.

When the capacitors are fully charged, they are discharged through the primary coil of a toroidal transformer by a standard 2Kilo-amp, 15 volt SCR. The transformer, however, requires considerable attention. The core is formed by packing approximately seventy five pounds of powdered ferrite and epoxy into an old tire and letting it harden. The ferrite powder can either be obtained from a neighbourhood powdered ferrite dealer, or by smashing up the cores from about 150,000 AM loopstick antenna coils. When hard, the core may be left in the tire, which acts to insulate

the transformer against core shorts. If a steel belted radial tire is used, the belts may increase permeability slightly.

The primary of the transformer consists of three turns of four inch cold rolled steel bar around the core. The secondary is about ten thousand turns of insulated number three bridge cable. One side of the secondary is, of course, grounded, and the other is run directly to the klystron oscillator. For added stability, a forty amp, 6000 volt zener diode may be used to regulate the supply.

The microwave energy from the tube is brought to a roof mounted horn antenna by waveguide hardware. The antenna should be aimed toward the right hand side of the car, about fifty yards distant.

As a final point, it should be noted that motorists finding themselves stranded can cook with this little jewel. Just suspend your burgers, franks, or family pet in front of the horn and depress the "fire" button.

Tribar: Canadian Company Sells To The Orient

This is always a badge of success. Let's start from the beginning.

Once upon a time (since the fifties) there was a U.S. manufacturer of police radar, by the name of Muni Quip. They were hot on the trail of perfecting the first digital-readout unit (all solid state!) when financial problems folded the company.

Tribar's president George Payne was handling distribution of Muni Quip products in Canada, and recognized a good idea when he saw it. So in 1968 he took the idea and prototype to a friend of his by the name of Fritz Engler. Engler was to feature in Tribar's success, first working in his spare time to work the bugs out of Muni Quips unit, then to join Tribar as Chief Engineer.

Tribar kept the Muni Quip name, and through the years developed a number of different models. Most recently "moving radar" proved to be an enticing challenge.

The story goes that Engler went on a two week "family fishing trip" with an RCA 1802 COSMAC kit (fish 'n' chips?) to learn about microprocessors. Tack this onto an active programmable filter system (lots of op amps and analog switches), distil many thousand lines of program down to a 1K ROM, and there (eventually) he had it.

THE MDR-1 TOUGH PROBLEMS

Ross Brimbecom told us that one of their toughest problems has not been necessarily the electronics, but how to enable the electronics to survive the tough treatment it tends to get. The ultra-heavy duty case on the T3 certainly looks and feels like it would be difficult to damage, and the MDR-1 has a dense foam covering (similar to that used for car dash boards) unlike cheaper models of other manufacturers, Brimbecom warns.

We figure the other problem they had was getting the electronics into the boxes. Both T3 and MDR-1 were packaging delights.

A near future project is the transition to K-Band operation, where decreased size of antenna and associated hardware, means smaller overall bulk, and more convenience.

SALES AND EXPORTS

Tribar sells over 500 radar units per year, 60 to 70% of these go overseas to Europe, Africa and Asia.

The remainder are sold in Canada. What, none to the US? Brimbecom estimated a market of 2-3000 units per year to the US, yet few Tribar sets are sold there. This he says is because Tribar sets cost more than sets made in the US, although Brimbecom claims higher quality, reliability, and more features than comparable US made units. It's the problem of dealing with essentially uneducated buyers who can't tell, or don't care, that Tribar's may be better.

And, as we mentioned, while we chatted with Ross Brimbecom, he was directing (with his other ear and hand) the production of a large order of units for shipment to Taiwan. Nice going!

BUY OR RENT?

Interested in buying a set? You can get a T3 for about \$1400, or how about an MDR-1 at \$3000. At last, something your friends don't have! (You'll have to convince the DOC that you need a licence however.) A 2 year warranty is included, except for only 1 year on the Gunn diode, and 90 days on the receiving diode.

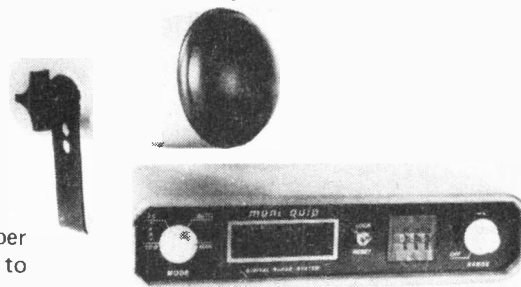

If you wish you (yes, anyone!) can rent a set for as little as \$75 per week, or \$150 per month, but be sure to book in advance. Contact Tribar Industries, 3650 Weston Road, Weston, Ontario M9L 1W2. (416) 749-6000.

WHO USES THEM?

Not only the police are interested in the speeds of things. Brimbecom reports that Tribar's units have been used for many purposes. These range from precisely measuring speeds of crop-dusting aircraft for correct spray adjustment, to the measurement of hockey puck speeds for the between-periods show on one of the network NHL series.

Radar systems have also been used in railway and ship speed measuring applications, and even for traffic light control.

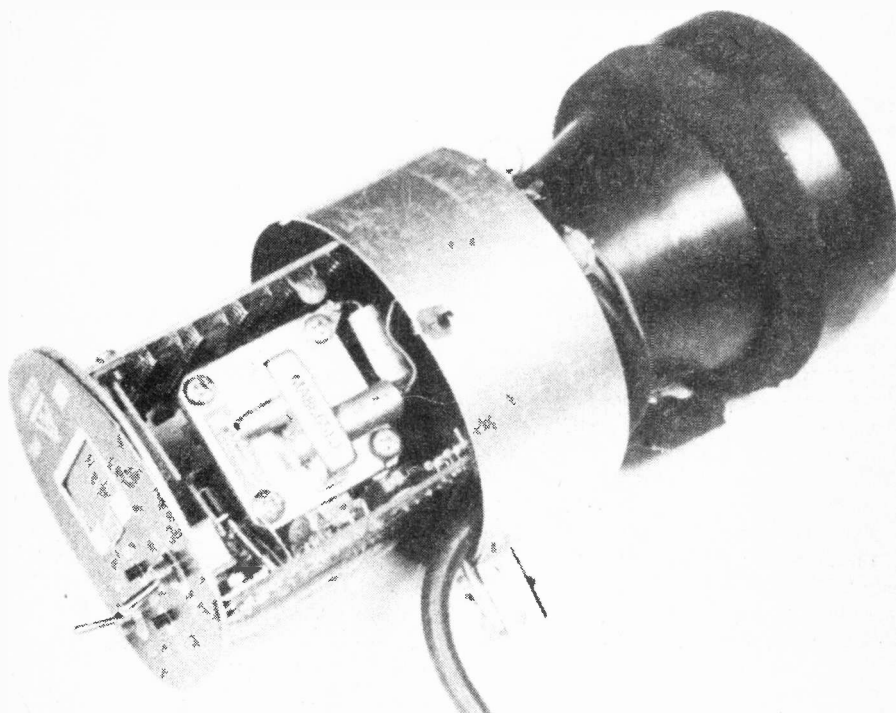

Inside the T3: a packaging dream (nightmare?)

An Act To Amend The Highway Traffic Act

BILL 112

1977

HER MAJESTY, by and with the advice and consent of the Legislative Assembly of the Province of Ontario, enacts as follows:

1. *The Highway Traffic Act*, being chapter 202 of the Revised Statutes of Ontario, 1970, is amended by adding thereto the following section:

52a.—(1) In this section, "radar warning device" means any device or equipment designed or intended for use in a motor vehicle to warn the driver of the presence of radar speed measuring equipment in the vicinity and includes any device or equipment designed or intended for use in a motor vehicle to interfere with the transmissions of radar speed measuring equipment.

(2) No person shall drive on a highway a motor vehicle that is equipped with or that carries or contains a radar warning device.

(3) A police officer may at any time, without a warrant, stop, enter and search a motor vehicle that he has reasonable grounds to believe is equipped with or carries or contains a radar warning device contrary to subsection 2 and may seize and take away any radar warning device found in or upon the motor vehicle.

(4) Where a person is convicted of an offence under this section, any device seized under subsection 3 by means of which the offence was committed is forfeited to the Crown.

(5) Every person who contravenes subsection 2 is guilty of an offence and on summary conviction is liable to a fine of not less than \$50 and not more than \$500.

(6) Subsection 2 does not apply to a person who is transporting radar warning devices in sealed packages in a motor vehicle from a manufacturer to a consignee.

4. We have already stated that radar operators are not required to take a training course, and hence the readings of these easy-to-use meters can be misinterpreted. Given that this state of affairs exists, we would like the opportunity of avoiding radar traps altogether.

5. The act is rather badly written with respect to technical points, and subject to large amounts of interpretation. For example, a device which would "interfere with the transmissions of radar . . ." is hardly a "radar warning device", yet it is sneaked in here.

And could one claim that one intended to use one's eyes to warn the driver about a radar trap, and consequently have them confiscated?

You probably didn't know that there is a precedent (albeit American) which establishes that it is illegal to warn oncoming motorists of a radar trap by flashing your lights.

And how is a police officer to know what is, or is not a "radar warning device"? Ham equipment can look quite similar. (A police officer is not for example expected to know if your vehicle is roadworthy, if he suspects not he sends you for a proper inspection by experts.)

This was clearly a difficult piece of legislation to implement. The government is not trying to stop people from speeding, it's trying to stop them from *not* speeding in radar traps. It's not even an attempt to stop a person from escaping justice for something illegal they were observed doing. It's an attempt to have the culprit continue breaking the law while the police are around, if that was what he was doing before.

May we draw the following analogy: Suppose a burglar intends to rob ten houses. It is found that such a burglar will stop robbing and run away when he hears police cars arriving. So the solution is to confiscate the ears from every citizen?

But ears are obviously of much greater value than radar detectors you argue? In this case we are using ears to represent the right to hear, and radar detectors to represent the right to "hear" radio waves. ie: to receive. Whether or not you agree with the use of radar detectors, the real issue is much larger than just this one piece of equipment. It smacks of the government having just a little too much say in our lives.

See also Bill Johnson's comments in QRM this month: the Ham's point-of-view.

WELL! Is that what Her Majesty thinks! Obviously not, but those acting in her name in several provinces do, and we find it very distasteful. There are a number of reasons why.

1. There is something basically sacred-feeling about the "right to receive", and a receiver is what a radar detector is. It's as basic somehow as freedom of speech. There are no other instances in North America of prohibition on radio reception. The U. S. F.C.C. agrees with this, and forced several states to drop their anti-radar-detector legislation, this being under Federal jurisdiction.

2. In Canada such a matter also comes under the jurisdiction of the Federal government we feel, (Department of Communications) and not the provincial government. This matter has been contested several times before, and this same conclusion reached. In the partic-

ular case of the Ontario Highway Traffic Act legislation, Lyntronics (Canadian distributors of the "Fuzzbuster") is funding the fight to again establish this point. In mid-September an appeal was heard from Lyntronics in the Divisional Court of the Supreme Court of Ontario. Lyntronics lost, because the judges felt that the use of a radar detector constituted a hazard analogous to having a TV set in the front seat of the car, also prohibited by the OHTA. No studies were quoted on the hazards caused by radar detectors. No attention was paid to the fact that the audio sense allows multiple inputs, while the video sense allows just one. ie: we don't feel convinced.

3. We feel people should have the opportunity of avoiding radiation if they choose, whether deemed hazardous by the authorities or not.

Microwave Radar: Is It Safe?

No doubt you've heard the controversy over leakage from microwave ovens. So what about that radiation from the radar antenna, which after all is *designed* as a transmitter.

While we would be most amused to see the chaos caused if we announced that police officers were slowly being cooked by their speed meters, let's not get so alarmed yet.

First let's get one thing straight. **MICROWAVE RADIATION HAS VERY LITTLE TO DO WITH NUCLEAR RADIATION!** Electromagnetic radiation is divided into two classifications; "Ionizing radiation: that which can ionize molecules, and thus for example change the structure of human skin molecules; "Non-ionizing radiation": that which cannot change molecular structure. The Three-Mile Island scare was about the former, microwave radiation belongs to the latter class.

EFFECTS

Microwave radiation is well known for its heating ability. To get an idea of power levels involved in such heating, a typical diathermy treatment might expose the body to a power density of 100 to 500 mW/cm², applied for 10 to 20 minutes. A microwave oven concentrates 600 W on a piece of steak, for times in the minutes for cooking.

DAMAGE

Damage which may result to the body from excessive exposure is in the form of burns to the cells of the skin, eye or whatever, either on the surface, or below it. Some damage, such as eye cataracts may be irreversible. According to the International Microwave Power Institute "Microwave Safety: Hazards in Perspective" (IS-2 Dec 75) it is thought at least 100mW/cm² applied for many minutes is required to produce such damage. Levels around 10mW/cm² may be felt but are not hazardous.

Also according to the IMPI report, certain Eastern European standards associations allege that temporary headaches and irritability may result from microwave exposure at even very low levels.

STANDARDS

Probably the most well known safety standard is that of the American Na-

tional Standards Institute, known as C95.1. It specifies a safe unlimited duration exposure level for the whole body as 10mW/cm²; or for any 0.1 hour period 1 mW-hour/cm². This they believe is at least a factor of ten below damaging levels.

In Canada, we have a safety code put out by Health and Welfare-Canada, called "Safety Code-6: recommended safety procedures for the installation and use of radio frequency and microwave devices in the frequency range 10MHz-300GHz".

This code specifically does not apply to portable transmitters of less than 50W output, but there is no reason why the *power density* (mW/cm²) warnings should not be heeded. In fact, no reason is given why lower power units are not included, which is surprising when you consider that the smaller units, such as police radar, are easy to stand next to or lean against.

The relevant parts of this standard are given in Fig.16, which gives, for example a limit of 1mW/cm² for the general public.

Fig. 16 Maximum exposure levels established by Health and Welfare Canada, 1 GHz to 300 GHz.

	Microwave Workers	General Public
Whole or partial body (except extremities) 1 hour average	5 mW/cm ²	
Same, but 1 minute ave.	25 mW/cm ²	1 mW/cm ²

Finally, Eastern European limits go as low as a long-term average of .01mW/cm² exposure. As usual, no one has the definitive answer as to how much for how long is bad for you.

RADAR OUTPUT

Referring to Fig.17, this gives an area covered by the radiation of 100 mW, and the corresponding power per square cm. This is the "power density", the figure measured for safety regulations.

Actual power densities will be slightly lower than these calculated values, since a small part of the transmitted power falls outside the 16 degree cone.

d, Distance (cm)	Area A (cm ²)	Power Density (mW/cm ²)
15	14	7.16
18	20	5.0
30	56	1.78
40	100	1
400	10000	.01

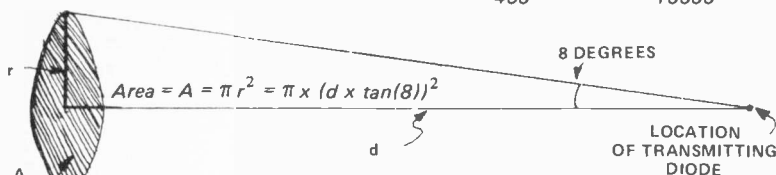

Fig. 17. Although the "sensitivity pattern" is quoted as 8 degrees for "half effectiveness", the transmitter pattern is actually 16 degrees wide at half power points.

As can be seen the power levels are not immediately dangerous, but at close distances do exceed some of the "Code-6" safety standards.

The plastic covered front of the "radome", radar antenna assembly is at about 15cm, this is the closest you can get to the radiating source. At this position the power density is some 7mW/cm², exceeding two of the "safety code 6" standards mentioned. At about 40 cm all North American standards are met, and at 4 meters (12 feet) even the East Europeans would be satisfied.

DANGER?

So is a radar unit dangerous? We've never heard any complaints, and it seems to us that radar can be operated with complete safety. However we would like to recommend certain procedures in handling radar units, so as not to subject oneself to radiation levels felt by safety authorities to be of "unknown" safety, to be absolutely sure.

1. Do not leave the radar operating when you don't need to. (It wears it out anyway, particularly the receiving diode.)
2. Do not operate the radar transmitter with your body in front of it. Especially avoid cradling an operating radar gun in your lap, or leaning against the outside of the patrol car with the antenna pointing at you, or your "customer", as examples.
3. Avoid operating the radar inside a vehicle in a position where excessive amounts of the radar beam can reflect back (from metal work) at your body. (This again will shorten the life of the receiving diode anyway.)

Bibliography

TRIBAR PUBLICATIONS:

Various product brochures, plus:

"Operational Notes - Muni Quip T3"

"Operating Instructions for Model T3"

"The Muni Quip Track Radar MDR-1 -

A Technical Discussion", "Muni Quip

MDR-1 Track Radar Operating Instructions",

"Muni Quip Radar Speed Detection Course."

OTHER SOURCES:

William O'Brian; "What Every Motorist Should Know About Speed Control Radar", From the Los Angeles County Law Library.

International Microwave Power Institute:

"Microwave Safety: Hazards in Perspective"

IS-2 Dec 1975.

"Safety Code 6 . . ." Available from the

Information Directorate, Dept National Health

and Welfare, Brooke Claxton Bldg, Ottawa

K1A 0K9.

S. A. Vakin and L. N. Shustov: "Principles of

Jamming and Electronic Reconnaissance":

Prepared by Translation Division, Foreign

Technology Division, WP-AFB Ohio.

(FTD-MT-24-115-69-Vol 2 May 69)

"Car and Driver" magazine, Feb 79 issue:

see your local library, they're all sold out of

back issues of this one!

Assorted Microwave Associates literature,

including "Microwave Components for Motion

Detection". M A Electronics Canada Limited,

3135 Universal Dr., Mississauga Ont L4X 2E7.

What's All This 'Ear'?

Anyone who has ever designed a synthesiser or other electronic musical instrument will, no doubt, have at some time cursed our remarkable sense of pitch, which puts so many design constraints on the oscillator system. Dr. R A Henson of The London Hospital explains just how the human sense of pitch works and turns up quite a few interesting pieces of information.

THE PITCH of a sound means its position on a scale of frequencies. Pitch sense is involved in perceiving all complex sounds: for example human speech has its set of pitches. In this article, I consider the way pitch relates to music.

In general, the pitch of a tone depends on its fundamental frequency, which determines whether it stands high or low on the musical scale. We tell one tone from another by their different fundamentals. Music is made up of a succession of tones and combinations of tones that are perceived, analysed and coded by the nervous system in ways to be explored, but questions of tuning and scales and how well we can hear them must be dealt with first.

Orchestral pitch is agreed nowadays as 440 Hz for A', that is, the note A above middle C. It became necessary to agree this internationally because different pitches were used in different places and because a progressive heightening of pitch in the 19th century led to A' as high as 461 Hz in some places. Musical scales are sets of pitches arranged in such a way that they contain a maximum of consonances, where various tones tend to blend pleasingly, and a minimum of dissonances, where they do not. Tuning in 'equal temperament' has held the field in western music for three centuries because, unlike the earlier 'perfect temperament', it makes possible the use of all 24 keys (C major, C minor, C sharp and so on) without retuning. In equal temperament the octave is divided into 12 logarithmically equal steps of frequency, each to a frequency 5.9 per cent greater than the step below. The steps, called semitones, are each divided into 100 further equal steps or cents, and an octave covers 1 200 cents. This method of tuning is imperfect and less accurate than the earlier forms. As Balbour, the eminent American composer and organist wrote, "all players and singers are playing false most of the time . . . these are errors of equal temperament."

Have we an inbuilt tuning system? Training and early exposure to musical stimuli make this question impossible to answer with any assurance. However, we can say that the western musician's internal pitch scale corresponds to equal temperament but with a slight tendency to sharpen all notes relevant to the tonic or keynote; the target pitch for notation is a shade sharper than equal temperament.

NORMAL CAPABILITY

How much of the normal range of frequencies is actually heard depends on the age of the hearer and also on what is meant by 'hearing' a frequency.

Some organ pipes are felt rather than heard.

The figures commonly given are 16 – 20 000 Hz for young people and 20 – 16 000 Hz for adults. Hearing is most sensitive for frequencies between 1000 and 3000 Hz, being much reduced

in the extreme lower and higher ranges. People's ability to discriminate in pitch ranges from those who are tune- or tone- deaf to those with absolute pitch sense. Though it is highly developed in some, there is no experimental evidence that they can do better than discriminate between quarter tone intervals consistently. The ability to detect small changes of frequency diminishes sharply above 4000 Hz.

A sense of relative pitch is necessary for hearing or singing a simple tune. Most of us perceive and remember music in terms of changing sequences of notes rather than in orchestral or other pitch values. Absolute or perfect pitch is the ability to name a sounded note or identify its frequency, or to do both this and to sing a given note accurately straight off.

Possessors of absolute pitch appear to have an inbuilt pitch grid against which to measure the incoming sounds.

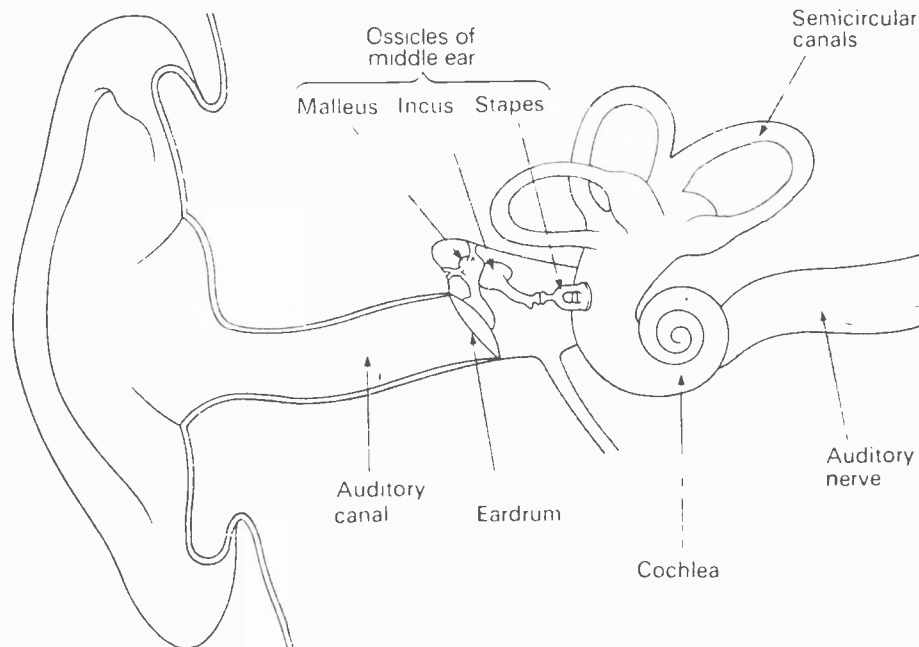

Sound waves are transmitted via the ear drum and the ossicles of the middle ear to the round window membrane, which sets up pressure changes in the cochlear fluids of the middle ear.

There has been a prolonged debate about whether absolute pitch is innate or acquired, but the present majority view is that both heredity and environment play their parts. Absolute pitch may be the normal manner in which we deal with frequency, but this is trained out of us by our musical environment, which depends on relative pitch. Certainly, absolute pitch can be learned in early childhood, but while pitch perception can be improved in adults by training, no-one has been able to train adolescents and older people who had little original ability in pitch naming. It is likely that highly developed pitch naming almost always derives from reinforcement of a child's behaviour by an adult.

Perfect pitch is an advantage in some aspects of practical musicianship, but it also carries handicaps. For example, a singer has to transpose consciously when a key is changed. Interestingly, all normal people can retain information on absolute pitch for periods ranging from ten seconds to a few minutes, but the information is then discarded.

THE PERIPHERAL ANALYSER

The capacity of the human ear to analyse sound waves is truly remarkable. Perception of musical sounds depends on several factors, including identification of the pitch, duration, intensity and rhythm of a series of tones, and this requires an efficient peripheral analyser of the sound waves produced. Here we are concerned solely with the problem of pitch perception.

Many theories of pitch discrimination have been advanced over the past hundred years, but even now a unified solution escapes us. Current knowledge and views appear to add up to what follows...

Sound waves are transmitted from outside via the ear drum and the ossicles of the middle ear to the round window membrane, which sets up pressure changes in the cochlear fluids of the inner ear. The sound receptors of the cochlea are the inner hair cells, disposed along the basilar membrane. These cells are activated by a travelling wave which always passes throughout the membrane from the base to the apex of the cochlea.

The travelling wave has its greatest amplitude at a point determined by the frequency of the sound stimulus. High frequencies cause vibrations in a small part of the base of the cochlear partition; low frequencies set the whole membrane into vibration.

The place where the inner hair cells are activated may well account for the

perception of high frequencies, and this idea is supported by the fact that people with disease at the base of the cochlea are deaf to high tones. But this theory does not explain how we perceive low tones, and it has been suggested that low frequencies are represented by the rate of nerve impulses engendered by the stimulus.

The cochlear nerve fibres, which join the ear to the brainstem, cannot carry more than 500 to 600 Hz, and this led to the 'volley' theory. This was that groups of fibres could carry frequency information, so that the stimulus frequency is represented in the combined pattern of nerve impulses produced.

This idea is acceptable in a general sense, but there are objections to it on physiological grounds, especially where frequencies over 3 kHz are concerned. Perhaps the place and frequency patterns in time all play their parts in pitch perception. Harmonics may help in identifying the fundamental lower tones, for if a set of overtones is sounded, without the fundamental, the listener's ear supplies it and he hears it just the same.

SECOND MECHANISM

This first stage of analysis by the basilar membrane is not enough to account for the fine degree of pitch discrimination achieved by the human ear. Studies on the mechanical tuning of the basilar membrane have shown that it acts as a heavily damped, broadly tuned structure; on the other hand, recent recordings of the activity of a single auditory nerve fibre have shown that the tuning here is sufficiently fine to meet psychophysical requirements.

There must be a second mechanism inside the cochlea to account for the differences between the two structures, and it has been suggested that the olivocochlear bundle, which runs from the brainstem to the inner ear, is involved in it. With higher intensities the neural tuning of the cochlea is broad, and it seems that there must be a further tuning mechanism within the nervous system to deal with loud sounds.

Single auditory neurons have their own best frequencies, but they can also respond to neighbouring frequencies: that is to say, the frequencies that neurons respond to overlap. Looking at how the system works, an arrangement of this type would be essential to ensure the transition from one sound to another that listening to music demands; it would also contribute towards the appreciation of loudness.

Psychophysical studies suggest the

frequency selectivity is achieved in man by the equivalent of a bank of overlapping filters, a system that would separate the individual components of a complex signal for analysis. Psychophysical measurements, known as critical bands, have been used to find the effective bandwidths of the human auditory system. It appears that these critical bands range from 200 Hz wide at 1 kHz to 2 kHz wide at 10 kHz.

Such a mechanism could explain why we hear the normal differences in tuning or sounding instruments or voices as the same note or tone. Tonal material that is not relevant to the task on hand is inhibited, a process called tuning or sharpening. The exquisite sensitivity of the human ear is shown by the way in which we can separate simultaneously heard tones with shared harmonics. So far we have been unable to sort out the mechanisms that produce these psychophysical effects.

A central pitch processor should transform incoming nervous impulses bearing information on pitch into patterns, so that all stimuli of the same periodicity are represented in the same way. This would produce individual sensations for different pitches.

We have already seen the need for an auditory system capable of categorical assessment and of dealing with tones of neighbouring frequency or shared harmonics. The nervous system meets this need in ways we do not understand. The auditory system must integrate stimuli presented to both ears, and its ability to do this is shown by the way harmonic components fed simultaneously into both ears combine so that the subject hears the fundamental.

Conventional neuroanatomical and neurophysiological studies have given little information about central pitch processing, although the complex pathways of hearing in the brainstem have been thoroughly investigated. Auditory nerve fibres from both inner ears stream up the brainstem on both sides after their first relay point in the cochlear nuclei. It appears that these fibres relay at four or more points in the brainstem nuclei before they reach the auditory cortex of the brain.

The final relay is in the thalamus, and from it auditory information flows to the auditory cortex. Apart from the complexity of the nuclei and linking tracts, investigations are made difficult because if anaesthetics are used, then evoked auditory responses in man and experimental animals are not normal, but, of course, more of these abnormal responses are obtained under anaesthesia than otherwise.



Your Zenith Distributor has the parts and accessories you need in one convenient place — your Zenith One-Stop Shopping Center.

REPLACEMENT PICTURE TUBES



Famous Super Chromacolor® picture tubes in a range of sizes to replace a total of 80 industry types. Plus Sunshine® and Cinebeam picture tubes to fit almost any brand of color TV. And Zenith black & white picture tubes to replace 401 other types of B & W tubes.

REPLACEMENT RECEIVING TUBES



A complete line of more than 1,000 Zenith quality tubes . . . the same tubes as used in Zenith original equipment. Built to operate with great reliability — to cut your callbacks. And they have the long life needed to increase the satisfaction of your customers.

ZENITH QUALITY PARTS



All the parts you need, from bel fuses to TV knobs. The star is the Zenith Instant Parts Program (ZIP). It puts the 100 most used replacement parts at your fingertips, in a specially designed, compact rack. ZIP makes inventory and re-ordering fast and easy for you. Also, Zenith now offers a line of capacitors, resistors, integrated circuits and universal semi-conductors and a full line of universal needles and cartridges.

ZENITH QUALITY ACCESSORIES



Here are just a few! Quad, stereo and monaural headphones. Broadened line of outdoor antennas featuring 13 all-new Super Chromatenna models. Complete new Chromatenna indoor antenna line. Antenna rotors. Three grades of batteries in a wide range of sizes. Electronic chemicals, including tuner degreaser, tuner cleaner, circuit cooler and tape head cleaner. Cassette and 8-track recording tape cartridges and record care products. A full line of test equipment & service aids.

Beside parts and accessories, your Zenith Distributor has the specialized "know how" to help solve tough service problems. Come in or phone today.



YOUR LOCAL ZENITH DISTRIBUTOR:

Major Appliances Div.,
Acklands Ltd.,
1725 Quebec Street,
Vancouver, B.C.
Phone-1-604-379-4631

B.R.E. Electric Ltd.,
5544-5th Street S.E.,
Calgary, Alta. T2H 1L3
Phone-1-403-253-7171

B.R.E. Electric Ltd.,
14840-115th Ave.,
Edmonton, Alta. T5M 3C1
Phone-1-403-455-7171

Major Appliances Div.,
Acklands Ltd.,
1155 Sherwin Rd.,
Winnipeg, Man. R3H 0V1
Phone-1-204-533 8679

Zenith Radio Corporation
of Canada Ltd.,
1020 Islington Ave.,
Toronto, Ont. M8Z 5X5
Phone-1-416-231-4171

Zenith Radio Corporation
of Canada Ltd.,
900 Boul St. Martin O.,
Chomedey, Lav. PQ
H7S2B6
Phone-1-514-663-0430

Waldale Limited,
Station Street, Box 339,
Amherst, N.S.
Phone-1-902-667-3308

Service News

MANUFACTURERS... REPRESENTATIVES... ORGANISATIONS... DISTRIBUTORS... SERVICE... Send us your news ideas for the successful shop. Address them to Service News, Electronics Today Magazine, Unit 6, 25 Overlea Blvd, Toronto, Ontario, M4H 1B1. Please note that your information must be received at least six weeks before the first of the month of the issue in which it is to appear. Any material published at our discretion.

Dick Cartwright takes a closer look at labour requirements in the service industry.

ON SEPTEMBER 26TH the MTTSA (Toronto Chapter of the Ontario Electronic Technicians Association — OETA) held their annual general meeting at the Yorkdale Holiday Inn, Toronto. The turnout was the best I have seen in a long time, and before getting down to Association business two very fine presentations were made, the first being by Mr. Mark Racicot who is the Ontario rep for Cyprus Products Inc., Vancouver. Mr. Racicot demonstrated to the technicians present a piece of equipment called the Huntron Tracker, with which he was able to check the operation of all manner of solid state devices without having to remove them from the apparatus on test.

The second speaker, Mr. Bill Gibbons of Philips, demonstrated their video disk machine. The versatility of this particular piece of equipment came as a surprise, I am sure, to many of the technicians present, as in fact did the remarkable picture definition. The indestructibility of the disk was also most surprising.

After a brief intermission the meeting was called to order and various items of Association business were then quickly dealt with. At the end of this most successful meeting the Association's new suggested price schedules were distributed.

ETA News

In the October magazine I mentioned briefly ETA's annual meeting held in Kitchener, Ontario, and I have just recently received a news release dated September 1979, and here are a few excerpts from this:

"Annual Meeting — Kitchener, Canada.

"The new officers of ETA and its divisions are confirmed as listed in your August Association Newsletter: Jess Leach continues as ETA Chairman; Bill Patullo as ETA-C Chairman; Leon Howland as CTD Chairman; and Alan Hartley as EEA Chairman.

"George Savage, PO Box 39, Donipahann, Neb., as announced in the August report, won the ETA "Man of the Year" Award — the Norris R. Browne Award. George also will be our National ETA Secretary and therefore one of our ETA Board of Directors members. (There are 7 board members). In addition, new ETA Treasurer John McPherson has turned over the Membership Committee chairmanship to Mr. Savage for the coming year.

"CET recognition by ETA as announced earlier extended to all CETs previously certified in NEA and ISCET. There has now been a change in that ETA policy. Because of the questions now surrounding the ISCET program, ETA will NOT RECOGNIZE any ISCET certified technicians who became certified after April 1, 1979. This was voted on and passed in Kitchener at the annual meeting. "We wish to thank the Canadians: Bill Patullo, Jim Sims, and Ray Pierce, for the great amount of time and effort they put into the Kitchener meetings and for their fine hospitality. Most of those who attended had not been to Canada before and these gentlemen and their wives made it a memorable time. Both Bingeman Park, and the Waterloo Motor Inn were beautiful locations for the convention and it may not be long before ETA returns."

SHORTAGE OF TECHNICIANS??

Very recently one of the largest TV service companies in Ontario had advertized extensively in the local press for experienced domestic electronic technicians. A number of responses were received, but for the most part the expenditure on advertising was wasted. Upon hearing this my somewhat befuddled mind remembered an article printed in an earlier edition of Service Contacts from CEASA (Canadian Electronic and Appliance Service

Association) which to a very large extent explained why this company was unable to satisfy its present requirements. The following is undoubtedly the finest explanation for the apparent labour shortage in the television servicing industry:

"In 1977, the total major appliance population in Canada was 26,416,000 units. This will increase to 35,000,000 by 1982. During the same period the service calls totalled 7,500,000 in 1977 and are expected to total 10,040,000 by 1982. With an average rate of 1,200 service calls per technician per year in 1977, a total of 6,300 technicians were required to provide the necessary service. By 1982, the average service calls per technician per year should rise to 1,450 and 6,925 service technicians will be required to maintain all of the domestic appliances. This represents a growth of 10% in technician population.

"Now let's take a look at the electronics picture for the same period of 1977 to 1982. IN 1977, the service calls on television totalled, 7,785,000, slightly higher than major appliances. The average rate of service calls per technician per year was 1,200 and 6,560 service technicians were required to deliver the much needed service. By 1982, the total service calls will be down 13% to 6,830,000 and with improved product design the number of service calls should increase to 1,450 calls per technician per year. The TV service technician population should drop to 4,700 or 28%.

"Combining the major appliance and TV service technician population figures, we find that in 1977 the total requirements were 12,860 and by 1982 the needs will be 11,635 or a total drop of 10%. That's enough to chase you right out of the service business, isn't it!! But whoa — WAIT — let's look at another factor — contrary to what the consumer

thinks, service technicians DON'T go on forever. Hopefully some will retire, win a lottery or turn the business over to someone a little younger. This means NEW BLOOD will be coming into the service business to replace those leaving.

"Statistics Canada reports that between the years 1977 and 1982, 2.3% of the service technicians will leave their jobs each year. A further turnover of 10% will result from sickness, death, promotion, opportunities in other fields, etc. This means that major appliance service technicians will be needed at the rate of between 865 and 1,000 new technicians each year to fill the demand. This represents 14% of the existing service technician population. Looking at the TV service technician needs for the same period, we find that

between 250 and 370 new technicians will be required each year to fill the service demands."

CONCLUSIONS -

"The service market is labour intensive — approximately 50% labour content vs. manufacturing at 10%-15%. The major appliance service market is expanding whereas the TV service market is dropping. Although the demand for TV service technicians is dropping, attrition due to age and turnover means more new service technicians will be required each year."

It is quite apparent from the foregoing that though the modern domestic electronic appliance is more reliable than ever before, there is still a great need for trained technicians. Hobbyists and enthusiasts alike should well

consider the job potential in this field and what further training will be required to achieve one of the extremely lucrative positions now available in the service industry. Salaries in excess of \$20,000 a year are not uncommon.

COMMENTS

In spite of the very recent formation of the Canadian branch of ETA-1, it is most gratifying to find myself the recipient of all sorts of interesting news releases, both technical and political in nature. Would that our Ontario Association (OETA) could find the time to do likewise. If it were not for two officers of our local association (MTTSA), Mr. David Van Ihinger and Mr. Len Longman, there would, I am afraid, be absolutely no information at all of OETA's activities.

LEADER'S checking line



Represented in
Canada by:

Model No.
LTC906.

\$279.00

LEADER'S New portable semi-checker that automatically identifies emitter, base, and collector and gives an absolute meter readout of gain and leakage.

- * In-Out Circuit
- * Automatic
- * L.E.D. Display
- * Transistors, F.E.T.s, Diodes
- * 2 YR. WARRANTY

AVAILABLE IN CANADA AT AUTHORIZED LEADER DISTRIBUTORS

omnitronix ltd.

2056 South Service Rd., Trans Canada Hwy,
Dorval, Québec. H9P 2N4
Tél. 683-6993 - Télex. 05-822692

There's never been a better time to buy an Apple® II plus

* THIS ADVERTISEMENT
WORTH \$150 ON ANY APPLE
II SYSTEM (ONE AD ONLY PER
SYSTEM) WHEN PRESENTED
TO:

COMPUSHOP

COMPUTERS FOR HOME & BUSINESS
CERTIFIED CHEQUE OR MONEY
ORDER VISA & MASTERCARD
ACCEPTED

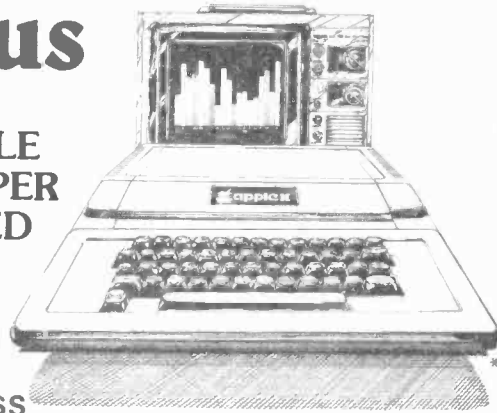

16K ... \$1750.00
DISK .. \$850.00

* MUSIC SYNTHESIZER,
LIGHT PEN, SPEECH
LAB, AC CONTROLLER,
PASCAL, 10 MBYTE
HARD DISK, ETC. ALL
AVAILABLE FOR APPLE II
AND APPLE II PLUS
SYSTEMS.
* AUTHORIZED SERVICE
CENTRE.

CALGARY
#103 723 - 14 Street N W
Calgary Alberta T2N 2A4
(403) 283-0751

CALGARY
#107 4014 Macleod Trail South
Calgary, Alberta T2G 3R7
(403) 243-3846

VANCOUVER
#100 1500 West Georgia Street
Vancouver, B.C. V6G 2Z6
(604) 687-5545

Circle No. 14 on Reader Service Card.

Service News

Again a special vote of thanks must be made to Mr. Bill White, General Manager, CEASA, and his board of directors of this most progressive association. Their Service contacts and their News Bulletins are among the finest of all service publications anywhere in Canada and the U.S.

To all technicians, both domestic and industrial, I would like to take this opportunity to wish you all a Very Merry Christmas and a Prosperous New Year.

Richard H. Cartwright.

Service News Letters

Dear Dick,

I'd like to thank you for your October feature on our Kitchener meetings. Since you had your turn at bat in association work, I'm sure you had let-down feelings many times when reports of your meetings or actions fell far short of properly reporting them. Maybe the 'usual' that we get used to is what makes this one that much sweeter. At any rate, it made my day, and my wife's, and it will continue to do so as others of the officers read it. Bravo.

Reinforcing my enthusiasm for ETI, let me throw a bouquet to the writer of the Cable article too. It was a jewel. On the other hand, the 'Teacher's Topics' on which way current flows left me more confused. If you understand it, sneak me a hint!

Thats all for now, keep up the 'great' work.

Sincerely,

Dick Glass, CET(US)
President, ETA

ETI CANADA—DECEMBER 1979

NORTH AMERICAN ELECTRONICS 1949-1979

AMIDON	Toroidal cores, Ferrite beads, Pot cores, etc.....
BARKER & WILLIAMSON	Coils and R.F. switches, etc.....
MAGNET WIRE J.MILLEN	Sizes 10 to 40..... Inductances, Ceramic coil forms, etc.....
J.W.MILLER	Inductances, all types, R.F. Coils, etc.....

AND MANY MORE

Our 40 page No. 17 catalog, marking our 30th anniversary as an electronics distributor is now being sent free of charge. WRITE for it or CALL us.....

NORAMEL,
2407 STE-CATHERINE ST. E.,
MONTREAL, QUE., H2K 2J7
(514) 522-8422

STOCKING STUFFING TIME!

SEE Page 63.



SHORTWAVE WORLD

PROGRAMS FOR SWLS

MANY OF THE INTERNATIONAL BROADCASTERS on the shortwave bands have programs especially for Short Wave Listeners. These programs range in length from just a few minutes to a half hour and they feature tips for the listener, times and frequencies of stations heard, technical help, etc. Each station handles these programs in a different manner. I'll start off this month with a calendar of programs showing the times and frequencies in chronological order and then tell you a little bit about each of the stations' programs for the hobbyist. The times given are in GMT (EST plus 5 hours) and the frequencies are in kilohertz. So 0100 Sunday GMT will be Saturday evening here in North America.

SUNDAY

0135 Radio Moscow 6175 7380 9530 11750 11770 11780 11960 12030 12055 15100 15240 15420 17700 kHz
0145 SRI Switzerland 6135 9725 11715 15305 kHz (2nd & 4th Sunday of the month)
0200 Radio Budapest 6105 9585 9835 11910 15225 17710 kHz
0200 Radio RSA South Africa 9585 9610 11900 15220 kHz
0230 HCJB Ecuador 9745 11915 kHz
0300 Radio Budapest 6105 9585 9835 11910 15225 17710 kHz
0300 ORF Austria 5945 9770 kHz
0335 Radio Moscow — same frequencies as 0135 plus 9700 9720 kHz
0350 Deutsche Welle Germany 9605 kHz (2nd Sunday of the month)
0430 SRI Switzerland 9725 11715 kHz (2nd & 4th Sunday of the month)
0435 Radio Moscow 9710 9730 11720 12000 12030 12050 15180 17760 kHz
0515 Voice of Spain 9630 11880 kHz
0635 Radio Moscow 9710 9730 11720 11750 12000 12030 12050 kHz
0745 BBC London 5975 9510 9640 11760 11955 15070 15400 17790 17885 21660 21710 kHz
0825 Radio Japan 17855 21610 kHz
0900 ORF Austria 6155 7170 9770 kHz
0915 Radio New Zealand 6105 11945 kHz (1st Sunday of the month)
0930 RTE Portugal 9670 kHz
1000 Radio Japan 11875 15235 kHz
1025 Radio Japan 9505 15195 17810 kHz
1100 SLBC Sri Lanka 11835 15120 17850 kHz
1125 Radio Japan 9675 11875 kHz
1200 Radio Tashkent USSR 11730 11925 15115 15460 kHz (2nd Sunday of the Month)
1210 Radio Moscow 7250 9450 11745 12000 15150 15295 17700 kHz plus many other frequencies
1300 Radio Finland 15400 (every 2nd Sunday)
1400 SLBC Sri Lanka 6075 9720 15425 kHz
1425 Radio Japan 9505 11815 15310 kHz
1540 Radio Japan 11705 15235 kHz
1710 BRT Belgium 17745 21475 kHz (2nd & 4th Sunday of the month)
1800 RCJ Canada 15260 17820 kHz
1805 ORF Austria 6155 15335 15560 21740 kHz
1855 Radio Japan 11855 15135 kHz
1900 RCJ Canada 5995 7130 15260 15325 17750 17820 21695 kHz
1915 Radio Moscow 5980 7250 7390 7420 9550 9685 9765 kHz
2000 Kol Israel 9009 9425 11655 15105 15415 17645 17685 21575 kHz
2000 RCJ Canada 5995 15325 17750 17820 21695 kHz
2010 Voice of Spain 9685 11840 kHz
2025 Radio Japan 11855 15135 kHz
2110 Voice of Spain 7105 9685 11840 kHz
2130 RCJ Canada 11945 15150 15325 17750 17820 kHz
2230 Kol Israel 9815 11655 11985 15105 15300 15415 17685 kHz
2305 ORF Austria 5945 9770 12015 kHz
2325 Radio Japan 9585 15195 17755 kHz

MONDAY

0005 Voice of Spain 9630 11880 kHz
0015 BRT Belgium 11715 15175 kHz (2nd & 4th Monday of the month)
0015 Radio Japan 15270 17825 kHz
0100 RCJ Canada 5960 9615 17820 kHz
0105 Voice of Spain 9630 11880 kHz
0200 Radio Japan 15270 17725 17825 21640 kHz
0200 RCJ Canada 5960 9615 11940 kHz
0300 RCJ Canada 5960 9535 9560 11845 11940 kHz
0400 RCJ Canada 5960 9535 11845 kHz
0800 HCJB Ecuador 9745 11915 kHz
0900 HCJB Ecuador 6130 9745 11900 kHz
1115 BBC London 9510 11775 15070 kHz plus many other frequencies
1200 Radio Bucharest Romania 15345 17830 kHz
1200 RBE East Germany 15165 17700 21465 21540 kHz (every 2nd week)

1210 Voice of Turkey 17775 kHz
1300 Radio Veritas, Philippines 9590 11955 15215 kHz
1315 RBE East Germany 21485 kHz (every 2nd week)
1400 RBE East Germany 17700 21465 21540 kHz (every 2nd week)
1500 Radio Bucharest Romania 11940 15255 17805 kHz
1530 RBE East Germany 7185 9730 kHz (every 2nd week)
1800 RBE East Germany 11970 15145 15170 kHz (every 2nd week)
1930 Radio Bucharest Romania 9690 11940 kHz
2000 RBE East Germany 9665 15390 kHz (every other week)
2130 HCJB Ecuador 15225 17890 21480 kHz
2135 Voice of Turkey 7170 9515 11880 11955 kHz

TUESDAY

0100 RBE East Germany 9730 11970 kHz (every other week)
0130 Radio Bucharest Romania 5990 9570 9690 11735 11840 11940 15380 kHz
0230 HCJB Ecuador 9745 11915 kHz
0230 RBE East Germany 9730 11970 kHz (every other week)
0330 RBE East Germany 11840 11890 11970 kHz (every other week)
0445 RBE East Germany 11720 11795 kHz (every other week)
0530 Radio Bucharest Romania 11830 15250 17745 kHz
0645 RBE East Germany 17700 21465 21540 kHz (every other week)
1115 Radio Sweden 9630 21690 kHz
1245 Radio Sweden 15240 21690 kHz
1415 Radio Sweden 21615 21700 kHz
1515 Radio Budapest Hungary 6110 7200 9585 9835 11910 15220 kHz
1610 Radio Moscow 7250 7280 7330 9450 9490 9685 9785 11630 11830 11960 12000 12055 15150 15375 15520 15535 17700 17735 17775 17885 21740 kHz
1615 Radio Sweden 6065 15240 kHz
1730 Radio Bucharest Romania 11790 15365 17720 kHz
1845 Radio Sweden 6065 15240 kHz
2100 BBC London 5975 6005 6120 6175 6180 6195 7120 7185 7325 9510 9570 9580 11750 11820 11910 11955 12095 15070 15260 15400 15420 15435 17705 17840 21710 kHz
2115 Radio Sweden 11905 15240 kHz
2315 Radio Sweden 11705 15275 kHz

WEDNESDAY

0045 Radio Sweden 11905 kHz
0245 Radio Sweden 9695 11705 kHz
0400 Radio Budapest Hungary 6105 9585 11910 15225 17710 kHz
1900 Radio Prague Czechoslovakia 5930 7245 7345 kHz
1930 Radio Bucharest Romania 9690 11940 kHz
2000 Radio Kiev USSR 6020 9560 9665 kHz (1st & 3rd Wednesday of the month)
2000 Radio Prague Czechoslovakia 5930 7345 kHz
2130 Radio Prague Czechoslovakia 6015 kHz
2130 RCJ Canada 11945 15150 15325 17750 17820 kHz
2210 Radio Moscow 6055 7250 7320 7330 7390 7420 9490 9500 9530 9640 9685 9735 9755 9765 11630 11740 11750 11770 11805 11950 11960 12000 12040 12055 15100 15265 15275 15535 kHz
2315 BBC London 3955 5975 6005 6120 6175 6180 6195 7120 7130 7185 7325 9410 9510 9580 9915 11750 11820 11910 11955 12095 15070 15260 15400 15420 15435 17705 17840 21710 kHz

THURSDAY

0030 Radio Kiev USSR 11735 15180 12060 17845 17870 kHz (1st & 3rd Thurs)
0130 Radio Bucharest Romania 5990 9570 9690 11735 11840 11940 15380 kHz
0230 HCJB Ecuador 9745 11915 kHz
0300 Radio Kiev USSR 9610 9655 11735 12000 15180 17765 17870 kHz (1st & 3rd Thursday of the month)
0750 Radio Neerland 9715 9770 kHz
0800 HCJB Ecuador 11835 15245 kHz
0850 Radio Neerland 9715 kHz
0900 HCJB Ecuador 6130 9745 11900 kHz
0950 Radio Neerland 5955 6045 7240 9895 11930 kHz
1210 Voice of Turkey 17775 kHz
1300 Radio Bucharest Romania 11940 15250 17850 kHz
1350 Radio Neerland 5955 6020 6045 9895 11930 kHz
1450 Radio Neerland 17855 21480 kHz
1850 Radio Neerland 6020 11730 17605 kHz
1935 Radio Moscow 5980 7250 7390 7420 9550 9685 9765 kHz
2050 Radio Neerland 11730 15220 17605 17695 21640 kHz
2130 HCJB Ecuador 15225 17890 21480 kHz
2135 Voice of Turkey 7170 9515 11880 11955 kHz

FRIDAY

0100 Radio Prague Czechoslovakia 5930 7345 9540 9740 11990 kHz
0250 Radio Neerland 6165 9715 kHz
0300 Radio Prague Czechoslovakia 5930 7345 9540 9740 11990 kHz
0550 Radio Neerland 6165 9715 kHz
1400 Radio Portugal 17895 kHz (2nd & 4th Friday of the month)
1515 Radio Budapest Hungary 6110 7200 9585 9835 11910 15220 kHz
1600 Radio Portugal 17895 kHz (2nd & 4th Friday of the month)
1800 Radio Portugal 15340 17880 kHz (2nd & 4th Friday of the month)
1810 Radio Moscow 7250 7280 7390 7420 9550 9765 9810 11630 11740 11960 12000 15150 15525 15535 17775 kHz
1930 Radio Bucharest Romania 9690 11940 kHz
2030 Radio Portugal 6025 9740 kHz (2nd & 4th Friday)
2040 Radio Australia 9580 9625 11725 11855 kHz
2130 Radio Sofia Bulgaria 11750 15135 kHz

SATURDAY

0000 Radio Sofia Bulgaria 15330 kHz
0030 Radio Veritas, Philippines 15135 15280 17790 kHz
0130 Radio Bucharest Romania 5990 9570 9690 11735 11840 11940 15380 kHz
0240 Radio Australia 15160 15240 15310 15355 17725 17795 17870 17890 21680 21740 kHz
0300 Radio Portugal 6025 11935 kHz (2nd & 4th Saturday of the month)
0400 Radio Budapest Hungary 6105 9585 9835 11910 15225 17710 kHz
0430 Radio Sofia Bulgaria 11750 kHz
0500 Radio Portugal 6025 11935 kHz (2nd & 4th Saturday of the month)
0700 SRI Switzerland 3985 6165 9535 9560 15305 21520 21695 kHz
0750 Deutsche Welle Germany 11705 kHz
0800 HCJB Ecuador 11835 15245 kHz
0810 Radio Moscow 7330 9450 9530 9600 9720 9765 9795 11735 11745 11830 11880 11965 11975 12050 12055 15110 15140 15210 15260 15320 15360 15515 17730 17765 17775 17825 17835 17845 17860 17880 21450 21490 21530 21740 kHz
0840 Radio Australia 6045 9570 9670 11740 17725 21570 21680 kHz
0845 TWR Monaco 9615 kHz (3rd Saturday of the month)
0900 HCJB Ecuador 6130 9745 11900 kHz
0900 SRI Switzerland 9560 15305 21520 21695 kHz (2nd & 4th Saturday)
0930 Deutsche Welle Germany 9650 11850 15275 17780 17800 21540 21680 kHz
1100 SRI Switzerland 3985 6165 9535 15430 17795 21520 21630 kHz (2nd & 4th Saturday of the month)
1150 Deutsche Welle Germany 6075 9545 kHz (2nd Saturday of the month)
1200 TWR Monaco 15255 kHz
1210 Voice of Turkey 17775 kHz
1315 SRI Switzerland 3985 6165 9535 15305 17735 17850 17850 21520 21570 kHz (2nd & 4th Saturday of the month)
1400 Radio Tashkent USSR 11730 11925 15115 15460 kHz (3rd Saturday of the month)
1440 Radio Australia 5995 6045 6060 6090 9770 11705 17795 21660 kHz
1500 TWR Monaco 7245 kHz (3rd Saturday of the month)
1530 SRI Switzerland 3985 6165 9535 15125 17830 21570 21585 kHz (2nd & 4th Saturday of the month)
1550 Deutsche Welle Germany 6075 9545 kHz (2nd Saturday of the month)
1720 Deutsche Welle Germany 9735 11965 15135 21600 kHz (3rd Saturday)
1815 SRI Switzerland 3985 6165 9535 15125 17730 17830 21585 kHz (2nd & 4th Saturday of the month)
1950 Deutsche Welle Germany 6160 9640 11765 15275 kHz (2nd Saturday of the month)
2100 Radio RSA South Africa 15155 17780 21535 kHz
2100 Radio Budapest Hungary 6025 7200 9655 9835 11910 15220 kHz
2130 HCJB Ecuador 15225 17890 21480 kHz
2135 Voice of Turkey 7170 9515 11880 11955 kHz
2335 Radio Moscow 6175 7380 9530 9720 11750 11770 11780 11960 12030 12055 15100 15240 15275 15420 17700 kHz
2350 Deutsche Welle Germany 3995 6145 9700 9735 11765 11795 15410 kHz (2nd Saturday of the month)

Notes on the above list:

- Some of the stated times are the exact time the program for DXers/SWLs starts. In other cases the news and perhaps another feature precede the DX program.
- Frequencies change from time to time but generally the time remains as shown.

LISTEN IN

As you can see there are a lot of programs for those interested in learning more about the hobby of shortwave listening. Some of these will be difficult to receive here in North America. Try some of the above times and frequencies and see what you can come up with.

And now a brief run-down of each of the DX programs:

- "Club Forum" (Radio Australia) — A fifteen minute program hosted by Warren Moulton Club Forum has a few

This month John Garner presents a veritable 'TV Guide' for shortwave listeners.

tips for listeners along with reviews of various clubs bulletins.

- "Shortwave Panorama" (ORF, Austria) A very good program but difficult to hear in North America due to poor propagation conditions. News of some of the harder to hear stations are often given.
- "DX Corner, Belgium" (BRT, Belgium) Frans Voosen hosts this program which features DX tips and listeners letters.
- (Radio Sofia, Bulgaria) — Their DX program is largely aimed at the Ham operator along with a few useful DXing tips.
- "DX Digest" (Radio Canada International) A very good show and highly recommended. Host Ian McFarland has technical answers for listeners along with interviews of experts in the communications field. Segments of the program are devoted to item such as: the female DXer, HAP/CHAP Report (Handicapped Aid Program); ANARC reports; DX news. There are four separate editions of the DX Digest — Edition I is aired at 1800, 1915 GMT Sunday and 0315 GMT Monday (Sunday night EST); Edition II is on at 1800, 2015 GMT Sunday and 0415 Monday; Edition III at 0115 GMT Monday and 2145 Wednesday; Edition IV at 0215 Monday and 2145 Wednesday. The DX tips in Edition II are given by Steve Webster of the Ontario DX Association and in Edition IV by Bill Butuk of Canadian S-W-L International while an American gives the tips in Editions I and III. These tips are phoned into RCI or sent by direct line through the CBC facilities just a few days before air time making them the most up to date as possible.
- (Radio Prague, Czechoslovakia) Most of this program concerns the Czechoslovak broadcasting system and is not of too much value to the DXer.
- "DX Party Line" (HCJB, Ecuador) Host Clayton Howard puts this show on three times a week for half an hour each. All three programs are different. Many DX tips are given but they are often out of date by the time they appear on the air. It is an especially good program for beginners.
- "World of Radio" (Radio Finland) This segment of Radio Finland in its Sunday Best is presented every other week on Sunday morning. Host David Mawby did a look at Radio Communica-

tions in the various bands earlier this year.

- "RBI DX CLUB" (Radio Berlin International) Mostly technical talks along with news about the RBIDX Club.
- (Deutsche Welle, Federal Republic of Germany) Their DX programs are sometimes mixed in with a German language program. Some Ham news, propagation conditions and news about broadcasters.
- "Calling DXers and Radio Amateurs" (Radio Budapest, Hungary) Some Ham tips, some listeners loggings although not usually very fresh, a few technical items. Not really a very good program in my opinion.
- "DX Corner" (Kol Israel) A very short DX program with some good technical information from host Ben Dalfen.
- "Tokyo Calling" (Radio Japan) Loggings and schedules are presented along with some Amateur Radio news items.
- "DX Jukebox" (Radio Nederland) One of the best DX programs on the air. DX tips, listeners letters, propagation predictions are mixed with some popular music intervals. Several reporters from around the world take turns reporting the latest on the DX scene from their viewpoint.
- "Arthur Cushen's DX World" (Radio New Zealand) Some good DX tips are presented on this program by one of the world's most famous DXers. However this is one of the programs that is usually not too easy to hear in North America.
- (Radio Portugal) Sometimes this program is quite good but I have trouble remembering which week it will be on.
- (Radio Bucharest, Romania) Much of this DX program is also slanted towards the Amateur Radio Operator but there are sometimes some good tips.
- "DX Corner" (Radio RSA, South Africa) Pieter Martins, who took over this program from long time host Gerry Woods is trying hard to come up with a good format for the show. Some items are interesting but I think we all would like to see Gerry back there.
- "CQ CQ" (Voice of Spain) This program starts out with an interval signal quiz to test your ability at picking out station IS's — some are easy, others are a little more difficult. A few good tips now and then.
- "Radio Monitors International (Sri Lanka Broadcasting Corporation) This

apparently is a very good program but I never been able to hear it. Perhaps reception conditions this winter will be such as to favor reception from this part of the world.

- "Sweden Calling DXers" Arne Skoog hosted this show from as far back as I can remember plus many years before that, until he retired last year, leaving the show to George Wood. DX tips and club news are presented.
- "Swiss Shortwave Merry-Go-Round" (SRI, Switzerland) Bob Thomann and Bob Zanotti (the two Bobs) co-host this program which is mostly a dialogue between the two of them discussing listeners' technical problems. Very enjoyable.
- "DX Corner" (Voice of Turkey) A few DX tips are given during each program. Not too much is reported on this show.
- "World Radio Club" (BBC, United Kingdom) Peter Barsby hosts this weekly 15 minute program of technical information. Often a few tips are given from the BBC Monitoring Service along with propagation forecasts. Henry Hatch answers listeners queries during the program.
- "DX Program, (Radio Moscow) Tips on this show are generally taken from other DX programs such as Sweden Calling DXers with no credit given to individual listeners or the other shows.
- (Radio Kiev) This program is aimed mostly at the amateur radio operators. Not usually too useful.
- (Radio Tashkent) I have never heard their DX program myself and don't really know anything about it. I must try to pick it up soon.

As you can see there are many programs for the DXer/SWL. Give them a try and learn a little more about the hobby.

Before closing for this month, I would like to take this opportunity to wish all of our readers a very Merry Christmas. Perhaps you might like to refer to the Shortwave Receiver Survey in October's ETI before writing your letter to Santa Claus.

Until next month all the best and good listening.



QRM QRM QRM

Bill Johnson VE3 APZ talks about the Eastern Amateur Radio Conference and radio hams versus the police.

EASTERN CANADA'S GREATEST amateur convention of the year has once again come and gone. This year's event took place at the Skyline Hotel in Ottawa and was hosted by the Ottawa Amateur Radio Club, on the weekend of October 12th.

The convention was well-attended, all seats for the Saturday evening banquet being sold out. The seminars were as busy, with standing room only at most of them.

As in most conventions there was a smattering of the old, current topics, and a look into the future with seminars on packet radio and narrow-band voice modulation.

When I first became involved in amateur radio a mere ten years ago, the latest thing was FM and repeaters. FM operators were looked at with awe. Some people thought we were gifted, but all were interested in what we had to say. Well, in a mere ten years, FM and repeaters have revolutionized the world above 50MHz. The technology has been perfected and the equipment condensed into the hand-held synthesized transceivers which were on sale in the commercial exhibits at the convention.

So, in just a few more years, packet radio will have been perfected. Packet repeaters already exist, and one was demonstrated at the packet radio session at the convention. Since packets consist of short bursts of high speed data, the repeating of these does not have to be full-duplex, making the construction of a repeater somewhat less complicated from an RF hardware point of view. Instead, the packets are passed on from repeater to repeater one after another in a 'hot potato' fashion.

If the seminar on packet radio was informative to those who want to look into the future then the D.O.C. Symposium was of equal value to those who are concerned with the present. Surprisingly enough, though, little was said of what is happening at WARC-79, now in progress in Geneva. It was mentioned that the hundreds of third-world countries are all grabbing at whatever frequencies they can get, since short-wave radio is and extremely

inexpensive means of domestic and international communication when compared to the alternatives of buried cable and satellite. It is becoming more and more attractive, also, since the major industrialised countries are all switching to satellites and freeing more channels.

ETI's readership was well-represented at the seminar, there was more than a small murmur of recognition when the writer addressed the panel. (It seems that more and more amateurs read ETI every year). One question that was addressed directly by the panel was their feelings that amateurs are concerned about the high failure rates of prospective amateurs. The D.O.C. admitted that some questions in past exams had been a little ambiguous, but they felt that to many clubs were just teaching to the questions and not going deeply enough into the subject matter. (Where did you read that before!). The D.O.C. generally feel that the syllabus is equal to that of a technology course but the level of knowledge required is much lower.

There were a couple of new, and somewhat startling things to come from the D.O.C. this year. One is that they are studying the possibility of implementing invigilation of exams by non-D.O.C. personnel. This would be of great assistance to those in remote areas who sometimes have to travel distances in the hundreds of kilometres just to attend an examination. They would not comment on how it could be done at the present time. The second was surprising, because it brought up the thought-to-be-dead topic of appliance-operator certificates (actual words used by D.O.C.). They are looking for input from clubs as to whether we want to have this kind of person on our bands. It would basically be a novice-type-easy-access to amateur radio for beginners.

A request for input from amateurs clubs and organizations has largely gone unanswered. So the deadline for replies on what you think of the present examinations has been extended to the end of the year instead of the end of October.

The D.O.C. want to hear what

you have to say about them, as well as any proposals for new questions

The D.O.C. announced that seven proposals for changes to regulations are now being shuffled back and forth between the Privy Council office and the D.O.C. office. These changes would

- Delete log-keeping requirements for mobile stations
- Delete the requirement to have a permanently-installed power meter
- Remove the 48 hour and 30 day notice/permission requirements for portable/mobile operation.
- Permit the use of F1 between 3.5 and 29.7 MHz.
- Permit the use of A3 from 7050 to 7100 KHz

The D.O.C. announced that seven proposals for changes to regulations are now being shuffled back and forth between the Privy Council office and the D.O.C. office. These changes would

- Delete log-keeping requirements for mobile stations
- Delete the requirement to have a permanently-installed power meter
- Remove the 48 hour and 30 day notice/permission requirements for portable/mobile operation.
- Permit the use of F1 between 3.5 and 29.7 MHz.
- Permit the use of A3 from 7050 to 7100 KHz
- Permit phone from 1800-2000 kHz
- Remove 420-430 MHz and introduce 902 to 928

All in all, the RSO convention was a success, despite some obscene jokes told in very bad taste at the beginning of the banquet.

The D.O.C. forum left lots of questions to be answered, and ETI will be reporting on these in the months to come. We also secured from the D.O.C. a promise to put us on their mailing list so we can keep you up-to-date on the many things that are going on in Ottawa.

Amateur Radio Experimentation Hampered by Ontario Legislation

To most of us, 'Regina vs Boivin', conjures up some abstract low case taking place in some remote courtroom and preserved amongst the pages of

yellowing, dog-eared law books. Amateurs in Ontario, however, stand to lose a lot because of the decision of Ontario's Supreme Court recently that upholds Ontario's right to ban any device that can detect or interfere with police radar.

The law was originally intended to curb the use of 'Fuzzbuster' type devices which warn drivers of the presence of police radar.

Barry Swadron, lawyer for Pierre-Francois Boivin, argued that the province does not have jurisdiction to make laws affecting radio. The judges stated that this case concerned highway safety, which is a provincial matter.

Although Boivin is not an amateur, the decision has a far-reaching effect for all amateurs who have mobile equipment, be it in the radar band or not. Most police radars operate in either the 'K' band on a frequency of 24.15 GHz, or the 'X' band on 10.525 GHz. While amateurs are confined to below 10.500 GHz, the 24.15 GHz allocation falls right

in the middle of the 24.0-24.25 GHz amateur band. The result is an interesting situation: you can be transmitting perfectly legally under the terms of your license on 24.15 GHz, but your equipment can be seized by an untrained police officer if he as much as suspects you are detecting, or interfering with signals from police radar. EVEN A RADIO INSPECTOR DOESN'T HAVE SUCH A RIGHT TO SEIZE EQUIPMENT-HE HAS TO GET A SPECIAL ORDER UNDER THE HAND OF THE MINISTER.

One might say that to experiment on 24.15 GHz is asking for trouble. I agree, that, since we are a secondary service on that band, we should not interfere with a known, primary service. The problem though, is that a police officer is not trained to determine whether we are interfering or not. All he needs is to have reasonable and probable

grounds to believe that we are! Also, many police radars are not sophisticated communications units, they are low-cost, mass produced pieces of equipment with no Federal standards for accuracy and freedom from spurious responses. We all know that poorly-shielded solid state equipment is extremely susceptible to overloading from strong RF fields. How do you know that such a field was not present in the radar unit when you last got a speeding ticket? You don't have to be in the same band if your signal is strong enough.

Two things have to be done.

- 1) Federal standards must be written for police radars, covering accuracy and internal rejection.
- 2) Provincial legislation impinging on the right of the Federal government to make regulations concerning radio must be repealed or fought in the courts.

As radio amateurs, you all have a unique opportunity to act as public watchdogs on radio matters because of your technical ability. Write to your Federal MP, Provincial MPP, and the Minister of Communications NOW!

73 de Bill, VE3 APZ

Useful design ideas from Electronics Today

ETI's More Circuits . . .

Chock full of exciting circuit ideas . . .
Just \$4.50 (plus postage and handling) . . .
Use card in this issue to order . . .

FROM THE PUBLISHERS OF electronics today
CANADA'S OWN ELECTRONICS MAGAZINE

EDITORIAL AND ADVERTISING OFFICES: Unit 8, 28 Queen Street West, Toronto, Ontario, M5H 1P1
Phone: (416) 591-7868
Fax: (416) 591-7868
Subscription Dept: Unit 8, 28 Queen Street West, Toronto, Ontario, M5H 1P1
Phone: (416) 591-7868
Fax: (416) 591-7868

FEATURES & INFO

- 8 PHOTO AMPLIFIERS
- 12 VOLT PA SYSTEM
- 13 CLASS A AMPLIFIER
- 14 CHOPPER FREQUENCY
- 15 HEADPHONE AMPLIFIER
- 16 SIGNAL PROCESSORS
- 17 TRACK AND HOLD CIRCUIT
- 18 ADJUSTABLE SLOPE
- 19 FREQUENCY TO VOLTAGE CONVERTER
- 20 FREQUENCY TO ANALOGUE CONVERTER
- 21 SCHMITT TRIGGER - OPTICAL
- 22 PULSE LENGTHENERS
- 23 SIGNAL GENERATORS
- 24 SQUARE WAVE, LOW FREQUENCY
- 25 MONOSTABLE MULTIVIBRATOR
- 26 TRIANGULAR WAVEFORM GENERATOR
- 27 MARKER GENERATOR
- 28 VOLTAGE AND FREQUENCY CALIBRATOR
- 29 VOLTAGE AND FREQUENCY CALIBRATOR
- 30 VCO, SAMPLE
- 31 TONE BURST GENERATOR
- 32 TONE BURST DECODER
- 33 ENVIRONMENTAL WAVEFORM GENERATOR
- 34 THERMISTOR OSCILLATOR
- 35
- 36
- 37
- 38
- 39
- 40
- 41
- 42
- 43
- 44
- 45
- 46
- 47
- 48
- 49
- 50
- 51
- 52
- 53
- 54
- 55
- 56
- 57
- 58
- 59
- 60
- 61
- 62
- 63
- 64
- 65
- 66
- 67
- 68
- 69
- 70
- 71
- 72
- 73
- 74
- 75
- 76
- 77
- 78
- 79
- 80
- 81
- 82
- 83
- 84
- 85
- 86
- 87
- 88
- 89
- 90
- 91
- 92
- 93
- 94
- 95
- 96
- 97
- 98
- 99
- 100

ALARMS

- 20-21 Comprehensive Burglar Alarm
- 22 SCR Alarm
- 23 Car Radio Protector
- 24 Fire Alarm, Simple
- 25 AMPLIFIERS & PREAMPLIFIERS
- 26 Non-Inverting Amplifier
- 27 IC Amplifier, Simple
- 28 Voltage Follower
- 29 Inverting Amplifier
- 30 Hi-Z Gain Amplifier
- 31 Constant Current Source
- 32
- 33
- 34
- 35
- 36
- 37
- 38
- 39
- 40
- 41
- 42
- 43
- 44
- 45
- 46
- 47
- 48
- 49
- 50
- 51
- 52
- 53
- 54
- 55
- 56
- 57
- 58
- 59
- 60
- 61
- 62
- 63
- 64
- 65
- 66
- 67
- 68
- 69
- 70
- 71
- 72
- 73
- 74
- 75
- 76
- 77
- 78
- 79
- 80
- 81
- 82
- 83
- 84
- 85
- 86
- 87
- 88
- 89
- 90
- 91
- 92
- 93
- 94
- 95
- 96
- 97
- 98
- 99
- 100

POWER SUPPLIES

- 47 Current Source, Drift Free
- 48 Constant Current, High Voltage
- 49 Overvoltage Protection
- 50 High Voltage, Variable Regulator
- 51 Buffered Output
- 52 Dual PSU
- 53 Stable Power Supply
- 54 Low Ripple PSU
- 55 Crosser, Simple
- 56 Circuit Low Voltage, Short Protection
- 57 Low Ripple & Low Current
- 58 30 Volt Regulators
- 59 Standard Configurations
- 60 Converting Single to Dual
- 61 Zener Assistance
- 62
- 63
- 64
- 65
- 66
- 67
- 68
- 69
- 70
- 71
- 72
- 73
- 74
- 75
- 76
- 77
- 78
- 79
- 80
- 81
- 82
- 83
- 84
- 85
- 86
- 87
- 88
- 89
- 90
- 91
- 92
- 93
- 94
- 95
- 96
- 97
- 98
- 99
- 100

DETECTORS & COMPARATORS

- 49 Low Battery Warning
- 50 Recording Voltmeter
- 51 Comparator
- 52 True RMS Detector
- 53 Battery Voltage Monitor
- 54 Temperature Sensor, Differential
- 55 True RMS Converter
- 56 Schmitt Trigger
- 57 Positive Peak Detector
- 58
- 59
- 60
- 61
- 62
- 63
- 64
- 65
- 66
- 67
- 68
- 69
- 70
- 71
- 72
- 73
- 74
- 75
- 76
- 77
- 78
- 79
- 80
- 81
- 82
- 83
- 84
- 85
- 86
- 87
- 88
- 89
- 90
- 91
- 92
- 93
- 94
- 95
- 96
- 97
- 98
- 99
- 100

MIXERS

- 48 Audio Mixer
- 49
- 50
- 51
- 52
- 53
- 54
- 55
- 56
- 57
- 58
- 59
- 60
- 61
- 62
- 63
- 64
- 65
- 66
- 67
- 68
- 69
- 70
- 71
- 72
- 73
- 74
- 75
- 76
- 77
- 78
- 79
- 80
- 81
- 82
- 83
- 84
- 85
- 86
- 87
- 88
- 89
- 90
- 91
- 92
- 93
- 94
- 95
- 96
- 97
- 98
- 99
- 100

INDICATORS

- 47 Neon Tube Indicator
- 48 Warning Flasher
- 49 Transistorized Flasher
- 50 Blown Fuse Indicator
- 51 SWITCHING
- 52 Stereo Input Selector
- 53 Logic Switch, Simple
- 54 Touch Switch
- 55 Stereo Only
- 56 Beam Splitter, Oscilloscope
- 57 Touch Switch, Thermocouple
- 58 AND NOT Switch
- 59 OR Gate, BCR
- 60 LED Character Circuit
- 61
- 62
- 63
- 64
- 65
- 66
- 67
- 68
- 69
- 70
- 71
- 72
- 73
- 74
- 75
- 76
- 77
- 78
- 79
- 80
- 81
- 82
- 83
- 84
- 85
- 86
- 87
- 88
- 89
- 90
- 91
- 92
- 93
- 94
- 95
- 96
- 97
- 98
- 99
- 100

POWER & CONTROL

- 47 Impulse Power
- 48 Half-Wave Control
- 49 Improved Heat Sink
- 50 Zero Burnback Temperature Control
- 51 Triac Slave Flasher
- 52 Triac Slave Controller
- 53 Light Slave, Simple
- 54 DC Line Immunity
- 55 Car or Train Speed Control
- 56 Temperature Controller
- 57
- 58
- 59
- 60
- 61
- 62
- 63
- 64
- 65
- 66
- 67
- 68
- 69
- 70
- 71
- 72
- 73
- 74
- 75
- 76
- 77
- 78
- 79
- 80
- 81
- 82
- 83
- 84
- 85
- 86
- 87
- 88
- 89
- 90
- 91
- 92
- 93
- 94
- 95
- 96
- 97
- 98
- 99
- 100

JM Distribution **JMC** Distribution Inc.
C.P. 142 88 Ave. Laval
Mont-Joli, P.Q., G5H 3K9

YOUR ORIGINAL JAPANESE SEMI-CONDUCTOR SUPPLIER.

LOWEST PRICE FROM CANADA'S LARGEST INVENTORY OF GENUINE REPLACEMENT PARTS FROM JAPAN.

WE'VE, TOO, THE LOWEST PRICE FOR OUR "JMC" TRANSISTOR LINE, SAME AS ECG.

TO RECEIVE OUR TWO (2) PRICE LISTS RUSH US YOUR NAME AND ADDRESS. AND YOUR TYPE OF BUSINESS.

PROMPT DELIVERY!

Special Subscriptions Offer!
For a Limited Time Only ...
FREE "More Circuits" With Your
Electronics Today
Subscription (New OR Renewal)

NEED MORE INFORMATION?

HERE'S HOW TO GET IT

- 1 Fill in the attached card with your name, address, etc.
- 2 Circle the appropriate Reader Service number for further information about advertised products.
- 3 Mail the card and the advertiser will send you literature free of charge. If the card has been removed, or if you want the information in a hurry, phone or write direct to the advertiser and refer to the ETI issue and page number.

MORE CIRCUITS
 FROM THE PUBLISHERS OF **electronics today**
 CANADA'S OWN ELECTRONICS MAGAZINE

EDITOR: STEVE BRACHOWSKI, BSC
Assistant Editor: GREGORY WITTEMAN, BSC
Advertising Manager: MARK CZERNIANSKI, BSC
Advertising Services: JUDITH WILSON
Advertising Representatives: JIM (118) STUM, A
Eastern Canada: RAYN STUM, A
ASSOCIATES INC.: 421 Cox Ave.,
 St. Laurent, Quebec H4E 1A8
Telephone: (514) 48-6561
Subscriptions Department: 881 (A.L.)
Accounts Department: 881 (A.L.)
Service: 881 (A.L.)
Layout and Assembly: G.L. (A.L.)

PUBLISHED SUMMER 1978

EDITORIAL AND ADVERTISING OFFICES: Unit 6, 25 Overlea Boulevard, Toronto, Ontario M4H 1B1
General Office: Unit 6, 25 Overlea Boulevard, Toronto, Ontario M4H 1B1
Production Office: Unit 6, 25 Overlea Boulevard, Toronto, Ontario M4H 1B1
Published by: Electronics Today Inc. (Incorporated in Canada) Ltd., 25 Overlea Boulevard, Toronto, Ontario M4H 1B1
Printed by: Sunlight Printing Ltd., 25 Overlea Boulevard, Toronto, Ontario M4H 1B1
 Copyright © 1978 by Electronics Today Inc. All rights reserved.

FEATURES & INFO

CIRCUIT CONSTRUCTION
 THE IMPORTANCE OF INSTRUMENTS 12
 EASY DIGITAL PANEL METER 18
 ETI PUBLICATIONS AND T-SHIRTS 19
ETI SUBSCRIPTIONS
 ETI CIRCUITS NO. 1 89
CRYSTAL OSCILLATORS
 SPEAKER CROSSEOVERS 94
CMOS FUNCTIONS
 102
TTL FUNCTIONS
 TRUTH TABLES 104
TTL PINOUTS
 CMOS PINOUTS 106
ADVERTISERS' INDEX

CIRCUITS

ALARMS
 Comprehensive Burglar Alarm 20
 SCR Alarm 20,21
 Car Radio Protector 21
FIRE ALARMS & PRE-AMPLIFIERS
 Fire Alarm, Simple 22
 Non-Inverting Amplifier 22
AC Amplifier, Simple
 Voltage Follower 24
 Flexible Response 26
 Hi-Z, Hi-Gain Amplifier 26
 Voltage Controlled Amplifier 26
 Recording Pickup 28
 High Impedance Bridge 28
 Direct Coupled Power 28
 CMOS Power Booster 28

MORE CIRCUITS

30
30
30
32
32
34
34
35
35
35
36
36
36
37
37
38
38
38
39
39
39
40
40
41
41
41
42
42
42,43
43
43
44
44
44
45
45
45
46
46
46
47
47
47

47 **POWER SUPPLIES**
 Current Source, Drift Free 48
 Constant Current, High Voltage 48
 Output Current, Adjustable 48
 High Voltage, Variable Regulator 49
 Switched Output 49
 Dual PSU 50
 Mobile Power Supply 50
 Low Ripple PSU 51
 Crowbar Simple 51
 Circuit Low Voltage, Short Protection 52
 Low Ripple at Low Current 52
 30 Volt Regulators 52
 Standard Configurations 57
 Converting Single to Dual 57
 Zener Assistance 57

TEST
 Logic Indicator, Audible 57
 FET Testing, Static 58
 Diode Tester 59
 Ammeter, Wide Range 59
 Multimeter, Audio 59
 DC Probe 100 000 Megohm 60
 Transformer Inductor Tester 60
 Pulse Catcher, Probe 60
FET Test, Quick
 DIGITAL
 Data Selector, Two Way 61
 3 Chip Dis 62
 Hex to 7 Segment 62
 Binary Calculator 63
 TTL Keyer 63
 ASCII Keyboard 63
 Counter Display Module 63
 Multiphas Clock Generator 63
 Self Clear 63
AUTOMOBILE
 Fuel Gauge, Digital 64
 Immobilization, Automobile 64
MISCELLANEA
 Emergency Light 64
 Digital Thermometer 65
 SCR Drive, Short 65
 SCR Multimeter 65
 Meter Amplifier 65
 Night Light, Automatic 66
 Headphone Additor 66
 Timing Edge Trigger 66
 Junction Transducer, Digital 66
 Temperature Stabilized Relay 66

REGULARLY \$4.50

Hurry! Offer closes Dec 15th 1979

The ETI newsstand rate is \$18 a year.
With a subscription you pay only \$14 dollars!

Please use the card to order your subscription

OR SEND a cheque, money order, Chargex, or Master Charge information, to Electronics Today Magazine, Unit 6, 25 Overlea Blvd., Toronto, Ontario, M4H 1B1.

Allow 6-8 weeks to receive your first issue.

YOUR COMPANY CLASSIFICATION (IF APPLICABLE):

- A. Manufacturer
- B. Retailer
- C. Government
- D. R & D
- E. Service
- F. Distributor
- G. Representative
- H. Educational Institution

IN THE FIELD OF:

1. Computer and Related Equipment
2. Communications Equipment and Systems
3. Navigation, Guidance or Control Systems
4. Test & Measurement Equipment
5. Consumer Products
6. Industrial Controls & Equipment
7. Components and Subassemblies
8. Other (Please specify on the card)

YOUR MAJOR JOB FUNCTION (IF APPLICABLE):

- A. Buying
- B. Technologist
- C. Educator
- D. Not employed in an electronics-related field
- E. Service Engineering Technician
- F. Manufacturing Supervisor
- G. Other (Please specify on the card)

WHAT INTERESTS YOU MOST ABOUT ETI? (YOUR FAVOURITE FIVE OR LESS):

- A. Audio
- B. Video
- C. Ham Radio
- D. Shortwave World
- E. Service News
- F. Components and Technology
- G. Reports on the Electronics Industry
- H. Microcomputers
- I. Softspot
- J. Projects
- K. News Digest
- L. Other (Please specify on the card)

Babani Books From ETI

Specially Imported from England!

Please Use Card to Order

Is electronics your interest? Then get into it more deeply in the special areas of your choice. Electronics Today carries a range of electronics books published by Babani Press and Bernards, amongst which are those described below. (If someone has already used the card, write to Electronics Today Magazine, Unit 6, 25 Overlea Blvd, Toronto, Ontario M4H 1B1)

Select from this collection of fascinating pocket books.

IC 555 Projects

BP44

- Every so often a device appears that is so useful that one wonders how it went on before without it. The 555 timer is such a device.
 - It was first manufactured by Signetics, but is now manufactured by almost every semiconductor manufacturer and is inexpensive and very easily obtainable.
 - Included in this book are Basic and General Circuits, Motor Car and Model Railway Circuits, Alarms and Noise Makers as well as a section on the 556, 558 and 559 timers.
 - An invaluable addition to the library of all those interested in Electronics.
- Price \$4.30 including 30¢ postage and handling

52 Projects Using IC741

BP24

- IC741 is one of the most popular, inexpensive and easily obtainable devices available to the home constructor. It is also extremely versatile and can be used in a great number of various applications.
 - This unique book, originally published in Germany, shows fifty-two different projects that can be simply constructed using only the IC741 and a few discrete components.
 - An invaluable addition to the library of all those interested in electronics.
- Price \$2.70 including 30¢ postage and handling

Mobile Discotheque Handbook

BP47

- The vast majority of people who start up 'Mobile Discos' know very little about their equipment or even what to buy. Many people have wasted a "small fortune" on poor, unnecessary or badly matched apparatus.
 - The aim of this book is to give you enough information to enable you to have a better understanding of many aspects of "disco gear".
 - The approach adopted is to assume the reader has no knowledge and starts with the fundamentals, hopefully the explanations given are simplified enough for almost anyone to understand but please not that this is by no means the full story.
 - The book is divided into six parts: — Basic Electricity, Audio Ancillary Equipment, Cables and Plugs, Loudspeakers, Lighting Equipment and the information has been considerably sub-divided for quick and easy reference.
- Price \$4.80 including 30¢ postage and handling

28 Tested Transistor Projects

No. 221

- Mr Richard Torrens is a well experienced electronics development engineer and has designed, developed, built and tested the many useful and interesting circuits included in this book.
 - Some of the circuits are completely new and, to the best knowledge of the author, unlike anything previously published while others may bear similarity to more familiar designs.
 - The projects themselves can be split down into simpler building blocks which are shown separated by boxes in the circuits for ease of description, and also to enable any reader who wishes to combine boxes from different projects to realize ideas of his own.
 - Most of the circuits are very economical on the use of components and in many cases the semiconductors employed are non-critical, commonly available and inexpensive types.
- Price \$3.15 including 30¢ postage and handling

First Book of Transistor Equivalents and Substitutes

BP1

- Shows alternatives and equivalents to many popular transistors made in Great Britain, U.S.A., Europe, Japan and Hong Kong etc.
 - Companion Volume to BP14 — SECOND BOOK OF TRANSISTOR EQUIVALENTS AND SUBSTITUTES
 - An invaluable addition to the library of all those interested in Electronics be they amateur or professional.
- Price \$2.30 including 30¢ postage and handling

Second Book of Transistor Equivalents and Substitutes

BP14

- Shows alternatives and equivalents to many popular transistors made in Gt. Britain, U.S.A., Europe, Japan and Hong Kong etc.
 - Companion Volume to BP1 — FIRST BOOK OF TRANSISTOR EQUIVALENTS AND SUBSTITUTES
 - An invaluable addition to the library of all those interested in Electronics be they amateur or professional.
- Price \$3.55 including 30¢ postage and handling

Radio Circuits Using IC's

BP46

- This book describes integrated circuits and how they can be employed in receivers for the reception of either amplitude or frequency modulated signals. The chapter on amplitude modulated (a.m.) receivers will be of most interest to those who wish to receive distant stations at only moderate audio quality, whilst the chapter on frequency modulation (f.m.) receivers will appeal to those who desire high fidelity reception of local v.h.f. stations possibly with stereo (and even quadrophony at some future date). Stereo decoder circuits and the devices available at present for quadrophonic circuits are discussed. Voltage regulator devices are also covered because they are so convenient in all varicap tuned receivers and because they have so many applications in all types of circuit.
 - Brian Dance is a highly experienced author who regularly contributes to many of the popular electronic magazines that are a valuable both in the U.K. and overseas.
 - An extremely valuable addition to the library of all Electronics enthusiasts.
- Price \$4.80 including 30¢ postage and handling

50 (FET) Field Effect Transistor Projects

BP39

- Field effect transistors (FET's) find application in a wide variety of circuits. The projects described here include radio frequency amplifiers and converters, test equipment and receiver aids (tuners, receivers, mixers and tone controls) as well as various miscellaneous devices which are useful in the home.
 - It will be found that in general the actual FET used is not critical and many suitable types will perform satisfactorily. The FET is a low-noise, high gain device with many uses, and the dual gate FET is of particular use for mixer and other applications.
 - This book contains something of particular interest for every class of enthusiast — shortwave listener, radio amateur, experimenter or audio devotee.
 - A valuable addition to the library of all electronic enthusiasts.
- Price \$3.85 including 30¢ postage and handling

Popular Electronic Projects

BP49

- Included in this book are a collection of the most popular types of projects which we feel sure will provide many designs to interest all electronics enthusiasts.
 - All the circuits utilise modern, inexpensive and freely available components.
 - The 27 projects selected cover a very wide range and are divided into four basic areas: Radio Projects, Audio Projects, Household Projects and Test Instruments.
 - An interesting addition to the library of both the beginner and more advanced constructor.
- Price \$5.10 including 30¢ postage and handling

Electronic Music and Creative Tape Recording

- Electronic Music is the new music of the 20th Century. It plays a large part in Pop and Rock music and in fact there is scarcely a group without some sort of electronic synthesiser or other effects generator.
 - It is possible with relatively simple apparatus to create complete compositions using electronic and sometimes non-electronic musical sources.
 - This book sets out to show how Electronic Music can be made at home with the simplest and most inexpensive equipment. It describes how the sounds are generated and how these may be recorded to build up the final composition.
 - With the constructor in mind, several ideas are given to enable a small studio to be built including a mixer and various sound effect units.
 - Circuits are included for VCO's, VCA's, Envelope Shapers, VCF's, Active and Passive Mixers, Fuzz, Noise Generators, Metronomes and a 10-Note Programmable Sequencer etc.
 - All the units shown have been successfully built and used by the author and most of the projects can be built by the beginner.
 - An unusual, fascinating and highly rewarding application of electronics.
- Price \$4.50 including 30¢ postage and handling

IC LM3900 Projects

BP50

- The purpose of this book is to introduce the LM3900 to the Technician, Experimenter and Hobbyist. It provides the groundwork for both simple and more advanced uses and is considerably more than just a collection of simple circuits or projects.
 - The LM3900 is different from conventional Op-Amps: it can be used for many of the usual applications as well as many new ones. It is one of the most versatile, inexpensive and readily available devices on the market today.
 - The book is divided into six basic sections: — Introduction, Audio Applications, Simple Linear Applications, Simple Digital Applications, Signal Generator Circuits, Special Applications.
 - The LM3900 can do much more than is shown here. This is just an introduction; imagination is the only limitation with this useful device but first the reader must know the basics and that is what this book is all about.
- Price \$4.80 including 30¢ postage and handling

1st Book of Hi-Fi Loudspeaker Enclosures

- Contains 26 practical designs and over 40 drawings to enable the enthusiast to construct his own Hi-Fi Loudspeaker enclosures.
 - Includes the following types of enclosures: Corner Reflex, Bass Reflex, Exponential Horn, Folded Horn, Tuned Port, Kipschorn, Labyrinth, Tuned Column, Loaded Port, Multispeaker, Parabolic etc.
 - Also covers general construction hints and embellishing of cabinets as well as a considerable amount of other useful information.
 - A must for the library of all audio enthusiasts.
- Price \$3.05 including 30¢ postage and handling

50 Simple L.E.D. Circuits

BP42

- The author of this book, Mr R.N. Soar, has compiled 50 interesting and useful circuits and applications, covering many different branches of electronics, using one of the most inexpensive and freely available components — the Light Emitting Diode (L.E.D.).
 - Also includes circuits for the 707 Common Anode Display.
 - A useful book for the library of both beginner and more advanced enthusiasts alike.
 - Companion volume to book No. BP36 — 50 CIRCUITS USING GERMANIUM, SILICON & ZENER DIODES by the same author.
- Price \$3.05 including 30¢ postage and handling

Handbook of IC Audio Preamplifier & Power Amplifier Construction

BP35

- Shows what audio IC's are, as well as how to use them.
 - Includes practical constructional details of various IC and Hybrid IC Transistor designs of about 250mW to 100W output.
 - This book is written by the very experienced and popular author Mr F.G. Rayer who deals with the subject in four parts: Part I Understanding Audio IC's, Part II Preamplifiers Mixers and Tone Controls, Part III Power Amplifiers and Supplies, Part IV Hybrid Circuits.
 - An ideal book for both beginner and advanced enthusiast alike.
- Price \$3.15 including 30¢ postage and handling

50 Projects Using Relays SCR's & Triacs

BP37

- Relays, silicon controlled rectifiers (SCR's) and bi-directional triodes (TRIACs) have a wide range of applications in electronics today. These may extend over the whole field of motor control, dimming and heat control, delayed timing and light sensitive circuits and include warning devices, various novelties, light modulators, priority indicators, excess voltage breakers etc.
 - In this book the very experienced and popular author Mr F.G. Rayer has given tried and practical working circuits which should present the minimum of difficulty for the enthusiast to construct.
 - In most circuits there is a wide latitude in component values and types, allowing easy modification of circuits or ready adaptation of them to individual needs.
 - An ideal book for both beginner and advanced enthusiast alike.
- Price \$4.05 including 30¢ postage and handling

50 Projects Using IC CA3130

No. 223

- The CA 3130 is currently one of the more advanced operational amplifiers that is available to the home constructor. This means that it is often capable of a higher level of performance than many other devices and that it often needs fewer ancillary components.
 - In this book Mr R.A. Penfold has designed and developed a number of interesting and useful projects which are divided into five general categories: I Audio Projects, II R.F. Projects, III Test Equipment, IV Household Projects, V Miscellaneous Projects.
 - An ideal book for both the beginner and more advanced enthusiast alike.
- Price \$3.15 including 30¢ postage and handling

Electronic Projects for Beginners

BP48

- In this book the newcomer to electronics will find a wide range of easily made projects, many complete with actual component and wiring layouts. Furthermore a number of projects have been arranged so that they can be constructed without any need for soldering and, thus, avoid the need for a soldering iron.
 - This book which is written by the very experienced author Mr F.G. Rayer is divided into four sections: —
 - 1 No Soldering Devices
 - 2 Miscellaneous Projects
 - 3 Radio and Audio Frequency
 - 4 Power Supplies
 - An absolute 'must' for all beginners in electronics.
- Price \$4.80 including 30¢ postage and handling

50 CMOS IC Projects

No. 224

- CMOS IC's are probably the most versatile range of digital devices for use by the amateur enthusiast. They are suitable for an extraordinarily wide range of applications and are now also some of the most inexpensive and easily available types of IC.
 - In this book Mr R.A. Penfold has designed and developed a number of interesting and useful projects which are divided into four general categories: I Multivibrators, II Amplifiers and Oscillators, III Trigger Devices, IV Special Devices.
 - An ideal book for both the beginner and more advanced enthusiasts alike.
- Price \$3.10 including 30¢ postage and handling

Electronic Calculator Users Handbook

BP33

- An invaluable book for all calculator users whatever their age or occupation or whether they have the simplest or most sophisticated of calculators.
 - Presents formulae, data, methods of calculation, conversion factors etc. with the calculator user especially in mind often illustrated with simple examples.
 - The way to calculate, using only a simple four function calculator.
 - Trigonometric functions (sin, cos, tan), Hyperbolic functions (sinh, cosh, tanh), Logarithms, square roots and powers.
 - A comprehensive section of conversion factors covering such common conversions as length, area, volume and weight etc. through to more specialised conversions such as viscosity, illumination, and cargo shipping measures etc.
 - Formulae and data for VAT, discounts and mark up, currency conversion, interest, solutions of equations, binary and octal numbers, areas and volumes, statistics and mathematics etc.
- Price \$3.20 including 30¢ postage and handling

ETI Special Book Service

Sam's Books from ETI

New Selection!

Please see page 66 for prices and ordering instructions.

LED CIRCUITS AND PROJECTS

by *Forrest M. Mims III*. Describes all kinds of LED applications—from digital displays and logic tester probes to communication systems and travel aids for the blind. Discusses LED installation, operating hints, LED detector circuits, multiple-color LEDs, diode laser theory and operation, and much more. Lots of photos, graphs, tables, and drawings. 176 pages; 5½ x 8½; softbound. (ISBN: 0-672-21006-1) © 1973

No. 21006

UNDERSTANDING IC OPERATIONAL AMPLIFIERS (2nd Edition)

by *Roger Melen and Harry Garland*. Explains how IC op amps work and how they can be used in many practical circuits. Features the newest material on FET op amps. Also gives detailed information on basic semiconductor electronics, integrated op-amp circuitry, practical design considerations in circuits using IC op amps, bias current, offset voltage, frequency compensation, and slew rate. 128 pages; 5½ x 8½; softbound. (ISBN: 0-672-21511-X) © 1978

No. 21511

ACTIVE-FILTER COOKBOOK

by *Don Lancaster*. A practical, user-oriented treatment of active filters. Explains what active filters are and how they work, and gives detailed information on design, analysis, and synthesis techniques. Explores some interesting applications for active filters in brainwave research, electronic music, quadrature art, and psychedelic lighting. 240 pages; 5½ x 8½; softbound. (ISBN: 0-872-21168-8) © 1975

No. 21168

WIND/SOLAR ENERGY for Radiocommunications and Low-Power Electronic/Electric Applications

by *Edward M. Noll*. This is a book for those with an eye towards the future. It discusses the use of wind and solar energy as alternative sources of electricity. It covers energy-conversion principles, batteries, inverters, alternators, the electric auto, and practical wind/solar applications such as a 200-watt wind generator and a solar-powered amateur radio station. 208 pages; 5½ x 8½; softbound. (ISBN: 0-672-21305-2) © 1975

No. 21305

AUDIO CYCLOPEDIA (2nd Edition)

by *Dr. Howard M. Tremaine*. A complete audio reference library in itself and the most comprehensive and authoritative work on audio available. Covers every aspect of the audio art—from the basic principles of sound to the latest in solid-state equipment. Complete coverage of acoustics, motion picture equipment, recording, reproduction, test equipment, audio measurements, and much more. 3650 entries and hundreds of illustrations and schematics. 1760 pages; 8½ x 9¾; hardbound. (ISBN: 0-672-20675-7) © 1969

No. 20675

ABC'S OF INTEGRATED CIRCUITS (2nd Edition)

by *Rufus P. Turner*. Especially written for readers with a knowledge of basic electronics, this book approaches the survey of the IC in a descriptive and practical manner. The new edition describes the latest circuits with a minimum of theory and mathematics. 96 pages; 5½ x 8½; softbound. (ISBN: 0-672-21462-8) © 1977

No. 21462

BUILDING AND INSTALLING ELECTRONIC INTRUSION ALARMS (2nd Edition)

by *John E. Cunningham*. Countermeasures to offset crime are suggested in this book written for the novice who wants to install a security system in his home and the technician who wishes to enter the lucrative field of security electronics. Countermeasures outlined include electromechanical intrusion alarms, sensors and switches, closed-circuit television, proximity alarms, power supplies, telephone attachments, and alarms for the protection of automobiles. 128 pages; 5½ x 8½; softbound. (ISBN: 0-672-21485-2) © 1977

No. 21485

UNDERSTANDING CMOS INTEGRATED CIRCUITS

by *Roger Melen and Harry Garland*. Takes a building-block approach to the subject of complementary metal-oxide semiconductors. Begins with basic digital ICs; then covers semiconductor physics, CMOS fabrication technology and design, and advanced CMOS applications. 144 pages; 5½ x 8½; softbound. (ISBN: 0-672-21129-7) © 1975

No. 21129

DBUG: AN 8080 INTERPRETIVE DEBUGGER

by *Jonathan A. Titus and Christopher A. Titus*. This text describes DBUG, a software debugging package for 8080-based microcomputers. It describes the operation of the program and how it can be applied to program development and testing. Complete with documented hexadecimal and octal listings. 112 pages; 5½ x 8½; softbound. (ISBN: 0-672-21538-5) © 1977

No. 21538

DESIGN OF PHASE-LOCKED LOOP CIRCUITS, WITH EXPERIMENTS

by *Howard M. Berlin*. The design of the basic PLL circuits is described; detector, phase comparator, and voltage-controlled oscillator circuits are detailed. Contains many practical circuits using the 560-series devices and the CMOS 4046 chip. With over 15 experiments. 288 pages; 5½ x 8½; softbound. (ISBN: 0-672-21545-4) © 1978

No. 21545

MODERN RECORDING TECHNIQUES

by *Robert E. Runstein*. Provides the information necessary to prepare pop music recordings. Explains the equipment, controls, and techniques found in the modern recording studio and how to use them not only properly but creatively to produce a desired result. Numerous photographs, diagrams, and charts. 368 pages; 5½ x 8½; softbound. (ISBN: 0-672-21037-1) © 1974

No. 21037

HOW TO READ SCHEMATIC DIAGRAMS (3rd Edition)

by *Donald E. Herrington*. Explains the various types of electronic diagrams, shows the schematic symbols for the various components in a circuit, and explains their operation. Tells how they are connected into circuits and gives the symbols for these connections. Variations likely to be encountered in both symbols and designations are treated at length. Review questions at end of each chapter. 192 pages; 5½ x 8½; softbound. (ISBN: 0-672-21127-0) © 1975

No. 21127

AVIATION ELECTRONICS (3rd Edition)

by *Keith Bose*. Using a practical approach, this third edition updates, describes, and shows representative types of electronic equipment that is vital in today's aircraft. This informative handbook has been written as a guide for aircraft owners, pilots, technicians, engineers, and anyone else who might require a knowledge of aviation electronic equipment. It is liberally illustrated with photographs, schematics, and drawings. 300 pages; 5½ x 8½; softbound. (ISBN: 0-672-21440-7) © 1977

No. 21440

SOLAR CELLS AND PHOTOCELLS

by *Rufus P. Turner*. An explanation of photocells and solar cells, and a selected collection of practical applications, such as a light-beam communicator, light-powered tone telegraph, and light-actuated remote control. Addressed primarily to experimenters, technicians, and science fair entrants; assumes that the reader is already familiar with general electronics. 96 pages; 5½ x 8½; softbound. (ISBN: 0-672-21175-0) © 1975

No. 21175

30 IC PROJECTS

by *Herbert Friedman*. Complete instructions, parts lists, and schematic diagrams for 30 different integrated-circuit projects, most of which can be built in a few hours and at low cost. The projects include a walkie-talkie power pack, budget-priced tape-head preamplifier, 4-channel microphone mixer, timed auto burglar alarm, light meter, stereo balancer, and portable intercom. 80 pages; 5½ x 8½; softbound. (ISBN: 0-672-21145-9) © 1975

No. 21145

Held Over!

TTL COOKBOOK

by *Donald Lancaster*. A complete and detailed guide to transistor-transistor logic. Explains what TTL is, how it works, and how to use it. Discusses practical applications, such as a digital counter and display system, events counter, electronic stopwatch, digital voltmeter, and a digital tachometer. 336 pages; 5½ x 8½; softbound. (ISBN: 0-672-21035-5) © 1974

No. 21035

IC TIMER COOKBOOK

by *Walter Jung*. Provides an excellent introduction to the field of IC timers by presenting a collection of various circuit "recipes" useful in applying the devices. Arranged in three parts, the first part gives basic and generalized information. Part II, the applications section, is the "meat" of the book and includes over 100 different circuits for a wide range of uses. Part III contains reproductions of manufacturers data sheets, second-source manufacturers, and more. This book is a valuable reference for the hobbyist, the technical or engineering student, or professional. 288 pages; 5½ x 8½; softbound. (ISBN: 0-672-21416-4) © 1977

No. 21416

Order Form *Bon de commande*

PLEASE PRINT

NAME/NOM: _____
 A(D)RESS(E): _____
 TOWN/CITY/VILLE: _____
 PROVINCE: _____ POSTAL CODE
 CODE POSTAL: _____

DATE: _____

QUANTITY QUANTITE	NO.	TITLE TITRE	TOTAL	WEIGHT POIDS
.....	21037	Modern Rec...15oz \$13.95	\$oz.
.....	21127	How to Read...8oz \$7.25	\$oz.
.....	21168	Active Filtr...10oz \$19.95	\$oz.
.....	21462	ABCs of ICs...5oz \$5.25	\$oz.
.....	21465	Building and Inst...6oz \$6.75	\$oz.
.....	21511	Understanding IC...6oz \$6.75	\$oz.
.....	21536	D.BUG 8080...5oz \$6.75	\$oz.
.....	21545	Design PLL...10oz \$11.95	\$oz.
.....	20675	Audio Cyclopedi...32oz \$52.95	\$oz.
.....	21305	Wind/Solar...9oz \$10.50	\$oz.
.....	21440	Aviation Elec...10oz \$11.95	\$oz.
.....	21129	Understand CMOS...7oz \$6.75	\$oz.
.....	21006	LED Circuits...7oz \$7.00	\$oz.
.....	21145	30 IC Proj...4oz \$4.75	\$oz.
.....	21175	Solar Cells...11oz \$5.50	\$oz.
.....	21035	TTL Cookbook...13oz \$12.75	\$oz.
.....	21416	IC Timer...12oz \$13.25	\$oz.
.....	21398	CMOS Cookbook... 16oz \$13.95	\$oz.
.....	21538	The 555 Timer...7.5oz \$7.95	\$oz.
.....	21524	Cheap Video...11oz \$7.95	\$oz.
.....	21313	TV Typewriter...11oz \$13.25	\$oz.
.....	21500	The Z80...12.5oz \$11.95	\$oz.
.....	21447	8080A Bugbook...16oz \$13.95	\$oz.
.....	21512	Using the 6800...8oz \$9.25	\$oz.
.....	F84	D'autres Montages...7oz \$14.60	\$oz.
.....	F130	100 Montages Electr...9oz \$17.90	\$oz.
.....	F75	Prod. Musique Electr...9oz \$16.85	\$oz.
.....	F91	Init. a l'Electricite...7oz \$15.95	\$oz.
.....	F7	L'amplificateur op...5oz \$11.90	\$oz.
.....	F12	Pour s'Initier...7oz \$12.90	\$oz.
.....	F3	Comment cons...10oz \$11.40	\$oz.
.....	F125	Initiation micro...16oz \$12.30	\$oz.
.....	F124	30 Montages d'alarme...5oz \$8.65	\$oz.
.....	F14	Les jeux...7oz \$14.15	\$oz.

ETI CANADA—DECEMBER 1979

Total Number of Books
Nombre Total de livres. _____

SUBTOTAL
 SOUS-TOTAL \$ _____ oz.

POST* \$ _____

TOTAL \$ _____

*Please refer to postal rate chart.
 Consulter le tableau des tarifs postaux.

Cheques over \$25 must be certified.
 Les chèques de plus de \$25 doivent être certifiés.

Please make cheque or money order payable to
 "ETI Special Book Service".

Les chèques ou les mandat-poste doivent être a
 l'ordre du "Service spécial de livres ETI."

Send to:
 Poster au:

Please note: we are only able
 to accept orders by mail!

Remarque: nous ne pouvons accepter que
 les commandes postales.

ETI Special Book Service, 4050, Jean Talon St., W., Montréal PQ H4P 1W1.

ETI Special Book Service

ORDERING INFORMATION

BY SPECIAL ARRANGEMENT, Electronics Today Magazine is able to supply Sam's Technical Books, and certain French language technical publications. These are available through the ETI Special Book Service, from Montreal. Use the coupon on this page to order these books.

In order to bring you these books in the most economical way, we are only able to accept payment by cheque or money order. Please make it payable to: ETI Special Book Service.

PLEASE SEE SEPARATE ORDERING INSTRUCTIONS FOR SUBSCRIPTIONS, BABANI BOOKS, AND OTHER ITEMS ON THE CARD IN THIS ISSUE, PAGE 62.

Service spécial des livres ETI

Renseignements Pour Les Commandes

SUITE À UNE ENTENTE SPÉCIALE, le magazine Electronics Today est en mesure de fournir les livres techniques Sam ainsi que certaines autres publications de langue française. On peut se les procurer en postant le bon de commande ci-joint au Service spécial de livres ETI de Montréal. Afin d'offrir ces livres à des prix minimaux, nous ne pouvons accepter que les paiements par chèque ou mandat-poste à l'ordre du Service spécial de livres ETI.

POUR TOUT RENSEIGNEMENT CONCERNANT LES ABONNEMENTS, LES LIVRES BABANI ET AUTRES RUBRIQUES, CONSULTEZ LA CARTE EN PAGE 62 DU PRÉSENT NUMÉRO.

Postal Rate Chart
 Pounds/Livres Tableau des tarifs postaux

Destination	0-5	6-10	11-20	21-30	31+
QUÉ.	.40	.30	.15	.12	.09
ONT.	.45	.35	.20	.14	.12
N.S.					
N.B.					
P.É.I.	.50	.40	.20	.15	.12
NFLD.					
MAN.	.55	.45	.25	.18	.15
SASK.					
ALB.	.60	.50	.25	.20	.17
B.C.	.65	.55	.30	.22	.19
YUKON	.80	.60	.35	.25	.21
NWT	.60	.55	.55	.60	.55

Cents/Pound Cents/Livre
 (Incl Ins/Incl ass.)

Example: Destination Yukon, weight/poids
 261 ounces/onces:
 261 oz = (approx/env) 17 lb
 5 x 80c + 5 x 60c + 7 x 35c = \$9.45

ETI Special Book Service, 4050 Jean Talon W., Montreal PQ H4P 1W1.

NOW!

Electronics Today is now offering this fine set of exciting electronics books from TAB!

Tab Books From ETI

Order by number using handy card in this issue!

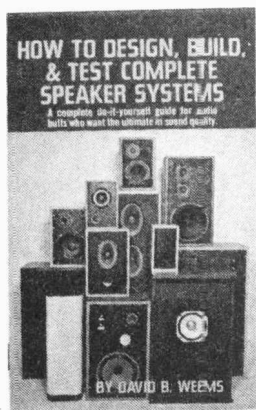

1064 \$8.50+.90=\$9.40

If you've always wanted to build your own speaker system, here is a book crammed with everything you need to know to do it right. The "real time" it contains a variety of ready-to-build speaker system projects, from simple speakers that can attach to stereo multi-track systems, plus all the information even a beginner needs to design and build his or her own. The clear guide shows you exactly how a speaker works, how its power and resonance are attained, and how speakers may differ from one another. The author also reveals details on single and multiple drive systems, crossover frequencies and networks, parallel net work, and voice coil induction. There are chapters on testing speakers and comparing speaker boxes, cross-coupling systems, radio systems, subwoofers and transmission lines, omnidirectional speakers, multiple speaker arrays and much more. It is as thorough a book as you'll find on the complete subject of speaker systems and enclosures. The author is a freelance writer whose articles have appeared in all major electronics magazines.

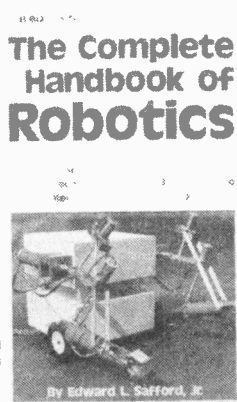

1071 \$9.75+.90=\$10.65

Create your own robot! As the information you need to build a walking, talking friend and companion or a helpful servant appears in this book. Your robot can take on many forms and operate in any way you choose. Every possible option is covered in minute detail, including sight, sound, heat and proximity sensors, microcomputer brains, laser and TV-CAD and optical system sources, scanner lenses, laser optic eyes, ball and gas valves, servo mechanisms, clutches and governors, stepping motors, solenoids, relay and relays, pneumatic and hydraulic systems and valves. The kit goes on and on. Do want to you want a robot for experimentation for a security application as a house help to answer the neighborhood kids or perform some task suitable for a "smart machine" all the ideas you need are packed into this book. Auth: of many previous TAB books. Ed Safford is a veteran writer and an authority on electrical and electronic subjects.

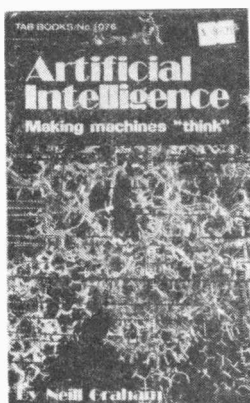

1076 \$9.75+.60=\$10.35

Artificial intelligence is the branch of computer science devoted to programming computers to carry out tasks that are carried out by human beings, and that require intelligence. Here is a book that deals with the design, development and programming of computers that can be considered intelligent. The author presents details on robotics and chess and other game playing programs, debugging and debugging specific circuit problems, searches, and accomplishments. The end result is a fast changing branch of computer science, an advanced programming, that will open a new world of computer accomplishment for you whether you are an engineer, technician or a computer hobbyist. Neil Frahm, an experienced computer technician, makes his home in Athens, West Virginia.

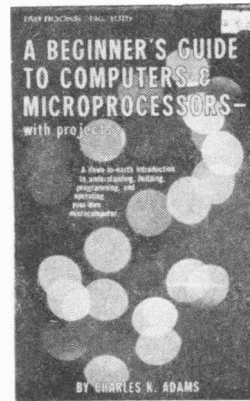

1015 \$8.50+.75=\$9.25

Here is a plain-English introduction to the fascinating world of the microcomputer - its capabilities, parts, functions, and programming, and how you can have one in your own home. Numerous projects using actual computer parts demonstrate the operation of a computer and lead to the assembly of a working microcomputer capable of performing many useful functions around the home and office. A typical family sized computer, with video screen, control panel and keyboard is fully described - a machine on which children can do homework, math to play games, and find out anything from the family budget to his income tax. You can have your own computer in your home now at a fraction of the cost of a commercially built unit, simply by obtaining the parts at reasonable cost and putting them together in your home. This book shows you how it is done. It explains the electronics, circuitry and how computers and microprocessors work and gives you instructions on assembling your own programming, if you wish to do effective use and maintaining it in top working condition. A detailed example of the assembling and programming of a specific computer is included.



1000 \$9.75+.60=\$10.35

Programs for everything from space war games to blackjack...from craps to Ping! This book contains 57 practical programs and games written in BASIC. The programs are designed to be easy to learn and use, and are suitable for both beginners and experienced programmers. The author is Ken Traxton, a freelance writer and programmer.

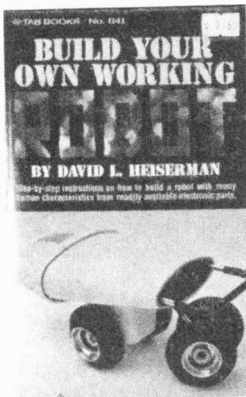

841 \$7.50+.60=\$8.10

Build your own working robot! This book shows you how to build a robot with many human characteristics from readily available electronic parts. The robot is designed to be easy to build and use, and is suitable for both beginners and experienced hobbyists. The author is David L. Heiserman, a freelance writer and hobbyist.



1070 \$10.95+1.35=\$12.30

How to design circuit to interface microprocessor computers and other digital devices with the analog world. This book shows you how to design circuit to interface microprocessor computers and other digital devices with the analog world. The author is David L. Heiserman, a freelance writer and hobbyist.



1101 \$11.95+1.35=\$13.30

The COMPLETE book on designing, building, programming, and modifying all kinds of TV games! This book shows you how to design, build, and program your own custom TV games. The author is David L. Heiserman, a freelance writer and hobbyist.

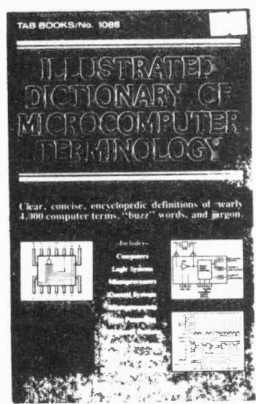

1088 \$9.75+.90=\$10.65

A comprehensive collection of 1001 integrated circuit and transistor circuits with all the data needed to put them to work. Alarm—Audio—Amplifiers—Automotive—Filters—Logic—Counters—Clocks—Power Supplies—Voltage Multipliers—Receivers—RF Pre-amplifiers & Converters—Regulators—RF Generators & Waveformers—RF Power Amplifiers—Test Equipment—Control & Tone Circuits—Carrier-Operated Relays and Other Repeater Circuits—Timers—Transmitters, Transceivers, Exciters & VFO Circuits—Battery Chargers—Diode Circuits—Miscellaneous Circuits.

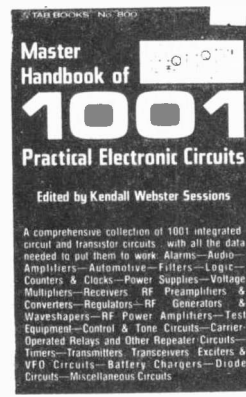

800 \$11.95+1.35=\$13.30

A comprehensive collection of 1001 integrated circuit and transistor circuits with all the data needed to put them to work. Alarm—Audio—Amplifiers—Automotive—Filters—Logic—Counters—Clocks—Power Supplies—Voltage Multipliers—Receivers—RF Pre-amplifiers & Converters—Regulators—RF Generators & Waveformers—RF Power Amplifiers—Test Equipment—Control & Tone Circuits—Carrier-Operated Relays and Other Repeater Circuits—Timers—Transmitters, Transceivers, Exciters & VFO Circuits—Battery Chargers—Diode Circuits—Miscellaneous Circuits.

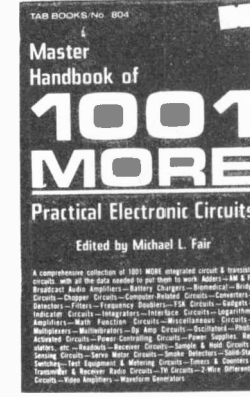

804 \$15.50+1.40=\$16.90

A comprehensive collection of 1001 more integrated circuit and transistor circuits with all the data needed to put them to work. Alarm—Audio—Amplifiers—Automotive—Filters—Logic—Counters—Clocks—Power Supplies—Voltage Multipliers—Receivers—RF Pre-amplifiers & Converters—Regulators—RF Generators & Waveformers—RF Power Amplifiers—Test Equipment—Control & Tone Circuits—Carrier-Operated Relays and Other Repeater Circuits—Timers—Transmitters, Transceivers, Exciters & VFO Circuits—Battery Chargers—Diode Circuits—Miscellaneous Circuits.

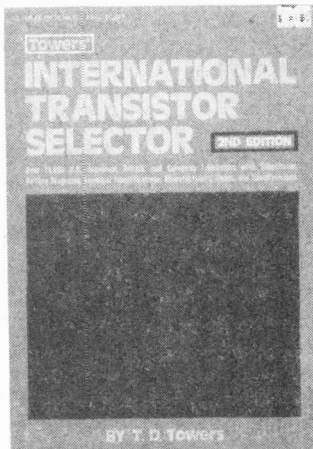

1010 \$8.50+.90=\$9.40

The 1975 edition of the transistor selector and circuitry handbook with 1,000 transistor types and 1,000 circuitry examples.

Prices shown are cover price plus postage and packing. As you can see from the postage, many of these books are heavies!

Practical Guide To Triacs Part I

Triacs are simple, versatile devices used throughout electrical and electronic engineering. Yet most electricians regard them with almost superstitious awe. This three-part article describes their uses in a totally practical way.

Part 1—Switching circuits

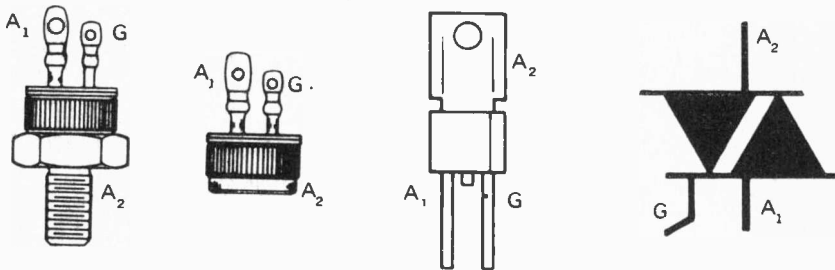

Fig. 1. Construction and electrical connections of typical Triacs.

ELECTRONICS, according to a friend of ours, is anything electrical that he doesn't use or understand.

Triacs, by this definition, must soon be considered non-electronic, for they are finding ever-increasing use throughout electrical engineering — in both consumer and industrial applications.

In effect, a Triac is similar to a latching relay. It closes — practically instantaneously — after being triggered, and remains closed until the supply voltage is reduced to zero (or changes polarity). When this occurs (twice every complete cycle if used on ac) the Triac opens, but will close again almost instantaneously if retriggered.

STATIC SWITCHING

Triacs can usefully replace mechanical switches in ac circuits. They allow the control of relatively high power by very low triggering current — and as Triacs latch each half-cycle there is no contact bounce; nor, as they open only at current zero, is any arcing or transient voltage developed due to stored inductive energy in the load or power lines. They eliminate completely the contact sticking and wear associated with electro-mechanical relay, contactors, etc.

Triggering arrangements are very flexible — most Triacs can be switched into conduction at any point on either half-cycle of the ac waveform by applying a low voltage of either polarity between the gate electrode and anode 1. (A few types of Triac can only be switched by a negative-going gate voltage or pulse.)

The triggering voltage can be obtained from a battery (Fig. 2) or simply from the ac mains (Fig. 3). In either case, full wave current will flow

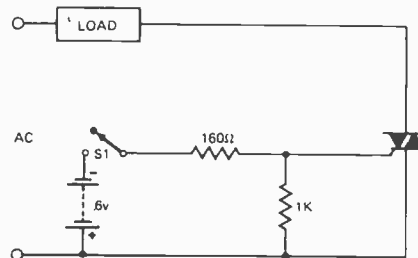

Fig. 2. Triac triggered by external dc voltage.

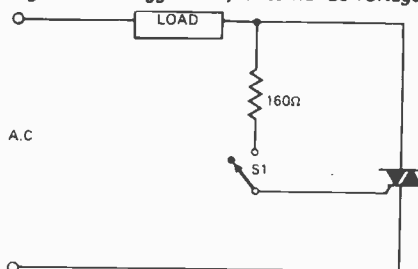

Fig. 3. Triac is triggered by input ac, in this application switch S1 will be 'live'.

when S1 is closed and current will cease to flow at the end of the half-cycle (whether positive or negative) in which S1 is opened (Fig. 4).

ELIMINATES BURNT CONTACTS

The simplest possible method of triggering is shown in Fig. 3. This circuit is often used to eliminate burnt contact breaker points in thermostats and similar devices which have to

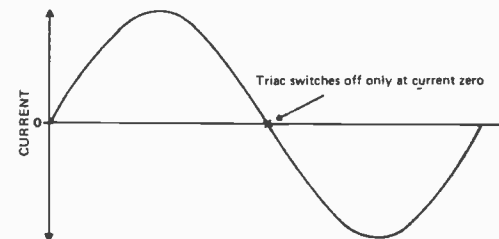
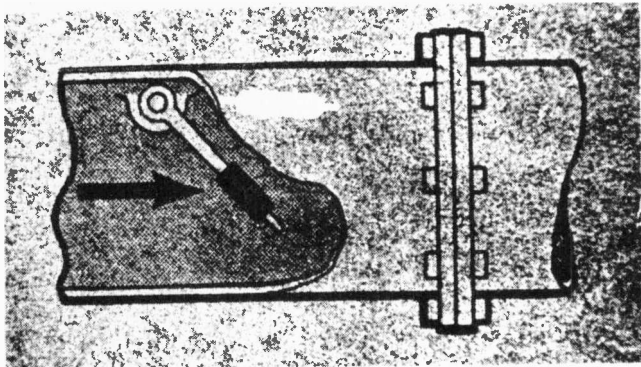

Fig. 4. A triac can be triggered into conduction at any point along the sine-wave, but will only switch off at current zero.

make and break large currents at frequent intervals. The existing make and break arrangement is retained but used only to switch the Triac, which in turn switches the main load current. The current flowing through the contacts is reduced to a few milliamps.

MOVEMENT SWITCHES TRIAC

A magnetic method of triggering may be used when a mechanical movement actuates an electrical circuit. To do this, a magnetically operated reed switch is used as S1. The switch contacts are closed when a magnet is brought near the switch. The actual distance will depend upon the sensitivity of the reed switch and the strength of the magnet ($\frac{1}{2}$ " to 1" is typical). Various applications of this principle are shown in Fig. 5.



Magnetic reed switch used for flow control minimises restraint on moving parts and avoids perforating tube wall.

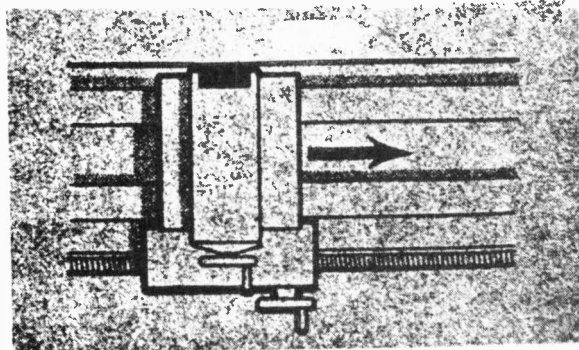

Reed switch simplifies positional control.

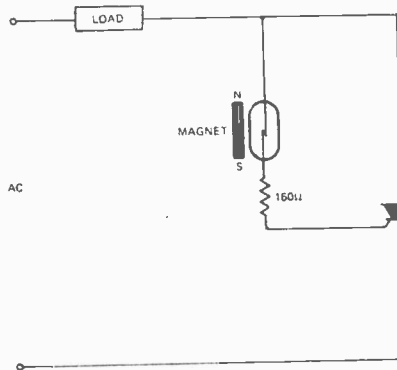
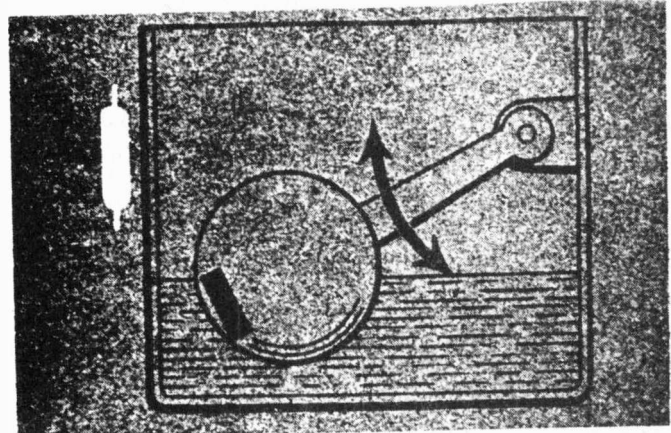

Fig. 5. A magnetically operated reed switch provides electrically isolated triggering from mechanical movement. The switch will close when the magnet is brought within half an inch or so. Suggested applications are shown in Figs 5a, 5b and 5c.



Liquid level control.

Reed switches may also be used to provide electrical isolation between the Triac and the triggering circuit. The reed is inserted in a coil which is then switched by a suitable low voltage dc supply (Fig. 6). As the life of reed switches exceeds several million operations, this is an extremely reliable method of switching.

Other simple methods used to isolate the triggering circuit from the Triac are shown in Figs. 7 and 8. The photo-cell coupling shown in Fig. 8 provides extremely high electrical isolation. Photo-cell couplers, in which a light source and photo-cell are integrally mounted, are commercially available for as little as a dollar.

An unusual off/half-power/full-power circuit is shown in Fig. 9. When half-power is required, the diode is switched in series with the triggering lead. This causes the Triac to conduct only on alternate half-cycles. The circuit is suitable for heating, or other resistive loads that have thermal inertia. It is not suitable for lighting control, as the halved frequency will cause an irritating flicker; nor should it be used for inductive loads such as motors or transformers.

A latching circuit is shown in Fig. 10. Momentarily depressing S1 will cause the Triac to conduct and to remain

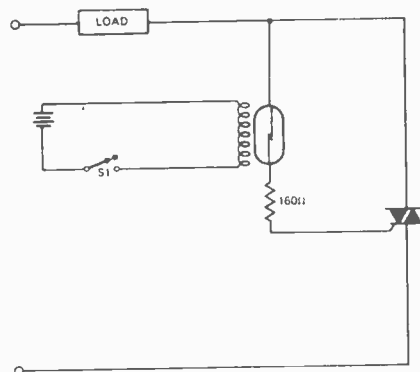

Fig. 6. Reed relay can be electrically operated to provide electrical isolation.

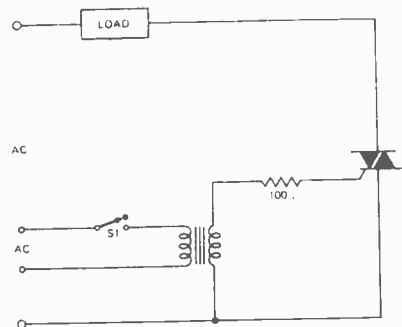

Fig. 7. Isolated ac provides triggering.

conducting after S1 is released. The circuit is reset by momentarily depressing S2. C1 should be a 0.5 μf to 2.0 μf , 630 volt working, non-polarised capacitor.

TIME DELAY CIRCUITS

Triac time delay circuits are shown in Figs. 11, 12 and 13. All three circuits will provide time delays up to 100 seconds or so and may be used for applications such as photographic timers, industrial machinery, etc.

In the circuit shown in Fig. 11 the Triac will conduct as soon as S1 is closed. After a time — determined by the setting of the one Megohm potentiometer — the unijunction will fire, causing SCR1 to conduct thus removing the triggering voltage from the Triac.

Another version of this time delay circuit is shown in Fig. 12.

A different type of time delay circuit is shown in Fig. 13. In this circuit the Triac will conduct after S1 is closed. The time interval is set by the one Megohm potentiometer.

Liquid level is used to switch the Triac circuit in Fig. 14. The Triac will conduct when the resistance between the sensing probes falls below 100K. The pulse transformer in this circuit must be well insulated to ensure that

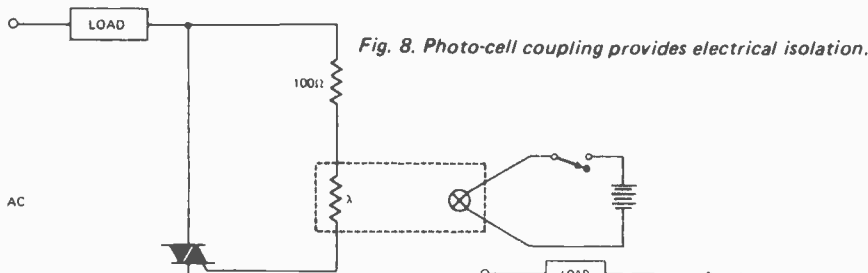

Fig. 8. Photo-cell coupling provides electrical isolation.

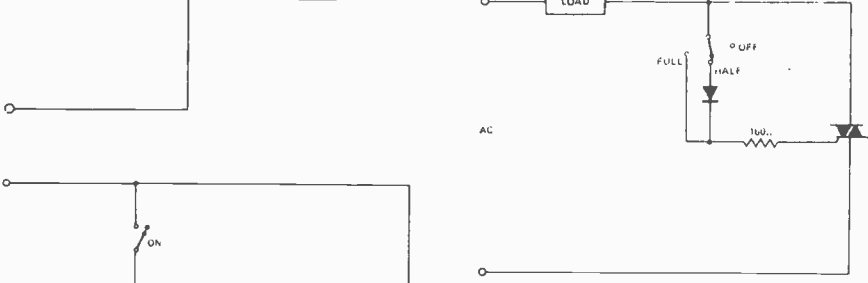

Fig. 9. Circuit can be switched to provide half or full power into load.

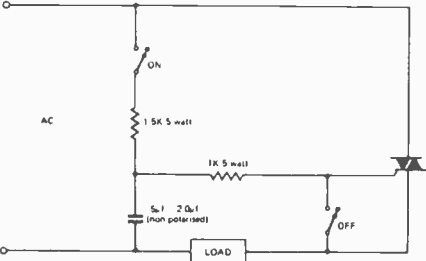

Fig. 10. This triggering circuit provides latching action.

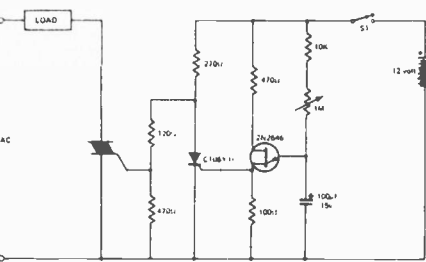

Fig. 11. Time delay circuit — power is disconnected from load after pre-set time.

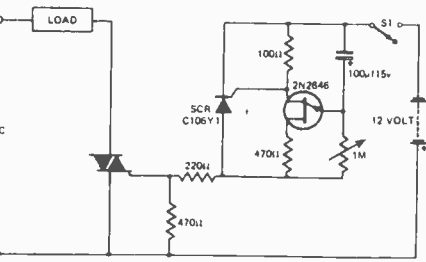

Fig. 13. Time delay circuit — power is connected to load at end of pre-set delay.

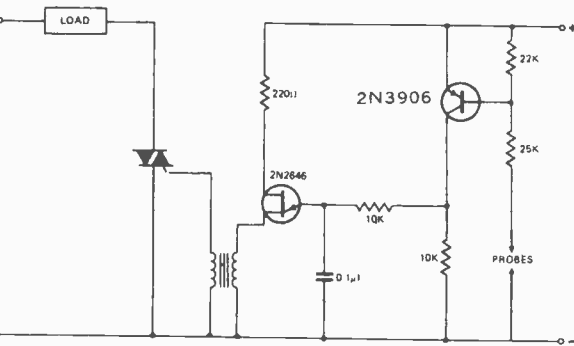

Fig. 14. Liquid level switch. Triac is switched when liquid covers probes.

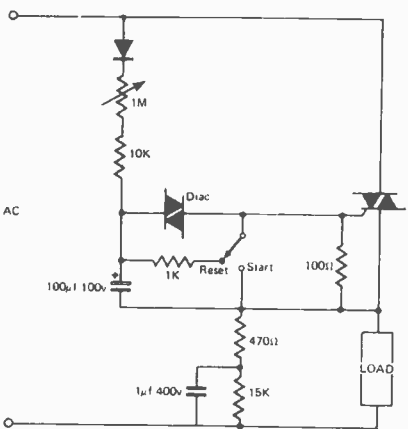

Fig. 12. Time delay circuit — action similar to Fig. 11.

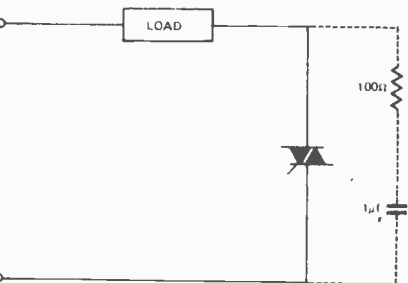

Fig. 15. Capacitor and resistor should be connected across the Triac when switching inductive loads.

line voltage cannot appear across the probes.

INDUCTIVE LOADS

All the circuits described so far will operate reliably with resistive loads. Inductive loads present a minor problem. For reliable operation it may be necessary to limit the rate of voltage rise immediately following turn-off. This is done by connecting a capacitor and series resistor across the Triac (Fig. 15).

A Triac's power rating is a function of its operating temperature. Thus a unit of 6 amps nominal rating used without a heat-sink must be derated to 1½ amps. A rough guide can be obtained from the Triac's external case temperature. This should not exceed 75-80°C.

In the majority of circuits the outer case of a Triac will be 'live'. Because of this it is necessary either to insulate the heat-sink from surrounding metalwork, or to insulate the Triac from the heat-sink.

Two flat mica washers and a Teflon collar will effectively insulate the Triac from the heat-sink, but there will be an appreciable loss in cooling efficiency. Where possible, it is better to have metal-to-metal contact and then to use an insulated mounting for the heat-sink itself.

Providing Triacs have adequate heat-sinks, it is permissible to run them permanently at their maximum designed rating. They can also withstand considerable overloads for short periods. A typical unit can withstand ten times its nominal rating for one half-cycle of a 50 Hz waveform.

DO NOT OVERLOAD

Despite this tolerance of short-term overloads, Triacs must not exceed their designed ratings for more than a fraction of a second. A short circuit will destroy them instantaneously. Fusing is usually ineffective, as a Triac will almost invariably fail first and protect the fuse.

An almost certain symptom of overloading is loss of gate control; the Triac will appear to have a short circuit from one anode to the other, although overloaded Triacs will occasionally still operate on one half-cycle only.

The second part of this article — to be published next month — describes the use of Triacs in power control, covering both zero voltage switching and phase control circuits.

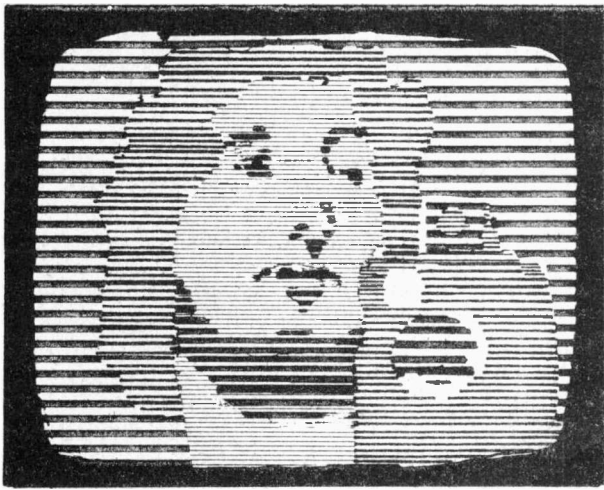

WHAT'S ON

Dial Steve Rimmer for info on flat TV, satellite TV, and the latest non-word on video discs.

NEW FALL SHOWS

IT TAKES ABOUT A DAY to think up one of these literary gems, three hours to type it, thirty minutes to proofread it, a few days to get up the energy to take it out to be retyped so as to be readable and probably an hour to get it down to ETI's offices in the 'urbs. After that, something happens to it for about three months . . . God only knows what; they don't like to talk about that part. One suggestion is that the editors have to wait for the next equinox before putting together the magazine . . . to avoid being hexed. (Nobody likes to read a magazine that's always sprouting eyes at you, after all).

The result of this delay is that there is something of a time warp about me; you are probably convinced that it's coming in December, while I am under a delusion of mid-September. The new fall shows have just sprung up, rather like hallucinogenic mushrooms that don't make you see anything. We have now been through one full week of *A Man Called Sloane*, *The New Archie Bunker* and *Out of the Blue* (And Under A Rock), and there is an air of hopefulness . . . that the mid-season replacements will be an improvement. But, you see, you already know this, existing as you do, some months in the future. You already know that all this hope was in vain.

Since what is on the tube is, generally, going down one, perhaps the time has come to turn our attention to the tube, itself. It is certainly more interesting to operate a push button tuner than to watch a spin off of a spin out, so this month we're going to have a look at some of the freaky new tubes developing this fall.

Each one guaranteed to outlast 95% of the current schedule.

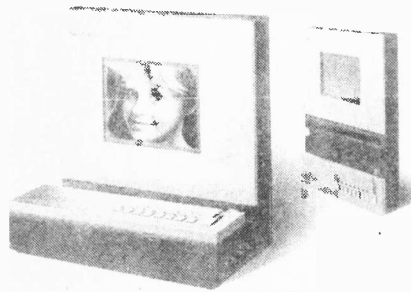

Fig. 1 Sharp's prototype flat TV set featuring their 'Electroluminescence Panel'.

FLATBACK TV

The device in figure 1 is the first production prototype of Sharp's solid state TV. That, on the surface, doesn't sound all that wonderful because manufacturers have been plugging solid state sets for years. However, if you think about it, as it stands now, an all solid state TV is impossible because of that one, rather obnoxious, tube that keeps staring out at you: the CRT. While all around it has gone from nine pin glass to three pin silicon, it has remained, a flickering blue mastodon, some fifty years behind the times. Now considerably larger than its support circuitry, it is the sole determinate of the size of a TV set, as well as accounting, directly or indirectly, for about half the parts count and a good three quarters of the power consumption. It's also expensive, unstable, delicate and, in the end, rather transitory. Since the mid-fifties, there have been numerous attempts at being rid of it.

While by no means the first, the Sharp set seems to be the closest toward getting into production. At present,

there are only five working models in existence, but the fact is that they are working. Within a few years, the tooling up procedure for turning the beastie out in quantity will have been completed and the things will be available at the local stereo emporium. While as much a harbinger of things to come as a revolution in itself, this "flat screen" set is a very, very interesting bit of hardware.

The specs of the set are the first, and probably the most amusing thing to catch the eye. You can almost see the ads in *Time* and *Playboy*. The whole works is two inches thick. It weighs about eight and a half pound, less than the power transformer on a twelve inch, CRT type set. It has a 50:1 contrast ratio and a thirty gradation grey scale. It runs on nine watts of power; about twice as much as used by the heater in a conventional CRT. Its parts count is less than that of a transistor radio. It has none of the conventional adjustments... horizontal linearity, vertical size, etc. ... associated with a not quite solid state TV. It will eventually probably sell for less than even a super bargain type "Ask Me No Questions" brand set peddles for today. It's a gas, but, with no tubes, it actually contains none.

The heart of the device is, of course, what it uses as a "picture tube". Sharp doesn't get all that descriptive about what this actually is. It's called an "Electroluminescence Panel". The description reads as follows: "It's a super flat display with an incredibly sharp picture that's created by pulses that alternately polarize and depolarize electrodes built into the screen". Now this sounds somewhat familiar. Rather like a liquid crystal display.

HISTORICAL PERSPECTIVE

There have been, traditionally, three approaches to flat screen TV. These

are: the phosphorescent dot method, the gas discharge method and the LCD. The first trip involved a matrix of lines with a potentially luminous dot at each intersection (later replaced by a self-scanning, charge coupled affair in some conceptions), wherein, when it came time for a dot to be excited, it got zapped with pulses on the corresponding lines (or by the appropriate charge coupled element). It had the advantage that, simply by overlaying three matrices, a full colour display could be arrived at, just as a colour picture tube comes about by having three guns and three sets of phosphor dots. The difficulty arose in the nature of phosphor. It is not all that efficient a transducer of electrical energy to light. Fairly hefty pulses were required to activate the dots, and these sorts of voltages and currents do not sleep well alongside teeny, tiny wires and micro-microtransistors.

The second attack on the problem, the gas discharge array, came, as one might expect, from Burroughs, who have always seemed to maintain a fascination with neon lights. Essentially, it is simply a matrixed plasma-type display, with a flock of high voltage drivers. In a sense, this type of approach has already met with some success in other video applications, such as alpha-numeric readouts. Where it comes into difficulty is in handling the complexities of analog video. Neon bulbs tend to like being either on or off, and in between, are something less than linear. This calls for some sort of pulse width modulation technique, which also poses several problems. Here, too, high voltages get to be a hassle. Lastly, and probably most uncomfortably, neon lights are orange and, as radically banal as it looks now, the CBC would seem ten times worse through perpetually rose-coloured glasses.

The third approach is the one which suggests itself when reading the description, however scanty, of the Sharp Electro-whatever. It uses a matrix of liquid crystal elements, LCDs, of the same sort as found in a digital watch or thin calculator. LCDs, unlike the previous two systems, don't give off any light. They are blobs of nematic fluid between transparently thin metal electrodes which can have their molecules polarized so as to make the stuff either opaque or transmissive. The "pulses" that switch them, at least in the case of the relatively low rate of change situations found in digital displays, are square waves at frequencies of thirty to fifty Hz. Any slower and

the display flickers; any faster and it ignores the switching signal.

This has been one of the stumbling blocks on the road to LCD video displays. You can't display a 4.5 Megahertz picture signal when the fastest available switching rate is less than the frequency of the vertical scan. The second problem is in that LCDs have been inherently slow to respond to a change of state; it takes time for the extremely large molecules of the nematic fluid to go scurrying around and find themselves a new orientation.

LOOKING AHEAD

If, in fact, a practical display has been arrived at, the possibilities are many. For one thing, wall-sized pictures are possible without the need for the behemoth Advent video projectors that cropped up a few years back. At the other end of the scale, one could put a set in a case the size of a pack of smokes or even a wristwatch. (Yes! That's the answer. We can't cancel Mork and Mindy, so we'll just shrink it down to the size where it can't be seen anymore.)

Inside of ten years, you may not sit down in front of the family tube, but rather, just drop it into your eye, like a contact lens.

The flat screen TV has been approaching from another direction as well. While it has seemed like the semiconductor screen was really quite a pie in the sky, for a long time now designers have been having varying degrees of success at making a flatter cathode ray tube. First of all, of course, it went from the 70° post oscilloscope tube to the 90° and later 110° affairs that eventually eradicated the sets that were bigger in the depth dimensions than in frontal area. However, there was also a lot of backroom thought given to coming up with a radically different sort of CRT. Envisioned as being about the size and shape of a paperback novel, the new tube would fire its beam down the long dimension of the shell, instead of front to back, bending them at the last moment to strike a screen on one of the large faces of the tube. In one version of the project, which emerged in 1965, there were two screens and the thing could be watched, simultaneously, from both sides. It had several disadvantages, though, not the least of which was that it didn't really work.

This, was only a major problem when you turned on the set. At all other times it really wasn't a bad design at all.

You have probably seen ads for the itty bitty pocket TV built by the British firm, Sinclair. While this set, in itself, embodies no new technological breakthroughs, it does foretell a few, for it

seems that Sinclair feels that the watchword for the future of the groove tube is small. Thus, the bent beam CRT has recently re-emerged across the water and, this time around, with somewhat more success. A pocket go-anywhere portable "mind rot" is expected to be on the market using it, presumably superceding Sinclair's present small set, in a couple of years.

Just think, you need never miss another commercial.

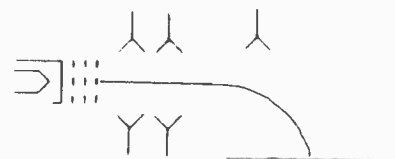

Fig. 2a Schematic representation of Sinclair flat picture tube.

As can be seen from the diagram, which should be around here somewhere, the tube is not one of the more complex devices. A beam skids down the thing and hits a screen. Very simple. Except that, as you might think, if a beam of circular cross section intersects a plane at something other than a right angle, the resulting shape of the area of intersection will be elliptical, not round. This would produce a picture having many of the characteristics of an Olde English Sheepdog lying on a rug during shedding season. Unless you're a real animal lover, this may not do you in.

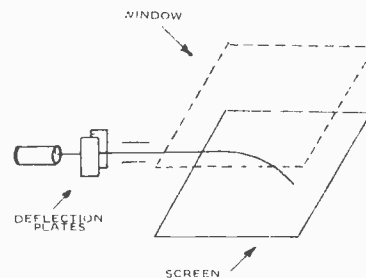

Fig. 2b Physical construction of Sinclair flat picture tube.

Therefore, some fairly heavy magnetic acrobatics are required to allow the beam to proceed as if it were going for the end of the tube, instead of the side, and then deflect it so it winds up in the proper portion of the screen. This is done by placing a metal electrode on the face of the tube opposite to the screen and making it extremely negative, thus repelling the beams.

(This, of course, is only one of the possible approaches. A photo of Joe Who, for example, pasted to the inside of the tube, would turn away all but the most conservative electrons and they could probably be sent on their

collective way by nothing more than a few threats.)

Now there are still a few problems. First of all, unlike in a regular TV, you don't look at the phosphor screen from the back. You view the same surface as the electron beam strikes, simply because it's brighter. However, back a paragraph or two ago, we seem to have covered over the window through which it is supposed to be viewed with a nasty, large metal electrode. Therefore, we must take the metal away, or, at least, most of it. What, in fact, comprises the deflecting electrode in a practical tube is a very thin metallic deposit, so thin that it is transparent. Curiously, this is essentially the same way that electrodes are formed in the liquid crystal displays back with the Sharp set.

The other difficulty is in getting the picture to come out with straight sides. Yes, we seem to have a problem here. Remember that a deflected electron beam forms a triangle, with the apex at the cathode. This doesn't make a great deal of difference when the beam is directed at a perpendicular screen, but this one is parallel to it. In other words, the bottom of the screen, closest to the gun, will not be covered with as wide a swath of electrons as the top, which is further away.

In order to get around this, it is necessary to make the horizontal deflection voltage a function of the vertical deflection, such that, as the beam gets closer to the bottom the horizontal deflection plates receive an increasingly higher voltage. In effect, what is required is that the horizontal signal be modulated with the vertical, at a small index of modulation, of course, lest the effect of the varying width be reversed.

The pocket CRT has many advantages. It is simple, light, cheap and uses much lower voltages than its larger ancestors, while it showed promise in many of the areas being aimed at by the developers of the solid state screen, it has the one big feature that you'll probably, be able to go out and buy one in only a few years and, probably for a great deal less than the initial amount all solid state sets will cost. The real beauty of something like this is that, as Clive Sinclair probably realizes all too well, little TVs are cute. They sell well, so they can be mass produced. Therefore, they're cheap. So they sell well and you can mass produce some more.

This, of course, is a self-defeating process, especially if you're a yet-to-be-manufactured TV set. Sooner or later, the fellow who's buy mass producing all these sets, mass produces enough to retire to Jamaica.

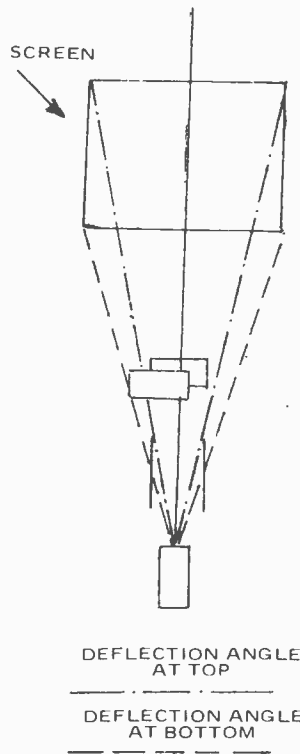

Fig. 2c Top view of Sinclair flat picture tube showing different deflection angles.

MORE ON SATELLITES

Lastly, I think that it is about time to gather together all the bits and pieces of satellite information that have accumulated since the appearance of the bit on satellite TV in August. There have been a number of letters which, after clearing them with the cat to make sure that they weren't edible (the cat usually gets to my mail before I do and checks out anything that looks like it might render a decent snack), I have discovered to contain vast wealths of information on such things as where to find receiver plans and a possible future source of very cheap TVRO ground stations. As well, I have come across a few good bits, myself. The cat, for the most part, has been of questionable value in the project. Cats, in general, have relatively little aptitude for high frequency electronics.

First of all, a Mr. Douglas Orlowski... the Mr. Douglas Orlowski, if you know him... has come up with a rather good list of sources of information for TVRO terminals. I wouldn't suggest sending for all of it; this could get a mite expensive and, besides which, there is considerable overlapping between authors. However, any one of these packages should be sufficient to get you going.

1. First, there is the Community Access Television Journal, which is actually the publication that got me started in this stuff, about a year ago. They have a large package of assorted material available for sixteen bucks, plus four tapes dealing with building your own downlink, at \$50 each for Beta or \$55 for VHS. They reside under the flag of Television Publications, Inc., Suite 106, 4209 NW 23rd, Oklahoma City, Ok. 73107.

2. There is a booklet put out by Space Coast Research, Box 442, Altamonte, Fla. 32701., on how to receive satellite TV. It goes for \$7.95.

3. Bill Weaver, Box 852, Tulsa, Oklahoma. 74101., has a booklet on setting up a downlink for \$3.00. (The book is \$3.00; the downlink will probably run slightly higher.)

4. For three dollars more you can have another book from Satellite Television, Box 140, Oxford, New York. 13830. You can guess what it's about.

5. Wireless World's June and July issues have a bit on building a weather satellite downlink, with some fairly good circuitry and a number of very clever design innovations. There would be some retuning and such required to use this as a television satellite downlink, but this should not be excessively difficult.

6. A bit of literature from Tape Time, Box G, Arcadia, Oklahoma. 73007., appeared beneath the cat a few weeks ago, dealing with the availability of cassettes of both satellite downlink constructional details and magazine-type looks at the material offered via satellite. The list is a bit long, so I'd suggest writing for a copy yourself.

Another reader... I shall apologize here for not knowing who; the cat did get at this one... brought up the most interesting issue of the attempts presently being made to have Canada sell Australia a satellite communication system. If this were, in fact, to come about, TVRO sets would be mass produced here, bringing the cost down to around... gadzooks; \$800.00! If you have been following the politics involved in this, you will know that this situation is still a very open question (although it may no longer be by the time this column reaches print), but this would certainly be a great step forward both for Canadian industry and the myriad great unwashed victims of the CBC.

A few other readers have written in suggesting that the prices suggested in the satellite piece were pessimistically high. In fact, for a bona fide, off the shelf ground station, the prices were about

What's On

right. While the figures that the American magazines are quoting now and then . . . i.e., that a fellow in California got one going for about a grand . . . are a bit unrealistic for an average technical gnome with average equipment, there are, definitely, short-cuts. One of these is the Robert Coleman terminal, which comes by the electronics of the system for about two to three hundred dollars. We'll have a look at that one as soon as I can find out how he does it.

There is also a bit of additional information dealing with the October cable TV column. The other day, I came across a list of the frequencies at which the cable converter channels are located. For those interested in home-made converters, table 1 lists them . . . which should save a bit of coaxial DXing.

Among the mail there have been several requests for information about specific video hardware. So far, I've been able to answer them, but it did occur to me, during a moment of no great import, that there may be quite a number of loose bits of gear out there in search of schematics, manuals or odd parts. If you are using one of these as a coffee table or paperweight, and could use a hand, place your fingers upon your typewriter. Address any requests, queries or Himalayan Cactus chants to this column and we'll print them, so that some other interested reader with a similar piece of furniture, but more documentation, can assist you through the wonders of return mail and xerox. To get things started, I've decided to toss out one of my own.

The . . . ahem . . . THING below is some sort of keyboard. I know not what sort, nor what hand claims responsibility for its creation, as it bears not a single marking. Anybody who has any ideas is requested to contact me here. (This

Anybody recognizing this poor wif should immediately send identifying data to the Steve Rimmer Home for Wayward Keyboards.

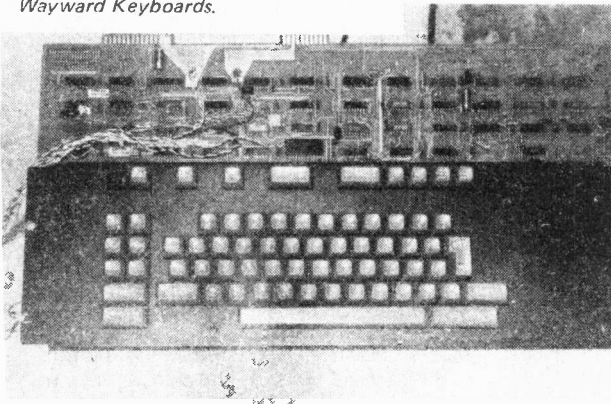

TABLE 1

Cable Converter Frequencies

These are the actual frequencies that come down the cable, to be beat down to channel 3 by a home converter. The frequencies given are lower channel limits; add 1.25 MHz to get the sound carrier frequency, and 5.75 MHz for video.

Converter channel	Frequency	Converter channel	Frequency
Midband		High Band	
A	120	J	216
B	126	K	222
C	132	L	228
D	138	M	234
E	144	N	240
F	150	O	246
G	156	P	252
H	162	Q	258
I	168	R	264

wretched beast is eventually supposed to be part of a video character generator which should appear herein some time next year, if I don't blow any more chips).

This being just about the end of the column, I should take this opportunity to thank eternal fiend and temporal munchkin Levi Usher for the pages he stole from the July 19, 1979 issue of Electronics Magazine, on my behalf, . . . I don't know who owned the copy in question . . . outlining the Sinclair flat TV tube; the tiny grain of data (well, two pages, actually) that sent me off looking for more and better insight to this marvellous creation, but I won't.

NEXT MONTH NO VIDEO DISCS

Next month . . . I don't know what's going to happen. I think that I can safely say that we will not be having a look at

video discs. By this time, anybody who hasn't read quite enough about the Phillips/Magnavision system has probably been dead for two years, and RCA hasn't really said a whole lot about theirs as of yet. Works in progress are a complete set of instructions for making an Ampex VP-4900 video player into an Ampex VR-5000 video recorder, and a look at an IC that generates all the complex nasties of TV sync pulsery. However, I hooked the power up backwards to the one I've got, so the appearance of the feature will be dependent upon whether or not the 'post office' arrives with a new one in time.

Until next month . . . stay tuned.

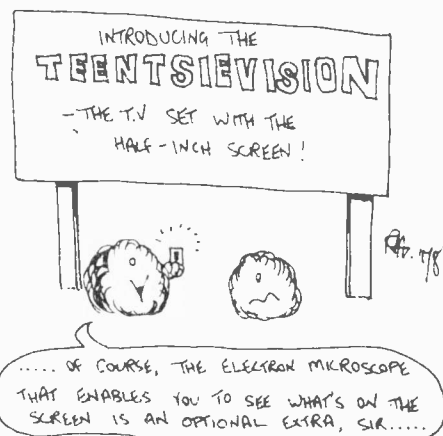

Fluorescent Displays

Conventional moving-coil meters on hi-fi equipment are being supplanted by fluorescent bar-graph displays on this year's new releases — here's the 'inside' story.

OUR ATTENTION was drawn to this trend in audio equipment design by a recent release from National Technics. Their two latest front-loading stereo cassette decks, the RS-M22 and RS-M33, feature these new displays, replacing conventional twin moving-coil VU meters common on this type of equipment to date.

Compared to a conventional meter, National claim the fluorescent bar-graph display has the following advantages:

- fast response time
- no overshoot
- excellent accuracy
- high reliability

A minimum response time of 5 μ s is typical, according to the Technics release, and accuracy is within ± 0.1 dB at 0 scale and within ± 0.5 dB across the rest of the scale. As the display uses digital techniques for its operation, response time may be selected for both 'peak' and 'VU' scale reading.

The construction ensures a rugged display device with a lifetime specified at 100 000 hours and greater resistance to shock than a moving-coil meter.

A cutaway, exploded view of portion of the fluorescent display showing the internal construction and arrangement of the special fluorescent anodes.

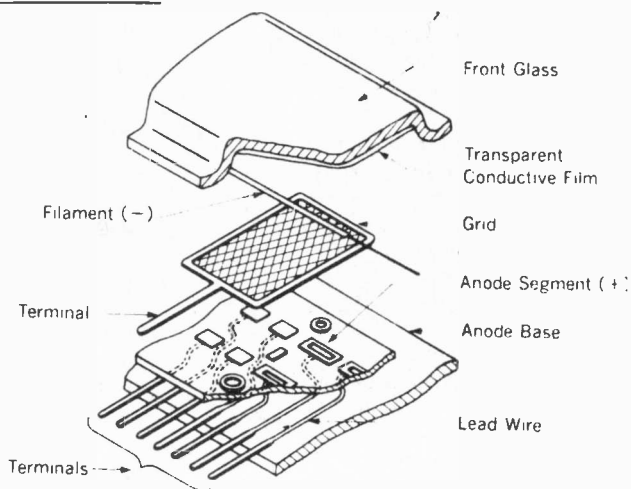

The device body is a flat vacuum tube sandwiching a filament, grid and anode elements between a glass base and moulded glass front panel which has a transparent conductive film on the under surface. The filament is heated by passing a current through it, causing it to emit electrons. These are attracted to the anodes, passing through the control grid. When electrons strike the anodes they fluoresce, emitting light.

There are no moving parts and control is entirely electronic resulting in

an extremely fast response time.

The anode shape is designed for easy viewing and a number of parameters can be seen at a glance — both peak and VU indications are available at the one time on the Technics display.

As the display emits light it can be easily read and interpreted from a distance. Brightness can be varied, either under manual or electronic control. The left and right hand channel displays are aligned in parallel allowing instant comparison.

The levels above 0 VU are displayed as rectangles with bright edges, whereas levels below this point are indicated by solid bright squares resulting in a display that can be interpreted at a glance.

The scale is divided into 12 steps between -20 dB and $+8$ dB with finer divisions around the 0 VU area. A newly developed monolithic IC drives the display and, since a full-wave rectifier circuit is used, the display will produce an accurate indication even when presented with an asymmetrical waveform.

It seems inevitable that these fluorescent bar-graph displays will enjoy wide success in both the consumer and professional audio equipment market.

Technics' M22 stereo cassette deck featuring a fluorescent bar-graph VU/peak meter.

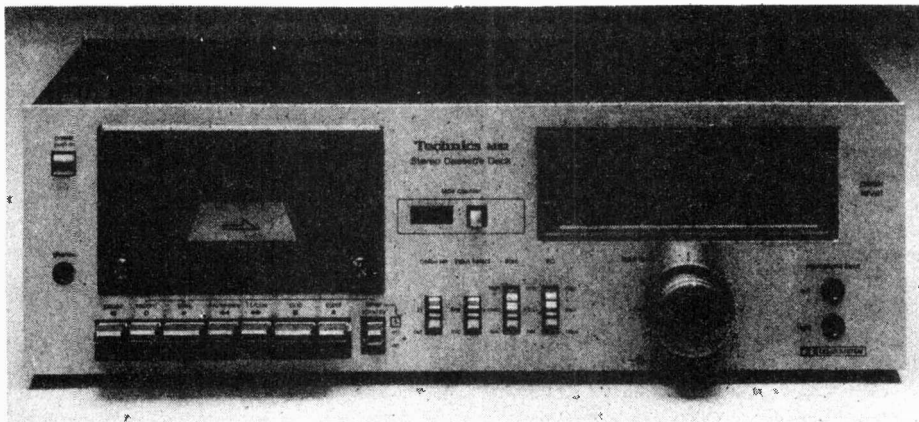

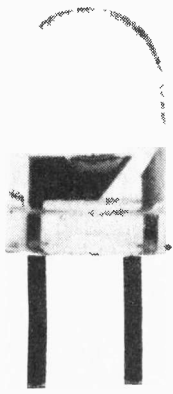

Teachers' Topics

ETI Canada's Editor, Graham Wideman, has some handy notes, and strong feelings on how circuit diagrams should be drawn.

I AM GOING to talk about drawing circuit diagrams. Not how to read them, or what the symbols mean, but about arranging the drawing itself. For some reason this is a function which is executed by many people in a "you don't talk about it, you just do it" manner.

But drawing a circuit diagram is not simply the combining of appropriate symbols. The diagram should not merely be the sum of the symbols. And it should not be done by starting off in one corner of the page, blackboard or napkin, and adding symbols until it is complete.

The circuit diagram exists to educate the diagram reader, or even the person who drew it, as to how the circuit works, and hence benefits greatly from an arrangement which makes it easy to understand.

SO HOW DO YOU DO IT?

I have seen many styles of diagrams, many sets of symbols, and many "rules" for drawing diagrams. What I feel is needed, is a set of rules which are easy to apply or modify for any situation you come across, and which must be easy to remember, and "feel right".

Symbols used should be either standard, or selected from those commonly used, and "look like" the thing they are intended to represent, again for ease of recognition and remembering.

What I have thus attempted to do below, is come up with a set of suggestions which I feel formally describes a way of drawing diagrams that has helped me understand, but more importantly quickly communicates to others what a circuit is all about.

WHAT IS A CIRCUIT DIAGRAM INTENDED TO SHOW?

(a) The entire *raison-d'être* for the circuit itself, is to do something to a signal, or signals. Thus it can be said

that a circuit may have a signal input(s), and always has outputs. It follows that one very important feature of the circuit diagram is to show how the signal(s) travels through the circuit.

(b) The circuit diagram must also show what happens to the signal in each "stage" of the circuit, and hence also show how each stage works.

(c) The circuit diagram layout should **not** be influenced by the physical layout of parts, unless this is convenient and does not interfere with ease of understanding of (a) and (b) above.

HOW DO WE ACHIEVE THESE?

1/ Adopt a convention of having signals travel from left to right on the diagram, inputs on the left, outputs on the right.

2/ Adopt a convention of drawing individual stages so that current flows down from top to bottom, or that voltage decreases when you go down the diagram.

This one is a little hard to visualize, but basically it's just a scheme for orienting components in a way which shows how they work in the "DC Analysis", or no signal condition.

Particular examples are: putting the + supply at the top and the - supply at the bottom; orienting a collector resistor for a common emitter amplifier vertically, but orienting an inter-stage signal carrying resistor horizontally.

It sounds tedious, but it falls into place in practice.

3/ Do **not** show all the power supply and ground points in the circuit connected to each other. Instead, anywhere a component is to be connected to a power supply or ground, draw in the symbols for power supply or ground.

The reason for this is to reduce the clutter of lines on the drawing, and to only show lines which carry signals around. This last point is very important. If power supply and ground lines are shown, then it is not necessarily clear from cursory inspection how the signal gets from input to output for example. If no supply lines are shown, it is very obvious what the signal path is, since it is the **only** path from beginning to end, and the only path between stages.

SIDE BENEFIT

An additional bonus of following the above three rules, is that it tends to make the same circuit electronic configuration appear the same from drawing to drawing. This makes it easy to recognize circuits (or parts there of) with which one is already familiar. It helps one to think in terms of circuit function blocks, rather than individual components.

SYMBOLS

Before we actually get into a few examples, we have to establish some symbols for power supplies and ground.

Here we are talking about hand written symbols particularly. The factors to consider are convenience of use, and if possible the selection of symbols which somehow look like their meaning.

POWER SUPPLY SYMBOL

The two commonly used symbols for a power supply connection are the arrow and the line:

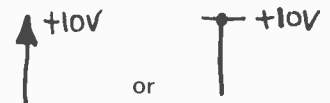

Personally, I prefer the line for several reasons. It is a horizontal line on a drawing where we said "going down the page" is like decreasing voltage, thus it says "constant voltage". Secondly the symbol can be approached from both sides, such as:



GROUND SYMBOL

Probably the most used symbol for ground is:



However this has a disadvantage, which is that it looks odd at other angles, and

is thus difficult to approach from the sides or especially below:

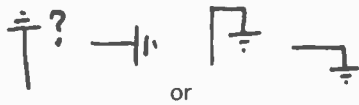

So why not use our power supply symbol for ground also, labelled 0V (zero volts):

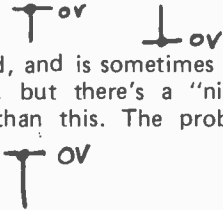

This is not bad, and is sometimes seen on schematics, but there's a "nicer" symbol even than this. The problem with the:

symbol is that it requires writing out "0V" everytime, which aside from being extra work, is easy to misread.

How about the occasionally used:



as our ground symbol? You can connect to it from all four sides, it doesn't require a written note, but does it "look like zero"? Yes, if you think of it in a 3-dimensional way, such as



it looks like the "origin" of three coordinate space.

NOW you can look at the examples!

CONCLUSIONS:

Systems such as the one I've just outlined, combine convenient notation, and a few straightforward rules.

You will probably find that using this drawing technique you tend to start drawing with the active parts, transistors and tubes, and "growing" the resistors, capacitors etc. around them. This is an effective way of thinking about the circuit, and whether you adopt this, or a similar scheme, after a few uses it becomes easier to draw a schematic this way than in any other arrangement. It has been found useful in initially drawing a design, "transcribing" someone else's design into an understandable form, and aids in explaining the circuit operation to other people.

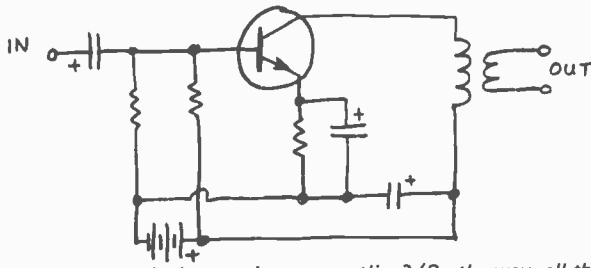

Fig. 1. Maybe the battery is arm wrestling? (By the way, all the "before" diagrams were either taken from, or copied from very respected sources. We promise not to say who they are unless they complain.)

After: Obviously a common emitter amp, very simple.

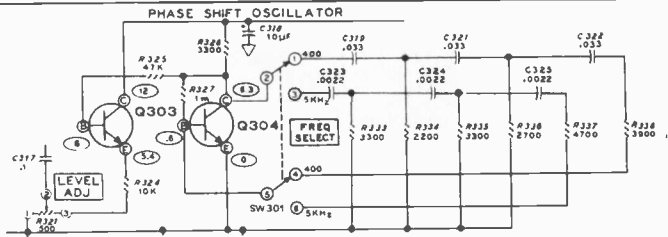
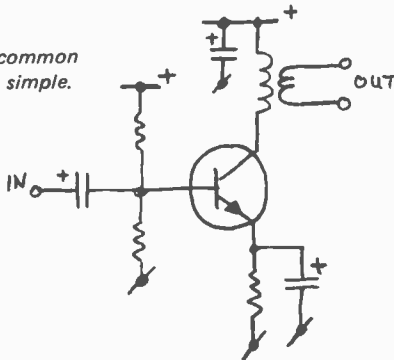
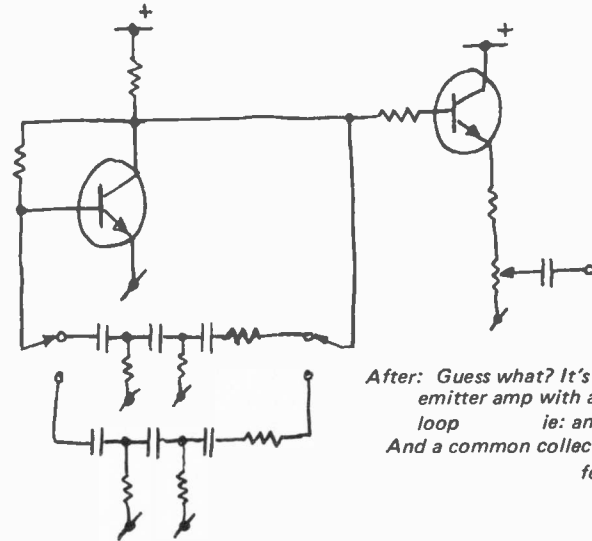

Fig. 2. A true bonanza of extra lines. What is it?



After: Guess what? It's a common emitter amp with a feedback loop ie: an oscillator. And a common collector amp to follow it up.

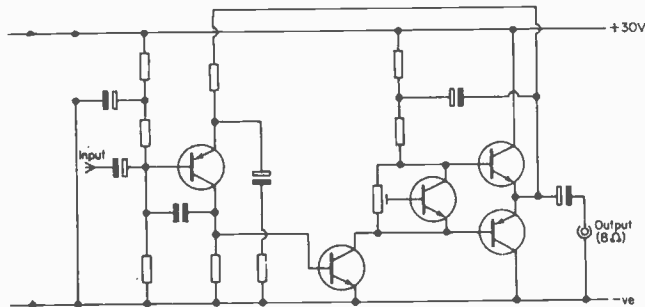
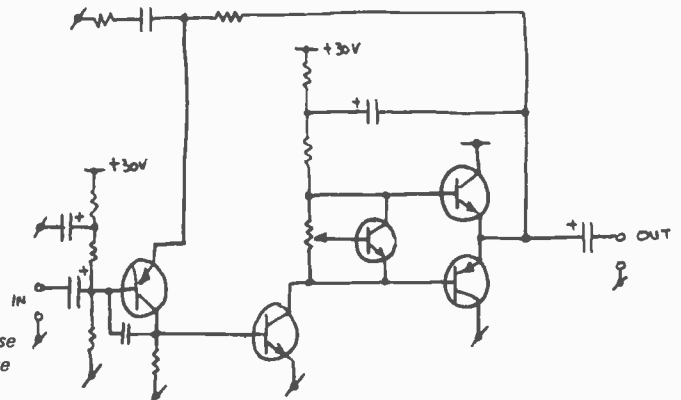
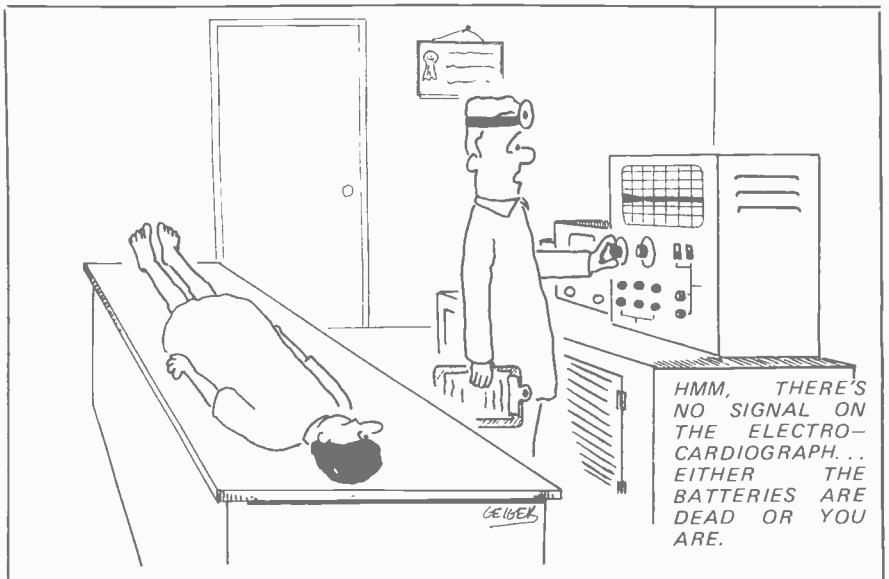

Fig. 3. A ten watt audio amp design. Try to follow the routes that signals take through this circuit.

After: Redrawn the ONLY wires shown joining transistors are those carrying signals. With very little expertise it's easy to spot the route forwards through the amplifier, and the two feedback paths.



The Fun of Electronics



HMM, THERE'S NO SIGNAL ON THE ELECTRO-CARDIOGRAPH... EITHER THE BATTERIES ARE DEAD OR YOU ARE.

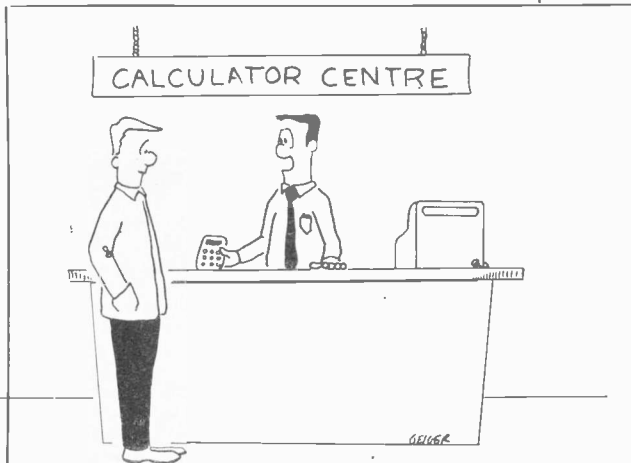

AND THIS IS ONE OF THE NEW "BEEP-TO-THE-TOUCH" CALCULATORS. IT COMES COMPLETE WITH A SUPPLY OF TRANQUILIZER PILLS THAT YOU CAN DISTRIBUTE TO ANYONE WHO HAS TO BE NEARBY WHEN YOU USE THE CALCULATOR.

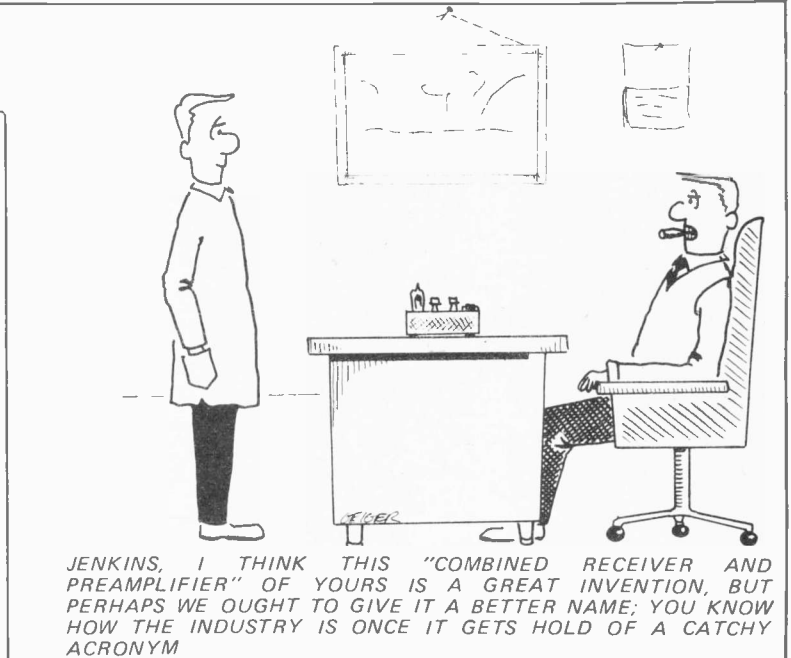

JENKINS, I THINK THIS "COMBINED RECEIVER AND PREAMPLIFIER" OF YOURS IS A GREAT INVENTION, BUT PERHAPS WE OUGHT TO GIVE IT A BETTER NAME; YOU KNOW HOW THE INDUSTRY IS ONCE IT GETS HOLD OF A CATCHY ACRONYM

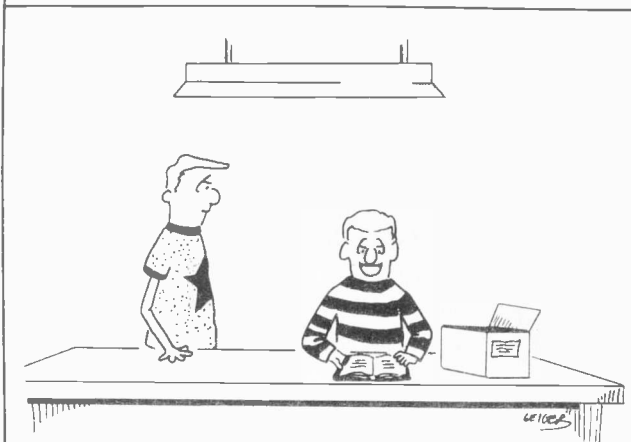

THIS IS THE TOUGHEST LESSON SO FAR IN MY TELEVISION REPAIR CORRESPONDENCE COURSE; IT'S ENTITLED "HOW TO KEEP A STRAIGHT FACE WHEN PRESENTING YOUR BILL TO THE CUSTOMER".

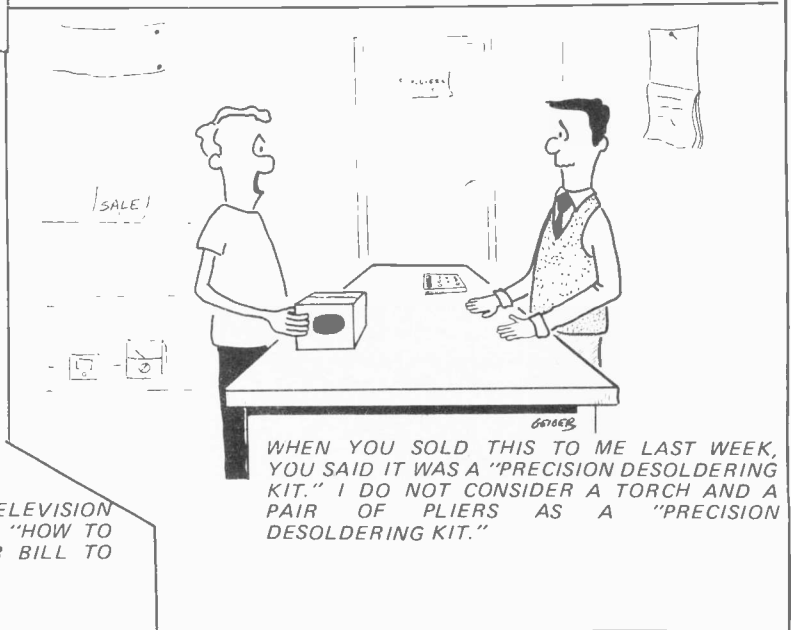

WHEN YOU SOLD THIS TO ME LAST WEEK, YOU SAID IT WAS A "PRECISION DESOLDERING KIT." I DO NOT CONSIDER A TORCH AND A PAIR OF PLIERS AS A "PRECISION DESOLDERING KIT."

You can write for ETI



75 cents per word

ETI's new classified advertising section allows you to reach 30,000 readers nation-wide. For as little as \$15 (there's a 20 word minimum) you can promote your business from coast to coast.

WHAT DO YOU DO?

Send us your typewritten or clearly printed words, your permanent address and telephone number, and your money (no cash please). Make your cheque or money order payable to 'ETI Magazine'. We're at Unit 6, 25 Overlea Blvd., Toronto, Ontario M4H 1B1.

WHAT DO WE DO?

We typeset your words (and put the first word and your company name in bold capital letters).

If we get your message by the 14th of the month, it will appear in ETI 1½ months later. For example, if we receive it by November 14th, you (and thousands more) will see it in the January issue

PRINTED circuit boards and kits from stock. No. 470-\$5.45; No. 541-\$2.95; No. 594-\$1.75; No.141-\$7.25; No.144\$8.05; No.254-\$2.10. Kits 591K U/D Counter c/w PCB \$35.95; 490K Audio Comp. c/w PCB \$22.78. Terms:- Cheque, or Money with order NO COD.. P&P 50¢. Send for full list. B&R ELECTRONICS, Box 6326F, Hamilton, Ontario L9C 6L9.

TRANSLATION SERVICES, D.L. Bousquet. Specialist in technical translations. Special rates and services for companies. For more info and free quotes, write or call: D.L. BOUSQUET, 50 Quebec Ave. Suite 404, Toronto, Ontario, M6P 4B4 (416) 769-4229.

CLASSIFIED

J&J ELECTRONICS LTD., P.O. Box 1437 E. Winnipeg, Manitoba R3C 2Z4. Surplus Semiconductor Specialists. Do you get our bargain flyer? Send \$1.00 to receive the current literature and specials and to be placed on the mailing list for future publications.

CRYSTALS - All types monitor, marine, CB, amateur, professional, wholesale & retail. Write for information. K&K ELECTRONICS P.O. Box 3243, Hamilton L8H 7K6

NEW STORE! for the Hobbyist, Ham Audio, CB'r. Special: Video Camera and Monitor \$349.95. Ont res. add 7% sales tax. GENERAL ELECTRONICS, 5511 Yonge St., Willowdale, Ont. 221-6174.

WSI RADIO - SWL Radios - Ham radios - 18 Sheldon Avenue North, Kitchener, Ontario N2H 3M2. Telephone (519) 579-0536. Write for giant catalog, free of course!! (VE3EHC)

PRINTED CIRCUIT boards from your sketch or artwork. Affordable prices. Also fun kit projects. Free details. DANOCINTHS INC. Dept. ETI, Box 261, Westland MI. 48185. U.S.A.

HOBBY Services. Novel construction plans, P.C. boards, complete kits and all associated services. Write for free information. TEKNIKIT Associates, 301 Flora St., Carleton Place, Ontario. K7C 3M8.

SPECIAL! Surprise box containing 1000 electronic pieces for \$10.00 or 3000 for \$25.00, including capacitor - transistor - switches - wire - resistor - relay - hardware etc. All new parts, first quality. Money back guarantee. Flyer & sample on request. SURPLUS ELECTRO QUEBEC, 2264 Montee Gagnon, Blainville, Quebec, Canada. J7E 4H5

\$1.00 Unusual Canadian and American parts and surplus catalogs. Hundreds of bargains. ETCO, Dept 087, 183G Hymus, Pointe Claire, Que.

COMPONENTS; Digital and Analog IC's, Transistors, Diodes, Zeners, Resistors, LED's, Displays. Send for Free Price List. ELECTRONICS LONDON, Dept ETI, Box 7096, London, Ontario. N5Y 4J9.

SURPLUS 70K linear PC Board Mount Miniature Slide Pots 32mm Travel Perfect for Graphic Equalizer Projects. 1-9 @ 80¢ each, 10-99 @ 75¢ each, 100-up @ 70¢ each. Inquiries to: M.B. COMMUNICATIONS 188 Henderson Hwy. Wpg. Man. R2L 1L6 Ph. 667-9576.

TTY-TELETYPE Model 33ASR, paper tape reader/punch. ASCII 20mA serial interface, excellent condition, complete manuals. URI COGAN, R.R.2 Claremont, Ont. L0H 1E0. (416) 294-9814.

MOTION detector, light level change sounds whoop alarm, LSI 14 pin DIP. \$9.95 PPD. ELECTRONICS, Dept. ETI, Box 68, Whitecourt, AB. T0E 2L0

ETI Project File

PLEASE NOTE: WE CANNOT ANSWER PROJECT QUERIES BY TELEPHONE.

Updates, news, information, ETI gives you project support

PROJECT FILE is our department dealing with information regarding ETI Projects. Each month we will publish the Project Chart, any Project Notes which arise, general Project Constructor's Information, and some Reader's Letters and Questions relating to projects.

PROJECT NOTES

Since this magazine is largely put together by humans, the occasional error manages to slip by us into print. In addition variations in component characteristics and availability occur, and many readers write to us about their experiences in building our projects. This gives us information which could be helpful to other readers. Such information will be published in Project File under Project Notes. (Prior to May 78 it was to be found at the end of News Digest.)

To find out if there are project notes for a project you are interested in, simply refer to Project Chart (see below). If there are project notes listed, they will have appeared in Project File (note, prior to May 78, project notes appeared at the end of News Digest)

Project notes can be ordered one of two ways. You can order the complete back issue, or you can order a photocopy from the ap-

propriate issue. In either case consult General Information For Readers. If you order a copy of a construction article, specify the issue where the project note can be found and we will include the at no cost. You must specify from which issue those project notes can be found.

PROJECT CHART

This chart is an index to all information available relating to each project we have published in the preceding year. It guides you to where you will find the article itself, and keeps you informed on any notes that come up on a particular project you are interested in. It also gives you an idea of the importance of the notes, in case you do not have the issue referred to on hand.

Component Notations and Units

We normally specify components using an international standard. Many readers will be unfamiliar with this but it's simple, less likely to lead to error and will be widely used sooner or later. ETI has opted for sooner!

Firstly decimal points are dropped and substituted with the multiplier, thus 4.7uF is written 4u7. Capacitors also use the multiplier nano (one nanofarad is 1000pF). Thus 0.1uF is 100n, 5600pF is 5n6. Other examples are 5.6pF = 5p6, 0.5pF = 0p5.

Resistors are treated similarly: 1.8M ohms is 1M8, 56k ohms is 56k, 4.7k ohms is 4k7, 100ohms is 100R, 5.6 ohms is 5R6.

Kits, PCBs, and Parts

We do not supply parts for our projects, these must be obtained from component suppliers. However, in order to make things easier we cooperate with various companies to enable them to promptly supply kits, printed circuit boards and unusual or hard-to-find parts. Prospective builders should consult the advertisements in ETI for suppliers for current and past projects.

Any company interested in participating in the supply of kits, pcbs or parts should write to us on their letterhead for complete information.

READER'S LETTERS AND QUESTIONS

We obviously cannot troubleshoot the individual reader's projects, by letter or in person, so if you have a query we can only answer it to the extent of clearing up ambiguities, and providing Project Notes where appropriate. If you desire a reply to your letter it must be accompanied by a self addressed stamped envelope.

ISSUE DATE	ARTICLE
Dec 78	Note: N
Aug 78	Porch Light & Neg.
Aug 78	IB Metal Locator & Neg.
Aug 78	Two Chip Siren & Neg.
Sept 78	Audio Oscillator
Nov 78	Neg.
Sept 78	Shutter Timer
Nov 78	Neg.
Sept 78	Rain Alarm
Oct 78	CCD Phaser
Nov 78	Neg.
Oct 78	UFO Detector
Nov 78	Neg.
Sept 79	C,D
Oct 78	Strobe Idea
Apr 79	Note:N
Nov 78	Cap Meter & Neg.
Nov 78	Stars & Dots
Nov 78	CMOS Preamp & Neg.
Dec 78	Digital Anemometer
Feb 79	Neg
Mar 79	Note:C, D
Dec 78	Tape Noise Elim
Feb 79	Neg
Dec 78	EPROM Programmer
Feb 79	Neg
Jan 79	Log Exp Convert.
Feb 79	Neg
Jan 79	Digital Tach.
Feb 79	Neg
Jan 79	FM Transmitter
Feb 79	Neg
Feb 79	Phasemeter & Neg
Feb 79	SW Radio
Feb 79	Light Chaser & Neg

ISSUE DATE	ARTICLE
Mar 79	Tape-Slide Synch
Mar 79	Synch. Sequ.
Mar 79	Dual Dice
Apr 79	Solar Control
Apr 79	Audio Compressor
Apr 79	Wheel of Fortune
May 79	Light Controller
May 79	AM Tuner
May 79	VHF Ant.
June 79	Easy Colour Organ
June 79	LCD Thermometer
June 79	Light Show Seq.
July 79	Note C
June 79	VHF Ant. 2
June 79	Bip Beacon
July 79	STAC Timer
July 79	Two Octave Organ
July 79	Light Activ. Tacho
Aug 79	Audio Power Meter
Aug 79	Two Octave Organ
Aug 79	Light Act Tacho.
Sept 79	Field Strength Meter
Sept 79	Sound Effects Unit
Sept 79	Digital Wind Meter
Sept 79	Up/Down Counter
Oct 79	Simple Graphic Eq
Oct 79	Digital Dial
Oct 79	Variwiper
Oct 79	Cable Tester
Nov 79	60W Amplifier
Nov 79	Model Train Controller
Nov 79	Curve Tracer

ETI Project Chart

PROJECT CHART

This chart is an index to all information available relating to each project we have published in the preceding year. It guides you to where you will find the article itself, and keeps you informed on any notes that come up on a particular project you are interested in. It also gives you an idea of the importance of the notes, in case you do not have the issue referred to on hand.

Canadian Projects Book

Audio Limiter	Metal Locator
5W Stereo	Heart-Rate Monitor
Notes N, D May 79	GSR Monitor
Overled	Phaser
Bass Enhancer	Fuzz Box
Modular Disco	Touch Organ
G P Preamp	Mastermind
Bal. Mic. Preamp	Double Dice
Ceramic Cartridge Preamp	Reaction Tester
Mixer & PSU	Sound-Light Flash
VU Meter Circuit	Burglar Alarm
Headphone Amp	Injector-Tracer
50W-100W Amp	Digital Voltmeter
Note N May 79	

Key to Project Notes

C:- PCB or component layout
D:- Circuit diagram
N:- Parts Numbers, Specs
Neg:- Negative of PCB pattern printed
O:- Other
S:- Parts Supply
T:- Text
U:- Update, Improvement, Mods

ETI Index Volume Three

* 1979 *

Below is a listing of all articles and features published by ETI since January, 1979. Not included in this list are individual columns, Tech Tips, or SoftSpots.

PROJECTS: AUDIO AND MUSIC

FM BROADCASTER	Jan
SYNTHESIZER SEQUENCER	Mar
TWO OCTAVE ORGAN	Jul
AUDIO POWER METER	Aug
ROAD RUNNER SOUND EFFECTS UNIT	Sep
SIMPLE GRAPHIC EQUALIZER	Oct
60 WATT AMPLIFIER	Nov
HIGH PERFORMANCE STEREO PREAMPLIFIER	Dec

PROJECTS: TEST EQUIPMENT

DIGITAL TACHOMETER	Jan
PHASEMETER	Feb
LCD THERMOMETER	June
LIGHT ACTIVATED TACHOMETER	Jul
CABLE TESTER	Oct
CURVE TRACER	Nov
LOGIC TRIGGER	Dec

PROJECT: RADIO, AMATEUR, CB

SHORTWAVE RADIO	Feb
AUDIO COMPRESSOR	Apr
AM TUNER	May
VHF ANTENNA	May
VHF ANTENNA, PART 2	Jun
FIELD STRENGTH METER	Sep
DIGITAL DIAL	Oct

PROJECTS: AMUSEMENT

DUAL ELECTRONIC DICE	Mar
WHEEL OF FORTUNE	Apr
SHOOTOUT	Aug
MODEL TRAIN CONTROLLER	Nov

PROJECTS: LIGHT EFFECTS

LIGHT CHASER	Feb
TAPE-SLIDE SYNCHRONISER	Mar
LIGHT SHOW CONTROLLER	May
EASY COLOUR ORGAN	Jun
LIGHT SHOW COLOUR SEQUENCER	Jun

PROJECTS: MISCELLANEOUS

LOG-EXPONENTIAL CONVERTER	Jan
DIFFERENTIAL TEMPERATURE CONTROLLER	Apr
10c RAIN ALARM	Apr
PCB DRILL	May
BIP BEACON	Jun
STAC TIMER	Jul
ETI-WET	Aug
DIGITAL WIND METER	Sep
UP/DOWN COUNTER	Sep
VARIWIPIER	Oct
DEVELOPMENT TIMER	Dec

AUDIO AND TELEVISION

OBTAINING A VIDEO RECORDER	Jan
RESURRECTING YOUR VIDEO MACHINE	Feb
VIDEO ACCESSORIES	Mar
DESIGN AUDIO AMPS	Apr
SURVEY OF VIDEO CASSETTE RECORDERS	Jul
TELEVISION ANTENNAS	Aug
MAGNETIC FIELD AUDIO AMP	Aug
ULTRA FIDELITY	Oct
ULTRA FIDELITY, PART II	Nov
FLUORESCENT DISPLAYS	Dec

MICRO PROCESSORS AND COMPUTING

ROBOTS: SOME FACTS	Jan
ROBOTS: BRAIN POWER	Jan
ROBOTS: BUILDING GUIDE	Jan
APL: GOOD FOR THE BRAIN	Mar
ETI COMPUTER CATALOG(UE), (SURVEY)	Jun
BRAINS AND COMPUTERS	Jul
OSI SUPERBOARD II/CHALLENGER 1P REVIEW	Sep
COMPUTER SPEECH	Oct
USING UARTS	Nov

SCIENCE AND TECHNOLOGY

ELECTRONICS IN CANADA	Jan
QUARKS	Feb
THE SPACE SHUTTLE	Mar
HOME CLIMATE CONTROL	Mar
SUN RAYS KEEP FALLING ON MY ROOF	Apr
SPACE SHUTTLE COMMUNICATIONS	May
ELECTRONICS AND COWS	Jul
INDUSTRIAL ELECTRONICS	Aug
SOLAR POWER FROM SATELLITES	Sep

COMPONENTS

VOLTAGE-CURRENT TRANSACTORS	Jan
OP AMPS	Feb
TRANSDUCERS IN MEASUREMENT AND CONTROL	May
OP AMPS PART 2	Jun
REED SWITCHES	Jul
OP AMPS 3	Jul
SURVEY OF BOXES AND CASES	Aug
REED SWITCHES PART 2	Aug
REED SWITCHES PART 3	Sep
SELF RESONANT CAPACITORS	Dec
PRACTICAL GUIDE TO TRIACS	Dec

GENERAL

JOBS FOR STUDENTS?	Feb
WHAT QUAD TERMS REALLY MEAN	Apr
RESEARCH IN CANADA	May
INSIDE INFO FROM ULTRASOUND	Jun
PROPAGATION AND THE IONOSPHERE	Jul
SMOKE DETECTORS: CHOOSING AND USING	Aug
INTERSIL COUNTER BOARD KIT	Aug
SHORTWAVE RECEIVER SURVEY KIT SURVEY	Oct
ETI SPECIAL REPORT ON POLICE RADAR	Dec
WHAT'S ALL THIS 'EAR?	Dec

General Information For Readers

Editorial Queries

Written queries can only be answered when accompanied by a self-addressed, stamped envelope, and the reply can take up to three weeks. These must relate to recent articles and not involve ETI staff in any research. Mark your letter ETI Query.

Projects, Components, Notation

For information on these subjects please see our Project File section.

Sell ETI

ETI is available for resale by component stores. We can offer a good discount and quite a big bonus, the chances are customers buying the magazine will come back to you to buy their components. Readers having trouble getting their copy of ETI could suggest to their component store manager that he should stock the magazine.

Back Issues and Photocopies

Previous issues of ETI-Canada are available direct from our office for \$2.00 each. Please specify issue by the month, not by the features you require. The following back issues are still available for sale.

1977	1978	1979
February	January	January
May	February	February
June	March	March
July	April	April
September	May	May
November	June	June
	July	July
	August	August
	September	September
	October	October
	November	
	December	

We can supply photocopies of any article published in ETI-Canada, for which the charge is \$1.00 per article, regardless of length. Please specify issue and article. (A special consideration applies to errata for projects, see Project File.)

LIABILITY: Whilst every effort has been made to ensure that all constructional projects referred to in this edition will operate as indicated efficiently and properly and that all necessary components to manufacture the same will be available, no responsibility whatsoever is accepted in respect of the failure for any reason at all of the project to operate effectively or at all whether due to any fault in design or otherwise and no responsibility is accepted for the failure to obtain any component parts in respect of any such project. Further no responsibility is accepted in respect of any injury or damage caused by any fault in the design of any such project as aforesaid.

Advertisers' Index

READER SERVICE NUMBER		Page	READER SERVICE NUMBER		Page
1,2,4	A-1 Electronics	41-44	15	H. Rogers Electronic Instruments	30
	Arkon Electronics	Page 2		J.M.C. Distribution	61
17	Atlas Electronics	Page 83	7	Jana Industrial Electronics	7
12	Audiex Electronics	Page 37	8	Len Finkler	40
13	Audiex Electronics	Page 35	9	Len Finkler	11
	Audiovision	Page 12	10	Len Finkler	30
	Classified	Page 79		Marktron	26
14	CompuShop	Page 57		McGraw-Hill	23
	D.C.B. Electronics	Page 30	16	Omnitronix	56
6	Exceltronix	Page 26		Noramel	57
11	Gladstone Electronics	Page 39		Sprague	84
	High - Tech	Page 12		Zenith Radio Corp.	54

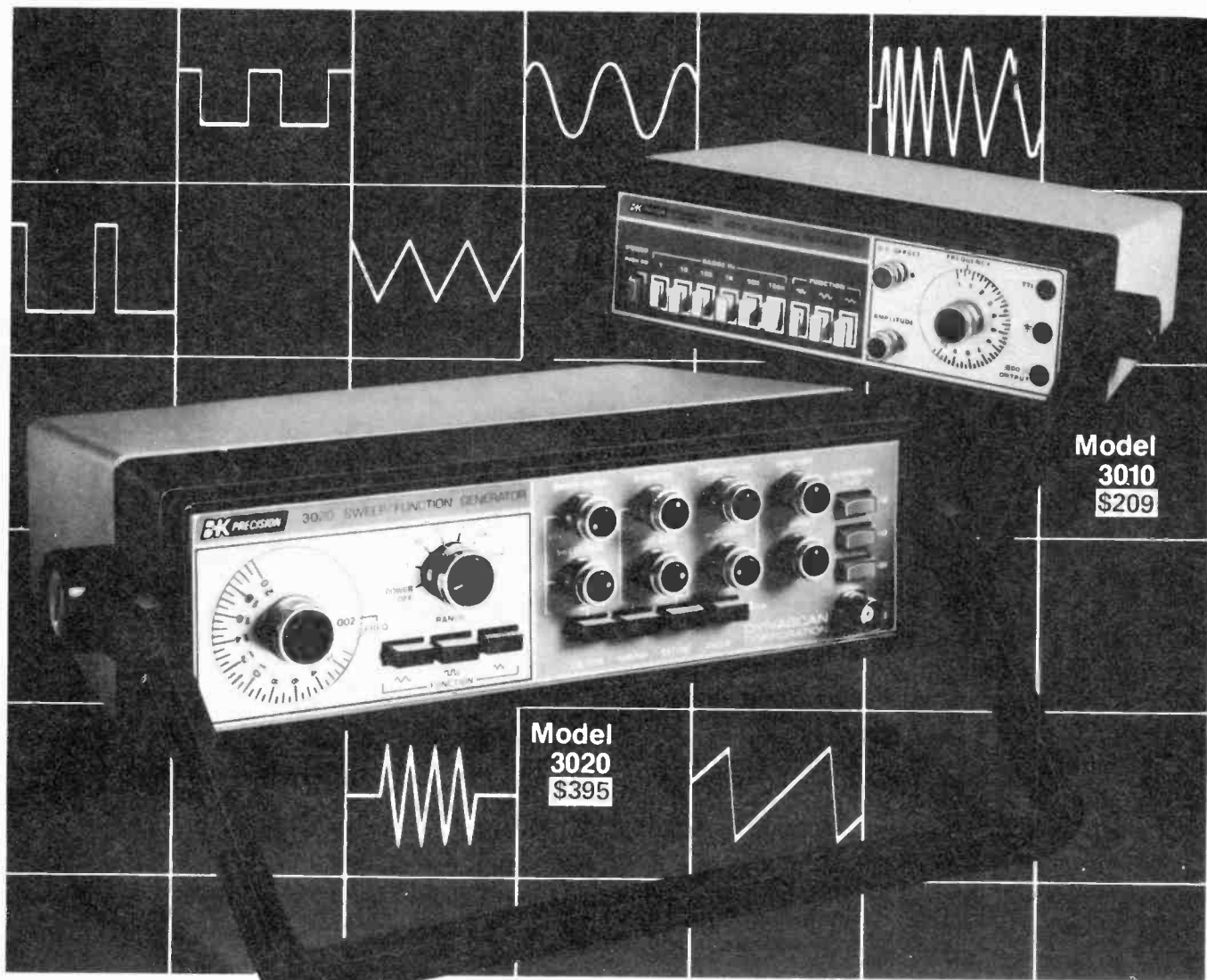

**Model
3010
\$209**

**Model
3020
\$395**

Generate virtually any wave shape with famous B&K-PRECISION cost-effectiveness!

The new B&K-PRECISION Model 3020 sweep/function generator is the most versatile signal source ever offered by B&K-PRECISION. This one instrument can actually replace a function generator, sweep generator, pulse generator and tone-burst generator. Frequency coverage spans 0.02Hz to 2MHz in seven ranges, with each range providing linear 1000:1 frequency control.

A low-distortion, high-accuracy signal source, the 3020 has the versatility to generate almost any waveform. Examples include sine waves, square waves, TTL square waves, tone-burst, pulses and ramps. All waveform types can be inverted. Internal linear and log sweep capability is also featured. Both modulation and carrier levels can be varied so even a double sideband suppressed carrier test signal can be generated.

For those applications requiring standard function generator signals only, B&K-PRECISION also offers the Model

3010 low distortion function generator. The 3010 generates sine, square, TTL square and triangle waveforms from 0.1Hz to 1MHz in six ranges. An external VCO input is provided for sweep frequency tests. Variable DC offset is also featured for engineering applications. Modestly priced, the 3010 is a stand-out value.

Like other B&K-PRECISION products, the 3020 and 3010 are available for immediate delivery at your local distributor. A ten day free trial is available at many locations.

For additional information and complete specifications, write:

BK PRECISION DYNASCAN CORPORATION

Atlas Electronics Limited, 50 Wingold Ave., Toronto, Ont. M6B 1P7 (416) 789-7761

Circle No. 17 on Reader Service Card.

Sprague gives you MORE with LESS



YOU DON'T HAVE TO BUY A STACK TO STOCK UP.

Six Extended-Range Twist-Lok® Capacitors will give you all you need to replace O.E.M. twist-mounting electrolytics in as many as 100 different ratings. Sometimes more. Just how many depends on which six Type TVLU capacitors you pick up. Or maybe you'll want a full dozen to cut down on phone and road time between you and your distributor.

These capacitors come in 299 different capacitance, voltage and case-size combinations for replacing over 2,000 existing can-type capacitors in entertainment and commercial applications requiring twist-prong mounting, wire-wrap terminals, or circuit board snap-in mounting.

Order Extended-Range Twist-Lok® Capacitors from your Sprague Distributor.

For the name of the Sprague distributor nearest you, write or call:

TRANS CANADA ELECTRONICS LTD.

2535 Gerrard St., East
Scarborough, Ont. M1N 1W9
Tel. (416) 757-4171

P.O. Box 117, Dollard Des
Ormeaux, Que. H9G 2H5
Tel. (514) 747-4266

SMITH-PATTERSON & ASSOCIATES

1120 Hamilton St.
Vancouver, B.C. R3E 2T1
Tel. (604) 681-0743

489 Kensington St.
Winnipeg, Manitoba R3J 1J8
Tel. (204) 885-1376

YOUR NUMBER 1 SOURCE FOR ELECTRONIC COMPONENTS

SPRAGUE®
THE MARK OF RELIABILITY

a subsidiary of **GK Technologies**
Incorporated