

AEROMODELLERS: SEE PAGE 24.

\$1<sup>50</sup>

# electronics today

JULY 1979

GG70409

## Build Our:

- **STAC Timer**
- **Light Triggered Tacho**

## Find Out About:

- **Propagation and the Ionosphere**
- **Reed Switches**
- **Think Like a Computer?**

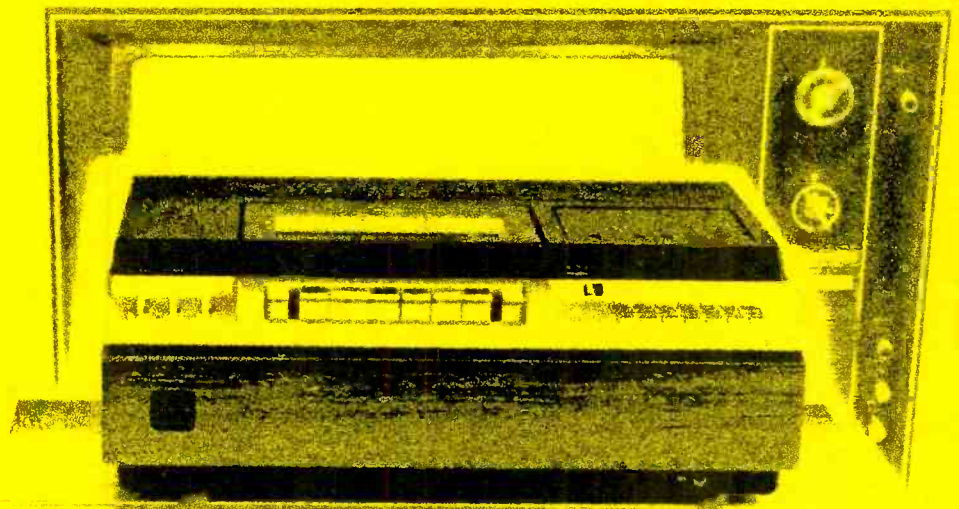

**VIDEO  
CASSETTE  
RECORDER  
SURVEY**

**SEE IT  
AGAIN!**



# Enjoy reading about electronics? Choose from the informative Babani Series and order using this card!

Is electronics your interest? Then get into it more deeply in the special areas of your choice. Electronics Today carries a range of electronics books published by Babani Press and Bernards, amongst which are those described below. (If someone has already used the card, write to Electronics Today Magazine, Unit 6, 25 Overlea Blvd, Toronto, Ontario M4H 1B1)

## IC 555 Projects

- Every so often a device appears that is so useful that one wonders how it was invented before without it. The 555 timer is such a device.
  - It was first manufactured by Signetics, but is now manufactured by almost every semiconductor manufacturer and is inexpensive and very easily obtainable.
  - Included in this book are Basic and General Circuits, Motor Car and Model Railway Circuits, Alarms and Noise Makers as well as a section on the 556, 558 and 559 timers.
  - An invaluable addition to the library of all those interested in Electronics.
- Price \$4.30 including 30¢ postage and handling

## 52 Projects Using IC741

- IC741 is one of the most popular, inexpensive and easily obtainable devices available to the home constructor. It is also extremely versatile and can be used in a great number of various applications.
  - This unique book, originally published in Germany, shows fifty-two different projects that can be simply constructed using only the IC741 and a few discrete components.
  - An invaluable addition to the library of all those interested in electronics.
- Price \$2.70 including 30¢ postage and handling

## Mobile Discotheque Handbook

- The vast majority of people who start up "Mobile Discos" know very little about their equipment or even what to buy. Many people have wasted a "small fortune" on poor, unnecessary or badly matched apparatus.
  - The aim of this book is to give you enough information to enable you to have a better understanding of many aspects of "disco" gear.
  - The approach adopted is to assume the reader has no knowledge and starts with the fundamentals, hopefully the explanations given are simplified enough for almost anyone to understand but please note that this is by no means the full story.
  - The book is divided into six parts — Basic Electricity, Audio, Ancillary Equipment, Cables and Plugs, Loudspeakers, Lighting Equipment and the information has been considerably sub-divided for quick and easy reference.
- Price \$4.80 including 30¢ postage and handling

## 28 Tested Transistor Projects

- Mr. Richard Torrins is a well experienced electronics development engineer and has designed, developed, built and tested the many useful and interesting circuits included in this book.
  - Some of the circuits are completely new and, to the best knowledge of the author, unlike anything previously published while others many bear similarity to more familiar designs.
  - The projects themselves can be split down into simpler building blocks, which are shown separated by boxes in the circuits for ease of description, and also to enable any reader who wishes to combine boxes from different projects to realise ideas of his own.
  - Most of the circuits are very economical on the use of components and in many cases the semiconductors employed are non-critical, commonly available and inexpensive types.
- Price \$3.15 including 30¢ postage and handling

## First Book of Transistor Equivalents and Substitutes

- Shows alternatives and equivalents to many popular transistors made in Great Britain, U.S.A., Europe, Japan and Hong Kong etc.
  - Companion Volume to BP14 — SECOND BOOK OF TRANSISTOR EQUIVALENTS AND SUBSTITUTES
  - An invaluable addition to the library of all those interested in Electronics be they amateur or professional.
- Price \$2.30 including 30¢ postage and handling

## Second Book of Transistor Equivalents and Substitutes

- Shows alternatives and equivalents to many popular transistors made in Great Britain, U.S.A., Europe, Japan and Hong Kong etc.
  - Companion Volume to BP14 — FIRST BOOK OF TRANSISTOR EQUIVALENTS AND SUBSTITUTES
  - All invaluable addition to the library of all those interested in Electronics be they amateur or professional.
- Price \$3.55 including 30¢ postage and handling

## Radio Circuits Using IC's

- This book describes integrated circuits and how they can be employed in receivers for the reception of either amplitude or frequency modulated signals. The chapter on amplitude modulated (a.m.) receivers will be of most interest to those who wish to receive distant stations at only moderate audio quality, whilst the chapter on frequency modulation (f.m.) receivers will appeal to those who desire high fidelity reception of local v.h.f. stations possibly with stereo (and even quadrophony at some future date). Stereo decoder circuits and the devices available at present for quadrophonic circuits are discussed. Voltage regulator devices are also covered because they are so convenient in all varicap tuned receivers and because they have so many applications in all types of circuit.
  - Brian Dance is a highly experienced author who regularly contributes to many of the popular electronic magazines that are available both in the U.K. and overseas.
  - An extremely valuable addition to the library of all Electronics enthusiasts.
- Price \$4.80 including 30¢ postage and handling

## 50 (FET) Field Effect Transistor Projects

- Field effect transistors (F.E.T.'s) find application in a wide variety of circuits. The projects described here include radio frequency amplifiers and converters, test equipment and receiver aids, tuners, receivers, mixers and tone controls, as well as various miscellaneous devices which are useful in the home.
  - It will be found that generally the actual F.E.T. used is not critical and many suitable types will perform satisfactorily. The F.E.T. is a low-noise, high gain device with many uses, and the dual gate F.E.T. is of particular use for mixer and other applications.
  - This book contains something of particular interest for every class of enthusiast — shortwave listener, radio amateur, experimenter or audio devotee.
  - A valuable addition to the library of all electronic enthusiasts.
- Price \$3.85 including 30¢ postage and handling

## Popular Electronic Projects

- Included in this book are a collection of the most popular types of projects which, we feel sure, will provide many designs to interest all electronics enthusiasts.
  - All the circuits utilise modern, inexpensive and freely available components.
  - The 27 projects selected cover a very wide range and are divided into four basic areas: Radio Projects, Audio Projects, Household Projects and Test Instruments.
  - An interesting addition to the library of both the beginner and more advanced constructor.
- Price \$5.10 including 30¢ postage and handling

## Electronic Music and Creative Tape Recording

- Electronic Music is the new music of the 20th Century. It plays a large part in "Pop" and "Rock" music and, in fact, there is scarcely a group without some sort of electronic synthesiser or other effects generator.
  - It is possible with relatively simple apparatus to create complete compositions using electronic and sometimes non-electronic musical sources.
  - This book sets out to show how Electronic Music can be made at home with the simplest and most inexpensive equipment. It describes how the sounds are generated and how these may be recorded to build up the final composition.
  - With the constructor in mind, several ideas are given to enable a small studio to be built including a mixer and various sound effect units.
  - Circuits are included for VCOs, VCAs, Envelope Shapers, VCFs, Active and Passive Mixers, Fuzz, Noise Generators, Metronomes and a 1G-Note Programmable Sequencer etc.
  - All the units shown have been successfully built and used by the author and most of the projects can be built by the beginner.
  - An unusual, fascinating and highly rewarding application of electronics.
- Price \$4.50 including 30¢ postage and handling

## IC LM3900 Projects

- The purpose of this book is to introduce the LM3900 to the Technician, Experimenter and Hobbyist. It provides the groundwork for both simple and more advanced uses and is considerably more than just a collection of simple circuits or projects.
  - The LM3900 is different from conventional "Op-Amps", it can be used for many of the usual applications as well as many new ones. Its one of the most versatile, inexpensive and freely available devices on the market today.
  - The book is divided into six basic sections —  
Introduction  
Audio Applications  
Simple Linear Applications  
Simple Digital Applications  
Signal Generator Circuits  
Special Applications
  - The LM3900 can do much more than is shown here — this is just an introduction. Imagination is the only limitation with this useful device, but first the reader must know the basics and that is what this book is all about.
- Price \$4.80 including 30¢ postage and handling

## 1st Book of Hi-Fi Loudspeaker Enclosures

- Contains 26 practical designs and over 40 drawings to enable the enthusiast to construct his own Hi-Fi Loudspeaker enclosures.
  - Includes the following types of enclosures —  
Corner Reflex, Bass Reflex, Exponential Horn, Folded Horn, Tuned Port, Klipschorn Labyrinth, Tuned Column, Loaded Port, Multispeaker Panoramic etc.
  - Also covers general construction hints and embellishing of cabinets as well as a considerable amount of other useful information.
  - A must for the library of all audio enthusiasts.
- Price \$3.05 including 30¢ postage and handling

## 50 Simple L.E.D. Circuits

- The author of this book, Mr. R.N. Soar, has compiled 50 interesting and useful circuits and applications, covering many different branches of electronics, using one of the most inexpensive and freely available components — the Light Emitting Diode (L.E.D.).
  - Also includes circuits for the 707 Common Anode Display.
  - A useful book for the library of both beginner and more advanced enthusiast alike.
  - Companion volume to book No. BP36 — 50 CIRCUITS USING GERMANIUM, SILICON & ZENER DIODES by the same author.
- Price \$3.05 including 30¢ postage and handling

## Handbook of IC Audio Preamplifier & Power Amplifier Construction

- Shows what audio IC's are, as well as how to use them.
  - Includes practical construction details of various IC and Hybrid IC/Transistor designs of about 250mW to 100W output.
  - This book is written by the very experienced and popular author Mr. F.G. Rayer who deals with the subject in four parts:  
Part I Understanding Audio IC's  
Part II Preamplifiers, Mixers and Tone Controls  
Part III Power Amplifiers and Supplies  
Part IV Hybrid Circuits
  - An ideal book for both beginner and advanced enthusiast alike.
- Price \$3.15 including 30¢ postage and handling

## 50 Projects Using Relays SCR's & Triacs

- Relays, silicon controlled rectifiers (SCR's) and bi-directional triodes (TRIAC's) have a wide range of applications in electronics today. These may extend over the whole field of motor control, dimming and heat control; delayed, timing and light sensitive circuits and include warning devices, various novelties, light modulators, priority indicators, excess voltage breakers etc.
- In this book, the very experienced and popular author — Mr. F.G. Rayer — has given tried and practical working circuits which should present the minimum of difficulty for the enthusiast to construct.
- In most circuits there is a wide latitude in component values and types, allowing easy modification of circuits or ready adaptation of them to individual needs.
- An ideal book for both beginner and advanced enthusiast alike.

## 50 Projects Using IC CA3130

- The CA3130 is currently one of the more advanced operational amplifiers that is available to the home constructor. This means that it is often capable of a higher level of performance than many other devices and that it often needs fewer ancillary components.
  - In this book Mr. R.A. Penfold has designed and developed a number of interesting and useful projects which are divided into five general categories:  
I Audio Projects  
II R.F. Projects  
III Test Equipment  
IV Household Projects  
V Miscellaneous Projects
  - An ideal book for both the beginner and more advanced enthusiast alike.
- Price \$3.15 including 30¢ postage and handling

## Electronic Projects for Beginners

- In this book the newcomer to electronics will find a wide range of easily made projects, many complete with actual component and wiring layouts. Furthermore, a number of projects have been arranged so that they can be constructed without any need for soldering and, thus, avoid the need for a soldering iron.
  - This book which is written by the very experienced author Mr. F.G. Rayer is divided into four sections: —  
1. "No Soldering" Projects  
2. Miscellaneous Devices  
3. Radio and Audio Frequency  
4. Power Supplies
  - An absolute "must" for all beginners in electronics.
- Price \$4.60 including 30¢ postage and handling

## 50 CMOS IC Projects

- CMOS IC's are probably the most versatile range of digital devices for use by the amateur enthusiast. They are suitable for an extraordinarily wide range of applications and are now also some of the most inexpensive and easily available types of I.C.
  - In this book Mr. R.A. Penfold has designed and developed a number of interesting and useful projects which are divided into four general categories:  
I Multivibrators  
II Amplifiers and Oscillators  
III Trigger Devices  
IV Special Devices
  - An ideal book for both the beginner and more advanced enthusiasts alike.
- Price \$3.10 including 30¢ postage and handling

## Electronic Calculator Users Handbook

- An invaluable book for all calculator users whatever their age or occupation, or whether they have the simplest or most sophisticated of calculators.
  - Presents formulae, data, methods of calculation, conversion factors etc. with the calculator user especially in mind, often illustrated with simple examples.
  - Includes:  
■ The way to calculate, using only a simple four function calculator:  
Trigonometric functions (sin, cos, tan)  
Hyperbolic functions (sinh, cosh, tanh)  
Logarithms, square roots and powers
  - A comprehensive section of conversion factors covering such common conversions as length, area, volume and weight etc. through to more specialised conversions such as viscosity, illumination, and cargo shipping measures etc.
  - Formulae and data for VAT, discounts and mark up, currency conversion, interest, solutions of equations, binary and octal numbers, areas and volumes, statistics and mathematics etc.
- Price \$3.20 including 30¢ postage and handling

See also pages: 11, 34, 55 for more publications from Babani, and also ETI.

Editor  
STEVE BRAIDWOOD BSc  
Assistant Editor  
GRAHAM WIDEMAN BSc  
Editorial Assistant  
JOHN VAN LIERDE

Advertising  
Advertising Manager  
MARK CZERWINSKI BSc  
Advertising Services  
SHARON WILSON

Advertising Representatives  
JIM O'BRIEN  
Eastern Canada JEAN SEGUIN &  
ASSOCIATES INC. 601 Cote Vertu,  
St. Laurent, Quebec H4L 1X8.  
Telephone (514) 748-6561.

Subscription Department  
BEBE LALL  
Accounts Department  
SENGA HARRISON  
Layout and assembly  
SARAH-JANE NEWMAN

Contributing Editors  
WALLACE PARSONS (Audio)  
BILL JOHNSON (Amateur Radio)  
JOHN GARNER (ShortWave Listening)  
DICK CARTWRIGHT (Servicing)

**EDITORIAL AND ADVERTISING OFFICES**

Unit 6, 25 Overlea Boulevard,  
Toronto, Ontario, M4H 1B1  
Telephone (416) 423-3262

Published by Electronics Today  
International (Canada) Ltd.

Printed by Livingstone Printing Ltd  
Delta Web Graphics

News Stand Distribution  
Gordon & Gotch, Toronto.

**COPYRIGHT**

All material is subject to worldwide  
copyright protection. All reasonable  
care is taken to ensure the accuracy  
of the information.

All ETI PCB Patterns are copyright .  
No company may sell boards to our  
designs without our permission.

**INTERNATIONAL EDITIONS**

Electronics Today International, 25-27  
Oxford St., London W1R 1RF U.K.

Editor Ron Harris

Electronics Today International

Ryrie House, 15 Boundary St.,  
Rushcutters Bay, Sydney, Australia.

Managing Editor Collyn Rivers.  
Acting Editor Roger Harrison

Elrad

Kommanditgesellschaft, Bissendorfer  
Strasse 8, 3000 Hannover 61 Germany

Editor Udo Wittig

*Postal Information*

Second Class Mail registration number  
3955. Return postage guaranteed. Post  
office returns to Unit 6, 25 Overlea  
Bld, Toronto, Ontario. M4H 1B1

# electronics today

international

INCORPORATING ELECTRONIC WORKSHOP

## PROJECTS

STAC TIMER .....	15
<i>Today your home, tomorrow the world!</i>	
TWO OCTAVE ORGAN .....	21
<i>Straightforward project to make musical instrument.</i>	
LIGHT ACTIVATED TACHOMETER .....	24
<i>RPM measured for aeromodellers and industrial applications.</i>	

## FEATURES

PROPAGATION AND THE IONOSPHERE .....	28
<i>Radio waves: They fly through the air with the greatest of ease . . .</i>	
SURVEY OF VIDEO CASSETTE RECORDERS .....	35
<i>No need to personally "stay tuned" any more.</i>	
REED SWITCHES .....	44
<i>If this conjures up visions of Moses in the rushes, then "read" on.</i>	
BRAINS AND COMPUTERS .....	49
<i>Comparison of bio and semi technologies.</i>	
OP AMPS 3 .....	52
<i>More on these ubiquitous little devices.</i>	
ELECTRONICS AND COWS .....	68
<i>Cows are now being surveyed by video.</i>	

## NEWS & COLUMNS

NEWS DIGEST .....	4
AUDIO TODAY .....	9
<i>Down with hype.</i>	
BINGO AND OHM'S LAW FOR CALCULATORS .....	56
<i>ETI Softspot: Under the N, 37k.</i>	
IONOSPHERIC EFFECTS ON SHORTWAVE LISTENING .....	59
<i>Short Wave World looks at how the signals get to your set.</i>	
A LOOK AT THE ETA .....	63
<i>Service News checks out this organization.</i>	
QRM .....	65
<i>Helping hams.</i>	
FUN OF ELECTRONICS .....	70
<i>The lighter side.</i>	

## INFO & MISCELLANEOUS

Electronics Paperbacks . . . . .	2, 11	More Circuits .....	55
Tower's I. T. S. ....	11	Classified Ads .....	71
ETI Binders .....	12	ETI Project File .....	72
ETI Subscriptions .....	20	ETI Marketplace .....	73
Canadian Projects Book .....	34	Reader Service Info .....	74
ETI Circuits No. 1 .....	34	Advertisers' Index .....	74
ETI T-Shirts .....	48		



# NEWS DIGEST

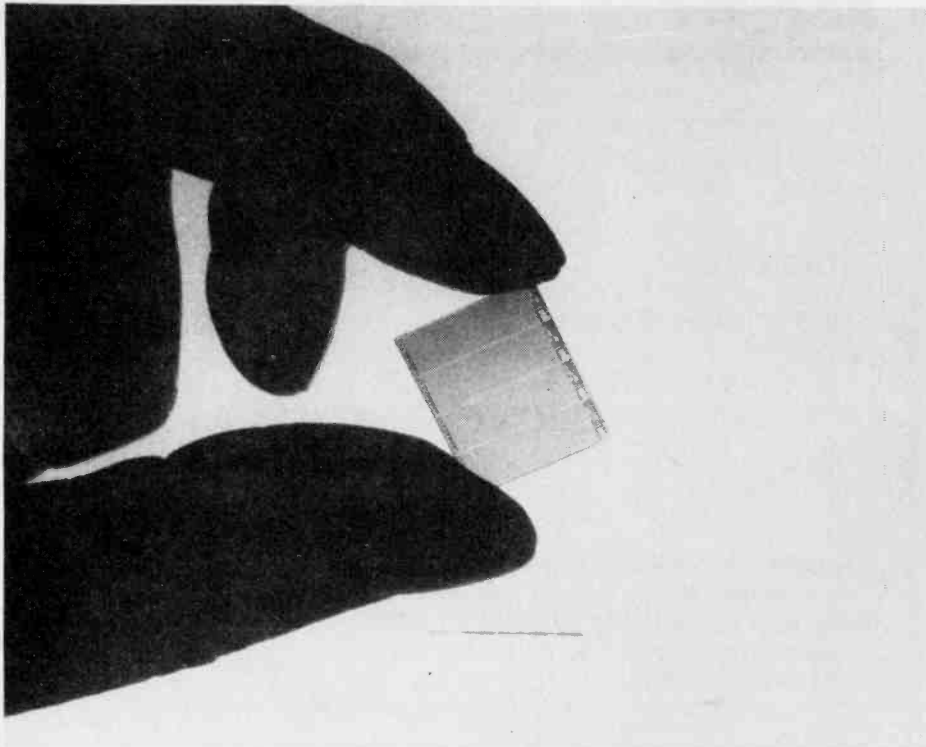

*FIRST MILLION-BIT MEMORY DEVICE — Magnetic bubbles store over a million bits of data in this new memory component from Intel Magnetics of Santa Clara, California. Intel Magnetics is a subsidiary of Intel Corporation.*

## One-Megabit Bubble Memory

Intel Magnetics, a subsidiary of Intel Corporation, today announced the world's first commercially available megabit (million-bit) memory device — the Intel® Magnetics 7110, a 1,048,576-bit Magnetic Bubble Memory.

Intel Magnetics also introduced a complete family of LSI support circuits that will enable system designers to design bubble memory systems easily and rapidly. With the support components, users of the megabit device can go immediately into system development without becoming involved in the intricacies of bubble memory technology.

A 128-kilobyte system, with its support components, can be easily constructed on only 16 square inches of board space; and a megabyte memory on only 90 square inches. These are only fractions of the area required by semiconductor memory devices. Moreover, error correction — which normally requires a separate subsystem — is built into the family.

Along with extremely high storage density, the chief advantage of bubble memory is non-volatility. Like magnetic

cores, tapes and disks, bubble memories retain data when the power is turned off, while conventional semiconductor read/write memories lose data.

The idea of using magnetic bubble to obtain very high density, non-volatile memory or logic elements was introduced in 1967 by Andrew Bobeck of Bell Telephone Laboratories.

The bubbles are small magnetic domains formed in thin, single-crystal films of synthetic garnet. The domains are only a few microns in size and can be moved by the creation of a magnetic gradient across the film. The device can be controlled to perform memory or logic functions. The presence of a bubble at a particular location corresponds to a binary "1" and the absence of a bubble corresponds to a binary "0".

Intel expects the component family to be used in microcomputer applications before it's used in large computer applications. Immediate applications exist for high-density bubble memory systems in microcomputers, while the architectures of large computers are expected to go through an evolution in the 1980's in order to utilize bubble memory.

Intel Magnetics will supply the components family to equipment manufacturers. A prototype kit which allows equipment designers to build a magnetic bubble memory system into new products can be ordered immediately. The price of the 7110 prototype kit is approximately \$2,000 (for that price, it had better not leave a bath tub ring. — Ed As.). Deliveries will begin this Fall.

Intel Magnetics, 3000 Oakmead Village Drive, Santa Clara, California 95051, Don Bryson (408) 987-7700.

## CB Radio in Britain

There is still much argument occurring in Britain as to whether Citizens band radio should be legalised. James Bryant, President of the Citizens Band Association, recently sent a letter to British Prime Minister James Callaghan urging him to take measures to legalise CB radio and pointed out what is considered by his association to be a growing increase in the illegal use of Citizens band equipment in Britain.

Apparently, four UK manufacturers (not yet named) are already prepared to manufacture CB sets if they should be declared legal. Bryant stated that the United Kingdom and Eire are the only European countries which do not allow private citizens some form of radio-communication.

It has been said that if Britain adopted the US system this would lead to a flood of Japanese-manufactured equipment into the country. The Citizens Band Association have therefore pointed out that every set sold could employ modern silicon chip technology fitted into the set at the factory which would transmit a unique identifying signal; it would not be possible for a person to change this set identifying signal without the resources of a microelectronics factory and the equipment could be made so that it would not transmit without it.

Such a system would not only prevent Japanese sets from underpricing the market, but would also greatly reduce the administration costs of the system whilst rendering criminal and antisocial use impractical.

Most countries use amplitude modulation in the 27 MHz band but the Citizens Band Association feel that this is impractical in such a heavily populated country as Britain. They suggest that unused parts of the 220 to

240 MHz band or frequencies of about 900 MHz might be suitable, especially as only a relatively small bandwidth of possibly less than 1 MHz is needed.

The Association fear that if the number of illegal users of CB equipment continues to grow, the Government could be forced to adopt a legalised system similar to that used in America and that this would prevent the later adoption of a better system. The Association feels that Britain should lead the world into the adoption of a Citizens band system which enables each transmission to be readily identified.

Nevertheless, there is still a considerable amount of feeling against the legalisation of this form of communication in Britain.

**From Brian Dance  
in the UK.**

## Solar Power

Contracts worth a total of some \$2.5 million for the development of new solar heating equipment by 10 Canadian firms were announced in Quebec City today by Pierre Bussières, Parliamentary Secretary to the Minister of Energy, Mines and Resources, on behalf of Public Works Minister André Ouellet.

Originally, over 150 firms from across the country entered the competition under the federal government's Program of Assistance to Solar Equipment Manufacturers (PASEM), being administered by Public Works Canada.

Mr. Bussières said that the federal government had not only committed significant resources to the development of a Canadian solar energy industry, but had also undertaken equally important technology transfer and public information programs.

He indicated it is the government's intention to pass on to architects, engineers, builders and developers in each province the technological and financial results of pioneering efforts with solar heating, a renewable energy source which is inexhaustible, non-polluting, and available across the country, and more important, free of price increases.

Mr. Bussières mentioned that the 10 winning submissions were selected from 42 entries after consideration by a panel of public and private sector engineering and business specialists. The project range from the

development and production of new solar panels to integrated solar heating systems.

Firms selected were Amherst Renewable Energies Ltd., Perth, Ontario, Electrohome Ltd., Kitchener, Ontario, Nortec Solar Industries Ltd., Ottawa, Ontario. E.H. Price Ltd., Winnipeg, Manitoba/St. Jerome,

Quebec, Solarsystems Industries Ltd., Surrey, British Columbia, Solartronics Ltd., Smiths Falls, Ontario, Solatherm Energy Systems Ltd., Mississauga, Ontario, Temperature Specialties Ltd., Downsview, Ontario, Thermo Solar Inc., Montreal, Quebec, Watershed Energy Systems Ltd., Toronto, Ontario.

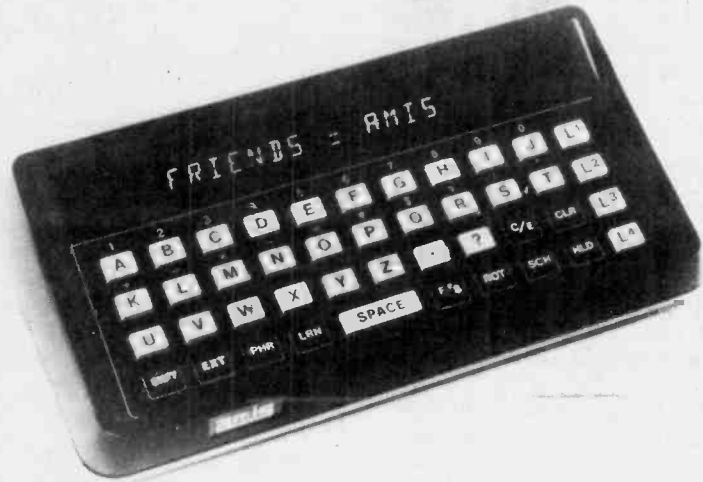

*The Amis MC 400 offers instant translation between three languages at a time and is being hailed as the world's first hand-held computer (well it sure beats pointing at the menu).*

## Major Breakthrough In Consumer Electronics

A hand-held computer that can translate instantly between three languages at a time is being acclaimed as the development of the decade in the consumer electronics field.

The Amis MC400 Translator, which resembles an advanced calculator but with a full alphabetical keyboard as well as numbers, fits in the palm of the hand and can translate words, phrases or complete sentences on bright-lit display according to the selection of plug-in memory capsules.

The Amis enables a completely unilingual person to communicate instantly in any of the languages programmed for the tiny unit. Conversely, any foreign word can be entered and the translation given instantly in the operator's native tongue.

Capsules have been developed for English, French, German, Italian, Spanish and Japanese, as well as phonetics, with Russian and others currently under development.

To speed up communications, the Amis comes programmed with 50 complete or partial phrases that can be accessed and translated at the touch of

a button. Complete sentences can be entered on the keyboard either with or without these ready phrases.

Languages are carefully programmed on the capsules by specialists to avoid confusing a beginner with complicated tenses and conjugations.

Among the features of the Amis is a review of words with double meanings. The unit displays each meaning and then translates the definition selected. It also corrects spelling errors automatically.

Languages actually are just the start. The Amis is really the first truly portable, handheld computer capable of accepting any data for retrieval. Capsules are already under development for first-aid treatments, horoscopes, calorie counters, etc. and very soon the Amis will be able to store entire dictionaries and works of reference, thus continually expanding its capability and literally putting the power of a computer in the palm of your hand.

For information please contact: Paul Berger, THE HOUSTON GROUP, 2015 Peel Street, Suite 500, Montreal, Quebec H3A 1T8 (514) 288-8290.

## Hot Stuff

New from Jana is a 30W soldering iron kit. The kit is totally self contained and comes with screwdrivers and tweezers to aid in assembly. We also noted this kit required no (thank goodness) soldering in its construction.

This would make a good beginners kit, and shouldn't require more than an evening to build.

Price is approximately \$ 10.00 from Jana Electronics, P.O. Box 489, Winnipeg, Manitoba R3C 2J3.

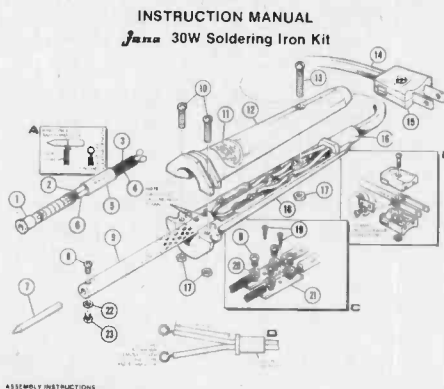

## DMA Controller

Intel Corporation announces the introduction of the 8237 and the 8237-2 DMA controllers for use in 8085A and 8088 microcomputer systems. Claimed to be the highest performance DMA controller chips available, these parts are designed to provide microcomputer peripherals a direct link to system memory, thus increasing input/output (I/O) speeds and reducing central processing unit (CPU) overhead. The 8237 is specified at 3 MHz, while the 8237-2 is specified at 5 MHz. Both parts are pin equivalent to the slower AMD 9517, 9517-1 and 9517-4.

In particular, the higher speed of the 8237-2 allows it to be used with the 8085A-2, the high-speed (5 MHz) version of Intel's 8-bit microprocessor, and with the newly announced 5-MHz 8088 which contains the architecture of Intel's high-performance 16-bit 8086 microprocessor, but preserves the 8-bit external bus structure.

The 100-piece prices of the 8237 and 8237-2 in plastic are \$20.00 and \$25.00 respectively. The parts are also available in cerdip at 100-piece prices of \$26.25 for the 8237; \$32.85 for the 8237-2.

INTEL CORPORATION, 3065 Bowers Avenue, Santa Clara, California 95051, Mike Peak (408) 987-8080.

## New Address

Icon told us to tell you their new address, mark it on your calendar. Icon Electronics Co., 333 McPhillips Street, Winnipeg, Manitoba, R3E 2K9.

The telephone number remains the same — 284-1703.

## Understanding Frequency Counters

With the increasing sophistication of frequency counter applications, such as time domain stability measurements, engineers need better defined counter specifications, as well as new specifications.

In a new 34-page application note from Hewlett-Packard, engineers and technicians are able to review basic counter specifications as well as become acquainted with new specs. This new AN 200-4 entitled *Understanding Frequency Counter Specifications* starts with a general introduction. Following is a section detailing input characteristics of counters including range, sensitivity, signal operating range, dynamic range and trigger level considerations.

Operating mode specifications are covered in Section III which includes various range specifications and a discussion of least significant digit, resolution and accuracy.

Several appendices cover topics such as time interval averaging, rms specifications, effects of wideband

noise and measurement of counter contributed noise.

Ask for AN 200-4, *Understanding Frequency Counter Specifications*, Publication No. 02-5952-7522.

Write to INQUIRIES MANAGER, Hewlett-Packard (Canada) Limited, 6877 Goreway Drive, Mississauga, Ontario. L4V 1M8

## DIP'd Batteries

These nickel cadmium battery models in miniature dip-style packages provide reliable standby power in microprocessors and micro electronics. DS2SD-2 .4V 65 mah, DS3SD-3.6V 65 mah standard and DS2GT-2.4V 65 mah, DS3GT-3.6V 65 mah gold top have continuous overcharge capabilities, polarity keyed terminals, and a flat discharge profile.

The gold top units are supposed to provide longer life at elevated temperatures. From CGE they can withstand high volume soldering techniques. For further information contact: Canadian General Electric Co. Limited Electronic Components Operation 189 Dufferin Street Toronto, Ontario M6K 1Y9.

## Car Tape Deck

Addition of a new AM/FM stereo cassette car radio to the famous Blaupunkt line of car radios distributed throughout Canada by Robert Bosch (Canada) Limited, has been announced by Alan Ingham, sales manager of the Blaupunkt car radio division.

The "Essen" AM/FM stereo cassette car radio from the Blaupunkt car radio division of Robert Bosch (Canada) Limited is claimed to have excellent FM sensitivity with clean, crisp audio output power. State of the art IC technology permits compact size (7" x 5-1/4" x 1-3/4") — 177 x 133 x 44 mm) allowing installation in most import

vehicles.

The cassette mechanism has locking fast forward and rewind controls with manual eject and power off eject.

The tuner/audio section features ASU (Noise Suppression Circuit for FM Reception) and controls for volume

on/off, tone, balance, mono/stereo switching and manual tuning.

Robert Bosch (Canada) Limited, 6811 Century Avenue, Mississauga, Ontario, L5N 1R1 Phone: (416) 826-6060.



# If you want more function generator for the money, you'll have to build it yourself.

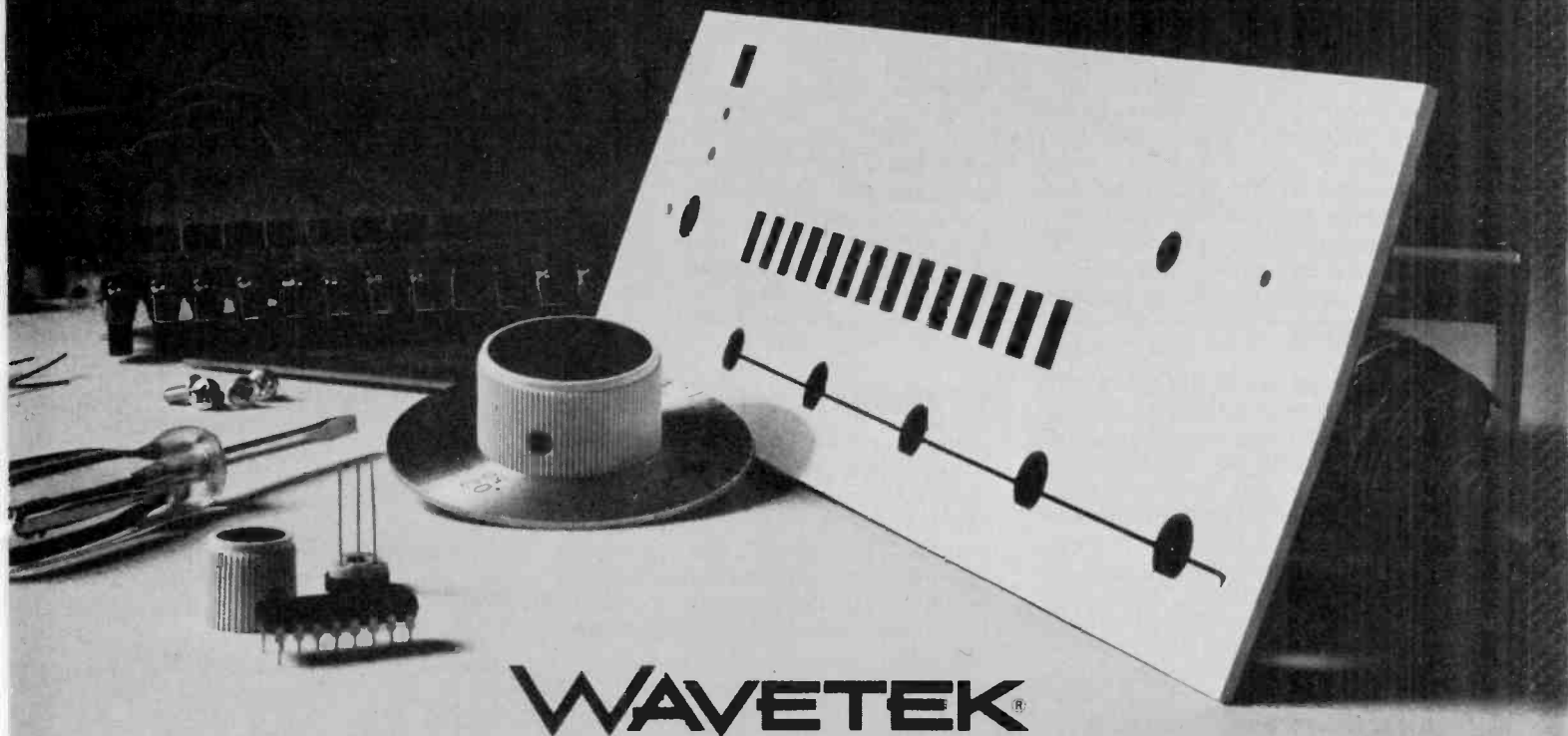

## WAVETEK®

But first, lay down that soldering iron and consider the following:

The Model 182 gives you sine, square and triangle waveforms, plus trigger and gate functions. Imagine getting tone bursts and pulse bursts out of an under-\$450 instrument!

What's more, the Model 182 can be used as a sweeper. The sweep range (up to 1,000:1

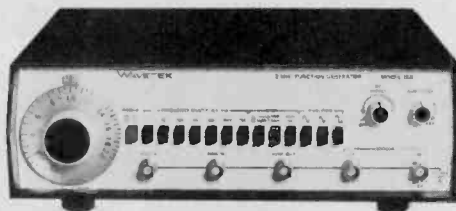

Model 182

or three decades) is controlled by an external voltage applied to the instrument.

For frequency range, you

get 0.002Hz to 2MHz, which is plenty broad for most applications.



### Allan Crawford Associates Ltd.

TORONTO MONTREAL VANCOUVER OTTAWA CALGARY HALIFAX  
155/675-1500 574/670-1212 684/674-1326 813/805-9651 403/230-1144 302/469-1865



## Tools 'n Instruments

Len Finkler announces some new products;

**CONTINENTAL SPECIALTIES** the MAX-550 pocket-sized 1KHZ to 550 MHZ Counter. Max-550 is a high-precision, 6-digit, audio-to-UHF counter in a calculator-sized package. Employing the latest LSI techniques, MAX-550 provides precise, guaranteed readings from 1000HZ to 550MHZ. It actually eliminates separate audio, LF, HF, VHF and UHF counters — yet fits in pocket or toolbox!

The MAX-550 is fully automatic, requiring no adjustment of polarity, slope, trigger or input level. It can read to 100 Hz resolution with inputs as low as 250 mV. Input is sampled for 0.1 second, readout updates 6 times per second.

And then there's the Hansen Model AT-210; 100,000 ohms per volt multimeter.

The model AT-210 is a handy type 100K ohms per volt high sensitivity VOM designed for wide range measuring and checking. With its solid meter movement, high readable scale



and the other many excellent characteristics, accurate measuring and checking are available.

For further information, please contact: Len Finkler Limited, 25 Toro Road, Downsview, Ontario. M3J 2A6 Phone - (416) 630-9103.

## Atlas News

New from Atlas are the Milbank MIL 'Series Two' line of Integrated Paging Amplifiers and Tuner/Amplifiers. With the MIL "Series Two" the following choices are available in ten different models 25, 50 and 75 watts output, AM or FM Tuner on 50 or 75 watt models, 110 VAC operation (or 12/24VDC-110VAC for MIL603MB), Each MIL "Series Two" Amplifier features, Attractive Styling, Solid State Design, Pre-Announcement Chime Capability.

Typical MIL "Series Two" applications will be offices, churches, schools, garages, taverns, restaurants and factories.

Cobra, a leader in CB transceivers has just announced the introduction of their new 99GTL IN-DASH ENTERTAINMENT CENTERS.

The 99GTL is the ultimate in the Cobra Autosound programme, with features like AM/FM/FM Stereo, Stereo Cassette Player, 5 AM/FM Memory Pushbuttons, 12 Watts RMS Audio Power per Channel, 1.8 uV Typical FM Sensitivity, Speaker Balance Control with Center Detent, Front/Rear Fader Control, Graphic Equalizer/Amplifier Adaptability.

Atlas Electronics Limited, 50 Wingold Avenue, Toronto, Ontario M6B 1P7 New Telephone (416) 789-7761.

## 'Tenna Catalog

An expanded catalogue featuring Land Mobile antennas for commercial two-way communications systems is now available from Cardon Import Canada Ltd.

The catalogue highlights several new antenna models from Antenna Inc. for whom Cardon is the exclusive Canadian distributor.

Fully illustrated, the catalogue provides reference material in an easy-to-read chart format. Included are low band and high band VHF mobile antenna lines and UHF models. A range of mounting configurations are shown and described.

For a free copy of the new catalogue, write to Cardon Import Canada Ltd., Box 937, Hamilton, Ontario.

## DIP Switch Cat

All important dimensions, circuitry, electrical characteristics, and materials and finishes are illustrated or defined in a new catalogue of DIP switches from Grayhill. Request Catalogue No. 3 from A. C. Simmonds & Sons Limited, 975 Dillingham Road, Pickering, Ontario, L1W 3B2.

## Chroma Racks

Hammond Mfg. (Guelph, Ont.) announces their new line of Chroma system racks. Standard 19" panel width racks come in 10 heights, each in 3 depths, 17, 24, and 31". A wide range of available options including panels, doors, turrets, blower systems, equipment chassis, drawers and more

make Chroma racks unbeatable for equipment mounting versatility. Various door and panel stylings and a wide range of standard finishes make Chroma racks compatible with any environment. Chroma racks and accessories can be seen in Hammond's new 9R-8 catalogue and are available now through your local Hammond distributor.

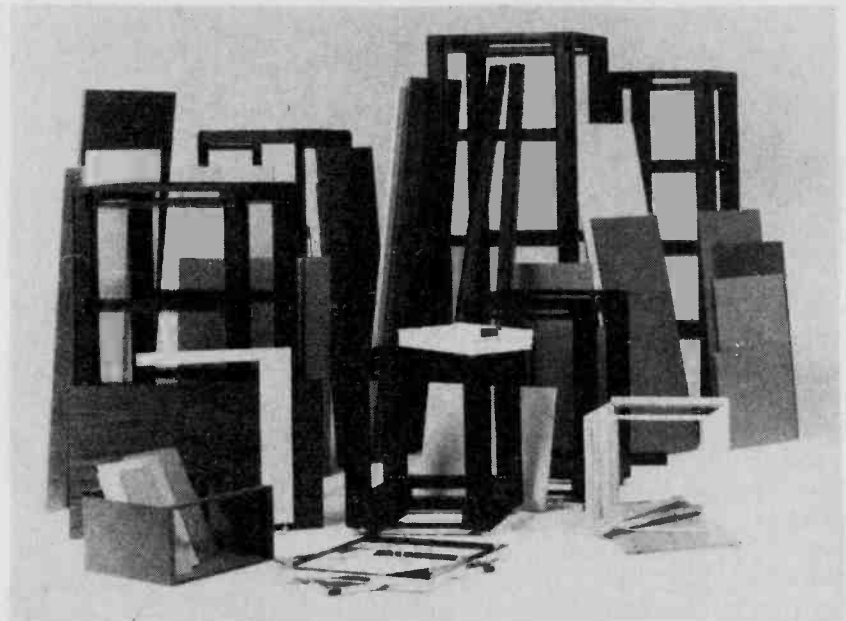





# Audio Today

Developments in audio reviewed by Wally Parsons

EVERY SO OFTEN, it seems to me, we should stop talking and writing about audio and start talking and writing about audio instead. No, the typewriter has not become stuck, and I hope the old professor is not coming unstuck.

We seem, at times, to become so pre-occupied with the hardware, and with the technology behind it that we often lose sight of the purpose of it all. I know I've dealt with this subject before, and will probably return to it again, but this seems to be necessary if we are to avoid wandering off into dead-end backwaters.

## FUNDAMENTAL REQUIREMENTS

Most treatments of High Fidelity and its basic requirements go on at great length about distortion, frequency response, dynamic range, and all that, and end up with the admonition to let your ears be the final judge. But no one seems prepared to say what they should be the final judge of, and by what criteria this final judgement should be made.

As a consequence, we find a rapidly growing market filled with all kinds of great new wonder devices, all of which constitute "break-throughs", "breaking down the final barrier" of something or other, "revolutionary new developments", and the like. Yet I can count on one hand the number of systems I've heard which would match the sense of realism I experienced in 1961, I believe it was, using a pair of Quad Electrostatic speakers, Quad

tube electronics, and one of the first Shure Stereo Dynetic pickup/arm systems. Or a direct-coupled tube amplifier at an earlier time whose degree of realism and transparency was so stunning that the memory still remains.

The first Stanton pickup I owned was the 681A. My first impression of it was the feeling of realism, particularly transient attacks, and the shimmer of struck cymbals. Even on discs which presented tracking problems, particularly on inner grooves (it used a spherical stylus) this quality was still there. With many of today's discs with their high recording levels and high accelerations it's hopelessly out-classed by other products, including that company's own successors, the 681EEES and 88 1S. Even so, very few achieve this quality of easy naturalness.

Perhaps recordings may be blamed, but here too, one hears all the evidence of technical improvement, and yet that elusive, indescribable quality of realism is so often absent. Not long ago while demonstrating speakers to a recording engineer friend the subject of depth imaging, that is, front to back location, came up. One of the recordings I used involved digging back 25 years to a now deleted Capitol recording, in *mono*. This was recorded in one of Capitol's own studios by, I believe, one of Capitol's staff engineers, back in the days when no advertising or marketing manager would have the gall to tell an engineer how much he hated engineers because

they get in the way of the marketer's schemes. Solo voice and orchestra, and the solo voice stood solidly in front of the orchestra. Why and how this came about neither of us could explain. Many of that same company's mono and stereo discs of twenty years ago featuring the Stan Kenton orchestra, plus others which were an attempt to revive in modern sound some of the big bands of the forties caught much of this feeling. Again, why, and how?

Much, if not most, of today's equipment seems to be designed by the marketing department, rather than by the engineers. The marketing man



That young devil Jenkins is on about lowering the modulus of elasticity of air. . . is he sending me up again Stan?!!

# Audio Today

decides what the public (i.e. dealers) want, not bothering to explain how this knowledge was acquired in spite of the fact that the public doesn't know what it wants. The engineer is then ordered to produce. The result is, not continued research and development into ways of producing better equipment, but rather into ways of creating new fads and fashions, new "in" sounds and design philosophies, fashions dictated by people with no knowledge of sound reproduction, and no real desire to acquire such knowledge.

## "WITH IT" DESIGN PHILOSOPHY

I recently had a good look at this philosophy when I was approached by a marketing type who had gotten nowhere with his present employers in his attempt to produce a line of speakers with a particular "British" sound, but which was little more than a counterfeit version of a very popular American design. This bright young lad quickly demonstrated a near-total ignorance of even the fundamentals of loudspeaker operation and an even more total disdain for engineers and other design types. The proposition would have involved my executing his brain-child, but not for the usual return, that is fee for service and a reasonable mark-up on each manufactured copy, if I should engage in the manufacturing, but rather a partnership, or, failing that, I should expect to recover my development costs through a relatively small mark-up on the manufactured copies.

I was quickly made aware of the reason why I should drop my own transmission lines, including the kind of cones materials which are acceptable to a certain market (one in which I have no interest) heard all the old wives' tales about horns and what's wrong with them (somebody should tell Klipsch and Electro-Voice; bet they'd be surprised), and so on and so forth.

There is such a thing as an "Underground Audio Movement" which, judging by what appears in their various club publications, never listens to music, never pays conscious attention to natural sounds, and generally functions on the basis of what Richard Heyser refers to as the "Catastrophe Theory". It's too complex to describe in a few words, but readers are urged to obtain the March, April, and May issues of "Audio" magazine for a full dissertation, as well as T.S. Kuhn's "The Structure of Scientific Revolution" on which much of Heyser's articles is based.

## SALES HYPE

What it boils down to, for the purpose of this discussion, is that a large segment of the sales and marketing community has fallen for its own sales hype, and set its criteria of performance accordingly. That wouldn't be so bad, except that the result is that so many of the perverted views which result have been rammed down the throats of many segments of the audiophile public when the latter have been at their least informed, and in the process set these perverse standards for that public. After a period of time, it becomes possible to "prove" that these are the standards to which "people" subscribe and equipment which is built to these standards are what people want.

There's really nothing new in all this. It's a total plagiarism from the automotive industry. During the fifties everybody wanted big cars with tail fins, and later they wanted big cars with lots of chrome. Today, of course, everybody wants small energy-efficient cars. Of course. The industry set us up by designing the kind of cars they decided we *should* want, then ramming them down our throats. When some people were critical, they pleaded that they were only giving the public what it wanted.

It's all hype, of course, and probably contributes more to energy waste than poor gas mileage.

## RESPONSIBILITY

It has occurred to me from time to time, that in writing this column I'm assuming a large responsibility. I am, as are most other journalists, attempting to provide leadership in setting the standards of my readers. Even when dealing with "facts" these are always, of necessity, presented from the perspective of my own values.

The fact that so many readers appear to find my observations and often highly opinionated views to be welcome is most gratifying.

This column and the letters section is a forum for discussion. Your observations are welcome.

## THE FOSGATE PUNCH

Ordinarily this corner doesn't devote much space to the subject of automotive sound or components thereof. The reason is simple: reader response suggests that more interests lie elsewhere. And, too, much of what has been introduced to the market has, with few exceptions, been little more than a joke when judged by high fidelity standards. After all, what is one to think of an industry which regards 8-track

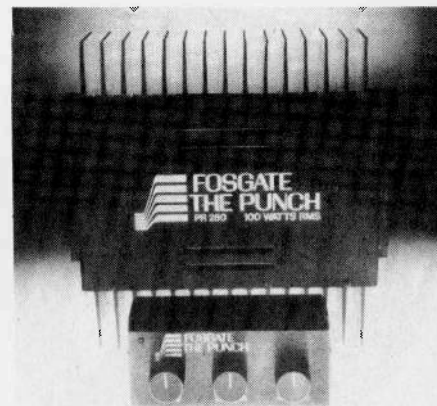

tape cartridges as a high fidelity source of music programme, or brags about specifications which would have been an embarrassment to the appliance manufacturers only a few years ago. Or entices customers with brand or model names like "Mind Blower" or "Mind Blaster".

However, during the past year or so this area of audio has undergone a mushrooming of development, with "legitimate" high fidelity manufacturers getting into it, and newcomers appearing with equipment which lays legitimate claim to high fidelity performance.

Typical of the latter, and in some respects better than most, is the current product line of automotive components by FOSGATE, dubbed "The Punch". It would be unfortunate if serious audiophiles were to lump product name in the same class as "Mindblowers" and the like, because it's an impressive line with impressive specs, and, although I've not measured performance, I have heard one of their systems installed, and can quite unreservedly describe it as the best automotive system I've ever heard.

At present, the system consists of four preamp/amplifier combinations, the PR-220, with 20 W/Ch, the PR-250 with 50 W/Ch, the PR-252 also with 50 W/Ch with three band independent tone controls and output level indicator (LED), and the PR-2100, with four 50 W amplifiers and built-in electronic crossovers (variable). In addition there are three speakers available, a 6" x 9" and a 5 1/4" long throw woofer, a 5 1/4" mid-range, and a 3" phenolic ring tweeter.

All electronic units claim a damping factor of 1000 or more, THD less than 0.05%, frequency response from 20 Hz to kHz within 0.25 dB, and very low

# THE KING

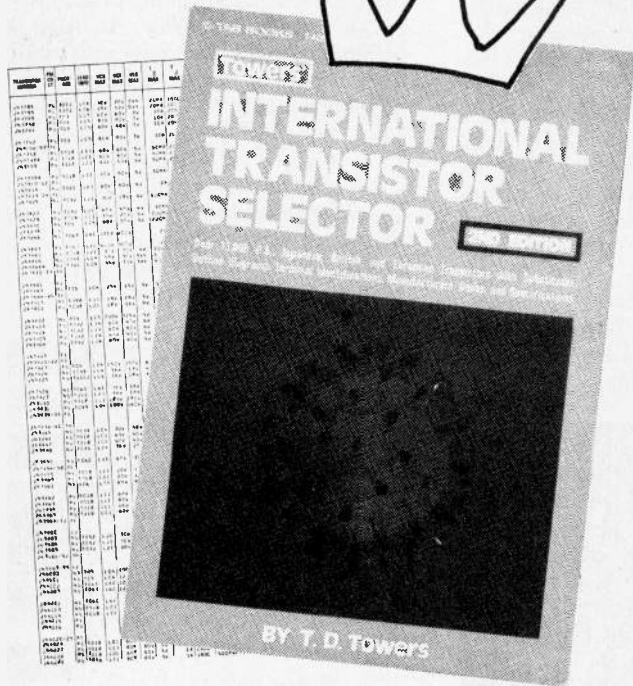
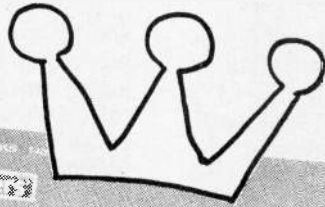

## OF TRANSISTOR GUIDES

TOWER'S INTERNATIONAL TRANSISTOR GUIDE is now available from ETI. We are proud to be able to bring you this "bible" of transistor data. It contains data on over 13000 transistor types, 2Ns, 2SCs, European and "replacement" types. Information includes polarity, material, package and lead info, maximum ratings for VCB, VCE, VEB, IC, TJ, P, minimum FT, HFE, typical use, manufacturer and suggested equivalents.

WE RECOMMEND THIS BOOK WITH CONFIDENCE BECAUSE THIS IS THE ONE WE USE.

To order use the card in this issue, or mail the coupon below to: TOWER'S, Electronics Today Magazine, Unit 6, 25 Overlea Blvd, Toronto, Ontario, M4H 1B1.

OK ETI — I don't want to be in the dark about transistor specs any longer — send me THE KING. Here's my \$8.95 plus .45 for postage and handling. (That's \$9.40 if your calculator battery is flat, or 2 for \$18.80)

NAME \_\_\_\_\_

ADDRESS \_\_\_\_\_

Cheque enclosed. DO NOT send cash.

Bill Mastercharge. A/C No. \_\_\_\_\_

Bill ChargeX. Expiry Date \_\_\_\_\_

Signature \_\_\_\_\_

## SPEAKER KIT SALE!

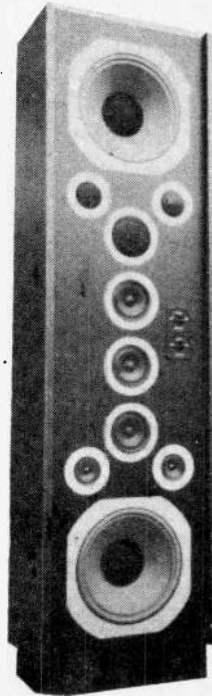

300 Watts RMS, DISCO Tower \$170. ea.  
200 Watts RMS, DISCO Tower \$127. ea.  
2-12" W, 4-5" Mid, 2-2"x5" Horn

150 Watts RMS, Home DISCO \$88. ea  
12" W, 5"-Mid, 2"x5" Horn

100 Watts RMS, Hi-Fi . . . . . \$67. ea  
12" W, 5"-Mid, 2"x5" Horn

All kits include crossover networks and terminals. Aluminum Trim Ring, Hi and Mid controls are optional.

12" Aluminum Ring . . . . . \$4.95 ea.

5" Midrange Ring . . . . . \$2.25 ea.

2"x5" Horn Ring . . . . . \$2.00 ea.

Hi/Mid control . . . . . \$4.95 ea.

Add 5% for shipping. Ontario residents add 7% sales tax.

KYLL Electronics Ltd.  
4544 Dufferin St. Unit No. 19  
Downsview, ONT. M3H 5R9  
(416) 633-2332

Open:  
10-6 TUES, WED, SAT.  
10-9 THURS, FRI.  
Closed: MON, SUN.

From those wonderful people who brought you the HANDBOOK OF IC AUDIO PREAMPLIFIER AND POWER AMPLIFIER CONSTRUCTION, comes

## 1st Book of Hi-Fi Loudspeaker Enclosures

by B.B. Babani

\$3.05 including 30 cents postage and handling.

CONTENTS	
CLASSES OF ENCLOSURE	5
SPHERICAL TWEETER REPRODUCER	7
BASS REFLEX HORN	13
TUNE PORT BASS REFLEX ENCLOSURE	13
LIBRARY ENCLOSURE	13
MINIATURE HORN LOADED REFLEX ENCLOSURE	13
BT - MINI-HORN	13
KARLSON ENCLOSURE	14
SEMI FOLDED HORN	14
INFINITE WALL BAFFLE	14
BASS REFLEX ENCLOSURE	15
90 DEGREE BALANCED REPRODUCER	16
CORNER FITTING LONG CHANNEL HORN ENCLOSURE	16
LONG CHANNEL ENCLOSURE	16
REAR LARGE HORN SLOT LOADED ENCLOSURE	16
MINIATURE ENCLOSURE WITH 1" / 1.5" SPEAKERS	16
NOVEL SEALED CABINET	16
REAR HORN REFLECTOR ENCLOSURE	16
FOLDED HORN ENCLOSURE	17
DISTRIBUTED PORT ENCLOSURE	17
GIANT AUDITORIUM ENCLOSURE	18
FIGURE TABLES A - F	18
GENERAL CONSTRUCTION HINTS	18
IMPELLING SPEAKER ENCLOSURES	19
CRITICAL DAMPING	21
CROSS OVER FILTERS	21
PHASING LOUDSPEAKERS	22
QUADROPHONY	23
FURTHER DEVELOPMENTS IN STEREOPHONY	24
QUAD-QUADROPHONY	25
DUMMY LOAD AND SPEAKER SWITCHING SYSTEM	26
HI-FI COMPATIBILITY PROBLEMS	30
FREQUENCY RESPONSE OF SOUND REPRODUCTION	30
DECIBEL AND POWER RATIOS	36
LOUDNESS LEVELS	36
FUNDAMENTAL FREQUENCY OF SOUND SOURCES	37
MUSICAL FREQUENCY SCALES	38
SPEAKER POWER DISTRIBUTOR	38
DIAGRAMS WITH DIMENSIONS FOR ALL SPEAKER DESIGNS	40 - 94

Please use card to order.

# Audio Today

T.I.M. distortion, attributed to the use of a high speed (60 V/usec) in the circuit.

One curious characteristic which constitutes radical departure from conventional techniques is the description of the tone controls which claim only to offer boost facilities, rather than boost-cut. I must admit that at mid settings they appear to give level response and indeed to act very much like conventional controls, with perhaps less cut than boost.

But at maximum boost it becomes obvious why the name "The Punch" was chosen. With the Fosgate speakers mounted as dual pairs in the rear parcel deck, and driven by the PR-2100 Bi-amp, full bass boost can give the feeling

reservations as to how achievable this is in an automotive environment) at least a clean, tight, peak-free bottom end, a smooth well projected mid-range, and a sparkling top end are a most welcome alternative to having holes between the ears.

Unavailable for examination was Fosgate's version of the Tate Directional Enhancement System (DES) SQ decoder, which is being marketed as the "Tetra-1", apparently using the electronics of the PR-2100, and similarly the "Tetra-2" professional-cum-audiophile decoder. Apparently Dolby labs have acquired the rights for use of the Tate DES in the film industry, and may signal a

shortcomings. Your cure for the cavity resonance is the basic reason for my letter. I would appreciate receiving your recipe for correcting this problem.

One question: why do you use fibreglass to fill the cavity and not long fibre wool? Is not long fibre wool the best at damping?

D.F., Montreal, P.Q.

*I'm glad you asked me that. Have you any idea how much fibreglass I have lying around the house?*

*Actually, one cannot legitimately make a blanket statement as to what is*

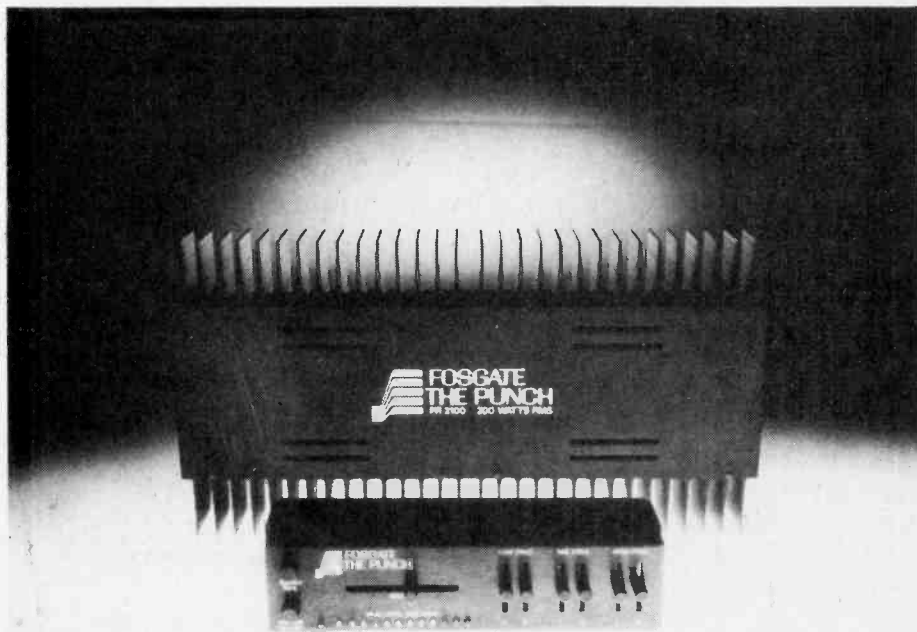

of a giant fist punching the back of the seat. (incidentally, full boost at high levels can drive even the 50Watt bi-amped system into clipping). Whether or not you would like to drive along the road with someone punching you in the back you'll have to decide for yourself (I wouldn't), but the result is extremely clean. Realistic, no, clean yes. After using large transmission line speakers as a reference standard I find it difficult to get enthusiastic about the "realism" achieved by any 5-1/4" woofers, no matter how many are used or what their excursion capabilities may be. But if we can't have realism (and I have serious

resurgence of interest in quadraphony.

For more information contact Paul Moores at Audio Dimensions, 198 North Queen St., Toronto Ont. M9C 4Y1

## LETTERS

First, I would like to say that you have made my subscription to ETI more enjoyable and constructive. It is especially interesting as of late because of your valued comments concerning Transmission Line (speaker) Systems.

A 4-way TL System I am building will use a Phillips AD 0211 SQ mid-range. In your July '78 Audio Today Products column you mentioned two of its

In response to many request from our readers we have arranged for binders to be made so that you can keep ETI's first volumes together and protected from damage. The binders are covered in attractive leather-look black plastic and are designed to hold twelve issues. The ETI design is printed in gold letters on the spine.

The binders cost \$6.00 each, which includes postage and packaging. Do not send cash -you can pay by cheque, MasterCard, or ChargeX. Credit card orders must include your account number, the expiry date, and your signature. In all cases allow six weeks for delivery. Send your order to ETI Binders, Unit 6, 25 Overlea bld., Toronto, Ontario M4H 1B1. Don't forget to include your name and address. Ontario residents add 7% PST or use the card opposite page three.

# BINDERS





# More Value, Versatility and Performance than any other 3½ Digit hand-held DMM... trust it.

**Data Precision  
Model 935  
\$198.\***

**HANDY** - easy to hold, to carry, to use, to read . . .

**ACCURATE** - basic 0.1% DC accuracy - better than that of many bench/lab DMM's.

**TOUGH** - built to take rough everyday field usage and electrical overload . . . yet maintain its calibration.

**VERSATILE** - all the functions and ranges and need . . . 29 in all: volts & amps, AC & DC, Switchable Hi & Lo Ohms.

**VISIBLE** - big, clear, high-contrast 3½-digit LCD display, readable anywhere . . . a full 0.5" high.

**EXPANDABLE** - uses standard DMM accessories to extend ranges even further.

**VALUABLE** - lowest cost of any high-performance hand-held DMM.

\*Duty paid, Fed. and Prov. taxes extra.



**WEBSTER  
instruments ltd.**

2446 Cawthra Road, Mississauga, Ont.  
L5A 3K6 416/275-2270  
Ottawa 613/725-1931  
Montreal 514/747-9747

Please send me

Data Precision Model 935

@ \$198 \$ \_\_\_\_\_

F.S.T. 9% \$ \_\_\_\_\_

Prov. sales tax (Ont. 7%;

Quebec 8%;

B.C. 5%) \$ \_\_\_\_\_

Shipping and handling \$ 2.00

Total enclosed \$ \_\_\_\_\_

**MAIL ORDER**

Payment: Certified Cheque  Charge/Visa

Money Order  Master Charge

Card Number

Expires \_\_\_\_\_

Card Holder Signature \_\_\_\_\_

SHIP TO: NAME \_\_\_\_\_

ADDRESS \_\_\_\_\_

CITY \_\_\_\_\_ PROV. \_\_\_\_\_ POSTAL CODE \_\_\_\_\_

# Audio Today

the "best" material for damping. Much depends on the damping technique used (e.g. thermo-dynamic energy exchange, acoustic line resistance, etc.) and the frequency band involved. Thus, felt generally offers the best performance for surface treatment of cabinet walls at mid and high frequencies if the problem is primarily due to reflections, but in this case (the Phillips unit) a cavity resonance is best controlled by filling the cavity with a material which offers high acoustic resistance at cavity resonance without developing back pressure behind the dome. Acoustic fibreglass seems to fill the bill.

In transmission lines I've been experimenting with various grades and types of glass fibre in conjunction with my own unique method of line termination, and some unusual sets of driver parameters. Unlike most TLS builders and manufacturers, I am not using the KEF B139 driver, which I consider unsuitable for use in such a system (and, incidentally, I'm no longer using the Philips 12100). The type of driver in use at present features an extremely linear dual cloth suspension and is capable of a 1" excursion with 10 Watts input at resonance. I'm awaiting a modified version with a different motor system and voice coil material. There are some business problems involved in getting commercial production which are holding things up (Canadian businessmen really are a 'fraidy-cat bunch), but the result of all this is a system capable of reproducing pipe organ and disco at live performance levels with reasonable power, and the kind of bass impact which can cause breathing problems.

The stuffing of the line is not a simple matter of finding the "best" damping material, but of achieving the appropriate impedance match to the radiation impedance of the driver.

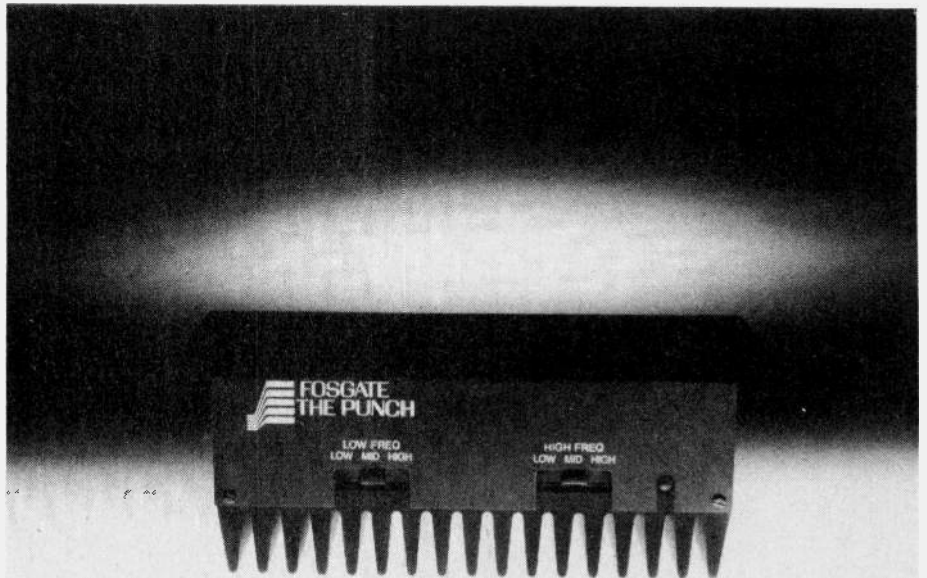

Getting the most suitable research facilities in this country is most difficult (I had set up a programme with an acoustic instructor at one of Ontario's better institutions, but the government cut off funds for equipment, so that fell through. Thanks Pierre!), so, like so many of my readers, I'm doing it the hard way.

Another synthetic fibre of interest is spun polyester, available as Fortrel, and known in the upholstery industry as "Fibrefill" which might be a trade-mark. It's used as the soft filler in quilts, etc. Long fibre wool is not that easy to get; mostly it's supplied to the mills in quantities absurdly large even for commercial speaker manufacturing. I

suspect that its use in England was influenced by the fact that the experimenters were near sheep-raising country and the material was easily obtained. It has a tendency to settle, and when used in a speaker does not hold up well in shipping.

I understand that Phillips might be introducing an open plate version of the AD 0211, in other words, a mid-range AD 1600 T, with some attention paid to the cavity resonance problem.

A lot of readers seem to be experimenting with TLS systems. How about writing and describing your results and sharing some experience with each other.

## Jensen Triaxial<sup>®</sup> 3-Way Speakers

Quite simply, the most advanced car stereo speaker ever.

For the best sound ever in your car. The first car stereo speaker with a woofer, a tweeter and a midrange.

Identical in principle to the best home stereo speakers. Jensen's midrange picks up a whole range of tones lost to any other car speaker.

**Write today for Free catalogues and the name of your nearest Jensen Dealer —**

Jensen finkler limited

25 Toro Road, Downsview, Ontario M3J 2A6  
Telephone (416) 630-9103 Telex 065-24010

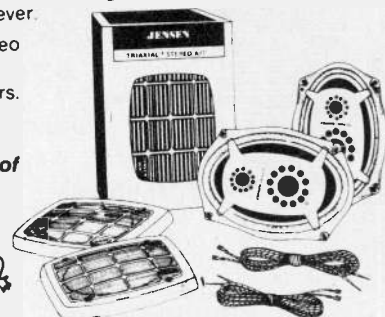

Not long ago I received a letter from a reader thanking me for my reply to his request for information on the modification of the Philips AD0211, but advising that the drawing and instruction sheet to which I referred was not included. In view of the fact that I had sent out responses to a large number of such enquiries, it occurs to me that other readers may have received a reply with the relevant sheets missing. If so, my apologies, and please drop me a line and I'll send them out. I have a nice pile of copies here.

# STAC Timer

The most sophisticated timer project we have ever published, this unit is based on the COPS STAC chip, giving it extraordinary versatility.



THE NAME OF this project is derived from that given by the manufacturer to the IC around which it is built. STAC stands for Standard Timer And Controller and the device is part of National's COPS (Calculator Orientated Processor System) group, a series of what are, in effect, dedicated microprocessors.

The STAC provides a 24-hour clock with four digit display, much as any clock IC, but has four control outputs which may be programmed to turn on, turn off, or to retain their current status at any one of four preset times during the day. STAC also has the facility to "skip" certain selected days within its seven or eight day (selectable) cycle.

The IC is thus a perfect basis for many control applications from air conditioning installations to fish tanks and hi-fi systems. The STAC's outputs operate four relays with normally open contacts, which can switch 120 volts at up to five amps.

A row of LEDs below the readout

shows the condition of the outputs, and is also useful for checking a program.

## PROGRAMMING

Setting up the STAC is quite straightforward and rather like using a programmable calculator. At switch-on the clock is set to 0000, all set points are zero and all outputs are off, all days are valid with the present day set to one. The display will show the clock output.

Setting the clock follows the usual procedure adapted with any digital clock. Pressing SET HOURS or SET MINUTES will advance the digits at a rate of four per second.

To enter the program mode the DATA ENTRY key is pressed momentarily. Upon activation, the first set program point time will be displayed, and its output status will be shown by the decimal points of the display. To set the time of an operation, the SET HOURS and SET MINUTES keys are operated until the desired time is displayed on the readout.

If it is desired to switch an output

on at this time, the SET STATUS key is pressed to light up the decimal point corresponding to the output. Each time the key is pressed the decimal point will move one place to the right. If a combination of outputs is required at this time, the HOLD STATUS key is used to hold the decimal point on, before moving on with the SET STATUS key to the next decimal point required to be on. Using the SET STATUS and HOLD STATUS keys, any combination of the outputs can be set up.

If an error is made in programming, using the SET STATUS key from the fourth point will clear all data and the proper information can be re-entered.

So far we have only programmed one of the four set point times. By pressing the ADVANCE SET POINT key the display will go to 0000, can again be set to a time, and the output conditions set up. Once this has been done four times, pressing ADVANCE SET POINT will return to the first set point time.

Programming can be verified by using

the MANUAL OPERATION key which transfers the decimal point information to the outputs. By pressing the DATA ENTRY key a second time the STAC is returned to the clock mode.

## DAY STATUS

Valid and invalid days can be set up by pressing the DAY MODE key, which displays the current day on the left of the readout and the day status on the right. When the SET DAY key is pressed the STAC advances to the next day, while the SET STATUS key changes the validity of the day as seen by a one or zero on the right of the readout. As the timer steps through a week the programmed conditions occur only on valid days. A second operation of the DAY MODE key returns the STAC to the clock mode.

The programming is now complete.

Operating the DEMO key will rapidly cycle through the program sequence at

a rate of one hour per second.

Pressing the RESET key in the clock mode will reset the clock to zero as well as the valid day information.

## CONSTRUCTION

The timer consists of three separate single sided pcb's. The relay board can be left out if not required, the outputs of the STAC being active low and capable of sinking 20 mA. Either a display board, or any common cathode multiplexed display can be used for the readout. Output connections from the relay contacts are taken to a nylon terminal strip mounted on the back panel together with the alarm.

Operation from 50 cycle mains is possible by inserting link 1 from the pcb, and an eight day cycle is achieved by connecting a link from pin 27 to pin 15 of IC1. When this link is in, the SET STATUS and SET MINUTES keys have the same function.

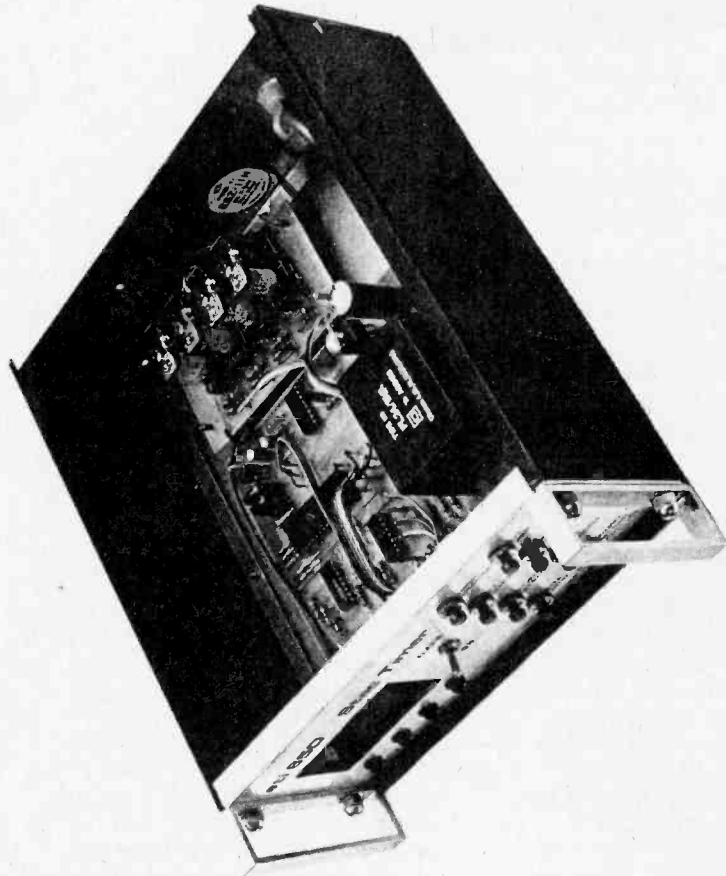

*The completed timer. Output connections are made by a terminal strip on the rear panel.*

The power supply for the STAC timer is comprised of the full wave rectifier, D1 and D2 and the regulator IC3. D3 raises the output voltage of the regulator by about 0.7V.

Some AC from the transformer is fed to IC2a and IC2b, via R3. These act as both a schmitt trigger and a monostable to clean up the waveform and to ensure that any transients on the mains are not counted by the timer. The 60Hz pulses are then fed to IC1 to provide the mains synchronised timing pulses. A soft start is provided by R4 and C5 to ensure proper initialization.

## HOW IT WORKS

The operation of the STAC IC is described in the text, the programming being done by the pushbuttons PB1 - 8. Link 1 changes the circuit from 60 to 50 Hz operation.

The multiplexed display is driven by the buffers IC4 and IC5. Outputs from the STAC are active low, and drive the LEDs

via buffer inverters, IC6, to provide an indication that a particular output is on. Output 1 can be fed, via SW1, to an astable formed by IC2c and IC2d. When the output goes low it enables the oscillator, which is then inverted by Q2 and fed to an emitter follower, Q1. The piezo alarm will pulse at a frequency determined by C6, C7 and R5. The two capacitors C6 and C7 are back to back and form a non-polarised capacitor.

The outputs from the STAC are fed to inverter and relay driver stages to provide a contact closure capable of switching 120 volts



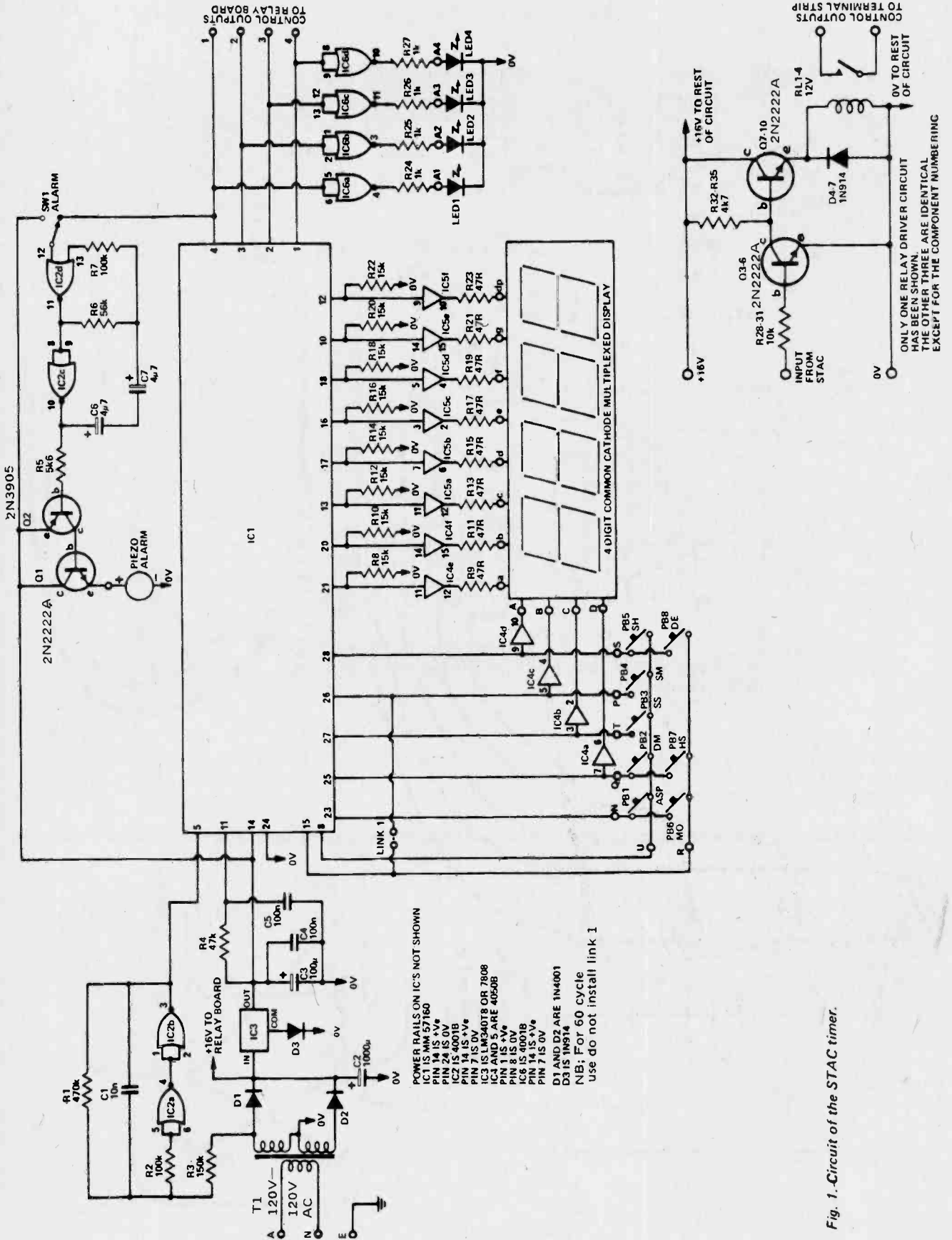

Fig. 1. Circuit of the STAC timer.

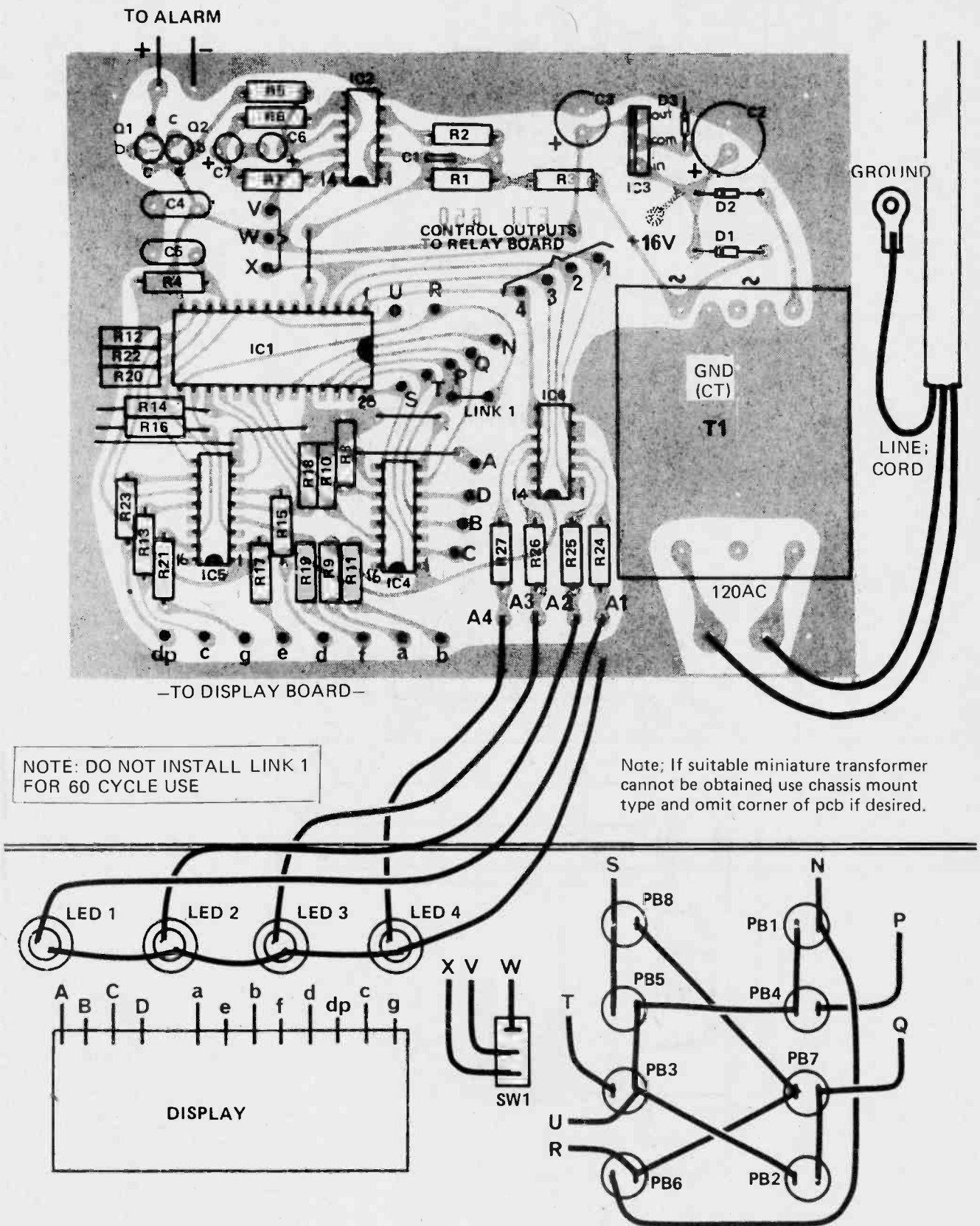
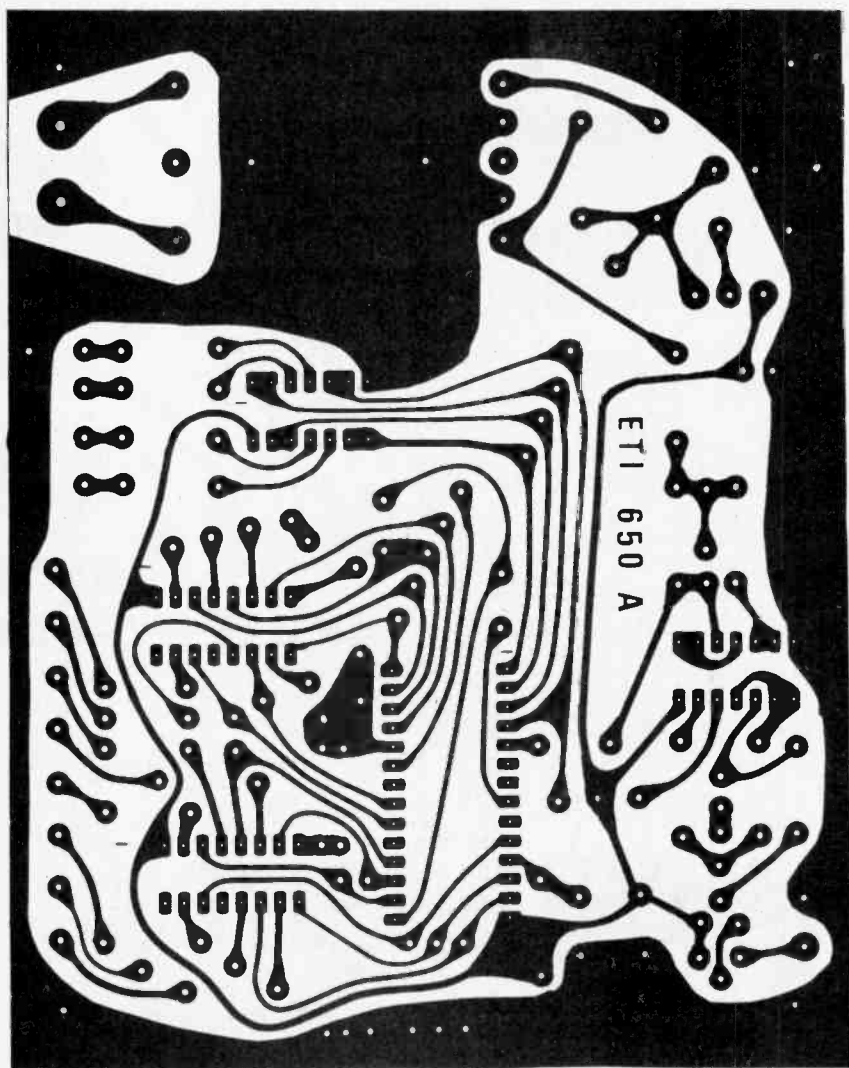

Fig. 2. Component overlay of the main pcb.



## PARTS LIST

### RESISTORS all 1/4W 5%

R1	.....	.470k
R2	.....	100k
R3	.....	150k
R4	.....	47k
R5	.....	5k6
R6	.....	56k
R7	.....	100k
R8, 10, 12, 14,		
16, 18, 20, 22	.....	15k
R9, 11, 13, 15,		
17, 19, 21, 23	.....	47R
R24 - R27	.....	1k

### CAPACITORS

C1	.....	10n greencap
C2	.....	1000μ 25 VW electro
C3	.....	100μ 16 VW electro
C4, 5	.....	100n greencap
C6, 7	.....	4μ7 16 VW electro

### SEMICONDUCTORS

IC1	.....	MM57160 STAC IC (National)
IC2	.....	4001B
IC3	.....	LM340T-8.0
IC4, 5	.....	4050B
IC6	.....	4001B 2N2222H
Q1	.....	2N2222A similar
Q2	.....	2N3905 or similar
D1, 2	.....	1N4001 or similar
D3, 4	.....	1N914
LED1 - LED4	.....	red light emitting diode

### Display

Common cathode  
multiplexed displays  
such as national  
NSB5881

### SWITCHES

PB1 - PB8	.....	miniature momentary push button switches
SW1	.....	SPDT min. toggle

### MISCELLANEOUS

piezo electric alarm such as Projects  
Unlimited A1400 case to suit, display  
filter, nylon terminal strip, molex pins,  
28 pin IC socket or molex pins, nuts,  
bolts, etc.

### TRANSFORMER

T1 120V/24ct @ 200mA

### Parts For Relay Board

R28 - R31	.....	10k 1/4W 5%
R32 - R35	.....	4k7 1/4W 5%
Q3 - Q10	.....	2N2222A
D4 - D7	.....	1N914
RL1 - RL4	.....	mini PC heavy duty 12V relay

PCBs for this project: check with  
Spectrum Electronics, 38 Audubon  
St. S., Hamilton Ont L8J 1J7 and  
B&R Electronics, P.O. Box 6326F  
Hamilton Ont L9C 6L9. The MM57160  
can be supplied by Northern Bear  
Electronics, P.O.Box 7260 Saskatoon,  
Sask. S7K 4J2.

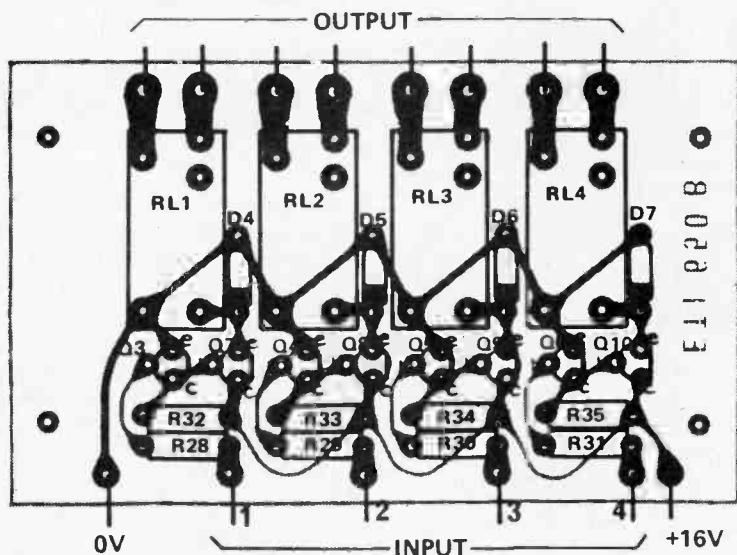
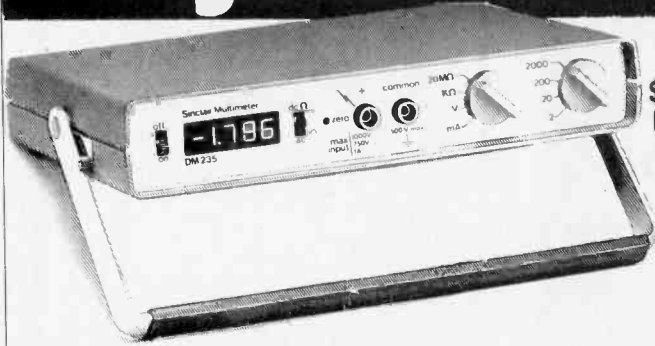

Fig. 3. Component overlay for example relay board.

# New Sinclair DM235 digital multimeter.



Reg. \$159.95

\$ **149** <sup>95</sup>

**SPECIAL LIMITED TIME OFFER AT THE DISTRIBUTORS LISTED BELOW.**

**3½ digits . . . 6 functions . . . fully portable!**

Sinclair DM235 offers the most important features in a bench-top meter in a rugged yet lightweight instrument for true portability! High basic accuracy (0.5% 2VDC range), high resolution (8mm LEDs), high input impedance (10 megohm) means superior performance at a price lower than any competitive makes. Special offer valid till August 31/79 at participating distributors. See it today!

Six Functions, 26 ranges . . . . .  
 DC Volts . . . . . 1mV to 1000V  
 AC Volts . . . . . 1mV to 750V  
 DC Current . . . . . 1uA to 1A  
 AC Current . . . . . 1uA to 1A  
 Resistance . . . . . 1 to 20M  
 Diode test . . . . . 0.1ua to 1mA

SINCLAIR DMM'S AVAILABLE IN: MONTREAL - Addison TV, Microtron, Visiontronique. TORONTO - A-1 Electronics, Arkon, Dominion Radio, Duncan Instr., General Electronics, Gladstone Electronics, MISSISSAUGA - Atwater, LONDON - Provincial Electronics, OTTAWA - Kris Electronics, Wackid Radio, WATERLOO - Waterloo Electronics, KITCHENER - Orion Electronics. HAMILTON - Canadian Admiral, GUELPH - Neutron Electronics.

Dealer/distributor enquiries welcome. AUDIEX ELECTRONICS, 1736 Avenue Rd., Toronto (416) 787-7367.

## STAC Timer

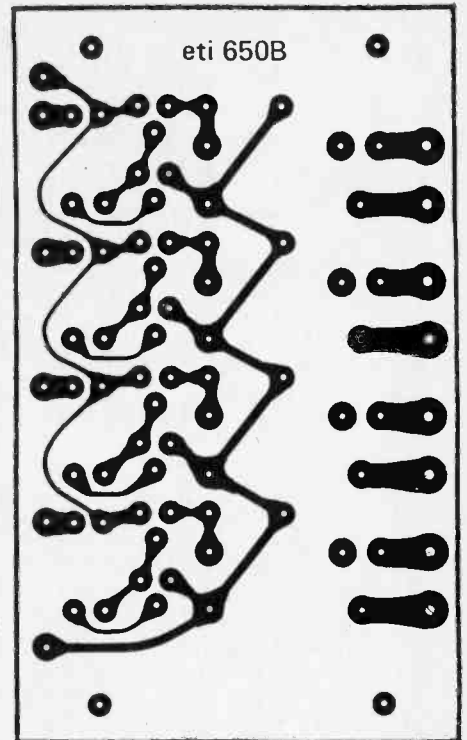

## NEW ISO-TIP

**cordless soldering iron completely recharges in 60 minutes.**

**MAKES CORDLESS SOLDERING PRACTICAL FOR HEAVY-USE APPLICATIONS.**

The Iso-Tip 60 can make up to 125 electronic joints or more per charge. When completely discharged, the iron can be recharged and used in a few minutes or fully recharged in an hour. Low voltage, battery powered, ground free isolated tip design.

**WAHL CLIPPER CORPORATION**  
 ORIGINATORS OF PRACTICAL CORDLESS SOLDERING

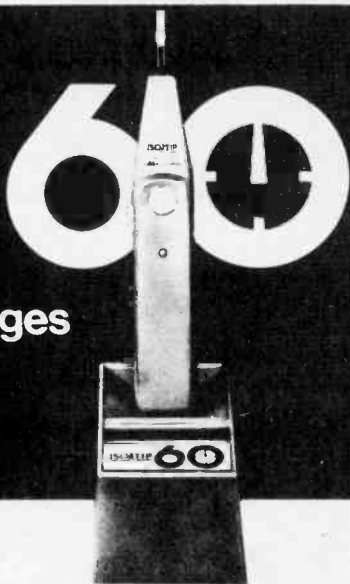

16 snap-in tips to fit any job

plus a PC Drill.

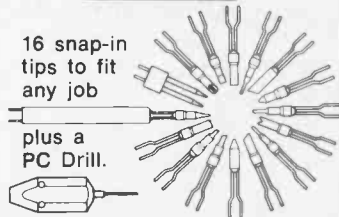

See your Electronics Distributor, or write for Free Lenline Catalogue.

**len finkler limited**

25 Toro Road, Downsview, Ontario M3J 2A6  
 Telephone (416) 630-9103 Telex 065-24010



# SUBS- CRIP- TIONS

\$14 / year (12 issues), \$26 / 2 years (24 issues), for U.S. please add \$3/ year, other countries \$5 / year.

To get a subscription to Electronics Today you can use the subscription card, but if someone's taken it already do the following:

Send a cheque, money order, Chargex, or Master Charge information, to **ELECTRONICS TODAY Magazine**, Unit 6, 25 Overlea Blvd., Toronto, Ontario, M4H 1B1.



# Two Octave Organ

Although cheap and simple to build, this monophonic electronic organ is tunable, covers a full two octave range, and has an adjustable tremolo control.

HERE'S A PROJECT where you can well and truly utilise your ingenuity!

A monophonic organ is limited in its scope simply in that only one note can be played at a time — that is you cannot play chords. In practice this is not as big a limitation as it might seem and a monophonic organ of this type will provide a great deal of pleasure and amusement for youngsters and older people who quickly find how easy it is to play.

The organ covers the range from C (262 Hz) to C (1047 Hz), with 12 notes per octave (that is it includes sharps and flats).

The frequency (pitch) of each note is determined by an associated resistor in the chain R8 through R31. We have made some minor compromises in that we have used standard readily available resistor values nearest to those actually required to obtain the exact pitch for each note. The pitch errors are quite small but if you need the pitch to be *exact* all you need to do is to wire additional resistors in series or parallel with the appropriate chain resistor until the exact pitch of that note is obtained.

The overall pitch is adjusted by potentiometer RV1 and the volume by potentiometer RV2. Tremolo may be switched in or out by switch SW1. The depth of tremolo may be altered by changing resistor R2.

As shown in our main circuit drawing and component overlays the circuit includes two output transistors (Q1 and Q2) and a loudspeaker. This enables the unit to be totally self-contained. Nevertheless it has been so designed that you can run into any other suitable amplifier or hi-fi system. If you wish to use an external system as suggested above simply leave out Q1 and Q2, change C6 to 1.0  $\mu$ F, and increase RV2 to 10 k. The positive end of C6 should be connected directly to pin 3 of IC2 and the input to the amplifier or hi-fi

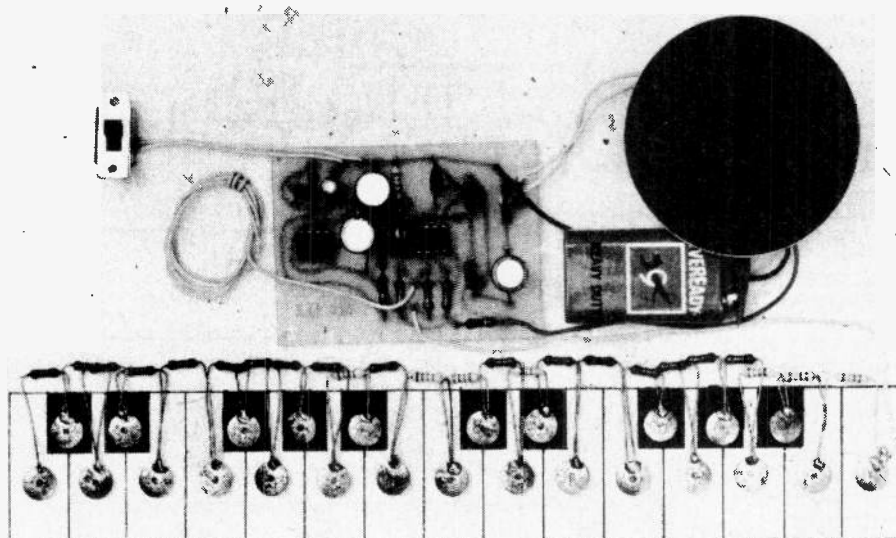

system taken from the point on RV2 which is currently wired to the speaker.

## CONSTRUCTION

The organ consists of two main assemblies, plus a battery or other nine volt power supply, and a loudspeaker.

Main board construction is quite straightforward — the usual precautions must be taken to ensure critical components are inserted the right way round and do check for solder bridges, particularly if you are using the Vero-board method of construction.

The second assembly is the keyboard. Here you have unlimited potential for modification. We have shown what we believe to be the cheapest possible construction — 25 pins stuck into a piece of heavy cardboard! But if you want to, you can build up a far more elaborate affair using proper metal or woodworking techniques.

The requirements for the keyboard are very basic. You need to arrange

some way by which one common wire may be caused to touch any one of a series of contacts. Our prototype shows a very basic way indeed. We have a series of drawing pins stuck into a piece of heavy cardboard with a keyboard pattern drawn on. The common wire is connected to a sharp probe and you simply touch the drawing pin heads with this probe. If this basic method is used a suitable probe can be made by epoxying a needle into the end of an old ball point pen. Note that the probe handle must be insulated to prevent 60 Hz mains voltage included in one's body modulating the pitch. A more elaborate way would be for each key to be sprung in such a fashion that when depressed it touched a common strip running right along the front of the keyboard. If you have the facilities for so doing, yet another way is to etch a keyboard on a strip of pc board material.

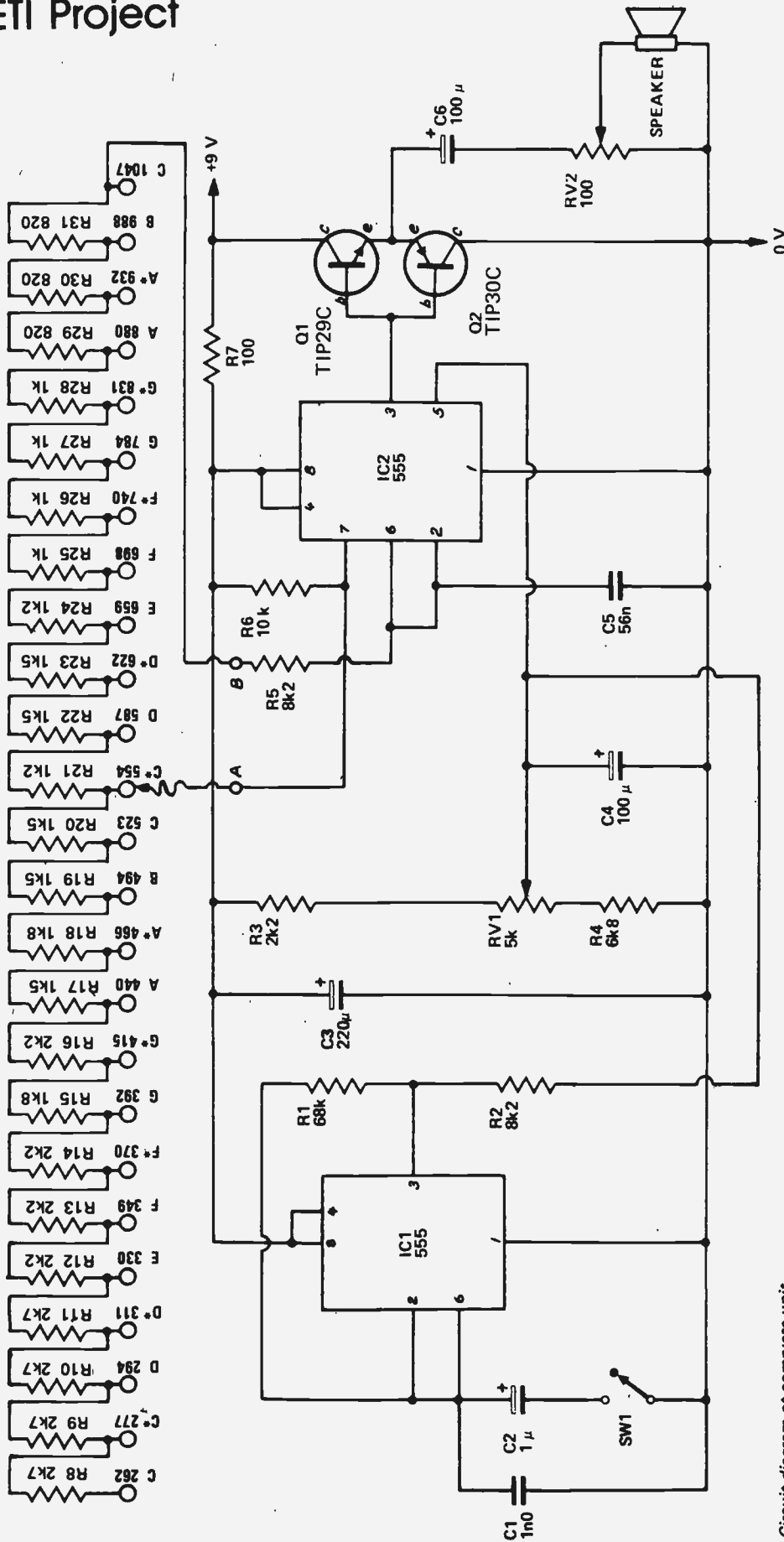

Circuit diagram of complete unit.

## HOW IT WORKS

Firstly consider IC2. This is a 555 oscillator circuit which oscillates at a frequency determined by whatever resistor in the chain R8 to R31 is selected. These resistors have been selected to give the closest possible approximation to the standard spacing between notes. These other resistors may be added in

series or parallel if an exact scale is required.

The output of IC2 is approximately a square wave. This is buffered by Q1 and Q2 before driving the loudspeaker. The control circuitry is decoupled by R7/C3 from the nine volt supply to prevent load fluctuations varying pitch. Potentiometer RV1 adjusts the over-

all frequency of the circuit thus acting as a pitch control.

Tremolo is generated by IC1. This IC oscillates at either 5 Hz or 5 kHz depending on the position of SW1. When switched to the 5 Hz position the output is applied to pin 5 of IC2 thus modulating the output of that IC. Capacitor C4 'kills' the

output when IC1 is switched to the 5 kHz position. The reason for this apparent anomaly is that it is desirable for the tremolo oscillator to be running at all times — whether tremolo is switched in or not — to eliminate the minor change in overall pitch otherwise caused by the load of IC1 being switched on or off.

# Two Octave Organ

When completed, the chain of resistors should be soldered in place. Do make sure you have good sound soldered joints as the failure of any one joint in this chain will prevent the organ from operating.

Finally connect the two assemblies together, connect up a battery and away you go!

Some refinements may be made it is

possible to delete the trim potentiometers currently shown located on the circuit board, replacing these with larger rotary potentiometers located remotely.

Resistor R2 may be changed to vary the depth of tremolo or replaced by a potentiometer (10 k in series with a 3k3 resistor) to allow immediate adjustment.

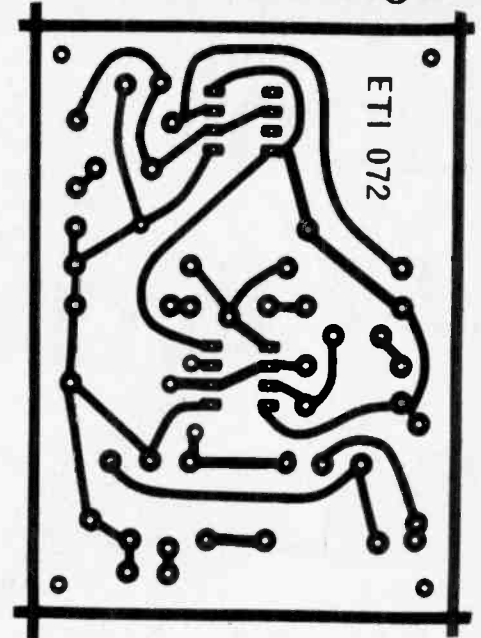

Printed circuit board layout - shown here full size.

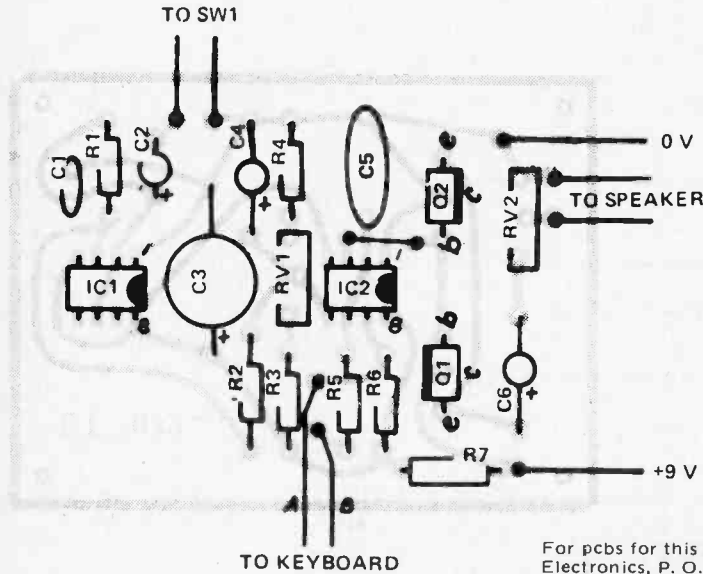

Component overlay for printed circuit board version.

For pcs for this project contact B&R Electronics, P. O. Box 6326F, Hamilton Ont. L9C 6L9, and Spectrum Electronics 38 Audubon St S, Hamilton Ont, L8J 1J7. A complete kit of pcb plus parts is available from Northern Bear Electronics, P.O. Box 7260, Saskatoon, Sask., S7K 4J2.

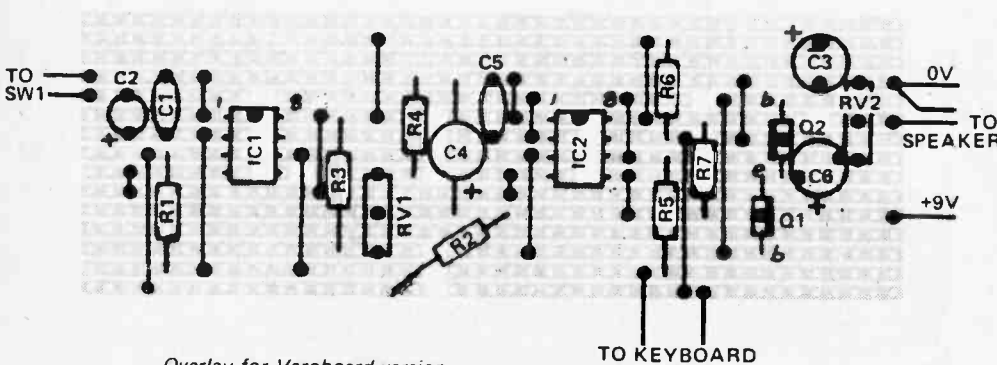

Overlay for Veroboard version.

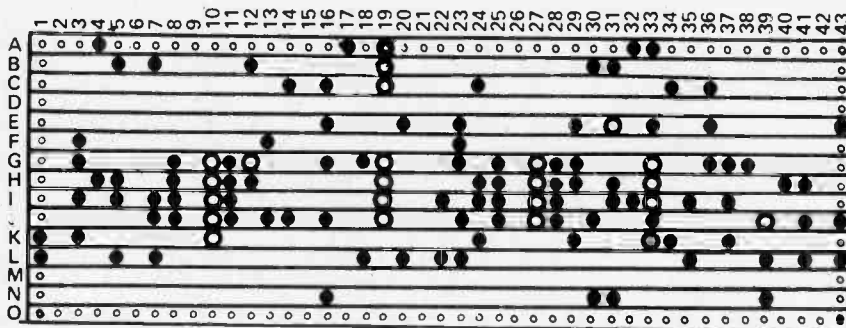

Drilling details for Veroboard.

## PARTS LIST

### RESISTORS

R1	68k	1/2 W 5%
R2	8k2	" "
R3	2k2	" "
R4	6k8	" "
R5	8k2	" "
R6	10k	" "
R7	100 ohms	" "
R8-R11	2k7	" "
R12-R14	2k2	" "
R15	1k8	" "
R16	2k2	" "
R17	1k5	" "
R18	1k8	" "
R19-R20	1k5	" "
R21	1k2	" "
R22-R23	1k5	" "
R24	1k2	" "
R25-R28	1k	" "
R29-R31	820	" "

RV1	Trimpot 5k
RV2	" 100 ohm

### CAPACITORS

C1	1n0 polyester
C2	1 uF electrolytic 16 V
C3	220 uF " "
C4	100 uF " "
C5	56 n polyester
C6	100 uF 16 V electrolytic

IC1/IC2	integrated circuits 555
Q1	transistor TIP29C
Q2	transistor TIP30C

Printed circuit board ETI 072 or Veroboard  
 SW1 single pole switch  
 Nine volt battery and clip  
 Small speaker

# Light Activated Tacho

This tachometer measures rotational speed without physical contact, by picking up reflected light.

THE USE OF a non-contact method of measuring RPM is not only convenient but sometimes the only method possible. Some motors used for model aircraft have a capacity of only 0.15cc yet run at speeds in the 25000 RPM region. The power required to turn a mechanical tacho would be many times the power of such a motor. Also on some machines there is no convenient place a normal tacho can be fitted.

## DESIGN FEATURES

As the main application for this unit was to be outdoors it was decided that an LCD display would be preferable to an LED and more easy to read than an analogue meter. Unfortunately LCDs are not yet readily available, and nor are the ICs needed to drive them.

However the Intersil Evaluation kit which we have used in the past is fairly easy to get hold of, and so we based the design around this unit. This meant converting the pulses from the sensor into a voltage. This however has another benefit in that a greater resolution can be obtained more quickly. To have a resolution of 10 RPM with a two bladed propeller a sample time of three seconds would be necessary.

The use of the BPW34 photodiode in the photovoltaic mode, ie actually generating a voltage, simplifies the biasing otherwise needed.

## SPECIFICATIONS

RPM range	
Low	0 – 20000
High	10000 – 30000
Resolution	10 RPM
Display	12mm LCD
Detection method	reflected light
Power	9V dc @ 4mA
Battery life 9V	about 150 hours

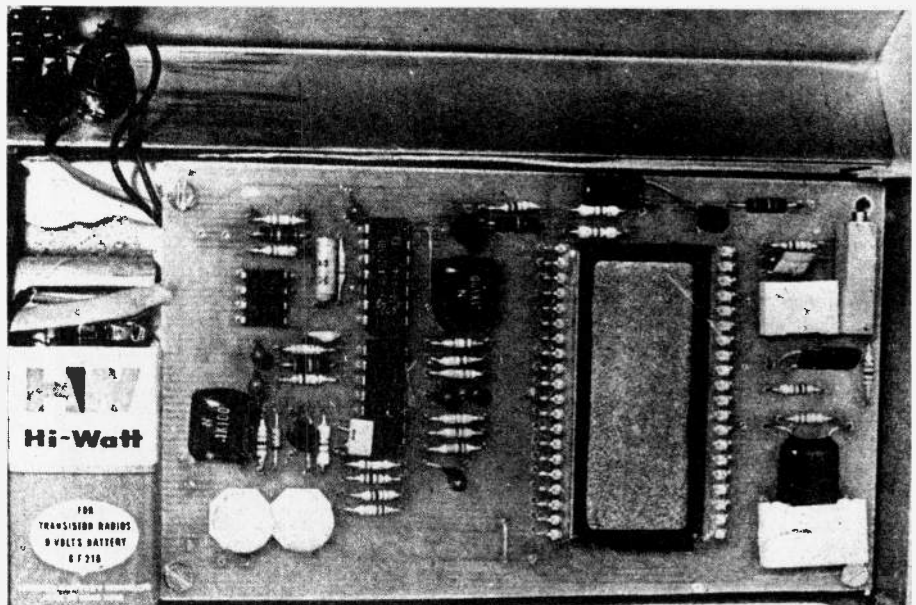





## CONSTRUCTION

All the electronic components are mounted on a single pc card with the exception of the photodiode. To save on real estate the main voltmeter IC is mounted under the display.

Initially, assemble all the components apart from the ICs and the display, taking care not to bridge between the tracks with solder. Also note that some of the capacitors have to be laid on their side to give a low height.

The ICs can now be added being careful to polarize them correctly. Due to the display being mounted over the main IC it is not possible to use a socket. A socket can be used for the display if desired however it will have to be modified by cutting it into two strips.

As there are no polarity marks on the display it is necessary to hold it at the light and look for the outline of the digits. A link for the decimal point should be added as shown in the diagram.

We mounted our unit in a metal box we made with the photodiode mounted about 25mm from the end of a 75mm long tube in front of the box. This narrows the field of view of the diode as well as giving a little more clearance

between high speed propellers and the fingers!

## CALIBRATION

Switch on the unit and cover the photodiode to prevent any light reaching it. Now adjust RV1 until the display reads zero.

Uncover the diode and point it at a fluorescent light. It will now give a reading and RV3 should be adjusted to indicate 3600 RPM.

Again cover the diode, then press the high range button and adjust RV2 to give a reading of -10000 RPM. Under fluorescent light it should read -6400RPM.

## OPERATION

This unit relies on a changing light level for its operation. For use with a model aircraft, holding the unit near the propeller enables detection of the changes in the reflected light level. To measure the speed of other rotating equipment it may be necessary to paint a series of white lines to give the sensor something to 'see'.

However the unit cannot be used

under fluorescent lights as it will see the 120 cycle flicker (see calibration section). In cases where this has to be done, and places where the ambient light is low, a small incandescent lamp can be used to shine on the spot looked at by the sensor.

The unit, as described, is scaled to read up to 20000 RPM with a 10 RPM resolution, assuming two input pulses per revolution. If a different number of input pulses is to be used, e.g. a three or four bladed propeller, the value of R1 can be changed. ( $R1 \approx 360k / \text{number of pulses}$ ). The use of more than four pulses per revolution is not recommended on this range. If 2000 RPM is more than is needed for your application the value of R1 can be increased by a factor of 10, preferably with more than ten pulses per revolution.

Unlike a frequency meter, overranging this unit will cause the display to blank and greater resolution cannot be obtained simply by using a lower range. However an offset of a fixed number of RPM can be used as described in the 'How It Works' section. Using the values given, when the high range button is pressed, 10000 RPM must be added to the reading.

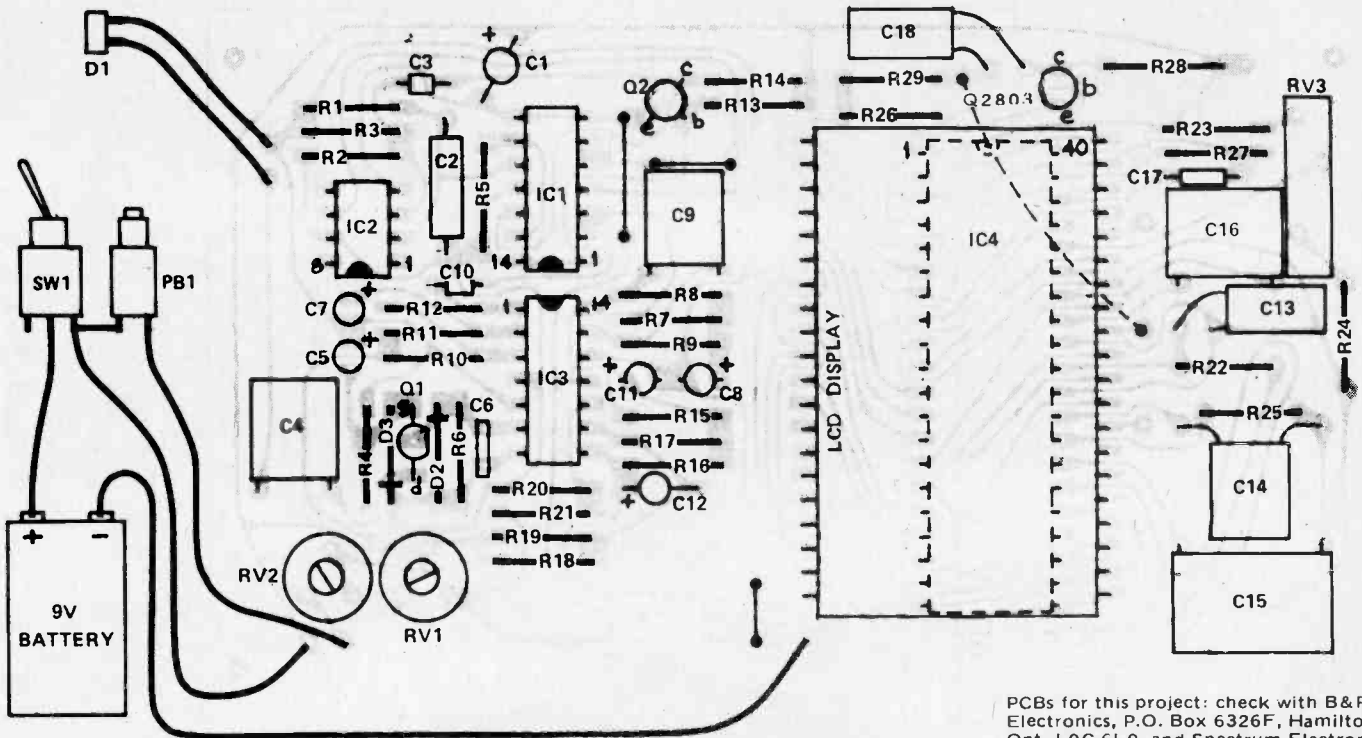

Fig. 1 The component overlay and wiring diagram of the tach. Note that the polarity of the sensor diode, D1, is not important.

PCB pattern: page 73.

PCBs for this project: check with B&R Electronics, P.O. Box 6326F, Hamilton Ont. L9C 6L9, and Spectrum Electronics 38 Audubon St. S., Hamilton Ont L8J 1J7. The ICL7106EV is available from Northern Bear Electronics, P. O. Box 7260, Saskatoon, Sask., S7K 4J2.

## HOW IT WORKS

When using this unit to measure RPM, be the application a model aircraft motor or some other rotating object, the propeller or the white line ( see operation section ) gives rise to a changing light level. D1 which is a photo diode used in the photovoltaic mode, sees this light level and gives out a voltage proportional to the light. As this is only a small signal it has to be amplified before it can be used. This is done by IC3a. The transistor Q1 is included to provide some gain control allowing the unit to be used in differing light conditions without the need for any adjustment. The output of the amplifier is rectified by D3 to provide a negative voltage on the gate of Q1. When the output of the amplifier is small the gate to source voltage will be near zero and the FET will appear as a low value resistor giving high gain to the amplifier. If the light change is such that the output of the amplifier is large, the rectified voltage on the gate of Q1 will cause the resistance of the FET to increase decreasing the amplifier gain. In this way the output of the amplifier is held relatively constant irrespective of the light level. Diode D2 is necessary to prevent the amplifier from saturating on the positive swing.

The output is then squared up by IC3b

where the positive feedback provided by R12 ensures that the output switches quickly. The output from this IC then triggers the monostable formed by Q2. What we have now is a pulse about 50µs long every time the propeller blade passes the light sensor.

Before continuing, you may have noticed that besides the +9V and 0V we also have a line marked Vref. This is derived from IC4 which is a voltmeter chip and is a stable voltage of about 2.8 volts below the +9V line.

The output of the monostable (Q2) turns on IC1a for 50µs, discharging C2 which is then allowed to recharge to Vref. This voltage is compared (by IC2) to the voltage set by R2 and R3. The output of IC2 is a negative pulse of about 900µs. As it is on a stable voltage supply, variations in battery voltage will have very little effect on the output pulse width. Capacitor C3 is used to force the positive input of IC2 above the negative one for the 50µs pulse ensuring that this time is not included in the output pulse. IC1b is used to invert this pulse and its output, and the output of IC2, control IC2c/IC2d. The output of IC2c/IC2d is a positive pulse switching between Vref. and the +9V line.

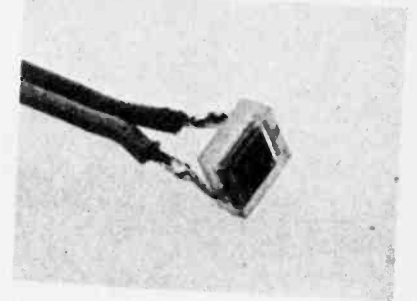

This is then filtered by two 2 pole active low pass filters, IC3c and IC3d. As these have a cutoff frequency of around 10 Hz the output for most applications will be the dc voltage component only. This is measured by IC4 which is a complete voltmeter.

As offset voltages and currents can cause the output of the filters not to be exactly zero with no input, the positive input of IC3d is biased up about 30mV and then by injecting a current into the negative input (by R19 and RV1) correction can be made. For measuring RPMs above 20000 and below 30000 a current is injected into the negative input via R18 and this subtracts 10000 RPM from the reading.

# Light Activated Tacho

## PARTS LIST

RESISTORS all 1/4W 5%

- R1 ..... 180k
- R2 ..... 150k
- R3 ..... 100k
- R4 ..... 1M
- R5 ..... 47k
- R6 ..... 4M7
- R7,8 ..... 180k
- R9 ..... 12k
- R10 ..... 10k
- R11 ..... 100k
- R12 ..... 330k
- R13 ..... 100k
- R14 ..... 10k
- R15 ..... 33k
- R16 ..... 15k
- R17 ..... 4k7
- R18 ..... 120k
- R19 ..... 1M
- R20 ..... 150k
- R21 ..... 1k
- R22 ..... 1M
- R23 ..... 10k
- R24 ..... 2k2
- R25 ..... 220k
- R26 ..... 4M7
- R27 ..... 100k
- R28 ..... 100k
- R29 ..... 4M7

POTENTIOMETERS

- RV1,2 ..... 50k VTP trim
- RV3 ..... 1k, 10 turn trim

CAPACITORS

- C1 ..... 1µ 35V tantalum
- C2 ..... 4n7 polystyrene
- C3 ..... 1n5 polyester
- C4 ..... 100n "
- C5 ..... 1µ 35V tantalum
- C6 ..... 100p ceramic
- C7,8 ..... 1µ 35V tantalum
- C9 ..... 100n polyester
- C10 ..... 820p ceramic
- C11 ..... 3µ3 16V tantalum
- C12 ..... 1µ 35V tantalum
- C13 ..... 10n polyester
- C14 ..... 100n "
- C15 ..... 220n "
- C16 ..... 100n "
- C17 ..... 100p ceramic
- C18 ..... 10n polyester

SEMICONDUCTORS

- IC1 ..... 4016 (CMOS)
- IC2 ..... 301A
- IC3 ..... 324
- IC4 ..... ICL7106

- Q1 ..... 2N5485
- Q2,3 ..... 2N3904
- D1 ..... BPW34 or BPX40
- D2,3 ..... 1N914

MISCELLANEOUS

- PC board ETI 555
- toggle switch
- pushbutton switch
- 3½ digit LCD
- case to suit
- battery clip
- 9V battery

\* Note; These components are supplied with the Intersil ICL7106EV evaluation kit.

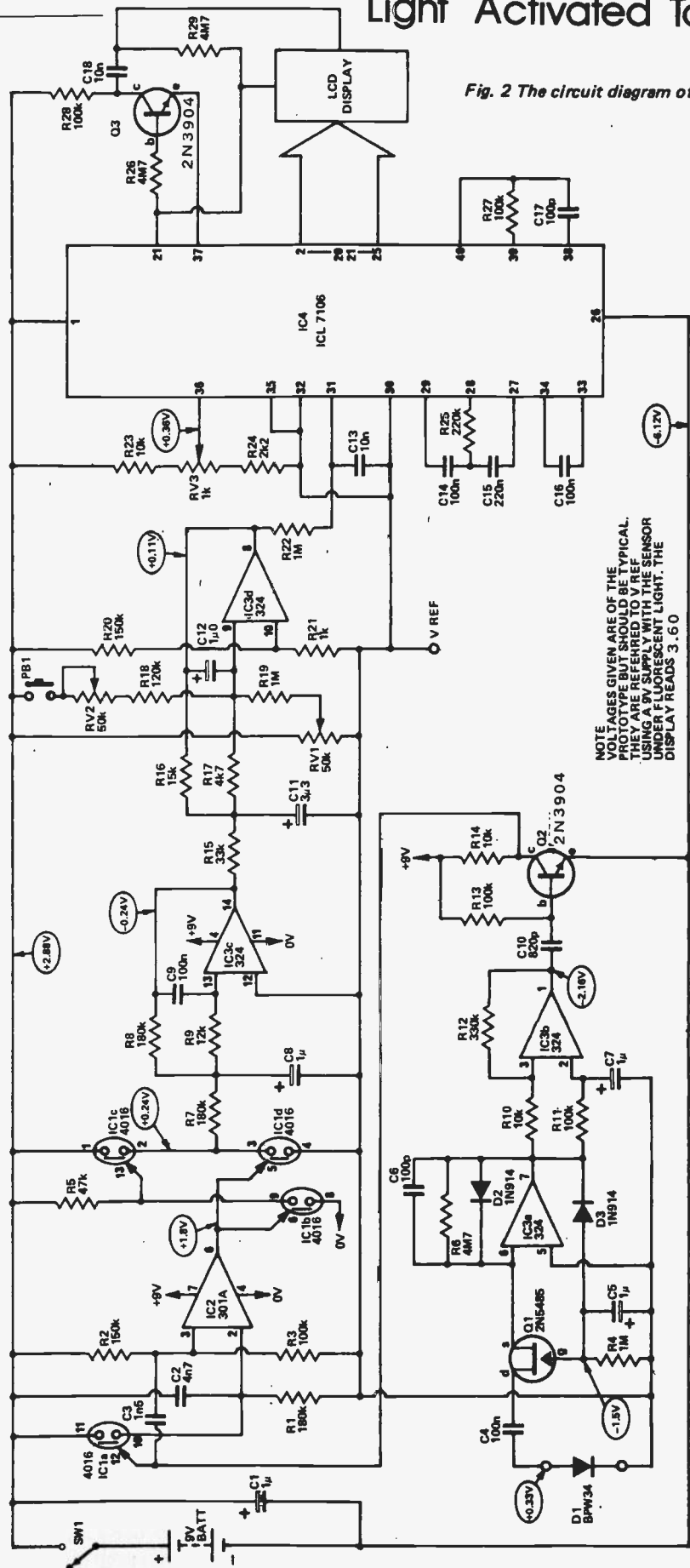

Fig. 2 The circuit diagram of the tacho.

NOTE: VALUES GIVEN ARE OF THE PROTOTYPE BUT SHOULD BE TYPICAL. THEY ARE REFERRED TO V REF. USING A 9V SUPPLY WITH THE SENSOR UNDER FLUORESCENT LIGHT, THE DISPLAY READS 3.60

# The Ionosphere and Propagation

Radio communications beyond the horizon in the high frequency (HF) spectrum between 3 MHz and 30 MHz are carried on as the result of the bending of the radio waves in the ionosphere, that region of our atmosphere extending from about 60 km to about 1000 km above the earth.

The ionosphere can bend radio waves so that they return to earth from hundreds of kilometres to many thousands of kilometres distant.

Without the existence of the ionosphere, long distance radio communications, shortwave broadcasting, amateur radio 'DX' etc would not be possible — and one G. Marconi would probably have died an unknown pauper!

The ionosphere enables shortwave radio stations such as Radio Australia, Radio Peking, The Voice of America etc to broadcast programmes across the world. It enables radiotelephone communications to ships at sea and contact with international aircraft.

## THE SOLAR PRIME MOVERS

The sun, which dominates almost every phase of our lives, influences all HF radio communication beyond the horizon. The sun generates the ionosphere; solar activity has a considerable influence on this area of our atmosphere and thus affects propagation of HF radio waves.

Ionisation of the upper atmosphere is brought about largely by ultraviolet radiation from the sun, along with solar X-ray radiation. This solar radiation strips electrons from the atoms of the rarified atmospheric gases existing in our upper atmosphere.

The result is not a single, thick region or 'band' of ionisation, as you may suppose. The ionosphere separates into several readily defined regions having varying densities, located in layers at different heights.

Each layer has a relatively dense region, called the *peak* of the layer, the ionisation tapering off above and below this region. The peak is not necessarily located in the centre of the layer, nor

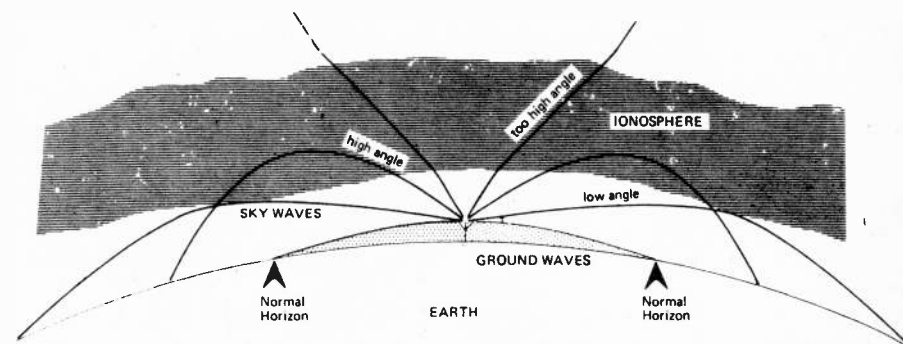

Figure 1. The ionosphere bends radio waves such that they travel great distances beyond the horizon.

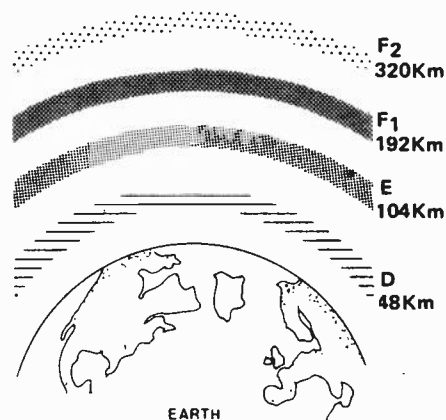

Figure 2. The ionosphere divides into readily defined regions which have been designated as illustrated here. The amount of ionisation in each layer varies diurnally (i.e.: throughout the day), seasonally (throughout the year) and through the 11-year sunspot cycle. Disturbances on the sun have a variety of effects on the ionosphere and thus on radio communications.

does the ionisation always disappear completely between layers.

## SPOTTING GOOD PROPAGATION

The sun's UV radiation output varies over an approximately 11-year cycle, greatly influencing the behaviour of the ionosphere. For many years this cyclic behaviour of the sun has been monitored by means of *sunspots* — dark areas

which appear on the face of the sun, and over the last two decades, by measurement of the *solar flux* (RF noise radiation) at 2800 MHz (10.7 cm wavelength).

Sunspots are enormous areas on the sun's surface which are cooler, and thus do not appear as bright as the surrounding area. Hence, they look like 'spots' on the face of the sun. Their size can range from several hundred kilometres across to greater than 100,000 km. By comparison, the earth's diameter is only 13,000 km.

The spots usually appear in clusters, the largest extending nearly half a million kilometres across the face of the sun on occasions.

Sunspots can form and remain visible from several days to several months, often growing in size the longer they last.

The sun rotates about its axis with a period of about 27 days. If a sunspot persists long enough, it can be seen to move across the face of the sun, taking about 13½ days to go from one side to the other (*limb to limb*, as they say). Having reached one side and disappeared, it may reappear on the other side about 13½ days later.

Man's interest in the sun and solar phenomena is clearly older than recorded history. Ancient Sumerian and Chinese cultures observed and recorded sunspots. Galileo turned his telescope,



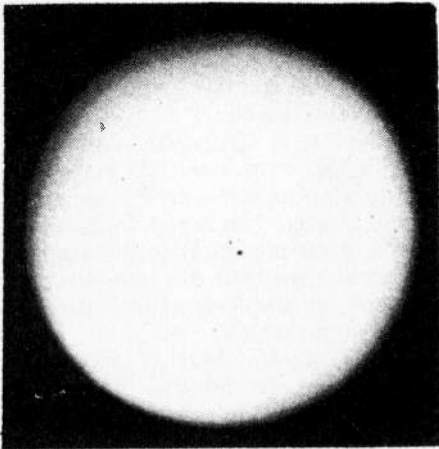

Figure 3. The sun as viewed in the visible light region showing several small spots, a relatively large spot and sunspot groups. (Photo courtesy of the Ionospheric Prediction Service.)

the first ever made, onto the predominant celestial body and observed spots! — he was labelled a heretic for telling what he saw.

**WARNING:** Do not attempt to look directly at the sun, especially through a telescope — this can result in blindness. The alternative technique of projecting the sun's image onto a card is described in many books on astronomy. Galileo may not have been a heretic, but if he ever looked through his telescope at the sun, he was probably a silly old twit.

Records of systematic sunspot observations date back some 300 years. However, reasonably reliable data is only available from about 1850.

The sun is monitored continuously from a number of observatories around the world. Sunspot observations are statistically smoothed to provide a continuous record — this is termed the Zurich Sunspot Number, which is a statistical 'fudge factor' on which ionospheric propagation predictions are based. More on this later.

Sunspot Number does not mean 'number of sunspots'. It is a statistical term which allows comparison with past figures and provides an index of sunspot activity.

The sunspot number has a cyclical variation with a mean period of 11 years. Periods between sunspot peaks have been as short as 9 years and as long as 13 years. The sunspot number between the peaks and minimums of the cycles also varies greatly. The sunspot cycles have been 'numbered', for the convenience of reference, back for 200 years. Cycle 18 peaked in 1947, cycle 19 — the biggest on record — peaked in 1957 with a sunspot number in excess of 200. Cycle 20 peaked in 1969 reaching a sunspot number of 120, which is about average intensity.

If you thought the DX wasn't any-

thing spectacular in 1969-70, you should have been around in 1907 when the sunspot number barely reached 60 during the peak!

Sunspot cycle minima don't always reach zero levels. Some minima however have shown little or no activity for many months.

The sunspot cycle, while having an 11-year mean period as observed between peaks, has been identified in recent years as actually being a roughly 22-year period based on the magnetic field variations of the sun. Alternate sunspot cycles show a pole reversal in the solar magnetic field.

## SOLAR DISTURBANCES

On occasions, the surface of the sun is disturbed by sudden 'storms'. These disturbances are not normally visible but are readily detected when the sun is viewed at a particular red light wavelength, known as H-alpha, emitted by hydrogen.

These very intense, localised outbursts increase very rapidly to a peak, taking a minute or less, and then the intensity of the H-alpha emission decreases to its normal value in about half an hour or so.

This phenomenon is called a *solar flare*, usually occurring near, or associated with, a sunspot.

Solar flares generate enormous amounts of energy, and increased solar X-ray radiation from these regions cause disturbance to the ionosphere and to communications. Electrons and protons are also emitted from solar flares, and these travel through solar wind towards the earth. The particles are emitted in a stream and are much more numerous and move at greater velocities than those particles contained



Figure 4. The sun as viewed in the red wavelength region emitted by hydrogen — H-alpha emission. Two large active regions can be seen along with associated 'filaments'. (Photo courtesy of the Ionospheric Prediction Service.)

in the normal solar 'wind'.

Upon reaching the region near the earth these particles have a considerable influence on the earth's ionosphere and magnetic field, producing sudden and dramatic changes as well as precipitating other events — such as aurorae — which will be described in more detail later.

Apart from flares, disturbances not associated with sunspots also cause disturbances to the ionosphere and the earth's magnetic field. *Hot Spots* — which are of longer duration than flares, are emitting regions on the sun's surface that expel streams of particles which affect the ionosphere. These, and other areas on the sun's surface which emit persistent streams of particles, have longer durations than flares but the effects of the particles emitted is less severe.

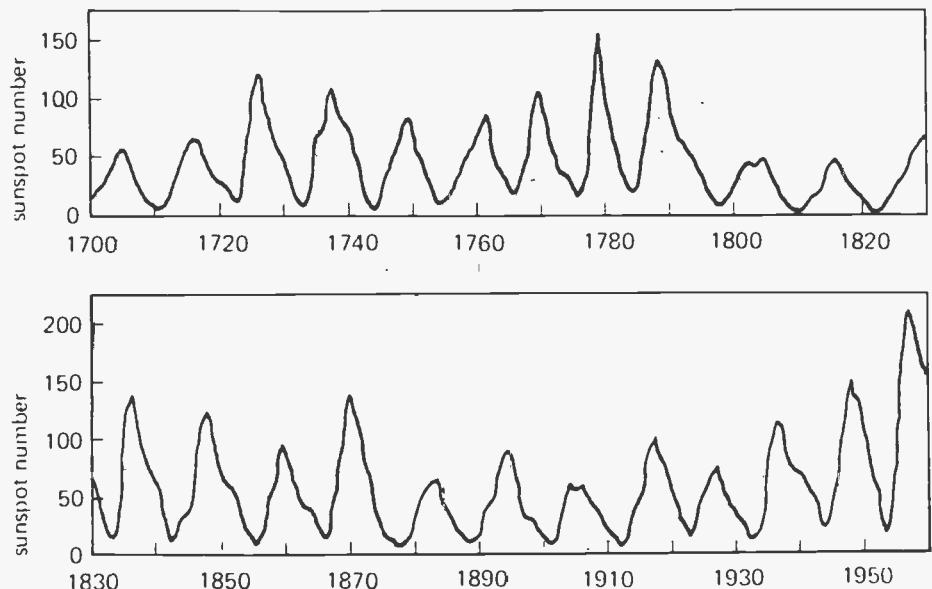

Figure 5. The 11-year solar cycle is clearly evident from this plot of the Sunspot Number from 1700 to 1960.

## FORMATION OF THE IONOSPHERE

As mentioned before, the ionosphere is produced principally by ultraviolet radiation from the sun. The amount of ionisation produced is almost wholly dependent on the strength of the UV radiation and its wavelength. Different wavelengths of the radiation ionise different gases.

The process of ionisation absorbs energy from the UV wave, and as the radiation proceeds down through the atmosphere, it is almost completely absorbed in this way.

This process of creation of ions and free electrons in the ionosphere is offset by recombination which is continually taking place between the two to form neutral atoms once again.

In the lower atmosphere, the molecular density is so great that recombination occurs almost immediately after ionisation the rate of recombination is very rapid. However, in the upper atmosphere, where the number of molecules is very much smaller, the chances of a free electron meeting up with an ion is very much less. Hence, recombination occurs at a much slower rate.

These two opposing mechanisms result in regions in the upper atmosphere where a large amount of ionisation is present, the amount being determined by the balancing forces between the rate of ion production and the recombination rate.

The gases of the upper atmosphere which the solar UV radiation meets first are very rarified, hence little ionisation results and little of the radiation energy is lost. As the radiation penetrates further, the molecular density of the gases increases and hence the ionisation increases.

More and more energy is extracted from the ionising radiation as it penetrates further and at some stage the amount of ionisation which the radiation can produce begins to decrease. There is thus a certain height at which ionisation is maximised. The region around this height is known as an ionisation layer.

This is how the ionosphere comes to derive its name. It is the region of the upper atmosphere where appreciable ionisation can take place.

The lower limit of the ionosphere is about 50km and it extends to beyond 1000km.

Sydney Chapman, a British scientist, investigated the production of ionisation in the early 1930's and showed that the rate of production of ionisation would vary with height as shown in figure 6. The corresponding layers of electrons have been called Chapman layers.

The height of the 'peak' is determined by the concentration at particular heights of the atmospheric gas and by the ability of the gas to absorb the solar radiation. The less easily absorbed wavelengths of the radiation penetrate lower in the atmosphere before forming a layer of electrons. The height of the layer does *not* depend on the strength of the ionising radiation.

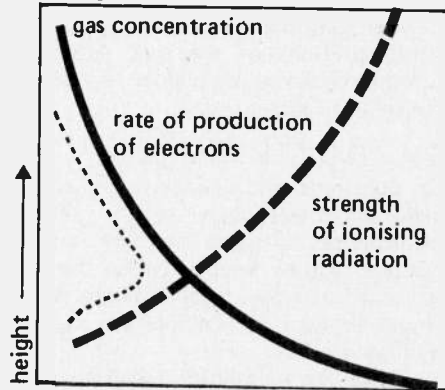

Fig. 6. How a layer of electrons is produced when ionising radiation comes from above the atmosphere. The gas concentration increases with decreasing height while the radiation strength decreases. Peak production of electrons occurs at the height where the curves cross.

The production rate of electrons at the peak of the layer depends on the strength of the ionising radiation and on its direction of arrival. When the radiation is vertically incident on the layer, ionisation is maximum, less when it arrives at an angle.

When curves representing the production rate of electrons of all possible shapes are 'normalised' with respect to the layer peak, they all look the same. See figure 7.

### THE THREE REGIONS

There are three main regions of the ionosphere. They are designated by the symbols 'D', 'E' and 'F'. The F-layer actually divides into two layers, F<sub>1</sub> and F<sub>2</sub>, which I will go into shortly.

The structure of the ionosphere varies widely over the earth's surface as the strength of the sun's radiation will obviously vary with geographical latitude.

### THE D-LEVEL

This is a region of low ionisation density which does not show the well-defined 'peak' of maximum ionisation density associated with the other layers.

The D-layer only appears during daylight hours and extends rather diffusely from about 50km to about 90km. The density of electrons in the D region is generally insufficient to cause appreci-

able bending of radio waves but they do suffer considerable attenuation in passing through this region.

Solar X-ray radiation with wavelengths less than about 20 Angstroms contributes to some of the ionisation in the D-layer. This radiation can ionise all the gases present at these heights in the atmosphere, but this alone does not account for the level of free electrons found in this region.

Nitric oxide (NO) is formed at heights between 60 and 90km by a photochemical process that diffuses atomic nitrogen down from the E-layer above 100km. This nitric oxide is ionised by UV radiation from the sun having a wavelength of 1216 Angstroms — the Lyman-Alpha wavelength.

Hydrogen in the sun radiates very strongly at this wavelength which coincides almost exactly with a 'spectral window' in the atmosphere which allows this radiation to penetrate to very low levels in the atmosphere with little attenuation.

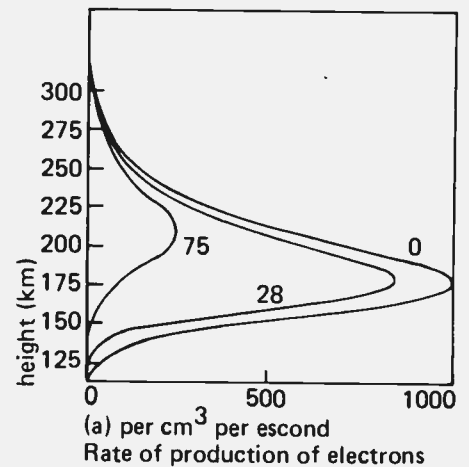

(a) per cm<sup>3</sup> per escond  
Rate of production of electrons

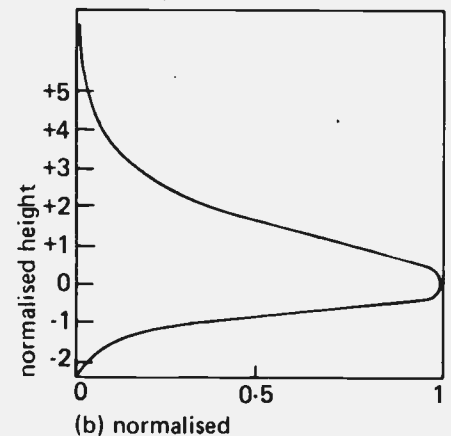

Fig. 7. (a) Theoretical 'Chapman' layers showing how electron production is affected by the angle of the sun's rays — best when sun is overhead (0° zenith angle).

(b) If all curves are 'normalised' about peak height, regardless of the sun's zenith angle, they all have the same shape.

# The Ionosphere and Propagation

Because it penetrates down to where the nitric oxide is produced there is an abundant supply of electrons which contribute to the general ionisation of the D-layer at a height of around 75km. Solar X-ray and Lyman-Alpha radiation contribute in roughly equal proportions to the ionisation of the D region. However, the strength of the X-rays varies by a large factor both daily and through the solar cycle as well as with solar disturbances. There is no appreciable change in the strength of the Lyman-Alpha radiation.

Increased X-ray radiation associated with solar flares can increase the ionisation of the D layer thus causing increased absorption of radio waves travelling through the D region. These solar disturbances can be the cause of a complete 'radio blackout' at times.

Ionisation in the very lowest part of the D region is caused by cosmic radiation which consists of high velocity charged particles coming from distant parts of space. They impinge on the earth more or less constantly and can penetrate right to ground level with little loss in energy. The rate at which they produce free electrons and ions is related to the density or concentration of air molecules available to be ionised.

As cosmic rays are deviated by the earth's magnetic field ionisation of the lower D region is greater near the magnetic poles than it is near the equator.

Since the D-layer absorbs radio waves it affects the propagation of radio signals. During the day signals below about 5MHz are almost completely absorbed. Only signals radiated at a very high angle, and above a critical frequency where all signals are absorbed, manage to pass through the layer, being subsequently reflected by the E-layer.

Communication during daylight hours on the lowest frequencies of the HF spectrum from 3MHz to about 5MHz or so is thus limited to short distances, not much beyond ground-wave coverage.

Low angle radiation on these frequencies during the day travels a long way through the D-region and is thus absorbed.

The D-layer of course affects higher frequencies but its attenuation effect lessens as the frequency is increased.

## THE E-LEVEL

This occurs during daylight hours, the maximum density or peak of the layer lying between about 100 and 150km. It remains weakly ionised at night.

During daylight hours it stays at practically a constant height. The height hardly varies from day to day. The electron density of the E-layer is lower in winter than in summer as the oblique angle of the solar radiation reduces the ionising effect.

E-layer ionisation is produced jointly by X-rays having wavelengths less than about 100 Angstroms — this ionising oxygen and nitrogen in the upper atmosphere at heights close to 100km — as well as UV radiation with wavelengths near 100 Angstroms which ionise oxygen.

The atmosphere in the E-region is still dense enough for recombination to take place fairly rapidly. As a consequence, the E-layer can only maintain its signal reflecting ability when it is continuously in sunlight.

Ionisation is generally the best around noon, disappearing rapidly some time after local sunset. (The sun sets on the ionosphere at a height of 100km about half an hour after local sunset.)

From a simple consideration of the geometry of the situation, communications via the E-layer has a maximum distance of about 2000km. See figure 8.

## THE F-LEVEL

The F-layer is that region of the ionosphere above about 150km extending up to 800km and beyond.

During daylight hours, two distinct layers appear in the F-region of the ionosphere — the lower is known as the  $F_1$  layer, the upper as the  $F_2$  layer.

The  $F_1$  layer generally occurs around a height of 200km and does not vary greatly in height. Its ionisation density is lower in winter than in summer.

As one would expect, the  $F_2$  layer, being the uppermost has the greatest ionisation and shows considerable variations in density and height.

The height of the base of the  $F_2$ -layer during daylight hours is very dependant on solar heating of the upper atmosphere. It varies between about 150km and 300km during winter months.

There is only one layer during the night in the F-region which is likewise dependant on atmospheric temperature. The height and density of the nighttime F-layer is also very variable owing to a number of factors.

Figure 9 illustrates typical variations of the F-layer throughout the day.

The principal ionising agent of the F-layer is the extreme ultra-violet region (EUV). Solar UV with wavelength between about 200 and 800 Angstroms does most of the work in this respect. Radiation at these wavelengths ionises molecular nitrogen and atomic oxygen at heights between about 150 and 180km.

The resulting electron distribution with height does not always show a peak at this level— when there is a peak it is usually that of the  $F_1$  layer.

The shape of the  $F_2$  layer electron distribution, and thus the height of the peak, is largely determined by the variation with height of the loss process and by diffusion of the electrons to other regions. Ions and electrons diffuse above the peak of the layer, the production and loss of electrons (by recombination etc) below the peak determine both the position of the peak and the shape of the layer. The peak then occurs at a height where the effects of diffusion and loss of electrons reaches an equilibrium.

The F-layer will provide communications out to a range of 4000km on a single 'hop', multi-hop propagation being used for distances greater than this.

The  $F_1$  layer will provide communications up to about 9 or 10 MHz during the day. The  $F_2$  layer will support propagation beyond 30 MHz under favourable conditions, even higher in frequency and for longer durations at lower frequencies, during a sunspot maximum.

The maximum usable frequency of the F-layer varies seasonally, being greater during summer than during winter.

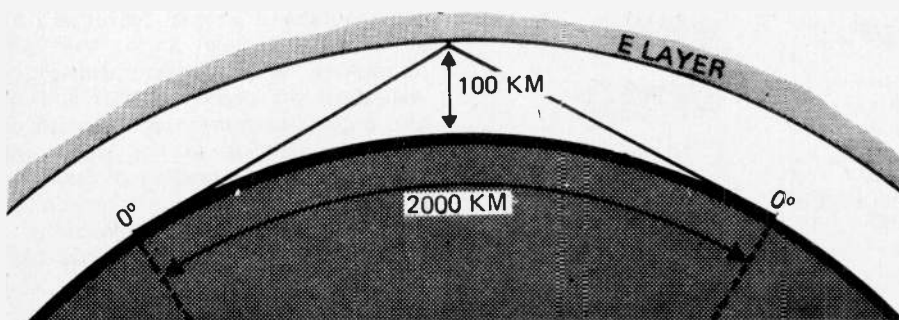

Fig. 8. Geometry of E-layer propagation. As the layer height is about 100 km, low angle radiation from a transmitter will reach distances of about 2000 km maximum.

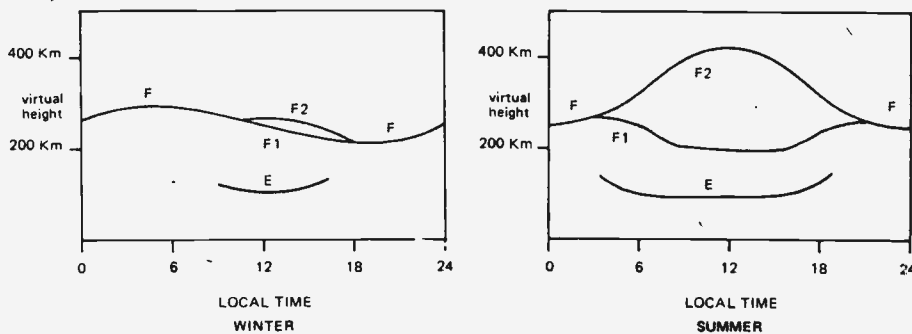

Fig. 9. Typical diurnal (daily) variations of the F-layer and E-layer heights for winter (left) and summer (right), as measured by an ionosonde — an instrument which measures the parameters of the various ionospheric layers.

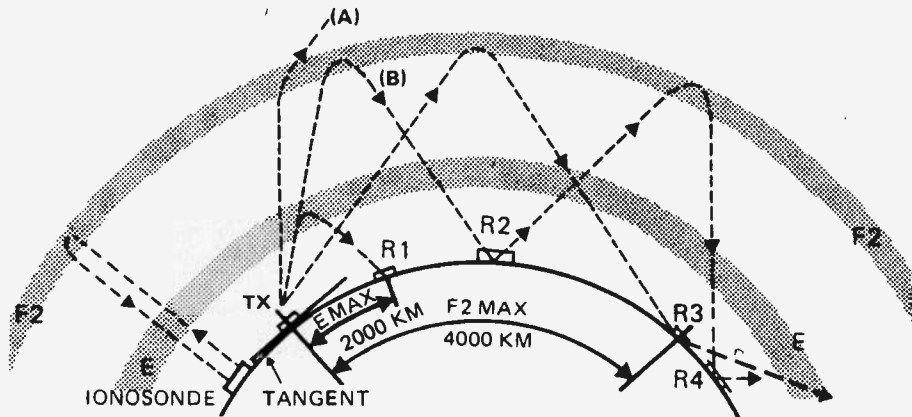

Fig. 10. The transmitter (TX) radiating RF at several different angles illustrates how signals are propagated by the various layers. A wave radiated at a high angle will be deviated by one or both of the layers, but unless the layer is dense enough, will pass through (A). A ray at a lower angle (B) will skip a relatively short distance and may do so several times (R2 - R4 etc.). A low angle ray from TX will skip a maximum of 4000 km from the F2 layer (TX to R3) and subsequently further. The ionosonde measures the heights and critical penetration frequencies of the layers vertically.

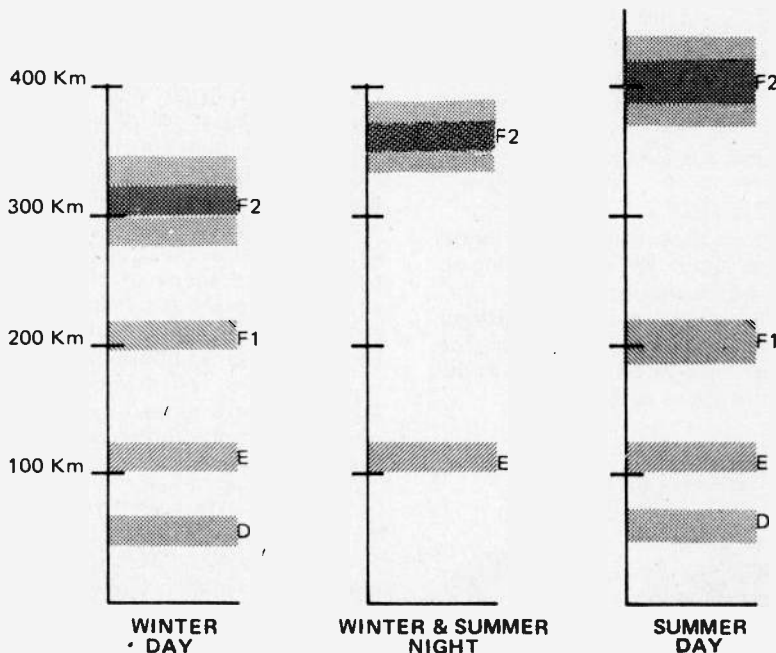

Fig. 11. Illustrating the diurnal and seasonal variations in the various layers.

Figs. 6 & 7 after J.A. Ratcliffe, 'SUN, EARTH AND RADIO', World University Library, 1970. In fact, if you want a good book on the subject, complete with charming historical anecdotes — this is it.

## SUMMARY SO FAR

The *daytime* ionosphere consists of an absorbing region — the D-region — with three reflecting ionised layers above that — the E, F<sub>1</sub> and F<sub>2</sub> layers.

The *night-time* ionosphere consists almost entirely of the F-layer.

It should be noted that the allocation of the letters of these layers was made by Sir Edward Appleton. It was he who did most of the early investigative work on the ionosphere. The F-layer, which he discovered, is also known as the "Appleton Layer". The E-layer was originally named the "Kennelly-Heaviside Layer" (or just the Heaviside Layer) after the two gentlemen who discovered its existence.

LONG DISTANCE propagation on the HF bands is not all by means of multi-hop reflections between the ionosphere and the earth. Considerable distance can be covered, or paths not supposed to be 'open' can be worked — often well beyond the MUF — by means of a variety of "anomalous propagation" modes.

The ionosphere is not an homogeneous medium. The cream is not mixed in with the milk, so to speak. It is a curious mixture of 'thick' patches and 'thin' patches, bulges and tilts — all the time on the move under the influence of a variety of forces. Some of which have already been explained.

## "CHORDAL HOP"

The base of the ionosphere is not 'flat', nor parallel to the earth's surface in many places. This characteristic gives rise to 'tilts' in the base of the ionosphere which can be exploited to provide multiple reflections from the ionosphere *without intermediate ground reflections*.

This is now commonly referred to as "chordal hop" propagation. The concept is illustrated in Figure 12.

When tilts occur at suitable points along a path, particularly at the ionospheric reflection point nearest each terminal of a path (the 'control point'), then chordal hop propagation often results. If a signal arrives at a tilt at a suitably low angle, then the ionosphere will support propagation well above the 'predicted' MUF and will also provide extremely strong signals on lower frequencies as the signal will spend less time travelling through the D-layer together with the decreased loss through successive ground reflections.

Chordal hop propagation has been exploited by amateurs working from Britain to Australia on several of the lower HF bands. Tilts occur in the base of the ionosphere at the 'sunset' zone



# The Ionosphere and Propagation

and at regions either side of the geomagnetic equator. Using the tilt south of the geomagnetic equator in the Indian ocean area, and the sunset tilt over the Mediterranean, British and West Australian amateurs have been able to make contact on the 3.5 and 7 MHz bands at times when they would normally be 'closed'.

Low angle radiation from the antenna is necessary to exploit these modes but due to the ionosphere "focussing" the signal rays, and the low angle of incidence on the ionosphere, very little power is necessary to produce surprising signal strengths.

## "PEDERSON RAYS"

Anomalies in the electron distribution well within the F-layer can entrap signals so that a sort of total internal reflection phenomena occurs. A signal trapped in such a manner can travel surprising distances, again without intermediate ground reflections, and re-emerge from the ionosphere via another anomaly or tilt.

Signals travelling through the ionosphere in this manner are referred to as Pederson Rays after the man who first described them. The phenomenon is illustrated in Figure 13.

A Pederson Ray generally travels through the ionosphere at considerable heights and experiences more "loss" than chordal hop signals. However, it is often experienced where high radiation angles occur from an antenna so that the signals enter the ionospheric anomalies at a favourable angle.

## TRANSEQUATORIAL PROPAGATION

This mode of propagation was discovered by radio amateurs in 1947. Confirmed contacts on the 50 MHz band between amateurs in the USA and South America exploited certain characteristics of the equatorial ionosphere unknown at that time and which have taken some 30 years of research to explain — and it's not finished yet!

There are two types of TEP known as "afternoon-type", or class 1, and "evening-type" or class 2.

Afternoon-type TEP is a true chordal hop propagation mode and occurs generally between 1200 hours and 1900 hours local mean time. Stations situated in the zone between about 20° and 40° geomagnetic latitude are able to contact stations in a similar zone on the opposite side of the geomagnetic equator. Figure 14 shows the

Australasian sector of the world with the class 1 zones cross-hatched thus: // // //.

Evening type TEP is generally experienced between 2000 hours and 2300 hours local mean time and stations located in the area between 10° and 30° geomagnetic latitude (cross-hatched // // // in Fig. 14) can contact stations in the similar zone on the opposite side of the geomagnetic equator.

Transequatorial propagation is predominantly an equinoctial occurrence, peaking in the months March-April and September-October but it can occur over many more months around the equinoxes (21 March and 21 September), particularly during high sunspot activity.

The propagation modes for both classes of TEP are illustrated in Figure 15. The afternoon-type mode is generally called a "supermode". The signal is reflected from two dense 'bulges' in the ionosphere located either side of the geomagnetic equator. The density of these bulges, and the tilts associated with them, cause 'ray focussing' which gives rise to the surprising signal strengths observed on afternoon-type TEP signals. Fading on these signals is small; propagation distortion experienced on 'normal' ionospheric modes is absent giving rise to good quality signals as well.

Signals up to 65-70 MHz may be propagated by class 1 TEP, which represents a considerable extension of the conventional MUF for these paths. Occurrences will increase in coming years as the sunspot activity increases.

The best paths for class 1 TEP are those which cross the geomagnetic equator at angles close to 90°. Even so, paths which have considerable obliquity — such as USA to Australia — are occasionally bridged during good conditions.

Evening-type TEP is a "field-guided" mode. The equatorial bulges (X and Y in Fig. 15) that exist during the afternoon in the equatorial region of the

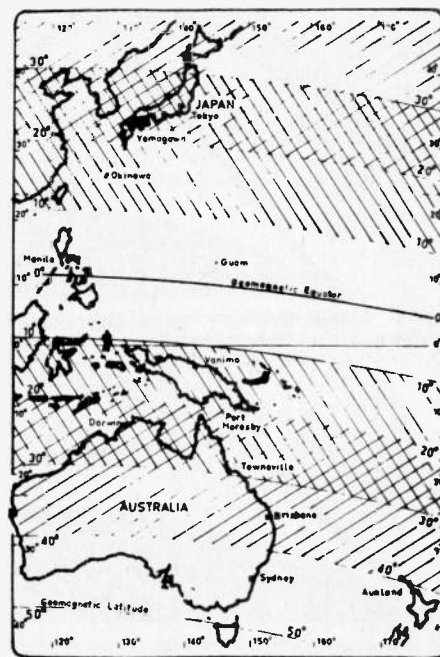

Fig.14. Australasian sector of the world showing terminal zones for class I TEP (20° to 40° geomagnetic latitude) and class II TEP (10° to 30° geomagnetic latitude).

ionosphere break up after sunset and the ionosphere over the geomagnetic equator develops dense 'slabs' of ionisation which align themselves with the earth's magnetic field. If a signal is sent towards this area of the ionosphere so that it arrives more or less at a tangent to the magnetic field then it may become 'trapped' between the 'slabs' of dense ionisation and conducted across the equator by successive reflection from a series of these irregularities.

Again, signals will be quite strong on evening-type TEP but considerable 'flutter' fading is generally experienced — generally at a rate between 5 and 15 Hz.

Evening-type TEP will support signals of much higher frequencies than for afternoon type. Until recently, it

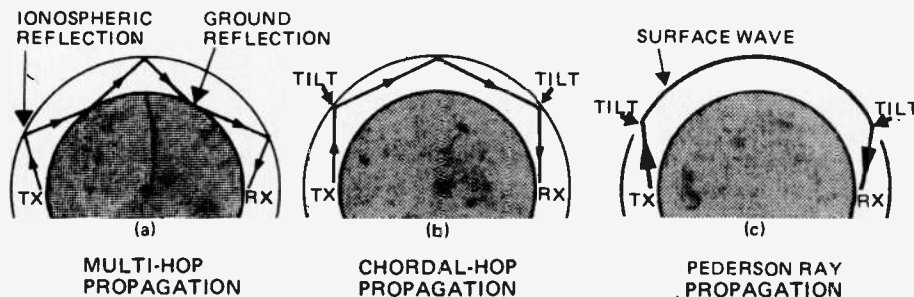

Fig.12.

Fig.13.

# The Ionosphere and Propagation

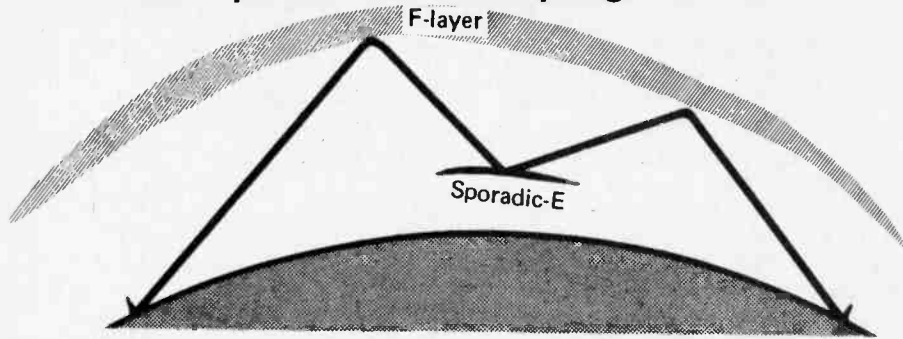

Fig. 16. 'M-reflection' - a complex propagation mode involving reflections from the F-layer and E-layer without intermediate ground reflection.

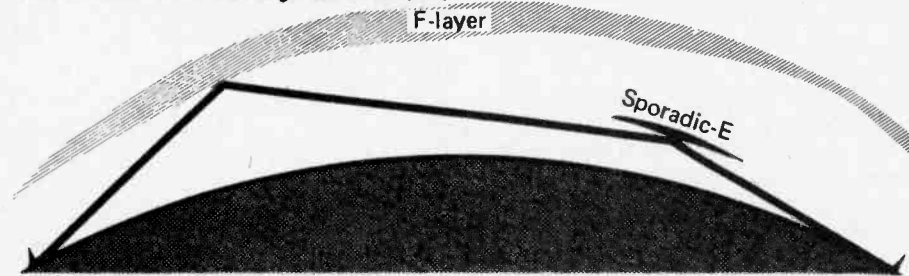

Fig. 17. A complex chordal hop mode involving reflections from the F-layer and E-layer without intermediate ground reflection.

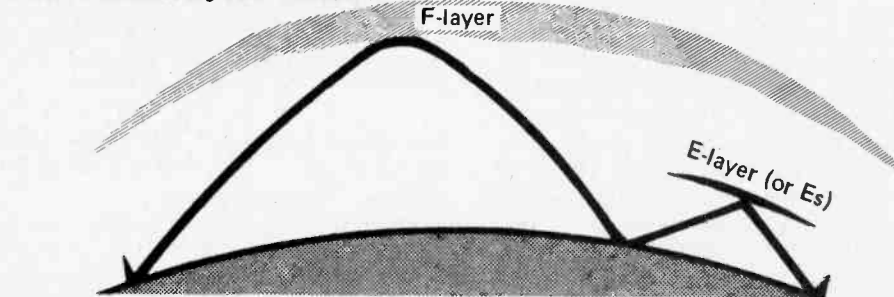

Fig. 18. A complex propagation mode involving one F-layer hop and one E-layer hop. Sometimes referred to as "N-reflection".

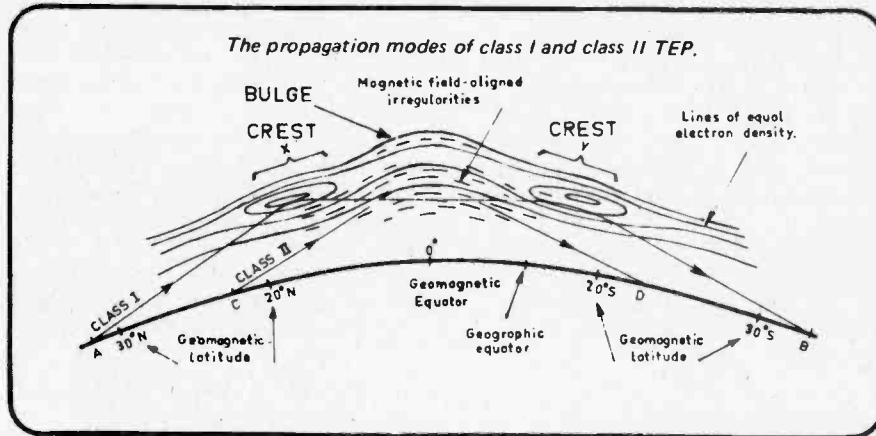

Fig. 15. The Propagation modes of class I and class II TEP.

was thought that the limit was in the vicinity of 100 MHz, but recent contacts between Australian and Japanese amateurs, as well as Puerto Rican and Argentinian amateurs, on the 144 MHz band clearly indicate that there is more to be learned about this mode of propagation.

Evening-type TEP is much more tolerant of path obliquity than

afternoon-type. However, the paths are generally shorter.

The zones for each class of TEP shown in Fig. 14 are calculated from the geometry of the propagation mechanism and don't necessarily indicate the limits. Amateurs from Sydney right down to Hobart have worked into Japan on the six metre band on many occasions, via class 1 TEP.

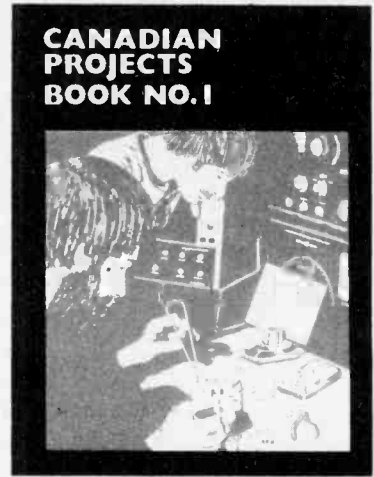

## Canadian Projects Book No 1.

Whether you want project plans to build from, or want to steal the designs to adapt to your own uses, this is a book for you. Includes audio designs (complete modular disco outfit, including Amps), sound or light triggered flash unit for photographers, test equipment, bio-electronics, guitar phaser and much more. Order yours for \$3.00 + 45c postage and handling from ELECTRONICS TODAY, Unit 6, 25 Overlea Blvd, Toronto, Ont., M4H 1B1. Also available where ETI is sold.

Thermometer  
Bridged supplies  
Accuracy Meter

# Number One ETI CIRCUITS

The first in a new series  
of 'ideas books' for the  
experimenter

GENERATOR

100 kHz Marker  
RF Voltmeter  
RF Detector  
LED RF Indicator  
RF Amplifier Protection  
ET-Radio  
Amp Radio

LIENS

Crystal Checker  
Good/Bad B  
Battery Tester  
Op-Amp Test  
Op-Amp Che  
Cheap Logic  
Audible TTL  
Audible Slow  
Logic Probe  
Logic Analyz  
I and O Displ  
Simple High  
Voltmeter  
Audio RF Tre  
Thermocoup  
Measuring Str  
Simple Freq

TIMERS &

Low Standby  
741 Timer

Phase Locked Loop  
Touch Doorbell  
Virtual Earth Mixer  
Virt Eliminator  
Loudspeaker Protection  
Digital Capacitance Pro  
Digital Tape Recorder  
Breakdown Diode  
Dual Function

POWER CONTROL

LDR Mains Control  
Floodlamp Control  
Zero Crossing Sync  
Train Controller  
Low Differential Thermal  
Simple Temperature Control  
Full Wave SCR Control

SEND \$5.00 TODAY  
To ETI Circuits, ETI Magazine  
Unit 6, 25 Overlea Boulevard  
Toronto, Ont. M4H 1B1  
Please add 45c for mailing  
and handling

FLASHER

# Video Cassette Recorders

No one yet knows what effect the ability to record TV programs will have. Suffice it to say it is extremely entertaining to be able to see what you want, when you want, Steve Rimmer surveys the current easy to use machines.

*"HEY MEESTER" Croaks the shadowy figure on the outskirts of the yellow pall of the street lamp. You turn to face the source of the accostation with grim, hard bitten reserve. "Mebbee you wanna buy some peechures?" The grey, hunched figure approaches you, two grimy palms crushing the lapels of a rain-streaked Moroccan leather great coat. You flash a non-committal smile. He continues . . . "These peechures are very eenteresting, no . . . I was geeven them by a good friend of mine . . . een the East." The man's perspiring, bearded countenance leers out from beneath the mildewed Fedora atop his gleaming skull, his rotted grin, flecked with dulled gold, scanning your own face like the eye of a sniper. "There are several from weech to choose." With a cobra-like flick of his sinewy wrists he tosses back the flaps of his coat, revealing a patchwork of inner pcokets, each one surrounding a small black box. "And all are available in Beta and VHS format.."*

Life is but a commercial.

Actually, far from being an underground industry, video cassettes of unedited "adult entertainment" (dirty movies, if you don't wish to assume the façade) are currently available both retail and by mail order from several dozen sources, many dealing in nothing other than pre-recorded tapes. Fare ranging from the most esoteric foreign flicks to full length, non "edited for television" Hollywood features, some available on tape even before they appear on the tube, can be purchased for viewing in the convenience and comfort of one's own home.

## FAMILY FUN

Or, perhaps you're tired of sit-comms and movies, and would like to use the idiot box to renovate your mind. Whereas several years ago the only way to do this might have meant pulling the plug, it is now possible to buy tapes

covering everything from Oriental cooking to the techniques of fencing to . . . electronics, for that matter. There's even one out providing instructions for servicing a VCR.

That one should probably be played before you need it.

Of course, a VCR can still retain its primary function; that of recording television programmes. The present generation of home video machines is capable of watching one show while you're tuned into another, and playing back the programme you might have missed otherwise later on. In fact, the new machines now incorporate built-in timers, and are thereby capable of switching themselves on and off to tape shows while you're asleep or away.

You can do the late late show over lunch, and never miss Godzilla tearing apart Tokyo again.

At the other end of the spectrum, the really dedicated home video enthusiast

can now purchase either a black and white or color video camera to attach to his recorder, and film his own extravaganzas. You can now remember the best moments of the five weeks your mother-in-law came to visit for as long as you wish (video tape is erasable, of course), re-live your wedding long after your divorce and even spy on the neighbours electronically.

Yes, television makes all men equal. If you can't be a big wheel, at least you can be a big brother. Hide the camera in a potted plant!

## HISTORY

Until recently, video machines were really quite simple, especially from the operator's point of view. A signal got stuck in one end, the tape rolled, when the recording was finished it was rewound, it rolled again, and the signal re-emerged. Getting heavily into "deluxe" features usually meant

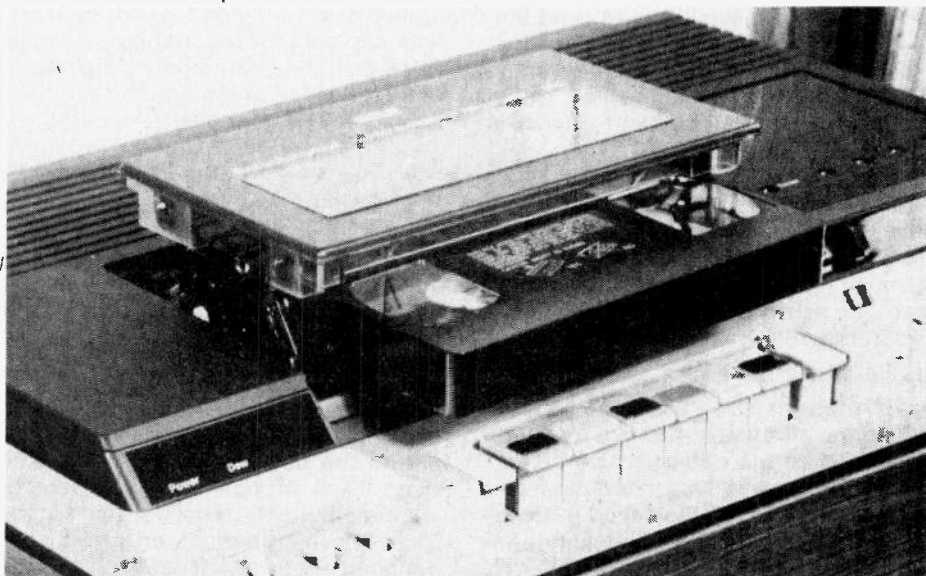

How to insert a video cassette. After years of speculation, VCR's are finally starting to appear in the home.

adding a "pause" control. Now, however, the actual recording systems are only half the fun. Some of the latest models of home VCRs have enough buttons, knobs, switches, levers, lights and infernal wizz-bangs to launch a missile.

While it has been suggested that several of the early model home VCRs were somewhat rushed through production in order to beat the competition into the new market, all of those early machines have been superceded by later models, and, as far as quality of construction and reliability goes, there does not appear to be much distinction between the various brands available. The choice, then, regarding which machine to squander the family fortune on must be made on a basis of which features the individual user wants. Here, in a rather bloated nutshell, is what is available.

#### WHAT'S A VCR

Starting from the middle, (a logical beginning) let us consider from whence the video signal which is to be recorded will come. Many home video enthusiasts intend, at a later date, to purchase TV cameras to attach to their VCRs, dreaming of creating little Hitchcock epics in the living room. However, at the moment, most cost more than the recorders themselves. As such, plan on most of your recording being done from broadcast television transmissions, at least for a while.

To get video out of the airwaves, one needs a **tuner**: essentially, a complete TV set without picture tube or speaker circuits. Most home VCRs have built in tuners which accept an input from either your antenna or cable TV line, tap off some for themselves and send the rest on to your television set. With this arrangement, it is possible to have the machine recording one show while you are watching another. A great way to end family fights.

There are a few systems which offer VCRs without built in tuners. These are machines designed primarily for portable operation, usually with a camera. If so desired, a separate tuner can be purchased to facilitate recording off the air.

#### TUNER TYPES

To further confuse the tuner situation, all tuners are not created equal. There are basically two types; the **rotary**, mechanical tuner with which we are all familiar, also called a turret tuner, and the **electronic**, pushbutton tuner in which a series of switches is used to apply predetermined voltages to a tuning diode, also called a very

expensive tuner. Each type has its advantages.

The electronic tuner is more reliable, and can be switched automatically by the machine (more on this in a minute). As each channel switch can be assigned to tune in any VHF or UHF station, one is not restricted to any specific stations. However, there is a limitation as to the number of stations one can pre-programme. Twelve to fourteen buttons are usually provided.

On the other hand, rotary tuners must be manually operated, and will require cleaning now and then, but can tune in as many channels as are available.

#### TIMERS

One of the most useful applications of a home video machine is the recording of programmes which would otherwise be missed when you are away or sacked out. For this reason, most machines are equipped with a timer to turn them on and off at pre-determined times.

There are also two types of timers. The first is simply a **digital clock** with a relay in the "alarm" circuit to actuate the recording mechanism. This type of timer is usually found on VCRs with turret type tuners. The second is a bit more complex... in fact, you may need a degree to operate it. Many of the "deluxe" machines have built in **micro-processors** which can be programmed with a set of switches to turn the VCR on at a desired moment, record for any length of time from one minute to as long as four hours, and then switch off. At any later time, the computer can turn things on once again, change the channel (hence the need for electronic tuners), and repeat the whole process, again, for any interval desired. Systems with capacity for recording up to four different programmes completely unattended are available.

Are you with me so far?

#### AD STOPPERS

If you are recording a programme off the air while watching it, a favorite flick to preserve for future edification, perhaps, you will probably want to eliminate about twelve minutes of every hour of material, these being the commercials and station breaks. In order to allow you a convenient way to stop the machine when the Saturday night movie goes for a beer, most VCRs incorporate a "**Pause**" feature which allows the user to instantly stop the tape. Tape motion can be resumed without hitting the record button again. The "Pause" function can usually be actuated either by a front panel switch or a control on a long cable, for armchair operation.

Leaving the "pause" pausing for an extended period of time, such as during a Prime Minister's speech, may cause the video heads and tape to become worn, so many machines have built-in timers to resume tape travel automatically after three to five minutes.

#### ACTION STOPPERS

Some machines are capable of producing stop action images, essentially displaying one frame of the recorded picture for as long as is desired. In this case, the "pause" control for recording may become the "**Freeze Frame**" button on playback.

#### SLO-MO

If "Freeze Frame" strikes you as being a bit too slow, several VCRs are available with "**Slow Motion**" controls, which allow a smooth variation of the playback speed from the regular playing mode right down to a dead stop. This is just the thing for rabid hockey fans.

#### FAST FORWARD

On the other hand, if an undetermined portion of a cassette is discovered to be occupied by Mork and Mindy, one would be justified in wishing to skip over it with all dispatch and locate the beginning of the next programme on the tape. To this end, some machines are equipped with a **double speed playback** circuit to permit rapid searching for a desired selection on a tape without having to watch everything prior to it.

#### SOUND

Most VCRs incorporate an "**Audio Dub**" feature, allowing one to record a new soundtrack on a tape without disturbing the existing video.

#### JACKS, SWITCHES, ETC.

Most VCRs have built in jacks to allow video and audio to be brought into the set directly, primarily to facilitate the use of a camera, or for dubbing a tape with a second VCR, and out again, to display the picture on a monitor and play the sound through a stereo system. Some have the jacks up front, which makes connections easy, and some have them on the rear apron, which is somewhat less convenient, but a lot neater for a system which is not going to get patched and unpatched all that often.

If you intend to use a camera with your VCR, the switch selecting between it as a source for audio and video signals and the machine's internal tuner will probably be used quite frequently. Some machines have it on the front panel, some hide it behind a little trap



## VHS Format

door and some tuck it away on the rear apron.

In some cases, it becomes necessary to adjust the **tracking** of the video heads during playback in order to produce a perfect picture. A knob is usually provided. Since this adjustment is rarely needed (generally only when playing tapes made on another machine), the knob does not really have to be on the front control panel... where somebody will probably fool around with it. Some machines hide the tracking control on the rear apron or in the same cubby hole as the source selector switch.

### SPEEDS

Most of the home VCRs now available have two speeds for recording and playback. The higher speed gives near perfect reproduction of the recorded image, while the slower one is somewhat more economical of tape, at a slight loss of picture quality. A few machines are available with only the lower speed.

With some recorders, it is necessary to manually set the speed when playing a tape back. In the more sophisticated systems, though, circuitry has been incorporated into the machines to detect the frequency of the recorded synchronization pulses and adjust the speed accordingly.

### HUMIDITY

Most machines have special circuitry which detects excessive moisture in the interior of the VCR's cabinet and disables the tape transport mechanism until things get dried out. Moisture buildup on the head drum can damage both the heads and the tape. The moisture detection circuitry has several trade names, but is usually called a **DEW alarm**.

Some DEW alarms do more than just stop all the wheels from rolling. In a few machines, they switch on internal **electrical heaters** to dry things out. Other machines have provided holes to blow a hair dryer through, which is better than nothing. Somewhat. If you aren't planning to shower with your VCR, extensive DEW precautions may not be all that vital.

### TAPE PATH

There are three basic types of systems for getting the tape out of the cassette and into the workings of the machine. All employ dozens of little mechanical munchkins to handle it. The Beta recorders use the **U system**, so called because the tape describes a

path that resembles a drunk U. It is a wonderfully confusing system, but since all Beta recorders use it, you don't have to try to understand it (and I don't have to try to explain it). Some VHS machines use the **B system**. A few use an **M system**, which ties up less tape in the machine, and thus makes loading and unloading a bit faster. It does, however, also appear to have a larger profusion of springs, levers and thing-amajigs moving around, which makes it somewhat more prone to Murphy's law. And Murphy, of course, was an optimist... read the warranty card!

### THE SYSTEMS

Lastly, there are two main formats of tape systems currently in use with home machines, these being Sony's **Beta** system and Japan Victor Company's (JVC) **VHS** system. They are not compatible, nor are they ever likely to be. The Beta system can run for a maximum of three hours, while VHS can go for four. The Beta system, furthermore, comes in two varieties; **Beta I** and **Beta II**. Beta II machines are equipped only with slow speed, so that tapes made on two speed machines at high speed will not play back on them. The following are the VCRs which are widely available in Canada at the present time. All prices are approximate Canadian, except where mentioned otherwise.

### RCA

RCA has two VCR models in its current "SELECTA-VISION" line, both of which use a VHS compatible format.

The **VCT 400** is the top of the line in RCA's offerings. Styled very similarly to the professional  $\frac{3}{4}$ " decks, features just about every gadget imaginable. These include a DEW alarm which deactivates the tape transport if the internal humidity of the machine exceeds a safe level, a fourteen button electronic VHF-UHF tuner and a programmable seven day timer with capacity for up to four different recordings. An additional feature of the timer is its ability to record the same programme every day, if desired, for as long as there is still tape on the cassette. The "Pause" feature of the machine can be actuated by either a front panel switch, a remote control (provided) or by the trigger mechanism on an optional camera. The tape counter is fitted with a mechanism to stop the tape from rewinding past any point where the counter has been set to zero if desired, thus simplifying the location of the beginning of a programme. The

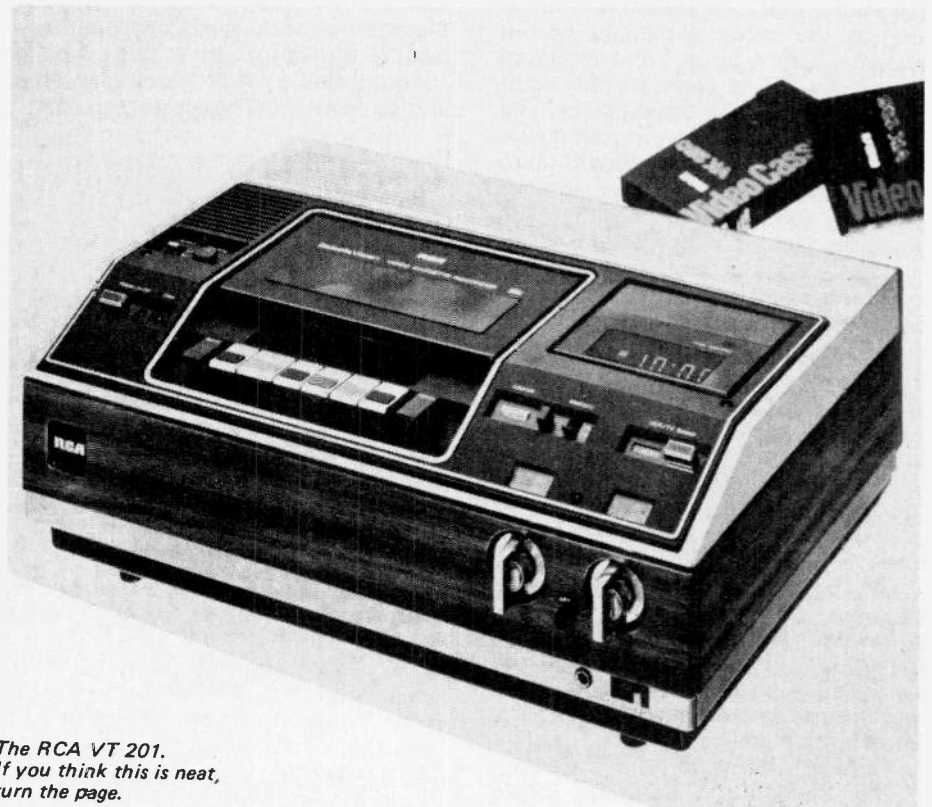

*The RCA VT 201.  
If you think this is neat,  
turn the page.*

machine is equipped with an audio dub feature to replace existing soundtracks with your own renderings of Honky Tonk Women on the kazoo. All user operated controls are either on the front panel or behind a front panel trap door, and all inputs, with the exception of the mic input jack for audio dubbing, are on the rear apron.

The current list price is \$1800.

The **VCT 201** is physically different from the 400, but electronically, quite similar. Several of the costlier features have been excoriated from this model, however, bringing the price down somewhat. The tuner is a rotary, mechanical type, which, although not quite so futuristic, does provide full VHF-UHF coverage, with an unrestricted number of channels. The non-programmable timer can only be set for one recording at a time, but is capable of switching the recorder off after any given length of time, as opposed to simply letting the tape run out. RCA cites this model as being inherently more reliable due to its simpler design.

This one is \$1600.

## JVC

The JVC Vidstar line consists of two very different machines, both using the VHS format pioneered by JVC.

The **HR-3300U** is the firm's home VCR-tuner entry. Its styling resembles one of the more expensive stereo systems, with a large, front mounted digital display to serve as the timer readout as well as a straight clock. The timer is of the non-programmable variety, and can be set to record up to four hours of continuous television, but won't do any channel hopping. The digital tape counter has a feature which will automatically stop the tape, on rewind, at any arbitrarily selected zero point. All important controls and the audio dub mic input are mounted on the front panel. The primary tape function keys — play, record, stop, and so forth — are large, but handled affairs for easy operation. Furthermore, their functions have been labelled both on the front and top of the machine, making the legends readable both from above and at eye level.

The current price is \$1530.

A new model, the **HR-3600** is expected very shortly. It will be essentially similar to the HR-3300U, but will include a variable speed feature, and a remote "pause" control. The price will be about the same as for the 3300.

The **HR-4100** is a scaled down version of the ¾" portable decks which

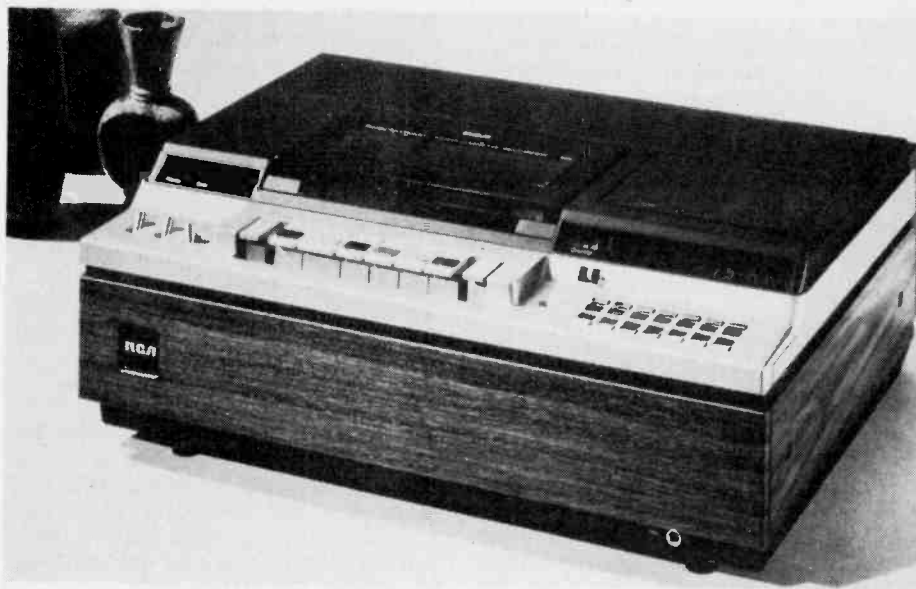

*RCA's VCT 400. Note the all electronic tuning.*

have recently found considerable acceptance in professional television news gathering systems. Using either internal batteries or an external power supply/battery charger (supplied with the unit), this briefcase sized VCR can go anywhere, regardless of the existence, or lack thereof, of suitable AC power. With its optional colour camera attached, it can become a complete one man portable studio (you supply the script girls). The machine incorporates a DEW warning to shut things down if the heads get too damp.

plus an electronic indexing system to locate where you began on the tape.

What separates this machine from most of the other home VCRs is that it does not have a built in tuner and timer. These two features are purchased in another package, called a **TU-41AU**. This gives the 4100 a decided advantage in terms of size and weight in situations where portability is desirable.

The cost of the HR-4100 VCR is \$1400., and its companion TU-41AU tuner is an additional \$450.



*The HR-3300U from JVC's Vidstar line.*

# Video Cassette Recorders

same price as the V I-5000A now retails for, but as Hitachi has discontinued its production, existing units may be available at a discount.

## Panasonic

Panasonic got into the home VCR race a bit late (just slightly behind our time, this time) with its Omnivision line of VHS recorders. At present, it includes two models specifically aimed at the home market, plus several others intended primarily for the industrial user.

The **PV-1500** is similar in some ways to the RCA VCT-400, with a complete line-up of every imaginable feature. These include a seven day programmable timer, a fourteen channel pushbutton tuner, a DEW circuit to prevent the machine from doing a head destructo if the internal humidity is too high, and a tape indexing system to permit the machine to rewind the tape to any pre-set point



*The HR4100 is a portable deck without tuner. Battery operation extends the usefulness of this unit.*

## Hitachi

Has one current model in the home VCR race, a VHS format model which, in some ways resembles the JVC machine . . . and, obtusely, looks a bit like a photocopy machine.

The **VT-5000A** is the "latest in a line of continuing developments in VCR technology", and features a twelve button electronic tuner, a twenty four hour digital clock-timer, an audio dub feature and a motor-tape handling arrangement which allows the cassette to be fast forwarded or rewind somewhat more rapidly than is possible with most other machines. There is a memory system to allow rewinding the tape back to any pre-set point, and, something rather unique, a DEW warning which not only prevents the machine from operating when there is a danger of tape and head damage due to excessive moisture, but actually turns on a heater to dry things out. All of the input jacks, with the exception of the antenna connections, are on the front panel for easy access, along with all of the frequently operated controls. (There are indications that the unit also includes an optional four slice pop-up toaster and a sabre saw.)

The suggested retail price, not including tax and government skimming, is \$1700.

An earlier model, the **VT-4200**, may also still be available in some areas. It is essentially the same as the VT-5000A, but without quite as many gadgets (no toaster . . . sorry). The tuner is of the mechanical, rotary type, and the high speed tape system is not employed. This model originally sold for about the

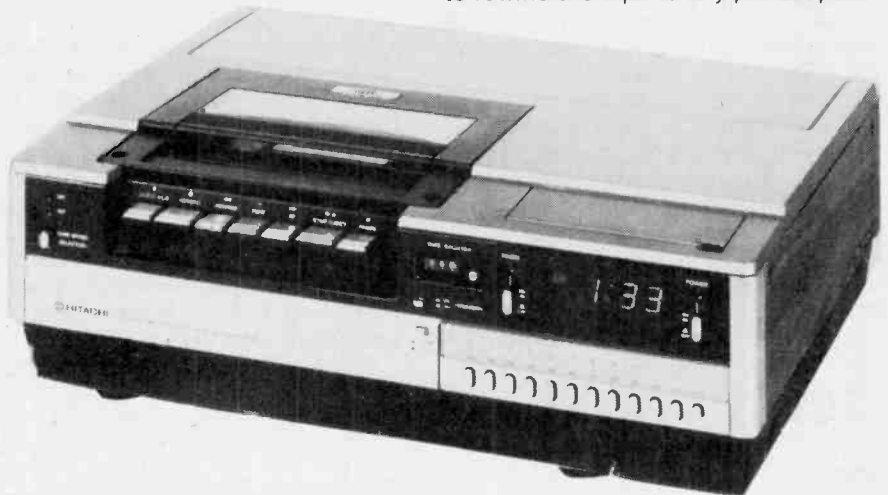

*Hitachi's VT5000A, one of the more advanced machines in our survey.*



*The VT4200. This unit has been discontinued, but shopping around could unearth one if you were so inclined.*



*PV 1500 from Panasonic. Another one of the 'thinking' machines.*

for easy replay. One nice touch on this model is a convenience outlet on the rear apron into which can be plugged the TV set's power cord, thus eliminating one more cube tap.

The suggested list price is \$1850.

The **PV-1100-K** is an economy model of the PV-1500. (Spotting something of a pattern in marketing strategies yet?) It is essentially the same as its big brother, electronically, but uses a mechanical type tuner and a non-programmable timer.

It costs \$1600.

## Beta Format

### Sony

The daddy of the Beta system format, presently has two models on the market, both of which are all but identical. The one difference between the two is that the **SL-8200** offers a choice of two speeds in which it can record and playback, allowing either one and a half or three hours of recording time on an L-750 cassette, while the newer **SL-8600** offers only a slow speed, with the maximum three hour time. Sony claims that the signal processing circuitry in the **SL-8600** makes the slow speed reproduction equal to or better than that obtainable on fast speed with its older machines.

The **SL-8200/SL-8600** is styled much like a studio model ¾" deck. It incorporates a twenty four hour timer, and a mechanical, rotary type tuner. It has three coloured indicator lights which come on when one of the primary function keys, "play", "record" and "pause", is actuated. The remote

"pause" control also has a light built into it, a yellow LED, which flashes when the machine is in its "pause" mode. An internal timer keeps you from pausing for longer than three minutes, to avoid excessive head and tape wear. The machines lack a few of the features of some of the competition, including audio dub capability, DEW warning and/or a dehumidifier and, in the case of the **SL-8600**, a two speed control. However, both come in at a bit less than any of the console models VHS VCRs.

The list price for either machine is \$1450.

### Zenith

**KR9000W** bears a striking resemblance to the Sony machines, both in terms of physical appearance and features. There is a twenty four hour timer to make the machine watch programmes you'd rather not, and a rotary, mechanical type tuner. A handy convenience outlet is provided on the rear apron to plug your set into. The major difference between the Zenith and Sony systems appears to be the light on the "pause" control... which is red in this case. However, if you can abide by the red lamp, the tag on the Zenith machine is somewhat less.

Current list price is \$1400.

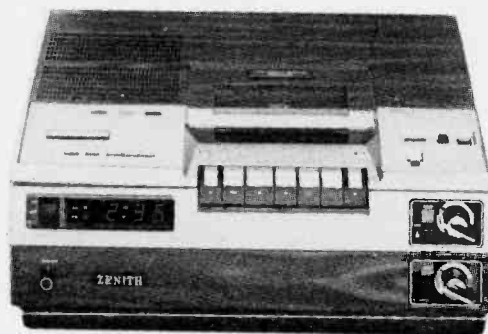

*Zenith's contribution, the KR9000W.*



*From the creators of the Beta system. The SL8600 from Sony offers slow speed for longer playing time.*

# Video Cassette Recorders

## Toshiba

Toshiba markets three VCRs, which are a sort of Beta version of JVC's system. The **V-5310** looks like something out of Star Wars, the case being almost entirely gleaming brushed silver in colour (also available with woodgrain side panels, if you aren't quite as spaced out). It has a rotary type tuner, and a twenty four hour timer. Like the Sony and Zenith machines, it has several front panel lights to indicate which mode the system is in. Unlike the previous two Beta entries, however, it also has a few of the more deluxe features, such as audio dub and a DEW sensor. It goes this last one a bit better, in fact, by providing a little trap door in the top of the machine's case to blow hot air from a hair dryer through if the internal workings need drying out.

The price, including a tape and salesman's Christmas bonus is \$1400.

The **V-5530** is similar to the JVC HR-4100, except, of course, that it uses JVC cassettes. It combines all of the features of the V-5310 with a choice of battery or AC operation, allowing complete portability. By attaching the optional IK-1610 colour video camera, it can become the ultimate home movie camera. Alternately, the optional TU-530 tuner can be connected, and recording made from off the air broadcasts in the traditional manner. The tuner incorporates a rotary type tuner, and a twenty four hour timer, just as in the V-5310.

The V-5530 goes for \$1650, plus \$350 for the TU-530 tuner. Sell the cat.

The **V-5420**, Toshiba's recently announced third entry into the video market, is probably the most deluxe Beta machine currently available, and is a button pusher's delight. It has a seven day programmable timer which can be set to record any three programmes on any three channels over the space of a week. It has a twelve channel electronic tuner of a rather... unusual design. Instead of twelve buttons, it only needs two; one to increase the channel numbers, and one to decrease them. It's called "Comput-

R-tune". Remember when they used to call you "stupid" for spelling like that? Another technological novelty incorporated into this VCR is a little coloured stripe which can be made to appear at the bottom of the TV screen to indicate how much tape is left on a cassette (you have to get up to turn on the stripe). The programme finder on the V-5420 is better than most, though; it can be set to stop either the rewind or the fast forward functions when it detects the beginning of a new selection on the tape, as opposed to when the counter hits zero.

And now... the price: \$1650.



Lookit all them buttons! The Toshiba V5420 features electronic switching.



Another portable, the V5530.



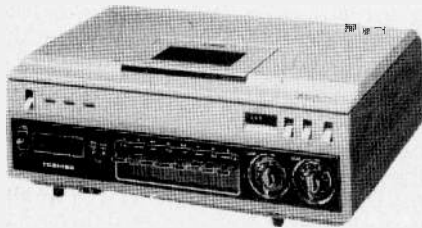

Toshiba's V5310.

## Sears

This department store chain, has its own private VCR, which will be available in the Fall and Winter catalog. Called simply the "Betavision", it has no number at all (a very innovative touch). It incorporates a rotary type tuner and a twenty four hour timer. Like the Sony machines, it has a set of indicator lights to tell you what the machine thinks it's doing, but no audio dub feature or DEW alarm (just don't take it out in the rain or swim with it).

At \$1300, it is the least expensive of the Beta systems. Put it on the charge card.

## CONCLUSIONS

Well, there you have it. Your mission, should you decide to accept it is to figure out which VCR you finally do want . . . and then find the bread to pay for it. (An article on this aspect of the world of video will appear shortly in ETI's sister publication, 'Video Today — Bankruptcy Tomorrow'.)

Despite its rather high initial cost, it looks like within the next few years the home VCR will become as much a part of our lives as the tube itself. Hopefully, this article has assisted you in deciding specifically which one is going to become a part of yours.

Next month will mark the beginning of a regular feature in ETI discussing a variety of aspects of home video. Until then, stay tuned.

# A Typical Home Video System

I'M DEFINITELY going to buy one of these things: Right after I pay for the rereads on the Plymouth.

The **RCA VCT-400** Video Cassette Recorder is typical of the deluxe home video systems now turning up. The one

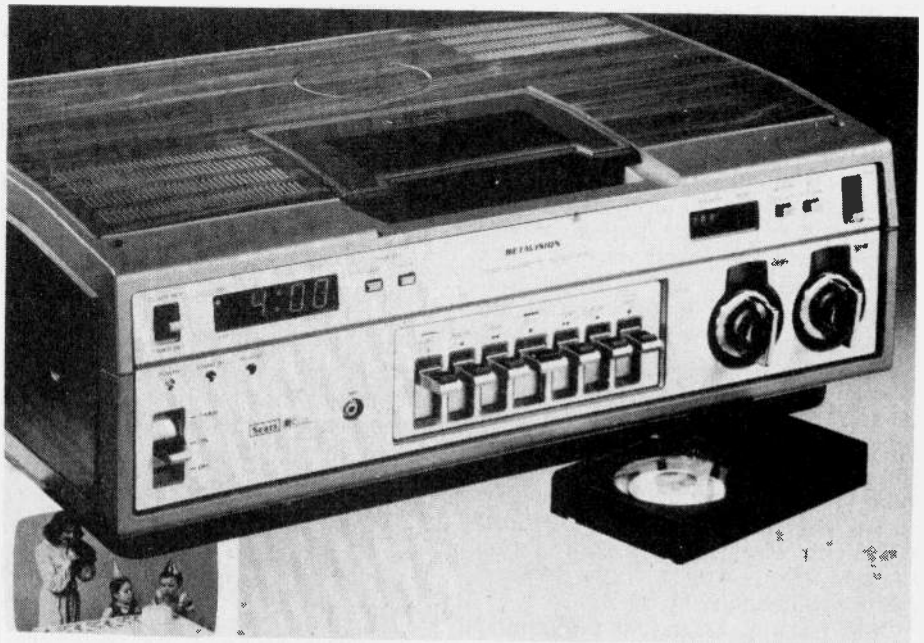

Betavision from Sears (what? No model number?).

which Starword Communications, distributors of the Selectavision line in Canada, loaned me for this article is pictured atop my reasonable facsimile of a colour TV on the cover. I am having grave doubts regarding my ability to give it back.

After exhuming the machine from its rather extensive styrofoam coffin, and removing several strata of collected debris from the top of the television, I finally succeeded in getting the whole arrangement hooked up . . . incorrectly, of course. The array of little screw terminals is a bit deceiving at first, especially if you don't read the directions before beginning to fool with them. Actually, the traditional antenna connectors on the rear apron are intended only for UHF aerials; a type 59 bushing, of the sort used for cable TV lead-ins, is provided for the VHF frequencies. If a non-cable system is to be used with the VCR, a special adapter, provided, matches the input to 300 ohm twinlead. When all else fails, read the manual.

Making a recording, once one discovers where, in all the styrofoam they have hidden the cassettes, is about as complicated as running an audio cassette deck. There are no levels to set, and, in fact, no meters with which to set them. Both audio and video have ALC circuits, and the tuner has AFC to minimize distortion caused by fine tuning errors. The tape prowls by at about half the speed of an audio recorder, making one suspect that the last guy who had this machine might have spilled coffee into the ventilating grill. However, upon playback,

the picture and sound are indistinguishable from the live ones a few minutes earlier. Simply blows the mind.

The front panel has a switch which selects between "SP" and "LP". This is eventually determined to indicate "Standard Play" and "Long Play". Now, if the tape seems slow in the regular speed . . . it's going so slow in the extended mode it could be in reverse. Still, on playback, the image quality is acceptable, although it does get a bit grainy in places. Patching the "Audio Out" jack of the VCR into a high fidelity amplifier and a decent speaker, there is a noticeable drop in sound quality in the "LP" mode, however, when running through the half ounce speaker in the TV, both sound the same. So far, very impressive. It does everything but make the popcorn and shut the dog up.

The tuner is a bit different from what most of us are used to . . . no knobs. Instead, it has fourteen little silver buttons that glow when touched, illuminating a channel number. In behind a secret front panel, there are fourteen little shafts by which each channel can be individually tuned to receive any VHF or UHF station. Furthermore . . . ah ha . . . the channels can also pick up many of the special converter channels which the cable companies are presently adding to their repertoires. Thus, for instance, I can swap one of our two identical CBC stations for a remote UHF broadcaster to get Monty Python's Flying Circus. What that we could really swap the CBC . . . oh, never mind.

Probably the most interesting bit of paraphernalia on the machine has

nothing directly to do with the video tape process. The digital clock-timer, actually a micro-processor in sheep's clothing, can keep even the most jaded amused for hours just playing with the numbers. Its versatility leads to a degree of complexity, though... I didn't get it working quite right all that often in the first week.

Now, we get zientific, ya...

Figure 1 shows a video cassette, holding four hours worth of tape for the VCT-400, a comparable amount of one inch tape for the one inch system which haunts my basement.....

(a large portion) takes up a ten inch reel. Inasmuch as my own system produces pictures which are comparable to off the air, broadcast quality programmes (God knows that with all that tape, it should), I was curious to see how the Selectavision compared to it. Physically less tape per minute around the head drum should mean less picture information stored, which, in turn, should show up in image quality.

The shots in figures 2a and 2b from the same transmission. One was taken from the playback of my one inch behemoth, and the other from the RCA VCR. Due to... er... a slight mix up in the darkroom, I am not all that sure which is which. The biggest problem in figuring out the problem is that both are identical. So we decided to leave out Figures 2a and 2b to save the embarrassment.

It is only really in test pattern checks that the difference between off the air quality and the playback from the VCR can be seen, and of course there is slightly more resolution with the faster speed.

Oh... and Figure 3 shows the lengths one has to go to for that extra bit of resolution. That's about a third of my one inch system. Big.

In the end though, I would not trade my large format VCRs for one of the new cassette machines. After all, they have a certain esoteric esthetic, much more versatility... and, besides, RCA told me I was crazy when I tried. However, if you can afford it, the new generation of VCRs has a lot to recommend it, especially if you don't watch a lot of test patterns up close.

And I've still got three weeks to play with this one until they take it back. Thanks to Gloria Collins at Starword Communications for the loan of the magic box, and to Bob McEwen at McEwen Photo for the pictures.



Fig.3 And now, a blast from the past. How to impress your neighbours and get a hernia. Actually, large format video recorders are going to be around for a long, long time.



Fig.1 The ubiquitous Philips Compact Cassette next to one o' them upstart VHS things. It's amazing the lengths a company will go for more bandwidth.

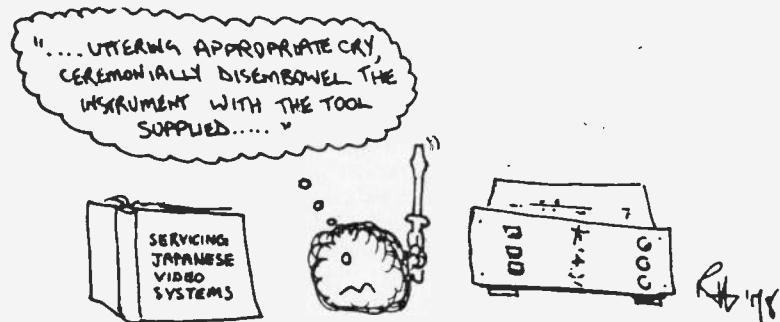

# Practical Guide to Reed Switches

## Part 1

It used to be ships in bottles, now it's switches in glass envelopes. Actually, reed switches have been around for a long time, but do you know what to do with them?

**T**he dry reed is an almost perfect low-current switch.

It is fast — operating times of less than one millisecond are typical. It is reliable — as many as one billion operations can be achieved. And it is cheap — quantity price is well under 50 cents.

The dry reed switch is not by any means a new device for it was invented back in 1945 by Dr. W. B. Ellwood of the USA's Western Electric Corporation.

But it was ahead of its time. It remained practically unnoticed by the engineering world until only a few years ago when it was 'rediscovered' by the telephone industry.

And since then reed switches are receiving interest and acceptance at an ever increasing rate.

In its basic form, a reed switch is a magneto-mechanical relay. In other words it relies upon a magnetic force to initiate a mechanical switching action.

### THE BASIC SWITCH

A typical reed switch is shown in Fig.1. It consists of two flattened ferromagnetic reeds sealed in a glass tube. The reeds are fixed, one at each end of the tube, so that their free ends overlap in the centre but with a 0.01" gap between them.

During the sealing operation the air inside the tube is pumped out and replaced by dry nitrogen so that the contacts operate in an inert atmosphere.

When the reed switch is brought within the influence of a magnetic

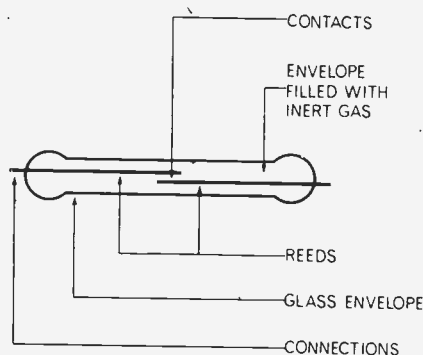

Fig. 1. The basic reed switch.

field (either from a coil or a magnet) the reeds — being ferromagnetic — become a flux-carrying portion of the magnetic circuit. The extreme ends of the reeds will assume opposite magnetic polarity, and if sufficient flux is present, the attraction forces overcome the stiffness of the reeds and they flex towards each other and touch.

When the magnetic field is removed the reeds spring back to their original positions. There is however a difference between the value of field required to close the reeds, and the reduced value that will allow them to open again.

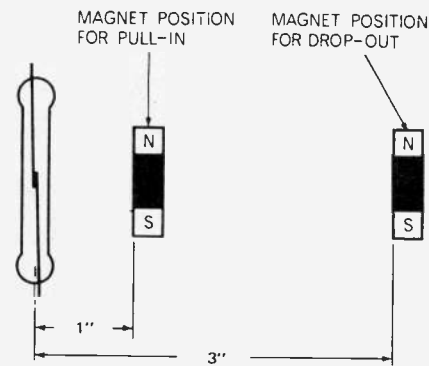

Fig. 2. The reeds close when the magnet is brought within one inch, and will remain closed until the magnet has been moved at least three inches away.

A typical example of this is shown in Fig.2. In this example the reeds close when the magnet is brought within one inch, but they will remain closed until the magnet has been moved about three inches away.

This phenomena — which is caused by magnetic hysteresis in the reeds — can be considerably reduced by

# Practical Guide to Reed Switches Part 1

introducing a second magnet, of opposite polarity, on the further side of the switch. This is illustrated in Fig.3. The fixed magnet must not be mounted within the normal pull-in position for single magnet operation, otherwise the reed switch will be held in a closed position by the second magnet and will open when the moving magnet is brought close to the switch. By selecting the correct types and strengths of magnets the differential can be set to practically any required value.

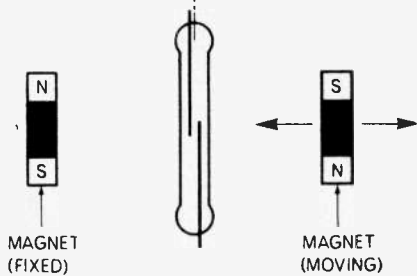

Fig. 3. A fixed magnet of opposite polarity to the moving magnet may be used to reduce pull-in, pull-out differential.

## OPERATING MODES

As can clearly be seen in Fig.1, the reed switch is 'normally open'. The reeds close when a magnet is brought close to the switch enclosure.

However there are many applications where the switch is required to be 'normally closed' and to open when the magnet is introduced. This can be done either by biasing the switch with a second magnet (as shown in Fig.4), or by using a reed switch with change-over contacts (Fig.5).

In most applications where a reed switch is opened or closed by a permanent magnet, the magnet is fitted to a moving part, and the reed is fitted to a stationary part.

There are, however, a number of applications in which both the magnet and the reed must be located on a

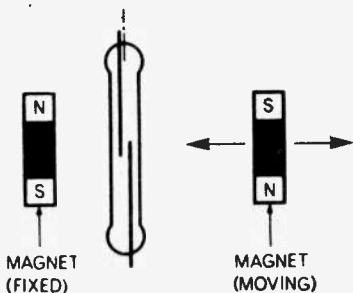

Fig. 4. 'Normally closed' operation can be obtained by biasing a 'normally open' reed switch with a fixed magnet. The moving magnet cancels out the fixed magnet and thus allows the switch to open.

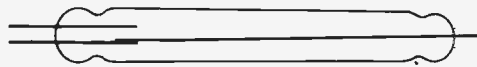
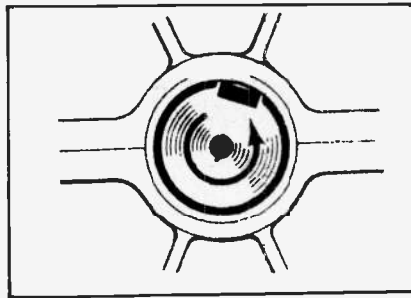

Fig. 5. This type of reed switch may be used for either change-over, or normally closed operation.



Tachometer applications, requiring the simplest addition to the moving part and offering ability to work in unfavourable conditions, plus high speed operation.

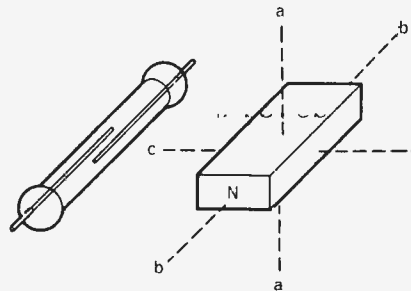

Fig. 6. Linear planes of operation; movement of the magnet in any of the planes indicated may be used to actuate the switch.

stationary component. Operation may then be effected through distortion of the magnetic field by an external moving ferrous mass. If the magnet and the reed are sufficiently close, the reeds switch will be normally closed, but will be opened by the magnetic shunting effect of the external ferrous object. Alternatively, the magnet may be located so that the reeds are normally open and the external ferrous object used to 'reinforce' the field and thus close the reeds.

There are many different ways in which a moving magnet may be caused to operate a reed switch.

Linear planes of operation are shown in Fig. 6.; movement of the magnet in any of the planes a-a, b-b, and c-c will operate the switch. Magnet selection is fairly critical if the switch is operated in mode b-b, spurious operation may be caused by negative peaks on the magnet's field pattern curve. If these are large, the reeds will pull-in three times as the magnet is moved from one end of the switch to the other.

Rotary motion may also be used. Various ways of achieving this are shown in Fig.7. (A most versatile and simple impulse generator can be put together in a few minutes by placing one or more magnets on a gramophone turntable and fastening a reed switch to the motor base board. (Fig.8). Switching rates from approx one every two seconds to well over 2000 a minute can be selected merely by changing the turntable speed and/or using more magnets!)

Since the reed switch is truly a sealed device, it can be used in applications where conventional switches are not permitted, or where they have very limited life. Reed switches are frequently used in simple on/off push buttons, and outdoors, in dusty areas such as cement plants, especially in areas where explosive gases may be present.

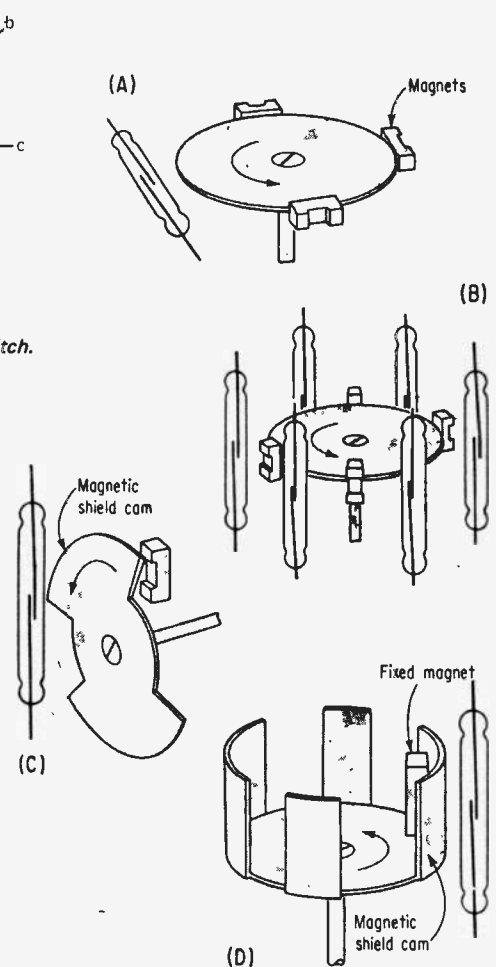

Fig. 7. Rotary motion may also be used to actuate a reed switch. In A and B the switches are stationary and the magnets rotate. In examples C and D both the switches and the magnets are stationary and the switch operates whenever the cutout portion of the magnetic shield is between magnet and switch.

The reed switch is functional and versatile. It is almost the simplest elemental form of switch and has innumerable applications — from straightforward functions in which switch actuation is initiated by the proximity of a permanent magnet — to complex logic and computing functions, using hundreds of electromagnetically driven reeds. This practical three-part article, by Collyn Rivers, explains how and why they are used.

## OPERATING LIFE

The operating life and load carrying characteristics of reed switches are interrelated. A switch may operate for 100 million or even 1000 million closures providing it is switching very

low currents. But the same type of switch may fail after half a dozen switching cycles if the load greatly exceeds the designed rating. The majority of reed switches are manufactured with contact ratings between 0.1A and 3.0A.

The current handling capacity of reed switches varies from type to type.

In general the rating will be determined by the size and surface plating of the reeds, for the reed is an

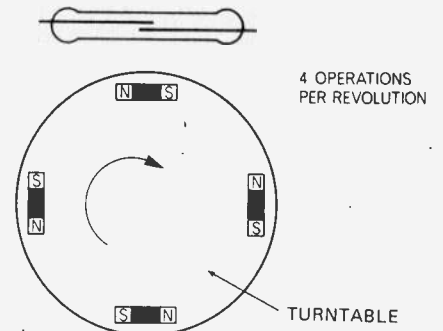
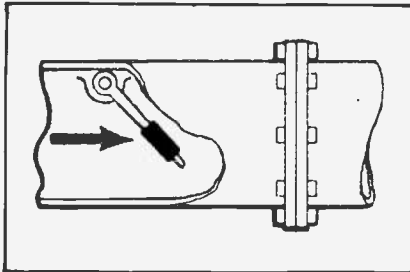
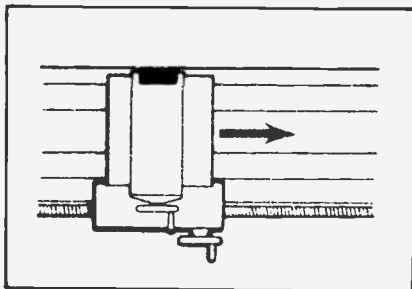

Fig. 8. Simple yet versatile impulse timer can be improvised by placing one or more magnets on a turntable.



Flow control and indication, minimizing restraint on the moving part and avoiding perforation of the container wall.



Position control and indication, obviating mechanical contact with its implications of wear, and simplifying mounting.

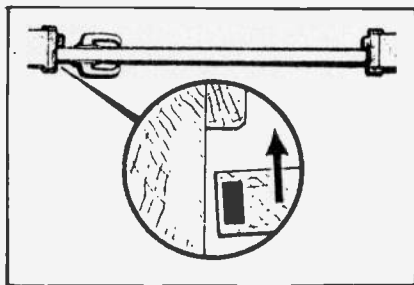

Door switches, obviating mounting and adjustment problems, and offering total concealment for security devices.

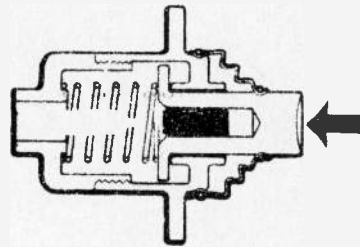

Switching in explosive atmospheres, obviating ignition risk; in dust filled atmospheres where conventional contacts would be unreliable; and in extremely cold conditions where ordinary switches would freeze up. In radioactive environments, magnetic operation can maintain integrity of shielding.

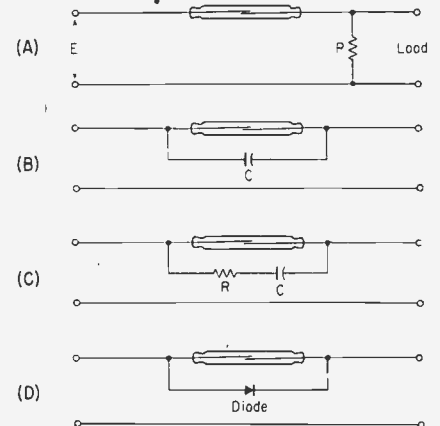
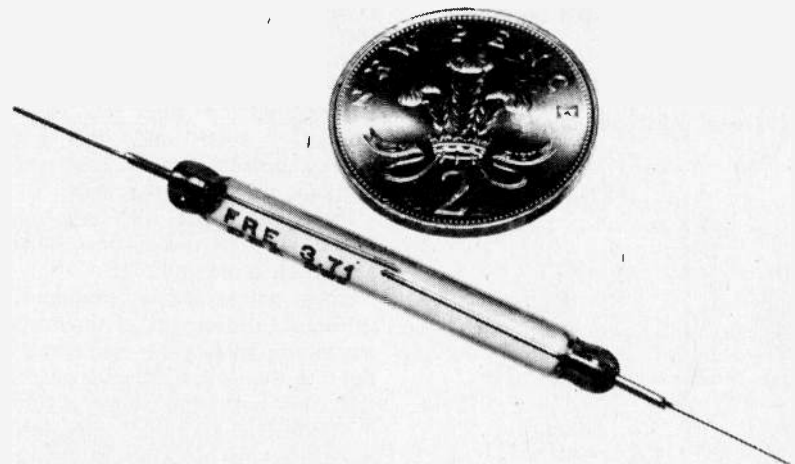

Fig. 9. Contact protection techniques: A — Resistor shunting load. B — Capacitor shunting contact. C — Resistor-capacitor series network for ac loads. D — Diode shunting.





# Practical Guide to Reed Switches Part 1

electrical conductor, and current rating will be a function of contact area.

The maximum rated contact loading is only applicable for purely resistive loads. If the load is capacitive or inductive the switch must either be drastically derated, or the switch contacts protected in a suitable fashion.

Four suitable methods of contact protection are shown in Fig.9.

In dc circuits all that may be required is a resistor shunted across the load (Fig.9A). Where the load is a relay coil or operating solenoid a resistor of approximately eight times the coil resistance is adequate to absorb a major portion of the induced energy when the circuit is interrupted. The addition of the resistor will of course increase the steady-state current flow but this extra load is negligible.

Another cheap and simple way to protect the reed switch is to wire a capacitor across the contacts. The required value depends upon load current, but something between 0.1 uf and 1.0 uf will be sufficient. (Fig.9B).

The most generally used method of protection is the resistor-capacitor series network shown in Fig. 9C. This circuit must be used if the switched load current is ac. The resistor should be approximately 160 ohms and the capacitor somewhere between 0.1 uf and 1.0 uf. That this is an extremely effective method was proven by a recent trial during which a motor starter was switched 50 million times without failure.

The component values may either be determined empirically (as described below) or mathematically. In the latter

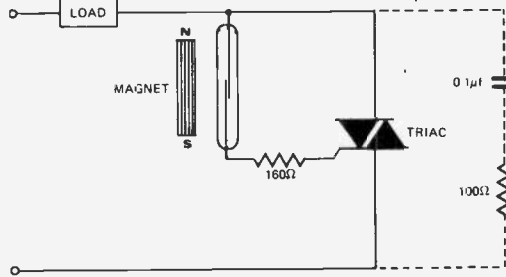

case, the component values can be obtained from —

$$C = \frac{I^2}{10} \mu F, R = \frac{E}{10 \times I(1 + \frac{5.0}{E})} \Omega$$

Where I is the closed circuit current in amps and E is the open circuit voltage in volts.

A fourth method of protection is to connect a diode across the switch contacts. (Fig.9D). This method is effective only with dc; diode polarity must of course be preserved.

Suitable protection circuits are often best determined empirically. One way is to connect the switch to the normal operating voltage and load, and then to actually observe the arcing across the reeds while the switch is in use.

## HEAVY CURRENT SWITCHING

There will be many applications in which a reed switch can usefully be used to switch very large currents. This can be done quite simply by combining a reed switch with a Triac. (Fig.10). Even miniature reed switches

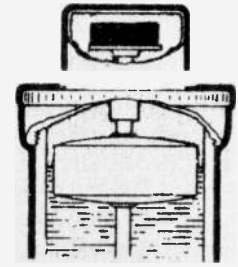

Hydraulic brake fluid level indicator, where feasibility depends on simplicity and ease of application.

Fig. 10. Reed switch/Triac combination may be used to switch single phase loads as high as 125 Amps. Components shown in dotted lines must be included if the load is reactive.

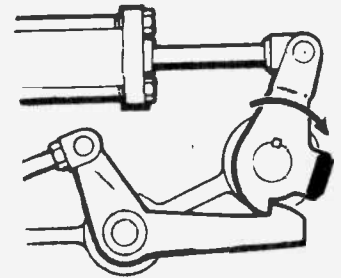

Safety interlock switching, giving extreme reliability and simplicity of application to complex mechanical layouts. Reed insert completes circuit to illuminate warning lamp or permit further stage of operation.

will safely carry the gate current required to trigger the largest Triacs, and by using this system it is possible to switch single phase loads of whatever Triac rating is used. Triacs can be readily obtained with ratings from 1 amp to 125 amps.

Three phase loads can also be switched by using the reed switch to energize a miniature three pole relay that in turn triggers a Triac in each of the phases of the supply.

## SWITCHING AT LOW LEVELS

One great advantage of the reed switch is its ability to operate reliably when switching currents and voltages at very low levels. This is a major problem with standard switches because there is insufficient energy to break down non-conducting films on the switch contacts. But a reed switch — due largely to its gold-plated contact surfaces and inert atmosphere — will perform satisfactorily for at least a billion operations.

### SPECIFICATIONS

Maximum voltage

### STANDARD

150 Vdc  
250 Vac

### MINIATURE

50 Vdc  
150 Vac

Maximum current

2.0A

0.5A

Maximum power

25W

6W

Max. initial resistance

50 m.ohms

100 m.ohms

Max. end-of-life resistance

2 ohms

2 ohms

Peak breakdown voltage

500 V

300 V

Closure rate

400 Hz

2000 Hz

Insulation resistance

5000 M.ohms

1000 M.ohms

Temperature range

-55°C to +150°C

-55°C to +150°C

Contact capacitance

1.5 pF

0.5 pF

Vibration

10G at 10-55Hz

10G at 10-55 Hz

Shock

15G minimum

15G minimum

Life at rated load

5 x 10<sup>6</sup> operations

5 x 10<sup>6</sup> operations

Life at zero load

500 x 10<sup>6</sup> operations

500 x 10<sup>6</sup> operations

Table 1. Typical specifications for standard and miniature reed switches.

# Practical Guide to Reed Switches Part 1

Some idea of the extraordinary reliability of reed switches was shown during a series of tests undertaken by the Bell Telephone Company in the USA. In one test four switches were operated at 120 closures a second carrying a load of 500 micro-volts, 100 microamps, dc. Each switch completed 50 million consecutive closures without a single instance of closed resistance exceeding 5 ohms.

particles are magnetic and collect in the air-gap. If these fragments become

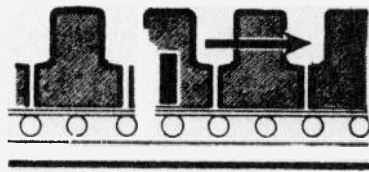

*Proximity counting, providing a very easy method of recording the passage of ferrous items past a point.*

numerous enough they intermittently bridge the gap and cause a

failure-to-open. It is also possible for these fragments to alter the closed contact resistance.

The most common cause of contact failure is the mechanical locking of a spike on one reed and a corresponding crater on the other. This type of failure is commonly called a 'weld' but it is not a weld in the true sense. The contacts are not joined by molten metal but are held by friction or interlocking, between the spike and the crater.

## NEXT MONTH

The second part of this article, which will be published next month, will describe applications in which reed switches are electrically energized. ●

## FAILURE

A reed switch rarely fails completely. As load currents are increased the contacts suffer the same form of contact erosion experienced in conventional switches. The resultant

# Promise her anything.. but give an ETI T-Shirt!



Our Canadian-made polyester-cotton T-shirts are awaiting your order. These are really top quality — not cheap foreign shirts that fade or shrink when you wash them. They're nice and long to stop draughts around the midriff. Colour scheme is blue with white design. (They are also available to people over the age of five.)

Fill out this coupon and send to ETI T-Shirts, Unit Six, 25 Overlea Blvd., Toronto, Ontario, M4H 1B1.

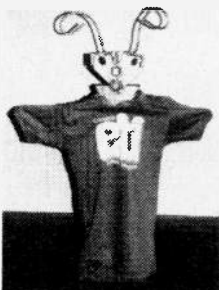

LARGE (40")

MEDIUM (37")

SMALL (34")

Number required

Number required

Number required

Please send me \_\_\_\_\_ ETI T-Shirts, sizes as indicated. I enclose \$\_\_\_\_\_.

Number of Shirts	1	2	3	4	5	Ontario Residents add
Price	\$5.50	\$10.00	\$15.00	\$20.00	\$25.00	Provincial Sales Tax

Name \_\_\_\_\_

Address \_\_\_\_\_

Town \_\_\_\_\_ Prov. \_\_\_\_\_ Postal Code \_\_\_\_\_

**DO NOT SEND CASH**

Cheque enclosed. A/C No. \_\_\_\_\_

Bill Mastercharge. Signature \_\_\_\_\_

Bill Chargex. Expiry Date \_\_\_\_\_

# Brains and Computers

---

Man is just a machine, or is he? Is his brain the ultimate mechanism or could it be improved by bio-engineering techniques? How can we develop artificial intelligence to match the abilities of our own brains and what do we have to learn from it? By S. Mc Clelland.

---

EVEN IF THE HUMAN BRAIN is regarded as being a digital computer it must be considered to be far more complex than anything man can devise — or is likely to devise in the foreseeable future. In a volume of tissue far less than that of a football it packs some  $10^{10}$  (that's 10 000 000 000) active elements, the nerve cells. In computer terms, its capacity to store information must run onto the 10 thousand megabit range *at least*.

Its organisation matches its abilities — on average in a normal human being it's been estimated that 1 nerve cell dies every 10 seconds throughout our lives. It is never replaced, for brain cells alone in the body cannot reproduce, and yet we never notice the loss since the brain is so well organised that many of its circuits are redundant and can be replaced by alternative channels should they fail — this has been the case even after serious injuries have been inflicted on the brain.

How much power does all this require? It's enough to make an engineer cringe — a meagre few watts!

What about the brain's higher capabilities — such as its capacity for inventiveness or 'original' thought? What was special about Mozart's brain circuits that enabled him to start composing music before he was 5 years old, or in Leonardo da Vinci's case, to design flying machines 500 years ahead of his time?

Sadly as yet we have no idea since so little is known about the brain!

## INPUTS AND OUTPUTS

All this uncertainty has not stopped a growing number of systems engineers and scientists from looking at the brain's organisation and operation (possibly with the idea of wanting to copy techniques in future systems!).

We can certainly find some aspects of central nervous system operation in common with computers. Both systems have of course what might be loosely termed 'input' and 'output' peripherals, for example. In the case of the brain the inputs are from the senses of the body, not only the primary ones of sight, hearing, smell and taste but also from many thousand of receptors near the surface of the body for various parameters such as temperatures and pressure.

Its outputs go to activate all the muscles in the body. This flow of information demands an enormous number of nerve fibres to convey it — up to a million nerve fibres are estimated to be associated with each major limb alone.

All of this of course prompts the question: "How does this information transfer take place?" To understand this we have to look at the most basic component of the whole system — the nerve cell itself.

## NEURONS

If we could remove a typical nerve cell from our bodies and look at it under a high power microscope, it would look something like Fig 1. Remember, this cell is probably only a few micrometres in diameter so what we're about to describe is a microscopic system-within-a-system.

The cell picks up signals from the other cells in its vicinity and these are fed down to the main part of the cell (containing the nucleus) and propagated along the long transmitter branch (axon) to the next cell.

It's along the inside of these long membranous

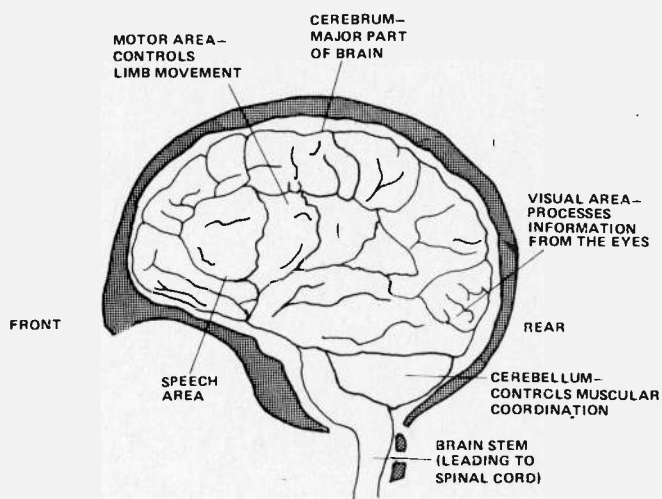

*This is what your CPU looks like with the cover off. Note the I/O bus at the bottom (not S-100). The power supply connections have been omitted for clarity. The case is of a sturdy polymeric material and the main PCB fits it nicely.*

branches that the electric impulses (or action potentials) are transmitted by the nerve.

The axon is no mere passive wire, however. If it was, the signals would soon be drastically attenuated by the leakage of the membrane to the outside after a very short travel. The cell membrane instead acts as its own signal booster to maintain the impulse at constant amplitude (about 100 mV) at any point on the axon. The action potential is either there or it isn't — there is no in-between state. A digital system? Perhaps. In fact, it's the frequency at which the action potentials are signalled that carries the information. We can now see why so many nerve fibres are needed to carry information. Each cell — and probably many others for the sake of redundancy — carries one 'bit' of information. The importance of this information depends on the frequency it is being signalled and it is likely that a high frequency signal establishes a higher priority than a lower frequency signal in a particular context — rather like signalling an 'interrupt' in a computer system.

Simple as it is, a frequency-dependent system carries its own problems. The sense organs must make amplitude-to-frequency code conversions for transmission down the fibre and at the other end, the brain must find a way of coping with a frequency-dependent signal.

A secondary point is that all the nerve cells concerned with a particular function or sub-function work in parallel. The advantages of parallel processing are fairly evident. It's faster than serial and has a higher signal-to-noise ratio (even if it does need more channels).

So we can visualise action potentials — small spikes of voltage — being flicked up and down all the nerve fibres in the body at varying frequency, but not nearly as fast as electrical impulses through cables. However, even in this, nature squeezes all the performance it can out of the human nervous system. Each nerve cell is wrapped in several layers of fatty tissue with 'nicks'

or 'breaks' in the fat at intervals along the axon. The effect of these 'breaks' or 'nodes of Ranvier' as they are known is to increase the speed of transmission of the action potentials down the nerve axon to about 100 metres per second.

## DELAYING TACTICS AND LOGIC GATES

If neurons propagate the action potentials, then it's the junctions between neurons (synapses) that route them. It's the synapses which work out if the incoming signals are of the right type and frequency to trigger the following cell to produce an action potential. From the point of view of the system, the synapses are the delay lines, one-way valves, triggers and gates all rolled into one.

It takes an electron microscope to even see the synapse regions and even then they don't look very special — they're merely bulbous terminations where nerve cells meet each other. Except that they don't meet each other — they're always separated by the absolutely microscopic distance of about 200 Å — so the action potential never gets across even the gap, let alone down the other side.

What actually crosses the gap is not the electric signal itself but very small quantities of hormones which are released from the transmitter bulb. The hormone crosses to the receptor membrane where (by a process that's not fully understood) it causes the generation of another action potential. Even across so small a gap the chemical transmission takes a finite time and is susceptible to interference by foreign chemicals (drug addicts please note — your synapse may be switched off!).

Some synapses, instead of generating an action potential in the receptor membrane actually inhibit it from doing so — so we've found the on-off switches for the nervous system. Can we identify Boolean logic gating arrangements in the nervous system? It's possible to speculate in those terms and certainly the basic mechanisms seem to be there, but unfortunately not enough is known about even simple neuron groups to permit an answer to this question.

## DON'T BELIEVE YOUR EYES!

The nervous system can do some very sophisticated things to the input signals it receives by way of data processing. It can, for example, selectively inhibit the triggering of neurons that carry no useful information in favour of ones that do.

This so-called 'lateral inhibition' not only cleans up potentially noisy channels by making them more 'contrasty' but in some animals is known to help the eye resolve very efficiently the boundaries between dark and light edges in an image. It probably occurs in the human nervous system as well where it is thought to give rise to some of the more common optical illusions as a by-product.

So much processing sophistication backing up the senses means that the brain can work on far less sensory information than it usually gets. For example, the brain really only requires a few per cent of the data it receives from the eyes in order to form a valid judgement as to the nature of the image. The same applies to the ear — speech has to be very badly distorted before the brain cannot recognise it. There is obviously a very close and

complex interaction between the senses and the memory, which is continually generating possible 'best-fit' models to match the latest information received. Each model is discarded until the brain is satisfied with the result.

Our senses show a fantastic sensitivity to the world around us — we *can* hear a pin drop in a quiet room. More staggering still, the vibration amplitude of the ear drum which the minimum audible sound creates is less than *the diameter of one hydrogen atom . . . !*

## DOWN MEMORY LANE

Digital computers have clearly-defined memory locations which are usually addressed under the control of a clocked pointer in the system. The human brain on the other hand seems to have no all-powerful organ of memory — attempts to find one have so far proved inconclusive. Rather, memory is a property of the system as a whole.

Secondly, data storage on a computer tape or disc is permanent until deliberately erased but information flow through the brain is far more dynamic and its retention more selective. Information floods into our brains from our senses at every living moment. Seen in this light it is neither desirable nor even possible to store it all. 'Store only the information that is important' the brain says to itself — but what is counted as being important?

Basically, we pick out the information about the *changes* in our environment, because it's the changes in it which may be threatening our immediate survival.

On a motivated level, we can store items deliberately. We remember by repetition (e.g. a telephone number). Most importantly we store information which is associated with something which has caused us great pain or pleasure in the past. How do we recall information once stored? It's clear that association plays a critical role. After all, we store not isolated events but connected ones — 'trains of thought' if you like. The memories are recalled when the right key of stimulus is provided. This stimulus may well be a piece of information associated with the group.

For example, the question "What do you remember about November 22nd 1963?" would probably elicit a blank reply from most people until (as various commentators have pointed out) that they are told its the day when the President John F. Kennedy was assassinated. Many people can recall where they were or what they were doing — it's a memory that persists over 15 years because it is associated with such a traumatic incident.

In this way we can visualise the human memory almost as 'conglomerates' of memories — pieces of information tied together in some fashion only requiring the right input trigger to push it all out.

Some very intriguing hypothesis about how the memory operates have been suggested. One exciting and topical suggestion is that it records information as a hologram records 3-D images in laser light. A particular part of the image is not localised to a particular part of the hologram — in fact even a fragment of the hologram can theoretically recreate the entire image, a property which makes it very similar to the brain.

We must wait for more basic information on the brain to confirm or disprove this.

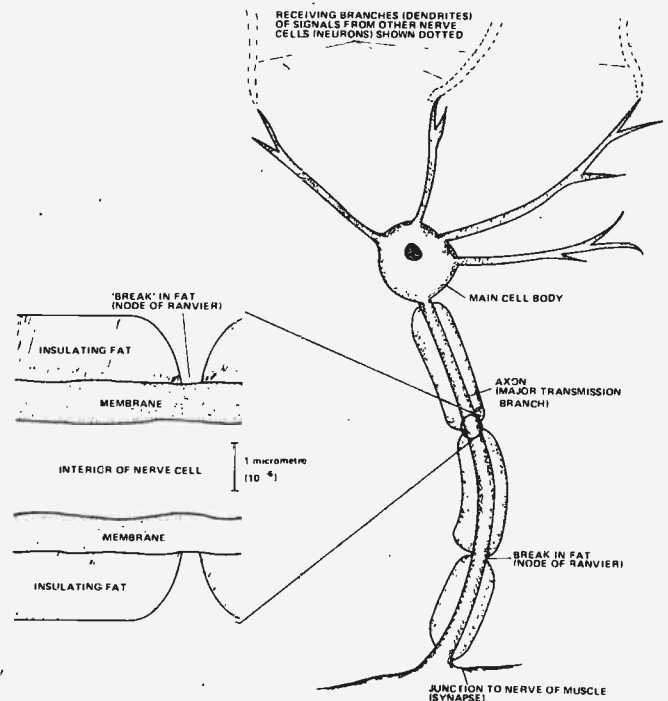

Figure 1: What a nerve! A typical nerve cell examined.

## TUNING INTO BRAIN WAVES

We can get some idea of what all this electrical activity is like by strapping electrodes — connected to a sensitive amplifier and chart recorder — to the skull.

We will obtain a rather confusing output of signals — referred to as an *electroencephalogram* or EEG. The EEG is usually a very weak signal — a few tens of  $\mu\text{V}$  amplitude at a range of frequencies mostly under 30 Hz, although higher frequency components are present.

The most well-known component of the EEG is the  $\alpha$ -wave. Present in about 90% of all individuals, this signal (with a frequency between 8 Hz and 13 Hz) is at its most active when the subject is relaxed and his eyes closed. It disappears as soon as the subject opens his eyes or starts to concentrate on something like mental arithmetic.

What does it mean? Basically, we don't know. Nor do we know where or how it's generated, although its source (there may be more than one) *seems* to be located to the upper rear of the brain. Correspondingly little is known about the other EEG components.

Although the EEG doesn't give a great deal of information about the working of the brain (indeed we'll probably have to wait until further studies of the brain explain the EEG!), it has found great use in diagnosis of brain disorders such as epilepsy. But could the EEG have a more fundamental significance than that? My own pure piece of speculation — for what it's worth — is that it's the brain's clock, although it's too low in frequency to cope with many of the fast muscular actions of the body. Even so the 'ticking' of a brain might have a biological significance similar to a digital system's 'clock frequency'!

**FURTHER READING:** For those who would like to read more fully about the brain, Professor Steven Rose's book "The Conscious Brain" (Penguin paperback offers a very readable account.



# Op Amps: Part 3

Op Amps are some of the most useful devices since the wheel was discovered. Our series of handy circuits continues . . .

## SIMPLE MUSICAL ENVELOPE GENERATOR

A simple generator can be constructed using the CA3080 (made by RCA). This circuit will also enable the use of an audio waveform the harmonic structure of which will not be significantly affected as it is modulated. The CA3080 is an op amp with a difference. It has a current output and an extra input into which a current,  $I_A$  is fed. The output is the product of the input voltage  $X I_A$ . Thus the  $I_A$  can be used to control the amplifier's gain.

The input voltage range for low distortion operation is very low, of the order of  $\pm 25$  mV.

The CA3080 is being used as a two-quadrant multiplier. A small voltage, ( $\pm 25$  mV), is applied to its non-inverting input. When the switch S1 is closed, the capacitor C is charged up and a current of about  $150 \mu\text{A}$  flows into the  $I_A$  input terminal. When S1 is opened, C discharges through the  $150 \text{ k}$  resistor into the  $I_A$  input. This current dies away exponentially. As the output is the product of the input voltage  $X I_A$ , then

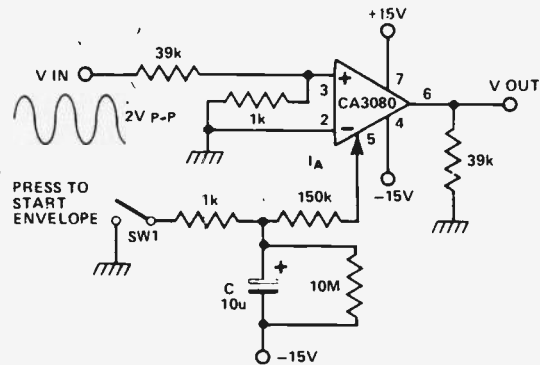

an exponential envelope is generated. Breakthrough after the decay is very good, better than  $-80$  dB.

## VARIABLE MARK-SPACE SQUARE WAVE GENERATOR WITH AUTOMATIC LEVEL ADJUST

By putting a triangle wave into one input of a comparator and a manually controlled DC level into the other, it is possible to generate a variable ratio mark/space square wave. However, if the amplitude of the triangle varies then so will the markspace ratio. Alternatively, if you want the manual control to produce a very thin waveform at one end of its travel, then you will probably need a preset and a very stable triangle amplitude. However this circuit solves these problems. The DC voltage is generated by a peak voltage follower, IC1, driven by the triangle itself. Thus the circuit tracks the peak voltage level. secondly, only 97% of this voltage is ever fed to the comparator, IC2, and so at the end of the markspace pot, a 60:1 ratio pulse train is generated. At the other end of the pot the ratio is 1:1. A 748 is used as the comparator because it has more bandwidth than the 741. As the frequency of the triangle increases, it may be necessary to use an even faster op-amp for IC2, or even a comparator.

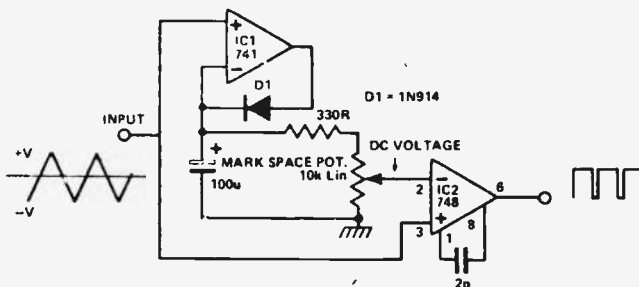

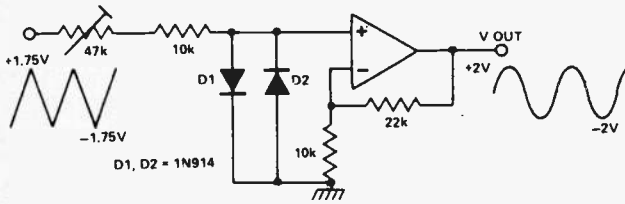

## SIMPLE TRIANGLE TO SINEWAVE CONVERTER

Here is a simple way of converting a triangle to a sinewave. The logarithmic characteristic of the diodes is used to approximate that of a sine curve. Distortion is 5% or so. However, the distortion may be tolerable if the sinewave is only used to generate audio tones.

## NOISE GENERATOR

The zener breakdown of a transistor junction is used in many circuits as a noise generator. The breakdown mechanism is random and so generates a small noise voltage. Also this voltage has a high source impedance. By using the op-amp as a high input impedance, high ac gain amplifier, a low impedance, large signal noise source is obtained. The preset is used to set the noise level by varying the gain from 40 to 20 dB.

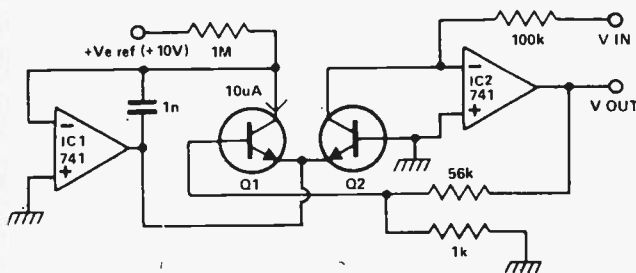
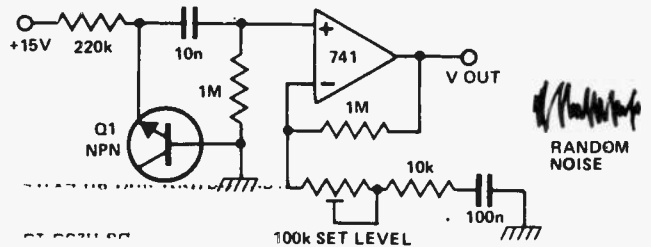

## LOGARITHMIC VOLTAGE TO VOLTAGE CONVERTER

The output voltage is logarithmically proportional to the input voltage. The difference between this circuit and the following is that the exponentiator is in the feedback loop of the op-amp and hence the mathematical function has been inverted. The circuit is useful for performing true logarithmic compression or for converting linear inputs into dBs.

## EXPONENTIAL VOLTAGE TO CURRENT/VOLTAGE CONVERTER

The circuit shown converts a linear input voltage into an exponential current or voltage. This type of circuit is used in music synthesizers to change linear control voltages into musical intervals. That is, if the circuit were used to control an oscillator, input increments of 1 V would change the pitch by one octave. The exponential characteristics of a transistor are employed to generate the correct transfer function. Q1 and Q2 are matched pairs of transistors, preferably a transistor dual. IC1 maintains Q1 at a constant current. Thus, the op-amp serves only to bias the emitter of the second transistor Q2 into a suitable operating region. The purpose of Q1 is to generate this bias voltage. The base emitter junction of a transistor

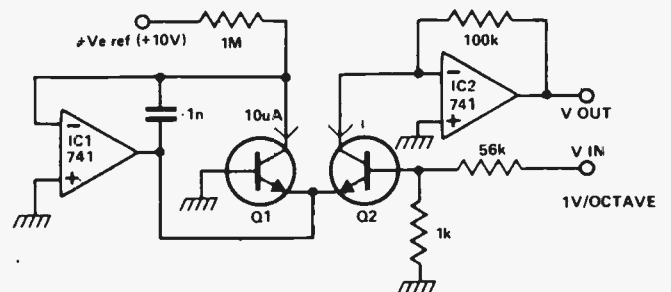

has a high temperature coefficient ( $-1.9 \text{ mV}/^\circ\text{C}$ ) and so the reason for using a matched pair is to use the first transistor, Q1, to provide temperature compensation for the second.

# Op Amps: Part 3

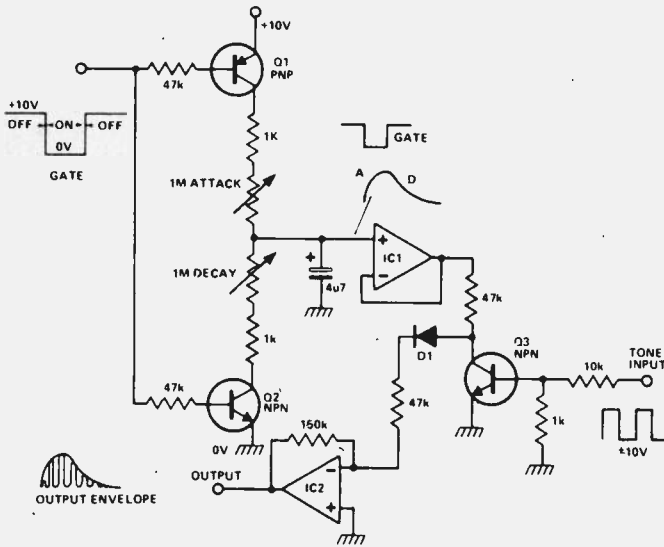

## MUSICAL ENVELOPE GENERATOR AND MODULATOR

A gate voltage is applied to initiate the proceedings. When the gate voltage is in the ON state, Q1 is turned on, and so the capacitor C is charged up via the attack pot in series with the 1 k resistor. By varying this pot, the attack time constant can be manipulated. A fast attack gives a percussive sound, a slow attack the effect of 'backward' sounds. When the gate voltage returns to its off state, Q2 is turned on and the capacitor is then discharged via the decay pot and the other 1 k resistor, to ground. Thus the decay time constant of the envelope is also variable.

This envelope is buffered by IC1, a high impedance voltage follower and applied to Q3 which is being used as a transistor chopper. A musical tone in the form of a squarewave is connected to the base of Q3. This turns the transistor on or off and thus the envelope is chopped up at regular intervals, the intervals being determined by the pitch of the squarewave.

The resultant waveform has the amplitude of the envelope and the harmonic structure of the squarewave. IC2 is used as a virtual earth amplifier to buffer the signal and D1 ensures that the envelope dies away at the end of a note.

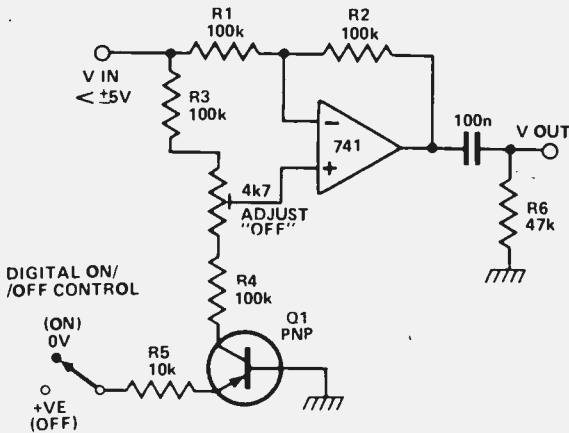

## TRANSISTOR USED TO TURN AN OP AMP ON OR OFF

When transistor Q1 is switched off, the circuit behaves as a voltage follower. By applying a positive voltage to the emitter of Q1 via a 10 k resistor, the transistor is made to turn on and go into saturation. Thus the lower end of R4 is shorted to ground. The circuit has now changed into that of a differential amplifier (see fig. 7), but where the voltage difference is always 0 V. Now as long as the resistors in the two branches around the op amp are in the same ratio then there should be zero output. A 4k7 preset is used to null out any ratio errors so that the 'OFF' attenuation is more than 60 dB. The high common mode rejection ratio of a 741 enables this large attenuation to be obtained.

## FAST SYMMETRICAL ZENER CLAMPING

There are several problems with using zeners, back to back in series to get symmetrical clamping, the knee of the zener characteristics is rather sloppy, charge storage in the zeners causes speed problems and the zeners will have slightly different knee voltages so the symmetry will not be all that good! This circuit overcomes these problems. By putting the zener inside a diode bridge the same zener voltage is always experienced. The voltage errors due to the diodes are much smaller than those due to the zener. Also the charge storage of the bridge is much less. Lastly by biasing the zener on all the time, the knee appears to be much sharper.

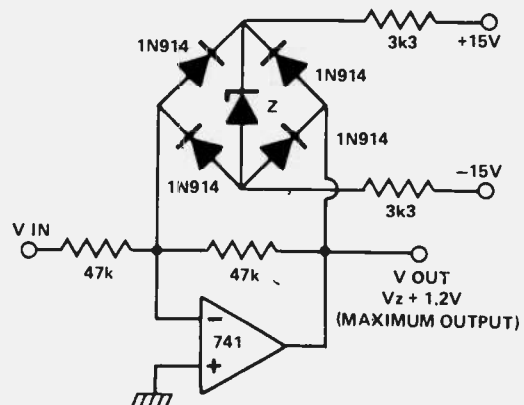

# NEW LOW COST LX303 DMM

## \$99.95



Operates up to 200 hours on a single 9 volt battery. 100 mV DC f.s. sensitivity. Features auto zero, polarity, overrange indication. Nineteen ranges and functions. With easy-to-read 1/2" LCD display for convenient use in any kind of light. Removeable cover stores test lead set furnished as part of the unit. Excellent overload protection. Colour coded panel. Carries a full one year warranty. Available accessories include 10 kV probe/adaptor, 40 kV probe, 10 amp DC shunt, AC adapter and deluxe padded vinyl carrying case.

### SPECIFICATIONS:

DC VOLTS (5 RANGES): 0.1 mV to 1000V; Accuracy  $\pm 0.5\%$  rdg  $\pm 0.5\%$  f.s.; Input imped: 10M ohm; Max. input 1kV except 500V on 200mV range. AC VOLTS (40Hz to 5kHz): 0.1V to 600V; Accuracy:  $\pm 1.0\%$  rdg  $\pm 0.5\%$  f.s. (-2db max. at 5kHz); Max. input: 600V.

RESISTANCE (6 LOW POWER RANGES): 0.1 ohm to 20M ohm; Accuracy:  $\pm 0.5\%$  rdg  $\pm 0.5\%$  f.s. ( $\pm 1.5\%$  rdg on 20M ohm range); input protected to 120 VAC all ranges.

DC CURRENT (6 RANGES): .01nA to 100mA; Accuracy:  $\pm 1.0\%$  rdg  $\pm 0.5\%$  f.s.

### DIMENSIONS AND WEIGHT:

5-7/8" x 3-3/8" x 1-3/4", 8 oz.; POWER: 9V battery (not included) or Hickok AC adapter; READ RATE: 3/sec.

**HICKOK**  
the value innovator

Duty and FST included.  
Chargex (Visa) accepted.  
Ont. res. add 7% sales tax  
F.O.B. Ajax.

**H ROGERS** electronic instruments Ltd.  
P.O. Box 310, 595 Mackenzie Avenue Units 1 & 2.  
Ajax, Ontario L1S 3C5. Tel. (416) 683-4211

# MORE CIRCUITS

\$4.50 Useful design ideas

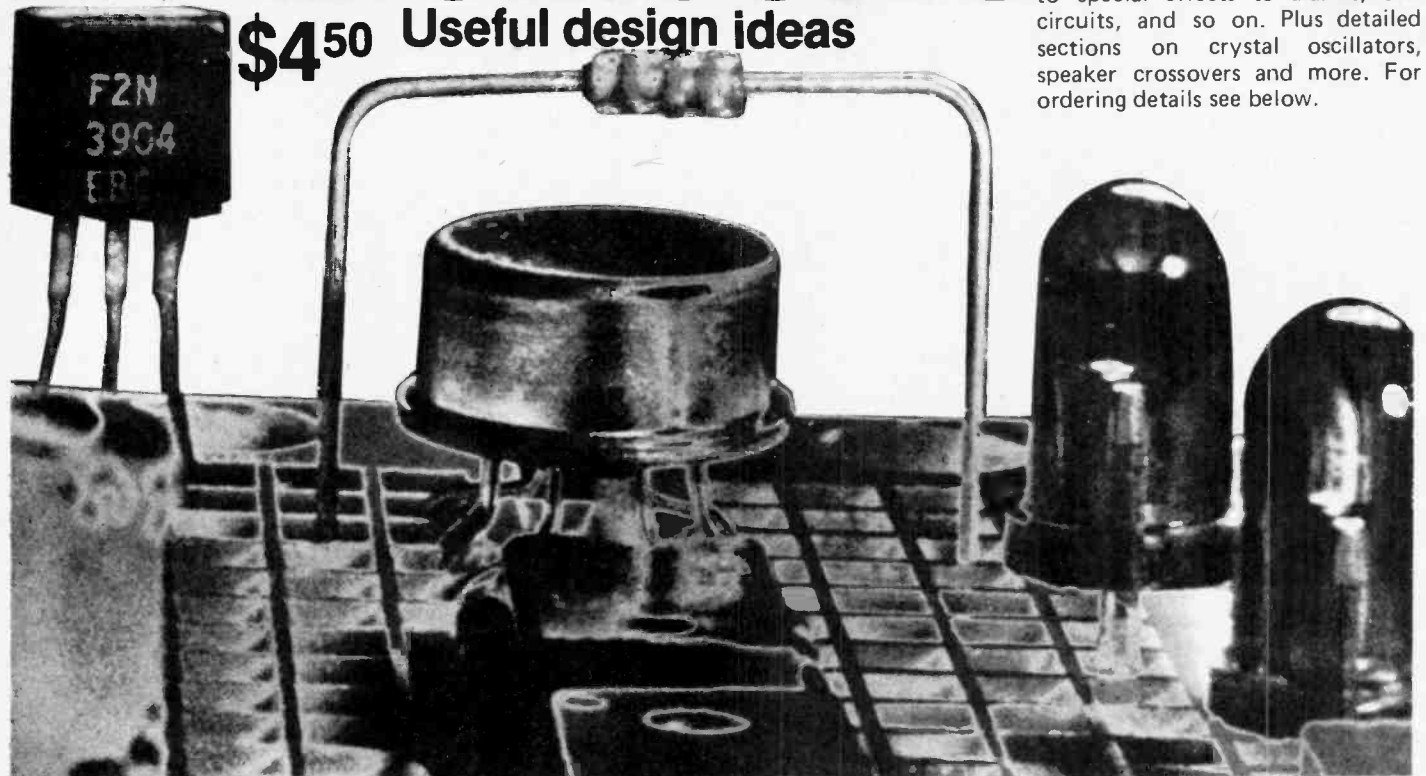

Circuits to get you thinking how to solve your special tasks, or just for fun. From power controls to special effects to alarms, test circuits, and so on. Plus detailed sections on crystal oscillators, speaker crossovers and more. For ordering details see below.

Obtain yours now from us directly by using the order card in this issue, or by mailing \$4.50 + 45c for postage and handling to MORE CIRCUITS, Electronics Today Magazine, Unit 6, 25 Overlea Blvd, Toronto, Ontario, M4H 1B1. Or if your local magazine shop has ET1 regularly, they'll be getting MORE CIRCUITS too.

# Bingo!

Let your TI59 call the numbers, so you can win! From Donald Lessard.

THIS PROGRAM is written for the TI 59 with or without the PC-100A printer. It works like real bingo. The number (chosen at random) drawn is printed or displayed. It can be chosen only one time in a game. The seed number determines the numbers drawn, which means that you can have 199017 different games of bingo.

After you load the memories (you need 90 memories to run the program. That's why it is suitable for TI 59 owners) and enter a seed number, pressing R/S causes the calculator to print or display a number. Each time you press R/S another number is printed or displayed. And each time the contents of the memories where this number was kept is replaced by 0. That's why when you want the list of all the numbers not drawn, the calculator prints or displays only the numbers which are in memory.

This program can be played without the printer. The changes you have to

make are: 1) load the memories with numbers from 1 to 75 starting at memory 12 which will be loaded with 1, memory 13 with 2 etc. 2) Key in the program without the printer. 3) All the operations are the same. Naturally you won't have the letters printed, so you will have to know that numbers 1 to 15 are for the letter B, 16 to 30 for letter I, etc. 4) You can have a list of the numbers not drawn. The calculator, after pressing B, will flash for about 2 seconds each number not taken.

Naturally, each time you want to play another game, you have to reload the memories. This is easy with the TI 59 because you've recorded the program and the memory contents on two magnetic cards. You have to remember that the calculator must be partitioned in 90 memories. So before reading or recording the calculator, you have to press 9 of 17.

## EXECUTION

- 1) Key in: 9 of 17. Display: 239.89
- 2) Key in the numbers to be put in memories 12 to 86.
- 3) Key in "Learn": Enter the program: Key in "Learn" to exit.
- 4) Now you can record the program and the content of the memories on two magnetic cards by pressing: 1 SND WRITE and 2 SND WRITE on one card and 3 SND WRITE and 4 SND WRITE on the other card.
- 5) Enter seed number ( $0 \leq \text{SEED} \leq 199017$ ) by pressing "A": display: 0.
- 6) Press "R/S" each time you want a new number. With the printer: The number will be printed and the display: 0.
- 6) Press "R/S" each time you want a new number. With the printer: The number will be printed and the display will show how many numbers

fig.2. If you don't own a printer then try this version.

```

000 91 R/S      041 01 1      080 36 PGM
001 36 PGM    042 44 SUM    081 15 15
002 15 15    043 88 88    082 12 B
003 13 C      044 00 0      083 01 1
004 42 STD    045 32 X:IT  084 04 4
005 88 88    046 73 RC+    085 02 2
006 00 0     047 88 88    086 04 4
007 32 X:IT  048 67 EQ    087 03 3
008 73 RC+   049 00 0    088 01 1
009 88 88    050 41 41    089 69 DP
010 87 EQ    051 69 DP    090 02 02
011 00 00    052 02 02    091 02 2
012 01 01    053 69 DP    092 02 2
013 69 DP    054 05 05    093 03 3
014 00 00    055 97 DSZ    094 02 2
015 69 DP    056 00 00    095 00 0
016 02 02    057 00 00    096 00 0
017 69 DP    058 41 41    097 00 0
018 05 05    059 00 0      098 00 0
019 69 DP    060 81 RST    099 00 0
020 28 28    061 76 LBL    100 00 0
021 00 0     062 11 A      101 69 DP
022 72 ST*   063 42 STD    102 03 03
023 88 88    064 87 87    103 69 DP
024 43 RCL   065 36 PGM    104 05 05
025 08 08    066 15 15    105 00 0
026 81 RST   067 10 E*    106 98 ADV
027 76 LBL   068 43 RCL    107 81 RST
028 12 B     069 87 87
029 07 7     070 36 PGM
030 05 5     071 15 15
031 75 -     072 15 E
032 43 RCL   073 01 1
033 08 08    074 02 2
034 95 =     075 36 PGM
035 42 STD   076 15 15
036 00 00    077 11 A
037 01 1     078 08 8
038 01 1     079 07 7
039 42 STD
040 88 88

```

fig.1. Bingo program for use with PC100A printer.

```

000 91 R/S      042 36 PGM
001 36 PGM    043 15 15
002 15 15    044 12 B
003 13 C      045 00 0
004 42 STD    046 81 RST
005 88 88    047 76 LBL
006 00 0     048 12 B
007 32 X:IT  049 07 7
008 73 RC+   050 05 5
009 88 88    051 75 -
010 87 EQ    052 43 RCL
011 00 00    053 08 08
012 01 01    054 95 =
013 42 STD   055 42 STD
014 87 87    056 00 00
015 69 DP    057 01 1
016 28 28    058 01 1
017 00 0     059 42 STD
018 72 ST*   060 88 88
019 88 88    061 01 1
020 43 RCL   062 44 SUM
021 87 87    063 88 88
022 81 RST   064 00 0
023 76 LBL   065 32 X:IT
024 11 A     066 73 RC+
025 42 STD   067 88 88
026 87 87    068 67 EQ
027 36 PGM   069 00 00
028 15 15    070 61 61
029 10 E*    071 66 PAU
030 43 RCL   072 66 PAU
031 87 87    073 97 DSZ
032 36 PGM   074 00 00
033 15 15    075 00 00
034 15 E     076 61 61
035 01 1     077 81 RST
036 02 2
037 36 PGM
038 15 15
039 11 A
040 08 8
041 07 7

```

```

14000200.    12 31000502.    52
14000300.    13 31000503.    53
14000400.    14 31000504.    54
14000500.    15 31000505.    55
14000600.    16 31000506.    56
14000700.    17 22000507.    57
14001000.    18 22000510.    58
14001100.    19 22000511.    59
14001200.    20 22000512.    60
1400201.     21 22000601.    61
1400202.     22 22000602.    62
1400203.     23 22000603.    63
1400204.     24 22000604.    64
1400205.     25 22000605.    65
1400206.     26 22000606.    66
2400207.     27 22000607.    67
2400210.     28 22000610.    68
2400211.     29 22000611.    69
2400212.     30 22000612.    70
2400301.     31 32000701.    71
2400302.     32 32000702.    72
2400303.     33 32000703.    73
2400304.     34 32000704.    74
2400305.     35 32000705.    75
2400306.     36 32000706.    76
2400307.     37 32000707.    77
2400310.     38 32000710.    78
2400311.     39 32000711.    79
2400312.     40 32000712.    80
2400401.     41 32001001.    81
31000402.     42 32001002.    82
31000403.     43 32001003.    83
31000404.     44 32001004.    84
31000405.     45 32001005.    85
31000406.     46 32001006.    86
31000407.     47 0.          87
31000410.     48 0.          88
31000411.     49 0.          89
31000412.     50
31000501.     51

```

fig.3. Memory initializations required before running. Store this on cards.



## FLOW CHART

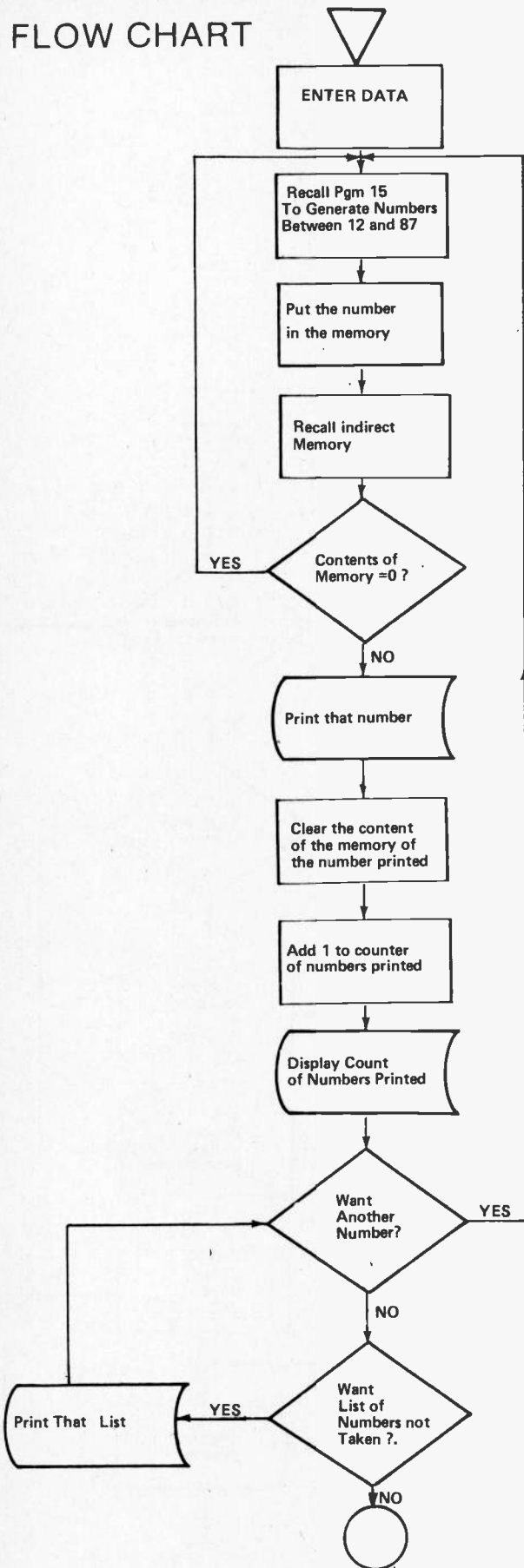

fig.4. Sample game (with seed number 123), first 42 numbers drawn. b) remaining numbers available. c) what memory looks like during a game.

### a) BINGO

N 39  
I 30  
I 17  
N 34  
G 60  
G 54  
N 32  
G 59  
B 3  
O 66  
O 65  
I 24  
N 36  
N 44  
I 21  
B 13  
O 61  
O 62  
I 16  
I 25  
N 31  
O 68  
G 57  
I 18  
B 4  
B 7  
G 53  
G 58  
G 55  
B 6  
O 75  
G 50  
B 9  
G 51  
B 15  
B 8  
N 45  
O 73  
B 13  
B 5  
G 46  
N 35

b) B 1  
B 2  
B 11  
B 12  
B 14  
I 19  
I 20  
I 22  
I 23  
I 26  
I 27  
I 28  
I 29  
N 33  
N 37  
N 38  
N 40  
N 41  
N 42  
N 43  
G 47  
G 48  
G 49  
G 52  
G 56  
O 63  
O 64  
O 67  
O 69  
O 70  
O 71  
O 72  
O 74

c)	14000200.	12	0.	50
	14000300.	13	31000501.	51
		14	31000502.	52
		15	31000503.	53
		16	31000504.	54
		17	0.	55
		18	0.	56
		19	0.	57
		20	22000510.	58
		21	22000511.	59
	14000202.	22	22000512.	60
	14000203.	23	0.	61
		24	0.	62
	14000205.	25	22000603.	63
		26	0.	64
		27	0.	65
		28	0.	66
		29	22000607.	67
	24000212.	30	0.	68
	24000301.	31	0.	69
		32	0.	70
	24000303.	33	0.	71
	24000304.	34	0.	72
		35	0.	73
		36	32000704.	74
	24000307.	37	32000705.	75
	24000310.	38	0.	76
	24000311.	39	0.	77
	24000312.	40	32000710.	78
		41	0.	79
		42	32000712.	80
		43	32001001.	81
		44	32001002.	82
		45	32001003.	83
		46	0.	84
		47	32001005.	85
	31000410.	48	0.	86
	31000411.	49		

## FLOW CHART SYMBOLS

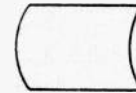

Information Output

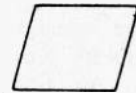

Data to be Input

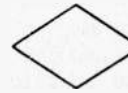

Branch

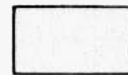

Operations



Program Entry Point



End

# Ohm's Law Made Foolproof

Programmable number crunching of this fundamental equation. By Rob Ings.

THIS PROGRAM is especially useful for those people who are not yet comfortable with Ohm's Law, or for those who have a lot of network problems to solve. In either case this program will take the values you have and return the unknown variable.

Known numerical variables are loaded into memory before execution, the unknown variable being assigned a value of zero. By a series of tests for zero the program determines which is the unknown and then performs the proper calculation. The final result is displayed (the idea of identifying an unknown by assigning it a zero is very useful for general purpose programs).

You might want to modify the input format of this program. Try for instance, assigning labels for each of the variables, or have the program call for the values when it is running.

The program listing given was written for a TI 57, but it can be adapted with very little difficulty to any of the TI programmables. Of course the fundamental algorithm can be applied to any programmable calculator.

**ERRATA:** In our May issue, the Trig In Feet, Inches and Fractions program has an error in it. After step 135, insert a CLR instruction after the STO 2 instruction.

In the June issue readers may be surprised to see half a program. That's because we couldn't decide whether to put it in or not, and in the end there was an accidental compromise! Readers wishing a copy of the entire program may write in for the whole thing, please enclose a stamped, self addressed envelope.

All programs we publish will be paid for.

Mail to: ETI Softspot  
Unit 6, 25 Overlea Blvd.,  
TORONTO, Ontario  
M4H 1B1

00	33	1	RCL 1
01	22		X<->t
02	15		CLR
03	33	6	RCL 6
04	66		2nd X=t
05	51	1	GTO 1
06	33	2	RCL 2
07	22		X<->t
08	15		CLR
09	33	6	RCL 6
10	66		2nd X=t
11	51	2	GTO 2
12	33	1	RCL 1
13	55		x
14	33	2	RCL 2
15	85		=
16	81		R/S
17	86	1	2nd Lbl.1
18	33	3	RCL 3
19	45		÷
20	33	2	RCL 2
21	85		=
22	81		R/S
23	86	2	2nd Lbl.2
24	33	3	RCL 3
25	45		÷
26	33	1	RCL 1
27	85		=
28	81		R/S

RCL 1 'resistance'  
RCL 2 'amperage'  
RCL 3 'volts'

## EXECUTION

eg. R=3 ohms  
A=40 amps  
V=?

Key into memory;

I 3  
II 40  
III 0

RST  
R/S

The display will read 120 (120 volts). To use again, key in INV 2nd CT & repeat.

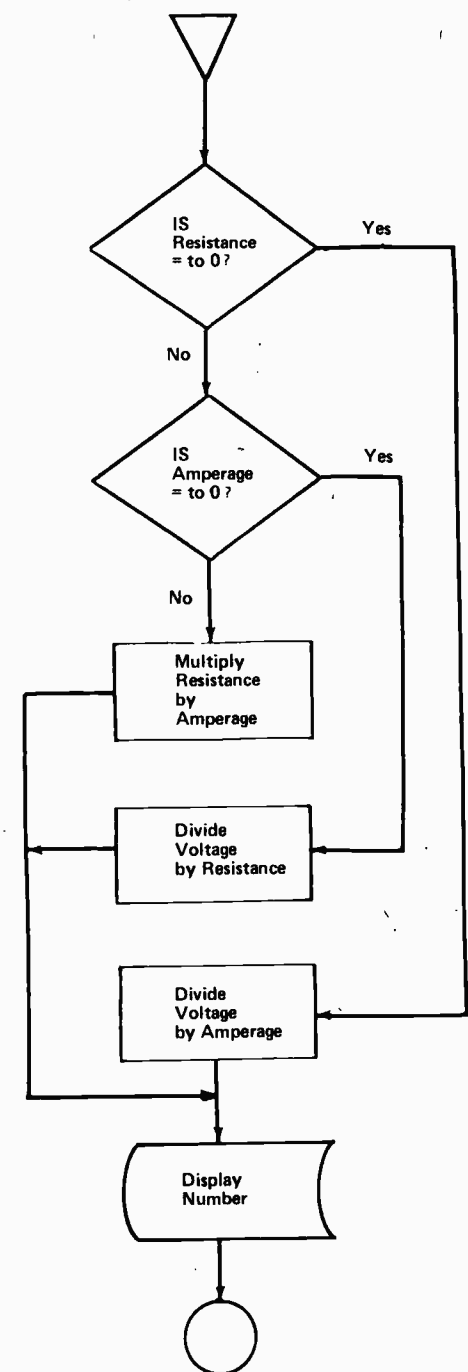

# SWL Via Ionosphere

The ionosphere affects the way in which the signals get to your set. John Garner tells why, and what it sounds like.

## HOW SHORTWAVE RADIO SIGNALS TRAVEL AROUND THE WORLD

NEAR THE EARTH the air is rather dense, but from above one hundred to one thousand kilometres (60 to 600 miles) above the earth the air is quite thin and radiated energy from the sun can ionize the widely spaced air molecules. This layer of the atmosphere is called the IONOSPHERE. The different degrees of ionization produced form into several recognizable layers. The ionized atmosphere allows the radiated wave to travel faster through it than in the more dense, un-ionized lower air. As a result, the top part of a wave front moving into the ionosphere speeds up and forges ahead of the lower part of the wave front and eventually may turn, or refract, the wave downward.

The lower the frequency of the waves, the less penetrating effect they have and the greater the proportion of them that may be turned back toward earth. The higher the frequency, the more penetrating energy the radio wave contains. Signals with frequencies of 10 to 30 megahertz may be deflected, or they may penetrate the ionosphere, depending on the time of day, the angle at which the wave strikes the ionosphere, and the degree of ionization present. With weak ionization they penetrate; with stronger ionization they may be refracted. With still stronger ionization the wave energy may be totally absorbed and dissipated in the ionosphere.

During times of sunspot activity and while the aurora borealis is active, ionization is considerably increased and

long-distance transmission may be interrupted because of almost complete absorption of all waves by the ionosphere.

Besides the frequency factor, the angle at which the radio wave enters the ionosphere determines the penetration, or refraction of the wave. While there may be some reflection of lower-frequency signals travelling directly upward, almost all higher-frequency waves that are transmitted at an angle of nearly 90° above the surface of the earth either penetrate or are absorbed by the ionosphere. As the angle becomes less than 90°, there is more chance of refraction. The higher the frequency, the greater the penetration and the lower the angle required to produce refraction. At high frequencies, there may be long distances between the end of the usable ground-wave signal and the reappearance of the reflected wave. At lower frequencies the sky wave often returns to earth in the ground-wave region.

If the sky wave returns to earth and strikes a good conducting surface such as salt water, it will be reflected back upward and take a double hop. A double hop may carry a signal a very long distance.

## FADING

The fading of signals stems from two major causes. If a sky wave is being received, variations in the ionosphere may refract more or less energy to any given receiving point at different instants, producing a varying amplitude or fading signal.

When the receiving antenna is within both ground and sky wave range, the

addition of the two waves may be in or out of phase. When arriving in phase, the waves add to each other, producing a strong signal. When out of phase 180°, they tend to cancel each other. Variations in the ionosphere can change the sky-wave travel distance and therefore the phase relationship of the ground and sky waves. The sky waves refracted to the same point by two different areas of the ionosphere may arrive in or out of phase and produce fading.

## LIGHTNING

A bolt of lightning produces RF energy across almost the whole usable radio spectrum, but the percentage of energy decreases as the frequency increases. At lower frequencies there is considerable energy, and with good ground-wave transmission, storms hundreds or thousands of miles away can produce considerable interference. The higher frequencies, particularly between 5 and 15 megahertz, are subject to local storms, but storms in the skip zones will not be heard. As a result, the higher frequencies are much less subject to lightning-produced radio noise, called static, and communications may be less subject to interruptions.

## SOLAR ACTIVITIES

The sun is the star about which the earth and other planets of our solar system revolve. It is the only star the surface of which we can see. All other stars, even through the best telescope, appear only as point sources of light. Like most other stars, the sun is a hot, glowing sphere of virtually pure hydrogen gas held

together by gravitational attraction. The light we see is created deep in the solar interior by thermonuclear reactions in which hydrogen atoms are fused to form helium atoms. After trickling through the sun, the radiation escapes from the PHOTOSPHERE, a very thin layer at the surface.

Above the photosphere lies the outer solar atmosphere — the CORONA — which extends for many solar radii and ultimately blends into the interplanetary gas. Because the coronal gas is very thin, it shines only faintly. Ordinarily hidden from view by the brightness of the daytime sky, the corona becomes visible during a total solar eclipse.

The gas density is highest at the sun's center, and steadily lessens toward the surface. The temperature, on the other hand, falls from about 13,000,000°K (°K=°C+273) at the center to about 4,000°K at the top of the photosphere and then rises again until it reaches 1,000,000°K in the corona. The reason for the high temperature of the corona is as yet incompletely understood.

The CHROMOSPHERE is a transitional region between the photosphere and the corona. It owes its name to the bright red light that it emits during a total solar eclipse.

On the average the sun undergoes an eleven-year cycle of activity. (The cycle has ranged from 7.3 to 17.1 years). During this period, the number of sunspots (dark patches on the photosphere), flares (sudden brightenings of the chromosphere), and prominences (cool, dense clouds of hydrogen suspended in the corona) varies in a remarkably regular fashion.

A SUNSPOT is fundamentally a region in the photosphere where a strong localized magnetic field emerges from the interior of the sun. The presence of the field inhibits the upward convective transport of energy in the layer just below the photosphere. Hence the gas of a sunspot is some hundreds of degrees cooler than its field-free surroundings, and appears darker. Individual spots usually possess a dark core (the UMBRA) surrounded by a somewhat brighter PENUMBRA. On the average, the temperature in these two regions may lie 1,500°K and 400°K, respectively, below the normal photospheric temperature. A spot first appears as a dark "pore" only 1000 miles or so across. Most pores disappear in less than a day, but a spot may persist for weeks and grow to a diameter of 19,000 miles. Sunspots move with the rotation of that part of the sun's surface upon which they appear.

Sunspots normally associate in groups of two to fifty. The group may exhibit a predominantly bipolar magnetic field, with spots of opposite magnetic polarity clustering at opposite ends of the group. Multipolar groups are also quite common.

The total number of sunspots varies periodically in an eleven-year cycle. At the beginning of a cycle, new spots form at high solar latitudes. As the cycle progresses and the total number of spots increases, spots form at progressively lower latitudes. A cycle ends with a few spots forming and breaking up at low solar latitudes. During a cycle most of the "leading" (westward) spots of bipolar groups in the northern solar hemisphere possess the same magnetic polarity. Leading spots in the southern hemisphere show the opposite polarity. In the next cycle the polarities of leading spots are reversed.

The chromosphere overlying a sunspot group may brighten suddenly and spew off gas at high speed. This event is called a FLARE, and it is one of the most complicated and least understood phenomena on the sun. Most flares are invisible in white light and can be seen only with special equipment and techniques. During the onset of a flare, the energy radiated may increase tenfold within minutes, then return to its original level within an hour.

Flares tend to break out near sunspot groups of complex magnetic structure, especially near groups in which new small spots are growing rapidly. Such a group may display several flares in a day. Small flares occur with the greatest frequency, large flares are rarer. The largest flares attain an area of 0.1 percent of the solar disc.

Flares also emit a complicated radio spectrum. During the early phases of a flare, fast "bursts" of radio-frequency radiation are often detected. The frequency of the burst falls from 600 to 100 megahertz in a few seconds, which suggests the propagation of a disturbance through the corona at speeds up to a tenth of the speed of light. Following a volley of fast bursts, a slow burst may occur. The frequency drop takes place within a few minutes.

In both types of burst, the drop in frequency can be interpreted as the effect of a rising disturbance. At every point along its path this generates radio noise of all frequencies, but only frequencies above a "critical" value (which is determined by the local electron density) can escape from the corona. As the disturbance moves outward through the corona it encounters a lower elec-

tron density (i.e. critical frequency), and thus lower and lower frequencies can be emitted.

Much thanks this month go to Bill Butuk of Thunder Bay for his research into the solar conditions which have so much to do with the way we are able to hear radio programming from the other side of the world.

As I'm typing up this article I'm listening to some beautiful Island music from Tahiti (15170 Kilohertz at 0330 GMT). This is one of my favorite stations in the late evening hours. The language is Tahitian but the music sounds good in any language.

**SHORTWAVE MAILBAG**, P.O. Box 142, Thunder Bay, Ontario, P7C 4V5.

H. Sparreboom of Tofield, Alberta writes: "I have been reading various magazines on this hobby, but it wasn't until last month that I picked up "Electronics Today". I find the equipment review of shortwave radios more useful, since the prices are more accurate. Personally I would like to see more technical data included such as sensitivity and selectivity and possibly some comparisons of the various receivers.

"At the present I am experimenting with an 8 band multiple dipole antenna. I use rotor cable with each wire cut to the desired length.

"Numerous countries broadcast from various locations such as Radio Nederland from Holland, Bonaire and Madagascar. Does this count as three countries heard or do you just count Holland for all transmissions?"

— *In a few months I will have a summary of radio receivers that have been reviewed. This will be in the form of a chart with technical specs and comparisons may be made. — Your idea of using rotor cable for a multiple dipole sounds very good. — If you hear Radio Nederland from all three locations, this would count as three countries heard. Thank you very much for your letter.*

## RECEIVER REVIEW

Last month I had a review of Radio Shack's latest receiver, the DX-300. This month we will look at other shortwave receivers from Radio Shack. **Realistic DX-40** — This is a four band portable which tunes AM and FM and 2 shortwave bands covering 4 to 12 MHz and 12 to 22 MHz. Features of the DX-40 are sliding volume and tone controls, 3½" speaker, SW fine tuning, pushbutton band selectors. The receiver operates on house current or four 'C' cells. The set measures 305

# SWL Via Ionosphere

mm wide, 180 mm high and 93 mm deep. The Canadian price is \$64.95.

**Realistic DX-60** — Another portable similar in size to the DX-40 but with three shortwave bands covering 3 to 7 MHz, and 18 to 26 MHz. The AM and FM bands are also included as well as a CB band covering all 40 channels. The DX-60 has a four inch speaker, built in AFC, 30" telescoping antenna for FM/CB/SW antenna, built in AM antenna. It also operates on house current or four 'C' cells. The Canadian price of the DX-60 is \$89.95.

**Patrolman CB-8** — An eight band portable featuring just the Shortwave band of 6 to 18 MHz as well as AM, FM, CB, CHF-Hi, VHF-Lo, UHF and VHF-Air. Another shortwave band would be an improvement. The set has dual antennas, fine

tuning, adjustable squelch, tone control. The CB-8 operates on AC or six 'C' cells and costs \$149.95.

**Realistic DX-160** — This is one of the more popular communications receiver especially among new SWLs/DXers because of its low cost. It is a very good receiver for its price. The main disadvantage is that the tuning is not the direct readout type as is used on the more expensive sets but the slide rule type making it difficult to know the exact frequency to which you are tuned. This is a five band set — 150 to 400 kHz Longwave, 535 to 1600 medium wave, 1.5 to 4.5 MHz shortwave, 4.5 to 13 MHz shortwave, and 13 to 30 MHz shortwave (which also includes CB channels 1-40). A product detector and variable BFO bring SSB and CW reception. Eleven front panel con-

trols including electrical bandspread tuning and calibrated logging scale. Also featured are FETs in all critical stages, Zener stabilization, noise limiting in IF and audio stages and illuminated 'S' meter. A separate speaker is included. The DX-160 operates from 120 V AC or 12 V DC negative ground. Dimensions are 165 mm high, 362 mm wide and 235 mm deep. The Canadian price is \$229.95.

Now that summer's here it would be a good time to think about buying a portable shortwave receiver and get out in the sun and enjoy the thrills of shortwave radio. And don't forget that if you are vacationing outside of Canada you can keep up to date on Canadian news by listening to Radio Canada International on shortwave.

Until next month 73 and good listening.

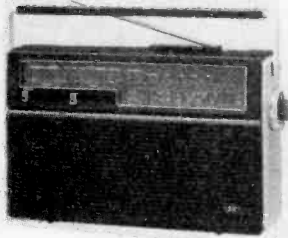

DX-40



DX-60



CB-8



DX 160

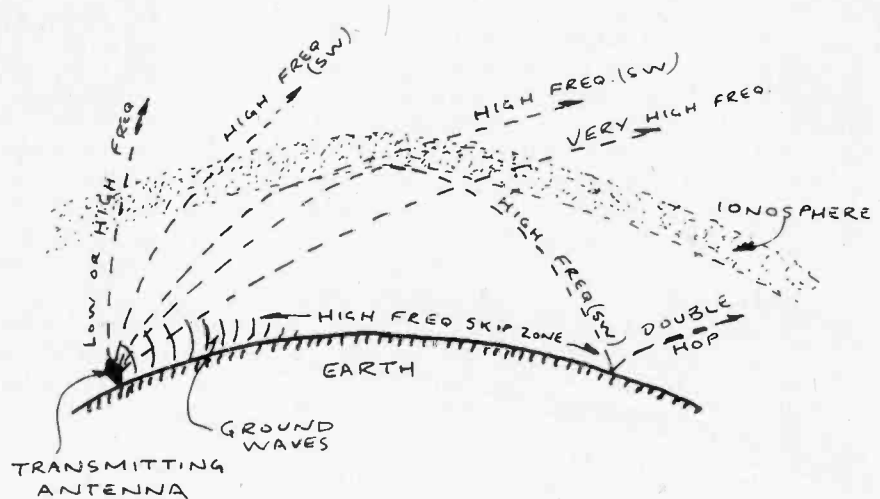

Path of Radio Waves in the Ionosphere





**Your Zenith Distributor has the parts and accessories you need in one convenient place — your Zenith One-Stop Shopping Center.**

#### REPLACEMENT PICTURE TUBES



Famous Super Chromacolor® picture tubes in a range of sizes to replace a total of 80 industry types. Plus Sunshine® and Cinebeam picture tubes to fit almost any brand of color TV. And Zenith black & white picture tubes to replace 401 other types of B & W tubes.

#### REPLACEMENT RECEIVING TUBES



A complete line of more than 1,000 Zenith quality tubes . . . the same tubes as used in Zenith original equipment. Built to operate with great reliability — to cut your callbacks. And they have the long life needed to increase the satisfaction of your customers.

#### ZENITH QUALITY PARTS



All the parts you need, from bel fuses to TV knobs. The star is the Zenith Instant Parts Program (ZIP). It puts the 100 most used replacement parts at your fingertips, in a specially designed, compact rack. ZIP makes inventory and re-ordering fast and easy for you. Also, Zenith now offers a line of capacitors, resistors, integrated circuits and universal semi-conductors and a full line of universal needles and cartridges.

#### ZENITH QUALITY ACCESSORIES



Here are just a few! Quad, stereo and monaural headphones. Broadened line of outdoor antennas featuring 13 all-new Super Chromatenna models. Complete new Chromatenna indoor antenna line. Antenna rotors. Three grades of batteries in a wide range of sizes. Electronic chemicals, including tuner degreaser, tuner cleaner, circuit cooler and tape head cleaner. Cassette and 8-track recording tape cartridges and record care products. A full line of test equipment & service aids.

Beside parts and accessories, your Zenith Distributor has the specialized "know how" to help solve tough service problems. Come in or phone today.



#### YOUR LOCAL ZENITH DISTRIBUTOR:

Major Appliances Div.,  
Acklands Ltd.,  
1725 Quebec Street,  
Vancouver, B.C.  
Phone-1-604-879-4631

B.R.E. Electric Ltd.,  
5544-5th Street S.E.,  
Calgary, Alta. T2H 1L3  
Phone-1-403-253-7171

B.R.E. Electric Ltd.,  
14840-115th Ave.,  
Edmonton, Alta. T5M 3C1  
Phone-1-403-455-7171

Major Appliances Div.,  
Acklands Ltd.,  
1155 Sherwin Rd.,  
Winnipeg, Man. R3H 0V1  
Phone-1-204-633-6679

Zenith Radio Corporation  
of Canada Ltd.,  
1020 Islington Ave.,  
Toronto, Ont. M8Z 5X5  
Phone-1-416-231-4171

Zenith Radio Corporation  
of Canada Ltd.,  
900 Boul St. Martin O.,  
Chomedey, Lav. PQ  
H7S2B6  
Phone-1-514-663-0430

Waldale Limited,  
Station Street, Box 339,  
Amherst, N.S.  
Phone-1-902-667-3308

# Service News

MANUFACTURERS... DISTRIBUTORS... SERVICE... REPRESENTATIVES... ORGANISATIONS... Send us your news ideas for the upcoming seminars, new products, releases for the successful shop. Address them to Service News, Electronics Today Magazine, Unit 6, 25 Overlea Blvd, Toronto, Ontario, M4H 1B1. Please note that your information must be received at least six weeks before the first of the month of the issue in which it is to appear. Any material published at our discretion.

The ETA isn't the estimated time of anything, except that we estimate that the time has arrived for more than a few Canadian technicians to be interested in this U. S. based organization. Dick Cartwright checks them out.

## HI!

After being requested by the Editor-in-Chief to do an article or series of articles on associations in our Province and/or Canada, I received a call from the magazine informing me that an association, ETA-I, was now operative in Canada. Orders: Check it out.

Very little research was required as I had through the office received a number of communications making it obvious that there had been some internal strife in the American association, the International Society of Certified Electronic Technicians (ISCET). A number of directors of this association (ISCET) had apparently become dissatisfied with progress being made, or lack of it, and decided to form a new association, so Electronic Technicians Association International, Inc. (ETA-I) was formed.

## ETA INTERNATIONAL

This news release from ETA International dated Nov. 10/78 was received Nov. 21, at my office for immediate release. (At that time controversy, confrontations, etc. within the various American associations seemed of little interest to my Canadian readers, and I did not report on them; however subsequent developments make it necessary for Electronics Today to do so.)

### ETA INTERNATIONAL formed as new electronics technicians association

"Today a group of interested technicians met in Indianapolis to form a new trade association: The ELECTRONICS TECHNICIANS ASSOCIATION, International, Inc. The association will be composed of individual member technicians, rather than being a business

league such as is typical of the other present industry trade associations."

Here follows a list of the directors of this association, a number of whom were previous directors of ISCET:

Chairman: Jesse B. Leach, Linthicum, Md.

Vice-Chairman: D. C. Larson, Houston, Texas.

Secretary: Leon F. Howland, Jr., Indianapolis, In.

Treasurer: Walter Cooke, Hampton, Va.  
EEA Division Chairman: Ron Crow, Ames, Ia.

The objectives of ETA are to provide a professional trade association for all electronics technicians; to expand and improve the present industry Certification programs for technicians; to establish continuing technical educational opportunities; to set training and competency standards; to collect, preserve, and distribute valuable technical information and to promote the interests of all electronics technicians.

A new educational division of ETA-I was included in the association structure. Its name is to be: ELECTRONICS EDUCATORS ASSOCIATION. Ron Crow, a previous director of ISCET was elected to head the division. Mr. Crow is also presently division head of the Electronics and Technical Education Extension at Iowa State University and supervisor of the Engineering Research Institute Electronics Shop, at ISU. Edward T. Carroll, CET, an instructor of Electronics Technology at the Indiana Vocational Technical Institute in Indianapolis was elected as Secretary/Treasurer of the division.

Returning to the apparent controversy developing within the ranks of ISCET, Chairman Leach stated that "The continuing and deepening rift within NESDA

has forced technicians to seek other opportunities for a representative association. In ETA we expect to carry on programs such as Certification, Serviceability and educational seminars similar to those presently administered by ISCET. We also are expanding the membership potential to the more than 250,000 technicians in the United States. Hopefully, by establishing the governing body as an elected Board of Directors rather than regional allied groups, we will have eliminated the seeds of dissension which have dampened past service association efforts."

## IN CANADA YOU SAY?

Now as previously mentioned, the foregoing events and information seemed to me at that time to be of little interest or importance to Canadian readers, until a further nudge from our editorial staff pushed me out of my winter hibernation and it became apparent that yet another association, ETA-C (Electronic Technicians Association — Canada) had surfaced here in Ontario (Canada). A series of phone calls and a belated research of my files quickly brought home to me the fact that our first international technical association was emerging.

A letter was received in my office from Mr. Bill Patullo who is the president of the Canadian branch of ETA-C. In this letter Bill stated that although at the time of writing, membership was relatively insignificant, he was confident that publicity, word of mouth, etc. would spread the word to the thousands of technicians across the country that here was an association devoting itself to the individual electronic technician.

Mr. Patullo sent me copies of letters from Mr. Dick Glass, CET, the president of ETA-I, and Mr. Ron Crow, CET, Direc-

## Service News

*NOTE: As we go to press we hear that the 3 day meeting mentioned in this article is to be held on August 3-4-5.*

tor of Certification, Educational Division Chairman. With these letters it became obvious that this association, unlike many of its predecessors, was not starting off with just high-sounding ideals and aspirations, but was already a thoroughly organized and directed association, and a quick perusal of the board of directors explains a great deal, as here was a considerable part of the previous board of IS CET.

A further news release was received in the latter part of April from ETA, as follows:

### "TECHNICIANS' ASSOCIATION TO MEET IN CANADA"

**"Annual Convention to be ETA's First.** According to Dick Glass, CET, President of ETA-I, the new international association of electronics technicians will hold an annual convention this summer in Kitchener, Ontario, Canada.

"Meeting in Yorktown, Virginia, April 14th, ETA's officers made the decision to conduct an annual convention despite the group's short existence of only six months. Chairman Jesse B. Leach, CET, said: 'It may appear to be a bit too soon for ETA to hold an annual member meeting, but strong support and member interest dictates that ETA 'get on with the program', and exert its efforts towards improving the profession for electronics technicians. An international convention will help the association to jell and to convince those who have been sitting on the sidelines to know that ETA is here to stay.'

"Exact location of the convention will

be announced later as will the specific dates for the planned 3-day confab. The tentative dates are for July 27-20 inclusive.

"In addition to the election of officers for ETA-I and the three divisions: ETA; ETA-Canada; and CTD, the Certified Technicians Division, the convention will concentrate on training ideas including lecture-seminars; training for electronics instructors; and methods-training for certification administrators and local ETA chapter leaders.

"Technicians interested in attending the Canadian convention should call 317-241-7783 or write to ETA-I, 7046 Doris Dr., Indianapolis, Indiana 46224."

Canadian technicians requiring further information contact Mr. Bill Patullo, 10 Windywood Crt., Kitchener, Ont. N2N 1L5.

### COMMENTS

Associations! I am suddenly up to my neck in them and I have not even discussed our original tried and true RETA, of which I am a past president. For nearly 25 years the surface of the electronic pond was rippled only occasionally by associations or ideas re associations, and basically except for the odd furore instigated infrequently by newspaper articles we, the domestic electronic industry, continued on in a reasonably placid fashion, but storms like all storms quickly subsided and our local technicians carried on much as before with an "I'm all right, Jack" attitude.

But then with the advent of MTTSA, which had some political clout, some

technicians began to change their attitude regarding the need for or lack of a professional technicians association. CEASA, the subject of my previous article, appears to be doing a great job, and as previously stated I can see no earthly reason why our Ontario association should not, in one way or another, affiliate themselves with this rapidly growing organization. Now we have ETA-C (Electronic Technicians Association — Canada) who are already firmly established in the U.S.A., expanding into Canada, and the first chapter, based in Kitchener, is apparently already fully operational. They, like our old friends of RETA, are directing their main thrust to the individual technician as opposed to OETA's attention to the business owners.

Conversations with the president of OETA and a member of the board of the Toronto chapter (MTTSA) produced no interesting response, though Mr. Steenhuisen (President, OETA) did at my suggestion arrange to send a representative of his group to a meeting held by ETA-Canada in Waterloo on May 1st. As a matter of interest, though it was at my suggestion that he sent a representative to this meeting, he did not think it important enough to comment on the proceedings. It is fairly obvious that OETA do not feel that ETA-I (Canada as well) pose any threat to their association structure, but my opinion, after talking to a number of technicians, is that they should maybe look very closely at this new competition.

All the best.

Richard H. Cartwright

## ALPHA. TUNER. SERVICE

### Fast Coast to Coast Tuner Repair Service



We provide a fast top quality tuner service to help you make a profit. Repairs to all makes and models at competitive prices. Domestic or import, tube or transistor. All repairs are serviced by trained technicians, using only top quality components. Tuner repair is our specialty and our only business.

- VHF or UHF \$13.95
- Varactors \$13.95
- FM Tuners \$15.95
- UV Combo \$21.95
- Parts and workmanship carry full 12 months warranty.

Charges for major parts and shipping charges are billed at cost (dealer net). Mail or bring your tuners to our Montreal head office.

## ats electronics

3226 6th Street, P.O. Box 172,  
Chomedey, Laval, Quebec H7V 3P5 (514) 681-0501

# QRM QRM QRM

Hams are essential to the preservation of society as we know it! Bill Johnson, VE3APZ tells how.

AS amateur radio operators, we sometimes feel it is our duty to volunteer our services to government agencies for public service communications. Those of us who have phoned our local police and other agencies to announce our presence and readiness know well the general attitude of indifference displayed towards us. Several events have occurred in the last few years in the Toronto area, however, that seem to indicate that the times are changing. In September 1976 the Toronto ARES group (Amateur Radio Emergency Service) and TFM (Toronto FM Society) were involved in a multi-agency simulated aircraft crash at Toronto International Airport. During the exercise, amateurs from the Toronto area passed hundreds of health-and-welfare and medical messages between the airport and several Toronto hospitals.

During the months following the exercise, there was much consultation between the Ontario Hospital Association and local amateurs with a view to establishing a local amateur radio network between the Toronto hospitals, with at least the antennas being paid for by the hospitals. The plan has not, to this date, materialised, probably because of cutbacks in hospital spending. The local Emergency Co-ordinator is, however, hopeful.

Various police departments are learning more and more about amateur radio's capabilities, as is evidenced by their more ready acceptance of emergency calls via autopatch without a lot of questioning.

It is, therefore, somewhat not surprising to hear that the Canadian Coast Guard, in forming a volunteer reserve, has announced that it will be recruiting amateurs to provide communications. Five units of the Canadian Marine Rescue Auxillary, Inc., are being formed by the Department of Transport. These units will each sign written agreements

with the Ministry to provide emergency and routine assistance to the regular coast guard units. In return, the auxillary units will receive specialised training in search and rescue, boating safety, and PR work, as well as being provided with insurance for their equipment while using it for official coastguard duties.

All vessels used in the auxillary will be owned either by individuals or corporations who are public service-minded enough to volunteer their facilities. Since few pleasure craft use the very expensive VHF marine radios, Amateurs will be enlisted to use portable and mobile equipment as a liaison between land and marine stations.

For those of you out there who are already 'chomping at the bit', be patient. At the present time, the five auxillary units (West Coast, Central Canada, Laurentian, Maritime, and Newfoundland) are just forming and looking for people with boats. Amateur operators may offer their facilities as well, but these applications will be held on file until such time as the organisation of the boaters is complete. Don't let this discourage you though, get your applications in soon, so they can get an idea of how many we are and what we can do. You can get application forms by calling the Canadian Coast Guard in Toronto, Vancouver, Quebec, St. Johns, or Dartmouth.

## LESSON - OF - THE - MONTH

With the increased use of VHF and UHF equipment, amateurs are subjecting themselves to more and more RF energy by the day. We have always been involved with high-power RF, but we don't usually climb our antenna tower while it is being used to transmit.

Since VHF/UHF lends itself to easy mobile and portable operation, espec-

ially with the numerous repeaters now in operation in all but the most remote parts of the country, it is natural for a lot of amateurs to own and operate low-power portable equipment of the hand-held variety.

Some more recent models of this type of radio have, as an optional extra, a remote microphone that plugs into the side of the unit, so that the radio may be held above the head, on the body and the radio still used. While the advent of these accessories is due mostly to their extra convenience, there is a very good reason why the amateur buying a portable should consider the extra cost. When these radios are being used to transmit, they are held so that the microphone is directly in front of the user's mouth. This places the antenna strategically in front of the victim's forehead, where most damage can be done to the living tissues of the human body. Recent studies of 450 MHz equipment have shown a decided heating effect in the skull. While this is only of minor proportions, we all know of the positively carcinogenic nature of microwave radiation. 450 MHz is getting pretty close to the microwave region, so it is better to be safe than sorry. The amount of energy radiated is directly proportional to frequency and power, so the higher up in frequency you go, the less power it takes to do the damage.

I don't want to be a scaremonger, but you should consider a remote speaker-mike if you are going to use a VHF/UHF portable radio whose output power is more than a watt or so. This is especially important to those people that insist on ragchewing on repeaters. And you thought that timing out the repeater was the only danger.....

## QRM LETTERS

In the March issue of Electronics Today... in QRM ... it was suggested by

## QRM

J. Riddell that you 'buy a copy of the 'Radio Amateur's Licensing Handbook'. In February 1979 ALH Publishing Co. informed me 'Sorry, all 10 editions sold out. Probably no more unless we can find somebody capable of taking over, as the author has retired.'

Anyone out there capable of filling in the vacuum?

Yours Truly, F.P., Thompson, Man.

(It was actually Bill Johnson who wrote that. J. Riddell's name was at the end of a letter, not the whole article. Watch this column for further developments.)

Dear QRM letters,

You asked for it — you got it. In response to your February 1979 ETI, this is to let you know that there are some amateurs out there in Ontario that do read QRM.

The magazine is a good one, covering a range of interests in the electronics hobby. I am not much of a builder but am glad to see a 'Canadian' magazine with some construction projects. Perhaps in the future there will be more amateur-related projects. i.e. VSWR bridges, speech processors, scope adaptors for modulation indicators, and RTTY work, etc.

I would like to see the personal observation context of QRM continue. I would also like to see QRM expanded to

more than one page and cover the Canadian amateur activities as well as DX news, Hamfests and regulation changes and proposals.

The magazine as a whole is good, but in keeping with the 'state of the art' let's not forget the basics. ICs are not the living end. There are still a lot of transistor and tube circuits that many people are interested in because they do not represent a 'black box' approach. The 741 op-amp article is OK, but how does the 741 work itself?

Back to the subject at hand. During this calendar year the number of Canadian amateurs should reach 10,000. I have purchased parts from your advertisers because I heard of them through ETI. I am sure other hams have done the same. So, we all profit in the end.

To sum up; a good magazine with a good column (QRM). As long as QRM is in there, so too shall I. Keep up the good work and let's get QRM expanded.

Congratulations Bill on Digital Ticket

73,

Larry Van Wart, VE3IVO

(You can see the original in my hallway if you don't believe it. Framed.)

With that, all I can say is 73.

See you next month.

Bill, VE3APZ

**Jana**  
ELECTRONICS LTD.

Distributors stocking  
Jana Projects:

A-1 Electronics  
ISLINGTON, ONTARIO

Arkon Electronics  
TORONTO, ONTARIO

Atwater Electronics  
MISSISSAUGA, ONTARIO

Brant Electronic Supply  
BRANTFORD, ONTARIO

Carsall Industries  
SAULT STE MARIE, ONTARIO

Robert J. Buckland Co  
LONDON, ONTARIO

Dominion Radio Ltd  
TORONTO, ONTARIO

General Electronics Co  
WILLOWDALE, ONTARIO

Gladstone Electronics  
TORONTO, ONTARIO

Heath Company  
MISSISSAUGA, ONTARIO

Jerry's T.V.  
SARNIA, ONTARIO

Kesco Electric Supply Ltd.  
PETERBOROUGH, ONTARIO

Kingston Electronic Supply Ltd  
KINGSTON, ONTARIO

Lighthouse Electronics  
WINDSOR, ONTARIO

Lamp Land Ltd  
PETERBOROUGH, ONTARIO

M I Supply Co Ltd  
BELLEVILLE, ONTARIO

Neutron Electronics Ltd  
GUELPH, ONTARIO

Niagara T V  
NIAGARA FALLS, ONTARIO

Northwestern Electronics Supply  
OWEN SOUND, ONTARIO

Provincial Electronics Distributors  
LONDON, ONTARIO

Radio Trades Supply Ltd  
TORONTO, ONTARIO

Sonic Northern  
SUDBURY, ONTARIO

Teltronics Ltd  
SCARBOROUGH, ONTARIO

D R. Walling Co Ltd  
LINDSAY, ONTARIO

Waterloo Electronic Supply  
WATERLOO, ONTARIO

Western Radio Supply Co.  
HAMILTON, ONTARIO

Westown Electronics  
TORONTO, ONTARIO

If you cannot find Jana  
Projects in your area,  
contact Doug Mann,  
Jana Electronics Limited,  
P.O. Box 489, Winnipeg,  
Manitoba R3C 2B3.



**MOTOROLA**  
MOTOROLA COMMUNICATIONS  
TWO WAY RADIO  
FIELD SERVICE

**CHALLENGING:** Career in servicing mobile communication equipment. Chance to work on a total line of products including mobile, base, repeater, and special systems.

**REQUIREMENTS:** Amateur radio license or three years experience in the communications field, plus technical school certificate. Must be self starter and possess a valid drivers license.

**EXCELLENT:** Employee benefits including profit sharing and advancement in the company based on individual merit programme.

PLEASE SEND RESUME TO:

EMPLOYMENT SUPERVISOR  
MOTOROLA CANADA LTD.  
3125 STEELES AVE. EAST.  
WILLOWDALE, ONTARIO  
M2H 2H6

ATTENTION: Toronto Service Manager



# Build even your tools yourself!

The **Jana**  
30-watt soldering iron:  
It's so good, you'll be  
proud you  
made it.

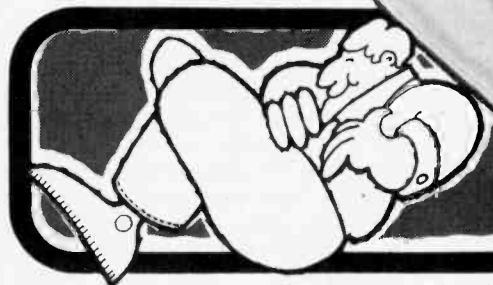

Where do you start learning electronics? Jana lets you start right at the beginning by building your most essential tool.

Getting a superior soldering iron at Jana's low kit price is only part of the advantage. Knowing how it works is important too.

No doubt you will later heat your iron up often. You will use it to solder transistors, diodes, chips and other elements into increasingly sophisticated projects. In time your soldering iron's efficiency will wear down a bit, but you will know how to restore it to peak performance because you built it.

Like all Jana kits, you get everything you need. Jana even includes two small screw drivers and tweezers you can use for picking up small parts. (They also



make a great heat sink.) Jana's step-by-step instructions include large, easy-to-follow illustrations.

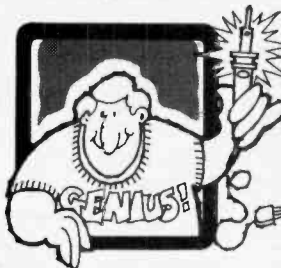

Start by building a Jana soldering iron. Then, before moving on to building your first computer, try a few more useful, entertaining Jana kits. Every one can increase your electronic expertise and understanding.

### Jana kits for many useful and entertaining purposes.

1. Automatic Headlight Reminder
2. Battery Operated Fluorescent Light
3. Bug Shoo
4. Code Oscillator
5. Crystal Radio
7. Curiosity Box II
8. Daily Lighter
9. Decision Maker
10. Fish Caller
11. Hi Power 12V DC Flasher
12. Photo Electric Night Light
13. 6V Power Supply
14. 9V Power Supply
15. 0-20V Power Supply
16. Single Channel Color Organ
17. Electronic Siren
18. Shimmer Strobe Light
19. Tone Generator
20. 5 Transistor 1 Watt Amplifier
21. Tube Continuity Checker
22. Xenon Strobe
23. 3 Channel Color Organ
24. Loudmouth Siren
25. Roulette Wheel
26. Electronic Skeet Game
27. Electronic Dice
28. Super Roulette
29. FM Mini Broadcaster
31. Shoot Out
32. Road Runner
33. Love-O-Meter
34. 30-Watt Soldering Iron Kit
35. Audio Wattmeter

Jana Electronic Projects are available through Cam Gard Supply and other distributors across Canada (partial list on facing page).

**CAM GARD SUPPLY LTD.**

Vancouver • Kamloops • Calgary • Edmonton • Red Deer • Regina  
Saskatoon • Winnipeg • Halifax • Fredericton • Moncton

**Jana**  
Industrial

1777 Ellice Ave., Winnipeg, Man. R3H 0W5 Phone: (204) 786-3133

# Electronics and Cows

When farmers first found cows milked better with FM radio, the electronic age for farms began! Now, they've got them on TV! Jim Essex explains.

**WHAT'S THE PURPOSE** of cows on TV? How'd it get started and how does it work?

The use of TV for selling cattle is a new idea. In fact, the first TV auction in Hanover, Ontario, was the first in Canada in which feeder cattle were actually sold via closed-circuit TV!

When the idea of this unique method of selling cattle was first mentioned last year, sceptics abounded. When first tried last fall, the only sign that this cattle auction was very different was seen in the parking lot. The usual large trucks were there, of course; but what was surprising was the preponderance of ordinary cars and light pickup trucks — a clear sign of acceptance by the small, independent farmers who don't have big trucks. The usual enclosure, inside the barn for parading cattle, was missing! In its place, was a huge "projection-type" TV screen, like the type widely used in hotel bars. But what was even more surprising was the fact that the cattle to be shown were absent; instead, what the farmers were going to see was all contained in a video cassette small enough to fit inside a lady's purse!

How did all this come about? And how can so much be processed into a seemingly insignificant video cart? And, could electronic pictures of cattle take the place of the real thing?

It all began when six farmers from the beef-rich Bruce County area realized they were losing money under the old method of auctioning cattle. The hazards involved were endless. Many times, they watched helpless while their cattle were shipped south to the huge stockyards in Toronto only to have hopes dashed when the offered price didn't meet their expectations. To ship cattle all the way back was too costly — and cattle kept in close quarters too long lost weight. In addition, disease from one is easily spread to others and they faced the hazard of bringing communicable disease back to their own farms. It was then they came up

with the idea of "showing" their cattle — without them ever leaving the barn! The enthusiasm of the group was only matched by Ginty Jocius, manager of the Ontario Beef Exchange. Together they formed "O B E X" (Ontario Beef Exchange) and set to work.

Most of the cattle are winter calves brought down the previous fall and fattened in Bruce, Huron and surrounding counties. Here, they are maintained through winter and grassed out to stocker or short-keep weight for fall sale. These cattle have a reputation for pretty high quality, so what they developed had to work.

They found help from Hill's TV, who provided the Projection screen and accompanying "Advent color projector," (see *Electronics Today* May '77). This gave a working image of sufficient brightness and detail to match the Sony electronic camera

model 1610 used with a 3800 recorder. Additional viewing would be provided by strategically placed 26" color monitors. Jim Sutherland of Lucknow, Ontario was employed to put it all together. (He now works full-time doing nothing but camera-takes on cattle). The 2" tape used mostly in Broadcasting was too costly, so they settled on 3/4" tape, — and were away. Luckily, nearby CKNX Wingham, Ontario can handle three-quarters, and Jim found them immensely helpful in editing. As transpired, this proved to be almost a necessity, for "shooting" is a random thing as it can be difficult getting the cattle to do what you want. The audio was added later for this reason, with "lots" and "numbers" describing each as the cattle parade past the screen. This resembles the parades which take place in the customary ring prior to an auction sale.



Fig. 1 Jim Sutherland takes video-tape movies on the farm.

## COW PARADE

When they had their first production test runs complete, all were satisfied detail "was as good as life". They were ready.

The enthusiasm of the group was only matched by the enthusiasm of preparation. Problems such as how to get the cattle to move when Sutherland arrived at each farm for pictures were resolved with a measure of "home grown" practicality! At a signal from Sutherland, perched on the back of his video van (see picture fig. 1), the farmer simply drove a truck with a bale or two of hay on the back into the nearest field, and the cows followed, chasing the hay while Jim took pictures. How they looked "on the screen" can be seen from Fig. 2.

The "Video Sale" was held in a regular sales barn — chosen as against an auditorium — the thinking here being that farmers feel more at home in a barn! The sale was conducted just like a live auction, with the usual display ring substituted by the huge screen. The auctioneers, themselves, were placed just to one side and a little to the left of this screen where bids were received, again, in the usual manner, as with a proper auction. (Fig. 3). For those who wanted to go for coffee breaks, — yet not lose out on the proceedings, — smaller 24" monitors were placed throughout — another innovation which sold the system to buyers.

## AMAZING

After it was ALL over, buyers expressed amazement at how well the cattle were portrayed. The over-flow crowd of 700 plus gained as much, if not more insight into what they were buying, as the TV display adequately told them about numbers, weight, delivery date and, of course, the terms. Most farmers had their money within 48 hours of the auction. But what was the real clincher was the fact sellers at last had the option of refusing the first bid, — since his cattle were still at home on his farm! Ernest Acker, one of the six owner-operators of OBEX, said he and his partners are "exceedingly happy with the reception" given by beef producers across Ontario.

## STARTLING STATS

The statistics are even more startling: To market cattle the old way, it costs somewhere in the vicinity of \$21.00, including trucking, brokerage fees, insurance etc. The TV was runs only \$9. to \$10! And that's for each head. Even local yards may run upwards of \$15.00 or more, so the saving is obvious. Disease, mentioned earlier, and things

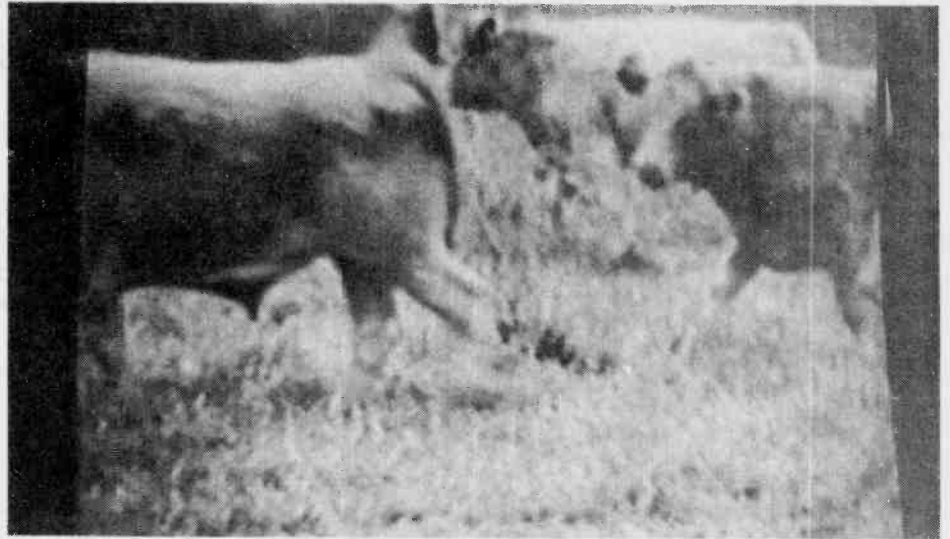

FIG.2 Advent reproduction of cattle as seen on "Advent" Screen Hanover, Ontario.

like weight loss — also costing the farmers dollars, — are now non-existent! A total of 2,897 feeder steers & heifers at an average weight of 900 pounds were sold in about three hours at Hanover! Sutherland reports that with practice, he can now video-tape 1000 head in an average week, — with a high of 1800 attained. And in a 1000 head lot, it is not uncommon to sell 800 of them right off, with no trucking involved and absolutely no disease carried back to farms for those which aren't sold. If the buyer's a dealer, all the better; they're fresh for re-sale.

A fringe benefit from all this has been the speed with which a "show" can be run off. Auctioneers don't have live animals to deal with, which can be ornery at times, and the hassle getting them in and out of the ring can be time consuming. You just need smart technicians, who if treated right, are much easier to handle! This first sale in Canada took a mere three hours, and all farmers participating were guaranteed payment, most under 48 hours.

The result of this large scale auction has successfully inaugurated smaller weekly auctions right in Toronto. Using 24" monitors, representatives from the major packing houses bid the cattle to be used for slaughter now without ever leaving the office.

## REPERCUSSIONS

The forward step taken at Hanover will have repercussions throughout the beef industry. It's now conceivable that western cattle could be filmed in far-off western pastures and auctioned off to Ontario feed-lot owners without the cattle ever having moved off their home pastures. In one fell-swoop, the

intermediate hassle of shipping and having to move through time consuming auction rings is thus eliminated, thanks to electronics. High prices and reduced disease can make TV auctioneering even more attractive with the anticipation of new markets soon to be within reach of every farmer. A seller can offer a buyer some additional advantages as well. Most sellers at Hanover allowed a "cutback"; that is, the buyer could sort out a certain number of animals on each lot that he didn't have to buy. This eliminated the chance of getting stuck with a few poor cattle, — increasing selective buying.

This first TV auction may be the herald of greater things to come for the cattle farmer — far exceeding that first experiment of playing radios to cows which made Carnation's "Contented Cow" slogan a reality.



Fig. 3 Auctioneers "calling the tune" at Hanover Cattle Auction.

# The Fun of Electronics



*I need a zener diode—The diodes I have at home are 'nt zene enough.*

GEIGER

*In this laboratory, we're trying to solve the toughest problem the watch industry has ever had—namely how to put mickey mouse's face on a digital watch.*

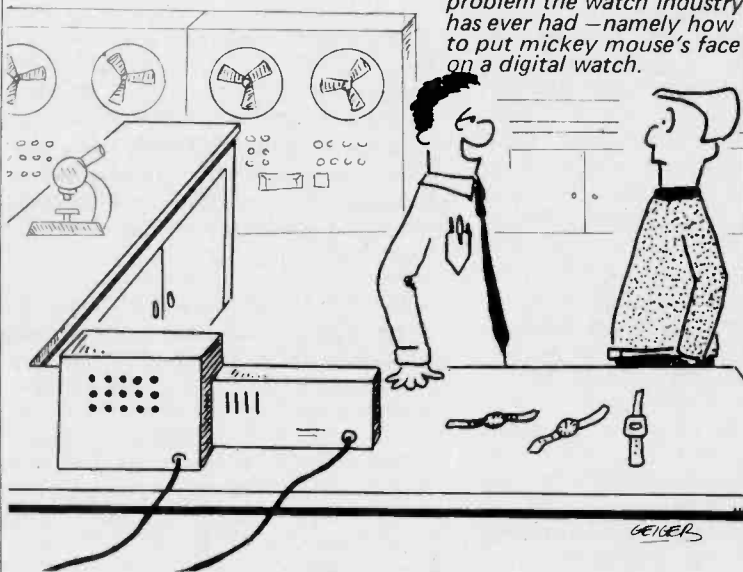

GEIGER

*I spent \$75 on an electronic combination lock that has over 9,000,000 possible combinations & virtually impossible to open if you don't know the correct sequence of digits. Last night a burglar kicked the door down & robbed the house.*

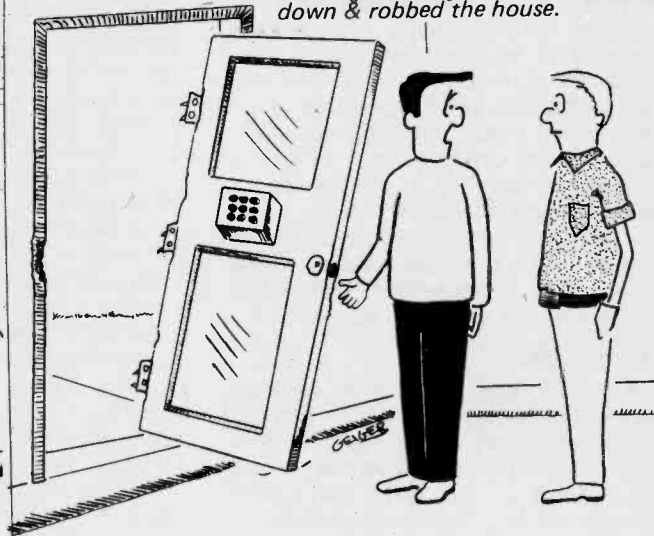

GEIGER

**NOW YOU CAN BUY A BATTERY & CHARGE IT!**



*The sign means that we take credit cards not, that we sell dead batteries, wise guy.*

GEIGER



*Now that—I've sold my CB & bought a short-wave radio don't have to listen to noise and static from all over the city... I can listen*

*to international noise and static from all over the world.*

GEIGER



# You can write for ETI



## 75 cents per word

ETI's new classified advertising section allows you to reach 30,000 readers nation-wide. For as little as \$15 (there's a 20 word minimum) you can promote your business from coast to coast.

### WHAT DO YOU DO?

Send us your typewritten or clearly printed words, your permanent address and telephone number, and your money (no cash please). Make your cheque or money order payable to 'ETI Magazine'. We're at Unit 6, 25 Overlea Blvd, Toronto, Ontario, M4H1B1.

There's no charge for including your postal (or zip) code. If you want to test reader reaction you can include 'Dept. ETI' as part of your address (free of charge).

### WHAT DO WE DO?

We typeset your words (and put the first word and your company name in bold capital letters).

If we get your message by the 14th of the month, it will appear in ETI 1½ months later. For example, if we receive it by November 14th, you (and thousands more) will see it in the January issue.

## CLASSIFIED

**NEW STORE!** for the Hobbyist, Ham Audio, CB'r. Special: Video Camera and Monitor \$349.95. Ont. res. add 7% sales tax. **GENERAL ELECTRONICS**, 5511 Yonge St., Willowdale, Ont. 221-6174.

**COMPONENTS;** Digital and Analog IC's, Transistors, Diodes, Zeners, Resistors, LED's, Displays. Send for Free Price List. **ELECTRONICS LONDON**, Dept ETI, Box 7096, London, Ontario. N5Y 4J9.

**YOU** need it? Chances are we sell it! Send us your parts list for free price quotations. Don't forget our list and flyers come out regularly. Don't miss out! **BRYAN ELECTRONICS**, P.O. 2068, Bramalea, Ontario. L6T 3S3.

**J&J ELECTRONICS LTD.**, P.O. Box 1437 E, Winnipeg, Manitoba R3C 2Z4. Surplus Semiconductor Specialists. Do you get our bargain flyer? Send \$1.00 to receive the current literature and specials and to be placed on the mailing list for future publications.

**\$1.00** Unusual Canadian and American parts and surplus catalogs. Hundreds of bargains. **ETCO**, Dept 087, 183G Hymus, Pointe Claire, Que.

**SPECTRUM ELECTRONICS** \* Quality pcbs \* 2 wks Del. \* 50c P&P \* Ont. res. add 7% PST \* 38 Audubon St. S., Hamilton, Ontario, L8J 1J7 \* ETI 551: \$5.15; 136: \$1.65; 553: \$6.70; 812: \$4.10, kit: \$5.35; 490: \$3.90; 592: \$14.80; 593: \$5.45, kit: \$26.25; 062: \$2.65; 243: \$2.00; 555: \$5.15; 650A: \$8.15; 650B: \$3.15; 650C: \$1.95; 072: \$2.50.

**AUDIO** compressor parts kit \$22.78: Wheel of Fortune parts kit \$17.50; both include PCB. We stock boards from Feb. 1977 to current issue, write for full list to: **B&R ELECTRONICS**, Box 6326F, Hamilton, Ont. L9C 6L9.

**WSI RADIO** - SWL Radios - Ham radios - 18 Sheldon Avenue North, Kitchener, Ontario N2H 3M2. Telephone (519) 579-0536. Write for giant catalog, free of course!! (VE3EHC)



Space restrictions did not allow us to print the pcb patter for the Light Show Sequencer, ETI 593 last month: here it is.

# Project File

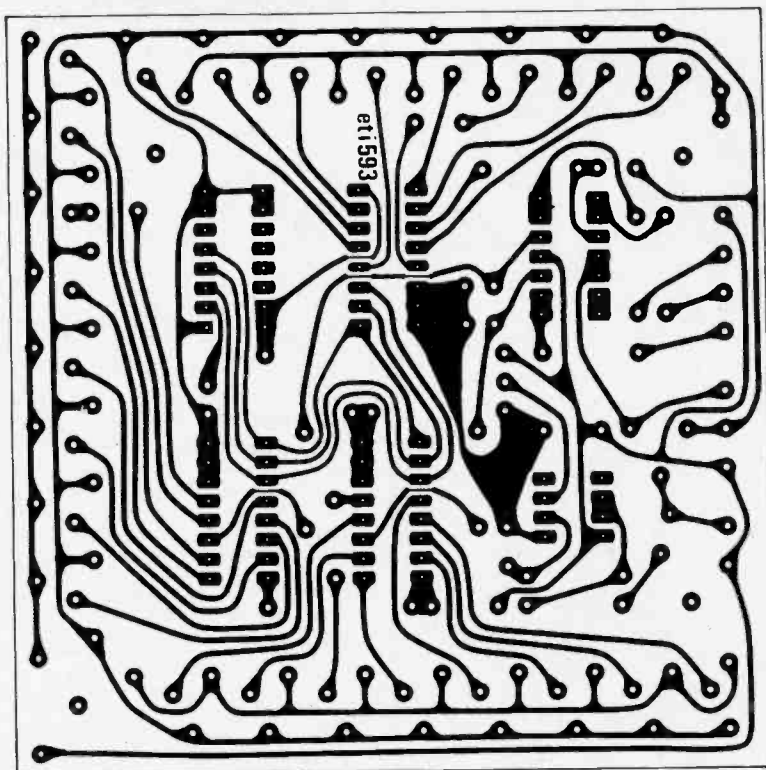

PROJECT FILE is our department dealing with information regarding ETI Projects. Each month we will publish the Project Chart, any Project Notes which arise, general Project Constructor's Information, and some Reader's Letters and Questions relating to projects.

## PROJECT NOTES

Since this magazine is largely put together by humans, the occasional error manages to slip by us into print. In addition variations in component characteristics and availability occur, and many readers write to us about their experiences in building our projects. This gives us information which could be helpful to other readers. Such information will be published in Project File under Project Notes. (Prior to May 78 it was to be found at the end of News Digest.)

Should you find that there are notes you wish to read for which you do not have the issue, you may obtain them in one of two ways. You can buy the back issue from us (refer to Project Chart for date of issue and see also Reader Service Information on ordering). Alternatively you may obtain a photocopy of the note free of charge, so long as your request includes a self addressed stamped envelope for us to mail it back to you. Requests without SASE will not be answered.

## Component Notations and Units

We normally specify components using an international standard. Many readers will be unfamiliar with this but it's simple, less likely to lead to error and will be widely used sooner or later. ETI has opted for sooner!

ISSUE DATE	ARTICLE
Apr 78	Computer PSU & Neg.
Apr 78	Audio Delay Line & Neg.
Apr 78	Gas Alarm & Neg.
May 78	White Line Follower
June 78	Neg.
Apr 79	Note: C
May 78	Acoustic Feedback Eliminator
June 78	Neg.
May 78	Add-on FM Tuner
June 78	Neg.
June 78	Audio Analyser
June 78	Ultrasonic Switch & Neg.
June 78	Phone Bell Extender & Neg.
July 78	Proximity Switch
Aug 78	Neg.
July 78	Real Time Analyser MK II (LED)
Aug 78	Neg.
July 78	Acc. Beat Metronome.
Aug 78	Neg.
July 78	Race Track
Aug 78	Neg.
Aug 78	Sound Meter & Neg.
Dec 78	Note: N
Aug 78	Porch Light & Neg.
Aug 78	IB Metal Locater & Neg.
Aug 78	Two Chip Siren & Neg.
Sept 78	Audio Oscillator
Nov 78	Neg.
Sept 78	Shutter Timer
Nov 78	Neg.
Sept 78	Rain Alarm
Oct 78	CCD Phaser
Nov 78	Neg.
Oct 78	UFO Detector
Nov 78	Neg.
Oct 78	Strobe Idea
Apr 79	Note: N

ISSUE DATE	ARTICLE
Nov 78	Cap Meter & Neg.
Nov 78	Stars & Dots
Nov 78	CMOS Preamp & Neg.
Dec 78	Digital Anemometer
Feb 79	Neg
Mar 79	Note: C, D
Dec 78	Tape Noise Elim
Feb 79	Neg
Dec 78	EPROM Programmer
Feb 79	Neg
Jan 79	Log Exp Convert.
Feb 79	Neg
Jan 79	Digital Tach.
Feb 79	Neg
Jan 79	FM Transmitter
Feb 79	Neg
Feb 79	Phasemeter & Neg
Feb 79	SW Radio
Feb 79	Light Chaser & Neg
Mar 79	Tape-Slide Synch
Mar 79	Synth. Sequ.
Mar 79	Dual Dice
Apr 79	Solar Control
Apr 79	Audio Compressor
Apr 79	Wheel of Fortune
May 79	Light Controller
May 79	AM Tuner
May 79	VHF Ant.
June 79	Easy Colour Organ
June 79	LCD Thermometer
June 79	Light Show Seq.
June 79	VHF Ant. 2
June 79	Bip Beacon

## ETI Project Chart

### PROJECT CHART

This chart is an index to all information available relating to each project we have published in the preceding year. It guides you to where you will find the article itself, and keeps you informed on any notes that come up on a particular project you are interested in. It also gives you an idea of the importance of the notes, in case you do not have the issue referred to on hand.

### Canadian Projects Book

Audio Limiter	Metal Locator
5W Stereo	Heart-Rate Monitor
Notes N, D May 79	GSR Monitor
Overled	Phaser
Bass Enhancer	Fuzz Box
Modular Disco	Touch Organ
G P Preamp	Mastermind
Bal. Mic. Preamp	Double Dice
Ceramic Cartridge Preamp	Reaction Tester
Mixer & PSU	Sound-Light Flash
VU Meter Circuit	Burglar Alarm
Headphone Amp	Injector-Tracer
50W-100W Amp	Digital Voltmeter
Note N May 79	

### Key to Project Notes

C:- PCB or component layout  
 D:- Circuit diagram  
 N:- Parts Numbers, Specs  
 Neg:- Negative of PCB pattern printed  
 O:- Other  
 S:- Parts Supply  
 T:- Text  
 U:- Update, Improvement, Mods  
 \*\*\*:- Notes for this project of complicated nature, write for details (enclose S.A.S.E., see text)

Firstly decimal points are dropped and substituted with the multiplier, thus 4.7uF is written 4u7. Capacitors also use the multiplier nano (one nanofarad is 1000pF). Thus 0.1uF is 100n, 5600pF is 5n6. Other examples are 5.6pF = 5p6, 0.5pF = 0p5.

Resistors are treated similarly: 1.8M ohms is 1M8, 56k ohms is 56k, 4.7k ohms is 4k7, 100 ohms is 100R, 5.6 ohms is 5R6.

### Kits, PCBs, and Parts

We do not supply parts for our projects, these must be obtained from component suppliers. However, in order to make things easier we cooperate with various companies to enable them to promptly supply kits, printed circuit boards and unusual or hard-to-find parts. Prospective builders should consult the advertisements in ETI for suppliers for current and past projects.

Any company interested in participating in the supply of kits, pcbs or parts should write to us on their letterhead for complete information.

### READER'S LETTERS AND QUESTIONS

We obviously cannot troubleshoot the individual reader's projects, by letter or in person, so if you have a query we can only answer it to the extent of clearing up ambiguities, and providing Project Notes where appropriate. If you desire a reply to your letter it must be accompanied by a self addressed stamped envelope.

**PLEASE NOTE: WE CANNOT ANSWER PROJECT QUERIES BY TELEPHONE.**

## Light Activated Tacho

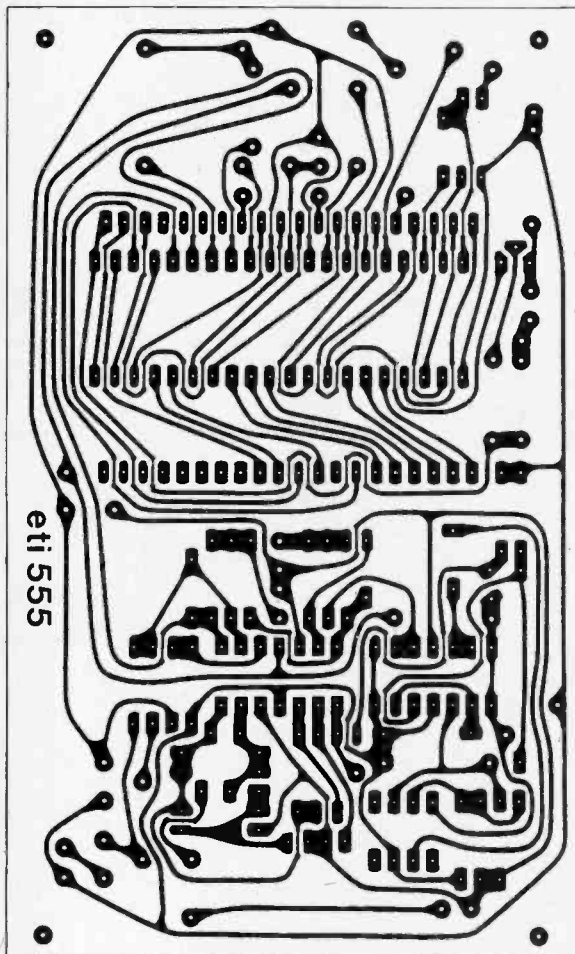

# MARKET PLACE

Hey! Where are all those ads? This is FREE you know. All you have to do is write what you want to buy/sell/swap on the back of a postcard or empty envelope and send it to: ETI Marketplace, 25 Overlea Blvd Toronto ONT M4H 1B1.

FOR SALE: LM382 AND LM379 ICs TO USE IN 5W STEREO PROJECT ETI 444 \$5.00 EA OR \$9.00 FOR BOTH. M. BERNIER, 12896 PLAISANCE, PIERRE-FONDS, QUEBEC H8Z 1Z2

I WANT TO BUILD OR BUY A SMALL FM TRANSMITTER TYPE BURGLAR ALARM FOR A MOTORCYCLE. THE ALARM SIGNAL IS TO BE PICKED UP ON A HOME RECEIVER OR BELT MOUNTED BEEPER ETC. D JACOBS PO BOX 197, ARMDALE, N.S. B3L 4J9

WOULD LIKE TO RECEIVE ARTICLE ON RCA COSMAC ELF. ANY PHOTO COPY WILL DO' A & S BOISVERT, 4830 DES PERVENCHES, ORSAINVILLE, QUE G1G 1R7

WANTED: BOOK "THE GOLDEN BOOK OF CHEMISTRY EXPERIMENTS" WILL PAY GOOD PRICE GEORGE VISENTIN 92 PETERBOROUGH AVE, TORONTO ONT M6H 2L1 CALL 652 1378

# KITS

Now Available

ETI True RMS Voltmeter	\$89.95
ETI Bucket Brigade	
Audio Delay Line	\$59.95
ETI Frequency Shifter	\$69.95
ETI Ultrasonic Switch	\$29.95
ETI CCD Phaser	\$79.95
0-24V 1 Amp Power Supply	\$19.95
3 Channel Colour Organ	
500W SCR	\$19.95
1500W TRIAC	\$29.95
2W 12V Audio Amplifier	\$8.95
Strobe Light	\$14.95
Light Chaser Kit (10 LEDs, Variable Speed)	\$19.95

Cheque, Money Order or Mastercharge  
Include card expiry date and number  
Ontario residents please add 7% sales tax

**DO NOT SEND CASH**  
Allow 3 weeks for delivery



**DOMINION RADIO & ELECTRONICS**  
535 Yonge St. Toronto  
Ontario M4Y 1Y5

# AUGUST

Ever wondered where to get a decent case for your projects? You'll find the answer in next month's Box and Case Survey. Is anyone still using TV antennas? You bet! We tell how to choose. Smoke alarms: principles of these hot items explained. Plus of course much more, including an Audio Power Meter project.

Next month is going to be pretty exciting for us, with the commencement of two new departments. Steve Rimmer continues his coverage of what's available on your TV screen with What's On, August's topic is TV from satellites. Meanwhile, we're going to start a write-in forum for teachers, students, any one who wants to learn how to teach or learn about electronics better (got that?). Suggestions on techniques, neat concepts etc are invited, along with news and proposals for organization among electronics educators.

(The articles mentioned are in an advanced state of preparation, however circumstances may require us to change the contents.)

# Reader Service Information

## Editorial Queries

Written queries can only be answered when accompanied by a self-addressed, stamped envelope, and the reply can take up to three weeks. These must relate to recent articles and not involve ETI staff in any research. Mark your letter ETI Query.

## Projects, Components, Notation

For information on these subjects please see our Project File section.

**LIABILITY:** Whilst every effort has been made to ensure that all constructional projects referred to in this edition will operate as indicated efficiently and properly and that all necessary components to manufacture the same will be available, no responsibility whatsoever is accepted in respect of the failure for any reason at all of the project to operate effectively or at all whether due to any fault in design or otherwise and no responsibility is accepted for the failure to obtain any component parts in respect of any such project. Further no responsibility is accepted in respect of any injury or damage caused by any fault in the design of any such project as aforesaid.

## Sell ETI

ETI is available for resale by component stores. We can offer a good discount and quite a big bonus, the chances are 'customers buying the magazine will come back to you to buy their components. Readers having trouble getting their copy of ETI could suggest to their component store manager that he should stock the magazine.

## Back Issues and Photocopies

Previous issues of ETI-Canada are available direct from our office for \$2.00 each. Please specify issue by the month, not by the features you require. The following back issues are still available for sale.

1977	1978	1979
February	<del>January</del>	January
May	February	February
June	March	March
July	April	April
September	May	May
November	June	June
	July	July
	August	
	September	
	October	
	November	
	December	

LOOK!  
We found  
some more!

We can supply photocopies of any article published in ETI-Canada, for which the charge is \$1.00 per article, regardless of length. Please specify issue and article. (A special consideration applies to errata for projects, see Project File.)

# Now Available

OUR ALL NEW  
LENLINE  
ELECTRONIC  
COMPONENTS  
CATALOGUE.

60 pages contain  
ing more than  
400 items, all  
fully illustrated  
and described.

SEND FOR  
YOUR FREE  
COPY TODAY!



Please send me your LENLINE Electronic Components Catalogue and the name of my nearest LENLINE Dealer.

NAME \_\_\_\_\_

ADDRESS \_\_\_\_\_

CITY \_\_\_\_\_

PROV. \_\_\_\_\_ CODE \_\_\_\_\_

len finkler ltd

25 Toro Road, Downsview, Ontario, M3J 2A6 • 630-9103



## Advertisers' Index

Allan Crawford Associates	7
Alpha Tuner Service	64
Classified Ads	71
Dominion Radio and Electronics	73
Gladstone Electronics	20
H. Rogers Electronic Instruments	55
Jana Industrial Electronics	66, 67
Kyll Electronics	11
Len Finkler	14, 20, 74
Motorola	66
McGraw-Hill	75
Sprague International	76
Webster Instruments	13
Zenith Radio Corp.	62

# New from NRI! 25" color TV that DIAGONAL tunes by computer, programs an entire evening's entertainment.

## Just part of NRI's training in servicing TV, stereo systems, video tape and disc players, car and portable radios.

Only NRI home training prepares you so thoroughly for the next great leap forward in TV and audio... digital systems. Already, top-of-the-line TV's feature digital tuning, computer programming is appearing, and new digital audio recording equipment is about to go on the market.

NRI is the only home study school to give you the actual "hands-on" training you need to handle servicing problems on tomorrow's electronic equipment. Because only NRI includes this designed-for-learning, 25" diagonal color TV with electronic tuning, built-in digital clock, and computer programmer as part of your training. With this advanced feature, you can pre-program an entire evening's entertainment... even key lock it in to control children's viewing.

### Exclusive Designed-for-learning Concept

The color TV you build as part of NRI's Master Course looks, operates, and performs like the very finest commercial sets. But behind that pretty picture is a unique designed-for-learning chassis. As you assemble it, you perform meaningful experiments. You even introduce defects, troubleshoot and correct them as you would in actual practice. And you end up with a magnificent, big-picture TV with advanced features.

### Also Build Stereo, Test Instruments

That's just a start. You demonstrate basic principles on the unique NRI Discovery Lab,<sup>®</sup> then apply them as you assemble a fine AM/FM stereo, complete with speakers. You also learn as you build your own test instruments, including a 5" triggered sweep oscilloscope, CMOS digital frequency counter, color bar generator, and transistorized volt-ohm meter. Use them for learning, use them for earning as a full- or part-time TV, audio, and video systems technician.

### Complete, Effective Training Includes Video Systems

You need no previous experience of any kind. Starting with the basics, exclusive "bite-size" lessons cover subjects thoroughly, clearly, and concisely. "Hands-on" experiments reinforce theory for better comprehension and retention. And your personal NRI instructor is always available for advice and help. You'll be prepared to work with stereo systems, car radios, record and tape players, transistor



radios, short-wave receivers, PA systems, musical instrument amplifiers, electronic TV games, even video tape recorders and tape or disc video playbacks.

### Send for Free Detailed Catalog

Mail the postage-paid card today for our free 100-page catalog with color photos of all kits and equipment, complete lesson plans, convenient time payment plans, and information on other electronics courses. You'll also find out about NRI's new Computer Technology Course that includes your personal microcomputer. Or Complete Communications with 2-meter transceiver. If card has been removed, write to:



**NRI Schools**  
McGraw-Hill Continuing  
Education Center  
330 Progress Avenue  
Scarborough, Ontario M1P 2Z5  
or telephone 416-293-1911



**Now from Sprague...**

2x ACTUAL SIZE

# The ultra-thin film capacitors you've been asking for.

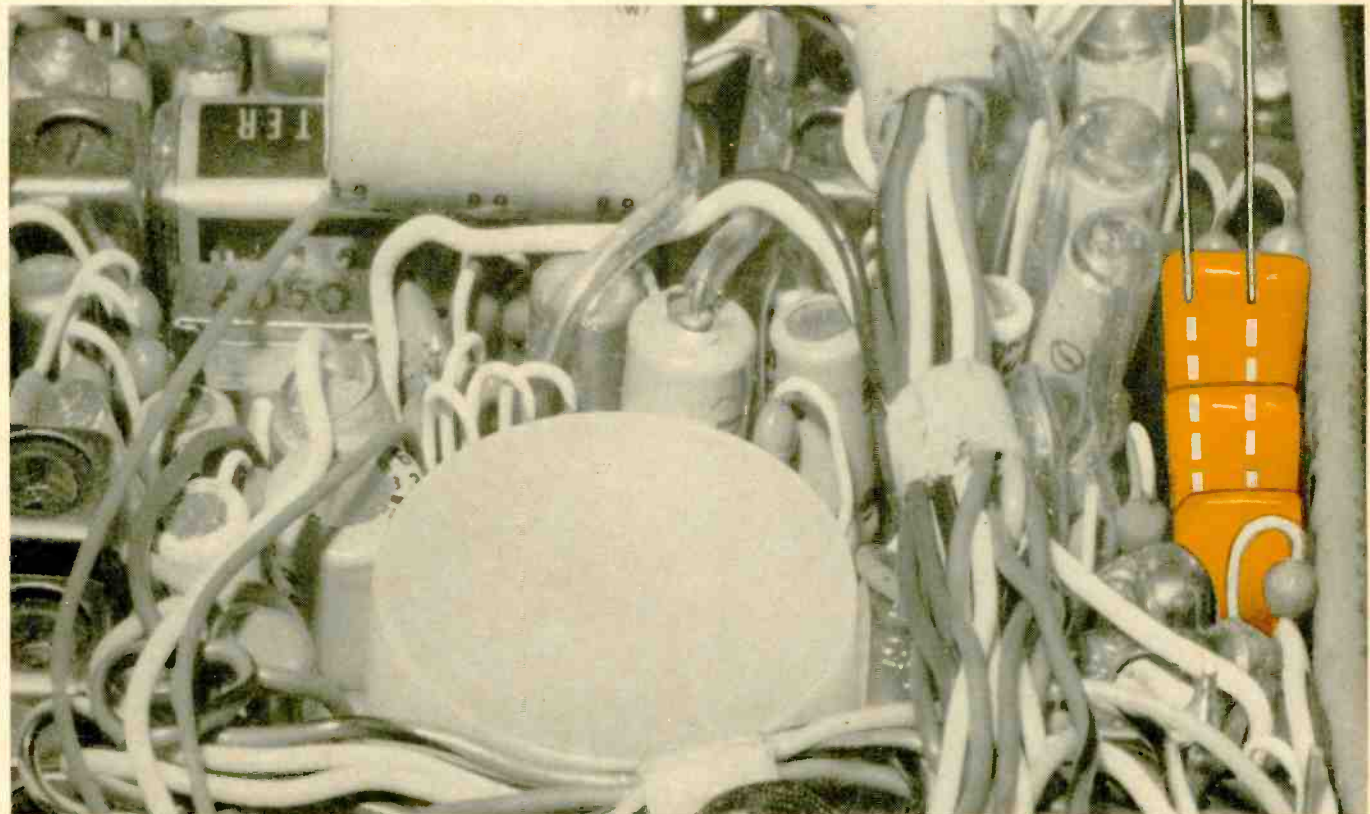

Low-cost Verti-Film\* epoxy-coated polyester-film capacitors help you beat the cost/space squeeze when servicing imported communications and entertainment electronic equipment, letting you make exact replacements on crowded PWBs quickly and easily. Their single-ended design permits vertical installation in far

less space than required by conventional axial- or radial-lead film capacitors.

Rated at 100 WVDC, Verti-Film Capacitors range in capacitance values from 0.001 to 0.47  $\mu\text{F}$  with a tolerance of  $\pm 10\%$ . Get Verti-Film Capacitors from your Sprague distributor.

\*Trademark

For the name of the Sprague distributor nearest you, write or call:

## TRANS CANADA ELECTRONICS LTD.

1900A Eglinton Ave. East  
Scarborough, Ont. M1L 2L9  
Tel. (416) 757-4171

P.O. Box 117, Dollard Des  
Ormeaux, Que. H9G 2H5  
Tel. (514) 747-4266

## SMITH-PATTERSON & ASSOCIATES

1120 Hamilton St.  
Vancouver, B.C. R3E 2T1  
Tel. (604) 681-0743

489 Kensington St.  
Winnipeg, Manitoba R3J 1J8  
Tel. (204) 885-1376

**YOUR NUMBER 1 SOURCE FOR ELECTRONIC COMPONENTS**

**SPRAGUE®**

THE MARK OF RELIABILITY

a  
**General  
Cable**  
subsidiary

\*Sprague and ® are registered trademarks of the Sprague Electric Co.