

electronics today

JULY 1978

Build These Projects:

Magic Proximity Switch

LED Audio Analyser

Electronic Race Track

Accentuated-Beat Metronome

How To Use Feedback/Heathkit Pinball Review
TI Programmer Review/Intro to Amateur Radio

Digital Multi-Meter Survey

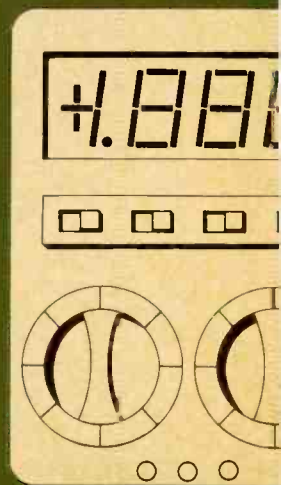
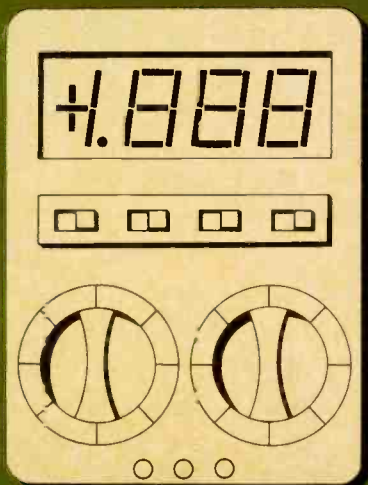
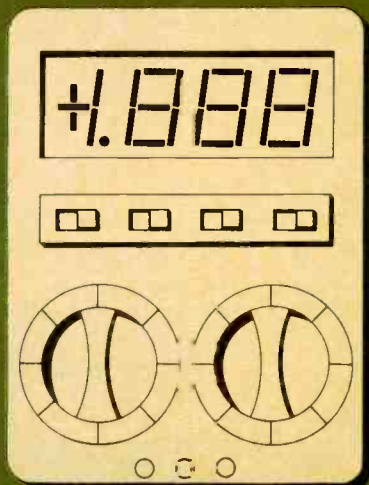
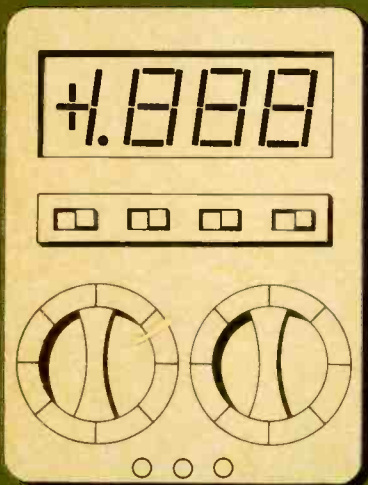
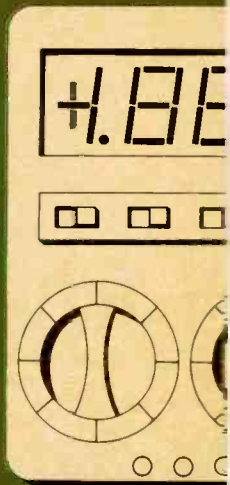
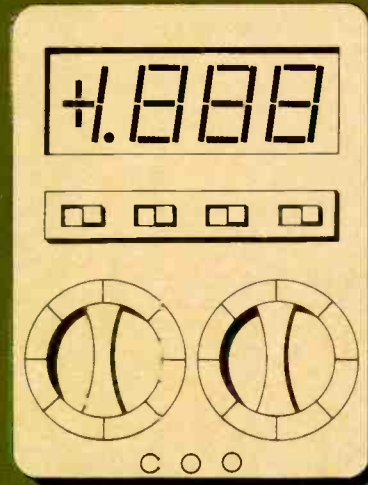
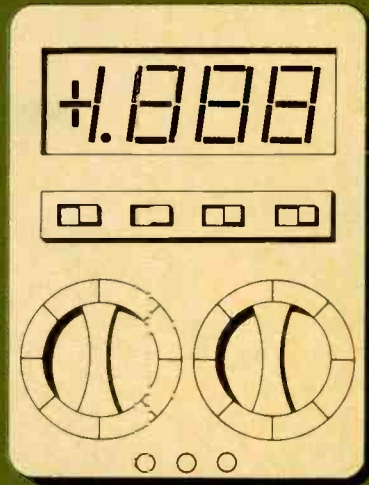

Best way to replace a dipped solid-tantalum capacitor

Use a Sprague Type SD Tantalex® Replacement Capacitor. You can count on its matching or exceeding the original quality of the capacitor it replaces. Quality features include:

- 1 High stability with very little capacitance change even at outer limits of operating temperature range of -55°C to +85°C (-67°F to +185°F).
- 2 Low dissipation factor permits higher ripple currents.
- 3 Capacitance tolerances of ±10%.
- 4 Hard epoxy coating that's highly resistant to moisture and mechanical damage.

Sprague makes it easy

Cabinet assortment KT-10 contains 70 Type SD Dipped Tantalex Solid-Tantalum Capacitors in 16 most-frequently-used ratings. They're prefiled for easy finding in six compartmentalized and labeled drawers. You pay for the capacitors only... the cabinet is yours at no extra cost!

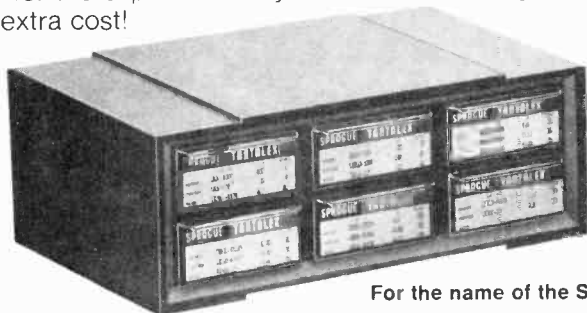

For the name of the Sprague distributor nearest you, write or call:

TRANS CANADA ELECTRONICS LTD.

1900A Eglinton Ave. East
Scarborough, Ont. M1L 2M1
Tel. (416) 757-4171

P.O. Box 117, Dollard Des
Ormeaux, Que. H9G 2H5
Tel. (514) 747-4266

SMITH-PATTERSON & ASSOCIATES

1120 Hamilton St.
Vancouver, B.C. R3E 2T1
Tel. (604) 681-0743

30 Midland St.
Winnipeg, Manitoba R3E 2Y6
Tel. (204) 774-1855

YOUR NUMBER 1 SOURCE FOR ELECTRONIC COMPONENTS



a
**General
Cable**
subsidiary

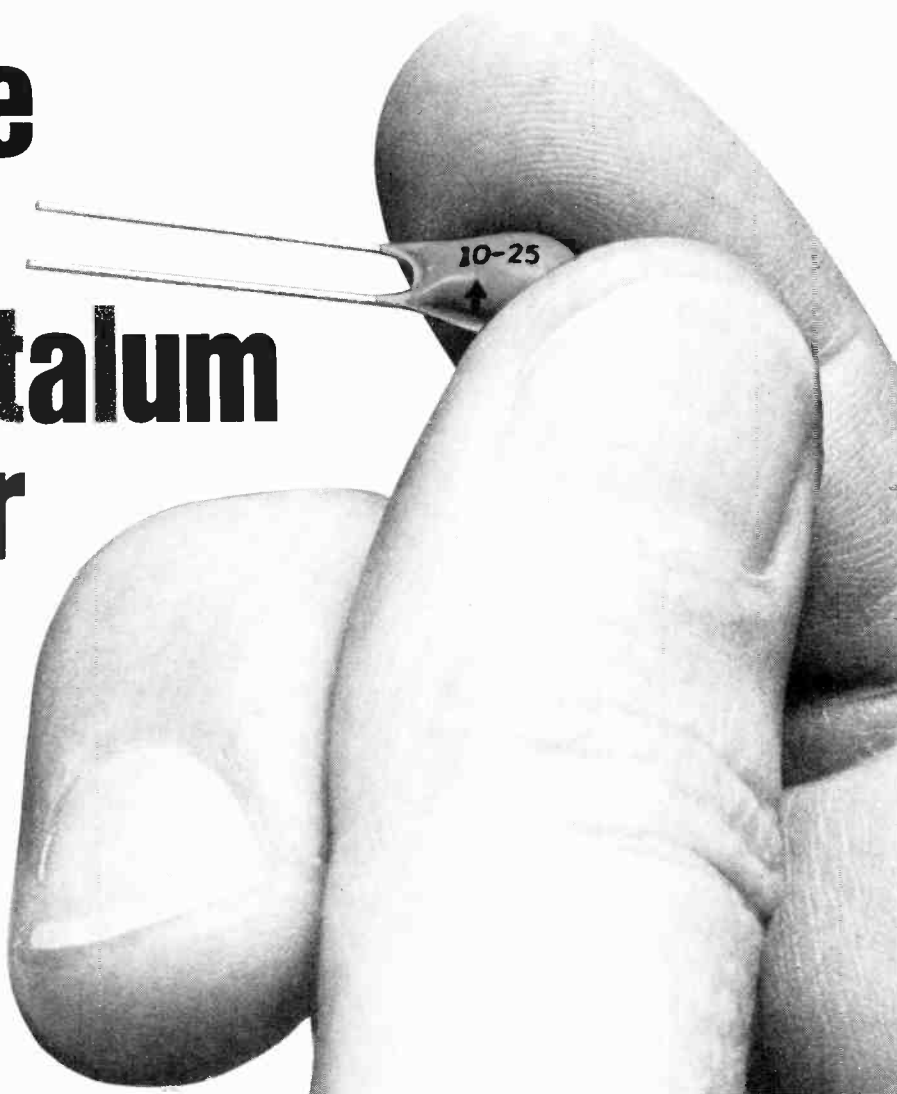

KT-10 ASSORTMENT (All units 35 WVDC)

Quan	Cat. No.	μF	Quan.	Cat. No.	μF
4	SD35-R109	1	4	SD35-2R29	2.2
2	SD35-R159	15	1	SD35-3R39	3.3
2	SD35-R229	22	8	SD35-4R79	4.7
2	SD35-R339	33	8	SD35-6R89	6.8
5	SD35-R479	47	10	SD35-109	10
2	SD35-R689	68	2	SD35-159	15
8	SD35-19	1.0	8	SD35-229	22
2	SD35-1R59	1.5	2	SD35-339	33

Editor
STEVE BRAIDWOOD BSC

Assistant Editor
GRAHAM WIDEMAN BASC

Marketing Manager and Advertising

PETER E. PRIEST

Advertising Services

SHARON WILSON

Advertising Representatives

JIM O'BRIEN

Eastern Canada JEAN SEGUIN &
ASSOCIATES INC., 601 Cote Vertu,

St. Laurent, Quebec H4L 1X8.

Telephone (514) 748-6561.

Subscriptions Department

BEBE LALL

Accounts Department

SENGA HARRISON

Layout and Assembly

GAIL ARMBRUST

Contributing Audio Editor

WALLACE J. PARSONS

EDITORIAL AND ADVERTISING

OFFICES

Unit 6, 25 Overlea Boulevard,

Toronto, Ontario, M4H 1B1

Telephone (416) 423-3262

Second Class Mail registration number 3955.

Return postage guaranteed. Post Office returns

to Unit 6, 25 Overlea Boulevard, Toronto,

Ontario, M4H 1B1.

Published by Electronics Today

International (Canada) Ltd.

Printed by Livingstone Printing Ltd.

News Stand Distribution Gordon &

Gotch, Toronto.

Subscription Rates \$12.00 per year,

\$20.00 for two years

Copyright: All material is subject to world-wide

Copyright protection. All reasonable care is

taken to ensure the accuracy of the information.

ALL ETI PCB PATTERNS ARE COPYRIGHT.

NO COMPANY MAY SELL BOARDS TO OUR

DESIGNS WITHOUT OUR PERMISSION.

INTERNATIONAL EDITIONS

Electronics Today International

25-27 Oxford St., London W1R 1RF, UK.

Editor Halvor Moorshead.

Electronics Today International,

Ryrie House, 15 Boundary St.,

Rushcutters Bay, Sydney, Australia.

Editor Collyn Rivers.

Electronica Top Internationaal,

Postbus 260, Emmen, Holland.

Editor Anton Kriegsman

Elrad,

Kommanditgesellschaft, Bissendorfer

Strasse 8, 3000 Hannover 61, Germany.

Editor Udo Wittig.

electronics today

international
incorporating electronic workshop

CANADA'S ELECTRONICS MAGAZINE

PROJECTS

REAL-TIME ANALYSER #2	34
<i>A simple design using LED displays</i>	
ELECTRONIC RACE TRACK	38
<i>A simple game using CMOS and LEDs.</i>	
PROXIMITY SWITCH	41
<i>Walk near the sensor and the relay switches on</i>	
ACCENTUATED-BEAT METRONOME	44
<i>Tick tick tock, tick tick tock. . .</i>	

FEATURES

AUDIO TODAY	9
<i>Wally Parsons says what he thinks</i>	
DIGITAL MULTIMETER SURVEY	16
<i>Graham looks at DMMs available in Canada</i>	
HEATHKIT/BALLY PINBALL MACHINE	26
<i>Steve shows you inside the Fireball</i>	
ETI DATASHEET	47
<i>The MM5837 digital noise source IC</i>	
FEEDBACK EXPLAINED	49
<i>Wally Parsons looks at feedback in electronic circuits</i>	
INTRODUCTION TO AMATEUR RADIO pt 1	55
<i>Amanda King tells you how to have fun</i>	
THE TI PROGRAMMER	62
<i>Bill Johnson shows us this calculator for computer people</i>	
ETI SOFTSPOT	64
<i>Factorials on your programmable calculator</i>	
TECH TIPS	66
<i>Ideas for experimenters</i>	
PROJECT FILE	73
<i>Updates for project builders</i>	

NEWS & INFORMATION

News Digest	4	Classified Advertising	63
ETI T-shirts	6	ETI Back Issues	67
Canadian Projects Book	8	ETI Panel Transfers	68
Audio Today Letters	14	The Fun of Electronics	70
Next Month's ETI	25	ETI Club Call	71
ETI Binders	48	ETI Publications	72
ETI Subscriptions	59	ETI Marketplace	74
ETI Feedback	60	Reader Service Information	74

NEWS DIGEST

The Replicator: Turns Signals Into 3D Forms

Imagine the possibilities: play a tape, dial a phone number, pick up a broadcast, connect to a computer — you could use any of the established media for generation, storage, or transmission of electrical signals — and feed a 'replicator'. Out comes a solid three-dimensional model made of plastic. It might be the spare part you ordered, the realisation of a design your computer just generated, a model of a microscopic/astronomic/buried/transient/fragile/or-otherwise-hard-to-grasp object, a 3D graph, etc.

OMTEC, a Californian company, has the patent (number 4078229) and commercial development of the idea is being negotiated in cooperation with Battelle Columbus Laboratory (developers of the first Xerox copying machines). Dr. Carl Verber, physicist at Battelle, has been working on a 3D television which uses, instead of a screen, a chamber of gas which fluoresces only when coincidentally

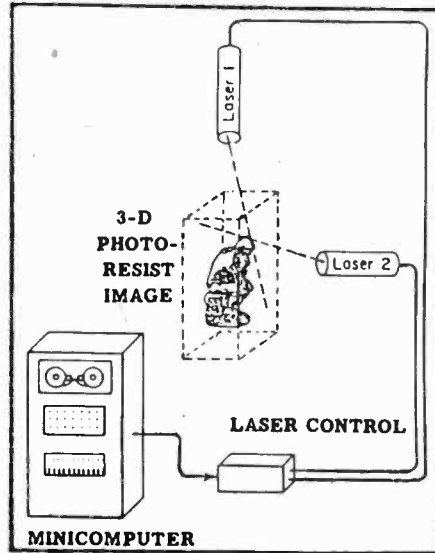

illumined by two laser beams. The space in the chamber is scanned in a

way analogous to that of 2D TV — but this time the dot covers all points in 3D space.

The replicator works like the 3D TV — in fact in some ways it is simpler. The replicator takes a single scan of the space in the chamber, but instead of fluorescent gas the chamber is filled with something like the photo-sensitive plastic used on printed circuit boards. The plastic hardens when the dot is bright and a solid model is produced.

The model can be easily used to make injection moulds or dies for precision manufacturing — modern casting and moulding technology in combination with the replicator could accelerate industrialisation in parts of the world with no present machine-tool infrastructure.

As far as the future, how about someone coming up with a version of the replicator which produces a solid model which changes with each new scan of a 3D TV signal; ie, solid 3D TV.

SMPS Capacitors

The 91F series capacitors from CGE are designed for use in switching-mode power supplies. They feature low ESR and high ripple current handling ability. More details from the Canadian General Electric Company at 189 Dufferin Street, Toronto, Ontario, M6K 1Y9. Phone (416) 537-4481.

DIP Nicad

Datasentry is a nickel cadmium battery in a miniature DIP-style package. There are two models available: DS2SD — 2.4 volt, 65 mAh — and DS3SD — 3.6 volt, 65 mAh (both measured at a 1 hour discharge rate). These batteries incorporate such features as: solvent resistant plastic case, continuous overcharge capabilities, resealable safety vent, polarity keyed terminals, and flat discharge voltage profile.

Datasentry batteries are recommended for use in microprocessor and microelectronics applications to protect memory and to provide reliable standby power. For further information contact Canadian General Electric Company, Electronic Components, 189 Dufferin Street, Toronto, Ontario, M6K 1Y9, Phone (416) 537-4481.

Sealed Lead Acid Battery

The newest of CGE's rechargeables is the Yuasa battery. This maintenance-free efficient power source can be operated in any position without fear of electrolyte leakage or loss of capacity. Many 6 volt & 12 volt models are available with conservative power ratings ranging from 1.2 Ah to 8.6Ah.

New Sams

Lenbrook Industries (1145 Bellamy Road, Scarborough, Ontario, M1H 1H5) have sent us details of nine new books from Sams. The titles are: The North American Radio-TV Station Guide (12th Edn.), Building and Installing Electronic Intrusion Alarms (2nd Edn.), Understanding IC Operational Amplifiers (2nd Edn.), Industrial Electrical Systems, Automotive Alternators by AEA/ASIA, Television Symptom Diagnosis, Cable Television, Semiconductor General-Purpose Replacements, and the first Photofact publication covering videocassette recorders: VCR-1 (for Sony machines). Photofact VCR is planned for RCA, Zenith, JVC, Magnavox, Panasonic and others.



Hameg Scope

The latest scope from Hameg is a dual-channel 10 MHz model with triggering up to 30 MHz. Including taxes the Canadian price is \$825, from BCS Electronics, Unit 5, 980 Alness Street, Downsview, Ontario, M3J 2S2. Phone (416) 661-5586.

Fast-Switching Transistors

A new family of high-voltage NPN silicon power transistors, called SwitchMax series, with fast switching speeds for off-line power supplies and other high-voltage switching applications, is now available from stock from RCA Solid State Division.

The transistors are particularly suited to such applications as off-line power supplies, inverter/converter circuits, and pulse-width-modulated regulators.

Copies of data bulletins (File No. 1090 for the 2N6671-3, File No. 1085 for the 2N6674-5, and File No. 1087 for the 2N6676-8) and an eight-page brochure, number 2M1217, may be obtained by writing RCA Solid State Division, Box 3200, Somerville, NJ 08876, or by calling Ed Uhler at (201) 685-6086. The brochure contains a certificate permitting a requester to obtain a free sample from an RCA distributor. U.S. unit prices range from \$3.82 (450V, 5A) to \$9.90 (650V, 15A) for hundreds.

ETCO catalogue

The new ETCO catalogue is available free to anyone who writes to ETCO Electronics, 183 Hymus Blvd, Pointe Claire, Quebec, H9R 1E9. The thirty-two pages list surplus bargains including tape decks 'removed from the House of Commons in Ottawa', Foto Vu security components (fake TV lenses, warning signs, turntable motors), microphones (underwater, shotgun, and other types), pots, transformers, and some test equipment.

CB regulations

The Department of Communications is recommending that the Minister amend or revoke and replace some sections of the General Radio Regulations, Part II. The proposals would prohibit GRS licensees from possessing linear amplifiers, would authorise station inspections, and would clarify some of the regulations open to misinterpretation.

The notice is numbered DGTR-005-78 and comments on the desirability of the proposals are invited by the Director, Operations Branch, 300 Slater Street, Ottawa, K1A 0C8, up to the middle of June.

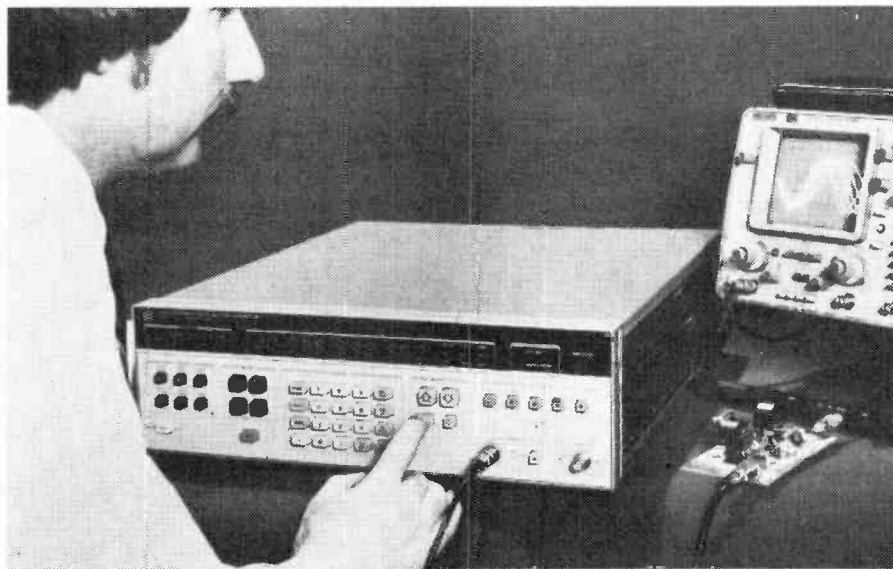

This microprocessor-based 40MHz spectrum analyser from Hewlett-Packard features 3Hz resolution and 0.5 dB accuracy over the range -137 dBm to +30 dBm. Using a controller CRT display titles and remote programming are possible via the IEEE-488 bus. Canadian price of the basic machine is \$22,190.

Display Devices Guide

A thirty-eight page product guide providing tabulated data and outline configurations for RCA's standard line of display devices has been released by RCA Electro-Optics and Devices, Lancaster, Pennsylvania. The product guide, STC-900E, gives a comprehensive treatment of display devices terms and definitions and phosphor screen characteristics. The guide includes data on the following: instrument CRTs, information display CRTs, photorecording CRTs, flying-spot scanner CRTs, display storage tubes, radar display CRTs, and projection kinescopes.

Copies of the STC-900E product guide may be obtained by writing to RCA, Box 3200, Somerville, New Jersey 08876, by calling (717) 397-7661, ext. 2712.

Energy Lifestyle

Whether or not we achieve efficiency in production and the use of energy will dictate the future of the lifestyle we now enjoy — according to the organizers of a special show for followers of the 'energy lifestyle'. The show will be held at The International Centre in Toronto on November 3-4-5, 1978. For further information contact 'The Energy Lifestyle Show', 3 Church St., Suite 603, Toronto, Ontario, M5E 1M2.

EICO phone

The new number for Eico is 883-5500; the number announced in last month's News Digest was incorrect.

Video Maintenance

The Recorder Care division of Nortronic Company, Inc, has announced QM-95 video cassette recorder maintenance kit. The manufacturers claim this to be the first



VCR maintenance kit for home machines. It contains all the products required to keep delicate heads free of dust, dirt and the accumulated tape oxide debris that can cause snowy pictures and possibly damage tapes.

For additional information contact Len Finkler Limited, 25 Toro Road, Downsview, Ontario, M3J 2A6.

You Too Can Look Like This:



They're here! ETI's quality Canadian-made polyester-cotton T-shirts are now in our office awaiting your order. These are really sharp merchandise — not cheap foreign shirts that fade and shrink when you wash them. They're nice and long to stop draughts around your midriff and they're trimmed on the collar and sleeves. Colour scheme is light blue with dark blue trim and design.

Fill out this coupon and send to ETI T-Shirts, Unit Six, 25 Overlea Blvd., Toronto, Ontario, M4H 1B1.

Please send me _____ ETI T-Shirts, sizes as indicated. I enclose \$ _____

Number of Shirts	1	2	3	4	5	Ontario Residents add
Price	\$5.50	\$10.00	\$15.00	\$20.00	\$25.00	4% Provincial Sales Tax



LARGE (40")

Number required



MEDIUM (37")

Number required



SMALL (34")

Number required

Name _____

Address _____

Town _____ Prov. _____ Postal Code _____

DO NOT SEND CASH

Cheque enclosed. A/C No. _____

Bill Mastercharge. Signature _____

Bill Chargex. Expiry Date _____



TRS-80 Microchess

Micro-Ware Limited of Toronto now has Microchess 1.5 for the TRS-80 microcomputer. Microchess is a 4K Z80 machine language program utilizing every available byte of user RAM in the TRS-80. The program has been designed to load using the CLOAD command.

Standard algebraic notation is used to describe the moves to the computer. Every move is verified for legality to prevent user error. A simple command allows temporary numbering of the squares to assist in move entry.

The chess board is displayed using the graphics mode on the TRS80. The moving pieces flash before they move to draw attention.

The program has three separate levels of play which will challenge all players from beginners to experts. Microchess 1.5 is an expanded and improved version of Microchess 1.0 which has been available for the 8080 and 6502 microprocessors for over a year.

Microchess 1.5 will be the first in a series of assembler and BASIC programs for the TRS80. Currently close to completion are 'Blockade', two-player game of skill and strategy; 'Robot', a dazzling computer graphics language with macro capabilities; and 'Life', the graphic cellular automata

simulation. All of these products will be available by July 1, 1978.

Micro-Ware products are available by direct mail from 27 Firstbrooke Rd, Toronto, M4E 2L2, or telephone (416) 424-1413. They are also stocked in computer stores across the continent. The price of Microchess 1.5 is \$19.95, postage prepaid.

VE3MPU

On Tuesday May 30th amateur FM in Toronto took a step forward — a microcomputer built by the Toronto FM Society was connected in circuit to control two FM repeaters: VE3RPT and VE3TFM. Users of VE3TFM, if they listen carefully, can hear a soft click 1s after the squelch closes. This is where the computer relinquishes control and the old logic takes over. The old logic will be left in VE3TFM until the microcomputer is fully tested and debugged (at which time the call VE3TFM will be changed to VE3MPU). During the transition the call VE3MPU will be used to alert users to the fact that the microprocessor is in full control.

Until such time as the program is fully developed, the repeater, when unattended, will be left in the 'failsafe' mode and the intelligent functions of

the program will not be available.

Users of VE3RPT and VE3TFM can look forward to greatly improved autopatch — in which users will not dial directly into the phone line, but the number will be dialled by the computer. This means that the club will have tighter control over unauthorised or improper use, as well as being able to offer some valuable extra functions, such as emergency speed calling. This enables users to be connected directly to Metro police or the OPP, simply by dialing 911 or 912 without having to know the autopatch access code.

Another benefit to the club is that non-members trying to figure out the repeater's command codes will be thwarted by a multi-level password system, the codes for which can be changed daily (and passed around only to those officials legally required to be in control of the repeater).

Bill Johnson, designer of the microprocessor-based system, will be talking about his work with the repeater at the RSO convention in London this October. A duplicate of the VE3MPU computer is planned to be used to control the VE3TTT repeater in London.

Micro Age 78

Sheridan College is hosting Micro Age 78, to be held June 1 and 2 at the Oakville Campus.

More than 30 exhibitors will display their latest microcomputer equipment (some not even on the market yet) and demonstrate uses for such fields as small business management, word processing, environmental management, education and process control.

The exhibition/conference, will run from 10 a.m. to 10 p.m. each day. Among the speakers is Daniel Alroy, President of Q1 Corporation, which manufactured the world's first microcomputer system in 1972 and was the first manufacturer to deliver magnetic bubble memory (1977).

Admission to Micro Age '78 is \$3 per person (free parking). Sheridan College is located on Trafalgar Rd. in Oakville, Ontario, just north of the QEW. For further information, contact the Oakville Campus, (416) 845-9430 or 823-9730, ext. 286.

CANADIAN PROJECTS BOOK NO. 1



5W Stereo Overled	Fuzz Box
Bass Enhancer	Mastermind
Disco Modules	Reaction Tester
Metal Locator	Burglar Alarm
GSR Monitor	Injector-Tracer
	Digital Voltmeter

HEART-RATE MONITOR

By clipping an illuminated bulb to one side of your ear-lobe and clipping an LDR to the other side, you can monitor the changing translucency of the tissue as blood spurts through the blood vessels. The signal from the ear-lobe detector is cleaned up and squared off and then fed to a frequency-to-voltage convertor which, after buffering, drives an analogue meter. This project is not meant for use as a serious diagnostic instrument. It can be used by those experimenting in biofeedback or by sportsmen in training.

DOUBLE DICE

A project to get you started in CMOS digital electronics. A decade counter is made to divide the output from an oscillator by six. The dice rolls while a button is pressed and continues to roll (now slowly) for a short while after release. Consumption from the battery is so low that we use no on-off switch. The results are truly random.

TOUCH ORGAN

What's so neat about this project is that it is all on one PCB. Twenty-seven touch-switches are laid out on the copper side of the board to give a full two-octave keyboard and tremolo switch. There are two voices available, and a volume control. The project is easy to build, uses 12 ICs and runs from a 9V battery.

PHASER

The effect of the phaser or phlanger will be well-known to readers who are interested in popular music. The ETI phaser achieves the desired effect by splitting an audio signal into two paths and re-mixing the components after one has undergone a phase change. This change takes place in six RC networks, each capable of 180° shift at high frequencies. This gives a comb-shaped response (3 minima) for the unit as a whole. The characteristic whooshing sound occurs when we change the resistive elements of each RC section (using a 4049 as six sets of complementary FETs) under voltage control from a triangle-wave oscillator.

AUDIO LIMITER

This stereo device uses a 4049 CMOS hex-inverter IC to provide enhancement-mode FETs for use in a voltage-controlled attenuator circuit. The project can be used to limit audio peaks to prevent amplifier clipping, to reduce the dynamic range of a signal for recording, or as a voltage-controlled volume control for remote or automatic operation.

SOUND-LIGHT FLASH

This project senses a change in light or sound and, after a predetermined delay, operates a photographic flash unit. You can photograph glass shattering, any violent impact, splash, clap explosion, etc.

Please fill out the card and send to: **ETI Magazine**
Unit 6, 25 Overlea Blvd., Toronto, Ontario, M4H 1B1

HUNTER AND *Tom*^{*} present

TORK-IT

A SUPER PROBLEM SOLVER THAT BELONGS IN EVERY TOOL BOX

- COMES WITH 5 DIFFERENT BLADES
- USED AS A REGULAR DRIVER
- HANDLE SWIVELS — STRAIGHT FOR NORMAL USE, "T" STYLE FOR HIGH TORQUE USE

Drives or loosens self-tapping sheet metal or case hardened screws. Will loosen frozen screws or those set with power or impact drivers. 6 piece set in heavy duty plastic kit comes complete with swivel handle, 3 phillips blades and 2 slotted hex driver blades. Blades are special shock resistant alloy tool steel, electronically heat treated and tempered.

**Tom* — OUR TOOL OF THE MONTH CAT!



Write for Free Hunter Tool Catalogue

len finkler ltd

25 Toro Road, Downsview, Ontario M3J 2A6
Telephone (416) 630-9103 Telex 065-24010



NEW! The NLS Portable Digital Multimeter Only \$142!

FST included

Full 3 digit display, the low price of an analog meter, and true portability make the NLS LM-300 the outstanding digital multimeter for service men.

Weight: under 10oz. Size: 1.9" x 2.7" x 4". Resolution 1mV. Auto zero and polarity indication, with + and — displayed. 3½ and 4 digit models available. For more information, contact

METERMASTER,
214 Dolomite Drive,
Downsview, Ontario
M3J 2P8.
(416) 661-3190

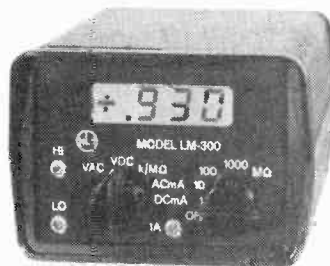

WITH LIQUID CRYSTAL DISPLAY

METERMASTER LM-300
Portable Digital Multimeter

Metermaster

R.H. NICHOLS

Toronto (416) 661-3190 • Montreal (514) 337-0425 • Edmonton (403) 432-7746



Audio Today

Developments in audio reviewed by Wally Parsons

MOST READERS, I'm sure, are aware of the importance of wide bandwidth, and of flat response. Modifying frequency response by boosting or attenuating certain frequencies produces a change in tonal character, but often the results are quite different from what is expected. Thus a high frequency boost might add harshness rather than brightness to the sound, or reducing the midrange can produce boominess, rather than spaciousness. And yet, large changes in response in some areas of the spectrum may produce only slight variations in overall sound or in the tonality of certain instruments. This can be quite perplexing and frustrating when setting up a multi-way speaker system, for example, and finding that no matter how the different drivers are balanced, it never really sounds right, so that vocal recordings may have just the right amount of presence (although still lacking that elusive quality of "realism"), and orchestral music becomes brittle, and lacking in fullness.

WHAT YOU HEAR

An examination of the audio frequency spectrum, the musical scale, and auditory response reveals greater complexities than commonly believed.

The human auditory system is responsive to frequencies between about 20 Hz and 15kHz sometimes higher in young persons, and deteriorating with age, assuming the system to be in healthy condition. Acuity tends to be greatest around 200 Hz to 5 kHz. The musical scale, as represented on a standard 88 key piano extends from 27.5 Hz for a bottom "A" to 4180 Hz for a top "C". Above this we find high harmonics (including some speech articulation sounds) and high transient sounds. The most active region for instrumental music tends to

be from about 110 Hz (A_2) to 880 Hz (A_4), a range of three octaves. The human voice also is placed in this range extending downward to about 80 Hz for a Bass up to just over 1 kHz for a Soprano. Obviously, what happens in this three-octave band is of considerable importance.

THE MIDDLE

One assumption which is almost an axiom, especially with respect to loudspeakers, is that the extreme lows and highs are very difficult to reproduce, therefore the midrange can generally be left to take care of itself. Nothing could be further from the truth and the realization of this on the part of the designer has made many an unspectacular looking speaker sound eminently listenable. A typical three-way speaker with cross-overs at 500 Hz and 5 kHz demands that the mid-range unit cover a decade bandwidth, and the woofer a decade or even more, with the cross-over in the middle of the most critical portion of the mid-band.

A prominent rise in the lower part of this band can give rise to a boxy kind of sound, whereas a dip can produce a quality of thinness. Excessive response in the bottom part of such a midrange unit (that is, just above 500 Hz) produces a muffled and constricted quality, while a broad suck-out may add a certain spacious, or airy quality, which seems better defined, yet actually lacking in detail. If woofer and midrange are not matched in level at the crossover we have the additional phenomenon of hearing abrupt level changes through the musical scale. Indeed, most major differences in sonic character between speakers can be attributed to relatively small differences in this lower midrange, largely due to differences in the

compromises made in the relationship between drivers.

A LITTLE HIGHER

Above the mid-range lies the upper mid-range, sometimes called the lower treble, covering the octave between 2500 Hz and 5000 Hz. Because of the ear's extreme sensitivity in this region, relatively small level changes can have a profound effect on the quality of "presence" or forward placement of voices and individual instruments. Moreover, this octave is predominantly harmonics, especially of the female voice and the upper musical registers, thus the harmonic structure and therefore the tonality of much of the music is profoundly dependent on this region. Too much level here can cause harshness, or brittleness. But if response is ragged we may have a choice of either excessive harshness, or lack of presence, but never "just right".

A LITTLE LOWER

Below the midrange lies an octave from about 160 Hz to 320 Hz which forms the upper bass region. This region is especially affected by speaker placement relative to the floor. Too low a placement accentuates response producing boominess, while too high a location results in thin bass. Both qualities contribute to listener fatigue and are particularly common to moderate size speakers of the kind a little too large for a bookshelf and too small for the floor. Also in this region lie the second harmonic of the low male speaking voice and some fundamentals of the tenor and female speaking voice, so anomalies in this region can do some strange things to speech tone.

It may come as a surprise to learn that most bass fundamentals occur in the next octave, that is down to about 80 Hz,

the lower limit of the trombone, and the full range of tympani. The double bass has an additional octave to 41.2 Hz and the piano goes down another major sixth to 27.5 Hz. Thus, response which rolls off below 80 Hz will lose little of the bass fundamentals. However, room resonances (both listening room and studio) may appear in this region, and much of the ambience of the performance which is responsible for that feeling of solidity which characterizes a very wide range system. Unfortunately, rumble and other undesirable effects also live down here and the removal of such mud will actually improve the feeling of solidity.

The region just below 100 Hz, as well as the upper bass, also contains many of the fundamentals of the speaking voice, and a boost here will give rise to "chestiness". Unfortunately, this is also caused by FM radio announcers trying to swallow the mike in order to sound sexy, a practice more common in this country at the private stations than at CBC, whose technicians go to the opposite extreme and castrate the voice with excessive bass cut.

NEAR THE TOP

Finally, a leap up to the highs, from about 5 kHz up to 20 kHz. Up here we

find only the harmonics of tonal instruments, and fundamentals of such percussive instruments as cymbals, castanets, etc. Variations in response in the first octave (5kHz to 10kHz) affects brightness, especially around 7.5kHz, and is most noticeable on strings, high woodwinds, soprano voice and sibilants. Many low compliance pickups begin to lose trackability in this range, which is why it shows up first on sibilants. Also, since it is so close to the commonly used cross-over of 5 kHz, interactions between mid-range and tweeter drivers, and cross-over design faults influence the reproduction of such signals. Beyond brightness lies stridency and shrillness, but, conversely, harshness can often be controlled by bringing down the response in this region. Some slight boost can also effectively extend the useful range of older recordings and AM (and even some FM) broadcasts.

The final octave, from 10 kHz to 20 kHz is important for the quality of airiness and realism imparted, provided there is actually some signal to reproduce, which is less often than we would like. A rising response here can accentuate noise and irregularities in pick-up performance, while a gradual roll-off, especially in conjunction with

the next octave below will often do a remarkable job of reducing noise without severely degrading signal quality.

PLAY WITH IT!

Readers with graphic equalizers might wish to experiment with them, altering the balance of several octaves at once to observe these effects. Similarly, consideration of these effects should prove useful in setting up multi-way speaker systems. In my own experience I've rarely encountered such a speaker which has been set up properly or gave any indication that the user knew what he was doing. Especially common is the practice of cranking up the tweeter in the mistaken belief that in operation it should definitely make its presence known. Or reducing both midrange and tweeter to bring up the bass. All that happens, of course, is that the sound is boomy and muffled. In fact, if bass and mid-range response are matched and level, the result is actually an **increase** in perceived bass, because by setting up the correct relationship between fundamental and harmonics, the bass instruments become more prominent to the ear-brain system.

Audio Today Products

Audio developments reviewed by ETI's Contributing Audio Editor Wally Parsons

About two years ago I began development of a large three-way transmission line loudspeaker system. Although it was completed quite some time ago the design has been modified and refined to the point where pleasingly high level of performance has been realized. The design featured a Philips model AD 0210/W8 dome midrange with a 12 dB/Octave cross-over at 500 Hz and 5000 Hz. Several modifications to the basic unit have been made, include diaphragm doping and transmission line loading with generally rewarding results.

PHILIPS DOME

It was with great interest, then, that I approached the task of evaluating the newest addition to the line, the Model **AD 0211 SQ/W8**. Basically it is the same

unit, but the paper dome has been replaced with a fabric which is continuous with the fabric suspension, fundamental resonance has been raised from 270 Hz to 370 Hz, and the rear loading chamber now utilizes a synthetic long fibre damping material.

Of particular concern was the prospect of improved transient response, the published response curves being essentially the same as the original model, as shown in Fig. 1.

When used as a direct replacement for the original unit the primary benefit was the improved transient response, but in addition a few other problems were solved. For one thing, distortion near the resonant frequency is lower, a quality where was especially apparent on choral music. In addition a smoother transition occurs between the mid-

range and the Peerless tweeter. Both are cloth dome devices and exhibit minimal, but similar colouration, while still remaining compatible with the Philips woofer.

Two problems did present themselves, however. The irregularity (dip and peak) above 7 kHz ordinarily might be considered insignificant since it is outside the intended pass-band, and is therefore attenuated by the crossover. I don't happen to agree. Even with a 12 dB/octave slope considerable energy is radiated by both tweeter and woofer and the phase shifts which result do have a detrimental effect, particularly with a system intended to exhibit a high level of phase coherency. This problem also existed with the predecessor and was due to the same cause: cavity resonance in the

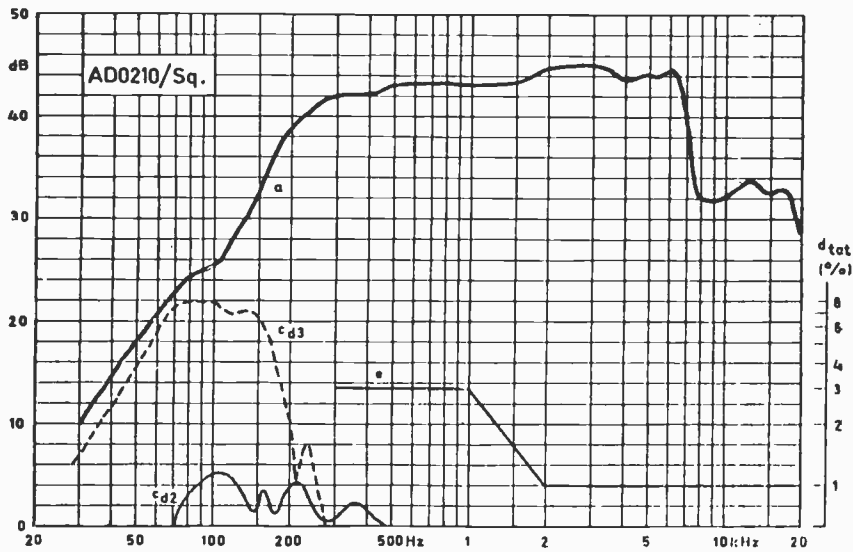

Curve a: Sound pressure measured in Anechoic room at 5 watts
 c: Second and third harmonic distortion measured at 5 watts Anechoic room.
 e: Maximum distortion limit of DIN 45500.

Fig. 1. Response of PHILIPS AD0211 SQ/W8

centre pole. This pole is really a hollow ring which couples the rear of the dome area to the loading chamber. The cure for the problem was the same. It involves removing the moving assembly (and, incidentally, voiding the warranty) and filling the cavity with fibreglass, then re-assembling the unit. I don't recommend this bit of surgery to someone with shaky hands, but should any reader be interested just drop me a line (with a stamped, self-addressed envelope) and I'll spell it out. Another contributing factor is the very short conical horn which produces a gradual rise in output with frequency. I understand that Philips plans on releasing a flat mount midrange dome later this year, but in the meantime I've made one of my own which is not yet in use.

It should be mentioned too, that this response is more likely if the unit is directly coupled to an L-Pad. Flatter response is obtained by using a high impedance source (relatively speaking) such as the circuit shown in Fig. 2.

At this point I found myself with a golden opportunity to begin development of a somewhat different approach. A 6 dB/octave constant resistance cross-over is inherently phase coherent. The trouble is that the cross-over has to be at least two octaves

above resonance. This dictated a 1500 Hz cross-over. But the Philips AD 12100 Woofer is not suited to such a high crossover. The solution is obvious: either change the woofer, or go to a four-way system. Happily, I had on hand a pair of Peerless U610's, with resonance at 85 Hz, and in a short transmission line delivers a lovely smooth response from 200Hz to over 2kHz after which it begins to rise slightly and become directional. Meanwhile, the Philips dome is nicely smooth above 1 kHz with a wide dispersion pattern. Crossing over at 1500 Hz made possible a lower midrange cross-over of 350 Hz, so that all drivers handle less than a decade, except for the woofer which, with transmission line loading covers the range of 20 Hz to 350 Hz. Such a set-up also makes possible fine, subtle, and very precise adjustment of the balances of each driver.

Fig. 2. Network for flatter response.

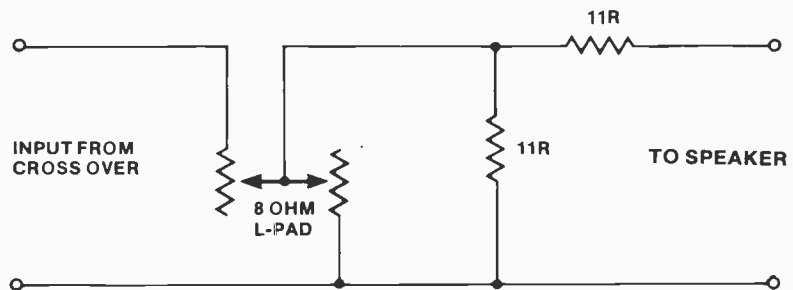

Jensen Triaxial® 3-way Speakers

Quite simply, the most advanced car stereo speaker ever.

For the best sound ever in your car. The first car stereo speaker with a woofer, a tweeter and a midrange.

Identical in principle to the best home stereo speakers. Jensen's midrange picks up a whole range of tones lost to any other car speaker.

Write today for Free catalogues and the name of your nearest Jensen Dealer —

len finkler ltd

25 Toro Road, Downsview, Ontario M3J 2A6
 Telephone (416) 630-9103 Telex 065-24010



Audio Today

Although some criticisms have been made they have been more along the lines of improving what is actually an excellent driver. Response is quite smooth considering the operating range and the difficulty in adequately loading a dome down to a relatively low frequency, efficiency is high enough to be compatible with most infinite baffle or reflex or transmission line woofer systems, and dispersion splendid. One of my minor amusements these days is to watch listeners trying to distinguish the transitions from lower mid-range to upper-mid-range (Philips dome) to tweeter. The performance of a complete system is, of course, a credit to the designer, but he still has to use good components.

Incidentally, Peter Thorne of Philips has suggested the model AD 7060/W as a suitable lower midrange unit, and I'm inclined to agree. Dispersion is wider than the Peerless, and it's a more rugged unit.

PHILIPS MODEL AD 0211 SQ, available in 8 ohms or 4 ohms from most Philips dealers, or contact PHILIPS ELECTRONICS LTD., Electron Devices Div., 601 Milner Ave., Scarborough, Ont. M1B 1M8.

NORTRONICS

From NORTRONICS the model QM230 cassette bulk eraser is hand held, and **self-powered**, requiring no batteries or external power source (that's what it says).

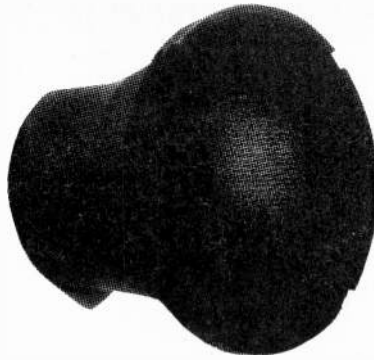

It lists for \$33.55, and is made in the U.S.A. Want to learn more? Contact LEN FINKLER LTD., 25 Toro Rd., Downsview, Ont., M3J 2A6

GAS

The Great American Sound Company (G.A.S.) introduces the SLEEPING BEAUTY Moving coil pickup, with a claimed response to 40 KHz, an output level of 0.27 mV at 5 cm/sec and compliance of 15×10^{-6} cm/dyne which means that you don't have to find a negative mass arm or invent anti-gravity to use it. Load impedance: 20-1000 ohms; Tracking force: 1.8 grams. Contact CHARLES W. POINTON LTD., 77 Akron Rd., Toronto, Ont., M8W 4W8

BLAUPUNKT

Blaupunkt introduces the HEIDELBERG AM/SW/LW/FM Stereo Cassette car radio and 6639 car speakers. The radio features electronic scanning on all bands and noise suppression on FM.

The speakers claim a response from 70-20,000 Hz, can handle 25 Watts music power (remember music power?) and look pretty neat.

Contact ROBERT BOSCH CANADA LTD., 6811 Century Ave., Mississauga, Ont. L5N 1R1.

NOTABLE BOOK

ELECTRONICS DESIGNERS CASE-BOOK Number 1, from McGraw-Hill, is a book which ordinarily wouldn't be reviewed in this column because it is not essentially an audio publication. However, two items of special interest include an article on active filters using loose tolerance parts and a nice little piece on hybrid transformer applications. Various other items of interest in other areas of electronics are covered in, and it lists at \$5.50. Contact LEN FINKLER (see Nortronics item).

When contacting distributors and dealers please remember to mention that you saw the product in ETI. That way the distributor will know he is dealing with a somebody who knows what he's about.

Distributors and manufacturers are invited to submit news of new products or developments. If you have a product (either complete component or component part) which you would like to see reviewed in these pages just let me know. Address mail to: AUDIO TODAY, Electronics Today International, 25 Overlea Blvd., Unit 6, Toronto, Ont. M4H 1B1.



Oscilloscope Probe

This passive probe incorporates a three-position slide switch in the head, and has a cable length of 1.5 metres.

Other probes available are:

x1	20MHz	Detector Probes
x10	100MHz	x100 Probes
x1 and x10	150MHz	H.V. Probes
x10	250MHz	

Model No. P522
Dual switchable
X 1 and X 10 100 MHz

\$41.95

Position x1
Bandwidth: D.C. to 10MHz

Position Ref.
Probe tip grounded via 9MΩ resistor, oscilloscope input grounded.

Position x10
Bandwidth: D.C. to 100MHz
Input Resistance: 10MΩ ± 2% when used with oscilloscopes with a 1MΩ input.
Compensation Range: 15 - 50 pF
Working Voltage: 500 Volts (inc. Peak AC)

BCS

ELECTRONICS LIMITED

UNIT 35, 980 ALNESS ST.
DOWNSVIEW, ONTARIO M3J 2S2

(416) 661-5585

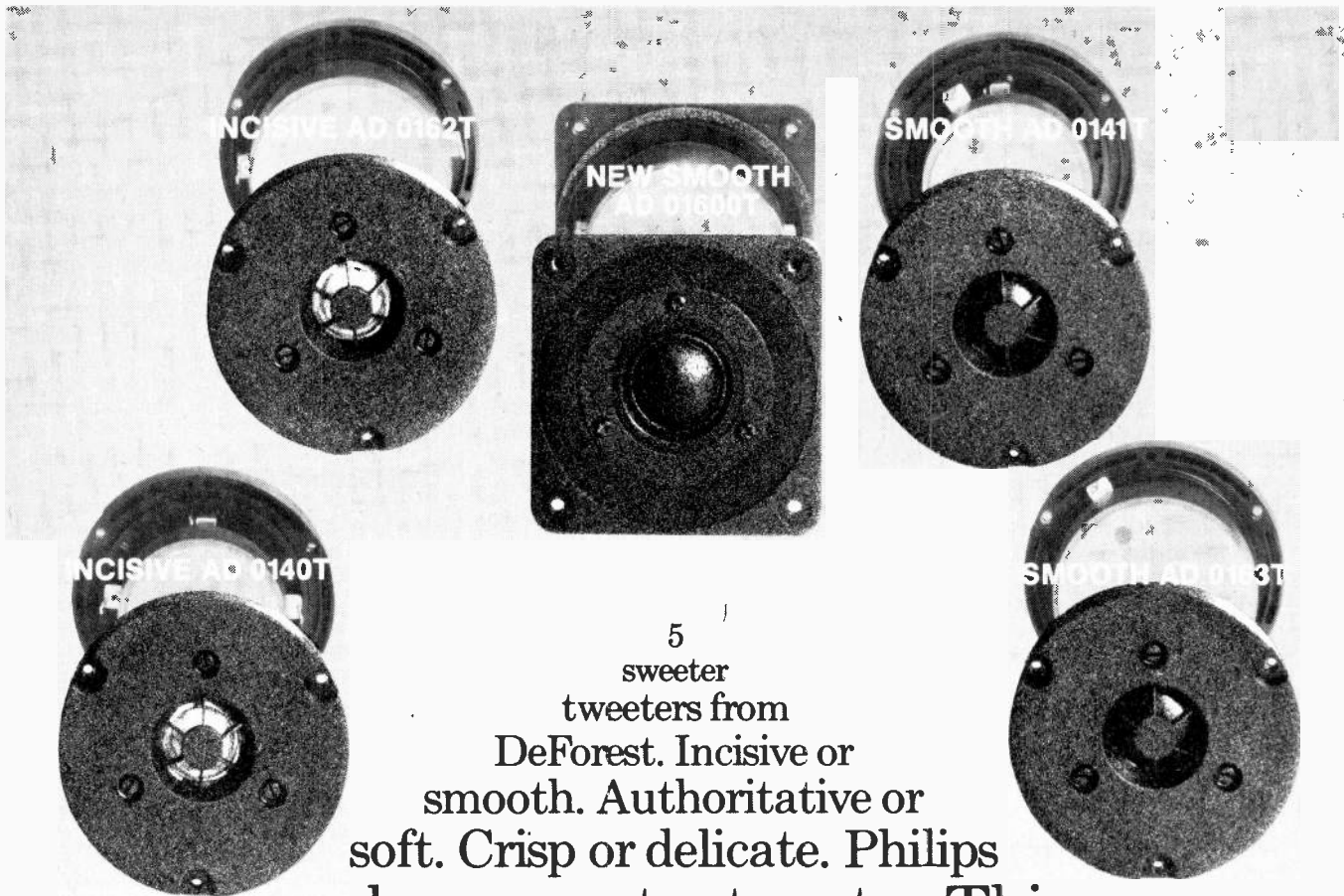

5
sweeter
tweeters from
DeForest. Incisive or
smooth. Authoritative or
soft. Crisp or delicate. Philips
makes a sweeter tweeter. This
is why the finest names in speaker
manufacturing around the world
use Philips DeForest tweeters.

Internationally, we, at Philips, have produced well over 3 million dome tweeters which is one reason our prices are low. Our large research team continually experiments, develops, innovates. We are one of the few who specify harmonic distortion levels for tweeters, midrange and woofers. When you choose a Philips DeForest tweeter you can be sure that you have a sweeter tweeter at a sweeter price.

Incisive AD 0140T 1" HiFi polycarbonate dome tweeter. Low distortion, medium sensitivity. Recommended for both 2- and 3-way systems. Rated 50 watts RMS (system) with crossover above 5000 Hz. Available in 4

and 8 ohm versions.

Incisive AD 0162T 1" HiFi polycarbonate dome tweeter. 10-ounce magnet. Low distortion, high sensitivity for direct or indirect arrays. Rated 40 watts RMS (system) with crossover above 3700 Hz. Available in 4, 8 and 15 ohm versions. 15 ohm versions can be used in 80 watt systems.

NEW: smooth AD 01600T 1" HiFi textile dome tweeter. 10-ounce magnet. Very low distortion, wide dispersion. Recommended for 3-way systems in single or multiple array. Rated 40 watts RMS (per tweeter) with crossover above 3700 Hz. Available in 4, 8 and 15 ohm versions.

Smooth AD 0141T 1" HiFi textile dome tweeter for frequencies from 1500 Hz to 22000 Hz provides very low distortion in 2-way and 3-way systems in accordance with DIN 45500. Rated 40 watts RMS (system) with crossover at 5000 Hz. Available in 4 and 8 ohm versions.

Smooth AD 0163T 1" HiFi textile dome tweeter. Very low second harmonic distortion and smoother high frequency response above 5000 Hz. Because of its high sensitivity, it is recommended for both direct and indirect radiating multi-element systems. Rated 50 watts RMS (system) with crossover at 5000 Hz. Available in 8 and 15 ohm versions.

For the location of your nearest Philips DeForest dealer, write:



**Electron
Devices
Division**

Philips Electronics Limited
Electron Devices Division
601 Milner Avenue, Scarborough,
Ontario M1B 1M8
Attention: Peter Thorne.

PHILIPS

Audio Today Letters

If you want to express your views or report on news write to Audio Today, ETI Magazine, Unit Six, 25 Overlea Blvd, Toronto, Ont. M4H 1B1.

8 Track or Elcaset?

I am considering updating my stereo recording with a reel to reel tape deck. I currently record in 8-track but the quality is poor even for my automobile. A friend recently pointed out the Sony "Elcaset" but investigation in the better audio stores shows this unit is not widely known or available. In fact I have seen it in only one store and the manager could not demonstrate it as he had no tape. It has all the features of reel to reel plus the convenience of cassette but at \$1200.00 I would like to know the following:

- 1) Will the unit be marketed world-wide?
- 2) Will a unit be put out for automobiles?
- 3) Is the quality of this machine equal to reel to reel?

Maybe a product review in your column would benefit not only me but fellow readers as well.

Any information you have will be greatly appreciated. Also congratulations on your new column; I feel that all ETI readers including myself will find it most beneficial.

P. D. Mississauga, Ont.

Thank you; congratulations are always appreciated. Now to your questions. First of all, the Elcaset seems to have stalled in the software department. Philips played it smart with the familiar Compact cassette by providing immediate licencing to anyone who agreed to stick to certain specifications as to format, speed, etc., so it was launched with no problems. Scuttlebut has it that Sony is not handling the Elcaset in quite the same way and that software licencing has bogged down. My feeling is that it will be straightened out and the format widely

distributed and accepted. That should answer question (1). Question (2): I don't know. I should think that public demand will determine this, especially with the trend to better automobile equipment. But I got out of the crystal ball business after the last Provincial Election, so I'm inclined to wait and see. Question (3) No. At least not in the strictest sense. Elcaset runs at 3.75 ips, and so cannot possibly match a good open reel machine running at 7.5 ips or higher. But the potential is so close and so convenient, and is vastly superior to the slower Compact cassette that it may become a high performance consumer standard type of machine, displacing the cheaper open reel jobs. You still don't have the flexible editing capability of open reel, and you can expect a noticeable loss in quality if you try copying your Elcaset. The choice essentially becomes one of really top performance and flexibility on the one hand, and excellent performance and convenience on the other, and the basis for choice will be your own standards and requirements. By the way, Elcaset was reviewed in our March '77 edition.

This is a simple little circuit using 741 IC's and common value resistors and capacitors. They are available from any electronic parts supplier, including many ETI advertisers.

Bass Help

In your August 1977 issue of ETI I would like to have more information on the Bass Enhancer. I would like to know if you supply all the available parts required and also the cost. Thank you.

R. M. Grand Falls N.B.

Incidentally, before building this device I hope you read the warning about making sure your equipment is up to it. If you have a little five-watt department store special amplifier and cardboard box speakers, forget it. You should have an amplifier of at least 20 Watts output or more and speakers capable of handling the full output. Otherwise, don't be surprised to see the cones go flying through the living room door.

Equalization

Re Equalization (March '78): I am working on a unit to put into my truck, a pre-amp power amp which will switch between my Uher cassette and proposed AM/FM stereo radio. I am thinking about bi-amping and am debating whether it would be simpler to provide separate bass and treble controls for each channel than separate level controls for each channel/amp. What are your thoughts on this?

R. W. S. Culver City California.

Definitely! Wouldn't you know that a Californian would bi-amp a truck (van?) system. Anyhoo, any one who would plunk down \$12.00 for an ETI subscription all the way from Canada's 11th province deserves a simple answer to a simple question. Level controls in each section of a bi-amped system allow you to balance woofer and tweeter but do not provide equalization/tone control action, but rather an abrupt step in the response. Use screwdriver adjustable controls to set the channel levels and include the tone controls in the preamp section. How about the ETI Graphic Equalizer?

Or how about scrapping the bi-amp idea and instead use an ambience Quadrophonic system. That's my own favourite technique.

Address letters to: Wally Parsons, Audio Today, Electronics Today International, 25 Overlea Blvd., Unit 6, Toronto, Ont. M4H 1B1.

For a personal reply, please include a stamped self-addressed envelope. Letters may be commentary, criticism, problems, you name it.

eti PANEL TRANSFERS

A really high quality system for finishing off your projects. The sheets include a mass of lettering and control scales for both rotary and linear pots.

The lettering is transferred simply by laying on to the panel and rubbing down — it's strong and permanent.

The markings are on two sheets (a full-sized one cut in half for easy postage) and contain sufficient lettering for dozens of projects.

Send \$3.50 (including postage) to ETI PANEL TRANSFERS, Unit Six, 25 Overlea Blvd., Toronto, Ontario, M4H 1B1. Ontario Residents add 4% PST.

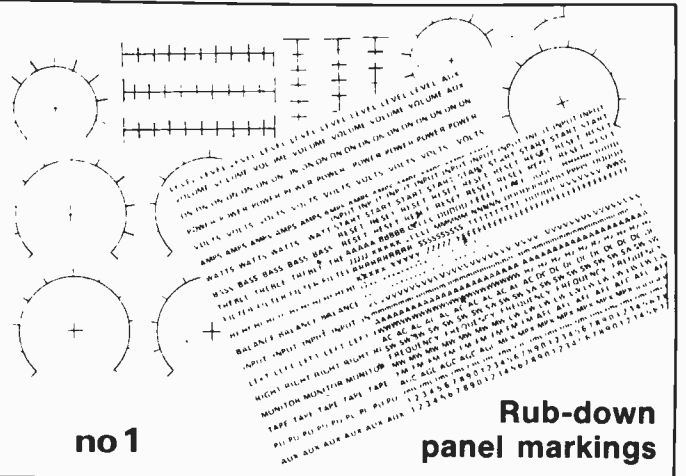

What do you want to measure... today?

STANDARD MEASUREMENTS

- 0.1 mV — 1000 V DC
- 750 V RMS AC
- 0.1 μ A — 2 A AC/DC
- 0.1 Ω — 20 M Ω
- 10,000 M Ω with conductance feature



Solve your measurement problem with a rugged, portable, 8020A DMM with extensive overload and transient protection.

ACCESSORIES



40 KV
60K-40 HIGH
VOLTAGE PROBE

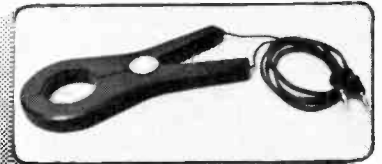

600A
80I-600 CLAMP-ON
CURRENT TRANSFORMER

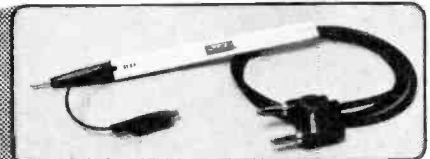

500 MHz
81RF HIGH FREQUENCY PROBE

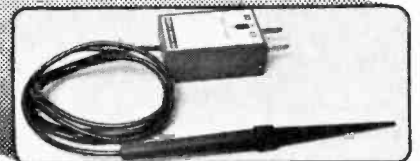

150°C
80T-150 TEMPERATURE
PROBE



20 A AC/DC
80J-10 CURRENT SHUNT

When you need to make a measurement you don't want to wait a day, a week, a month, or even longer for the equipment to do the job. Now extensive inventories ensure instant availability of popular models of digital multi-meters, scopes, waveform generators, power supplies and more. Pick up the instrument you need today at the ACA Electronic Centre nearest you.



*Canadian price. Duty and FST included. Provincial taxes extra where applicable. Shop in person or by mail. Phone or write for free catalog.

Allan Crawford Associates Ltd.

ACA Electronic Centres, Stocking Showrooms

Toronto: 6503 Northam Drive, Mississauga 416/678-1500
Montreal: 1330 Marie Victorin Blvd., Longueuil 514/670-1212
Calgary: 2280-39th Ave., N.E. Calgary 403/276-9658
Vancouver: 3795 William St., Burnaby 604/980-4831
(new Vancouver address effective July 1/78)

Digital Multimeter Survey

A wide range of prices and features are available on meters for personal, business or educational use.

THE FIRST THING anybody involved with electronics wants to do to check the operation of a circuit is to test certain voltages or currents, or perhaps measure the resistance of some component. So essential is the facility to measure these three parameters that most of us would probably give up electronics out of frustration if forced to live without a meter.

BASIC METER

At the very bottom of the price and performance scales is the basic "analog" (needle) volt-ohm-milliammeter. It is capable of handling many jobs and for many people it has sufficed for a long time. The basic meter has drawbacks, in lack of accuracy, lack of sensitivity, loading on circuit under test and reading problems such as parallax and confusion over scale etc.

So where to from there? Increased accuracy, and sensitivity with decreased loading is achieved with the addition of electronic amplification. This in the past has led to the Vacuum Tube VOM and FET VOM.

DIGITAL

More recently there has been a strong trend toward the digital meter. High impedance input circuitry is combined with analog to digital convertor and digital display to give more resolution, in many cases easier reading, and at least as far as the digital part of the circuit, stability over time, temperature and humidity. In addition the manufacturing economics of the robust multi digit seven segment display are great compared to the delicate mechanical analog meter. That's not to say that there aren't still some occasions when the analog meter provides a clearer indication, such as peaking or nulling, observing an increase or decrease.

THE SURVEY

To better our readers' awareness of the range of meters available we set about surveying the field. Very quickly it became apparent that many more multimeters were available from Canadian suppliers than we had been aware of (on the other hand we have yet to discover a DMM designed and built in Canada). One thing is certain, the marketing approach for many meters has been, to say the least, low profile, if not invisible.

MARKETING

The problem is that a majority of meters have been aimed at the industrial or educational market where the customer may be expected to buy many. Thus, a salesman is sent around to demonstrate the meter and sell it to the customer in person. This approach obviously is too costly and ineffective to be useful for the small business or personal buyer interested in a \$200-\$300 instrument. He wants to actually see and play with his prospective purchase, but he's not big enough to be served by the traveling salesman.

Just as Data Terminal Mart is succeeding with the "drop in to our store and browse" approach to terminal marketing, Allan Crawford Associates are trying the same tactic with their first four "ACA Electronic Centres".

Some of the other companies we spoke to dropped hints of expanded marketing plans, so watch for more meters and instruments on display at your local components outlet, and perhaps new outlets rivalling ACA.

METER SHACK?

Even the consumer electronics "giant", Radio Shack, appears interested. The word from our UK edition is that they are marketing Sinclair meters under the Micronta brand name in England, so perhaps we will see the same thing here soon.

In any case, with the growing awareness that there's a big market of smaller quantity users, and in addition a lack of publicity to the big buyers, DMMs are going to become more competitive. Hopefully this will mean more choice of readily available meters, and at lower cost.

HOW TO CHOOSE

Suppose you've already decided that a digital multimeter is for you, for such reasons as outlined above, and because it impresses your friends, customers or business associates. (let's face it, all those digits can give you a much more confidence inspiring image!) How do you choose a meter for your applications? It's going to be a price-performance tradeoff, and you're probably going to need much more information than we've presented here. However, the initial choice will depend on what functions you want to measure, what ranges and with what accuracy. Using our listings you'll be able to see what's available that fills your basic criteria, then obtain complete literature for a detailed study. Let's look at some of the important specifications, then the convenience factors.

FUNCTIONS

Most digital meters today use some form of analog to digital convertor to convert a DC voltage to a digital number. Hence the DC measurement is the basic, simplest one, while all the others involve a conversion to DC voltage first. For example, an AC voltage to be measured will be rectified and filtered making a DC signal which is then fed to the A/D convertor.

All DMMs then have a DC volts function and may include AC volts, DC and AC current, resistance, ratio of two signals, and occasionally frequency or time.

Input impedance on voltage functions is generally 10M ohms with only a few meters deviating from this standard.

AC functions can be either average reading, scaled to give RMS value on sine

wave signals, or may be a "true RMS" measurement. The latter may be accomplished by for instance an integration procedure, or comparing the heat generated by the buffered input signal in a known resistance with that of a reference.

Unless mentioned otherwise all meters in our survey are AC averaging, scaled to read the RMS value for sine waves.

Resistance may be measured in a variety of ways with two terminals, several manufacturers sing the praises of their own methods. In addition the four terminal method is sometimes used to reduce the effects of the test leads. A commonly available feature is the high and low test voltage selection. One is able to measure in circuit resistances with or without forward biasing diodes or transistors.

Current readings are generally obtained by measuring the voltage developed across a known "shunt" resistance. These are internal on meters with current scales, and external for other meters, or for high currents.

RANGES

Specification of ranges on a particular meter could be so easy, but varies from company to company, and even meter to meter in the same brochure.

The first confusion lies over whether a particular range is known by its full scale reading (eg. "the 1.999V scale"), or by the multiplier associated with it ("the 1V scale"). To further confuse the issue some companies specify for example "100% over range", which goes along with X½ digit meters specified by multiplier.

The above example would be a 1V scale with 100% overrange. We have put them all on the same basis with the full scale quantities listed (rounded off a little). The advantage of the extra half digit, by the way, so that it provides overlap between ranges, while keeping a X10 relationship between ranges.

The next trick is to specify the overall measuring range as from the least significant digit on the lowest range. Thus a 3½ digit meter with a 2V (1.999) scale would be described as "measures 1mV". You can work out the resolution yourself, knowing the number of digits and lowest range.

ACCURACY

As might be gathered from the description of how the meter operates, the DC voltage function is always the most accurate, and the accuracy generally befits the number of digits. It is usually specified as a percent of full scale, of the reading, and plus or minus so many digits.

Of the other functions, AC current and voltage are usually least accurate, especially at frequencies much higher or lower than 60Hz. This is one spec worth checking into if you are particularly interested in this measurement.

PROTECTION

An important factor if you propose to measure high voltages or currents, or widely varying quantities, is protection. This means both for you and your meter. This feature varies quite significantly from meter to meter so check it closely. Insulation to a few thousand volts is available, especially important in hand held models. Similarly, ability to withstand AC line voltage on the ohms function without damage and other amazing feats are also obtainable.

AUTO CONVENIENCE

There are three main "auto"s in DMMs. "Autopolarity" is a feature almost all DMMs have (it's easy to incorporate), and it gives you an automatic minus sign if the test lead polarity is reversed. This means of course no switching leads if you've got them backwards.

"Auto zero" is a feature wherein the meter adjusts itself to read 0.000 for a zero input. Remember the zero adjustment on your analog meter for the resistance function? Most (but not all) DMMs have auto zero.

"Auto ranging" means the meter adjusts the scale for you (it tells you which one you're on!), a great convenience when observing varying quantities for hours on end, or making measurements with hands full. A feature to look for on an "autoranger" is the hysteresis between ranges, for example the meter may "change up" at 1.999 and "change down" at 1.800. Thus if you are measuring a voltage varying between say 1.9 and 2.1, the meter will change up one scale and stay there, rather than flip back and forth.

Some meters have "semi-auto-ranging", which means they autorange within a high or low group of ranges.

PORTABILITY

Another choosing point is the portability of the DMM. This comes down to battery operation (with AC adapter?) or AC power only. Even on the test bench near an AC outlet, battery operation is a convenience, but there's a wide variation in length of operation on one set of batteries or between charges.

FINALLY

The last test is to go and look at the meter, at which point you'll probably succumb and buy the thing.

PRICES

The prices in our survey are (unless otherwise mentioned) in Canadian dollars and include duty and federal sales tax where applicable.

WHO'S INCLUDED

We have tried to include every DMM company we could, but there are probably one or two who we've missed. If this is the

case we will try to find a space in News Digest in future issues for information we receive after the survey deadline.

ADDRESSES

The addresses below are those to contact to find out where to get the meters listed. In some cases these are the addresses where the meters themselves may be obtained, in other cases you may be advised where to get their meters in your area. In any case literature should be obtainable from these sources.

Allan Crawford Associates, 6503 Northam Drive, Mississauga, Ontario L4V 1J2.

Associated Test Equipment, 3530 Pharmacy Avenue, Scarborough, Ontario.

Atlas Electronics, 50 Wingold Ave., Toronto, Ontario M6B 1P7.

Bach Simpson Ltd., 1255 Brydges St., P.O. Box 5484, London, Ontario N6A 4L7.

Duncan Instruments, 122 Millwick Dr., Weston, Ontario M9L 1Y6.

EICO Canada Limited, P.O. Box 268, Richmond Hill, Ontario, L4C 4Y6.

Len Finkler Ltd., 25 Toro Road, Downsview, Ontario M3J 2A6.

Gladstone Electronic Supply Co. Ltd., 1736 Avenue Road, Toronto, Ontario M5M 3Y7.

HeathKit, 1480 Dundas St. E., Mississauga, Ontario L4X 2R7.

Hewlett-Packard (Canada) Ltd., 6877 Goreway Dr., Mississauga, Ontario L4V 1L9.

Megatronix Ltd., 100 Penn Dr., Weston, Ontario M9L 2A9.

Metermaster Div. of R. H. Nichols Co. Ltd., 214 Dolomite Dr., Downsview, Ontario M3J 2P8.

Omnitronix Ltd., 2056 South Service Road, Trans Canada Hwy., Dorval, Quebec H9P 2N4.

Phillips Electronics Ltd., 601 Milner Ave., Scarborough, Ontario. M1B 1M8.

Radionics Limited, 195 Graveline St., Montreal, Quebec H4T 1R6.

H. Rogers Electronic Instruments, Ltd., P.O. Box 310, Ajax, Ontario L1S 3C5.

Sabtronics International Inc., 13426 Floyd Circle, Dallas, Texas 75206, U.S.A.

Superior Electronics, 1330 Trans Canada Hwy. S., Montreal, Quebec H9P 1H8.

Tenco Electronics, 75 Denison St., Markham, Ontario L3R 1B5.

Tele Radio Systems Ltd., 301 Supertest Rd., Downsview, Ontario M3J 2M4.

VIZ, 335 E Price Street, Philadelphia, PA 19144.

Webster Instruments, 2446 Cawthra Rd., Mississauga, Ontario L5A 3K6.

DMM Survey

AMPROBE



Amprobe ACD-1

Features: 3 digit, LED display, autoranging, battery operated. Clamp-on current measuring.

Functions and Ranges: 100 and 1000 ohms, AC volts and amps.

Comes with: Test leads, alligator clip adaptor, ohm meter leads and case.

Price: \$200.

Contact: Atlas Electronics Limited.

BACH-SIMPSON



Simpson 360(-2)

Features: 3½ digit, LED display, autopolarity, battery operated. (-2) model incorporates analog meter in addition for peaking or nulling type use.

Functions and Ranges: 200mV to 1000V DC, 200mV to 600V AC, 20uA to 10A DC, 200uA to 10A AC, 200 ohm to 20M ohm with two low test voltage ranges.

Comes with: Test leads, AC adapter/charger.

Accessories: Case, high voltage, RF and high current probes.

Price: \$385 for 360

Contact: Bach Simpson

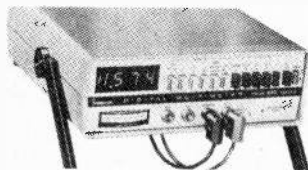

Simpson 460-3

Features: 3½ digit, LED display, autopolarity, incorporates analog meter.

Functions and Ranges: 200mV to 1000V DC, 200mV to 600V AC, 200uA to 10A AC and DC, 200 to 2M ohms low test voltage, 2k to 20M standard.

Comes with: Test leads, alligator clips.

Accessories: Same as 360 plus rechargeable battery option.

Price: \$420.

Contact: Bach Simpson

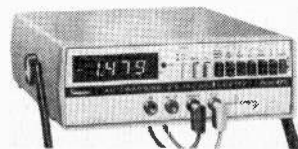

Simpson 461/464/465

Features: 3½ digit, LED display, autopolarity, battery operated/AC, autoranging with hold feature on 465.

Functions and Ranges: 200mV to 1000V DC, 200mV to 600V AC, 200uA to 2A AC and DC, (10A on 464) 200 ohm to 20M.

Comes with: Batteries, AC adapter/charger (461) test leads.

Accessories: Same as 360, AC/battery option.

Price: \$200/\$315/\$440.

Contact: Bach Simpson

BALLANTINE

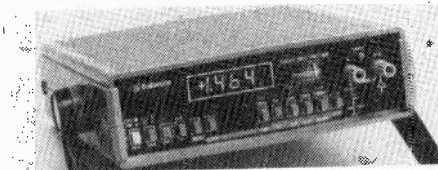

Ballantine 3028A

Features: 3½ digit, LED display, autopolarity.

Functions and Ranges: 200mV to 1200V DC or AC, 200uA to 2A DC or AC, 200 to 20M ohm with high or low test voltage.

Comes with: Test leads.

Options: Printer output, battery operation, analog meter for nulling or peaking, 20A range.

Accessories: HV and RF probes, rack mount, carrying case.

Price: \$435.

Contact: Associated Test Equipment

B & K

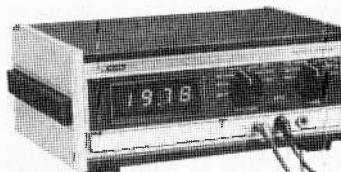

B & K 283

Features: 3½ digit, LED display, autopolarity.

Functions and Ranges: 2 to 1500V DC and AC, 2 to 2000mA DC and AC, 100 ohms to 10M. High and low test voltage available on resistance function.

Comes with: Test leads.

Accessories: Battery pack, isolation, demodulator, and high voltage probes, current shunt, case.

Price: \$240.

Contact: Atlas Electronics Limited.

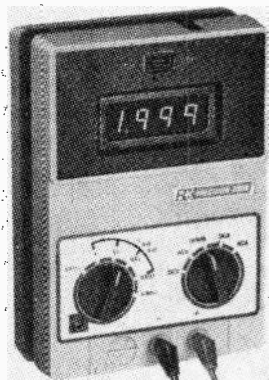

B & K 2800

Features: 3½ digit, LED display, autopolarity, battery operated.

Functions and Ranges: 2 to 2000VDC or AC, 2 to 2000mA AC or DC, 200 ohm to 20M with high or low alternate test voltage.

Comes with: test leads.

Accessories: Same as 283.

Price: \$140.

Contact: Atlas Electronics Limited.

B & K 2810

Features: 3½ digit, LED display, autopolarity, battery operated.

Functions and Ranges: 200mV to 2000V AC or DC, 2 to 2000mA AC or DC, 20 to 20M ohms high or low test voltage.

Comes with: test leads.

Accessories: Same as 283.

Price: \$175.

Contact: Atlas Electronics Limited.



B & K 2830

Features: 3½ digit, LED display, autopolarity.

Functions and Ranges: 200mV to 2000V AC or DC, 200uA to 20A AC or DC, 20 to 20M ohm high or low test voltage.

Comes with: test leads.

Accessories: Same as 283.

Price: Not available til fall 78.

Contact: Atlas Electronics Limited.

CIMRON

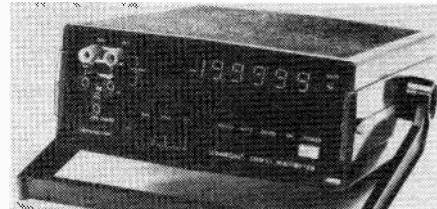

Cimron DMM53

Features: 5½ digit, LED display, autopolarity, autoranging.

Functions and Ranges: 200mV to 1200V DC, 200mV to 1000V AC, 200 to 20M ohms.

Options: Data output

Price: \$1470.

Contact: Megatronix Ltd.

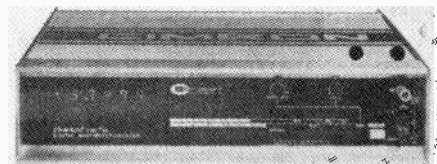

Cimron DMC-45

Features: 4-2/3 digit (39999 count), LED display, autopolarity.

Functions and Ranges: 400mV to 1200V DC, 400mV to 750V AC, 400uA to 2A DC or AC, 400 to 40M ohm, 400Hz to 20MHz.

Options: Battery options, data output.

Accessories: Cable, rack mount.

Price: Not received.

Contact: Megatronix Ltd.

DANA

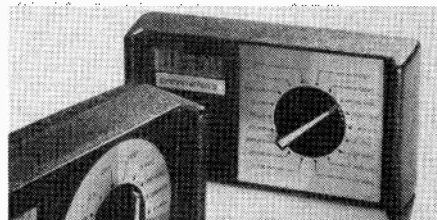

Dana 2000A/2100A

Features: 3½ digit, LCD display, autopolarity, battery operated.

If it feels like somebody else is making all the money, maybe it's time you looked at NRI home training for TV and audio technicians.

No matter how hard you try, there are some jobs that just seem to go nowhere. And others so monotonous, they drive you up the wall. While all around, you see people enjoying what they do and making a good living at it.

NRI Can Set You Free

There's a way out of the rut. NRI home-training in TV and audio servicing. At home, in your spare time, you can learn to become a TV electronics technician. Qualified to hold down a good paying job as a serviceman or troubleshooter. Even start your own full- or part-time business. And you learn at your own pace without quitting your present job.

Learn by Doing, Actual Bench Experience

NRI is more than book learning. Sure, we give you all the fundamentals and theory. But it's reinforced with practical experience every step of the way. In our Master Course, you build actual electronic circuits and test them. You construct a 4-channel audio center, a 25" diagonal solid state

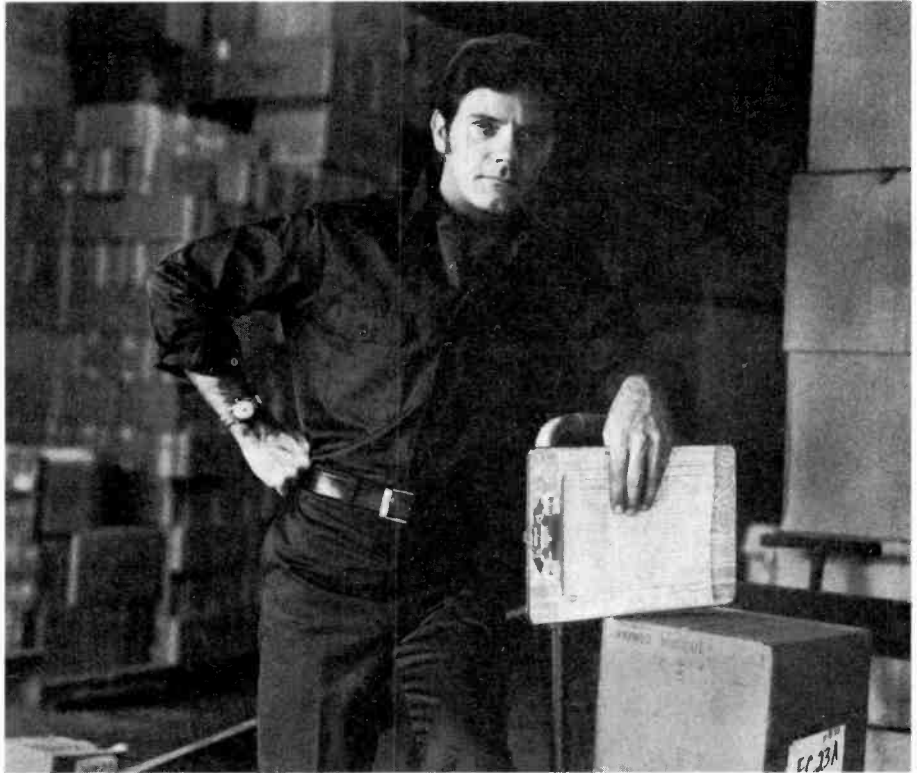

color TV, introduce and correct typical service problems. You even assemble test instruments that you use for learning and earning.

Your equipment includes a transistorized Volt-Ohm Meter, TV color pattern generator, advanced design 5" triggered sweep oscilloscope and CMOS digital frequency counter... the basic tools of the pro. In addition, you build the 4-channel audio center and 25" color TV while performing more than 120 in-set, power-on experiments that give you real bench experience while you learn.

Ask the Professionals

A documented national survey confirms for the second time that almost half the professional TV servicemen have had home-training. And among them, they recommend NRI as first or only choice by more than 3 to 1! That's because NRI training works, as

it has for 63 years and more than a million students.

Send for Free Catalog... No Salesman Will Call

Get all the facts on how NRI career training can mean new opportunities for you. Send for our free catalog describing lessons and equipment, other courses in digital computer electronics, CB radio servicing, communications, and more. No salesman will call. Mail the postage-paid card today and see if you can't make more of yourself in this wide-open field. If card has been removed, write to:



NRI Schools
McGraw Hill Center for
Continuing Education
330 Progress Avenue
Scarborough, Ontario M1P 2Z5

Functions and Ranges: 2 to 1000V DC and AC, 20uA to 2A DC, 2k to 20M ohm (200 to 200M on 2000).

Accessories: Case, mounting options, leads, HV, RF probes, AC current shunt.

Price: \$250/\$315.

Contact: Tele Radio Systems

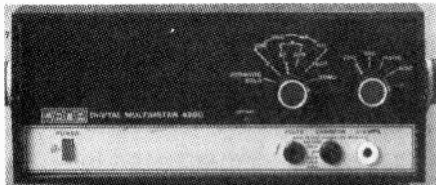

Dana 4200

Features: 4½ digit, LED display, autopolarity.
Functions and Ranges: 200mV to 1000V DC, 2V to 500V AC, 200 to 20M ohm, 20uA to 2A DC.
Accessories: Similar to 2000.

Price: \$610.

Contact: Tele Radio Systems

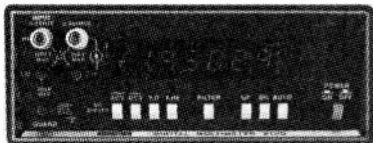

Dana 4600/5100

Features: 4½/5½ digit display, autopolarity, autoranging.

Functions and Ranges: 0.2V to 1000/1200V DC, 0.2/2V to 1000V AC, 200 to 20M ohms, 2mA to 2A AC or DC (4600), 2MHz to 20MHz (5100), current and true RMS options available for 5100.

Accessories: As 2000 plus data output option etc.

Price: \$840/\$1750.

Contact: Tele Radio Systems

DATA PRECISION



Data Precision 175/245/248/258

Features: 3½(175)/4½ digit, LED/LCD (258)/Plasma (245) display, autopolarity, battery operated.

Functions and Ranges: 0 1V to 1000V DC (2V to 1000V 245), 0.2V to 500V AC (2V to 500V 245), 2K to 20M ohms (200 ohm on 175), 200uA to 2A AC or DC (2mA to 2A on 245) 248 reads true RMS on AC functions.

Comes with: Rechargeable batteries and charger.

Accessories: Current probe, RF, Test leads, antenna.

Price: \$280/\$450/\$450/\$450.

Contact: Webster Instruments Ltd.



Data Precision 1350

Features: 3½ digit, LED display, autopolarity.
Functions and Ranges: 200mV to 1200V DC, 200mV to 1000V AC, 200 to 20M ohm, 200uA to 2A.

Accessories: As 175.

Price: \$260.

Contact: Webster Instruments Ltd.



Data Precision 1750

Features: 3½ digit, LED display, autopolarity.
Functions and Ranges: 200mV to 1000V DC or AC, -60 to +20dBm, 200uA to 20A, 200 to 20M ohm. True RMS reading on AC functions.

Accessories: As 175 plus battery pack, data output.

Price: \$425.

Contact: Webster Instruments Ltd.

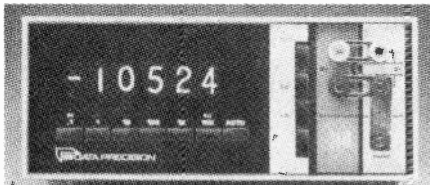

Data Precision 2420/2430/2435/2440

Features: 4½ digit, Nixie display, autopolarity, autoranging.

Functions and Ranges: 1.2V to 1200V DC, 1.2V to 600V AC, 1k to 10M ohm, DC Ratio: .1:1 to 100:1. Additional 0.1V range optional. 2440 includes all functions, other models have subsets of these.

Accessories: As 175 plus rack mount, connectors, battery option.

Price: \$880/\$950/\$960/\$1020, add \$150 for 0.1V range.

Contact: Webster Instruments Ltd.

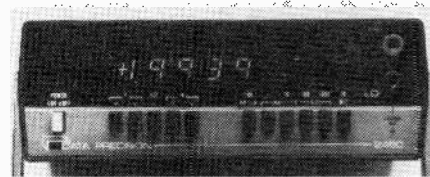

Data Precision 2480(R)

Features: 4½ digit, LED display, autopolarity.
Functions and Ranges: 200mV to 1200V DC, 200mV to 1000V AC, 200uA to 2A AC or DC, 2k to 20M ohm. R model has true RMS feature.

Accessories: Battery pack, and similar to 175.

Price: \$425/\$450.

Contact: Webster Instruments Ltd.



Data Precision 3400(R)/3410

Features: 4½ digit, LED display, autopolarity, autoranging. 3410 has IEEE 488 interface bus.
Functions and Ranges: 0.2V to 1000V DC, 0.2V to 750V AC, 100 to 10M ohm, Ratio 0.01:1 to 100:1. 3400R reads true RMS on AC functions.

Accessories: As 2420 (no batteries), current shunts.

Price: \$1200/\$1350/\$1200.

Contact: Webster Instruments Ltd.

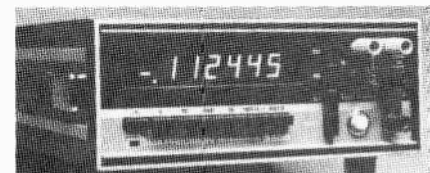

Data Precision 3500

Features: 5½ digit, autopolarity, autoranging, BCD data output.

Functions and Ranges: 0.12V to 1200V DC, 0.12V to 700V AC, 120 to 12M ohm, Ratio .01:1, 100:1.

Accessories: As 3400.

Price: \$1500.

Contact: Webster Instruments Ltd.

DIGITEK



Digi Tek 2210

Features: 4½ digit, LED display, autopolarity, battery operated.

Functions and Ranges: 2V to 1000V DC and AC, 2k to 20M ohm.

Options: Isolated data output.

Accessories: Test leads, rack mount.

Price: \$970.

Contact: Megatronix Ltd.

Digi Tek 2120/2180

Features: 3½ digit, LED display, autopolarity, battery operated/AC.

Functions and Ranges: 200mV to 1000V DC and AC, 200uA to 2A, 200 to 20M ohms, 2180 has -60 to +60 dB with two references.

Accessories: Test leads, high voltage probe, battery pack case.

Price: \$520/\$760.

Contact: Megatronix Ltd.

EICO

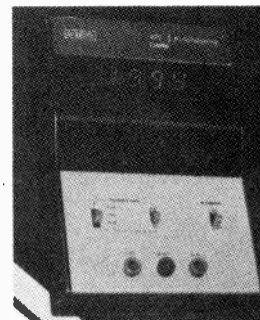

EICO 270/275

Features: 3½ digit, LED display, autopolarity, battery operated. Model 275 has autoranging.

Functions and Ranges: 2, 20, 200, 2000V. A, AC, DC and ohms plus 20M ohms.

Comes with: Test leads.

Accessories: AC adapter.

Price: \$175, \$140 kit for 270. Price for 275 not received.

Contact: EICO Canada Limited



EICO 272

Features: 3 digit, LED display, autopolarity, battery operated, (will replace 275)
Functions and Ranges: 1V to 1000V DC, 1V to 600V AC, 1mA to 1A AC and DC, 1k to 1M ohm.
Comes with: Test leads.
Accessories: Case.
Price: Not received.
Contact: EICO

FLUKE

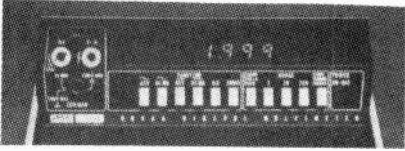

Fluke 8000A

Features: 3½ digit, LED display, autopolarity.
Functions and Ranges: 200mV to 1200V AC and DC, 200µA to 2A AC and DC, 200 to 20M ohms.
Options: Rechargeable batteries, data output, extended current and resistance ranges, analog meter, mA meter.
Price: \$440 (\$505 with rechargeable batteries).
Contact: Allan Crawford Assoc.

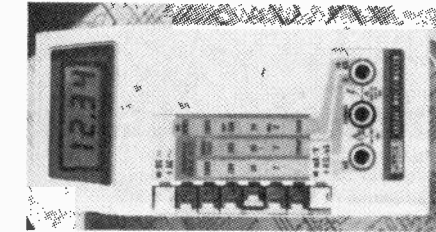

Fluke 8020A

Features: 3½ digit, LCD display, autopolarity, battery operated.
Functions and Ranges: 200mV to 1000V DC, 200mV to 750V AC, 2mA to 2A AC and DC, 200 to 20M ohms, 200nS to 2mS High and low test voltage resistance ranges.
Comes with: Batteries and test leads.
Accessories: AC adapter, carrying case, current clamp, HV probe, temp. probe, RF probe.
Price: \$220.
Contact: Allan Crawford Assoc.

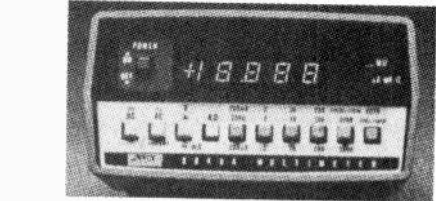

Fluke 8030A/8040A

Features: 3½/4½ digit, LED display, autopolarity, battery operated, AC measurements are true RMS.
Functions and Ranges: 200mV to 1100V DC, 200mV to 750V AC, 200µA to 2A AC and DC, 200 to 2M ohm, diode test.
Comes with: Disposable batteries, AC adaptor and test leads.
Accessories: Rechargeable battery option, current shunt, HV, RF and temp. probes, AC current transformer, carrying case etc.
Price: \$360/\$600.
Contact: Allan Crawford Assoc.

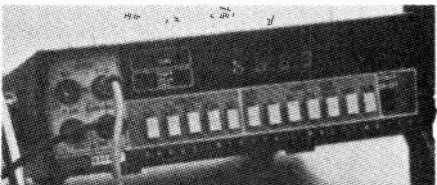

Fluke 8600A

Features: 4½ digit, LED display, autopolarity, autoranging.
Functions and Ranges: 200mV to 1200V AC and DC, 200µA to 2A AC and DC, 200 to 20M ohm.
Options: Rechargeable batteries, data output.
Accessories: As 8030, plus deluxe test leads, dust cover and rack mount kits.
Price: \$820.
Contact: Allan Crawford Assoc.



Fluke 8800A/8810A

Features: 5½ digit, LED display, autopolarity, autoranging.
Functions and Ranges: 200mV to 1200V DC, 2V to 1200V AC, 200 to 20M ohm. 8810 also allows true RMS and averaging AC volts options.
Option: Data output.
Accessories: Same as 8030A.
Price: \$1500 for 8800A.
Contact: Allan Crawford Assoc.

GOULD ADVANCE



Gould Advance Alpha III

Features: 3½ digit, LED display, autopolarity. No further information received.
Contact: Duncan Instruments Ltd.

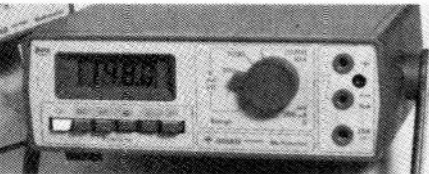

Gould Advance Beta

Features: 3½ digit, LCD display, autopolarity, battery operated.
Functions and Ranges: We guess: 200mV to 2000V DC, 200mV to 750V AC, 200µA to 10A AC and DC.
Accessories: Temperature probe.
Price: Not received.
Contact: Duncan Instruments Ltd.

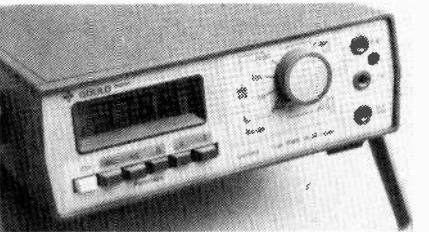

Gould Advance Gamma

Features: 3½ digit, LCD display, autopolarity, battery operated. True RMS reading on AC functions.
Functions and Ranges: 200mV to 2000V AC and DC, 200µA to 10A AC and DC, 200 ohm to 20M.

Accessories: RF and high voltage probes, case, temperature probe.
Price: Not received.
Contact: Duncan Instruments Ltd.

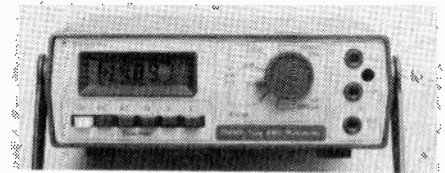

Gould Advance DMM9

Features: 4½ digit, LCD display, autopolarity, True RMS on AC functions.
Functions and Ranges: 200mV to 2000V AC and DC, 200µA to 10A AC and DC, 2k to 20M ohms.
Accessories: Battery option, BCD output, temperature and RF probes.
Price: Not received.
Contact: Duncan Instruments Ltd.

HEATHKIT

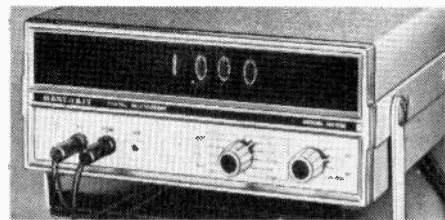

Heathkit IM-102

Features: 3½ digit, Tube display, autopolarity.
Functions and Ranges: 200mV to 1000V DC, 200mV to 500V AC, 200µA to 2A AC and DC, 200 to 20M ohms.
Comes with: Test leads.
Price: \$400 kit.
Contact: Heathkit

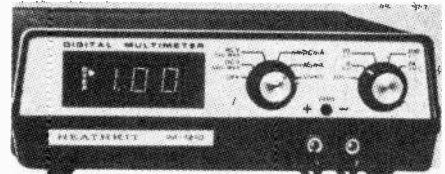

Heathkit IM-1210

Features: 2½ digit, LED display, autopolarity, autoranging, battery operated.
Functions and Ranges: 2V to 1000V DC, 2V to 700V AC, 2mA to 2A DC or AC, 200 ohm to 2M.
Comes with: Test leads.
Price: \$110 kit \$145 Ass.
Contact: Heathkit



Heathkit IM-2202

Features: 3½ digit, LED display, autopolarity, battery operated/AC.
Functions and Ranges: 2V to 2000V DC, 2V to 750V AC, 200µA to 2A AC and DC, 200 to 2M ohm with high and low test voltage ranges.
Comes with: Test leads.
Price: \$300 kit.
Contact: Heathkit

HEWLETT-PACKARD

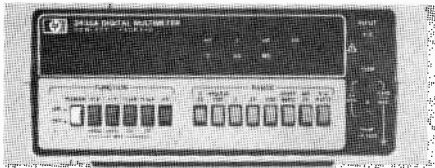

Hewlett Packard 3435A

Features: 3½ digit, LED display, autopolarity, autoranging, battery operated/AC.
Functions and Ranges: 200mV to 1200V DC and AC, 200µA to 2A DC and AC, 20 to 20M ohm.
Comes with: Test leads and terminals.
Accessories: Extensive, includes RF and high voltage probes, case etc.
Price: Not received.
Contact: Hewlett Packard

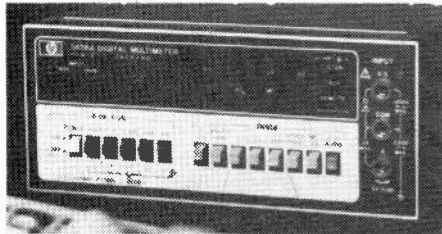

Hewlett Packard 3438A

Features: 3½ digit, LED display, autopolarity, autoranging.
Specs: Similar to 3435A but also interfaces to HP's version of the IEEE 488 interface bus.
Price: Not received.
Contact: Hewlett Packard

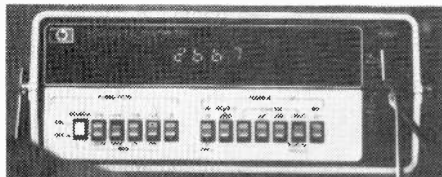

Hewlett Packard 3465A/B

Features: 4½ digit, LED display, autopolarity, battery operated (various power options), A — rack mount, B — portable.
Functions and Ranges: 20mV to 1000V DC, 200mV to 500V AC, 200µA to 2A AC and DC, 20 to 20M ohms.
Price: Not received.
Contact: Hewlett Packard

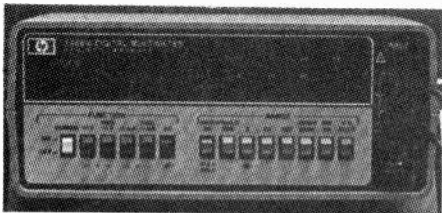

Hewlett Packard 3466A

Features: 4½ digit, LED display, autopolarity, autoranging, battery operated (option). Portable or rack mount options. True RMS reading on AC functions.
Functions and Ranges: 20mV to 1200V DC, 200mV to 1200V AC, 200µA to 2A AC or DC, 20 to 20M ohms, diode drop test.
Price: Not received.
Contact: Hewlett Packard

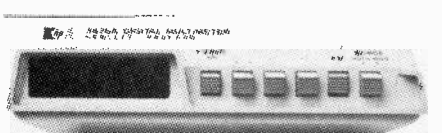

Hewlett Packard 3476A/B

Features: 3½ digit, LED display, autopolarity, autoranging, battery operated (B option only)
Functions and Ranges: 0.11V to 1000V DC, 0.11V to 700V AC, 0.11, 1.1A AC and DC, 1.1k to 11M ohm.
Price: Not received.
Contact: Hewlett Packard

HICKOK



Hickok 334

Features: 3½ digit, Green Fluorescent display, autopolarity.
Functions and Ranges: 200mV to 1200V DC, 200mV to 1000V AC, 200µA to 2A AC and DC, 20 to 20M ohms.
Comes with: Probes.
Price: \$300.
Contact: H. Rogers Electronic Instruments

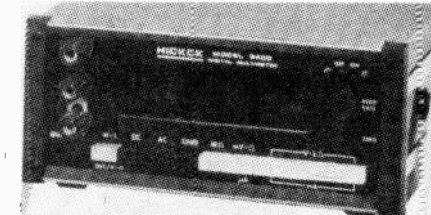

Hickok 3400/10/20

Features: 4½ digit, Fluorescent display, autopolarity, battery operated (option).
Functions and Ranges: 200mV to 1500V DC (plus 20mV on 3410), 200mV to 1000V AC, 200µA to 2A AC and DC (not on 3420) 200 to 20M ohm (plus 20 ohm on 3410). In addition 3420 has 1KHz to 30 MHz frequency ranges.
Options: Extended over range capabilities, true RMS on functions.
Price: \$1060/1240/1335.
Contact: H. Rogers Electronic Instruments.

KEITHLEY

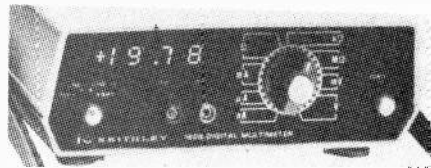

Keithley 160B

Features: 3½ digit, LED display, autopolarity, autoranging, data output and calculator control options.
Functions and Ranges: 2mV to 1200V DC, 20nA to 1A DC, 20ohm to 2000M ohm.
Accessories: As 168.
Price: \$930.
Contact: Radionics Limited

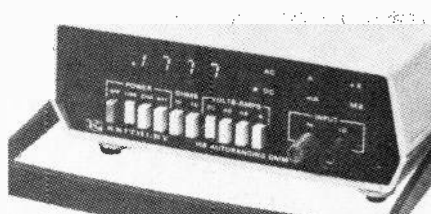

Keithley 168

Features: 3½ digit, LED display, autopolarity, autoranging.
Functions and Ranges: 200mV to 1000V DC or AC, 0.2mA to 1A AC or DC 200 to 20M ohm. High or low test voltage on ohms.
Accessories: Battery pack, HV, RF. Current probes and clamps, leads cases, rack mount etc.
Price: \$510.
Contact: Radionics Limited

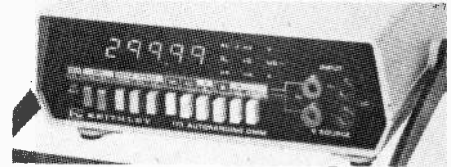

Keithley 172/173

Features: 4-2/3 digit, (30000 count), LED display, autopolarity, autoranging.
Functions and Ranges: 300mV to 1200V DC, 300mV to 1000V AC, 300 to 300M ohm (with high or low test voltage), 300mA to 3A (172) or 300µA to 3A (173).
Accessories: As 168.
Price: \$820/\$1065.
Contact: Radionics Limited

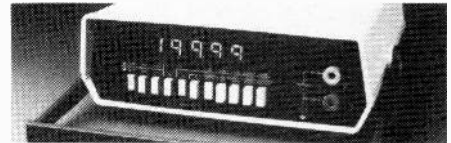

Keithley 178/179

Features: 4½ digit, LED display, autopolarity.
Functions and Ranges: 2V to 1200V DC (200mV on 179), 2V to 1000V AC (200mV on 179), 2k to 20M ohm, (high or low test voltage on 179), 200µA to 2A DC or AC True RMS (179 only).
Accessories: As 168.
Price: \$315/\$455.
Contact: Radionics Limited

KYORITSU

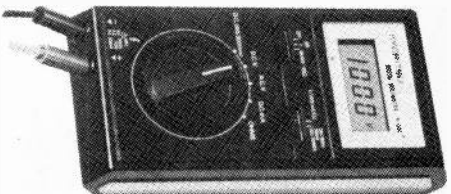

Kyoritsu K-1000

Features: 3½ digit, LCD display, autopolarity, semi-autoranging, battery operated.
Functions and Ranges: 200mV to 1000V DC, 2V to 750V AC, 2mA to 200mA DC, 2K to 2M ohm with high and low test voltage.
Accessories: Charger/Adapter.
Price: \$345.
Contact: Tenco

LEADER



Leader LDM-851

Features: 3½ digit, LED LCD Fluorescent display, autopolarity, semi-autoranging, battery operated.
Functions and Ranges: 2V to 1000V AC or DC, 20 to 200mA DC, 2k to 20M ohm.
Accessories: Current clamp, high voltage probe, AC adapter, case.
Price: \$265.
Contact: Omnitronix.

LTS

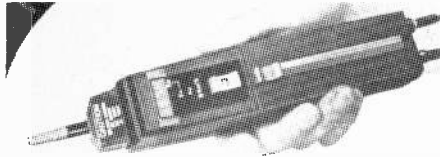

LTS 12(A), (TA)

Features: 3½ digit, LED display, autopolarity, autoranging, battery operated.
Functions and Ranges: 1.5 to 1000V DC, 1.5 to 750V AC, 1.5K to 20M ohms, -55 to +153° degrees C (TA only).
Comes with: AC adapter-charger, NiCd batteries, case.
Accessories: Remote probes.
Price: \$320(A), \$400(TA).
Contact: Metermaster

NLS

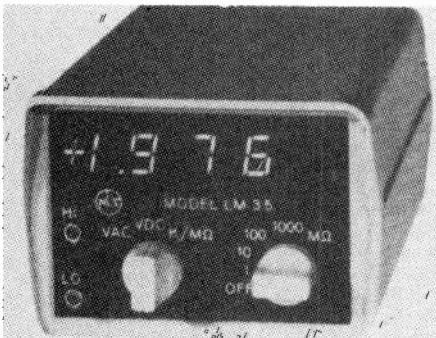

NLS LM-3A

Features: 3 digit, LED display, autopolarity, battery operated.
Functions and Ranges: 1 to 1000V DC and AC, for current readings external shunt must be used, 100uA to 1A, 1k to 10M ohms
Accessories: Current shunts, high voltage probe, leather case, test leads, adapter charger.
Price: \$185.
Contact: Metermaster

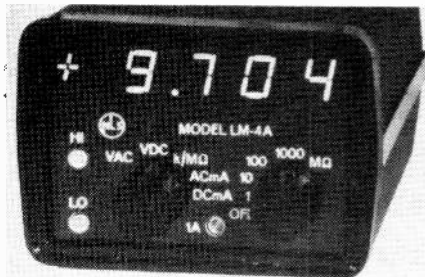

NLS LM-3.5A/4A

Features: 3¾ digit, LED display, autopolarity, battery operated.
Functions and Ranges: 2V to 1000V DC and AC, 100uA to 1A with optional external shunts, 2k to 20M ohm.
Accessories: As LM-3.
Price: \$210/\$325.
Contact: Metermaster

NLS LM300

Features: 3 digit, LCD display, autopolarity, battery operated.
Functions and Ranges: 1V to 1000VDC, 1V to 700V AC, 1k to 10M, 1mA to 1A DC or AC.
Accessories: As LM-3.
Price: \$145.
Contact: Metermaster

NLS LM350 (RMS 350)

Features: 3½ digit, LCD display, autopolarity, battery operated.
Functions and Ranges: 2V to 1000V DC, 2V to 700V AC, 2k to 20M ohm, 2mA to 2A AC and DC. True RMS on AC functions.
Accessories: As LM-3.
Price: \$170 (\$270 RMS).
Contact: Meter master

PHILIPS

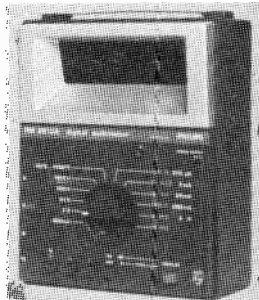

Philips PM2513(A)

Features: 3½ digit, LED display, autopolarity, battery operated, automatic switch off.
Functions and Ranges: 0.2V to 1000V AC and DC (200mV for A model), 0.2mA to 2A AC or DC (200uA for A), 200 to 2M ohm (20M for A).
Comes with: Test leads.
Accessories: AC supply, RF, HF, HV, Temperature probes, case, data hold probe etc.
Price: \$275 for A.
Contact: Philips



Philips PM2517X/E

Features: 4 digit, LED (E) LCD (X) display, autopolarity, autoranging, battery operated.
Functions and Ranges: 0.1V to 1000V AC or DC, up to 10A, 100 to 10M ohm, diode test. True RMS reading on AC functions.
Accessories: AC adapter, temperature probe.
Price: Not Received.
Contact: Philips

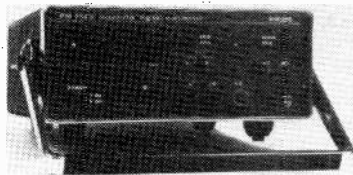

Philips PM 2523

Features: 3½ digit, LED display, autopolarity, autoranging, battery operated/AC.
Functions and Ranges: 0.2V to 1000V DC, 0.2V to 600V AC, 200 to 20M ohm.
Comes with: Test leads, line cord.
Accessories: Similar to PM2513.
Price: \$335.
Contact: Philips

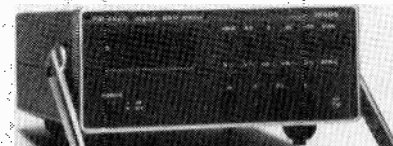

Philips PM2522A/2524A

Features: 4½ digit, LED display, autopolarity, autoranging (2524A).
Functions and Ranges: 2V to 1000V DC (200mV for 2524A) 2V to 600V AC, 2k to 20M ohm, 2mA to 2A AC or DC.
Accessories: Optional battery operation, also similar to PM2513.
Price: \$410/\$800.
Contact: Philips

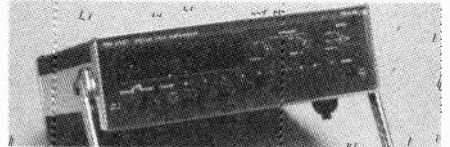

Philips PM2526A/2527A

Features: 4½ digit, LED display, autopolarity, autoranging.
Functions and Ranges: 200mV to 1000V DC, 20mV to 600V AC, 200 to 20M ohm (to 2000M ohm for 2527A), 2uA to 2A (2527A only), True RMS reading on AC functions.
Accessories: Same as PM2522A.
Price: \$1350/\$1500.
Contact: Philips

SABTRONICS



Sabtronics 2000

Features: 3½ digit, LED display, autopolarity, battery operated.
Functions and Ranges: 200mV to 1400V DC, 200mV to 1000V AC, 20uA to 2A AC or DC, 200 to 20M ohm.
Accessories: Test leads, AC adapters, NiCd batteries.
Price: US \$70. (kit).
Contact: Sabtronics

SENCORE



Sencore DVM 32/37

Features: 3½ digit, LED display, autopolarity, battery operated.
Functions and Ranges: 2 to 2000V DC, 2 to 1000V AC, 2mA to 2A (200uA on DVM37) AC or DC, 200 to 20M ohms with high and low test voltage.
Comes with: Probes.
Accessories: AC adapter, HV probe.
Price: \$350/\$430.
Contact: Superior Electronics Inc.



DMM Survey

Sencore DVM38

Features: 3½ digit, LED display, autopolarity, semi-autoranging.
Functions and Ranges: 200mV to 2000V DC, 200mV to 1000V AC 200uA to 2A DC or AC, 20 to 20M ohm.
Accessories: As DVM32.
Price: \$605.
Contact: Superior Electronics Inc.

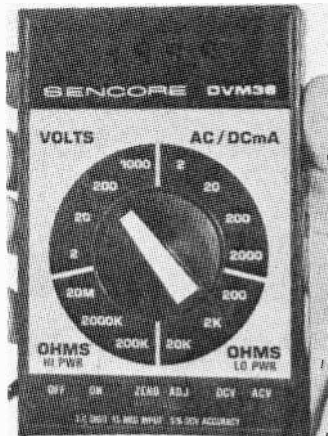

Sencore DVM 35/36

Features: 3/3½ digit, LED display, autopolarity, battery operated.
Functions and Ranges: 1V to 1000V DC or AC, 1mA to 1A AC or DC, 100 to 10M ohms with high and low test voltage. Multiply ranges by 2 for DVM 36 except 1000V.
Comes with: Probe with "push on" switch and X2 attenuator switch.
Accessories: As DVM32.
Price: \$235/\$275.
Contact: Superior Electronics Inc.

SINCLAIR

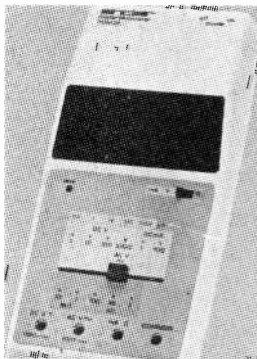

Sinclair PDM35

Features: 3½ digit, LED display, autopolarity, battery operated.
Functions and Ranges: 2V to 1000V DC, 500V AC, 0.2 uA to 200mA DC, 1k to 10M ohm.
Comes with: Test leads and case.
Accessories: AC adapter, deluxe case, high voltage probe.
Price: \$78.
Contact: Gladstone Electronic Supply Co. Ltd.



Sinclair DM2

Features: 3½ digit, LED display, autopolarity, battery operated.
Functions and Ranges: 2V to 1000V DC, 2V to 500V AC, 200uA to 1A DC, 2mA to 1A AC, 2k to 10M ohm.
Comes with: Test leads.
Accessories: AC adapter.
Price: \$130.
Contact: Gladstone Electronic Supply Co. Ltd.

Sinclair

The following models are expected in 1978:
DM235 New Low Cost Bench Multimeter suggested retail price not established, estimated at \$130-150.
DM350 Low cost, fully portable, 5 function, 3½ digit multimeter of greater accuracy. Suggested retail price not established, estimated at \$160-200.
DM450 4½ digit multimeter, auto-ranging, auto-zero. Suggested retail price not established, estimated at \$250-300.

SOAR

Soar ME521

Features: 3 digit, LED display, autopolarity, battery operated.
Functions and Ranges: Up to 1000V DC, 600V AC, 1A AC or DC, 1M ohm.
Accessories: AC adapter.
Price: \$100.
Contact: Duncan Instruments Ltd.

TRIPLETT

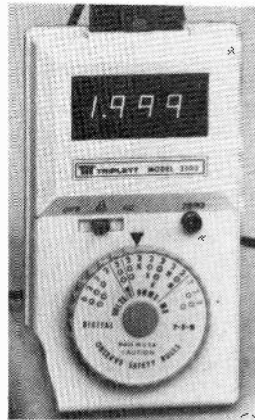

Triplet 3300

Features: 3½ digit, LED display, autopolarity, battery operated.
Functions and Ranges: 0.2 to 600V DC or AC, 2 to 200mA DC or AC, 200 to 20M ohms including low test voltage scales
Price: US \$175.
Contact: Len Finkler Limited

VALHALLA SCIENTIFIC

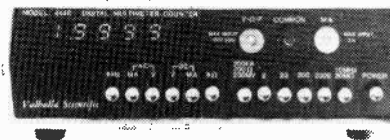

Valhalla Scientific 4440

Features: 4½ digit, LED display, autopolarity, battery operated.
Functions and Ranges: 200mV to 2000V DC or AC, 200uA to 2A AC or DC, 200 to 20M ohm, 2kHz to 20MHz (optional).
Accessories: Charger/adapter, high voltage, RF and current probes, case.
Price: Not Received.
Contact: Duncan Instruments Ltd.

VIZ

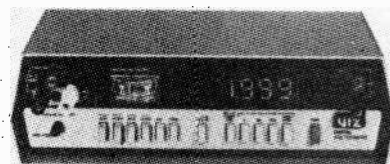

VIZ WD750A

Features: 3½ digit, LED display, autopolarity, battery operated/AC, analog meter for nulling or peaking.
Functions and Ranges: to 1200V AC or DC, to 2A AC or DC, to 20M ohm with high or low test voltage.
Price: US \$270.
Contact: VIZ



VIZ WD751A

Features: 3½ digit, LCD display, autopolarity, semi-autoranging, battery operated/AC.
Functions and Ranges: to 1000V AC or DC, to 200mA AC or DC, to 2M ohm.
Comes with: Test leads.
Price: US \$150.
Contact: VIZ

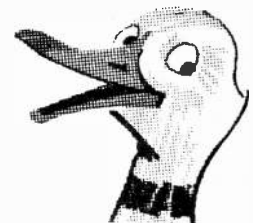

PCB BREAKTHROUGH ceresist^c

RUB-ON

TRANSFERS FOR PCBs
 Pads, ICs, Lines etc.

Use 3 ways—

- Apply to PCB and etch
- Use for paper artwork
- Works on clear films

Beats lacquers, tapes,
 PC pens!

FAST — EASY ECONOMICAL

Send \$1 (refundable) for
 sample & lists. Discounts to
 schools, dealers etc. In
 Toronto, 'shop Dominion' for
 CERES products.

CERES
 53 BURNETT AVE.
 WILLOWDALE, ONT.
 M2N 1V2
 (Mail order only)



QUESTION TIME

(1) DO YOU KNOW AN INTERNATIONAL RECTIFIER DEALER IN HALIFAX?

(2) WHO IS FAIRCHILD'S REPRESENTATIVE IN TORONTO?

(3) WHO IN CANADA STOCKS OPCOA LEDS?

(4) WOULDN'T IT BE NICE IF SOMEONE PUBLISHED A BIG CHART SHOWING WHO WAS REP OR DEALER FOR MAJOR SEMICONDUCTOR LINES IN CANADA?

Correct Answers — (1) Yes (2) R. N. Longman (3) Future/Active (4) No.

If your answer to any one of the above questions does not match the answer given above then we can help.

Next month in ETI — at no additional cost — we will tell you who carries what semiconductor lines. This valuable chart will save you much frustration — be sure to pin it up on the wall of your office/workshop.

PROJECTS

There is no need to say how great next month's projects are going to be... if you are new to ETI just ask someone who is

familiar and they will tell you what you have missed. Briefly, next month we will show you how to build (a) a sound level meter, (b) an automatic porch light (c) an advanced version of the ETI induction-balance metal locator, and (d) an electronic siren.

PLUS

We'll be seeing what's new in oscilloscopes, telling you about the interesting world of short-wave radio, keeping you up to date on the latest in technology, etc.

NATIONAL MA 1003
12 Volt Car/Boat Clock Module
Crystal Controlled

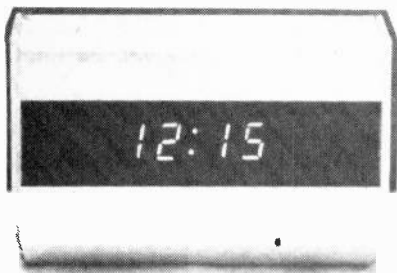

Complete with Aluminum case and switches

Module only \$26.95
Case only \$5.95

\$29.95
with all data

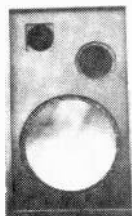

SPEAKER CABINETS

3 Way 12" \$59.95 pr.
6 Way 12" \$79.95 pr.
3 Way 15" \$79.95 pr.

Many Others

Send for our FREE 1978 Catalogue

ARKON ELECTRONICS LTD.,
91 Queen Street East, Toronto, Ont.
M5C 1S1 Tel: (416) 868-1315

Kits for ETI Projects

Now Available

ETI Project No. 134
True RMS Voltmeter
\$89.95

ETI Project No. 450
Bucket Brigade
Audio Delay Line
\$48.50

ETI Project No. 486
Frequency Shifter
\$69.95

ETI Project No. 585
Ultrasonic Switch
\$29.95

DO NOT SEND CASH
Cheque, Money Order
or Master Charge
include card expiry date
and number

Allow 3 weeks for delivery



DOMINION RADIO & ELECTRONICS
535 Yonge St. Toronto
Ontario M4Y 1Y5

**SERVING CANADIANS
FOR OVER 25 YEARS**

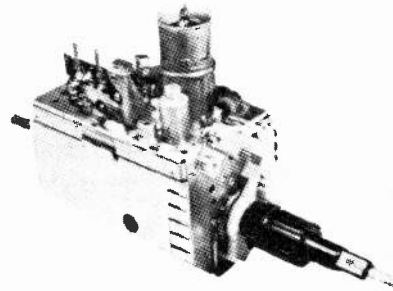

**UHF . VHF . FM
VARACTOR TUNERS**
Solid State our Speciality

We service more TV Tuners than all other tuner companies combined.

We also service all makes of TV cable convertors.

**CASTLE
TUNER SERVICE**

24 Cranfield Road,
East York, Toronto M4B 3H1
Tel: 752-7330/1

Build Your Own Pinball Machine

This product was too much fun to put in the hands of a reviewer: after playing with the machine at home for a couple of weeks I thought I'd better write something myself. So here you have Steve Braidwood's views on the Heathkit version of the Bally Fireball.

THE *BALL 1* LIGHT comes on, the machine chimes Beethoven's Fifth, and the steel ball clunks into the shooting channel. Rollovers *A*, *B*, *C*, and *D* light up.

I pull back the shooter and fire the ball to the top of the playfield. As the ball drops through rollover *C* I notch up a thousand points on the seven-segment display, and the *1000 bonus* light comes on. A bit of nifty flipping I manage to knock out targets *1* and *2*, and the machine replies by playing Zippadee Doo Dah and lighting the *double bonus* bulb. The next tune is Half Time Fight Song, which marks the *triple bonus* I get for hitting target *3*.

Before I lose my first ball down one of the side alleys I manage to flip it up to the top of the field through rollover *A* and it falls back through rollover *D*. That leaves only one rollover alight: when this one is tripped I'll get extra points and maybe a free ball.

At the end of play the bonus is added (three times over in this case) to the basic score, giving me 80,100 points.

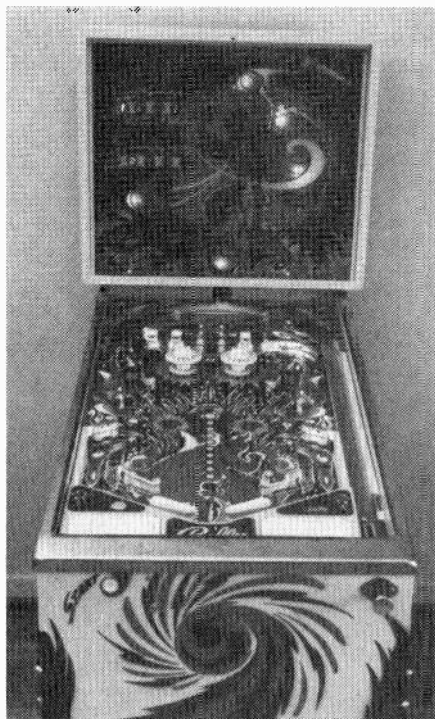

My main objective with the next ball is to get another triple bonus (for a player at my level this strategy wins most points). And when I get the chance I should go for that remaining rollover. Well I miss the bonus multiplier (hitting targets *1* and *3* is no good . . . until I get target *2*) but I do get the rollover.

My third ball comes in with my score at 130,300. This is a free ball (free balls are issued when the score passes 100000, 200000, and 300000) and the ball in play indicator still says *ball 2*. This time I do get the triple bonus and update my score to 177,950. This ball (*2b*) was an easy one because the benefits won with ball *2a* were carried forward (the free ball status of the side alleys won by clearing all four rollovers, the targets and rollovers that were tripped by the previous ball stay tripped). The ball was lost down a side alley so the next ball is another free one, ball *2c*.

This time I miss the bonus multipliers but do clear the rollovers (which relights the *free ball* indicators in the

Fig. 2. The Fireball instructions and ratings.

<p>1 to 4 CAN PLAY</p> <p style="text-align: center;">FIREBALL INSTRUCTIONS</p> <ul style="list-style-type: none"> • Press button on front of game once for each player up to a total of 4 players • Shooting ball thru top rollovers lanes A & C D awards player 75 000 and hits bottom rollovers for extra ball action • Hitting targets 1 & 2 awards double bonus • Hitting targets 1 2 & 3 awards triple bonus • Collect bonus when ball leaves playfield • Awards extra ball at 100 000 200 000 & 300 000 <p style="text-align: right;">HEATHKIT</p>		<p style="text-align: center;">RATINGS</p> <table style="width: 100%; border-collapse: collapse;"> <tr> <td style="width: 70%;">Score over 150 000</td> <td style="width: 30%;">FIREBALL</td> </tr> <tr> <td>Score over 125 000</td> <td>WIZARD</td> </tr> <tr> <td>Score over 100 000</td> <td>FANTASTIC</td> </tr> <tr> <td>Score over 75 000</td> <td>CHAMP</td> </tr> <tr> <td>Score over 40 000</td> <td>SUPER</td> </tr> <tr> <td>Score under 40 000</td> <td>AMATEUR</td> </tr> </table> <p style="text-align: right;">HEATHKIT</p>	Score over 150 000	FIREBALL	Score over 125 000	WIZARD	Score over 100 000	FANTASTIC	Score over 75 000	CHAMP	Score over 40 000	SUPER	Score under 40 000	AMATEUR
Score over 150 000	FIREBALL													
Score over 125 000	WIZARD													
Score over 100 000	FANTASTIC													
Score over 75 000	CHAMP													
Score over 40 000	SUPER													
Score under 40 000	AMATEUR													

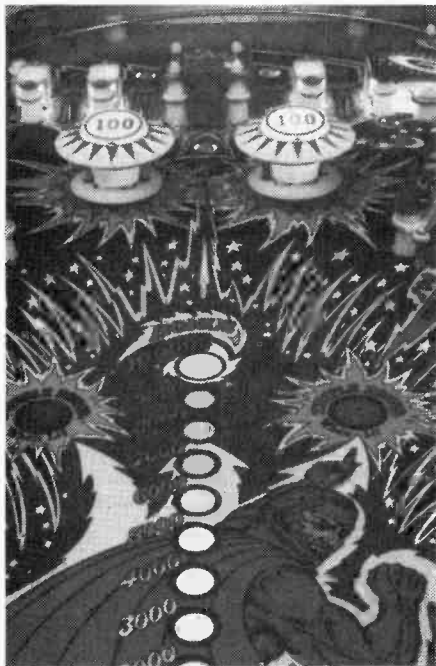

Photo 3. Rollovers A and D are extinguished, and target 3 remains lit. The bonus stands at 16000 points.

side alleys). The ball is lost between the flippers so I shouldn't get a free ball. I do, because my score passes the 200,000 mark. (Now I have 213,500).

Ball 2d was one of those unlucky ones. I'm all psyched up to flip targets 1 and 2 as the ball drops through rollover B. But after buzzing about midfield a bit the ball decides it's had enough and exits stage left. I didn't even have the chance of one stab with the flippers. Still, the side alley was primed for a free ball, so it's not too bad.

Ball 2e was pretty standard — a double bonus bringing my score up to 264500 as the ball 3 light comes on.

Ball 3 was a disappointment, with no multiplier for my mediocre 13000 bonus.

Ball 4 came in on a score of 283500. I soon had the line of bonus lights up to 10000 and on its second run. The bonus tripler was quickly arranged and the bonus light was at its maximum of 19000 when I lost the ball. Score now was 352,150, giving me my final (score-related) free ball at 300,000.

Ball 4b was another of those balls that don't even get a tickle from the flippers. But things aren't too bad; a bit of classy shooting cleared the final lit rollover and the side-alleys were ready to award a free ball by the time it mattered.

Now I'm getting nervous. I'm only a few tens of thousands short of the ETI office record (set by Graham at our mini-tournament a couple of days before, but that wasn't a fair contest —

he'd only had one drink). Was I going to blow it? Just two balls to go — it should be easy, but the pressure was on. Well I get target 3 easily and slow the ball down for some low-angle shots to targets 1 and 2. But the increased tension upsets the critical timing and casually the ball sails past the frozen flipper. The 1000 point bonus (the minimum) is an insult.

Ball 5 wasn't much better (3000 bonus) and suddenly the game is all over. No free ball for passing 400,000, and a final score of 400,550. Still it is a record, so I don't feel so bad after all.

According to the ratings any score above 150,000 is Fireball standard. But this machine was modified, so I can't honestly accept the title.

THE GAME

From the (true) story above and the information in Fig. 2 and the photographs you will have a good idea of how the game works. Up to four players can compete: the machine keeps track of each player's score and the status of the targets, rollovers and free ball alleys. At each player changeover the display sequences the scores of all the players, so you don't lose track of the opposition. Other variations can be organized — pinball parties, teams, you-control-the-left-flipper-and-I'll-do-the-right, prizes, forfeits — by the owner.

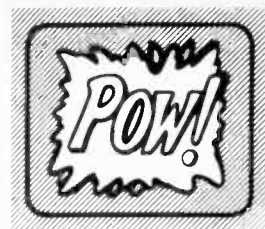

The complexity of the game was just right: certainly it wasn't up to the standard of some of the commercial machines, but in the time we had the machine we didn't get bored (but we were still in the phase of developing the basic skills). The single LED display was found to be adequate and the gimmicky tunes add a bit of cute appeal. In addition to the tunes mentioned above the machine plays You're In The Money (when you get a free ball), the bugler's Charge (when you clear all four rollovers), The Party's Over (game end), and the Funeral March (when you tilt the machine). When the machine is tilted the scoring circuits are inhibited for the rest of the play of that ball.

When first playing the game seems to be 90% luck but still it is very exciting. After a week of playing success is 90% skill, and presumably this can increase to almost 100% in time. The operation of the shooter is initially skillless, but tests showed a non-random set of results for different playing techniques. Different players developed personal skills at shooting for specific rollovers — at the best one had two or three rollovers which could be hit with 50% to 80% certainty.



Photo 4. Here target 1 can be seen, and the side alley. The way to cheat is also shown: the two rubber bumpers stuck to the wall of the side alley serve to bounce the ball out of the alley under certain conditions.

Fig. 5. Basic structure of the game, showing how the playfield sits up for maintenance.

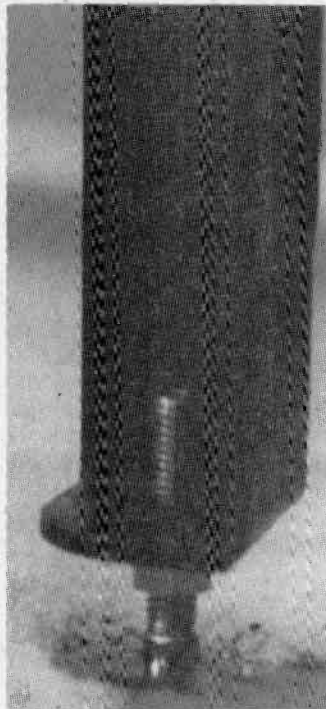
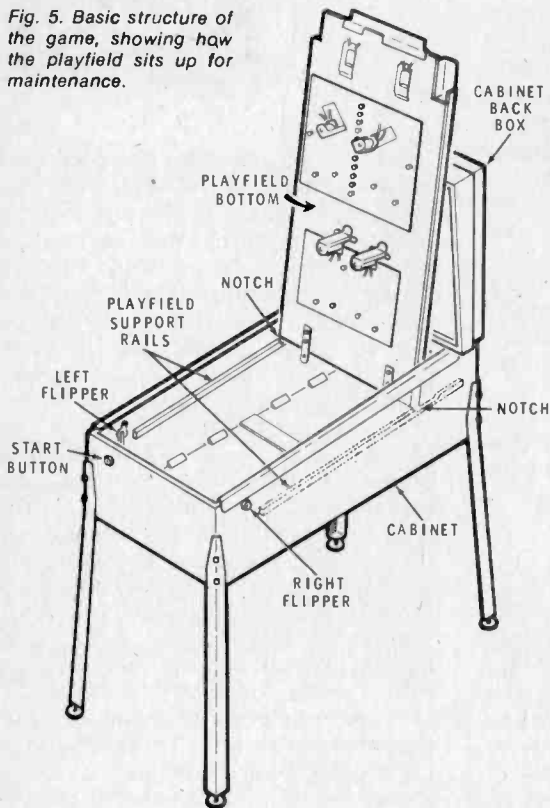

Photo 6. The adjustable foot of the Fireball.

something I'd be proud of. Especially if I'd made it myself.

Perhaps I shouldn't pick on Heathkit/Bally for the finish. If you are building the machine yourself then you can always customise your own cabinet — the way the machine comes is to suit the lowest common denominator, the kids' playroom. But if this is the approach I take then I'll have to complain about the price, but later. Anyway, the external finish is something very obvious so potential buyers can make up their own minds.

The switches and solenoids look like they're built to last, and with a company like Bally behind them I don't expect anyone will have any trouble. From the photographs you can see how well they're made.



Photo 9. Solenoid for firing the ball off the side bumpers.

THE MECHANICS

The pinball machine is housed in a particle board box, edged with chrome strips and topped with glass, which provides a successful compromise between frustration-proofing and domestic manoeuvrability. The unit was strong enough to withstand bashing by ETI staff, so it probably would cope with any other average family. The minimal compliance to operator thrusts was utilised by some players to achieve some measure of real-time control of low-speed balls dithering at the mouth of the desired rollover. But this practice can be dangerous — as I found out to my peril. Every time I used persuasion of this type I got the Funeral March chiming.

Fig. 5 and Photo 6 show the basic construction and the adjustable feet (necessary for leveling the machine). Now some bad news. Photos 7 and 8 show the rear controls. Not up to the standard I'd expect at this price. But who sees the back? The woodwork at the front, however, is also not very well finished. The fascia and the playfield — the two areas behind glass — are great. The rest looks like it's been quickly finished for use in a kids' playroom. Maybe I'm unusual but I'd like a personal pinball machine to be a piece of pop art, a piece of furniture,

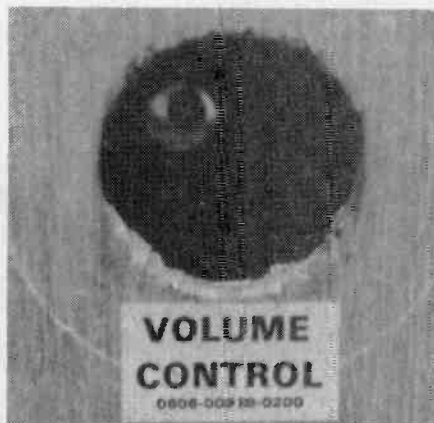

Photo 7. A rough hole in the display-section rear-panel gives very poor access to the pcb-mounted volume control.

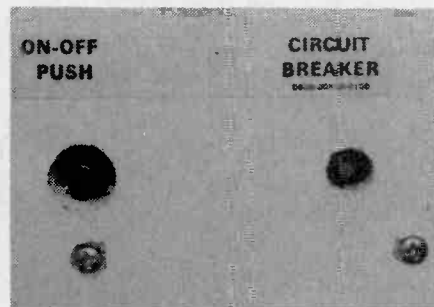

Photo 8. Two bolts holding in the power-supply module, plus the controls as labelled. The wooden cabinet is finished in chipboard spray-painted to a rough finish.

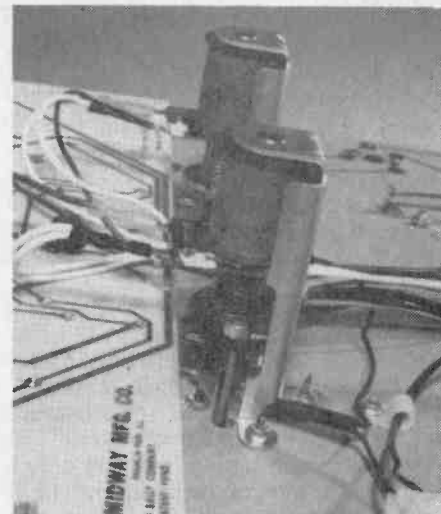

Photo 10. Solenoids attached to the two mushroom-shaped bumpers in the centre of the playfield.

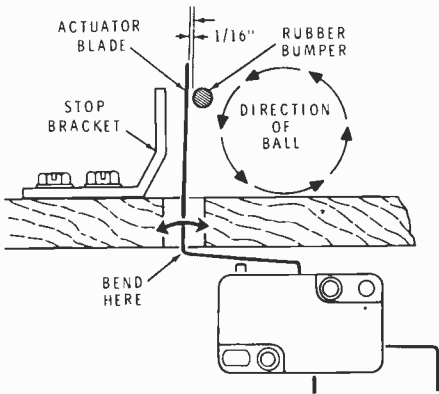

Fig. 11. The side-bumper switch mechanism.

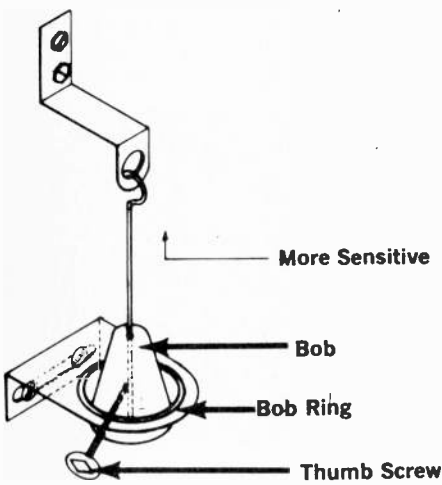

Fig. 13. Ever wondered how the tilt switch works?

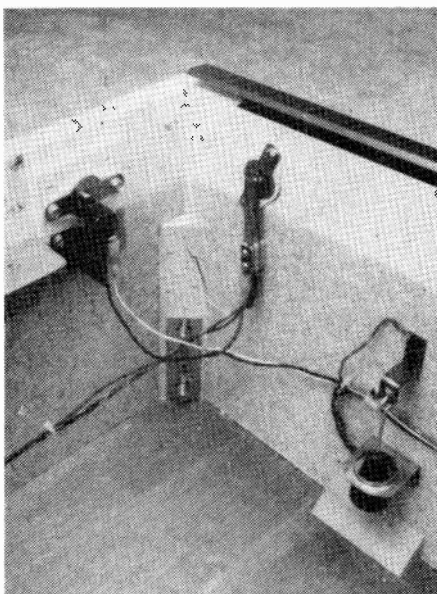

Photo 14. The start switch, the flipper switch and the tilt switch. The woodwork can also be seen here.

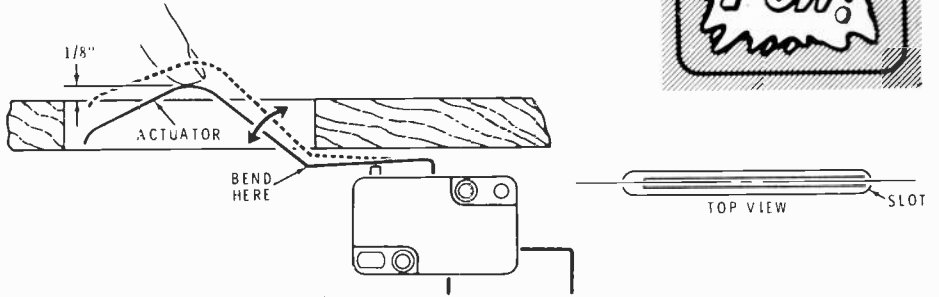

Fig. 12. The rollover switch mechanism.

THE ELECTRONICS

The pinball machine has four printed-circuit boards — two playfield boards, one logic board, and the power supply.

The playfield boards just wire up the switches and lights in a matrix format. Figure 15 shows how this matrix forms part of the overall system and Fig. 16 shows the matrix diagram from the Bally manual (yes, there is a repair

manual from Bally, as well as the building manual from Heathkit).

The brain is an F8 microprocessor, which looks at the status of all the switches and everytime one is operated it gives a response according to a program stored in ROM (two 1K ROMs). The actual wiring is thus quite simple — the matrix makes it easy to wire up all the switches and lights and all the logic is inside the ICs. Imagine how it would look if all the logic

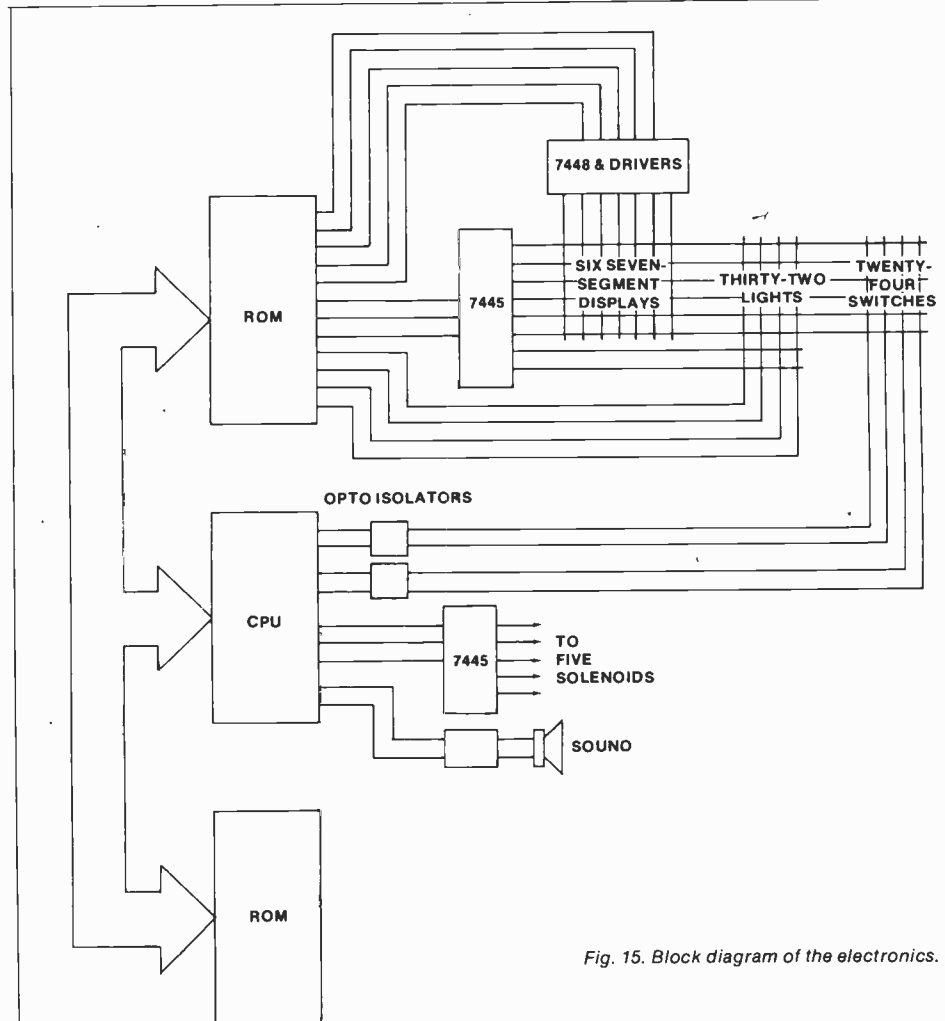

Fig. 15. Block diagram of the electronics.

functions had to be hard-wired.

There's not much else to say without going into the program itself or explaining how the F8 works. By treating the three computer ICs as black boxes sitting on a bus all there is to understand is the means by which all the individual parts of the game (the segments of the LEDs, the solenoids, the switches, the lights) are connected to these ICs., via decoders, buffers, opto isolators, diodes, etc. If this part is not clear then it suggests you need

learn a bit about simple digital electronics.

THE DIAGNOSTICS

By flicking a switch on the logic board the machine will test itself. A faulty CPU or ROM shows on the LED display (see Fig. 22) and a stuck switch can be identified using the table reproduced in Fig. 23. Burned-out bulbs can be easily replaced, as they have clip-in sockets (see Fig. 24).

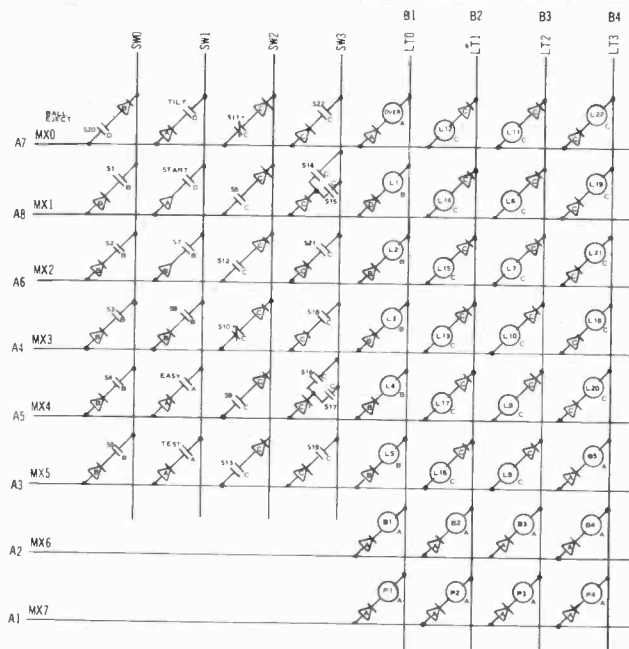

Fig. 16. Diagram of the matrix of switches and lights from the Bally manual.

NOTE: S-10 and S-11 are mechanically held activated; a ball will deactivate them.

- A = Located on Logic PCB
- B = Located on Upper Playfield PCB
- C = Located on Lower Playfield PCB
- D = Located in Playfield Cabinet

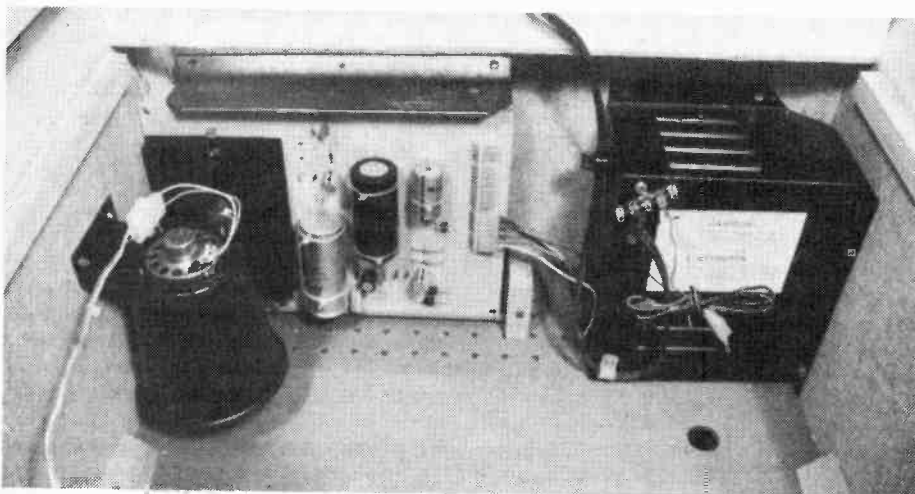

Photo 18. Power supply and loudspeaker.

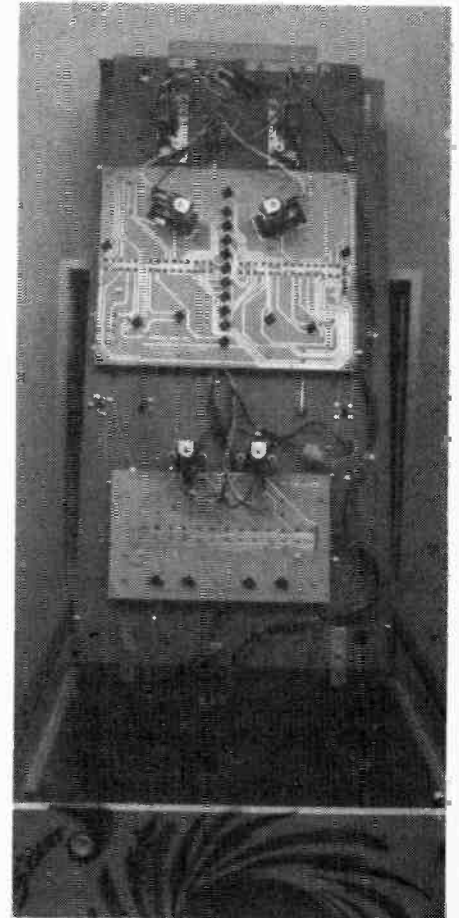

Photo 17. Underneath the playfield, showing pcbs, solenoids, clip-in bulbs, and simplicity of wiring.

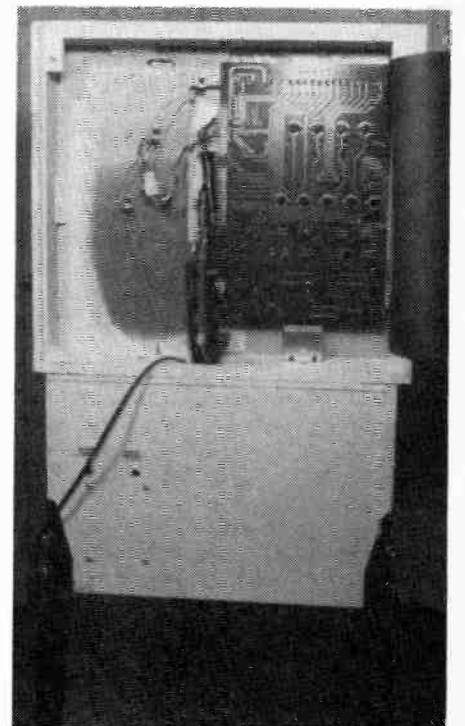
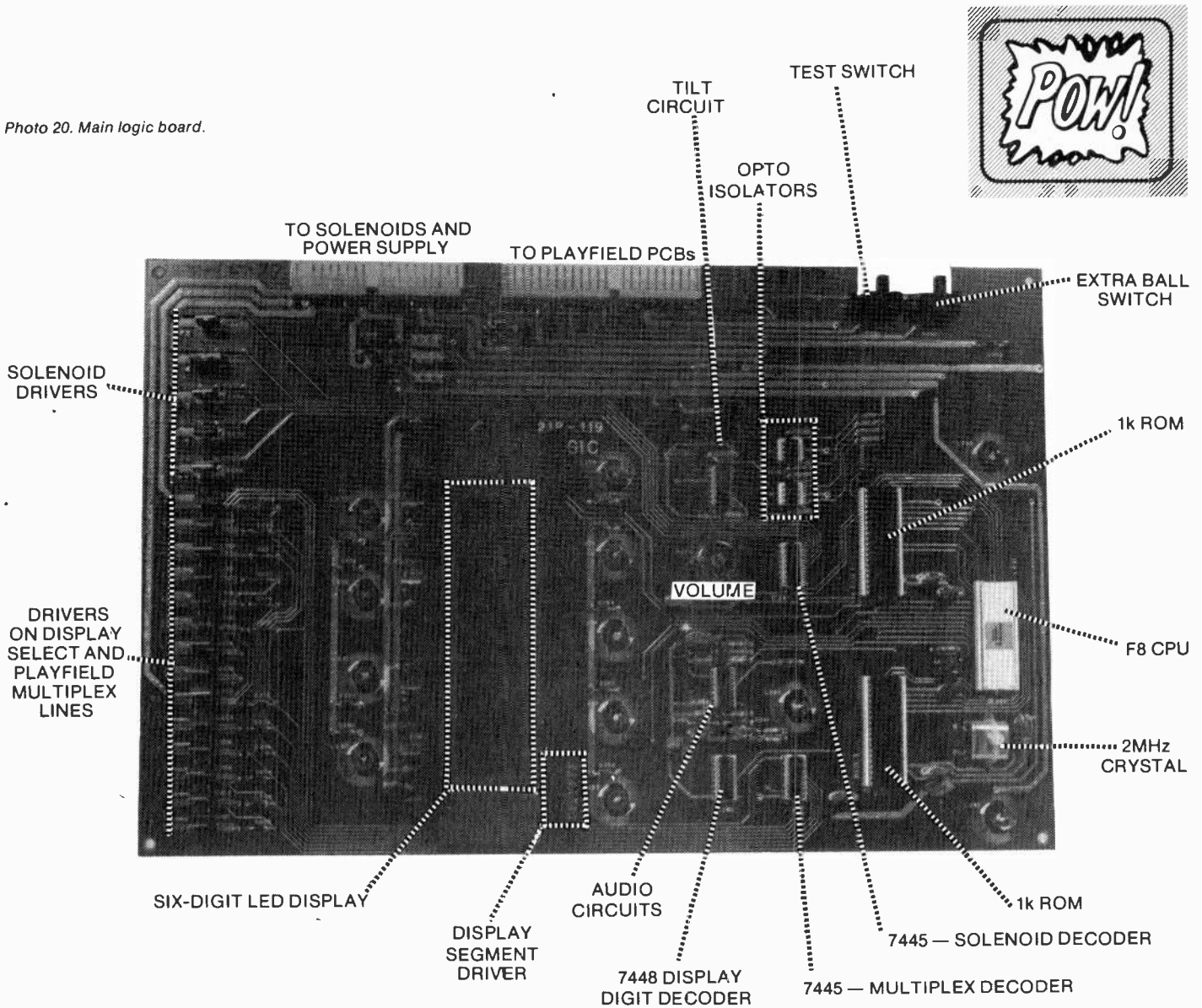

Photo 19. Rear of the machine with back removed.

Photo 20. Main logic board.



MODIFICATION

First refer to Photo 21. The 50k/100k switch here decides whether you get extra balls at scores of 50k/100k/150k or at 100k/200k/300k. The hardware modification on the machine we had can be seen in Photo 4. At the entrance to the side alley you can see two dark squares, actually stick-on rubber 'feet'. These give you an extra chance when the ball is trying to escape. They do not have a great effect — they just save some of the frustration.

BUILDING

Unfortunately we didn't have time to build up a machine from the kit, the unit in the photographs was built-up by a chap at Heathkit's Canadian headquarters in Mississauga. It took him a couple of days to build, but the average guy at home would perhaps take twice as long.

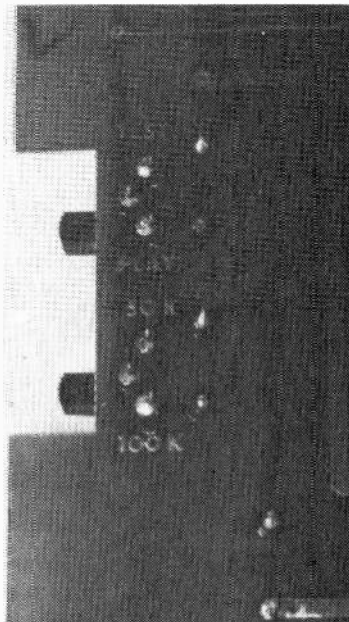
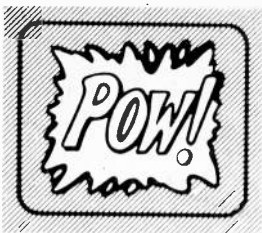

Photo 21. The test and extra-ball switches.

Anyone who has built up a Heathkit project before will know how much work they put into the manual. Every step of the building process is carefully explained, so even if you are not a regular project builder you should have no trouble. More experienced builders could run into trouble — there is a temptation to skip the instructions because they're too detailed and Heathkit don't provide any simple aids (like the ETI complete component overlay).

OVERALL

In the states Heathkit advertise the GD-1110 pinball machine at \$600. If they were Canadian dollars and the Canadian price the machine would be worth buying by people who are not already pinball fanatics. But with a Canadian price of almost \$1200 you have to definitely be a pinball fan to buy one. That money buys you four games a



Cross-Reference for 'Stuck' Switches

READ OUT ON DISPLAY

	1	2	4	8	3	5	6	7	9	C	コ	U	E	E	X	
LOCATION ON DISPLAY	1	S20	TILT	S11	S22	S20 TILT	S20 S11	TILT S11	S20 TILT S11	S20 S22	TILT S22	S20 TILT S22	S11 S22	S20 S11 S22	TILT S11 S22	S20 TILT S11 S22
	10	S1	START	S6	S14 or S15	S1 START	S1 S6	START S6	S1 START S6	S1 S14 or S15	START S14 or S15	S1 START S14 or S15	S6 S14 or S15	S1 S6 S14 or S15	START S6 S14 or S15	S1 START S6 S14 or S15
	100	S2	S7	S12	S21	S2 S7	S2 S12	S7 S12	S2 S7 S12	S2 S21	S7 S21	S2 S7 S21	S12 S21	S2 S12 S21	S7 S12 S21	S2 S7 S12 S21
	1K	S3	S8	S10	S18	S3 S8	S3 S10	S8 S10	S3 S8 S10	S3 S18	S8 S18	S3 S8 S18	S10 S18	S3 S10 S18	S8 S10 S18	S3 S8 S10 S18
	10K	S4	X	S9	S16 or S17	X	S4 S9	X	X	S4 S16 or S17	X	X	S9 S16 or S17	S4 S9 S16 or S17	X	X
	100K	S5	X	S13	S19	X	S5 S13	X	X	S5 S19	X	X	S13 S19	S5 S13 S19	X	X

day, every day of the year, for 3¼ years at 25¢ a game. But there is much more to having a pinball machine in your home than just playing pinball. You immediately become popular with all your neighbours, you see friends much more often than you ever did before, and you probably get all kinds of other problems resulting from your increased popularity. You will likely spend more on beer, chips, etc, than you did on your pinball machine.

Fig. 22 and Fig. 23. How the display is used in diagnosis.

Any other number indicates that there is more than one 'stuck' switch. In this case, the displayed number is the sum of these switches.

When using this diagnostic test a faulty F8 component is displayed as follows:

CPU	PSU-1	PSU-2	9368	DECODER 7447	74247
good	good	good	bbB00d	bbB00C	bbB00C
good	bad	good	1bbBAd	1bbBCC	1bbBCC
good	good	bad	b2bbAd	b2bbCC	b2bbCC
bad	bad	bad	12bbAd	12bbCC	12bbCC
	good	good		all blank or jibberish	

NOTE: If PSU #1 is bad in the area where the test program is located, then it will give the same result as a bad CPU.

DIGITAL MULTIMETER MODEL ME-521

NEW! HIGH QUALITY - LOW COST

Designed to replace many high priced analog meters

DC	AC	OHMS
1V	1V	1K
10V	10V	10K
100V	100V	100K
1000V	600V	1M
1mA	1mA	
10mA	10mA	
100mA	100mA	
1A	1A	

\$99

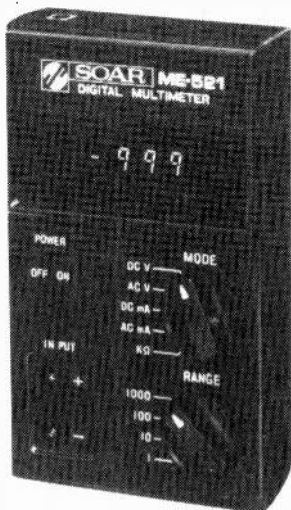

ACCURACY 1%

Display: 7 segment LED

maximum indication 999

Measuring mode: DC V, AC V, DC mA, AC mA, OHMS

Polarity: Automatic, negative polarity indication

Zero ADJ: Automatic

Size: 95(W) x 155(H) x 44(D)

Over range indication

Weight: 300 g

Protection: Fuse & Diode

Power: 4 AA Size Cells

Federal Sales Tax Included

FOB WESTON

AC Line Adaptor \$8.50

(In Ontario, add Prov. Sales Tax)

DUNCAN INSTRUMENTS LTD.

ELECTRICAL MEASURING INSTRUMENT SPECIALISTS

122 MILLWICK DRIVE, WESTON, ONTARIO, M9L 1Y6

TELEPHONE (416) 742-4448 ■ TELEX 06-969636

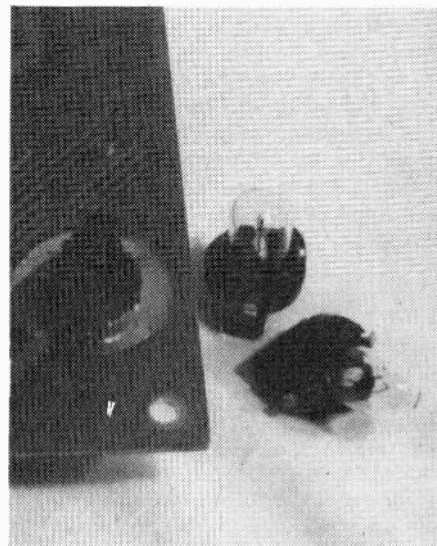

Photo 24. The bulbs are easy to replace with their clip-in sockets.

DATA PRECISION MODEL 1350



Regular price \$256

SPECIAL INTRODUCTORY OFFER

NOW
\$229*

*Canadian Funds, duty and federal sales tax included. Provincial sales tax extra where applicable. Offer expires Sept. 30, 1978.

A full function 3½ digit lab-bench DMM that maintains 0.1% accuracy and gives you ranges, features, and functions you've never seen at this price.

Protected on all ranges, in all modes, the 1350 is designed for a long, trouble-free life of accurate measurements.

FULL FUNCTION DMM

Not just AC and DC Volts and Resistance, but AC and DC Current, also. And HI/LO Ohms excitation, too!

Parameter	Min. Reading	Max. Reading	No. Rgs.
DC Volts	±100μV	±1200V	5
AC Volts	100μV	1000V	5
Resistance	100mΩ	19.99MΩ	6*
DC Current	±0.1μA	±1999mA	5
AC Current	0.1μA	1999mA	5

*Plus 5 more for low excitation.

PERFORMANCE

DC Volts accuracy of ±0.1% input ±1 l.s.d. That's as much as five times better than conventional DMM's in the same price range. Comparable high accuracies on other measurements.

ACCESSORIES

A full range of accessories are available, including high voltage DC probe and AC clamp-on current probe. Phone or write for full details.

In Eastern Canada (Ontario and east) order from

WEBSTER INSTRUMENTS LTD.

2446 Cawthra Road, Mississauga, Ont. L5A 3K6 Tel(416) 275-2270

In Western Canada (Manitoba and west) order from

NATIONAL ELECTROLAB LTD.

1536 Columbia St., North Vancouver, B.C. V7J 1A4 Tel(604) 985-0511

What you get

For a limited time only the Data Precision model 1350 is being offered in Canada at a special introductory price of \$229. But you must act now. You must order your model 1350 by Sept. 30, 1978 in order to qualify for this low price. Price includes the model 1350, test leads, AC line cord, warranty, manual, test data and certificate of conformance.

MAIL ORDER COUPON

WEBSTER INSTRUMENTS LTD.
NATIONAL ELECTROLAB LTD.

Payment: Certified Cheque Money Order Chargex/Visa Master Charge

Card Number

Expires _____

Card Holder Signature _____

Please send me _____ Data Precision Model 1350
@ \$229 \$ _____

Provincial sales tax (Ont. 4%; Quebec 8%; B.C. 5%) \$ _____

Shipping and handling \$ 2.00

SHIP TO: Total enclosed \$ _____

NAME _____

ADDRESS _____

CITY _____

PROV _____ POSTAL CODE _____

Real Time Analyser Mk II

LED display for compact, easy-to-build unit.

OUR PREVIOUS Real Time Audio Analyser design produced beautiful displays on the screen of an oscilloscope but this means, of course, that to use the device one has to have a scope. Not everyone has, and with this in mind, we contemplated the design of a more conventional analyser with LED bargraph display.

This version has the great advantage of portability over the previous design, and also looks better than a scope sitting next to your brand new, 21st Century styled hi-fi! It is also easier to set up and trouble-shoot.

DESIGN FEATURES

When we proposed a LED version of the spectrum analyser we initially were going to use the original filter board and design a new logic board which multiplexed the LED display. The only question at that time was whether to multiplex the LEDs as columns or as individual LEDs. The column method is easier on the power supply as the peak current is only 10 times the average current while singly the peak current is 80 times the average. This is not quite accurate because a multiplexed LED requires less average current for the same output than one continuously on. However the column method also requires one extra diode per LED to give the isolation required between columns.

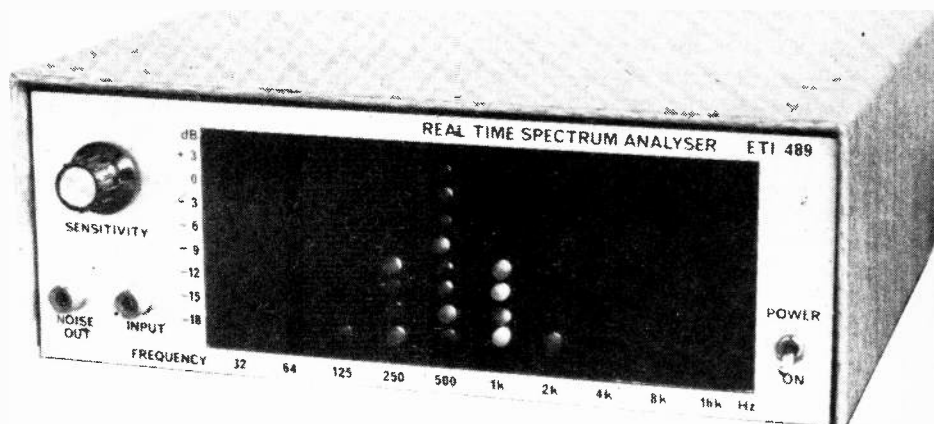

SPECIFICATION — ETI 489

No. of bands	10
Frequencies	31, 63, 125, 250, 500, 1k, 2k, 4k, 8k, 16k
Filter characteristics	-12dB, one octave from nominal centre frequency
Display	LED display 3dB spacing
Input level	50mV - 10V
Input impedance	200k
Pink noise output	200mV

After struggling with the PC board layout which was developing into a double sided board similar to the filter board of the previous analyser, we decided there must be an easier way to make a living! The question was then raised of whether it was worthwhile to multiplex the display at all and the answer was the project as it appears here.

The individual board approach not only makes fault finding easier and less likely, it also allows single sided PC boards to be used throughout. The system can also be expanded (or cut down) as desired simply by changing the filter components and the number of display boards. The power supply is capable of supplying up to 20 display boards without increasing the filter capacitors.

CONSTRUCTION

Assemble the power supply board and the ten filter display boards with the aid of the overlays. The filter components can be selected from Table 1 noting that if unpolarized tantalum capacitors are not used in the three lower octaves a bias resistor R15 is needed. The LEDs should be installed as evenly as possible with the polarity correct.

We assembled the units on 1/8" threaded rod with 12.5mm spacers between the boards. Metal brackets are used at each end to support the assembly. On the filter display boards the power rails and the input are all common and for the power supply we used long lengths of tinned copper wire threaded through the holes. The input lead should be done with separate links to allow the units to be serviced later if needed.

Before assembling the unit however each board should be checked with an oscillator to check it for the correct frequency and to adjust the calibration potentiometer. This is best done by measuring the sensitivity of the 16 kHz board with RV2 set for maximum sensitivity and adjusting all the others till they are the same.

We made a metal box with a piece of red plexiglas for a window to house the unit. If it is to be used with an equaliser (such as the ETI 484) it could be built into the same box.

It will be found with the economical LEDs available that there will be some difference in brilliance between them. If desired matched LEDs are available but not for 20 cents each!

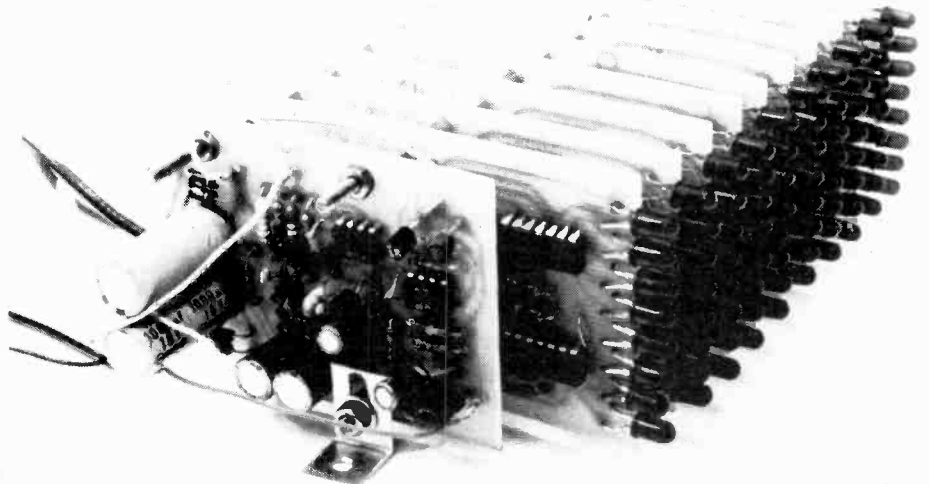
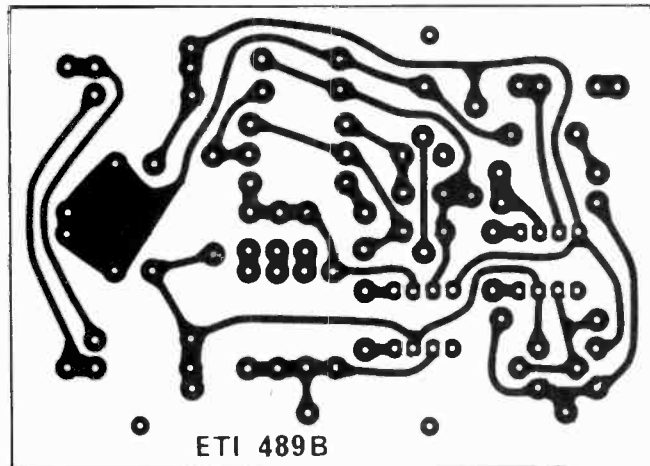
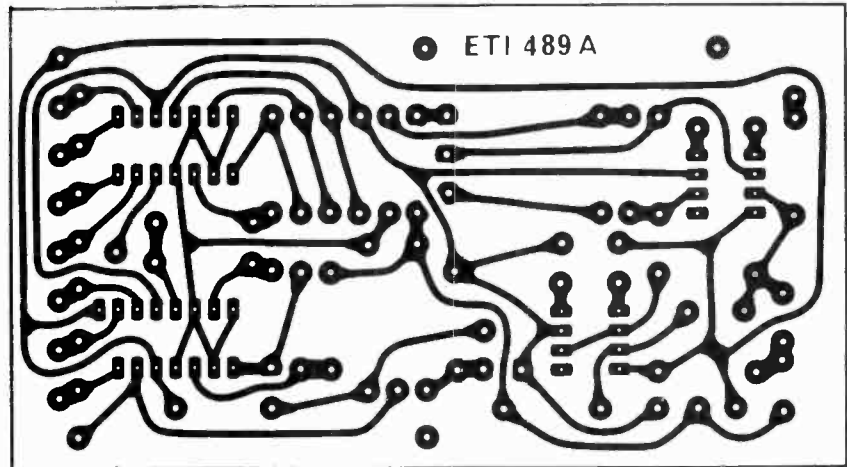

TABLE 1

Centre frequency	R15	C14,C15 tantalum	C16 polyester	C17 polyester
32	1M	3 μ 3	—	68n
63	1M	1 μ 5	—	33n
125	1M	1 μ 0	—	18n
250	—	—	220n	8n2
500	—	—	100n	3n9
1k	—	—	47n	2n2
2k	—	—	27n	1n0
4k	—	—	12n	560p
8k	—	—	6n8	270p
16k	—	—	3n3	150p

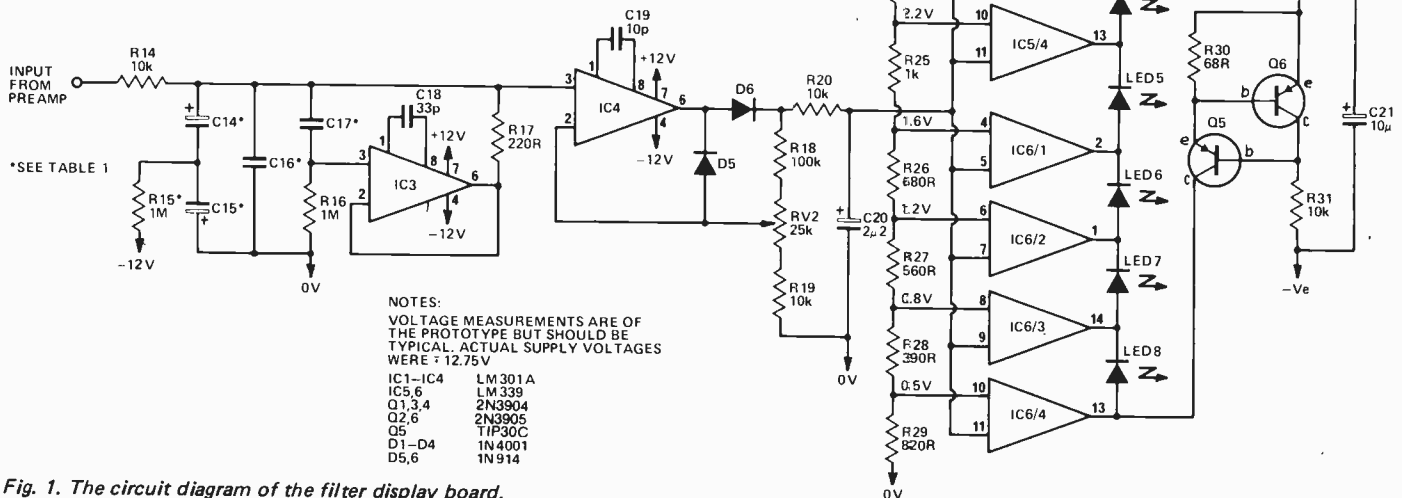

Fig. 1. The circuit diagram of the filter display board.

PARTS LIST — ETI 489A

Filter-Display boards 10 required

- RESISTORS all $\frac{1}{2}W$ 5%
- R14 10k
 - R15 see table 1
 - R16 1M
 - R17 220R
 - R18 100k
 - R19-R21 . . . 10k
 - R22 2k7
 - R23 2k2
 - R24 1k5
 - R25 1k
 - R26 680R
 - R27 560R
 - R28 390R
 - R29 820R
 - R30 68R
 - R31 10k

- POTENTIOMETERS
- RV2 25k trim

- CAPACITORS
- C14-C17 . . . see table 1
 - C18 33p ceramic
 - C19 10p ceramic
 - C20 2 μ 2 25V electro*
 - C21 10 μ 25V electro*

- SEMICONDUCTORS
- IC3,4 LM301A
 - IC5,6 LM339
 - Q5 TIP30C
 - Q6 2N3905
 - D5,6 1N914
 - LED1-LED8

- MISCELLANEOUS
- PC board ETI 489A

HOW IT WORKS

The input signal to the unit is initially buffered and amplified by IC1 and is then split into octave bands, rectified and displayed by a "bar" of LEDs. We have used 10 separate boards for the rectifier-display as only the component values in the filter are different.

The filter is a parallel LC network where the inductive part is a gyrator formed by IC3, C17, R16 and R17. The value of such an "inductor" is $R16 \times R17 \times C17$ Henrys (C17 in Farads). This, with the parallel capacitor C16 and the series resistor R14, form a band pass filter.

The output of the filter is half wave rectified by IC4 which also provides a gain of about 5 before the signal is smoothed by C20.

The eight LEDs in each individual display are connected in a series chain which is supplied with 10 mA by the constant current source Q5, Q6. Control of how many LEDs will be on is done by IC5 and IC6. These are quad voltage comparators which have as the output

stage an open collector NPN transistor with its emitter connected to the negative supply. These compare the output of the rectifier with the voltage set on the resistive divider R21-R29 and "short" out the unwanted LEDs.

The power supply is a simple fullwave rectified with a centre tap giving $\pm 12V$ dc. Due to the load (about 150 mA) there is about one volt ripple on the supply rail but this does not affect the operation of the unit. As the current drawn by the filter display boards does not change with the number of LEDs on the supply voltage remains reasonably constant.

The 120 Hz ripple does however affect the noise generator and this has been changed from the 487 analyser to accommodate this. The noise generator consists of Q3 which is used as a zener diode where the noise current is amplified by Q4. The output of Q4 is white noise and to give pink noise a 3 dB/octave filter is needed. IC2 and the associated capacitors and resistors provide this filter.

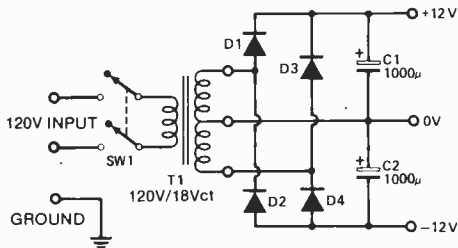

Fig. 2. The power supply circuit.

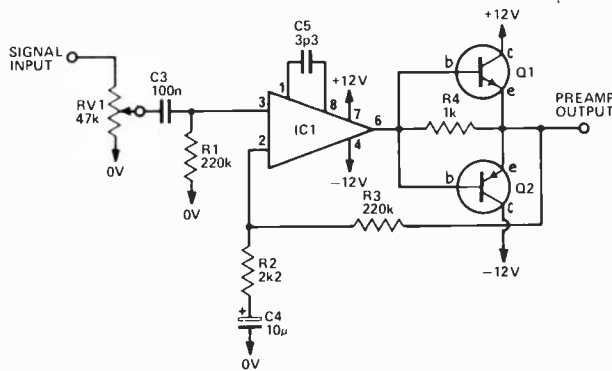

Fig. 3. The circuit of the preamplifier-buffer.

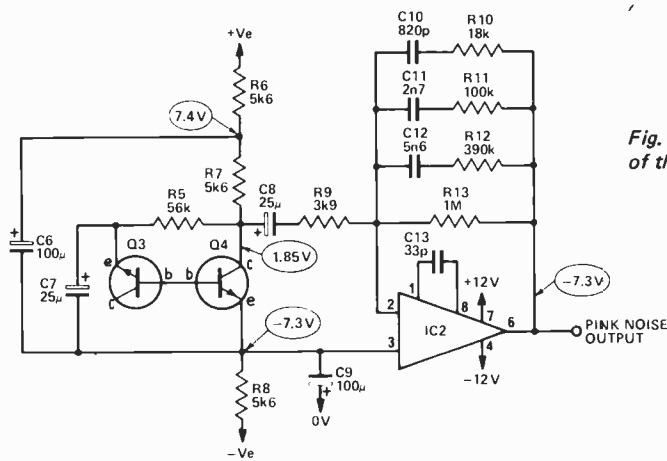

Fig. 4. The circuit diagram of the pink noise generator.

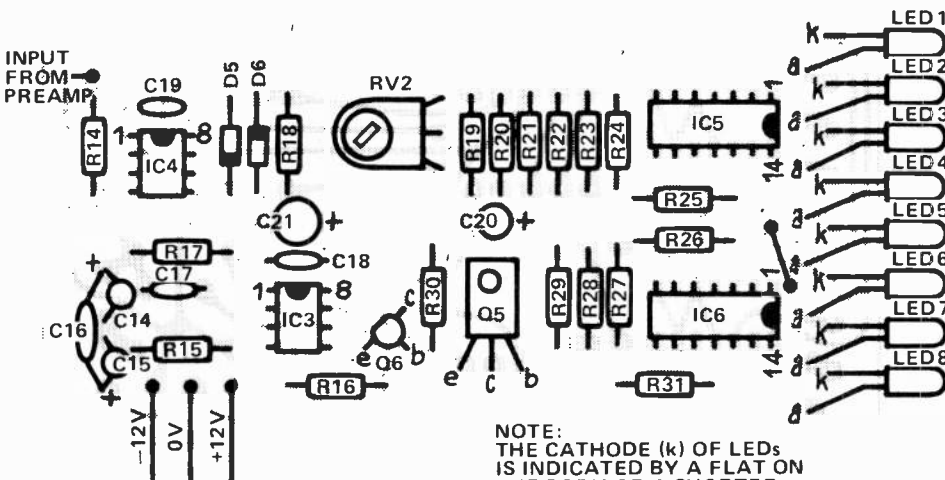

Fig. 6. The component overlay of board A.

NOTE:
THE CATHODE (k) OF LEDs
IS INDICATED BY A FLAT ON
THE BODY OR A SHORTER
LEAD. (TEST ORIENTATION
WITH 9V BATTERY AND
1K RESISTOR)

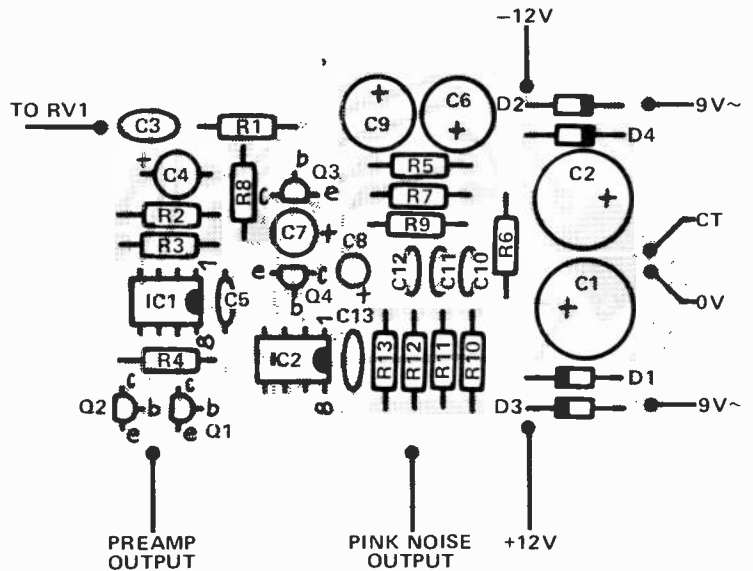

Fig. 5. The component overlay of board B.

PARTS LIST — ETI 489 B

Power Supply board

RESISTORS all 1/2W 5%

- R1 220k
- R2 2k2
- R3 220k
- R4 1k
- R5 56k
- R6-R8. 5k6
- R9 3k9
- R10. 18k
- R11. 100k
- R12. 390k
- R13. 1M

POTENTIOMETERS

- RV1 47k log rotary

CAPACITORS

- C1,2 1000µ 16V electro*
- C3 100n polyester
- C4 10µ 25V electro*
- C5 3p3 ceramic
- C6 100µ 25V electro*
- C7,8 25µ 25V electro*
- C9 100µ 25V electro*
- C10. 820p ceramic
- C11 2n7 polyester
- C12 5n6 polyester
- C13 33p ceramic

SEMICONDUCTORS

- IC1,2 LM301 A
- Q1 2N3904
- Q2 2N3905
- Q3,4 2N3904
- D1-D4. 1N4001

MISCELLANEOUS

- PC board ETI 489 B
- Transformer 120V/18V ct
- SW1 DPDT 120V toggle switch
- Case to suit

*all electrolytic capacitors PC board or single ended type.

Electronic Race Track



We bet you'll have fun with this game. Designed by Roy Cooper

THE DESIRE TO place bets upon almost any event, from the outcome of the Queen's Plate to the likelihood of life on other planets, is a deep seated one in many of the inhabitants of this one. That old joke about the guy who bet his friend a couple of bucks that he can give up gambling for a week would not be amusing, but for the fact that it were so near the truth.

THREE WAY BET

Bets fall into a number of different categories. They may be made on disagreements of fact ('I bet mine's bigger than yours'), about events capable of being modified by skill or lack of it ('I bet I can get mine to go faster than yours'), or bets made upon random events (The mind boggles!).

It is this latter type of bet, the toss of a coin, cut of a card or spin of a roulette wheel, that is probably the most popular form of gambling amongst groups of people, our race track game provides an exciting means of indulging in this type of activity.

The game is really a development of the well known 'heads or tails' type of game, but whereas most games of this sort are visually unexciting, the race

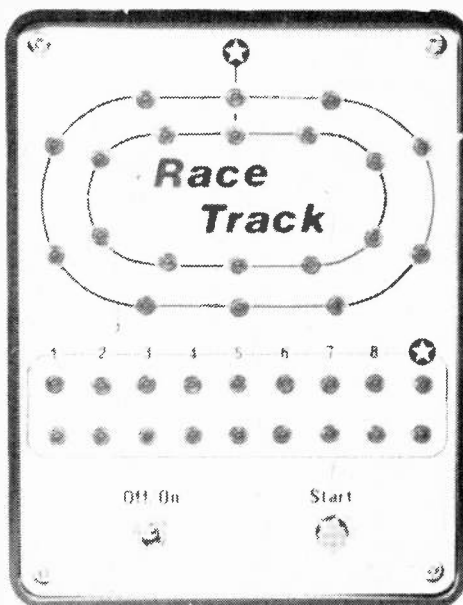

track game more than makes up for any shortcomings in this area!

THEY'RE IN THE LED

When the game's reset button is pressed all the LEDs are off and the 'horses' line up at the starting post. Now is the time to choose a horse and place bets if you wish.

Releasing the button starts the action with the circles or LEDs representing the 'horses' starting to flash as first one horse then the other takes the lead. As each horse completes a lap the appropriate lap LED lights. The first horse to cross the finish line lights his 'win' LED and halts the racing horses. If lady luck did not smile on you this time, pressing the reset button gives her, and you, another chance.

CONSTRUCTION

Mount all the components on the PCB as indicated in our overlay diagram. We recommend that sockets are used for ICs 1-6 as these are CMOS devices and should not be placed in circuit until all constructional work is complete. The LEDs are hard wired to the PCB and the interconnection information is given in Tables 1 and 2. Note that LEDs 37 and 38 have their cathodes taken to 0 V via R6 and R7 and not directly to ground as the rest.

The value of R1 could be selected to give the best display on the race track. A value somewhere between 4M7 and 10M should suit.

Now is the time to turn on, place your bets and probably loose your shirt.

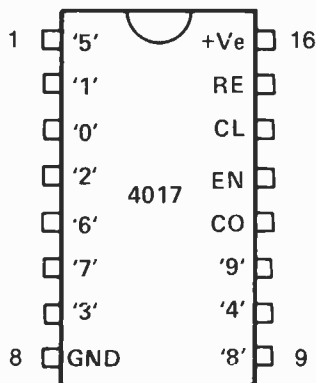
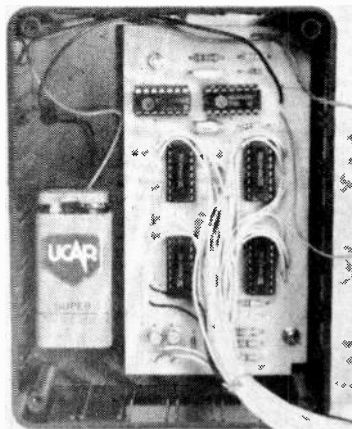

Fig. 1 Pin-out for 4017 IC



The photograph of the game shown left shows the general method of construction used in the prototype. Connection details for the wires between the board and front panel are shown in the circuit diagram and Fig. 5.

HOW IT WORKS

The circuit uses two oscillators each based on two of the NOR gates in the 4001 Quad NOR CMOS package. One of these (IC1/3 and IC1/4) runs at a high frequency and its output is fed to the input of one half of a 4013 Dual D type flip-flop. The device divides the output of the high speed oscillator by two and provides two signals that are 180° out of phase at its Q and Q̄ outputs. These signals enable either IC3 or IC5, the ICs being enabled if their enable input is held low.

The second oscillator based on IC1/1 and IC1/2 runs at a lower speed and is arranged to provide a non-unity mark space ratio, in fact a very short "high" output followed by a much longer "low".

This non-unity mark space ratio is achieved by the inclusion of D1 in the oscillator's timing network. This second oscillator can be gated on and off by signals to be described below.

Circuit action is as follows. PB1 is closed and this resets all the counters to zero as well as inhibiting the slow running oscillator. Upon releasing PB1, IC3 or IC5 will be clocked as the first positive pulse is generated by IC1/1 and IC1/2. Which counter is incremented will depend upon the state of IC2's outputs.

In general as the two oscillators are out of phase the counters will appear to be clocked in a random manner. A further random element is introduced because

while a 4017 is normally clocked with positive going pulses at the clock input with enable held low, it is possible for it to be clocked with a negative going pulse at enable while clock is high. Thus occasionally IC2 will act as a clock.

At the end of a lap a pulse is generated from the carry out (CO) output of either IC3 or IC5 and is used to advance the lap counters (IC4 and IC6).

The game ends on the ninth lap when the '9' output of either lap counter goes high. This turns on either Q1 or Q2 and in turn lights the appropriate win LED. The signal from either '9' output is ORED by diodes and this signal used to halt the game by disabling the slow running oscillator.

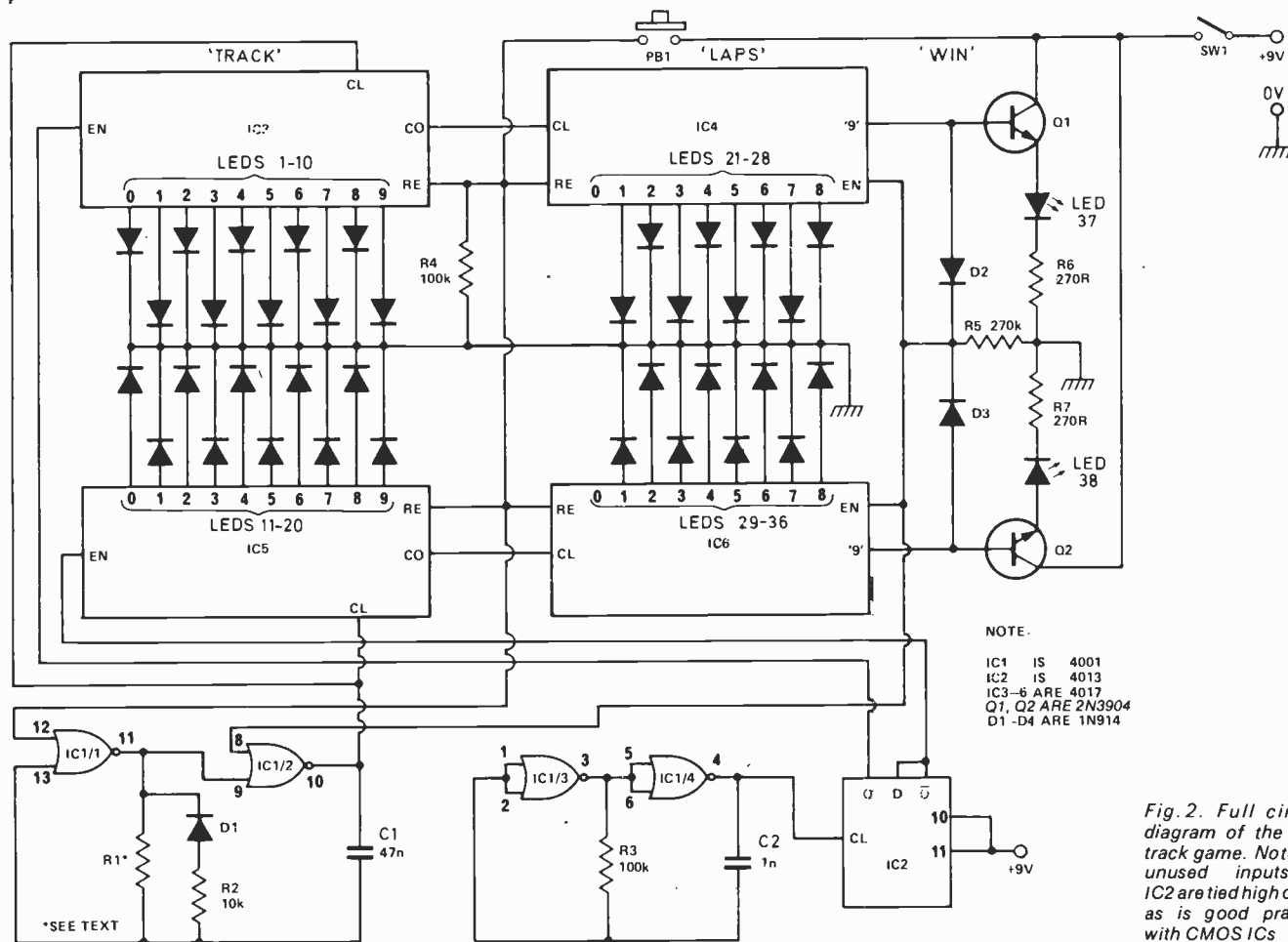
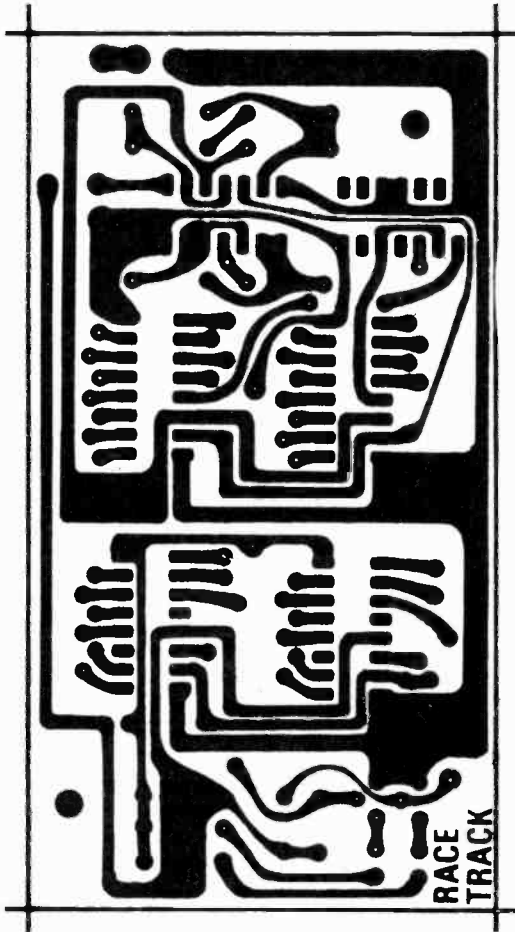

Fig. 2. Full circuit diagram of the race track game. Note the unused inputs of IC2 are tied high or low as is good practice with CMOS ICs

Fig. 3. Full size (115 x 62mm) foil pattern



PARTS LIST

RESISTORS all 1/4W 5% unless otherwise marked

- R1 * see text
- R2 10k
- R3,4 100k
- R5 270k
- R6,7 270R

CAPACITORS

- C1 47n polyester
- C2 1n ceramic

SEMICONDUCTORS

- IC1 4001
- IC2 4013
- IC3-6 4017
- Q1,2 2N3904
- D1-3 1N914
- LED1-38 TIL209 red

SWITCHES

- PB1 Push to make type
- SW1 SPST toggle

MISCELLANEOUS

Battery clip, flex, PCB as pattern, case to suit.

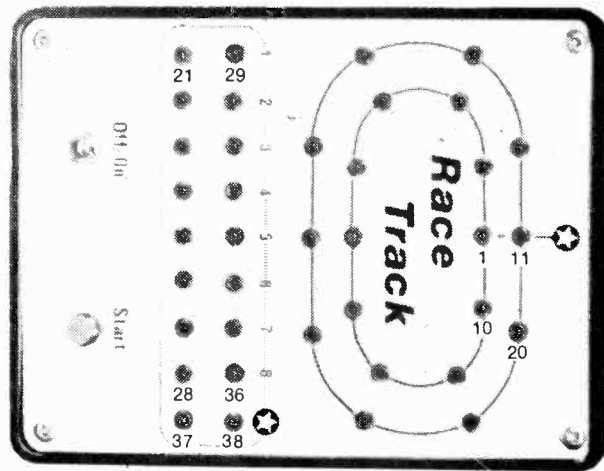

Fig. 5. Positions of LEDs on the front panel.

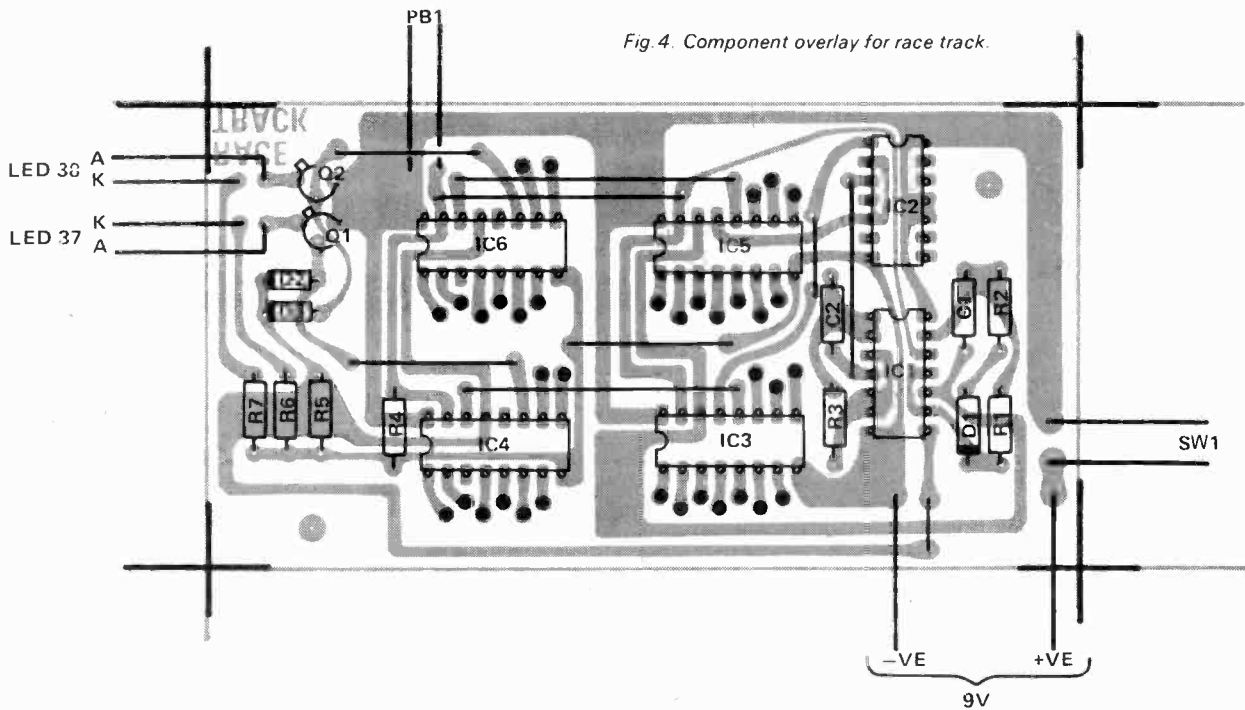

Fig. 4. Component overlay for race track.

Proximity Switch

This "no touch" switch has a multitude of applications.

Designed by John Cox

ALTHOUGH THIS PROJECT may look a bit complicated for a 'mere' switch, it has some unique features, both in design and function, as will be clear from the following:

1. It is a true proximity switch. You do not have to actually touch anything to operate it.
2. There are no light beams, sound waves etc. While radio frequencies are used, switching action results solely from the capacitance of 'approaching bodies.'
3. The sensor may be some distance away from the device, and also may extend several feet in length.
4. The sensor — and, if you want to mystify your friends, the switch itself — can be completely concealed from view.
5. The switch latches ON or OFF each time it is operated. No special re-set provision is needed.
6. Since a relay is used for the actual switching, the 117V circuit and the 'electronics' are isolated from each other.

In our application, the 'Magic Switch' was installed so that when one walked through a doorway a light in the further room automatically went on. Also, the sensor extended close to the floor, so that even the family dog was able to 'light the way'. (Admittedly, this at first struck terror and bewilderment into the mind of the canine, but, as usual, he soon came to accept the miracle as just one more example of human omnipotence!) Other applications could well include burglar alarms etc., all of which is to say nothing of its main function, which is to impress your friends.

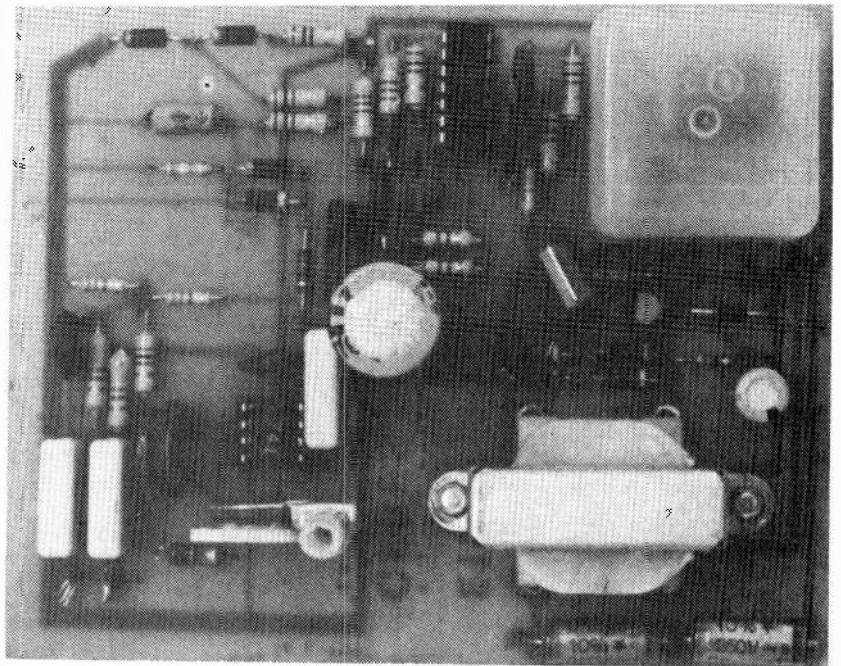

CONSTRUCTION

Use of the PCB of Fig. 2 is recommended, though three prototypes were built using different layouts, and all worked well. Note that this PCB has space for the power transformer and relay, but is left blank as far as the foil pattern for those units is concerned. This enables you to use whatever components you happen to have, or which may be available to you. You can either fill in your own foil pattern, or hard-wire the units into the circuit. Beyond this, no special comments are necessary, except to mention that it is preferable to use IC sockets or Molex strip connectors — having four op amps in IC2 makes this chip rather tricky to replace if you should ever have to do so.

ADJUSTMENT

The success of the project depends on the oscillator being just, but only just, within its tolerance limits, and the operating point is set by RV1 (coarse) and RV2. This adjustment is critical, but as a rule RV1 can be preset on the bench and RV2 adjusted at the time of installation. The exact operating point, and hence sensitivity, depends on the length of sensor used.

When you have completed wiring the switch, and have carefully checked your work, plug it in and clip a length of wire (12"-18") to the sensor input at point A. Set RV2 to mid-rotation, and adjust RV1 until you hear the relay clicking. This is an approximate adjustment, but at some nearby setting you will find that the

ETI Project

relay clicks every time you approach the sensor wire with your hand. If you clip the sensor wire to point B you will find the circuit somewhat less sensitive; since sensitivity increases with sensor length, this is useful where long sensors are to be used.

You can trace the sequence of events using an ordinary voltmeter. Point Y, the rectified oscillator signal, should read about 3V, and drop to 0V every time the sensor is approached. The reference voltage can also be measured at point Z. If you have a 'scope, you can display the waveform at point X, and see it 'collapse' when the switch is operated. Further tracing can be done at point L (comparator output), M (shaper) and N (flipflop), which makes it easy to pinpoint problems should they arise.

INSTALLATION

This will depend on the purpose for which your 'Magic Switch' is intended, but the following hints and observations will apply.

1. Aluminum foil strip (1" wide) makes a good sensor. It can be 10' or even longer, and is easy to conceal behind vinyl decorator tape, wallpaper, tile etc. If the switch is to be some

distance away from the sensor, a length of wire can be used to connect it, but this will add on to the effective length.

2. The longer the sensor is the more sensitive the switch will be, and you will find the provision of two inputs helpful. While it is true that you do not have to actually touch the switch to operate it, long sensors and extreme sensitivity can raise problems. If, for instance, the switch is made sensitive out to 4' from the sensor, merely walking around will probably cause it to switch on and off erratically. This is due to local capacitance-field effects and not to any shortcoming in the switch itself, and therefore makes it desirable to operate with more limited sensitivity.

3. If operation is erratic, it will usually help to connect circuit (-) to a true ground (waterpipe etc.) In most cases, however, this is not necessary.

4. The switch can be directly connected to any metal object (e.g., filing cabinet) you might wish to protect. Likewise, it can be used to operate any external circuit, such as an alarm. As a protection device, the 'Magic Switch' will baffle any intruder, if not psych him out completely.

INTERFERENCE

The 'Magic Switch' is relatively immune to interference such as line surges, field disturbances etc. About the only time trouble may possibly arise is when the switch is run off the same 117V circuit as is used to power some inductive load, e.g., a refrigerator. The reason is that every time the inductive device is switched on, a large transient voltage is developed on the ac line (chiefly across the 1 ohm resistance of the main fuse). If your room lights dim every time the 'fridge goes into action, you will appreciate the magnitude of this type of surge. Experience has shown that the 'Magic Switch' can cope with most things — SCR dimmers, tape recorders, vacuum cleaners, to name three which we have operated off the same 117V line — but in a few cases special precautions are necessary. Line surge suppressors may be fitted, or an L-pad wired across the trouble-causing inductive device, but generally it is simplest just to run the 'Magic Switch' off a different ac circuit.

ADDENDA

1. In a very few cases, RV1 needs to be more than 2k2. The easiest thing is to pad the control with a 1K series resistor. This can easily be mounted on board and the existing trace connecting RV1 to RV2 broken, the additional resistor being 'tapped in' in its place.
2. Since 117v AC will be present on-board, the unit should be housed in a suitable cabinet such as a 7-3/4" x 4-3/8" plastic utility box. An AC outlet receptacle could be mounted to the box, plus a main switch if desired.

A complete kit for parts for this project is available from Dominion Radio. The PCB alone is available from CERES. (See their ads in this issue).

Fig. 1 (a) Power supply circuit diagram

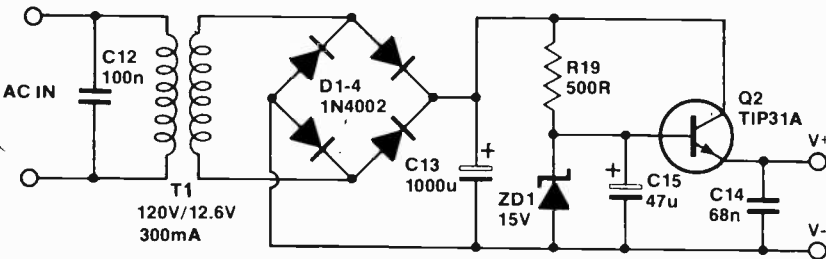
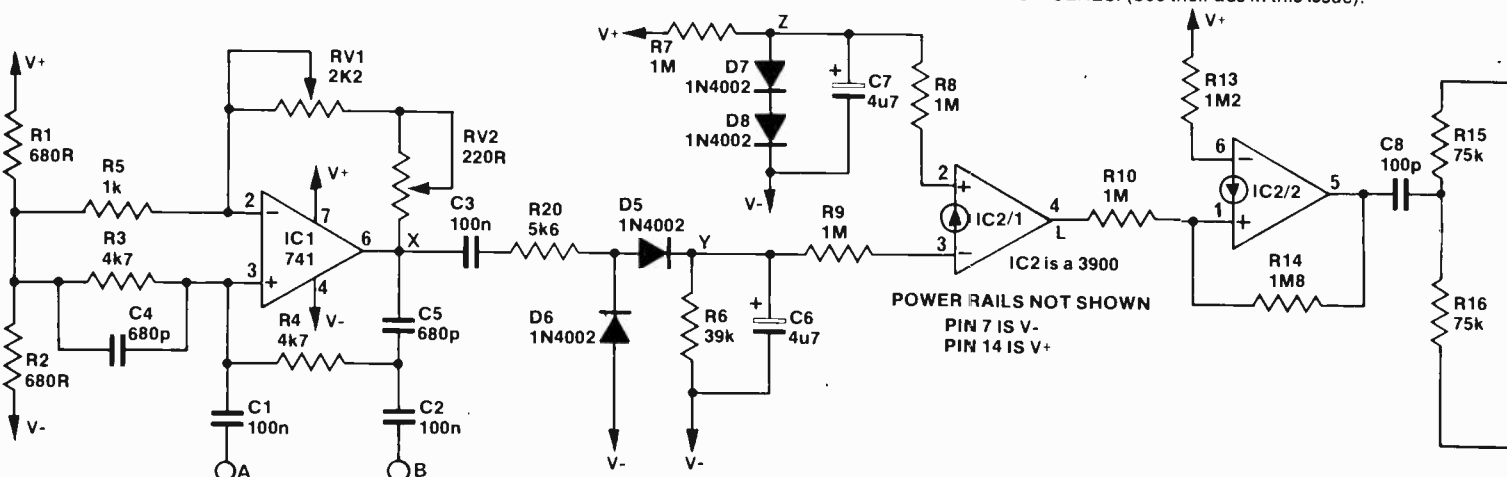

Fig. 1 (b) Main circuit diagram of proximity switch



HOW IT WORKS

IC1 is a standard LM741 Op Amp configured as an oscillator operating at a supersonic frequency. The circuit is adjusted so that it is 'on the edge,' and the capacitance effect of a body approaching its sensor causes it to 'drop out.' The rectified signal is fed to section 1 of IC2 (an LM3900 quad 'current differencing' amplifier) where it is compared with a reference voltage obtained from the R7-D7-D8 network. When the oscillator drops out, the signal voltage falls below the reference level, causing the comparator to produce a pulse at its output. This is 'squared up' by section 2 of IC2 to positively trigger a flipflop, composed of sections 3 and 4, and the output of this is used to operate a relay via driver Q2.

Because the relay draws enough current to cause a change in supply volts every time it is ON, and this would de-stabilise the oscillator, a simple voltage regulator is used of the series pass transistor type. This works like an emitter follower, in which the circuit as a whole is the load. The emitter of Q1 tracks the base, which is clamped by a zener diode to 12V. In addition we reap the advantage of 'capacity multiplication,' since C11 smooths any ripple etc. present in the base supply. Though C11 is small, the filtering effect is impressed on the output, and in practice the value of the capacitor is multiplied by the gain of the transistor.

PARTS LIST

RESISTORS

R1	680R
R2	680R
R3	4k7
R4	4k7
R5	1k
R6	39k
R7	1M
R8	1M
R9	1M
R10	1M
R11	1M
R12	1M
R13	1M2
R14	1M8
R15	75k
R16	75k
R17	3k3
R18	*68R 1/2W
R19	500R
R20	5k6
RV1	2k2
RV2	220R

CAPACITORS

C1	100n
C2	100n
C3	100n
C4	680p

C5	680p
C6	4u7
C7	4u7
C8	100p
C9	100p
C10	100p
C11	100n 250v
C12	100n 250v
C13	1000u 16V
C14	68n
C15	47u

SEMICONDUCTORS

IC1	LM741
IC2	LM3900
Q1	2N3019
Q2	TIP31A
DI-9	1N4002 or similar
ZD1	15V Zener diode 1/2W
T1	120V/12.6V @300mA
RL1	Coil: 10-30mA, 15V or less. Dominion type 4L2- 0015-01; Radio Shack type 275-004.

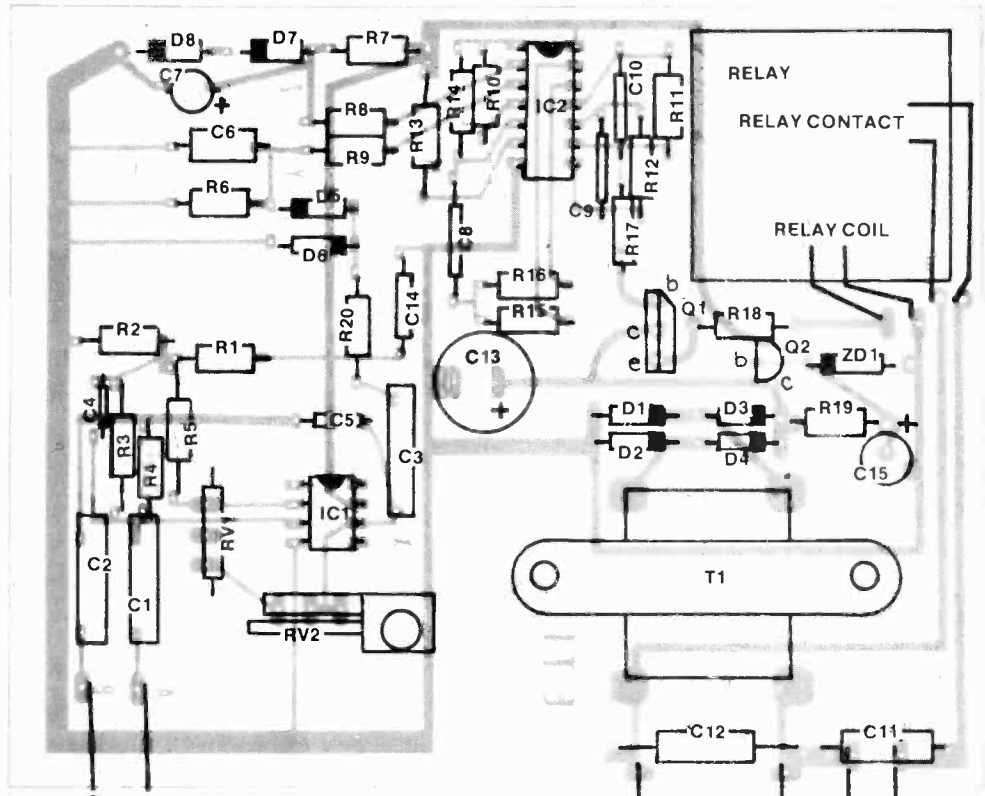
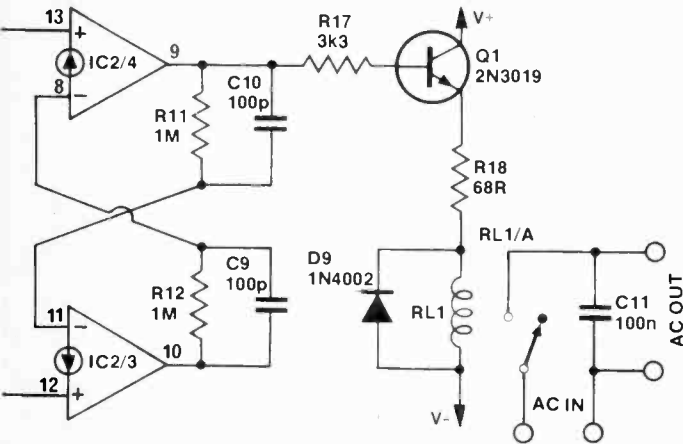
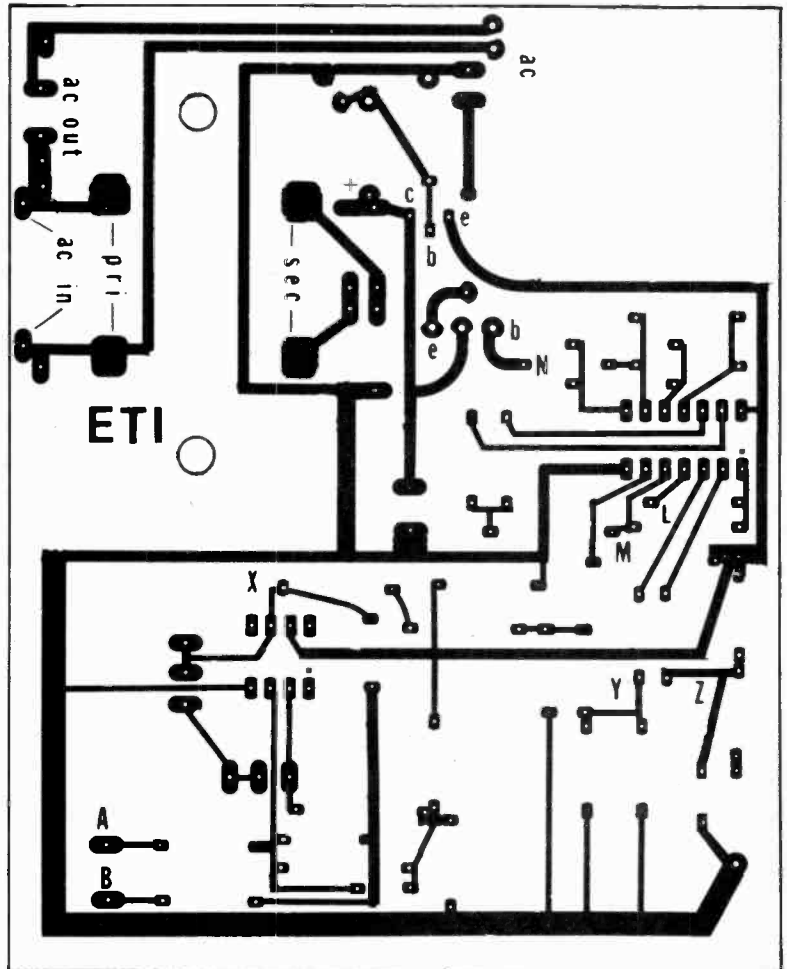

Fig. 2 (a) Component overlay for pcb

Fig. 2 (b) Printed circuit board pattern (full size)



Accentuated-Beat Metronome

This metronome design accentuates one beat out of every bar to help with complex rhythms.

IT SEEMS THAT a sense of rhythm is acquired by aspiring musicians as they practise, rather than being an inborn ability. Many people don't have an 'easy' sense of rhythm, and the majority of people, if left to themselves in keeping a rhythm, will speed up or slow down slightly without realising it.

This project is an electronic version of the familiar mechanical metronome. However, we have used the potential of electronics to improve on the old design and have come up with one which will always accentuate a particular beat in the bar, e.g. 3/4 for waltzes. This can be a great benefit to those starting out in music, and can also help the more advanced musician with those awkward rhythms!

DESIGN FEATURES

The metronome designs published so far simply use a dc pulse to drive the loudspeaker. The only way to change the sound of this type of output to give the accentuation required and to maintain an even beat is to change the amplitude. As this is not very satisfactory we decided to use a tone burst method instead.

Initially we tried a pulsed LC network which produced a very good sound but was a little complex and

SPECIFICATION — ETI 604

Rate	1 / sec. to 15 / sec.
Beat	Off, 1-1 to 1-9
Output power 9 volt supply	8 watts peak
Output frequency	800 Hz, 2 500 Hz
Power supply	6 – 15 volts DC

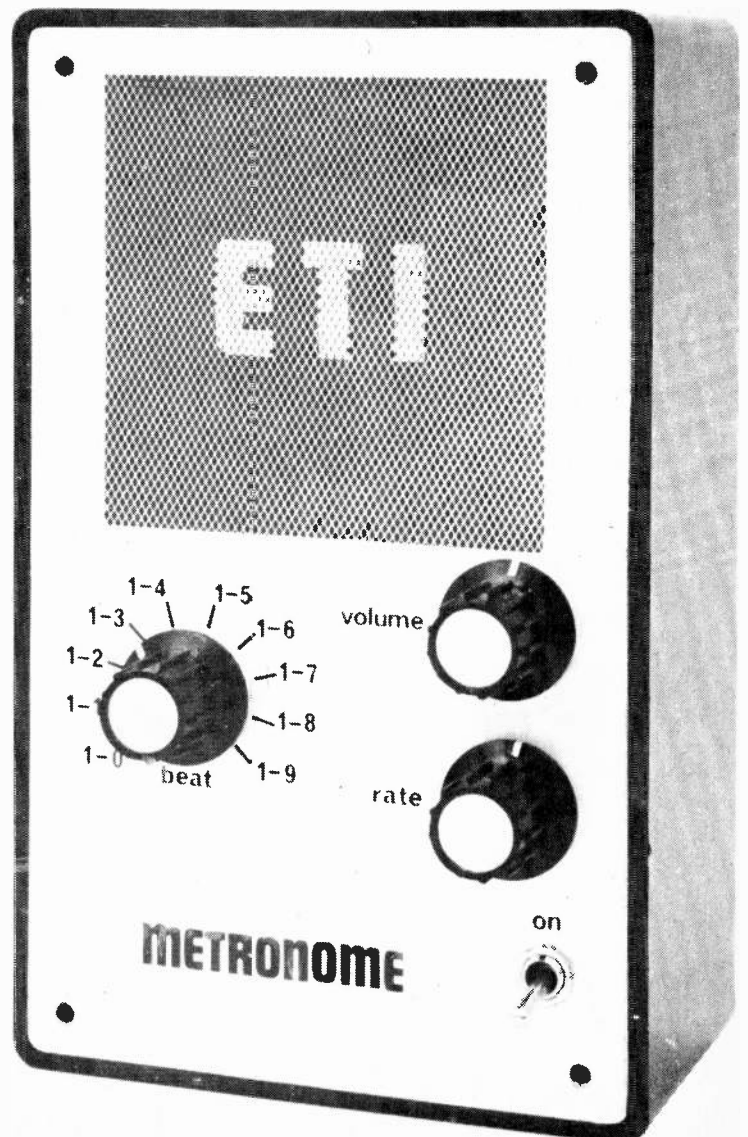

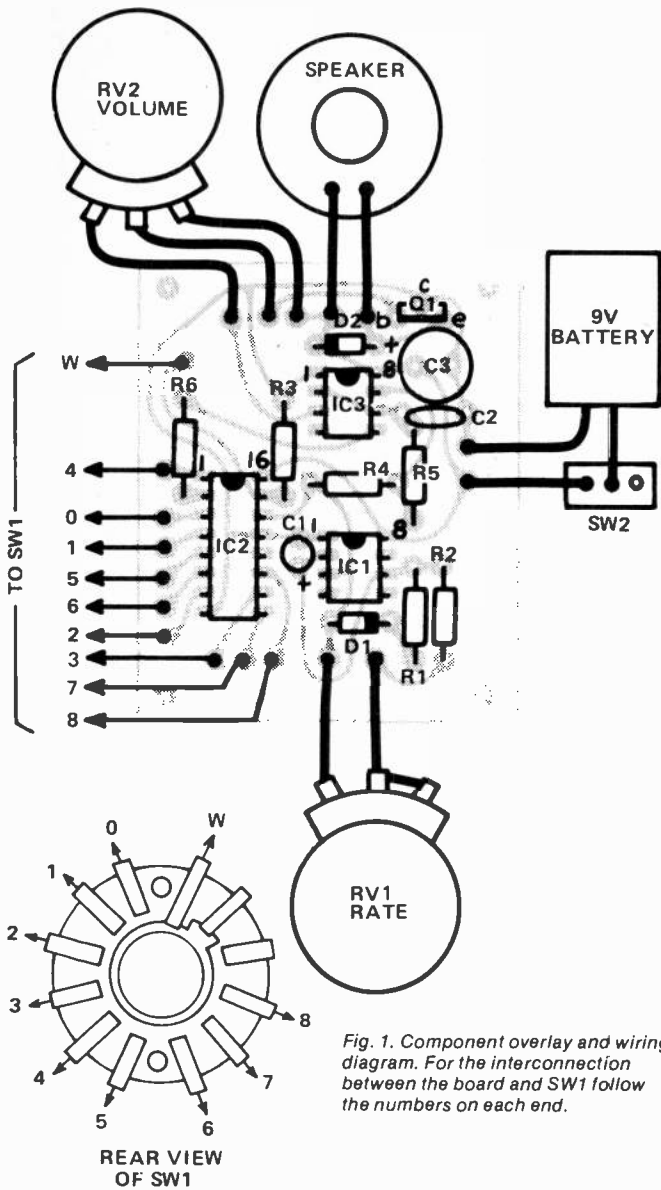

Fig. 1. Component overlay and wiring diagram. For the interconnection between the board and SW1 follow the numbers on each end.

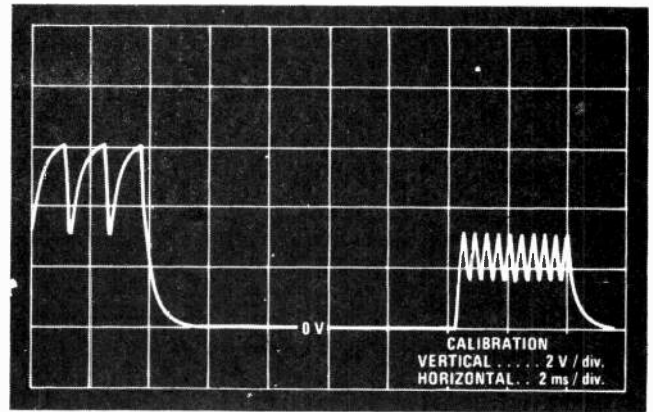

Fig. 2a. Waveform on pins 2 and 6 of IC3.

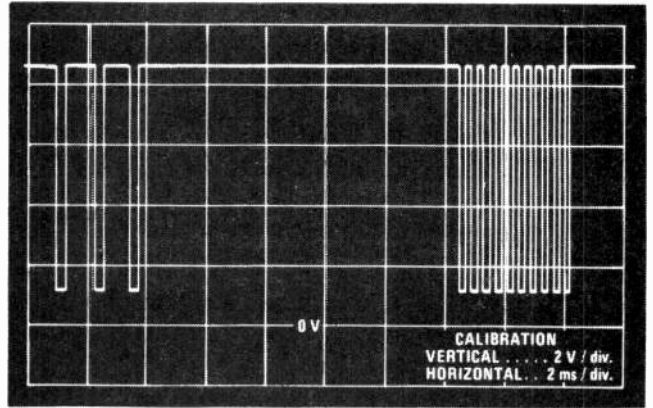

Fig. 2b. Waveform on pin 3 of IC3.

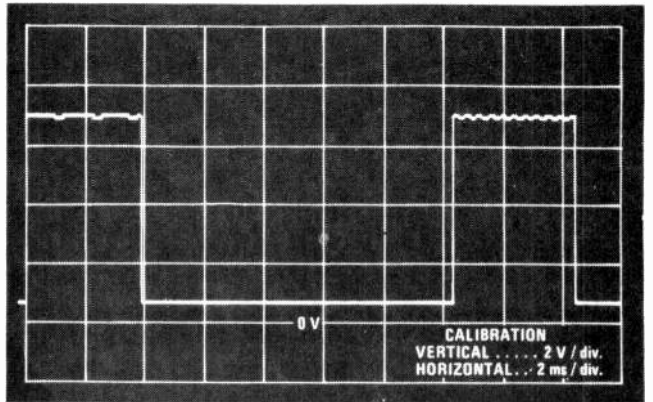

Fig. 2c. Waveform on pin 3 of IC1. On these waveform diagrams the beat rate has been increased to show the two different outputs available.

PARTS LIST — ETI 604

RESISTORS all 1/2 W 5%

R1 2k2
R2 47k
R3,5 15k
R4 1k
R6 4k7

POTENTIOMETERS

RV1 1M lin rotary
RV2 500R lin rotary

CAPACITORS

C1 1u 16 V
C2 22n polyester
C3 100u electrolytic

SEMICONDUCTORS

IC1,3 555
IC2 4017
Q1 TIP30c transistor
D1,2 1N4004

SWITCHES

SW1 single pole 11 position switch
SW2 single pole toggle switch

MISCELLANEOUS

PCB as pattern, speaker,
plastic box, batteries
plus holder to suit, 3 knobs.

expensive so we finally decided on a pair of 555 timers. With this system we alter the tone frequency simply by varying the control voltage on the 555 driving the speaker. The other 555 timer is used to give the time between beats and the duration of the burst. A 4017 is used to count the beats and at the required time changes the control voltage of IC3.

When designing the PC board we considered mounting it on the rear of the wafer switch. However due to the number of different switches available we used wires to interconnect the switch to the PC board.

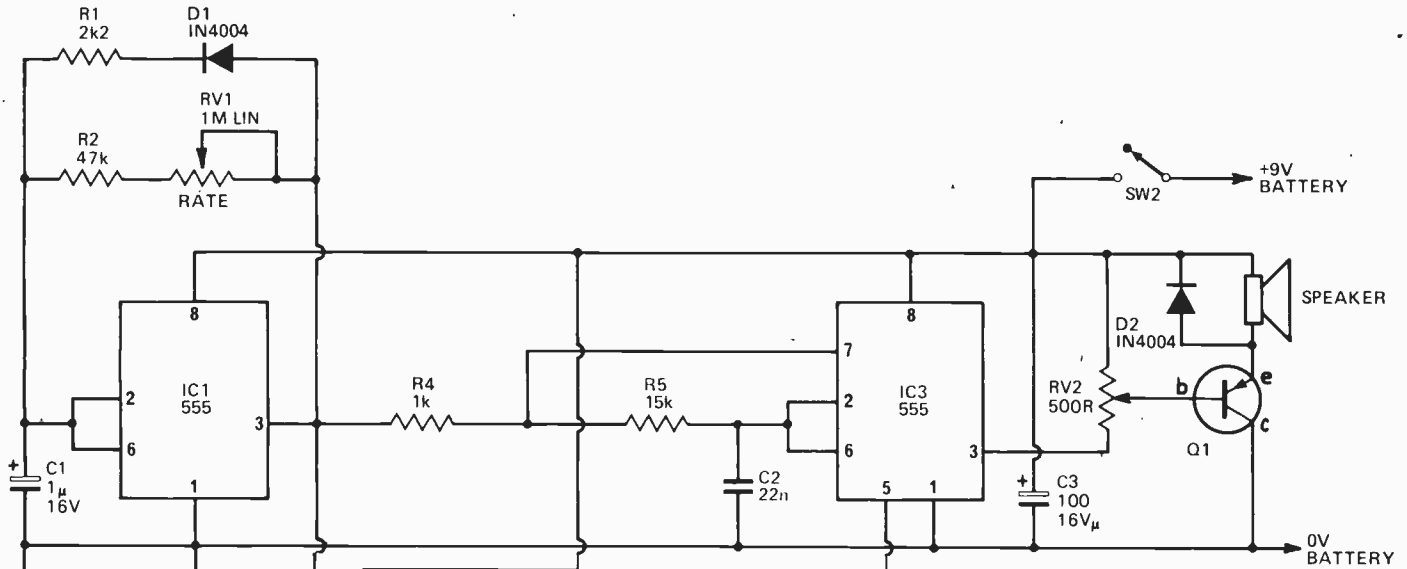

Fig. 3. Circuit diagram of the metronome.

correct way round. Some care should be taken in handling the 4017 IC; the pins should not be touched more than necessary and as well as it being the last component installed, pins 8 and 16 should be soldered first.

We built the unit into a plastic box with the potentiometers, switches and speaker mounted onto the aluminum front panel. The speaker itself was glued to the panel with quick dry epoxy.

The PC board was mounted using double sided tape onto the rear of the speaker although it can be mounted in the rear of the box. The potentiometers, switches and speaker can be connected with hookup wire as shown in the overlay-wiring diagram. When connecting the battery ensure the polarity is correct as the unit will be damaged if it is reversed.

LATE NEWS

In our prototype we used nicad batteries which have a low internal resistance. Later we discovered when using standard dry cells that a slight irregularity occurred on the accentuated beat due to battery voltage fluctuations. If this is a problem with your unit it can be cured as follows:

1. Cut the PC board track between pin 8 of IC1 and the point where the wire from SW2 is joined and fit a diode (1N914 etc.), cathode to IC8, across the break.

2. Add a 100 uF 16V capacitor across pins 1 and 8 of IC1 (+ve to pin 8).

3. Add a 10 uF 16V capacitor across pins 1 and 5 of IC1 (+ve to pin 5).

Alternatively, buy some nicads!

HOW IT WORKS — ETI 604

The operation of the unit is relatively simple. IC3 acts as an oscillator which operates if the output of IC1 (pin 3) is high; i.e. about 8 volts. The frequency is determined by R5 and C2 and the voltage set on pin 5 of that IC. With the values used the two frequencies produced are about 800 Hz and 2500 Hz. The output of IC3 is shown in Fig. 2b and after being attenuated (if required) by RV2, is buffered by Q1 which drives the speaker. The diode D2 is used to prevent reverse voltage from the speaker damaging Q1.

The first IC is used to generate the tone duration (about 4 ms.) and the time interval between beats. The interval is adjustable by RV1 while the tone duration is set by R1. Diode D1 isolates R1 in the interval period. The output of IC1 is shown in Fig. 2c.

The output of IC1 also clocks IC2 which is a decade counter with ten decoded outputs. Each of these outputs go high in sequence on each clock pulse. The second output of IC2 is connected to the control input of IC3 and is used to change the frequency. Therefore the first tone will be high frequency, the second low and the third to tenth will be high again. This gives the 9-1 beat. If the reset input is taken high the counter reverts back to the first state. We use this to limit the sequence length to less than ten by taking the appropriate output back to the reset input. If for example the 5th output is connected to the reset, the first tone will be high, the second low, the third and fourth high, then when the 5th output goes to a '1' it resets it back to the first which is a high tone. We then have 3 high and one low tone or a 3-1 beat. Actually the 5th output goes high only for about 100 ns. while the counter resets.

CONSTRUCTION

The unit is simple to build if the PC board is used. Assemble the board with the aid of the overlay diagram taking care to insert the transistor, ICs, diodes and the capacitors the

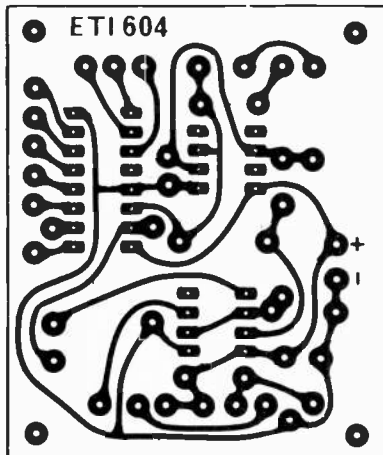

Fig. 4. Printed circuit layout. Full size 60 x 50 mm.

Noise Source

The MM5837 from National Semiconductor.

General description

The MM5837 digital noise source is an MOS/MSI pseudo-random sequence generator, designed to produce a broadband white noise signal for audio applications. Unlike traditional semiconductor junction noise sources, the MM5837 provides very uniform noise quality and output amplitude. The circuit is packaged in an 8-lead Epoxy-B mini-DIP.

Features

- Uniform noise quality
- Uniform noise amplitude

Applications

- Electronic music rhythm instrument sound generators
- Music synthesizer white and pink noise generators
- Room acoustics testing/equalisation

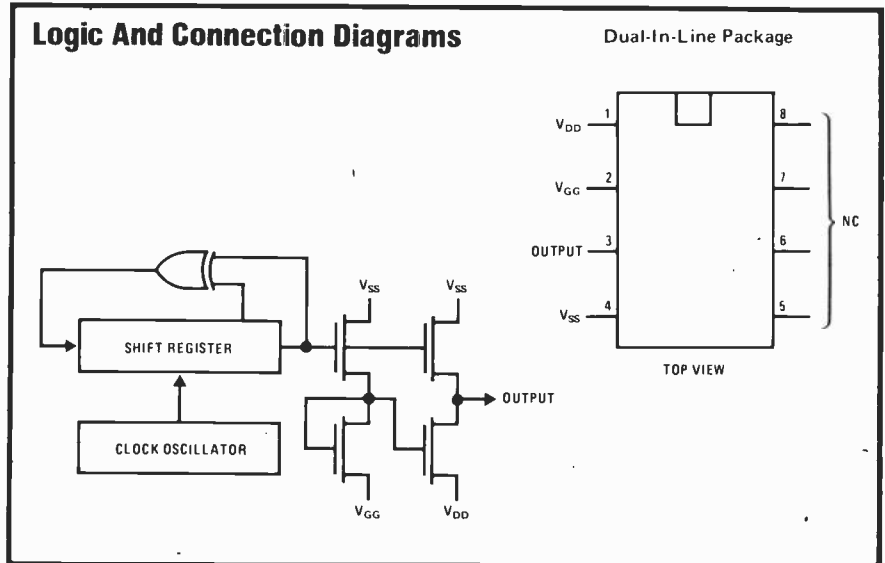

Electrical Characteristics					
T_A within operating range, $V_{SS} = 0V$, $V_{DD} = -14V \pm 1.0V$, $V_{GG} = -27V \pm 2V$, unless otherwise noted.					
PARAMETER	CONDITIONS	MIN	TYP	MAX	UNITS
Output (Loaded 20 k Ω to V_{SS} and 20 k Ω to V_{DD})	$T_A = 25^\circ C$			$V_{SS} - 1.5$	V
				V_{DD}	V
				V_{DD}	V
Supply Currents	$V_{GG} = V_{DD}$				
I_{DD}	No Output Load	3		8	mA
I_{GG}				7	mA

Absolute Maximum Ratings At $T_a = 25^\circ C$ (Unless Otherwise Specified)

Supply voltage, V_{cc} (1), pin 15	6.0V	Supply voltage, V_{cc} (2), pin 14	12.0V
Input voltage applied to any device terminal	6.0V	Storage temperature	-65 $^\circ C$ to +150 $^\circ C$
Operating temperature range	-55 $^\circ C$ to +120 $^\circ C$	Lead temperature inch from case for 10 seconds	+260 $^\circ C$

Recommended operating conditions

	MIN	TYP	MAX	UNITS
Supply voltage, V_{cc1} , pin 15	4.5	5.0	5.5	V
Supply voltage, V_{cc2} , pin 14	5.7		9.0	V
Operating free-air temperature	0	25	70	$^\circ C$

BINDERS

In response to many requests from our readers we have arranged for binders to be made so that you can keep ETI's first Canadian volume together and protected from damage. The binders are covered in attractive leather-look black plastic and are designed to hold twelve issues. The ETI design is printed in gold letters on the spine.



The binders cost \$5.00 each, which includes postage and packaging. Do not send cash — you can pay by cheque, Mastercharge, or ChargeX. Credit card orders must include your account number, the expiry date, and your signature. In all cases allow six weeks for delivery. Send your order to ETI Binders, Unit 6, 25 Overlea Blvd., Toronto, Ontario M4H 1B1. Don't forget to include your name and address. Ontario residents add PST.

THE NEW ONES FROM EICO

NEW MODEL!



272 Digital Multimeter
 • Factory Assembled • Inexpensive
 • Auto polarity • Auto zero • Over range Indicator • Overload protected • Measure 1mV to 1000V DC, to 600V AC, 1uA to 1A AC or DC, 1 ohm to 1M ohm • High Accuracy: 0.5% on DC volts, 1% on all other functions



270 digital multimeter
 • Flashing Over-Range Indicator • Auto Polarity, Overload Protected • 3 1/2 Digits. Includes functional tilt stand!



1200 frequency counter
 • Easy Pushbutton Operation • Frequency Range 5 Hz to 30 MHz • Operates Base or Mobile • Six Large 0.5" LEDs.



700 frequency counter
 • Operates Automatically on Transmit • 10 MHz Crystal Timebase • Covers all 40 CB Channels.

Available but not illustrated.

482 dual trace 10 MHz oscilloscope
 • Automatic Selection of Alternate or Chop Mode • Pushbutton Operation • 100% Solid State • Includes 10:1 Probes • Useable Def. to 15 MHz.

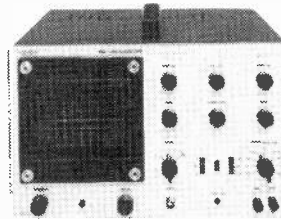

462 10 MHz solid state oscilloscope
 • Low-Cost "Basic" Scope • 10 MV/cm Sensitivity • Five-Inch Bright Display CRT • 100% Solid State.

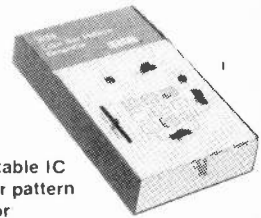

368 portable IC color bar pattern generator

Pattern generator. Digital Logic IC Design, for Compact Reliability.

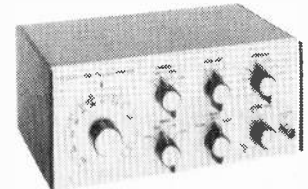

390 function/sweep generator
 • Offers Linear, Logarithmic Sweeps • Six-Position Calibrated Attenuator • BNC Front Panel Output Jack.

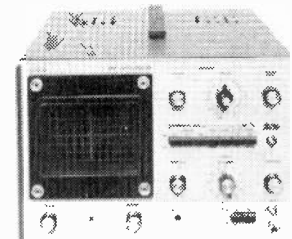

80 10 MHz triggered sweep oscilloscope
 • 10 mV/cm Sensitivity • Automatic Triggering • Useable Deflection to 15 MHz • 100% Solid State • Includes 10:1 Probe

Send for your
FREE
 1978 EICO catalogue

THE BEST VALUE IN DO-IT-YOURSELF KITS AND FACTORY ASSEMBLED ELECTRONIC EQUIPMENT



EICO CANADA LIMITED (416) 883-5500
 P.O. BOX 268, RICHMOND HILL, ONTARIO L4C 4Y6

Feedback Explained

You've heard about feedback, here Wally Parsons explains why and how to use it.

ALTHOUGH THERE SEEMS to be no hard evidence to prove it, no doubt the first application of an active electronic device was amplification. And in no time experimenters began seeking ways to modify its characteristics, and it wasn't long before someone took part of the output signal and fed it back to the input; and so feedback was born as a design tool, and a useful one it is, too.

Just about every modern IC circuit or application provides for negative feedback (nfb) and every modern power amplifier uses large amounts of it to achieve impressive performance characteristics. In fact, I recently came across a design, that of a pre-preamp whose most interesting design feature, aside from the balanced grounded-emitter configuration was the **absence** of an overall feedback loop. But despite the apparent simplicity of the technique there are some complications which are not always appreciated by the hobbyist, and, I suspect, many engineers.

NFB is said to provide the following benefits:

1. Improved gain stability,
2. Wider frequency response,
3. Lower distortion,
4. Modified input impedance,
5. Modified output impedance,
6. Improved speaker damping (in the case of audio power amps),
7. Lower noise, and
8. Greater phase linearity.

This looks pretty wonderful at first glance, but as is often the case, there are a few catches. Parsons' First Law of Physics states: "There ain't no free lunch", and to see why this free lunch is

an illusion, let's look at what nfb **really** does, and the mechanism by which it is accomplished.

STABILITY

Any feedback does only one thing: expands or compresses gain changes within the feedback loop. In the case of nfb, the compression serves to reduce gain *changes* within the loop, thus stabilizing gain. The mechanism of this forms the basis of many other desirable side benefits.

Consider an amplifier with a gain A of 100, or 40 dB, as in Fig. 1: ($E_o = 100V_i$). A fraction of its output E_o appears across the voltage divider R_1, R_2 . Let this equal $0.1E_o$. The gain of this network, then, is 0.1, or -20 dB. Now, if 'B' is connected in series with the input signal, the voltage appearing at the input will be the difference between the two voltages, since they are of opposite phase: $E_o = 100(E_i - V_i) = 100 E_i - 10E_o$. Therefore $E_o = 9.09E_i$. An input of 1.1V will yield an output of 10V. With the loop closed, to maintain this 10V output, we require not only the original 0.1V signal, but an additional 1V to overcome the effect of feedback, for a total of 1.1V. Gain is now reduced to 9.09 or slightly less than 20 dB. Since $A = 40$ dB, the reduction is just over 20 dB.

Suppose the gain A is reduced to 50, or 34 dB. If the output remains at 10V, then the required input without feedback is 0.2V, feedback voltage is 1V, and the required input with the loop closed is now 0.2V signal, and 1V to overcome the effects of feedback, for a total of 1.2V. Gain now becomes 8.3, still only slightly less than 20 dB.

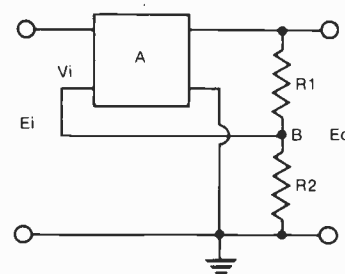

Fig. 1. Typical amplifier with negative feedback.

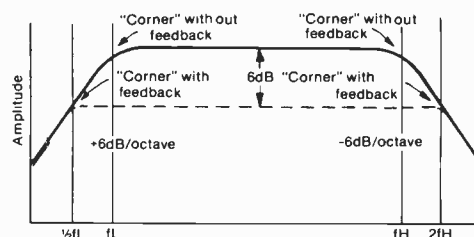
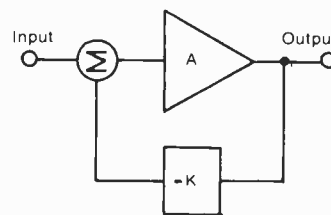

Fig. 2. Effects of feedback on amplifier response.

FREQUENCY RESPONSE

What might cause such a change in forward gain A of the amplifier? The most obvious is frequency. Continuing our example, with amp gain in the 100s range and .1 "feedback factor", if response at 10 kHz is down 6dB relative to 1 kHz, with feedback this becomes 0.6 dB. Which illustrates our first rule: *changes* in gain are reduced by a factor equal to the overall gain reduction due to feedback. This also shows that bandwidth is extended by the same amount. (Fig. 2)

DISTORTION

Distortion reduction is accomplished in similar fashion. Fig. 3 shows a non-linear transfer characteristic. (That is, a graphical picture showing the relation between output and input). Notice that the steepness of the slope varies during the length of the characteristic, (the same as saying gain varies with signal voltage) and since gain is represented by that steepness, the gain varies during portions of the input signal. This is easy to show graphically, but quantifying it is a little easier if we use a different approach.

Suppose our amplifier 10V output included 1V second harmonic distortion component (most nonlinearities result in extra frequency components at harmonics of the original signal). For example, the second harmonic of 1kHz is 2kHz. If this appears at the output at a level of 1V in

our example amp, 0.1V will be fed back to the input. Since this signal was generated internally, there is no counterpart at the input and constitutes a gain considerably greater than the normal 100 (ie 1V out for 0V in!) and since feedback stabilizes gain, this component's level is reduced by a value equal to the feedback applied. It is apparent, too, that nfb produces its most dramatic distortion reduction at relatively low values of 'B', not because greater values don't do the job, but, rather, the law of diminishing returns sets in. In view of the fact that a great many very respectable amplifiers boast of distortion level of over 0.1%, it would seem that the benefits of further reduction become less important as the figures go below this low figure, and the disadvantageous problem which appear with large values of nfb begin to outweigh the benefits. And there are problems, as we shall see.

OUTPUT IMPEDANCE

This is probably the biggest area of misunderstanding of the effects of nfb. Power amplifiers are required to work into loudspeakers whose impedance may vary from as little as 4 ohms to as high as 30 or even 50 ohms, depending on frequency. Generally, as load impedance approaches or drops below source impedance, voltage gain drops. This gain change is corrected by the feedback loop, so the amplifier behaves as if its output impedance were lower than that of the load.

SPEAKER DAMPING

This is closely related to output impedance. At resonance a speaker's impedance rises due to the back EMF developed as the voice coil moves in the magnetic gap. Moreover, this EMF is also generated whenever the voice coil continues to move after removal of driving power, as at resonance. If a resistance is connected across a speaker's terminals and the speaker moved by hand, the generated power will be dissipated in this resistance, thus damping the speaker. If the resistance is very low in comparison with the speaker at resonance, a very high level of damping results.

Similarly if the inherent output impedance of the amplifier is high, the generated EMF will appear as a voltage across the output terminals, and fed back like any other signal. The feedback will attenuate this signal just as it attenuates any signal which is different from the input.

LOWER NOISE

This characteristic was given more prominence in the past with reference to vacuum tube circuits, especially as regards heater hum. It should be obvious from what has already been written that hum originating within the loop will be attenuated in a manner similar to distortion components but how about random, or white noise? It's often been assumed that the same mechanism is at work, but fails to explain the fact that such amplifiers generally have a higher noise level than would be predicted, and there is a change in character, being noticeably sharper and harder, as if concentrated at higher frequencies. And that is exactly what happens. E_{in} and E_B are added vectorally and if considered as frequency components, can be reduced to simple addition **only** when they are either exactly in phase, or 180° out of phase. Any amplifier has a finite transit time, and a fixed time delay from input to output. If two signals of different frequency are delayed by the same duration, the **phase** delay will become progressively greater with frequency. Therefore, at higher frequency the input/output will not be quite 180° out of phase, and the cancellation will not be as great as at lower frequencies (see next section). Since white noise contains all signal frequencies generated at random, lower frequency noise components are reduced to a greater degree than higher frequencies.

Fig. 3. Transfer characteristics of amp with distortion.

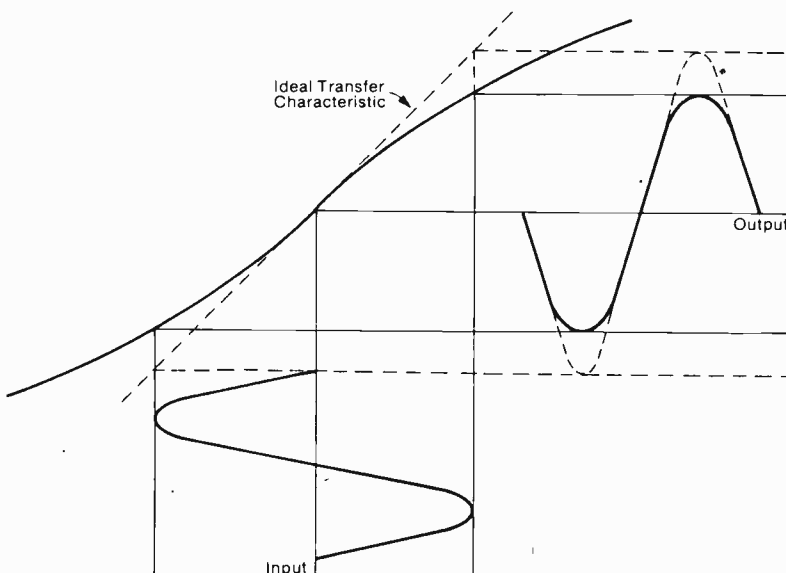

PHASE LINEARITY

It is not my purpose here to enter into the debate on the importance of relative phase; my views on the matter have been mentioned before (ETI, March/78) but it's connection with feedback circuits is rarely mentioned. Fig. 4 shows two signals separated by $90^\circ + 180^\circ$, or 270° , but otherwise undistorted. The resultant waveform remains undistorted but the shift in phase has been reduced. It can be shown that the resultant phase is identical to that produced by a change in frequency response produced by the same amount of feedback.

SO WHY NOT

By now you probably wonder why I opened this article by bad-mouthing this marvellous technique. It obviously is the answer to just about any problem, and the only real question is why do we not design for near-infinite gain and buckets of feedback. Well, that is exactly what many people try to do, including some engineers who ought to know better, with much resulting grief. To find out why, let's look at the trade-offs.

The key to successful operation of nfb circuits is to provide that a portion of the output signal be fed back and combined with the input, only with their relative phase reversed exactly 180° (ie inversion with no time delay). If this condition exists at every instant in time, and with no relative amplitude changes this provision could easily be met. It would also mean that we began with a perfect amplifier, which would require no feedback anyway! In actually using feedback we compare the input and output signals and where they differ the difference provides a correction signal to **reduce** the difference.

Every real amplifier has a frequency and phase response characteristic, as shown in Fig. 5. We have seen that in the region where response falls off, feedback also is reduced. The result is a wider flat response. However, the degree of reduction in distortion, speaker damping, impedance modification are directly related to the amount of nfb. At some frequency there will be very little feedback, and if the distortion was originally high, there is no nfb to reduce it. Similarly if nfb is used up extending frequency response you can't expect to have any left over for speaker damping. This is a common cause of poor low frequency performance on the part of many low priced tube amplifiers. It was common

practice to economize by using an output transformer of inadequate inductance and RC coupling networks with short time constants. When used with many of today's speakers with poor inherent damping there is simply not enough feedback to provide adequate damping, and the result sounds boomy. Similarly, an impedance rise with frequency due to tweeter voice coil inductance will not be adequately damped by any amplifier which possesses too great an open loop high frequency roll-off. Likewise impedance irregularities due to improper cross-over design.

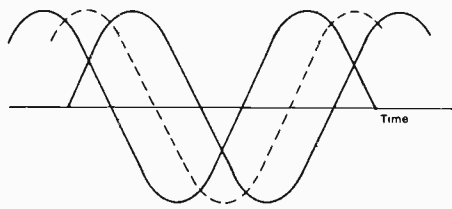

Fig. 4. Phase effects of feedback.

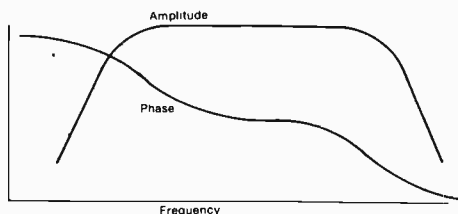

Fig. 5. Phase and amplitude response of typical amplifier.

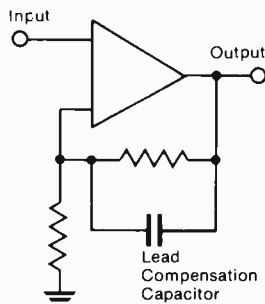

Fig. 6. Where to stick the capacitor for lead compensation.

Similarly, if feedback is used as the means of allowing us to get away with an impedance mismatch, e.g. a power amplifier which will provide optimum performance on a 20ohm load, driving a conventional 4-50ohm speaker, we can expect relatively high distortion at frequencies where the mismatch occurs, especially where it goes low, because of the loss of feedback.

COMPENSATION

In any amplifier of finite bandwidth there will be one frequency (two in an AC amplifier) at which the gain is unity. In such an amplifier there is also some frequency at which phase has shifted by 90° , and if there are two frequency discriminating mechanisms at work, 180° . If this signal is fed back 180° out of phase with the input (inverted), the net phase shift is 360° , they are in phase, and the feedback becomes positive. If $A \times B$, or **loop gain** is greater than unity at this frequency the amplifier becomes an oscillator, and at values close to unity gain, and/or phase shifts near 180° it becomes marginally or even completely unstable. Since positive feedback produces the opposite effects of negative feedback, this is clearly undesirable. The solution is either to reduce phase shift, or reduce gain. Today this is important at high frequencies. Usually this is accomplished by reducing open loop high frequency response using one or more **compensation capacitors**. Since the maximum possible phase shift per section is 90° , it is a relatively simple matter to select values suitable to provide enough rolloff.

One serious disadvantage of this **lag compensation** method is that a time delay is introduced due to the time constant, and if a transient input is introduced whose rise time is shorter than the compensation time constant there will be a delay in the application of feedback. If the amplifier has insufficient headroom it may overload, especially in the input stage, with distortion rising to 100%. Since there is no feedback at that instant there is no reduction in distortion and the result is pretty horrible.

Another technique uses **lead compensation**, which shifts phase forward, thus reducing maximum phase shift, and also increases loop gain at high frequencies, thus maintaining feedback. By its nature it also speeds up the application of nfb and reduces transient overload distortion (Fig 6).

METHODS AND APPLICATION

Types of nfb circuits may be described according to sampling and summing techniques used. These are **voltage** and **current** sampling, and **series** and **shunt** summing.

(Constant) Voltage Feedback is so called because the feedback voltage is proportional to output voltage. It is the more commonly used form and has been assumed throughout this discussion. See Fig. 7.

(Constant) Current Feedback derives a feedback voltage which is proportional to output current. Its primary effect is to increase output impedance and reduce electrical damping of the load. It is useful in constant current regulators, constant current signal sources such as magnetic tape recording amplifiers and has been used in the past in conjunction with constant voltage feedback to provide variable speaker damping. This is accomplished by varying the proportions of constant voltage and constant current feedback, Fig. 8.

In Fig. 1 and subsequent discussions we used **series summing** in which the input and feedback signals were summed in series. Fig. 9 shows a practical circuit. In Fig. 10 we see an example of shunt summing in which the signals are added in parallel. This

technique lowers the input impedance.

A third type is essentially a shunt summing technique, but the summing points are effectively isolated from each other in most configurations and, depending on the specific circuit details allows considerable control of input impedance. This is the **familiar differential amplifier**, shown in Fig. 11.

Finally, one of the most familiar circuits is also one of the least understood. Space does not permit a full discussion of the **emitter follower**, but it is unique in that it uses a common sampling and summing point, by making the input and output circuits essentially common. Feedback is 100% and gain always less than unity. Input impedance is high and output is low. If instead, the load is placed in the collector circuit and a resistor in the emitter, part of the output is developed in series with the input and is current dependent. The resultant constant current feedback produces an increased output impedance and input impedance, Fig. 12.

I have attempted to demonstrate the mechanism whereby negative feedback can be used to improve bandwidth, reduce non-linear distortions, and stabilize amplifier characteristics. It is a useful tool, but should not be regarded as a cure-all for bad design. It will improve a good

amplifier, but is of little help for a poor one, and may even make it worse in many respects. We have seen that very large amounts of feedback, often applied on the basis of the mistaken belief that if a little is good, a lot is better, does not stand up in theory or in practice.

It should be mentioned that feedback **cannot** increase an amplifier's power output; this is a function of output device voltage/current capability and power supply characteristics. After all, amplifiers do not provide power, they only effect delivery of it from the power supply. All feedback can do is hold down distortion until the onset of clipping, at which point there is no increase in output, therefore no increase in feedback voltage.

In Fig. 13 we illustrate this with amplifier distortion curves with and without feedback.

So the next time you see an amplifier advertisement with distortion figures showing lots of zeroes following the decimal point, or boasting high feedback levels you will be on solid grounds if you feel skeptical. Similarly you will probably think twice before attempting to clean up that horrible amplifier by adding more feedback. Or, for that matter, tinkering with a feedback loop in the next ETI project you build.

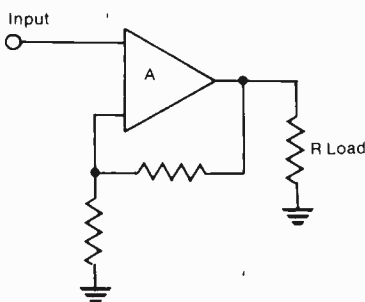

Fig. 7. Voltage sampling feedback arrangement.

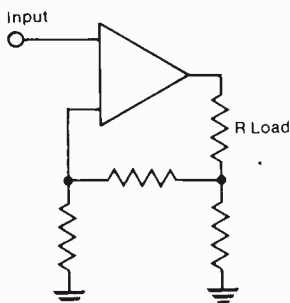

Fig. 8. Current sampling feedback.

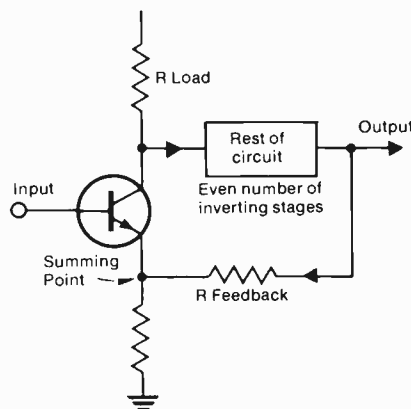

Fig. 9. Summing input and feedback signals in series.

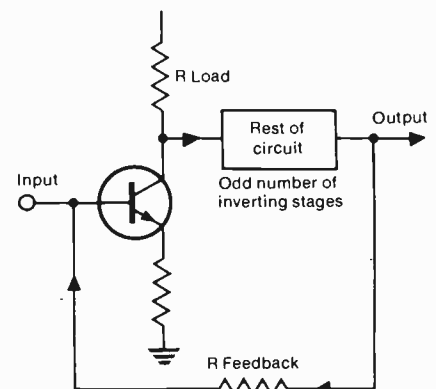
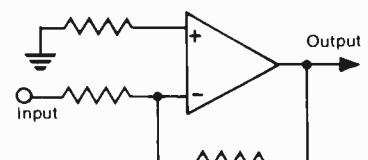

Fig. 10. Shunt summing of input and feedback.



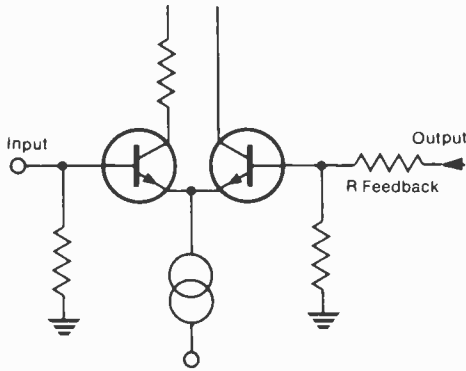

Fig. 11. The differential input stage.

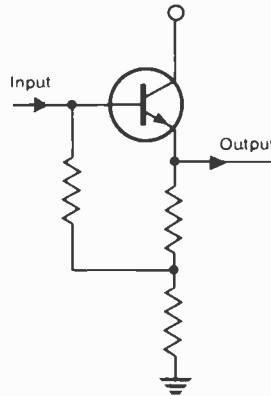

Fig. 12. Emitter follower input stage.

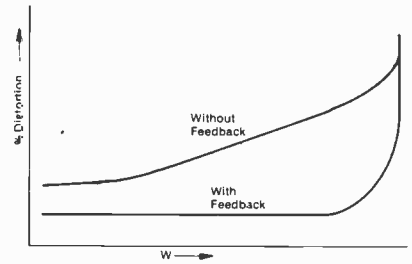

Fig. 13. What happens with and without feedback in a typical amp circuit.

ETI CIRCUITS No. 1

ALARMS

Basic Alarm
Photo Intruder Alarm
Intruder Alarm
Photo Electric Relay
Low Temperature/Lights out
Temperature Sensor
Coolant level
Water Level
Electronic Lock
Car Battery Watchdog
Simple Car Alarm
Simple Lock

AMPLIFIERS & PREAMPLIFIERS

High Input Impedance
High Impedance Buffer
Low Output Impedance
High Input Impedance
Low Frequency Extender
Virtual Earth Preamp
IC Tape Head Preamp
Simple Stereo Tape Player
2.5 Watt
20 Watt Slave
10 Watt
Loudspeaker Microphone
Voltage Controlled Amp
Wide Band Amplifier
Video Power Amp
Broadband Amp

SIGNAL PROCESSORS

Fuzz Box
Guitar Fuzz
Fuzz Box
Waa Waa
Disco Autofade
Simple Autofade
Information Transfer
Optical Pulse Conditioner
TV Sound Pickoff
Cracklefree Potentiometer
Voltage to Frequency
Sine to Square Wave
Precision AC to DC
Voltage Processor
Universal Meter
Double Precision
Fast Half Wave
Simple Chopper
Noise Rejecting SCR Trigger
Phase Shifter

SIGNAL GENERATORS

Simple
Variable Duty cycle
Fast Edge
FET
Improved Multivibrator
Variable Duty cycle
Stable RC
Cheap (CMOS)
Simple TTL XTAL
Uncritical XTAL
Pulse
Zero Crossing
Simple Pulse

Needle Pulse
Stable Linear Sawtooth
Zener
Noise
Pink
Simple Relaxation
Triangle with independent slope
Exponential
Widerange Multivibrator
Multiple Waveform
Linear Sweep
Step Frequency
Beeper
7400 Siren
Simple Siren
Ship Siren
Two Tone
Toy Siren
Kojak, Startrek
Sound Effects
Sound Effects

FILTERS

Bandpass
Low & High Pass
Rejection Notch
Bandpass
Cartridge EQ & Rumble
Hum Stopper
Tape Hiss Reduction
Simple Crossover

DIGITAL

Thermometer
Heads or Tails
Binary Calculator
Vollmeter
Seven Segment to Decimal
Die
Random Binary
CMOS Die
Multiplexer Hints
Learning Memory
CMOS Clock

POWER SUPPLIES

Constant
Temperature Stable
Constant
Voltage Controlled
Precision Voltage Divider
Dual Polarity
Simple Balanced
Voltage Divider
Low Regulated
Short Circuit Protected
Simple TTL Supply
ZN414 Supply
Stable Reference
Transformerless inverter
DC to DC AC
Voltage Multiplier
Automobile Converter
Shaver Adaptor
DC-DC
High Voltage From Battery
Variable +ve or -ve output
Simple
12V from Battery Charger
Bucket Regulator
Adjusting Zener Voltage

Variable Zener
Zener Boosting of Regulators
High Power
Electronic Fuse
Better Fuse
Regulator & Fuse
Fast Acting
SCR Crowbar
Voltage Polarity
NI CAD Discharge
Current Limiting

TEST

Diode Checker
GO NO GO Diode Tester
Zener Check
GO.NO GO Transistor Tester
Quick JFET Test
Current Gain Tester
Basic Transistor Tester
Simple Transistor:SCR
SCR Tester
Crystal Check
Crystal Checker
Good/Bad Battery Tester
Battery Tester
Op-Amp Tester
Op-Amp Checker
Cheap Logic Probe
Audible TTL Probe
Audible Slow Pulses
Logic Probe
Logic Analyser
I and O Display Probe
Simple High Impedance
Vollmeter
Audio/RF Tracer
Thermocouple Thermometer
Metering Stabilised supplies
Simple Frequency Meter

TIMERS & DELAYS

Low Standby Drain
741 Timer
Self Triggering Timer
Pulse Timer
Pulse Delay
Voltage Controlled Monostable
Sequential Relays
Door Chime Delay

SWITCHING

Touch Triggered Bistable
Touch Sensitive Switch
Electronic Switch
Sound Operated 2 Way
SPST Switch Flip Flop
Two Signals on one Wire

INDICATORS

Line-o-Light
3 Step Level
Light Level
Bargraph Display
Fuse Failure
Blown Fuse
Back Up Lamp
DC Lamp Failure

FM Tuner Station
Current Flow
Disco Cue

FLASHERS

Dancing Lights
Low Frequency Strobe
Flasher
Ultra Simple

POWER CONTROL

LDR Mains Control
Floodlamp Control
Zero Crossing Sync
Tran Controller
Low Differential Thermostat
Simple Temperature Control
Full Wave SCR Control

AUTOMOBILE

Brake Lamp Failure
Courtesy Light Delay
Simple Hazard Light
Light Extender & Reminder
Four Way Flasher
Headlamp Dipper
Wiper Delay
Suppressed Zero Voltmeter
Rev Counter/Tachometer
Auxiliary Battery

DETECTORS & COMPARATORS

Peak Detect & Hold
Window Detector
Peak Program
Positive Peak
Reaction Comparator

RADIO FREQUENCY

Crystal Marker
100 kHz Marker
RF Voltmeter
RF Detector
LED RF Indicator
RF Amplifier Protection
FET-Radio
Op-Amp Radio

MISCELLANEA

Phase Locked Loop
Touch Doorbell
Phase Lock Control
Audio Mixer
Virtual Earth Mixer
Pop Eliminator
Loudspeaker Protection
Digital Capacitance Probe
Digital Tape Recorder Adaptor
Breakdown Diode Substitution
Dual Function Charger
Dual Mode Amp

Capacitor Substitution
Electronic Capacitor
Speeding Up Darlington's
Shutter Saver
Thyristor Sensitivity
Sound Operated Flash
Strength Tester
Logic Noise Immunity

TIPS

Identifying 74 Series
Supply Pins
Soldering IC's
Tinning With Solder Wick
PCB Stencils
Front Panel Finish
Oil Drilling
Fluorescent Starting
Avoiding Insulated Heat Sinks
TTL Mains Interface
Boost Your Mains
High Resistance on Low Meters
High Voltage Electrolytics
Transistor Identification
Template & Heat Sink for
Power Transistors
Transistor Socket
Solder Flow Problems
Odd Resistor Values
Resistors in parallel
CMOS DIL Handling
Identifying Surplus ICs
Extending Battery Life
Battery Snaps
Power Supply or Battery
Battery Checking
Muck Remover
Transformers in reverse
Loudspeaker Checking
Improving UJT Linearity
Signal Tracer
Crystal Earpieces
Cheap Varicaps
Zener Lifts Capacitor Rating

DATA

741 Op-Amp Data
BC 107-109 Data
BC 177-179 Data
CMOS & TTL Data
2N3055 Data
MJ2955 Data
Bipolar Data Tables
Bipolar FETs Rectifiers
Diodes Pinouts Zener Misc

AN IDEAS BOOK FOR EXPERIMENTS

SEND \$5.00

To ETI Circuits,
ETI Magazine,
Unit Six, 25 Overlea
Blvd., Toronto,
Ontario. M4H 1B1

available from

CESCO

Texas Instruments
octal, decimal, and hexadecimal
calculator/converter



only
\$74.95

PROGRAMMER for computer professionals

A hand held calculator providing conversions between octal, decimal and hexadecimal number systems. Performs arithmetic in any of three number bases. Arithmetic and logical operations make it ideally suited for applications in computer programming and flexibility in minicomputer and microcomputer applications. Independent memory. Constant mode. Rechargeable battery and AC adapter charger. Only \$74.95.

There is a complete range of Texas Instruments calculators from the budget TI1000 at \$10.95 to the card programmable TI59 at \$369.95. Complete information available on request. A special 10% discount offer to ETI readers is in effect until July 30th, 1978. You may order by phone or mail or visit any of our branches for a demonstration.

SPECIAL 10% DISCOUNT

CESCO
electronics ltd.

MONTREAL	4050 JEAN TALON ST. W.	(514) 735-5511
QUEBEC	98 ST. VALLIER O.	(418) 524-4641
OTTAWA	1300 CARLING AVE.	(613) 729-5118
TORONTO	24 MARTIN ROSS AVE.	(416) 661-0220

wire wrapping

ok® center ok®

**NEW HOBBY WRAP
MODEL BW 630**

Battery
wire
wrapping
tool

Batteries
not included
COMPLETE WITH BIT
AND SLEEVE

**STRIP/WRAP/UNWRAP
MODEL WSU-30**



**DIP IC INSERTION
TOOL WITH PIN
STRAIGHTENER**

**MODEL
INS-1416**



**WIRE DISPENSER
MODEL
WD-30-B**

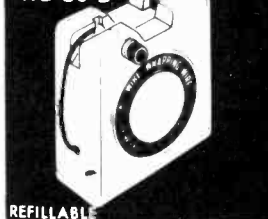

REFILLABLE

Write for complete OK Machine & Tool Catalogue

len finkler ltd

25 Toro Road, Downsview, Ontario M3J 2A6
telephone 630-9103 telex 065-24010



Now the new Beta Digital Multimeter

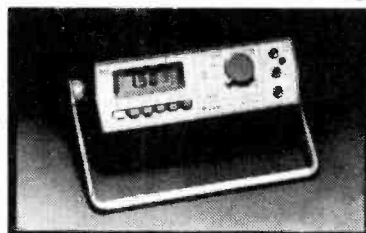

Beta has the years-ahead custom-designed features and performance

Very advanced, state of the art CMOS chip incorporating all analogue and digital circuitry including 'on chip' oscillator, high impedance input, auto calibration, auto zero and multiplexed digital outputs

- 29 ranges
- Basic accuracy of 0.1%
- 10 amp AC/DC capability
- Autopolarity and zeroing
- A full 2-year guarantee
- Low power consumption from 4 throwaway 'C' cells



Maximum Reading 1999
Power Consumption 50mW
Internal d.c. supply Four C cells
Dimensions 246mm x 180mm x 72mm
Weight 1.4 Kg
Accessories Supplied Test leads

A.C. RANGES	D.C. RANGES	RESISTANCE
200mV 200µA	200mV 200µA	200Ω
2V 2mA	2V 2mA	2KΩ
20V 20mA	20V 20mA	20KΩ
200V 200mA	200V 200mA	200KΩ
2000V 2A	2000V* 2A	2MΩ
(750V) 10A	(1KV max) 10A	20MΩ
R.M.S. max)	10A range is via separate UNPROTECTED input	

Options
Battery Eliminator \$15
Input 115 volts
Temperature Probe
Range -20 C to +120 C
H.V. Probe
1KV to 40KV
R.F. Probe
100mV-30V
Carrying Case

Display 3½ digit 0.4" 7 segment Liquid Crystal display with decimal point and polarity indication. Over-range is indicated by a flashing display

VALUE-PRICED

Federal Sales Tax Included

FOB Weston

In Ontario, add Prov. Sales Tax

\$298

DUNCAN INSTRUMENTS LTD.

ELECTRICAL MEASURING INSTRUMENT SPECIALISTS

122 MILLWICK DRIVE, WESTON, ONTARIO, M9L 1Y6

TELEPHONE (416) 742-4448 ■ TELEX 06-969636

An Introduction To Amateur Radio

Amanda King describes how you can become part of the global network of radio enthusiasts. This month, part one; next month, final part.

FIRST OF ALL, what is a ham? Amateur radio operators can be engineers, housewives, technicians, salespersons, journalists, movie stars, politicians, students, businessmen, . . . anyone can be a ham. Their equipment can vary from the most up-to-date solid-state transceiver to a home-made one-tube transmitter resting in top of an old shortwave receiver. Their activities range from slow Sunday afternoon conversations with a friend across town to bouncing signals off the moon. Many hams love to build, test, and modify their own equipment using the latest technology electronics has to offer; other hams find just as much joy in the operating side of amateur radio and the thrill of contacting hams around the world.

But every ham has this in common: participation in a scientific hobby which offers vast opportunities to gain and apply skill in the field of electronics, as well as offering a means of communicating with citizens all over the world by shortwave radio.

That's not even half the story. Amateur radio offers hams a chance to socialize; share technical knowledge; exercise abilities in the art of making local and long-distance contacts; get involved in community events and civic groups; and lend a hand in emergencies.

Interested?

FIRST STEPS

In spite of what you may have heard, it's not difficult or very time-consuming

to get your 'Certificate of Proficiency in Radio, Amateur Class'. To pass the Department of Communications' examination that all prospective hams must take, three general areas of knowledge are required:

(a) A basic knowledge of radio theory and the operation and adjustment of radio equipment.

(b) A knowledge of the rules and regulations governing both Canadian and international amateur radio.

(c) The ability to send and receive in the international radiotelegraph code at a speed not less than 10 words per minute.

To assist prospective hams in finding out exactly what they're getting into, the DOC publishes a list of regulations for ham radio and a syllabus of the exam.

The first part of the exam consists of a paper with about 50 multiple-choice questions which test the prospective ham's knowledge of theory and regulations: a small amount of simple math is also included. The passing grade for the paper is 70%.

The second part requires the candidate to draw simple schematic diagrams — they don't have to be works of art — of the following pieces of equipment: a receiver, transmitter, wave trap, key click filter, power supply, frequency meter, and over-modulation indicator. The passing grade is 50%.

Finally code proficiency is tested by having the candidate send and receive text containing both letters and numbers at a speed not less than 10 words per minute. A perfect score —

100% — is required to pass this part of the exam.

(Note that all three parts of the exam must be passed before you are eligible for your certificate.)

The regulations regarding the exam are currently undergoing revision, especially in the area concerning diagrams. No date has yet been set for these revisions; the exam syllabus will carry any changes made in the future.

So here you are with your growing interest in amateur radio and a copy of the DOC regulations and exam syllabus.

What next?

For people already involved in electronics either as a hobby or as part of a career the radio theory requirements can easily be dealt with: read one or two books dealing with amateur radio theory and equipment operation so that you can pin-point the areas where you need to focus your knowledge.

These books can be found in all stores selling ham radio equipment as well as in many electronics stores. The content of these books varies from very basic to fairly advanced.

One of the best ones to start with is called the CARF (Canadian Amateur Radio Federation) Certificate Study Guide by Bill Bushell, VE3DXY, and Bert Hovey, VE3EW. It can be used by persons having levels of electronic knowledge varying from none to professional. It is a guide telling the prospective ham what is needed to satisfy the certificate requirements in Canada, and the theory described in

the book is useful especially for beginners.

The Radio Amateur Licensing Handbook by Jim Kitchin, VE7KN, provides instruction and technical data for obtaining your certificate and contains a complete list of Canadian amateur radio clubs, latest regulations, short-wave listening stations, and a fascinating historical section.

The Ham Handbook for Beginners by Morton Bibeck, VE3CSE, is a little out of date for those familiar with the latest electronic developments, but it clearly outlines all the basic requirements.

Good supplementary reading for persons with some background in electronics can be found in the ARRL (American Radio Relay League) publications. These cover everything from learning the code, to operating procedures, to antennas, to FM, and hints for improving your future station.

Then there's the granddaddy of all amateur radio manuals: the Radio Amateur's Handbook. First published in 1926 and updated yearly by the ARRL, the "Handbook" covers everything that could remotely be of any possible interest to a ham and is excellent reading for prospective and licensed hams.

There is no lack of reading material about ham radio, and a technically-oriented person will probably find few problems in boning up on radio theory and passing the exam with relative ease.

There is also another way beginners can learn all they need to know about the theory, and receive help with the code...

HAM CLUBS CAN HELP

The atmosphere of a ham club is friendly and informal, and a lot of people interested in ham radio find there the help and encouragement that a book can't really supply. And that's not mentioning the friends you'll certainly make.

When considering joining a ham club, you should also keep in mind that clubs often have access to equipment which candidates taking the instruction can practise on and become familiar with. That can be a relief to a prospective ham with little money to spare for buying equipment.

Of course, the other people studying with you for their certificates can provide a certain amount of encouragement for you to get yours as soon as possible! Encouragement, or lack of it, is one of the chief factors causing many promising hams to bog down along the way.

As far as learning the code is concerned, many candidates find it harder to master than the theory. A ham club's code classes should be seriously investigated by a prospective ham for the following reasons:

- (a) A club can sometimes supply code practise oscillators, keys, and sometimes cassettes which many people either can't build or can't afford.
- (b) The regularity of the classes provides a more effective learning experience for some people than does home study. It's the old "there is no choice; the class is tonight" idea.
- (c) The presence of other people provides encouragement and opportunities for practise.

Consider joining a ham club in your area. The Canadian Amateur Radio Federation, commonly known as CARF, can provide you with a list of clubs nearest you and also specify whether or not they provide instruction in theory and code. Write to CARF, Box 356, Kingston, Ontario, K7L 4W2.

But for those who can't attend ham club classes, or for those who learn better on their own, home study will certainly suffice.

LEARNING THE CODE

First, commit the code to memory not as dots and dashes but as dah-di-di-dit "words". Get a friend to send you the letters, numbers, and punctuation marks slowly and clearly using a code practise oscillator. If you don't want to build an oscillator from scratch there are several reasonably-priced kits and ready-made units available.

The point is, though, that you should have an oscillator to **hear** the code being sent to you **right from Day One** in order to learn it properly. And of course you must also be able to send code yourself.

You can also use other methods to build speed. If you browse through ham radio magazines you will find advertisements for code cassettes. Available from several companies, these will play perfect code from 5 words per minute on up.

Actually listening to hams transmitting CW (hams call code 'CW') on a shortwave receiver equipped with a circuit called a BFO is an effective way of getting the "feel" of real-life ham radio, and it's a good test of your abilities to copy. Many shortwave receivers mark the 80, 40, 20, 15, and 10-meter ham bands on their dials. Tuning in one of these bands and using the bandspread feature on the receiver will allow you to find the CW section of

each ham band. In Canada these are the following:

3.5 to 3.725 MHz on 80 meters
7 to 7.15 MHz on 40 meters
14 to 14.1 MHz on 20 meters
21 to 21.1 MHz on 15 meters
28 to 28.1 MHz on 10 meters
(also see the regulations for amateur radio distributed by the DOC — Schedules 2 to 5.)

If your code speed is only five words per minute (as it will be as soon as you memorize the code), you will probably find most of what you hear is too fast for you to copy. Don't worry; just pick out what you can. As you practise your speed will gradually increase — almost without your noticing it — to the point where you'll suddenly discover you're copying most of a seven or eight word per minute transmission.

From there, ten words per minute is no problem.

If you don't already have a shortwave receiver you can certainly get second-hand one for under \$100. Now that solid-state receivers have replaced tube sets, old receivers — many in excellent condition — are real bargains. Make sure the one you buy has a BFO circuit to enable CW reception.

Having a shortwave receiver may also allow you to hear the ARRL station W1AW in Connecticut which broadcasts perfect "machine" code at speeds from five words per minute on up. The monthly ham radio magazine QST lists the times (in Universal Time) and frequencies for W1AW's code practise broadcasts.

But through all this you should keep practising either with code cassettes or with a friend sending to you. And remember to practise sending code as well; most people find sending easier than receiving, but it is very important nevertheless to develop crisp, clear sending.

And now a word of warning: don't give up. Some prospective hams find that when they first start on the code their speed rises quickly to about six or seven words per minute. Then a peculiar block may set in that somehow seems to make the transition from seven to ten words per minute take forever. The whole thing can become frustrating and some may be tempted to abandon the whole effort. Don't! Just give it time; eventually everything will fall into place and the code will be a "piece of cake".

It's an excellent idea to bring your speed up to eleven or twelve words per minute before taking the exam; it gives you an extra "edge" you'll appreciate.

And this brings us to the exam day.

(You can't, unfortunately, just walk into your nearest DOC office and ask to write the exam. You have to call up ahead of time and make an appointment; in fact in heavily-populated areas you may have to make the appointment several months in advance. Then make a red circle on your calendar and keep studying!)

The exam will generally take a couple of hours. Nervousness is the prospective ham's worst enemy at this time; the only thing to do is to relax as much as possible and keep in mind that there is no time limit. When the code proficiency part comes along you'll be grateful for that one or two extra words per minute you slipped in the week before!

Immediately after writing the exam you will be told whether or not you passed all three parts. If you are successful you'll receive your Certificate of Proficiency in Radio, Amateur Class, in the mail.

The certificate allows you to transmit from any licensed amateur station. When you set up your own station, however, you will also need a station licence which includes a ham call-sign. The licence must be renewed each year by April 1, and an annual fee of \$13 is required. If you like you can receive a licence as soon as you have passed the exam.

Some feel elated, some quietly satisfied; but you'll remember the day you walk out of the DOC office with the ink on your station licence still wet!

Now what?

GETTING ON THE AIR

This may be as simple as reviewing operating procedures, sitting down in front of the convenient but expensive transceiver you bought while you were studying, tuning up, and calling CQ with a shaking hand.

Or you may have to go out and assemble a station.

It isn't necessary to spend a great deal of money on equipment. Your nearest ham club can be of immense help: club members often know where the bargains are, and if you buy from a fellow ham you can be 99% certain you're getting an honest deal. Many clubs hold regular auctions where some fine old pieces of equipment can be had quite cheaply. You can also sniff out some good buys in an electronics second-hand store if you take the time to browse carefully.

If you're experienced with things electrical you can save a lot of money by investing in equipment that needs

minor repairs. While you're at it you can also add your own touches and modifications. The technical side of ham radio is covered exhaustively in ARRL publications, other manuals, and in all ham radio magazines.

What kind of equipment do you need? Basically it all depends on what you are legally permitted to operate and on your own personal preferences. Many hams get along just fine with a transmitter, receiver, power supply, key, and a scratch pad. Others feel uncomfortable unless they are surrounded with dials and knobs, an antenna rotator, computer terminal, teletype, electronic keyer, VHF rig, and so on. It depends on what aspects of ham radio you enjoy, on your budget, and on how much noise your family, landlord, or the people downstairs can tolerate.

Antennas can also vary greatly: from a multi-element beam mounted on a tower to a simple wire tossed over an apartment balcony. The first is expensive but worth every penny; the second is an act of desperation.

A beam antenna increases the strength of your signal by tightly focussing the energy in one direction only. A vertical antenna has no "amplifying" properties and radiates in all directions. A dipole is like one element of a beam antenna and radiates in front and behind only. And of course there are countless other types; the above are the most common.

Which antenna should you choose? First, what bands are you operating on? A full-length vertical for the 80-meter band, for instance, is not practical because it would have to be 20 meters high. It is possible to make a vertical which is, say, 6 meters high work like an 80-meter vertical by placing inductors at the base — "loading" it — but efficiency suffers.

The most popular antenna for 80 and 40 meters is the dipole, which is simple to make and can be hung from trees or between buildings. For the higher frequency bands a combined 20-15-10 meter beam is used frequently, and full-length verticals also become practical.

Ham stores sell various kinds of antennas. They also sell an excellent reference manual — the ARRL Antenna Book.

So assuming you have bought your equipment and have set it up, tested it, and proved it works, the bands are ready and waiting for you, right? Right: but with some reservations.

OPERATING

Operating requires common sense

and good manners as well as a knowledge of certain procedures and regulations. There is such a thing as a good contact (or "QSO") and a bad one.

Much has been written about this aspect of ham radio, spelling out operating procedures in great detail, in books like the ARRL Radio Amateur's Operating Manual and the recently-published ARRL Ham Radio Operating Guide. But here are a few basic things to remember first off about operating:

Somehow you have to establish contact. You have two choices:

(1) Find a clear frequency, make sure you've tuned up the rig, and send in code a series of three CQs followed by DE and then your call-sign three times. Listen carefully, and if no one answers try again. It is irritating and bad manners to send a never-ending string of CQs; most hams simply won't answer.

(2) You can tune around until you hear someone else called CQ at around your code speed, then when he finishes send his call-sign three times followed by DE and then your call-sign three times. (If he answers, don't panic. Take several deep breaths and concentrate on copying what he is sending you.)

Generally the first method works best for making contacts in Canada and the United States, and the second method works out fairly well for making long-distance contacts.

At the beginning of a typical QSO two hams will exchange information on signal readability, strength, and tone: abbreviated as RST. Readability is estimated on a scale from 1 to 5 whereas strength and tone are scaled from 1 to 9. The best RST report is 5-9-9, and because of the wide-spread use of solid-state rigs with excellent oscillators (in Canada and the US) tone is nearly always 9 even though readability and strength vary. It is inconsiderate to send everyone an automatic 5-9-9; the hams you talk to are genuinely interested in how they sound.

It is bad manners to send code at a speed much greater than the other ham is sending to you. On the other hand, it is perfectly all right to send the term "WRS" (send more slowly) to someone who is going too fast for you. In fact there is a whole series of these "Q"-terms which can be used to help speed up a conversation; these are listed in ham books dealing with general operating or CW. A few of the more common "Q"-terms which are today used also in ham conversations are: QRP — low power, QRM — man-made interference, QRN — natural

An Introduction To Amateur Radio

interference, *QSB* — fading, *QSO* — contact, *QTH* — location, *QRJ* — receiving badly, *QSY* — changing to another frequency, *QRO* — high power (or increase power).

Also listed in books about general operating are some other abbreviations hams use on CW. Some of the ones used most often are:

K — means "over" or "go ahead"; always used after calling CQ but not when answering a CQ or calling any station when contact is not established. *AR* — (sent as one character) — means "end of transmission" but is not necessarily an invitation to transmit.

SK (sent as one character) — used at the end of the last transmission in a QSO, equivalent to the word "clear".

CL — closing station.

KN (sent as one character) — used to invite only the station being called to transmit. It's bad manners for other stations to answer when *KN* is used.

BT (sent as one character) — a sort of general purpose punctuation mark, separating thoughts during a conversation. Punctuation marks other than question marks are seldom used.

IMI (sent as one character) — question mark. Can be used to indicate that a word will be repeated.

R — means solid copy (message received fully), NOT yes.

C — yes.

N — no.

ES — means "&"; used very frequently in place of "and".

And a very common ham term used both on CW and phone is "73", meaning "the best to you". (For a lady, you can also use "88" meaning "kisses".)

A typical QSO usually goes something like this: once contact is made you exchange RSTs, locations, names, and perhaps something miscellaneous like "U ARE MY FST SASK STN". Sometimes a ham will send "HW" or "HW CPY" which means "How do you copy?" at the end of his first transmission to you.

When the important information has been exchanged, many hams like to "rag-chew" for a while, swapping information about rigs, antennas, the weather (abbreviated as WX; you'll get to know that one quickly), occupations, and sometimes, the possibilities of exchanging "QSL" cards.

QSL & DX

QSL cards are postcards which confirm the contact. They always bear both station call-signs, the time and date (in Universal Time) of the QSO, the frequency in MHz, and the location of

the sender. Many creative hams design and print their own cards (see "How To Make Better QSL's" at your nearest ham store), and many hams like to collect as many as they can from all corners of the earth.

Sometimes, "QSL-ing" can be difficult. For example, you may really want Joe in South Dakota to send you his QSL card, but Joe may not particularly want a third card from Ontario. It helps matters somewhat if Joe is your first South Dakota, your first QSO ever, or if you are a YL (a lady ham). If Joe still doesn't budge, don't insist. (He's obviously not very nice, and you'll get another South Dakota someday.)

The ARRL offers awards including the Worked All States, the Worked All Continents, and the DX Century Club Award: for QSLs from 100 countries. More information about these awards is available in the ARRL Ham Radio Operating Guide. In Canada, the Nortown Amateur Radio Club (PO Box 146, Station "A", Willowdale, Ontario, M2N 5S8) offers a Worked All VEs award, and a few other Canadian ham clubs and organizations also offer various awards and certificates. (Note: VE is the call-sign prefix for Canadian stations.)

In order to receive these awards you will have to be able to show your QSL cards. No substitutions or facsimilies are accepted. (So next time you get South Dakota give it a good try!)

But South Dakota is not as difficult to get as that which hams call "rare DX". DX means distance; "rare" means Tanzania, the Revilla Gigedo Islands, or the Voltaic Republic. Even long-time hams have difficulty with these; but DX itself is quite within the reach of operators with ordinary, even low-power, equipment.

In fact DX is a whole world in itself, a fascinating world which keeps many hams riveted to their rigs during the wee hours, a world which tests the operating abilities of hams and often rewards their patience with *hey, guess what, Costa Rica!* And that's not bad.

Of course, the better the antenna and the more sensitive the rig, the more DX you'll get. Point the antenna south-west and you may hear Japan or Australia. Point it south and South America, Mexico, and Central America come in. North-east, and you will hear signals from Britain, Germany, France, or Russia.

When "DX-ing" from Canada you stand a good chance of getting answered by a DX country if you call CQ DX three times. A lot of DX countries

want Canadian contacts: in a lot of cases it's the prolific American ones they don't want! Therefore, try calling CQ DX sometime, and be thankful you aren't in New York or California. (There are more hams in California than there are in all of Canada.)

And of course you'll want that QSL card from Outer Mongolia. The only problem is that so does every other American who contacts that Outer Mongolian. QSL cards can be expensive to print in a lot of countries, and postage can be costly.

One way to increase your chances of a DX QSL return is to send your own QSL card in an envelope along with an International Reply Coupon. In effect, you pay the other ham's postage, and your chances of getting his card are greatly increased.

One can't talk about DX-ing without mentioning the DX-er's Bible: the Radio Amateur Callbooks. Published in two volumes — the United States listings and the DX listings — these contain frequently-updated names, addresses, and calls of almost every ham in the world. For Canadian contacts, Jim Kitchin's Radio Amateur Licensing Handbook also has a complete list of the names, addresses, and calls of Canadian hams.

During a QSO, it's useful to ask the other ham "ARE U IN CALLBOOK?" if you are considering exchanging QSL cards. This can prevent an unnecessary exchange of addresses.

But before you rack up a string of QSOs, don't forget that the DOC requires you to log each one. Logbooks are available in all ham stores and many electronics stores. The DOC requires you to show your logbook when you are applying for any endorsements on your certificate, or when and if you decide to get your advanced certificate: the next class up.

One endorsement many hams obtain is the 10-meter endorsement, when enables the ham to use voice (phone) on the 10-meter band as well as CW. After six months of activity a ham is eligible to receive his endorsement and must show his logbook to the DOC to prove that he has been active in the CW portions of the "low-bands", or HF: 160 meters right up to 10.

Without a 10-meter endorsement a ham can still use phone on portions of the 6-meter and 2-meter bands, and on up to certain UHF and experimental frequencies (spelled out in more detail in the regulations). The portions on which phone may be used on 6 and 2 meters are 51 to 54 MHz on 6 meters and 144.1 to 148 MHz on 2 meters.

Continued next month

Attention computer programmers **NEW FROM TEXAS INSTRUMENTS**



THE "PROGRAMMER"

Hexadecimal & Octal Calculator/Converter

Will delight anyone involved with computer programming. An efficient time saving solution for computer programming professionals and hobbyists involved with large mini-or micro computers. Featuring: hexadecimal, octal and decimal conversions; handles arithmetic computation in all three bases; provides two's complement arithmetic, AND, OR, exclusive OR (XOR)

and shift instruction; even handles mixed number bases and combined logical and arithmetic operation; has three key memory and up to 4 levels of parenthesis; constant mode allows constant operations with all arithmetic and logic operations. Performs all basic calculations. COMPLETE WITH CHARGER, RECHARGEABLE BATT. & CARRYING CASE.

BONUS OFFER

Buy a TI Programmer Calculator at \$74.95 and receive a Commodore KIM-1 Microcomputer at \$255, saving you \$40. from regular price. The TI Programmer will greatly help you in programming the KIM-1 or many other microcomputers.

TI PROGRAMMER ONLY \$74.95

Send coupon to: **MARKETRON CORP. LTD. 1240 BAY STREET MALL, TORONTO, ONT. M5R 2A7 Phone (416) 923-1917**

Enclosed Check Money Order Charge

Master Charge American Express

Card Number _____ Expires _____

Holder's Signature _____

Ordering

_____ TI Programmer \$74.95 _____

_____ KIM-1 Microcomputer \$255.00 _____

Ontario res. add 4% sales tax _____

Delivery _____ \$3.50 _____

Total enclosed _____

NAME _____

STREET _____

TOWN _____ PROVINCE _____ CODE _____

2.4 issues of ETI — FREE*
or 8 issues of ETI — FREE**

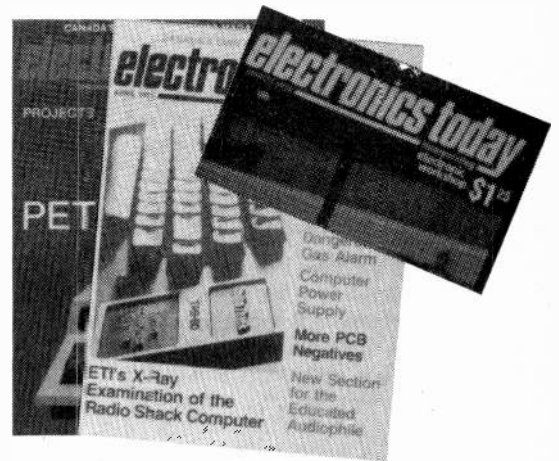

*you get twelve issues of ETI on a 1 year subscription for the price of 9.6 issues at your newstand.

**you get twenty-four issues of ETI on a 2 year subscription for the price of 16 issues at your newsstand (bigger savings if ETI's cover price increases!)

WHEN WILL YOUR SUBSCRIPTION START?
March ETI is mailed to subscribers in February and we have to tell our computer to make up labels in late January. So if you want your subscription to start with the March issue we have to receive your order by mid-January. For the September issue we have to know by mid-July; you typically have to wait six weeks between sending in your order and receiving your first subscription copy.

To: ELECTRONICS TODAY INTERNATIONAL, Unit 6, 25 Overlea Blvd., Toronto, Ont. M4H 1B1

Send me ETI for one year (12 issues) for \$12.00 Send me ETI for two years (24 issues) for \$20.00
For U.S. add \$3.00 per year for postage, outside North America add \$5.00 per year.

7/78

PLEASE PRINT CLEARLY

NAME _____

ADDRESS _____

TOWN/CITY _____ PROVINCE/STATE _____

CODE _____ DATE _____

Cheque enclosed. DO NOT send cash.

Bill Mastercharge. A/C No. _____ Signature _____

Bill Chargex. A/C No. _____ Expiry Date _____

FEEDBACK

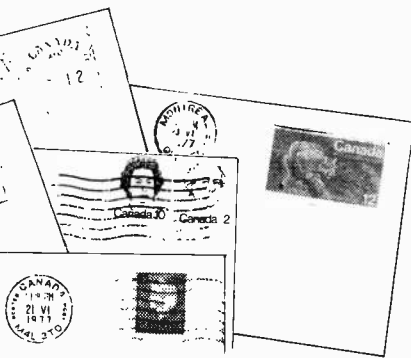

LETTERS to the editorial staff for ETI should be addressed to the appropriate department, Project File, Audio Today, or ETI Query for questions on other articles, and ETI Feedback for letters of general interest. If you wish a personal reply you must enclose a self addressed stamped envelope. Letters without will probably end up in our round file. Write to: Appropriate Department, Electronics Today International, Unit 6, 25 Overlea Blvd., TORONTO, Ontario, M4H 1B1.

ETI PCB Negs

I would like to compliment you on the negatives you are printing in ETI projects appearing in your magazine. A wonderful idea and very useful for home constructors.

I have written to a very well-known American Amateur magazine mentioning ETI to ask if they could do something along the same lines. They wrote back that they had been printing circuit board templates for their projects for some time. Obviously they had no idea of what I was talking about, although I explained "negatives" clearly.

You have all kinds of projects going on up there. Any information on an electric fence unit for us rural folk to keep the varmints out, Raccoons, etc.?

Donald C. Hanna, VE2CD,
Mansonville, Que.

At the moment we have no plans for an electric fence project — but we'll bear in mind your request. Hopefully other magazines will copy our ideas for the benefit of their readers, but it is likely to take some time for them to catch on.

ETI's Paper ETI Reviews PCB Negs Reader Support

My first cursory glance at ETI did not impress me too much. What I saw was the rather monotonous black-and-white pages of a publication printed on low-quality paper bound with flimsy staples. It appeared to be just another amateurish periodical aimed at a relatively low volume Canadian market. As such, it was almost dismissed as being useless to my needs.

Most fortunately, however, I decided to read a bit just in case something useful was to be found. What I found surprised me. Not only were the articles interesting and enjoyable, but they concerned relevant topics which were

represented with (apparently) a high degree of accuracy.

I was particularly pleased with the critical reviews concerning the Commodore PET and Radio Shack TRS-80 microcomputers. I suppose that it is easy enough giving credit where credit is due (your writers appeared to have the knowledge to spot it), but it takes courage for a magazine to make pointed negative comments about a product, particularly when one considers that it would be to the magazine's advantage to earn advertising money by advertising the product in question within its pages. Obviously, ETI was more concerned with giving the reader the straight lowdown. Good show! This philosophy is rarely seen in your competition's publications.

Another point which was met with initial skepticism was ETI's PCB Negatives "centrefold." Ordinarily, high quality PCBs cannot be made too well from magazine articles (as compared to photo-graphically reproduced boards from taped artwork). ETI's one-side printed, on-scale negatives are the closest you can come to the ideal without actually making the page out of litho film! I urge you to continue this feature! My skepticism changed to elation when I found that ETI developed a compact PCB for the Intersil A/D converter. The manufacturer's evaluation board was not too efficient when it came to real estate utilization. I always wanted to design a compact board, but had no time. Then ETI came along.

Praise is encouraging and nice to hear, and I have plenty of it, but it really doesn't do anybody any service in IMPROVING their product. In this light, I present these suggestions and criticisms: your magazine falls apart when constantly referring to it. Please improve the quality of the paper and especially the binding. Please do not let upon your "textbook" style articles e.g. "Fast Fourier Transforms", "Transmission Lines", etc. Don't be afraid to present more complex

projects. And most important, don't stop trying to improve the technical quality of the articles. Although they are good, you've got a long way to go.

Some of these improvements need reader support. I am doing my insignificant bit by entering two subscriptions to ETI: one for myself and one for a friend. With this good product, I should be able to "sell" a few more.

Ralph Winterle, Hamilton, Ont.

ETI Availability

Lack of availability of back issues (no March, April, or August 1977 issues available as of this April) is truly bothersome to late arriving devotees of your publication.

Realizing that re-publication of issues is out of the question (or is it?) — a viable alternative would be producing microfilm reels (No. 1 in the U.S. already does this).

Late comers could then choose: microfilm reels to be read at their local library; or a diminishing selection of back issues. Your excellent introductory articles are simply too good to be missed by the large portion of your readers who are new to the field!

Also, as your magazine continues to gain in popularity, you are missing out on nationwide library stocking of your publication, due to your acknowledged lack of back issues.

Donald Rycroft, Victoria, B.C.

We realize it causes a problem when we sell out of back issues, but there are ways we help people who need information from these issues. We reprint the best projects (approximately annually) in 'Projects Books'. If there is a specific article you require we can supply you with photocopies of the pages for one dollar per article.

As far as libraries are concerned we would be delighted to send the magazine to any library that takes out a subscription. If the magazine is not in your local library then why not suggest to the librarian that he does something about it.

ONE STOP MAILORDER SHOPPING AT LOW PRICES

21 L02 (450 ns) Static Rams 100 @ \$1.10 ea.	1702A E-PROM 8 @ \$3.75 ea.	6502 Microprocessor 5 @ \$11.00 ea.	2708 (450 ns) E-PROM 8 @ \$11.00 ea.	21 L02 (250 ns) Static Rams 100 @ \$1.36 ea.	Z-80A Microprocessor 5 @ \$25.00 ea.	8212 8 Bit I/O Port 25 @ \$3.00 ea.	4116 (200 ns) 16K Dyn. Ram 16 @ \$24.00 ea.
Z-8U Microprocessor 5 @ \$20.00 ea.	8224-4 Ck.Gen.&Dvr. 25 @ \$8.75ea.	410D (200 ns) Static Ram 100 @ \$8.75ea.	4096 Dynamic Ram 100 @ \$3.50 ea.	4200A (200 ns) Static Rams 25 @ \$10.00 ea.	74 LS367 Hex Buffer 100 @ .70¢ ea.	74 LS368 Hex Inverter 100 @ .70¢ ea.	2513 (5v) Character Gen. 5 @ \$9.00 ea.

MICROCOMPUTER COMPONENTS

MICROPROCESSOR'S

F8	16.95
Z80	22.00
Z80A	22.00
CDPI 802 CD	19.95
2650	24.95
AM2901	22.95
6502	11.95
6800	16.95
6802	25.00
8008-1	9.95
8035	22.00
8080 A	11.95
8085	27.00
TMS9900 TL	75.00

8080A SUPPORT DEVICES

8212	3.50
8214	3.50
8216	3.75
8224	3.50
8224-4	3.75
8226	3.95
8228	7.95
8238	9.95
8251	9.95
8253	21.95
8255	21.95
8257	21.95
8259	21.95
8275	20.00
8279	20.00

FLOPPY DISC CONTROLLER

1771 B	55.95
1771 B-01	57.95

KEYBOARD CHIPS

AVS-2376	13.75
AVS-3600	13.75

PROM'S

1702 A	4.00
1704	15.00
2708	12.00
2716	30.00
2716 int	30.00
2758	26.00
D3601	13.50
D3604	13.00
5203 AQ	5.00
5204 AQ	7.50
6834	14.50
6834-J	14.95
82523 B	4.00
82523 B	4.25
8273 B	4.50

6800 SUPPORT

6810 P	4.95
6810 P	6.00
6820 P	7.50
6821 P	7.50
6828 P	11.25
6834 P	16.95
6850 P	9.25
6852 P	11.75
6860 P	10.00
6862 P	14.50
6871 P	28.00
6875 P	8.75
6880 P	2.50

Z80 SUPPORT DEVICES

3881	12.95
3882	12.95

STATIC RAMS

21 L02	1.50	1.24	1.18
21 L02 (350)	1.60	1.35	1.25
21 LD2 (250)	1.75	1.60	1.50
410 D	10.75	10.00	9.25
1101 A	1.00	.90	.80
2101-1	2.95	2.75	2.60
2102-1	1.25	1.15	1.00
2111-1	3.95	3.50	3.25
2112-1	2.95	2.80	2.69
2114-3	11.00	10.00	9.25
2125 L	11.10	9.00	8.30
2147	37.50		
31 LD1	2.50	2.35	2.00
3106	3.25	3.70	3.25
3107	9.95	9.00	8.95
4205 A	9.95	9.00	8.95
TMS-4045	11.00	10.00	9.25
5101	8.30	7.40	7.25
74 CS9	2.25	2.05	1.90
7489	2.25	2.10	1.90
745201	4.50	4.00	3.75
PM101	4.20	3.40	2.80
PM155	17.00	14.00	
PM156	21.00	18.00	
8599	1.88	1.75	1.60
9102 BPC	1.65	1.45	1.30

CHARACTER GENERATORS

2513	6.75
2513 5v upper	9.75
2513 5v lower	10.95
2516	10.95
MCME 571	10.95
MCME 571 A	10.95
MCME 574	13.25
MCME 575	13.25

WAVEFORM GENERATOR

8038	3.50
MG4024	2.25
566	1.50

DYNAMIC RAMS

416 D/4116	32.00
1103	1.00
2104	4.00
2107 B	4.25
2107 B-4	3.95
TMS4050	4.00
TMS4060	4.50
TMS4070-2	32.00
4096	4.00
4116/416 D	32.00
MM5270	4.50
MCME6505	5.00

USRT

S2350	10.75
-------	-------

UART'S

AVS-1013A	5.25
AVS-1014 A	8.25
TR1602 B	5.25
TMS6011	5.95
IM6402	16.00
IM6403	10.80

JADE 8080A KIT

\$100.00 KIT

BARE BOARD \$30.00

MISC. OTHER COMPONENTS

N8 T20	3.39
N8 T26	2.10
N8 T90	1.35
N8 T96	1.35
N8 T97	1.35
N8 T98	1.35
81 LS95	2.00
81 LS97	2.00
1488	1.75
1489	1.75
D3205	4.00
D3207 A	4.00
D3208 A	14.20
D3211	10.00
B3222	9.75
B3242	10.15
D3245	5.60
C3404	6.75
P3408 A	12.00
PM201 A	5.20
MMS320	1.90
MMS369	1.90
TMS5501	24.95
DM8130	2.95
DM8131	2.95
DM8833	2.50
DM8835	2.50
DM8837	1.75
MKS0240	20.00
MKS0250	15.00

E-PROM BOARDS

MR 8 1BK uses 2708	KIT	\$99.50
with 1K RAM		
MR 16T 16K uses 2716	KIT	\$99.50
with 1K RAM		
MM 16 (16K uses 2708)		\$99.00
RAM/ROM (16K uses any		
E PROM)	KIT	\$117.00
JG B 16 uses 2708 or 2716	KIT	\$59.95
BARE BOARD		\$30.00

TU-1

Convert T.V. set to Video Monitor.
KIT \$8.95

STATIC RAM BOARDS

8K		
250ns ASSEMBLED & TESTED		\$189.95
450ns ASSEMBLED & TESTED		\$149.75
250ns KIT		\$169.95
450ns KIT		\$125.00
BARE BOARD		25.00
6800 ADAPTER to S-100 System		
KIT		\$12.95

16K

250ns ASSEMBLED & TESTED		\$435.00
450ns ASSEMBLED & TESTED		\$380.00
450ns KIT		\$335.00

32K

250ns ASSEMBLED & TESTED		\$850.00
450ns ASSEMBLED & TESTED		\$775.00
450ns KIT		\$675.00

DYNAMIC RAM BOARDS

On board Refresh power is provided with no wait states or cycle stealing required.
*8VDC 400MA DC *18VDC 400MA DC and *18VDC 30MA DC.

EXPANDABLE 32K		
8K (375ns) KIT		\$151.00
16K (375ns) KIT		\$259.00
24K (375ns) KIT		\$367.00
32K (375ns) KIT		\$425.00
EXPANDABLE 64K		
16K (375ns) KIT		\$281.00
32K (375ns) KIT		\$519.00
48K (375ns) KIT		\$757.00
64K (375ns) KIT		\$995.00

MOTHER BOARD'S - S-100 Style

13 slot - w/front panel slot		
BARE BOARD		\$35.00
KIT		\$95.00

22 slot

ASSEMBLED & TESTED		\$149.95
--------------------	--	----------

THE PROM SETTER

WRITE & READ EPROM		
1702A - 2708 - 2716		
5204 - 6834		

* Plugs directly into your ALTAIR IMSAI Compute Includes Main Module Board and External EPROM Sockets Unit.
* The EPROM Socker Unit is connected to the Computer through a 25 pin connector.
* Programming is accomplished by the Computer. Just insert in the Program to be Written on the EPROM into your Processor and let the Computer do the rest.
* Use Socker Unit to Read EPROM's Contents into your Computer.
* Software included.
* No external power supplies. Your computer does it all.
* Doubles as an Eight Bit Parallel I/O Manual included.

KIT		\$210.00
ASSEMBLED & TESTED		\$375.00

KIM-1

ASSEMBLED & TESTED		\$245.00
--------------------	--	----------

MEMORY PLUS

for KIM-1		
8K RAM (21L02)		
8K EPROM		
ASSEMBLED & TESTED		\$245.00

JADE Z80

with PROVISIONS for KIT

ONBOARD 2708 and POWER ON JUMP

\$135.00 EA. (2MHZ)

\$149.95 EA. (4MHZ)

BARE BOARD \$35.00

JADE Z80 "UPGRADE" KIT

Change your JADE 2MHZ Z80 to a 4MHZ version with this simple kit.
only \$119.95 with trade \$49.95 purchase.

To trade, you must give us your 2MHZ Z80 chip and 8224 clock driver.
The "UPGRADE KIT" includes:
Z80A chip, 1.8K resistor
8224-4 clock driver 20 pf. capacitor
35MHz crystal

COMPUTIME CT 100

S100 BUS COMPATIBLE TIME & CALENDAR
Microprocessors need the power that a real-time clock can offer. Date and time becomes instantly available. COMPUTIME does not have to be initialized every time the system is powered up. It possesses a crystal-controlled time base to obtain superior accuracy and has two settable coincidence counters: Time, date, and counters are set via software.

COMPUTATIONAL FUNCTION
Microprocessors need to be complemented by hardware arithmetic to free up memory pages dedicated to floating point routines and mathematical software. COMPUTIME provides a 40 function calculator array so that algebraic, trigonometric, basic arithmetic problems can be solved without the need of developing sophisticated software.
Buy It Your Way

COMPU/TIME CT100	\$199	KIT	\$245	Assembled
COMPU only	C101	\$149	KIT	\$189 Assembled
TIME only	T101	\$165	KIT	\$205 Assembled
COMPU/TIME PC Board only				\$80

JADE VIDEO INTERFACE KIT

FEATURES \$99.95

S-100 Bus Compatible
32 or 64 Characters per line
16 lines
Graphics (128 x 48 matrix)
Parallel & Composite video
On board low-power memory

Powerful software included for cursor, home, EOL, Scroll Graphics/Character, etc.
Upper case, lower case & Greek
Black-on-white & white-on-black.

full ASCII

PROFESSIONAL KEYBOARDS

Full 128 Character ASCII
Tri-Mode MOS Encoding
MOS DTL TTL Compatible Output
Two-key Roll-over
Level and Pulse Strobe
Shift and Alpha Lock
Selectable Parity
Positive or Negative Logic
PRICING INFORMATION
Model 756 (assembled) \$75.95
Model 756K (kit) \$49.95
Model 702 Enclosure \$9.95
Model 710 Numeric Pad \$9.95
Model 756MP Mtg Frame \$9.95

CONNECTORS

DB - 25P	\$3.00
DB - 25S	\$4.00

COVER \$1.50

44 Pin - PC & EYE	\$1.95
44 Pin - WW	\$2.50
86 Pin - (6800) PC	\$5.00
86 Pin - (COSMAC ELF) PC	\$5.00
100 Pin - (Altair) PC	\$4.50
100 Pin - (Imtsai) PC	\$3.75
100 Pin - (Imtsai) WW	\$4.25

JADE

REAL TIME CLOCK FOR S-100 BUS

- 1 MHz Crystal Oscillator
- Two independent interrupts
- One interrupt uses 16 bit counter in 10 USEC steps
- Other interrupt is in decade steps from 100 USEC to 10 sec.
- Both software programmable
- Other interrupt can be selected by 128 device code pairs
- Complete documentation includes software to display time of day.
- Double sided solder mask
- Silk screen parts layout

JG-RT ASSEMBLED & TESTED	\$179.95
JG-RT KIT	\$124.95
BARE BOARD with Manual	\$30.00

TARBELL CASSETTE INTERFACE

- Plugs directly into your IMSAI or ALTAIR*
- Fastest transfer rate: 187 (standard) to 540 bytes/second
- Extremely Reliable - Phase encoded (self-clocking)
- 4 Extra Status Lines, 4 Extra Control Lines
- 37-page manual included
- Device Code Selectable by DIP switch
- Capable of Generating Kansas City tapes also
- No modification required on audio cassette recorder

JADE KIT*	\$99.95	ASSEMBLED	\$175.00
*16 month warranty from JADE		MANUAL	\$4.00

JADE PARALLEL/SERIAL INTERFACE KIT

S-100 \$124.95 KIT
2 Serial Interfaces with RS232 interfaces or 1 Kansas City cassette interface.
Serial interfaces are crystal controlled. Selectable baud rates.
Cassette works up to 1200 baud.
1 parallel port.

DATA COMMUNICATIONS ADAPTER

80-103A Serial I/O and FSK modem for professional and hobby communications.
* Completely compatible with your IMSAI, ALTAIR* S01-1* or other S-100 microcomputers.
* Trademarks of "MITS," *Processor Technology
* Designed for use on individual telephone or TWX networks, or 2-wire dedicated lines, meets all FCC regulations when used with a CBT coupler.
* All digital modulation and demodulation with on board crystal clock and precision filter mean that NO ADJUSTMENTS ARE REQUIRED
* Best 103 standard frequencies
* Automated dial (push) and answer
* Originate and answer mode
* 110 or 300 BPS speed select
* Complete self test capability
* Character length, stop bit and parity
* 90 day warranty and full documentation

PRICES:	BARE BOARD and Manual	\$49.95
	Assembled (48 hr. burn in)	\$279.95
	JG-OCA KIT	\$159.95

NUMBER CRUNCHER

The CT200 is a number-oriented microprocessor intended for use in those applications that require fast versatile mathematical solutions.
THIS IS NOT A CALCULATOR CHIP. THERE ARE NO KEY DELAYS.
The CT200 has a unique architecture that is designed to be a TASK processing system within a system. It is unique architecture will allow the CT200 to work and run with ANY S100 BUS microprocessor system. It is completely compatible with 280, 4MHZ version also, 8080, 6800, 6502 microprocessor. A micro incoded instruction set allows programming in a calculator like language. The instruction set includes a full set of test and branch instructions. All decoding of S100 bus signals (for select or control functions) is performed with strobed latches to eliminate the possibility of glitches.
PRICE: \$249.00
Includes - Manual, ASSEMBLED & TESTED.

JADE Computer Products

5351 West 144th Street, LAWDALE, California 90260, (213) 679-3313

Discounts available at OEM quantities. All prices above are quoted in US\$ F.O.B. Lawndale, Calif. USA. To expedite shipments please include international money order or bankers check payable against any USA bank in US\$, or affiliated credit cards of Bank America or Master Charge welcome (include card No. expiration date and signature). Add 10% of total order for postage. For orders less than \$10 add \$1.50 service charge. New catalog now available.



TI Programmer

The local calculator shop still holds some surprises for the computer person!
Bill Johnston's views and review.

YOU MAY HAVE heard the story about the IBM customer Engineer whose wife worked as a Field Engineer with DEC. Whenever they tried to talk shop to each other, they got into the most horrendous fights over the mathematical details, because the husband always dealt with numbers to base sixteen (hex) and his wife considered base eight (octal) to be the only way. There was such a breakdown in communications in the marriage that it ended in divorce.

The same problem confronts many people in the computer industry today. The problem is that there are two different numbering systems used when dealing with the physical, electronic, end of computers, and a third for general use by plebes, and also salesmen when talking about price.

While there is no real need to convert from decimal to octal (or Hex) when talking about the price of a computer (unless you want to make your price appear lower) there is a real need for a device to convert between the bases when programming at the machine level or repairing the beast.

People who have access to high-level compilers and interpreters, such as FORTRAN, COBOL, APL, and BASIC, etc, have very little need for operating in bases other than our standard, everyday decimal numbering system, since they are sufficiently removed from the realities of the machine to not have to bother with such technical details.

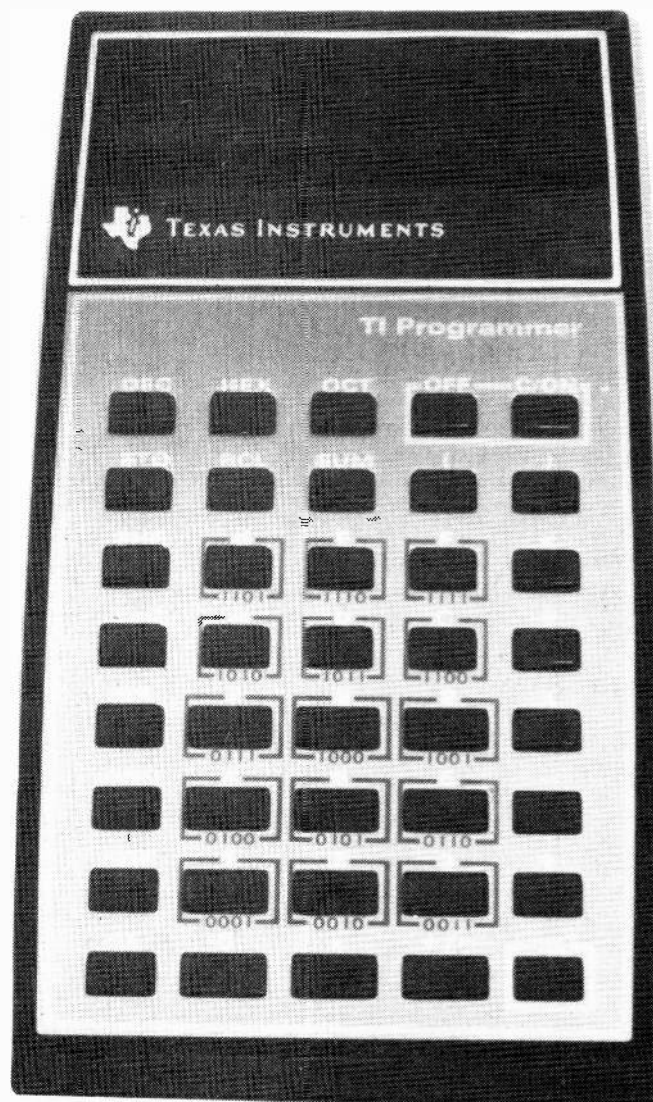

TI TO THE RESCUE

The TI Programmer is a device whose introduction I, personally, would have welcomed six years ago, when I first got involved in fixing mini-computers and mainframes. I have spent dozens, no, 256's of hours drawing little ones and zeroes on little slips of paper trying to understand what the beast is doing to data (in order to fix a problem) or what it should do (to program it).

As you will know from reading Bits, Bytes, and Bauds, a number is represented in a computer by ones and zeroes. To simplify writing these numbers down, these bits are grouped into threes (octal) or fours (hex) depending on the computer. Conversion between hex and octal is relatively easy since it is simply a matter of writing down the bits in one grouping and re-grouping them — without any mathematics at all. Since this procedure is so simple that anybody can use it, Murphy's law dictates that it will never be needed. Murphy's law is right.

Conversion from hex and octal to decimal is used all the time, but is complicated by mathematics, and this is where the Programmer really shines! Whenever you want to use a micro, for instance, to work on decimal numbers, you have to know how the micro will view these numbers in its own hexadecimal code, in order to understand how it will perform the operations that you program and what to expect as results. Addition and subtraction are not the only tools available to the programmer. There are shifts, logical ORs, ANDs, exclusive ORs, and 1's complements to worry about also.

BRAIN STRAIN

One of the difficulties of the human brain is in performing constantly repetitive, simple operations under a fixed set of strict conditions. The program that you write, may, in your analysis, give the results that you desire from your data input, but when the computer applies its cold logic to your test data, it may come up with a totally different set of results. With the logical functions of the TI Programmer, the programmer can follow all the data through his programmed operations, and quickly see where his logic is failing.

The hardware person will probably be the most ardent admirer of this handy little pocket calculator, since he is constantly wanting to compare the

results he should be getting with what his scopetells him he actually is getting. This is especially true when locating a memory problem. As savants will know, memory is organized in chunks of '1k'. This means 1024 locations, or 2000 oct or 400 hex. If you want to know what the top address of a 12k memory is, you could write down all the bits to represent 12k and figure out that way, or you could press the 12, X, 1024, =, Oct, (or hex) keys to get the answer in Octal (30000) or hex (3000). Converting memory addresses from octal or hex to decimal is an asset to the programmer in getting an idea of the relative size of chunks of memory in terms that he can easily visualise. For the experimenter who is writing machine-level programs without the use of an assembler, there is the added advantage that he can easily calculate the offsets to branch instructions, since the TI Programmer performs arithmetic in Octal and hexadecimal as well as base ten.

The calculator comes complete with the usual add, subtract, multiply and divide keys, as well as fifteen sets of brackets that can be used on each of four processing levels. Memory store, recall and sum to memory are available (1 location only) and conversion to the current base is automatic on recall.

Operation is in the standard signed, floating point arithmetic when in decimal mode, and integer, two's complement arithmetic when in octal or hex modes.

The calculator has a dandy little battery saver which blanks the display after a minute or so of non-use and causes the untrained user to go running to the instruction manual to discover what the decimal point is doing travelling across the display. This, and the other feature, of turning the unit completely off after about ten minutes of non-use, can be disabled by the user.

We don't know whether it was the lack of keys, or the belief that programmers don't think that big, that prompted the Programmer's designers to omit the scientific notation feature on this calculator, but it is, nevertheless, an oversight in my opinion, even if you would only use it for calculating the size of memories that you could only dream of owning. Another thing that was overlooked was the ability to calculate yx — very handy for discovering bit-weights.

I was very disappointed to discover the lack of a '1024' key on this calculator. Since the number is as universally-used amongst computer pi people as pi is amongst mathemati-

cians, the inclusion of a key entering 1024 as the pi key enters 3.141592654 on a regular calculator would have been appreciated.

The only other thing wrong with this calculator is the poor choice of name. Before finally coming on intelligent life at CESCO Electronics here in Toronto, who so kindly lent us an evaluation unit (which the author subsequently bought) we spent many fruitless hours trying to track one down at branches of the major department and office-supply stores in Toronto, only to discover that the term 'programmer' is almost indistinguishable from 'programmable' to the untrained ear.

Available at many calculator shops, also CESCO Electronics in Toronto, Ottawa, Quebec and Montreal.

CLASSIFIED

AUDIO MODULES

15W Tone Control + IC Power Amp. + Power Supply + Power Transformer	\$36.00
60W Low T.I.D. Power Amp.	\$31.00
30W + 30W Stereo Amp.	\$56.00
50W + 60W Stereo Amp.	\$91.00

Free Catalogue

AUDIOVISION SERVICE

P.O. Box 955, Stn. B,
Willowdale, Ont. M2K 2T6

FREE CATALOGUE

Send for your FREE Electronics Bargain catalogue now. Resistors, Transistors, Diodes, Capacitors, and much more. Write today to:-

**MAZTEC, 365 Holly Street,
Waterloo, Ontario, N2L 4G2**

HAMTRADERS INC.
45 BRISBANE ROAD, UNIT 18
DOWNSVIEW, ONTARIO M3J 2K1
"CANADA'S FRIENDLIEST
AMATEUR RADIO STORE"

Write for FREE literature
Tel (416) 661-8800

J & J ELECTRONICS LTD.,

P.O. Box 1437 E,
Winnipeg, Manitoba R3C 2Z4

Semiconductor Specialists

Do you get our bargain flyers? Send \$1.00 to receive the current literature and specials and to be placed on the mailing list for the future publications.

Factorials

Here's a calculator program for factorial fans. Sent to us by Barry Lalonde of Cornwall, Ontario.

THE FACTORIAL function is a useful and frequently used operation in statistics and other branches of math and physics. (If you didn't hit factorials in school somewhere, the factorial of a positive integer N is written N! and is the product of all integers from zero to N).

Other than for simple curiosity, the factorial function is used, for example, in calculating "combinations and permutations". Most scientific and programmable calculators have the function built in, but since they are limited to an exponent of 99 will only work out factorials up to 69!

The following program Barry wrote to calculate higher factorials. It does so by multiplying all the numbers together, and at the point where the exponent would exceed 99, the program takes the log of the exponent and keeps track of it separately. Hence the results can now go up to:

$$10^{10^{99}}$$

For an example if you wanted to find the factorial of 778 you put 1 in memory 0 and 778 in memory 1. Once it is finished a single 9 will show on display, then you display memory 0, if there is an exponent in memory 0 remember it then add the exponent from memory 0 to memory 2 and you have the full exponential power (exponent). For 778 memory 0 shows 1.4×10^9 and memory 2 shows 1907, so you would take the exponential part of memory 0 and add it to memory 2 which is 1913. So the factorial of 778 = 1.4×10^{1913} .

EXECUTION

Put 1 in register 0
 Put 0 in registers 2, 3
 Put mantissa of number to be factorialized in register 1.
 Run
 Go for coffee.
 Display register 0
 Display register 2
 Result is obtained by adding register 2 to the exponent of register 0.

PROGRAM

Program for Commodore PR100 calculator.

00	81	1
	21	F
	84	M+
	83	3
	52	MR
	83	3
	85	-
	52	MR
	81	1

FLOW CHART SYMBOLS



Information Output

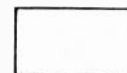

Operations



Data to be Input



Program Entry Point



Branch



End

10 95 =
 15 SKIP
 14 GOTO
 72 5
 73 6
 52 MR
 83 3
 21 F
 74 Mx
 91 0
 52 MR
 20 91 0
 85 -
 93 EE
 63 9
 91 0
 95 =
 94 + / -
 15 SKIP
 14 GOTO
 30 91 0
 52 MR
 91 0
 33 log
 75 ÷
 81 1
 91 0
 33 log
 95 =
 21 F
 40 52 INT
 51 M
 71 4
 21 F
 33 10^x
 21 F
 75 M÷
 91 0
 52 MR
 71 4
 50 21 F
 84 M+
 32 2
 14 GOTO
 91 0
 91 0
 52 MR
 72 5
 94 + / -
 15 SKIP
 60 14 GOTO
 61 7
 91 0
 82 2
 94 + / -
 51 M

72 5
 14 GOTO
 81 1
 71 4
 70 63 9
 13 R/S

FLOW CHART

N: Number to be factorialized
 C: Counter
 F: Factorialized number
 E: Exponent to the factorialized number.
 L: Log in for exponent
 J: Negative constant.

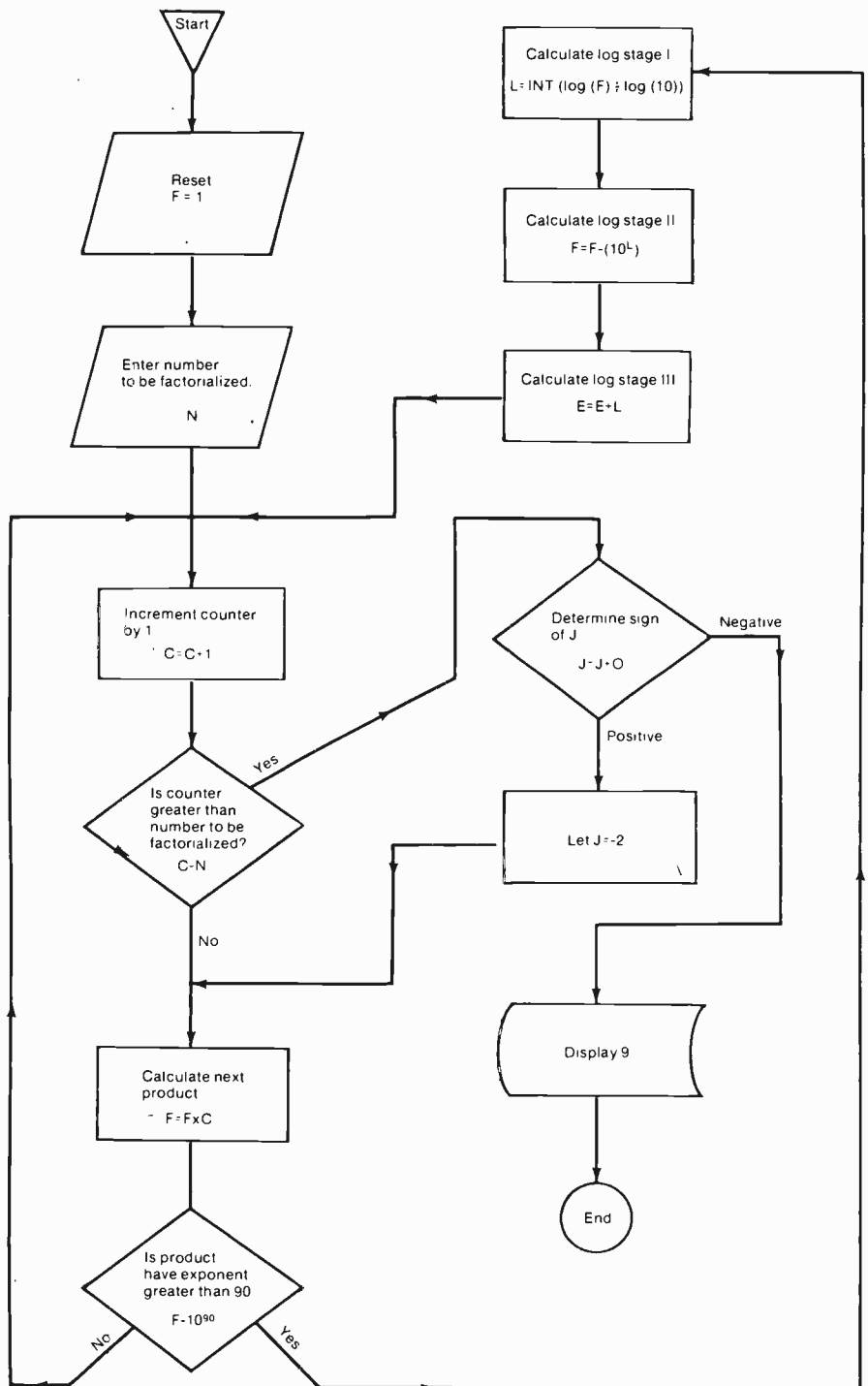

Tech Tips

Tech-Tips is an ideas forum and is not aimed at the beginner. ETI is prepared to consider circuits or ideas submitted by readers for this page. All items used will be paid for. Drawings should be as clear as possible and the text should preferably be typed. Circuits must not be subject to copyright. Items for consideration should be sent to ETI TECH-TIPS, Electronics Today International, Unit 6, 25 Overlea Blvd., Toronto, Ontario, M4H 1B1.

CAPACITY CHECKER

D. Chivers.

This bridge was originally designed to find values for odd, unmarked or undecipherable capacitors. While not being of great accuracy, it does give a very good indication as to the value of the capacitor.

A known value component is placed across terminals A-A, polarity is not important, but polarised capacitors must not be used, and cannot be tested. The capacitor under test is inserted in B-B, the unit is switched on and VR1 rotated until a maximum value reading is obtained on meter M1. At this point, a reading is taken from the calibration scale on the pot which initially must be calibrated in ratios, ie:

1000:1, 100:1, 10:1, 1:1, 1:10, 1:100 etc. The unknown value is then calculated from this reading. Original calibration is from known values.

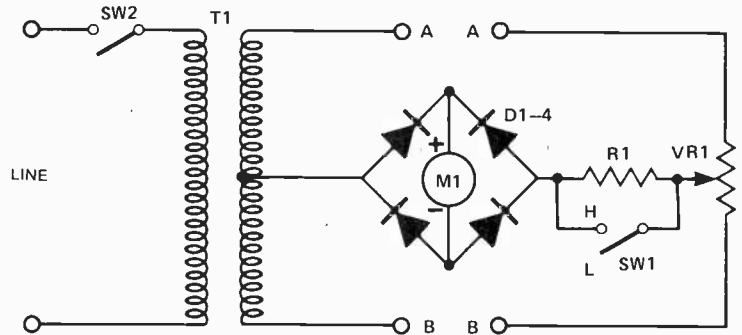

	H	L
10n	X	
100n	X	X
1u		X

M1 = 100uA
D1-4 = 1N4001
R1 = 25k
VR1 = 10k Lin
T1 = 120V/3V-0-3V

To increase the range of the circuit switch SW1 has been included to bypass R1. Since the frequency used is 60 Hz from the line, ranges are limited; if

another source were used, driving an audio output transformer, the versatility of the unit would then be further increased.

CAR LIGHTS REMINDER

Many circuits to warn motorists that they have left their headlights on after switching the engine off have appeared in the past. I feel this circuit is an improvement over many of these in that it requires no switches, and it is only necessary to make three connections to the car's electrical system.

If the ignition is switched off while the lights are on, an audible warning is sounded for about ten seconds. This tone is produced by NAND gates IC1/2, IC1/3 and IC1/4. Operation of this oscillator is inhibited by an '0' on the gating input of IC1/2. This in turn corresponds to a logic '1' present at the input to IC1/1 while the ignition switch is on, supplying a high logic level to IC1/1, the oscillator is thus disabled.

When the ignition is switched off, the output of IC1/1 goes high, enabling the oscillator. At this stage C2, which has until now been charged up via D1, begins to discharge via R4. While the voltage on C2 is high, the gating input of IC1/4 allows oscillator operation,

D. J. Rayner.

however as C2 discharges, this action is inhibited. This occurs after about ten seconds.

Power for the circuit is provided by R3 and ZD1 from the vehicle's 12 V line.

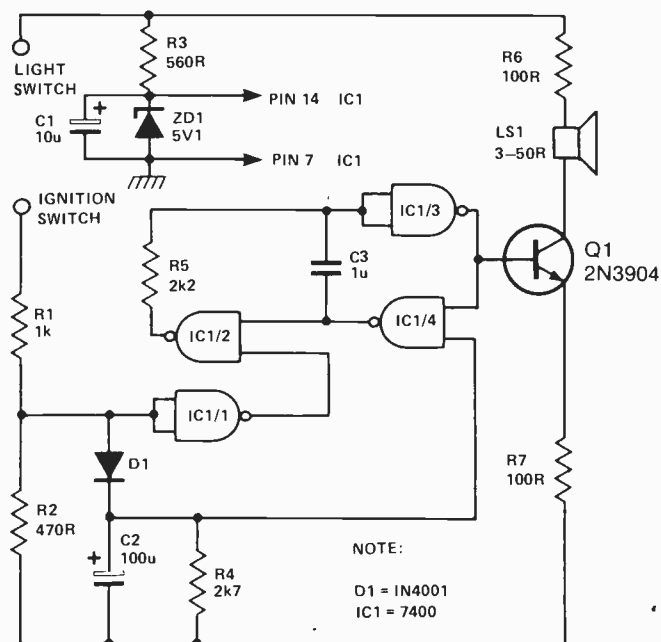

NOTE:
D1 = 1N4001
IC1 = 7400

LOOK WHAT YOU'VE BEEN MISSING

Since we started publishing ETI in Canada the circulation growth has been dramatic. That means that there's thousands of our readers who have missed some terrific issues. The issues we can't supply are March 77, April 77 and August 77.

The chart shows just the main features and projects in the various issues we have available, but for some months we are selling out fast so you'd better hurry and get your copies now. Just send us \$2 (not cash) for each issue you require, to ETI BACKNUMBERS, Unit 6, 25 Overlea Blvd., Toronto, Ontario M4H 1B1.

Features

THE CN TOWER: MORE THAN JUST A LANDMARK. 22
The technical features in the world's tallest building

BIO RHYTHM CALCULATOR 24
Find out your condition from a machine!

VCT 31
Can these new devices kill off the op-amp?

555 TIMER APPLICATIONS 35
38 circuits using this popular IC.

YAMAHA BI REVIEWED 49
Powerful amplifier uses power FETs.

SCOPE TEST YOUR CAR 60
Tune your automobile with just a scope.

MICROFILE 65
Microprocessors and microcomputers for the hobbyist

Projects

FIVE WATT STEREO AMPLIFIER 16
Use just two ICs to make this project.

PHILIPS LOUDSPEAKER SYSTEM 27
An all-in-shelf speaker!

REACTION TESTER 52
Measure your reaction time against your friends.

SHORT CIRCUITS: PATCH DETECTOR HEADS OR TAILS SCR TESTER 55

FEB 77

Features

PROJECTION TV 20
The high-tech screen in your home.

741 COOKBOOK 28
A through view at the Op Amp.

CATALOGUE SURVEY 51
A look at what's available from whom by mail.

EASIER WAY TO MAKE PCB'S 57
Now to copy out ETI's patterns.

CHOOSING A MICROCOMPUTER 60
The choice now in Canada is pretty wide.

Projects

BURGLAR ALARM 13
Fetch an intruder from just months' notice.

CERAMIC CARTRIDGE PREAMP 17
Guarantees top-notch performance.

NI-CAD BATTERY CHARGER 43
Top to show them with this circuit.

SHORT CIRCUITS: BENCH POWER SUPPLY FUZZ BOX 47
..... 48

STEREO RUMBLE FILTER 54
Eliminate rumble artifacts.

MAY 77

Features

DIGITAL SOUND SYNTHESIS 16
From monophonic to polyphonic.

A GENERATION AWAY 25
Evolution or revolution?

MULTIMETER GUIDE 30
Make sure you get what you want.

LIQUID CRYSTAL DISPLAYS 40
What goes on behind the screens.

INTRODUCTION TO COMPUTERS 44
What's involved and how it evolved.

Projects

G.S.R. MONITOR 12
Learn to relax with this unit.

TAPE/SLIDE SYNC 36
Upgrade your slide shows.

SHORT CIRCUITS

INJECTOR TRACER 54

METRONOME 56

DRILL CONTROLLER 57

JUNE 77

Features

A GENERATION AWAY 2 10
Evolution or revolution?

I'L EXPLAINED 17
The low-noise analog.

C.B. SUPPLEMENT 27
Techniques and technology.

INTRODUCTION TO COMPUTERS. 2 40
What's involved and how it evolved.

Projects

MASTERMIND 21
Can't break this electronic game.

DIGITAL VOLT METER 45
High quality, fast gear.

SHORT CIRCUITS: THE OVERLEAD TURN INDICATOR CANCELLER 53
..... 55

JULY 77

Features

PICKUP PRINCIPLES 20

SCIENTIFIC CALCULATOR REVIEW 26

BITS BYTES AND BAUDS 34

INTRODUCTION TO THE OSCILLOSCOPE 2 37

ACTIVE FILTERS 2 56

Projects

AUDIO SWEEP OSCILLATOR 10
Control your scope.

SHORT CIRCUITS: SOIL MOISTURE INDICATOR MICROAMP 46
..... 49

ELECTRONIC BONGOS 51

ALARM ALARM 53

SEPT 77

Features

VFETS FOR EVERYONE 16

MICROBIOGRAPHY 23

ELECTRONICS IN PHOTOGRAPHY 34

ACTIVE FILTERS 3 46

MURPHY'S LAW 55

COLOUR T.V. DEMISE 61

Projects

GRAPHIC EQUALISER 9
Graphic design - not back to wind.

SHORT CIRCUITS

LOUDHAULER 40

CONTINUITY TESTER 42

STEREO SIMULATOR 44

OCT 77

Features

BASIC CONSTRUCTION METHODS 8

MICROBIOGRAPHY 17

LASERS AT PLAY 24

VFETS FOR EVERYONE Part 2 33

CHARGE COUPLED DEVICES 41

BITS BYTES AND BAUDS 50

THE FIRST CENTURY 52

Projects

DIGITAL THERMOMETER 12

SHORT CIRCUITS: THREE-CHANNEL TONE CONTROL WATCHDOG 22
..... 28

NOV 77

PROJECTS

FIFTY WATT PER CHANNEL AMPLIFIER 28

SPIRIT LEVEL INTOXICATION INDICATOR 37
Prevention is better than cure.

EGG TIMER 41
We can't have our readers using grainy, blue-tinted film!

FEATURES

AM STEREO 8
How to use an MPX decoder hardware logic.

BATTERIES 12
The different types and where they are used.

THE TUBES THAT WON THE WAR 23
How they are still being used today.

DATASHEET 43
Use the universal LED.

THE ONE-ARMED MPU 46
How to use an MPU in a micro hardware logic.

MICROBIOGRAPHY 51
The art of using your body.

BITS BYTES AND BAUDS 57
Microprocessors and the radio amateur.

TECH TIPS 61
Ideas for experimenters.

FEEDBACK 64
Letters from our readers.

DEC 77

PROJECTS

ETI CLOCK 21
A versatile IC shows you several options.

LED BEACON 27
Essentially every you can make as a gift.

COMPANDER 31
Our simplest noise-reduction device for the full constructor.

FEATURES

NOISE REDUCTION TECHNIQUES 8
A look at the different systems available.

NOISE REDUCTION BY AUTO-CORRELATION 12
A look at the Phase-Locked Loop.

MAKE PCB'S FOR ETI PROJECTS 16
You can make your own boards at home.

TRANSMISSION LINES 37
How to get signals from A to B with minimum loss.

DATA SHEET 43
The SMD201 dual INAS to DC converter.

CONVERT YOUR TV FOR VIDEO INPUT 45
So you can plug in your video game or computer without a modulator.

BITS BYTES AND BAUDS 51
But attention please to more basic computer concepts.

MICROBIOGRAPHY 57
This month the RCA CMOS microprocessor COSMAC.

TECH TIPS 61
Ideas for experimenters.

FEEDBACK 64
Letters from our readers.

JAN 78

PROJECTS

TACHOMONITOR 25
A simple guide to effective gear-changing.

DIGITAL PANEL METER 29
An accurate digital voltmeter with liquid crystal display.

CB POWER SUPPLY 44
A new built design for using your mobile rig at home.

FREEZER ALARM 48
A simple way to safeguard against accidental defrosting.

FEATURES

THE COMMODORE PET 10
Answers to the questions everyone is asking.

ELECTRICES EXPLAINED 20
The magic ingredients of many microphones, cartridges and headphones.

CLASS G AUDIO AMPLIFIER 22
A new technique used in the theatre. Dynamic range.

DATA SHEET 32
The master IC 7108 7103 digital panel meter IC.

TRANSFORMERS 52
How to choose them how to use them.

BITS BYTES & BAUDS 57
Bill Johnson's complete introduction.

SINCLAIR CAMBRIDGE PROGRAMMABLE CALCULATOR 60
A cheap programmable with conditional branching.

TECH TIPS 66
Ideas for experimenters.

FEB 78

ETI Tech Tips

SEVEN TO BINARY WITH A SPECIAL BIT

T. Nash.

This circuit, which uses only four TTL or CMOS ICs, converts a seven segment digit to binary, with indication of the 'special' characters: minus, E (exponent or overflow), and optionally blank. Both types of 6, 7 & 9 can be handled, and for ease of manipulation blank is encoded as binary zero.

For a calculator — microprocessor interface the 'X' output should be fed to the sign position for ease of testing: this method is more economical in time and memory space than testing for a specific binary value. The extra bits needed for the equivalent ASCII character could also be added at the interface.

The segment identification shown above is the standard seven segment lettering system and so should be familiar to most constructors.

The letters also refer in this case to the circuit diagram and the truth

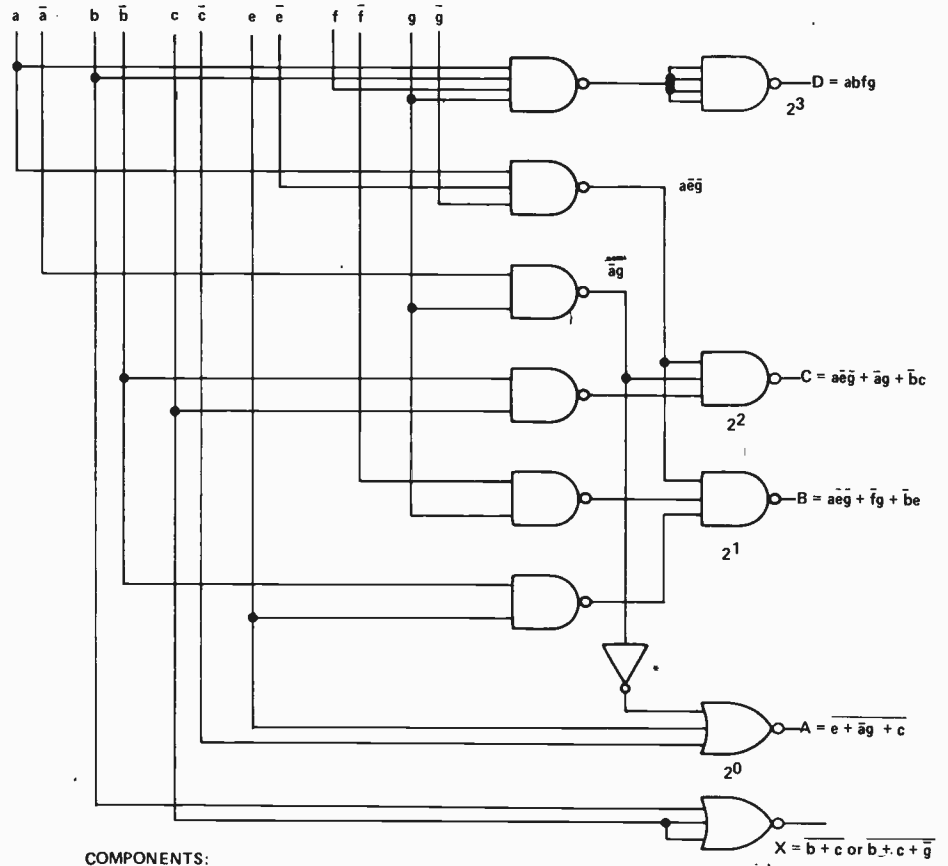

COMPONENTS:

- 1 x 7400/4011
- 1 x 7410/4023
- 1 x 7420/4012
- 1 x 7427/4025/4000 (4000 SHOWN)

FIRST VARIATION SETS X FOR BLANK, SECOND DOES NOT.

* SEE DIAGRAM

* FOR TTL AND 4025 VERSIONS, use 3 input nor.

table given below on the right hand side of the page.

No power supply connections are shown for the circuit as this depends on which version, TTL or CMOS is constructed.

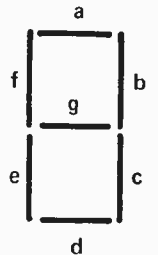

All in ETI's 741 Cookbook:

- | | |
|--|---|
| Differential voltage comparator | boosted output |
| Open-loop inverting DC amplifier | Unity-gain inverting DC adder (audio mixer) |
| Closed-loop inverting DC amplifier | Unity-gain balanced DC phase splitter |
| Non-inverting DC amplifier | Unity-gain differential DC amplifier (subtractor) |
| Unity-gain DC voltage follower | Semi-log AC voltage amplifier |
| X100 inverting DC amplifier | Constant-volume amplifier |
| Variable gain inverting DC amplifier | 1kHz tuned amplifier |
| High impedance x100 inverting DC amplifier | 1kHz notch filter |
| X100 inverting AC amplifier | Variable low-pass filter |
| Non-inverting x100 DC amplifier | Variable high-pass filter |
| Non-inverting variable-gain DC amplifier | Variable-voltage supply |
| High input impedance, non-inv, x100 AC amplifier | Stabilised power supply |
| Non-inverting x100 AC amplifier | Stabilised power supply with overload protection |
| DC voltage follower | Precision half-wave rectifier |
| AC voltage follower | Precision half-wave AC/DC converter |
| Very high input impedance voltage follower | DC voltmeter converter |
| Unidirectional DC v-follower, boosted output | DC voltage or current meter |
| Bidirectional DC v-follower, | Precision DC millivoltmeter |
| | Precision AC millivoltmeter |
| | Linear-scale ohmmeter |
| | Audio Wien-bridge oscillator |
| | Square-wave generator |
| | Precision temperature switch |

Available from ETI for \$2 (includes postage). Just order our May 1977 issue from ETI Back Issues Dept, Unit Six, 25 Overlea Blvd, Toronto, M4H 1B1.

7-SEG	a	b	c	d	e	f	g	D	C	B	A	X
BLANK	0	0	0	0	0	0	0	0	0	0	0	*
0	1	1	1	1	1	1	0	0	0	0	0	0
1	0	1	1	0	0	0	0	0	0	0	1	0
2	1	1	0	1	1	0	1	0	0	1	0	0
3	1	1	1	1	0	0	1	0	0	1	1	0
4	0	1	1	0	0	1	1	0	1	0	0	0
5	1	0	1	1	0	1	1	0	1	0	1	0
6	0	0	1	1	1	1	1	0	1	1	0	0
7	1	0	1	1	1	1	1	0	1	1	0	0
8	1	1	1	0	0	1	0	0	1	1	1	0
9	1	1	1	1	1	1	1	1	0	0	0	0
-	0	0	0	0	0	0	1	0	1	1	1	1
E	1	0	0	1	1	1	1	0	0	1	1	1

DIODES/ZENERS				SOCKETS/BRIDGES				TRANSISTORS, LEDS, etc.					
1N914	100v	10mA	.05	8-pin	pcb	.20	ww	.35	2N2222	NPN (2N2222 Plastic .10)	.15		
1N4005	600v	1A	.08	14-pin	pcb	.20	ww	.40	2N2907	PNP	.15		
1N4007	1000v	1A	.15	16-pin	pcb	.20	ww	.40	2N3906	PNP (Plastic - Unmarked)	.10		
1N4148	75v	10mA	.05	18-pin	pcb	.25	ww	.75	2N3904	NPN (Plastic - Unmarked)	.10		
1N4733	5.1v	1 W Zener	.25	22-pin	pcb	.35	ww	.95	2N3054	NPN	.35		
1N753A	6.2v	500 mW Zener	.25	24-pin	pcb	.35	ww	.95	2N3055	NPN 15A 60v	.50		
1N758A	10v	"	.25	28-pin	pcb	.45	ww	1.25	T1P125	PNP Darlington	.35		
1N759A	12v	"	.25	40-pin	pcb	.50	ww	1.25	LED Green, Red, Clear, Yellow		.15		
1N5243	13v	"	.25	Molex pins .01		To-3 Sockets		.25	D.L.747	7 seg 5/8" High com-anode	1.95		
1N5244B	14v	"	.25	2 Amp Bridge		100-prv		.95	MAN72	7 seg com-anode (Red)	1.25		
1N5245B	15v	"	.25	25 Amp Bridge		200-prv		1.95	MAN3610	7 seg com-anode (Orange)	1.25		
									MAN82A	7 seg com-anode (Yellow)	1.25		
									MAN74A	7 seg com-cathode (Red)	1.50		
									FND359	7 seg com-cathode (Red)	1.25		

C MOS				- T T L -									
4000	.15	7400	.10	7473	.25	74176	.85	74H72	.35	74S133	.40		
4001	.15	7401	.15	7474	.30	74180	.55	74H101	.75	74S140	.55		
4002	.20	7402	.15	7475	.35	74181	2.25	74H103	.55	74S151	.30		
4004	3.95	7403	.15	7476	.40	74182	.75	74H106	.95	74S153	.35		
4006	.95	7404	.10	7480	.55	74190	1.25			74S157	.75		
4007	.20	7405	.25	7481	.75	74191	.95	74L00	.25	74S158	.30		
4008	.75	7406	.25	7483	.75	74192	.75	74L02	.20	74S194	1.05		
4009	.35	7407	.55	7485	.55	74193	.85	74L03	.25	74S257 (8123)	1.05		
4010	.35	7408	.15	7486	.25	74194	.95	74L04	.30				
4011	.20	7409	.15	7489	1.05	74195	.95	74L10	.20	74LS00	.20		
4012	.20	7410	.15	7490	.45	74196	.95	74L20	.35	74LS01	.20		
4013	.40	7411	.25	7491	.70	74197	.95	74L30	.45	74LS02	.20		
4014	.75	7412	.25	7492	.45	74198	1.45	74L47	1.95	74LS04	.20		
4015	.75	7413	.25	7493	.35	74221	1.00	74L51	.45	74LS05	.25		
4016	.35	7414	.75	7494	.75	74367	.75	74L55	.65	74LS08	.25		
4017	.75	7416	.25	7495	.60			74L72	.45	74LS09	.25		
4018	.75	7417	.40	7496	.80	75108A	.35	74L73	.40	74LS10	.25		
4019	.35	7420	.15	74100	1.15	75491	.50	74L74	.45	74LS11	.25		
4020	.85	7426	.25	74107	.25	75492	.50	74L75	.55	74LS20	.20		
4021	.75	7427	.25	74121	.35			74L93	.55	74LS21	.25		
4022	.75	7430	.15	74122	.55			74L123	.85	74LS22	.25		
4023	.20	7432	.20	74123	.35	74H00	.15			74LS32	.25		
4024	.75	7437	.20	74125	.45	74H01	.20	74S00	.35	74LS37	.25		
4025	.20	7438	.20	74126	.35	74H04	.20	74S02	.35	74LS38	.35		
4026	1.95	7440	.20	74132	.75	74H05	.20	74S03	.25	74LS40	.30		
4027	.35	7441	1.15	74141	.90	74H08	.35	74S04	.25	74LS42	.65		
4028	.75	7442	.45	74150	.85	74H10	.35	74S05	.35	74LS51	.35		
4030	.35	7443	.45	74151	.65	74H11	.25	74S08	.35	74LS74	.35		
4033	1.50	7444	.45	74153	.75	74H15	.45	74S10	.35	74LS86	.35		
4034	2.45	7445	.65	74154	.95	74H20	.25	74S11	.35	74LS90	.55		
4035	.75	7446	.70	74156	.70	74H21	.25	74S20	.25	74LS93	.55		
4040	.75	7447	.70	74157	.65	74H22	.40	74S40	.20	74LS107	.40		
4041	.69	7448	.50	74161	.55	74H30	.20	74S50	.20	74LS123	1.00		
4042	.65	7450	.25	74163	.85	74H40	.25	74S51	.25	74LS151	.75		
4043	.50	7451	.25	74164	.60	74H50	.25	74S64	.15	74LS153	.75		
4044	.65	7453	.20	74165	1.10	74H51	.25	74S74	.35	74LS157	.75		
4046	1.25	7454	.25	74166	1.25	74H52	.15	74S112	.60	74LS164	1.00		
4049	.45	7460	.40	74175	.80	74H53J	.25	74S114	.65	74LS193	.95		
4050	.45	7470	.45			74H55	.20			74LS367	.75		
4066	.55	7472	.40							74LS368	.65		

4069/74C04	.25
4071	.25
4081	.30
4082	.30
MC 14409	14.50
MC 14419	4.85
4511	.95
74C151	1.90

9000 SERIES			
9301	.85	95H03	1.10
9309	.35	9601	.20
9322	.65	9602	.45

MICRO'S, RAMS, CPU'S, E-PROMS			
74S188	3.00	8214	8.95
1702A	4.50	8224	3.25
MM5314	3.00	8228	6.00
MM5316	3.50	8251	8.50
2102-1	1.45	8255	10.50
2102L-1	1.75	8T13	1.50
2114	9.50	8T23	1.50
TR1602B	3.95	8T24	2.00
TMS 4044	9.95	8T97	1.00
		2107B-4	4.95
8080	8.95	2708	9.50
8212	2.95	Z80 PIO	8.50

MCT2				LINEARS, REGULATORS, etc.			
8038	3.95	LM320T5	1.65	LM340K15	1.25	LM723	.40
LM201	.75	LM320T12	1.65	LM340K18	1.25	LM725N	2.50
LM301	.45	LM320T15	1.65	LM340K24	1.25	LM739	1.50
LM308 (Mini)	.95	LM324N	1.25	78L05	.75	LM741 (8-14)	.25
LM309H	.65	LM339	.75	78L12	.75	LM747	1.10
LM309K (340K-5)	.85	7805 (340T5)	.95	78L15	.75	LM1307	1.25
LM310	.85	LM340T12	.95	78M05	.75	LM1458	.65
LM311D (Mini)	.75	LM340T15	.95	LM373	2.95	LM3900	.50
LM318 (Mini)	1.75	LM340T18	.95	LM380 (8-14 PIN)	.95	LM75451	.65
LM320K5 (7905)	1.65	LM340T24	.95	LM709 (8, 14 PIN)	.25	NE555	.35
LM320K12	1.65	LM340K12	1.25	LM711	.45	NE556	.85
						NE565	.95
						NE566	1.25
						NE567	.95

INTEGRATED CIRCUITS UNLIMITED

7889 Clairemont Mesa Blvd., San Diego, CA 92111 U.S.A.
No Minimum

All prices in U.S. dollars. Please add postage to cover method of shipping. Orders over \$100 (U.S.) will be shipped air no charge.
Payment should be submitted with order in U.S. dollars.
All IC's Prime/Guaranteed. All orders shipped same day received.

SPECIAL DISCOUNTS	
Total Order	Deduct
\$35 - \$99	10%
\$100 - \$300	15%
\$301 - \$1000	20%

Phone (714) 278-4394 BarclayCard / Access / American Express / BankAmericard / Visa / MasterCharge

The Fun of Electronics

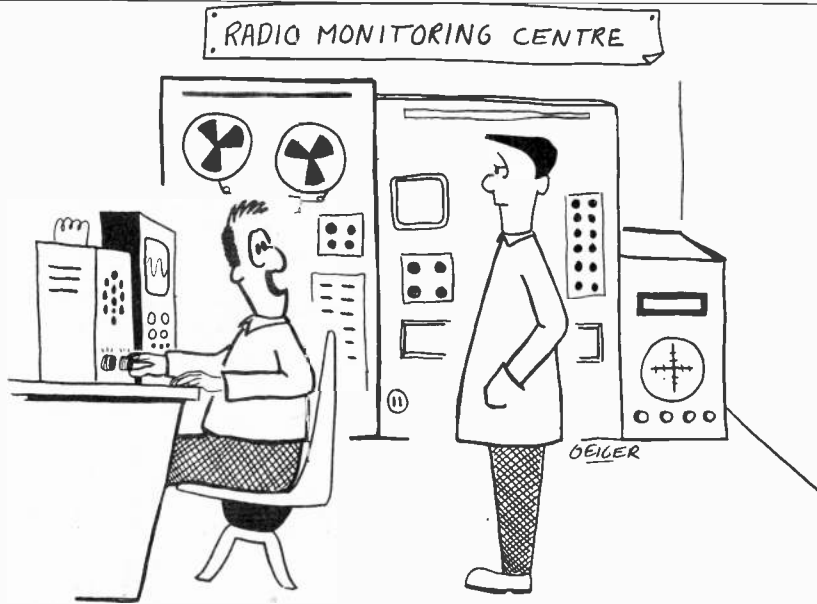

We've picked up an unfamiliar voice signal, sir: It's either some sort of life form broadcasting from the other side of the galaxy, or a CB'er with a speech impediment.

AL'S REPAIR SHOP

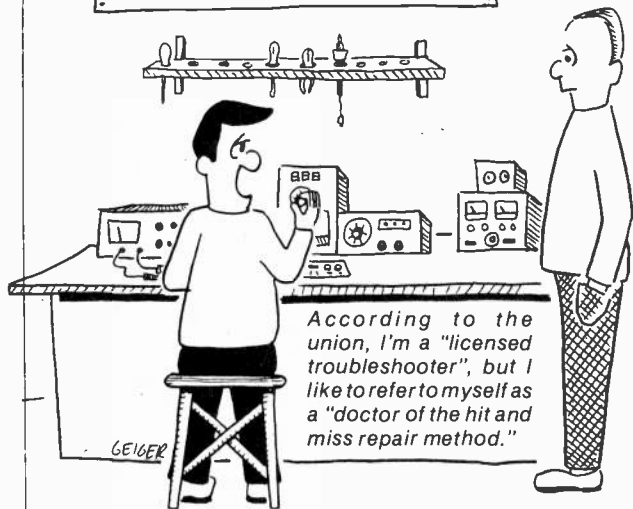

According to the union, I'm a "licensed troubleshooter", but I like to refer to myself as a "doctor of the hit and miss repair method."

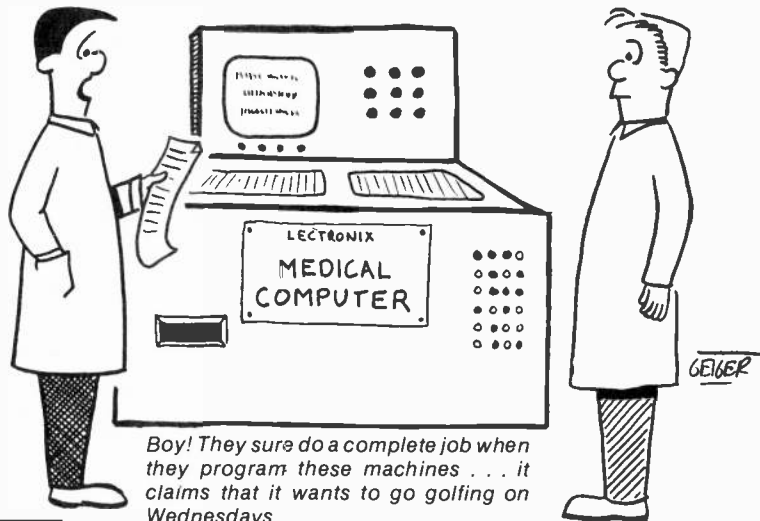

Boy! They sure do a complete job when they program these machines . . . it claims that it wants to go golfing on Wednesdays.

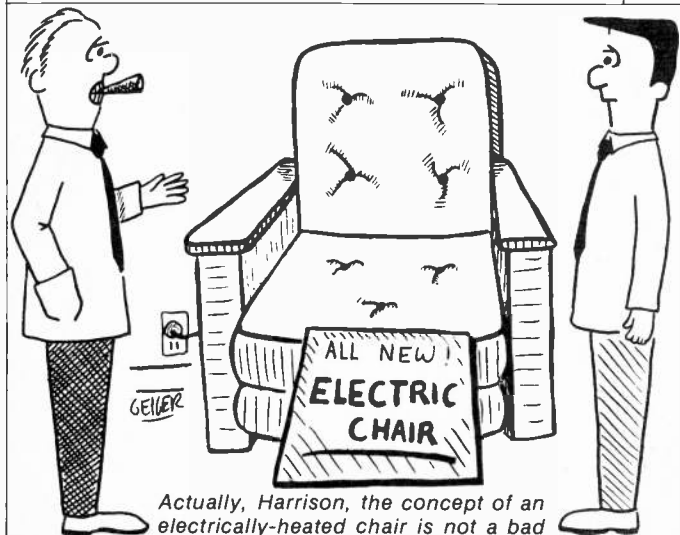

Actually, Harrison, the concept of an electrically-heated chair is not a bad one. However, we're going to have to talk to the boys in marketing about coming up with a better name for it.

Harold, no!! When I said my computer program needed "debugging", I didn't mean with insecticide!



Club Call

Electron Devices Society

The Electron Devices Society of the IEEE has issued a call for papers for the 1978 International Electron Devices Meeting in Washington, DC, December 4-6. Papers should be sent to Professor R. E. Thomas, 1978 IEDM Technical Program Chairman, Department of Electronics, Carleton University, Colonel By Drive, Ottawa, Ontario, K1S 5B6. The deadline for receipt of the abstracts in August 4, 1978.

The Electron Devices Society is part of the Institute of Electrical and Electronics Engineers, with headquarters at 345 47th Street in New York, NY 10017.

BARC Hamfest

Burlington Amateur Radio Club (PO Box 836, Burlington, Ontario, L7R 3Y7) are hosting Ontario Hamfest 78 on July 7th and 8th, 1978, at Milton Fairgrounds (south of intersection of highways 401 & 25 — exit 39). The main events are on Saturday (Friday night is devoted to a sing-song by the anacronymizeable Freeman Amateur Radio Transmitting Society) and include contests, displays, dinner and caberet. Gate registration is \$6 and camping facilities are available.

MARC

Macrogram is the newsletter of the Montreal Amateur Radio Club. We received a copy of the April issue recently — a special issue looking at the proposals for an Amateur Experimenter licence and 'packet data' transmissions. MARC has made a submission to the Minister which asks for several amendments to the proposed scheme. MARC has been in operation for 40 years and has about 350 members. Their address is PO Box 280, Westmount, Quebec.

NESDA

A letter from the National Electronic Service Dealers Association of 1715 Expo Lane, Indianapolis, Indiana, 46224, USA, arrived this month. Charles L. Porter, Executive Vice President, argues for joining a trade association. NESDA has a workmen's compensation program, free technical tips, free ServiceShop magazine, business aid, etc. In Portland, Oregon, on August 7 to 13, NESDA members will get together at the 1978 National Electronics Service Convention.

Previously Listed Clubs

TRACE: Computer Club, Toronto. See p7 Jan 78 ETI.

CSWLI: SWL Club, Thunder Bay. See p7 Mar 78 ETI.

TRAC: Amateur Radio Club, Thornhill. See p7 Mar 78 ETI.

ODXA: SWL Club, Don Mills. See p61 Apr 78 ETI.

CCCC: Computer Club, Montreal. See p61 Apr 78 ETI.

ECEC: Electronics Club, Elphinstone. See p61 Apr 78 ETI.

CHSSCC: (Computer Club, Houston. See p37 May 78 ETI.

WIARC: Amateur Radio Club, Dorval. See p37 May 78 ETI.

OSWCC: SWL Club, Prescott. See p37 May 78 ETI.

LARC: Amateur Radio Club, London. See p. 61 June 78 ETI.

FGARC: Amateur Radio Club, Prince George. See p. 61 June 78 ETI

Club Call

Send information about any clubs not mentioned on this page to ETI Club Call, ETI Magazine, Unit 6, 25 Overlea Blvd., Toronto, Ontario, M4H 1B1.

ONLY **Commodore PET Microcomputer**

\$1195.00 TWO GAME PROGRAMS FREE WITH PURCHASE



Send Coupon to:
MARKETRON CORP. LTD.
 1240 BAY STREET MALL,
 TORONTO, ONT. M5R 2A7
 Phone (416) 923-1917

KIM — 1
 Microcomputer
 Still available at
\$275.00

Has 1024 Byte RAM 2048 ROM Bytes 30 I/O pins, 2 timers, complete with LED Display and keyboard interfaces to teletype and standard audio recorder.

A most versatile microcomputer with 8K RAM user memory and 14K ROM providing: 8K of extended basic 4K operating system, 1K machine language and 1K diagnostic routine — offers much more than other units at comparable price. Uses IEEE488 interface. RS232/S100 bus is readily available from various sources to interface printer, floppy disk — available shortly.

Enclosed is: Cheque Money Order Am. Exp.
 Chargex Master charge

Card Number _____
 Expire Date _____ Signature _____
 _____ Commodore PET 2001 @ \$1200 _____
 _____ Commodore KIM-1 \$275 _____

Shipping charge PET \$10.00 KIM \$5.00 _____
 NAME _____
 Street _____
 Town _____ Prov. _____ Postal Code _____



ETI Publications

Canadian Projects Book No. 1

\$3.00

Top projects from the early issues of ETI's Canadian edition, plus some of the projects from the UK edition's issues which were distributed in Canada in 1976. All projects use parts available in Canada. Those projects from UK edition have been completely re-worked in Canada for Canadian constructors. Includes a series of modular disco projects, plus games, biofeedback, metal locator, etc.

Circuits No. 1

\$5.00

A brand new concept from the house of ETI. More than 100 pages packed with a wide range of experimenters circuits. Based on the 'Tech Tips' section carried in the overseas editions of ETI, Circuits 1 is the first of a series of specials — produced for the enthusiasts who know what they want, but not where to get it! Circuits 1 will also act as a catalyst for further development of ideas, ideal for the experimenter. The collection of more than 200 circuits is complemented by a comprehensive index, making searches for a particular circuit quick and simple. Also, similar circuits can be compared easily, due to the logical layout and grouping used throughout. Last and by no means least, Circuits 1 has no distracting advertisements in the main section!

Projects Books 3 & 4 now sold out.

Send your order, with payment (not cash), to

ETI PUBLICATIONS,
Electronics Today International
Unit Six
25 Overlea Boulevard
Toronto, Ontario
M4H 1B1

Electronics — it's easy Volume 1

\$3.50*

The best introductory series to electronics ever published in a magazine. Volume three completing the series, will be available in a few months. Volume One introduces electronics to the beginner by going through the systems approach, basic concepts, meters and measurements, frequency and wavelengths, electronics and communication, capacitance and inductance, capacitive and inductive reactance, resistance, capacitance and inductance in combination, detection and amplification, elements of transistor amplifiers, emitter followers and DC amplifiers, and basic operational amplifiers.

Electronics — it's easy Volume 2

\$3.50*

Volume Two introduces the sources of power, simple power supplies, how regulated power supplies work, general purpose supplies, generating signal waveforms, generating non-sinusoidal waveforms, all about electronic filters, more about filters, introducing digital systems, the algebra of logic, integrated circuit forms of logic functions, digital sub-systems, counters and shift registers.

Please specify which publications you require, and print your name and address clearly.

\$6.00 For Both*



MAIL ORDER SPECIALS

EVEREADY Rechargeable NiCad Batteries & Charger. PST Extra
Kit 4AAK (AA Penlight) Kit includes 4 batteries Reg. \$22.95
4AAC charger and clips for 2, 3 & 4 batteries. **Special \$17.00**
9 Volt NiCad batteries Reg. \$15.95 **Special \$11.75**
Charger N88C Reg. \$6.35 **Special \$5.40**



Mobile/Portable Digital Clock

Runs on 12 volts DC or 115 volt AC with adapter (Adapter not included)
Overall size 4" x 2" x 1-5/8" deep. 4 digit .3" green fluorescent display
Black plastic case, complete with swivel mounting bracket PST Extra
Also available in kit form. **\$34.95**



ALKALINE BATTERIES

E92AAA Penlight **Special \$.95¢**
E91AA Reg. \$1.30 **Special \$.99¢**
E93C Reg. \$1.62 **Special \$1.25**
E95D Reg. \$1.75 **Special \$1.35**
9 Volt 522 Reg. \$2.85 **Special \$2.20**

STANDARD 6 VOLT LANTERN BATTERIES

409 Reg. \$3.85 **Special \$3.00**
731 Reg. \$7.85 **Special \$6.00**

GRANADA Tri-Axial Speakers
6" X 9" woofer 3" mid range 2" tweeter
20 oz. magnet. 30 watts max.
Complete unit grilles and wires
SPECIAL \$69.95 per pair



The Professional Smoke & Fire Detector
Dual chamber ionization. Battery operated, battery lasts 1 year. Built in test switch to check all functions.
Only **\$26.95**
PST Extra

MAXELL Cassettes PST Extra
UDC — 60 Reg. \$5.00 **Special \$3.95**
UDC — 90 Reg. \$6.00 **Special \$4.85**

ROTRON Muffin Fans, Surplus excellent condition PST Extra
like new Size 4 1/4 x 4 1/4. Six blades 115 Volts 16 cycles **\$6.95**



Chargex Include expiry date, Card No., and Signature.



GENERAL ELECTRONICS

5511 Yonge Street, Willowdale Toronto, Ontario M2N 5S3
Tel: (416) 221-6174 (Just South of Finch Ave. Ample parking available)

CYBERNEX TH6416

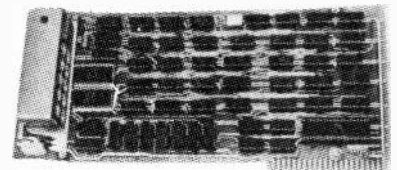

STAND ALONE TERMINAL

Display — 4X7 dot mx, 64 char X 16 lines
I/O — Serial asynchronous, 10/11 unit code
110, 150, 300, 600, 1,200, 2,400, 4,800, 9,600
Baud

Features: — Full/half duplex, cursor on/off parity enable, even/odd parity, baud rate select, break, here is, 10R2 stop bits, scroll, up/down, composite video o/p, 8 bit parallel input port, TTL in/out, upper/lower case.

Power — 5 volts DC at 900MA

Kit	Asmbld.
TH6416 \$199.00	\$299.00
TH6416P \$215.00	\$320.00
Cybernex TH3216 (32 char X 16 lines) upper case only	
TH3216 \$179.00	\$269.00
TH3216P \$195.00	\$289.00

Please allow 3 weeks for delivery,
COD, Chargex, Mastercharge

Send for Data Sheet

Arkon Electronics
91 Queen St. E., Toronto
Ontario M5C 1S1
(416) 868-1315

ETI Project File

Updates, news, information, ETI gives you project support

ETI OPTION CLOCK JANUARY 1978

Mostek has discontinued production of the MK50362N clock chip, so it's no use bugging Weber about it! However, an electrically identical chip is available, the MK50366 from Toko of America, 350, 5th Avenue NYC, NY, 10001 USA. Price is U.S. \$5.00 (with order) all inclusive, delivery 2-3 weeks and customs. The catch is the pin outs are different so request a data sheet or pin diagram at the same time. If any reader makes a pcb design for the Toko chip and sends us a copy, we will be pleased to publish it.

PROJECT FILE is our department dealing with information regarding ETI Projects. Each month we will publish the Project Chart, any Project Notes which arise, general Project Constructor's Information, and some Reader's Letters and Questions relating to projects.

PROJECT CHART

This chart is an index to all information available relating to each project we have published in the preceding year. It guides you to where you will find the article itself, and keeps you informed on any notes that come up on a particular project you are interested in. It also gives you an idea of the importance of the notes, in case you do not have the issue referred to on hand.

Every few months we print a pull out section in the magazine which may be used as a photographic negative for making printed circuit boards (as described in our January 78 issue). Each edition of this sheet contains projects from the preceding few issues. Information on where to find which negative is included in the chart.

PROJECT NOTES

Since this magazine is largely put together by humans, the occasional error manages to slip by us into print. In addition variations in component characteristics and availability occur, and many readers write to us about their experiences in building our projects. This gives us information which could be helpful to other readers. Such information will be published in Project File under Project Notes. (Prior to May 78 it was to be found at the end of News Digest.)

Should you find that there are notes you wish to read for which you do not have the issue, you may obtain them in one of two ways. You can buy the back issue from us (refer to Project Chart for date of issue and see also Reader Service Information on ordering). Alternatively you may obtain a photocopy of the note free of charge, so long as your request includes a self addressed stamped envelope for us to mail it back to you. Requests without SASE will not be answered.

Component Notations and Units

We normally specify components using an international standard. Many readers will be unfamiliar with this but it's simple, less likely to lead to error and will be widely used sooner or later. ETI has opted for sooner!

Firstly decimal points are dropped and substituted with the multiplier, thus 4.7uF is written 4u7. Capacitors also use the multiplier nano (one nanofarad is 1000pF). Thus 0.1uF is 100n, 5600pF is 5n6. Other examples are 5.6pF = 5p6, 0.5pF = 0p5.

Resistors are treated similarly: 1.8M ohms is 1M8, 56k ohms is 56k, 4.7k ohms is 4k7, 100 ohms is 100F, 5.6 ohms is 5R6.

ETI Project Chart June 77 to June 78

ISSUE DATE	ARTICLE	ISSUE DATE	ARTICLE	ISSUE DATE	ARTICLE
July 77	Mastermind	Dec 77	Spirit Level	June 78	Neg
Oct -77	Note: O	Jan 78	Neg.	June 78	Audio Analyser
July 77	Digital Voltmeter	Dec 77	Egg Timer	June 78	Ultrasonic Switch & Neg
Sept 77	Note: N	Jan 78	Neg.	June 78	Phone Bell Extender & Neg
or CPB1		Jan 78	Option Clock & Neg.	July 78	Proximity Switch
July 77	Overled	July 78	Note: S	July 78	Real Time Analyser MK II (LED)
July 77	Turn Indicator Cancellor	Jan 78	LED Pendant	July 78	Acc. Beat Metronome.
Aug 77	Skeet	May 78	Note: C		
Nov 77	Notes: C, D,	Jan 78	Compander & Neg.		
Aug 77	Dig. Freq. Meter	Feb 78	Tachomonitor		
Aug 77	Bass Enhancer	Apr 78	Neg		
Aug 77	Tachometer	Feb 78	LCD Panel Meter		
Sept 77	Audio Sweep Osc.	Apr 78	Note: C		
Sept 77	Microamp	Apr 78	Neg.		
Sept 77	Bongos	Feb 78	CB Power Supply		
Sept 77	Alarm Alarm	Apr 78	Neg		
Oct 77	Graphic Equaliser	May 78	Note: N		
Feb 78	Note: D	Feb 78	Freezer Alarm		
Oct 77	Loud Hailer	Apr 78	Neg		
Oct 77	Continuity Tester	Mar 78	Hammer Throw		
Oct 77	Stereo Simulator	June 78	Neg		
Nov 77	Digital Thermometer	Apr 78	Computer PSU & Neg.		
Jan 78	Note: C, T, S;	Apr 78	Audio Delay Line & Neg		
Jan 78	Neg.	Mar 78	True RMS Meter		
Feb 78	Note: S	Apr 78	Neg		
Nov 77	3-Channel Tone Control	Mar 78	Home Burglar Alarm		
Jan 78	Neg.	Apr 78	Gas Alarm & Neg.		
Nov 77	Watchdog	May 78	White Line Follower		
Jan 78	Neg.	June 78	Neg		
Dec 77	50D50 Amplifier	May 78	Acoustic Feedback Eliminator		
Jan 78	Neg.	June 78	Neg		
Feb 78	Note: T	May 78	Add-on FM Tuner		

Canadian Projects Book

Audio Limiter	Metal Locator
5W Stereo	Heart-Rate Monitor
Overled	GSR Monitor
Bass Enhancer	Phaser
Modular Disco	Fuzz Box
G P Preamp	Touch Organ
Bal. Mic. Preamp	Mastermind
Ceramic Cartridge Preamp	Double Dice
Mixer & PSU	Reaction Tester
VU Meter Circuit	Sound-Light Flash
Headphone Amp	Burglar Alarm
50W-100W Amp	Injector-Tracer
Note: N Apr. 78	Digital Voltmeter

Key to Project Notes

C:- PCB or component layout
 D:- Circuit diagram
 N:- Parts Numbers, Specs
 Neg:- Negative of PCB pattern printed
 O:- Other
 S:- Parts Supply
 T:- Text
 U:- Update, Improvement, Mods
 ***:- Notes for this project of complicated nature, write for details (enclose S.A.S.E., see text)

Reader Service Information

Editorial Queries

Written queries can only be answered when accompanied by a self-addressed, stamped envelope, and the reply can take up to three weeks. These must relate to recent articles and not involve ETI staff in any research. Mark your letter ETI Query.

Projects, Components, Notation

For information on these subjects please see our Project File section.

Sell ETI

ETI is available for resale by component stores. We can offer a good discount and quite a big bonus, the chances are customers buying the magazine will come back to you to buy their components. Readers having trouble getting their copy of ETI could suggest to their component store manager that he should stock the magazine.

Back Issues and Photocopies

Previous issues of ETI-Canada are available direct from our office for \$2.00 each. Please specify issue by the month, not by the features you require. The following back issues are still available for sale.

1977
February
~~March~~
~~April~~
May
June
July
~~August~~
September
October
November
December

1978
January
February
March
April
May
June
July

We can supply photocopies of any article published in ETI-Canada, for which the charge is \$1.00 per article, regardless of length. Please specify issue and article. (A special consideration applies to errata for projects, see Project File.)

LIABILITY: Whilst every effort has been made to ensure that all constructional projects referred to in this edition will operate as indicated efficiently and properly and that all necessary components to manufacture the same will be available, no responsibility whatsoever is accepted in respect of the failure for any reason at all of the project to operate effectively or at all whether due to any fault in design or otherwise and no responsibility is accepted for the failure to obtain any component parts in respect of any such project. Further no responsibility is accepted in respect of any injury or damage caused by any fault in the design of any such project as aforesaid.

ETI MARKET PLACE

FREE ADVERTISING

We will allow you up to twenty-five words to advertise items you want to buy or sell, or to publicise meetings of clubs, etc. Advertising will be accepted at our discretion — we will not accept commercial or any form of company advertising. For more insertions mail in again.

PLEASE SEND IN YOUR ADVERTISEMENT IN THIS FORM. USE AN EMPTY SEALED ENVELOPE. WITH YOUR MESSAGE ON THE BACK.

FOR SALE ETI REACTION TESTER,
\$30.95, ALLOW SIX MONTHS
DELIVERY. ALSO MODERN CATS-
WHISKER WIRELESS, \$11.49. J.J. FLASH
APT. 1105, EARTH BLVD, VANCOUVER V5J7K6.

ETI MARKETPLACE
UNIT 6, 25 OVERLEA BLVD,
TORONTO, ONTARIO.
M4H 1B1

FOR SALE OR TRADE TYCO NIGHT GLOW DOUBLE LOOP RACING SET WITH LAP COUNTER, 25 FEET OF TRACK.

FOR SALE: REALISTIC 40W STEREO AMP. \$150.00 CASH* PAID \$200.00 — LIKE NEW. CALL 652-1378 BETWEEN 7:00pm-8:00pm. TORONTO RESIDENTS ONLY.

WANTED: INFO ON STARK MODEL TA-1 "VOHMASTER" VTUM: OR STARK'S ADDRESS. WILLIAM McKENNA 652 GREYSTONE TERRACE, APT. 6, SAINT JOHN, NEW BRUNSWICK, CANADA E2M 3S7.

FOR SALE: FOUR DEC. P.D.P.8.I. COMPUTERS COMPLETE WITH 28K CORE MEM. OFFERS ACCEPTED. R. MISKIMAN, 1447 MAXIME ST. OTTAWA, ONT.

WANTED ELECTRIC PARTS AND BOOKS. PHONE 987-2095.

FOR SALE OR TRADE: BRAND NEW CHANNEL 10 VIDEO MODULATOR SOLID STATE OUTPUT +40DBMV TO +54DBMV TRU-INPUT DIPLEXED OUTPUT \$130.00. BARRY MARTIN, BOX 302, BEETON, ONT. C0G 1A0.

FOR SALE OR TRADE: PHILLIPS 1/2 REEL TO REEL VIDEO TAPE RECORDER NEEDS HEAD ONLY OFFER OVER \$100.00. BARRY MARTIN, BOX 302, BEETON ONT. L0G 1A0.

FOR SALE OR TRADE: 9" SHIBADEN VIDEO MONITOR VIDEO IN & OUT \$75. BARRY MARTIN, BOX 302, BEETON, ONT. L0G 1A0.

Get both price and performance

Make a detailed price/performance comparison and you'll find that these DMMs come out on top. Only these models give you bench-top features like four digits and auto ranging plus the kind of price that used to be reserved for field service instruments. Not that the PM 2517 isn't ideal for field service.

Dimensions are compact, construction rugged. It also has an ergonomic layout, choice of LED or LCD readouts and all the professional features listed below. In other words, we invite you to make a detailed comparison because there really isn't one.

Full 4-digit displays: give higher resolutions than $3\frac{1}{2}$ digits. We also give you a parameter readout.

Choice of LED or LCD: so whatever your light/line requirements, there's a Philips DMM to match.

Autoranging: for quicker, much more convenient readings. Manual too, of course.

True RMS: instead of average. The only true way to measure AC signals other than sinewaves without stopping and thinking.

High resolution and accuracy: due to the combination of four full digits and high sensitivity ranges.

Current to 10 A: as volts go down, currents go up, for same output. So 10 A should be a must, not an option.

Overload protection: almost the only way to damage this DMM is accidentally on purpose.

Suggested Retail price \$375.00 or less

Small but sturdy: no cheap plastic cases or sloppy controls.

Ergonomic design: works in any position. Works without fuss or fumble, and automatically in the Auto position.



Temperatures too: this low-cost option is a virtual must for trouble-shooting.

Data hold: a big Philips plus. Touch the test point, push the ring on the probe and the measurement data is "frozen" until you can turn round and read it. This option is a must for tricky service situations.

Meets International Standards: you name them and the PM 2517 meets them. But what else would you expect?

The no-compromise 4-digit instrument



PHILIPS

Service Branches from coast to coast: **Hallfax:** 902-429-2060 — **Quebec City:** 418-681-4639 — **Montreal:** 514-342-9851 — **Ottawa:** 613-829-9295 — **Toronto, West:** 416-781-5201 — **Toronto, East:** 416-438-9822 — **Hamilton:** 416-547-4914 — **London:** 519-686-9671 — **Sudbury:** 705-560-4866 — **Winnipeg:** 204-774-1931 — **Saskatoon:** 306-244-2299 — **Regina:** 306-543-0446 — **Calgary:** 403-243-7737 — **Edmonton:** 403-452-8491 — **Vancouver:** 604-434-6647.

Service
Service
Service

THORDARSON

TV

REPLACEMENT PARTS GUIDE

Deflection Yokes, Flybacks, Transformers, Coils

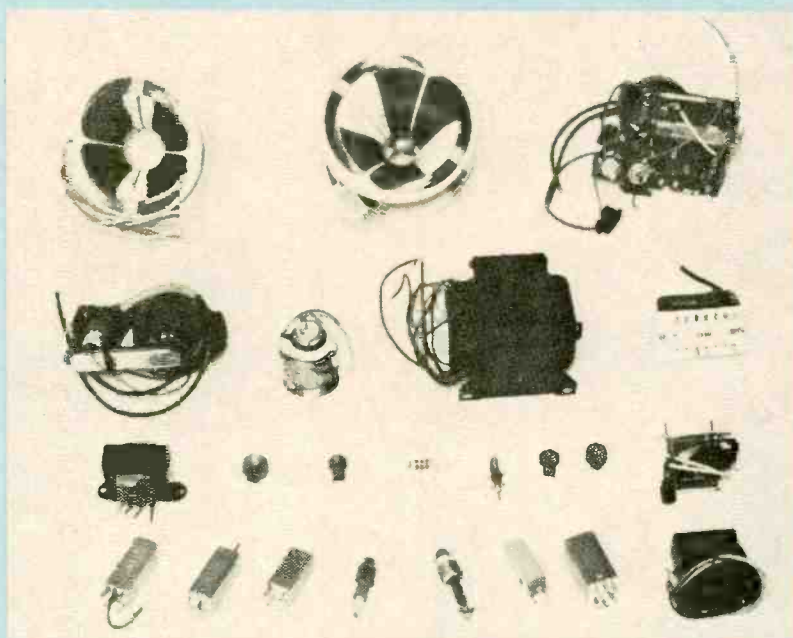

PART TO PART CROSS REFERENCE TO AMERICAN & FOREIGN BRANDS

- | | | | |
|----------------|------------------|-----------------------|---------------|
| ADMIRAL | EMERSON | ○ NIPPON ELECTRIC CO. | SILVERTONE |
| AIRLINE | FLEETWOOD | ○ NIVICO | SIMPSON SEARS |
| ○ AMC | GAMBLE SKOGMO | OLYMPIC | ○ SINGER |
| ○ ANDREA | GENERAL ELECTRIC | PACKARD BELL | SONY |
| ○ ARVIN | GEUNDIG MAJESTIC | PANASONIC | ○ SPARTON |
| BRADFORD | HITACHI | PEN-NC REST | SYLVANIA |
| CATALINA | ○ HOFFMAN | J. C. PENNEY | SYMPHONIC |
| CHANNEL MASTER | HOTPOINT | PHILCO | TOSHIBA |
| CLAIRTONE | ○ JVC | PHILIPS | TRUETONE |
| ○ CLOVIS | MAGNAVOX | QUASAR | WESTERN AUTO |
| CORONADO | MARCONI | RCA | WESTINGHOUSE |
| CURTIS MATHES | MATHES | SANYO | WHITE STORES |
| ○ DELMONICO | MATSUSHITA | SEARS ROEBUCK | ZENITH |
| DUMONT | MONTGOMERY WARD | ○ SETC HELL-CARLSON | |
| ELECTROHOME | MOTOROLA/QUASAR | SHARP | |

SYLVANIA

Electronic Components and Systems

GTE Sylvania Canada Limited

8750 COTE DE LIESSE ROAD, MONTREAL, QUEBEC H4T 1H3 (514) 735-4201 TELEX: 05-825884