

getting the most out of
VACUUM
TUBES

by **Robert B. Tomer**



Types and causes of tube failures, what to expect from tubes, testing methods, and all about tube maintenance programs.

getting the most out of
VACUUM TUBES

by **Robert B. Tomer**

**Vacuum Tubes—The Important
4/5ths of Electronic Circuits**

Over 80% of all electronic equipment defects result, directly or indirectly, from tube failures. Why do tubes fail? What can be done to prevent them from failing before their time? How can you determine whether a tube is good or bad, or how well and how long it will work in a given circuit? Should tubes be replaced periodically, whether they've failed or not . . . or should they be tested every so often, and replaced if indications show them to be below par? This book supplies the answers to these profound questions . . . plus many, many more.

**Like Watching a Play
From Backstage**

Author "Bud" Tomer, an international authority on tubes, is well-known for his candid "Tech Tip" bulletins and his slide-film presentations to service, military and engineering groups. Within these covers you'll find a virtual encyclopedia on vacuum tubes—yet the author has not delved into mathematical details that would be of interest to only a few tube engineers. Everything is focused toward the interest of those who *use* tubes—either for replacement purposes or in original equipment designs.

In his refreshing, down-to-earth style, Mr. Tomer sheds a bright light on such areas as, "Why so many tube types?" "What About Tube Testers?" etc.

(continued on back flap)

\$3.50

CAT. NO. VTT-1

getting the most out of

YACUUM TUBES

by Robert B. Tomer



HOWARD W. SAMS & CO., INC.

THE BOBBS-MERRILL COMPANY, INC.

Indianapolis • New York

FIRST EDITION
FIRST PRINTING—JULY, 1960

GETTING THE MOST OUT OF VACUUM TUBES

Copyright © 1960 by Howard W. Sams & Co., Inc., Indianapolis 6, Indiana. Printed in the United States of America.

Reproduction or use, without express permission, of editorial or pictorial content, in any manner, is prohibited. No patent liability is assumed with respect to the use of the information contained herein. The views expressed in this book are those of the author and do not necessarily reflect those of the publisher.

Library of Congress Catalog Card Number: 60-13843

PREFACE

The purpose of this book is not to add another volume to the many excellent ones available on what makes the vacuum tube work. Rather, it is intended to shed light on the almost completely neglected subject of why these versatile devices sometimes do not work.

Informed scientists and engineers have frequently stated that the life of a vacuum tube in normal service should exceed 5,000 or even 10,000 hours. The fact that some of them do not last this long is well known. The question then is, "Why do they so often give less than their predicted or possible potential?"

J. M. Bridges, Director of Electronics, Office of the Assistant Secretary of Defense, speaking before the RETMA (now EIA) "Symposium on Reliable Applications of Vacuum Tubes" at the University of Pennsylvania in May 1956, said: "It has been demonstrated by service tests that the average number of tube failures per operating hour in two equipments of equal complexity, having approximately the same tube complement, can differ by as much as a factor of ten, due entirely to differences in the thoroughness and completeness of engineering design."

If the failure rate of tubes in military equipment can vary as much as ten to one because of circuit design alone, what influence do maintenance practices have on over-all reliability and failure rates? For an answer to this, we refer to Aeronautical Radio's General Report, Number Two, on "Electronic Reliability in Military Applications," July 1957, which states: "All available evidence indicates that this factor—the influence of maintenance personnel—is one of the dominant causes of unreliability in military equipments." Later in this same report we read, "The conclusion was reached that about one out of every three tubes removed from military equipment was a 'good tube.'"

What can we deduce from all this? It appears possible that more effective maintenance practices can in some

instances, reduce over-all tube failure rates by as much as 90%. Extensive military records, covering thousands of tubes in all types of electronic apparatus all over the world, have shown that these results are entirely possible.

It is for the purpose of pointing out those engineering practices leading to premature tube failures, and those maintenance practices contributing to additional failures, that this book is written. I hope that, as a result of this knowledge, those responsible for the maintenance and servicing of home entertainment, business, industrial, and military equipment will gain a new appreciation of vacuum tubes, so they can obtain greater satisfaction from them in the future.

May, 1960

A handwritten signature in black ink, reading "Bud Vorel". The signature is written in a cursive style with a large, looping initial "B" and a long, sweeping underline that extends across the name.

TABLE OF CONTENTS

Chapter 1. CATASTROPHIC FAILURES	7
Glass Failures—Heater Failures—Arcing—Fixed <i>versus</i> Bias	
Chapter 2. DEGENERATIVE FAILURES	22
Gas—Getters—Spurious Emissions—Interelectrode Leakage—Interface Resistance—Cathode Depletion	
Chapter 3. SUBJECTIVE FAILURES	37
Hum—Microphonics—Noise	
Chapter 4. CHARACTERISTIC VARIABLES	53
Predicting Variables—How Standards Are Set—The Bogey Tube—The Limit Tube—Correlating Measurements—Typical Correlation—Characteristic Spreads—Quality Control—Sampling—Design Tolerances	
Chapter 5. SELECTED AND PREMIUM TUBES	69
How Tubes Are Selected—Results of Tube Selection—Premium Tubes—The Multi-Spec Tubes—Standardization and Reliability—How Standards Are Set—Universal Tubes—The Universal Commodity—Defining Reliability—Reliability and Standardization	
Chapter 6. WHY SO MANY TUBE TYPES?	83
Filament Voltage Sources—2-Volt and 6.3-Volt Tubes—TV Types—Hybrid Types—Physical Changes—Miniatures and Subminiatures—Multipurpose Tubes—Electrical Characteristics—Competition—Technological Developments	
Chapter 7. PREDICTING TUBE PERFORMANCE	96
Life Expectancy By Structure—Life Expectancy By Application—Tests for Initial Performance—Predicting Life	
Chapter 8. TUBE TESTERS	111
Early Tube Testers—Classification of Tube Testers—Shorts and Gas Tests—Maintenance Practices	
Chapter 9. SPECIAL-PURPOSE TUBES	128
Filamentary Tubes—Low-Voltage Tubes—Phototubes—Voltage-Regulator Tubes—Thyratrons	
Chapter 10. METHODS FOR LENGTHENING TUBE LIFE	145
Measuring Bulb Temperature—Dissipation Control—Voltage and Current Regulation—Low-Voltage Operation—Mechanical—Maintenance	
Glossary	154
Index	158

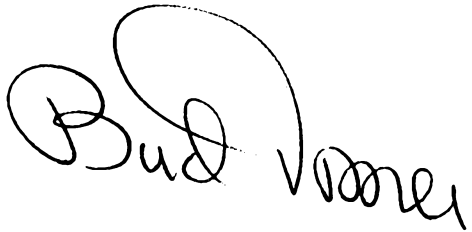
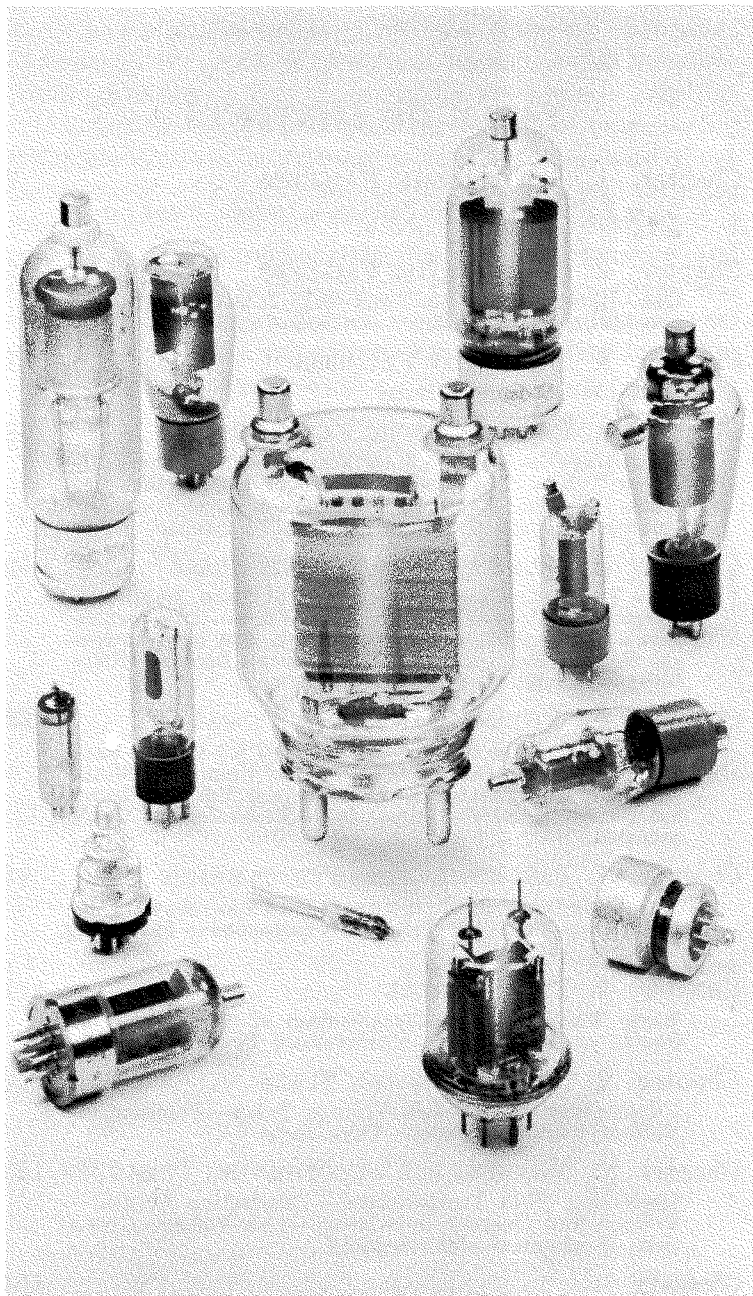

(Courtesy of CBS Electronics.)

CHAPTER 1

CATASTROPHIC FAILURES

If one gives more than the most casual thought to the problem of how and why vacuum tubes fail, it becomes apparent that the word "failure" can mean more than one thing, depending upon who uses it. A failure may be a tube that fails to meet the requirements of some arbitrary test, as for instance, a tube checker's "good-bad" scale. Or it may be one which fails to meet some numerical value for a characteristic such as transconductance or plate current in a prescribed test. It may be a tube which, when used in a certain piece of equipment, reduces the performance of that equipment to below some arbitrary level. Finally, it may be a tube which simply fails to function at all, as for instance, one in which the heater doesn't even light.

It should be thoroughly understood that these situations are not merely degrees of the same simple phenomenon. A tube that fails to meet any one of several tests may still perform with complete satisfaction in most equipment. A tube which meets all normal tests may fail to work satisfactorily in some equipment. Most tubes, new or old, contain some measurable defects; yet many tubes which are rejected as unusable will have no measurable defects. These are some of the confusing facts which must be dealt with in any serious study of the causes and corrections for the majority of tube failures. This is why there is no universal test that can be used to define a "good" or a "bad" tube, a subject that is discussed more fully in later chapters.

In order not to confuse the reader, the term "failure," as used throughout this discussion, will be limited to those types of failures which, by their very nature, can be

assumed to result in equipment failure or serious malfunctioning most of the time. Where anything else is meant, it will be clearly stated and explained.

For purposes of analysis, it is convenient to divide failures into three broad categories. These are somewhat arbitrary and, without a doubt, overlap each other extensively. Nevertheless, they have become fairly standard among those who have made a study of the problem, and as a consequence, will be used here with some slight modifications.

Catastrophic failures are those which occur without warning and cause the equipment to become inoperable almost immediately. By far the vast majority of such failures occur within the first hundred hours of operation. They reach a very low incidence after 500 to 1000 hours and, with proper operation, become fixed at an extremely low level after 5000 hours of use. This normal curve or rate of failure (Fig. 1-1) can be interfered with by several factors which will be discussed. It should be carefully noted, therefore, that whenever the rate of catastrophic failures does not follow this normal curve, the secondary factors are usually to blame, rather than the tubes.

A second important inference can be drawn from this curve: As far as catastrophic failures are concerned, the longer a tube is in use, the better are its chances of continuing to remain in use. This will be referred to many times in this discussion, for there are many interrelated reasons why this apparent contradiction is true.

GLASS FAILURES

A not uncommon cause of the catastrophic failure is cracked glass. Although known to man since ancient times, glass is seldom recognized for what it really is. Glass cold-flows; in so doing, it develops strains which eventually exceed its elastic limit until it breaks. If a sheet of glass is clamped on a bench so half of it extends over the edge and a weight is placed on the unsupported portion, a strain will be set up which will eventually cause the glass to break off. It may take weeks—or even months—but it is only a question of time.

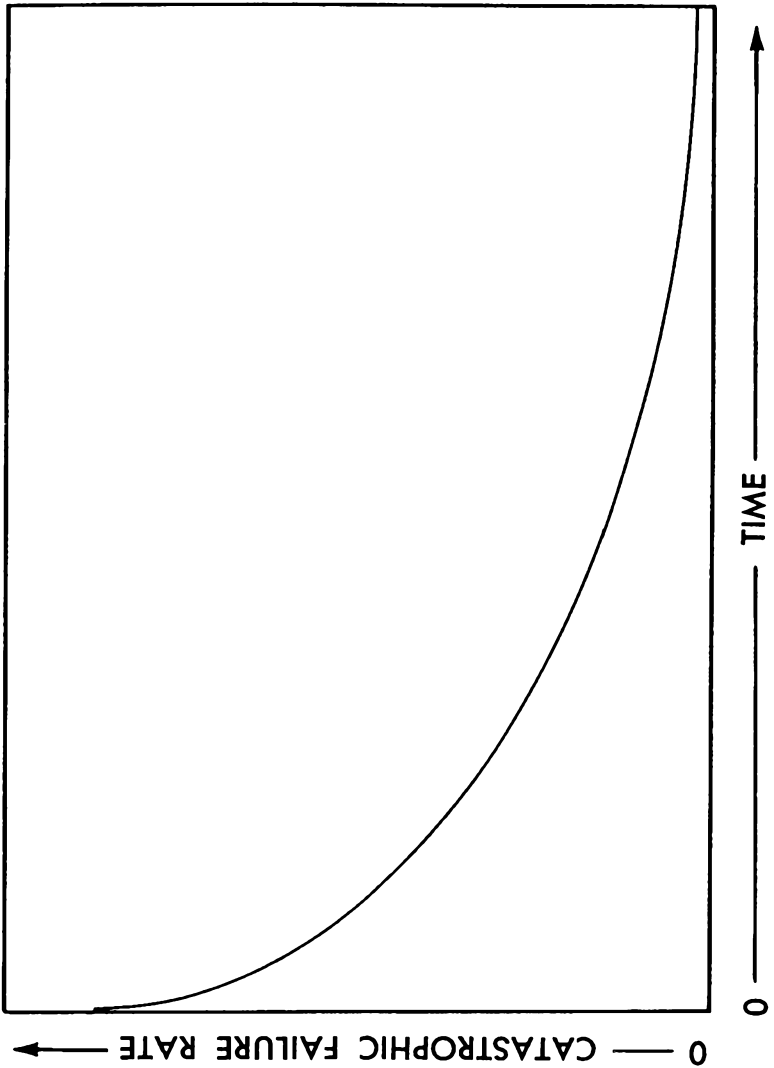

Fig. 1-1. Most catastrophic failures occur early in the life of a tube. This curve shows the longer a tube is in service, the better its chances are against catastrophic failure.

A very common cause of glass breakage in vacuum tubes is bent pins. When they are inserted into sockets that tend to force them into alignment, tension is developed where the pin enters the glass. This tension increases when the tube is heated and cooled. Depending on the severity of the strain, this force will eventually cause the glass button to break. Using a pin straightener before inserting the tube in the socket will help minimize the chances of this happening. Not disturbing tubes that are functioning properly will also help reduce the incidence of this type of failure, because it is a proven fact that merely removing and inserting the same tube in the same socket too many times will eventually lead to broken pins and cracked glass.

Incorrectly designed tube sockets can cause unnecessary glass breakage. The sockets are supposed to have floating contacts or inserts. These inserts may fit the pins snugly, but they must be free to move and align themselves with the pin. Sometimes an otherwise well-designed socket will be rendered dangerous to tube life by incorrect soldering techniques. Socket inserts should never be bent over and soldered directly to the chassis so there is no allowance for free movement of the insert. Stiff wires that restrict the movement of socket inserts can do the same thing. Naturally, allowing solder to run down the sides of the socket terminals, until it puddles at the bottom and "freezes" the insert, is to be avoided for the same reason.

Another source of trouble, as far as glass is concerned, are certain types of tube clamps that press upon the dome or sides of a tube and cause differential cooling. Glass has very low heat conductivity. If a metal ring is allowed to contact the envelope of a tube in some way, the sharp heat gradient which will develop at the point of contact, between the cold metal and the hot glass, will almost certainly result in a strain that will crack the glass sooner or later. In fact, a favorite method of removing the neck of a picture tube is simply to reverse this situation and wrap a hot wire around the cold glass. It will break off in a jiffy and leave a neat, clean edge.

Pin holes, or "star cracks" as they are called, are sometimes encountered in tubes located near very high-voltage

sources, as in the high-voltage compartment of some TV sets. These cracks result from high-velocity electrons being beamed toward very small areas of the glass, resulting in local heating and consequent glass strain. Often the cause will be found in a high-voltage lead which passes too close to the affected bulb. Or these cracks may be caused by external arcing to the tube, as when inadequate corona shielding is employed.

Another little-known fact about glass is that its resistance changes with temperature. Where a very high voltage and a high temperature are encountered simultaneously, there is danger of sufficient leakage current developing to cause electrolysis. This is a chemical decomposition of the glass which leads to surface damage similar to scratches, and this in turn leads to cracked glass. Plate caps that run very hot, or that carry high voltage or large amounts of RF current, should be cooled by using radiator caps with fins. A marked reduction in glass failure will result within the usable life span of the tubes if this precaution is taken.

HEATER FAILURES

Whenever one speaks of tube failures, the most likely cause that comes to mind is open heaters. Like cracked glass, this type of defect is both obvious and conclusive. Even the nontechnical person can understand and frequently identify this type of defect. But just because it is so common, it is often taken for granted and accepted as a cause when it is far more apt to be a result or a symptom.

There are three methods by which a heater can become open. One is the result of long life and having been cycled "on" and "off" many thousands of times. This is characterized by a stretching of the tungsten heater wire which leads to eventual fracturing. A second means of producing an open heater is to run it excessively hot and literally vaporize the metal. When the wire finally parts, the ends are fused and balled, making this type of failure easily identifiable. Finally, a weld which is not properly made can open up. This, too, leaves a very characteristic tell-tale story. Tungsten wire does not weld to nickel, so it must

be imbedded in the support wires. If this is done properly, it will break before it will pull out. But if it is done incorrectly, it will come away intact.

Thus, in analyzing tubes which have failed because of open heaters, one can assign the cause of failure with a high degree of accuracy. Studies of tens of thousands of tubes returned for this cause show clearly that far more than half of them were "burnouts."

The most common cause of heater burnout is excessive heater voltage. Tubes are designed to operate at a particular heater voltage. This is based upon many compromises in designing the tube. All of these compromises reach an optimum value when the tube is operated at precisely the voltage for which it is rated. When this voltage is exceeded by even a small percentage, the rate at which these compromises begin to deteriorate is very rapid. This fact is illustrated in Fig. 1-2. Equipments operated at ten percent over the rated line voltage have been shown to experience more than a one hundred percent increase in breakdowns over a given period of time. Tubes, when operated at ten percent above their rated heater voltage, will suffer up to a fifty percent decrease in heater life. A voltage under the rated value on the other hand, while having some disadvantages as far as certain other characteristics go, tends to increase heater life substantially.

Whenever a heater is turned on from a cold start, there is a very high initial surge of current. This is because the cold resistance of the heater is many times less than its hot resistance. The surge current has a tendency to cause the heater to convulse and stretch, and it is this effect which leads to many premature heater failures.

Limiting Surge Current

Various means have been used to reduce this high initial surge current. Many recent TV sets have incorporated a surge-limiting resistor having a negative temperature coefficient. These resistors offer their maximum resistance when cold, and gradually decrease in resistance as they become hotter. In this way, they counteract the opposite characteristics of the heater. The use of these resistors is strongly recommended by all tube manufacturers. As

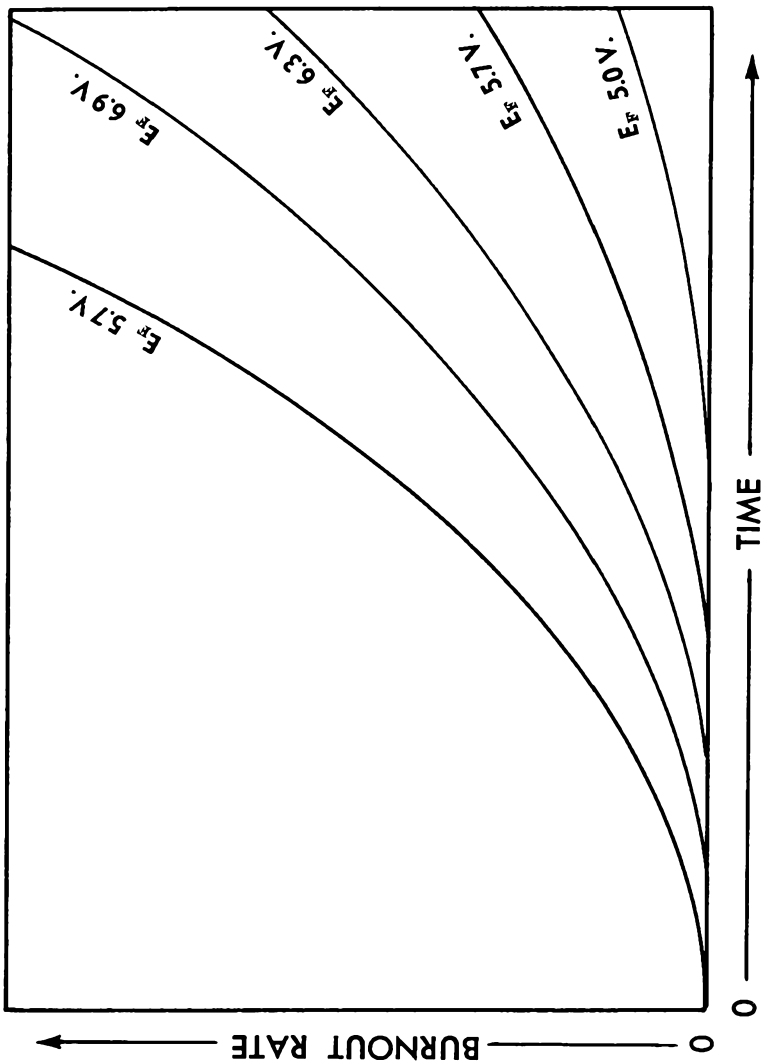

Fig. 1-2. Curves showing how rate of tube failure rises as heater voltage increases.

much as a four-to-one decrease in heater burnout rate can be expected when surge-limiting resistors are used. Other advantages can be obtained from their use, but these will be discussed in a later chapter.

In the case of very large equipment using hundreds or even thousands of tubes, it has been proven economical, in terms of reduced maintenance costs, to allow heaters to be left on at all times, even when not in use. There are certain precautions that should be observed when resorting to this practice, because what one gains in increased heater life may be lost in other defects. (These are described in the next chapter, under interface resistance.) However, it can safely be said that reducing heater voltage to one-half its normal value during long periods of standby will preserve heater life considerably, and will not cause any additional problems, other than the very brief delay required to bring them up to operating temperatures again.

Many circuits have several tube heaters connected in series. In quite a number of these circuits, the heater mix is quite drastic; that is, tubes having relatively low-wattage heaters are in series with other tubes having relatively high-wattage heaters. Resistors are often shunted across one or more heaters to equalize the currents, as when 300-milliamperere tubes are in series with 450- or 600-milliamperere tubes.

Such combinations usually result in heater warm-up imbalance. The lower-wattage heaters will heat up most rapidly because their mass is frequently lower than the higher-wattage types and, hence, their thermal lag is less. During this warm-up period, the heater voltages are not distributed uniformly; thus, the wattages may temporarily become very far out of balance. This is another form of the current surge problem, brought on by dissimilar warm-up times in a complex series-parallel heater arrangement.

Some tubes have the same warm-up time, regardless of their individual wattages. When these tubes are used in a series arrangement, there will be no surge current imbalance, because the resistance change with temperature in all tubes is the same. Thus, no one tube will light up brightly while all the others remain cold.

Filamentary Tubes

Tubes of the filamentary types, such as rectifiers and most battery or 1.4-volt types, have certain problems unique to themselves. Among these is the one called "filament sag." When heated, metal expands. Filaments are usually designed with provisions to compensate for this characteristic; however, certain precautions are required of the user in order to make these provisions effective.

Power rectifiers may develop shorts between filament and plate if the tube is operated for long periods of time in the wrong mounting position. Manufacturers specify that the tube, when mounted horizontally, shall be so oriented that the longer axis of the plate cylinder is vertical. This provides the filament with the maximum latitude for sag. Not all brands of identical tube types have the mount structure oriented in exactly the same position; consequently, some tubes could be oriented in such a way that even a small amount of sag will cause an arc or a short. Remounting a socket to favor the exact filament plane in the most commonly used tubes will result in a significant reduction of rectifier shorts and burnouts.

An interesting problem arises when equipment using vertically-mounted rectifier tubes is tipped up for bench servicing. Many rectifier tube failures occur at just such a time, especially if they have seen considerable service and have developed a fair amount of sag already. There is no simple solution to this problem except to recognize that it exists and to refrain from leaving sets running in such a position for long periods of time, as for instance, when waiting out intermittents.

Battery-type filamentary tubes are usually designed with a spring hook which takes up the filament slack. In order for this spring to be most effective, it is best to operate these tubes in a vertical position, even though most tube manuals say they can be mounted in any position.

There are many heater failures that appear to be simply that and nothing more, but which in reality are the end result of heater insulation breakdown. This is particularly true where a relatively high heater-to-cathode voltage exists. Until a few years ago, all indirectly-heated cathode-

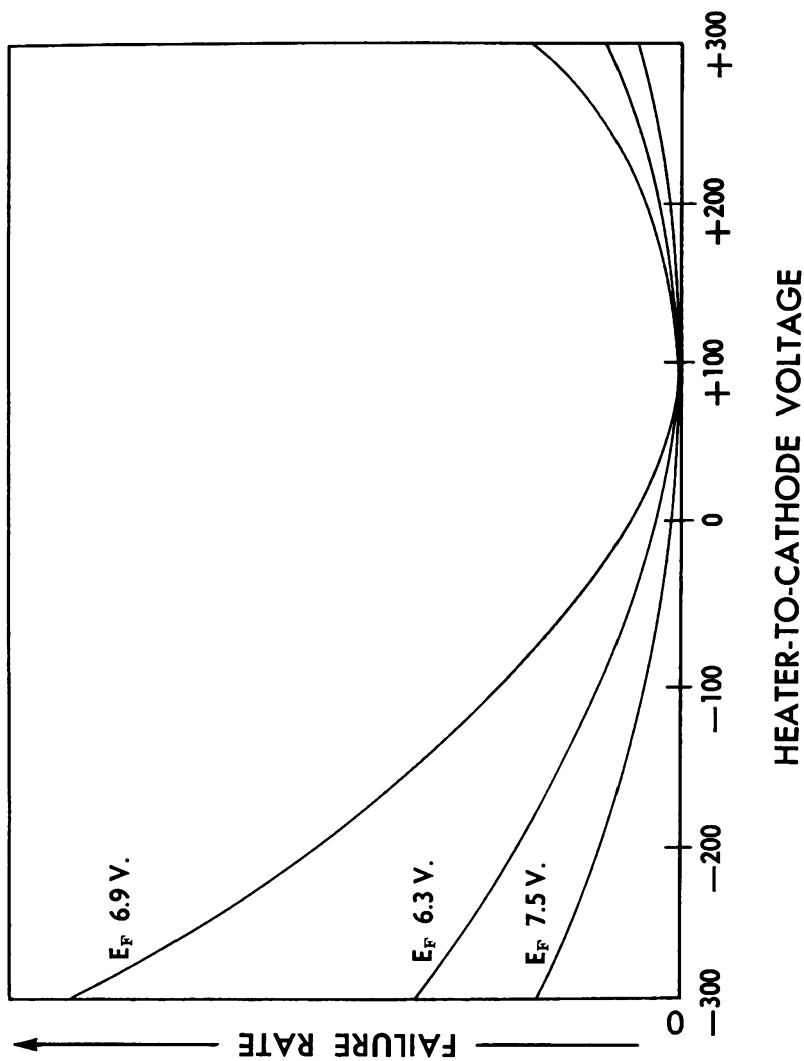

Fig. 1-3. Heater-to-cathode voltage versus life. Failure rate is minimum when heater-to-cathode voltage is kept within the 90-volt limit.

type tubes had a heater-to-cathode rating of approximately 90 volts. This was based on the known limitations of the insulating material used on heaters. There has been no change in this material over the years, yet heater-to-cathode voltage ratings have steadily increased. This doesn't make much sense—from an engineering point of view—even though it does permit the design of many circuits not possible under the older, more conservative ratings. As a result, we have far more breakdowns of this type in the field today than we had some years ago.

Life tests on a large number of tubes have shown a very definite relationship between the heater-to-cathode voltage and the length of time before a failure occurs (Fig. 1-3). For maximum reliability, this voltage should be kept below the 90 volts (between 50 and 90 volts being optimum) originally thought to be a safe maximum. Where excessively high heater-to-cathode voltages are encountered, reduced heater temperatures will help to minimize the damaging effect. In other words, high heater voltages and high heater-to-cathode voltages produce effects which are cumulative; when encountered simultaneously, heater life will be drastically foreshortened.

Some tube types are rated to withstand extremely high pulse voltages between heater and cathode. These tubes are made with a special ceramic insert between the inside of the cathode sleeve and the filament. Their voltage breakdown point can be raised to a considerably higher level than can be safely used for those types which use only the heater coating itself as the insulation. However, due to the large inert mass which this sleeve adds, these tubes are slow in reaching a suitable operating temperature at the cathode surface—leading into another problem, namely, that of arcing.

ARCING

Arcing in high-vacuum tubes can be caused by several things—among them lint, gas, and the drawing of large amounts of cathode current before the cathode temperature has reached its optimum working level.

Tubes which arc destructively are usually very gassy. Arcing produces gassing, so if we examine some of the

more common causes of arcing, we should find some methods for reducing the premature gassing of tubes. A very common cause of arcing is lint or other loose particles within the envelope. These become dislodged due to vibration or handling, and then fall through the tube structure where they become vaporized by the electron stream. This produces a localized gas cloud which, in effect momentarily reduces the spacing between elements separated by relatively high potentials. The electrostatic stresses plus additional electron collisions cause this gas to ionize, providing a lowered resistance path between the elements. A heavy current follows; often, it is sufficiently strong to physically damage the grids of the cathode, and a metallic short develops. Gently tapping new tubes, base down, before they are installed will do much to insure that any loose particles within the envelope will drop to the bottom where they will do no harm. Refraining from removing satisfactorily operating tubes for the purpose of routine testing will also eliminate the possibility of stirring up loose particles that may cause arcing later.

A very common cause of destructive arcing is drawing maximum emission current before the cathode has reached its normal operating temperature. This is a frequent cause of damper and rectifier tube failure. What happens is this. An indirectly-heated cathode-type tube does not draw its plate current directly from its cathode, but from a reservoir of electrons in the space around the cathode. This reservoir (space charge) is supposed to stay ahead of the plate current demands. As long as it does, the plate current is drawn from the space charge. The cathode supplies the space charge with new electrons to replenish those drawn away.

The ability of the cathode to supply electrons, and hence to replenish the space charge, depends on temperature. When the cathode is warming up from a cold start, its ability to supply electrons is fairly limited. This is what is known as its region of temperature-limited emission. If very heavy plate current demands are made on a tube while it is temperature limited, the reservoir of electrons will be completely swept away, leaving the cathode exposed to bombardment by the heavy negative gas ions that are always present. These negative gas ions are repulsed

by the negative space charge when it exists, but when it has been drawn away, there is nothing to stop the ions from plunging violently into the cathode coating where they erupt the surface like miniature volcanos.

The erupted cathode coating becomes vaporized in the electron stream, and more gas ions are formed. In far less time than it takes to describe, a gas arc has built up and serious pitting or stripping of the cathode has occurred. Quite frequently, the arc is sufficiently hot to burn a hole through the cathode sleeve and extend on into one of the heater folds where the arc current then finds a path to ground, opening the heater in the process.

The cure for this situation is a fundamental one; it will be referred to in greater detail, when specific types are discussed in later chapters. In essence, all cathodes must reach their optimum operating temperature at the same time, or if this is impractical, to see that those tubes required to *supply* the current reach their optimum operating temperature before those tubes which *draw* upon the supply. In other words, be sure the load is not applied until after the rectifiers have reached their full operating temperature.

Rectifier tubes become the victims of another form of destruction which is frequently misunderstood. It has to do with the effects of peak and average currents and their relationship to such things as filter capacitors and their deterioration characteristics. The average current passed by a rectifier tube is the DC current drawn by the load. Rarely does this current exceed the tube ratings, unless there is a short within the set. If so, rectifier arcing will very often occur, followed by cathode stripping or burn-out.

It is beyond the scope of this discussion to go into the causes affecting breakdown in other areas of the equipment, except to point out that they are frequently the direct cause of tube failure. In the case of filter capacitors, there is that direct relationship, so they will be discussed in terms of how they affect rectifier tube life.

The amount of capacitance used in the input section of a filter has a very great effect on the peak current drawn from the rectifier tube cathode. This is the intermittent current which flows at the peak of each rectification cycle,

replacing the current lost by the capacitor as a result of load and leakage currents. As filters age, their internal leakage current rises; if unused for long periods of time, their leakage current increases. When equipment with leaky electrolytics is turned on, the rectifier peak currents may exceed the tube ratings by quite a margin, and it is at these times that rectifiers are most apt to arc and burn out. This is why so many TV sets, for example, develop rectifier troubles immediately following a period of long disuse, as for instance, when the owner returns from vacation. When this happens, it would be in the customer's best interests if the service technician were to replace the leaky electrolytics with new ones, thereby preventing further tube failures the next time the set is left unused for a few days.

Simple circuit changes which will not interfere with the normal functions can be incorporated into the equipment to help minimize excessive peak currents that might otherwise destroy tubes. The principle requirement is that sufficient resistance be added in series with the rectifier plate to limit the peak current to a safe value. One place to add such resistance is in series with the center tap of the high-voltage transformer. Where no transformer is used, the resistance can be added directly in series with each plate.

FIXED *VERSUS* BIAS

While in this area of failures caused by other circuit breakdowns, it may be just as well if we touch upon two other prime sources of tube failures and their appropriate cures. Various types of equipment make use of some form of fixed bias, either for reasons of economy or because of some supposed improvement in performance. Whatever the reasons may be, this form of operation is regarded as very hazardous and unreliable by most tube people. The reasons have been copiously stated before, but they apparently require restating periodically.

Fixed-bias operation magnifies the inevitable minor differences between vacuum tubes. It provides no built-in margin of safety in the event of circuit or tube malfunctions. When trouble does develop in a fixed-bias circuit,

due to a deficiency in an associated component or the tube itself, the results are usually quite destructive. The alternative — cathode bias — provides increased tolerance of characteristic variables and an automatic degenerative action which inhibits runaway conditions, thus helping to reduce destructive breakdowns.

One should not assume that fixed-bias operation is limited to only those applications that come under the heading of high-power equipment. It is becoming common in many of the latest hi-fi and stereo amplifiers, and several TV sets incorporate this type of circuit in their AGC circuits. These will be dealt with specifically in the chapter devoted to UHF and VHF tubes and their special problems.

Another form of fixed-potential operation which is a frequent cause of tube failures is fixed-screen operation. Not only does this also tend to magnify small variations in tube characteristics, but it likewise provides no safety factor in the event of other component malfunctions. For example, if plate voltage is removed from a tube operated from a fixed-screen supply, the screen current will rise to the point where the screen will probably run red hot. This will cause destructive gassing of the tube, vaporization of protective materials from the screen, and perhaps warping and shorting of the elements. The use of screen-grid dropping resistors provides current degeneration with its many benefits, including greater tolerance to tube variables, built-in runaway protection, plus a variable gain characteristic that will lead to longer, more satisfactory tube life.

In the foregoing paragraphs, the many causes for sudden and disastrous tube failures have been pointed out. It has been shown that the great majority of them can be minimized—if not eliminated entirely—by thoughtful design considerations, or by simple maintenance and modification procedures. The incorporation of these principles into existing equipment has been demonstrated to have reduced catastrophic failures by several hundred percent. This means that far more tubes lived long enough to wear out. The subject of why tubes *do* wear out eventually, and how their time of usefulness can be lengthened, is the subject of the next chapter.

CHAPTER 2

DEGENERATIVE FAILURES

There are several factors which contribute to the slow but eventual deterioration of all vacuum tubes. In separating them into specific topics for discussion, we must keep in mind that these factors are often interrelated. In fact, they seldom occur separately. However, one is usually more pronounced than the others, and therefore the prime cause of failure can be attributed to that specific factor—even though the others may have contributed their share in bringing tube life to an end.

GAS

High on the list of phenomena which contribute to tube failures, and which are of an evolutionary nature, is gas. The presence of gas in a tube does not necessarily mean it has reached the end of its useful life, or its life expectancy will be less than some other tube. This is one of the common assumptions frequently made by those who presume to “test” tubes in the field.

To illustrate the point, tubes have been manufactured without getters. Using conventional “grid testers,” these tubes were very “gassy.” Yet, when placed in controlled life tests and compared with similar tubes that had getters but showed little or no gas indication, these so-called “gassy” tubes outlived and outperformed their more normal mates.

Why should this be so? The answer is not well understood, even by tube engineers. It is apparent that there can be harmless gas conditions as well as those that are harmful. It is obvious that all gases are not harmful to tube life, because some tubes are made with certain gases in them, gases that are essential to their proper function-

ing. These tubes live long, trouble-free lives when properly used.

Without attempting to identify the specific forms of harmful gassing, we will discuss those conditions which, as learned through experience, leads to relatively early gas evolution and shortened tube life. Elevated heater temperatures, brought on by high heater voltages, have long been looked upon as a prime cause of premature gassing. This may be the result of the liberation of water vapor bound in the heater insulation, or it may only be a contributory cause since raising the heater temperature increases the temperature of every other part of the tube. This will cause gas evolution from other areas, as will be pointed out shortly.

High cathode current density is known to contribute to early gassing. Possibly, this is because the higher current increases the formation of ions, thereby making the measurement of the gas easier. Or it may be that the heavier electron stream produces increased cathode temperature, especially in localized areas, and thereby releases more gas into the tube.

Operation of screen grids and plates at elevated temperatures has long been associated with early gas formation. It is possible that this is caused by the evaporation of some of the relatively volatile materials used in coating these elements. In order to help reduce the temperature of screens and plates, they are frequently coated with such substances as carbon, thereby increasing their capacity to radiate heat. However, these same substances can be very harmful to tube life if they become volatilized due to excessive heat.

GETTERS

This brings to mind the question of why certain tubes—power tubes used in some of the older RF applications specifically—consistently ran with red plates. Why didn't these tubes gas up immediately? Well, the answer is that there are a few tubes which are designed to run with red hot plates, and running them this way actually extends their life. This is because these tubes contain a substance (carbon or zirconium) for combating the evolution of gas,

and this substance works most effectively when it is hot. When plates are made of carbon, or coated with zirconium, they will absorb gases which are evolved by other parts of the tube and will entrap them in a chemically inert state, provided they are run hot enough. However, this is not true of most small tubes. In fact, precisely the opposite effect takes place in tubes having the characteristic silvering or blackening on their sides or tops.

These "getters," as they are called, are patches of evaporated metal which have adhered to the inside of the glass. Their purpose is to absorb gases which evolve during the life of the tube. They work best when warmed by the normal bulb temperature, but can be evaporated by excessive bulb temperature. Thus, not only will they add their own vapors to the gas content of the tube, but in so doing, they will release any gases which they may have entrapped.

Getters show certain physical changes when they are worn out, or when they have been subjected to excessive temperatures. A tube which has an air leak will have a milky white getter. This is obviously a bad tube. Tubes with getters which are thin, and which are discolored or "washed out" at the edges, have undoubtedly seen excessively high temperatures and are a poor risk, even though they may be working quite satisfactorily at the time. Even a few new tubes may show small, poorly defined getters. These may indicate shelf deterioration and may represent poor risks in critical sockets.

While on the subject of new tubes, it should be pointed out that some increase in gas content can be expected in tubes which have not been operated for long periods of time, whether new or old. Performing gas tests on such tubes without adequate preheating may lead to false conclusions. After a short period of operation, the apparent gassy tube may clean up completely, due to getter action becoming more active when heated.

Perhaps the most effective means for preventing premature gassing is the control of bulb temperature. This subject is so important that it will be treated in much greater detail in a subsequent chapter. It is sufficient to point out here, however, that all the heat generated within the tube must find a way out, or the tube and its elements

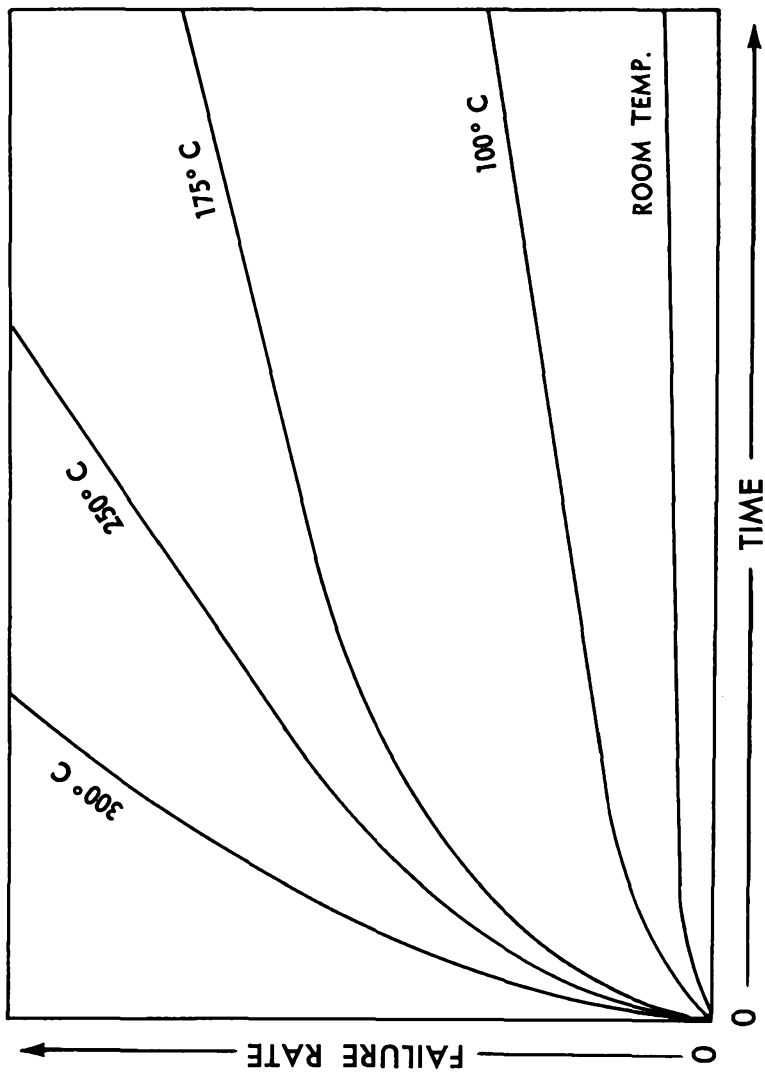

Fig. 2-1. Ambient bulb temperature has a marked effect on tube life.

may melt. In fact, in certain extreme instances of poor heat control, bulbs have been known to melt and collapse right around the tube structures. Some of these tubes were still working when removed from their sockets!

There are only three means by which the internal heat of the tube can get out—by metallic conduction through the pins, by conduction and convection to and from the glass, and by radiation through the glass. Very little heat escapes through the pins of most tubes. They are too small and the route is too long. Direct radiation accounts for some heat loss; however, much of this energy is converted to low frequency heat in passing through the glass, resulting in an increase of the bulb temperature itself. About the only way to cool the bulb is to circulate cool air past it rapidly, so that the excess heat is removed faster than it builds up. The presence of close-fitting shields or enclosed compartments or containers often makes this very difficult to accomplish. Nevertheless, the successful accomplishment of this objective can result in amazing reductions in over-all failure rates. Controlled tests have shown a ten-to-one increase in failures versus hours of use when bulb temperatures were raised from room temperature to an ambient temperature of 300°C. (Fig. 2-1). Even an increase of as little as 100° in the ambient temperature can increase failure rates as much as three-to-one.

SPURIOUS EMISSIONS

In any discussion of gas in vacuum tubes, it soon becomes apparent that what is most often referred to as "gas" is more properly described by the term "grid current." All grid current is not gas current. In fact, gas is only one of four or more currents which are commonly associated with the grid of vacuum tubes (Fig. 2-2). While true gas current may be regarded as a defect, or a sign of degeneration, certain other grid currents are normal and their reduction or absence may actually indicate deterioration rather than improvement. Others, while not desirable in all cases, are actually beneficial in some circumstances. Some grid currents build up with time—others decrease. The measurement and isolation of each,

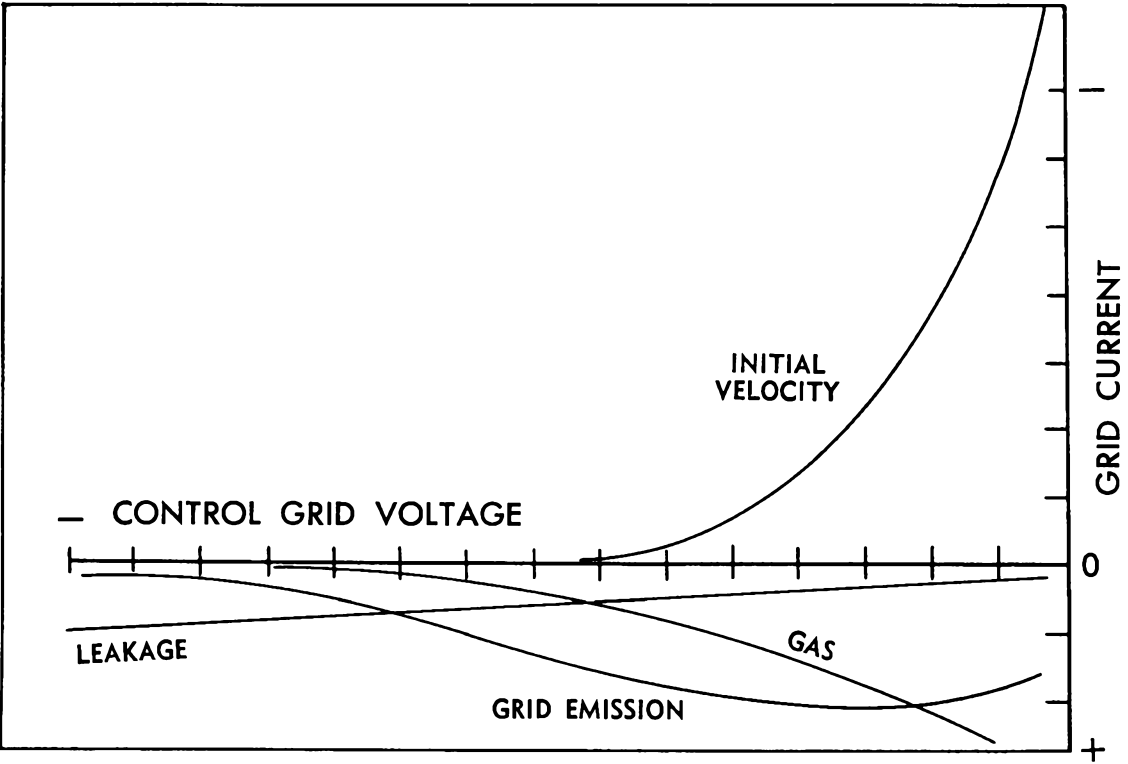

Fig. 2-2. Curves showing changes in the four types of grid current with different values of grid voltage.

individually, is both difficult and inconclusive. There is no simple grid-current test that means the same thing every time. Not only do these currents vary in magnitude, but also in polarity and effective impedance.

“Initial velocity” current, sometimes improperly called “contact potential,” results when some electrons leave the cathode solely due to the temperature at its surface. These electrons have enough velocity to keep them going until they hit the grid. If a resistor is placed between the grid and cathode, a current will flow causing the grid end to become negative. This current usually varies directly with cathode temperature. Initial velocity current changes with age and usually decreases as cathode activity declines. This current is used in simple biasing circuits such as those found in many high-gain audio stages where a resistor of several megohms appears between the grid and cathode. It is also used in some cascode RF-amplifier circuits to provide the bias for the second section. If this current is absent, these circuits will not function properly. In the case of the cascode tube, the absence of initial velocity current will lead to early tube failures. Grid-current testers which reject any tube having grid current will contribute to early tube failures in front ends for this reason as well as others. This topic will be enlarged upon when we discuss tuner tube problems in a later chapter.

True gas current is an ionic current which will usually be present only during plate-current conduction. If a tube is measured when in a cutoff condition, or with no plate current flowing, the positive grid current which may be read will not be gas current. Gas current consists of positive ions, and hence, is opposed to initial velocity current. In fact, they may cancel each other and the result will be a reading of “no current” in the grid circuit. This does not mean the grid has infinite impedance; in fact, its impedance might be much lower than a tube which showed considerable grid current. Ionic gas current usually increases with age and conduction current, disappearing when conduction is stopped.

The electron flow away from the grid, due to excessive grid temperatures which cause the grid to become an emitting surface, is what is called “primary” grid emission. Grid emission is rarely encountered in tubes whose

grids do not swing positive. This rules out most receiving tubes. Grid emission will not be present unless the grid is allowed to become quite hot. Thus, any test for grid emission which does not operate the tube at full dissipation is probably not reading grid emission. It is an unstable characteristic and may increase or decrease with life. It may be caused by excessive cathode temperatures which boil off emissive materials onto the grid. Reducing heater voltage will often slow down or stop grid emission if it has not already progressed too far. Decreasing grid current in those applications where grid current is supposed to flow will also reduce grid emission. Grid emission is a current which causes the grid to develop a positive voltage across a resistor connected between it and the cathode. Since grid emission is almost directly a function of grid temperature, and a reduction of bias usually results in increased dissipation with a consequent further increase in grid temperature, its presence will usually lead to destructive "run-away" unless grid resistors are maintained fairly low. In fact, that is about the best protection the user can employ against any form of shifting grid current; i.e., to use the lowest value of grid resistor practical and to avoid the use of fixed bias supplies whenever possible.

There are several other forms of spurious emission in vacuum tubes. In high-power tubes (horizontal-deflection amplifiers, for example), screen grid emission is not uncommon. This results from excessive screen dissipation, usually caused by improper setting of the drive control. Observing manufacturers' recommendations with regard to maximum cathode currents will do much to eliminate this form of trouble. This will be covered in more detail in a later chapter.

Screen emission can result in another form of grid emission—secondary grid emission. This occurs when the plate voltage goes negative and the screen-emitted electrons are driven back at high velocity toward the cathode. Many of them strike the grid where they knock off additional electrons with each impact. The effect is much like that of primary grid emission, except that it may result in even higher grid currents. This is frequently the case when a horizontal-amplifier tube all but stops functioning

after several hours of satisfactory use. If allowed to cool sufficiently, it may start up again and behave quite normally for several more hours, only to collapse again with very little warning. If the set is removed from the cabinet and allowed to operate on the bench where the ventilation is better, it may run indefinitely with the same tube in the socket and no sign of a failure. In this we see again the close connection between bulb temperature, proper ventilation, and tube life.

INTERELECTRODE LEAKAGE

The individual elements of a vacuum tube are supported and insulated from each other by one of several materials, of which mica is by far the most common. Mica is a mineral occurring in nature in chunks which are mined, cut into rectangular sections, and later split into sheets. The mica sections used in making tubes are then punched from these sheets.

Natural mica has very excellent insulating properties and can be subjected to very high temperatures without break-down. However, in a vacuum tube, there are materials operating at temperatures near their vapor point. When these metallic vapors settle on the smooth mica surfaces, they produce a gradually decreasing resistance. To slow down this process, micas are coated with a finely divided substance that tends to break up the metallic vapor films. This results in a situation similar to that which occurs when raindrops fall on a clean automobile hood. Many small droplets appear first, widely separated from each other. As more rain falls, the drops become larger until finally one or two merge and then suddenly a whole series of drops become connected as a small stream of water starts running down the slope of the hood. In the vacuum tube, that small stream is one leakage path. The more it forms, the lower the resistance between elements becomes.

The nature of these leakage paths is such that their resistance tends to change with the applied voltage. What may be a very high resistance initially, becomes a much lower resistance when higher and higher voltages are applied across it. That is why it is possible for many of

the so-called "short testers" to actually produce shorts where none existed before. This will be covered in more detail in the chapter on testing tubes.

Insulation leakage caused by the deposition of metal films proceeds at a uniform rate in all tubes; however, it is greatly accelerated by such excesses as high heater voltages and high electrode dissipation. Cooling bulbs will often retard its development considerably because the vapors will usually deposit on the coolest surface. If this is the glass envelope, they will generally cause less harm there than on the micas. As insulation resistance begins to decrease, it will progress very rapidly even though its initial build-up may be extremely slow. This is because even though the release of metallic vapors is more or less constant, the early effect is to produce islands of metallic film which are not connected with one another. As the islands become larger, the chances of their remaining isolated gets smaller, until finally, many islands connect and form multiple leakage paths almost simultaneously.

There is a special case of leakage that was touched upon in the previous chapter, but which can be enlarged upon now that we are looking at the causes of progressive deterioration. This is the leakage between heater and cathode (Fig. 2-3). In the previous chapter, it was pointed out that destructive leakage developed much faster if there was a high potential between the heater and cathode. We now want to point out some of the unique characteristics of this leakage phenomenon.

It has been demonstrated that the development of leakage is much slower when the heater is positive, rather than negative, with respect to the cathode. Apparently, there is a semiconductor characteristic to this insulation material, causing it to behave very much like a rather inefficient diode. This is borne out when an AC potential is applied between the heater and cathode. Rectification is quite nonlinear, resulting in high-order harmonics of the fundamental appearing on the cathode, if there is considerable resistance in series to ground. Leakage testers which use rectified AC voltage as the test potential will show very little correlation with equipment usage when attempting to measure this characteristic. That is

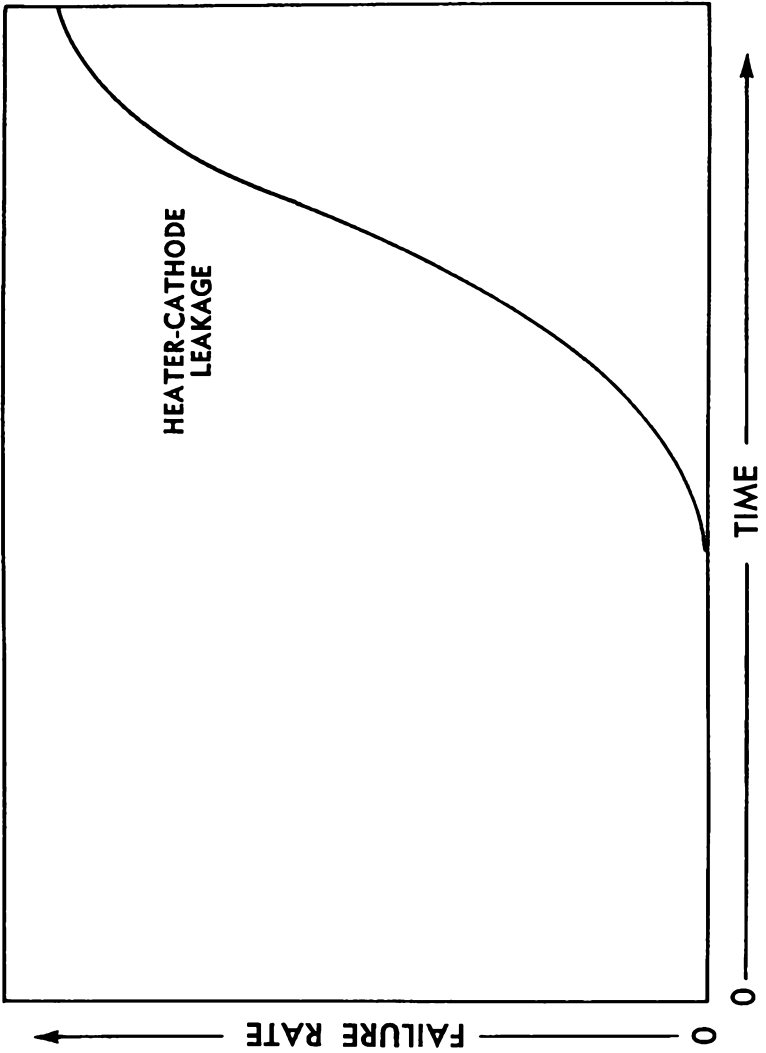

Fig. 2-3. Heater-to-cathode leakage increases sharply with age.

why the neon-bulb leakage testers in the ordinary field tube testers provide little evidence of the true insulation conditions of the heater. There are tests for this condition which do correlate, but they will be discussed in more detail later.

INTERFACE RESISTANCE

Ordinary receiving tubes, as they are so often miscalled these days, were designed to operate in circuits where normal amounts of cathode current are drawn, more or less continuously, over long periods of time. Modern applications have placed many of these tubes in circuits where current is drawn only in pulses, and then only for relatively short and infrequent intervals. The pulse current may be hundreds of milliamperes; yet, the average or RMS current may be only microamperes. Under these conditions, tubes have been known to lose up to 50 percent of their transconductance in only a few hundred hours. A typical application is a blocking oscillator, and the symptoms would be failure to run at the correct frequency, or failure to sync.

When measured, these tubes appear to have low transconductance; yet, on further analysis, it can be shown that this is not the case because they may be restored almost to normal by merely raising their heater voltage. This condition is what is known as cathode interface resistance, or "sleeping sickness." It comes about after long periods of operation at very low plate current. It is known to be greatly accelerated by raising filament voltages.

The exact mechanism by which the formation of cathode interface takes place is still a matter of conjecture among tube engineers; however, some relatively plausible explanations can be offered. The phenomenon appears to be a resistance in series with the cathode, shunted by a small capacitance. It is this resistance which causes the apparent loss in transconductance, as well as a loss of circuit gain. Raising heater voltage momentarily appears to reduce this resistance, while lowering heater voltage greatly increases it. This, of course, is after the interface has already developed. This acts almost as though the cathode coating itself were separated from the nickel

cathode sleeve, and that heating and cooling it caused alternate expansion with its better contact, and contraction with its poorer contact resistance. This may not be exact, but it offers a satisfactory mental image of the phenomenon.

Computer tubes and others used in similar applications requiring long periods of standby are especially subjected to this form of deterioration. There is no simple cure for it, but there are at least two ways to reduce its rate of development. The first is to operate heaters at below ratings whenever possible, and the second is to permit tubes on standby to draw some plate current. Where neither of these expedients is practical, it is possible to purchase tubes having special cathodes that are nearly immune to this phenomenon. These are usually tubes of the "premium" variety which have special tests or controls added to make them more reliable. Freedom from interface formation is generally one of them.

CATHODE DEPLETION

If a tube survives all the many pitfalls we have been describing, and operates for many thousands of hours, it will in time succumb to some form of cathode deterioration. This deterioration is generally described as loss of emission, and is the characteristic most commonly associated with tube failure in most users' minds. In reality, however, it is a fairly rare development.

Modern oxide-coated cathodes have such adequate supplies of emission built into them that by the time a tube actually has lost emission, it is a pretty dead tube by a number of other standards. Almost all service testers measure emission in one way or another. Even the so-called mutual conductance checkers are more sensitive to emission current than they are to transconductance. We will see why this is true in the chapter on tube testing and tube testers.

Theoretically, a normal cathode should have tens of thousands of hours of emission capabilities. This is frequently not the case because of some of the things which happen to cathodes as a result of other phenomena within the tube. Most of these have been mentioned already under

separate headings. We will now try to bring them all together and see how they affect the cathode itself.

A cathode may lose emission very rapidly by having much of its active surface removed by successive arcs. When this happens, the vaporized coating material will usually generate so much gas that the entire interior of the tube will be filled with a blue glow, a very obvious sign that the tube has reached the end of its useful life.

Some gases, especially those liberated from excessively hot glass envelopes, have the capacity to combine with the emitters in the cathode coating, rendering them inert. This chemical poisoning of the cathode can also occur when certain metals used to protect the grids, to prevent them from emitting, become vaporized and combine with the cathode surface metals. These inert substances, such as gold or carbon, then cause the cathode itself to become relatively inert.

In the normal cathode, there is an electrolytic migration of electrons from lower atomic layers to those on the surface, and thence to the space charge surrounding the cathode. When excessive peak currents are drawn from the space charge and it becomes depleted, the electrostatic fields act directly upon the cathode itself and cause deep layer eruptions. The electrons driven upwards under these circumstances are not replaced from below, and a depletion layer develops. As a result, peak emission is permanently reduced.

Reactivation

From the earliest days of vacuum tubes, some form of cathode reactivation has been practiced. It is still very much with us today in the form of picture tube boosters and reactivators. Many cathodes suffering from reduced emission can be restored to normal emission for at least a short while, and in some instances, for quite a long time.

Reactivation methods are all based on the two phenomena discussed in the foregoing paragraphs. The most common one is to simply raise the heater voltage about ten percent. This will frequently restore the cathode to more or less normal activity, provided the cause of failure is one associated with interface resistance, or the formation of a depletion layer. Of course, this method has the

disadvantage of hastening the day when the heater will burn out or the insulation between it and the cathode will break down because, as we have shown, these are greatly accelerated by elevated heater voltages.

The second method is to raise the heater voltage about fifty percent for a few minutes while drawing about twice the rated cathode current through a suitable load. The success or failure of this method depends upon whether or not the heater burns out during the process—if not, on whether the cathode can be reactivated by boiling up new sources of free emitter atoms from deep within the cathode coating. When this method is used, and the immediate results are not disastrous, the benefits that follow are usually fairly stable. Sometimes the life of a tube can be doubled, or even tripled, in this way. It does require some skill and a certain amount of familiarity with the different tubes and their particular cathodes. It also assumes that the cathode defect is one that will be corrected by such treatment.

In the next chapter, we will discuss tube defects that are not catastrophic, in that they do not usually occur without warning. Nor are they degenerative, in that they do not usually build up gradually. These are the defective tubes that are apparent almost immediately in some applications. Yet, in some other application, they may be perfectly satisfactory.

CHAPTER 3

SUBJECTIVE FAILURES

Tubes which meet all normal tests, but fail to work satisfactorily in certain critical applications, are called "subjective" failures. In some other application, they may prove to be entirely satisfactory. In this chapter, we are going to limit our discussion to those failures which come under the broad headings of hum, microphonics, and noise. There are, however, additional types of subjective failures which will be discussed in another chapter under the heading of selected tubes.

One of the major difficulties involved in studying subjective failures is the fact that their characteristics are so intimately associated with circuit considerations. This makes their measurement and evaluation extremely difficult. In fact, there is almost no way of defining these characteristics except in terms of their effect upon a particular circuit. If you place these tubes in some other circuit, their performance will be completely changed; sometimes for the better, sometimes for the worse. It is this inability to predict performance on the basis of standard tests which makes the control of these characteristics so difficult for the manufacturer and the user.

HUM

Hum is the name given to that form of unwanted signal which originates from the power line. It may be at the power line frequency or any multiple of it. There are several methods by which these unwanted signals can become superimposed upon the wanted signal. An understanding of each of them is essential before taking up the subject of corrective measures.

As was mentioned in an earlier chapter, leakage current which passes between the heater and cathode can be one source of hum. This is usually the result of a diode action in which the very hot heater wires actually emit electrons to the cathode during the half cycle when the heater is more negative than the cathode. The path for this emission current may be from the bare ends of the heater folds, or from cracks or chips in the heater coating inside the cathode sleeve. This particular form of leakage is very hard to detect because it often changes with each new heating cycle or after very slight jarring of the tube. This form of interference can be identified from the several other possible sources by isolating the suspected heater and placing about 50 volts between it and the cathode-return point. The positive terminal should be at the heater, and the negative terminal at the cathode return (Fig. 3-1).

Another possible source of hum is emission from the heater to the grid. This is particularly troublesome in circuits which have a very high grid resistance and depend upon this for tube bias. Emission current, from the exposed ends of the heater, either at the folds, or at their ends, may go directly to the grid side rods. This form of hum will frequently be combined with and difficult to distinguish from heater-to-cathode leakage hum. A relatively simple test is to ground the grid at the socket. If the hum disappears, it is being picked up on the grid.

Heater-to-grid is not the only method by which hum can be introduced into the grid circuit. There are many electrostatic and electromagnetic fields present in most all electronic equipment. There are power-line fields just about everywhere that electronic equipment is to be found. These fields may be very weak; however, they are often strong enough to modulate some of the weak space currents that reach the tube grid, and cause a hum signal to be superimposed upon it. Evidence that the cause lies outside the tube can generally be established if shielding the tube reduces its effect. Of course, all high impedance leads connected to the grid must be meticulously shielded also.

Electromagnetic interference is not always recognized for what it is and, consequently, may be difficult to cope

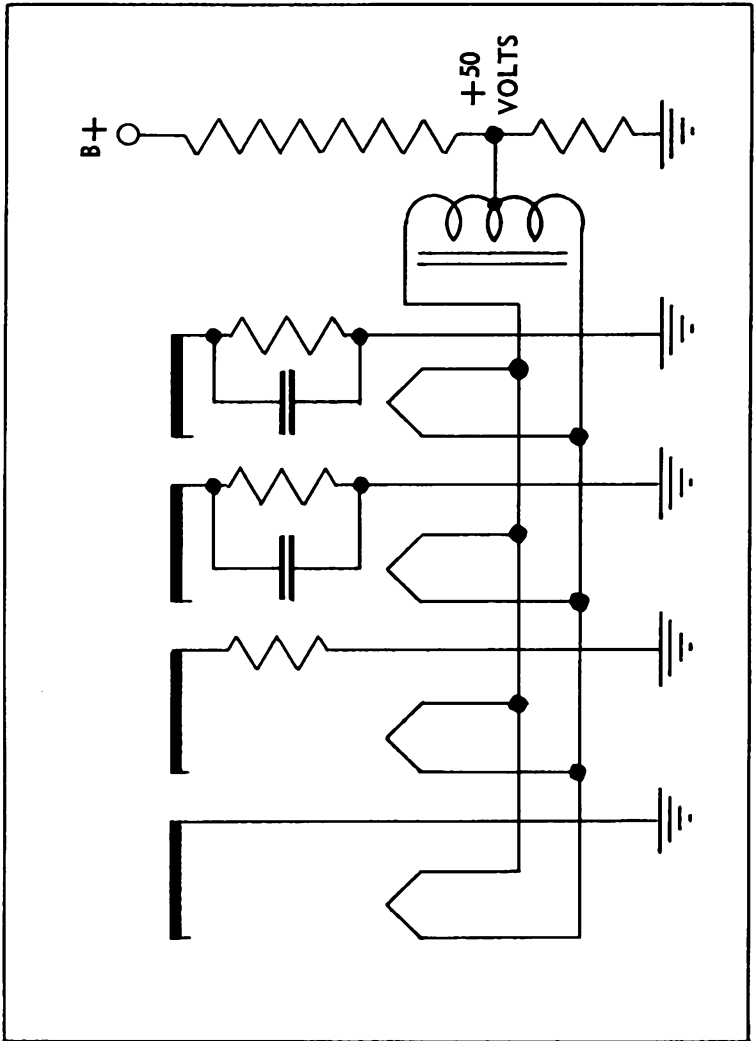

Fig. 3-1. Placing 50 volts between filament and cathode-return point to identify interference.

with. Wherever there is electromagnetic interference, there is usually also electrostatic interference. The latter must be completely minimized before the effects of the former can be evaluated. This means that the affected stage must be completely shielded from electrostatic interference first. The effect of heater-cathode interference must be eliminated by heater biasing. The test for electromagnetic interference is a permanent magnet. When this magnet is brought near the suspected tube, the hum will be found to increase or decrease, depending upon the position of the magnet. Hum which can be affected by a DC magnetic field is magnetically caused and is usually the result of uncanceled heater current fields within the tube.

Hum Bucking

Frequently, it will be found that making one or more of the suggested tests in an endeavor to isolate the cause of hum in a circuit actually causes the hum to increase. This is a very confusing situation until one understands more thoroughly just what is going on. Because of the many methods by which power line interference can take place, considerable distortion of the sine wave source usually develops. This takes the form of both phase and amplitude distortion. The result is a net signal which is often very complex in structure. If one element of this complex waveform is altered, as for instance, by biasing heaters positively, the resulting elimination of one signal source, with its particular amplitude and phase, may now unmask another source. The net effect is an increased amplitude of the interfering signal in the output.

There are two ways of working with this problem. One is to systematically eliminate each possible source of the interference and arrive at a design that is both theoretically and practically correct. This is the course most often followed in designing the better electronic equipment. But in the mass produced equipment, where price is often a major consideration, certain short cuts are sometimes resorted to which introduce complex problems.

One of these is the technique known as "hum bucking." Hum bucking is the intentional introduction into the signal circuit of a small amount of hum voltage of such magnitude and phase that it tends to cancel the residual hum.

This is mainly a circuit consideration, but inasmuch as it has a considerable effect on how tubes appear to perform, it is important that we discuss it.

Several methods are used to introduce a hum bucking voltage; however, we will discuss only the two most common ones. One of these is the use of a small air core coil located near some heavy power frequency field, such as a power transformer. The coil is made movable for orientation so that almost any amplitude or phase can be picked up from the field around the transformer. The coil is placed in the position which results in the least hum in the output circuit.

Another method of hum bucking is the use of a hum balancing control, usually a low-resistance potentiometer, connected across the heater winding with its center arm connected to ground (Fig. 3-2). Its effectiveness depends upon the introduction of a small amount of unbalanced power frequency into the input stages. This unbalanced power frequency is used to buck out additional hum voltages that are picked up elsewhere in the circuit. If the adjustment for minimum hum comes somewhere near the center range of the control, it is not being used to introduce a bucking voltage. However, when the hum is minimum at some point near either extreme end of the control, it is being used as a hum bucking.

Wherever hum bucking is resorted to, it becomes very difficult to analyze tubes and their relation to the hum problem. The reason has been suggested before. If a tube having a given amount of hum leakage is used in a circuit that has been adjusted for minimum hum, the substitution of a new tube having less hum leakage will result in an apparent increase in the hum level. If the average level of the hum introduced by several tubes is sufficient to cancel each other, the introduction of a new tube having either more or less hum leakage will result in a noticeable increase in the over-all hum level. Very often the adjustment range which is possible within the hum bucking circuit is insufficient to compensate for the large change introduced by a replacement tube, be it better or worse than the original tube. This makes a much better tube actually perform no better than a much worse tube as far as the net effect is concerned.

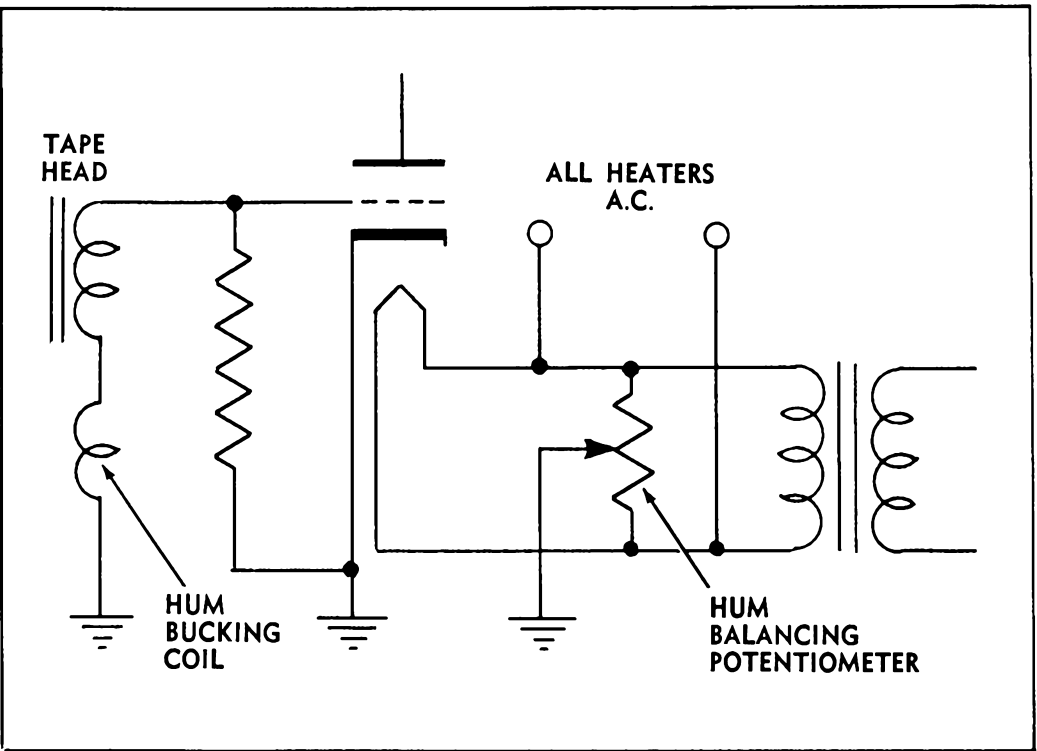

Fig. 3-2. A circuit with hum bucking and hum balancing.

Corrective Measures

There are certain accepted methods for minimizing the hum problem and a knowledge of these techniques can be of great assistance in trying to separate those situations that are brought on by poor circuit design from those that are strictly tube problems.

The heaters of all high-gain audio equipment should always be powered from a center-tapped transformer winding. Grounding the center tap reduces the heater-to-cathode voltage. This will more than halve any leakage current which might otherwise flow in this circuit.

When one side of the heater circuit is grounded, not only is the heater-to-cathode voltage increased by a factor of two, but another source of power line interference is introduced. This interference results from the creation of large chassis currents which are in series with the normal signal ground returns. These chassis currents make the selection of ground points very critical and almost inevitably lead to a system of hum bucking.

Wherever possible, the cathodes of very high gain input stages should be grounded and grid bias should be obtained by means of relatively large grid resistors which make use of the normal grid current effect. Where this method is not used, adequate cathode bypassing should be employed. The effective impedance of the cathode bypass capacitor should not be more than 10 percent of that of the cathode resistor at the power line frequency.

There are special circumstances where bypassing is out of the question, as for instance, when the feedback loop is introduced across a fairly large cathode resistor in an input stage. In these instances, serious problems may arise from even a very small amount of heater-to-cathode leakage, the exact magnitude of the problem depending upon how large a value of cathode resistor is used.

One method of dealing with this problem is to isolate the heater supply to these tubes from ground and return it to a voltage point of approximately +50 volts. This is called heater biasing, and it depends for its success upon the fact that heater-to-cathode leakage (either direct or via an emission route) is much less when the heaters are positive than when they are negative.

Another method of solving the leakage problem in critical sockets is to operate the heaters of these tubes from a DC source. Sometimes the AC source voltage is rectified and smoothed, using a large, low-voltage capacitor, and then fed directly to the tube heaters. This is an excellent solution, but may involve some added expense. Most high-gain audio equipment terminates in a power amplifier stage. When this is true, a very simple source of DC current is available for lighting the heaters of the input stages, practically for nothing.

The output stage of a high-gain audio amplifier often consists of two power tubes in push-pull. There is usually a common cathode resistor which provides bias for the push-pull tubes (Fig. 3-3). The current flowing through this resistor is essentially a DC current because the current flowing to the individual tubes in the push-pull stage is at all times 180° out of phase. The signal current is thus canceled out and only a steady DC current flows through the common cathode resistor.

If the heaters of the input tubes are substituted for this cathode resistor, they can be lighted by this current while their voltage drop provides the necessary bias for the output stage. This is a case of getting something for nothing because the current is there anyhow, so why use it to heat up a cathode resistor when it could be used to light the heaters of one or more of the critical tubes in the circuit.

It is surprising that this system of hum control is not resorted to more often because it has other advantages that are not so immediately obvious. What better way is there to improve the life of those small input tubes than to protect their heaters from sudden current surges when they are turned on? By using this DC current to light them, these critical tubes enjoy a very gradual warm-up and cooling-off period. This has the effect of greatly increasing their heater life—their principal cause of failure in most applications.

Where DC on the heaters is not a practical solution, a very economical method of reducing heater-to-cathode leakage in high-gain audio stages is simply to operate the heaters at about 10 percent below their normal ratings. This is possible with most applications of this type be-

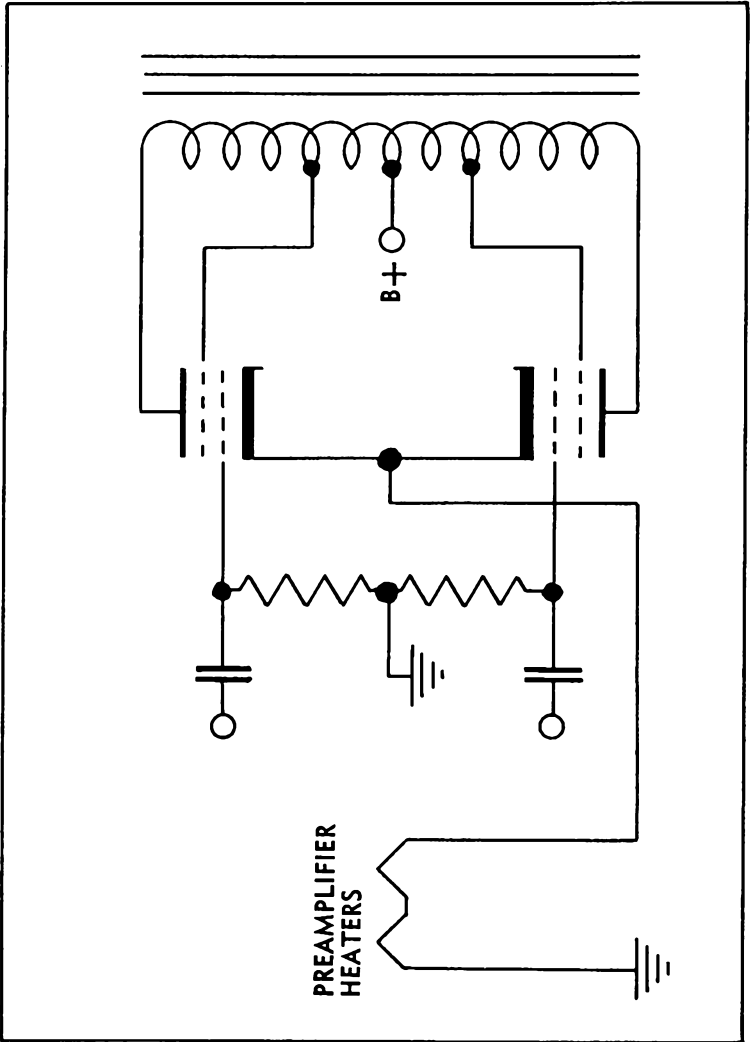

Fig. 3-3. Using amplifier cathode current for heaters. The heater voltage drop provides the necessary bias for the output stage.

cause they usually use the tube in a resistance-coupled amplifier, where plate loads are so high that very little actual current flows from cathode to plate. These are voltage amplifier stages and do not require very much current from the cathode in order to perform their functions adequately. The tubes used for this purpose are designed with much greater emission capabilities than they are usually called upon to deliver. Therefore, operation at reduced heater voltage will provide all the current that is needed for a voltage amplifier stage. Also, the lowered heater temperature will often result in a very great reduction in leakage and hum. An added advantage will be improved heater life due to the lower heater temperature.

The use of tubes in series strings in high-gain audio equipment is not a recommended practice. The problems introduced by this form of operation are quite large, especially when consideration is given to the connecting together of several elements into a complete system. The danger of introducing heavy chassis currents, with the consequent high hum levels resulting from them, keeps most designers away from this type of circuitry. Where it is resorted to, in spite of recommendations to the contrary, there are certain precautions that will prove to be advantageous.

The most critical tube should be wired so that its heater is nearest to the grounded end of a series string. The second most critical tube should be the next tube in the string, and so forth. The most critical tube will be the tube nearest the input, or the one nearest the input which uses the largest, unbypassed cathode resistor.

In order to reduce the heater temperature of critical tubes in a series-string circuit, it may be necessary to shunt them with a low value of resistance. This should be accounted for in the design so that the remainder of the tubes in the string do not operate at above normal currents.

Special Tubes

There are available certain special tubes designed to operate in the critical sockets of high-gain audio equipment, and to minimize those causes of hum which origi-

nate within the tube itself. These tubes have not been mentioned until now for the following reason. The user must realize that they may not always improve the over-all hum level when substituted for certain older types, because of the many interrelated causes for hum interference discussed earlier.

A low-hum, high-gain tube must have very low heater-to-cathode leakage—either by direct current flow through the insulation, by emission from uninsulated areas, or by induction and consequent modulation of the electron stream. All of these requirements are best achieved by the use of a “coiled heater.”

The ordinary heater used in most vacuum tubes consists of a length of insulated tungsten wire folded into a neat bundle, and then inserted into the cathode sleeve. In order to fold the insulated wire, the insulation must be removed at the end of each loop. These exposed loops of bare wire are the trouble starters, because they can emit directly to the cathode. They move as a result of expansion and contraction and eventually short to each other, or to the inside of the cathode sleeve. Finally, because the heater bundle is a randomly dispersed mass of folded wire, it does not effectively cancel out its own magnetic field. Some may do better than others, purely by accident. Those that are satisfactory at first may become redispersed due to differential expansion and contraction and cause trouble later.

The coiled heater is made like a long spring. It is coiled and then folded once, in a gentle bend at the top, and then the entire heater is coated with insulation. It has no open or exposed ends to emit or eventually short out. It expands and contracts around the turns of the spring and, in this way, almost eliminates longitudinal stretching. Finally, it is a perfect coil and tends to cancel its own magnetic field very uniformly.

Tubes of this general construction are known to have much lower leakage paths between the heater and all other elements. They can be used to provide greatly improved performance in critical sockets where hum is a major problem. They should provide longer life and greater over-all reliability. But it should be borne in mind that when substituting this type of tube in older equipment

not designed around them, the immediate results may seem disappointing. If the hum problem is isolated and reduced at its source, as suggested in the foregoing paragraphs, there is then every reason to expect improved performance through the use of these improved tube types.

MICROPHONICS

Microphonics is defined as any signal appearing in the output of the vacuum tube which originates within the vacuum tube. It is caused by some mechanical stimulation of the tube. Microphonics is classified as a subjective failure because it too depends very much on the use to which the tube is put and the physical nature of its environment.

An outstanding example is often found in phonographs or compact, miniature radio sets. A particular tube will be found to cause the equipment to break into a sustained howl when used in one model; however, the same tube will perform quite normally in another model. It is not uncommon to find that a tube which causes sustained howling in one unit may be perfectly normal in another unit of the same make or model. The answer to this apparent contradiction lies in understanding the nature of this particular tube characteristic.

There are three ways the electron stream within the tube can be modulated. One is through the use of a magnetic field; this is demonstrated in the picture tube. The second method is electrostatic; this is the most commonly used in controlling all vacuum tubes. The third method, seldom used but just as valid, is to change the positions of the elements while holding the voltages constant. This is what occurs when a tube responds to mechanical vibration and reproduces the waveform of the stimulating energy as an AC component in its plate current. This third method is also the cause of microphonics.

Since the moving element within the tube may be an entire structure (the cathode assembly) or only part of a structure (a grid side-rod or a single grid turn), the frequency at which the element vibrates may cover a very wide spectrum. It then becomes almost impossible to

measure a specific tube in terms of its susceptibility to microphonics. Some effort has been made to analyze the spectrum response when a vacuum tube is stimulated by a sharp impact. Although there is a correlation between tubes that are very tight and those that have very little output at any audio frequency, the fact also remains that many tubes having relatively high outputs at certain specific frequencies do not appear to be microphonic. Apparently the mechanical stimulation they encounter does not fall into that portion of the spectrum.

There are certain limited ways of dealing with microphonics. All forms are affected by the amount of mechanical stimulation delivered to the tube elements. Therefore, any technique which lengthens or raises the impedance of the path by which the stimulation will be fed back to the tube will reduce its susceptibility to microphonics. Thus, sensitive sockets should be positioned as far from mechanical vibrators as possible. Some vibrators, such as speakers, convey some of their energy directly to the tube via the air space between them. In such instances, it is desirable not to place the socket where the maximum sound pressure can be developed against the tube envelope.

Most mechanical energy is fed to the tube elements by means of the common supporting member, such as the chassis. Standing waves are often present which effectively couple a high percentage of the energy directly to the tube elements. Two methods are very effective in breaking up the standing-wave pattern and hence in reducing the feedback loop. One of these is to add a weighted shield over the tube, thereby changing its vibration period and eliminating the mechanical resonant circuit. Another method is to isolate the socket from the chassis by using rubber grommets.

In a few cases, low microphonic tubes are available for some of the more critical applications. These tubes attempt to solve the problem through the use of tube structures that are known to be less susceptible to microphonics. These techniques cannot be applied to very many tubes because they will alter the performance of these tubes too greatly. Therefore, they are appropriate for only a limited number of tubes.

In general, the technique is to shorten the unsupported distance between the top and bottom micas as much as possible, thereby reducing bending of elements. Heavier micas are also used; they are sometimes forced into the envelope under tension in order to stiffen the entire mount. These tubes often are effective in reducing microphonism, although depending upon them to always solve the problem is not recommended because some of them are inferior to their prototypes or to other, more efficient tubes.

NOISE

Noise is defined as an output signal originating within the tube and is not specifically hum or microphonics. There are several possible sources of noise signals. Whether they constitute a defect depends upon how the tube is used. Hence, noise is considered to be a subjective failure since the actual application of the tube is the significant factor in determining whether or not it actually becomes classified as a failure.

The most common form of noise within a vacuum tube is that caused by intermittent shorts or opens. The nature of these intermittents is such that it makes a big difference how much voltage is applied between elements and at which source impedance, as to whether they exist or not. Also, it is important to define what kind of detection device is going to be used before you can decide whether you have an intermittent or not.

The classic short tester is a neon lamp in series with a voltage source and a resistance to limit the current flow. It is assumed that if an intermittent short occurs, a circuit will be formed and a current will flow. At the same time, the lamp will flicker and the user will know that he has an intermittent short. But will he? The neon bulb is often used in a self-rectifying circuit with an AC voltage applied to it. The voltage required to cause the lamp to ionize is not present during the entire cycle. During a very significant portion of each cycle, the lamp cannot light even if a dead short occurs because the voltage across the circuit is insufficient. Suppose that the voltage is just sufficient, but falling, when the short occurs. The neon

lamp requires a finite time to ionize and fire; hence, if the short occurs at the time the voltage is approaching the critical value there will be insufficient time to record it and it will pass unnoticed.

There is also the matter of nonrepeatable shorts and intermittents. Particles sometimes shake loose from within the tube structure and drop down between the elements. These occasions produce momentary shorts which in all probability will not occur again. Nevertheless, in some pulse-triggered applications, as for instance, in counting circuits, these random noise pulses can cause false operation.

Repeated testing of tubes in an endeavor to eliminate this failure has been unsuccessful. An exact explanation for this involves problems in statistical probability that are not within the scope of this discussion. However, it can be mentioned that the use of a statistical approach to this problem can be quite successful. For instance, if 100 tubes are measured and the number showing momentary shorts is noted and compared with another lot of 100 tubes similarly tested, the lot having the significantly lower number of random intermittent shorts will always show this characteristic, no matter how many times it is remeasured. This means that statistical sampling can be used to indicate the probability of the occurrence of intermittent shorts in future use.

The second and most common form of noise in vacuum tubes is sometimes referred to as "frying noise." It is most often the result of leakage paths across the micas. The measurement of this characteristic is complicated because it has impedance and frequency characteristics that make a universal test very impractical. For example, there are tubes which will produce considerable noise when tested in a high-gain RF amplifier, but none when tested in a high-gain audio amplifier. The converse is also true. Tubes which produce extraneous noises in an audio amplifier may produce no noise at all in a high-gain RF amplifier. The reasons for this observed phenomenon are not well known. Neither is it thoroughly understood why the relation between the amount of noise detected and the sensitivity of the amplifier used to detect the noise is not a linear function.

Noise in vacuum tubes is a problem which depends almost entirely upon the users' requirements. It does not lend itself to accurate definition and there are very few methods, if any, by which the user or the designer can protect himself against it. About the only method is to make use of the laws of probability in some way or another. In fact, so many vacuum-tube characteristics resolve themselves into a matter of statistical probability, it is felt that some understanding of this subject is essential before proceeding into some of the other areas of vacuum-tube knowledge. For this reason, the subject of characteristic variables and their normal ranges and limits is discussed in Chapter 4.

CHAPTER 4

CHARACTERISTIC VARIABLES

The expression, familiar to all of us—"They're as alike as two peas in a pod"—is really not based on very careful observations. The truth is, the peas in a pod are not just alike, nor, for that matter, are any of the other myriads of things that go to make up the world around us, whether they are the products of man or nature. Though they may appear to be very similar to many other creations in their particular classification or species, they are never just exactly like them. These variations do not occur in a random fashion either. They follow a very precise mathematical law which anyone can understand.

If you were to carefully collect all of the leaves from one of the trees in your yard and measure their dimensions, you would discover an interesting fact. There would be small, large, and average-sized leaves.

If you should chart all this data with their size measurements along the bottom and the number of leaves you had found which were of each size along the left-hand side, you would find that you had constructed a chart shaped very much like the one in Fig. 4-1. This is known as the curve of normal distribution. In graphic form, it says that most of the product of any process, natural or artificial, will be found to adhere closely to some average characteristic; that only a small percentage will deviate very far from this "norm" and that this percentage is a predictable quantity.

This curve has certain known mathematical characteristics. The line through the center is the average value of all the samples measured. There is always an upper maximum value and a lower minimum value. Approximately 70 percent of all samples measured will fall within $\pm\frac{1}{3}$ of the maximum variation from this average. Approxi-

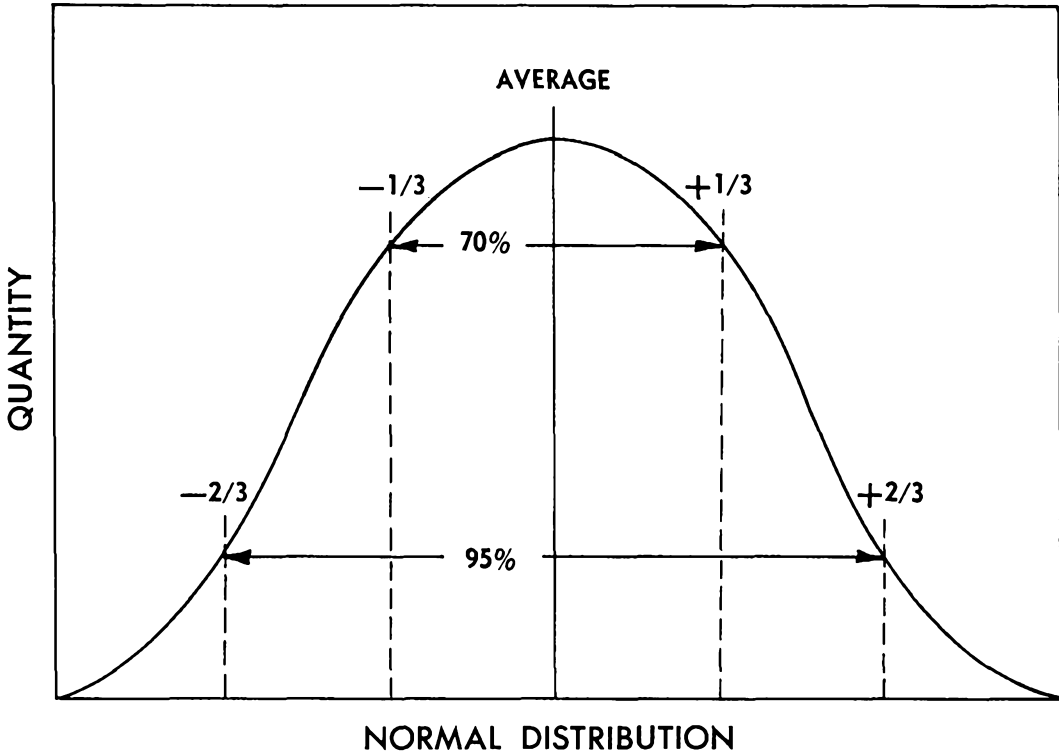

Fig. 4-1. Normal distribution curve.

mately 95 percent will fall between $\pm\frac{2}{3}$ of the maximum variation from the average.

PREDICTING VARIABLES

The width of the distribution, or the range, will depend upon the particular process or phenomenon being measured. Some processes show very narrow distributions. Others are quite broad. But broad or narrow, the curve will always be of this shape and a known percentage will always fall within limits which are plus or minus a certain percentage of the maximum deviation. Because this will happen with mathematical certainty, it is possible to use this knowledge to make certain very accurate predictions. If you take a few samples out of any process—enough to permit you to ascertain the shape of the curve—you can predict with great accuracy the total number of units, or the percentage of units of any given dimensional deviation that will occur in 100, 1,000, 10,000, or 1,000,000 samples. This fact is the basis of all modern mass production quality control techniques.

Vacuum tubes are the end result of a variety of mechanical and chemical manufacturing processes. These processes all have their normal variations which are the characteristic variables noted whenever you measure a large group of tubes. Plate current, screen current, transconductance, and plate resistance are all typical of the characteristics which follow the law of normal distribution. They have an average value which is the one usually published as the rated, or bogey value. This is the value that is more likely to be measured more often than any other value. It is also the value that all the other values will average if they are added together and divided by the number of samples measured.

This last concept is the important one to keep in mind. It is perfectly possible to measure a large group of tubes and never find even one tube which measures what is given in the manuals as the rated value. They will measure all around this value, but never exactly on it. This is "normal" when you remember that the rated value is really only an average. That means it must be derived from many measurements of tubes that are both above

and below this value. Sometimes the mathematical results of such an averaging do not result in a "real" value at all. The value is real enough if you are considering a very large quantity of tubes, but it may be quite theoretical as far as a few tubes are concerned.

HOW STANDARDS ARE SET

There is another fact about these bogey values for tube characteristics that is very important to keep in mind. These values are agreed upon by all tube manufacturers only after each one has submitted manufacturing records showing how his product has been running. This data is turned over to the Joint Electron Device Engineering Committee—JEDEC for short—of the EIA. Quite frequently, the several manufacturers of a given type will all submit different averages to the standardizing committee. When this happens, it is the established practice of the committee to average the averages in obtaining the ultimate value which will appear in a tube manual. This is another reason why these values may be very hard to find in a particular manufacturing product.

We have discussed the so-called "normal" distribution and shown that it was a symmetrical curve which always followed known mathematical laws. There is another curve which is just as normal for certain characteristics; however, it is not a symmetrical curve. It is a one-sided curve and is known as the "skewed" distribution. (Fig. 4-2).

The skewed distribution is associated with those characteristics which have zero or infinity as one limit of their range. Such characteristics as leakage and plate-current cutoff are typical of the skewed distribution. A maximum number of the samples in any lot should approach the zero or infinite axis. The curve is asymptotic in that it never quite reaches this limiting value.

The bogey value for such a characteristic cannot be an average, obviously, since you cannot average either infinity or zero. What is usually done is to set a limit which includes 95 percent of the so-called "normal" product. The value obtained will be a long way from what a majority of the product will measure. There will be very

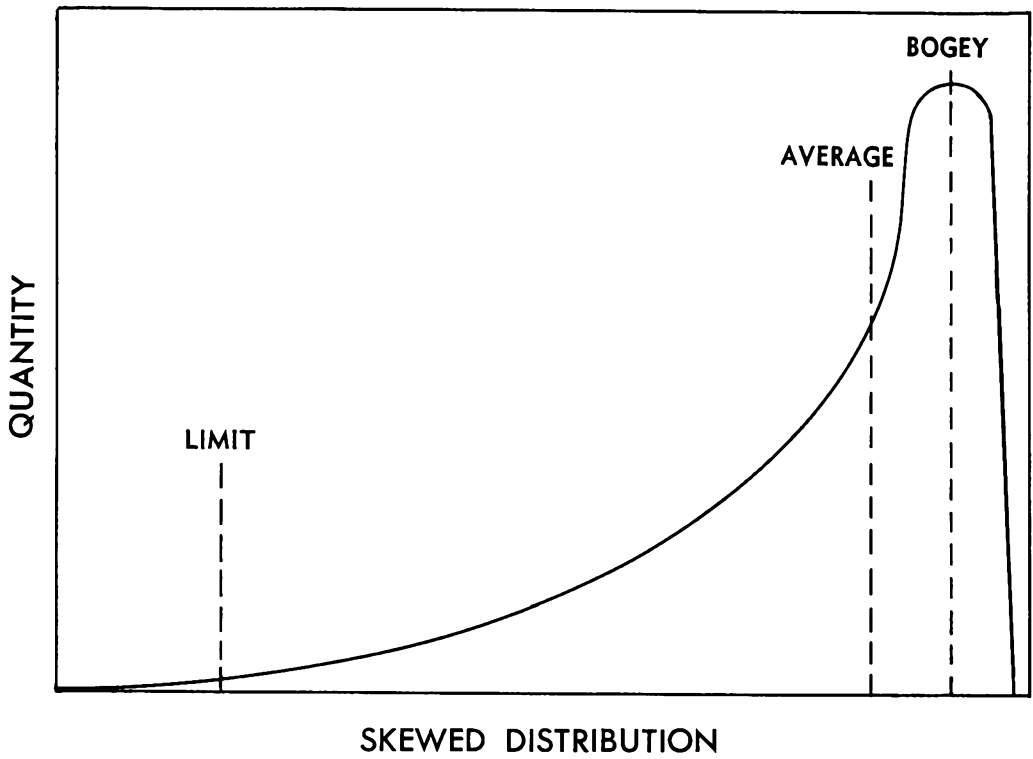

Fig. 4-2. Skewed distribution curve.

few tubes in a given lot that will approach this limit—most of them will be near the other limit. Yet, these few tubes which are quite different from the bulk of the lot are considered “normal” by definition.

THE BOGEY TUBE

In any discussion of characteristic variables and the normal ranges that must be expected, someone is bound to ask, sooner or later—“What about bogey tubes? Why not supply technical people with tubes that are known to be average. In this way, they could design or adjust circuits so that they would work best with average tubes, and this would insure their proper functioning with a large majority of all tubes encountered in the field.”

This is a very plausible suggestion and it would seem like the logical thing to do until one has made further examinations. Most tube characteristics are interrelated so that although we can often find a tube having one of its characteristics on bogey, the chances of finding one with two characteristics on bogey are fairly small. As more characteristics are added to the list of requirements, the chances get even more remote until by the time we have added as few as five or six, the chances are almost zero. It is very much like trying to find a living example of the average man. He doesn't really exist except in the realm of statistics. The same is true of the bogey tube.

THE LIMIT TUBE

The next question usually is—“All right, so there are really no bogey tubes; what about limit tubes?” Here, the problem is not quite as bad. Since many limits are fairly broad, tubes that are remote from bogey, but not necessarily on the upper or lower limits, are fairly common. To get tubes that are lower limit for several characteristics, may be quite a problem, especially since several characteristics are so related that the upper limit of one is produced by the lower limit of another.

But even where limit tubes are obtainable, their value is of some doubt because they tend to be unstable tubes. By their very nature, they are abnormalities. These ab-

normalities are often produced by mechanical or chemical deficiencies in their manufacture. These deficiencies result in unstable characteristics so that even though they may have been limit tubes when they were picked, their continued reliability—even as limit tubes—is very poor.

The best method of establishing operating characteristics of a large group of tubes in a particular piece of equipment is simply the statistical sampling procedure used by the manufacturer to control the characteristics of his product in the first place. Obtain a large sample of the tubes in question, test them in the equipment they are to be used, and measure an important characteristic such as gain. By noting the most extreme variations that take place, you will have a measure of what to expect from the majority of tubes that may be encountered in the field.

CORRELATING MEASUREMENTS

Tube characteristics may be classified into two groups; performance and correlated characteristics. Such characteristics as gain and power output are performance characteristics. They are the functions for which tubes are designed to be used. There are very exact means of measuring these characteristics, but they are somewhat involved and require particular knowledge as to the exact method in which the tubes will be used. In an attempt to simplify the testing of tubes and to generalize their characteristics for cataloguing, the methods known as correlative measurements were developed many years ago.

Correlative measurements are those measurements which are supposed to predict performance. They are not of themselves significant except as a means for predicting significant performance characteristics. Because these characteristics are the ones most generally listed in tube manuals and data sheets, their actual significance is sometimes exaggerated. There is almost never any direct correlation between these measurements and their performance related characteristics. If correlation is 80 percent, this is considered rather good. A correlation of 50 percent is no correlation at all; in fact, a 50 percent correlation would be regarded as a random phenomenon, or one based on chance alone.

Some of the more common correlated measurements are transconductance, electrode currents, and plate resistance. There are many others that will be discussed more fully in a later chapter on special tests for estimating tube performance. Of these, the most frequently referred to correlated measurement is transconductance. This is the ratio of plate current change to the grid voltage causing that change, and is supposed to be a direct measure of the gain possibilities of the tube. Under highly controlled conditions, it can be, but under the conditions most commonly encountered in most test equipment, it can mean very little. Let us examine some of the reasons why this is so.

Transconductance varies inversely with grid bias, between some optimum value near zero bias and a minimum value near cutoff. It varies directly with plate current, over the same range of grid bias voltages. Plate current depends on plate, screen, and grid voltage.

Gain, on the other hand, is dependent upon the change in plate current which takes place across a particular load with a given plate current flowing. The effective value of the plate load is determined by the external load in shunt with the tube resistance or R_p . Thus, a knowledge of the transconductance of a given tube without similar knowledge about its plate resistance and plate current can do very little to predict actual performance.

TYPICAL CORRELATION

A typical correlation chart for a group of tubes is shown in Fig. 4-3. Their measured transconductance is plotted against gain. It will be noted that there is a very good general correlation between the two phenomena. In most cases, the higher transconductance tubes show higher measured gain and vice versa. But just how good a correlation exists between individual tubes? Taking the tubes that are indicated (A, B, C and D), note that although they fall nicely within the general grouping for all of the other tubes, specifically they do not correlate at all. Tube A has the same gain as B; yet, the transconductance of tube A is lower than that of B. Tubes B and C have the same transconductance; yet, tube C has con-

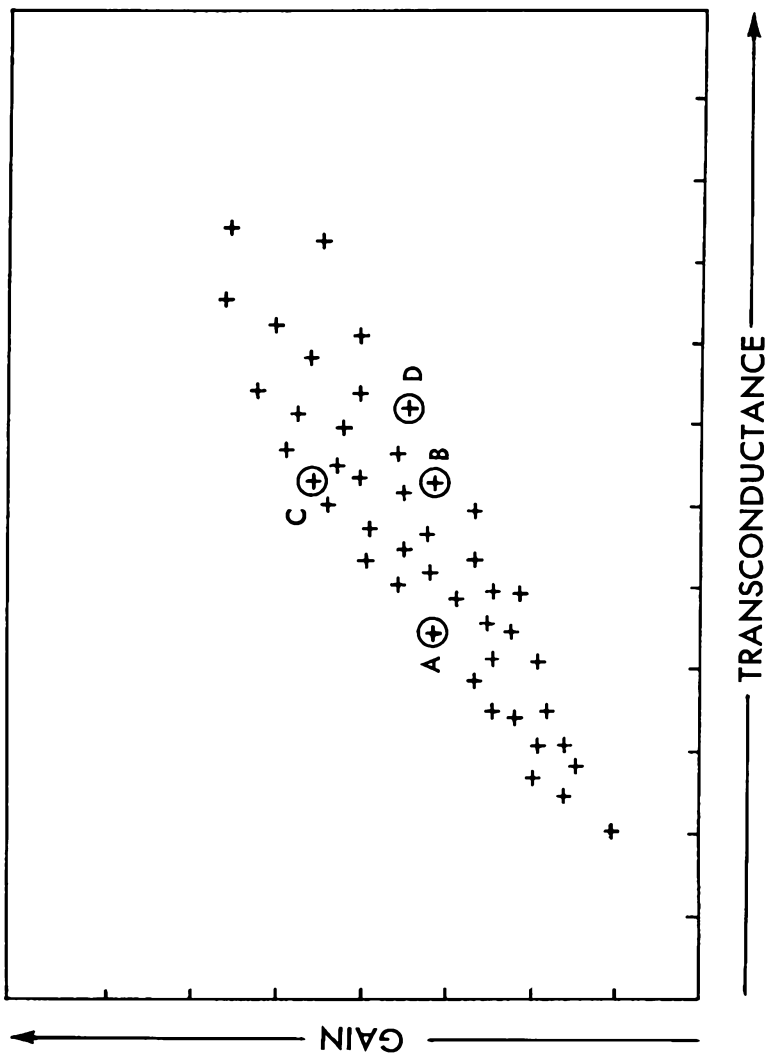

Fig. 4-3. Typical correlation chart showing gain and transconductance relationships between various tubes.

siderably more gain. Tube C has more gain than D whose transconductance is somewhat higher than that of C.

Such failures to correlate are common experiences for anyone who has taken the time to study tubes as they are, rather than as they are supposed to be. This doesn't mean that there is anything wrong with the engineering formulas which indicate that gain and transconductance are a first-order effect and should correlate. They do, under the right conditions. What we are looking at here is simply the result of not measuring all of the other tube characteristics which affect gain. If this were done, the apparent contradictions would not be contradictions at all.

One of the most common causes for the apparent lack of correlation which sometimes exists between transconductance measurements and gain lies in the fact that the majority of applications use cathode bias, whereas most instruments used to measure transconductance have fixed bias. With fixed bias, it is assumed that all tubes have the same transfer characteristics which, of course, is not true. Transfer characteristics vary, especially in the region where the tube is most critical to bias changes. This is shown in Fig. 4-4. Note that these curves coincide at points X and Y. These are frequently the commercial test points because more than likely they are the points used in rating the tubes. If these tubes are used in equipment, they will more likely operate in the region of A, B, or C, which are all within 0.5 volt of each other in the minus 1 volt region. Over this very small voltage range, the transconductance may vary as much as 20 percent, and with it, the effective gain. Here are three tubes which, according to standard measurement techniques, have the same transconductance; yet, which in use, will be found to have three different gain measurements.

Similar examples could be shown for tubes having the same transconductance, but with differing plate resistances. These too would show a gross miscorrelation. The purpose in making this clear is to point out to the reader that correlated measurements are not in themselves overly significant. When applied to a single tube, they may have absolutely no significance. They are a characteristic which, on the average, shows a definite relationship to a performance characteristic, but which are based on

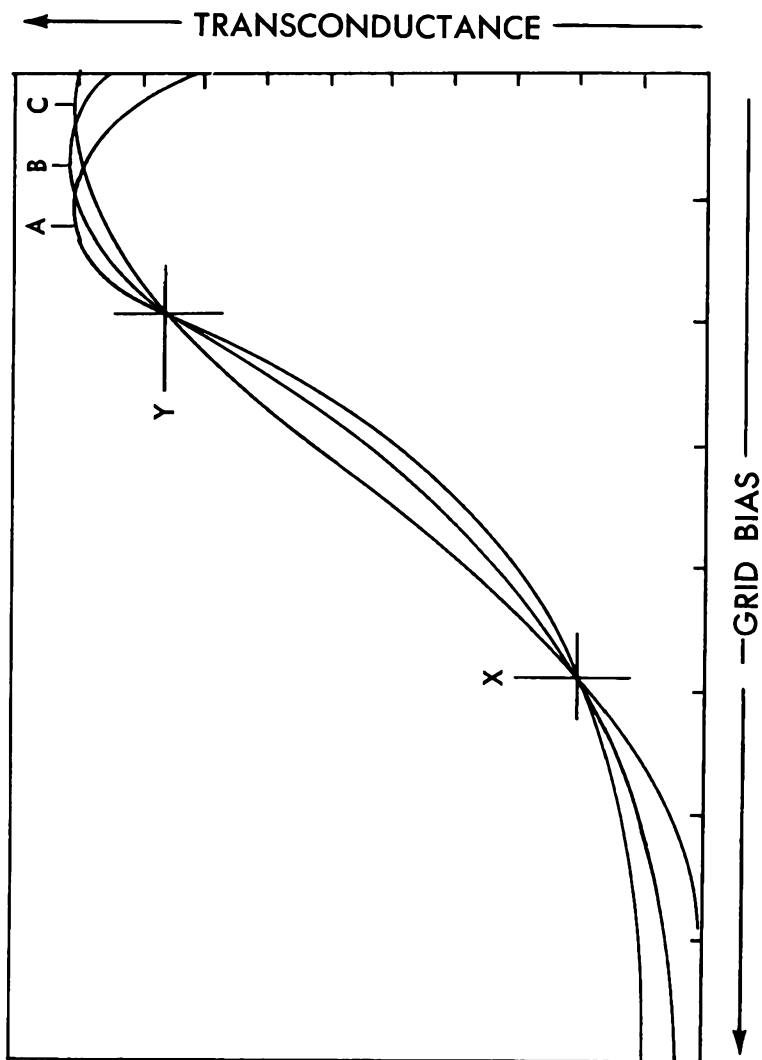

Fig. 4-4. Curves showing that transfer characteristics vary, especially in the region where the tube is most critical to bias changes.

averages and are not, therefore, applicable to individual tubes as such. This fact should be borne in mind as we go on to discuss characteristic ranges.

CHARACTERISTIC SPREADS

We have said in earlier paragraphs that all tube characteristics follow the known laws of variation, and distribute themselves around an average value known as the bogey value. The degree for which each characteristic is allowed to deviate from this central value is known as the spread of that characteristic. Characteristic spreads are not given in most tube specifications which include, for the most part, only the average or bogey figure. Although the exact limits are an individual company's own prerogative to choose, they may vary from tube type to tube type and from company to company. There is, however, fairly general agreement throughout the industry as to what constitutes good engineering practice, and so, commercial practice. These practices apply to tubes sold for general renewal use and do not apply to specially selected tubes sold to some equipment manufacturers, or to those premium quality tubes sold either commercially or to the military. These special groups will be dealt with in subsequent chapters.

Transconductance is usually permitted to vary about ± 40 percent of the published bogey value. This means that if the registered value for a given tube type is 2,000 micromhos, you can expect to find tubes reading anywhere from 1,200 micromhos to 2,800 micromhos in any sample you measure. This does not mean that there will necessarily be a similar spread in gain when these tubes are compared in typical applications. It is probable that the gain spread will be narrowed by at least half this amount because of the foregoing reasons.

Plate current cutoff is a published characteristic of considerable significance in many applications. This characteristic is normally controlled at about twice the published rating. In other words, if the rating sheet for the tube states that the plate current will be 50 microamperes at minus 10 volts, you can expect to find some tubes that do not reduce to this level until the grid voltage is raised

to -20 volts. Once again, this is not a serious departure from specifications as far as performance is concerned because the plate current of some tubes may be only 100 microamperes at -10 volts, but it takes that extra 10 volts on the grid to reduce it the additional 50 microamperes. Either current is quite inconsequential for all practical purposes.

Plate current is usually controlled within limits of ± 20 percent and plate resistance, because of its intimate relation to transconductance, is likewise a ± 40 percent characteristic. The correlation between either or both of these characteristics and any measure of performance is rather low, except in the case of certain unique applications. For these applications, the limits may be quite often tightened.

Screen current is one that is controlled on the high side only, being usually about twice the published rating. The reasoning here is that you can't have too little screen current, since it is only a loss current anyhow. If a tube has a better than average plate-to-screen current ratio, it is just a more efficient tube, and no one is going to find anything wrong with it. High screen current, on the other hand, will waste power; reduce the effective screen voltage and, hence, cause the tube to cut off sooner and have lower transconductance at a given grid bias. High screen current will also contribute to excessive screen dissipation with the danger of screen emission and runaway.

Grid current is controlled at about 1 microampere for most small tubes, but is allowed to get up to as high as 5 microamperes for some power tubes. This is important to recognize when attempting to measure this characteristic on commercial type testers. There isn't any one gas current test that will apply to all tubes.

This is also true of heater-to-cathode leakage. In a later chapter devoted to tube testing and tube testers, this will be dealt with more completely; however, it is normal for tubes with different powered heaters to vary from as little as 5 microamperes of leakage to as much as 100 microamperes. Again, there isn't any universal test, such as a neon bulb checker, that can evaluate all tubes for this characteristic. Such a test is either too sensitive or not sensitive enough.

Finally, heater current is a variable and usually falls between ± 10 percent of the ratio value. For example, 600-milliampere heaters that read as low as 530, or as high as 670 milliamperes, would not be outside of specifications. This applies to either series-string or parallel heater types. The significance of a 10 percent heater current variation is probably not too great, although the lower limit tubes will probably fail to operate if they are used where the line voltage is 10 percent below normal as well. The reasoning that backs up these limits is the fact that far more situations exist where line voltages are high than low. Also, the statistical number of tubes falling in the lower limit is very few; probably less than 1 percent.

QUALITY CONTROL

Quality is a word that is used by many people to describe many different things. There is no other word that can be used as an adequate substitute, and this probably accounts for its great use and even its frequent misuse. Regardless of what the advertising men may have made it appear to mean, the term "quality control" to a manufacturing man means just one thing—uniformity control.

The model or prototype as released by the development group, has certain characteristics. These have been established as the optimum or most desirable ones that the products should have in order to comply with a majority of the anticipated customers' needs. As we have noted earlier in this chapter, all manufacturing processes result in variations from the established design. The problem is to control all the individual variations so that their combined effect on the end product will result in gross variations that are not unacceptable in the market. It follows, therefore, that the successful control of quality is an economic necessity for any manufacturer in order that he may stay in business.

It has been correctly stated by competent authorities in the field of industrial management that it is cheaper to make a quality (uniform) product than it is to make a poor quality (non-uniform) product. This may seem like a paradox, but it is not. When all of the minor variables in a complex process are carefully controlled and

minimized, the end product goes together with fewer misfits and, consequently, fewer rejects. Rejects add enormously to cost and, therefore, the fewer the rejects, the lower the manufacturing costs. It would be hard to find a manufacturer who is not continually striving to lower his manufacturing costs, and for this reason, no manufacturer can afford to produce any product that doesn't meet good quality standards. The foregoing facts are pointed out in order to make it clear to the reader that what follows is not a surrender to penny pinching on the part of the manufacturer, but it is, in fact, a highly scientific activity, motivated by the soundest of engineering and management principles.

SAMPLING

The complete testing of any vacuum tube in order to insure its conformance to an original design is a very complicated and detailed matter. Over 50 individual tests and measurements are frequently called for. Naturally, it becomes impossible to do this on 100 percent of the product. Even if time and cost were no consideration at all, some of the tests, such as life tests, are self destructive. Therefore, if 100 percent of the product were tested, there wouldn't be any product left to ship. That is why the practice of sampling is of such a necessity.

Sampling consists of taking a given number of tubes from every hour's production and submitting them to various tests. These tests are designed to disclose process changes or dimensional changes that might indicate a trend. One of the cornerstones of all mass production quality controls is the fact that a process cannot vary beyond certain known limits except through a long program of change. In other words, it can drift, but it cannot jump from one state to another. Knowing this, quality controls are designed to watch for trends as when tools begin to wear, or machines start to go out of adjustment. Noting these trends permits corrective action to be taken before serious departures from normal have occurred.

So, the whole philosophy of quality control is aimed at producing a large quantity of the most uniform product possible and at the most economical cost. Because of the

many tests performed and the manner in which one test cross checks another, it becomes virtually impossible for more than a very insignificant number of true defects to actually slip through to the customer. When they do, they are never in so-called "runs." The statistical probability of one individual obtaining two defects in a row is quite low. When it comes to getting three or four such defects in a row, the chances are almost zero. When such a situation seems to have been encountered, it is almost certain that one of the following circumstances is the real culprit. Either the test device is at fault, or the equipment is designed around tubes having a different set of bogey characteristics. This leads us into a new topic—that of matching tubes and equipment for optimum performance.

DESIGN TOLERANCES

In the design of electronic equipment, one of the principle responsibilities of the design engineer is an understanding of the normal variations which will exist in all of the components which will go into the mass-produced article. A well designed piece of apparatus, like a well designed machine, will accept all standard replacement parts which are normally available on the market. Most designs do follow this common sense rule; however, there are a few, and it is unfortunately true that their numbers have been increasing in recent years, that do not. These latter designs are developed as a result of price squeezing short cuts which, while they may save cost for the equipment manufacturer, add much to the problems of the service industry and the public. There are varying degrees to which this practice is followed by various equipment manufacturers. In general, it has been severely dealt with by the military services wherever it has been possible to prove its existence. But private industry continues to practice it wherever it will gain for them some temporary advantage over their competition. This practice is known as "tube selection" and will be discussed in the next chapter.

CHAPTER 5

SELECTED AND PREMIUM TUBES

In the previous chapter, we mentioned some of the normal variations that exist in vacuum tubes and the natural laws that govern them. In the early days of the electronics industry, when radio and communications were the principle uses to which vacuum tubes were put, these variations seemed to be of little consequence. More recently, during World War II, electronics played a vital role in many theaters of activity. The tubes used in the tremendous variety of military equipment ran the full range of all their normal characteristic variables. There is no evidence to indicate that they were any the less satisfactory for this reason.

Following the war, and with the advent of commercial television, a new crop of circuit engineers seems to have been born. Many of them had received at least a part of their training during their military service or in one of the military-supported electronics industries. Because of this training, they appear to have acquired a new engineering philosophy, based on the "cost-plus" unrealities of a war-time economy. This philosophy had as its main tenet the assumption that a circuit engineer's primary function was to write involved specifications, minutely describing each component in his hand-tinkered creation, and then leave it up to some other engineer—probably in his supplier's plant—to solve the problem of how they were to be made. Since very few significant advancements in any science or art have come about as a result of an edict, these specification writers didn't produce any miracles either. What they did produce was a practice which has now become so universally adopted that familiarity and indifference have begun to give it an air of respectability. This is the practice of an equipment manufac-

turer writing his own procurement specification for tubes which, though they bear a standard type number designation, are materially different from the tubes sold under this same designation to the replacement market or, for that matter, to some other equipment manufacturer. These are what are known as "selected tubes."

HOW TUBES ARE SELECTED

There are many characteristics for which tubes are selected. Some of these are fairly harmless, like the tuner manufacturer who insists that the range of input capacity in the tubes he purchases should be held within such limits that his production workers have only to turn the trimmer screws, in or out, one turn. This saves him production time, he says. This is a harmless selection because the tubes his specification reject could be used in his tuners for replacements, and no one could tell the difference after the trimmers were readjusted.

But there are other selections that involve characteristics not so whimsical, as for instance, the cutoff characteristics of some IF tubes. In order to make an AGC circuit function over an extreme range of signal strengths, tube selection is held to those which have a sharper than normal cutoff characteristic. These are used in one of the controlled stages. When a nonselected tube is used in this same socket, "sync buzz" is apt to be heard, or perhaps poor vertical hold may result due to clipping in the final IF stages. It is fairly common practice among some set manufacturers to use colored paints to identify those tubes which have been selected for use in critical circuits. This paint is often applied to the tip or sometimes to the base of the tube. Very often, there is no indication at all that these tubes are in any way different from others which bear the same type designation.

Selection of tubes, in order to make a marginal design work long enough to get it out of the factory, is a common resort of some in-plant engineering groups. Another fairly common practice is to select tubes that will cover up for some other component deficiency, as for example, a flyback transformer which is improperly designed. Many special selections have been set up to eliminate the picture

interference known as "snivets," which is caused by a combination of tube characteristics and transformer design. Tubes that fail to work with one design are bound to work with another, and those that work well in one set may not work in another. The most undetectable forms of tube selection are those which deal with unregistered characteristics. In a particular equipment design, it will be found that certain tubes fail to work as well as others. After much investigation, some obscure characteristic will be isolated and the cause assigned to it. A specification will be written, requiring that tubes having that characteristic be removed from the shipments going to that particular manufacturer. However, since it is an unregistered characteristic and no one else measures it in his product, the probability is that no other manufacturer's tubes will work satisfactorily in that socket. If the characteristic were a registered one, someone would discover, sooner or later, that one manufacturer's tubes were uniquely different in one respect, and standardization would begin to take place. But there are many unregistered characteristics and variations that can go unnoticed for years.

RESULTS OF TUBE SELECTION

There is one aspect about tube selection which is almost invariably true. It almost never produces a better product as far as the user is concerned. The same problem could have been solved in a number of other ways, all of which would have lead to the same amount of customer satisfaction. Where the customer gets hurt is when the selected tube finally gets into trouble and has to be replaced. The question of whether or not a standard tube having standard tolerances will replace it is often a very expensive one for the customer to resolve.

Selected tubes are generally more prone to failure than nonselected ones; not because they have been selected, but because the circuit in which they are used is generally abnormally critical. That's why it requires a selected tube in the first place! Its design is such that all the normal tolerances have been left out, and as soon as the selected tube's characteristics begin to drift, it is in trouble. In fact, herein lies the reason for a great deal of the mis-

leading evidence which has been built up concerning the unreliable nature of tubes in general. When normal tubes are used to replace tubes which were originally selected to make a critical circuit work, the results are apt to be somewhat less than satisfactory.

Selecting tubes on a performance basis, so that they will operate at their best in certain common applications, is not always a harmful practice in itself, provided some indication that they are in some manner unique is given. Occasionally, an equipment manufacturer will put a special part number on such a tube. This tells anyone who later is faced with the problem of replacing such a tube that it is a special one. It will then be realized that the equipment may not function as well if a replacement tube is used, or that the circuit may require additional adjustment to make the new tube work properly.

A special form of this situation exists when tubes are sold as matched pairs for use in hi-fi and other audio applications. These tubes have been selected from the normal distribution of all the tubes in the product and matched so that they have similar characteristics. Usually, plate current is the characteristic that is matched. When these tubes are used as a pair, because their plate currents are nearly identical, cancellation in the output transformer will minimize any tendency toward DC saturation of the core, with its consequent increase in distortion. Of course, if the amplifier is equipped with a balancing potentiometer in the cathode circuit of the output tubes, the same thing can be accomplished with unmatched tubes, but the pretested and prematched tubes make it easier and don't require the use of any instruments when making the substitution.

PREMIUM TUBES

We have talked about various forms of special selection as it applies to standard, commercial grade tubes. However, there is another large class of selected tubes. This class includes types which are known as industrial and military tubes. These are frequently referred to as premium tubes because they sell at somewhat higher prices than their prototypes. They are also referred to as reli-

able tubes. This latter reference is the one we want to explore at this time.

Immediately following World War II, a great deal of interest was expressed by the military in the development of specially designed tubes that would have a higher degree of survival in military applications than the then existent commercial-grade receiving tubes. The story was told about an extensive search of military maintenance files, which disclosed that about the only thing wrong with electronics was that vacuum tubes were involved, and they were just plain unreliable! All sorts of statistics were brought forth, tending to prove that with the currently-available, low-reliability tubes going into military equipment at that time, the new giant bombers which used several thousand tubes in their electronic brains simply wouldn't be able to get off the ground. Theoretically, at least, enough tubes would fail just during the ground checkout period to render the mission a failure. The fact that there were many airplanes in the air at that moment, apparently none the worse for this situation, didn't alter the argument. Tubes were highly unreliable devices and had to be improved. It was amid such an atmosphere that the first reliable tubes were born. They were the outgrowth of a crash program to bring out tubes which could be immediately substituted for existing types in existing sockets. Their prototypes were the popular 6AL5, 6J6, 6AK5, 12AU7, and similar types.

These early "reliable" types proved to be little, if any, more reliable than their prototypes. This was a disappointment to some who immediately launched into a renewed program of specification writing aimed at tighter or more reliable specifications for those same tube types. As each new wave of specifications was produced, new numbers were appended to the originals until at last there was no more room to put additional numbers on the bulb!

THE MULTI-SPEC TUBES

The 6AL5 is a typical example of what took place during this era of reliable-tube specification writing. Beginning as the EIA type 6AL5, it was a simple dual diode designed for second detector and AVC service in pre-

World War II days. It was perhaps one of the most reliable tubes in the applications for which it was intended. But, it found its way into many unique, and originally undreamed of, applications when it went to war. It was used as a clipper, clamper, bias rectifier, and as a low-power switch. It was used at frequencies ranging from the very lowest to over 500 megacycles. It became a very common tube type in many very uncommon usages. In short, it became a universal component, having many and varied requirements.

Well, its first metamorphosis came when it was drafted into military service as the JAN-6AL5. A specification was written, describing its average characteristics; these were, in general, taken directly from the EIA registration data for this type. Many thousands of these JAN-6AL5's were purchased by the military services or their contractors, and most of them went into finished equipment where they proved normally satisfactory. After the war, when a general campaign got under way to "ruggedize" all military tubes, certain shock and vibration tests were added to the old JAN specification, and the tube became known as the JAN-6AL5W.

"Ruggedization" meant more or less what its name implied. Tubes were being used in more and more places where they were subject to rough handling as well as heavy vibration. Trucks and jeeps bouncing over rough terrain, as well as multi-engine aircraft, and even the newer jets were subjecting tubes to additional stresses which they had not been required to withstand previously. Some tubes underwent large structural changes in order to qualify for the new "W" suffix. The 6AL5 wasn't changed in any recognizable form because it was pretty rugged to begin with.

The ruggedization program soon became lost in the larger one called the new "reliable tube" program. So, new specifications were written, adding a few more controls and test points, and the 6AL5 became the JAN-5726. This hadn't been around too long before some additional changes were made in the style of specification being written, and the JAN-5726 became the JAN-6097.

There were now four specifications, including the EIA registration for the original 6AL5, and they all described

the same tube. This was obviously not in the best interests of anyone, so some attempts were made to simplify the whole situation by combining the salient features of all of these specifications into one. The first attempt at this produced the tube type JAN-5726/6AL5W. Apparently, someone overlooked something because that was followed by a later specification, summing up all the former specifications and including the previous summations. That became known as the JAN-5726/6AL5W/6097. It was at this point that they ran out of space to print any more numbers on the bulb, and someone facetiously suggested that the tube be called the 6AL5 again which, of course, it really was anyhow.

How is it possible for such a comedy of well-intentioned, misdirected efforts to take place in this age of space probes, atomic energy, and wonder drugs? In order to understand the reasons, it is necessary for us to draw back the curtain on another area of popular misinformation—an area which was very much less understood when all this was happening than it is today. This has to do with the very heart of the problem—the nature of reliability and the standards or specifications that aim to define it.

STANDARDIZATION AND RELIABILITY

Standardization is one of the fundamental requirements of any complex society such as that in which we live. Without it, we would have absolute chaos in our dealings with other people, and our vast industrial economy would be unable to function. Because of standards, we can buy the various products of a host of manufacturers, all with absolute confidence that they will do what we want them to do. There is hardly any article we come across in our daily lives that is not made in accordance with some standard or another. Some of these, like the food and drug standards, are government-enforced. Others—like automobile tires, electric light bulbs, or thread—are carefully controlled by mutual agreement between the manufacturers themselves, for their benefit as well as that of their customers.

Standardization is important to the manufacturer because it allows him to reduce his costs by having only one

kind of machinery, one type of process, one set of tools, or by having to train his people in fewer operations. It reduces inventories and obsolescence, and thus further reduces costs.

To the user, standardization means a better product at lower prices. Standardization encourages competition, and this works to the user's advantage as far as available choice is concerned as well as being a further stimulus toward better quality and lower prices. The user can also feel confident that when he buys a standard article, it will satisfy his needs most effectively. Why? Because of the very method by which standards are developed.

HOW STANDARDS ARE SET

Most standards are arrived at by collective study and compromise. The end use for the product is first studied very thoroughly. If there is more than one use, they must all be studied in turn. Next, with the requirements of each end use well known, the product is then measured to see how well it fits these needs. The variations in product are matched to the variations in end use, and an over-all specification is arrived at to describe the best possible compromise between the two. It is axiomatic that the fewer the end uses are, the more confining and detailed the specification can be. This is the secret of a good standard—a specific application and a specific product to meet it.

Take a very simple example—the electric light bulb. There are many kinds of electric light bulbs, such as the various sizes made for house lighting, industrial lighting, and decorative lighting. Then there are automobile lights of all sizes, flashlights, instrument lights, various signal lights and outdoor advertising lights. Yes, the list is a long one and it is apparent that there is far from a single standard that could be applied to all these lamps. There are voltage differences, socket variations, environmental ranges, and a lot of other factors that aren't applicable to each and every bulb.

This problem is met in a simple, straight-forward manner. No one specification is attempted for all electric light bulbs. Instead, there is an individual specification for each

specific application. Thus, all house lamps are made to work on one voltage and to fit one standard screw socket. There are differences in wattage and bulb color, but that's about all. With only those few variables to deal with, a standard is possible and practical. Similarly, there are standards for all other sizes, shapes, and end uses for electric light bulbs—all tailored to their specific end use.

Thus, in order to have a standard at all, you must first know the end purpose for which it is intended, and the end uses for the product must be more than similar. They must be specifically alike. When this can be said to be true, then standardization—the making of all products intended to fill that end need in an identical manner, or with as few variables as possible—is a direct way of producing improved reliability. In short, specialization, which is only possible if you have standardization, is a very effective means of approaching perfection—the essence of reliability.

UNIVERSAL TUBES

Tubes are sometimes thought of as being first cousins to electric lights, probably because they both use filaments of hot wire in performing their functions. They are largely constructed of glass and must be evacuated in order to perform at all. It was because of this common association that we used the electric light bulb in our earlier example of the standardization of a very common article of manufacture. But this assumed relationship is extremely remote if one becomes familiar with the facts. In spite of the commonness of the electric light bulb, it is far from a universal product. If it were, a few types would be found doing just about all the lighting jobs there are. But this is not the case. Each lighting task has its own special shapes, bases, voltage ratings, wattages, etc. No one would think of taking a lamp intended for one type of service and forcing it to do some other kind of service.

Vacuum tubes, on the other hand, are one of the most universally-applied products around us. This may not be apparent to many because the differences are not usually visible. But there is just as great a difference between the

requirements of a tube intended for blocking-oscillator applications and one intended to be used as a DC amplifier as there is between a lamp intended for intermittent flash-light use and one intended for use as a radio tower warning light.

Many applications for vacuum tubes are actually such that they require characteristics not mutually attainable in the same tube. Attempting to enforce both of these characteristics in the same design, to have a more widely applicable tube, usually results in excessive cost as well as a compromise of both of the primary objectives—namely, reliability and efficiency. In order to see more clearly how this comes about, let us take another simple example from something outside the electronics field, but one which is familiar to everyone.

THE UNIVERSAL COMMODITY

Water is perhaps one of the most universally-used commodities on our planet. In fact, we regard it as so essential that we can't even imagine life without it. Suppose we examine some of its many uses or applications and see whether we could write a simple, universal test that would insure that some strange new liquid, just discovered on a new planet, could be used wherever water was needed.

Water is used by both man and animal as a beverage. For this purpose, we require that it be tasteless, as well as germicidally pure. It would have to be chemically inert as far as our systems were concerned. As a matter of preference, we like our beverages to be either nearly ice cold or almost boiling hot. We also use water for laundering and bathing. For this purpose, we like it to have a low mineral content, or to be "soft," and we want it to be clear and colorless. For our internal combustion engines, which use water as a coolant, we merely concern ourselves with its boiling and freezing points—the higher on one end and the lower on the other, the better.

Water is used in fire fighting. Here, it must be non-flammable and plentiful. There are many industrial uses for water that require it to be free of all chemicals, as well as of all organic matter. Agriculture uses water, and is concerned principally with nature's distribution system.

Water is also used for transportation; here, its specific gravity is of primary importance.

There are many other ways in which water serves as a universal commodity, but these examples are enough to illustrate the point. How would you set up a universal specification for the applicability of a sample of water for all of these applications? Well, you could simply test it for everything. This would be so costly as to render it too expensive for several of its primary applications. But, suppose you overlooked this fact and decided to test it for everything—just to make sure it would work in any application. This approach would defeat your primary purpose because several of the more severe requirements are incompatible and at cross purposes with some of its other application requirements. For example, chemically and organically pure water is not suitable for use as a beverage. It doesn't even taste like water!

DEFINING RELIABILITY

We come now to the subject of reliability itself. Although we have been using the word throughout this chapter, we are quite sure that it has many different meanings in the minds of most readers. The least realistic of you will have been thinking in terms of a tube which, when plugged into any equipment suited to its general characteristics, will perform better and longer than the original tube. More realistic readers may have in mind only a longer useful life under conditions somewhat more grueling than normal. Others may think in terms of no better over-all performance or life—simply a freedom from early, or sudden and unpredictable, failures.

In varying degrees and amounts, these are the wishes of all those who seek reliable tubes. Some want better performance from existing equipment to be brought about by a simple tube change. Others want improved performance in new designs built around super tubes. Yet all, for the most part, want the same broad characteristic as the prototype had. In other words, it must still taste like water.

There are several methods by which an attempt is made to specify reliability. The favorite one is to narrow the

range of characteristic spreads in the belief that a more restricted range (higher uniformity) can, of itself, describe reliability. This is largely wishful thinking unless something else is also done to control the bogey shift. In other words, all tubes may fall within narrowed limits, but who is to say that they won't all be just within either the upper or lower limit of the specification, as would be the case if they were selected to meet the specification. If the shape of the distribution is described and controlled by statistical methods, the uniformity of a given characteristic may be well maintained. Whether this has any correlation with reliability depends more or less upon what definition of reliability you are using.

Environmental and accelerated life testing are other common methods frequently employed to attempt to measure reliability. The success or failure of this approach depends very much upon the degree of correlation which exists between the method chosen and the end use. For instance, merely vibrating tubes does not insure that they will not succumb to some specific mode or period of vibration in the equipment for which they are intended, unless the test conditions are identical to the field conditions.

RELIABILITY AND STANDARDIZATION

A specification aimed at insuring the reliability of all tubes which pass it is the ultimate objective of many procurement people. The fact that so many specifications have been written, all describing the same few tube types in so many different ways, would tend to indicate that most of these objectives had failed. There were many who foresaw this and argued against the concept of the universal reliable tube. While their voices were drowned in the babble of those who usually had something to sell as each new reliable tube formula was advanced, the evidence available today preponderably supports their contentions.

The reliability of any product cannot be improved without a complete knowledge of the precise application for which it is intended. When this is known, and suitable correlative tests have been established, it is quite possible that very significant improvements in performance, sta-

bility, life, and freedom from initial failures can all be accomplished by a standard or a specification which accurately describes that particular product—but *only insofar as its use in that specific application is concerned*.

Where the use of prototypes is involved in older equipment, the chances of making significant improvements are less than where new tubes are being designed into new equipments. The requirement that tubes fulfill more than one specific function, or that they work in existing equipment with no circuit alterations, minimizes the amount of improvement that can be expected.

Existing, so-called reliable tubes have only a small chance of being actually more reliable in replacing prototypes in uncorrelated applications. In many instances, the exact reverse has been experienced, wherein so-called reliable types have proved to be less reliable than the original equipment types. This comes about quite logically, and is in no way a contradiction of logic. In one instance, it turned out to be the result of the extra micas used in the more reliable types to reduce vibration; this resulted in greater cathode cooling and, in a particular application, failure of a local oscillator to function at high frequencies. The tube had been made more reliable for certain pulse applications, but that didn't make it a better high-frequency oscillator. Examples of this type are fairly common with many of the early reliable types, where a change was made to correct one specific trouble without enough knowledge of all the applications involved to make sure that none of them were adversely affected.

As a result of this, there have been developed more recently, several groups of tubes that are not known as reliable tubes. However, their use in the particular applications for which they are intended may materially improve their over-all reliability. These are not universal tubes and their use in some other function, other than their intended one, may even result in an over-all reduction in equipment reliability. Typical of these are certain unique low-noise audio tubes that may be used to replace older versions like the 12AX7. Then there are a number of computer tubes intended just for that type of service. Even the early rugged tubes are definitely more rugged if physical shock is what you are talking about. More rec-

ently, instrument tubes have been introduced for use in such equipments as scopes and direct-coupled amplifiers. In fact, the modern trend is not to attempt to make some one tube better for all applications, but instead to make specific tubes, or families of tubes, which are more precisely tailored to meet a limited number of applications. This is leading to a lot more tube types, a trend that will continue as we enter the period of specialization.

In summary, it can be safely stated that there are not now, and there are not likely to be, any universally reliable tubes. We can have unreliable universal tubes, or we can have highly reliable special-purpose, limited-application tubes. But we can't have both in one tube. They are incompatible requirements. In our next chapter, we will examine some of these special tubes when we answer the question—"Why So Many Tube Types?"

CHAPTER 6

WHY SO MANY TUBE TYPES?

This question has been asked by many people over the past few years. Those who have been in electronics for many years look back to the time when there were relatively few types performing all the functions necessary for successful equipment operation. They argue that most applications haven't changed enough in a few years to warrant all these new tubes. After all, there are only a limited number of fundamental tube configurations—diodes, triodes, and pentodes—and they work at various power levels. You can vary their basic characteristics just so much before they start to overlap one another, so how can you possibly need almost a thousand different tube types?

The newcomer to the field of electronics is perplexed as he discovers tube after tube, many of which are apparently intended for the same general service. He naturally wonders, "Are all these overlapping and minor variations on the same theme really essential?"

The answer to both of these questions is the same. No, all of these many types are not really necessary. The electronics industry as we know it today could get along without many of the active types now on the market. Well, if this is true, then why don't they do it and make life easier for everyone? The answer is simple and direct. They can't.

Tube manufacturers cannot mutually agree to eliminate any type which has been produced if there is still a market for it. To do so would be in violation of our laws regarding monopolistic practices and restraint of trade. It follows then, that although there are many competing companies, and any one of them may choose what he wishes to manufacture, no one of them can afford to be too independent unless he is willing to give up his share of the market

to his competition. For this reason, and others that will be discussed in the succeeding paragraphs, the number of tube types has been increasing and is bound to keep on increasing at an ever-expanding rate in future years. Actually, this has been the case ever since the earliest days of this industry. It has merely accelerated in recent years because of the tendency toward specialization. To see how this has come about, we will trace the evolution of some of today's types and the reasons for their existence.

FILAMENT VOLTAGE SOURCES

One of the most prolific forces which has contributed to the development of many new tube types is the power source used to supply the heater voltage. The earliest tubes were designed around standard 1.5-volt dry cells—more commonly known in those days as “door-bell batteries.” Although these cells were called 1.5-volt batteries and, when new, did have a no-load reading which approached that value, they rather quickly dropped off to a value much nearer to 1.2 or 1.3 volts. Sets using tubes designed for this source of power usually included a filament rheostat and a voltmeter, right on the panel, and the user adjusted the filament voltage to 1.1 volts as the battery voltage gradually decreased.

The second phase, the DC heater era, came when wet batteries were adopted as the more popular form of filament supply. This gave rise to a number of types designed to operate with 5 volts on their filaments. Rheostats were still used, and the 5-volt rating allowed for some battery voltage fall-off before recharging was necessary. It was customary to haul the battery down to a local garage once a week for recharging. Most users hadn't discovered the trickle charges as yet, so batteries were more often partially discharged, and the 5-volt ratings were nearly optimum under these circumstances.

The first AC heater tubes were designed to work at 2.5 volts. No one seems to remember just why this was so. A few of the heavier filamentary types could be operated directly from an AC source, provided the filaments were center tapped. This seems to have set in motion a sort of standard, some remnants of which still exist in the form

of the 5-volt filamentary rectifiers of today. In that particular era, filament ratings came in 2.5-volt steps. You had 2.5-volt, 5-volt, 7.5-volt, and some 10-volt tubes. Things were off to a nice, easy-to-understand system. But it didn't stay that way for long!

2-VOLT AND 6.3-VOLT TUBES

Rural electrification had not spread into too many areas of the country, but radio was reaching the remotest hamlet in our land. The residents there wanted the same kind of reliable radio reception their city cousins were enjoying. To answer this need, as well as the need for better lighting because the rural folks began to stay up later to listen to their radios, wind-driven, farm-electric systems came on the market. These were fairly efficient in some areas and provided a reasonably reliable source of available DC power. Since they maintained a fairly high charging rate, even in a light breeze, the battery terminal voltage stayed fairly close to the theoretical 2 volts per cell of the normal lead-type storage battery. So, a group of tubes were developed to work with 2 volts on their filaments, and they became known as "farm-radio tubes."

About the same time, a few radical souls began putting radios in their automobiles by connecting the 2.0-volt tubes in series across the 6-volt battery. This set in motion another major chapter in tube industry. It became apparent, even to those early planners of a new industry, that tube types were becoming too numerable, so they decided to bring out some more types, making a first try at standardization. The value of 6.3 volts was chosen as being representative of what batteries and electrical systems in cars of those days averaged. The tubes were made with indirectly-heated cathodes, thereby making them suitable for AC operation also. By that simple act, the 2.5-volt types became obsolete overnight and practically went out of existence in a couple of years.

About this time, another trend started in the AC-powered sets which eventually broke the temporary period of standardization and re-opened the trend toward specialization. This was the elimination of power transformers and the connection of heaters in series across the

117-volt line, limited by a series-dropping resistor in the form of a ballast tube, or a line-cord resistor. These sets used the then standard 6.3-volt tubes which had been standardized at a 300-milliampere heater current. In order to fill out the complement, special higher voltage rectifiers and power tubes having 300-milliampere heaters were introduced. The AC-DC era was under way. But it wasn't long before it became apparent that specially-designed tubes, just for this service, would make the elimination of ballast tubes and line-cord resistors possible. The trick was simply to reduce the heater current to 150 milliamperes and maintain the same wattage by doubling the heater voltage. And so, the 12.6-volt types were born.

TV TYPES

The arrival of television brought with it many new tube types, although most people have forgotten that some of the first, large-scale production models of the early TV days used the same tubes that had been in use for years in radio. They even went back for a short time and started using the old 6.3-volt, 300-milliampere tubes in series strings. But, although they appear to have been remarkably satisfactory at the time, the trend toward larger screens and wider deflection angles soon left these original TV types by the wayside. Many new types were born, using the old automotive standard heater voltage of 6.3 volts.

This continued for several years, until interest turned toward reducing the price of TV sets once more, and the series-string circuit was again explored. This time a new crop of engineers were on the drawing boards, and they decided that in order to operate in series, tubes must have identical heater warm-up characteristics. No one had thought of this before and, as a consequence, all types of equipment had been made using tubes with uncontrolled heaters, and they seem to have been none the worse for this fact. But in the new age of specialization, this fact was ignored.

A large new crop of tube types was born at first by just adding the letter A to their previous type number, or the

letter B if they were already sporting an A for some other obscure reason. As new types were introduced, they automatically got the controlled-heater treatment right from their inception, so they had no letter following their type number at all. This led to some confusion, but only for a short while, because a new class of tubes began to appear and confusion over these took the attention away from the former ones.

The miniature or portable TV had made its appearance, and with it a whole new group of tubes having 450-milliampere heaters in a series-string circuit. Why 450 milliamperes? Well, the 600-milliamperes tubes being used in the larger TV sets proved to be too hot in the smaller compact sets. Heater wattage had to be reduced in order to decrease the amount of heat liberated in the smaller enclosures. Why they didn't go back to the 300-milliamperes versions of the same tubes they were accustomed to using, no one has ever fully explained. Instead, the 450-milliamperes value was chosen. This meant that almost the entire TV complement had to be redesigned and brought out as additional new tube types. Even new picture tubes had to be designed to fulfill the requirements of series-string filament circuits.

HYBRID TYPES

The introduction of transistors into the entertainment electronics field, and especially into the auto radio field was spearheaded by the automotive manufacturer's decision to go to a 12-volt electric system. The economics of the situation were such that it appeared to be most advisable to use transistors in only the power output stage and tubes in all the other stages. As a result, the 12-volt hybrid tubes were born. These tubes were not only designed with 12-volt heaters to match the new 12-volt electric systems, but they were also designed to operate with only 12 volts on their plates and screens. They thus became an entirely different type of tube from any of their former 12-volt heater types. Once again, specialization had won out over standardization, and the combination automotive and AC-operated tubes were a thing of the past.

PHYSICAL CHANGES

There were a number of physical or mechanical changes which also lead to the releasing of large numbers of new tube types. (See Fig. 6-1 for a chart on the evolution of tubes.) Some of these were brought about by technical improvements in manufacturing which lead to reduced costs. Others were the result of attempts to gain control of the replacement tube market through design changes that required costly retooling by other tube manufacturers.

Tubes started off as an extension of the lamp industry and were made in lamp bulbs with lamp-making machinery and lamp-making techniques. Thus, all tubes were originally made in glass on a pressed stem with a tip on the upper end. When the screen-grid tube was invented, permitting much lower grid-to-plate capacitance, it became necessary to keep the grid lead well shielded from the plate. So it was convenient to bring the grid out of the top of the tube, and to mount a grid cap there for making the connection.

Later, when metal tubes were invented and the octal base was introduced, these same grid caps hung on for awhile. It soon became apparent that grids and plates could come out of the same end of a tube if certain precautions were observed, so the single-ended tubes came into being. Not at all dismayed by the attempt of one manufacturer to corner the market with the radically-new metal tubes, other manufacturers proceeded to duplicate them in glass. Thus were born the GT's, or *Bantams*, as they were then called. They were cheaper and actually more reliable than their metal counterparts, so they became the more popular.

MINIATURES AND SUBMINIATURES

World War II provided the stimulus needed to develop the much smaller subminiature tubes that were used in anti-aircraft shells in the remarkable proximity fuse. Although some of these tubes had been made for hearing aids, both before and after the war, their greatest contribution was in the techniques they taught, which were

Fig. 6-1. Evolution of tubes.

UNIVERSAL
ERA

SPECIALIZED
ERA

- 1907—DeForest's "Audion"
- 1920—1.1-volt battery radios; 5.0-volt pure tungsten; 00 and 01 tube types
- 1923—5.0-volt thoriated tungsten; 01A, 01AA tube types
- 1925—3.3-volt thoriated tungsten; X99 tube types
- 1927—2.5-volt indirectly-heated cathode tubes; screen-grid tetrode
- 1928—2.0-volt oxide filament; 30, 32, 33, 34 tube types
- 1931—6.3-volt auto sets and transformer radios
- 1933—300-ma series-string radio with ballast tube
- 1934—Acorn types for high frequency
- 1935—Metal envelope tubes
- 1938—150-ma series-string radios; GT and lock-in tubes; first miniature tubes
- 1939—TV beginnings, video amplifiers developed
- 1941—World War II HF radio, radar, special devices
- 1946—TV first-era small screens and radio tubes
- 1948—Computer tube developments
- 1950—TV large deflection angle scanner tubes—cascode tuner tubes
- 1951—Multisection tubes for TV, series-strings with thermistors
- 1954—TV series-strings, warm-up controlled heaters; TV low-voltage B+ tubes
- 1956—12-volt hybrid automobile radio tubes

FUTURE

SECONDARY EMISSION TUBES

COLD CATHODES — SPACE CHARGE TUBES

later incorporated in the 7- and 9-pin miniatures of the post-war period and the later TV era. These tubes largely replaced all the former GT types, except in a very few instances where the larger bulb and base were essential to the power-handling capabilities of the tube.

The threading of the thin lead wires through the base of a GT-type tube was always a major cost item to the manufacturer. With the ever-rising cost of labor during the great inflation which followed the war, manufacturers were forced to find cheaper methods of doing things. This led to the development of the button stem for octal-based tubes, using stiff wires formed right in the glass, just like the 7- and 9-pin miniatures. The octal base was then slipped directly over these stiff-wire leads, saving much time and effort for the assembler, and thus reducing costs. Because many of these types also went to straight-sided bulbs when this change was made, they usually were given new type designations, consisting of the letter G following the former designation. If they were also given new electrical ratings, they sometimes got the letters GA or GB added behind their original identifying numbers.

The latest cause for the release of additional new tubes is a new group of miniatures similar to the 7- and 9-pin varieties, but this time having a 12-pin base. These slightly larger miniatures have been introduced in response to the ever-present need to reduce the production cost of equipment. They permit even more functions within one envelope than the dual-purpose tubes formerly available. These new tubes will be known, no doubt, as "triple-purpose tubes."

MULTIPURPOSE TUBES

The multipurpose tube is quite old, dating as it does from the first commercial AC types, back in the 2.5-volt heater days. The first multipurpose tubes had a common cathode with two sets of electrodes around it. In one instance, as with the diode-triodes, one section was built above the other and the common cathode merely extended down through both. In the other instance, the two sections were concentric about the same cathode with a simple triode being assembled inside a conventional pentode. These were the pentagrid mixers.

More recently, a new method of building a multi-element tube with only one cathode was developed, typified by the dual triode 6J6. This method consists of building the structure with half plates and grids and locating them on one side of the cathode. The mating section is similarly constructed on the other side. The 6X8 is a triode-pentode having this type of construction.

Many designers wanted independent cathodes in these multi-element tubes to permit greater flexibility of circuit design. For this reason, the dual-diodes, dual-triodes, and later the triode-pentodes, all with individual cathodes, became very common. It is a mathematical law that the more elements you have to work with, the more combinations you can develop. In the case of the multi-element tube, the number of combinations which have come out of the three or four elements is truly remarkable. With the addition of the new 12-pin miniatures, which will allow as many as three triodes in one envelope, the number of combinations becomes enormous. Their offspring should be very numerous.

ELECTRICAL CHARACTERISTICS

Aside from the simple filament voltage and mechanical size or shape variables which have been mentioned, and which have served to increase the number of available types many fold, there are those types which were added because of improved electrical characteristics. The individual instances are too numerous to mention, but they fall into certain broad classes that are repeated each time a new family is introduced.

Some of the earliest reasons for introducing new tubes were changes in amplification factor, transconductance, and transfer characteristics or cutoff. These are still being juggled. Each time a new type is released, someone will find that a similar type having a higher or lower rating can also be used to some advantage.

Many similar audio-power output types exist, each varying somewhat in drive requirements or, in other words, efficiency. Some are the result of a real or an imagined need; others are the result of a special selection which ultimately became so widely used that the manu-

facturer chose to register its characteristics, thus making it legitimate and available to all.

COMPETITION

Another factor influencing new tube releases is the simple fact of competition between equipment manufacturers who frequently require a new type in order to permit them to have something "original" in their annual product redesign. Some of these innovations are actually technological improvements, while others are pure whimsy. Cost reduction and circuit simplification are strong driving forces that have resulted in many new tube types. Once in a while, some will be developed that do not have what it takes to do the job, and result in poor field records and a damaged reputation for the equipment manufacturer. When this occurs, there is a reaction period and new tubes are brought out to cover up for the weaknesses in the earlier models. Sometimes these are true improvements; more often they are simply a distraction intended to take the minds of their field people off their unsavory experience with older types that were simply misapplied.

Recently, a new factor has been added to the competitive aspect of new tube developments. That is the competition of foreign equipment and tube manufacturers. Starting largely in the high-quality audio component field, this influence has been spreading into the TV and industrial field. Tubes made in Europe, having different design concepts, are gaining favor with some domestic equipment manufacturers. When this happens, the domestic tube supplier loses business, so he immediately counters by making a similar or an identical type.

There are now quite a number of these foreign-originated tubes being made in this country under EIA type numbers. As the foreign electronics industries develop further, we must expect even more of their ideas to affect our own industry. This means more tube types. Many of these are real contributions to the technology of our times. Some are merely different ways of doing the same thing that something else could have done just as well. But ideas move in fads. Right now there is a popular fad among

equipment designers to regard any foreign introduced tube as a "must" in his new design. Perhaps it is the result of the popular preoccupation with foreign cars. But whatever its cause is, the result will be many new tube types having a slightly foreign accent in the next few years.

TECHNOLOGICAL DEVELOPMENTS

The tube industry has been one of those industries that appears to have sprung into being, completely developed. Of course it wasn't really that way and much development and research went into the very early tubes. But it is true that since their appearance in commercial form, very few major technological advancements have been made. Almost all new tubes have been of the "rework last year's model" type. Thus, there have been many changes in heaters, as well as in bulb sizes and shapes, and bases and caps have come and gone. But these changes were not fundamental, and they permitted no new uses or major improvements in performance. This is why we waited until this point to discuss those really significant developments which, while they meant the introduction of some new tube types, were more than justified because of their effect in moving the art ahead by gigantic steps.

The first of these was the introduction of the indirectly-heated cathode with its special low-temperature, high-activity coatings. Besides making direct AC filament operation practical, these cathodes provided the necessary peak powers needed in many later applications where pulse operation was essential. To this day there have been no major improvements in cathodes or in their coatings, even though a great deal of research has been devoted to this subject. Although some success is being reported with cold cathode techniques, they are far from being practical at this time.

The second major advancement in tube structures was the invention of the screen grid. The improvement in gain and efficiency permitted by this development over the original triode has not been duplicated by any single advancement since that time.

The beam power tube ranks as a major development because it permitted the evolution of the most efficient

pentodes ever produced. Certain classic designs, developed soon after this principle was discovered, have never really been improved upon. They have been scaled up to meet newer requirements, but their fundamental excellence remains unchallenged.

The hybrid tubes for use in conjunction with transistors seem to have been overlooked by many designers in their feverish attempt to transistorize everything today. Perhaps in a more sober era of re-examination, their true potentialities will be recognized. Their gain, efficiency, economy, and stability are really far out in front of most transistors available today. Their continued use in automotive equipment is pretty well assured, but why they have not seen expanded use in many other forms of equipment is still something of a mystery to many who are familiar with their potentialities.

Space-charge tubes have always held great theoretical interest for most tube designers. Until recently, very few practical examples of this type of tube had been produced. In the hybrid automotive line, there is one type—the 12K5—which is a good example of what can be accomplished using this principle. It is well suited to transistor and tube combinations. If this form of circuitry becomes more popular, the space-charge tube should produce many variations and contribute its share to the ever-expanding family of tubes.

Another major contribution of fairly recent origin is the frame-grid tube. Unlike some of the sales-invented slogans of the past, describing such standard production techniques as "gold grids," the frame grid is a real step ahead. The grid windings for very close-spaced tubes, such as are required for extremely high transconductance, or for very high frequency performance, had about reached its limit some years ago. The frame grid permits a much finer winding, or closer spacing to be achieved with production type tubes. These tubes are finding an immediate use in TV tuners as well as in various industrial and military applications. It is expected that their numbers will increase rapidly as their field benefits are recognized.

One final development shows promise of being the forerunner of many new types in the next few years. This is

the secondary emission tube. This principle has long been known and has been used in photomultiplier type tubes. But the use of this principle in a successful Class-A amplifier is a major development of great significance. The transconductance of tubes using this principle can be very high. In addition, their high-frequency characteristics make them very attractive in the wide-band amplifier field and in such applications as computers where very high frequency switching is a requirement.

WHY SO MANY TUBE TYPES?

The answer to “why there are so many tube types”—is found from our discussion to be the result of many factors, involving technological evolution and competition (both foreign and domestic), but most of all a trend away from standard tubes for more or less standard applications, toward the development of highly specialized functions. As this trend is certain to continue with the ever-more specialized nature of the different segments of this industry, the number of tube types available is likewise certain to go on expanding at an accelerated rate, unless, or until, some other device replaces them entirely. But in that case, the problem won't be ended. It will just have a new name. In case you weren't aware of it, there are approximately 5000 semiconductor devices registered already, and they've only been with us about one-fifth the time that vacuum tubes have!

CHAPTER 7

PREDICTING TUBE PERFORMANCE

The problem of estimating the future performance of tubes is faced by almost everyone who works with them. The engineer wants some assurance that he is choosing the right type to do the best job in some equipment he is designing. The maintenance engineer wants to know how long the tubes in his equipment will continue to function. The service technician wants to convince his TV customers that certain tubes should be replaced before they fail, and the do-it-yourself individual wants to know if any of the tubes he has removed from his set are any good, and if so, which ones. The next two chapters will deal with this rather universal problem and will explore some of the methods available for resolving it.

Tubes may be classified according to their various structural differences. When this is done, they will inadvertently be roughly classified in accordance with their over-all reliability. In other words, some fairly dependable rules of thumb exist, based on experience alone, which can serve as a first approximation for estimating the service to be expected from certain classifications of tubes. Other modifying factors that may affect specific applications are discussed in succeeding paragraphs.

LIFE EXPECTANCY BY STRUCTURE

Generally speaking, if two tubes are designed to perform similar functions, the one having the larger envelope will prove to be the more reliable. All other things being equal, there appears to be a direct relationship between bulb size and the average life expectancy of tubes. This undoubtedly stems from the simple fact that the larger bulb runs cooler because its larger area permits greater dissi-

pation of the heat generated within the tube. A striking example of this is the 6AQ5 and the 6V6GT, the former being a miniature version of the latter, but carrying the same ratings. The 6AQ5 has never been able to perform at these ratings and still turn in the same life figures as its larger forerunner.

Similarly, there appears to be a fairly good correlation between reliability and the size of the tube elements. Tubes having larger plate structures and larger grids and cathodes are more reliable than miniaturized versions having the same general characteristics.

It naturally follows that tubes having the greatest spacing between elements are less prone to premature failures than those in which the spacings between elements are much less. This has to do particularly with grid-to-cathode spacings, and is not only due to the reduced insulation paths, but also to the fact that the nearer the grid is to the cathode, the hotter it will run and the more likely it is to become contaminated with the coating material on the cathode.

The length of the mount, or more precisely, the length-to-height ratio seems to be important also. Here, the evidence seems to support the short, stubby structure over the long, thin structure. There are several reasons, but they all add up to the simple fact that the shorter mount is usually more rigid and permits less bending between the upper and lower mica supports.

Generally, it is also true that the more complex the tube becomes in terms of the total number of active elements, the more prone it is to a premature failure. Thus, the simplest tubes, which are the diodes, are generally the most reliable ones. This is, of course, modified by their usage as will be pointed out shortly. Next come the triodes, followed by the pentodes, and finally the pentagrid converters. Actual field returns support these failure ratios, although the exact reason for them is not as clearly documented. It can be assumed that the laws of statistics certainly play some role in this situation. The probability of a short occurring, for example, must inevitably increase if the number of opportunities increases—and the more elements there are within a given structure, the more chances there are for a short to develop.

The same rule of thumb exists for multisection tubes, but not for exactly the same reasons. In a multisection tube, we usually have two or more completely separate, individual tubes. Yet, they are looked upon as a single tube. The chances of a failure occurring within a given envelope increases at some rate which is not simply the arithmetic sum of the number of units within the envelope. It is more nearly an exponential rate, largely due to the fact that if one section fails, the other section must inevitably be called a failure also, since they are inseparable. There is also the matter of interaction between the elements. One section may be operated so that it contributes to the failure of another section while suffering no serious malfunction itself. This is especially true of the nonsymmetrical multisection tubes.

A nonsymmetrical multisection tube is one in which the sections are not identical—for example, a triode and pentode within the same envelope. Due to differences in usage, one section will more than likely operate at a higher dissipation level than the other. When this is true, the normal processes of degradation which take place during life, such as gas evolution and metal evaporation, will not occur at uniform rates for each section. It is a natural phenomenon that these processes of degradation will affect the cooler section first. The lightly-loaded section usually suffers for the more heavily-loaded section. Failure occurs prematurely since neither would have failed for this reason had they been operated individually.

Although metal tubes are not much of a factor today, it is interesting to note that they have been, at least twice in the past, and that they are making a new bid for acceptance in a new, miniaturized form today. Historically, the metal receiving tubes of the '30's and the metal TV picture tubes of the '50's did not prove as reliable as their all-glass equivalents. Whether or not the latest attempts in the direction of metal-enclosed subminiatures will prove to be an exception to this rule remains to be seen.

LIFE EXPECTANCY BY APPLICATION

Just as there is a general relationship between tube structures and their life expectancy, so is there a fairly

close relationship between tube applications and life expectancy. Naturally, there are many ways a tube may be used in a given service. Its actual life will depend upon whether the specific application is conservative or excessive for that class of service.

Nevertheless, certain types of service are known to enjoy better average life expectancies than others (Fig. 7-1). By recognizing that some forms of service are inherently more severe than others, and that a higher failure rate is to be expected from tubes in these services, a lot of imaginary problems can be ruled out before they get started. If the user knows that his 400-horsepower rolling palace is supposed to burn more gas than his neighbor's two-cycle scooter bike, there are apt to be less hard feelings than if he doesn't know it!

Tube applications can be classified in several ways, but there are three main areas that affect their life most intimately. Of greatest importance are the three inseparable ones—voltage, current, and temperature. Tubes operated at low voltage and current densities will probably also run fairly cool. These are the tubes that seem to live forever. Conversely, tubes that operate at the other extreme will not live very long. Naturally, there are combinations of conditions between these extremes, but the presence of any one of these three factors will inevitably shorten the life of any tube.

There is then the question of intermittent versus steady-state operation. Once again, there are exceptions, but in general, tubes that are operated continuously, without interruption, are more inclined to give long, trouble-free service than those that are operated intermittently. This is because many of the reasons for sudden failure are the result of strains developed from heating and cooling. A hot tube tends to clean up its own gas involvement. Most circuit-induced failures usually occur immediately after equipment is turned on after long periods of idleness. By not turning it off, these failures are avoided.

There is a special form of intermittent operation which is not always recognized for what it is and thus deserves some additional clarification. This is the type of service usually referred to as "pulse service." Multivibrators, blocking oscillators, or any tubes which amplify or pass

APPLICATION SEVERITY

Pulse Rectifiers—high power

UHF Amplifiers & Oscillators

Power Rectifiers—large

Amplifiers & Oscillators—high power

Pulse Generators—medium power

Amplifiers & Oscillators—medium power

Pulse Amplifiers—medium power

VHF Amplifiers & Oscillators

Amplifiers & Oscillators—low power

Amplifiers, Class A—medium power

Power Rectifiers—small

Amplifiers, Class B—medium power

Amplifiers, Class A—low power

RELATIVE LIFE EXPECTANCY

Fig. 7-1. Relative expectancy chart shows a tube's life depends on its application.

signals developed by these devices are typical pulse circuits. One important characteristic of a pulse circuit is its duty cycle. This is the percentage of time it conducts compared to the total time the equipment is turned on. Typical TV pulse tubes have duty cycles of less than 15 percent. This means that the tube is conducting for only 15 percent of the time and is cut off 85 percent of the time. This is intermittent operation even though the tube never cools down between cycles. Tubes used in this manner, and not specifically designed for this type of service, will be affected by the formation of cathode interface resistance, which will lead to an earlier-than-normal loss of transconductance. Tubes intended for pulse operation are made and processed differently from those intended for DC or Class-A operation. When designed properly, they do not develop interface resistance.

A third general classification for the application of tubes may be made according to the frequency at which they operate. There is a fairly close parallel between frequency of operation and useful life. This is due, in part, to the fact that most tubes intended for use at very high frequencies are constructed differently from those intended for use at lower frequencies. Thus, most high frequency tubes tend to be small, and to have very closely-spaced elements. This is an inevitable compromise on the electronic laws that govern transit time, lead lengths, interelectrode capacities, etc. Nevertheless, tubes operated at high frequencies, even those not especially designed with that purpose, do suffer from certain effects not so noticeable at the lower frequencies—and these effects do foreshorten tube life.

The normal amounts of gassing and insulation leakage which all tubes suffer from as time elapses have a more detrimental effect on their performance at higher frequencies than they do at some lower frequency. Thus, a tube may stop oscillating at 750 megacycles, yet be quite satisfactory as an oscillator at 300 megacycles. A given amount of gas current may have no ill effect upon a tube at 5 megacycles, yet may raise its noise output by enough to be quite unusable as an amplifier at 50 megacycles.

In the case of power tubes which are operated at the higher frequencies, a sort of compounding of these effects

takes place. Because the internal losses are higher, these tubes tend to develop more heat as their frequency of operation is increased. This increased dissipation contributes to a more rapid evolution of gas and to the earlier formation of excessive leakage paths. Normally, tubes intended for operation as power amplifiers or oscillators at the higher frequencies are derated as frequency increases. This is an attempt to compensate for these natural effects. While this derating does result in their enjoying more nearly comparable life spans to tubes operated at some lower frequency, they are generally not the same. Where several tubes of the same type are used in the same piece of apparatus, it is often possible to use those that are no longer satisfactory in the highest frequency stages in some other lower frequency stage. Many hours of additional satisfactory service may thus be obtained from them.

TESTS FOR INITIAL PERFORMANCE

One of the most common preoccupations of those who use tubes is the practice of pretesting tubes before using them in an endeavor to determine their ability to perform satisfactorily. There are many ways of pretesting tubes, but very few of those in common usage are worth the time spent in performing them. Unless conducted properly, most tube testing is about as ineffective in predicting anything as reading tea leaves would be. Even when conducted according to the best techniques known to those who have spent a major part of their lives studying tubes, the results are often disappointingly vague. Some tests correlate better than others. Some applications require a measurement of so many characteristics that correlation becomes almost impossible. One thing will become apparent, however, as we examine some of the specific tests which can be performed: there is no one test that gives very good correlation with any application. Even the simplest application usually requires that several readings be taken before an estimate of the tube's ability to perform satisfactorily can be made.

Let there be no mistake about one thing. Instruments are available for measuring every known characteristic

of tubes, no matter how obscure or involved it may be. These instruments (Fig. 7-2) are very complex and highly accurate in their specialized area of measurement. This is not the difficulty when it comes to predicting tube performance on the basis of measurement. The trouble lies in trying to relate the many measurements that can be made, and from them to preparing an accurate prediction of tube performance in a given piece of apparatus. No machine capable of performing this complex function exists; consequently, no exact method for measuring and predicting tube performance exists either. What is done is a compromise; imperfect as it may be, it serves the useful purpose of controlling uniformity and estimating actual performance to a reasonable degree—as long as the statistical approach is applied to many tubes and not to just one tube.

Testing for Gain

Perhaps the simplest test to correlate with actual performance is the one commonly associated with Class A amplifier gain. Assuming the frequency to be below 10 megacycles, transconductance gives a very good estimate of circuit gain or amplification, provided the test conditions are the same as those in the circuit. For example, if the tube is an IF amplifier operated with 100 volts on the screen, 250 volts on the plate, and -1 volt between grid and cathode, and these conditions are set up in the classic transconductance circuit, the reading will bear a close correlation to actual performance. It should be remembered that this is only a relative reading and is meaningful only when compared to several other readings taken on similar tubes under the same test conditions. The tube having the highest transconductance should have the highest measured gain in the IF strip, provided all tubes have the same plate resistance. If they do not, the tube having the highest combined transconductance and the highest plate resistance will have the highest gain.

Power Output

There is no power-output test that correlates well with performance, except to operate the tube in a manner more or less identical to circuit conditions and to measure the



Fig. 7-2. Master tube bridge for measuring every known characteristic of tubes. (Courtesy of CBS Electronics.)

true power output across the proper load. This can be done at one frequency, for example, 60 cycles; as far as the tube is concerned, it will prove to be quite accurate even at relatively high frequencies—say up to 60 megacycles. The load must be appropriate for the chosen test frequency, and the same current and voltage conditions that exist in the actual circuit must be used during the test. It is important that the drive voltage and, in some cases, the drive impedance also be the same. When these conditions are met, the correlation will be very close to 100 percent. At frequencies higher than 10 megacycles, RF loading effects, lead inductances, and interelectrode capacitances become important. Therefore, correlation will become progressively poorer as the frequency is raised.

AC Amplification

Voltage amplifiers or tubes having very high μ are best tested in a circuit which simulates their AC and DC conditions, with the result being read as a simple ratio of *voltage in* versus *voltage out*. μ can, of course, be read on a tube bridge, but this characteristic alone does not take into account many of the practical circuit conditions encountered and, therefore, correlates poorly. In measuring AC amplification, it is extremely important that the tube be tested with the same high-impedance grid resistor normally found in the circuit, and that the grid drive voltage remain safely below the effective grid bias level. This usually means a signal of 0.5 volt or less, in order to prevent grid clipping which produces a false reading. The output should be read as a simple AC voltage, using a high-impedance meter in the plate circuit. It is important that the signal source have a relatively high impedance so that it simulates the normal stage preceding a voltage amplifier stage. It is interesting to note that when properly conducted, this is a very sensitive gas test, also, because even a very minute amount of gas will cause a nonsymmetrical loading of the input signal, thereby reducing its amplitude and consequently reducing the output signal. This same amount of gas will be undetected in so-called "gas" tests, but it will cause serious distortion during actual application of the tube.

Frequency Converters

Correlation is most difficult for converter tubes, especially those of the multigrid type. These are really pentodes with a triode built within the usual grid-to-cathode spacing. There are several characteristics you can measure, but when you put them all together, the results often don't agree with the actual performance measurements.

To begin with, you can ignore the pentode and measure the triode, which is usually measured for transconductance. Then you can separately measure the pentode for transconductance. It just so happens that there is a fair measure of correlation between these two measurements over a limited range of oscillator coil characteristics, and it usually goes in the inverse direction for the triode and directly for the pentode. The reasons are as follows: Since the triode is usually used as a self-excited oscillator, it is self-biased by means of its grid resistor. This bias also sets the operating point for the pentode since the oscillator grid is the number one grid, or the one nearest the cathode. Since the transconductance of the triode will determine the amount of feedback obtained from a given oscillator coil, and since this will control the amount of drive delivered to the number one grid, the higher the transconductance of the triode, the higher will its bias become and therefore the further will the pentode be biased toward cutoff. So, the pentode's effective transconductance will be decreased by the high activity of the oscillator. But since the oscillator is self-biased and, therefore, more or less self-regulating, this relationship is valid only over a very narrow design range for the oscillator coil. Outside this range, the relationship may reverse.

Some mixer circuits use an additional characteristic of the pentagrid converter tube and thereby render correlation and measurement almost impossible. These circuits introduce regeneration, usually at the IF frequency, either by feeding back some plate circuit energy into the cathode circuit, or by using the screen grid as a partially active element and introducing the in-phase signal by means of a small tap on the IF coil primary. When this latter circuit is used, the transconductances of the screen grid, control grid, and triode grid all become interrelated in a

complex manner. The result is that no reasonable correlation will exist between any of these measurements.

There are methods for testing pentagrid converters, using 60 cycles to drive both the number one and number three grids at the proper amplitude and in the proper phase, and then measuring the degree of cancellation in the output. This method, while useful for control purposes, is not very effective in correlating with actual application. About the only successful method of measuring pentagrid converters is in a circuit which duplicates the actual application, at least, insofar as the oscillator coil and grid resistor are concerned. The signal is introduced into the control grid circuit and the converted IF frequency is measured in the plate circuit. The relative magnitude of the two signals is expressed, in micromhos, as conversion transconductance. When the circuit elements are the same as those used in the actual equipment, the correlation is very nearly 100 percent.

Oscillators

Test measurements of oscillators are very often complicated by the fact that they are intended for use at high frequencies. Where an oscillator is to be used at low frequencies, two characteristics are important. Transconductance will determine whether the tube has enough gain to overcome circuit losses and hence sustain oscillations. If some sort of power output is important, then pulse emission may have to be measured. Pulse emission is not to be confused with ordinary DC emission, which is simply the short circuit DC current drawn from the cathode with all other elements connected together as a diode. It is usually conducted at less than 50 volts and was originally intended as a manufacturing process control.

Pulse-emission testing is performed with the individual tube elements properly isolated and connected to appropriate voltage sources. The tube is held in a cutoff condition by a large negative grid bias and is then driven into conduction for brief intervals by a grid driving signal. If the tube is one where the grid normally swings positive, it will be driven momentarily into this positive grid region by the driving signal. The peak current drawn from the cathode may be very high under these conditions, but will

not result in damage if the duration is kept very short. Thus, the average, or RMS value may be only milliamperes, even though the peak value is amperes.

This method of testing permits a very complete analysis of cathode capabilities, although to be most easily interpreted, it should be read on a scope. A lack of peak emission capability is often the cause of poor oscillator or Class-C amplifier performance, especially as the frequency of operation is increased. Even though the cathode may show excellent DC emission, it may be incapable of supplying current in sudden, short bursts as is required in oscillators or pulse tubes. This method of pulse-emission testing is essential in evaluating pulse oscillators or amplifiers also.

Another characteristic important to pulse oscillators, generally associated with timing circuits, is what is known as grid perveance. The diode slope of the grid-to-cathode characteristic when the grid is positive is an important indicator of significant differences in tubes which, while normal in most other respects, tend to oscillate at the wrong, or at least at a different, frequency. This characteristic will be measured in the positive grid region and at values of voltage usually less than three volts. By measuring the current to the grid when a +1 volt is applied to it, the difference between those tubes which operate on frequency and those that do not can usually be distinguished.

Another important characteristic that needs to be measured when evaluating pulse tubes is cutoff. The negative voltage required to reduce the plate current to 50 microamperes or less, when the rated plate and screen voltages are applied, is usually what is defined as cutoff. Pulse tubes are supposed to operate very much like a switch. They have two essential modes of operation, one of which is closed circuit, or *on*, and the other is open circuit, or *off*. It is essential that this cutoff characteristic be read with the full potentials applied to the plate and screen electrodes. Many tubes which cut off normally at low anode voltages, do not cut off well at their operating potentials. When this happens, the "switch" is leaky, and circuits such as horizontal-sweep amplifiers in TV will not function properly. This is a frequent cause for the loss of

high voltage, even though there is a reasonable amount of sweep. Failure to cut off properly will have little effect upon the conduction time, and cannot be evaluated by any test which measures the tube in a conducting condition.

Diodes and Rectifiers

Detector diodes have at least two important characteristics, one of which is the diode perveance already mentioned in connection with the grid of pulse tubes. Diode perveance is simply the slope of the rectification curve. The most significant part of this curve is in the 0-to-3 volt region. The second characteristic is closely associated with the first, but must be separately measured. It is known as initial velocity voltage, or contact potential. This is the voltage which will be read across a large value of resistance (one megohm or greater) when connected between the diode plate and its cathode. It should be read on a high impedance voltmeter.

Initial velocity voltage is a negative potential, so it opposes any positive potential applied to the diode plate. It has a great effect upon the diode curve in the low-voltage region. Initial velocity voltage is sometimes used as the bias for several other tubes and, therefore, its actual value may have an indirect effect on the over-all performance of a given piece of equipment.

High-power diodes, such as damper diodes, are sometimes used to rectify large pulse currents. In such applications, the principal characteristic to be evaluated is pulse emission. Again it should be emphasized that there is no correlation between DC emission and pulse emission. Defective damper tubes which cause compression on the left side of the picture often will be found to have normal DC emission but a much reduced pulse emission. These same tubes are quite prone to arcing, especially when initial power is applied.

Power rectifiers would seem like very simple tubes to test; compared to some other types, they are. For all practical purposes, they can be tested under load and the voltage output taken as a figure of merit. While this gives assurance that the tube can rectify and that the tube voltage drop has not risen to a serious level, it does not take into account a rectifier tube's weakest link so to speak.

Rectifiers must withstand rather high inverse voltages during the nonconducting half of each cycle. During these periods, great damage can occur to the tube and its associated equipment if a certain condition is present. This condition is back emission from the plate. Back emission may be present initially as a result of ineffective process control, or it may develop with use or age. In either event, tubes with high back emission are not good risks. They may arc at any time, or they may rapidly lose peak emission capabilities. Back emission is read as a current flowing away from the plate when it is highly negative with respect to the cathode.

PREDICTING LIFE

The question is often asked, "Is there any method for predicting the life of a tube based on initial readings?" The answer is almost a flat "No." True, there are some characteristics, such as an excessive gas, which some will interpret as a sure sign of early failure. This, however, is not always true. It depends upon *what* gas is present. Some forms of gas are normal; others clear up during use; still others cause cathode poisoning. To say that the presence of gas will provide any indication of life expectancy is pretty unrealistic.

Such things as back emission and grid emission are sometimes pointed out as sure signs of early failure, but again, this is not always true either. Back emission, if caused by initial processing, often clears up by itself, and there is at least one very popular transmitting tube that won't function properly unless it has a certain amount of grid emission right from the start! Without grid emission, tubes of this type can't pass the military or the customer's acceptance specifications!

There is no single measurement of an initial nature which is of any real value in predicting life. The next chapter deals with various techniques the trained observer can use to isolate those tubes which have degenerated and are no longer a good risk from a life expectancy point of view. These are not initial tests, and they are not "one shot" procedures, but they are rather effective if properly conducted.

CHAPTER 8

TUBE TESTERS

In almost every discussion of tubes and their peculiarities, the subject of tube testers is bound to be raised sooner or later. Indeed, there is probably no more universally misused or misunderstood piece of equipment in the field today than the modern tube tester. In order to try to dispel some of the mystery, or what at times amounts to downright superstition, with regard to these devices, much of this chapter will be devoted to an explanation of their basic characteristics and capabilities.

One of the principal reasons for the wide divergence of opinion regarding the merits of tube testers stems from the many individual motives behind tube testing. There are at least three, and perhaps four, distinctly different motivations behind those who want to test tubes. Tube tester manufacturers are fully aware of this, and they design their many models in an attempt to satisfy these various aims. When used for the express purpose for which they were designed, most of these instruments perform useful and necessary functions. It is certainly not the fault of the manufacturers that many users of their instruments fail to understand their real purposes or limitations.

EARLY TUBE TESTERS

The original purpose of tube testers was to provide tube sellers with a means for making on-the-spot proof of tube operability. Since tubes have been sold to all sorts of do-it-yourselfers right from the earliest days of radio, they were sold on a no-exchange basis, and it was necessary to show the customer that the tube was working when he purchased it. For this purpose, early tube cartons were made in such a manner that the prongs could be inserted

into a tester socket without removing the tube from its factory-fresh carton. Proving that a tube was good merely meant that it had an intact filament and that it was capable of emission.

For this type of service, the instrument had to be extremely simple. It was often used by salesgirls or other nontechnical people, and all they wanted was a "good-bad" indication. Such checkers tested all tubes as diodes. About the only adjustments were the filament voltage selector and the meter shunt, or "English" dial. This same type of instrument, with very few modifications, is still being used today in some of the so-called "quick checkers" and drugstore do-it-yourself checkers. There are even some portable models which can be carried into the home to perform this same "good-bad" test where the customer can see it being done.

As the business of servicing electronic equipment became larger, the need for a better instrument that could help the technician in diagnosing defective units became apparent. Such an instrument needed greater flexibility than the simple device just described. It needed individual connections made to the different tube elements, as well as some sort of a qualitative measure of the tube's performance. This gave rise to the multiswitch units that measured something called "dynamic mutual conductance." These instruments are present today in large numbers, and constitute the largest single type of tester used in the industry. They are not as fast as the simplest type, but they are not as crude either, so what is lost in speed is made up for in the relatively greater meaning of the information they provide.

A third fundamental need for tube testing is found in the more advanced service and maintenance establishments, and in schools, laboratories, and factories, where the emphasis is more on measuring tube defects and in making a more significant quality comparison. Instruments for such usage have to be somewhat more flexible than either of the other two types. They must apply individual voltages to each element in the tube, and usually allow for individual adjustment of these voltages, or at least some of them. They will also provide a measurement which is closely correlated with true transconductance.

Finally, we have the need of the laboratory or the large user of tubes who wishes to measure tubes in terms that are standard throughout the industry. For this purpose, the tube tester must be extremely flexible. It is necessary that each electrode in any tube be separately supplied and separately monitored, both for voltage as well as for current. It is necessary that the driving voltage be adjustable and monitored. The output indicator must be independent of the DC current flowing in the plate circuit, and it must read in terms that are standard and repeatable from one instrument to the next.

From the foregoing, it should be apparent that the various needs for the different kind of tube checkers precludes any possibility of there being a universal instrument. No one instrument can fulfill all these requirements. The simple fast-check device is not capable of measuring tube characteristics with any degree of accuracy, other than to indicate those that are "dead." On the other hand, the complex tube tester which is capable of measuring qualitatively, requires special skill and knowledge on the part of the operator. Furthermore, operation and evaluation is necessarily too slow and much too elaborate for it to be used as a portable instrument. So we come to the inevitable conclusion that a tube tester, in order to be practical, has to be designed with some compromises. It is thus questionable as to whether or not these devices are capable of providing *all* the information needed to *predict the probable usefulness* of tubes used in a given piece of apparatus.

Evidence of this is given in Fig. 8-1, which shows the result of testing 100 tubes in three different commercial tube checkers and comparing the results with those obtained from testing the same tubes in standard laboratory equipment. It will be seen that instrument "A" shows reasonably good correlation. This is an instrument which applies appropriate voltages to each element of the tube under test. It is a top-quality service-type instrument.

The instrument designated as tester "B" is a somewhat simpler unit. It uses a metering circuit wherein the DC plate current of the tube under test plays an important part in the actual reading. This is shown in the much wider spread of its readings. Note that although 95 percent of all the tubes were actually over the bogey or pub-

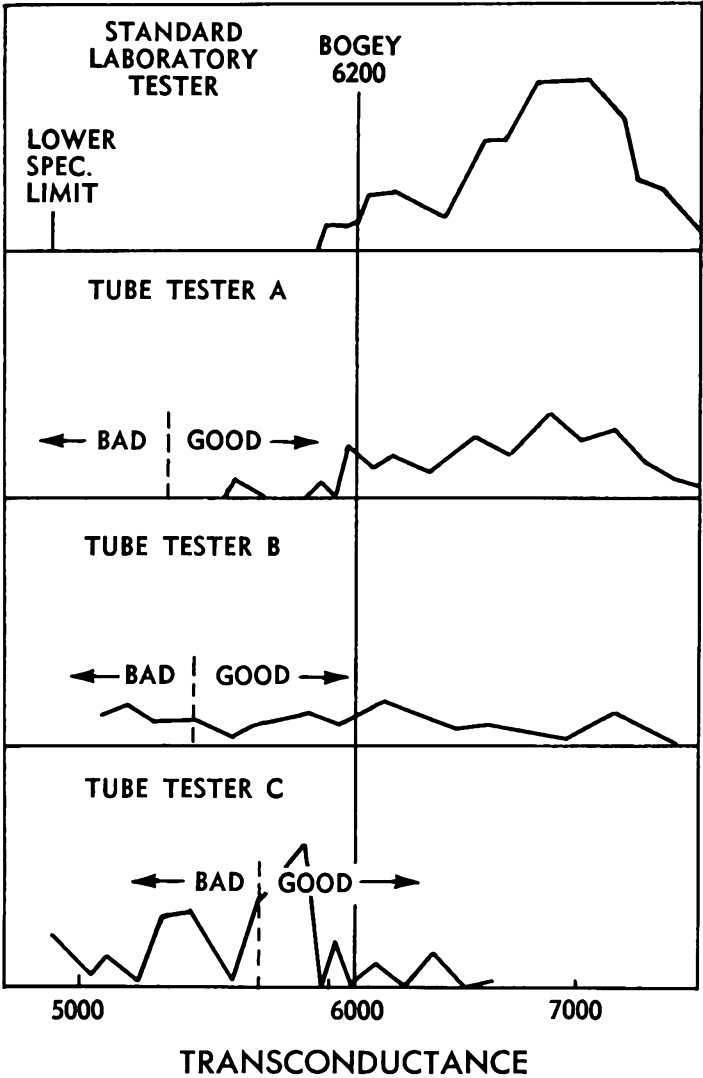

Fig. 8-1. Comparison of results obtained when a number of tubes were tested in three commercial tube testers and in a standard laboratory tester.

lished value for transconductance, this tester read over half of them as being below this value.

The final instrument is of the quick-test variety which connects all tubes as if they were triodes. The lack of correlation here is all too apparent, inasmuch as the readings are completely unrelated to transconductance. Not only did most of the tubes "fail" on this tester, but some of them, when retested in the laboratory instrument, had lost much of their transconductance. This was found to have been the result of the excessive current drawn by the quick-tester. Tubes are operated as triodes in this tester, and raw AC voltage is applied to all elements, including the grid. In relatively high transconductance tubes, the grid is very close to the cathode. Heavy rectification current, caused by driving the grid positive, results in excessive heating of the grid wires. This causes the grid rods to warp and critical spacings to become upset, accounting for the loss of transconductance discovered during the comparative reading tests.

CLASSIFICATION OF TUBE TESTERS

We have been discussing the general classes of tube testers in a somewhat remote manner. Actually, this isn't necessary because there are EIA standards which define the various classifications of tube testers very completely. This allows the individual purchasing one of these devices to know just what he is getting for his money. Although the availability of these standards has not been widely publicized, they can be obtained by anyone who is interested enough to write to the manufacturer of the instrument in question, asking him in what classification his instrument falls.

The EIA standards for tube testers recognize only four basic circuits. Fig. 8-2 shows these in their simplest form, and are identified as Groups I, II, III, and IV. It should be explained that various mechanical and electrical features will distinguish one model from others in the same group. Such variations as push buttons, punched cards or prewired panels do not in any way change the ultimate effectiveness of the instrument. They can only affect its convenience. Likewise, no distinction is made regarding

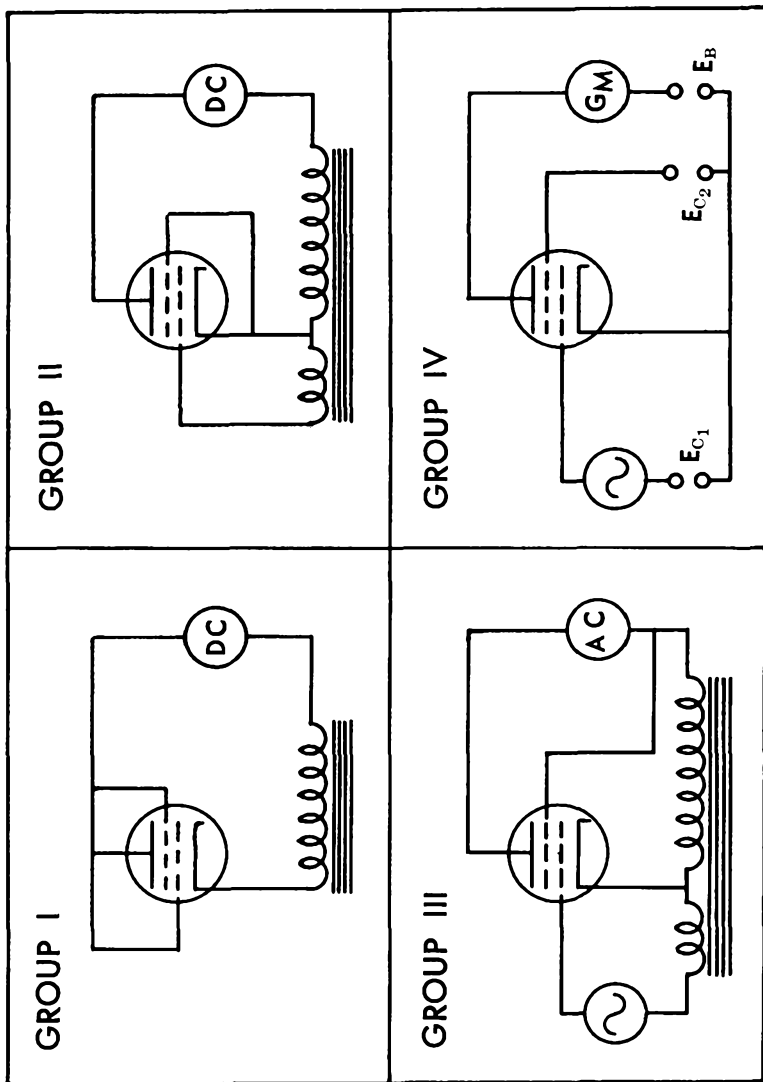

Fig. 8-2. Four basic circuits used in tube testers, as specified by EIA standards.

the tolerances or the accuracy of the various instruments in a given group. Such things as filament voltage regulation are important quality considerations the user should explore before investing his money. For example, he should try inserting a tube with a heavy heater current in the tester and then reading the actual applied filament voltage. Does 6.3 volts turn out to be 4.7 volts? Would you check a new car, or a used one for that matter, with kerosene in the gas tank? Then why try to test a tube at any voltage other than the one at which it was designed to work?

Let's examine the four basic types of tube tester circuits and see just exactly what they are and what they can and cannot be expected to do. Tube testers in Group I are defined as "a device incorporating a circuit in which all available electrodes except cathode are connected together and an AC voltage is applied through a DC indicator between the interconnected electrodes and cathode." This is a common emission checker or "dynamic emission" checker where the tube is used as a rectifier to provide its own DC current. Such testers usually apply the same potential to all tubes, merely changing the value of the meter shunt to keep it from going off scale on the higher conductance types. Usually, no consideration is given to the fact that true emission testing should be performed at a different voltage for each tube type. Placing just any voltage across a tube, and drawing all the emission current the cathode will supply, is a sure way to gas up many tubes and to warp grids or cathodes in others.

Tube engineers know that every cathode has a maximum safe current limit. This is based on the area of the cathode, and a specific constant applies for any given type of cathode construction. This constant is expressed in terms of the current per square centimeter of cathode area. If this limit is exceeded, damage to the cathode surface will certainly follow. It may not be immediately apparent; in fact, it probably won't be. But it will shorten tube life just as sure as racing a cold motor will shorten its life.

Group II tube checkers are defined as "a device incorporating a circuit in which separate AC voltages are applied between grid and cathode and between other ele-

ments, individually or collectively, and cathode. A DC indicator is connected in series with the plate." Such devices make a simple AC amplification test, which is only vaguely related to true transconductance.

Because these instruments use a DC indicator in the plate circuit, they are heavily influenced by the actual DC plate current of the tube under test. In other words, two tubes having similar transconductances but different plate currents will differ widely in their readings. This would be of small concern were it not for the fact that the tube having the higher plate current will read as the better quality tube. It will read higher on the "good-bad" scale, or on the transconductance scale, if one is provided. Two things may happen in this case. First, if the tube is used in a circuit where the effective plate load is high, it will not be able to draw the higher plate current; so in reality, its transconductance will be lower than actually measured during the test. Its performance, as actually measured in the equipment, will thus be inferior to the tube which gave a lower "good" reading on the meter. Second, if the tube is used in a circuit where the load resistance is low enough to permit the higher plate current to flow, it will run hotter than the second tube and thus will not last as long. This is an example of the weakness of this type of tester to check tube "quality." Actually, it is possible for the tester to pick the wrong tube as being the "best" one, either from the standpoint of initial performance or of useful life. It is the one most common situation encountered when using an instrument in which plate current, and not signal current, is used in obtaining a measurement.

Another point to consider regarding instruments in Group II has to do with their method of applying a grid signal. A common signal is usually applied to all tubes regardless of their normal bias requirements, sharpness of cutoff, or anything else. This results in many tubes being overdriven into their positive grid regions. When this happens, the grids conduct, thereby loading down the signal source and effectively reducing the amplitude of the drive. This results in lowered plate current and a lower reading on the meter, which tends to place a premium on remote cutoff tubes. Tubes having poorly aligned grids can

actually rate much better in this type of tester than those that are mechanically perfect. Since misaligned grids may also contribute to lowered transconductance, these are really the poorer quality tubes; yet, they may read best on such a tube checker.

These are two examples of why most tube engineers will agree that you can't measure tube quality with a checker classified under Group II standards. Yet, there is probably the opinion among most users of tube testers that tube engineers frown on them because they call too many of his "good" tubes "bad." This may be true, but it is just as true that no instrument can err on one side of the ledger all of the time. These devices are often indiscriminate. They are, on occasion, capable of calling "bad" tubes "good"!

Group III tube checkers are defined as "a device incorporating a circuit wherein separate grid signal and bias voltages are applied with the indicator responsive only to the grid-signal-produced component of the output current." Here at last we are beginning to deal with a measuring device. Instruments in this class provide individual bias and signal sources so that the tube can be operated in a manner similar to that in which it will be used. Grids are not driven into conduction, and the indicator is not dominated by the DC plate current. Such an instrument may be said to read transconductance, or something very close to it. Because of practical considerations, the signal voltage amplitude may not be exactly known and the output indicator does not have zero impedance, as it should have, but these are very minor deviations from the ideal. Provided reasonably good voltage regulation is built into the instrument, it is capable of making comparative checks on tubes, using transconductance as the measure of quality.

The only argument that can be brought up in connection with such an instrument is the fundamental one regarding the significance of transconductance itself. Where the application is one which involves Class A amplification of a sine wave signal, there can be no question but what transconductance is a good figure of merit. There are limitations to its use as a direct indication of individual tube merit, as pointed out in the previous discussion of corre-

lation. But having granted its general usefulness as a measure of the gain characteristics of a tube, we then have to ask the logical question, "In how many typical applications are tubes used as Class-A amplifiers of sinusoidal signals?" The answer is something less than 10 per cent, which means that even the finest instrument available for reading transconductance is reading a characteristic which can be correlated with only about one out of every ten applications.

What of all the other applications where some other characteristic, such as zero-bias plate current, pulse emission, cutoff, or power output are most significant? Can transconductance be used in any way to indicate whether or not a tube has these other essential characteristics? Only in one very limited sense. If a tube is dead and has no transconductance, it will have none of these other characteristics either. That we can say with certainty—but the opposite is *not* true. Because a tube has normal, or greater or less than normal, transconductance can in no way be interpreted as an indication of how it will perform in a pulse-operated circuit. Therefore, we must conclude that a tube tester, no matter how accurate it may be, can give us information which is only of very limited value in estimating just how well a tube will perform in its ultimate application.

Group IV testers will not be discussed except to point out that these are the laboratory type instruments used by tube manufacturers and others interested in making standard measurements in a standard manner. Their accuracies are unquestioned and are usually periodically calibrated against the National Bureau of Standards. Nevertheless, they will not perform any miracles. They can only read tube characteristics, such as transconductance, plate resistance, or amplification factor. They can make no valid predictions about tube performance in many kinds of applications. For these purposes, special tests are added to these instruments, including pulse generators, scopes, and various forms of high frequency reactance measuring apparatus. In spite of all this, it is almost impossible to estimate a tube's performance from readings alone. It must eventually be tested in the equipment for which it is designed.

SHORTS AND GAS TESTS

What about the use of tube testers in estimating the amount of degradation a tube has suffered in service? Can they be used to tell when a tube should be replaced? This involves the other circuits often found in a tube tester, intended to show whether the tube is shorted or gassy. The problem here is one of degree, and is less easily answered than the one involving transconductance. Transconductance is a well-defined, mathematically-expressible voltage and current relationship which can be reproduced anywhere, anytime, by anyone. But what is a short circuit? You undoubtedly thought you knew until you tried to define it in terms of resistance. What will we call it? Is it a circuit having zero ohms, 10 ohms, 100 ohms, or 10,000,000 ohms? There are short-test circuits in some tube checkers that read "short" when the resistance between two terminals is 10 megohms. *This is not a short circuit!* This is very high resistance leakage and, consequently, it is extremely doubtful that it will have any effect on most normal circuits. A tester which utilizes a meter to indicate the true value of the short is much more helpful, since readings can be compared with engineering specifications.

All tubes have some leakage between elements, even when they are new, and this leakage increases with life. But it usually has to fall far below a megohm before it has any significance. The point is that these leakages are not something that you can set arbitrary limits on. Take, for example, the very real case of heater-to-cathode leakage. Heaters are insulated from themselves and from the cathode sleeve into which they fit by a coating of aluminum oxide. This insulation must operate at something like 800°C. and still offer millions of ohms of resistance to the flow of current. This resistance naturally decreases as the amount of area increases (a simple application of Ohm's law—the more parallel resistance paths you have, the lower will be the net resistance between the two points which the paths connect).

In low-powered tubes, the cathode and heater areas are small. Thus, the amount of surface exposed to leakage is also small. But high-powered tubes must have larger

cathodes and more heater folds, so there is more area exposed to leakage. Logically, therefore, heater-to-cathode leakage in the high-powered tubes should be greater than in the smaller, low-powered types. This is shown in Fig. 8-3, which is a chart of heater power versus the normal leakage of a number of well-known tube types. The range is from a minimum of five microamperes to a maximum of 100 microamperes. How can there be a single test for leakage for all of these tubes? If you set the limit at 100 microamperes, you will pass a lot of tubes that should be rejected. If you set it at some point less than 100 microamperes, you will reject many good tubes as "shorted."

Aside from the foregoing ambiguities, there is the possibility of short tests causing tube damage. The manner in which these circuits generally work necessitates the use of a rather high voltage. This high potential, in being applied across the tube elements under test conditions, can produce "shorts" where none previously existed. It may do this by electrostatically attracting particles of cathode coating, causing microscopic bridges from grid to cathode, or causing the fusing together of microscopic particles of metal on the mica insulators to form solid connecting paths between other elements. However it is accomplished, repeated "short" testing of otherwise good tubes in a typical tube tester may result in some of the tubes reading "short" after sufficient tests have been performed.

Let's take a look at the so-called "gas" test circuits in some of these testers. We say "so-called" because, except in rare instances, they do not measure gas. They measure a grid current, but the question is which one and how much? These tests are based on the assumption that *any* grid current is a sign of a bad tube. This, of course, is not true; some circuits depend on one of the several possible grid currents in order to function properly. Eliminating all tubes that show any signs of grid current conduction without regard to which one or how much is like throwing the baby out with the bath water.

So what have we learned? Except in the small percentage of cases where transconductance can be used as an indicator, tube testers do not measure anything that can be truly related to tube quality. And it is quite obvious

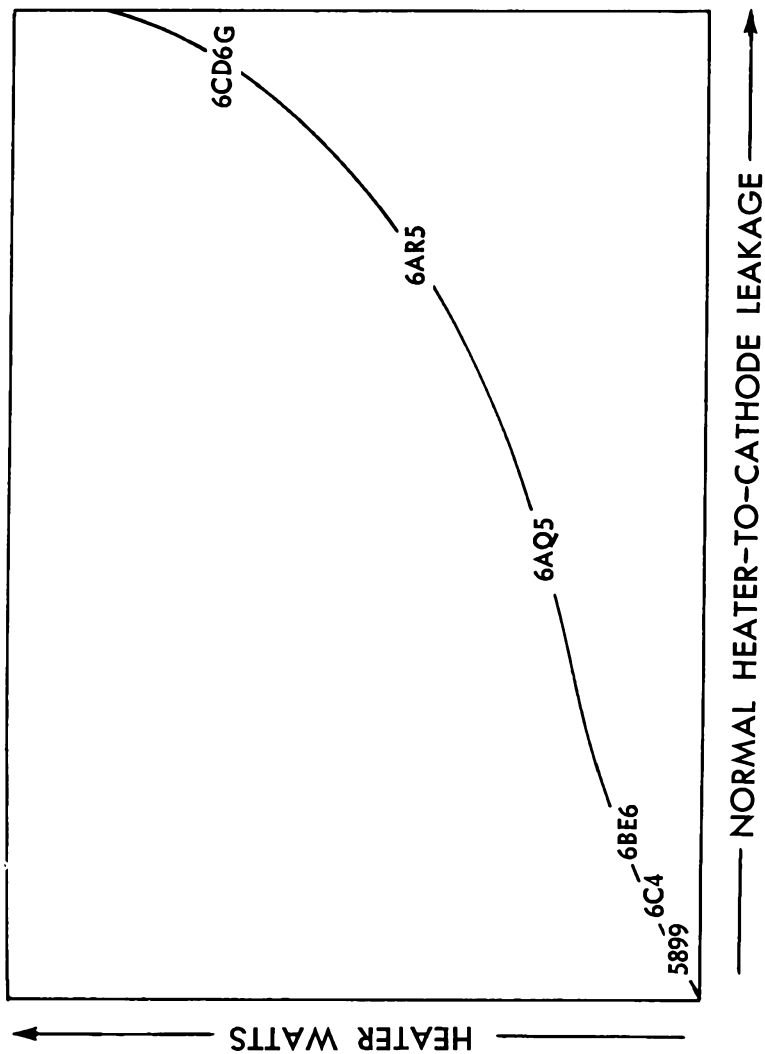

Fig. 8-3. A chart of heater power versus the normal leakage of a number of well-known tube types.

that no tester can *predict* how well tubes will perform in a given circuit—not even the \$10,000 instruments used by tube manufacturers! It takes a tube engineer with many years of experience to interpret information provided by such instruments.

What good, then, are tube testers which are more modestly priced? Well, even the crudest test will provide certain indications of discontinuity or abnormality. For example, if 20 tubes of a given type were dropped into a bucket of water, and only one of them sunk while the others floated, it is reasonable to assume that the one that sunk is bad. This does not necessarily mean, however, that the other 19 tubes are good! They have passed only this one test, and it is conceivable that other tests would eliminate a few more tubes which would not conform to a pattern set by the others. Of course, if only 10 tubes float while the other 10 sink, the test has no validity whatsoever—except to prove that a specific type of tube may, or may not, float.

Obviously, the above is grossly exaggerated, but similar reasoning can be applied to tube testers. On the basis of one or more tests, a suspected tube either conforms to a predetermined norm or it doesn't. The greater the number of significant tests made, the greater are the chances of proving a tube good or bad.

Tube testers, therefore, are particularly helpful in providing indications of abnormality. Direct substitution for a suspected tube is the best test of all, but even this is still not entirely conclusive. Not having a replacement tube at hand, use of a tube tester can provide indications as to whether or not a tube could be causing the trouble. At least, if the tester shows a tube to be good, tests of other circuit components are in order; if the tester shows it to be bad, a replacement should be obtained and tried before spending time on other component tests.

Thus, the value of a tube tester really depends upon the user. It is up to him to know what is being measured and how to interpret the results. Further, by remembering that the indications of tube testers are not always conclusive, he will use his instrument judiciously—either to supplement other tests or confirm suspicions, or to provide indications that will guide him in making further tests.

MAINTENANCE PRACTICES

Electronic maintenance is a big job today in many phases of our industrial society. There are installations where thousands of tubes are involved and where the annual bill for maintenance and replacement is very substantial. There are competent engineers and technical people involved in the problem of keeping this equipment running with a minimum of expense—and even more important, with a minimum amount of “down” time. Such individuals have often asked for information on the various methods used in formal maintenance programs, their relative merits, and, if possible, for the one best method of obtaining the maximum benefit from men as well as equipment. The closing paragraphs of this chapter will attempt to answer these inquiries.

One of the oldest methods of performing routine maintenance of electronic equipment has been to set up a program of planned replacement. Under this plan, tubes are removed after some arbitrary period of time, regardless of their condition, and replaced with new ones. This system has one very serious drawback; it completely ignores the laws governing failure patterns. The most unreliable period in a tube's life is the first one hundred hours of usage. (Fig. 1-1 in Chapter I illustrates this classic truth.) Therefore, by completely retubing the apparatus at regular intervals, the period of unreliability is perpetuated, and unpredictable failures will be more sudden and more numerous than would normally be expected. Arbitrary wholesale replacement is therefore not recommended except in very rare instances dealing with certain known short life tubes. Even in such instances, there are better methods, which will be described a little later.

Another favorite maintenance procedure is to periodically remove all tubes for test and replace those found to have some measurable defect. This practice is undesirable from an extended tube life point of view. In the first place, it involves handling a lot of tubes, which means that some will inevitably become damaged through pin breakage, glass strains due to hasty insertions, and by being dropped or bumped. Some of these damages will go unnoticed, and the tubes will be put back into service, only to give trouble

later. Then there are the facts established earlier; namely, that certain tube checkers don't provide indications which correlate with end usage, and that certain tests themselves may make a defective tube out of one that was satisfactory—or they may only make it a potential failure. So this procedure is not recommended either, first of all because it is costly, and secondly because it gives little assurance of reliability.

A third method, which may be regarded as almost no method at all, is to wait until something stops functioning before ferreting out and replacing the defective tube. While this system has the advantage of simplicity and the assurance of maximum usage of the tubes, it lacks any element of prevention. Therefore, it cannot be recommended except in cases where duplicate standby equipment is always available. When this is the case, it may be the most efficient method of operation.

A minor modification of the above method, one which offers a more reasonable degree of preventive maintenance, involves periodic testing of the entire apparatus for some functional characteristic. If some over-all response—such as power output, gain, or signal-to-noise ratio—can be measured without disturbing any functioning part, evidence of deterioration can usually be spotted and an analysis of its cause begun before a major failure takes place.

If the entire unit cannot be so tested, then perhaps sections of it can. When performing this kind of a test, it is very helpful if the line voltage can be dropped a measured amount and the change in the significant characteristic noted. Among the useful techniques for sectional testing of much apparatus is the square wave or pulse technique. A pulse of short duty cycle will often disclose information which can be correlated with specific elements within a given piece of equipment.

In a highly sophisticated maintenance program, it will be found advisable to have some system for double-checking of all tube failures. This should be done by some individual other than the one who rejected them in the first place. A very large percentage of tubes that fail in one specific application may be perfectly satisfactory in some other application. Sometimes they will be found to

operate quite satisfactorily in their original application, having been rejected in error.

It is advisable to have some method of marking such "reissued" tubes so that when they are rejected a second time, they can be disposed of forthwith. While at first it may appear to be taking an unwarranted risk to reuse a tube which has been previously rejected, experience has shown that, with a little judgement, such a program can usually cut annual tube replacement costs by as much as 30 percent without increasing down time a bit. It should be pointed out, however, that the use of reissued tubes is recommended only where accurate and detailed records can be kept; thus, the practice lends itself more readily to equipment used in industrial and military applications than for home entertainment units such as radio and television receivers.

Finally, there is the matter of keeping adequate records—again, particularly with regard to industrial and military equipment. This is perhaps the most important part of a good preventive maintenance program. A record should be maintained of every tube replacement. Every socket in every piece of apparatus should have a record card. Each time a piece of equipment is serviced, a record should be made of the tube type, socket number, supplier's name, and the technician doing the work. Although maintaining this record may appear laborious and unnecessary, it will pay for itself many times if kept up to date.

Studies prove that most failures are predictable and preventable, if you have adequate records to show you the trends. Some circuits will prove to be much tougher on certain tubes than others. Learning why may prevent further failures. Some tube types may prove quite unreliable when compared to others. Designing these out of the equipment, or changing their operating conditions, may reduce their failure rate. Some supplier's types may not be as reliable as others. Records will prove this, and permit you to make a better choice of supplier. Studies based on good records will almost always show methods of reducing failure problems and obtaining better combined equipment and tube life. Like accidents—most tube failures don't just happen, they are caused—and records can point to the causes.

CHAPTER 9

SPECIAL-PURPOSE TUBES

In the preceding chapters, we have discussed tubes in a broad, general manner, dealing with those aspects which are common to the vast majority of those in use. In this chapter, we will take up some of the special-purpose tubes that require individual treatment because of certain unusual characteristics which they possess.

FILAMENTARY TUBES

Filamentary tubes require certain special considerations if they are to provide the maximum useful life of which they are capable. One of the most important of these concerns the way they are mounted. Filaments are generally hung or mounted, in suspension, between some mechanical point on the top mica and the stiff wires in the base. They depend upon tension to keep them taut. When heated, the filament naturally stretches and, as a result, may sag against some other electrode within the tube.

Most filamentary tubes have a specified mounting position which is usually base down. This provides maximum assurance that filament sagging will not cause a short. Certain rectifier tubes may be horizontally mounted if the planes of the filaments and the major axis of the plates are so oriented that they lie vertically. There is a standard relationship between the plane of the tube elements and the base so that mounting specifications may read as, for example, in the case of the 5U4G, "horizontal operation is permissible if pins 1 and 4 are in a vertical plane." Due to differences in manufacturing techniques, the actual position of the mount with reference to the base pins may vary considerably among manufacturers. The tolerance on this

specification is quite broad and in some cases, it will be found that the tubes are mounted in such a position that their filaments can sag against the plates, causing premature arcing and early failures. Where large numbers of tubes are involved, it may pay the user to orient the sockets so that they coincide with the construction of some one manufacturer's tubes and then to insist on using only that brand, or tubes which are physically identical to them, in that equipment. A real improvement in life will result if this precaution is taken.

Another consideration when using filamentary tubes is the matter of their rapid warm-up time. This can be either an advantage or a disadvantage, depending upon the circumstances. In many applications, such as mobile operations, filamentary tubes permit complete shutdown during standby. This gives them a substantial advantage in power economy and increases their useful life since they can be ready for instant operation without the needless burning of filaments that are not actually in use.

This same feature may give rise to undesirable effects when filamentary tubes are used in conjunction with indirectly-heated tubes. These latter types have a much longer warm-up time; therefore, some circuits may be under full power when they are not fully biased or otherwise properly loaded, during this warm-up period. This is a potential cause for other tube failures and it should be suspected wherever filamentary- and indirectly-heated tubes are used in the same equipment.

LOW-VOLTAGE TUBES

The new low-voltage tubes which are designed to be used with transistors in hybrid equipment are very much like their higher voltage counterparts in most respects. However, they differ in two respects that are important to be familiar with if they are to give their best possible service. The first of these has to do with testing or using them in circuits which subject them to more than their 30-volt maximum rating.

Much of the success these tubes enjoy over conventional tubes when operated at the very low anode potential of 12 volts is due to special cathode processing. In other

words, they are so activated a very large space charge is produced. This space charge provides the reservoir for the low-velocity electrons which make the relatively remarkable transconductances of the tubes possible.

If these tubes are subjected to higher-than-rated anode potentials, even for a few moments, this delicate cathode condition is upset and its capacity to deliver current at low voltages is impaired. This causes a drop in transconductance as well as a shift in other characteristics that are essential to their operation. So, it must be stated quite emphatically that these low-voltage tubes must never be tested or operated at any voltage which exceeds their maximum ratings—usually 30 volts.

One other consideration is important if they are to give maximum satisfaction. Only one type of bias circuit works well with these tubes and, fortunately, it is the cheapest and simplest to achieve from a circuit standpoint. This circuit provides contact potential or grid-leak bias. The grid circuit should be returned to the cathode through a large resistor of several megohms and the cathode should then be grounded.

PHOTOTUBES

Most phototubes are of the photoemissive variety; that is, they have a cathode like most other vacuum tubes, only this cathode is not heated to make it give off electrons. Instead, it is energized by light which passes into the tube and illuminates the cathode. Electrons are released from the cathode when the photons of light energy strike it, each photon releasing one electron. Thus, the electron emission is proportional to the light intensity on the cathode.

In many respects, the phototube behaves very much like a temperature-limited diode, inasmuch as changes in plate voltage have very little effect upon the cathode current. This is because the anode draws away practically every free electron as soon as it is emitted from the cathode surface and no space charge exists. The only way that the anode current can be increased is by increasing the number of photons arriving at the cathode, and this, of course, means a more intense light source.

The cathode of a photoemissive tube is usually a semicylinder of metal which has been coated with a photosensitive substance. The anode is quite often a small rod extending across the open side of this semicylinder. The "plate," as it would be called if this were a diode, is made as small as mechanical considerations will permit so that it casts as little shadow as possible on the much larger cathode surface. The cathode is made large so that as much surface can be present for illumination as possible. In spite of this fact, the phototube's output is exceedingly small, usually only a few microamperes.

Phototubes are made with different responses to different colors of light. Some can "see" better in red light, and some are best suited for use where the light is more blue. Most light sources which are of an incandescent nature produce a reddish-yellow light, whereas the "cold" sources, such as fluorescent lamps, produce a bluish light.

There are two broad classes of phototubes—high vacuum and gas. Gas is introduced into certain types of phototubes to increase their sensitivity. This produces a phenomenon called "gas amplification." Gas amplification results when electrons from the photoemissive cathode collide with the gas atoms and knock off additional electrons which are then added to the total anode current. This effect can produce about a 10:1 increase in current sensitivity for a given amount of light energy.

Gas phototubes have some disadvantages to offset their increased sensitivity; namely, they are less linear than the high-vacuum types and have frequency limitations. It takes a definite amount of time for a gas to ionize or deionize. Above a certain frequency, these tubes lose sensitivity because they can't ionize rapidly enough and they then act more like the high-vacuum phototubes. This frequency is in the middle or upper audio region so that although gas phototubes are used in such apparatus as moving picture projectors, they require frequency compensation to maintain uniform output across the audio spectrum.

Vacuum-type phototubes have characteristics very much like a temperature-limited diode as shown in Fig. 9-1. This illustrates the fact that above a certain minimum voltage, further increases in plate voltage have no effect

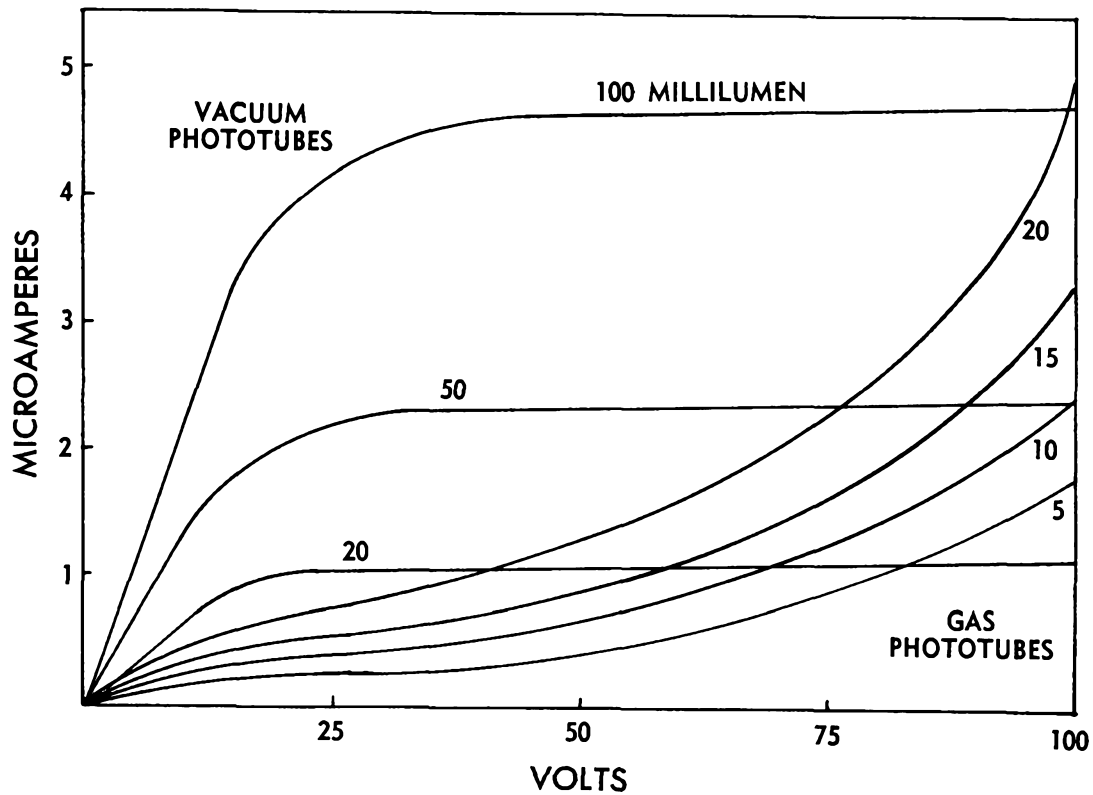

Fig. 9-1. Comparison curves of vacuum and gas phototubes.

upon the cathode current. If voltages are increased beyond the 100-volt point, cathode damage will probably result, therefore, operation is generally limited to about 90 volts.

Gas phototubes show this same characteristic at plate-voltage levels below the ionization point. But as soon as ionization commences, the current rises rapidly with an increase in plate voltage. If the plate voltage is increased far enough, the gas will break into a glow discharge form of ionization and damage to the photocathode will follow, so it is not recommended that they be operated in this condition. The voltage at which most gas phototubes will break into a glow discharge is in the vicinity of 125 to 150 volts, so a maximum rating of about 90 volts is also placed on the gas phototubes.

Since the useful current from a phototube is generally in microamperes, it is most important that all socket and wiring leakages be kept at a minimum. Sockets and insulation should be of the best and all forms of moisture should be kept away from them. In most cases, the tube and socket, as well as all associated wiring, should be shielded to prevent electrostatic pickup.

The source of light used to illuminate the phototube is not important as long as its general color temperature matches that of the phototube being used. The use of an optical system which spreads the light over as much of the cathode as possible is desirable, both as a means for increasing initial sensitivity and for increasing the overall life of the tube. If the light is concentrated in a small spot, there will be a loss of initial sensitivity and that portion of the cathode will become inactive prematurely.

Phototubes can be damaged by excessive illumination even when there is no plate voltage. Very high levels of illumination, such as direct sunlight, can cause a loss of sensitivity which will usually be restored after sufficient "rest" in a darkened condition.

Testing phototubes is very simple. Certain visual signs indicate whether the cathode has become poisoned due to air leaking into the bulb. The blue-sensitive cathodes turn a sooty black, while the red-sensitive types develop a mottled, or spotty, appearance. Placing the tube in series with a sensitive microammeter and a 90-volt battery and exposing the cathode to light, will demonstrate whether it

is working or not. Exact sensitivities cannot be measured, of course, without a calibrated light source. But if the tube reacts to light, the only other defect it can have is a loss of sensitivity. This can be confirmed by substituting a new tube in the equipment. If this is inconvenient, the questionable tube can be tested on the bench and its output compared to that of a new tube under the same lighting conditions.

VOLTAGE-REGULATOR TUBES

Voltage-regulator tubes are constructed, in some respects, very similar to phototubes. They generally have a cylindrical cathode which is usually coated or treated in a special manner. The anode is a wire rod running through the middle of the cathode. The bulb is filled with some kind of gas.

Voltage-regulator tubes of this type depend upon the phenomenon in a gas-filled tube known as the glow discharge. When a voltage is placed between the anode and cathode of such a tube, current will not flow until the voltage is raised to a certain critical value known as the starting voltage. When this point is reached, there is a sudden flow of current accompanied by the appearance of a small glow area on the inside of the cathode cylinder. The voltage across the tube drops considerably to a value known as the regulated value, and remains there even though the source voltage is increased further. The only change that takes place as the source voltage is raised is that more current flows through the tube. As the current through the tube increases, the glow area on the cathode also increases until it covers the entire inner surface of the cylinder. When this point is reached, the tube is said to be saturated. If the source voltage is further increased, the voltage across the tube will start to rise again. The tube is no longer in a regulated state and operation outside this region will damage the characteristics of the tube.

Voltage regulators of this type are used as shunt regulators; that is, the tube and the load are in parallel, and both are in series with a common dropping resistor from the voltage source. The value of this resistor is chosen so

that at minimum load current, the voltage-regulator current is at, or near, its saturation value. When the load current increases, the voltage-regulator tube current will decrease by an equal amount and the voltage across the common series resistor will remain unchanged. This insures that the voltage across the load will remain unchanged also. If the range of current drawn by the load exceeds that of the voltage-regulator tube, which is generally from about 5 to 30 milliamperes, the tube will extinguish and the voltage will go out of control.

Voltage regulators have certain undesirable characteristics which sometimes interfere with their satisfactory operation. A knowledge of these characteristics can do much to help the user recognize them and eliminate their effects. Fig. 9-2 illustrates one of these characteristics. The small discontinuity in the curve is what is sometimes called a "pip." It is a small departure from the otherwise smooth regulation curve. As current through the tube is varied, it will sometimes be noted that the voltage goes through a discrete shift at some fixed current point. Portions of this curve may actually have a negative resistance slope. Operation at one of these points may result in oscillation in the controlled equipment. This may be at a very slow rate, in which it is known as motor boating, or it may take place at some rate which produces an RF disturbance.

The appearance of these "pips" may occur at any time in the life of the voltage-regulator tube. They are unstable and may appear at different current levels at various times. They are caused by the sudden jumping of a small portion of the glow area as it expands or contracts due to current changes through the tube. When there is a large unsaturated area of the cathode, there are more places for the glow area to jump to and so these pips are more likely to occur when the tube is operated in the lower current region of its range. Operation nearer to saturation lessens the opportunity for this type of instability to occur.

Another form of instability is repeat starting. Two problems here are closely related. First, there is the matter of reliable starting every time the voltage is applied; and second, there is the matter of returning to the

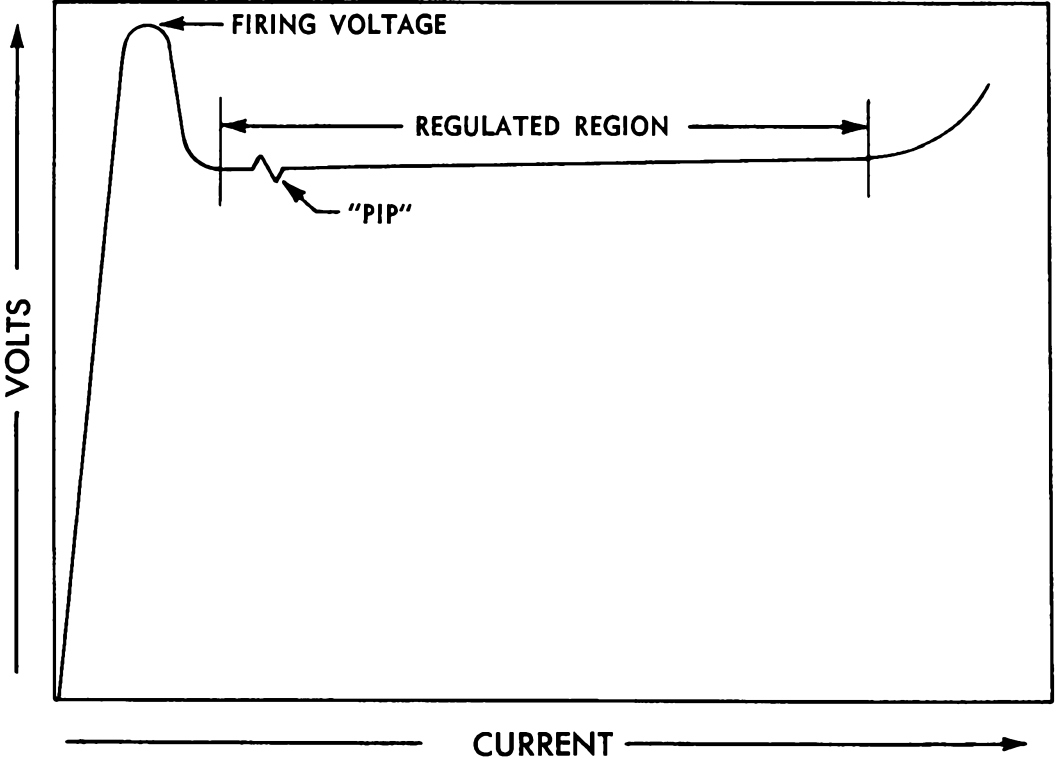

Fig. 9-2. Operating curve of voltage-regulator tubes.

same regulating point each time the tube is started. The voltage-regulator tube has to be started by a considerably higher voltage than the one at which it is designed to regulate. If the starting voltage is too low, starting will be irregular.

Providing enough voltage to guarantee the tube fires vigorously is another way of also insuring that this tube will regulate at the same voltage each time it is fired. Failure to provide this extra voltage contributes to irregular starting. This, in turn, produces an erratic repeating in the regulation point. Both problems can be materially decreased by introducing a minute amount of radioactive material into the tube. This is done in some military or industrial voltage regulators (such as the 6626 and 6627) which are quite similar to the 0A2 and 0B2.

Voltage-regulator tubes are sometimes operated in series in order to get two voltages that are regulated, one of which exceeds the ratings of a single regulator tube. Certain problems sometimes develop when this is done, although with precautions, there is no reason why they cannot be operated in this manner.

The load current drawn from the point between the two tubes must be added to the load current drawn from the higher voltage point. This combined value must not exceed the maximum rating of either one of the tubes that are in series. Starting problems may be encountered unless resistors are placed across the tubes to insure the proper distribution of voltage when they are first turned on. If this precaution is not taken, the leakage current through the tubes will determine the voltage across them. If one tube differs significantly, and it may because this is not a controlled characteristic, one tube will start operating and drop the voltage so low that the second tube cannot start. Their leakage resistance will vary on life also, so two tubes which fire initially without any divider resistors may still get into trouble after they have been used for some hours.

Voltage-regulator tubes should never be overloaded even for very brief moments. When this occurs, there will be a shift upwards in their regulation characteristic which will then gradually drift back to normal. This shift in its regulation characteristic will take place even though the

overload is only momentary and its effect will continue for some time after it is removed.

Voltage-regulator tubes of the glow-discharge type should never be operated on AC voltages, or where the polarity of the voltage is opposite to that normally applied to the tubes. In other words, voltage-regulator tubes are polarized just like electrolytics, or semiconductors. Operating them so that reverse currents will flow through them will destroy their operating characteristics and they will become simply gas diodes.

THYRATRONS

Thyratrons are one of the most unfamiliar tubes to most people in electronics; that is, unless they have had some experience with them. They are a gas tube, featuring very high current carrying abilities. They may be designed as triodes and, in a few cases, as pentodes. In spite of their superficial similarity to vacuum tubes, they are really very different. These differences can be summed up in the following manner. The thyatron is a high-current, low-voltage tube compared with most vacuum tubes which are essentially high-voltage, low-current devices. The voltage drop across a thyatron is much lower than that across a vacuum tube and, therefore, the ohmic losses are much lower, making them much more efficient for handling large amounts of power. The vacuum tube is an amplifier whose plate current is always under the control of its grid. The thyatron is more like a relay which is triggered off by the grid, but which must be reset by some other means. The grid loses all control over plate current once conduction has started. The current carriers in a vacuum tube are electrons, whereas in a thyatron they are ions.

In discussing voltage-regulator tubes, the glow-discharge phenomenon was discussed. If a tube is in a glow-discharge condition and the current is increased beyond the saturation point, the voltage across the tube will rise. If current through the tube is increased still further, a point will be reached where the voltage drops suddenly and the current rises sharply. The entire interior of the tube will then glow, and it is then said to be in the arc-

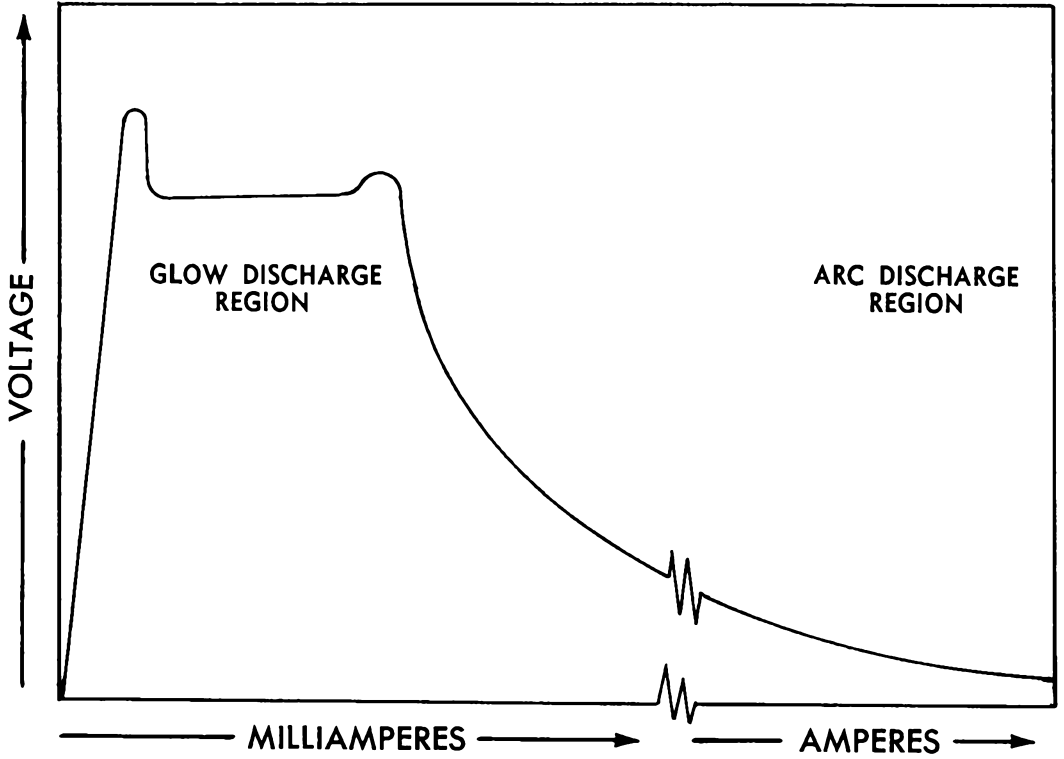

Fig. 9-3. A curve showing the glow-discharge and arc-discharge regions of voltage-regulator tubes.

discharge region. This is illustrated in Fig. 9-3. If the current is increased still further, it will rise into the ampere region while the voltage drop across the tube remains very low and substantially unchanged. This is the region in which thyratrons and gas rectifiers work.

In the arc discharge, conditions are very different from those existing in a vacuum tube. Current conduction is entirely by means of ions. Electrons released by the cathode are merely used as bullets to bombard the gas atoms and provide more ions. Once initiated, the arc can neither be controlled in amplitude, nor stopped by the grid. If a negative voltage is applied to the grid, it will attract positive ions which will form a shield around it and thereby cancel its effect. Similarly, if a positive voltage is applied to the grid, negative electrons will be attracted, neutralizing the effect of the grid upon the arc discharge.

The grid of a thyatron serves only one purpose—to determine the conditions under which the tube will fire. For every value of grid voltage, there is a corresponding value of plate voltage that will just fire the tube. This is known as the “critical characteristic” for the tube and is illustrated in Fig. 9-4. The curve is shown as an area rather than as a single line because of variations in this characteristic due to temperature, aging, and other factors which will be discussed. The critical characteristic may lie completely within the negative-control region; or it may lie partly or entirely within the positive-control region.

Most thyratrons are triodes; however, a few have an additional element known as a screen grid. One purpose of the screen grid is to reduce the current drawn by the grid. By placing the screen grid at cathode potential, the control grid is shielded from much of the ionic current. This raises control-grid impedance so that this type of thyatron can be used directly with such high impedance devices as phototubes.

The particular type of gas used in a thyatron makes quite a difference in its individual characteristics. Three types of gases are normally used—hydrogen, the inert gases (neon, argon, and xenon), and mercury vapor. Occasionally, combinations of two or more gases will be used to produce a compromise of characteristics. Gener-

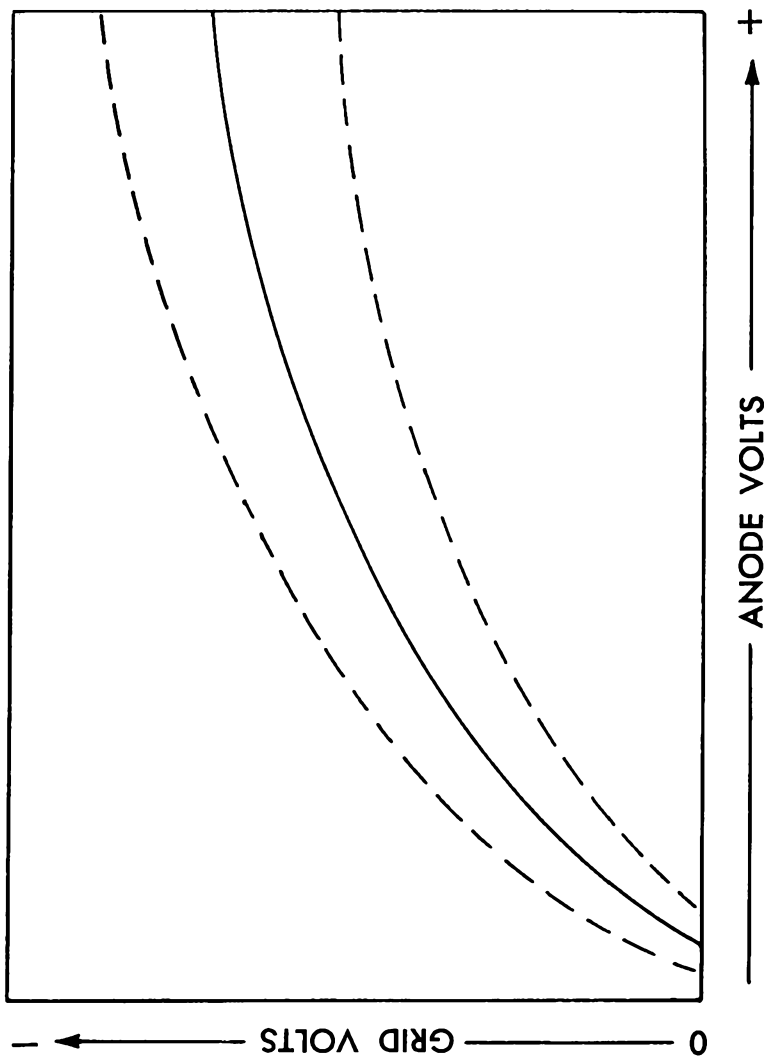

Fig. 9-4. Critical characteristic curve of a thyatron.

ally speaking, the lighter gases are less temperature sensitive, require less warm-up waiting, and will operate at higher frequencies. Mercury vapor, on the other hand, permits higher current and voltage ratings. That is why mercury vapor is used in most of the heavy duty thyratrons.

Ionization and Deionization Time

As mentioned earlier, a thyatron operates by ionic conduction rather than by current conduction between its anode and cathode. Ions are atoms which have lost or gained an electron, so they carry either a positive or a negative charge. Electrons are much smaller than ions and are almost weightless. Ions, on the other hand, are large and heavy. The simple laws of mass and energy apply to these particles of matter just as they do to much larger particles. Electrons can be easily stopped or started, but not the heavier ions. It takes time to get them moving, and like any other heavy body, once they are moving, they cannot be stopped instantly.

Ionization is started when a few electrons from the cathode start moving rapidly toward the anode under the effects of the anode potential. These electrons act like bullets and soon collide with the bigger gas atoms in the space between the cathode and the plate. Electrons are knocked out of these atoms and they become ions. Because they are no longer neutrally charged, but now have a positive charge, they begin to move away from the positively charged plate. As these ions gather speed, they run into more atoms and, as a result, additional ions are formed. Thus, a chain reaction gets underway and soon the entire space is filled with ions and electrons moving rapidly toward the plate and the cathode. This is the condition within the arc discharge when complete ionization has taken place.

When the anode voltage is removed, these ions keep right on going for awhile. With no accelerating force to supply the electron bullets needed to make new ions, the old ions begin to recapture their lost electrons. They then become neutral again and start to slow down. Eventually, all stray electrons have recombined with an ion and the gas is said to be deionized. This is the process which must

take place each time a thyratron fires and before it can fire again.

Since weight obviously governs the acceleration and deceleration of atoms in a gas, the lighter the gas, the less time it will take to ionize and deionize. For this reason, hydrogen thyratrons have the shortest ionization and deionization time, and mercury vapor has the longest.

Temperature also influences the ionization time. Again, the lighter gases are much less affected. Mercury vapor is especially sensitive because, as the temperature rises, more mercury is vaporized and the gas becomes more and more crowded with mercury atoms. The electrons and atoms thus collide more frequently and have greater difficulty acquiring enough velocity to produce ions. This slows down both the ionization and deionization processes.

Although the lighter gases are little affected by temperature, they do suffer from a phenomenon known as "gas cleanup." This is a reduction in gas pressure due to the combining of the gas with the elements of the tube itself, which eventually makes the tube unusable. This is the most common cause of failure in this type of thyratron.

Gas cleanup can be greatly increased or decreased by certain circuit conditions. When the current passing through the tube is very high just before the anode voltage is switched off, and when there is a large and sudden increase in the inverse anode potential immediately after the interruption, gas cleanup proceeds at a very rapid rate. This can be greatly retarded by observing certain precautions in circuit designs. Small reactive elements are connected in series with the anodes, tending to delay the rise rate of the inverse voltage. This will give greatly prolonged tube life.

Waiting Time

Another important precaution which must be observed with thyratrons is the matter of "waiting time." This is the length of time after the tube filament is turned on before anode potential may be applied. When a thyratron is first turned on, its cathode is cold. If anode voltage is applied at this time, nothing will happen because there are no electrons to start the ionizing process. As the

cathode heats, some electrons will become available, but they will be immediately drawn toward the anode. As ions form, they will start moving in the direction of the cathode, and will meet with little opposition because the space is relatively free of other fast moving particles. By the time they reach the cathode, they will be traveling rather fast. Unless there is a large cloud of free electrons immediately surrounding the cathode to slow them down, they will crash into the cathode surface with sufficient force to destroy its emitting surface in a fraction of a second.

In order to prevent this sudden destruction of thyratrons, the heater must be turned on before the anode voltage is applied and sufficient time must be allowed for the cathode to reach full operating temperature. The rare gas thyratrons require less waiting time than do the mercury vapor types. In the case of the latter types, enough time must be allowed to permit the condensed mercury to evaporate. This requires that the bulb temperature itself must be raised to the vapor point of mercury at its coldest point.

Before installing mercury-vapor thyratrons for the first time, it is a good idea to hold them base downward and then to swing them in a wide arc several times. This is to make certain that all of the liquid mercury is in the base of the tube and that none of it has lodged on insulators or other supporting members of the tube where it may cause flash-over and damage to the equipment or the tubes. During shipment, the mercury scatters all through the tube, so it is necessary to take this precaution to avoid unnecessary arcing and sputtering. When these thyratrons are taken out of service and are to be stored, they should be left standing base down, so that when re-installed they will operate properly.

CHAPTER 10

METHODS FOR LENGTHENING TUBE LIFE

We have discussed the various aspects which influence the survival rate of tubes from a more or less theoretical point of view. In this chapter, we will point out some practical steps which will take advantage of these natural laws and make them work to the benefit of the user.

Our first topic is cooling. Indeed, the most effective method of reducing all kinds of tube failures is to lower the temperature of their envelopes. The cooling of a vacuum tube starts out as a problem in radiation and then usually becomes one of conduction and convection. The heat generated within the tube is radiated toward the envelope which becomes heated and, in turn, heats the surrounding air by conduction. As the warmed air starts to move due to convection, new, cooler air comes in behind it and the process continues. If the air surrounding the tube is confined to a small space, its temperature soon rises to the point where very little difference exists between the air and bulb temperatures. The rate of cooling is slowed down and the bulb gets hotter and hotter and may eventually soften and melt.

The most obvious method for keeping bulb temperature down is to make sure that there is an unrestricted volume of air surrounding the tube so that air circulation is as free as possible. There are many circuit and mechanical considerations that frequently interfere with this objective. Shields, compartments, and cases or cabinets tend to restrict the free flow of air. Starting with tube shields, there are changes that can be made to improve the situation. Bright, shiny metal shields tend to reflect heat back into the tube. If their interiors are blackened, shields will then absorb heat more rapidly and can conduct it into the larger metal parts of the assembly, like the chassis,

which act as "heat sinks." A heat sink is a large, heat absorbing body which permits the heat to be dispersed over more area and, hence, be more easily radiated or conducted into the surrounding air.

The simple laws of convection currents in air should be observed when mounting, or assembling apparatus using tubes. Heated air rises, bringing in cooler air below it. If a tube is mounted on a flat chassis pan, there is little available cool air to replace the warmed air surrounding it. If holes are punched in the chassis surrounding the socket, cool air can be drawn up through these holes and natural, convection cooling will be enhanced. When chassis are mounted vertically, it is well to remember that the upper tubes will run somewhat hotter than those at the bottom, because heated air from the tubes at the bottom will provide less cooling when it reaches those at the top. If the hottest tubes are not located at the bottom, there will be a marked variation in the life of tubes in the enclosure.

Where many tubes are located in a small enclosure, or where the normal dissipation of even a few tubes is quite high, ordinary free air circulation may not provide sufficient cooling. Under these conditions, forced-air cooling will be found very beneficial. In fact, forced-air cooling can almost always be counted on to increase over-all tube life by as much as 100 percent. In controlled life tests in the factory, the effects of forced-air cooling can be easily demonstrated.

MEASURING BULB TEMPERATURE

There are three methods for measuring the effectiveness of any experimental cooling system. The first is to simply place a thermometer inside the enclosure and read it after an hour of operation. The temperature of the air inside the enclosure will give a relative indication of the effectiveness of any changes which are made in the ventilation of the enclosure. Of course, the real concern is bulb temperature. Nevertheless, the air temperature within the enclosure is a good indication of the rate at which the heat is being drawn off. If the inside temperature is not too far above that of the outside air, there is probably no serious

problem. But if the inside temperature is fairly high, the next thing to do is to measure actual bulb temperatures.

There are several methods by which this can be done. The simplest is to use temperature-calibrated wax sticks, known as *Temple* sticks. They come in sets with their melting temperature indicated on each one. Several sticks can be used to "bracket" the temperature of the bulb by noting which one melts and which one does not.

A thermocouple attached to the bulb with some kind of putty will read the temperature very accurately. If this is not available, a laboratory thermometer can be attached to the tube with a patch of putty, and it will give a reliable indication if the thermometer bulb is in contact with the tube bulb. The question of what temperature is desirable is difficult to answer. There is no magic number. The lower the temperature can be held, the better will be the results. There is a close relationship between bulb temperature and over-all life. A drop of even a few degrees will have some beneficial effects.

DISSIPATION CONTROL

It is interesting to note that bulb temperature can also be used as a valuable indication of operation efficiency in the case of many Class B and Class C tubes, and certain pulse applications. It is a fact that it is only the heat wasted in a tube which causes the bulb to heat. In many power tube applications, this heat is a direct indication of the amount of power which is not reaching the intended useful load. By adjusting circuit values so as to develop the minimum amount of heat while still accomplishing the intended function for which the circuit is designed, the maximum utilization of power will be accomplished. This may actually result in improved output while still achieving longer tube life. An efficiently operated power stage (one that wastes as little power as possible in heating up the tube and the air around it) will deliver more power to its load, and will live longer in doing it, than an inefficiently operating one.

This is often true in such applications as horizontal-deflection amplifiers in television. If a check is made of various drive conditions and the bulb temperature is

measured at each, one will be found which produces optimum output and minimum bulb temperature. This is also the condition which assures the very best possible life for that tube.

In the case of rectifiers, bulb temperature may often be reduced by limiting the peak current while not greatly affecting the average output. This results because with some transformer designs, the leakage reactance is so low there is almost no limit to the flow of peak currents except for the internal tube resistance or "tube drop." These peak currents flow every cycle and may be rather high in amperes; yet, they contribute little to the steady-state DC current supplied to the load. By installing a low value of resistance in series with each plate, these peak currents can be reduced and the heat removed to these resistors. This will effectively reduce the temperature of the rectifier tubes and will increase their useful life.

VOLTAGE AND CURRENT REGULATION

Voltage control or regulation is probably the second largest area for improving over-all tube life. The most important tube voltage to control is that applied to the filaments or heaters. There are many ways of accomplishing this objective. Saturable reactors are available which can maintain their output within a few percent. These can be applied to the primary voltage sources and when this is done, the improvement will be most noticeable.

There are excellent ways of regulating heater voltages only. One of these is through the use of a zener-diode regulator as shown in Fig. 10-1. The chart accompanying this simple circuit illustrates the immense improvement which can be accomplished in terms of voltage stability. The effect upon the life of regulated tubes will depend upon many other factors; however, a two-to-one improvement is not unusual, especially where line surges are fairly common.

The history of power line voltages in this country has been invariably upwards. Twenty-five to thirty years ago the standard line voltage was 110 volts. During the years that followed, this voltage kept creeping up until a new standard of 117 volts was agreed upon. The increase is

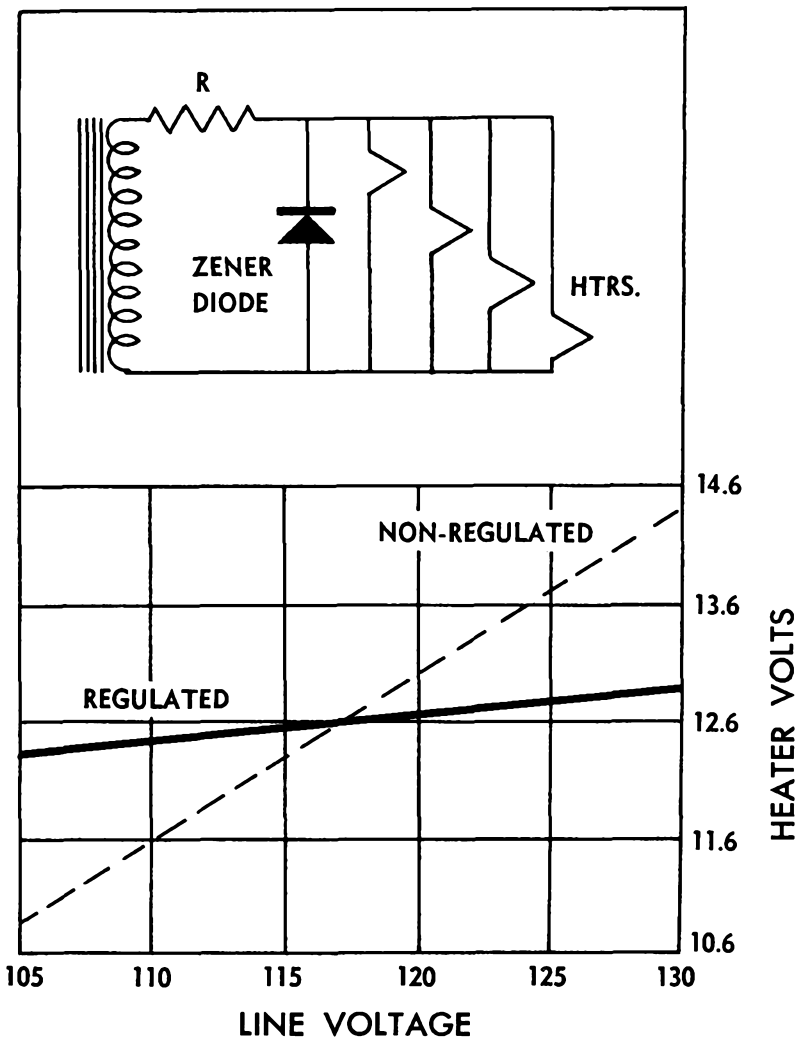

Fig. 10-1. Zener-diode regulator and chart, showing the improvement of the voltage stability.

still in evidence today, and many sections of the country now report 125 volts, and in some cases, 130 volts as being not uncommon. Because of this, it is a good idea to design equipment that is intended to be very reliable with this trend in mind.

LOW-VOLTAGE OPERATION

Tubes are designed to be operated at their rated filament voltages. To get the best over-all satisfaction from their use, they should be operated as near this value as possible. However, where this is not possible, it is safer to err on the low side than it is on the high side. In other words, if they are operated at 5 to 10 percent below their rated center value, they may possibly fail to give quite as many hours of service at the remote end of their life span, but they are not apt to suffer from as many complications, or be prone to catastrophic failures as if they are operated at 5 to 10 percent above their ratings. Where line voltages are known to be high or unstable, the use of auto transformers to reduce the voltage a fixed percentage will be a great help in stretching tube life.

Where many tubes are involved in a single piece of equipment, as in various computers, broadcast studios, and in some forms of processing, it becomes important to consider the advantages to be gained from continuous heater operation. There is much experimental data to prove that intermittent operation of heaters is more destructive than steady burning. There are the economics of power consumption to be weighed; however, from a strict life point of view, it would seem much better never to turn off such apparatus. One compromise to economy can be made by not turning such equipment off, but merely turning it down. Placing heaters on about 50 percent of their rated voltage will keep them warm and will prevent the shock of beginning operation from a cold start.

In this connection, there is much that can be done to improve the life of tubes which are switched on and off regularly. Damage to heaters is caused by the heavy surge current which flows when tubes are first turned on from a cold start. If some form of limiting resistor is placed in series with them, this surge can be largely eliminated,

and with it the harmful aspects of their being turned on and off.

There are many forms of these devices on the market. They go under various trade names, such as *Surgister*, *Thermister*, *Tube Protector*, *Tube Sentry*, *Fuse Resistor*, and *Globar*. They are quite inexpensive and easily installed. Some can even be installed in the power line outside the actual equipment.

They consist of two general types, one of which is the simple negative temperature coefficient resistor which has its maximum resistance when cold and drops to a low value when heated. The second type includes a bi-metallic switch which is actuated by the heating of the resistor. This switch is in series with the high voltage so that the voltage is delayed until all tubes have reached their full operating temperature. This matter of voltage delay is important to prolonging the life of rectifier and damper tubes. It may indirectly save other tubes by reducing the number of voltage breakdowns in capacitors and transformers caused by the high initial voltage often present before the tubes reach maximum conduction.

MECHANICAL

Some tubes are inherently sensitive to mechanical jarring or vibration. This is usually true in high-gain audio circuits, or video amplifiers. Instead of searching for tubes that will remain free of microphonics in such applications, it is often simpler and more rewarding to make slight revisions in the method of mounting the tube. If the socket can be remounted using rubber grommets and cup washers, the tolerance to chassis-transmitted vibration will be greatly improved. Using weighted shields over the tube, in addition to the shock mounting, will reduce pickup of air-borne vibrations.

MAINTENANCE

Certain maintenance practices reduce failures while certain others tend to increase them. These were discussed in a previous chapter from the theoretical point of view. Here we would like to make certain specific recommen-

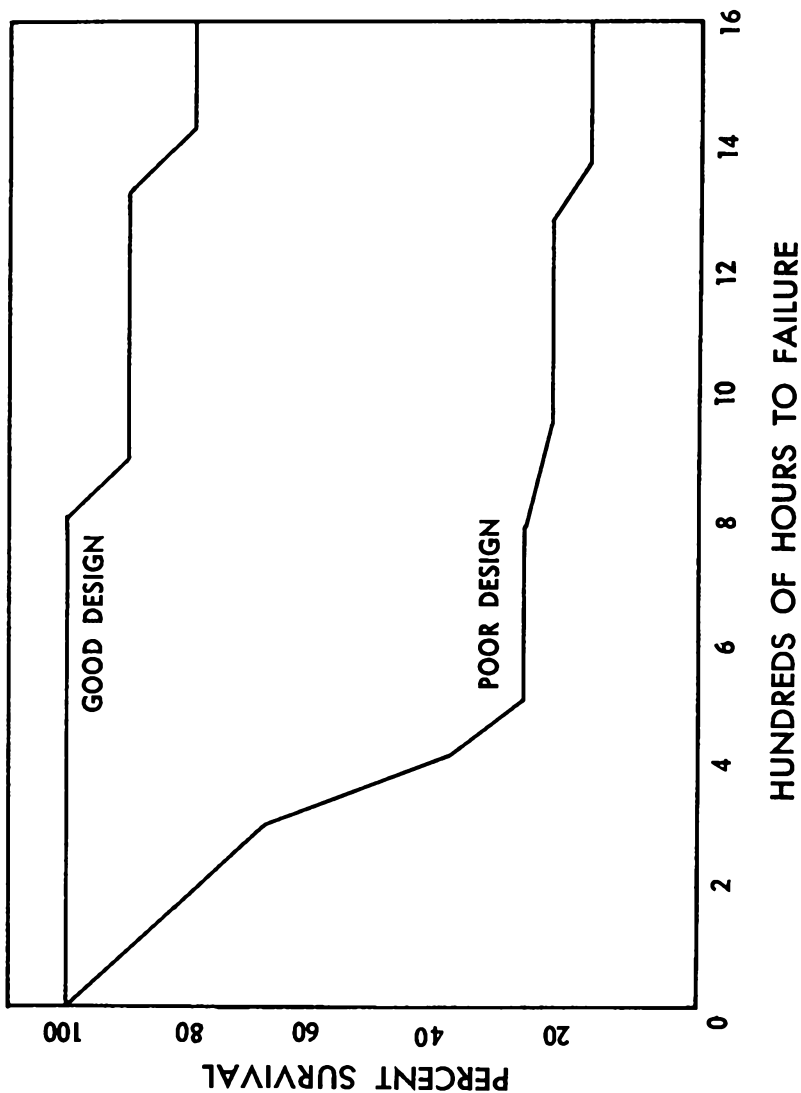

Fig. 10-2. Life-test results of two similar pieces of apparatus, both with the same kind of tubes and tested under the same conditions.

dations which, if carried out, will go a long way towards reducing maintenance-caused failures.

Never test any tube if you can possibly avoid doing so. Testing never improved a tube's condition and it can frequently do them a lot of harm. Leave this highly complicated business to experts. Concentrate your efforts on testing equipment with the tubes in their sockets. In this connection, it is frequently advisable to add jacks or to bring out test points so that tubes and circuits can be measured in their functioning condition. The fewer times you disturb tubes, the more reliable they will prove to be.

Recognize the fact that tubes don't just fail — there must be a reason! More often than not, the reason is completely within your province and you can eliminate it if you know how. Do not overestimate the capabilities of tube checkers and thus be led into a sense of false security. Become more familiar with the characteristics and symptoms of tubes as they really are. Soon you will realize there is really nothing so unreliable about tubes that more reliable applications couldn't cure.

This is borne out by Fig. 10-2, which shows the results of life tests conducted on two similar pieces of apparatus, both using the same kind of tubes and tested under the same conditions. Similar mass studies have been conducted by the military and they all bear out the same simple truth.

Most tube failures in equipment can be attributed to designs that don't take into consideration the basic nature of tubes and, therefore, are not designed with them in mind. It is hoped that some of the facts that have been disclosed in this book will inspire designers and maintenance people to recognize these truths and that through them, they may enjoy greater tube life and reliability.

GLOSSARY

- Ambient Temperature.** The temperature of the surrounding air, as in a room or inside a cabinet where electronic equipment is housed.
- Back Emission.** Emission from an electrode, occurring only when the electrode is polarized in a manner opposite to that required for normal conduction; a form of primary emission common to rectifiers during the inverse portion of their cycle.
- Ballast Tube.** A device used in series heater radios to limit the current to normal. Not really a tube because it is not evacuated; it contains a resistor and resembles a metal tube.
- Bogey.** The average, or published, value for a tube characteristic. A bogey tube would be one having all characteristics on bogey.
- Button Stem.** The glass base of a tube on which the mount structure is assembled. The pins may be sealed into the glass, in which case no base is needed. In some large tubes, the stiff wires are passed directly into the base pins to give added strength. (See "Pressed Stem.")
- Catastrophic Failures.** Those failures which occur suddenly and without warning; they usually render the equipment unusable.
- Cathode Activity.** A measure of the efficiency of an emitter; the mathematical relationship between the two values of emission current measured under two conditions of cathode temperature.
- Cathode-Current Density.** The current per square centimeter of cathode area, expressed as amperes or as milliamperes per centimeter squared.
- Cathode Interface.** A layer formed between the nickel sleeve and the oxide coating of an indirectly-heated cathode. The layer exhibits resistance and capacitance; it can be largely nullified by raising the cathode temperature.
- Characteristic Spread.** The range between the minimum and maximum values for a given characteristic that is considered normal in any large group of tubes.
- Class-A Amplifier.** An amplifier in which the grid is never driven positive nor beyond cutoff. Plate current flows throughout the entire 360° of signal swing.
- Class-B Tubes.** Tubes designed especially for use in Class-B amplifiers. The tube, essentially cut off at zero bias, conducts when its grid is driven positive. Used only in pairs to form a Class-B amplifier. Plate current flows for only 180° of the full cycle for each tube.
- Class-C Tubes.** Tubes designed to be operated in Class-C amplifiers, where the tube is biased well beyond cutoff and is driven into conduction by short excursions of the grid, which goes far into the positive-grid region.
- Contact Potential.** An electrical force which develops between dissimilar metals when heated. Specifically, a voltage developed at the grid of a tube as a result of metallic differences in the grid and cathode structures. Often used as a misnomer for all grid currents.
- Correlated Characteristic.** A characteristic known to be reciprocally related to some other characteristic.

- Critical Characteristic.** A characteristic not having the normal tolerance to variables.
- Cutoff.** That condition in a vacuum tube where the grid has been made sufficiently negative to reduce the plate current or the transconductance virtually to zero. Often specified as the 50-microampere or 50-micromho point on the I_p - E_g curve.
- Differential Cooling.** Cooling which takes place at a different rate at various points on an object or surface.
- Filament Sag.** The bending of a filament as a result of slack caused by heating and expansion.
- Fixed Bias.** The application of a potential to a tube grid which is unaffected by other operating conditions of the tube.
- Fixed Screen.** The application of a potential to a screen grid which is unaffected by other operating conditions within the tube.
- Folded Heater.** A type of heater made from a single strand of coated wire folded and inserted into a cathode sleeve. The insulation is removed at each fold to make it possible for the wire to be folded.
- Frame Grid.** A type of grid construction which stretches the individual grid wires across a rigid frame. They are not wound like conventional grids.
- Gas Cleanup.** The process by which many gas-filled tubes tend to lose their gas pressure and hence become inoperable. Gas, in the form of ions, is driven at high velocity into the metal parts or the glass envelope of the tube, where they form stable compounds and are lost as far as the tube is concerned.
- Gas Current.** The current which flows in the grid circuit when gas ions are present within the tube and the grid is polarized favorably in order to attract them.
- Getters.** Substances which have a strong affinity for gas evolved within a tube and which, by their action, bind these gas atoms into themselves, where they remain inactive and harmless.
- Glow Discharge.** Within a vacuum tube, that form of ionized discharge which precedes the arc discharge and is characterized by a glow which covers the cathode surface.
- Grid-Circuit Testers.** Testers designed to measure the grid resistance of vacuum tubes without discrimination as to the type or polarity of impedance measured.
- Grid Current.** Any current which flows in the grid-to-cathode circuit of a vacuum tube; it is usually a complex current made up of several individual currents having a variety of polarities and impedances.
- Heat Gradient.** The difference in temperature between two parts of the same solid object.
- Heat Sink.** The object used to absorb heat from some other object. The ultimate heat sink is our atmosphere, since all heat must eventually be transferred to it. Most heat sinks seek to transfer the heat directly to the surrounding air.
- Heater Biasing.** The application of a DC potential to the heaters of vacuum tubes for the purpose of eliminating diode conduction between the heater and some other element within the tube.
- Hum-Balancing Pot.** A potentiometer usually placed across the heater circuit. The arm of the potentiometer is grounded, thereby permitting the heater voltage to be balanced with respect to ground.
- Hum Bucking.** The introduction of a small amount of voltage, at the power-line frequency, into a circuit to cancel unwanted power-line interference.
- Initial Velocity Current.** A current which flows between an electrode, such as the grid of a vacuum tube, and its cathode as a result of electrons thrown off from the cathode because of heat alone. Their velocity is sufficient to allow them to reach the grid without the need for an accelerating field.

- Interelectrode Leakage.** The current which is not the result of normal conduction and which flows between elements not normally connected in any way.
- Interface Resistance.** See "Cathode Interface."
- Law of Normal Distribution.** The Gaussian law of the frequency distribution of any normal, repetitive function. It describes the probability of the occurrence of deviants from the average.
- Leakage Reactance.** The reactance represented by the uncoupled inductance of two mutually coupled inductances. When two inductances are mutually coupled and their value is measured, aiding as well as bucking, the difference between these two values is the uncoupled inductance, and its reactance is the leakage reactance.
- Microphonics.** The mechanical translation of vibration or shock into an electrical signal by a vacuum tube.
- Mount Structure.** That portion of a vacuum tube which consists of all of the essential elements except the glass envelope. It is the "works," minus the enclosure.
- Negative Ions (Gas).** Atoms of some gas which have taken on additional electrons and so have an excess negative charge.
- Negative Resistance.** A resistance which exhibits characteristics contrary to normal resistors; namely, when the voltage is increased across such a resistor, the current will decrease.
- Negative Temperature Coefficient.** A device having characteristics which respond to a change in temperature in a manner opposite to other so-called "normal" devices. For example, most resistors increase in value when heated. A resistor which drops in value when heated has a negative temperature coefficient.
- Peak Current.** The maximum current which flows during the complete operational cycle.
- Performance Characteristic.** A characteristic measurable in terms of some useful denominator, such as gain, power output, etc.
- Pin Holes.** Small punctures in the glass envelope of a vacuum tube.
- Positive Ions (Gas).** Atoms of some gas which have lost an electron and so have an excess positive charge.
- Preburning.** The process of stabilization which calls for the continuous operation of tube heaters for a given number of hours. Cathode current may or may not be drawn at the same time, and the tubes may be vibrated all or part of the time.
- Pressed Stem.** That type of vacuum-tube construction which forms all support wires into a flattened piece of glass tubing, similar to and a relic from the lampmaker's art. Now considered an obsolete method of tube construction.
- Primary Grid Emission.** Grid emission which results from contamination of the grid wires by cathode coating material or from excessive grid temperatures.
- Pulse Emission.** Emission drawn for short periods; it may or may not follow a regular repetition rate.
- Reactivation.** The restoration of an emitter to useful life by means of some process which usually consists of elevating its temperature and momentarily drawing large currents from it.
- Reliability.** The degree to which a piece of apparatus can be expected to perform its normal function without interruption, whenever called upon to do so.
- Ruggedization.** The redesign of a piece of equipment or its components to make them able to withstand operation in environments where vibration and mechanical shock are commonplace.
- Runaway.** Any condition, additive in nature, under which continued exposure to them will result in eventual destruction of the device.
- Saturable Reactor.** A transformer or an inductor designed to take advantage of the core-saturation principle.
- Secondary-Emission Tube.** A tube which makes use of secondary

emission to achieve a useful end. The photomultiplier tube is an example.

Secondary Grid Emission. Emission from the grid of a tube as a result of high-velocity electrons being driven against it and thereby knocking off additional electrons. The effect is the same as for primary grid emission.

Selected Tubes. Tubes which, though bearing a standard designation, do not contain all the characteristics of other tubes bearing the same designation, because they have been subjected to special tests which may or may not be registered or carried out by other tube manufacturers.

Skewed Distribution. A frequency distribution of any natural phenomenon which has zero or infinity for one of its limits.

"Sleeping Sickness." Slang for cathode-interface resistance.

Space Charge. The electron cloud which surrounds the hot cathode of a vacuum tube.

Space Charge Tube. A tube which makes use of the space charge in a unique manner to greatly increase its transconductance. A positively charged grid is placed next to the cathode, before the control grid. This enlarges the space charge, moving it out to where the control grid can have a greater effect on it, and hence, on the plate current.

Spurious Emission. Any emission not controlled by the designated control grid (in other words, unwanted emission).

Standing Waves. When a condition of resonance exists in a linear electrical circuit or in a mechanical system, standing waves will usually be present. This means the location of the energy maxima and minima along the system will remain fixed with reference to the ends of the system.

Star Cracks. Also known as "pin holes," these are small fractures in the glass envelope with pointed, starlike radials emanating from them.

Starting Voltage. The voltage necessary to cause a gaseous voltage regulator to ionize or start conducting. As soon as this point is reached, the voltage drops to the operating voltage.

Temperature Limited. A cathode is said to be temperature limited when all the electrons emitted from it are drawn away by a strong positive field. The only way to increase the flow of electrons is to raise the cathode temperature.

Thermal Lag. The time taken to raise the entire mass of a cathode structure to the temperature of the heater.

Thermocouple. A device for converting heat into electrical energy. It consists usually of two dissimilar metals connected to a sensitive current indicator.

Tipoff. That portion of a vacuum-tube bulb which is the last to be melted and sealed after evacuation of the bulb.

Transconductance. The ratio of the amount of grid voltage needed to cause a given change in plate current.

Tube Bridge. An instrument used in the precise measurement of vacuum-tube characteristics. It contains one or more bridge-type measuring circuits, plus power supplies and signal sources for all possible electrode combinations.

Tube Drop. The voltage measured across a tube, from plate to cathode, when the tube is conducting at its maximum current rating.

Waiting Time. The time that must elapse between the turning on of heaters and the application of plate voltage to certain tubes, like thyratrons.

Warm-up Time. The time which elapses, after the heater is turned on, before the cathode reaches its optimum operating temperature in an indirectly-heated type of tube.

Zener Diode. A particular type of semiconductor diode operated in a reverse-biased manner and exhibiting voltage-regulator characteristics at the Zener breakdown point.

INDEX

A

- AC amplification, 105
- Ambient temperature, 154
- Arcing, 17-20

B

- Back emission, 154
- Ballast tube, 154
- Bogey value, 55, 56, 154
- Bucking, hum, 40-41
- Bulb temperature, measuring, 146-147
- Burnout, heater, 12
- Button stem, 154

C

- Catastrophic failures, 7-21, 154
 - arcing, 17-20
 - fixed versus bias, 20-21
 - glass, 8-11
 - heater, 11-17
 - filamentary tubes, 15-17
 - limiting surge current, 12-14
- Cathode
 - activity, 154
 - depletion, 34-36
 - interface, 154
 - reactivation, 35-36
- Cathode-current density, 154
- Changes, physical, 88
- Characteristic spreads, 64-66, 154
- Characteristic variables, 53-68
 - characteristic spreads, 64-66
 - correlating measurements, 59-60
 - design tolerances, 68
 - how standards are set, 56-58
 - limit tube, 58-59
 - predicting variables, 55-56
 - quality control, 66-67
 - sampling, 67-68
 - typical correlation, 60-64
- Classification of tube testers, 115-120
- Commodity, universal, 78-79
- Competition between equipment manufacturers, 92-93
- Contact potential, 154
- Control
 - dissipation, 147-148
 - quality, 66-67
- Converters, frequency, 106-107
- Corrective measures, hum, 43-46
- Correlated characteristic, 154
- Correlating measurements, 59-60
- Correlation, typical, 60-64
- Critical characteristic, 155
- Current, initial velocity, 28, 155
- Current and voltage regulation, 148-149
- Curve, skewed distribution, 56, 57
- Curve of normal distribution, 53, 54

D

- Defining reliability, 79-80
- Degenerative failures, 22-36
 - cathode depletion, 34-36
 - gas, 22-23
 - getters, 23-26
 - interelectrode leakage, 30-33

- Degenerative failures—(cont'd)
 - interface resistance, 33-34
 - spurious emissions, 26-30
- Deionization and ionization times, 142-143
- Depletion, cathode, 34-36
- Design tolerances, 68
- Development, technological, 93-95
- Differential cooling, 155
- Diodes and rectifiers, 109-110
- Dissipation control, 147-148

E

- Early tube testers, 111-115
- Electrical characteristics, tubes, 91-92
- Emission, temperature-limited, 18-19
- Emissions, spurious, 26-30

F

- Failures, catastrophic, 7-21
 - arcing, 17-20
 - fixed versus bias, 20-21
 - glass, 8-11
 - heater, 11-17
 - filamentary tubes, 15-17
 - limiting surge current, 12-14
- Failures, degenerative, 22-36
 - cathode depletion, 34-36
 - gas, 22-23
 - getters, 23-26
 - interelectrode leakage, 30-33
 - interface resistance, 33-34
 - spurious emissions, 26-30
- Failures, subjective, 37-52
 - hum, 37-48
 - bucking, 40-41
 - corrective measures, 43-46
 - special tubes, 46-48
 - microphonics, 48-50
 - noise, 50-52
- Filament sag, 15, 155
- Filament voltage sources, 84-85
- Filamentary tubes, 128-129
- Fixed bias, 155
- Fixed screen, 155
- Fixed-screen operation, 21
- Fixed versus bias, 20-21
- Folded heater, 155
- Frame grid, 155
- Frequency converters, 106-107

G

- Gain, testing for, 103
- Gas, 22-23
 - cleanup, 155
 - current, 155
- Gas and shorts tests, 121-124
- Getters, 23-26, 155
- Glass
 - breakage, causes of, 10
 - failures, 8-11
- Glow discharge, 155
- Grid-circuit testers, 155
- Grid current, 26, 155

H

- Heat gradient, 155
- Heat sink, 155

- Heater
 - biasing, 155
 - burnout, 12
 - failures, 11-17
 - filamentary tubes, 15-17
 - limiting surge current, 12-14
 - How standards are set, 56-58, 76-77
 - How tubes are selected, 70-71
 - Hum, 37-48
 - balancing pot, 155
 - bucking, 40-41, 155
 - corrective measures, 43-46
 - special tubes, 46-48
 - Hybrid tube types, 87
- I**
- Initial velocity current, 28, 155
 - Interelectrode leakage, 30-33, 156
 - Interface resistance, 33-34, 156
 - Ionization and deionization times, 142-143
- L**
- Leakage, interelectrode, 30-33
 - Leakage reactance, 156
 - Life expectancy by application, 98-102
 - Life expectancy by structure, 96-98
 - Limit tube, 58-59
 - Low-voltage
 - operation, 149-151
 - tubes, 129-130
- M**
- Maintenance practices, 125-127, 151-153
 - Measurements, correlating, 59-60
 - Measuring bulb temperature, 146-147
 - Methods for lengthening tube life, 145-153
 - dissipation control, 147-148
 - low-voltage operation, 149-151
 - maintenance practices, 151-153
 - measuring bulb temperature, 146-147
 - mechanical, 151
 - voltage and current regulation, 148-149
 - Microphonics, 48-50, 156
 - Miniatures and subminiatures, 88-90
 - Mount structure, 156
 - Multipurpose tubes, 90-91
 - Multi-spec tubes, 73-75
- N**
- Negative
 - ions, 156
 - resistance, 156
 - temperature coefficient, 156
 - Noise, 50-52
 - Normal distribution
 - curve, 53, 54
 - law, 156
- O**
- Operation
 - fixed-screen, 21
 - low-voltage, 149-151
 - Oscillators, 107-109
 - Output, power, 103-105
- P**
- Peak current, 156
 - Performance characteristic, 156
 - Phototubes, 130-134
 - Physical changes, 88
 - Pinholes, 156
 - Positive ions, 156
 - Power output, 103-105
 - Practices, maintenance, 151-153
 - Preburning, 156
 - Predicting tube life, 110
 - Predicting tube performance, 96-110
 - Predicting variables, 55-56
 - Premium and selected tubes, 69-82
 - defining reliability, 79-80
 - how standards are set, 76-77
 - how tubes are selected, 70-71
 - multi-spec tubes, 73-75
 - premium tubes, 72-73
 - reliability and standardization, 75-76, 80-82
 - results of tube selection, 71-72
 - universal commodity, 78-79
 - universal tubes, 77-78
 - Premium tubes, 72-73
 - Pressed stem, 156
 - Primary grid emission, 156
 - Pulse emission, 156
- Q**
- Quality control, 66-67
- R**
- Rate of tube failure, 8, 9
 - Reactivation, cathode, 35-36, 156
 - Rectifiers and diodes, 109-110
 - Regulator, Zener-diode, 148
 - Reliability, defining, 79-80, 156
 - Reliability and standardization, 75-76, 80-82
 - Resistance, interface, 33-34
 - Resistor, surge-limiting, 12
 - Results of tube selection, 71-72
 - Ruggedization, 156
 - Runaway, 156
- S**
- Sampling, 67-68
 - Saturable reactor, 156
 - Secondary-emission tube, 156
 - Selected and premium tubes, 69-82, 157
 - defining reliability, 79-80
 - how standards are set, 76-77
 - how tubes are selected, 70-71
 - multi-spec tubes, 73-75
 - premium tubes, 72-73
 - reliability and standardization, 75-76, 80-82
 - results of tube selection, 71-72
 - universal commodity, 78-79
 - universal tubes, 77-78
 - Shorts and gas tests, 121-124
 - 6.3- and 2-volt tubes, 85-86
 - Skewed distribution curve, 56, 57, 157
 - "Sleeping sickness," 33, 157
 - Space charge, 157
 - Special-purpose tubes, 128-145
 - filamentary, 128-129
 - low-voltage, 129-130
 - phototubes, 130-134
 - thyratrons, 138-144
 - voltage-regulator, 134-138
 - Special tubes, 46-48
 - Spreads, characteristic, 64-66
 - Spurious emissions, 26-30, 157
 - Standardization and reliability, 75-76, 80-82

Standing waves, 157
Star cracks, 157
Starting voltage, 157
Subjective failures, 37-52
 hum, 37-48
 bucking, 40-41
 corrective measures, 43-46
 special tubes, 46-48
 microphonics, 48-50
 noise, 50-52
Subminiatures and miniatures, 88-90
Surge-limiting resistor, 12

T

Technological developments, 93-95
Temperature-limited emission, 18-19, 157
Testers, tube, 111-127
 classification of, 115-120
 early, 111-115
 maintenance practices, 124-127
 shorts and gas tests, 121-124
Testing for gain, 103
Tests for initial performance, 102-110
 AC amplification, 105
 diodes and rectifiers, 109-110
 frequency converters, 106-107
 oscillators, 107-109
 power output, 103-105
 testing for gain, 103
Thermal lag, 157
Thermocouple, 157
Thyratrons, 138-144
 ionization and deionization times, 142-143
 waiting time, 143-144

Tipoff, 157

Tolerances, design, 68

Transconductance, 157

Tube

 bridge, 157

 drop, 157

 electrical characteristics, 91-92

 failure, rate of, 8, 9

 life, methods for measuring, 145-153

 dissipation control, 147-148

 low-voltage operation, 149-151

 maintenance practices, 151-153

 measuring bulb temperature, 146-147

 mechanical, 151

 voltage and current regulation, 148-149

 limit, 58-59

 performance, predicting, 96-110

 selection, results of, 71-72

 testers, 111-127

 classification of, 115-120

 early, 111-115

 maintenance practices, 124-127

 shorts and gas tests, 121-124

Tube types

 why so many, 83-95

 competition, 92-93

 electrical characteristics, 91-92

 filament voltage sources, 84-85

 hybrid types, 87

 miniatures and subminiatures, 88-90

 multipurpose tubes, 90-91

 physical changes, 88

 technological developments, 93-95

 TV types, 86-87

 2- and 6.3-volt tubes, 85-86

Tubes

 filamentary, 128-129

 how selected, 70-71

 low-voltage, 129-130

 multipurpose, 90-91

 multi-spec, 73-75

 premium, 72-73

 selected and premium, 69-82

 defining reliability, 79-80

 how standards are set, 76-77

 how tubes are selected, 70-71

 multi-spec tubes, 73-75

 premium tubes, 72-73

 reliability and standardization, 75-76, 80-82

 results of tube selection, 71-72

 universal commodity, 78-79

 universal types, 77-78

 special, 46-48

 special-purpose, 128-145

 filamentary, 128-129

 low-voltage, 129-130

 phototubes, 130-134

 thyratrons, 138-144

 voltage-regulator, 134-138

 2- and 6.3-volt, 85-86

 universal, 77-78

 voltage-regulator, 134-138

TV types, 86-87

2- and 6.3-volt tubes, 85-86

Typical correlation, 60-64

U

Universal commodity, 78-79

Universal tubes, 77-78

V

Variables, characteristic, 53-68

 characteristic spreads, 64-66

 correlating measurements, 59-60

 design tolerances, 68

 how standards are set, 56-58

 limit tube, 58-59

 predicting variables, 55-56

 quality control, 66-67

 sampling, 67-68

 typical correlation, 60-64

Voltage and current regulation, 148-149

Voltage-regulator tubes, 134-138

Voltage sources, filament, 84-85

W

Waiting time, thyatron, 143-144, 157

Warm-up time, 157

Why so many tube types, 83-95

 competition, 92-93

 electrical characteristics, 91-92

 filament voltage sources, 84-85

 hybrid types, 87

 miniatures and subminiatures, 88-90

 multipurpose tubes, 90-91

 physical changes, 88

 technological developments, 93-95

 TV types, 86-87

 2- and 6.3-volt, 85-86

Z

Zener-diode regulator, 148, 157

Other Interesting and Informative Subjects Include . . .

- 10 reasons why tubes fail
- Predicting tube performance
- Selected and premium tubes
- Lengthening tube life

Anyone who has anything at all to do with electronic equipment—whether he is responsible for maintenance, design, or proper use—should read this book. It is written for the benefit of service personnel who repair and maintain consumer goods such as radio, TV, and hi-fi equipment—or industrial equipment used in production and manufacturing processes—or even military equipment such as missiles, satellites, computers and radar gear. It also will be of use to engineers and technicians who design any of this equipment, as well as for those who use it.

You'll Also Learn About

- Catastrophic failures—what they are, when and why they are most likely to occur.
- Degenerative failures—what happens to tubes over a period of time.
- Subjective failures—why a seemingly normal tube fails to work in certain applications.
- Characteristic variables—differences that may exist between tubes of the same type.
- Special-purpose tubes—considerations for filamentary, low E_p , phototube, voltage-regulator and thyatron types.



HOWARD W. SAMS & CO., INC.

THE BOBBS-MERRILL COMPANY, INC.



ABOUT THE AUTHOR

ROBERT B. TOMER, or "Bud" as he is known throughout the industry, has literally pulled himself up by his own bootstraps. Starting as a helper in a radio store, Bud progressed to test-equipment builder, laboratory technician, production foreman, design engineer, chief engineer, director of industrial

engineering, and director of commercial engineering. Today he is manager of field engineering for CBS Electronics, and a recognized authority on tubes, transistors, and a number of other subjects. Born in Springfield, Massachusetts, Bud (like many others during the Depression) was forced to forego his formal education. In his own words: "My first major contribution to science was a reaffirmation that you must eat to live. I lost out in an attempt to prove otherwise!" Still, his profound knowledge is quite diversified (he holds several patents in photography and color television and, since 1932, has held a ham license with call letters W1P1M). Since 1944 his articles have appeared in numerous trade journals. In addition, he has published twelve papers on engineering and ham topics, is author of CBS Electronics' "Tech Tips," and has written ten major engineering bulletins on tubes and transistors. He also is co-author of the CBS Electronics Transistor Home Study Course. Most service technicians know Bud from his lectures, which he has conducted before more than 20,000 people in the past three years. He illustrates his lectures with slides he prepares himself, including the photography and sound. Copies of these slide talks have been presented by others to another 150 to 200 audiences, bringing the total who have heard his lectures to over 40,000.