

ALLIED ELECTRONICS DATA HANDBOOK

Written and Compiled by the
Publications Division
ALLIED RADIO CORPORATION
Under the Direction of
EUGENE CARRINGTON

Edited by
NELSON M. COOKE,
Lieutenant Commander, United States Navy (Ret.)
Senior Member, Institute of Radio Engineers. Author, "Basic Mathematics for Electronics."

FOURTH EDITION
Fourth Printing, March 1965

Library of Congress
Catalog Card No: 62-21444

Published by
ALLIED RADIO CORPORATION
100 North Western Avenue
Chicago 80, Ill., U. S. A.

FOREWORD

Allied Radio Corporation has long recognized the need for a comprehensive and condensed handbook of formulas and data most commonly used in the field of radio and electronics. It was felt also that such a book should serve entirely as a convenient source of information and reference and that all attempts to teach or explain the basic principles involved should be left to classroom instruction and to the many already existing publications written for this distinct purpose.

The *Electronics Data Handbook*, therefore, consists of formulas, tables, charts and data. Every effort has been made to present this information clearly and to arrange it in a convenient manner for instant reference. All material was carefully selected and prepared by *Allied's* technical staff to serve the requirements of many specific groups in the radio and electronics field. It is hoped that our objectives have been successfully attained and that this *Handbook* will serve as: (1) A valuable adjunct to classroom study and laboratory work for the student and instructor; (2) A dependable source of information for the beginner, experimenter and set builder; (3) A reliable guide for the service engineer and maintenance man in his everyday work; (4) A time-saving and practical reference for the radio amateur, technician and engineer, both in the laboratory and in the field of operations.

The publishers are indebted to the McGraw-Hill Book Company, Inc., for their permission to use material selected from "*Basic Mathematics for Electronics*" by Nelson M. Cooke. *Allied* also takes this opportunity to thank those manufacturers who so generously permitted our use of current data prepared by their engineering personnel. Special recognition and our sincere appreciation are extended to Commander Cooke for his helpful suggestions and generous contribution of his time and specialized knowledge in editing the material contained in this book.

ALLIED RADIO CORPORATION

TABLE OF CONTENTS

Fundamental Mathematical Data	4-5
Mathematical Constants	4
Mathematical Symbols	4
Decimal Parts of an Inch	4
Fundamental Algebraic Formulas	5
Greek Alphabet Designations	65
Decibel Tables, Attenuators and Matching Pads	5-10
Decibels, Fundamental Formulas	5
DB Expressed in Watts and Volts	5
Decibel-Voltage, Current and Power Ratio Table	6
Table of Values for Attenuator Network Formulas	7
Attenuator Network Formulas	8-9
Minimum Loss Pads	10
Most Used Radio and Electronic Formulas	11-29
70-Volt Loud-Speaker Matching Formulas	11
Resistance	12
Capacitance	12
Inductance	12-13
Reactance	13
Resonance	13
Frequency and Wavelength	13
"Q" Factor	14
Impedance	14-16
Conductance	17
Susceptance	17
Admittance	17
Transient I and E in LCR Circuits	18-19
Steady State Current Flow	19
Transmission Line Formulas	20
Capacity of a Vertical Antenna	20
Trigonometric Relationships	21
Vacuum Tube Formulas and Symbols	22
R.M.S., Peak and Average Volts and Current	22
Transistors—Basic Formulas, Symbols and Circuits	23-25
D-C Meter Formulas	26-27
Ohm's Law for A-C and D-C Circuits	28-29
Engineering and Servicing Data	30-69
R-F Coil Winding Formulas	30
Wire Table	31
R-F Coil Winding Data Chart	32-33
Inductance, Capacitance, Reactance Charts	33-36
Metric Relationships	37
How to Use Logarithms	38-40
Directly Interchangeable Tubes	41-58
Directly Interchangeable TV Picture Tubes	59-65
Abbreviations and Letter Symbols	65, 75
Pilot Lamp Data	66-67
EIA and Military Color Codes for Resistors and Capacitors	68-71
EIA Color Codes for Chassis Wiring	72-74
Schematic Symbols Used in Radio Diagrams	76-77
Log and Trig Tables	78-85
Four-Place Common Log Tables	78-89
Table of Natural Sines, Cosines and Tangents	80-85
Allied Publications	86-87
Index	88

Mathematical Symbols

- × or · Multiplied by
- ÷ or : Divided by
- + Positive. Plus. Add
- Negative. Minus. Subtract
- ± Positive or negative. Plus or minus
- ∓ Negative or positive. Minus or plus
- = or :: Equals
- ≡ Identity
- ≈ Is approximately equal to
- ≠ Does not equal
- > Is greater than
- ≫ Is much greater than
- < Is less than
- ≪ Is much less than
- ≥ Greater than or equal to
- ≤ Less than or equal to
- ∴ Therefore
- ∠ Angle
- Δ Increment or Decrement
- ⊥ Perpendicular to
- ∥ Parallel to
- |n| Absolute value of n

Mathematical Constants

- $\pi = 3.14$
- $2\pi = 6.28$
- $(2\pi)^2 = 39.5$
- $4\pi = 12.6$
- $\pi^2 = 9.87$
- $\frac{\pi}{2} = 1.57$
- $\frac{1}{\pi} = 0.318$
- $\frac{1}{2\pi} = 0.159$
- $\frac{1}{\pi^2} = 0.101$
- $\frac{1}{\sqrt{\pi}} = 0.564$
- $\sqrt{\pi} = 1.77$
- $\sqrt{\frac{\pi}{2}} = 1.25$
- $\sqrt{2} = 1.41$
- $\sqrt{3} = 1.73$
- $\frac{1}{\sqrt{2}} = 0.707$
- $\frac{1}{\sqrt{3}} = 0.577$
- $\log \pi = 0.497$
- $\log \frac{\pi}{2} = 0.196$
- $\log \pi^2 = 0.994$
- $\log \sqrt{\pi} = 0.248$

Decimal Inches

- Inches × 2.540 = Centimeters
- Inches × 1.578 × 10⁻⁵ = Miles
- Inches × 10³ = Mils

Inches		Decimal Equivalent	Millimeter Equivalent
1/64	1/32	.0156 .0313	0.397 0.794
3/64	1/16	.0469 .0625	1.191 1.588
5/64	3/32	.0781 .0938	1.985 2.381
7/64	1/8	.1094 .1250	2.778 3.175
9/64	5/32	.1406 .1563	3.572 3.969
11/64	3/16	.1719 .1875	4.366 4.762
13/64	7/32	.2031 .2188	5.159 5.556
15/64	1/4	.2344 .2500	5.953 6.350
17/64	9/32	.2656 .2813	6.747 7.144
19/64	5/16	.2969 .3125	7.541 7.937
21/64	11/32	.3281 .3438	8.334 8.731
23/64	3/8	.3594 .3750	9.128 9.525
25/64	13/32	.3906 .4063	9.922 10.319
27/64	7/16	.4219 .4375	10.716 11.112
29/64	15/32	.4531 .4688	11.509 11.906
31/64	1/2	.4844 .5000	12.303 12.700
33/64	17/32	.5156 .5313	13.097 13.494
35/64	9/16	.5469 .5625	13.891 14.287
37/64	19/32	.5781 .5938	14.684 15.081
39/64	5/8	.6094 .6250	15.478 15.875
41/64	21/32	.6406 .6563	16.272 16.669
43/64	11/16	.6719 .6875	17.067 17.463
45/64	23/32	.7031 .7188	17.860 18.258
47/64	3/4	.7344 .7500	18.635 19.049
49/64	25/32	.7656 .7813	19.446 19.842
51/64	13/16	.7969 .8125	20.239 20.636
53/64	27/32	.8281 .8438	21.033 21.430
55/64	7/8	.8594 .8750	21.827 22.224
57/64	29/32	.8906 .9063	22.621 23.018
59/64	15/16	.9219 .9375	23.415 23.812
61/64	31/32	.9531 .9688	24.209 24.606
63/64	1.0	.9844 1.0000	25.004 25.400

Algebra

Exponents and Radicals

$$a^x \times a^y = a^{(x+y)}, \quad \frac{a^x}{a^y} = a^{(x-y)}$$

$$(ab)^x = a^x b^x, \quad \left(\frac{a}{b}\right)^x = \frac{a^x}{b^x}$$

$$\sqrt[x]{\frac{a}{b}} = \frac{\sqrt[x]{a}}{\sqrt[x]{b}}, \quad a^{-x} = \frac{1}{a^x}$$

$$(a^x)^y = a^{xy}, \quad \sqrt[x]{\sqrt[y]{a}} = \sqrt[xy]{a}$$

$$\sqrt[x]{ab} = \sqrt[x]{a} \sqrt[x]{b}, \quad a^{\frac{x}{y}} = \sqrt[y]{a^x}$$

$$a^{\frac{1}{x}} = \sqrt[x]{a}, \quad a^0 = 1$$

Solution of a Quadratic

Quadratic equations in the form

$$ax^2 + bx + c = 0$$

may be solved by the following:

$$x = \frac{-b \pm \sqrt{b^2 - 4ac}}{2a}$$

Transposition of Terms

$$\text{If } A = \frac{B}{C}, \text{ then } B = AC, \quad C = \frac{B}{A}$$

$$\text{If } \frac{A}{B} = \frac{C}{D}, \text{ then } A = \frac{BC}{D}$$

$$B = \frac{AD}{C}, \quad C = \frac{AD}{B}, \quad D = \frac{BC}{A}$$

$$\text{If } A = \frac{1}{D\sqrt{BC}}, \text{ then } A^2 = \frac{1}{D^2BC}$$

$$B = \frac{1}{D^2A^2C}, \quad C = \frac{1}{D^2A^2B}, \quad D = \frac{1}{A\sqrt{BC}}$$

$$\text{If } A = \sqrt{B^2 + C^2}, \text{ then } A^2 = B^2 + C^2,$$

$$B = \sqrt{A^2 - C^2}, \quad C = \sqrt{A^2 - B^2}$$

Decibels

The number of db by which two power outputs P_1 and P_2 (in watts) may differ, is expressed by

$$10 \log \frac{P_1}{P_2};$$

or in terms of volts,

$$20 \log \frac{E_1}{E_2};$$

or in current,

$$20 \log \frac{I_1}{I_2}$$

While power ratios are independent of source and load impedance values, voltage and current ratios in these formulas hold true only when the source and load impedances Z_1 and Z_2 are equal. In circuits where these impedances differ, voltage and current ratios are expressed by,

$$db = 20 \log \frac{E_1 \sqrt{Z_2}}{E_2 \sqrt{Z_1}} \quad \text{or,} \quad 20 \log \frac{I_1 \sqrt{Z_1}}{I_2 \sqrt{Z_2}}$$

DB Expressed in Watts & Volts

DB*	Above Zero Level		Below Zero Level	
	Watts	Volts	Watts	Volts
0	0.0010	0.775	1.00×10^{-3}	0.7746
1	0.0013	0.869	7.94×10^{-4}	0.6904
2	0.0016	0.975	6.31×10^{-4}	0.6153
3	0.0020	1.094	5.01×10^{-4}	0.5483
4	0.0025	1.227	3.98×10^{-4}	0.4888
5	0.0032	1.377	3.16×10^{-4}	0.4356
6	0.0040	1.545	2.51×10^{-4}	0.3883
7	0.0050	1.734	2.00×10^{-4}	0.3460
8	0.0063	1.946	1.59×10^{-4}	0.3084
9	0.0079	2.183	1.26×10^{-4}	0.2748
10	0.0100	2.449	1.00×10^{-4}	0.2449
11	0.0126	2.748	7.94×10^{-5}	0.2183
12	0.0159	3.084	6.31×10^{-5}	0.1946
13	0.0200	3.460	5.01×10^{-5}	0.1734
14	0.0251	3.882	3.98×10^{-5}	0.1545
15	0.0316	4.356	3.16×10^{-5}	0.1377
16	0.0398	4.888	2.51×10^{-5}	0.1228
17	0.0501	5.483	2.00×10^{-5}	0.1095
18	0.0631	6.153	1.59×10^{-5}	0.0975
19	0.0794	6.904	1.26×10^{-5}	0.0869
20	0.1	7.746	10^{-5}	7.75×10^{-2}
30	1.0	24.493	10^{-6}	2.45×10^{-2}
40	10.0	77.460	10^{-7}	7.75×10^{-3}
50	10^2	244.93	10^{-8}	2.45×10^{-3}
60	10^3	774.60	10^{-9}	7.75×10^{-4}
70	10^4	2,449.0	10^{-10}	2.45×10^{-4}
80	10^5	7,746.0	10^{-11}	7.75×10^{-5}
90	10^6	24,493.0	10^{-12}	2.45×10^{-5}
100	10^7	77,460.0	10^{-13}	7.75×10^{-6}

*Zero db = 1 milliwatt into a 600 ohm load. Power ratios hold for any impedance, but voltages must be referred to an impedance load of 600 ohms.

Decibel—Voltage, Current and Power Ratio Table

-		DB	+		-		DB	+	
Voltage or Current Ratio	Power Ratio		Voltage or Current Ratio	Power Ratio	Voltage or Current Ratio	Power Ratio		Voltage or Current Ratio	Power Ratio
1.0000	1.0000	0	1.000	1.000	.4898	.2399	6.2	2.042	4.169
.9886	.9772	.1	1.012	1.023	.4842	.2344	6.3	2.065	4.266
.9772	.9550	.2	1.023	1.047	.4786	.2291	6.4	2.089	4.365
.9661	.9333	.3	1.035	1.072	.4732	.2239	6.5	2.113	4.467
.9550	.9120	.4	1.047	1.096	.4677	.2188	6.6	2.138	4.571
.9441	.8913	.5	1.059	1.122	.4624	.2138	6.7	2.163	4.677
.9333	.8710	.6	1.072	1.148	.4571	.2089	6.8	2.188	4.786
.9226	.8511	.7	1.084	1.175	.4519	.2042	6.9	2.213	4.898
.9120	.8318	.8	1.096	1.202	.4467	.1995	7.0	2.239	5.012
.9016	.8128	.9	1.109	1.230	.4416	.1950	7.1	2.265	5.129
.8913	.7943	1.0	1.122	1.259	.4365	.1905	7.2	2.291	5.248
.8810	.7762	1.1	1.135	1.288	.4315	.1862	7.3	2.317	5.370
.8710	.7586	1.2	1.148	1.318	.4266	.1820	7.4	2.344	5.495
.8610	.7413	1.3	1.161	1.349	.4217	.1778	7.5	2.371	5.623
.8511	.7244	1.4	1.175	1.380	.4169	.1738	7.6	2.399	5.754
.8414	.7079	1.5	1.189	1.413	.4121	.1698	7.7	2.427	5.888
.8318	.6918	1.6	1.202	1.445	.4074	.1660	7.8	2.455	6.026
.8222	.6761	1.7	1.216	1.479	.4027	.1622	7.9	2.483	6.166
.8128	.6607	1.8	1.230	1.514	.3981	.1585	8.0	2.512	6.310
.8035	.6457	1.9	1.245	1.549	.3936	.1549	8.1	2.541	6.457
.7943	.6310	2.0	1.259	1.585	.3890	.1514	8.2	2.570	6.607
.7852	.6166	2.1	1.274	1.622	.3846	.1479	8.3	2.600	6.761
.7762	.6026	2.2	1.288	1.660	.3802	.1445	8.4	2.630	6.918
.7674	.5888	2.3	1.303	1.698	.3758	.1413	8.5	2.661	7.079
.7586	.5754	2.4	1.318	1.738	.3715	.1380	8.6	2.692	7.244
.7499	.5623	2.5	1.334	1.778	.3673	.1349	8.7	2.723	7.413
.7413	.5495	2.6	1.349	1.820	.3631	.1318	8.8	2.754	7.586
.7328	.5370	2.7	1.365	1.862	.3589	.1288	8.9	2.786	7.762
.7244	.5248	2.8	1.380	1.905	.3548	.1259	9.0	2.818	7.943
.7161	.5129	2.9	1.396	1.950	.3508	.1230	9.1	2.851	8.128
.7079	.5012	3.0	1.413	1.995	.3467	.1202	9.2	2.884	8.318
.6998	.4898	3.1	1.429	2.042	.3428	.1175	9.3	2.917	8.511
.6918	.4786	3.2	1.445	2.089	.3388	.1148	9.4	2.951	8.710
.6839	.4677	3.3	1.462	2.138	.3350	.1122	9.5	2.985	8.913
.6761	.4571	3.4	1.479	2.188	.3311	.1096	9.6	3.020	9.120
.6683	.4467	3.5	1.496	2.239	.3273	.1072	9.7	3.055	9.333
.6607	.4365	3.6	1.514	2.291	.3236	.1047	9.8	3.090	9.550
.6531	.4266	3.7	1.531	2.344	.3199	.1023	9.9	3.126	9.772
.6457	.4169	3.8	1.549	2.399	.3162	.1000	10.0	3.162	10.000
.6383	.4074	3.9	1.567	2.455	.2985	.08913	10.5	3.350	11.22
.6310	.3981	4.0	1.585	2.512	.2818	.07943	11.0	3.548	12.59
.6237	.3890	4.1	1.603	2.570	.2661	.07079	11.5	3.758	14.13
.6166	.3802	4.2	1.622	2.630	.2512	.06310	12.0	3.981	15.85
.6095	.3715	4.3	1.641	2.692	.2371	.05623	12.5	4.217	17.78
.6026	.3631	4.4	1.660	2.754	.2239	.05012	13.0	4.467	19.95
.5957	.3548	4.5	1.679	2.818	.2113	.04467	13.5	4.732	22.39
.5888	.3467	4.6	1.698	2.884	.1995	.03981	14.0	5.012	25.12
.5821	.3388	4.7	1.718	2.951	.1884	.03548	14.5	5.309	28.18
.5754	.3311	4.8	1.738	3.020	.1778	.03162	15.0	5.623	31.62
.5689	.3236	4.9	1.758	3.090	.1585	.02512	16.0	6.310	39.81
.5623	.3162	5.0	1.778	3.162	.1413	.01995	17.0	7.079	50.12
.5559	.3090	5.1	1.799	3.236	.1259	.01585	18.0	7.943	63.10
.5495	.3020	5.2	1.820	3.311	.1122	.01259	19.0	8.913	79.43
.5433	.2951	5.3	1.841	3.388	.1000	.01000	20.0	10.000	100.00
.5370	.2884	5.4	1.862	3.467	.03162	.00100	30.0	31.620	1,000.00
.5309	.2818	5.5	1.884	3.548	.01	.00010	40.0	100.00	10,000.00
.5248	.2754	5.6	1.905	3.631	.003162	.00001	50.0	316.20	10 ⁵
.5188	.2692	5.7	1.928	3.715	.001	10 ⁻⁶	60.0	1,000.00	10 ⁶
.5129	.2630	5.8	1.950	3.802	.0003162	10 ⁻⁷	70.0	3,162.00	10 ⁷
.5070	.2570	5.9	1.972	3.890	.0001	10 ⁻⁸	80.0	10,000.00	10 ⁸
.5012	.2512	6.0	1.995	3.931	.00003162	10 ⁻⁹	90.0	31,620.00	10 ⁹
.4955	.2455	6.1	2.018	4.074	10 ⁻⁸	10 ⁻¹⁰	100.0	10 ⁵	10 ¹⁰

Table of Values for Attenuator Network Formulas

db	B	C	D	E	db	Voltage or Current Ratio	B	C	D	E
1	.98855	86.360	.005756	86.857	27.0	.044668	.95533	.046757	9.1448	.089515
2	9.7724	42.931	.011512	43.426	27.5	.039811	9.5783	.040426	9.1907	.084490
2.5	9.7163	34.739	.014390	34.739	28.0	.039811	9.6019	.041461	9.2343	.079748
3	9.6605	28.456	.017268	28.947	30.0	.031623	9.6838	.032655	9.3869	.063309
4	9.5499	23.219	.023022	21.707	32.0	.025119	9.7488	.023766	9.5099	.050269
5	9.4406	16.876	.028774	17.362	32.5	.023714	9.7629	.024900	9.5367	.047454
6	9.3325	13.982	.034525	14.428	33.0	.022387	9.7761	.022900	9.5621	.044797
7	9.2257	11.915	.040274	12.395	34.0	.019953	9.8005	.020359	9.6088	.039921
7.5	9.1728	11.088	.043147	11.567	35.0	.017883	9.8222	.018105	9.6506	.035577
8	9.1201	10.365	.046019	10.842	36.0	.015849	9.8415	.016104	9.6880	.031706
9	9.0157	9.1996	.051762	9.6337	37.5	.013335	9.8666	.013515	9.7368	.026675
1.0	8.9175	8.1955	.057501	8.6667	38.0	.012589	9.8741	.012750	9.7513	.025183
1.5	8.8140	5.3050	.086133	5.7619	40.0	.010000	9.8878	.010138	9.7781	.022443
2.0	7.9433	3.8621	.11462	4.3048	42.0	.0079433	9.9206	.010101	9.8020	.020002
2.5	7.9899	2.9883	.14293	3.4268	42.5	.0074989	9.9250	.0080069	9.8424	.015888
3.0	7.9205	2.4240	.17100	2.8385	44.0	.0063096	9.9369	.0075556	9.8511	.014999
3.5	7.0795	2.0152	.19879	2.4158	45.0	.0056234	9.9369	.0063496	9.8746	.012620
4.0	6.6834	1.7097	.22627	2.0966	45.0	.0056234	9.9438	.0056552	9.8882	.011247
4.5	5.9566	1.4732	.25340	1.8465	47.5	.0042170	9.9578	.0042348	9.9160	.0084341
5.0	5.6234	1.2849	.28013	1.6448	48.0	.0039811	9.9602	.0039970	9.9207	.0079623
5.5	4.9881	1.0048	.33228	1.3386	50.0	.0031623	9.9684	.0031723	9.9370	.0063246
6.0	4.5332	1.00728	.38247	1.1160	51.0	.0028184	9.9718	.0028264	9.9438	.0056368
7.0	3.7830	.79220	.46577	1.0258	52.0	.0025119	9.9749	.0025182	9.9499	.0050238
7.5	4.2170	.66143	.43051	9.4617	54.0	.0019953	9.9800	.0019993	9.9602	.0039905
8.0	6.0189	.56143	.47622	8.1183	55.0	.0017783	9.9822	.0017815	9.9645	.0035566
9.0	3.5481	.54994	.51949	7.0723	56.0	.0015849	9.9842	.0015874	9.9684	.0031698
10.0	3.1623	.46248	.56026	6.1231	57.0	.0014125	9.9859	.0014145	9.9718	.0028251
11.0	2.8184	.33545	.59848	5.3621	60.0	.0010000	9.9900	.0010010	9.9800	.0020000
12.0	2.5119	.31085	.61664	5.0253	64.0	.00063096	9.9937	.00063136	9.9874	.0017619
13.0	2.3714	.28845	.63416	4.7137	65.0	.00056234	9.9944	.00056266	9.9888	.0017247
13.5	2.2387	.26926	.66732	4.4156	66.0	.00050119	9.9950	.00050144	9.9900	.0017024
14.0	2.0953	.24929	.69804	3.6727	68.0	.00039811	9.9960	.00039827	9.9920	.0016792
15.0	1.8783	.21626	.72639	3.2515	70.0	.00031623	9.9968	.00031633	9.9937	.0006325
16.0	1.6849	.18334	.75246	2.8826	72.0	.00025119	9.9975	.00025125	9.9950	.0005024
17.0	1.4125	.15387	.76468	2.7153	75.0	.00017783	9.9982	.00017786	9.9964	.0003557
17.5	1.3335	.14402	.77637	2.5584	76.0	.00015849	9.9984	.00015851	9.9968	.0003170
18.0	1.2589	.12638	.79823	2.2726	78.0	.00012589	9.9987	.00012591	9.9975	.0002518
19.0	1.1120	.11111	.81818	2.0202	80.0	.00010000	9.9990	.00010000	9.9980	.0002000
20.0	1.00000	.097846	.83634	1.7968	84.0	.00006310	9.9994	.00006310	9.9987	.0001262
21.0	.89125	.086287	.85282	1.5987	85.0	.00005623	9.9994	.00005624	9.9989	.0001125
22.0	.079433	.079057	.86048	1.5083	90.0	.00003162	9.9997	.00003162	9.9994	.00006325
22.5	.074989	.081069	.86048	1.5083	95.0	.00001778	9.9998	.00001778	9.9996	.00003557
24.0	.063096	.067345	.88130	1.2670	96.0	.00001585	9.9998	.00001585	9.9996	.00003170
25.0	.056234	.059585	.89352	1.1283	100.0	.00001000	9.9999	.00001000	9.9998	.00002000
26.0	.050119	.052763	.90455	1.0049						

Attenuator Networks

For Insertion Between Equal Impedances

For data covering networks between unequal impedances, see Minimum Loss Pads on page 10. See also Decibel—Voltage Current and Power Ratio Table on page 6.

See table on page 7 for values of A, B, C, D, E used in the following attenuator network formulas.

In the case of L and U networks where only the input or output can be matched, as required, the matched side is indicated by an arrow pointing toward the pad. On all other networks, both the input and output circuits are matched.

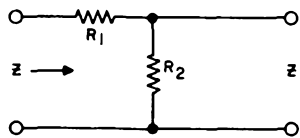

$$R_1 = ZB$$

$$R_2 = ZC$$

L

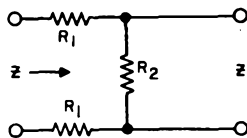

$$R_1 = \frac{ZB}{2}$$

$$R_2 = ZC$$

U

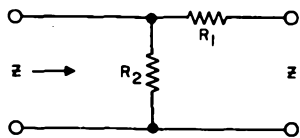

$$R_1 = \frac{Z}{C}$$

$$R_2 = \frac{Z}{B}$$

L

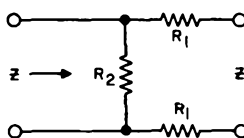

$$R_1 = \frac{Z}{2C}$$

$$R_2 = \frac{Z}{B}$$

U

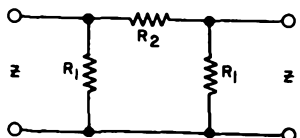

$$R_1 = \frac{Z}{D}$$

$$R_2 = \frac{Z}{E}$$

π

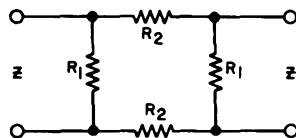

$$R_1 = \frac{Z}{D}$$

$$R_2 = \frac{Z}{2E}$$

O

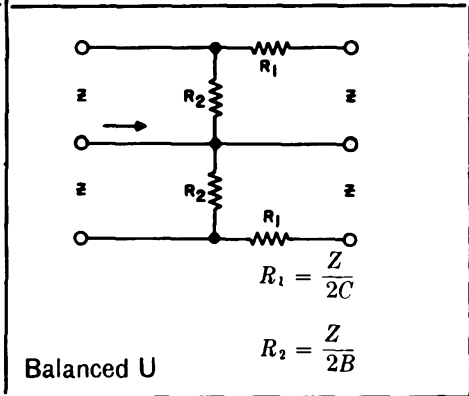
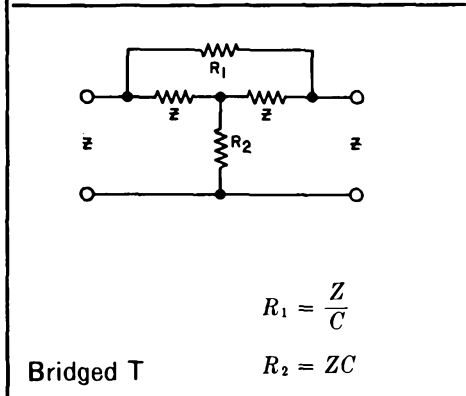
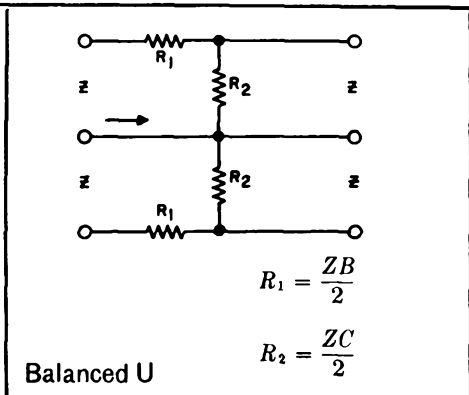
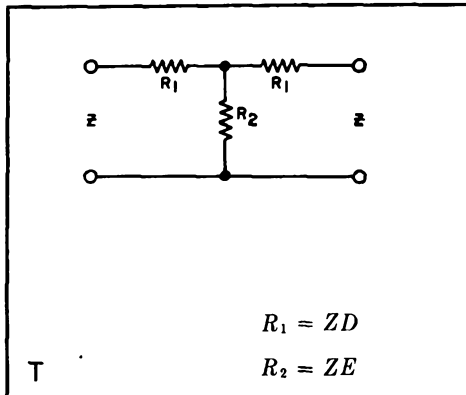

Constant Impedance Attenuators in Parallel

Table of R_1 Values in Ohms

Z	Number of Channels				
	2	3	4	5	6
30	10	15	18	20	21.5
50	16.6	25	30	33.3	35.7
150	50	75	90	100	107
200	66.6	100	120	133	143
250	83.3	125	150	166	179
500	166	250	300	333	357
600	200	300	360	400	428
Network db Loss	6	9.5	12	14	15.5

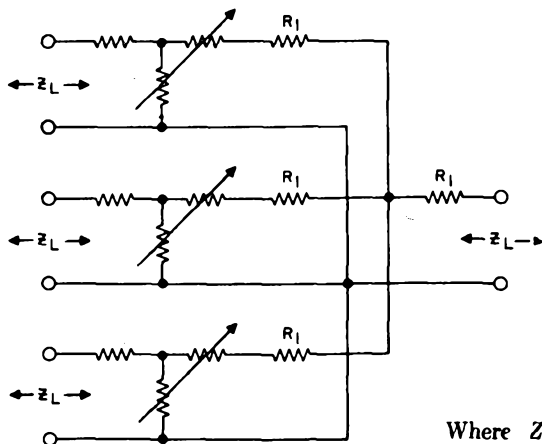

$$R_1 = Z_L \left(\frac{N-1}{N+1} \right) \quad \left| \quad \begin{array}{l} \text{Insertion loss} \\ \text{in db} = 20 \log_{10} N \end{array} \right.$$

Where Z_L = identical line and load impedances; and N = number of channels in parallel.

Minimum Loss Pads

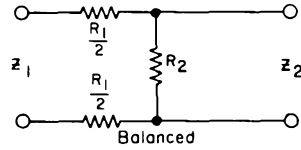
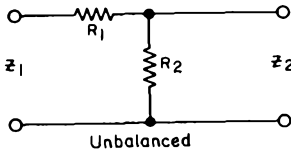

For Matching Two Impedances where $Z_1 > Z_2$

$$R_1 = \sqrt{Z_1 (Z_1 - Z_2)}$$

$$R_2 = \frac{Z_1 Z_2}{R_1}$$

$$db \text{ loss} = 20 \log_{10} \left(\sqrt{\frac{Z_1}{Z_2}} + \sqrt{\frac{Z_1}{Z_2} - 1} \right)$$

matched, use a resistor R_L in series with the smaller impedance such that

$$R_L = Z_1 - Z_2$$

$$db \text{ loss} = 20 \log_{10} \sqrt{\frac{Z_1}{Z_2}}$$

If the smaller impedance only is to be matched, use a resistor R_S in shunt across the larger impedance such that

$$R_S = \frac{Z_1 Z_2}{Z_1 - Z_2}$$

Where Only One Impedance is to be Matched

If the larger impedance only is to be

Here also $db \text{ loss} = 20 \log_{10} \sqrt{\frac{Z_1}{Z_2}}$

Tables of R_1 and R_2 Values

When Z_1 is 600 ohms and Z_2 is less than 600 ohms.

Z_2	500	400	300	250	200	150	100	75	50	40	30	25
R_1	245	346	424	458	490	520	548	561	575	580	585	587
R_2	1,225	694	425	328	245	173	110	80.2	52.2	41.4	30.8	25.6
db Loss	3.8	5.7	7.6	8.7	10.0	11.4	13.4	14.8	16.6	17.6	18.9	19.7

When Z_2 is less than 25 ohms,

$$\text{let } R_1 = 600 - \frac{Z_1}{Z_2}$$

$$\text{and } R_2 = Z_2$$

Where Z_2 is 600 ohms, and Z_1 is greater than 600 ohms

Z_1	800	1,000	1,200	1,500	2,000	2,500	3,000	3,500	4,000	5,000	6,000	8,000	10,000
R_1	400	632	849	1,162	1,673	2,180	2,683	3,186	3,688	4,690	5,692	7,694	9,695
R_2	1,200	949	849	775	717	688	671	659	651	638	633	624	619
db Loss	4.8	6.5	7.6	9.0	10.5	11.6	12.5	13.3	13.9	15.0	15.8	17.1	18.1

When Z_1 is greater than 10,000 ohms,

$$\text{let } R_1 = Z_1 - 300$$

$$\text{and } R_2 = 600$$

70-Volt Loud-Speaker Matching Systems

The EIA 70.7 volt constant voltage system of power distribution provides the engineer and technician with a simple means of matching a number of loudspeakers to an amplifier. To use this method:

1. Determine the power required at each loudspeaker.
2. Add the powers required for the individual speakers and select an amplifier with a rated power output equal to or greater than this total.
3. Select 70.7-volt transformers having primary wattage taps as determined in step 1.*
4. Wire the selected primaries in parallel across the 70.7-volt line.
5. Connect each secondary to its speaker; selecting the tap which matches the voice coil impedance.

For transformers rated in impedance, the following formulas may be used to determine the proper taps in step 3.

$$\text{Primary Impedance} = \frac{(\text{Amplifier output voltage})^2}{\text{Desired speaker power}}$$

or
$$Z = \frac{E^2}{P} \quad (1)$$

*These transformers have the primary taps marked in watts and the secondaries marked in ohms.

Since the voltage at rated amplifier power is 70.7, this reduces to:

$$Z = \frac{70.7^2}{P} = \frac{5000}{P} \quad (2)$$

From formula (2) these relationships are:

- 1 watt requires 5000 ohm primary
- 2 watts requires 2500 ohm primary
- 5 watts requires 1000 ohm primary
- 10 watts requires 500 ohm primary

Once the primary taps have been determined, continue on through step 4 and 5 as outlined above. When selecting transformer primary taps, use the next highest available value above the computed value. A mismatch of 25% is generally considered permissible.

Example: Required

One 6 watt speaker with 4 ohm voice coil.
Two 10 watt speakers with 8 ohm voice coils (use one transformer at this location).

(1-2) Total power = 6 + 10 + 10 = 26 watts (use a 30-watt amplifier or other amplifier capable of handling at least 26 watts)

(3) $Z_{6 \text{ watts}} = \frac{5000}{6} = 833 \text{ ohms}$ (use 1000 ohm transformer)

$Z_{20 \text{ watts}} = \frac{5000}{20} = 250 \text{ ohms}$

(4-5) See sketch below.

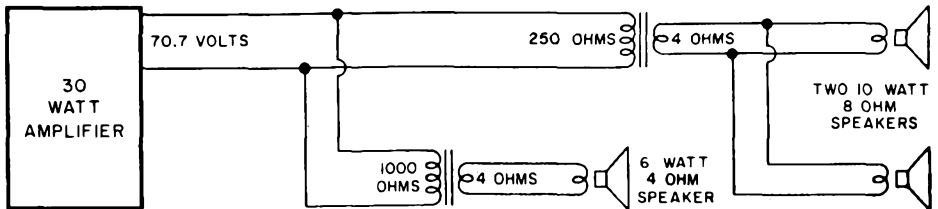

Most Used Formulas

Resistance Formulas

In series $R_t = R_1 + R_2 + R_3 \dots \text{etc.}$

In parallel $R_t = \frac{1}{\frac{1}{R_1} + \frac{1}{R_2} + \frac{1}{R_3} \dots \text{etc.}}$

Two resistors in parallel $R_t = \frac{R_1 R_2}{R_1 + R_2}$

Capacitance

In parallel $C_t = C_1 + C_2 + C_3 \dots \text{etc.}$

In series $C_t = \frac{1}{\frac{1}{C_1} + \frac{1}{C_2} + \frac{1}{C_3} \dots \text{etc.}}$

Two capacitors in series $C_t = \frac{C_1 C_2}{C_1 + C_2}$

The Quantity of Electricity Stored Within a Capacitor is Given by

$$Q = CE$$

where Q = the quantity stored, in coulombs,

E = the potential impressed across the capacitor in volts,

C = capacitance in farads.

The Capacitance of a Parallel Plate Capacitor is Given by

$$C = 0.0885 \frac{KS(N-1)}{d}$$

where C = capacitance in mmfd.,

K = dielectric constant,

* S = area of one plate in square centimeters,

N = number of plates,

* d = thickness of the dielectric in centimeters (same as the distance between plates).

* When S and d are given in inches, change constant 0.0885 to 0.224. Answer will still be in micromicrofarads.

DIELECTRIC CONSTANTS

Kind of Dielectric	Approximate* K Value
Air (at atmospheric pressure).....	1.0
Bakelite.....	5.0
Beeswax.....	3.0
Cambric (varnished).....	4.0
Fibre (Red).....	5.0
Glass (window or flint).....	8.0
Gutta Percha.....	4.0
Mica.....	6.0
Paraffin (solid).....	2.5
Paraffin Coated Paper.....	3.5
Porcelain.....	6.0
Pyrex.....	4.5
Quartz.....	5.0
Rubber.....	3.0
Slate.....	7.0
Wood (very dry).....	5.0

* These values are approximate, since true values depend upon quality or grade of material used, as well as moisture content, temperature and frequency characteristics of each.

Self-Inductance

In series $L_t = L_1 + L_2 + L_3 \dots \text{etc.}$

In parallel $L_t = \frac{1}{\frac{1}{L_1} + \frac{1}{L_2} + \frac{1}{L_3} \dots \text{etc.}}$

Two inductors in parallel $L_t = \frac{L_1 L_2}{L_1 + L_2}$

Coupled Inductance

In series with fields *aiding*

$$L_t = L_1 + L_2 + 2M$$

In series with fields *opposing*

$$L_t = L_1 + L_2 - 2M$$

In parallel with fields *aiding*

$$L_t = \frac{1}{\frac{1}{L_1 + M} + \frac{1}{L_2 + M}}$$

In parallel with fields *opposing*

$$L_t = \frac{1}{\frac{1}{L_1 - M} + \frac{1}{L_2 - M}}$$

where L_t = the total inductance,
 M = the mutual inductance,
 L_1 and L_2 = the self inductance of the individual coils.

Mutual Inductance

The mutual inductance of two r-f coils with fields interacting, is given by

$$M = \frac{L_A - L_O}{4}$$

where M = mutual inductance, expressed in same units as L_A and L_O ,
 L_A = Total inductance of coils L_1 and L_2 with fields *aiding*,
 L_O = Total inductance of coils L_1 and L_2 with fields *opposing*.

Coupling Coefficient

When two r-f coils are inductively coupled so as to give transformer action, the coupling coefficient is expressed by

$$K = \frac{M}{\sqrt{L_1 L_2}}$$

where K = the coupling coefficient;
 $(K \times 10^2 = \text{coupling coefficient in } \%)$,
 M = the mutual inductance value,
 L_1 and L_2 = the self-inductance of the two coils respectively, both being expressed in the same units.

Resonance

The resonant frequency, or frequency at which inductive reactance X_L equals capacitive reactance X_C , is expressed by

$$f_r = \frac{1}{2\pi \sqrt{LC}}$$

also $L = \frac{1}{4\pi^2 f_r^2 C}$

and $C = \frac{1}{4\pi^2 f_r^2 L}$

where f_r = resonant frequency in cycles per second,
 L = inductance in henrys,
 C = capacitance in farads,
 $2\pi = 6.28$
 $4\pi^2 = 39.5$

Reactance

of an inductance is expressed by

$$X_L = 2\pi fL$$

of a capacitance is expressed by

$$X_C = \frac{1}{2\pi fC}$$

where X_L = inductive reactance in ohms, (known as positive reactance),
 X_C = capacitive reactance in ohms, (known as negative reactance),
 f = frequency in cycles per second,
 L = inductance in henrys,
 C = capacitance in farads,
 $2\pi = 6.28$

Frequency from Wavelength

$$f = \frac{3 \times 10^5}{\lambda} \text{ (kilocycles)}$$

where λ = wavelength in *meters*.

$$f = \frac{3 \times 10^4}{\lambda} \text{ (megacycles)}$$

where λ = wavelength in *centimeters*.

Wavelength from Frequency

$$\lambda = \frac{3 \times 10^5}{f} \text{ (meters)}$$

where f = frequency in *kilocycles*.

$$\lambda = \frac{3 \times 10^4}{f} \text{ (centimeters)}$$

where f = frequency in *megacycles*.

Q or Figure of Merit

of a simple reactor

$$Q = \frac{X_L}{R_L}$$

of a single capacitor

$$Q = \frac{X_C}{R_C}$$

where Q = a ratio expressing the figure of merit,

X_L = inductive reactance in ohms,

X_C = capacitive reactance in ohms,

R_L = resistance in ohms acting in series with inductance,

R_C = resistance in ohms acting in series with capacitance,

Impedance

In any a-c circuit where resistance and reactance values of the R , L and C components are given, the absolute or numerical magnitude of impedance and phase angle can be computed from the formulas which follow.

In general the basic formulas expressing total impedance are:

for series circuits,

$$Z_t = \sqrt{R_t^2 + X_t^2}$$

for parallel circuits,

$$Z_t = \frac{1}{\sqrt{G_t^2 + B_t^2}}$$

See page 17 for formulas involving impedance, conductance, susceptance and admittance.

In series circuits where phase angle and any two of the Z , R and X components are known, the unknown component may be determined from the expressions:

$$Z = \frac{R}{\cos \theta} \qquad Z = \frac{X}{\sin \theta}$$

$$R = Z \cos \theta \qquad X = Z \sin \theta$$

where Z = magnitude of impedance in ohms,

R = resistance in ohms,

X = reactance (inductive or capacitive) in ohms.

Nomenclature

Z = absolute or numerical value of impedance magnitude in ohms

R = resistance in ohms,

X_L = inductive reactance in ohms,

X_C = capacitive reactance in ohms,

L = inductance in henrys,

C = capacitance in farads,

R_L = resistance in ohms acting in series with inductance,

R_C = resistance in ohms acting in series with capacitance,

θ = phase angle in degrees by which current leads voltage in a capacitive circuit, or lags voltage in an inductive circuit. In a resonant circuit, where X_C equals X_L , θ equals 0° .

Degrees $\times 0.0175$ = radians.

1 radian = 57.3° .

Numerical Magnitude of Impedance . . .



of resistance alone

$$Z = R$$

$$\theta = 0^\circ$$

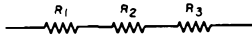

of resistance in series

$$Z = R_1 + R_2 + R_3 \dots \text{etc.}$$

$$\theta = 0^\circ$$

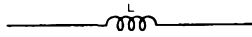

of inductance alone

$$Z = X_L$$

$$\theta = +90^\circ$$

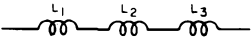

of inductance in series

$$Z = X_{L1} + X_{L2} + X_{L3} \dots \text{etc.}$$

$$\theta = +90^\circ$$

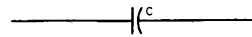

of capacitance alone

$$Z = X_C$$

$$\theta = -90^\circ$$

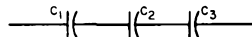

of capacitance in series

$$Z = X_{C1} + X_{C2} + X_{C3} \dots \text{etc.}$$

$$\theta = -90^\circ$$

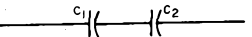

or where only 2 capacitances C_1 and C_2 are involved,

$$Z = \frac{1}{2\pi f} \left(\frac{C_1 + C_2}{C_1 C_2} \right)$$

$$\theta = -90^\circ$$

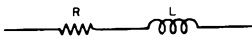

of resistance and inductance in series

$$Z = \sqrt{R^2 + X_L^2}$$

$$\theta = \arctan \frac{X_L}{R}$$

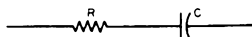

of resistance and capacitance in series

$$Z = \sqrt{R^2 + X_C^2}$$

$$\theta = \arctan \frac{X_C}{R}$$

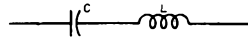

of inductance and capacitance in series

$$Z = X_L - X_C$$

$$\theta = -90^\circ \text{ when } X_L < X_C$$

$$= 0^\circ \text{ when } X_L = X_C$$

$$= +90^\circ \text{ when } X_L > X_C$$

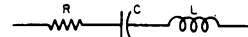

of resistance, inductance and capacitance in series

$$Z = \sqrt{R^2 + (X_L - X_C)^2}$$

$$\theta = \arctan \frac{X_L - X_C}{R}$$

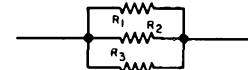

of resistance in parallel

$$Z = \frac{1}{\frac{1}{R_1} + \frac{1}{R_2} + \frac{1}{R_3} \dots \text{etc.}}$$

$$\theta = 0^\circ$$

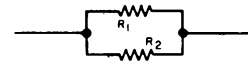

or where only 2 resistances R_1 and R_2 are involved,

$$Z = \frac{R_1 R_2}{R_1 + R_2}$$

$$\theta = 0^\circ$$

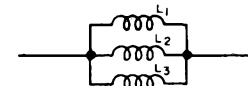

of inductance in parallel

$$Z = \frac{1}{\frac{1}{X_{L1}} + \frac{1}{X_{L2}} + \frac{1}{X_{L3}} \dots \text{etc.}}$$

$$\theta = +90^\circ$$

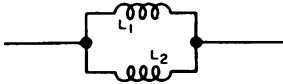

or where only 2 inductances L_1 and L_2 are involved,

$$Z = 2\pi f \left(\frac{L_1 L_2}{L_1 + L_2} \right)$$

$$\theta = +90^\circ$$

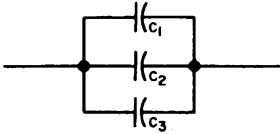

of capacitance in parallel

$$Z = \frac{1}{\frac{1}{X_{C_1}} + \frac{1}{X_{C_2}} + \frac{1}{X_{C_3}} \dots \text{etc.}}$$

$$\theta = -90^\circ$$

or where only 2 capacitances C_1 and C_2 are involved,

$$Z = \frac{1}{2\pi f (C_1 + C_2)}$$

$$\theta = -90^\circ$$

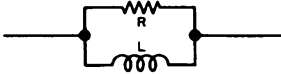

of inductance and resistance in parallel,

$$Z = \frac{RX_L}{\sqrt{R^2 + X_L^2}}$$

$$\theta = \text{arc tan } \frac{R}{X_L}$$

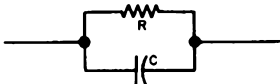

of capacitance and resistance in parallel,

$$Z = \frac{RX_C}{\sqrt{R^2 + X_C^2}}$$

$$\theta = -\text{arc tan } \frac{R}{X_C}$$

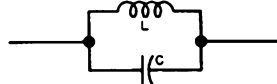

of inductance and capacitance in parallel,

$$Z = \frac{X_L X_C}{X_L - X_C}$$

$$\theta = 0^\circ \text{ when } X_L = X_C$$

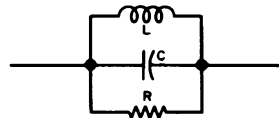

of inductance, resistance and capacitance in parallel

$$Z = \frac{RX_L X_C}{\sqrt{X_L^2 X_C^2 + (RX_L - RX_C)^2}}$$

$$\theta = \text{arc tan } \frac{RX_C - RX_L}{X_L X_C}$$

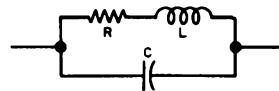

of inductance and series resistance in parallel with capacitance

$$Z = X_C \sqrt{\frac{R^2 + X_L^2}{R^2 + (X_L - X_C)^2}}$$

$$\theta = \text{arc tan } \left(\frac{X_L X_C - X_L^2 - R^2}{RX_C} \right)$$

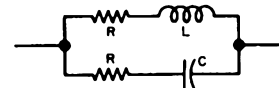

of capacitance and series resistance in parallel with inductance and series resistance

$$Z = \sqrt{\frac{(R_L^2 + X_L^2)(R_C^2 + X_C^2)}{(R_L + R_C)^2 + (X_L - X_C)^2}}$$

$$\theta = \text{arc tan } \frac{X_L(R_C^2 + X_C^2) - X_C(R_L^2 + X_L^2)}{R_L(R_C^2 + X_C^2) + R_C(R_L^2 + X_L^2)}$$

Conductance

In direct current circuits, conductance is expressed by

$$G = \frac{1}{R}$$

where G = conductance in mhos,
 R = resistance in ohms.

In d-c circuits involving resistances R_1, R_2, R_3 , etc., in parallel,

the total conductance is expressed by

$$G_{\text{total}} = G_1 + G_2 + G_3 \dots \text{etc.}$$

and the total current by

$$I_{\text{total}} = E G_{\text{total}}$$

and the amount of current in any single resistor, R_2 for example, in a parallel group, by

$$I_2 = \frac{I_{\text{total}} G_2}{G_1 + G_2 + G_3 \dots \text{etc.}}$$

R, E and I in Ohm's law formulas for d-c circuits may be expressed in terms of conductance as follows:

$$R = \frac{1}{G}, \quad E = \frac{I}{G}, \quad I = EG,$$

where G = conductance in mhos,
 R = resistance in ohms,
 E = potential in volts,
 I = current in amperes.

Susceptance

In an alternating current circuit, the susceptance of a series circuit is expressed by

$$B = \frac{X}{R^2 + X^2}$$

or, when the resistance is 0, susceptance becomes the reciprocal of reactance, or

$$B = \frac{1}{X}$$

where B = susceptance in mhos,
 R = resistance in ohms,
 X = reactance in ohms.

Admittance

In an alternating current circuit, the admittance of a series circuit is expressed by

$$Y = \frac{1}{\sqrt{R^2 + X^2}}$$

Admittance is also expressed as the reciprocal of impedance, or

$$Y = \frac{1}{Z}$$

where Y = admittance in mhos,
 R = resistance in ohms,
 X = reactance in ohms,
 Z = impedance in ohms.

R and X in Terms of G and B

Resistance and reactance may be expressed in terms of conductance and susceptance as follows:

$$R = \frac{G}{G^2 + B^2}, \quad X = \frac{B}{G^2 + B^2}.$$

G, B, Y and Z in Parallel Circuits

In any given a-c circuit containing a number of smaller parallel circuits only,

the effective conductance G_t is expressed by

$$G_t = G_1 + G_2 + G_3 \dots \text{etc.},$$

and the effective susceptance B_t by

$$B_t = B_1 + B_2 + B_3 \dots \text{etc.}$$

and the effective admittance Y_t by

$$Y_t = \sqrt{G_t^2 + B_t^2}$$

and the effective impedance Z_t by

$$Z_t = \frac{1}{\sqrt{G_t^2 + B_t^2}} \text{ or } \frac{1}{Y_t}$$

where R = resistance in ohms,
 X = reactance (capacitive or inductive) in ohms,
 G = conductance in mhos,
 B = susceptance in mhos,
 Y = admittance in mhos,
 Z = impedance in ohms.

Transient *I* and *E* in LCR Circuits

The formulas which follow may be used to closely approximate the growth and decay of current and voltage in circuits involving *L*, *C* and *R*:

- where *i* = instantaneous current in amperes at any given time (*t*),
E = potential in volts as designated,
R = circuit resistance in ohms,
C = capacitance in farads,
L = inductance in henrys,
V = steady state potential in volts,
V_C = reactive volts across *C*,
V_L = reactive volts across *L*,
V_R = voltage across *R*

RC = time constant of *RC* circuit in seconds,

$\frac{L}{R}$ = time constant of *RL* circuit in seconds,

t = any given time in seconds after switch is thrown,

ϵ = a constant, 2.718 (base of the natural system of logarithms),

Sw = switch

The time constant is defined as the time in seconds for current or voltage to fall to $\frac{1}{\epsilon}$ or 36.8% of its initial value or to rise to $(1 - \frac{1}{\epsilon})$ or approximately 63.2% of its final value.

Charging a De-energized Capacitive Circuit

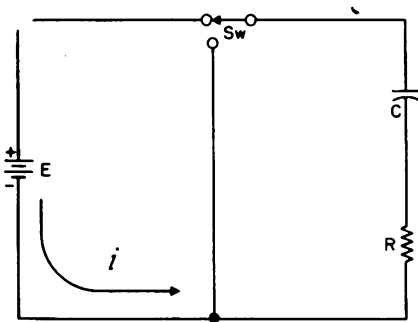

E = applied potential.

$$i = \frac{E}{R} \epsilon^{-\frac{t}{RC}}$$

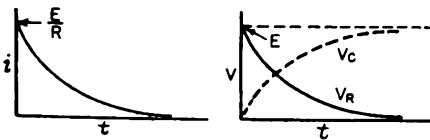

$$V_C = E \left(1 - \epsilon^{-\frac{t}{RC}} \right) \quad V_R = E \epsilon^{-\frac{t}{RC}}$$

Discharging an Energized Capacitive Circuit

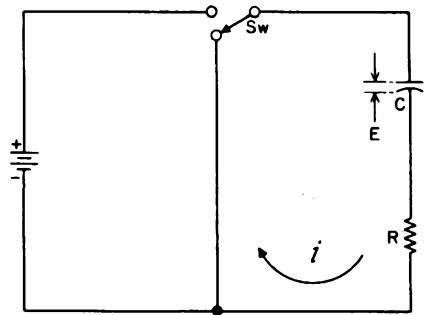

E = potential to which *C* is charged prior to closing *Sw*.

$$i = \frac{E}{R} \epsilon^{-\frac{t}{RC}}$$

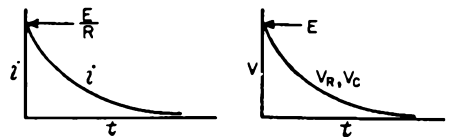

$$V_C = V_R = E \epsilon^{-\frac{t}{RC}}$$

Voltage is Applied to a De-energized Inductive Circuit

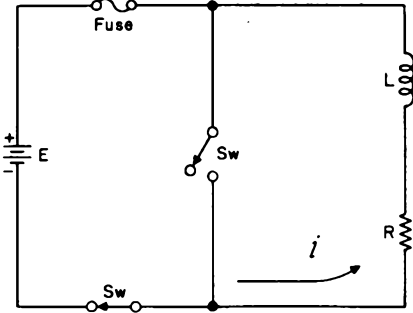

E = applied potential

$$i = \frac{E}{R} \left(1 - e^{-\frac{Rt}{L}} \right)$$

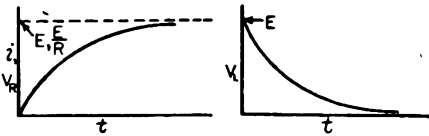

$$V_R = E \left(1 - e^{-\frac{Rt}{L}} \right)$$

$$V_L = E e^{-\frac{Rt}{L}}$$

An Energized Inductive Circuit is Short Circuited

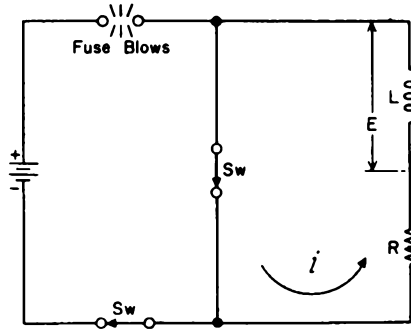

E = counter potential induced in coil when switch is closed.

$$i = \frac{E}{R} e^{-\frac{Rt}{L}}$$

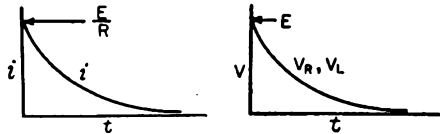

$$V_L = V_R = E e^{-\frac{Rt}{L}}$$

Steady State Current Flow

In a Capacitive Circuit

In a capacitive circuit, where resistance loss components may be considered as negligible, the flow of current at a given alternating potential of constant frequency, is expressed by:

$$I = \frac{E}{X_C} = \frac{E}{\left(\frac{1}{2\pi fC} \right)} = E (2\pi fC)$$

where I = current in amperes,
 X_C = capacitive reactance of the circuit in ohms,
 E = applied potential in volts.

In an Inductive Circuit

In an inductive circuit, where inherent resistance and capacitance components may be so low as to be negligible, the flow of current at a given alternating potential of a constant frequency, is expressed by

$$I = \frac{E}{X_L} = \frac{E}{2\pi fL}$$

where I = current in amperes,
 X_L = inductive reactance of the circuit in ohms,
 E = applied potential in volts.

Transmission Line Formulas

Concentric Transmission Lines

Characteristic impedance in ohms is given by

$$Z = 138 \log \frac{d_1}{d_2}$$

R-f resistance in ohms per foot of copper line, is given by

$$r = \sqrt{f} \left(\frac{1}{d_1} + \frac{1}{d_2} \right) \times 10^{-3}$$

Attenuation in decibels per foot of line, is given by

$$a = \frac{4.6\sqrt{f}(d_1 + d_2)}{d_1 d_2 \left(\log \frac{d_1}{d_2} \right)} \times 10^{-3}$$

where Z = characteristic impedance in ohms,

r = radio frequency resistance in ohms per foot of *copper line*,

a = attenuation in decibels per foot of *line*,

d_1 = the *inside* diameter of the *outer conductor*, expressed in inches,

d_2 = the *outside* diameter of the *inner conductor*, expressed in inches,

f = frequency in megacycles.

Two-Wire Open Air Transmission Lines

Characteristic impedance in ohms is given by

$$Z = 276 \left(\log \frac{2D}{d} \right)$$

Inductance in microhenrys per foot of *line* is given by

$$L = 0.281 \left(\log \frac{2D}{d} \right)$$

Capacitance in micromicrofarads per foot of *line* is given by

$$C = \frac{3.68}{\log \frac{2D}{d}}$$

Attenuation in decibels per foot of *wire* is given by

$$db = \frac{0.0157 R_f}{\log \frac{2D}{d}}$$

R-f resistance in Ohms per loop-foot of *wire*, is given by

$$R_f = \frac{2 \times 10^{-3} \sqrt{f}}{d}$$

where Z = characteristic impedance in ohms,

D = spacing between wire centers in inches,

d = the diameter of the conductors in inches,

L = inductance in microhenrys per foot of *line*,

C = capacitance in micromicrofarads per foot of *line*,

db = attenuation in decibels per foot of *wire*,

R_f = r-f resistance in ohms per loop-foot of *wire*,

f = frequency in megacycles.

Vertical Antenna

The capacitance of a vertical antenna, shorter than one-quarter wave length at its operating frequency, is given by

$$C_a = \frac{17l}{\left[\left(\log \epsilon \frac{24l}{d} \right) - 1 \right] \left[1 - \left(\frac{fl}{246} \right)^2 \right]}$$

where C_a = capacitance of the antenna in micromicrofarads,

l = height of antenna in feet,

d = diameter of antenna conductor in inches,

f = operating frequency in megacycles,

ϵ = 2.718 (the base of the natural system of logarithms).

Trigonometric Relationships

In any right triangle, if we let

θ = the acute angle formed by the hypotenuse and the base leg,

ϕ = the acute angle formed by the hypotenuse and the altitude leg,

H = the hypotenuse,

A = the side adjacent θ and opposite ϕ ,

O = the side opposite θ and adjacent ϕ ,

then $\text{sine of } \theta = \sin \theta = \frac{O}{H}$

$\text{cosine of } \theta = \cos \theta = \frac{A}{H}$

$\text{tangent of } \theta = \tan \theta = \frac{O}{A}$

$\text{cosecant of } \theta = \csc \theta = \frac{H}{O}$

$\text{secant of } \theta = \sec \theta = \frac{H}{A}$

$\text{cotangent of } \theta = \cot \theta = \frac{A}{O}$

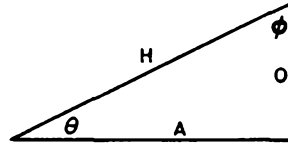

also $\sin \theta = \cos \phi$ $\csc \theta = \sec \phi$
 $\cos \theta = \sin \phi$ $\sec \theta = \csc \phi$
 $\tan \theta = \cot \phi$ $\cot \theta = \tan \phi$

and $\frac{1}{\sin \theta} = \csc \theta$ $\frac{1}{\csc \theta} = \sin \theta$

$\frac{1}{\cos \theta} = \sec \theta$ $\frac{1}{\sec \theta} = \cos \theta$

$\frac{1}{\tan \theta} = \cot \theta$ $\frac{1}{\cot \theta} = \tan \theta$

The expression "arc sin" indicates, "the angle whose sine is" . . . ; likewise arc tan indicates, "the angle whose tangent is" . . . etc. See formulas in table below.

Known Values	Formulas for Determining Unknown Values of . . .				
	A	O	H	θ	ϕ
A & O			$\sqrt{A^2 + O^2}$	$\text{arc tan } \frac{O}{A}$	$\text{arc tan } \frac{A}{O}$
A & H		$\sqrt{H^2 - A^2}$		$\text{arc cos } \frac{A}{H}$	$\text{arc sin } \frac{A}{H}$
A & θ		$A \tan \theta$	$\frac{A}{\cos \theta}$		$90^\circ - \theta$
A & ϕ		$\frac{A}{\tan \phi}$	$\frac{A}{\sin \phi}$	$90^\circ - \phi$	
O & H	$\sqrt{H^2 - O^2}$			$\text{arc sin } \frac{O}{H}$	$\text{arc cos } \frac{O}{H}$
O & θ	$\frac{O}{\tan \theta}$		$\frac{O}{\sin \theta}$		$90^\circ - \theta$
O & ϕ	$O \tan \phi$		$\frac{O}{\cos \phi}$	$90^\circ - \phi$	
H & θ	$H \cos \theta$	$H \sin \theta$			$90^\circ - \theta$
H & ϕ	$H \sin \phi$	$H \cos \phi$		$90^\circ - \phi$	

Vacuum Tube Formulas and Symbols

Vacuum Tube Constants

Amplification factor (Mu or μ) is given by

$$\mu = \frac{\Delta E_p}{\Delta E_g} \text{ (with } I_p \text{ constant)}$$

Dynamic plate resistance in ohms, is given by

$$r_p = \frac{\Delta E_p}{\Delta I_p} \text{ (with } E_g \text{ constant)}$$

Mutual conductance in mhos, is given by

$$g_m = \frac{\Delta I_p}{\Delta E_g} \text{ (with } E_p \text{ constant)}$$

Vacuum Tube Formulas

Gain per stage is given by

$$\mu \left(\frac{R_L}{R_L + r_p} \right)$$

Voltage output appearing in R_L is given by

$$\mu \left(\frac{E_s R_L}{r_p + R_L} \right)$$

Power output in R_L , is given by

$$R_L \left(\frac{\mu E_s}{r_p + R_L} \right)^2$$

Maximum power output in R_L which results when $R_L = r_p$, is given by

$$\frac{(\mu E_s)^2}{4r_p}$$

Maximum undistorted power output in R_L , which results when $R_L = 2r_p$, is given by

$$\frac{2(\mu E_s)^2}{9r_p}$$

Required cathode biasing resistor in ohms, for a single tube is given by

$$\frac{E_g}{I_k}$$

Vacuum Tube Symbols

Mu or μ = Amplification factor,

r_p = Dynamic plate resistance in ohms,

g_m = Mutual conductance in mhos,

E_p = Plate voltage in volts,

E_g = Grid voltage in volts,

I_p = Plate current in amperes,

R_L = Plate load resistance in ohms,

I_k = Total cathode current in amperes,

E_s = Signal voltage in volts,

Δ = change or variation in value, which may be either an increment (increase), or a decrement (decrease).

Peak, R.M.S., and Average A-C Values of E & I

Given Value	To get . . .		
	Peak	R.M.S.	Av.
Peak		$0.707 \times \text{Peak}$	$0.637 \times \text{Peak}$
R.M.S.	$1.41 \times \text{R.M.S.}$		$0.9 \times \text{R.M.S.}$
Av.	$1.57 \times \text{Av.}$	$1.11 \times \text{Av.}$	

Transistor Formulas and Symbols

Common Emitter Configuration

Transistors can be made to amplify, detect, or to oscillate in much the same manner as vacuum tubes. Shown in the drawings below is a comparison between a triode vacuum-tube and a PNP transistor; where the transistor

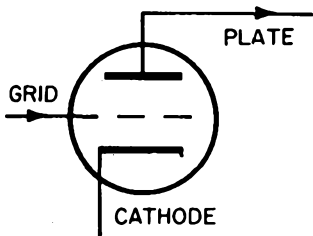

Triode Vacuum Tube

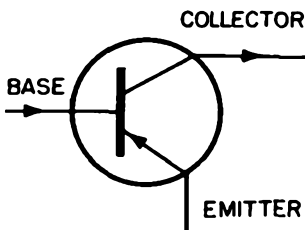

PNP Transistor

base is comparable to the tube grid, the transistor emitter is comparable to the tube cathode, and the transistor collector is comparable to the tube plate.

Transistor Formulas

Input Resistance,

$$R_i = \frac{\Delta V_i}{\Delta I_i}$$

Current Gain,

$$A_i = \frac{\Delta I_c}{\Delta I_b} \text{ (with } V_c \text{ constant)}$$

Voltage Gain,

$$A_c = \frac{\Delta V_c}{\Delta V_b} \text{ (with } I_c \text{ constant)}$$

Output Resistance,

$$R_o = \frac{\Delta V_o}{\Delta I_o}$$

Power Gain,

$$A_p = \frac{\Delta P_o}{\Delta P_i}$$

The current gain of the common base configuration is alpha, where

$$\alpha = \frac{\Delta I_c}{\Delta I_e} \text{ (with } V_c \text{ constant)}$$

The current gain of the common emitter is beta, where

$$\beta = \frac{\Delta I_c}{\Delta I_b} \text{ (with } V_c \text{ constant).}$$

Transistor Symbols

α = Current gain common base

A_c (A_v) = Voltage gain

A_i = Current gain

A = Power gain

B = Current gain common emitter

I_b = Base current

I_c = Collector current

I_e = Emitter current

I_i = Input current

P_i = Input power

P_o = Output power

R_i = Input resistance

R_o = Output resistance

V_b = Base voltage

V_c = Collector voltage

V_i = Input voltage

A direct relationship exists between the alpha and beta of a transistor.

$$\alpha = \frac{B}{1 + B} \quad B = \frac{\alpha}{1 - \alpha}$$

Courtesy Howard W. Sam's Photofact Publication: "ABC's of Transistors."

Transistor Amplifier Circuit Configurations

With Vacuum & Tube Counterparts

The transistors of primary interest to the radio engineer and service technician are the PNP and NPN junction types, whose transistor actions are identically alike, except that symbolically, the emitter arrow points towards the base in the PNP and away from the base in the NPN. The common-emitter circuits are used almost

exclusively for most amplification purposes as are the common or grounded-cathode vacuum tube circuits. The common-base and common-grid as well as common-collector common-plate circuits are used more for special applications such as impedance matching to and from audio transmission lines, etc.

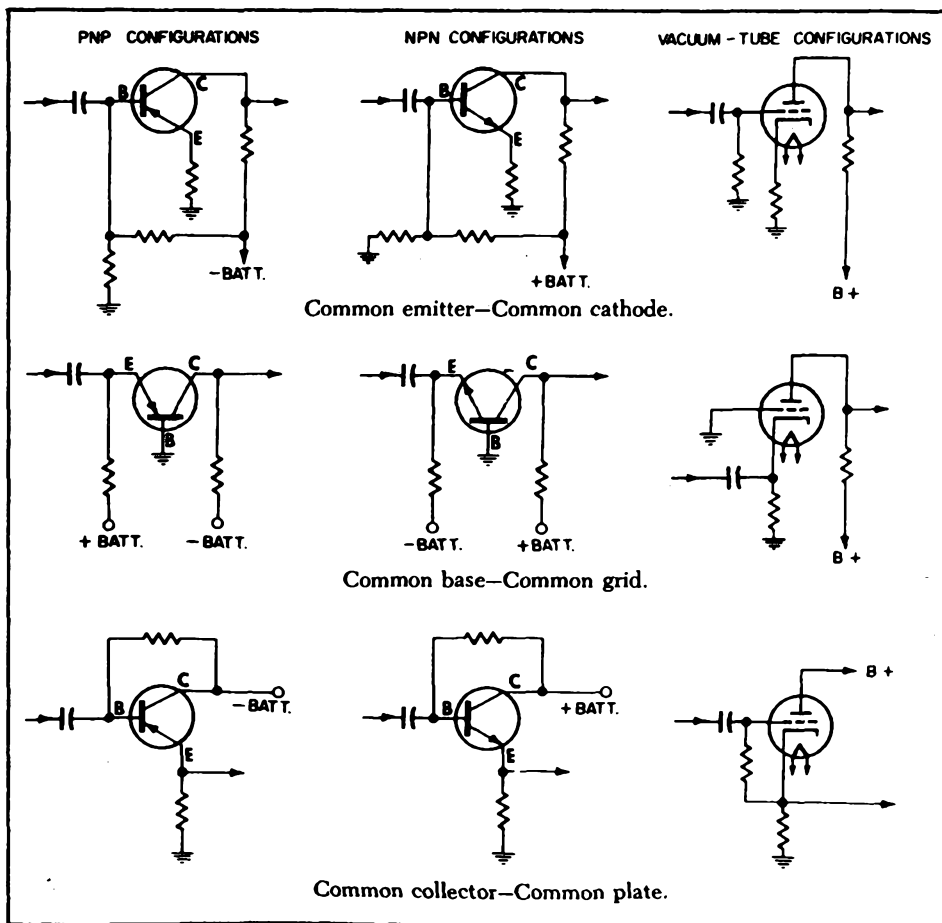

Common-Emitter Amplifier Circuits Using Transistors Only

In comparing the PNP and NPN circuits shown here, note that the current flow in the components of one is completely reversed in the other. With the vacuum tube, this complete interchange of current and voltage polarities does not exist. Because of

this interchange in the transistor, circuits which have no parallel in vacuum-tube circuitry can be produced. Nevertheless, the circuits of transistorized equipment are still quite similar in many respects to those of equipment employing vacuum tubes.

Using PNP Transistors

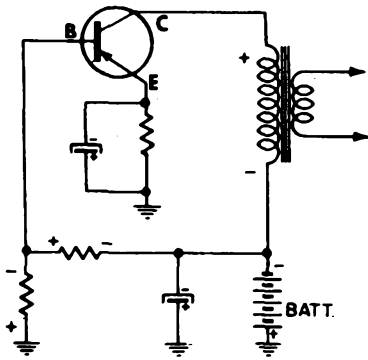

With Positive
Battery Terminal Grounded

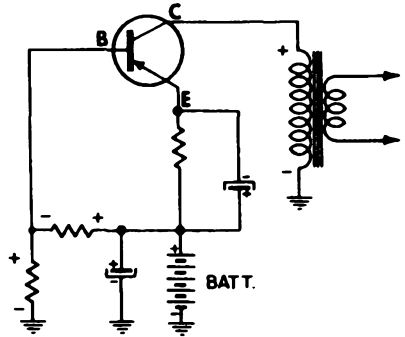

With Negative
Battery Terminal Grounded

Using NPN Transistors

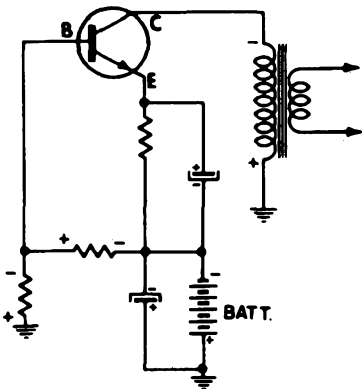

With Positive
Battery Terminal Grounded

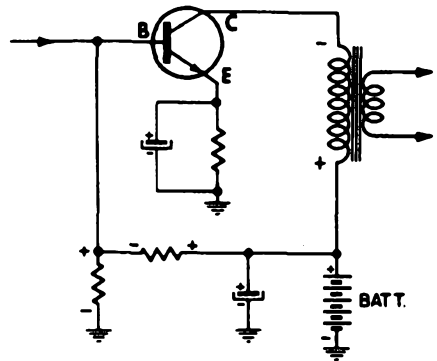

With Negative
Battery Terminal Grounded

D-C Meter Formulas

Meter Resistance

The d-c resistance of a millimeter or voltmeter movement may be determined as follows:

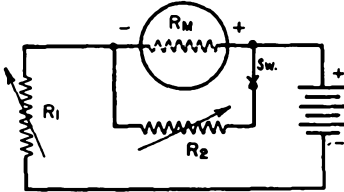

1. Connect the meter in series with a suitable battery and variable resistance R_1 as shown in the diagram above.
2. Vary R_1 until a full scale reading is obtained.
3. Connect another variable resistor R_2 across the meter and vary its value until a half scale reading is obtained.
4. Disconnect R_2 from the circuit and measure its d-c resistance.

The meter resistance R_m is equal to the measured resistance of R_2 .

Caution: Be sure that R_1 has sufficient resistance to prevent an off scale reading of the meter. The correct value depends upon the sensitivity of meter, and voltage of the battery. The following formula can be used if the full scale current of the meter is known:

$$R_1 = \frac{\text{voltage of the battery used}}{\text{full scale current of meter in amperes}}$$

For safe results, use twice the value computed. Also, never attempt to measure the resistance of a meter with an ohmmeter. To do so would in all probability result in a burned-out or severely damaged meter, since the current required for the operation of some ohmmeters and bridges is far in excess of the full scale current required by the movement of the average meter you may be checking.

Ohms per Volt Rating of a Voltmeter

$$\Omega/V = \frac{1}{I_{fs}}$$

where Ω/V = ohms per volt,

I_{fs} = full scale current in amperes.

Fixed Current Shunts

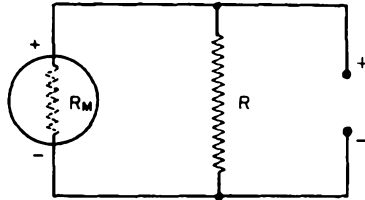

$$R = \frac{R_m}{N - 1}$$

R = shunt value in ohms,

N = the new full scale reading divided by the original full scale reading, both being stated in the same units,

R_m = meter resistance in ohms.

Multi-Range Shunts

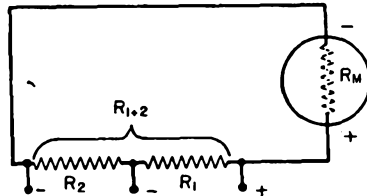

$$R_1 = \frac{R_{1+2} + R_m}{N}$$

R_1 = intermediate or tapped shunt value in ohms,

R_{1+2} = total resistance required for the lowest scale reading wanted,

R_m = meter resistance in ohms,

N = the new full scale reading divided by the original full scale reading, both being stated in the same units.

Voltage Multipliers

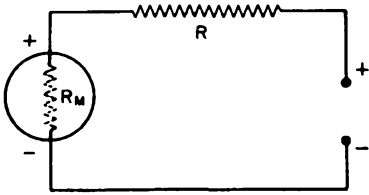

$$R = \frac{E_{fs}}{I_{fs}} - R_m$$

R = multiplier resistance in ohms,
 E_{fs} = full scale reading required in volts,
 I_{fs} = full scale current of meter in amperes,
 R_m = meter resistance in ohms.

Measuring Resistance

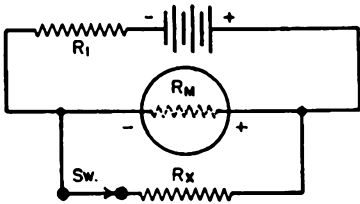

with Milliammeter and Battery*

$$R_x = R_m \left(\frac{I_2}{I_1 - I_2} \right)$$

R_x = unknown resistance in ohms,
 R_m = meter resistance in ohms, or effective meter resistance if a shunted range is used,
 I_1 = current reading with switch open,
 I_2 = current reading with switch closed,
 R_1 = current limiting resistor of sufficient value to keep meter reading on scale when switch is open.

* Approximately true only when current limiting resistor is large as compared to meter resistance.

Shunt Values for 27-Ohm 0-1 Milliammeter

FULL SCALE CURRENT	SHUNT RESISTANCE
0-10 ma	3.0 ohms
0-50 ma	0.551 ohms
0-100 ma	0.272 ohms
0-500 ma	0.0541 ohms

Measuring Resistance—(Continued)

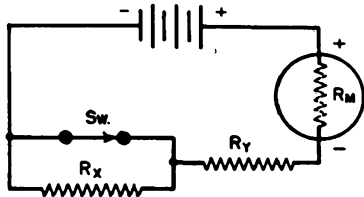

with Millimeter, Battery and Known Resistor

$$R_x = (R_y + R_m) \left(\frac{I_1 - I_2}{I_2} \right)$$

R_x = unknown resistance in ohms,
 R_y = known resistance in ohms,
 R_m = meter resistance in ohms,
 I_1 = current reading with switch closed,
 I_2 = current reading with switch open.

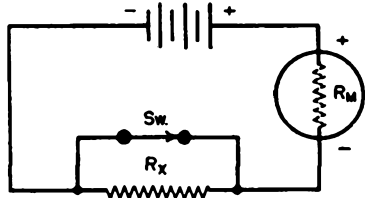

with Voltmeter and Battery

$$R_x = R_m \left(\frac{E_1}{E_2} - 1 \right)$$

R_x = unknown resistance in ohms,
 R_m = meter resistance in ohms, including multiplier resistance if a multiplied range is used,
 E_1 = voltmeter reading with switch closed,
 E_2 = voltmeter reading with switch open.

Multiplier Values for 27-Ohm 0-1 Milliammeter

FULL SCALE VOLTAGE	MULTIPLIER RESISTANCE
0-10 volts	10,000 ohms
0-50 volts	50,000 ohms
0-100 volts	100,000 ohms
0-250 volts	250,000 ohms
0-500 volts	500,000 ohms
0-1,000 volts	1,000,000 ohms

Ohm's Law for A-C Circuits

The fundamental Ohm's law formulas for a-c circuits are given by

$$I = \frac{E}{Z}, \quad Z = \frac{E}{I},$$

$$E = IZ, \quad P = EI \cos \theta$$

where I = current in amperes,
 Z = impedance in Ohms,
 E = volts across Z ,
 P = power in watts,
 θ = phase angle in degrees.

Phase Angle

The phase angle is defined as the difference in degrees by which current leads voltage in a capacitive circuit, or lags voltage in an inductive circuit, and in series circuits is equal to the angle whose tangent is given by the

ratio $\frac{X}{R}$ and is expressed by

$$\text{arc tan } \frac{X}{R}$$

where X = the inductive or capacitive reactance in ohms,

R = the non-reactive resistance in ohms,

of the combined resistive and reactive components of the circuit under consideration.

Therefore

in a purely resistive circuit, $\theta = 0^\circ$

in a purely reactive circuit, $\theta = 90^\circ$

and in a resonant circuit, $\theta = 0^\circ$

also when

$\theta = 0^\circ$, $\cos \theta = 1$ and $P = EI$,

$\theta = 90^\circ$, $\cos \theta = 0$ and $P = 0$.

Degrees $\times 0.0175$ = radians.

1 radian = 57.3° .

Power Factor

The power-factor of any a-c circuit is equal to the true power in watts divided by the apparent power in volt-amperes which is equal to the cosine of the phase angle, and is expressed by

$$p.f. = \frac{EI \cos \theta}{EI} = \cos \theta$$

where

$p.f.$ = the circuit load power factor,

$EI \cos \theta$ = the true power in watts,

EI = the apparent power in volt-amperes,

E = the applied potential in volts

I = load current in amperes.

Therefore

in a purely resistive circuit,

$$\theta = 0^\circ \text{ and } p.f. = 1$$

and in a reactive circuit,

$$\theta = 90^\circ \text{ and } p.f. = 0$$

and in a resonant circuit,

$$\theta = 0^\circ \text{ and } p.f. = 1$$

Ohm's Law for D-C Circuits

The fundamental Ohm's law formulas for d-c circuits are given by,

$$I = \frac{E}{R}, \quad R = \frac{E}{I},$$

$$E = IR, \quad P = EI.$$

where I = current in amperes,

R = resistance in ohms,

E = potential across R in volts,

P = power in watts.

Ohm's Law Formulas for D-C Circuits

Known Values	Formulas for Determining Unknown Values of ...			
	<i>I</i>	<i>R</i>	<i>E</i>	<i>P</i>
<i>I</i> & <i>R</i>			IR	I^2R
<i>I</i> & <i>E</i>		$\frac{E}{I}$		EI
<i>I</i> & <i>P</i>		$\frac{P}{I^2}$	$\frac{P}{I}$	
<i>R</i> & <i>E</i>	$\frac{E}{R}$			$\frac{E^2}{R}$
<i>R</i> & <i>P</i>	$\sqrt{\frac{P}{R}}$		\sqrt{PR}	
<i>E</i> & <i>P</i>	$\frac{P}{E}$	$\frac{E^2}{P}$		

Ohm's Law Formulas for A-C Circuits

Known Values	Formulas for Determining Unknown Values of ...			
	<i>I</i>	<i>Z</i>	<i>E</i>	<i>P</i>
<i>I</i> & <i>Z</i>			IZ	$I^2Z \cos \theta$
<i>I</i> & <i>E</i>		$\frac{E}{I}$		$IE \cos \theta$
<i>I</i> & <i>P</i>		$\frac{P}{I^2 \cos \theta}$	$\frac{P}{I \cos \theta}$	
<i>Z</i> & <i>E</i>	$\frac{E}{Z}$			$\frac{E^2 \cos \theta}{Z}$
<i>Z</i> & <i>P</i>	$\sqrt{\frac{P}{Z \cos \theta}}$		$\sqrt{\frac{PZ}{\cos \theta}}$	
<i>E</i> & <i>P</i>	$\frac{P}{E \cos \theta}$	$\frac{E^2 \cos \theta}{P}$		

Coil Winding Data

Turns Per Inch

Gauge (AWG) or (B&S)	Number of Turns per Linear Inch			
	Enamel	S.S.C.	D.S.C. and S.C.C.	D.C.C.
1	—	—	3.3	3.3
2	—	—	3.8	3.6
3	—	—	4.2	4.0
4	—	—	4.7	4.5
5	—	—	5.2	5.0
6	—	—	5.9	5.6
7	—	—	6.5	6.2
8	7.6	—	7.4	7.1
9	8.6	—	8.2	7.8
10	9.6	—	9.3	8.9
11	10.7	—	10.3	9.8
12	12.0	—	11.5	10.9
13	13.5	—	12.8	12.0
14	15.0	—	14.2	13.8
15	16.8	—	15.8	14.7
16	18.9	18.9	17.9	16.4
17	21.2	21.2	19.9	18.1
18	23.6	23.6	22.0	19.8
19	26.4	26.4	24.4	21.8
20	29.4	29.4	27.0	23.8
21	33.1	32.7	29.8	26.0
22	37.0	36.5	34.1	30.0
23	41.3	40.6	37.6	31.6
24	46.3	45.3	41.5	35.6
25	51.7	50.4	45.6	38.6
26	58.0	55.6	50.2	41.8
27	64.9	61.5	55.0	45.0
28	72.7	68.6	60.2	48.5
29	81.6	74.8	65.4	51.8
30	90.5	83.3	71.5	55.5
31	101.	92.0	77.5	59.2
32	113.	101.	83.6	62.6
33	127.	110.	90.3	66.3
34	143.	120.	97.0	70.0
35	158.	132.	104.	73.5
36	175.	143.	111.	77.0
37	198.	154.	118.	80.3
38	224.	166.	126.	83.6
39	248.	181.	133.	86.6
40	282.	194.	140.	89.7

Coil Winding Formulas

The following approximations for winding *r-f* coils are accurate to within approx. 1% for nearly all small air-core coils, where

- L* = self inductance in microhenrys,
- N* = total number of turns,
- r* = mean radius in inches,
- l* = length of coil in inches,
- b* = depth of coil in inches.

Single-Layer Wound Coils

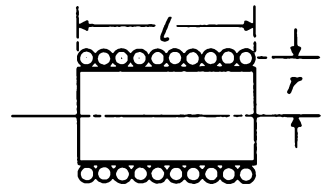

$$L = \frac{(rN)^2}{9r + 10l}$$

$$N = \frac{\sqrt{L(9r + 10l)}}{r}$$

Multi-Layer Wound Coils

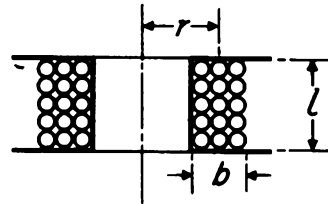

$$L = \frac{0.8(rN)^2}{6r + 9l + 10b}$$

Single-Layer Spiral Wound Coils

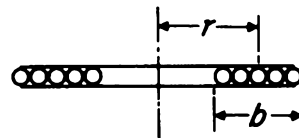

$$L = \frac{(rN)^2}{8r + 11b}$$

**Table of Standard Annealed Bare Copper Wire
Using American Wire Gauge (B&S)**

Gauge (AWG) or (B & S)	DIAMETER INCHES			AREA Circular Mils	WEIGHT Pounds per M'	LENGTH Feet per Lb.	RESISTANCE AT 68° F			Current * Capacity (Amps)— Rubber Insulated
	Min.	Nom.	Max.				Ohms per M'	Feet per Ohm	Ohms per Lb.	
0000	.4554	.4600	.4646	211600.	640.5	1.561	.04901	20400.	.00007652	225
000	.4055	.4096	.4137	167800.	507.9	1.968	.06180	16180.	.0001217	175
00	.3612	.3648	.3684	133100.	402.8	2.482	.07793	12830.	.0001935	150
0	.3217	.3249	.3281	105500.	319.5	3.130	.09827	10180.	.0003076	125
1	.2864	.2893	.2922	83690.	253.3	3.947	.1239	8070.	.0004891	100
2	.2550	.2576	.2602	66370.	200.9	4.977	.1563	6400.	.0007778	90
3	.2271	.2294	.2317	52640.	159.3	6.276	.1970	5075.	.001237	80
4	.2023	.2043	.2063	41740.	126.4	7.914	.2485	4025.	.001966	70
5	.1801	.1819	.1837	33100.	100.2	9.980	.3133	3192.	.003127	55
6	.1604	.1620	.1636	26250.	79.46	12.58	.3951	2531.	.004972	50
7	.1429	.1443	.1457	20820.	63.02	15.87	.4982	2007.	.007905	
8	.1272	.1285	.1298	16510.	49.98	20.01	.6282	1592.	.01257	35
9	.1133	.1144	.1155	13090.	39.63	25.23	.7921	1262.	.01999	
10	.1009	.1019	.1029	10380.	31.43	31.82	.9989	1001.	.03178	25
11	.08983	.09074	.09165	8234.	24.92	40.12	1.260	794.	.05053	
12	.08000	.08081	.08162	6530.	19.77	50.59	1.588	629.6	.08035	20
13	.07124	.07196	.07268	5178.	15.68	63.80	2.003	499.3	.1278	
14	.06344	.06408	.06472	4107.	12.43	80.44	2.525	396.0	.2032	15
15	.05650	.05707	.05764	3257.	9.858	101.4	3.184	314.0	.3230	
16	.05031	.05082	.05133	2583.	7.818	127.9	4.016	249.0	.5136	6
17	.04481	.04526	.04571	2048.	6.200	161.3	5.064	197.5	.8167	
18	.03990	.04030	.04070	1624.	4.917	203.4	6.385	156.5	1.299	3
19	.03553	.03589	.03625	1288.	3.899	256.5	8.051	124.2	2.065	
20	.03164	.03196	.03228	1022.	3.092	323.4	10.15	98.5	3.283	
21	.02818	.02846	.02874	810.1	2.452	407.8	12.80	78.11	5.221	
22	.02510	.02535	.02560	642.4	1.945	514.2	16.14	61.95	8.301	
23	.02234	.02257	.02280	509.5	1.542	648.4	20.36	49.13	13.20	
24	.01990	.02010	.02030	404.0	1.223	817.7	25.67	38.96	20.99	
25	.01770	.01790	.01810	320.4	.9699	1031.	32.37	30.90	33.37	
26	.01578	.01594	.01610	254.1	.7692	1300.	40.81	24.50	53.06	
27	.01406	.01420	.01434	201.5	.6100	1639.	51.47	19.43	84.37	
28	.01251	.01264	.01277	159.8	.4837	2067.	64.90	15.41	134.2	
29	.01115	.01126	.01137	126.7	.3836	2607.	81.83	12.22	213.3	
30	.00993	.01003	.01013	100.5	.3042	3287.	103.2	9.691	339.2	
31	.008828	.008928	.009028	79.7	.2413	4145.	130.1	7.685	539.3	
32	.007850	.007950	.008050	63.21	.1913	5227.	164.1	6.095	857.6	
33	.006980	.007080	.007180	50.13	.1517	6591.	206.9	4.833	1364.	
34	.006205	.006305	.006405	39.75	.1203	8310.	260.9	3.833	2168.	
35	.005515	.005615	.005715	31.52	.09542	10480.	329.0	3.040	3448.	
36	.004900	.005000	.005100	25.00	.07568	13210.	414.8	2.411	5482.	
37	.004353	.004453	.004553	19.83	.06001	16660.	523.1	1.912	8717.	
38	.003865	.003965	.004065	15.72	.04759	21010.	659.6	1.516	13860.	
39	.003431	.003531	.003631	12.47	.03774	26500.	831.8	1.202	22040.	
40	.003045	.003145	.003245	9.888	.02993	33410.	1049.	0.9534	30540.	
41	.00270	.00280	.00290	7.8400	.02373	42140.	1323.	.7559	55750.	
42	.00239	.00249	.00259	6.2001	.01877	53270.	1673.	.5977	89120.	
43	.00212	.00222	.00232	4.9284	.01492	67020.	2104.	.4753	141000.	
44	.00187	.00197	.00207	3.8809	.01175	85100.	2672.	.3743	227380.	
45	.00166	.00176	.00186	3.0976	.00938	106600.	3348.	.2987	356890.	
46	.00147	.00157	.00167	2.4649	.00746	134040.	4207.	.2377	563900.	

*Note: Values from National Electrical Code...

Single-Layer Wound Coil Chart

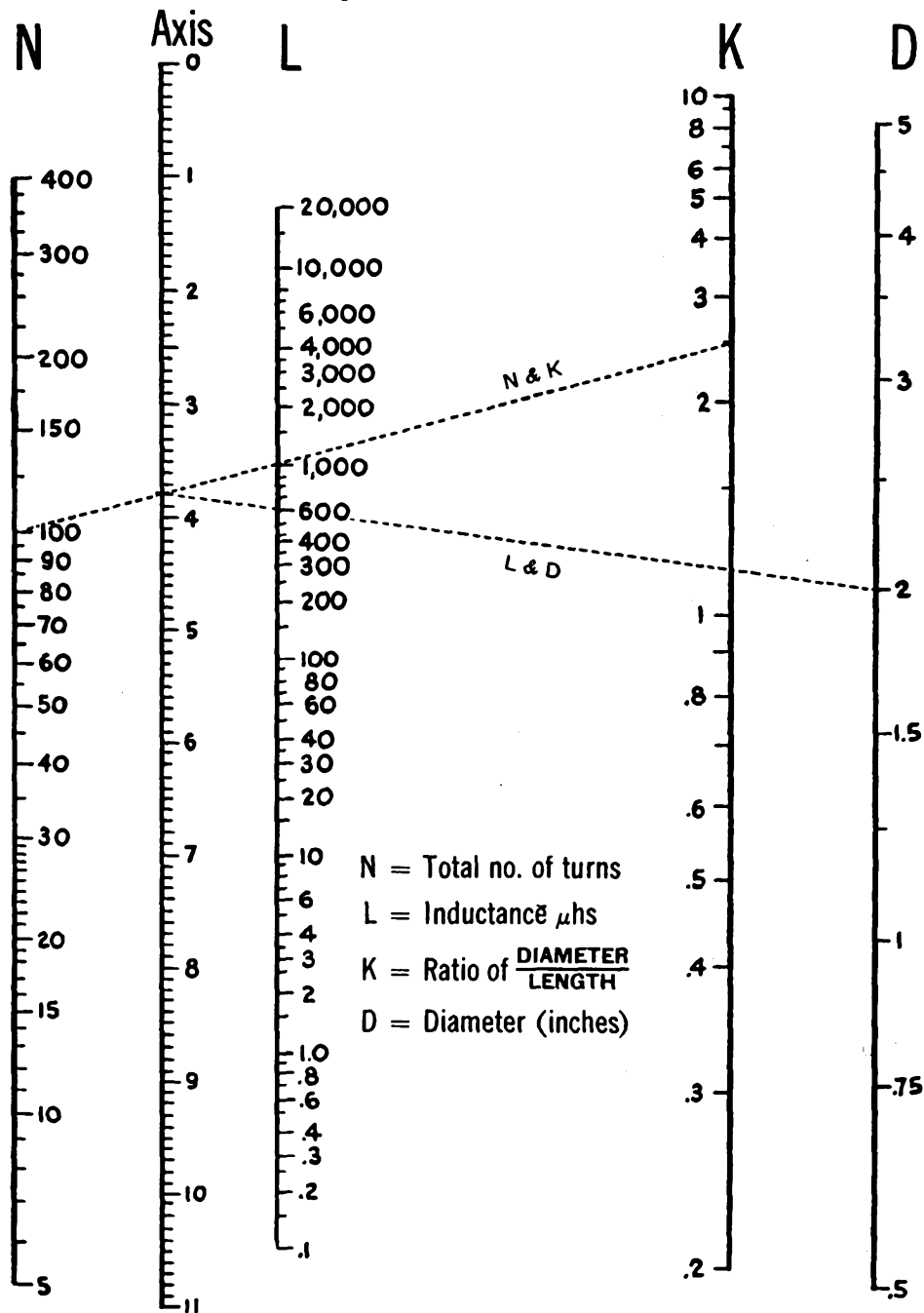

N = Total no. of turns
 L = Inductance μ hs
 K = Ratio of $\frac{\text{DIAMETER}}{\text{LENGTH}}$
 D = Diameter (inches)

Courtesy, P. R. Mallory & Co., Inc.

Single-Layer Wound Coil Chart

The chart on the opposite page provides a convenient means of determining the unknown factors of small sized single-layer wound r-f coils. Values thus found so closely approximate those determined by measurement or mathematical calculation as to be entirely satisfactory for all practical purposes of experimentation, design, and repair work. Since in all coils of this type, the difference between the mean and inner diameter of the winding is so slight as to be negligible, D in all instances may be either the mean or inner diameter as desired.

Example: Given the total number of turns, winding length and diameter of a coil,— to find the inductance:

1. Place a straightedge on the chart so as to form a line intersecting the number of turns N , and the ratio of diameter to length K , and note the point intersected on the linear axis column.

2. Now move the straightedge so as to form a second line which will intersect this same point on the axis column, and the diameter D .

3. The point where this line intersects the L column indicates the inductance of the coil in microhenries.

Example: Given the diameter, winding length and inductance in microhenries,— to find the number of turns;

1. Simply reverse the process outlined above for determining inductance.
2. After finding the number of turns, consult the wire table on page 26 and determine the size of wire to be used.

The dotted lines appearing on the chart illustrate the correct plotting of a 600-microhenry coil consisting of 100 turns of wire, wound to 51/64" on a form 2" in diameter.

Inductance, Capacitance, Reactance Charts

The direct-reading charts appearing on the following three pages are designed for determining unknown values of frequency, inductance, capacitance and reactance components operating in a-f and r-f circuits.

The simplifications embodied in these charts make them extremely useful. The frequency range covered comprises the frequency spectrum from 1 cycle per second up to 1000 megacycles per second. All of the scales involved are plotted in actual magnitudes so that no computations are required to determine the location of the decimal point in the final result.

To make these conditions possible the frequency spectrum has been divided into three parts:

Chart I (page 30)—Covers the range from 1 cycle to 1000 cycles.

Chart II (page 31)—From 1 kilocycle to 1000 kilocycles.

Chart III (page 32)—From 1 megacycle to 1000 megacycles.

Inductance, capacitance, reactance and frequency have been plotted so that the reactance offered by an inductance or capacitance at any frequency may be readily determined by placing a straight-edge across the chart connecting the known quantities.

Since $X_L = X_C$ at resonance in most radio circuits, the charts may also be used to find the resonant frequency of any combination of L and C .

To illustrate with a simple example, suppose the reactance of a 0.01 μ f. capacitor is desired at a frequency of 400 cycles. Place a straight-edge across the proper chart so as to connect the points 0.01 μ f. and 400 cycles per sec. The quantity desired is the point of intersection with the reactance scale which is 40,000 ohms. The straight-edge also intersects the inductance scale at 15.8 henrys indicating that this value of inductance likewise has a reactance of 40,000 ohms at 400 cycles per sec. and furthermore, that these values of L and C produce resonance at this frequency.

There are many practical uses for these charts. The radio experimenter, maintenance man and engineer will find them helpful in the rapid solution of many reactance problems. Unusual care was exercised in laying out the various scales in order to secure a high degree of accuracy for the charts. Results should be obtainable which are at least as accurate as might be secured with a ten-inch slide rule.

Inductance, Capacitance, Reactance—(Continued)

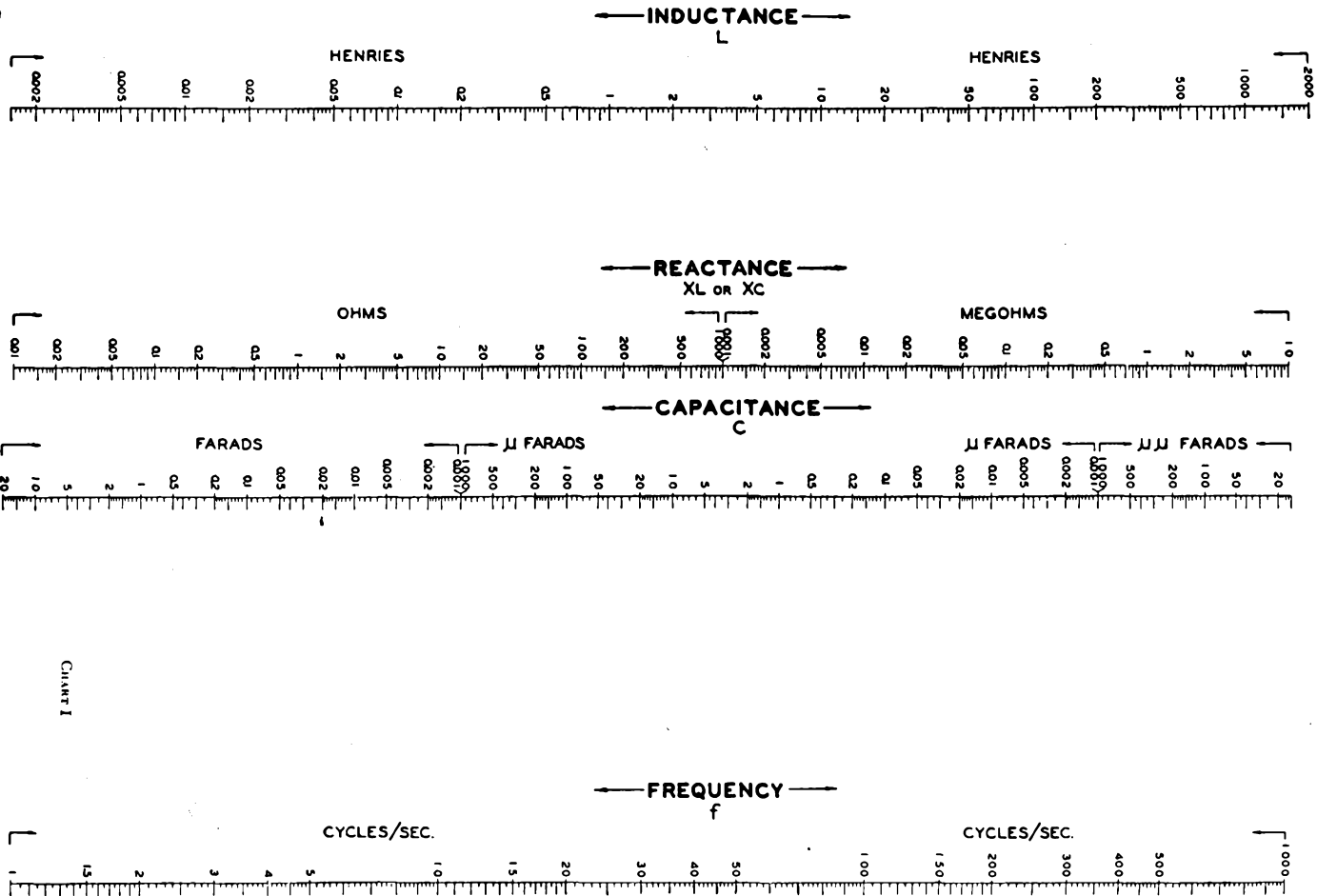
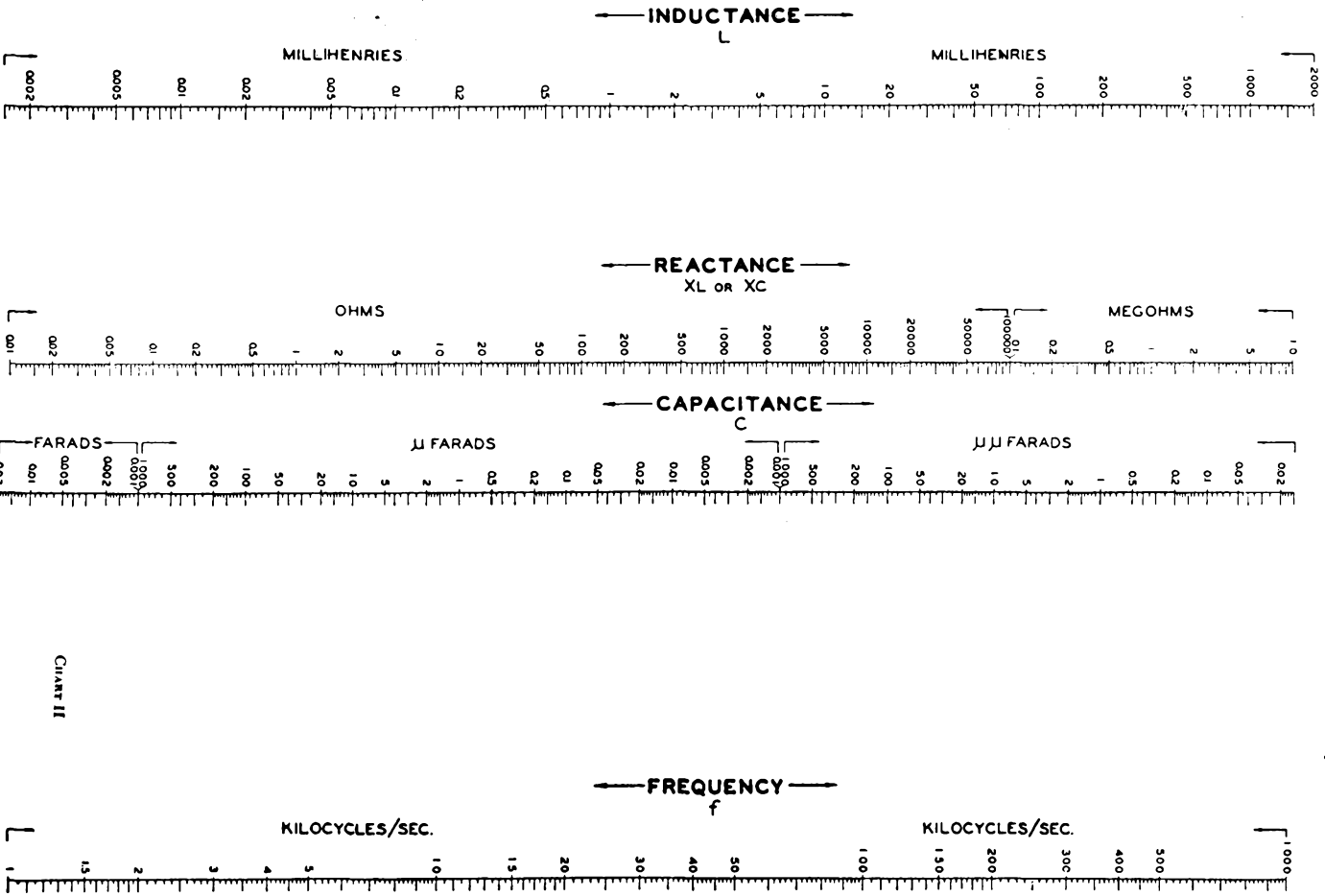

CHART I

Inductance, Capacitance, Reactance—(Continued)



Courtesy, Sylvania Electric Products Inc.

CHART II

Inductance, Capacitance, Reactance—(Continued)

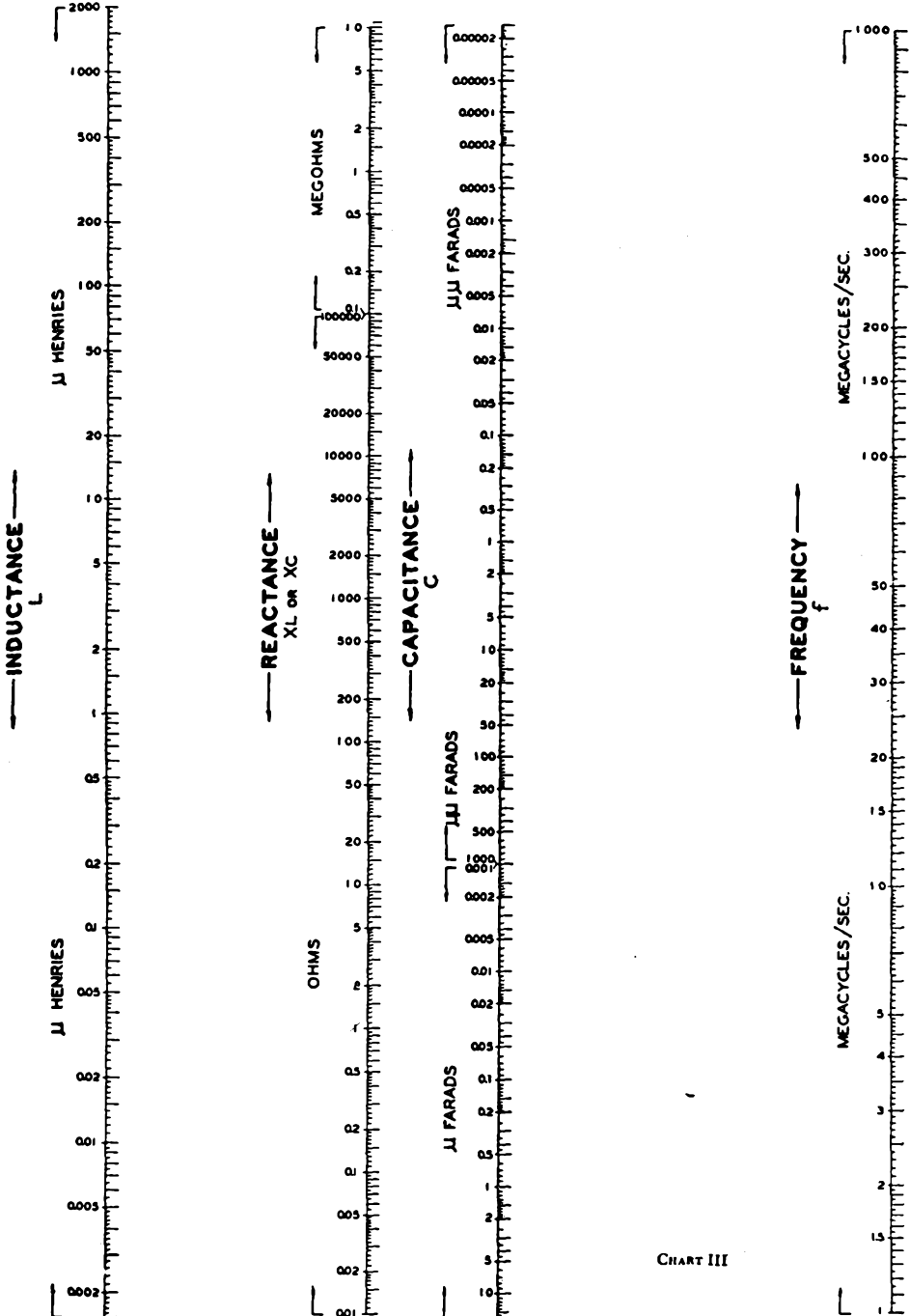
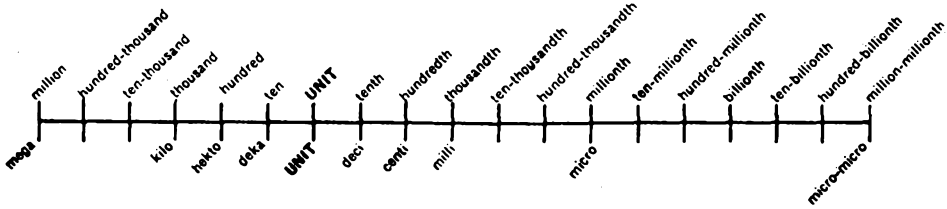

CHART III

Courtesy, Sylvania Electric Products Inc.

Metric Relationships



The above chart shows the relation between the American and the metric systems of notation.

This chart also serves to quickly locate the decimal point in the conversion from one metric expression to another.

Example: Convert 5.0 milliwatts to watts. Place the finger on milli and count the number of steps from there to units (since the

term watt is a basic unit). The number of steps so counted is three, and the direction was to the left. Therefore, 5.0 milliwatts is the equivalent of .005 watts.

Example: Convert 0.00035 microfarads to micromicrofarads. Here the number of steps counted will be six to the right. Therefore 0.00035 microfarads is the equivalent of 350 micromicrofarads.

Metric Conversion Table

ORIGINAL VALUE	DESIRED VALUE							
	Mega	Kilo	Units	Deci	Centi	Milli	Micro	Micromicro
Mega		3 →	6 →	7 →	8 →	9 →	12 →	18 →
Kilo	← 3		3 →	4 →	5 →	6 →	9 →	15 →
Units	← 6	← 3		1 →	2 →	3 →	6 →	12 →
Deci	← 7	← 4	← 1		1 →	2 →	5 →	11 →
Centi	← 8	← 5	← 2	← 1		1 →	4 →	10 →
Milli	← 9	← 6	← 3	← 2	← 1		3 →	9 →
Micro	← 12	← 9	← 6	← 5	← 4	← 3		6 →
Micromicro	← 18	← 15	← 12	← 11	← 10	← 9	← 6	

The above metric conversion table provides a fast and automatic means of conversion from one metric notation to another. The notation "Unit" represents the basic units of measurement, such as amperes, volts, ohms, watts, cycles, meters, grams, etc. To use the table, first locate the original or given value in the left-hand column. Now follow this line horizontally to the vertical column headed by the prefix of the desired value. The figure and arrow at this point indicates number of places and direction decimal point is to be moved.

Example: Convert 0.15 ampere to milli-amperes. Starting at the "Units" box in the left-hand column (since ampere is a basic unit of measurement), move horizontally to the column headed by the prefix "Milli", and read 3 →. Thus 0.15 ampere is the equivalent of 150 milliamperes.

Example: Convert 50,000 kilocycles to megacycles. Read in the box horizontal to "Kilo" and under "Mega", the notation ←3, which means a shift of the decimal three places to the left. Thus 50,000 kilocycles is the equivalent of 50 megacycles.

How to Use Logarithms

Logarithms are used to simplify numerical computations involving multiplications, division, powers and roots. With logarithms, multiplication is reduced to simple addition, and division is reduced to simple subtraction. Raising to a power is reduced to a single multiplication, and extracting a root is reduced to a single division.

The common logarithm of any number is the power to which 10 must be raised in order to equal that number.

Therefore, since

$$\begin{aligned} 1000 &= 10^3 \\ 100 &= 10^2 \\ 10 &= 10^1 \\ 1 &= 10^0 \\ 0.1 &= 10^{-1} \\ 0.01 &= 10^{-2} \\ 0.001 &= 10^{-3} \\ 0.0001 &= 10^{-4} \end{aligned}$$

it is true that

$$\begin{aligned} \log 1000 &= 3 \\ \log 100 &= 2 \\ \log 10 &= 1 \\ \log 1 &= 0 \\ \log 0.1 &= -1 \\ \log 0.01 &= -2 \\ \log 0.001 &= -3 \\ \log 0.0001 &= -4 \end{aligned}$$

The common system of logarithms has for its base the number 10, and is written \log_{10} or more commonly \log , since the base 10 is always implied unless some other base is specifically indicated. There are formulas however which use the natural system of logarithms. This system has for its base the number 2.718... which is represented by the Greek letter e and is always written $\log e$.

A table of natural logarithms has not been included in this handbook however, since the common \log of a number is approximately equal to 0.4343 times the natural \log of the same number. Conversely, the natural \log of a number is approximately equal to 2.3026 times the common \log of the same number.

In observing the following exponential and logarithmic relationships,

Exponential Form	Logarithmic Form
100 = 10^2	$\log 100 = 2.000$
15 = $10^{1.176}$	$\log 15 = 1.176$
10 = 10^1	$\log 10 = 1.000$
7 = $10^{0.845}$	$\log 7 = 0.845$
1 = 10^0	$\log 1 = 0.000$
0.1 = 10^{-1}	$\log 0.1 = -1.000$
0.7 = $10^{-1.845}$	$\log 0.7 = -1.845$
0.015 = $10^{-2.176}$	$\log 0.015 = -2.176$
0.001 = 10^{-3}	$\log 0.001 = -3.000$

it will be seen that only the direct powers of 10 have whole numbers for logarithms; also that the logarithms of all numbers lying between a power of 10, consist of a whole number and a decimal. The whole number is called the characteristic, and the decimal, the mantissa. Since the characteristic serves only to fix the location of the decimal point in the expression indicated by the \log , it can be found by inspection and is not included in the \log table. The following will be helpful:

1. The characteristic of any number greater than 1 is always positive and is equal to one less than the number of digits to the left of the decimal.
2. The characteristic of any number less than 1 is always negative and is equal to one plus the number of zeros to the decimal.
3. The characteristic of any number may be determined by expressing the number as a power of 10 and using this power as the characteristic of the logarithm for that number.

Since only the characteristic of a logarithm is ever negative, the mantissa always being a positive number, it is customary to write a \log containing a negative characteristic as follows:

$$\log 0.7 = \bar{1}.845,$$

or, by adding +10 to the characteristic and, in order to maintain equality, -10 at the right of the characteristic,

$$\log 0.7 = 9.845 - 10$$

Examples:

150	1.5×10^2	2
15	1.5×10^1	1
1.5	1.5×10^0	0
0.15	1.5×10^{-1}	-1 or 9 - 10
0.015	1.5×10^{-2}	-2 or 8 - 10
0.0015	1.5×10^{-3}	-3 or 7 - 10

Therefore, to find the logarithm of any number:

1. Write the number as a power of 10, and put down the resulting exponent of 10 as the characteristic.
2. Determine the mantissa from the log tables on page 56, and write this as a decimal figure following the characteristic.
3. If the resulting logarithm has a negative characteristic, change this to the positive form.

Example: Find the logarithm of .00623:

Since $.00623 = 6.23 \times 10^{-3}$, the characteristic is -3. The mantissa as shown by the log table is 7945. The resultant logarithm = 3.7945 or when written in its positive form, 7.7945 - 10.

To find the log of any number having more than three significant figures (by interpolation):

1. Determine the characteristic.
2. Find the mantissa corresponding to the first three significant figures.
3. Find the next higher mantissa and take the tabular difference.
4. Find the product of the tabular difference and the digit following the first three significant figures of the given number written as a decimal.
5. Add this product to the lesser mantissa.

Example: Find the logarithm of 54.65.

Since $54.65 = 5.465 \times 10^1$, the characteristic is 1.

Next higher mantissa	=	.7380
Next lower mantissa	=	.7372
Tabular difference	=	.0008
		$\times .5$
Product		.00040
Plus lesser mantissa		.7372
Mantissa of 5.465		.7376

$\therefore \log 54.65 = 1.7376$

Although a four-place log table is used here, for purposes where accuracy to 3 significant figures is required, generally, a three place table is sufficiently accurate for all practical purposes. Since the mantissa of a logarithm represents only the significant figures of any number, the same mantissa is used for .04, 4, 400, etc., the decimal point being fixed later by the characteristic. Therefore any number consisting of 1 or 2 significant figures may be found in the column marked **N**, and its mantissa will be found on the same line in this column headed by **0**. For any number containing 3 significant figures, locate the first two figures in the **N** column, and the third figure in the column headed by the corresponding digit. The mantissa will be found in this column, on a line even with the first two digits.

Example:

log	21	=	1.3222
log	2.1	=	0.3222
log	210	=	2.3222
log	.0021	=	7.3222 - 10
log	213	=	2.3284
log	.0213	=	8.3284 - 10
log	3	=	0.4771
log	300	=	2.4771
log	.003	=	7.4771 - 10

The number corresponding to a given logarithm is called the antilogarithm, and is written "antilog". Example: Since log of 692 = 2.8401, the antilog of 2.8401 = 692.

Finding the antilog of a number is the reverse of finding the logarithm. First locate the mantissa in the log table, and determine its corresponding number. Now, place the decimal as indicated by the characteristic.

Example: To find the antilog of 3.9138, look up 9138 in the log table. Its corresponding number is 82, or expressed as a power of 10, equals 8.2. A characteristic of 3 means that 8.2 must be multiplied by 10^3 . Therefore, antilog 3.9138 = $8.2 \times 10^3 = 8200$.

Similarly

Antilog	5.9138	=	$8.2 \times 10^5 = 82,0000$
Antilog	0.9138	=	$8.2 \times 10^0 = 8.2$
Antilog	7.9138 - 10	=	$8.2 \times 10^{-3} = 0.0082$
Antilog	9.9138 - 10	=	$8.2 \times 10^{-1} = 0.82$

To find the antilogarithm of a logarithm

whose mantissa is not exactly given in the table,

1. Find the tabular difference between the next highest and next lowest mantissas.
2. Divide this by the difference between the given mantissa and the next lowest mantissa.
3. Add the resulting quotient to the significant figures expressed by the next lower mantissa.
4. Place the decimal as indicated by the given characteristic.

Example: Find the antilog of 1.7376

Next higher mantissa .7380

Next lower mantissa .7372

Tabular difference .0008

Given mantissa .7376

Next lower mantissa .7372

Tabular difference .0004

$$\text{Quotient of } \frac{.0004}{.0008} = .5$$

The resultant figure therefore is .5 larger than the significant figures expressed by the lesser mantissa .7372 or 546. The sequence of figures therefore is 546.5

$$\therefore \text{the antilog of } 1.7376 = 54.65$$

NOTE: When interpolating as shown above, do not exceed four significant figures in your answer since interpolated results from a four-place table are not accurate beyond this point.

Logarithms are added or subtracted like arithmetical numbers, provided they are written with positive characteristics. If the characteristic in the total is greater than 9, and the notation -10, -20, -30, etc., appears after the mantissa, subtract a multiple of 10 from the positive part and add the same multiple of 10 to the negative part, so as to make the resultant characteristic less than 10.

EXAMPLES:

Addition of logarithms

2.764	6.326 - 10	6.328 - 10
4.304	6.284	7.764 - 10
7.068	12.610 - 10	9.104 - 10
	or	23.196 - 30
	2.610	or
		3.196 - 10

Subtraction of logarithms

$$\begin{array}{r} 4.107 \\ 6.986 \end{array} \left\{ \begin{array}{l} = 14.107 - 10 \\ = 6.986 \\ \hline 7.121 - 10 \\ 11.672 - 10 \\ \hline 5.785 - 10 \\ \hline 5.887 \end{array} \right.$$

The relationships of logarithmic operations are expressed by the following formulas:

$$\log (a \times b) = \log a + \log b$$

$$\log \left(\frac{a}{b} \right) = \log a - \log b$$

$$\log (a)^b = b \log a$$

$$\log \sqrt[b]{a} = \frac{\log a}{b}$$

EXAMPLES

To Multiply 1.24 by 246

$$\log \text{ of } 1.24 = 0.0934$$

$$\log \text{ of } 246 = 2.3909$$

$$\text{Total } 2.4843$$

The antilog of 2.4843 = 305, which is as accurate as can be determined with a four-place table. The full answer to this problem is 305.04.

To Divide 961 by 224

$$\log \text{ of } 961 = 2.9827$$

$$\log \text{ of } 224 = 2.3502$$

$$\text{Difference } 0.6325$$

The antilog of 0.6325 = 4.29 which is as accurate as can be determined with a four-place table. The product of 224 and 4.29 is 960.96.

Powers: Find 12² by logarithms:

$$\log \text{ of } 12 = 1.0792$$

$$\times 2$$

$$2.1584$$

The antilog of 2.1584 = 144.

Roots Find $\sqrt[3]{343}$

$$\log \text{ of } 343 = 2.5353 \div 3 = .8451$$

$$\text{The antilog of } .8451 = 7.$$

Logarithms of Negative Numbers. Because the logarithms of negative numbers are imaginary in character, they cannot be used in computation as with positive numbers. However, since the numerical results of multiplying, dividing, etc., are not affected by the signs, you can determine the numerical results by logarithms and later affix the final + or - signs by inspection.

Directly Interchangeable Tubes

NOTE: Tubes in the "Tube Number" column are directly replaceable with tubes in the "Replace With" column. The reverse, however, will not be a correct replacement on many tube types.

Replacements shown for many older tube types are the newer more reliable industrial equivalents. Many of these will be listed only in the catalog of Allied Radio's industrial subsidiary, Allied Electronics Corp., but may be purchased from Allied Radio. Prices on request.

Tube Number	Replace with	Tube Number	Replace with	Tube Number	Replace with
01A	40	1AX2	{ 1H2 1S2A	1LA4	1LA4E
0A2	{ 6073 6626			1LA6	1LC6
0A3	VR75			1LC5	1LN5
0A4	1267	1B3GT	{ 1AU3 1G3GT 1G3GT/1B3GT 1J3GT 1K3GT	1LC6	1LA6
			{ 1N2 1N2A	1LE3	1LF3
0B2	{ OB2WA 6074 6627			1LF3	1LE3
0B3	VR90			1LN5	1LC5
0C3	VR105			1M3	1N3
0D3	VR150			1N2	{ 1N2A 1AU3 1J3A
0Y4	OY4G	1B4	{ 1A4 1A4P 1A4T 1B4P 1B4T	1N2A	{ 1N2 1AU3 1J3A
0Z4	{ 1003 OZ4A		{ 32 34 951	1N5	1P5
		1C5	1Q5	1P5	1N5
1A4	{ 1A4P 1A4T 1B4 1B4P 1B4T 32 34 951	1C8	1E8	1Q5	1C5
		1D5	1E5	1R5SF	1AQ5
1A5	1T5	1D8	1B8	1S2	{ 1S2A 1H2
1AC5	1V5	1DN5	1U5	1S6	1T6
1AD5	1W5	1E4	1G4		
		1E5	1D5	1T4SF	{ 1AF4 1AJ4 1AM4
1AF4	{ 1A4 1A4T 1B4 1B4P 1B4T 32 34 951	1E8	1C8		
1AF5	{ 1A5 1A5T 1B5 1B5P 1B5T 32 34 951			1T5	1A5
1AH5	{ 1AF5 1AR5	1G3GT	{ 1AU3 1B3GT 1G3GT/1B3GT 1J3GT 1K3GT	1T6	1S6
1AJ4	{ 1AF4 1AM4 1T4SF		{ 1N2 1N2A	1U4	5910
1AM4	{ 1AF4 1AJ4 1T4SF	1G4	1E4	1U5	1DN5
1AR5	{ 1AF5 1AH5	1G5	1J5	1U5SF	1AS5
1AQ5	1R5SF			1V	6Z3
1AS5	1U5SF			1V5	1AC5
1AU3	{ 1N2 1N2A			1W5	1AD5
		1X2			
		1X2		1X2	{ 1X2A 1X2B
		2A3		2A3	{ 2A3H 5930
		2A7		2A7	2A7S
		2AF4		2AF4	{ 2AF4A 2AF4B
		2B7S		2B7S	2B7
		2CY5		2CY5	{ 2EA5 2EV5
		2EA5		2EA5	2EV5
		2ER5		2ER5	{ 2FQ5 2FQ5A 2FY5

Directly Interchangeable Tubes—(Continued)

Tube Number	Replace with	Tube Number	Replace with	Tube Number	Replace with
2EV5	2EA5	3C5	3Q5	3W4	{ 3S4SF 3Z4
2E30	5812				
2E31	2E32	3CB6	{ 3BZ6 3CF6 3DK6	3Z4	{ 3S4SF 3W4
2E32	2E31				
2E35	2E36	3CE5	3BC5	4AU6	4BA6
2E36	2E35			4BA6	4AU6
2E41	2E42	3CF6	{ 3BZ6 3CB6 3DK6	4BC5	4CE5
2E42	2E41				
2FH5	{ 2ES5 2FQ5 2FQ5A 2GK5	3CS6	{ 3BE6 3BY6	4BC8	{ 4BQ7A 4BS8 4BX8 4BZ7 4BZ8 5BK7A
2FQ5	{ 2ES5 2FQ5A 2GK5	3CY5	{ 3EA5 3EV5	4BE6	4CS6
2FS5	2GU5	3DK6	{ 3BZ6 3CB6 3CF6		
2FY5	{ 2ER5 2FQ5 2FQ5A 2GK5	3EA5	3EV5	4BQ7A	{ 4BC8 4BS8 4BX8 4BZ7 4BZ8 5BK7A
		3EH7	3EJ7		
		3EJ7	3EH7		
2GK5	{ 2FQ5 2FQ5A	3ER5	{ 3FQ5 3FQ5A 3FY5	4BS8	{ 4BC8 4BQ7A 4BX8 4BZ7 4BZ8 5BK7A
2GU5	2FS5	3EV5	3EA5	4BU8	{ 4GS8 4HS8
2G21	2G22				
2G22	2G21	3FH5	{ 3ES5 3FQ5 3FQ5A 3GK5	4BX8	{ 4BC8 4BQ7A 4BS8 4BZ7 4BZ8 5BK7A
3A3	3AW3, 3B2				
3AF4A	3AF4B	3FQ5	{ 3FQ5A 3ES5 3GK5	4BZ6	{ 4CB6 4DE6 4DK6
3AU6	3BA6	3FS5	3GU5		
3AW3	3A3	3FY5	3ER5	4BZ7	{ 4BC8 4BQ7A 4BS8 4BX8 4BZ8 5BK7A
3B2	{ 3A3 3AW3	3GK5	{ 3FQ5 3FQ5A		
3B7	1291	3GS8	{ 3BU8 3BU8A 3HS8	4BZ8	{ 4BC8 4BQ7A 4BS8 4BX8 4BZ8 5BK7A
3BA6	3AU6				
3BC5	3CE5	3GU5	3FS5		
3BE6	{ 3BY6 3CS6	3GS8	{ 3BU8 3BU8A 3GS8	4BZ8	{ 4BC8 4BQ7A 4BS8 4BX8 4BZ8 5BK7A
3BU8	{ 3BU8A 3GS8 3HS8				
3BX6	3BY7	3LE4	3LF4		
3BY6	{ 3BE6 3CS6	3Q4	3S4	4BZ8	{ 4BC8 4BQ7A 4BS8 4BX8 4BZ7 5BK7A
3BY7	3BX6	3Q5	3C5		
3BZ6	{ 3CB6 3CF6 3DK6	3S4SF	{ 3W4 3Z4		

Directly Interchangeable Tubes—(Continued)

Tube Number	Replace with	Tube Number	Replace with	Tube Number	Replace with
4CB6	{ 4BZ6 4DE6 4DK6	5BK7A	{ 4BC8 4BQ7A 4BS8 4BX8 4BZ7 4BZ8	5U4GA	{ 5U4GB 5AS4 5AS4A 5AU4 5DB4 5R4 5V3
4CE5	4BC5	5BQ7A	{ 5BS8 5BZ7	5U4GB	{ 5AS4 5AS4A 5DB4
4CS6	4BE6	5BS8	{ 5BQ7A 5BZ7	5U8	{ 5EA8 5GH8
4DE6	{ 4BZ6 4CB6 4DK6	5BZ7	{ 5BQ7A 5BS8	5V4	{ 5V4GY 5AR4
4DK6	{ 4BZ6 4CB6 4DE6	5CG4	{ 5AR4 5V4 5Z4	5W4	{ 5AR4 5A24 5CG4 5R4 5T4 5V4 5Y3 5Z4
4EH7	4EJ7	5CG8	5FG7	5X3	{ 13 80 83V 88
4EJ7	4EH7	5CM6	5CZ5		5Y3
4EW6	4GM6	5DB4	{ 5AS4 5AS4A 5U4GB	5Z3	
4GS8	{ 4BU8 4HS8	5DH8	5CL8		5Z4
4HS8	{ 4BU8 4GS8	5DJ4	5DN4	6AB5	
5AS4	{ 5AS4A 5DB4 5U4GB 5V3 5V3A	5DN4	5DJ4		6AB7
	5AU4	5EA8	{ 5GH8 5U8	6AC5G	
5AW4	{ 5AS4 5AS4A 5AU4 5DB4 5R4G 5U4GB 5V3 5V3A	5EW6	5GM6		5T4
	5AX4	{ 5AR4 5AS4 5AS4A 5R4G 5T4 5U4GB 5V4	5FV8	5BR8	
5AZ4		{ 5AR4 5A X4 5CG4 5R4 5T4 5V4 5V3 5Z4	5GH8	{ 5EA8 5U8	5U4G
	5Z3	5Z4	5GM6	5EW6	
5Z3			{ 83 1275	5T4	{ 5AR4 5R4
5Z4	{ 5AR4 5CG4 5V4 6087	5U4G	{ 5AR4 5R4	5U4G	5U4G
6AB5	6N5	5U4G	{ 5AR4 5R4		
6AB7	{ 6AC7 6AJ7 1853	5U4G	{ 5AR4 5R4	5U4G	5U4G
6AC5G	6AC5GT	5U4G	{ 5AR4 5R4		

Directly Interchangeable Tubes—(Continued)

Tube Number	Replace with	Tube Number	Replace with	Tube Number	Replace with
6AC7	{ 6AB7 6AJ7 1852 6134	6AT6	{ 6AV6 6BK6 6BT6 6066	6AX8	{ 6EA8 6GH8 6U8 6U8A
6AD4	{ 5637 5719 5719A 5898 SD917A	6AU4GT 6AU5GT	6AU4GTA 6FW5	6AY3	{ 6AY3A 6BA3
6AD6 6AE5 6AF5 6AF6 6AF11	6AF6 6AF5 6AE5 6AD6 6AS11	6AU6	{ 6AU6A 6BA6 6136 7543	6AY3A	{ 6AY3 6BA3
6AG5	{ 6BC5 6CE5 6186	6AU7	7AU7	6B6	6Q7
6AJ7	{ 6AB7 6AC7	6AU8A	{ 6AU8 6AW8A 6BA8A 6BH8	6BA3	{ 6AY3 6AY3A
6AK5	{ 6AJ5 1220 5654 6096 6968	6AV5GA	{ 6AV5GT 6FW5	6BA6	{ 6AU6 6AU6A 6BD6 6CG6 5749 6660 7496 7543
6AK7	6AG7	6AV6	{ 6AT6 6BK6 6BT6	6BA8	{ 6AU8 6AW8A 6BH8
6AK8	{ 6T8 6T8A	6AW6	{ 6CB6 6CB6A 6CF6 6CD6 6DE6	6BC5	{ 6AG5 6CE5
6AL5	{ 6EB5 5726 6058 6097 6663 7631	6AW8	{ 6AU8A 6BA8A	6BC8	{ 6BQ7 6BQ7A 6BS8 6BX8 6BZ7 6BZ8 6HK8 X155
6AM8	6HJ8	6AW8A	{ 6AW8 6AU8 6AU8A 6BA8 6BA8A	6BD6	{ 6BA6 6CG6
6AQ5	{ 6AQ5A 6BM5 6005 6095 6669	6AX4GT	{ 6AX4GTA 6AX4GTB 6AS4GT 6DA4 6DA4A 6DM4 6DQ4	6BE6	{ 6BY6 6CS6 5750 5915
6AS4	6DQ4	6AX4GT	{ 6AX4GTB 6DA4 6DA4A 6DM4 6DQ4	6BF6	6BU6
6AS7G	{ 6AS7GA 6AS7GT 6080 6520	6AX4GTA	{ 6AX4GTB 6DA4 6DA4A 6DM4 6DQ4	6BG7	{ 6BF7 6021
6AS11	6AF11			6BH8	{ 6AU8 6AU8A 6AW8 6AW8A 6BA8 6BA8A

Directly Interchangeable Tubes—(Continued)

Tube Number	Replace with	Tube Number	Replace with	Tube Number	Replace with
6BJ6	{ 6BJ6A 6662 7694	6BU6	6BF6	6CA5	6EH5
6BK6	{ 6AT6 6AV6 6BT6	6BU8	{ 6BU8A 6GS8 6HS8	6CB5	{ 6CB5A 6CL5
6BL7GT	{ 6BL7GTA 6BX7GT 6DN7	6BW7	{ 6BX6 6EL7	6CB5A	6CL5
6BL8	{ 6U8 6U8A	6BX6	{ 6BW7 6BY7 6EL7	6CB6	{ 6CB6A 6AW6 6CF6 6DC6 6DE6 6DK6 6HQ6 6676 7732
6BM5	{ 6AQ5 6AQ5A	6BX7GT	{ 6BL7GT 6BL7GTA 6DN7	6CD6G	{ 6DN6 6EX6
6BQ5	{ 7189 7189A 7320	6BX8	{ 6BC8 6BQ7 6BQ7A 6BS8 6BZ7 6BZ8 6HK8 X155	6CF6	{ 6AW6 6BZ6 6CB6 6CB6A 6DC6 6DE6 6DK6
6BQ6GT	{ 6BQ6GTA 6BQ6GTB 6BQ6GTB/6CU6 6CU6 6DQ6A 6DQ6B 6FH6 6GW6	6BY6	{ 6BE6 6CS6	6CG6	{ 6BA6 6BD6
6BQ7	{ 6BQ7A 6BC8 6BS8 6BX8 6BZ7 6BZ8 6HK8 X155	6BY7	6BX6	6CG8	{ 6CG8A 6FG7
6BR5	6DA5	6BZ6	{ 6DC6 6HQ6	6CG8A	6FG7
6BR8	{ 6BR8A 6FV8 6FV8A	6BZ7	{ 6BC8 6BQ7 6BQ7A 6BS8 6BX8 6BZ8 6HK8 X155	6CH7	6CX7
6BR8A	{ 6FV8 6FV8A	6BZ8	{ 6BC8 6BQ7 6BQ7A 6BS8 6BX8 6BZ7 6BZ8 6HK8 X155	6CJ6	6DR6
6BS8	{ 6BC8 6BQ7 6BQ7A 6BX8 6BZ7 6BZ8 6HK8 X155	6C4	{ 6100 9002	6CM6	6CZ5
6BT6	{ 6AT6 6AV6 6BK6	6C5	{ 6J5 6L5	6CS5	6DW5
		6C6	{ 77 1221 1223 7700	6CS6	{ 6BE6 6BY6
				6CU6	{ 6BQ6GTB 6BQ6GTB/6CU6 6DQ6 6DQ6A 6DQ6B 6FH6 6GW6
				6CW4	{ 6DS4 7895
				6CW7	6CF7
				6CX7	6CH7
				6CX8	{ 6EB8 6GN8 6HF8 6JE8

Directly Interchangeable Tubes—(Continued)

Tube Number	Replace with	Tube Number	Replace with	Tube Number	Replace with		
6HS8	{ 6BU8 6BU8A 6GS8	6SQ7	6SQ7W	6W4GTA	{ 6AX4GTA 6AX4GTB 6DA4 6DA4A 6DM4 6DQ4 6U4GT		
6J5	{ 6C5 6L5	6SU7	6I88				
6J7	{ 1233 1620 7000	6T5	{ 6G5 6H5 6U5				
6JE8	{ 6EB8 6GN8 6HFB	6T8	{ 6T8A 6AK8				
6K4	6778	6U4GT	{ 6AS4GT 6AX4GT 6AX4GTA 6AX4GTB 6DA4 6DA4A 6DM4 6DQ4 6W4GT 6W4GTA	6X5GT	0Z4		
6K7	{ 6U7 5732		6U5	{ 6G5 6H5 6T5	6X8	6X8A	
6K11	6Q11			6U7	6K7	6Z3	1V
6L4	6F4				6U8	{ 6U8A 6AX8 6EA8 6GH8 1252 6678 7731	7A4
6L6	{ 6L6G 6L6GA 6L6GAY 6L6GB 6L6GC 6L6GT 6L6GX 1622 5881 5932 7581 7581A	6U8A				{ 6EA8 6GH8	7A7
	6L7		{ 1612 1620			6V6	7AB7
	6N5		{ 6N5G 6AB5	6W4GT			7AG7
	6N8		{ 6AD8 6DC8		6V6G 6V6GT 6V6GTA 6V6GTX 6V6GTY 6V6GX 6V6GY 7408 7871		7AH7
6Q7	{ 6B6 6118	6W4GTA 6AS4GT 6AX4GT 6AX4GTA 6AX4GTB 6DA4 6DA4A 6DM4 6DQ4 6U4GT	7A17				1273
6SA7	{ 6SB7Y 5961		6W4GT			7AN7	7EK7
6SD7	6SE7			7AU7		6AU7	
6SE7	6SD7			7B7	7AH7		
6SJ7	5693	7C4		{ 1203 1203A			
6SK7	6137	6W4GT	7E5	1201			
6SL7	6113		6W4GTA 6AS4GT 6AX4GT 6AX4GTA 6AX4GTB 6DA4 6DA4A 6DM4 6DQ4 6U4GT	7E7	7R7		
6SN7	{ 6SN7GTA 6SN7GTB 5692			6W4GT	6W4GTA 6AS4GT 6AX4GT 6AX4GTA 6AX4GTB 6DA4 6DA4A 6DM4 6DQ4 6U4GT	7EK7	7AN7
						7ES8	7DJ8
		7FC7				7EK7	
		7G7	1232				
6SN7	{ 6SN7GTA 6SN7GTB 5692	6W4GT	6W4GTA 6AS4GT 6AX4GT 6AX4GTA 6AX4GTB 6DA4 6DA4A 6DM4 6DQ4 6U4GT	7H7	{ 7A7 7A7LM		
				7J7	7S7		
				7R7	7E7		
				7S7	7J7		
6SN7	{ 6SN7GTA 6SN7GTB 5692	6W4GT	6W4GTA 6AS4GT 6AX4GT 6AX4GTA 6AX4GTB 6DA4 6DA4A 6DM4 6DQ4 6U4GT	7V7	7G7		
				8AU8A	8AW8A		
				8AW8A	8AU8A		
				8BA8A	{ 8AU8 8AU8A 8AW8A 8BH8		
6SN7	{ 6SN7GTA 6SN7GTB 5692	6W4GT	6W4GTA 6AS4GT 6AX4GT 6AX4GTA 6AX4GTB 6DA4 6DA4A 6DM4 6DQ4 6U4GT	8B8A	{ 8AU8 8AU8A 8AW8A 8BA8A		

Directly Interchangeable Tubes—(Continued)

Tube Number	Replace with	Tube Number	Replace with	Tube Number	Replace with
8CX8	{ 8EB8 8GN8 8JE8	12AG6	12AD6	12AZ7	12AZ7A
8EB8	{ 8CX8 8GN8 8JE8	12AT6	{ 12AT6A 12AV6 12AV6A 12BK6 12BT6	12B7	{ 14A7 14H7
8GN8	{ 8CX8 8EB8 8JE8	12AT6A	12AV6A	12BA6	{ 12BA6A 12AU6 12AU6A
8JE8	{ 8CX8 8EB8 9GN8	12AT7	{ 12AT7WA 12AT7WB 6060 6201 6671 6679 7492 7728	12BA6A	12AU6A
9A8	{ 9U8 9U8A	12AU6	{ 12AU6A 12BA6 12BA6A	12BD6	{ 12BA6 12BA6A
9U8	{ 9U8A 9A8	12AU7	{ 12AU7A 12AU7W 12AU7WA 5963 6067 6189 6680 7316 7489 7730	12BE6	{ 12BE6A 12CS6
10DE7	10EW7	12AV6	{ 12AV6A 12AT6 12AT6A 12BK6 12BT6	12BH7	{ 12BH7A 6913
10DR7	{ 10FD7 10FR7	12AV6A	12AT6A	12BK6	{ 12AT6 12AT6A 12AV6 12AV6A 12BT6
10EB8	{ 10GN8 10HF8 11JE8	12AX4GT	{ 12AX4GTA 12AX4GTB 12D4 12D4A 12DM4 12DQ4	12BL6	12AF6
10EG7	10EM7	12AX7	{ 12AX7A 12DF7 12DT7 5721 6057 6681 7025 7025A 7494 7729	12BQ6GT	{ 12BQ6/12CU6 12CU6 12DQ6A 12DQ6B 12GW6
10EM7	10EG7			12BT6	{ 12AT6 12AT6A 12AV6 12AV6A 12BK6
10FD7	10FR7			12BU6	12BF6
10FR7	10FD7			12BV7	{ 12BY7 12BY7A 12DQ7
10GN8	{ 10EB8 10HF8 11JE8			12BY7	{ 12BY7A 12BV7 12DQ7 7733
10HF8	{ 10EB8 10GN8 11JE8			12BY7A	12DQ7
11C5	12DM5			12C5/12CU5	{ 12C5 12CU5 12R5
11JE8	{ 10EB8 10GN8 10HF8			12CA5	12EH5
12AE6	{ 12AE6A 12FT6				
12AE6A	{ 12AE6 12FT6				
12AF6	{ 12BL6 12AC6				

Directly Interchangeable Tubes—(Continued)

Tube Number	Replace with	Tube Number	Replace with	Tube Number	Replace with
12CS5	{ 12DT5 12DW5	12EK6	{ 12DZ6 12EA6	14R7	14E7
12CS6	{ 12BE6 12BE6A	12EN6	{ 12L6GT 12W6GT	14S7	14J7
12CU6	{ 12BQ6GTB 12BQ6GT/12CU6 12DQ6A 12DQ6B 12GW6	12EZ6	12CX6	15EA7	13EM7
12CX6	12EZ6	12FK6	12FM6	16A5	15CW5
12D4	{ 12D4A 12AX4GTB 12DM4 12DQ4	12FM6	12FK6	17AX3	17BE3
12D4A	{ 12DM4 12DQ4	12FT6	{ 12AE6 12AE6A	17AX4GT	{ 17AX4GTA 17D4 17D4A 17DM4 17DQ4
12DF7	{ 12AX7 12AX7A 12DT7 7025 7025A	12G4	12H4	17AX4GTA	{ 17D4 17D4A 17DM4 17DQ4
12DM4	{ 12D4A 12DQ4	12GW6	12DQ6B	17BQ6GTB	{ 17DQ6A 17DQ6B 17GW6
12DM5	11C5	12L6GT	{ 12EN6 12W6GT	17C5	{ 17CU5 17R5
12DQ6	{ 12DQ6A 12DQ6B 12GW6	12L8	1644	17CU5	{ 17C5 17R5
12DQ6A	{ 12DQ6B 12GW6	12SA7	12SY7	17D4	{ 17D4A 17AX4GTA 17DM4 17DQ4
12DQ6B	12GW6	12SC7	1634	17D4A	{ 17DM4 17DQ4
12DQ7	12BY7A	12SK7	5661	17DM4	{ 17D4A 17DQ4
12DT7	{ 12AX7 12AX7A 12DF7 7025 7025A	12SN7	12SX7	17DQ6	{ 17DQ6A 17DQ6B 17GW6
12DW7	7247	12SR7	12SW7	17DQ6A	{ 17DQ6B 17GW6
12DZ6	{ 12EA6 12EK6	12SW7	12SR7	17DQ6B	{ 17DQ6B 17GW6
12EA6	{ 12DZ6 12EK6	12SX7	12SN7	17DQ6B	{ 17DQ6B 17GW6
12EH5	12CA5	12SY7	12SA7	17DQ6B	{ 17DQ6B 17GW6
		12W6GT	{ 12EN6 12L6GT	17DQ6B	{ 17DQ6B 17GW6
		13DR7	{ 13FD7 13FR7	17DQ6B	17GW6
		13EM7	15EA7	17DQ6B	17DQ6B
		13FD7	13FR7	17DQ6B	17W6GT
		13FR7	13FD7	17DQ6B	17L6GT
		14A7	{ 12B7 14H7	17DQ6B	17L6GT
		14A7	XXD	17DQ6B	17L6GT
		14C7	1280	17DQ6B	17GW6
		14E7	14R7	17DQ6B	17DQ6B
		14GT8	{ 14GT8A 14JG8 7724	17DQ6B	17W6GT
		14H7	{ 12B7 14A7	17DQ6B	17L6GT
		14J7	14S7	18FW6	{ 18FW6A 18GD6 18GD6A
		14JG8	{ 14GT8 14GT8A	18FW6A	18GD6A
				18FY6	{ 18FY6A 18GE6 18GE6A

Directly Interchangeable Tubes—(Continued)

Tube Number	Replace with	Tube Number	Replace with	Tube Number	Replace with
18FY6A	18GE6A	25CU6	{25BQ6T 25BQ6GTB/25CU6 25DQ6A}	34GD5	{34GD5A 32ET5 32ET5A}
18GD6	{18GD6A 18FW6 18FW6A}			34GD5A 37	32ET5A 76
18GD6A	18FW6A	25DN6	{25CD6GB 21EX6}	39	{39/44 44}
18GE6	{18GE6A 18FY6 18FY6A}	25EC6	{25CD6GB 21EX6}	39/44	{39 44}
18GE6A	18FY6A	25EH5	25CA5	44	{39 39/44}
19AU4	{19AU4GT 19AU4GTA 17DE4}	25L6GT	{25W6GT 6046}	50EH5	{50EH5A 50CA5}
19AU4GT	{19AU4 19AU4GTA 17DE4}	25S	{25 1B5 1B5/25S}	50HK6	50HC6
19C8	{19T8 19T8A}	25U4GT	{25AX4GT 25D4 25W4GT}	50Y7	50Z7
19CL8A	{19CL8B 19JN8}	25W4GT	{25AX4GT 25D4 25U4GT}	50Z6	50AX6
19EA8	19EA8A	25W6GT	{25L6GT 6046}	50Z7	50Y7
19JN8	{19CL8A 19CL8B}	25Y5	25Z5	56	27
19T8	{19T8A 19C8}	27GB5	56 28GB5	76	37
21EX6	25CD6GB	32	{1A4 1A4P 1A4T 1B4 1B4P 1B4T 34 951}	77	6C6
25AX4GT	25D4			78	6D6
25BQ6GA	{25BQ6GTB/25CU6 25CU6 25DQ6A}	32ET5	{32ET5A 34GD5 34GD5A}	80	{5X3 13 83V 88}
25CA5	{25C5 25EH5}	32L7	25A7	81	{16 16B}
25CD6G	{25CD6GA 25CD6GB 25DN6 21EX6}	34	{1A4 1A4P 1A4T 1B4 1B4P 1B4T 32 951}	83	5Z3, 80
25CD6GA	{25CD6GB 25DN6 21EX6}			117L7	117M7
25CD6GB	21EX6	117N7	117P7	807	5933
				CK1005	{0Y4 0Z4A}
				CK1013	5517
				1201	7E5
				1203	7C4
				1204	7AB7
				1206	768
				1221	6C6
				1223	6J7
				1229	1A4
				1230	30
				1231	7V7
				1232	7G7
				1267	0A4
				1273	7A7

Directly Interchangeable Tubes—(Continued)

Tube Number	Replace with	Tube Number	Replace with	Tube Number	Replace with	
1274	6X5	5672	5678	7025	{ 7025A 12AX7 12AX7A 12DF7 12DT7	
1275	{ 5X3 80 83	5678	5672			
		5691	{ 6SN7 5692			
		5692	{ 5691 6SN7			
1280	14H7	5693	6S17	7247	12DW7	
1284	12B7		7408	6V6		
1291	3B7	5725	{ 6AJ5 6AK5	7543	{ 6AU6 6AU6A	
1294	1R4		5731	955	7581	{ 7581A 6L6GC
1299	3D6			5824	{ 25A6 25B6 25C6 25L6	XXB
1612	6L7	5881	{ 6L6GC 7581 7581A		XXD	14AF7
1614	6L6		5910	1U4	XXFM	7X7
1620	6J7	5915		6BE6	XXL	7A4
1634	12SC7		6080	6AS7	X155	{ 6BC8 6BQ7 6BQ7A 6BS8 6BX8 6BZ7 6BZ8
1644	12L8	5591	5590	5608-A		53
5517	CK1003		5654		{ 6AJ5 6AK5	

Directly Interchangeable Tubes

Foreign to American Tubes

Foreign Tube Number	Replace with American Tube	Foreign Tube Number	Replace with American Tube	Foreign Tube Number	Replace with American Tube
1C1	1R5	5M-HH3	5J6	6F22	6267
1C2	1AC6	5P29	6CN6	6F23	6EL7
1C3	1AB6	5S1	807	6F24	6EJ7
1D13	1A3	6AT7N	6DT8	6F25	6EH7
1F2	1L4	6B32	6AL5	6F26	6BY7
1F3	1T4	6BC32	6AV6	6F31	6BA6
1FD1	1AH5	6CC31	6J6	6F33	6AS6
1FD9	1S5	6D2	6AL5	6F36	6AH6
1H35	1AB6	6F10	6AC7	6FD12	6DC8
1P1	3C4	6F12	6AM6	6G-B3A	6GW6
1P10	3S4	6F16	6CJ5	6G-B6	6BQ6GT
1P11	3V4	6F18	6EC7	6G-B9	6DQ6A
4R-HH2	4BS8	6F19	6BY7	6G-K17	6AU4GT
4Y25	807	6F21	6CQ6	6H31	6BE6

Continued on page 52

Directly Interchangeable Tubes—(Continued)

Foreign to American Tubes

Foreign Tube Number	Replace with American Tube	Foreign Tube Number	Replace with American Tube	Foreign Tube Number	Replace with American Tube
6L10	6AG7	30P16	16A5	DF904	1U4
6L12	6AQ8	30P18	15CW5	DH77	6AT6
6L13	12AX7	30P19	25GF6	DH118	14L7
6L31	6AQ5	30PL1	13GC8	DH142	14L7
6L34	6AQ4	30PL13	16GK8	DH149	7C6
6L43	6CL6	52KU	5Z4G	DH150	6CV7
6LD3	6CV7	62DDT	6CV7	DH719	6AK8
6LD12	6AK8	62TH	6CU7	DK32	1A7GT
6LD13	6BD7	62VP	6CJ5	DK91	1R5
6M-HH3	6J6	63TP	6AB8	DK92	1AC6
6P9	6BM5	64ME	6CD7	DK96	1AB6
6P15	6BQ5	64SPT	6BX6	DL33	3Q5GT
6P17	6AM5	65ME	6BR5	DL35	1C5GT
6R-HH2	6BS8	66KU	6BT4	DL36	1Q5GT
6R-R8C	5847	67PT	6CK5	DL91	1S4
6S5G	6E5	108C1	0B2	DL92	3S4
6Z4	6BX4	121VP	12AC5	DL93	3A4
6Z31	6X4	141DDT	14L7	DL94	3V4
7D9	6AM5	141TH	14K7	DL95	3Q4
7D10	6CH6	150C2	0A2	DL96	3C4
7F16	6CJ5	150C3	0D3	DM70	1M3
8A8	9A8	171DDP	17C8	DM71	1N3
8D3	6AM6	213PEN	21A6	DY30	1B3GT
8D5	6BR7	311SU	31A3	DP61	6AK5
8D6	6BW7	451PT	45A5	DY70	5642
8D7	6BS7	A1834	6AS7G	DY80	1X2A
8D8	6267	AD	6Z3	DY86	1S2
8R-HP1	6CQ6	B36	12SN7GT	DY87	1S2A
9D6	6CQ6	B152	12AT7	EAA91	6AL5
9P5	9BM5	B309	12AT7	EABC80	6AK8
10C14	19D8	B319	7AN7	EAF42	6CT7
10LD3	14L7	B329	12AU7	EB91	6AL5
10P18	45B5	B339	12AX7	EBC41	6CV7
10PL12	50BM8	B739	12AT7	EBC8	6BD7
12BC32	12AV6	B749	12AU7	EBC90	6AT6
12F31	12BA6	B759	12AX7	EBC91	6AV6
12G-B3	12GW6	BF61	6CK5	EBF80	6N8
12G-B6	12BQ6GT	BPM04	6AQ5	EBF81	6AD8
12G-K17	12D4A	D2M9	6AL5	EBF83	6DR8
12H31	12BE6	D63	6H6	EBF89	6DC8
13D2	6SN7GT	D77	6AL5	EC84	6AJ4
17N8	17C8	D152	6AL5	EC86	6CM4
18AK5	6028	D717	6AL5	EC90	6C4
19AJ8	19D8	DA90	1A3	EC91	6AQ4
19BD	19X3	DAC32	1H5GT	EC92	6AB4
19M-R9	18GD6	DAF91	1S5	EC94	6AF4
19SU	19Y3	DAF92	1U5	EC95	6ER5
19U3	19X3	DAF96	1AH5	EC97	6FY5
20D3	12AH8	DD6	6AL5	ECC81	12AT7
20D4	6AJ8	DD7	6AM5	ECC82	12AU7
25G-B6	25BQ6GT	DDR7	6AM5	ECC83	12AX7
30C1	9A8	DF33	1N5GT	ECC84	6CW7
30F5	7ED7	DF62	1AD4	ECC85	6AQ8
30L1	7AN7	DF91	1T4	ECC86	6GM8
30L15	7EK7	DF92	1L4	ECC88	6DJ8
30P4	25GF6	DF96	1AJ4	ECC89	6FC7
30P12	12FB5	DF97	1AN5	ECC91	6J6

Directly Interchangeable Tubes—(Continued)
Foreign to American Tubes

Foreign Tube Number	Replace with American Tube	Foreign Tube Number	Replace with American Tube	Foreign Tube Number	Replace with American Tube
ECC180	6BQ7A	EM81	6DA5	N77	6AM5
ECC189	6ES8	EM84	6FG6	N78	6BJ5
ECC230	6O80	EM840	6FG6	N119	45B5
ECF80	6BL8	EQ80	6BE7	N142	45A5
ECF82	6U8	EY80	6U3	N144	6AM5
ECF86	6HG8	EY81	6R3	N150	6CK5
ECH42	6CU7	EY82	6N3	N152	21A6
ECH80	6AN7	EY86	6S2	N153	15A6
ECH81	6AJ8	EY87	6S2A	N154	16A5
ECH83	6DS8	EY88	6AL3	N308	25E5
ECL80	6AB8	EZ35	6X5G	N309	15A6
ECL82	6BM8	EZ40	6BT4	N329	16A5
ECL84	6DX8	EZ80	6V4	N359	21A6
ECL86	6GW8	EZ81	6CA4	N709	6BQ5
EF41	6CJ5	EZ90	6X4	OBC3	12SQ7
EF80	6BX6	EZ91	6AV4	OF1	6S7
EF81	6BH5	GZ30	5AZ4	OH4	12A8
EF82	6CH6	GZ32	5V4G	OSW2190	6AC7
EF85	6BY7	GZ34	5AR4	OSW2192	6AG7
EF86	6267	H63	6F5GT	OSW2600	6AC7
EF89	6DA6	HAA91	12AL5	OSW2601	6AG7
EF89F	6DG7	HABC80	19T8	OSW3104	6SA7
EF91	6AM6	HBC90	12AT6	OSW3105	6SQ7
EF92	6CQ6	HBC91	12AV6	OSW3106	6V6GT
EF93	6BA6	HCC85	17EW8	OSW3109	6H6
EF94	6AU6	HCH81	12AJ7	OSW3110	6E5
EF95	6AK5	HD14	1H5GT	OSW3111	6SK7
EF96	6AG5	HF61	6CJ5	OSW3112	6J5
EF97	6ES6	HF93	12BA6	P17A	807
EF98	6ET6	HF94	12AU6	PABC80	9AK8
EF183	6EH7	HF121	12AC5	PC86	4CM4
EF184	6EJ7	HK90	12BE6	PC95	4GK5
EF190	6CB6	HL90	19AQ5	PCC84	7AN7
EH90	6CS6	HL92	50C5	PCC85	9AQ8
EK90	6BE6	HL94	30A5	PCC88	7DJ8
EL34	6CA7	HMO4	6BE6	PCC89	7FC7
EL36	6CM5	HP6	6AM6	PCF80	9A8
EL37	6L6	HY90	35W4	PCF82	9U8
EL38	6CN6	KT32	25W6GT	PCF86	7HG8
EL41	6CK5	KT63	6FG6	PCL82	16A8
EL80	6M5	KT66	6L6GC	PCL84	15DQ8
EL81	6CJ6	KT71	50L6GT	PF9	6K7
EL82	6DY5	KT77	6CA7	PH4	6A8
EL83	6CK6	KT88	6550	PL36	25E5
EL84	6BQ5	KTW61	6S7	PL81	21A6
EL85	6BN5	L63	6J5	PL82	16A5
EL86	6CW5	L77	6C4	PL83	15A6
EL90	6AQ5	LN152	6AB8	PL84	15CW5
EL91	6AM5	LZ319	9A8	PL500	27GB5
EL95	6DL5	LZ329	9A8	PL820	21A6
EL180	12BY7	N14	1C5GT	PL1267	0A4G
EL500	6GB5	N15	3Q5GT	PLL80	12HU8
EL821	6CH6	N16	3Q5GT	PM04	6BA6
EL822	6CH6	N17	3S4	PM07	6AM6
ELL80	6HU8	N18	3Q4	PY80	19X3
EM34	6CD7	N19	3V4	PY81	17Z3
EM80	6BR5	N25	3C4	PY82	19Y3

Directly Interchangeable Tubes—(Continued)
Foreign to American Tubes

Foreign Tube Number	Replace with American Tube	Foreign Tube Number	Replace with American Tube	Foreign Tube Number	Replace with American Tube
PY83	17Z3	UBC81	14G6	X63	6A8
QB65	6SN7GT	UBF80	17C8	X64	6L7
QB309	12AT7	UCH42	14K7	X77	6BE6
QE06/50	807	UCH81	19D8	X81	7S7
QL77	6C4	UCL82	50BM8	X119	19B8
QV05-25	807	UF41	12AC5	X142	14K7
QW77	6CQ6	UL41	45A5	X148	7S7
QZ77	6AM6	UL84	45B5	X719	6AJ8
R16	1T2	UU12	6CA4	X727	6BE6
R19	1X2A	UY41	31A3	XC95	2ER5
R52	5Z4G	UY42	31A3	XCC189	4ES8
SP6	6AM6	UY85	38A3	XCF80	4BL8
STV108/30	0B2	UY89	38A3	XF183	3EH7
STV150/30	0A2	V2M70	6X4	XF184	3EJ7
T2M05	6J6	V61	6BT4	XL36	13CM5
TM12	6J4	V884	6CQ6	XL84	8BQ5
U26	2J2	VP6	6CQ6	Y25	1M3
U37	1T2	VP12D	12C8	YF88	16AQ3
U41	1B3GT	W17	1T4	YF183	4EH7
U50	5Y3GT	W25	1AJ4	YF184	4EJ7
U52	5U4G	W61	6K7	Z14	1N5GT
U70	6X5G	W63	6K7	Z63	6J7
U76	35Z5GT	W76	12K7	Z77	6AM6
U119	38A3	W77	6CQ6	Z152	6BX6
U142	31A3	W119	13EC7	Z300T	0A4G
U147	6X5G	W142	12AC5	Z719	6BX6
U149	7Y4	W148	7A7	Z729	6267
U150	6BT4	W149	7B7	ZD17	1S5
U152	19X3	W719	6BY7	ZD25	1AH5
U153	17Z3	W727	6BA6	ZD152	6N8
U154	19Y3	W739	6EC7		
U192	19Y3	WD142	12S7		
U309	19X3	WD150	6CT7		
U319	19Y3	WD709	6N8		
U381	38A3	X14	1A7GT		
U707	6X4	X17	1R5		
UAA91	12AL5	X18	1AC6		
UAF42	12S7	X20	1AC6		
UBC41	14L7	X25	1AB6		

See Below to Page 58
for Listing of
American to Foreign
Directly Interchangeable
Tubes.

Directly Interchangeable Tubes
American to Foreign Tubes

American Tube Number	Replace with Foreign Tube	American Tube Number	Replace with Foreign Tube	American Tube Number	Replace with Foreign Tube
0A2	{ 150C2 M8223 STV150/30	0B2	{ 108C1 M8224 STV108/30	1A3	{ 1D13 DA90
0A4G	{ PL1267 Z300T	0D3	150C3	1A7GT	{ DK32 X14

Directly Interchangeable Tubes—(Continued)
American to Foreign Tubes

American Tube Number	Replace with Foreign Tube	American Tube Number	Replace with Foreign Tube	American Tube Number	Replace with Foreign Tube
1AB6	{ 1C3 1H35 DK96 X25	1T2	{ R16 U37	5Y3GT	V50
1AC6	{ 1C2 DK92 X18 X20	1T4	{ 1F3 DF91 W17	5Z4G	{ 52KU GZ30 R52 U77
1AD4	DF62	1U4	DF904	6A6	B63
1AH5	{ 1FD1 DAF96 ZD25	1U5	DAF92	6A8	{ PH4 X63
1AJ4	{ 1F1 DF96 W25	1V6	DCF60	6AB4	EC92
1AN5	DF97	1X2A	{ DY80 R19	6AB8	{ 63TP ECL80 LN152
1B3GT	{ DY30 U41	2ER5	XC95	6AC7	{ 6F10 OSW2190 OSW2600
1C5GT	{ DL35 N14	2J2	U26	6AD8	EBF81
1E3	DC80	3A4	DL93	6AF4	EC94
1H5GT	{ DAC32 HD14	3C4	{ 1P1 DL96 N25	6AG5	EF96
1L4	{ 1F2 DF92	3D6	DL29	6AG7	{ 6L10 OSW2192 OSW2601
1M3	{ DM70 DM71 Y25	3EH7	XF183	6AH6	6F36
1N3	{ DM70 DM71 Y25	3EJ7	XF184	6AJ4	EC84
1N5GT	{ DF33 Z14	3Q4	{ DL95 N18	6AJ8	{ 6C12 20D4 ECH81 X719
1Q5GT	DL36	3Q5GT	{ DL33 N15 N16	6AK5	DP61
1R5	{ 1C1 DK91 X17	3S4	{ 1P10 DL92 N17	6AK8	{ 6LD12 DH719 EABC80
1S2	DY86	3V4	{ 1P11 DL94 N19	6AL3	EY88
1S2A	DY87	4BL8	XCF80	6AL5	{ 6B32 6D2 D2M9 D77 D152 D717 DD6 EAA91 EB91 EAA901 EAA901S M8079 M8212 QA2404
1S4	DL91	4BS8	4R-HH2		
1S5	{ 1FD9 DAF91 ZD17	4CM4	PC86		
		4EH7	Y183		
		4EJ7	Y184		
		4ES8	XCC189		
		4GK5	PC95		
		5AR4	{ GZ34 U77		
		5AZ4	GZ30		
		5J6	5M-HH3		
		5T4	U52		
		5U4G	U52		
		5V4G	{ 53KU 54KU GZ32 GZ33 U77		

Directly Interchangeable Tubes—(Continued)
 American to Foreign Tubes

American Tube Number	Replace with Foreign Tube	American Tube Number	Replace with Foreign Tube	American Tube Number	Replace with Foreign Tube
6AM5	{ 6P17 7D9 DD7 DDR7 EL91 N77 N144 QA2402	6BE6	{ 6H31 EK90 HM04 X77 X727	6CB6	EF190
	6AM6		{ 6F12 8D3 EF91 HP6 M8083 PM07 QA2403 QZ77 SP6 Z77	{ 6BE7 6BH5 6BH6 6BJ5 6BJ6 6BL8 6BM5 6BM8 6BN5	{ EQ80 EF81 E90F N78 E99F ECF80 6P9 ECL82 EL85
6AN7		ECH80	6BQ5	{ EL84 N709	6CF6
6AQ4	{ 6L34 EC91 M8099	6BQ6GT 6BQ7A	6G-B6 ECC180	6CJ5	{ 6F16 7F16 6ZVP EF41 HF61
	6AQ5	{ 6L31 BPM04 EL90 M8245	6BR5		{ 65ME EM80
6AQ8		{ 6L12 ECC85	6BR7 6BS7 6BS8	8D5 8D7 6R-HH2	6CK5
	6AS6	{ 6F33 M8196	6BT4	{ 66KU EZ40 U150 V61	
6AS7G	{ A1834 ECC230	6BW7 6BX4	8D6 6Z4	6CN6	{ EL38 5P29
6AT6	{ DH77 EBC90	6BX6	{ 64SPT EF80 Z152 Z719		6CQ6
6AU4GT 6AU6 6AV4	6G-K17 EF94 EZ91	6BY7	{ 6F19 6F26 EF85 W719	6CS6	
6AV6	{ 6BC32 EBC91	6C4	{ EC90 L77 M8080 QA2401 QL77	6CT7	{ EAF42 WD150
	6BA6		{ 6F31 EF93 M8101 PM04 W727	6CA4	{ EZ81 UU12
6BD7		{ 6LD13 EBC81	6CA7	{ EL34 KT77	6CV7

Directly Interchangeable Tubes—(Continued)

American to Foreign Tubes

American Tube Number	Replace with Foreign Tube	American Tube Number	Replace with Foreign Tube	American Tube Number	Replace with Foreign Tube		
6CW5	EL86	6J5	{ L63 OSW3112	6X5G	{ EZ35 U70 U147		
6CW7	ECC84						
6DA5	EM81	6J6	{ 6CC31 6M-HH3 ECC91 M8081 T2M05	7AN7	{ 30L1 B319 PCC84		
6DA6	EF89						
6DC8	{ 6FD12 EBF89						
6DG7	EF89E	6J7	{ A863 Z63	7A7	W148		
6DJ8	ECC88			7B6	DH81		
6DL5	EL95	6K7	{ PF9 W61 W63	7B7	W149		
6DQ6A	6G-B9			7C6	DH149		
6DR8	EBF83			7DJ8	PCC88		
6DS8	ECH83			7ED7	30F5		
6DT8	6AT7N	6L6	EL37	7EK7	30L15		
6DX8	ECL84			6L6GC	KT66	7FC7	PCC89
6DY5	EL82	6L7	X64	7HG8	PCF86		
6E5	{ 6S5G OSW3110	6M5	EL80	7S7	{ X81 X148		
		6N3	EY82				
		6EC7	{ 6F18 W739	6N8	{ EBF80 WD709 ZD152	7Y4	U149
6EH7	{ 6F25 EF183	6Q7	DH63	8BQ5	XL84		
6EJ7	{ 6F24 EF184			6R3	EY81	9A8	{ 8A8 30C1 LZ319 LZ329 PCF80
6EL7	6F23	6S2	EY86	9AK8	PABC80		
		6S2A	EY87				
		6ER5	EC95	6S7	{ KTW61 OF1	9AQ8	PCC85
		6ES6	EF97	6SA7	OSW3104	9EN7	30C15
		6ES8	ECC189			6SK7	OSW3111
		6ET6	EF98	6SN7GT	{ 13D2 B65 QA2408 QB65	9U8	PCF82
		6F5GT	H63			12A8	OH4
		6F6G	KT63				
		6FC7	ECC89				
		6FG6	{ EM84 EM840	6SQ7	OSW3105	12AC5	{ 121VP HF121 UF41 WF41 W142
6FY5	EC97	6T8	{ 6LD12 DH719 EABC80	12AH8	20D3		
6GB5	EL500			12AJ7	HCH81		
6GM8	ECC86	6U3	EY80	12AL5	{ HAA91 UAA91		
6GW8	ECL86					6U8	ECF82
6H6	{ D63 OSW3109			6V4	EZ80	12AT6	HBC90
6HG8	ECF86	6V6GT	OSW3106	12AT7	{ B152 B309 B739 ECC81 M8162 QA2406 QB309		
6HU8	ELL80	6X4	{ 6Z31 EZ90 U707 V2M70				
6J4	{ M8232 TM12						

Directly Interchangeable Tubes—(Continued)

American to Foreign Tubes

American Tube Number	Replace with Foreign Tube	American Tube Number	Replace with Foreign Tube	American Tube Number	Replace with Foreign Tube
12AU6	HF94	15CW5	{ 30P18 PL84	25GF6	30P4
12AU7	{ B329 B749 ECC82 M8136	15DQ8	PCL84	25W6	KT32
12AV6	{ 12BC32 HBC91	16A5	{ 30P16 163PEN N154 N329 PL82 PL87	27GB5	PL500
12AX7	{ 6L13 B339 B759 ECC83 M8137	16A8	PCL82	30A5	HL94
12BA6	{ 12F31 HF93	16AQ3	XY88	31A3	{ 311SU U142 UY41 UY42
12BE6	{ 12H31 HF90	16GK8	{ 30PL13 30PL14	35W4	HY90
12BQ6GT	12G-B6	17C8	{ 17N8 171DDP UBF80	35Z4GT	U76
12BY7	EL180	17EW8	HCC85	38A3	{ U119 U381 UY85
12C8	VPI2D	17Z3	{ PY81 PY83 U153	45A5	{ 451PT BF451 N142 UL41
12DF7	ECC83	18GD6	19M-R9	45B5	{ 10P18 N119 UL84
12DT7	ECC83	19AQ5	HL90	50BM8	{ 10PL12 UCL82
12FB5	30P12	19CS4	U191	50C5	HL92
12HU8	PLL80	19D8	{ 10C14 UCH81 X119	50L6GT	KT71
12K7	W76	19T8	HABC80	807	{ 4Y25 5S1 P17A QE06/50 QV05-25
12Q7GT	{ DH74 DH76	19X3	{ 19BD 19U3 PY80 U152 U309	5642	DY70
12SN7GT	B36	19Y3	{ 19SU PY82 U154 U192 U319	5847	6R-R8C
12S07	OBC3	21A6	{ 213PEN N152 N359 PL81 PL820	6080	{ A1834 ECC230
12SX7GT	B36	25BQ6GT	25G-B6	6267	{ 8D8 6F22 EF86 M8195 Z729
13CM5	XL36	25E5	{ N308 PL36	6550	KT88
13EC7	{ 10F18 W119	15A6	{ N153 N309 PL83	7025	{ B339 B759 ECC83 M8137
13GC8	30PL1			7543	EF94
14G6	UBC81			7581	KT66
14K7	{ 141TH UCH42 UCH43 X142				
14L7	{ 10LD3 141DDT DH118 DH142 UBC41				

Directly Interchangeable TV Picture Tubes

Tube Number	Replace with	Tube Number	Replace with	Tube Number	Replace with
7NP4	7WP4*	12ZP4	{ 12ZP4A 12KP4* 12KP4A*	14NP4A	{ 14NP4 14SP4 14WP4* 14ZP4*
7WP4	7NP4				
8AP4	8AP4A				
8AP4A	8AP4				
9AQP4	9AQP4A				
9AQP4A	9AQP4	12ZP4A	{ 12ZP4 12KP4* 12KP4A*	14QP4	{ 14QP4A 14HP4
10ABP4	{ 10ABP4A 10ABP4B 10ABP4C	14ACP4	14AEP4*	14QP4A	{ 14QP4 14HP4
	10BP4	14AJP4	{ 14ASP4* 14AVP4*	14RP4	{ 14RP4A 14NP4 14NP4A 14SP4 14WP4* 14ZP4*
10EP4	10CP4	14ASP4	14AVP4	14RP4A	{ 14RP4 14NP4 14NP4A 14SP4 14WP4* 14ZP4*
10FP4	10FP4A	14AUP4	14AWP4		
10FP4A	10FP4	14AVP4	14ASP4		
10MP4	10MP4A	14AWP4	14AUP4		
10MP4A	10MP4	14BP4	{ 14BP4A 14CP4 14CP4A 14EP4		
12KP4	12KP4A			14BP4A	{ 14BP4 14CP4 14CP4A 14EP4
12KP4A	12KP4				
12LP4	{ 12LP4A 12LP4C 12KP4* 12KP4A*				
	12LP4A	{ 12LP4 12LP4C 12KP4* 12KP4A*			
		12LP4C	{ 12LP4 12LP4A 12KP4* 12KP4A*		
			12QP4	{ 12QP4A 12RP4 12JP4*	14CP4A
12QP4A	{ 12QP4 12RP4 12JP4*	14DPA	14UP4*	14XP4	14XP4A
12RP4	{ 12JP4* 12QP4 12QP4A	14EP4	{ 14BP4 14BP4A 14CP4 14CP4A	14XP4A	14XP4
	12TP4			{ 12LP4* 12LP4A* 12LP4C*	14FP4
12UP4	12UP4A	14KP4	14KP4A	15CP4	
12VP4	12VP4A				14NP4
12XP4	{ 12ZP4 12ZP4A	16AP4	{ 16AP4A 16AP4B	15DP4A	
	16AEP4				16ARP4
16AP4	{ 16AP4A 16AP4B	16AP4A	{ 16AP4 16AP4B	16AP4B	{ 16AP4 16AP4A

*Connect external connector to chassis.

*Remove ion trap

Directly Interchangeable TV Picture Tubes—(Continued)

Tube Number	Replace with	Tube Number	Replace with	Tube Number	Replace with
16CP4	15CP4				
16DP4	{ 16DP4A 16HP4*	16GP4A	{ 16GP4 16GP4B 16GP4C		{ 17AVP4A 17ATP4 17ATP4A 17BUP4 17CBP4 17CLP4 17BJP4* 17DCP4*
16DP4A	16DP4	16GP4B	{ 16GP4 16GP4A 16GP4C	17AVP4	{ 17BUP4 17CBP4 17CLP4 17BJP4* 17DCP4*
16EP4	{ 16EP4A 16EP4B				
16GP4	{ 16GP4A 16GP4B 16GP4C	16KP4A	{ 16KP4 16RP4 16RP4A		{ 17AVP4 17ATP4 17ATP4A 17BUP4 17CBP4 17CLP4 17BJP4* 17DCP4*
16GP4C	{ 16GP4 16GP4A 16GP4B	16MP4	{ 16MP4A 16JP4 16JP4A 16HP4 16HP4A	17AVP4A	{ 17BUP4 17CBP4 17CLP4 17BJP4* 17DCP4*
16HP4 16HP4A	16HP4A 16HP4				
16JP4	{ 16HP4 16HP4A 16JP4A	16MP4A	{ 16MP4 16JP4 16JP4A 16HP4 16HP4A	17BJP4 17BKP4 17BKP4A 17BMP4	17CZP4 17BKP4A 17BKP4 17BNP4*
16JP4A	{ 16HP4 16HP4A 16JP4				
16KP4	{ 16KP4A 16RP4 16RP4A	16RP4	{ 16RP4A 16KP4 16KP4A	17BP4	{ 17AP4* 17BP4A* 17BP4B* 17BP4C* 17JP4*
16KP4A	16TP4	16RP4A	{ 16RP4 16KP4 16KP4A	17BP4A	{ 17AP4 17BP4B 17BP4C 17JP4
16LP4	{ 16LP4A 16ZP4	16UP4	16XP4*		
16LP4A	{ 16LP4 16ZP4	16WP4A	{ 16SP4 16SP4A	17BP4B	{ 17AP4 17BP4A 17BP4C 17JP4
16MP4 16MP4A 16QP4	16MP4A 16MP4 16XP4	16XP4	16QP4		
16RP4	{ 16KP4 16KP4A 16TP4	17ATP4	{ 17ATP4A 17AVP4 17AVP4A 17BUP4 17CBP4 17CLP4 17BJP4* 17DCP4*	17BP4C	{ 17AP4 17BP4A 17BP4B 17JP4
16RP4A	{ 16RP4 16KP4 16KP4A			17BRP4 17BUP4	17CKP4* 17CBP4
16SP4 16SP4A 16VP4	16SP4A 16SP4 16YP4*	17ATP4A	{ 17ATP4 17AVP4 17AVP4A 17AUP4 17CBP4 17CLP4 17BJP4* 17DCP4*	17BVP4	{ 17BWP4* 17CSP4*
16WP4	{ 16SP4* 16SP4A* 16WP4A* 16WP4B*			17BWP4	17CSP4
				17BZP4	{ 17CAP4 17CKP4 17CWP4 17DSP4

*Connect external connector to chassis.

*Remove ion trap.

Directly Interchangeable TV Picture Tubes—(Continued)

Tube Number	Replace with	Tube Number	Replace with	Tube Number	Replace with
17CAP4	{ 17BZP4 17CKP4 17CWP4 17DSP4	17HP4B	{ 17HP4 17HP4A 17KP4 17KP4A 17RP4 17RP4C 17DWP4*	19ACP4	{ 19CHP4 19CKP4
17CBP4	17BUP4	17JP4	{ 17AP4 17BP4A 17BP4B 17BP4C	19AFP4	19AUP4
17CFP4	17CYP4	17KP4	17KP4A	19AP4	{ 19AP4A 19AP4B 19AP4C 19AP4D
17CKP4	17DSP4	17KP4A	17KP4	19AP4A	{ 19AP4 19AP4B 19AP4C 19AP4D
17CLP4	{ 17ATP4 17ATP4A 17AVP4 17AVP4A 17BUP4 17CBP4 17BJP4*	17LP4	{ 17LP4A 17VP4 17VP4B	19AP4B	{ 19AP4 19AP4A 19AP4C 19AP4D
17CP4	17CP4A	17LP4A	{ 17LP4 17VP4 17VP4B	19AP4C	{ 19AP4 19AP4A 19AP4B 19AP4D
17CP4A	17CP4	17QP4	{ 17QP4A 17YP4	19AP4D	{ 19AP4 19AP4A 19AP4B 19AP4C
17CRP4	17CXP4	17QP4A	{ 17QP4 17YP4	19AUP4	19AFP4
17CSP4	17BWP4	17RP4	{ 17RP4C 17HP4 17HP4A 17HP4B 17KP4 17KP4A 17DWP4*	19AXP4	19AYP4
17CTP4	{ 17DHP4 17EBP4	17RP4C	{ 17RP4 17HP4 17HP4A 17HP4B 17KP4 17KP4A 17DWP4*	19BAP4	{ 19BCP4 19CEP4
17CUP4	17DCP4	17UP4	{ 17QP4 17QP4A 17YP4	19BCP4	{ 19BAP4 19CEP4
17CWP4	{ 17DSP4 17DTP4	17VP4	{ 17VP4B 17LP4 17LP4A	19BHP4	19AVP4
17CXP4	17CRP4	17VP4B	{ 17VP4 17LP4 17LP4A	19BLP4	{ 19AVP4 19BHP4 19XP4
17CYP4	17CFP4	17YP4	17QP4A	19BNP4	19BQP4
17DAP4	17DRP4		17YP4	19BQP4	19BNP4
17DCP4	17CUP4			19CFP4	{ 19CHP4 19CKP4
17DHP4	17EBP4			19CHP4	19CKP4
17DLP4	17DSP4			19CKP4	19CHP4
17DRP4	17DAP4			19CLP4	19BDP4
17FP4	17FP4A			19DP4	19DP4A
17FP4A	17FP4			19DP4A	19DP4
17HP4	{ 17HP4A 17HP4B 17KP4 17KP4A 17RP4 17RP4C 17DWP4*	17VP4A	17QP4A	19EP4	19JP4
17HP4A	{ 17HP4 17HP4B 17KP4 17KP4A 17RP4 17RP4C 17DWP4*				

*Connect external connector to chassis.

*Remove ion trap.

Directly Interchangeable TV Picture Tubes—(Continued)

Tube Number	Replace with	Tube Number	Replace with	Tube Number	Replace with
19FP4	{ 19DP4* 19DP4A* 19GP4	20HP4	{ 20HP4A* 20HP4B 20HP4C 20HP4D* 20JP4* 20LP4* 20MP4*	21ALP4	{ 21ALP4A 21ALP4B 21ATP4 21ATP4A 21ATP4B 21BTP4 21CWP4 21BAP4* 21BNP4* 21CVP4*
19GP4	{ 19DP4 19DP4A				
19JP4 19XP4 19YP4	19EP4 19AVP4 19BTP4	20HP4A	{ 20HP4B* 20HP4D 20JP4 20LP4 20MP4	21ALP4	{ 21ALP4 21ALP4B 21ATP4 21ATP4A 21ATP4B 21BTP4 21CWP4 21BAP4* 21BNP4* 21CVP4*
19ZP4	{ 19AVP4 19BLP4 19XP4				
20CP4	{ 20CP4B 20CP4C 20DP4 20DP4B 20CP4A 20CP4D 20DP4A 20DP4C	20HP4B	{ 20HP4 20HP4A* 20HP4C 20HP4D* 20JP4* 20LP4* 20MP4*	21ALP4A	{ 21ALP4 21ALP4B 21ATP4 21ATP4A 21ATP4B 21BTP4 21CWP4 21BAP4* 21BNP4* 21CVP4*
	20CP4A				
20CP4B	{ 20CP4 20CP4C 20DP4 20DP4B 20CP4A* 20CP4D* 20DP4A* 20DP4C*	20HP4D	{ 20HP4A 20JP4 20LP4 20MP4	21AMP4	{ 21AMP4A 21ACP4 21ACP4A 21BSP4 21CUP4
	20CP4C				
20CP4C	{ 20CP4 20CP4B 20DP4 20DP4B 20CP4A* 20CP4D* 20DP4A* 20DP4C*	20LP4	{ 20HP4A 20HP4D 20JP4 20MP4	21AMP4	{ 21AMP4 21ACP4 21ACP4A 21BSP4 21CUP4
	20CP4D				
20DP4	{ 20CP4 20CP4C 20CP4A* 20DP4A*	20MP4	{ 20HP4A 20HP4D 20JP4 20LP4	21AMP4A	{ 21AMP4 21ACP4 21ACP4A 21BSP4 21CUP4
	20FP4				
20HP4	{ 20HP4A* 20HP4B 20HP4C 20HP4D* 20JP4* 20LP4* 20MP4*	21ACP4	{ 21ACP4A 21BSP4 21CUP4	21ANP4	{ 21ANP4A 21ALP4* 21ALP4A* 21ATP4* 21ATP4A* 21ATP4B* 21BAP4** 21BNP4** 21BTP4* 21CVP4** 21CWP4*

*Connect external connector to chassis.

*Remove ion trap.

Directly Interchangeable TV Picture Tubes—(Continued)

Tube Number	Replace with	Tube Number	Replace with	Tube Number	Replace with									
21ANP4A	{ 21ANP4 21ALP4* 21ALP4A* 21ALP4B* 21ATP4* 21ATP4A* 21ATP4B* 21BAP4** 21BNP4** 21BTP4* 21CVP4** 21CWP4*	21ATP4B	{ 21ATP4A 21ALP4A 21ALP4B 21BTP4 21CWP4 21BAP4* 21BNP4* 21CVP4*	21BNP4	{ 21BAP4 21CVP4									
						21BSP4	{ 21ACP4 21ACP4A 21CUP4							
				21BTP4	{ 21BAP4* 21ALP4B 21BNP4* 21ATP4A 21CVP4*									
						21AQP4	{ 21AQP4A 21ACP4* 21ACP4A* 21AMP4* 21AMP4A* 21BSP4* 21CUP4*	21AUP4	{ 21AUP4A 21AUP4B 21AVP4 21AVP4A 21AVP4B 21BDP4*	21CBP4	{ 21CBP4A 21CBP4B 21DQP4 21DRP4 21FLP4			
				21AUP4A	{ 21AUP4 21AUP4B 21AVP4 21AVP4A 21AVP4B 21BDP4*									
												21CBP4A	{ 21CBP4B 21DRP4 21FLP4	
				21AQP4A	{ 21AQP4 21ACP4* 21ACP4A* 21AMP4* 21AMP4A* 21BSP4A* 21CUP4*									21AUP4B
						21ARP4 21ARP4A	21AVP4	{ 21AVP4A 21AVP4B 21AUP4 21AUP4A 21AUP4B 21BDP4*	21CDP4A 21CEP4 21CGP4 21CKP4	21CDP4 21CEP4A 21CHP4* 21CBP4A				
											21ASP4	{ 21AYP4* 21XP4* 21XP4A*	21CMP4	
				21ATP4	{ 21ATP4A 21ATP4B 21ALP4 21ALP4A 21ALP4B 21BTP4 21CWP4 21BAP4* 21BNP4* 21CVP4*	21AVP4A	{ 21AVP4 21AVP4B 21AUP4 21AUP4A 21AUP4B 21BDP4*	21CUP4	{ 21ACP4 21ACP4A 21BSP4					
21AVP4B	{ 21AVP4 21AVP4A 21AUP4 21AUP4A 21AUP4B 21BDP4*	21CVP4	{ 21BAP4 21BNP4											
										21ATP4A	{ 21ATP4B 21ALP4B 21BTP4 21BAP4* 21BNP4* 21CVP4*	21AYP4	{ 21XP4 21XP4A	21CWP4
21BAP4	{ 21BNP4 21CVP4													

*Connect external connector to chassis.

*Remove ion trap.

Directly Interchangeable TV Picture Tubes—(Continued)

Tube Number	Replace with	Tube Number	Replace with	Tube Number	Replace with
21CXP4	21DSP4	21XP4A	{ 21XP4 21AYP4	23BEP4	23BSP4
21CZP4	{ 21DAP4* 21DEP4* 21DEP4A*	21YP4	21YP4A	23BGP4	23BHP4
21DAP4	{ 21DEP4 21DEP4A	21YP4A	21YP4	23BHP4	23BGP4
21DEP4	{ 21DEP4A 21DAP4	21ZP4	{ 21ZP4A* 21ZP4B* 21AWP4*	23BKP4	{ 23ANP4 23ATP4 23BLP4
21DFP4	{ 21CEP4 21CEP4A	21ZP4A	{ 21ZP4B 21AWP4	23BLP4	{ 23ANP4 23ATP4 23BKP4
21DLP4	21DQP4	21ZP4B	{ 21ZP4A 21AWP4	23BMP4	{ 23BDP4 23BTP4 23YP4
21DRP4	{ 21CBP4A 21CBP4B 21FLP4	22AP4	22AP4A	23BNP4	{ 23CBP4 23CP4 23CP4A 23GP4 23SP4
21DSP4	21CXP4	22AP4A	22AP4	23BP4	23BAP4
21ELP4	21DJP4	23ACP4	23TP4	23BQP4	23CBP4
21EP4	{ 21EP4A 21EP4B	23AFP4	{ 23BTP4 23BVP4	23BRP4	{ 23BYP4 23CSP4 23RP4
21EP4A	21EP4B	23AHP4	{ 23AUP4 23CZP4	23BSP4	23BEP4
21EP4B	21EP4A	23ANP4	{ 23ATP4 23BKP4 23BLP4	23BVP4	23AFP4
21FJP22	21FKP22	23ASP4	23AUP4	23BYP4	23CSP4
21FKP22	21FJP22	23ATP4	{ 23ANP4 23BKP4 23BLP4	23CUP4	23AUP4
21FLP4	{ 21CBP4A 21CBP4B 21DRP4	23AUP4	23CZP4	23FP4	23FP4A
21FP4	{ 21FP4A 21FP4C 21KP4 21KP4A	23AVP4	{ 23BNP4 23CP4 23CP4A 23GP4	23GP4	{ 23CP4A 23BNP4
21FP4A	{ 21FP4C 21KP4A	23AWP4	23BJP4	23HP4	{ 23AVP4 23BNP4 23CP4 23CP4A
21FP4C	{ 21FP4A 21KP4A	23AYP4	{ 23BEP4 23BSP4 23SP4	23KP4	23KP4A
21JP4	21JP4A	23BAP4	23BP4		
21JP4A	21JP4	23BCP4	23CMP4		
21KP4	21KP4A*	23BDP4	{ 23BMP4 23BTP4 23YP4		
21WP4	21WP4A				
21WP4A	21WP4				
21XP4	{ 21XP4A 21AYP4				

*Connect external connector to chassis.

*Remove ion trap.

Directly Interchangeable TV Picture Tubes—(Continued)

Tube Number	Replace with	Tube Number	Replace with	Tube Number	Replace with
23MP4	{ 23MP4A 23FP4 23FP4A	24AP4	{ 24AP4A 24AP4B	24TP4	{ 24ADP4 24CP4 24CP4A 24VP4 24VP4A
23MP4A	23FP4A	24AP4A	{ 24AP4 24AP4B	24VP4	{ 24VP4A 24ADP4
23RP4	{ 23BRP4 23BYP4 23CSP4	24AP4B	{ 24AP4 24AP4A	24VP4A	{ 24VP4 24ADP4
23SP4	{ 23AYP4 23BEP4 23BSP4	24CP4	{ 24CP4A 24ADP4 24QP4 24TP4 24VP4 24VP4A	24XP4	{ 24ADP4* 24CP4* 24CP4A* 24TP4* 24VP4* 24VP4A*
23UP4	{ 23BQP4 23CBP4	24CP4A	{ 24CP4 24ADP4 24TP4 24VP4 24VP4A	24YP4	{ 24AEP4* 24ANP4 24DP4 24DP4A 24ZP4*
23WP4	{ 23MP4 23MP4A	24DP4	{ 24DP4A 24ANP4 24YP4 24AEP4* 24ZP4*	24ZP4	24EP4
23XP4	{ 23BDP4 23BMP4 23BTP4 23YP4	24DP4A	{ 24DP4 24ANP4 24YP4 24AEP4* 24ZP4*	27EP4	{ 27GP4 27RP4*
23YP4	{ 23BDP4 23BMP4 23BTP4	24QP4	{ 24ADP4 24CP4 24CP4A 24TP4 24VP4 24VP4A	27GP4	{ 27EP4 27RP4*
24ADP4	{ 24VP4 24VP4A			27NP4	27RP4
24AEP4	24AUP4			27SP4	27UP4
24AHP4	24ALP4			27UP4	27SP4
24AJP4	24ATP4			27VP4	27XP4
24ALP4	24AHP4				
24ANP4	24AUP4*				

*Connect external connector to chassis.

*Remove ion trap.

Greek Alphabet Designations

Name	Capital	Lower Case	Commonly used to designate	Name	Capital	Lower Case	Commonly used to designate
Alpha	Α	α	Angles. Area. Coefficients	Nu	Ν	ν	Reluctivity
Beta	Β	β	Angles. Flux density. Coefficients	Xi	Ξ	ξ	Co-ordinates
Gamma	Γ	γ	Conductivity. Specific gravity	Omicron	Ο	ο
Delta	Δ	δ	Variation. Density	Pi	Π	π	3.1416 (Ratio of circumference to diameter)
Epsilon	Ε	ε	Base of natural logarithms	Rho	Ρ	ρ	Resistivity
Zeta	Ζ	ζ	Impedance. Coefficients. Coordinates	Sigma	Σ	σ	Sign of summation
Eta	Η	η	Hysteresis coefficient. Efficiency	Tau	Τ	τ	Time constant. Time phase displacement
Theta	Θ	θ	Temperature. Phase angle	Upsilon	Υ	υ
Iota	Ι	ι	Unit vector.	Phi	Φ	φ	Magnetic flux. Angles
Kappa	Κ	κ	Dielectric constant. Susceptibility	Chi	Χ	χ	Electric susceptibility. Angles
Lambda	Λ	λ	Wave length	Psi	Ψ	ψ	Dielectric flux. Phase difference
Mu	Μ	μ	Micro. Amplification factor. Permeability	Omega	Ω	ω	Capital, ohms. Lower case, angular velocity

Pilot Lamp Data

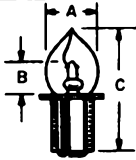
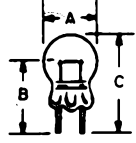
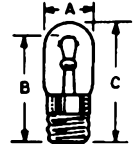
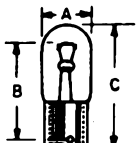
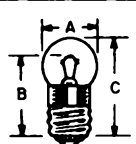
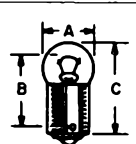
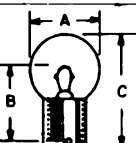
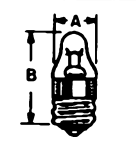
Bulb Silhouette	Maximum Size (See Chart Below)			Bulb No.	Base	Bulb Type	Lamp Numbers
	A	B	C				
	7/16"	1/4"	1 1/4"	B-3 1/2	S.C. Flange (Miniature)	Small Round	PR2 PR3 PR4 PR6 PR12
	7/16"	3/8"	1 1/4"	G-3 1/2	2-Pin (Miniature)	Small Round	12
	1 1/2"	1 3/4"	1 3/4"	T-3 1/4	Screw (Miniature)	Tubular	40 41 42 46 48 1892
	1 1/2"	3/4"	1 3/4"	T-3 1/4	Bayonet (Miniature)	Tubular	43 44 45 47 49 1490 1891
	7/16"	2 1/2"	1 3/4"	G-3 1/2	Screw (Miniature)	Small Round	50
	7/16"	1/2"	1 3/8"	G-3 1/2	Bayonet (Miniature)	Small Round	51
	5/8"	1/2"	1 1/4"	G-4 1/2	Bayonet (Miniature)	Large Round	55 57
	3/8"	3/8"	1 3/8"	G-5	Bayonet (Miniature)	Large Round	1458
	3/8"	—	1 3/8"	TL-3	Screw (Miniature)	Pinched Round	112 222

Pilot Lamp Data (Cont'd)

Lamp No.	Bead Color	Base (Miniature)	Bulb Type	Rating		Used For
				Volts	Amps.	
PR-2	Blue	Flange	B-3½	2.4	0.50	Flashlights
PR-3	Green	Flange	B-3½	3.6	0.50	Flashlights
PR-4	Yellow	Flange	B-3½	2.3	0.27	Flashlights
PR-6	Brown	Flange	B-3½	2.5	0.30	Flashlights
PR-12	White	Flange	B-3½	5.95	0.50	Flashlights
12	2-Pin	G-3½	6.3	0.15	Dials
40	Brown	Screw	T-3¼	6-8	0.15	Dials
41	White	Screw	T-3¼	2.5	0.5	Dials
42	Green	Screw	T-3¼	3.2	↓	Dials
43	White	Bayonet	T-3¼	2.5	0.5	Dials and Tuning Meters
44	Blue	Bayonet	T-3¼	6-8	0.25	Dials and Tuning Meters
45	Bayonet	T-3¼	3.2	↓	Dials
46*	Blue	Screw	T-3¼	6-8	0.25	Dials and Tuning Meters
47	Brown	Bayonet	T-3¼	6-9	0.15	Dials
48	Pink	Screw	T-3¼	2.0	0.06	Battery Set Dials
49	Pink	Bayonet	T-3¼	2.0	0.06	Battery Set Dials
50	White	Screw	G-3½	6-8	0.2	Auto-Radio Dials; Flashlights
51*	White	Bayonet	G-3½	6-8	0.2	Auto-Radio Dials; Panel Boards
55	White	Bayonet	G-4½	6-8	0.4	Auto-Radio Dials; Parking Lights
57	White	Bayonet	G-4½	14	0.24	Auto Radio Dials
112	Pink	Screw	TL-3	1.1	0.22	Flashlights
222	White	Screw	TL-3	2.2	0.25	Flashlights; Soldering Guns
1458	Bayonet	G-5	20.0	0.25	Dials
1490	White	Bayonet	T-3¼	3.2	0.15	Dials
1891	Pink	Bayonet	T-3½	14	0.23	Auto Radio Dials
1892	White	Screw	T-3½	14	0.12	Auto Panel Lights

*White in G.E. and Sylvania; Green in National Union Raytheon and Tung-Sol.

†0.35 in G.E. and Sylvania; 0.5 in National Union Raytheon and Tung-Sol.

*Have frosted bulb.

Neon Glow Lamps

High Brightness

Lamp Number	Hours of Average Useful Life*	Maximum Overall Length	Base	Nominal Current in Ma.	Circuit Volts, AC or DC	Nominal Watts 110-125 V.
NE-2H	25,000	¾"	2" Wire Term.	1.7	110-125	1/5
NE-2J	25,000	1¼"	S.C. Mid. Flange	1.7	110-125	1/5
NE-2P	25,000	¾"	1" Wire Term.	1.7	110-125	1/5
NE-51H	25,000	1¼"	Min. Bay.	1.2	110-125	1/7

Standard Brightness

NE-2	25,000	1¼"	1" Wire Term.	0.5	110-125	1/17
NE-2D	25,000	1¾"	S.C. Mid. Flange	0.6	110-125	1/15
NE-2E	25,000	¾"	2" Wire Term.	0.6	110-125	1/15
NE-2M	25,000	¾"	1" Wire Term.	0.5	110-125	1/17
NE-7	7,500	1¼"	1¼" Wire Term.	2.0	110-125	¼
NE-17	7,500	1½"	D.C. Bay	2.0	110-125	¼
NE-21	7,500	1½"	S.C. Bay	2.0	110-125	¼
NE-30	10,000	2¼"	Med. Screw	12.0	110-125	1
NE-34	10,000	3½"	Med. Screw	18.0	110-125	2
NE-42	10,000	3½"	D.C. Bay	30.0	110-125	3
NE-45	7,500	1½"	Cand. Screw	2.0	110-125	¼
NE-48	7,500	1½"	D.C. Bay	2.0	110-125	¼
NE-51	15,000	1¾"	Min. Bay	0.3	110-125	1/25
NE-56	10,000	2¼"	Med. Screw	5.0	220-250	1
NE-57	7,500	1½"	Cand. Screw	2.0	110-125	¼
NE-58	7,500	1½"	Cand. Screw	2.0	220-250	½
NE-79	10,000	2"	D.C. Bay	12.0	110-125	1

Argon Glow Lamps

AR-1	1,000	3½"	Med. Screw	18.0	110-125	2
AR-3	150	1½"	Cand. Screw	3.5	110-125	¼
AR-4	150	1½"	D.C. Bay	3.5	110-125	¼
AR-9	50	1¼"	1" Wire Term.	0.3	110-125	1/25

*On A.C. unless otherwise noted. D-C life is approximately 60% of A-C values.

Resistor Color Code

EIA STANDARD RS-172

MILITARY STANDARD MIL-R-11C

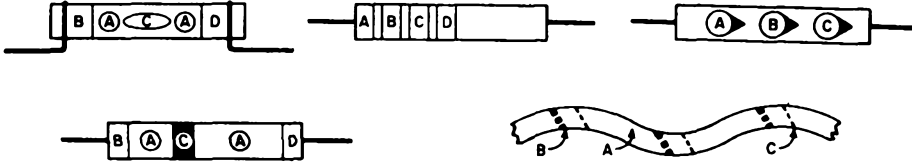

Color	1st Digit A	2nd Digit B	Multiplier C	Tolerance D
Black	0	0	1	—
Brown	1	1	10	—
Red	2	2	100	—
Orange	3	3	1,000	—
Yellow	4	4	10,000	—
Green	5	5	100,000	—
Blue	6	6	1,000,000	—
Violet	7	7	10,000,000	—
Gray	8	8	100,000,000	—
White	9	9	—	—
Gold	—	—	0.1	± 5%
Silver	—	—	0.01*	± 10%
No Color	—	—	*EIA ONLY.	± 20%

INSULATION CODING

EIA: Insulated resistors with axial leads are designated by a background of any color except black. The usual color is natural tan. Noninsulated resistors with axial leads are designated by a black background color.

MILITARY (MIL): Same as EIA with the addition of: Noninsulated resistors with radial leads designated by a black background color or by a background the same color as the first significant figure of the resistance value.

Mica Capacitor Color Code

MILITARY STANDARD

MIL-C-5B

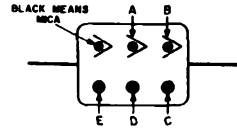

Color	Digits of Capacitance ($\mu\mu\text{f}$)		Multiplier C	Tolerance % D	Characteristic. See table below E
	A	B			
Black	0	0	1	± 20	—
Brown	1	1	10	—	—
Red	2	2	100	± 2	B C D E
Orange	3	3	1,000	—	F
Yellow	4	4	—	—	—
Green	5	5	—	—	—
Blue	6	6	—	—	—
Violet	7	7	—	—	—
Gray	8	8	—	—	—
White	9	9	—	—	—
Gold	—	—	0.1	± 5	—
Silver	—	—	0.01	± 10	—

DESCRIPTION OF CHARACTERISTIC

Characteristic	Temperature Coefficient (parts per million per °C)	Maximum Capacitance Drift	Minimum Insulation Resistance (megohms)
B	Not specified	Not specified	7500
C	± 200	± 0.5%	7500
D	± 100	± 0.3%	7500
E	+100 -20	± (0.1% + 0.1 $\mu\mu\text{f}$)	7500
F	+70	± (0.05% + 0.1 $\mu\mu\text{f}$)	7500

VOLTAGE RATING

(Indicated by dimensions rather than color coding)

Maximum Inches			Style CM	Capacitance ($\mu\mu\text{f}$)	Rating (v d-c)
Long	Wide	Thick			
$\frac{3}{16}$	$\frac{1}{16}$	$\frac{1}{16}$	15	5-510	300
$\frac{1}{4}$	$\frac{1}{8}$	$\frac{1}{8}$	20	5-510 560-1000	500 300
$\frac{1}{2}$	$\frac{1}{4}$	$\frac{1}{4}$	25	51-1000	500
$\frac{3}{8}$	$\frac{3}{16}$	$\frac{3}{16}$	30	560-3300	500
$\frac{1}{2}$	$\frac{1}{2}$	$\frac{1}{2}$	35	3600-8200 6800-10,000	500 300
$\frac{1}{2}$	$\frac{1}{2}$	$\frac{1}{2}$	40	3300-8200 9100-10,000	500 300

Mica Capacitor Color Code

EIA STANDARD RS-153

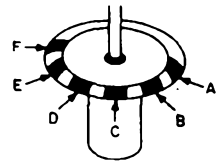
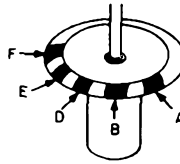
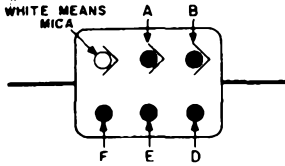

Color	Digits of Capacitance (μf)			Multiplier D	Tolerance % E*	Characteristic— See table below F
	A	B	C			
Black	0	0	0	1	± 20	A
Brown	1	1	1	10	± 1	B
Red	2	2	2	100	± 2	C
Orange	3	3	3	1,000	± 3	D
Yellow	4	4	4	10,000	—	E
Green	5	5	5	—	± 5	—
Blue	6	6	6	—	—	—
Violet	7	7	7	—	—	—
Gray	8	8	8	—	—	—
White	9	9	9	—	—	—
Gold	—	—	—	0.1	—	—
Silver	—	—	—	0.01	± 10	—

*or $\pm 1 \mu\text{f}$, whichever is greater.

DESCRIPTION OF CHARACTERISTIC

Characteristic	Temperature Coefficient (parts per million per $^{\circ}\text{C}$)	Maximum Capacitance Drift	Minimum Insulation Resistance (megohms)
A	± 1000	$\pm (5\% + 1 \mu\text{f})$	3000
B	± 500	$\pm (3\% + 1 \mu\text{f})$	6000
C	± 200	$\pm (0.5\% + 0.5 \mu\text{f})$	6000
D	± 100	$\pm (0.3\% + 0.1 \mu\text{f})$	6000
E	+100 -20	$\pm (0.1\% + 0.1 \mu\text{f})$	6000
—	—	—	—
—	—	—	—

VOLTAGE RATING

(Indicated by dimensions rather than color coding)

Maximum Inches			Style	Capacitance (μf)	Rating (v d-c)
Long	Wide	Thick			
$\frac{1}{8}$	$\frac{15}{32}$	$\frac{1}{32}$	20	5-510 560-1000	500 300
$1\frac{1}{4}$	$\frac{15}{32}$	$\frac{1}{32}$	25	5-1000 1100-1500	500 300
$\frac{3}{8}$	$\frac{3}{8}$	$\frac{9}{32}$	30	470-6200 Over 6200	500 300
$\frac{3}{8}$	$\frac{3}{8}$	$\frac{3}{8}$	35	3300-6200 Over 6200	500 300
$1\frac{1}{2}$	$\frac{41}{64}$	$\frac{11}{32}$	40	100-2400 2700-7500 Over 7500	1000 500 300

Mica Capacitor Color Code

Obsolete Style

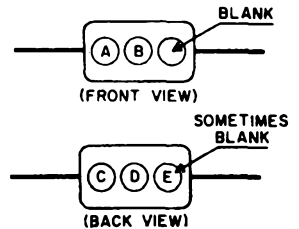
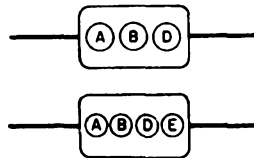
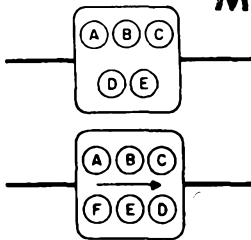

Dot Color	Digits of Capacitance (μf)			Multiplier D	Tolerance % E	Voltage Rating (v d-c) F
	A	B	C			
Black	0	0	0	1	± 20	—
Brown	1	1	1	10	± 1	100
Red	2	2	2	100	± 2	200
Orange	3	3	3	1,000	± 3	300
Yellow	4	4	4	10,000	± 4	400
Green	5	5	5	100,000	± 5	500
Blue	6	6	6	1,000,000	± 6	600
Violet	7	7	7	10,000,000	± 7	700
Gray	8	8	8	100,000,000	± 8	800
White	9	9	9	1,000,000,000	± 9	900
Gold	—	—	—	0.1	± 5	1,000
Silver	—	—	—	0.01	± 10	2,000
No Color	—	—	—	—	± 20	500

Ceramic Capacitor Color Code

EIA STANDARD RS-198

MILITARY STANDARD JAN-C-20A

Proposed Mil-C-20C

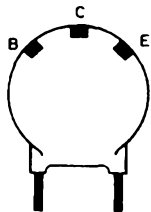

3-Dot Disc Capacitors (RETMA ONLY)
(Voltage rating is always 500 v., tolerance is always -0.)

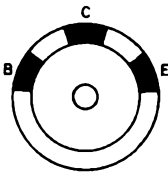

3-Dot Button Capacitors (EIA ONLY)

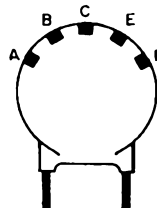

5-Dot Disc Capacitors (EIA ONLY)
(Voltage rating is always 500 v.)

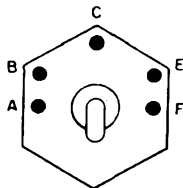

Feed Through Capacitors (EIA ONLY)

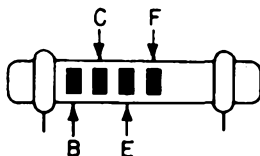

High Capacity Tubulars (Insulated or Non-Insulated)

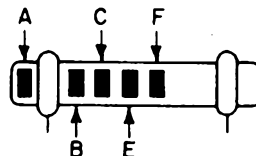

Temperature Compensating Tubulars

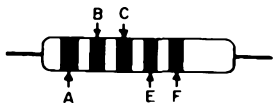

Tubular Capacitors (Voltage rating is always 500 v.)

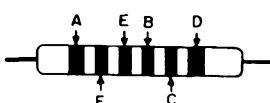

Tubular Capacitors (Old RMA)

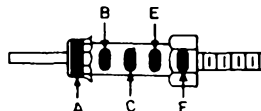

Stand-Off Capacitors (EIA ONLY)

Color	Digits of Capacitance (μmf)			Multiplier E	Tolerance F		Temp. Coef. A (Parts per million per °C.)	
	B	C	D		10 μmf or less (μmf)	Over 10 μmf (%)	EIA	MILITARY
Black	0	0	0	1	± 2.0	$\pm 20^*$	0	0
Brown	1	1	1	10	$\pm 0.1^*$	± 1	- 33	- 30
Red	2	2	2	100	—	± 2	- 75	- 80
Orange	3	3	3	1,000	—	$\pm 2.5^*$	- 150	- 150
Yellow	4	4	4	10,000*	—	—	- 220	- 220
Green	5	5	5	—	± 0.5	± 5	- 330	- 330
Blue	6	6	6	—	—	—	- 470	- 470
Violet	7	7	7	—	—	—	- 750	- 750
Gray	8	8	8	0.01	± 0.25	—	+150 to -1500	+ 30
White	9	9	9	0.1	± 1.0	± 10	+100 to -750	+330*
Gold	—	—	—	—	—	—	—	+100

*EIA only

Paper Capacitor Color Code

MILITARY STANDARD MIL-C-91A

(Commercial codes are same except as noted)

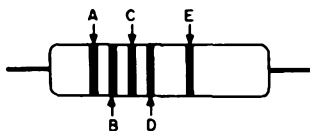

Tubular Capacitors
(Commercial Only)

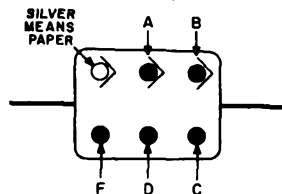

Rectangular Capacitors

Color	Digits of Capacitance (μmf)		Multiplier C	Tolerance % D	Tubular Voltage Rating (v d-c) E	Temp. Rating °C and Characteristic F
	A	B				
Black	0	0	1	± 20	—	85-A
Brown	1	1	10	—	100	85-E
Red	2	2	100	—	200	—
Orange	3	3	1,000	± 30	300	—
Yellow	4	4	10,000	—	400	—
Green	5	5	—	—	500	—
Blue	6	6	—	—	600	—
Violet	7	7	—	—	700	—
Gray	8	8	—	—	800	—
White	9	9	—	—	900	—
Gold	—	—	—	—	1,000	—
Silver	—	—	—	± 10	—	—

VOLTAGE RATING FOR RECTANGULAR CAPACITORS

(Indicated by dimensions rather than color coding)

Maximum Dimensions (inches)			Style C/N	Capacitance (μmf)	Voltage Rating (v d-c)
Length	Width	Thickness			
$1\frac{1}{4}$	$1\frac{1}{2}$	$\frac{1}{2}$	20	1000	400
				2000-6000	200
				10,000	120
$1\frac{7}{8}$	$1\frac{3}{4}$	$1\frac{1}{4}$	22	2000-3000	400
				6000-10,000	300
				20,000	120
$1\frac{3}{4}$	$1\frac{3}{4}$	$\frac{3}{8}$	30	1000-2000	800
				3000	600
				6000-10,000	400
$1\frac{3}{4}$	$1\frac{3}{4}$	$1\frac{1}{2}$	35	20,000	120
				3000	800
				6000-10,000	600
$1\frac{1}{4}$	$1\frac{1}{4}$	$\frac{3}{8}$	41	20,000	400
				30,000	300
				10,000	120
$1\frac{1}{2}$	$1\frac{1}{4}$	$1\frac{1}{2}$	42	1000-6000	1000
				10,000-20,000	600
				30,000	400
				50,000	300
				100,000	120
$1\frac{1}{2}$	$1\frac{1}{4}$	$1\frac{3}{8}$	43	10,000	1000
				20,000-30,000	600
				50,000-100,000	400
				200,000	120

TYPOGRAPHICALLY MARKED TUBULAR CERAMICS

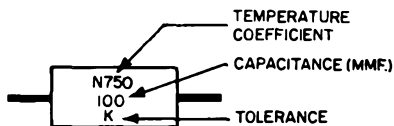

JAN LETTER	TOLERANCE	
	10 μmf or Less	Over 10 μmf
C	± 0.25 μmf
D	± 0.5 μmf
F	± 1.0 μmf	± 1%
G	± 2.0 μmf	± 2%
J	± 5%
K	± 10%
M	± 20%

EIA Color Codes

The color codes on the preceding and two following pages are used by most radio and instrument manufacturers in the wiring of their products, and by parts manufacturers for identifying lead placement or resistor and capacitor values, ratings, and tolerances. These have been included for whatever help they may provide in identifying parts and

leads when trouble-shooting. Since all manufacturers do not use these codes, however, due caution must be observed to determine whether or not the set, instrument, or part under examination does or does not follow the code colors given here. A quick check with a voltmeter, ohmmeter, or continuity meter is usually all that is needed to establish this fact.

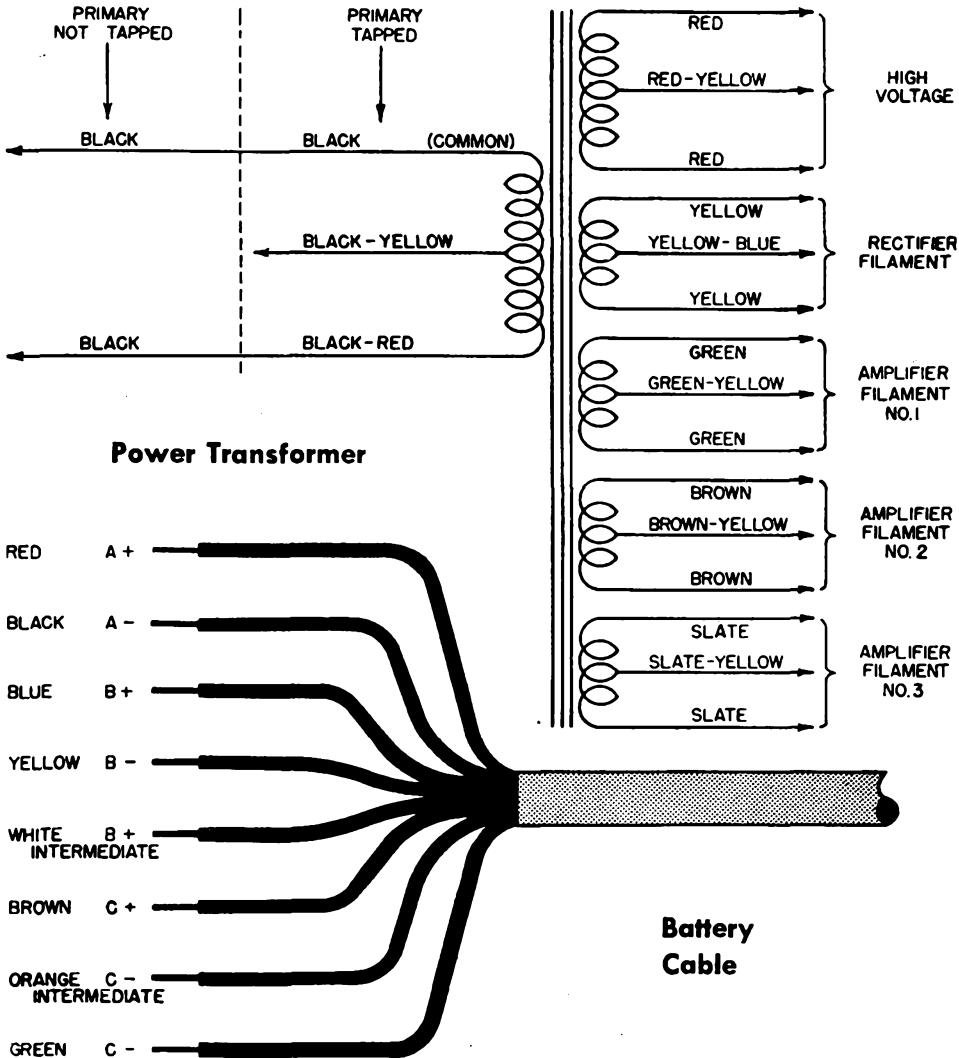

Speaker Leads and Plug Connections

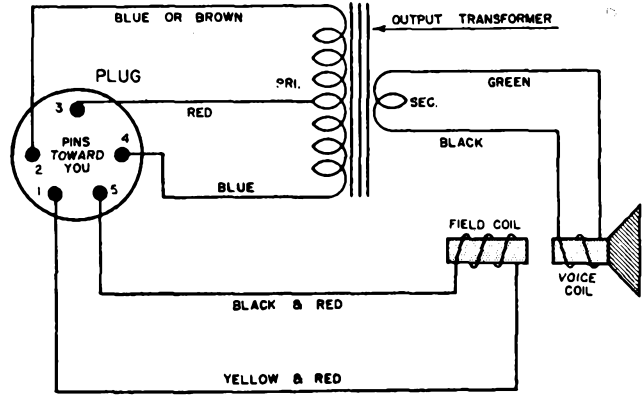
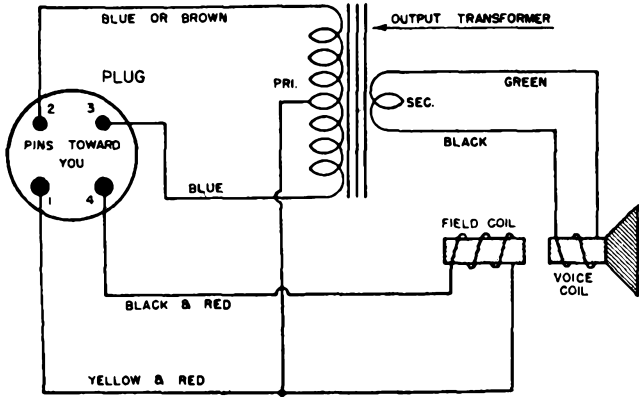

Speaker Leads and Plug Connections

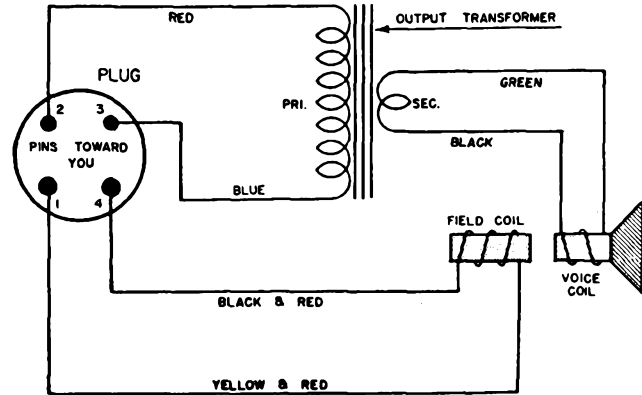
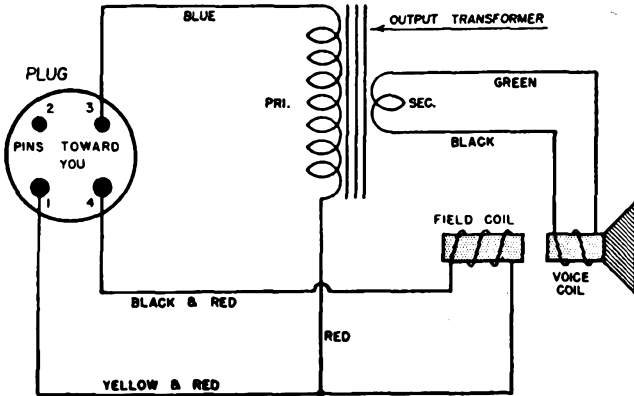

Speaker Lead Color Codes—(Continued)

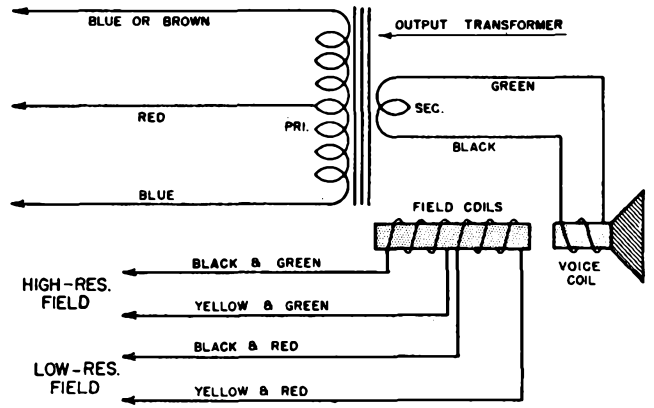
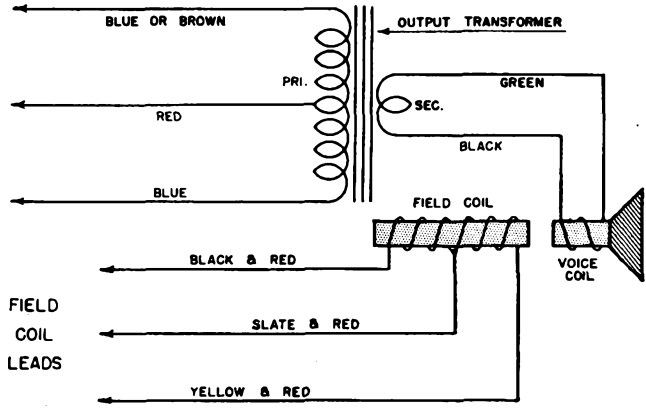

EIA Color Codes—(Continued)

I-F Transformers

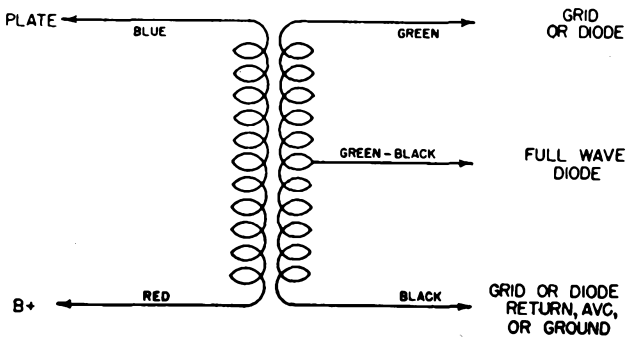

Audio & Output Transformers

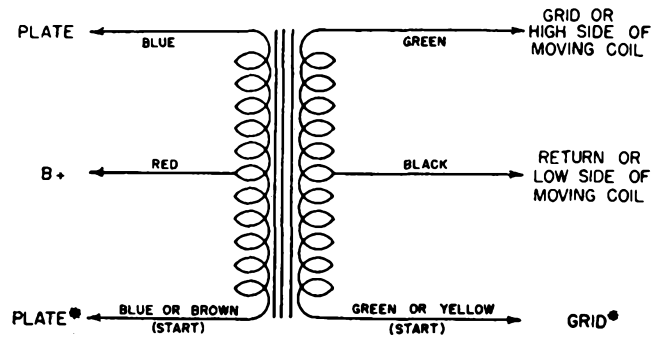

* FOUND ONLY ON PUSH-PULL PRIMARY OR SECONDARY WINDINGS

Abbreviations and Letter Symbols*











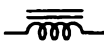
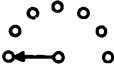







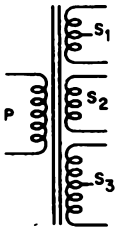















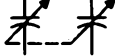





Many of the abbreviations given are in lower-case letters. Obviously, however, there will be occasions such as when the abbreviations are used in titles where the original word would have been capitalized. In these cases, the abbreviation should be similarly capitalized.

A two-word adjective expression should contain a hyphen.



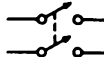











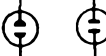

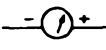









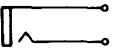







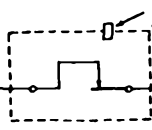

<i>Term</i>	<i>Abbreviation</i>	<i>Term</i>	<i>Abbreviation</i>
Admittance.....	Y	Low-frequency (adjective).....	l-f
Alternating-current (adjective)....	a-c	Low frequency (noun).....	l.f.
Alternating current (noun).....	a.c.	Magnetic field intensity.....	H
Ampere.....	a	Megacycle.....	Mc
Angular velocity (2 π f).....	ω	Megohm.....	M Ω
Antenna.....	ant.	Meter.....	m
Audio-frequency (adjective).....	a-f	Microampere.....	μ a
Audio frequency (noun).....	a.f.	Microfarad (mfd).....	μ f
Automatic volume control.....	a.v.c.	Microhenry.....	μ h
Automatic volume expansion.....	a.v.e.	Micromicrofarad (mmfd).....	$\mu\mu$ f
Capacitance.....	C	Microvolt.....	μ v
Capacitive reactance.....	X_C	Microvolt per meter.....	μ v/m
Centimeter.....	cm	Microwatt.....	μ w
Conductance.....	G	Milliampere.....	ma
Continuous waves.....	c.w.	Millihenry.....	mh
Current.....	I, i	Millivolt.....	mv
Cycles per second.....	\sim	Millivolt per meter.....	mv/m
Decibel.....	db	Milliwatt.....	mw
Direct-current (adjective).....	d-c	Modulated continuous waves.....	m.c.w.
Direct current (noun).....	d.c.	Mutual inductance.....	M
Double cotton covered.....	d.c.c.	Ohm.....	Ω
Double pole, double throw.....	d.p.d.t.	Power.....	P
Double pole, single throw.....	d.p.s.t.	Power factor.....	p.f.
Double silk covered.....	d.s.c.	Radio-frequency (adjective).....	r-f
Electric field intensity.....	E	Radio frequency (noun).....	r.f.
Electromotive force.....	e.m.f.	Reactance.....	X
Frequency.....	f	Resistance.....	R
Frequency modulation.....	f.m.	Revolutions per minute.....	r.p.m.
Ground.....	gnd.	Root mean square.....	r.m.s.
Henry.....	h	Self-inductance.....	L
High-frequency (adjective).....	h-f	Short wave.....	s.w.
High frequency (noun).....	h.f.	Single cotton covered.....	s.c.c.
Impedance.....	Z	Single cotton enamel.....	s.c.e.
Inductance.....	L	Single pole, double throw.....	s.p.d.t.
Inductive reactance.....	X_L	Single pole, single throw.....	s.p.s.t.
Intermediate-frequency (adjective).....	i-f	Single silk covered.....	s.s.c.
Intermediate frequency (noun).....	i.f.	Tuned radio frequency.....	t.r.f.
Interrupted continuous waves.....	i.c.w.	Ultra high frequency.....	u.h.f.
Kilocycle.....	kc	Vacuum tube voltmeter.....	v.t.v.m
Kilohm.....	k Ω	Volt.....	v
Kilovolt.....	kv	Voltage.....	E, e
Kilovolt ampere.....	kva	Volt-Ohm-Milliammeter.....	v.o.m.
Kilowatt.....	kw	Watt.....	w

* See Page 23 for Transistor Symbols.

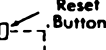
Schematic Symbols Used in Radio Diagrams

	ANTENNA (AERIAL)		IRON CORE CHOKE COIL		SWITCH (ROTARY OR SELECTOR)
	GROUND		R. F. TRANSFORMER (AIR CORE)		CRYSTAL DETECTOR
	ANTENNA (LOOP)		A. F. TRANSFORMER (IRON CORE)		LIGHTNING ARRESTER
	WIRING METHOD 1 CONNECTION		POWER TRANSFORMER P - 115 VOLT PRIMARY S ₁ - CENTER-TAPPED SECONDARY FOR FILAMENTS OF SIGNAL CIRCUIT TUBES S ₂ - SECONDARY FOR RECTIFIER TUBE FILAMENT S ₃ - CENTER-TAPPED HIGH-VOLTAGE SECONDARY		FUSE
	NO CONNECTION				PILOT LAMP
	WIRING METHOD 2 CONNECTION		FIXED CAPACITOR (MICA OR PAPER)		HEADPHONES
	NO CONNECTION				LOUDSPEAKER, P. M. DYNAMIC
	TERMINAL		FIXED CAPACITOR (ELECTROLYTIC)		LOUDSPEAKER, ELECTRODYNAMIC
	ONE CELL OR "A" BATTERY		ADJUSTABLE OR VARIABLE CAPACITOR		PHONO PICK-UP
	MULTI-CELL OR "B" BATTERY		ADJUSTABLE OR VARIABLE CAPACITORS (GANDED)		VACUUM TUBE HEATER OR FILAMENT
	RESISTOR		I. F. TRANSFORMER (DOUBLE-TUNED)		VACUUM TUBE CATHODE
	POTENTIOMETER (VOLUME CONTROL)		POWER SWITCH S. P. S. T.		VACUUM TUBE GRID
	TAPPED RESISTOR OR VOLTAGE DIVIDER		SWITCH S. P. D. T.		VACUUM TUBE PLATE
	RHEOSTAT		SWITCH D. P. S. T.		3-ELEMENT VACUUM TUBE (TRIODE)
	AIR CORE CHOKE COIL		SWITCH D. P. D. T.		ALIGNING KEY OCTAL BASE TUBE

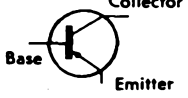
Schematic Symbols Used in Radio Diagrams

	SLIDE SWITCH		FILAMENT LAMPS		PHONE PLUG
	MULTI-CONTACT SWITCH		NEON LAMPS		PHONO PLUG
	GENERAL MICROPHONE		METER		INTER-CONNECTING PLUG Male
	CAPACITOR MICROPHONE		METER		INTER-CONNECTING PLUG Female
	DYNAMIC MICROPHONE		VARIABLE CORE INDUCTOR		LINE PLUG
	CRYSTAL MICROPHONE			VARIABLE CORE INDUCTOR	
	PHONE JACK			AIR CORE INDUCTOR	
	PHONE JACK			IRON CORE INDUCTOR	
	PHONO JACK			POWDERED-IRON CORE INDUCTOR	
	SHIELDED PAIR SHIELD			RELAYS	
	SHIELDED WIRE SHIELD			CIRCUIT BREAKER	
	SHIELDED ASSEMBLY			Reset Button	
	COMMON GROUND			SILICON CONTROLLED RECTIFIER	
	WIRES SHIELDED BETWEEN TWO POINTS			NPN TYPE TRANSISTOR C B E	

Common Logarithms

N	0	1	2	3	4	5	6	7	8	9	N
10	0000	0043	0086	0128	0170	0212	0253	0294	0334	0374	10
11	0414	0453	0492	0531	0569	0607	0645	0682	0719	0755	11
12	0792	0828	0864	0899	0934	0969	1004	1038	1072	1108	12
13	1139	1173	1206	1239	1271	1303	1335	1367	1399	1430	13
14	1461	1492	1523	1553	1584	1614	1644	1673	1703	1732	14
15	1761	1790	1818	1847	1875	1903	1931	1959	1987	2014	15
16	2041	2068	2095	2122	2148	2175	2201	2227	2253	2279	16
17	2304	2330	2355	2380	2405	2430	2455	2480	2504	2529	17
18	2553	2577	2601	2625	2648	2672	2695	2718	2742	2765	18
19	2788	2810	2833	2856	2878	2900	2923	2945	2967	2989	19
20	3010	3032	3054	3075	3096	3118	3139	3160	3181	3201	20
21	3222	3243	3263	3284	3304	3324	3345	3365	3385	3404	21
22	3424	3444	3464	3483	3502	3522	3541	3560	3579	3598	22
23	3617	3636	3655	3674	3692	3711	3729	3747	3766	3784	23
24	3802	3820	3838	3856	3874	3892	3909	3927	3945	3962	24
25	3979	3997	4014	4031	4048	4065	4082	4099	4116	4133	25
26	4150	4166	4183	4200	4216	4232	4249	4265	4281	4298	26
27	4314	4330	4346	4362	4378	4393	4409	4425	4440	4456	27
28	4472	4487	4502	4518	4533	4548	4564	4579	4594	4609	28
29	4624	4639	4654	4669	4683	4698	4713	4728	4742	4757	29
30	4771	4786	4800	4814	4829	4843	4857	4871	4886	4900	30
31	4914	4928	4942	4955	4969	4983	4997	5011	5024	5038	31
32	5051	5065	5079	5092	5105	5119	5132	5145	5159	5172	32
33	5185	5198	5211	5224	5237	5250	5263	5276	5289	5302	33
34	5315	5328	5340	5353	5366	5378	5391	5403	5416	5428	34
35	5441	5453	5465	5478	5490	5502	5514	5527	5539	5551	35
36	5563	5575	5587	5599	5611	5623	5635	5647	5658	5670	36
37	5682	5694	5705	5717	5729	5740	5752	5763	5775	5786	37
38	5798	5809	5821	5832	5843	5855	5866	5877	5888	5899	38
39	5911	5922	5933	5944	5955	5966	5977	5988	5999	6010	39
40	6021	6031	6042	6053	6064	6075	6086	6096	6107	6117	40
41	6128	6138	6149	6160	6170	6180	6191	6201	6212	6222	41
42	6232	6243	6253	6263	6274	6284	6294	6304	6314	6325	42
43	6335	6345	6355	6365	6375	6385	6395	6405	6415	6425	43
44	6435	6444	6454	6464	6474	6484	6493	6503	6513	6522	44
45	6532	6542	6551	6561	6571	6580	6590	6599	6609	6618	45
46	6628	6637	6646	6656	6665	6675	6684	6693	6702	6712	46
47	6721	6730	6739	6749	6758	6767	6776	6785	6794	6803	47
48	6812	6821	6830	6839	6848	6857	6866	6875	6884	6893	48
49	6902	6911	6920	6928	6937	6946	6955	6964	6972	6981	49
50	6990	6998	7007	7016	7024	7033	7042	7050	7059	7067	50
51	7076	7084	7093	7101	7110	7118	7126	7135	7143	7152	51
52	7160	7168	7177	7185	7193	7202	7210	7218	7226	7235	52
53	7243	7251	7259	7267	7275	7284	7292	7300	7308	7316	53
54	7324	7332	7340	7348	7356	7364	7372	7380	7388	7396	54
N	0	1	2	3	4	5	6	7	8	9	N

Common Logarithms (Continued)

N	0	1	2	3	4	5	6	7	8	9	N
55	7404	7412	7419	7427	7435	7443	7451	7459	7466	7474	55
56	7482	7490	7497	7505	7513	7520	7528	7536	7543	7551	56
57	7569	7586	7574	7582	7589	7597	7604	7612	7619	7627	57
58	7634	7642	7649	7657	7664	7672	7679	7686	7694	7701	58
59	7709	7716	7723	7731	7738	7745	7752	7760	7767	7774	59
60	7782	7789	7796	7803	7810	7818	7825	7832	7839	7846	60
61	7853	7860	7868	7875	7882	7889	7896	7903	7910	7917	61
62	7924	7931	7938	7945	7952	7959	7966	7973	7980	7987	62
63	7993	8000	8007	8014	8021	8028	8035	8041	8048	8055	63
64	8062	8069	8075	8082	8089	8096	8102	8109	8116	8122	64
65	8129	8136	8142	8149	8156	8162	8169	8176	8182	8189	65
66	8195	8202	8209	8215	8222	8228	8235	8241	8248	8254	66
67	8261	8267	8274	8280	8287	8293	8299	8306	8312	8319	67
68	8325	8331	8338	8344	8351	8357	8363	8370	8376	8382	68
69	8388	8395	8401	8407	8414	8420	8426	8432	8439	8445	69
70	8451	8457	8463	8470	8476	8482	8488	8494	8500	8506	70
71	8513	8519	8525	8531	8537	8543	8549	8555	8561	8567	71
72	8572	8579	8585	8591	8597	8603	8609	8615	8621	8627	72
73	8633	8639	8645	8651	8657	8663	8669	8675	8681	8686	73
74	8692	8698	8704	8710	8716	8722	8727	8733	8739	8745	74
75	8751	8756	8762	8768	8774	8779	8785	8791	8797	8802	75
76	8808	8814	8820	8825	8831	8837	8842	8848	8854	8859	76
77	8865	8871	8876	8882	8887	8893	8899	8904	8910	8915	77
78	8921	8927	8932	8938	8943	8949	8954	8960	8965	8971	78
79	8976	8982	8987	8993	8998	9004	9009	9015	9020	9025	79
80	9031	9036	9042	9047	9053	9058	9063	9069	9074	9079	80
81	9085	9090	9096	9101	9106	9112	9117	9122	9128	9133	81
82	9138	9143	9149	9154	9159	9165	9170	9175	9180	9186	82
83	9191	9196	9201	9206	9212	9217	9222	9227	9232	9238	83
84	9243	9248	9253	9258	9263	9269	9274	9279	9284	9289	84
85	9294	9299	9304	9309	9315	9320	9325	9330	9335	9340	85
86	9345	9350	9355	9360	9365	9370	9375	9380	9385	9390	86
87	9395	9400	9405	9410	9415	9420	9425	9430	9435	9440	87
88	9445	9450	9455	9460	9465	9469	9474	9479	9484	9489	88
89	9494	9499	9504	9509	9513	9518	9523	9528	9533	9538	89
90	9542	9547	9552	9557	9562	9566	9571	9576	9581	9586	90
91	9590	9595	9600	9605	9609	9614	9619	9624	9628	9633	91
92	9638	9643	9647	9652	9657	9661	9666	9671	9675	9680	92
93	9685	9689	9694	9699	9703	9708	9713	9717	9722	9727	93
94	9731	9736	9741	9745	9750	9754	9759	9763	9768	9773	94
95	9777	9782	9786	9791	9795	9800	9805	9809	9814	9818	95
96	9823	9827	9832	9836	9841	9845	9850	9854	9859	9863	96
97	9868	9872	9877	9881	9886	9890	9894	9899	9903	9908	97
98	9912	9917	9921	9926	9930	9934	9939	9943	9948	9952	98
99	9956	9961	9965	9969	9974	9978	9983	9987	9991	9996	99
N	0	1	2	3	4	5	6	7	8	9	N

Natural Sines, Cosines, and Tangents
0°-14.9°

Degs.	Function	0.0°	0.1°	0.2°	0.3°	0.4°	0.5°	0.6°	0.7°	0.8°	0.9°
0	sin	0.0000	0.0017	0.0035	0.0052	0.0070	0.0087	0.0105	0.0122	0.0140	0.0157
	cos	1.0000	1.0000	1.0000	1.0000	1.0000	1.0000	0.9999	0.9999	0.9999	0.9999
	tan	0.0000	0.0017	0.0035	0.0052	0.0070	0.0087	0.0105	0.0122	0.0140	0.0157
1	sin	0.0175	0.0192	0.0209	0.0227	0.0244	0.0262	0.0279	0.0297	0.0314	0.0332
	cos	0.9998	0.9998	0.9998	0.9997	0.9997	0.9997	0.9996	0.9996	0.9995	0.9995
	tan	0.0175	0.0192	0.0209	0.0227	0.0244	0.0262	0.0279	0.0297	0.0314	0.0332
2	sin	0.0349	0.0366	0.0384	0.0401	0.0419	0.0436	0.0454	0.0471	0.0488	0.0506
	cos	0.9994	0.9993	0.9993	0.9992	0.9991	0.9990	0.9990	0.9989	0.9988	0.9987
	tan	0.0349	0.0367	0.0384	0.0402	0.0419	0.0437	0.0454	0.0472	0.0489	0.0507
3	sin	0.0523	0.0541	0.0558	0.0576	0.0593	0.0610	0.0628	0.0645	0.0663	0.0680
	cos	0.9986	0.9985	0.9984	0.9983	0.9982	0.9981	0.9980	0.9979	0.9978	0.9977
	tan	0.0524	0.0542	0.0559	0.0577	0.0594	0.0612	0.0629	0.0647	0.0664	0.0682
4	sin	0.0698	0.0715	0.0732	0.0750	0.0767	0.0785	0.0802	0.0819	0.0837	0.0854
	cos	0.9976	0.9974	0.9973	0.9972	0.9971	0.9969	0.9968	0.9966	0.9965	0.9963
	tan	0.0699	0.0717	0.0734	0.0752	0.0769	0.0787	0.0805	0.0822	0.0840	0.0857
5	sin	0.0872	0.0889	0.0906	0.0924	0.0941	0.0958	0.0976	0.0993	0.1011	0.1028
	cos	0.9962	0.9960	0.9959	0.9957	0.9956	0.9954	0.9952	0.9951	0.9949	0.9947
	tan	0.0875	0.0892	0.0910	0.0928	0.0945	0.0963	0.0981	0.0998	0.1016	0.1033
6	sin	0.1045	0.1063	0.1080	0.1097	0.1115	0.1132	0.1149	0.1167	0.1184	0.1201
	cos	0.9945	0.9943	0.9942	0.9940	0.9938	0.9936	0.9934	0.9932	0.9930	0.9928
	tan	0.1051	0.1069	0.1086	0.1104	0.1122	0.1139	0.1157	0.1175	0.1192	0.1210
7	sin	0.1219	0.1236	0.1253	0.1271	0.1288	0.1305	0.1323	0.1340	0.1357	0.1374
	cos	0.9925	0.9923	0.9921	0.9919	0.9917	0.9914	0.9912	0.9910	0.9907	0.9905
	tan	0.1228	0.1246	0.1263	0.1281	0.1299	0.1317	0.1334	0.1352	0.1370	0.1388
8	sin	0.1392	0.1409	0.1426	0.1444	0.1461	0.1478	0.1495	0.1513	0.1530	0.1547
	cos	0.9903	0.9900	0.9898	0.9895	0.9893	0.9890	0.9888	0.9885	0.9882	0.9880
	tan	0.1405	0.1423	0.1441	0.1459	0.1477	0.1495	0.1512	0.1530	0.1548	0.1566
9	sin	0.1564	0.1582	0.1599	0.1616	0.1633	0.1650	0.1668	0.1685	0.1702	0.1719
	cos	0.9877	0.9874	0.9871	0.9869	0.9866	0.9863	0.9860	0.9857	0.9854	0.9851
	tan	0.1584	0.1602	0.1620	0.1638	0.1655	0.1673	0.1691	0.1709	0.1727	0.1745
10	sin	0.1736	0.1754	0.1771	0.1788	0.1805	0.1822	0.1840	0.1857	0.1874	0.1891
	cos	0.9848	0.9845	0.9842	0.9839	0.9836	0.9833	0.9829	0.9826	0.9823	0.9820
	tan	0.1763	0.1781	0.1799	0.1817	0.1835	0.1853	0.1871	0.1890	0.1908	0.1926
11	sin	0.1908	0.1925	0.1942	0.1959	0.1977	0.1994	0.2011	0.2028	0.2045	0.2062
	cos	0.9816	0.9813	0.9810	0.9806	0.9803	0.9799	0.9796	0.9792	0.9789	0.9785
	tan	0.1944	0.1962	0.1980	0.1998	0.2016	0.2035	0.2053	0.2071	0.2089	0.2107
12	sin	0.2079	0.2096	0.2113	0.2130	0.2147	0.2164	0.2181	0.2198	0.2215	0.2232
	cos	0.9781	0.9778	0.9774	0.9770	0.9767	0.9763	0.9759	0.9755	0.9751	0.9748
	tan	0.2126	0.2144	0.2162	0.2180	0.2199	0.2217	0.2235	0.2254	0.2272	0.2290
13	sin	0.2250	0.2267	0.2284	0.2300	0.2318	0.2334	0.2351	0.2368	0.2385	0.2402
	cos	0.9744	0.9740	0.9736	0.9732	0.9728	0.9724	0.9720	0.9715	0.9711	0.9707
	tan	0.2309	0.2327	0.2345	0.2364	0.2382	0.2401	0.2419	0.2438	0.2456	0.2475
14	sin	0.2419	0.2436	0.2453	0.2470	0.2487	0.2504	0.2521	0.2538	0.2554	0.2571
	cos	0.9703	0.9699	0.9694	0.9690	0.9686	0.9681	0.9677	0.9673	0.9668	0.9664
	tan	0.2493	0.2512	0.2530	0.2549	0.2568	0.2586	0.2605	0.2623	0.2642	0.2661
Degs.	Function	0'	6'	12'	18'	24'	30'	36'	42'	48'	54'

Natural Sines, Cosines, and Tangents—(Continued)

15°-29.9°

Degs.	Function	0.0°	0.1°	0.2°	0.3°	0.4°	0.5°	0.6°	0.7°	0.8°	0.9°
15	sin	0.2588	0.2605	0.2622	0.2639	0.2656	0.2672	0.2689	0.2706	0.2723	0.2740
	cos	0.9659	0.9655	0.9650	0.9646	0.9641	0.9636	0.9632	0.9627	0.9622	0.9617
	tan	0.2679	0.2698	0.2717	0.2736	0.2754	0.2773	0.2792	0.2811	0.2830	0.2849
16	sin	0.2756	0.2773	0.2790	0.2807	0.2823	0.2840	0.2857	0.2874	0.2890	0.2907
	cos	0.9613	0.9608	0.9603	0.9598	0.9593	0.9588	0.9583	0.9578	0.9573	0.9568
	tan	0.2867	0.2886	0.2905	0.2924	0.2943	0.2962	0.2981	0.3000	0.3019	0.3038
17	sin	0.2924	0.2940	0.2957	0.2974	0.2990	0.3007	0.3024	0.3040	0.3057	0.3074
	cos	0.9563	0.9558	0.9553	0.9548	0.9542	0.9537	0.9532	0.9527	0.9521	0.9516
	tan	0.3057	0.3076	0.3096	0.3115	0.3134	0.3153	0.3172	0.3191	0.3211	0.3230
18	sin	0.3090	0.3107	0.3123	0.3140	0.3156	0.3173	0.3190	0.3206	0.3223	0.3239
	cos	0.9511	0.9505	0.9500	0.9494	0.9489	0.9483	0.9478	0.9472	0.9466	0.9461
	tan	0.3249	0.3269	0.3288	0.3307	0.3327	0.3346	0.3365	0.3385	0.3404	0.3424
19	sin	0.3256	0.3272	0.3289	0.3305	0.3322	0.3338	0.3355	0.3371	0.3387	0.3404
	cos	0.9455	0.9449	0.9444	0.9438	0.9432	0.9426	0.9421	0.9415	0.9409	0.9403
	tan	0.3443	0.3463	0.3482	0.3502	0.3522	0.3541	0.3561	0.3581	0.3600	0.3620
20	sin	0.3420	0.3437	0.3453	0.3469	0.3486	0.3502	0.3518	0.3535	0.3551	0.3567
	cos	0.9397	0.9391	0.9385	0.9379	0.9373	0.9367	0.9361	0.9354	0.9348	0.9342
	tan	0.3640	0.3659	0.3679	0.3699	0.3719	0.3739	0.3759	0.3779	0.3799	0.3819
21	sin	0.3584	0.3600	0.3616	0.3633	0.3649	0.3665	0.3681	0.3697	0.3714	0.3730
	cos	0.9336	0.9330	0.9323	0.9317	0.9311	0.9304	0.9298	0.9291	0.9285	0.9278
	tan	0.3839	0.3859	0.3879	0.3899	0.3919	0.3939	0.3959	0.3979	0.4000	0.4020
22	sin	0.3746	0.3762	0.3778	0.3795	0.3811	0.3827	0.3843	0.3859	0.3875	0.3891
	cos	0.9272	0.9265	0.9259	0.9252	0.9245	0.9239	0.9232	0.9225	0.9219	0.9212
	tan	0.4040	0.4061	0.4081	0.4101	0.4122	0.4142	0.4163	0.4183	0.4204	0.4224
23	sin	0.3907	0.3923	0.3939	0.3955	0.3971	0.3987	0.4003	0.4019	0.4035	0.4051
	cos	0.9205	0.9198	0.9191	0.9184	0.9178	0.9171	0.9164	0.9157	0.9150	0.9143
	tan	0.4245	0.4265	0.4286	0.4307	0.4327	0.4348	0.4369	0.4390	0.4411	0.4431
24	sin	0.4067	0.4083	0.4099	0.4115	0.4131	0.4147	0.4163	0.4179	0.4195	0.4210
	cos	0.9135	0.9128	0.9121	0.9114	0.9107	0.9100	0.9092	0.9085	0.9078	0.9070
	tan	0.4452	0.4473	0.4494	0.4515	0.4536	0.4557	0.4578	0.4599	0.4621	0.4642
25	sin	0.4226	0.4242	0.4258	0.4274	0.4289	0.4305	0.4321	0.4337	0.4352	0.4368
	cos	0.9063	0.9056	0.9048	0.9041	0.9033	0.9026	0.9018	0.9011	0.9003	0.8996
	tan	0.4663	0.4684	0.4706	0.4727	0.4748	0.4770	0.4791	0.4813	0.4834	0.4856
26	sin	0.4384	0.4399	0.4415	0.4431	0.4446	0.4462	0.4478	0.4493	0.4509	0.4524
	cos	0.8988	0.8980	0.8973	0.8965	0.8957	0.8949	0.8942	0.8934	0.8926	0.8918
	tan	0.4877	0.4899	0.4921	0.4942	0.4964	0.4986	0.5008	0.5029	0.5051	0.5073
27	sin	0.4540	0.4555	0.4571	0.4586	0.4602	0.4617	0.4633	0.4648	0.4664	0.4679
	cos	0.8910	0.8902	0.8894	0.8886	0.8878	0.8870	0.8862	0.8854	0.8846	0.8838
	tan	0.5095	0.5117	0.5139	0.5161	0.5184	0.5206	0.5228	0.5250	0.5272	0.5295
28	sin	0.4695	0.4710	0.4726	0.4741	0.4756	0.4772	0.4787	0.4802	0.4818	0.4833
	cos	0.8829	0.8821	0.8813	0.8805	0.8796	0.8788	0.8780	0.8771	0.8763	0.8755
	tan	0.5317	0.5340	0.5362	0.5384	0.5407	0.5430	0.5452	0.5475	0.5498	0.5520
29	sin	0.4848	0.4863	0.4879	0.4894	0.4909	0.4924	0.4939	0.4955	0.4970	0.4985
	cos	0.8746	0.8738	0.8729	0.8721	0.8712	0.8704	0.8695	0.8686	0.8678	0.8669
	tan	0.5543	0.5566	0.5589	0.5612	0.5635	0.5658	0.5681	0.5704	0.5727	0.5750
Degs.	Function	0'	6'	12'	18'	24'	30'	36'	42'	48'	54'

Natural Sines, Cosines, and Tangents—(Continued)

30°-44.9°

Degs.	Function	0.0°	0.1°	0.2°	0.3°	0.4°	0.5°	0.6°	0.7°	0.8°	0.9°
30	sin	0.5000	0.5015	0.5030	0.5045	0.5060	0.5075	0.5090	0.5105	0.5120	0.5135
	cos	0.8660	0.8652	0.8643	0.8634	0.8625	0.8616	0.8607	0.8599	0.8590	0.8581
	tan	0.5774	0.5797	0.5820	0.5844	0.5867	0.5890	0.5914	0.5938	0.5961	0.5985
31	sin	0.5150	0.5165	0.5180	0.5195	0.5210	0.5225	0.5240	0.5255	0.5270	0.5284
	cos	0.8572	0.8563	0.8554	0.8545	0.8536	0.8526	0.8517	0.8508	0.8499	0.8490
	tan	0.6009	0.6032	0.6056	0.6080	0.6104	0.6128	0.6152	0.6176	0.6200	0.6224
32	sin	0.5299	0.5314	0.5329	0.5344	0.5358	0.5373	0.5388	0.5402	0.5417	0.5432
	cos	0.8480	0.8471	0.8462	0.8453	0.8443	0.8434	0.8425	0.8415	0.8406	0.8396
	tan	0.6249	0.6273	0.6297	0.6322	0.6346	0.6371	0.6395	0.6420	0.6445	0.6469
33	sin	0.5446	0.5461	0.5476	0.5490	0.5505	0.5519	0.5534	0.5548	0.5563	0.5577
	cos	0.8387	0.8377	0.8368	0.8358	0.8348	0.8339	0.8329	0.8320	0.8310	0.8300
	tan	0.6494	0.6519	0.6544	0.6569	0.6594	0.6619	0.6644	0.6669	0.6694	0.6720
34	sin	0.5592	0.5606	0.5621	0.5635	0.5650	0.5664	0.5678	0.5693	0.5707	0.5721
	cos	0.8290	0.8281	0.8271	0.8261	0.8251	0.8241	0.8231	0.8221	0.8211	0.8202
	tan	0.6745	0.6771	0.6796	0.6822	0.6847	0.6873	0.6899	0.6924	0.6950	0.6976
35	sin	0.5736	0.5750	0.5764	0.5779	0.5793	0.5807	0.5821	0.5835	0.5850	0.5864
	cos	0.8192	0.8181	0.8171	0.8161	0.8151	0.8141	0.8131	0.8121	0.8111	0.8100
	tan	0.7002	0.7028	0.7054	0.7080	0.7107	0.7133	0.7159	0.7186	0.7212	0.7239
36	sin	0.5878	0.5892	0.5906	0.5920	0.5934	0.5948	0.5962	0.5976	0.5990	0.6004
	cos	0.8090	0.8080	0.8070	0.8059	0.8049	0.8039	0.8028	0.8018	0.8007	0.7997
	tan	0.7265	0.7292	0.7319	0.7346	0.7373	0.7400	0.7427	0.7454	0.7481	0.7508
37	sin	0.6018	0.6032	0.6046	0.6060	0.6074	0.6088	0.6101	0.6115	0.6129	0.6143
	cos	0.7986	0.7976	0.7965	0.7955	0.7944	0.7934	0.7923	0.7912	0.7902	0.7891
	tan	0.7536	0.7563	0.7590	0.7618	0.7646	0.7673	0.7701	0.7729	0.7757	0.7785
38	sin	0.6157	0.6170	0.6184	0.6198	0.6211	0.6225	0.6239	0.6252	0.6266	0.6280
	cos	0.7880	0.7869	0.7859	0.7848	0.7837	0.7826	0.7815	0.7804	0.7793	0.7782
	tan	0.7813	0.7841	0.7869	0.7898	0.7926	0.7954	0.7983	0.8012	0.8040	0.8069
39	sin	0.6293	0.6307	0.6320	0.6334	0.6347	0.6361	0.6374	0.6388	0.6401	0.6414
	cos	0.7771	0.7760	0.7749	0.7738	0.7727	0.7716	0.7705	0.7694	0.7683	0.7672
	tan	0.8098	0.8127	0.8156	0.8185	0.8214	0.8243	0.8273	0.8302	0.8332	0.8361
40	sin	0.6428	0.6441	0.6455	0.6468	0.6481	0.6494	0.6508	0.6521	0.6534	0.6547
	cos	0.7660	0.7649	0.7638	0.7627	0.7615	0.7604	0.7593	0.7581	0.7570	0.7559
	tan	0.8391	0.8421	0.8451	0.8481	0.8511	0.8541	0.8571	0.8601	0.8632	0.8662
41	sin	0.6561	0.6574	0.6587	0.6600	0.6613	0.6626	0.6639	0.6652	0.6665	0.6678
	cos	0.7547	0.7536	0.7524	0.7513	0.7501	0.7490	0.7478	0.7466	0.7455	0.7443
	tan	0.8693	0.8724	0.8754	0.8785	0.8816	0.8847	0.8878	0.8910	0.8941	0.8972
42	sin	0.6691	0.6704	0.6717	0.6730	0.6743	0.6756	0.6769	0.6782	0.6794	0.6807
	cos	0.7431	0.7420	0.7408	0.7396	0.7385	0.7373	0.7361	0.7349	0.7337	0.7325
	tan	0.9004	0.9036	0.9067	0.9099	0.9131	0.9163	0.9195	0.9228	0.9260	0.9293
43	sin	0.6820	0.6833	0.6845	0.6858	0.6871	0.6884	0.6896	0.6909	0.6921	0.6934
	cos	0.7314	0.7302	0.7290	0.7278	0.7266	0.7254	0.7242	0.7230	0.7218	0.7206
	tan	0.9325	0.9358	0.9391	0.9424	0.9457	0.9490	0.9523	0.9556	0.9590	0.9623
44	sin	0.6947	0.6959	0.6972	0.6984	0.6997	0.7009	0.7022	0.7034	0.7046	0.7059
	cos	0.7193	0.7181	0.7169	0.7157	0.7145	0.7133	0.7121	0.7108	0.7096	0.7083
	tan	0.9657	0.9691	0.9725	0.9759	0.9793	0.9827	0.9861	0.9896	0.9930	0.9965
Degs.	Function	0'	6'	12'	18'	24'	30'	36'	42'	48'	54'

Natural Sines, Cosines, and Tangents—(Continued)

45°-59.9°

Degs.	Function	0.0°	0.1°	0.2°	0.3°	0.4°	0.5°	0.6°	0.7°	0.8°	0.9°
45	sin	0.7071	0.7083	0.7096	0.7108	0.7120	0.7133	0.7145	0.7157	0.7169	0.7181
	cos	0.7071	0.7059	0.7046	0.7034	0.7022	0.7009	0.6997	0.6984	0.6972	0.6959
	tan	1.0000	1.0035	1.0070	1.0105	1.0141	1.0176	1.0212	1.0247	1.0283	1.0319
46	sin	0.7193	0.7206	0.7218	0.7230	0.7242	0.7254	0.7266	0.7278	0.7290	0.7302
	cos	0.6947	0.6934	0.6921	0.6909	0.6896	0.6884	0.6871	0.6858	0.6845	0.6833
	tan	1.0355	1.0392	1.0428	1.0464	1.0501	1.0538	1.0575	1.0612	1.0649	1.0686
47	sin	0.7314	0.7325	0.7337	0.7349	0.7361	0.7373	0.7385	0.7396	0.7408	0.7420
	cos	0.6820	0.6807	0.6794	0.6782	0.6769	0.6756	0.6743	0.6730	0.6717	0.6704
	tan	1.0724	1.0761	1.0799	1.0837	1.0875	1.0913	1.0951	1.0990	1.1028	1.1067
48	sin	0.7431	0.7443	0.7455	0.7466	0.7478	0.7490	0.7501	0.7513	0.7524	0.7536
	cos	0.6691	0.6678	0.6665	0.6652	0.6639	0.6626	0.6613	0.6600	0.6587	0.6574
	tan	1.1106	1.1145	1.1184	1.1224	1.1263	1.1303	1.1343	1.1383	1.1423	1.1463
49	sin	0.7547	0.7559	0.7570	0.7581	0.7593	0.7604	0.7615	0.7627	0.7638	0.7649
	cos	0.6561	0.6547	0.6534	0.6521	0.6508	0.6494	0.6481	0.6468	0.6455	0.6441
	tan	1.1504	1.1544	1.1585	1.1626	1.1667	1.1708	1.1750	1.1792	1.1833	1.1875
50	sin	0.7660	0.7672	0.7683	0.7694	0.7705	0.7716	0.7727	0.7738	0.7749	0.7760
	cos	0.6428	0.6414	0.6401	0.6388	0.6374	0.6361	0.6347	0.6334	0.6320	0.6307
	tan	1.1918	1.1960	1.2002	1.2045	1.2088	1.2131	1.2174	1.2218	1.2261	1.2305
51	sin	0.7771	0.7782	0.7793	0.7804	0.7815	0.7826	0.7837	0.7848	0.7859	0.7869
	cos	0.6293	0.6280	0.6266	0.6252	0.6239	0.6225	0.6211	0.6198	0.6184	0.6170
	tan	1.2349	1.2393	1.2437	1.2482	1.2527	1.2572	1.2617	1.2662	1.2708	1.2753
52	sin	0.7880	0.7891	0.7902	0.7912	0.7923	0.7934	0.7944	0.7955	0.7965	0.7976
	cos	0.6157	0.6143	0.6129	0.6115	0.6101	0.6088	0.6074	0.6060	0.6046	0.6032
	tan	1.2799	1.2846	1.2892	1.2938	1.2985	1.3032	1.3079	1.3127	1.3175	1.3222
53	sin	0.7986	0.7997	0.8007	0.8018	0.8028	0.8039	0.8049	0.8059	0.8070	0.8080
	cos	0.6018	0.6004	0.5990	0.5976	0.5962	0.5948	0.5934	0.5920	0.5906	0.5892
	tan	1.3270	1.3319	1.3367	1.3416	1.3465	1.3514	1.3564	1.3613	1.3663	1.3713
54	sin	0.8090	0.8100	0.8111	0.8121	0.8131	0.8141	0.8151	0.8161	0.8171	0.8181
	cos	0.5878	0.5864	0.5850	0.5835	0.5821	0.5807	0.5793	0.5779	0.5764	0.5750
	tan	1.3764	1.3814	1.3865	1.3916	1.3968	1.4019	1.4071	1.4124	1.4176	1.4229
55	sin	0.8192	0.8202	0.8211	0.8221	0.8231	0.8241	0.8251	0.8261	0.8271	0.8281
	cos	0.5736	0.5721	0.5707	0.5693	0.5678	0.5664	0.5650	0.5635	0.5621	0.5606
	tan	1.4281	1.4335	1.4388	1.4442	1.4496	1.4550	1.4605	1.4659	1.4715	1.4770
56	sin	0.8290	0.8300	0.8310	0.8320	0.8329	0.8339	0.8348	0.8358	0.8368	0.8377
	cos	0.5592	0.5577	0.5563	0.5548	0.5534	0.5519	0.5505	0.5490	0.5476	0.5461
	tan	1.4826	1.4882	1.4938	1.4994	1.5051	1.5108	1.5166	1.5224	1.5282	1.5340
57	sin	0.8387	0.8396	0.8406	0.8415	0.8425	0.8434	0.8443	0.8453	0.8462	0.8471
	cos	0.5446	0.5432	0.5417	0.5402	0.5388	0.5373	0.5358	0.5344	0.5329	0.5314
	tan	1.5399	1.5458	1.5517	1.5577	1.5637	1.5697	1.5757	1.5818	1.5880	1.5941
58	sin	0.8480	0.8490	0.8499	0.8508	0.8517	0.8526	0.8536	0.8545	0.8554	0.8563
	cos	0.5299	0.5284	0.5270	0.5255	0.5240	0.5225	0.5210	0.5195	0.5180	0.5165
	tan	1.6003	1.6066	1.6128	1.6191	1.6255	1.6319	1.6383	1.6447	1.6512	1.6577
59	sin	0.8572	0.8581	0.8590	0.8599	0.8607	0.8616	0.8625	0.8634	0.8643	0.8652
	cos	0.5150	0.5135	0.5120	0.5105	0.5090	0.5075	0.5060	0.5045	0.5030	0.5015
	tan	1.6643	1.6709	1.6775	1.6842	1.6909	1.6977	1.7045	1.7113	1.7182	1.7251
Degs.	Function	0'	6'	12'	18'	24'	30'	36'	42'	48'	54'

Natural Sines, Cosines, and Tangents—(Continued)

60°-74.9°

Degs.	Function	0.0°	0.1°	0.2°	0.3°	0.4°	0.5°	0.6°	0.7°	0.8°	0.9°
60	sin	0.8660	0.8669	0.8678	0.8686	0.8695	0.8704	0.8712	0.8721	0.8729	0.8738
	cos	0.5000	0.4985	0.4970	0.4955	0.4939	0.4924	0.4909	0.4894	0.4879	0.4863
	tan	1.7321	1.7391	1.7461	1.7532	1.7603	1.7675	1.7747	1.7820	1.7893	1.7966
61	sin	0.8746	0.8755	0.8763	0.8771	0.8780	0.8788	0.8796	0.8805	0.8813	0.8821
	cos	0.4848	0.4833	0.4818	0.4802	0.4787	0.4772	0.4756	0.4741	0.4726	0.4710
	tan	1.8040	1.8115	1.8190	1.8265	1.8341	1.8418	1.8495	1.8572	1.8650	1.8728
62	sin	0.8829	0.8838	0.8846	0.8854	0.8862	0.8870	0.8878	0.8886	0.8894	0.8902
	cos	0.4695	0.4679	0.4664	0.4648	0.4633	0.4617	0.4602	0.4586	0.4571	0.4555
	tan	1.8807	1.8887	1.8967	1.9047	1.9128	1.9210	1.9292	1.9375	1.9458	1.9542
63	sin	0.8910	0.8918	0.8926	0.8934	0.8942	0.8949	0.8957	0.8965	0.8973	0.8980
	cos	0.4540	0.4524	0.4509	0.4493	0.4478	0.4462	0.4446	0.4431	0.4415	0.4399
	tan	1.9626	1.9711	1.9797	1.9883	1.9970	2.0057	2.0145	2.0233	2.0323	2.0413
64	sin	0.8988	0.8996	0.9003	0.9011	0.9018	0.9026	0.9033	0.9041	0.9048	0.9056
	cos	0.4384	0.4368	0.4352	0.4337	0.4321	0.4305	0.4289	0.4274	0.4258	0.4242
	tan	2.0503	2.0594	2.0686	2.0778	2.0872	2.0965	2.1060	2.1155	2.1251	2.1348
65	sin	0.9063	0.9070	0.9078	0.9085	0.9092	0.9100	0.9107	0.9114	0.9121	0.9128
	cos	0.4226	0.4210	0.4195	0.4179	0.4163	0.4147	0.4131	0.4115	0.4099	0.4083
	tan	2.1445	2.1543	2.1642	2.1742	2.1842	2.1943	2.2045	2.2148	2.2251	2.2355
66	sin	0.9135	0.9143	0.9150	0.9157	0.9164	0.9171	0.9178	0.9184	0.9191	0.9198
	cos	0.4067	0.4051	0.4035	0.4019	0.4003	0.3987	0.3971	0.3955	0.3939	0.3923
	tan	2.2460	2.2566	2.2673	2.2781	2.2889	2.2998	2.3109	2.3220	2.3332	2.3445
67	sin	0.9205	0.9212	0.9219	0.9225	0.9232	0.9239	0.9245	0.9252	0.9259	0.9265
	cos	0.3907	0.3891	0.3875	0.3859	0.3843	0.3827	0.3811	0.3795	0.3778	0.3762
	tan	2.3559	2.3673	2.3789	2.3906	2.4023	2.4142	2.4262	2.4383	2.4504	2.4627
68	sin	0.9272	0.9278	0.9285	0.9291	0.9298	0.9304	0.9311	0.9317	0.9323	0.9330
	cos	0.3746	0.3730	0.3714	0.3697	0.3681	0.3665	0.3649	0.3633	0.3616	0.3600
	tan	2.4751	2.4876	2.5002	2.5129	2.5257	2.5386	2.5517	2.5649	2.5782	2.5916
69	sin	0.9336	0.9342	0.9348	0.9354	0.9361	0.9367	0.9373	0.9379	0.9385	0.9391
	cos	0.3584	0.3567	0.3551	0.3535	0.3518	0.3502	0.3486	0.3469	0.3453	0.3437
	tan	2.6051	2.6187	2.6325	2.6464	2.6605	2.6746	2.6889	2.7034	2.7179	2.7326
70	sin	0.9397	0.9403	0.9409	0.9415	0.9421	0.9426	0.9432	0.9438	0.9444	0.9449
	cos	0.3420	0.3404	0.3387	0.3371	0.3355	0.3338	0.3322	0.3305	0.3289	0.3272
	tan	2.7475	2.7625	2.7776	2.7929	2.8083	2.8239	2.8397	2.8556	2.8716	2.8878
71	sin	0.9455	0.9461	0.9466	0.9472	0.9478	0.9483	0.9489	0.9494	0.9500	0.9505
	cos	0.3256	0.3239	0.3223	0.3206	0.3190	0.3173	0.3156	0.3140	0.3123	0.3107
	tan	2.9042	2.9208	2.9375	2.9544	2.9714	2.9887	3.0061	3.0237	3.0415	3.0595
72	sin	0.9511	0.9516	0.9521	0.9527	0.9532	0.9537	0.9542	0.9548	0.9553	0.9558
	cos	0.3090	0.3074	0.3057	0.3040	0.3024	0.3007	0.2990	0.2974	0.2957	0.2940
	tan	3.0777	3.0961	3.1146	3.1334	3.1524	3.1716	3.1910	3.2106	3.2305	3.2506
73	sin	0.9563	0.9568	0.9573	0.9578	0.9583	0.9588	0.9593	0.9598	0.9603	0.9608
	cos	0.2924	0.2907	0.2890	0.2874	0.2857	0.2840	0.2823	0.2807	0.2790	0.2773
	tan	3.2709	3.2914	3.3122	3.3332	3.3544	3.3759	3.3977	3.4197	3.4420	3.4646
74	sin	0.9613	0.9617	0.9622	0.9627	0.9632	0.9636	0.9641	0.9646	0.9650	0.9655
	cos	0.2756	0.2740	0.2723	0.2706	0.2689	0.2672	0.2656	0.2639	0.2622	0.2605
	tan	3.4874	3.5105	3.5339	3.5576	3.5816	3.6059	3.6305	3.6554	3.6806	3.7062
Degs.	Function	0'	6'	12'	18'	24'	30'	36'	42'	48'	54'

Natural Sines, Cosines, and Tangents—(Continued)

75°-89.9°

Degs.	Function	0.0°	0.1°	0.2°	0.3°	0.4°	0.5°	0.6°	0.7°	0.8°	0.9°
75	sin	0.9659	0.9664	0.9668	0.9673	0.9677	0.9681	0.9686	0.9690	0.9694	0.9699
	cos	0.2588	0.2571	0.2554	0.2538	0.2521	0.2504	0.2487	0.2470	0.2453	0.2436
	tan	3.7321	3.7583	3.7848	3.8118	3.8391	3.8667	3.8947	3.9232	3.9520	3.9812
76	sin	0.9703	0.9707	0.9711	0.9715	0.9720	0.9724	0.9728	0.9732	0.9736	0.9740
	cos	0.2419	0.2402	0.2385	0.2368	0.2351	0.2334	0.2317	0.2300	0.2284	0.2267
	tan	4.0108	4.0408	4.0713	4.1022	4.1335	4.1653	4.1976	4.2303	4.2635	4.2972
77	sin	0.9744	0.9748	0.9751	0.9755	0.9759	0.9763	0.9767	0.9770	0.9774	0.9778
	cos	0.2250	0.2232	0.2215	0.2198	0.2181	0.2164	0.2147	0.2130	0.2113	0.2096
	tan	4.3315	4.3662	4.4015	4.4374	4.4737	4.5107	4.5483	4.5864	4.6252	4.6646
78	sin	0.9781	0.9785	0.9789	0.9792	0.9796	0.9799	0.9803	0.9806	0.9810	0.9813
	cos	0.2079	0.2062	0.2045	0.2028	0.2011	0.1994	0.1977	0.1959	0.1942	0.1925
	tan	4.7046	4.7453	4.7867	4.8288	4.8716	4.9152	4.9594	5.0045	5.0504	5.0970
79	sin	0.9816	0.9820	0.9823	0.9826	0.9829	0.9833	0.9836	0.9839	0.9842	0.9845
	cos	0.1908	0.1891	0.1874	0.1857	0.1840	0.1822	0.1805	0.1788	0.1771	0.1754
	tan	5.1446	5.1929	5.2422	5.2924	5.3435	5.3955	5.4486	5.5026	5.5578	5.6140
80	sin	0.9848	0.9851	0.9854	0.9857	0.9860	0.9863	0.9866	0.9869	0.9871	0.9874
	cos	0.1736	0.1719	0.1702	0.1685	0.1668	0.1650	0.1633	0.1616	0.1599	0.1582
	tan	5.6713	5.7297	5.7894	5.8502	5.9124	5.9758	6.0405	6.1066	6.1742	6.2432
81	sin	0.9877	0.9880	0.9882	0.9885	0.9888	0.9890	0.9893	0.9895	0.9898	0.9900
	cos	0.1564	0.1547	0.1530	0.1513	0.1495	0.1478	0.1461	0.1444	0.1426	0.1409
	tan	6.3138	6.3859	6.4596	6.5350	6.6122	6.6912	6.7720	6.8548	6.9395	7.0264
82	sin	0.9903	0.9905	0.9907	0.9910	0.9912	0.9914	0.9917	0.9919	0.9921	0.9923
	cos	0.1392	0.1374	0.1357	0.1340	0.1323	0.1305	0.1288	0.1271	0.1253	0.1236
	tan	7.1154	7.2066	7.3002	7.3962	7.4947	7.5958	7.6996	7.8062	7.9158	8.0285
83	sin	0.9925	0.9928	0.9930	0.9932	0.9934	0.9936	0.9938	0.9940	0.9942	0.9943
	cos	0.1219	0.1201	0.1184	0.1167	0.1149	0.1132	0.1115	0.1097	0.1080	0.1063
	tan	8.1443	8.2636	8.3863	8.5126	8.6427	8.7769	8.9152	9.0579	9.2052	9.3572
84	sin	0.9945	0.9947	0.9949	0.9951	0.9952	0.9954	0.9956	0.9957	0.9959	0.9960
	cos	0.1045	0.1028	0.1011	0.0993	0.0976	0.0958	0.0941	0.0924	0.0906	0.0889
	tan	9.5144	9.6768	9.8448	10.02	10.20	10.39	10.58	10.78	10.99	11.20
85	sin	0.9962	0.9963	0.9965	0.9966	0.9968	0.9969	0.9971	0.9972	0.9973	0.9974
	cos	0.0872	0.0854	0.0837	0.0819	0.0802	0.0785	0.0767	0.0750	0.0732	0.0715
	tan	11.43	11.66	11.91	12.16	12.43	12.71	13.00	13.30	13.62	13.95
86	sin	0.9976	0.9977	0.9978	0.9979	0.9980	0.9981	0.9982	0.9983	0.9984	0.9985
	cos	0.0698	0.0680	0.0663	0.0645	0.0628	0.0610	0.0593	0.0576	0.0558	0.0541
	tan	14.30	14.67	15.06	15.46	15.89	16.35	16.83	17.34	17.89	18.46
87	sin	0.9986	0.9987	0.9988	0.9989	0.9990	0.9990	0.9991	0.9992	0.9993	0.9993
	cos	0.0523	0.0506	0.0488	0.0471	0.0454	0.0436	0.0419	0.0401	0.0384	0.0366
	tan	19.08	19.74	20.45	21.20	22.02	22.90	23.86	24.90	26.03	27.27
88	sin	0.9994	0.9995	0.9995	0.9996	0.9996	0.9997	0.9997	0.9997	0.9998	0.9998
	cos	0.0349	0.0332	0.0314	0.0297	0.0279	0.0262	0.0244	0.0227	0.0209	0.0192
	tan	28.64	30.14	31.82	33.69	35.80	38.19	40.92	44.07	47.74	52.08
89	sin	0.9998	0.9999	0.9999	0.9999	0.9999	1.000	1.000	1.000	1.000	1.000
	cos	0.0175	0.0157	0.0140	0.0122	0.0105	0.0087	0.0070	0.0052	0.0035	0.0017
	tan	57.29	63.66	71.62	81.85	95.49	114.6	143.2	191.0	286.5	573.0
Degs.	Function	0'	6'	12'	18'	24'	30'	36'	42'	48'	54'

THE ALLIED ELECTRONICS LIBRARY

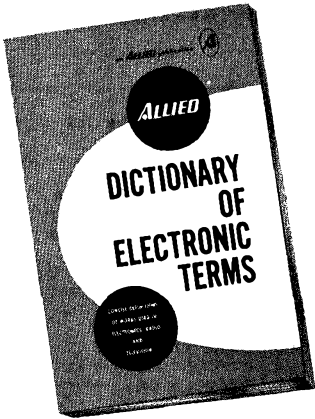

DICTIONARY OF ELECTRONIC TERMS

Up-to-date, clear, concise definitions of more than 3800 electronic terms encountered in general and professional usage. Edited by Robert E Beam, Ph.D., Professor of Electrical Engineering, Northwestern University. Includes over 125 illustrations and diagrams. Appendix covers the EIA color code, standard schematic symbols, and abbreviations and letter symbols. Includes information on getting started in Amateur radio and a special section with definitions of terms used in Citizens Band Radio. Makes an ideal reference for servicemen, hobbyists, Amateurs, CB'ers, technicians—everyone in the field of electronics. Solves the spelling problems of secretaries and typists working for electronics firms. 88 pages. Size, 6x9".

37 K 756. Postpaid in U.S.A. 75c

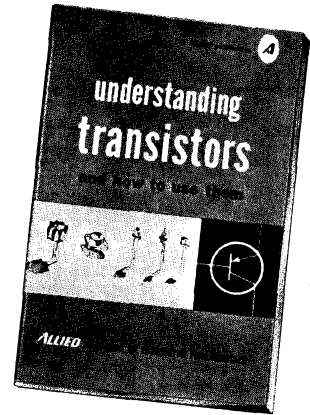

UNDERSTANDING TRANSISTORS And How To Use Them

A clearly written presentation on transistor applications, characteristics, and construction. Ideal for home study, classroom use, beginners, hobbyists, experimenters, etc. Unexcelled for supplementing a course in electronics, whether the student's interest is primarily in transistors, or electronics in general. Covers NPN, PNP, alloy-junction, drift, tetrode, surface barrier, power types, etc. Contains transistor symbols, diagrams of various amplifier circuits, etc. Includes interesting construction projects using transistors for useful and "fun" devices around the home. Circuit theory as related to transistor operation is discussed in simple terms. 96 pages. Size, 5 1/2 x 8 1/2".

37 K 602. Postpaid in U.S.A. 50c

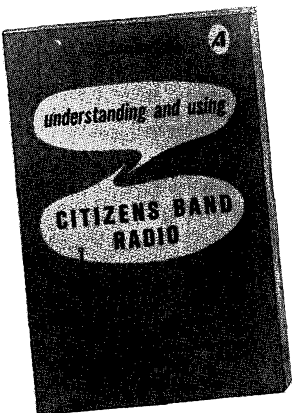

UNDERSTANDING AND USING CITIZENS BAND RADIO

A useful and interesting book for both Citizens Band newcomers and oldtimers. Clearly written, practical, informative and complete. Chapter headings: Getting Acquainted With CB Radio, Obtaining the License, About the Equipment, Setting Up A Station (Mobile and Base Station Installations), CB Antennas, Operating CB Equipment, The Uses and Abuses of CB Radio. Discusses test equipment for CB servicing and gives helpful servicing hints. Gives valuable advice on operating procedure and using the "10" signals, listed in the appendix. Helps anyone to understand, select and make best use of Citizens Band equipment. Prepared and edited by experts. Another Allied book value worth several times the price. 112 pages. Size, 5 1/2 x 8 1/2".

37 K 701. Postpaid in U.S.A. 50c

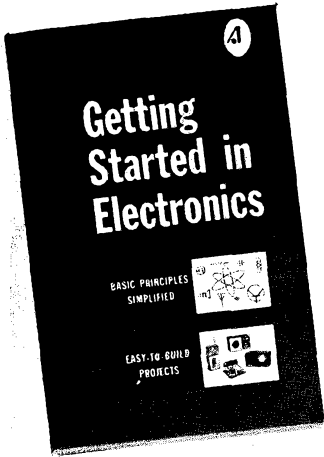

**GETTING STARTED
IN ELECTRONICS**

Easy to read and understand. Covers radio signals and types of transmission—AM, FM, TV, CW and short wave. Clearly explains uses of basic components, electron theory, resistance, magnetism, capacitance, inductance, reactance and the stages of radio and their functions. Discusses antenna installations and test equipment. Tells how to read schematic diagrams. Section on construction hints is followed by interesting building projects including a crystal set, walkie-talkie, 1-tube set, transistor set, intercom, burglar alarm, light detector, code practice oscillator, and 5-tube superhet receiver. Many illustrations. Excellent for beginners, and for classroom and home study courses. 112 pages, 5 1/2 x 8 1/2". Quantity prices on request.

37 K 705. Postpaid in U.S.A. 50c

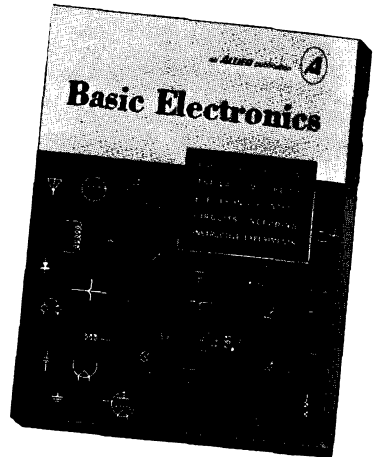

**BASIC ELECTRONICS
HANDBOOK**

Written for beginners without any previous electronics experience. A step-by-step guide to the principles involved in electronic communications and control circuits. Discusses the vacuum tube, rectifiers and power supplies, amplifiers, detectors and radio receivers, oscillators, superhet and electronic control circuits. Includes six fascinating experiments based on the Knight-Kit 12-in-1 Electronic Lab Kit. Numerous diagrams in each chapter for faster, easier learning. Prepared with the classroom in mind, it is ideal for use in elementary courses in science, physics, radio, electricity and industrial arts. Stimulates continued student interest in electronics. Schools are invited to write for quantity prices. 24 pages. Size, 8 1/2 x 11".

37 K 060. Postpaid in U.S.A. 25c

**ALL ABOUT HIGH FIDELITY
AND STEREO**

New, authoritative, easy-to-read explanation of high fidelity and stereo. Prepared by audio experts under direction of Allied's technical staff to help you understand, select and enjoy your music system. Explains high fidelity and monophonic and stereo sound; covers amplifiers, preamplifiers, tuners, speaker systems and enclosures, record players, tone arms, cartridges and needles; tells about monophonic and stereo program sources—records, tape, broadcasts; discusses tape recorders, kits, use of transistors in hi-fi products; includes valuable data on planning a "built-in" system. Discusses merits of components versus package units. Glossary gives clear definitions of hi-fi terms. Many charts and illustrations. Written in non-technical language. 96 pages. Size, 5 1/2 x 8 1/2".

37 K 699. Postpaid in U.S.A. 50c

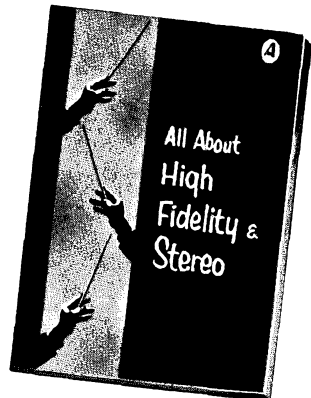

INDEX

Abbreviations	23, 75	Ohm's Law	28-29
Admittance	17	Open-Air Transmission Lines	20
Algebraic Formulas	5	Peak Current	22
Algebraic Symbols	4	Peak Volts	22
Attenuator Networks	7-9	Phase Angle	28
Average Current	22	Pilot Lamp Data	66-67
Average Volts	22	Power Factor	28
Capacitance	12, 20, 33-36, 68-71	"Q" Factor	14
Capacitors	12, 68-71	Quadratic Equations	5
Coefficient of Coupling	13	R-F Coils	30, 32-33
Coils	30, 32-33	R.M.S. Current	22
Concentric Transmission Lines	20	R.M.S. Volts	22
Conductance	17	Radicals and Exponents	5
Constants	4, 12, 22	Radio Color Codes	68-74
Conversion Chart	37	Reactance	13, 33-36
Coulombs	12	Resistance	12, 26, 28-29
Coupled Inductance	12	Resistor, Capacitor Color Codes	68-71
Coupling Coefficient	13	Resistors	68
Decay of E & I in LCR Circuits	18-19	Resonance	13, 33-36
Decibels	5-6	Schematic Symbols	76-77
Diagram Symbols	76-77	Self-Inductance	12
Dielectric Constants	12	Shunts	26-27
Exponents and Radicals	5	Solution of a Quadratic	5
Fractional Inches	4	Speaker Matching—70 Volt System	11
Frequency	13, 20, 33-36	Steady State I and E	19
Greek Alphabet Designations	65	Susceptance	17
Growth of E & I in LCR Circuits	18-19	Symbols	23, 75-77
Impedance	14-16, 20	Transient I and E	18-19
Inches to Millimeters	4	Transistor Circuits	24-25
Inductance	12, 13, 30, 32-36	Transistor Formulas	23
Interchangeable Tubes	41-65	Transistor Symbols	23
Log Tables	78-79	Transmission Lines	20
Logarithms—How to Use	38-40	Trigonometric Formulas	21
Mathematical Constants	4	Trigonometric Functions	21
Mathematical Symbols	4	Trigonometric Tables	80-85
Meter Formulas	26-27	Vacuum Tube Constants	22
Metric Relationships	37	Vacuum Tube Formulas	22
Millimeters to Inches	4	Vacuum Tube Symbols	22
Mixers	9	Vertical Antenna, Capacitance	20
Multipliers	26-27	Wavelength	13, 20
Minimum Loss Pads	10	Wire Tables	30-31
Mutual Inductance	13		