

1972 EDITION \$1.00

# RADIO TV REPAIR

**SAVE OVER \$100 THIS YEAR**  
WITH THIS HANDY HOME SERVICEMAN'S GUIDE

- Fix TVs—Color, Black-and-White, Even Toughie Portables
- Debug Those CB Walkie-Talkies
- Get the Lowdown on TV Towers and 'Tennas
- Discover Proven Ways to Soup-Up Receivers
- Plus More on Tape Machines, Cartridge Players, Phonos, etc.!

Another  
**Science &  
Mechanics**  
Do-It-Yourself  
Guide!

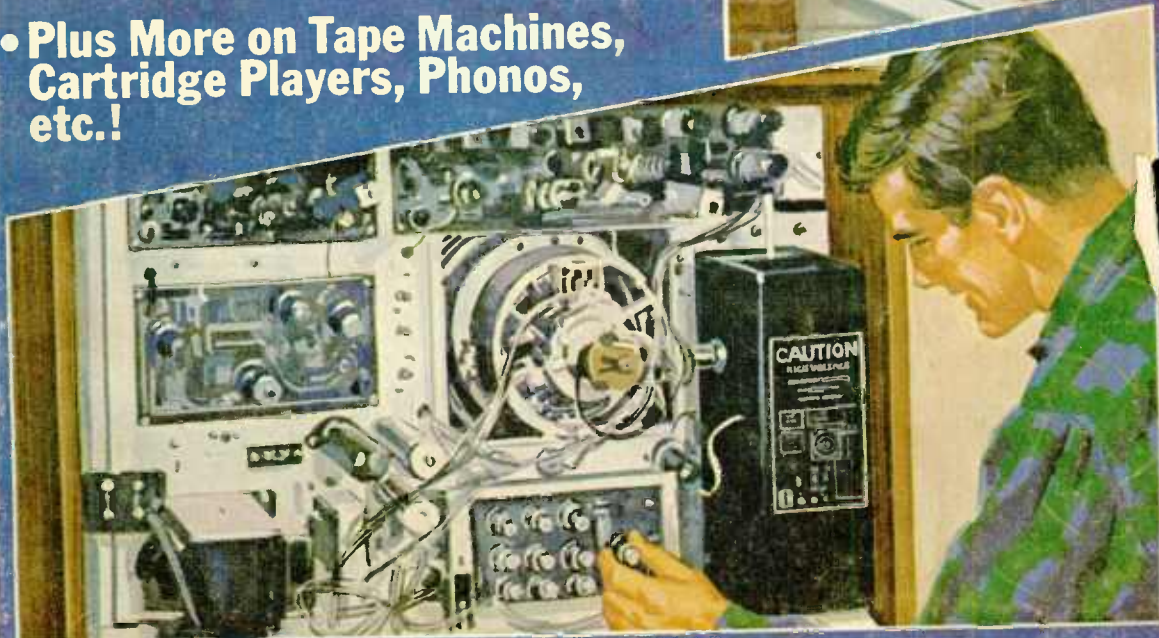

# Discover the ease and excitement of learning Electronics with programmed equipment NRI sends you

When you train at home with NRI, you train with your hands as well as your head. You learn the WHY of Electronics, Communications, TV-Radio the NRI pioneering "3-Dimensional" way. NRI training is the result of more than half a century of simplifying, organizing, dramatizing subject matter, and providing personal services unique for a home study school. You get the kind of technical training that gives you priceless confidence as you gain experience equal to many, many months of training on the job.

*NRI—The 53 Year Leader in Electronics Training*



## APPROVED UNDER NEW GI BILL

If you served since January 31, 1955, or are in service, check GI line in postage-free card.



*Earn \$5 or more an hour  
spare or full time in*

## **TV-RADIO SERVICING**

Color Television has arrived. Sales are soaring, along with the continuing popularity of other home entertainment equipment like portable radios, tape recorders, hi-fi sets, phonographs and auto radios. TV-Radio servicing is one of your best routes to spare-time earnings, a good paying job or a business of your own. NRI not only trains you quickly and expertly, but also shows you how to get started in Servicing soon after you enroll, earning as you learn. NRI trains you in today's methods of installing and repairing all Electronic equipment for the home—including booming Color TV. You even build, experiment with and keep to enjoy your own solid-state radio and your choice of black-and-white or Color TV receiver. Like thousands of others, you can be earning \$5 or more an hour extra in spare time starting soon.

## *There's money and success awaiting you in* **BROADCASTING— COMMUNICATIONS**

The experience you gain from intensely practical NRI training in Complete Communications equals as much as two years of training on the job. With NRI, you can train for a choice of careers ranging from mobile, marine and aviation radio to TV broadcasting and space communications. You learn how to install, maintain and operate today's remarkable transmitting and receiving equipment by actually *doing* it. You build and experiment with test equipment, like a VTVM you keep. You build and operate amplifier circuits, transmission line and antenna systems, even build and use a phone-cw transmitter suitable for transmission on the 80-meter amateur band. Whichever of five NRI Communications courses you choose, you prepare for your FCC License exams, and you must pass your FCC exams or NRI refunds your tuition in full.

## *Move ahead in America's fast growing industry as* **ELECTRONICS TECHNICIAN**

Electronics touches everyone's lives. This vast field of opportunity is open to you with NRI training. Industrial/Military Electronics training—like all NRI courses—prepares you quickly, thoroughly the practical "hands on" way. You build with, and learn to understand the functions of, today's miracle solid-state components like printed circuits, diodes and transistors. You build and experiment with Electronic circuitry used in automation, data processing, ultrasonics, telemetry. Whatever your interest in Electronics, NRI training can fill your needs. Prove to yourself what nearly a million NRI students could tell you . . . that you get more for your money from NRI. Check the postage-free card and mail it today for your FREE NRI Color Catalog. No salesman will call. NATIONAL RADIO INSTITUTE, Electronics Division, Washington, D.C. 20016.

**YOU GET MORE FOR YOUR MONEY FROM NRI** — Build, test, explore, discover. Everything you see here is included in one NRI course—including Color TV. Other courses equally complete. And you'll be surprised at the low tuition costs. Text for text, kit for kit, dollar for dollar—you get more for your money from NRI.

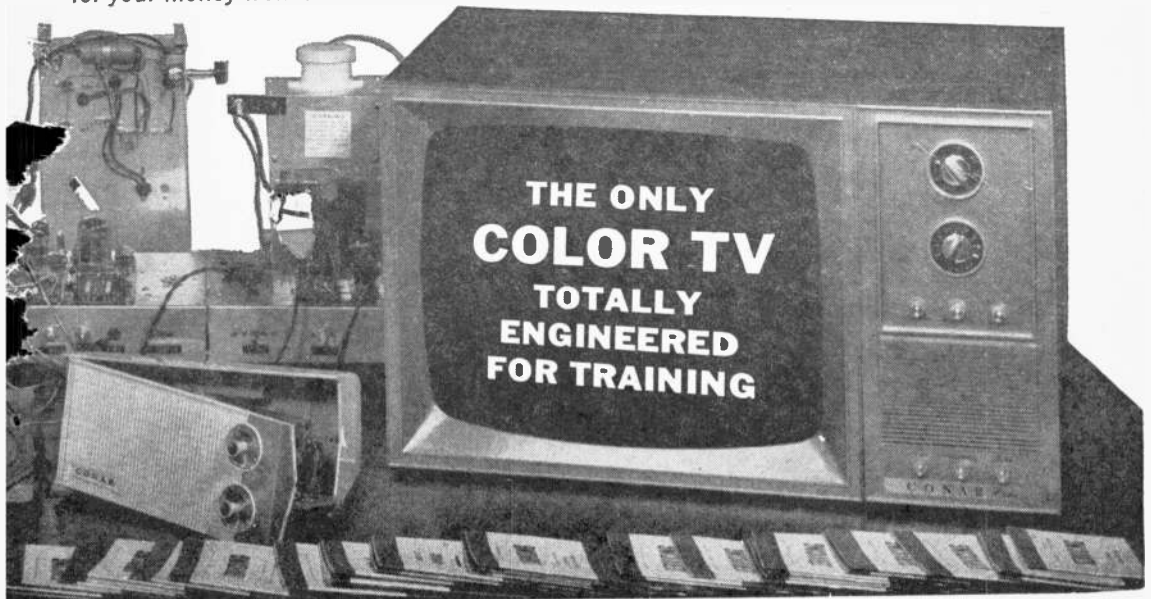

# RADIO TV REPAIR

1972

EDITION

## CONTENTS

- 11 *Second TV Cure—All***  
Just match the pic with the problem and bye-bye tough dog
- 17 *When Color Won't Stay Put***  
Sync in with true color like the professionals do
- 23 *Let's Tackle that Tatable TV***  
Keep that portable off the workbench and on the patio
- 31 *9th Life for a Kiddie Phono***  
Even those cheapie record players can be fixed quickly
- 34 *8 Steps to Car Tape Player Repair***  
Get back on the road with auto audio the easy way
- 38 *Your TV Set Will Get You if You Don't Watch Out***  
Pleasure may be peril if you play with your TV set
- 40 *Those Minor Tape Troubles***  
Why lose audio because preventative maintenance is not performed
- 43 *Get Your CB Signals All Put Out***  
CB is fun when everything works—otherwise, it's hell
- 48 *11 Steps to Walkie-Talkie Repair***  
You can fix it most of the time before you take the 12th step
- 51 *Superheterodyne***  
You can't fix your radio unless you know how it works
- 57 *Tuning up the All American 5***  
A few twists and turns of chassis controls and AM comes in great
- 63 *No Buck Semiconductor Tester***  
Use your VOM to test solid-state devices quickly
- 69 *Erecting a Rooftop Tower***  
Get your TV antenna, or any antenna, up high in the soup
- 74 *Discovering Prefixes and Exponents***  
A little bit on the technical lingo of shop talk
- 83 *Ten Timely Tips for Resistance Measurements***  
That Ohmmeter is useless unless you put it to good use

## DEPARTMENTS

- 6 *Service Shop Tips***
- 7 *Reader Service Page—No. 1***
- 9 *Literature Library***
- 10 *Something for Everyone—New Products***
- 95 *Classified Ads***
- 96 *Reader Service Page—No. 2***

# Update your Radio/TV skills with these aids

Completely up-to-date, written by experts and easy to follow . . . they are "best sellers" to radio/TV technicians and amateurs alike.

## COLOR-TV FIELD-SERVICE GUIDES

Invaluable for servicing Color-TV in the customer's home. Each volume contains 80 diagrams covering over 3,000 chassis . . . sensibly organized with detailed chassis layout charts on one page and specific adjustment procedures on opposite page. Indexed for instant reference.

Vol. 1 No. 20796—\$4.95  
Vol. 2 No. 20807—\$4.95  
Vol. 3 No. 20847—\$4.95



## TRANSISTOR AUDIO AMPLIFIERS

By Jack Darr

Gives you a good, working knowledge of transistor circuits found in audio equipment of all sizes. Shows how the circuits work normally, what changes take place when trouble occurs, and how to service the solid-state equipment. An invaluable guide for all who service transistor circuits. No. 20838—\$5.50



## 1-2-3-4 SERVICING TRANSISTOR COLOR TV

By Forest H. Belt and Associates

Details the simple 1-2-3-4 servicing method and steps that get transistor Color-TV sets fixed easily and right every time. No. 20777—\$4.95



## 1-2-3-4 SERVICING AUTOMOBILE STEREO

By Forest H. Belt & Associates

Explains the simple 1-2-3-4 servicing method, shows how easy it is to apply the method to automobile stereo, fm multiplex, and tape cartridge systems. Clear, easy-to-read illustrations, charts and schematics to make servicing easy. No. 20737—\$3.95



## STUDY GUIDE FOR CET EXAMINATIONS

By J. A. Wilson, CET and Dick Glass, CET

A comprehensive review of the material covered by the CET (Certified Electronics Technician) examination. It's almost a "must" for gaining a CET designation, for passing a state or local licensing exam, or as a "brush-up" in applying for a position in the electronics field. Includes question-and-answer sections and a 50-question test in each chapter. No. 20834—\$5.95



## UNDERSTANDING OSCILLATORS

By Irving M. Gottlieb

What you want to know about oscillators . . . how they work, their many personalities and variations, strong and weak points, how they are used in practical applications, how to service them. A most useful text for engineers and technicians. No. 20837—\$4.50



## 99 ELECTRONIC PROJECTS

By Herbert Friedman

An intriguing, easy-to-follow book for hobbyists as well as those experienced in electronics. Covers sixteen groups of projects, including audio, photography, automotive, remote controls, lamp and motor control circuits, etc., many of which can be built inexpensively. No. 20818—\$3.50



## 101 QUESTIONS AND ANSWERS ABOUT CB ANTENNAS

By Jim Ashe

Best overall guide to the selection and installation of the proper antenna for your Citizens band radio. An ideal guide for beginners, it also answers questions about how to improve performance and range of already operating equipment and to repair and maintain CB antennas. No. 20745—\$2.95



## CITIZENS BAND RADIO HANDBOOK, 4th Edition

By David E. Hicks

Now that two-way radio is available to any citizen, this revised edition answers the many problems and questions of all who use, or plan to use, CB equipment. Covers how to obtain a CB license, operating procedures, equipment, accessories, circuit analysis, servicing data, trouble-shooting hints, etc. No. 20839—\$4.95



## SECOND-CLASS RADIOTELEPHONE LICENSE HANDBOOK, 4th Edition

By Edward M. Noll

Information needed to pass the 2nd class FCC radiotelephone exam. Questions and answers are based on the FCC exam for Elements I, II and III. Also covers communications theory and practices, solid-state two-way equipment, FCC Rules and Regulations, operating practices and procedures, reference data, etc. No. 20824—\$6.50



You'll find everything you want to know about Radio or TV in the modern Sams Technical Library. Send for our free catalog.



HOWARD W. SAMS & CO., INC.



HOWARD W. SAMS & CO., INC.

Order from your Electronics Parts Distributor, or mail to Howard W. Sams & Co., Inc., Dept. RR022 4300 West 62nd Street, Indianapolis, Indiana 46268

Send books checked at right, \$\_\_\_\_\_ enclosed.

Please include sales tax where applicable.

Send FREE 1971 Sams Book Catalog.

Name \_\_\_\_\_

(Please Print)

Address \_\_\_\_\_

City \_\_\_\_\_ State \_\_\_\_\_ Zip \_\_\_\_\_

20796  20834

20807  20837

20847  20818

20838  20749

20777  20839

20737  20824

CIRCLE NO. 1 ON PAGE 7 OR 96

# International Catalog

free!



**IGM**  
INTERNATIONAL CATALOG

your electronics buying guide for precision made radio crystals and electronic equipment

## International Crystal Mfg. Co., Inc.

10 North Lee, Oklahoma City, Oklahoma 73102

NAME \_\_\_\_\_ PLEASE PRINT

ADDRESS \_\_\_\_\_

CITY \_\_\_\_\_ STATE \_\_\_\_\_ ZIP \_\_\_\_\_

CIRCLE NO. 2 ON PAGE 7 OR 96

## THOUSANDS OF BARGAINS TOP VALUES IN ELECTRONIC PARTS

Transistors, Modules, C. B., Speaker, Stereo, Hi-Fi, Photo Cells and Thousands of Other Electronic Parts.  
Send for FREE Catalogue

### ELECTRONIC DISTRIBUTORS INC.



**EDI**  
Dept. TA-2, 4900 Elston  
Chicago, Ill. 60630  
 RUSH CATALOGUE  
Name.....  
Address.....  
City.....  
State..... Zip Code.....

CIRCLE NO. 3 ON PAGE 7 OR 96

## PARTS! CORNELL TUBES!

FREE Send For FREE  
CORNELL'S  
New Color  
Catalog  
48 Pgs. New Items  
**33¢** per tube  
IN LOTS OF 100  
**36¢** per tube  
ORDER FREE  
IF NOT SHIPPED  
IN 24 HOURS!

4219 E UNIVERSITY AVE. SAN DIEGO, CALIF. 92105

CIRCLE NO. 4 ON PAGE 7 OR 96

19

# RADIO TV REPAIR

72

*Editor-in-Chief*

**JULIAN S. MARTIN, WA2CQL**

*Technical Editor*

**STEPHEN B. GRAY**

*Repair Editor*

**PETER L. DEXNIS, WA3LOQ**

*News Editor*

**CAROL J. BRUCKNER**

*Citizens Band Editor*

**KATHI MARTIN, KA1Ø614**

*Workbench Editor*

**HANK SCOTT**

*Art Director*

**JIM MEDLER**

*Cover Art Director*

**IRVING BERNSTEIN**

*Assistant Art Director*

**ANDY STEIGMEIER**

*Advertising Director*

**DAVID J. MILLER**

*Production Director*

**CARL BARTEE**

*Production Manager*

**GERTRUD BORCHARDT**

*Assistant Production Manager*

**MARILYN VARGAS**

*Newsstand Circulation Manager*

**DON GABREE**

*Instructions Division Manager*

**WILFRED M. BROWN**

*Chairman of the Board*

**B. G. DAVIS**

*President and Publisher*

**JOEL DAVIS**

*Vice-President and General Manager*

**LEONARD F. PINTO**

*Vice-President and Treasurer*

**VICTOR C. STABLE, KBPØ681**

RADIO-TV REPAIR is published annually by Davis Publications, Inc. Editorial, business offices: 229 Park Ave. South, New York, N.Y. 10003. Advertising offices: New York: 229 Park Ave. South, 212-673-1300; Chicago: 520 N. Michigan Ave., 312-527-0330; Los Angeles: J. E. Publishers Rep. Co., 8380 Melrose Ave., 213-653-5841; Long Island: Len Osten, 9 Garden Street, Great Neck, N.Y. 516-487-3305; Southwestern advertising representative: Jim Wright, 4 N. Eighth St., St. Louis, 314-241-1965.

EDITORIAL CONTRIBUTIONS must be accompanied by return postage and will be handled with reasonable care; however, publisher assumes no responsibility for return or safety of manuscripts, art work, or photographs. Contributions should be addressed to the Editor, RADIO-TV REPAIR, 229 Park Ave. South, New York, New York 10003.

Copyright 1972 by Davis Publications, Inc.

RADIO-TV REPAIR

# Why over-pay as much as \$1000 for a new car?

Now \$1.50 gives you the bargaining muscle to get the car you want at the lowest price

160-plus full y-indexed pages by make and model of car • Thousands of listings • Prices for all domestic cars including American Motors, Chrysler, Ford, GM, GMC, International, Jeep • All models and accessories prices • Prices on light trucks.

## Join thousands of smarter car buyers

More than a car-buying guide! More than a price-comparison listing. You get the easy-to-use, reliable, accurate dollars-and-cents figures that put you on even terms with professional auto-sales people who seek profits as avidly as you seek savings—on one of the biggest single dollar investments you make! Car/Puter's AUTO-FAX is an indispensable working tool for insurance companies settling claims, for banks in financing loans, for car dealers and salesmen in "cutting" from list prices. AND FOR YOU, THE CONSUMER, WHO AT LAST HAS THE FIGURES TO SAVE HUNDREDS & HUNDREDS OF DOLLARS ON ANY NEW CAR PURCHASE!

Dealers will take a small profit over their cost, rather than lose a sale—if it's offered to them! And this is where AUTO-FAX gives you real bargaining power!

With this truly valuable price-facts book, in seconds you flip to the new car you want... you check the dealer's cost... and you MAKE YOUR OFFER RIGHT THERE ON THE SPOT! Today, thousands have already saved unbelievable sums of money—this simple, no-begging way. BEFORE YOU BUY ANY NEW CAR, get your copy of AUTO-FAX.

Simply fill in and mail the coupon below with \$1.50 (cash payment only) and the newest issue of AUTO-FAX will be sent to you immediately. Or if you prefer a subscription, send \$7.50 cash for all 5 editions shown in the coupon.

If you're buying or selling a USED CAR, get the complete listing of all American make cars (and light trucks) for the past 7 years. There are two AUTO-FAX used car editions—Spring and Fall—complete with wholesale and retail prices. Only \$1.50 each.

## AUTO-FAX

REVISED NEW 1972 CAR PRICES

INCLUDES LATEST GOVERNMENT APPROVED PRICE INCREASE

- WHOLESALE
- RETAIL
- CARS
- LIGHT TRUCKS
- ACCESSORIES

BONUS OFFER  
ANY NEW CAR FOR ONLY \$125 OVER DEALER'S COST

THIS ISSUE the latest Government approved price-hike

Fill in and mail this coupon today! do it now... limited copies!

- WHAT DEALERS ACTUALLY PAY FOR CARS
- HOW MUCH DEALERS MARK UP THEIR COST ON THOSE "SPECIAL DEALS" YOU'RE OFFERED
- EXACT COST OF OPTIONS AND ACCESSORIES
- CHARGES THAT CAR DEALERS CAN ADD ... and lots more useful information.

### SPECIAL BONUS FOR AUTO-FAX READERS!

How to get a brand new car for only \$125 over dealer's cost!

New 48-hour computerized service helps you make the best deal with any dealer, on your own—or you can arrange purchase through UAB for a car delivered to you for a flat \$125 over cost... GUARANTEED!

HOW? Through the United Auto Brokers' Car/Puter organization, participating with 400 automobile dealers across the country. Your purchase price includes freight, federal excise tax, and pre-delivery service. No service fees, hidden charges or gimmicks!

Take delivery from a local dealer without delay and red tape. A brand new car of your choice with every option you selected. THE SAME NEW CAR WARRANTY AND SERVICE as if you had paid full list price... the same financing and terms as if you had dealt with the dealer directly.

You'll find complete information in your copy of Car/Puter's AUTO-FAX. Send for your copy now!

You'll find a BONUS COUPON in your copy of AUTO-FAX. It entitles you to a 20% discount off the Car/Puter computerized service described above. (The money you save with your BONUS COUPON actually pays for your issue of AUTO-FAX.)

Car/Puter's AUTO-FAX • Davis Publications, Inc.  
229 Park Avenue South • New York, N.Y. 10003

Please enter my order for Car/Puter's AUTO-FAX as indicated below:

- Send April issue of 1972 New Car Prices (latest Gov't-approved price hikes). Payment enclosed of \$1.50 plus 25¢ for postage and handling.
- Send Fall edition of Used Car Prices. Payment enclosed of \$1.50 plus 25¢ for postage and handling.
- I prefer a full year's subscription (April issue; June issue of estimated '73 new car prices; Nov. issue of actual '73 new car prices; Spring Used Car edition; Fall Used Car edition.
- Payment enclosed of \$7.50.

Write publisher for bulk rates. Add \$1 per issue for orders outside Continental USA & Canada.

name \_\_\_\_\_ (please print)  
address \_\_\_\_\_  
city \_\_\_\_\_ state \_\_\_\_\_ zip code \_\_\_\_\_

MAIL THIS COUPON TODAY! B-AFX

AUTO-FAX  
USED CAR PRICES

SPECIAL HALF-PRICE  
OFFER TO

## ELEMENTARY ELECTRONICS

ONE FULL YEAR ONLY \$1.98

(Regular Subscription Price \$3.95)

# NOW YOU CAN

## LEARN MORE ABOUT ELECTRONICS THIS EASY WAY AND SAVE 50%



EVERY ISSUE of ELEMENTARY ELECTRONICS brings you easy-to-follow aids for better understanding of theory and applications of electricity and electronics... in word and picture with diagrams that are easy to follow... a source of up-to-the-minute information for everyone interested in electronics who wants to increase his knowledge... followed every issue by thousands of CBers, Hams, SWLs, Experimenters.

**SAVE  
50%**

MAIL THE COUPON below today and you can save 50% off the regular subscription price... you pay only \$1.98 for six great issues... and you're sure you won't miss a single information-packed issue... because the mailman will bring your copy to your door just as soon as each issue is off the press.

So hurry, don't delay Fill out and mail the coupon below.

ELEMENTARY ELECTRONICS, Dept. 641  
229 Park Ave. So., N.Y., N.Y. 10003

Yes, enter my subscription to EE... saving me 50% off the regular price, for:

1 yr.—\$1.98     2 yrs.—\$3.98     3 yrs.—\$5.98  
(I save \$1.98)    (I save \$3.98)    (I save \$5.98)

Name \_\_\_\_\_

Address \_\_\_\_\_

City \_\_\_\_\_ State \_\_\_\_\_ Zip \_\_\_\_\_

# service shop tips

by Hank Scott, Workshop Editor

## DXing Ice Cubes

*My DX-150A Realistic SW receiver equipped with a Hy-Gain window-mount antenna experiences extremely strong interference from the refrigerator compressor in our home. Is there an inexpensive way to cure this?*

—C. S. E., Poultney, VT

If your refrigerator does not have a three prong plug, ground the unit to the outlet plate with a #12 copper wire. By the way, your radio is trying to tell you your refig's motor may go anyway. Start saving for a new unit.

## Hissterical

*Recently I purchased Lloyd's model 3G45 AM/FM/FM-stereo receiver with record changer. After a week, the FM stereo section has developed a noticeable hiss by switching to FM mono, but I would rather listen to FM stereo without the hiss. I have tried a dipole antenna, but it didn't improve the situation much. What gives?*

—T. G., St. Louis, MO

Sounds like your multiplex has split a gut; to be exact, a diode! But, before you poke inside, see if you can get your local dealer to fix the unit. There must be some sort of guarantee. Next time spend a few more bucks on a quality brand name. It pays.

## One to Spare

*I have a FET (transistor) which has four leads. What's the fourth one for?*

—W. P., Bronx, NY

It connects to the shield can of the transistor. Ground it.

## 2 Barrel Request

*I have been trying to find circuit diagrams for a Jacob's Ladder and an electric arc welder/brazer with little success.*

—H. K., Brooklyn, NY

(Continued on page 8)



## READER SERVICE PAGE

• The Editor of RADIO-TV REPAIR — 1972 ISSUE offers readers an easy way to get additional information about products and services advertised in this issue. To become proficient in your home and repair projects you must obtain the correct quality parts, knowledge, test gear, tools and many other items. Become a knowledgeable buyer by obtaining information on the products and services mentioned in this issue and keyed with a Reader Service Number, it's yours for the asking. Just follow the instructions below and the literature you requested will be sent to you promptly and at no cost. It will be a pleasure to serve you.

• The coupon below is designed for your convenience. Just circle the numbers that appear next to the advertisement or editorial mention that interests you. Please limit your selections to 20 or less. Then, carefully print your name and address on the coupon. Cut out the coupon and mail to RADIO-TV REPAIR, Box 886, Ansonia Station, New York, N. Y. 10023. Do it today!

Mail Coupon to: This offer expires December 31, 1972

**RADIO-TV REPAIR**

Box 886 Ansonia Station, New York, N.Y. 10023

• Okay, I want some information and I want it fast. Please arrange to have the literature whose numbers I've circled at right sent to me as soon as possible. I understand this is a free service; however, I must limit the circled items to 20.	1	2	3	4	5	6	7	8
	9	10	11	12	13	14	15	16
	17	18	19	20	21	22	23	24
	25	26	27	28	29	30	31	32
	33	34	35	36	37	38	39	40
	41	42	43	44	45	46	47	48

Name \_\_\_\_\_

Address \_\_\_\_\_

City \_\_\_\_\_ State \_\_\_\_\_ Zip \_\_\_\_\_

## SERVICE SHOP TIPS

(Continued from page 6)

A Jacob's Ladder setup is easy. See diagram. Note that the vertical wires are close together at the bottom (about one inch) and spread out slowly and evenly as they go up. The neon-sign transformer is available at electrical suppliers. Watch out—you can zap yourself with it!

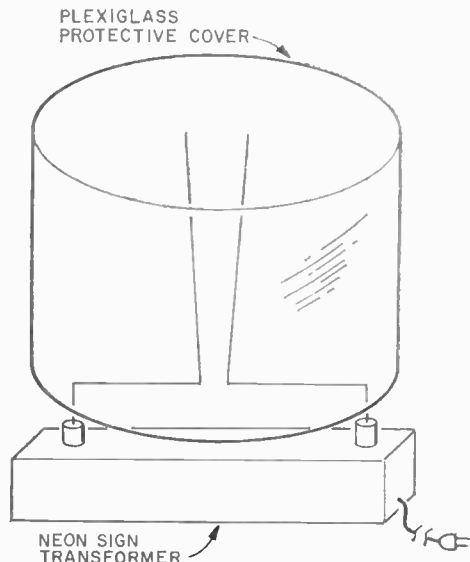

As for an arc welder/brazer, do as I do. Go to Sears and buy! Watch out for some of those cheap mail order units. They're transformerless and connect directly to the AC line. These cheapies can kill you 2.5 milli-seconds faster than the Jacob's Ladder.

### Builds Well, Theory is Weak!

I have a home-brew one-transistor radio, superhet type, which doesn't bring in too many stations. Would an I. F. amp help?

—D. M., Plantation, FL

You bet it would, if it were a superhet. But it's not. Actually you assembled a wierd one-stage TRF. Not much hope here except to add a stage of audio amplification. Gee—I thought nobody built TRF's anymore.

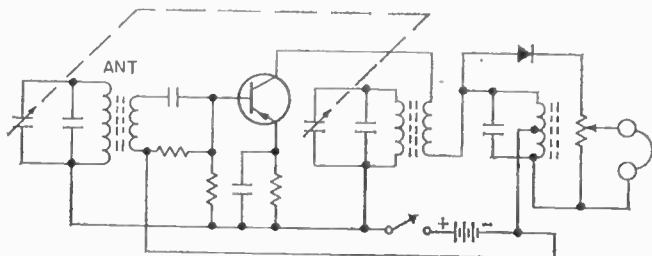

### For the Need of a Word!

I would like to call to your attention a misprint on page 35 in the November-December issue of ELEMENTARY ELECTRONICS. I refer to Fig. 5. (See below). Something is wrong! In the diagram I believe "to antenna" should be "to receiver". I have built the antenna trim and it works very well.

—D. R. R., Old Saybrook, CN

You're right, we blew it. Actually, the wording should have been, "TO ANTENNA TERMINAL". Oh well, you win a few and lose a few. Anyway, good to hear you're back in trim.

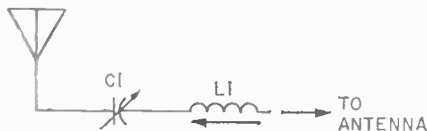

### It's Where You Look!

I have a Lear Radio and need a tube that so far we can't find. It's a 6SF7. What do I do?

—J. L., Hoopeston, IL

I didn't believe your address was real till I checked the postmark. Nice to know we have friend(s) in Hoopeston. As for the 6SF7, gad—they should be all over like *umgowha!* Find the oldest TV or radio repairshop in your neck of the woods and I'll bet you they have a basement full. If the owner has trouble finding some, tell him they're under the pile of 6SN7's.

### Receiver Hot Line

What type of aerial would pull in the most DX possible? Is it a doublet, a long-wire antenna, a loop, a directional loop or a transistor radio type loopstick?

—F. B., Montreal, Quebec

A long wire antenna because the longer and higher the wire, the greater its capture effect. However, in a metropolitan area, such as Montreal, there are so many strong radio signals on the air that selectivity will suffer and even receiver overloading can occur. Better, use a tuned antenna in such an area, but this will require retuning the antenna system when you retune the receiver.

### Sounds Like Football Signals

What American tube types can I use in my Telefunken AM-FM-SW receiver in place of ECL82, EL84, EABC80, ECH81, ECC85, and ECC83?

—T. M., Kettering, OH  
6BM8, 6BQ6, 6AK8,  
6AJ8, 6AQ8 and 12AX7A,  
respectively. ■



# LITERATURE LIBRARY

50. Edmund Scientific's new catalog contains over 4000 products that embrace many sciences and fields.
51. Bargains galore, that's what's in store! Ply-Paks Co. will send you their latest 8-page flyer.
52. Custom Alarms reveals how inexpensive professional alarms can really be. Install one yourself. Circle 52 for exclusive catalog.
53. Get it now! John Meshna, Jr.'s new 96-page catalog is jam packed with surplus buys.
54. Troubleshooting without test gear? Get with it—let Accurate Instrument clue you in on some great buys for your test bench.
55. Burstein-Applebee offers a new giant catalog containing 100s of big pages crammed with savings.
56. Now available from EDI (Electronic Distributors, Inc.): a catalog containing hundreds of electronic bargains.
57. Pick Cornell's Electronics' 10th anni. catalog and discover yesterday prices. Tubes go for 36¢ and 33¢. Plus many other goodies!
58. Allied Radio Shack wants to introduce you to the colorful world of electronics. Discover great buys from wide selections. Get the details from Radio Shack today!
59. It's just off the press—Lafayette's all-new 1972 illustrated catalog packed with CB gear, hi-fi components, test equipment, tools, ham rigs, and more—get your free copy!
60. Get all the facts on Progressive Edu-Kits Home Radio Course. Build 20 radios and electronic circuits; parts, tools, and instructions included.
61. Olson's catalog is a multi-colored newspaper that's packed with more bargains than a phone book has names.
62. Magnetic nutdrivers! They are new and exclusive with Xcelite, and come in 1/4" and 5/16" sizes. They are color-coded, and have fixed handles in regular, extra long, and super long styles. They come in midjet pocket clip types and interchangeable shanks for Series 99 handles.
63. Before you build from scratch, check the Fair Radio Sales latest catalog for surplus gear.
64. For CB'ers and SWL's there is a free 12-page catalog from Mosley Electronics. Antennas for every need—base station verticals and beams, mobile, marine, SWL; also complete line of accessories is included.
65. RCA Experimenter's Kits for hobbyists, hams, technicians and students are the answer for successful and enjoyable projects.
66. B&F Enterprises has an interesting catalog you'd enjoy scanning. Goodies like geiger counters, logic cards, kits, lenses, etc. pack it. Get a copy!
67. Heath's new 1972 full-color catalog is a shopper's dream. Its pages are full of gadgets and goodies everyone would want to own.
68. Get two free books—"How to Get a Commercial FCC License" and "How to Succeed in Electronics"—from Cleveland Institute of Electronics.
69. National Schools will help you learn all about color TV as you assemble their 25-in. color TV kit.
70. Free 1972 Catalog describes 100s of Howard W. Sams books for the hobbyist and technician. Includes books on projects, basic electronics and many related subjects.
71. You can become an electrical engineer only if you take the first step. Let ICS send you their free illustrated catalog describing 17 special programs.
72. For success in communications, broadcasting and electronics, get First Class FCC license. Grantham School of Electronics will show you how.
73. CB antenna catalog by Antenna Specialists makes the pickin' easy. Get your copy today!
74. Here's a free 20-page booklet that tells you how to improve your TV pic and a do-it-yourself approach to installing a Master Antenna TV (MATV) system. Mosley Electronics will wing it your way.
75. Want some groovey PC boards plus parts for communication projects? Then get a hold of International Crystal's complete catalog.
76. H. H. Scott has a parcel of pamphlets describing their entire 1972 line of quality hi-fi products. They have Scottkits, too!
77. McGee Radio's 1972 catalog is free with bargains in hi-fi and general-use speakers. There are also a thousand-and-one other electronics products at low, low prices.
78. Get your copy of Hallicrafters' "Shortwave Puts You Where It's At." Get started today on shortwave radio for more fun tomorrow!
79. Want a deluxe CB base station? Then get the specs on Tram's super CB rigs. Become a super CBER today.
80. Prepare for tomorrow by studying at home with Technical Training International. Get the facts on how to step up in your job.
81. Pep-up your CB rig's performance with Turner's M+3 mobile microphone.
82. CBers, Midland has come up with a neat colorful brochure on their line. Before you buy, check on Midland.

## RADIO-TV REPAIR

1972 Edition

Box 886

Ansonia Station

New York, N.Y. 10023

Please arrange to have this literature whose numbers I have circled at right sent to me as soon as possible. I am enclosing 25¢ to cover handling. (No stamps, please.)



50	51	52	53	54	55	56	57	58	59
60	61	62	63	64	65	66	67	68	69
70	71	72	73	74	75	76	77	78	79
80	81	82							

Indicate total number of booklets requested  
 Sorry, only 20 circled items maximum.

NAME \_\_\_\_\_

ADDRESS \_\_\_\_\_

CITY \_\_\_\_\_

STATE \_\_\_\_\_ ZIP \_\_\_\_\_

Not Valid After December 30, 1972

# Something for everyone . . .

## Spark Snapper-Upper

A revolutionary new CDI (capacitive discharge ignition) system that restores engine power lost through smog-control devices has been introduced by the pioneer of CDI—Delta Products, Inc. The firm's Mark Ten B unit combines the magic of solid state electronics with patented Vari Spark circuitry that extends the spark dura-

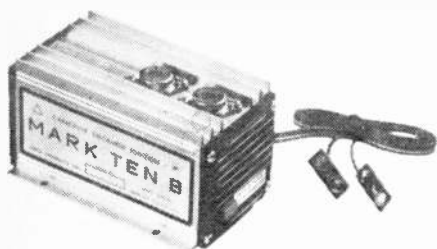

tion during the starting and idle modes. Mounted on the firewall, the small device installs in ten minutes and operates from any 12 volt negative ground engine. The two-piece aluminum housing has neoprene seals that provide dust and moisture protection. It also has a handy switch for instant return to standard ignition. A new brochure is available by circling No. 48 on the Reader Service Coupon on page 7 or 96.

## Open Sesame

The Heath Company has applied its do-it-yourself technology to the remote control garage door opener—thus putting a convenience within the grasp of almost everyone who owns a garage. Costing just \$99.95 mail order, it's complete with one remote transmitter. The new GD-309-A System is actually a "mini-kit" with most electronics (transmitter and in-garage receiver) preassembled. Conventional tools and the easy-to-follow

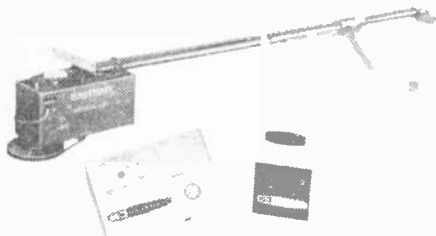

Heathkit manual are all the customer needs to automate his single or double overhead door. The GD-309-A has a powerful ¼-hp motor with a quiet but strong chaindrive mechanism. It includes receiver, pocket-size transmitter with visor clip, and a pushbutton that can be permanently installed in the garage. Deluxe features include a built-in light that turns on whenever the door is actuated, automatic safety reversing and a fuse protected motor. For more information, circle No. 44 on the Reader Service Coupon on page 7 or 96.

## Get The Angle

The newly developed Miller "Y" angle drafting aid saves time and effort in drawing isometric, three-dimensional pictorial views as well as orthographic views. By combining into one precision unit all the separate pieces required, it eliminates unnecessary shifting and rotating motions. It is ideal for both quick sketches and detailed technical drawings. Featuring seven scaled beveled drawing edges at four pre-set

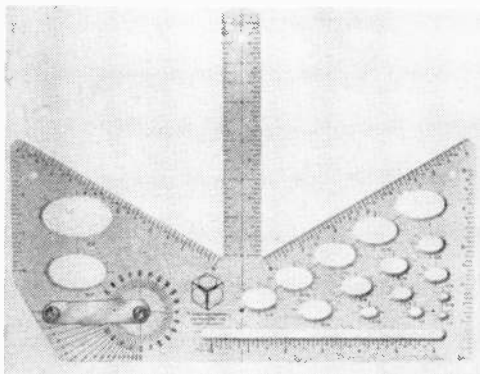

angles—0°, 30°, 90°, and 150°—the Miller "Y" angle drafting aid also includes 360° protractor and 17 isometric ellipse cutouts marked. Fully guaranteed, the Miller "Y" angle sells for \$15.00 complete with illustrated comprehensive instructions. Full details and a brochure are available from David Miller and Associates. You can obtain more information by circling No. 42 on the Reader Service Coupon on page 7 or 96.

## Test Bench Scope

Dynascan Corporation has expanded its oscilloscope line with the introduction of a new DC to 10 MHz oscilloscope, featuring the new exclusive Cali-Brain which provides an instantaneous peak-to-peak voltage reading on the most complex

*(Continued on page 88)*

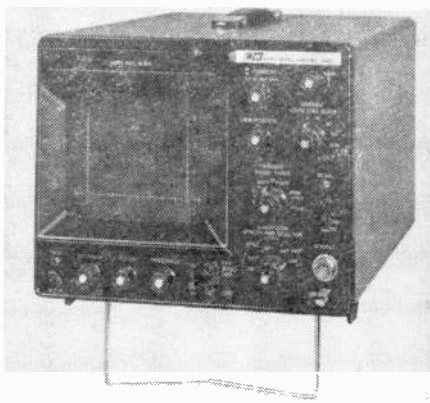

# 21-SECOND TV CURE-ALL

By Homer L. Davidson

Nothing pleases like an AOK TV set (well, almost nothing, let's say), and nothing irks like a TV set on the fritz. Thing is, TVs have a way of telling you what—if anything—ails them with a message plain as the nose on your face. It's the image on the picture tube that tells the story; the problem lies in interpreting what it's trying to say. But that's easy—our 21-Second TV Cure-all includes 21 of the most frequently encountered TV ills, tells where the fault lies and how to go about correcting it. Let's start with the nicest story of all—a properly displayed test pattern on an AOK TV set.

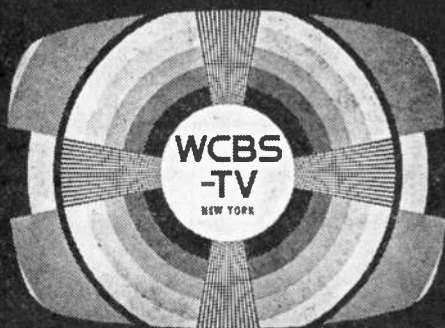

**1** Typical TV test pattern is transmitted perfectly round, perfectly centered, and with all wedges of equal length. Height and width have 3:4 ratio.

*(Continued overleaf)*

# TV CURE-ALL

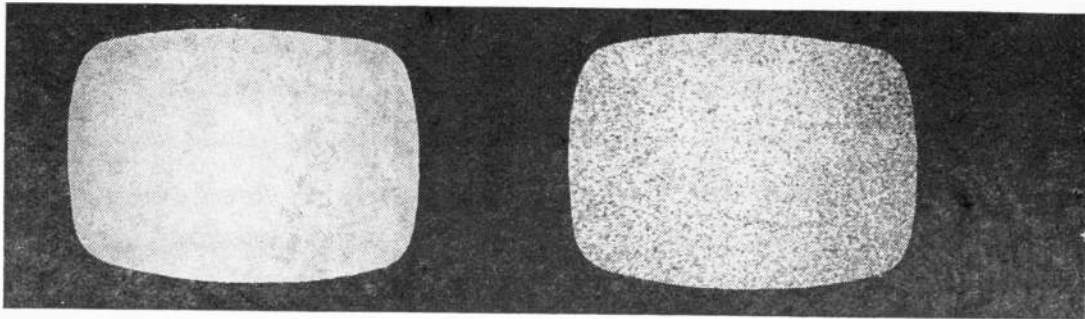

**2 WHITE ALL OVER.** OK, so your set isn't pouring forth with the beautiful TV test pattern shown on the preceding page. Let's say all you can see is a white screen with raster lines. There may be a tweeting sound or perhaps no sound at all coming from the speaker. First thing to check is the local oscillator tube. Next, check the first RF tube. If there's still no picture, check the IF and first video tubes. If you're still up the TV creek, check the IF tuner cable between tuner and chassis; a loose or poor soldered connection will result in no picture or an intermittent picture on the TV screen. As a last resort, check the AGC and second detector tube. And if yours is an older set, check even the sound output tube. Reason is that sets have been made where the sound tube actually furnished voltage to the tuner and IF stages.

**3 RUSH, RUSH, RUSH!** Here we have a TV screen with no picture, snowy screen, and a loud rushing sound issuing from the speaker. Switching the tuning selector from channel to channel has no effect whatever. And while the screen can be lightened or darkened, there's still no picture or intelligible sound. Thing to do is check the first RF amplifier tube in the tuner (most RF tubes are located at the rear of the tuner). If the oscillator tube in the tuner were defective, there would be no snow on the screen or rushing sound in the speaker. And since we have plenty of both in this picture, replacing the RF tube should do it. If not, check the antenna lead-in. Assuming this passes with flying colors, take a close look at the antenna matching coils on the top of the tuner next to the lead-in. These may be shorted or open.

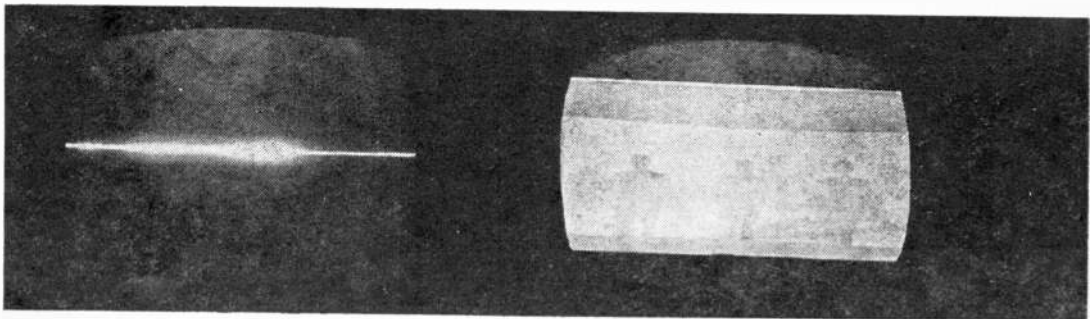

**6 LIKE A LASER BEAM.** A horizontal white line on the screen indicates lack of vertical sweep. First things to check are the vertical oscillator and vertical output tubes (dual-purpose tubes are often found in late-model TV receivers). Also check adjustment of vertical linearity height controls. Be sure to first turn the brightness control down so only a faint white line remains, however, since leaving a bright horizontal line on the screen can easily burn a line across the phosphor on the pic-tube face. If you're handy with a VOM, you may want to pull the TV chassis. This done, check voltages on the vertical oscillator and output tubes, then give the vertical output transformer a resistance test.

**7 SHORT AND SQUATTY.** Trouble here is plain and simple: insufficient vertical sweep. Best bet for locating culprits is to check both the vertical output and oscillator tubes, though you might start by checking the settings of the vertical linearity and height controls. A shorted or vertical transformer winding will cause the same trouble. Can't find the vertical output tube? Here's a quick rundown—in consoles: 6AQ5, 6BL7, 6CG7, 6CM6, 6CM7, 6CS7, 6CW5, 6CZ5, 6CY7, 6DE7, 6DR7, 6EA7, 6EM7, 6EW7, 6FD7, 6GE7, 6GL7, 6KGT, 6KY8, 6S4, 6SL7, 6SN7, 6U8, 12AT7, 12AU7, 12AX7, 12BH7, 12BZ7, 12B4; and in portables: 5AQ5, 5CZ5, 5V6, 7AV7, 8CG7, 8CM7, 8CW5, 8CS7, 10CW5, 10DE7, 10DR7, 10EM7, 10GF7, 11CY7, 13DE7, 13DR7, 13FD7, 13GF7, 15KY8.

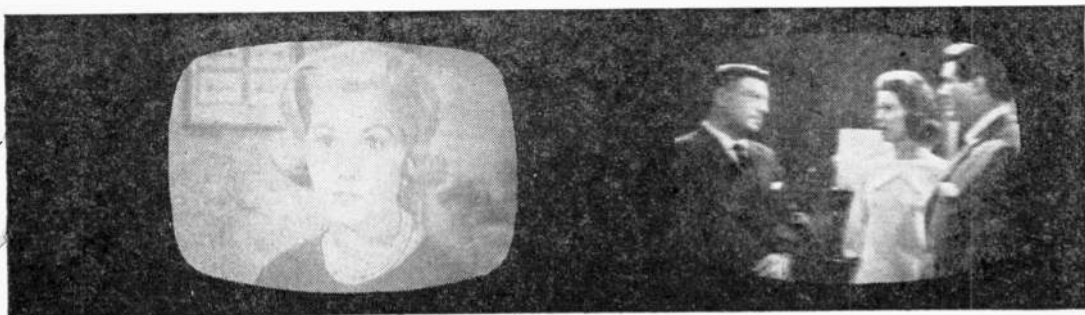

**4 ALL WASHED UP.** Even with the contrast control wide open, the best we can get out of this one is a light, washed-out picture. While local stations can be picked up, distant stations come in ever so faintly or not at all. The problem is likely a weak video or IF tube or perhaps the AGC control setting. In the event the picture has a slight trace of snow, check the RF tube or TV antenna. For the record, common video tubes for AC sets are 6AC7, 6AG5, 6AG7, 6AM8, 6AN8, 6AW5, 6AS8, 6AU8, 6AW8, 6AZ8, 6BA8, 6BH8, 6BK5, 6BK8, 6CB6, 6CH8, 6CL6, 6CL8, 6CV8, 6CX8, 6EB8, 6GN8, 6FH8, 6HL8, 6JV8, 6K6GT, 6KV8, 6LF8, 6U8, 6V6GT, 6W6GT, 12BH7, 12BY7, 12GH7; common video tubes in portables are 3BU8, 5AM8, 5AN8, 5AQ5, 5AS8, 5U8, 5V6, 8AU8, 8AW8, 8BA8A, 8BH8, 8CX8, 8EB8, 8GN8, 8JV8, 10GN8, 10HF8, 10JA8, 11KV8, 11LQ8, 12AT7, 12L6, 12W6, 16GK6, 25BK5.

**5 LOOKS LIKE SNOW.** A snowy picture can be caused by a weak RF or oscillator tube. First step is to replace the RF tube, and, if that doesn't pay off, replace the oscillator tube. Also, check the lead-in going to the TV tuner and try rotating the fine-tuning control to clear up the picture. If a lightning- or thunderstorm has been in the area, check for a burned or open antenna coil. Some coils are mounted on top of the tuner close to the lead-in cable; others are mounted within the TV tuner itself. Still another thing to check is the outside antenna for a broken lead-in wire. Then, too, wind or rotator may have turned the antenna in the wrong direction. And, last but not least, the antenna may actually have damaged elements.

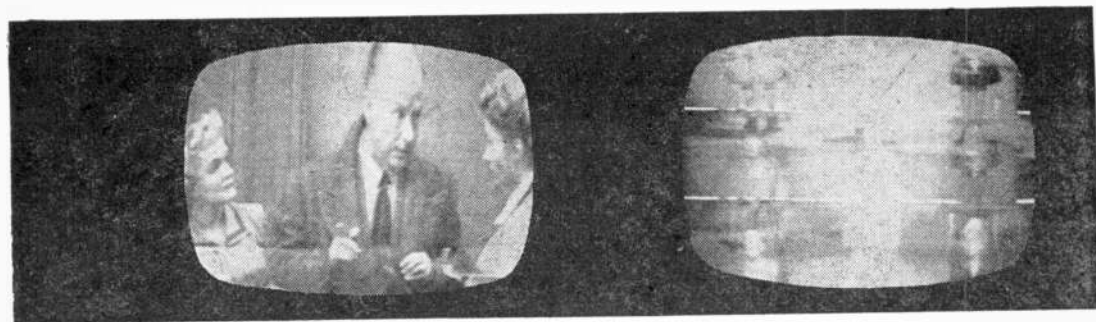

**8 TALLER THAN TALL.** A distortion of the sort pictured here would never be the case with a properly adjusted TV set, so it's obvious that this set's owner didn't take full advantage of the TV test pattern shown in case No. 1. If you go in for fun-house mirrors, you may also dig the TV equivalent. Lacking this rather rare proclivity, you'll no doubt want to adjust the set so it displays an image as faithful to the original as possible. The vertical linearity control is your tool in this case. And while you could try to alter its setting until heads here assumed reasonable proportions, you would be far better advised to make such adjustment with a test pattern. Also, remember that many sets incorporate not one but two controls affecting vertical linearity (the second is usually termed an auxiliary control), so both must be adjusted.

**9 RUNNING UPHILL.** Though a picture can roll both up and down, the site of the trouble is almost always the same: the vertical sync section. Best remedy is to replace both the vertical oscillator and sync tubes (often found in the one and same envelope). If this doesn't solve the problem, try adjusting both the vertical height and linearity control settings. In some TV sets, incorrect adjustment of these two controls will result in a rolling picture. Physically check the vertical hold control for possible loose or poorly soldered connections. Should the vertical hold control let the picture roll in one direction only, look for a defective resistor or capacitor in the plate circuit of the vertical oscillator tube. And should vertical fold-over occur only at the bottom of the TV screen, it's a safe bet that the trouble is the vertical output tube.

*(Continued overleaf)*

# TV CURE-ALL

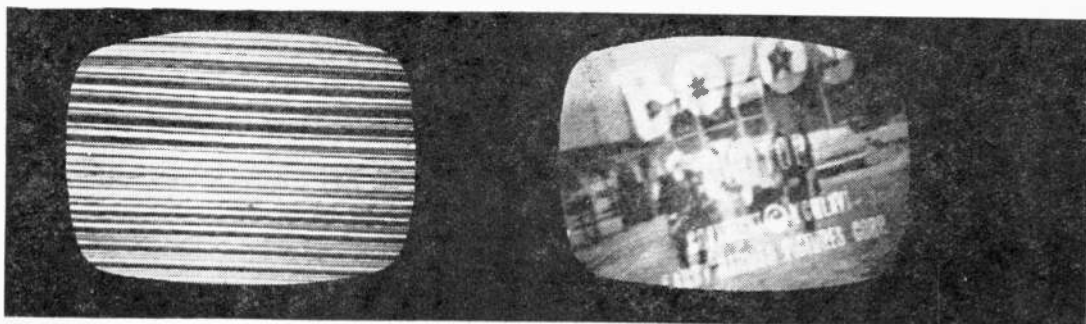

**10 THE LINES HAVE IT.** A screenful of black and white lines can be caused by a defective horizontal oscillator tube. First, check to see if the horizontal hold control is properly set. Once it is, check the horizontal oscillator frequency setting as well as the AFC and sync clipper tube. Since the AFC tube has been replaced by a dual-diode solid-state receiver in many of the newer sets, you may discover such a unit either plugged into a socket or soldered directly into the PC board. However, all is not lost—you can replace the soldered job by snipping off the three leads close to the body of the diodes, then forming small loops in new diode rectifier leads and soldering them to the ends of the leads you just snipped off. Bear in mind that there are two basic types of hookups: a series and a parallel.

**11 TILT!** A tilted picture can be caused by only one thing: a loose mounting screw on the deflection yoke assembly. In other words, the deflection yoke has turned on the neck of the picture tube, which can easily happen if the mounting bolt on the deflection yoke is the least bit loose. Most older TV sets have a wing nut at the top of the yoke assembly; newer ones generally have a metal yoke band with a 1/4-in. cinch-nut tightener. In the latter case, the metal band fits over the plastic tabs of the yoke assembly and snugs against the neck of the picture tube. In both instances, the procedure is exactly the same: you first set the yoke level with the frame of a picture at the top of the TV screen, then adjust this picture into position with the vertical hold control. You then recheck the level, and lock the yoke in place.

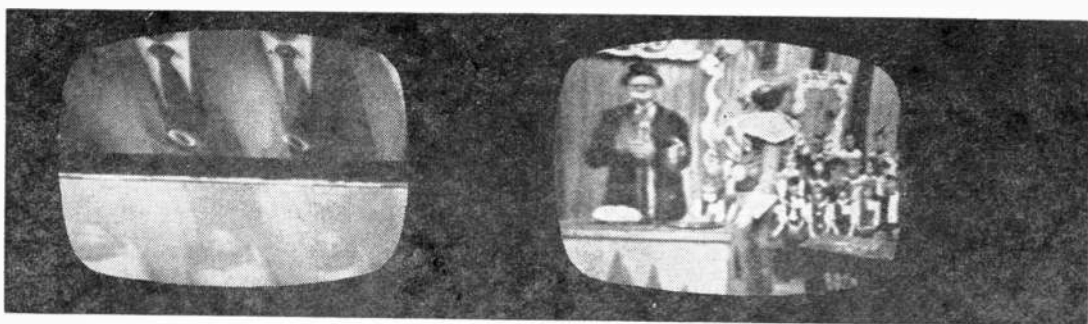

**14 BOTTOMS UP!** Any TV picture running sideways or up-and-down is sure indication that sync trouble is at hand. Check both the horizontal and vertical sync tubes, bearing in mind that these tubes may be in two separate envelopes or, conversely, snug as a bug in a rug in but a single vacuum bottle. Can't find the sync tubes? In consoles, the most probable types are 6AL8, 6AM8, 6AN8, 6AU6, 6AU8, 6AX8, 6HZ8, 6BE6, 6BH8, 6BU8, 6BY6, 6CG7, 6CH8, 6CS6, 6CQ8, 6CU8, 6CX8, 6EA8, 6EB8, 6GN8, 6GW8, 6GY6, 6HF8, 6JV8, 6KA8, 6LC8, 6SN7, 6U8, 12AU7, 12AX7, 12BZ7; and in portables, 3BU8, 3BY6, 3CS6, 3GS8, 4BU8, 4CS6, 4GS8, 4HS8, 5AM8, 5AN8, 5EA8, 5U8, 7AU7, 8AU8, 8AW8, 8CG7, 8CN7, 8CX8, 8EB8, 8GN8, 8JV8, 8KA8, 8LC8, 9AU7, 10GN8, 10HF8, 10JA8, 11KV8, 11LQ8, 12AT7, 12AU7, 12BH7, 12SN7.

**15 SQUEEZED AND SQUASHED.** Bigger-than-life objects on an advertised-in-Life TV are normally the result of a defect in the low-voltage power supply. In older consoles, you can suspect a rectifier tube of some description; in later model sets and portables, you can expect to find a selenium rectifier or a silicon diode in its place. Pinpointing a defective solid-state job with a voltmeter is a pretty simple task: with the lead between the positive terminal and chassis ground, a half-wave rectifier should produce a voltage of 125 to 150 VDC. And given a full-wave job or a voltage-doubler, output should be something on the order of 225 to 260 VDC. Should this approach prove fruitless, you might also check for improper setting of the tube positioning magnet on the rear of the deflection yoke (it can also produce roughly the same symptoms).



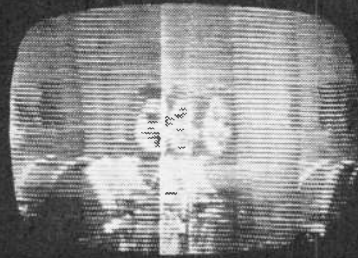
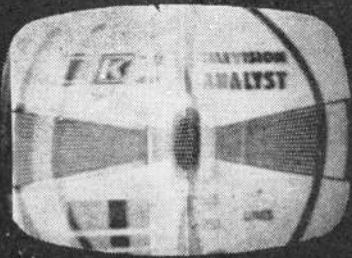

**12 CHRISTMAS IS HERE!** An extreme condition known as the Christmas tree effect, this problem stems from a horizontal oscillator tube or a horizontal output tube. (It generally takes the form of a vertical white bar somewhere on the screen.) Also worth checking are the horizontal drive and horizontal frequency controls. First, make sure that the horizontal drive trimmer isn't more than  $\frac{1}{2}$ -turn from its tight-up position. Next, set the horizontal hold control to its center-rotation position, then adjust the horizontal frequency slug within the horizontal oscillator coil with a plastic adjustment tool. Turn the slug until the fine horizontal lines become wider and then plow into a full picture (if the slug is turned too far, the lines will slant in the opposite direction). Once this looks satisfactory, try rotating the station selector to see if the picture stays in view.

**13 FOLDED GRILLE.** Looking much like the dented grille of a brand-spanking new chrome-plated gas-eating chariot, this condition can result from the very same ills that were responsible for the problems in photo 12. The demon may be the horizontal oscillator tube. Again, it may be the dual-diode AFC rectifier, so if replacing the horizontal oscillator tube doesn't help, the next thing to tackle is the AFC diodes. Should a shorted or leaky dual-diode rectifier be the defective component, you'll generally hear a high-pitched whistle or peeping sound from the speaker. In this case, your course of action is to replace those lousy diodes as outlined previously, turn on the set, and search for a folded grille that hopefully will be no more.

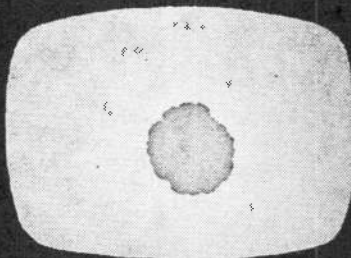
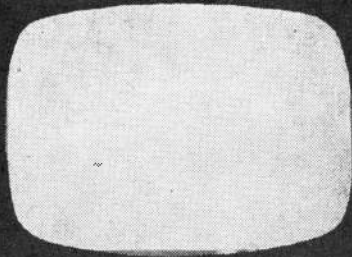

**16 WIGGLE WORM.** Though a trifle hard to show photographically, wiggles on a TV screen are ordinarily due to a 60- or 120-Hz component in the low-voltage power supply. They normally evidence themselves by causing the image to wobble back and forth; oftentimes, there will also be one or two dark stripes across the screen. First thing to suspect is an electrolytic capacitor in the doubler circuits. To remedy the situation, simply bridge a 100- $\mu$ F, 450-V electrolytic capacitor across the suspect. Should things improve, replace the tired and testy old job with a brand-new one, having the exact capacity and voltage ratings. Also worth knowing is the fact that a defective input filter capacitor in AC/DC portables can even result in no picture, no sound, or no raster!

**17 SPOTTED SCREEN.** The trouble shown above started with a spot the size of a pin head, which, within two weeks, had grown to be big as an orange. Wha happen? Simple! The phosphor on the pic-tube was burning off. And the only remedy is replacement of the pic tube itself. Thing to watch for here, with older TVs at least, is incorrect setting of the ion trap (newer TVs are devoid of this device). The ion trap should always be set as close as possible to the picture-tube pin base so as to produce the greatest possible brightness. Sit! another way to ruin a pic tube is to operate a set having a defective vertical oscillator tube. As pointed out in case No. 6, the single horizontal white line across the screen will produce devastating destruction in short order, unless the brightness control is turned way, way down.

*(Continued overleaf)*

# TV CURE-ALL

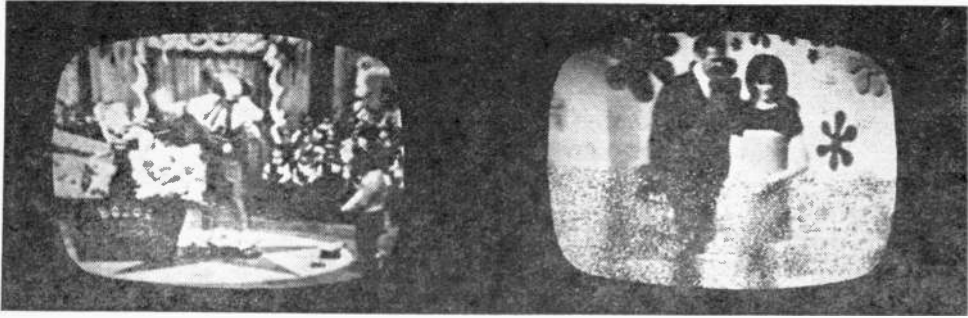

**18** **BLURRY, FUZZY, AND DIM.** TV pic tubes that come on with all the speed of a turtle in Tipperary are probably tired as a fleet-footed floozy after an 8000-meter race. For like all tubes, boob tubes begin their journey to tube burying ground the first time they're turned on. Eventually, images are blurred and fuzzy, even though brightness and contrast controls are wide open; closeups of faces reveal extreme white and blotchy areas even though such blemishes aren't present in the flesh. Tube brighteners or a special process called charging can stave off the inevitable for a time, but stalling for time is only delaying the inevitable. Best bet is to do the thing you'll eventually have to do—replace the picture tube.

**19** **ROAR! ROAR! ROAR!** Though images of this sort make for anything but pleasurable viewing, there's really little you can do to relieve the situation. The particular form of TV interference (TVI) shown here was caused by a defective power transformer somewhere on the same power line; roughly half the picture is covered with dots and dashes, and there is a good deal of picture tearing. Since there are so many causes of TVI—police radio, CB equipment, hams, even radio-TV stations—pinpointing the culprit may take some time. Installing a TVI trap in series with the antenna lead-in sometimes helps. And anything you can do to increase signal strength at the receiver itself is also worth trying. Among the various steps in this direction are installing a narrow-band (yagi) antenna; raising the antenna in height; and using shielded lead-in cable between antenna and TV set.

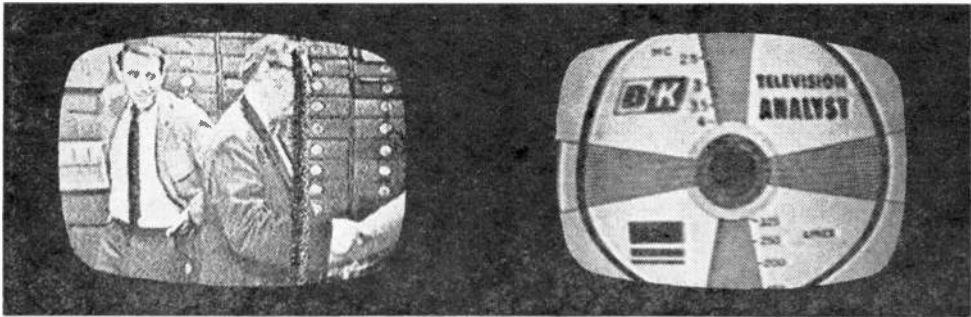

**20** **STRING OF ROPE.** A vertical weaving line down the TV screen is generally evidence of Barkhausen, snivets, or RF oscillation (Barkhausen and snivet lines predominate on VHF channels). First step is to replace the horizontal output tube, which, though it may check out OK in a tube tester, may still be oscillating and causing interference. In many cases, this same type of oscillation will become more pronounced on weak or distant stations. Dressing the antenna leads away from the high-voltage cage should help. Should there be a white vertical line present on the screen, the horizontal drive control should be backed off until the line disappears. In extreme conditions, it may also be necessary to replace the horizontal output and oscillator tubes.

**21** **TEST PATTERNS, AGAIN!** Having examined case after case of typical TV ills, we're back again to the faithful test pattern. The reason is easy to explain: nothing else tells you half as much about a TV set's performance—good or bad. When you come right down to it, there are dozens of TV test patterns, since each station transmits its own particular version (the one shown in case No. 1 is that transmitted by New York's WCBS-TV; the one above is that produced by the B&K Television Analyst). But regardless of which pattern you have at your disposal, you can use it to determine whether your set is properly adjusted for aspect ratio, linearity, and contrast; and how it stacks up in terms of line count, line resolution, and low-frequency phase shift. In short, TV happiness is a properly displayed test pattern!



Color sync has been the cause of many a good man's cop-out, but take heart! Here's what to do

# WHEN COLOR WON'T STAY PUT

By Len Buckwalter, K1ODH

**O**f all the troubles that attack the color TV screen, running hue is one of the easiest to spot. It produces a number of weird patterns, but there's always one revealing symptom—color seems to separate from the black-and-white image. The monochrome picture keeps operating normally while color washes in waves across the screen. Stripes can drift horizontally, vertically, or diagonally. They might rush by at dizzying speed or float lazily to and fro. Worse yet, width of roaming color stripes often varies from narrow to broad.

This classic symptom—separation of color from the black-and-white picture—is strong evidence that the problem is “lack of color sync” (synchronization). A similar effect in a black-and-white receiver is uncontrolled vertical rolling, or a slashing of the image into horizontal lines. In those troubles, the receiver's vertical and horizontal stages are not in step with signals transmitted by the TV station. When color sync is lost, the receiver also fails to mesh with transmitted signals.

**Sync-ing Fast.** There's good reason why the color set must latch onto the transmitting station. When today's color system was approved, the FCC decided color must not interfere with regular black-and-white reception. To fulfill the requirement, engineers created a vehicle to carry color in a manner the black-and-white set would ignore. They came up with the “color subcarrier.” When color voltages from the studio camera are modulated onto a frequency of 3.58 MHz, the color subcarrier, it was found they would drop into “holes” already existing in the black-and-white signal. Now color and monochrome receivers could co-exist in a compatible system.

But the color receiver must have special circuits to recover the subcarrier. Reason is that color *modulation* is transmitted, but the subcarrier remains behind. (Color modulation exists just above and below 3.58 MHz.) This system proves technically economical. Since the subcarrier is killed at the transmitting end (after it's done its job of creating color modulation frequencies), it simply

# COLOR WON'T STAY

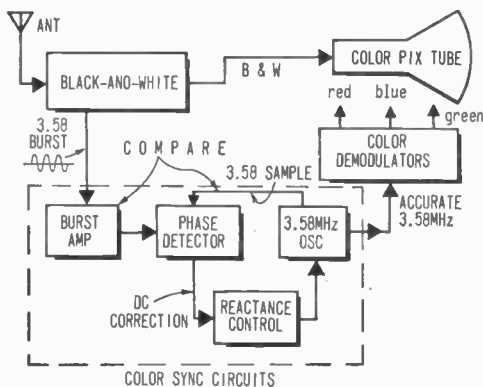

Fig. 1. Color sync circuits are enclosed in dotted line. To maintain correct color on screen, both frequency and phase of 3.58-MHz Oscillator is locked-on to station signal.

isn't present to interfere with black-and-white reception. The color receiver, however, must create a *local* subcarrier to serve as a key for decoding, or demodulating, the original color signal generated at the studio.

**Just Like CW.** This action can be compared to tuning a ham or shortwave receiver for code reception. Code enters the receiver as a radio-frequency signal which can't be fed directly to the speaker. So the receiver provides a local radio signal (from a BFO, or beat-frequency oscillator) and the resulting mixture creates an audio tone. In the color receiver, the subcarrier reconstructs the original camera signals so they can be fed to the picture tube.

Because of incredible accuracy needed for good color, the color circuits have a few refinements.

For one thing, the station transmits only a tiny sampling of the 3.58 subcarrier. Since it's about 8 cycles long, it's aptly called the "burst." So brief is the signal that it can be squeezed in during the time the screen is dark for a fraction of a second at the end of each horizontal scanning line. The burst, though, is long enough to inform the receiver of the correct subcarrier frequency. This is the initial step in synchronizing color between transmitter and receiver.

As for that subcarrier, the color receiver generates its own on 3.58 MHz. It's done with a stable, crystal-controlled oscillator.

Nevertheless, the oscillator can't approach the required accuracy, and the incoming burst is used to kick it on frequency.

Another element of the color sync system is a control "loop." As we'll see, this will tie the incoming burst—the reference—to the local crystal oscillator. Anything which disturbs this system causes running color, an aimless spilling of tints off the basic black-and-white image.

**A Trip On AFPC.** In Fig. 1 is a block diagram of major stages for color sync. This is the set's AFPC, or Automatic Frequency Phase Control system. As the name implies it controls both frequency and phase of the receiver's locally generated subcarrier. Actually, frequency and phase are mostly a matter of degree. When the oscillator is a few dozen cycles above or below 3.58 MHz the system may be considered controlling frequency.

But as the burst signal and oscillator start

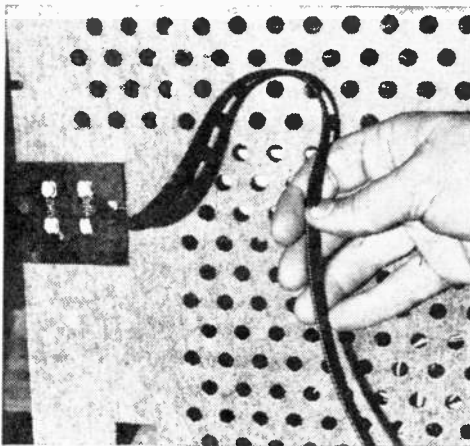
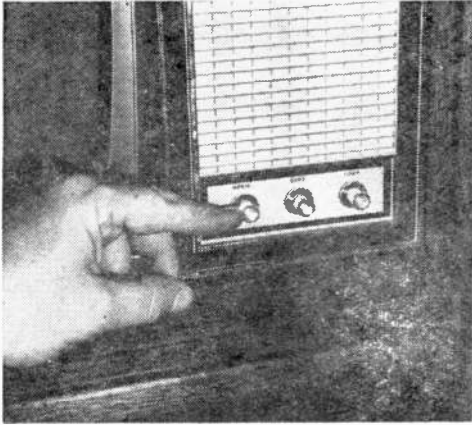

Fig. 2. Poor sync or runny color can sometimes be traced to a defective antenna or lead-in. Flat twin-lead exposed to the elements is especially subject to color-wrecking damage.

to get into step, the control system operates on the more precise level of phase; that is, both signals must begin at zero at exactly the same instant, then alternate through 360 degrees together. Unless locking action is total, picture hues may shift toward the green or purple end of the scale. Major functions of the color-sync section, blocked in Fig. 1, are as follows.

**Burst Amp.** An incoming colorcast travels through the conventional part of the receiver at upper left. Note that it is basically a black-and-white receiver that feeds

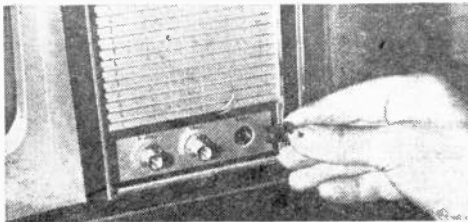

*Fig. 3. Before tearing into the color TV to look for causes of poor color sync, make sure that all the controls are properly set—especially the horizontal hold control.*

the specialized color circuits found below. Synchronizing action begins as an incoming burst signal reaches the Burst Amp. This is the rapid-fire group of cycles sent as a reference by the TV station and thus they become the reference for the complete control system. They are strengthened by the Burst Amplifier before proceeding further. Notice that the burst is next applied to the Phase Detector.

**Phase Detector.** An electronic comparison occurs here. The stage is designed to accept two signals, then produce one output voltage which encodes any differences between the original signals. The burst is one signal; the other is from the 3.58 MHz Oscillator.

**3.58 MHz Oscillator.** This crystal-controlled oscillator generates the local color subcarrier. As mentioned earlier, it is stable, but not accurate enough. A small portion of oscillator signal is sent to the Phase Detector as a 3.58 MHz sample. The Phase Detector is now receiving two signals for

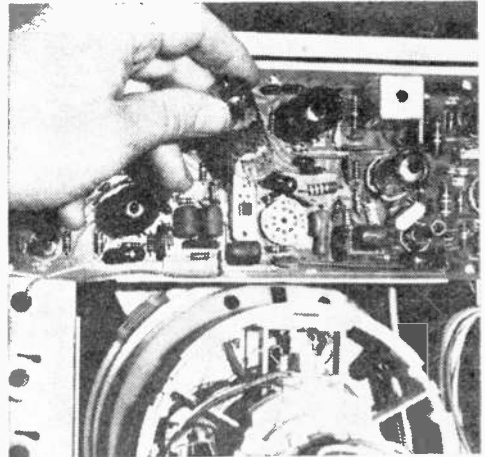

*Fig. 4. Another adjustment that can affect color sync is the AGC. Here, control is located behind a front-panel knob, though usually it's on the rear apron. Set AGC as described in text.*

comparison and it produces an output (shown as the DC correction).

**Reactance Control.** This tube serves as an electronic tuning capacitor, much the same as the tuning capacitor used to tune any radio. Only it has no moving plates. Its capacity can be controlled by the DC correction voltage supplied by the Phase Detector. Further, the Reactance Tube is connected as a variable capacitor across the tuning circuits of the 3.58 MHz Oscillator.

To sum up the overall action of Fig. 1: an incoming burst signal is compared with the local 3.58 Oscillator at the outset. The Phase Detector senses error between the two, then operates the Reactance Control. Capacity changes then re-tune the 3.58 Oscillator until it is on the exact subcarrier frequency. Note that the oscillator produces a continuous signal, though it is being controlled by the burst.



*Fig. 5. Tubes account for most sync circuit troubles. They will usually all be found on the set's chroma board; checking by substitution is the easiest way to find a bad one.*

The 3.58 signal, now precisely correct, goes to the Color Demodulators which produce correct voltages for operating the picture tube guns. At this point, any loss of sync detaches color from the black-and-white image.

**Manual Control.** When color sync acts up, there are a couple of initial checks which will determine whether it's caused by something outside the chassis. We'll assume the set is receiving a normal black-and-white picture in order to rule out problems which might originate in other sections of the receiver. The antenna and lead-in (Fig. 2) are also considered to be in good condition and aren't deteriorating the color signal before it enters the receiver.

# COLOR WON'T STAY

Turn to a color program and carefully adjust the fine-tuning control. This is critical to stable color reception since it places the burst into correct position within the set's tuning circuits. If the burst is attenuated, it won't be available to control the crystal oscillator. Another adjustment that might

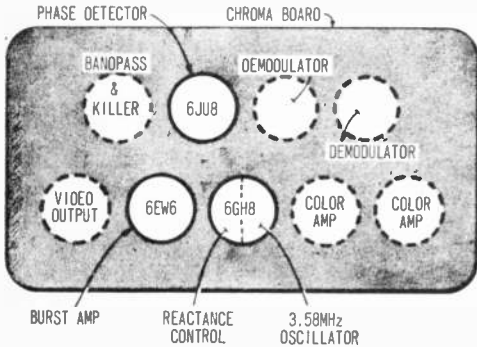

Fig. 6. On this typical chroma board, stages directly concerned with color sync are shown in solid circles. Poor sync is usually caused by one or more of these tubes being defective.

affect the burst signal is the horizontal hold control (Fig. 3).

Though these circuits occur in different sections of the receiver, there is some interaction. You may recall that a burst occurs at the end of every horizontal scanning line. To help keep the Burst Amplifier firing properly, it is locked into the set's horizontal scanning section. Mistuning of the horizontal hold control is apt to disturb the timing. For this reason, always set the horizontal hold

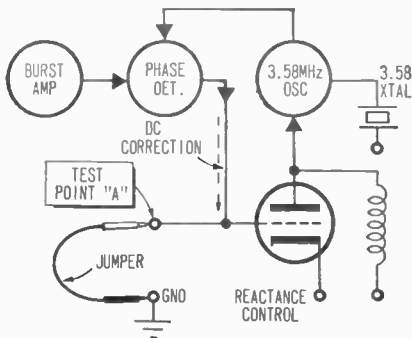

Fig. 7. If tubes are not the problem, shorting the grid of the reactance tube to ground may isolate trouble. Manufacturer's service literature may be needed to locate test point.

so the picture is centered on the screen. (You'll note the hold is able to shift the picture slightly left or right before the image breaks up.)

**Consider The Killer.** Another adjustment to check is the Color Killer. This circuit doesn't directly participate in color sync but it could have an effect. The "killer" is a stage which closes off the receiver's color stages during black-and-white reception to keep color from accidentally spilling through and disturbing the image.

If the killer is set at a critical point, it's possible for a part of the color signal to be wiped away, which could lead to unstable operation. Turn the control fully off to check if this is the sync problem. The correct setting is one that doesn't produce colored "confetti" on the screen when the set is tuned to an unused channel. Location of the killer control is usually along the rear

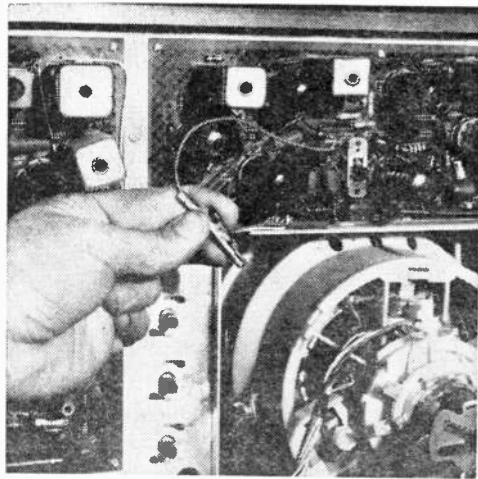

Fig. 8. If color sync improves when reactance tube grid is grounded, reactance and oscillator stages are probably alright. Be careful not to disturb yoke components while working on set.

chassis apron: on some sets it's accessible when one of the front-panel knobs is removed.

Finally, check the AGC (automatic gain control) adjustment if the set has one (Fig. 4). Should AGC be set too high (thereby severely reducing gain of the receiver's front-end), there could be partial clipping of the color signal. The usual adjustment for AGC is done while viewing the strongest local channel. The control is turned until the picture starts tearing or turns negative, which indicates overload. Then the control is re-

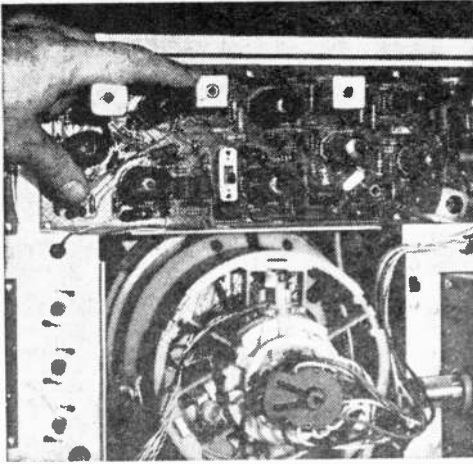

Fig. 9. Alignment of transformers in the color section should not be disturbed since realignment is complicated. However, transformer windings can readily be checked for continuity.

One useful test point indicates whether the fault is in the Burst Amp and Phase Detector stages or the Reactance Control and 3.58 Oscillator stages. If the simplified diagram in Fig. 7 is traced, it is seen that a test point (A) occurs in the grid of the Reactance Control tube. This is the stage that acts like a variable capacitor across the oscillator and continuously adjusts frequency with a DC correction voltage.

The test point enables you to ground the DC correction voltage and observe certain effects. Watch the color picture when you ground the test point with a clip lead to the chassis (Fig. 8). If it improves color sync—color stops moving through the picture—it's a good sign the Reactance Control and oscillator stages are not at fault.

**No Reactance Volts.** During this test, you removed the action of the Burst Amplifier and Phase Detector from the circuit. Further, in grounding the test point, you

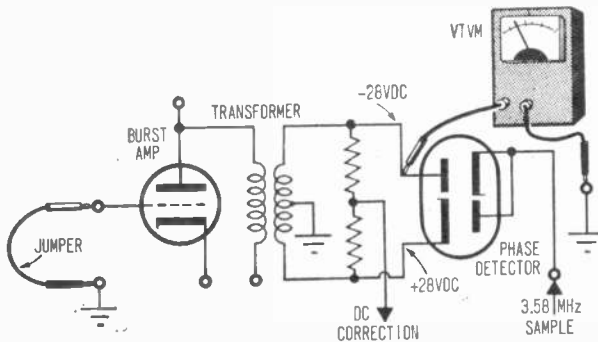

Fig. 10. To determine if Burst Amp and Phase Detector are working properly, ground the Burst Amp grid as shown, then measure the voltages (with a VTVM) on the transformer side of the diode. The actual voltages will vary from set to set, but should be equal and of opposite polarity.

tarded slightly until a normal image is obtained. If these preliminaries don't cure a case of color instability, the back cover of the set is removed for the next step.

**Troublesome Tubes.** As in most other circuits, tubes account for the bulk of color-sync faults. You can locate tubes (Fig. 5) associated with color sync by examining the set's chroma (or color) board. It's usually a subchassis or printed circuit that bears most circuitry for processing color signals. The layout of a color board used in a recent Westinghouse receiver is shown in Fig. 6. When color sync acts up, check those tubes by substituting known good ones before probing more deeply into the set.

Manufacturers often provide convenient test points on a color chassis to help pinpoint troublespots. Thus, it's a good idea to obtain the service literature for a particular set if you wish to probe further into a color sync problem.

placed zero volts on the grid of the Reactance Control stage, a voltage which is about right during normal reception. If color sync improves, you have proved that both reactance and oscillator stages are capable of approximately normal operation.

We say "approximate" since color may

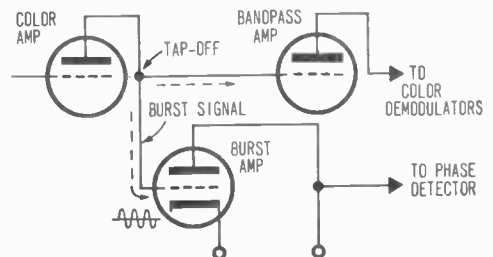

Fig. 11. The next circuit to have a close look at is the Burst Amp. If Phase Detector voltages are incorrect, perhaps the burst signal is being interrupted between Color and Burst Amp. The only way to find out is with a scope.

# COLOR WON'T STAY

not lock completely in place, but possibly drift slowly across the screen. If you get this action, shift suspicion to the burst and detector stages. Measure tube-socket values of voltage and resistance to find the faulty component. Leaky capacitors are frequently the trouble, followed by resistors which have changed value (rarely will a 3.58 crystal go bad). Alignment of various coils or transformers in this section (Fig. 9) shouldn't be touched unless you've exhausted all other test possibilities.

**Slap In The Phase.** One shortcut helps tell whether Phase Detector or Burst Amp is at fault. In Fig. 10 is a simplified schematic of these stages, as used in an RCA color chassis. During operation, the Burst Amp is boosting the received burst signal and applying it to the Phase Detector. Here the signal is split in the transformer leading to a tube with a pair of detector diodes. At the same time, a 3.58 MHz Sample is applied to the other side of the diodes. This circuit com-

*(Continued on page 94)*

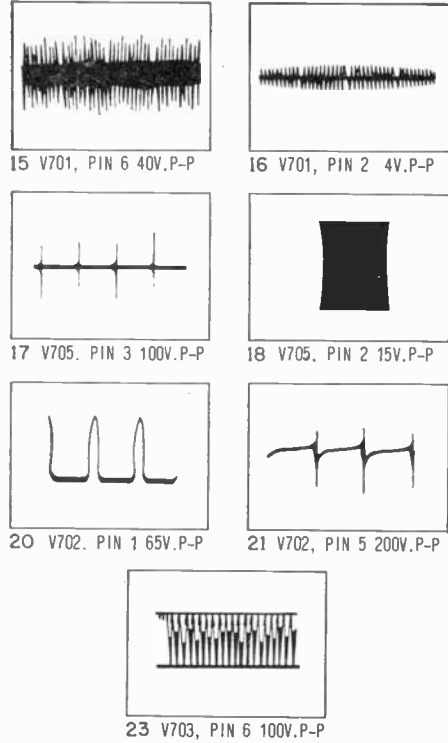

*Fig. 12. Typical service literature provides waveforms at different circuit points so that burst and other signals can readily be traced through various stages with an oscilloscope.*

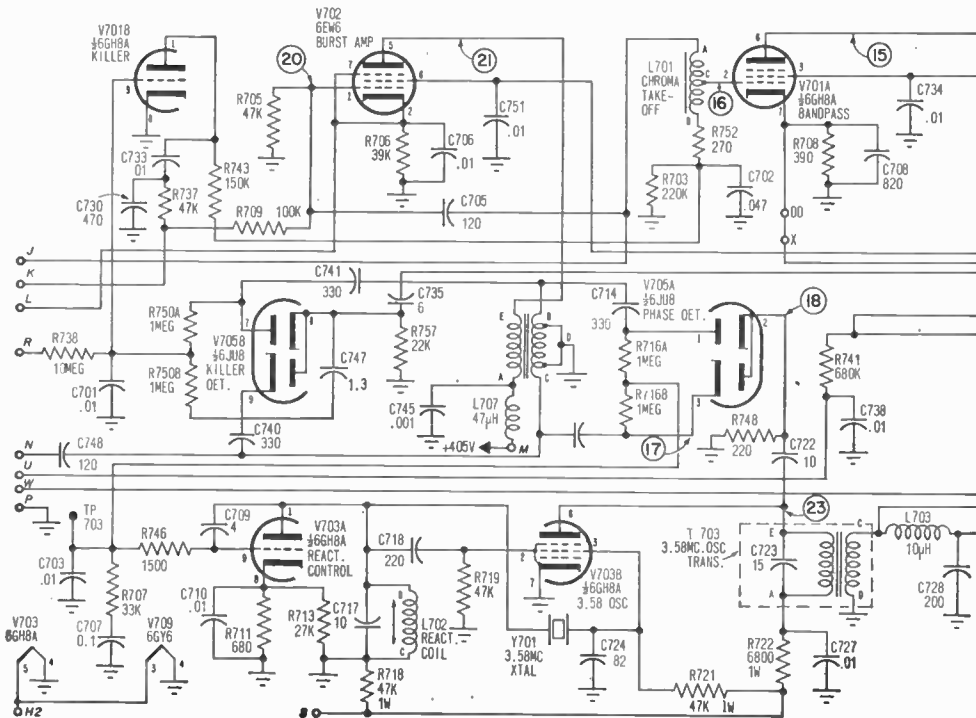



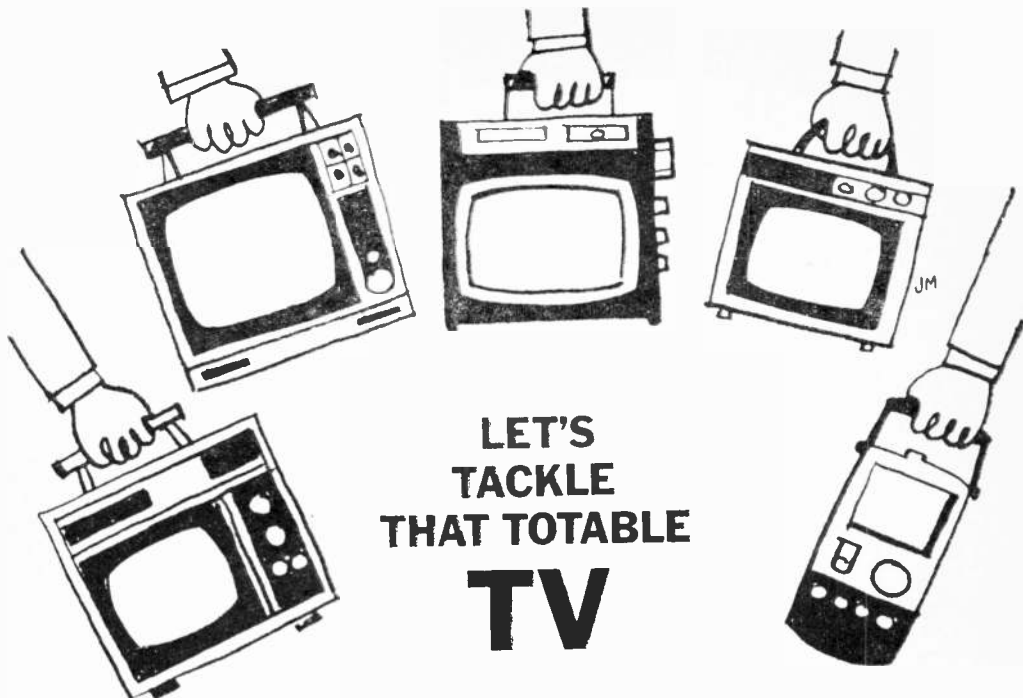

## LET'S TACKLE THAT TOTABLE TV

By Homer L. Davidson

Fixing that portable takes a knowing hand; here a pro lends his!

**W**hen that portable TV is on the blink, you've got two choices: figure on spending a bundle having it fixed, or doing it yourself. Of course, doing it yourself can be a problem even if you've had experience with big-brother console. That's because size considerations makes for design and construction differences. But take heart—the most common problems of a portable TV are often the easiest to repair. And with a few items of test gear and a little know-how you can tackle that misbehaving portable with confidence.

**No Nothing.** This symptom is the easiest trouble of all to correct. Let's take a look at the block diagram in Fig. 1. We see that practically every stage gets power from the low-voltage power supply. Let's begin right here.

Roll up your sleeves and pull the TV back cover off. First, see if the portable is an AC/DC or power-transformer type. The AC/DC portable TV receiver does not have a power transformer like the one shown in Fig. 2. All filaments in the AC/DC portable are hooked in series. In the power-transformer variety, the transformer supplies 6.3

VAC to all tubes in a parallel circuit.

Now check the circuit breaker on the rear apron of the TV chassis. In most late-model sets, it's in the form of a small protruding red rod. Push this and the circuit breaker will reset. If this was the problem, the filaments should begin lighting. Often a tube in the sweep circuit, such as the damper tube, will arc over, kicking out the circuit breaker. If the tube starts arcing when the circuit breaker is reset, replace the tube.

**Fused Fuse.** Take a look and see if all tubes light up. If they don't, check for a defective fuse. Some portable receivers have a circuit breaker and a low-ampere fuse in the AC line. Check the continuity of the fuse with an ohmmeter. Just looking at the fuse may not tell the tale. OK, the fuse is blown, so in goes another one. In some cases, only the type designed for the set will plug into the fuse holder.

Look at the schematic of your set and see if the fuse in the low-voltage power supply is like the hookup in Fig. 3. Here is a 2-A fuse protecting the overload that may occur in the low-voltage power supply if

# THAT TOTABLE TV

associated circuitry suddenly shorts out.

What makes the fuse blow in the low-voltage power supply? Check for a shorted selenium or silicon diode rectifier. Then go to the filter capacitors and check for other possible defective components that can be shorted causing an overload in the B+ line.

string portable TVs (transformerless) is shown in Fig. 4. Here the fuse is a 0.4-amp type at the output of the power supply. After checking the fuse, go directly to plug-in resistor, R113 and see if it has burned open.

Now check the front-to-back resistance of SR101 and SR102, the two silicon diodes. Remember to always cut one lead loose for accurate measurement. If they're OK, then check the voltage-doubler capacitor, C111. These capacitors will dry out after several

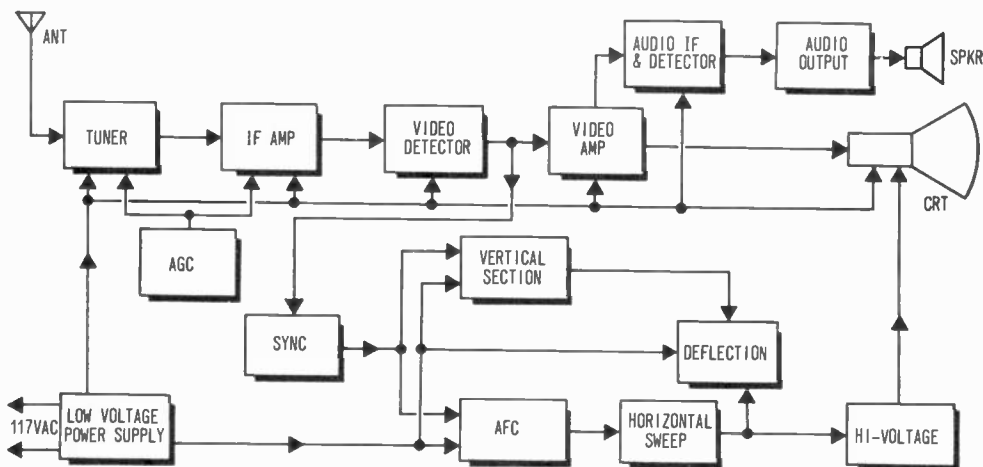

Fig. 1. Block diagram of standard TV set is useful when attempting to track down power supply troubles.

You can make a quick check of silicon diodes with the low-ohms scale of the VOM. Remove one end of the suspected diode, then place the ohmmeter leads across the diode rectifier. You should have a 5- to 15-ohm reading in one direction. Now reverse the ohmmeter leads. Does the ohmmeter still read 5 to 15 ohms? If so, the diode is shorted. A very high resistance reading should be noted with reversed ohmmeter leads. Very rarely do silicon diodes go open; they usually short out.

**Smelly Selenium.** Selenium rectifiers will have a resistance reading from 20 to 25 ohms in one direction and over 3000 in the other. You can easily spot a defective selenium rectifier by its pungent smell. Also, black burned spots form on the selenium side of a defective rectifier of this type.

Let's say, for instance, the fuse is good but there's still no output voltage from the low-voltage supply. In this same circuit (Fig. 3), check to see if the 3-ohm resistor is open.

A voltage-doubler circuit used in series

years of use. A white substance may have leaked out at the bottom of the filter, indicating the capacitor is defective.

To check the capacitor, shunt a new one across it. If that cures the problem, replace the defective capacitor.

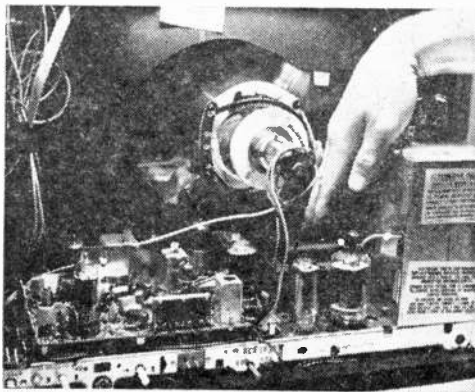
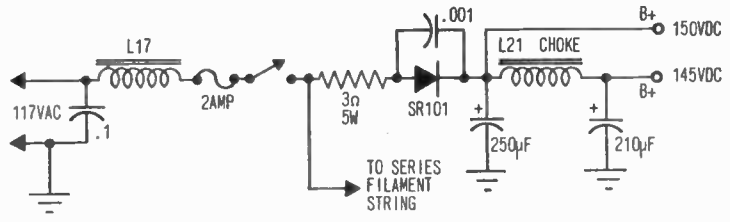
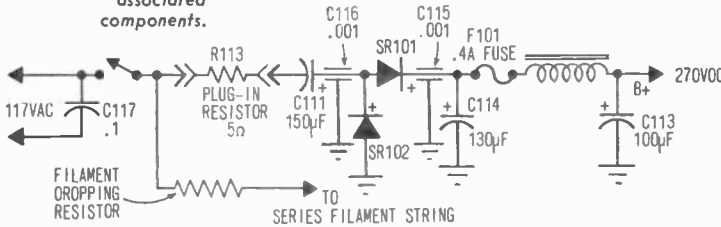

Fig. 2. Hand points to power transformer in transformer type set. The absence of this or similar transformer indicates TV set is of the series string variety, which the majority of low-cost portables are.

**Fig. 3.** Schematic shows typical transformerless low-voltage power supply used in many current portable TV models. Here, a 2-Amp fuse is used to protect set from damage in case of short circuit developing in the B-plus line or associated components.



**Fig. 4.** In this power supply circuit, the B-plus output is fused by F101 and the AC line protected by fusible resistor R113. This hookup is a voltage doubler, the output being twice the input rms value.



**Fig. 5.** In some sets, a thermistor is connected in series with the AC line to prevent voltage surges from damaging set when turned on. The thermistor protects set by having high initial resistance which then drops as thermistor warms up.

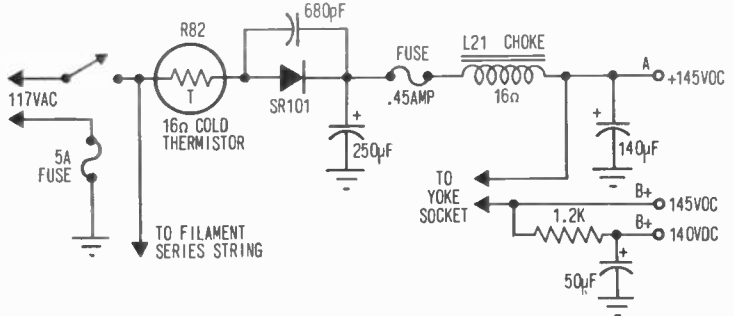

**Hummm . . .** If there's hum in the sound or dark bars across the screen, check the filter capacitor in your set equivalent to C113 and C114 in Fig. 4. Shunt a new capacitor of at least 450-VDC rating across the suspected filter capacitor and see if the hum disappears—if so, you've located the fault. When checking the power supply, always have the AC switch turned *off* while clipping the test capacitor across a suspect filter capacitor.

In Fig. 5 is another low-voltage power supply using a silicon diode as rectifier. Notice the thermistor resistor ahead of the diode. This resistor protects the series-string tubes by preventing surge voltage from being applied to cold tubes.

After several years' usage, the wires soldered to each side of the thermistor can pop off or come loose, leaving a high-resistance or open-current path. The results are intermittent or no output from the low-voltage power supply.

A low-voltage power supply circuit using a power transformer is shown in Fig. 6. The

secondary winding is wired up for full-wave rectification with two silicon diodes in each leg. Notice the circuit breaker in the center leg of the transformer. In case heavy current drain in the B+ results because of defective components or a short circuit, the circuit breaker will kick out.

**No H.V.?** When this type of set is dead, check the B+ output supply voltage with a DC voltmeter. Also check the resistance of the two silicon diodes. Generally, when one is found defective, both silicon diodes in that leg should be replaced. If the circuit breaker keeps kicking out after it's been reset a few seconds, short across the terminals with an alligator clip. Occasionally, the circuit breaker will become defective and will not hold under the ordinary power load and will have to be replaced.

The second winding on the power transformer is the heater circuit. Tubes in transformer-type portable sets usually all operate on 6.3 VAC. This particular heater winding (hot side) has a 1-in. piece of #28 fuse wire so that in case of a filament or

# THAT TOTABLE TV

pilot lamp short circuit, the wire will open, protecting the transformer winding from overload. If the filaments don't light, check for an open fuse wire—if OK, check for an open transformer winding with an ohmmeter and one transformer lead disconnected.

When the tubes are dark in a series-string set, all tubes will have to be checked for an open filament because if one goes out, none will light. So with a tube filament checker as

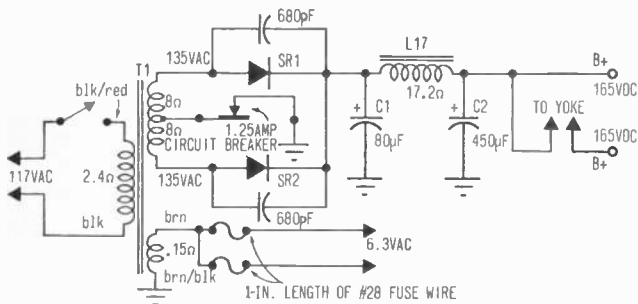

*Fig. 6. Transformer power supply is used in better portable TVs. Typically, a circuit breaker is used in either AC line or in B-plus circuit as shown here. Full-wave rectification is provided by the use of two silicon diodes in this configuration, or in some cases, a bridge circuit employing four diodes. Typical DC-ohms values shown on transformer windings and choke lets them be easily tested with an ohmmeter.*

shown in Fig. 7 or with an ohmmeter, check filament continuity.

**Continuity Check.** We know that one of these tubes, or possibly two, may have an open heater element. Take one tube out at a time and check it for continuity. Start with the horizontal output tube, damper, and sound output tube, in that order. These tubes run hot and are most likely to have a defective filament.

When checking filament continuity with an ohmmeter, switch to a low-ohm scale and place the probes across the heater terminals. The larger the heater voltage required by the tube, the greater the filament resistance measured should be. See Fig. 8 for a filament resistance chart.

In case the problem hasn't been found after checking tube continuity, bring out the AC voltmeter (see Fig. 9). Switch the voltmeter to the 150-VAC scale. Place the voltmeter probes across the *on/off* switch—it could be open. If this checks out OK, put one voltmeter lead to the *on/off* switch and trace the heater wires starting at the grounded side (Fig. 10).

Most tuner tubes are located at the grounded side of the series filament string. Quickest way to eliminate a possible defec-

tive tube socket or broken heater wire in the tuner is to clip a shunt wire from the brown heater wire going from the tuner to the chassis ground. If the problem is in the tuner, the other series string of tubes will light up when the set is turned on. If so, you have isolated the heater trouble to the tuner section.

**Mostly Series.** Remember that most portable receivers are of the series heater variety. When one tube goes out, the whole string is open like a cheap string of Christmas tree lights.

Fig. 11 shows a typical power transformer heater circuit with all tubes wired in parallel. In this type, one or two tubes may not light

up indicating they are dead or their heater wiring defective. If all the tubes are dead in a power-transformer TV set, check for defective power transformer, broken heater wires, or open fuse wire.

When the picture tube has a raster, but there is no sound or picture, the trouble is probably in the tuner. The tuner is just behind the station selector knob. Substitute or check the RF and oscillator tube. If substituting tubes here doesn't produce picture or

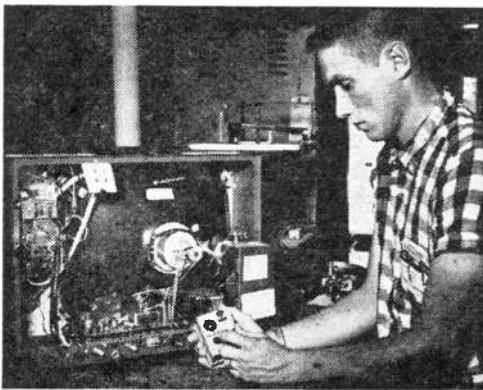

*Fig. 7. Easiest way to check many tube filaments in a series-string TV is with simple continuity tester. What happens in this type of set is that when one filament burns out, none of the tubes will light up.*

TUBE HEATER RATINGS

VOLTAGE (VOLTS)	3	6	12	17	25	35	50
RESISTANCE (OHMS)	1-1½	2-5	3-12	5-12	10-20	30-50	50-60

Fig. 8. If a continuity tester isn't available, tube filaments can be checked with an ohmmeter. Listed above is the approximate resistance value for tubes of various voltage ratings, e.g., 12BQ6 is 3-12.

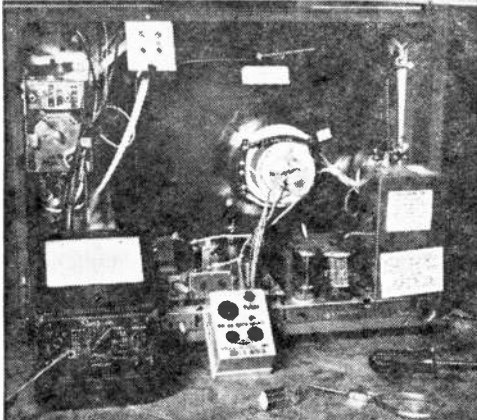

Fig. 9. If all tube filaments check out good, test the AC power switch with an AC voltmeter. If switch is good, no voltage should be indicated when on, 117 VAC should be indicated when off.

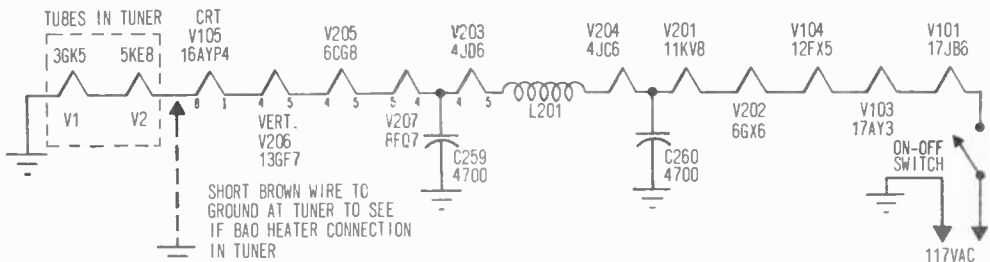

Fig. 10. Typical series-string hookup can be quickly traced with AC voltmeter to locate break in circuit.

sound, check the IF and video output tube. Always replace these tubes if any element indicates shorted on a tube tester.

If the problem persists, try pulling the AGC (automatic gain control) tube out of its socket (with the set on) and see if the picture or sound returns for a split second. If so, your set has AGC troubles. A defective AGC tube can cut off both picture and sound. Another method for checking AGC is to turn to a weak TV station. The picture and sound may appear on a weak signal but can be blocked by AGC action on a strong TV station.

**No Picture — Raster — Good Sound.**

When there is sound, a good raster, but no picture, the trouble is likely to be in the video circuits. Most portable TV sound circuits are connected to the beginning of the video circuit, so the problem will be somewhere after this point. Substituting or checking the video amplifier tubes will usually solve this problem.

The cause of excessive picture smear and tearing can usually be found in the video amp circuits. Open peaking coils in the video output circuit will result in a smeary picture—see Fig. 12. An open or leaky coupling capacitor from video amp to CRT can also cause picture smear.

Another possibility is a shorted picture tube. Simply tap near the end of the CRT, but *gently*, while watching the picture in a hand mirror. If the fault comes and goes while you're tapping, replacement of the CRT is the answer.

**No Sound—Good Picture.** When everything is fine but the sound is missing, go directly to the sound amplifier section and check the sound tubes, starting with the output tube—see Fig. 13. A defect here can cause no sound, extreme distortion, or excessive hum. If a tube is not at fault, check

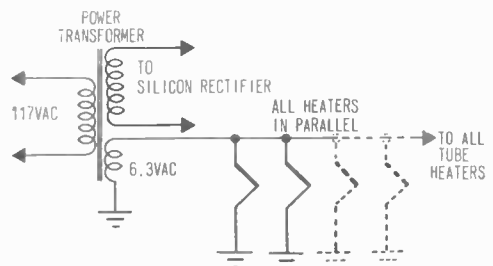

Fig. 11. In transformer type set, one or two filaments may not light up indicating tube or associated heater wiring is defective. If no tubes light up in this type of set, check the power transformer, fuses in AC or filament line or circuit breaker, and AC switch.

# THAT TOTABLE TV

Fig. 12. Picture smear with complete loss of detail is caused by defects in either the video amplifier circuit or a shorted picture tube. Easy way to check picture tube is to tap it gently on the base and neck while watching picture in mirror.

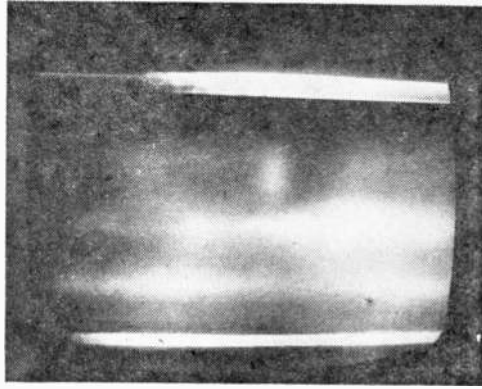
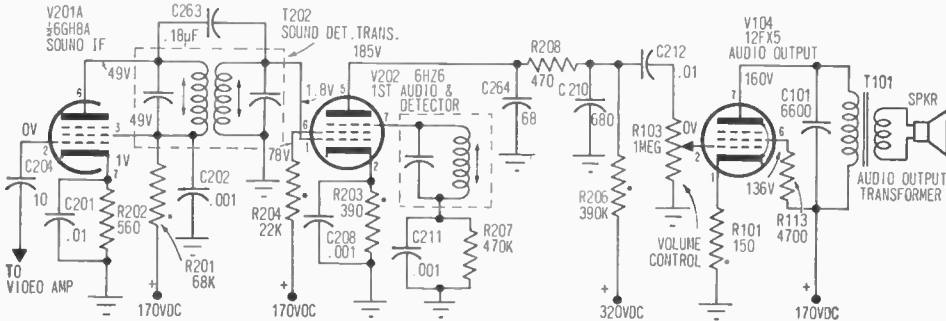

Fig. 13. The audio circuitry in your portable TV will look very much like this. If poor, distorted or weak sound is the problem, start by checking these tubes or their counterparts in your set. The next thing to check is the speaker (see text).



the speaker and cable connections. Also check for a defective output transformer. This can easily be accomplished with an ohmmeter continuity check. Distorted sound can be caused by the cone resting on the center pole piece, in which case the speaker must be replaced. Small holes poked into the speaker cone can be repaired with glue.

Intermittent sound can be caused by a cracked PC board. Push and move the small parts on the PC board with an *insulated* tool

while the set is on. Intermittent IF and detector coils may have cold solder connections inside the metal can.

**Black Screen—Good Sound.** Here we probably have a horizontal sweep problem (but be sure it is not just the brightness control turned all the way down). Be extremely careful when working in this section as **LETHAL** voltages exist. Keep the set turned *off* unless stated otherwise. The CRT capacitively stores up to a 20,000-volt charge

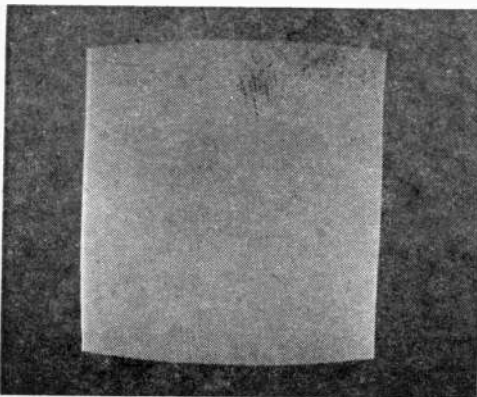

Fig. 14. Insufficient width is caused by the horizontal sweep voltage being low. This problem is most often traced to a weak or defective horizontal output or damper tube, but can also be low B-plus voltage.

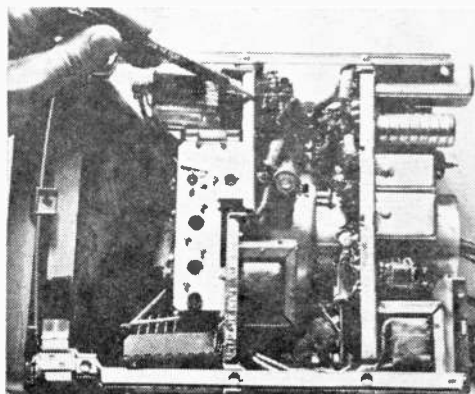

Fig. 15. If tubes are not the cause of a narrow raster, circuit components associated with the horizontal and damper tubes are likely candidates. The pencil points to the horizontal output tube circuit.

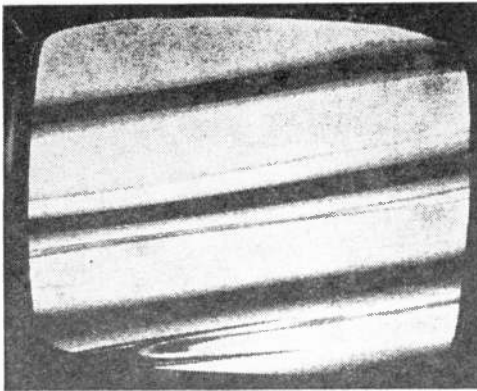
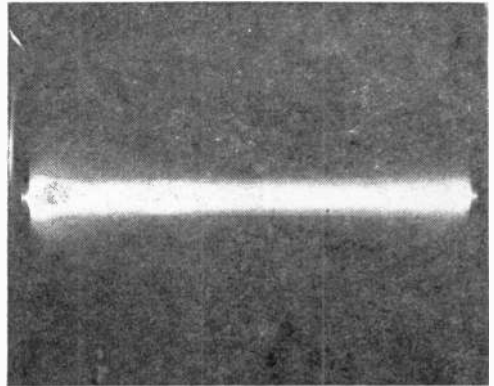
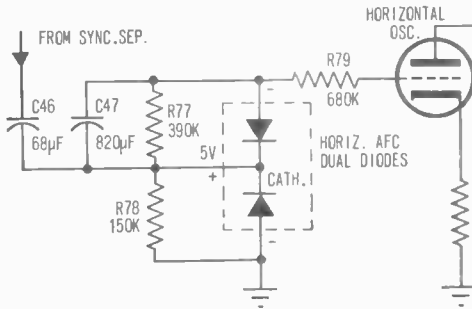

Fig. 16. When the horizontal won't lock in, check the horizontal oscillator and output tubes. If alright, try adjusting the horizontal frequency coil slug, usually on rear skirt of set.

Fig. 17. If horizontal still can't be locked in, the next thing to check is the AFC (automatic frequency control) diodes. They are usually in the form of a single common-cathode three-lead package.

Fig. 18. A single bright horizontal line usually means the vertical oscillator or output tube is defective. Also try adjusting the vertical height and linearity controls (see text).



so do not touch the high voltage nipple—even with the set *off*. As a further precaution, keep one hand *behind* your back, away from the ground or chassis, working with the other. This will keep possible shock from being dangerous.

First off, check the horizontal output, damper, and horizontal oscillator tube, in that order, with the set *off*. Then check the high-voltage rectifier tube after shorting all exposed high-voltage cage connections to

ground to assure everything is discharged.

Look closely for a burned spot on the fly-back transformer indicating it is defective and may have to be replaced. Then take a small, *well-insulated* screwdriver blade, slip the blade under the horizontal output cap while the set is *on* and draw a small arc from the plate terminal. If no arc appears, there is probably insufficient drive voltage to the horizontal output tube. Take a voltage reading at the grid pin; it should be from  $-5$  to  $-25$  VDC.

All of these checks can be made from the top of the chassis. Never measure the cap, or plate, voltage on a horizontal output tube. You can easily wrap the meter hand around the stop terminal. To measure the grid drive voltage, pull the plate cap off the horizontal output with the set *off* and then turn set *on*. If the voltage is normal, the horizontal oscillator section is performing. The trouble must be between the horizontal output tube to the CRT.

**Careful Now.** With the set *off*, carefully pull the cap off the high voltage rectifier tube with a pair of insulated long-nose pliers.

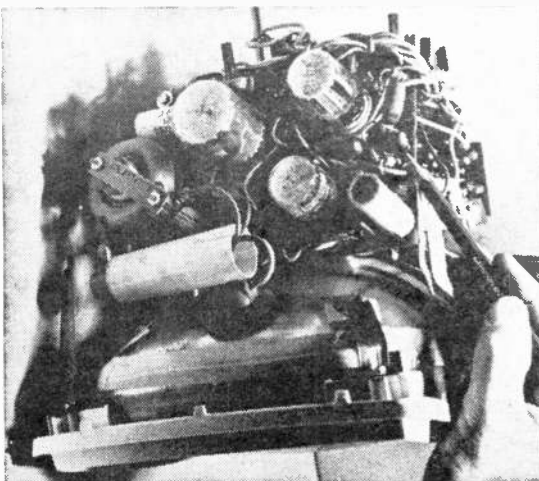

Fig. 19. The vertical oscillator circuit can also cause the absence of vertical sweep. The pencil points to the oscillator feedback coupling capacitor, one possible suspect; also check the vertical transformer.

# THAT TOTABLE TV

Turn the set *on*, let it warm up, and then arc the screwdriver blade to the terminal inside of the high voltage cap. A good hot arc can be drawn up to half an inch long, if the horizontal sweep section is working properly. Turn the set *off* and replace the tube cap.

To see if the high voltage is being applied to the CRT, short the high voltage nipple on the CRT to chassis ground with a long, *well-insulated* screwdriver. Be extremely careful here. Placing the metal screwdriver



Fig. 20. A snowy picture with little contrast and weak detail is often caused by a weak RF amplifier tube in the tuner. This symptom can also mean a broken lead-in wire, shorted antenna, or open antenna coils.

to the ground and sliding it to the high-voltage anode connection should produce a sharp high-voltage arc.

If not, shut down the TV. Short the picture tube high-voltage cap to chassis ground. Also discharge the CRT by using two large screwdrivers, one on the anode connection and the other to black CRT coating. Snap

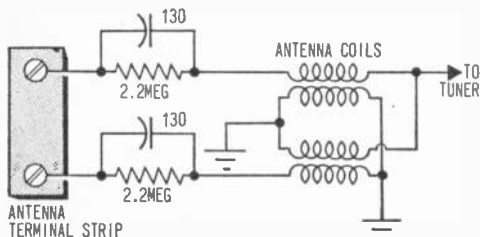

Fig. 21. The antenna coils are usually hooked up in this way. The capacitor/resistor network is designed to prevent lightning from damaging tuner. Check that capacitors, resistors and coils haven't been damaged.

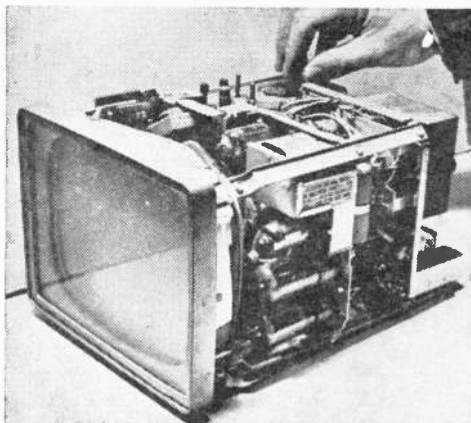

Fig. 22. If the picture jumps around every time you touch the channel selector, the tuner probably needs cleaning. Get a good spray lube and spray it on the contacts while briskly rotating the selector knob.

out the high-voltage cable and fire up the receiver. Arc the high-voltage cable to chassis and a sharp-high-voltage arc should occur. In case there is plenty of high voltage, the picture tube is probably defective.

**Sides Pulled In.** Insufficient horizontal width indicates insufficient high voltage on the CRT. The trouble can be a weak horizontal output, damper, oscillator tube, or all three. Don't overlook the possibility of a weak low-voltage rectifier tube that supplies power to the horizontal sweep stages. Check the setting of the horizontal linearity or width coil, as shown in Fig. 14.

The screen-grid resistor and bypass capacitor of the horizontal output tube are likely components to check if insufficient width is  
(Continued on page 93)

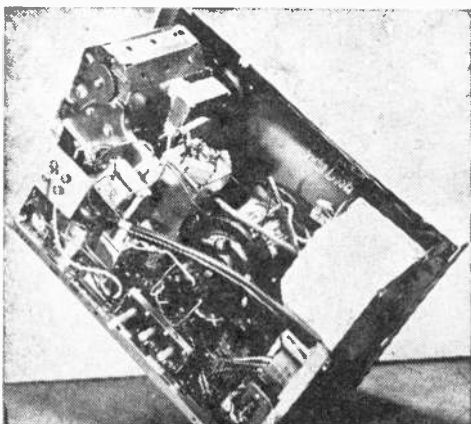
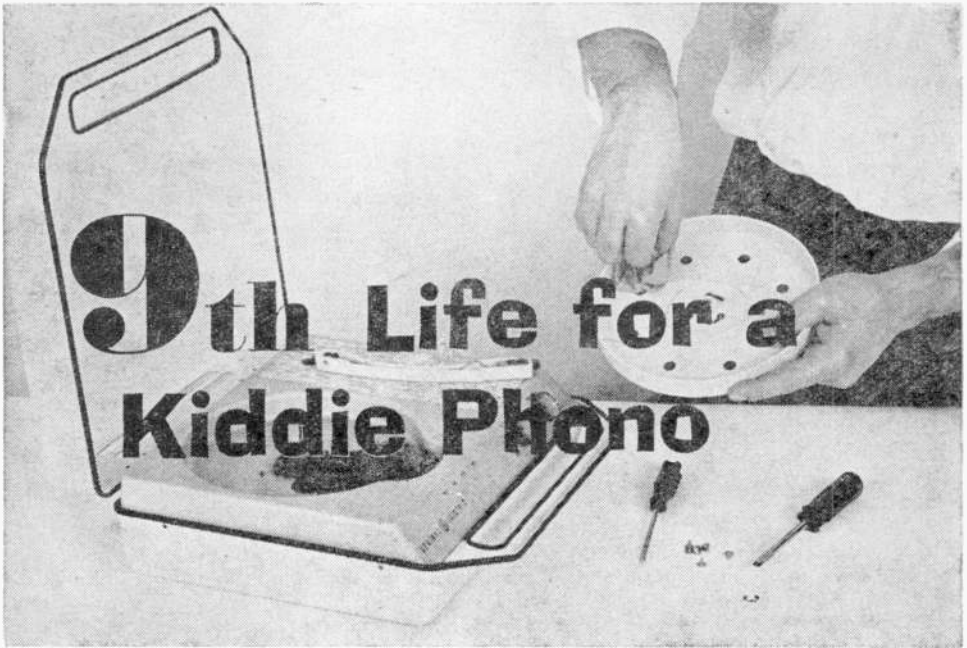

Fig. 23. Attempts at reducing overall size of portable TV sets have resulted in very crowded chassis layouts. This makes the portable a great deal more difficult to work on and care must be used not to damage set.





■ If your child's phonograph has given up the ghost for what you insist *has* to be the last time, think again. For a kiddie phono is so simple a gadget it's bound to have nine lives (perhaps even ninety-nine) before it ends in the trash can. And whether due for its ninth or its ninety-ninth life, any kiddie phono requires a minimum of skill to return to working order.

One of the reasons kiddie phonos are such a breeze to repair stems from the fact that there is really very little that can go wrong. Basically, any kiddie phono consists of a

motor and turntable, a pickup and cartridge, an amplifier and speaker—plus a cabinet to house the lot. And aside from a broken cabinet, most repairs to kiddie phonos center around one of these three basic areas. In other words, it's either the motor and turntable, the pickup and cartridge, or the amplifier and speaker that the due for your servicing attention.

Unless the motor has conked out completely—in which case the entire assembly should be replaced, a general cleanup will probably put things back in the AOK cate-

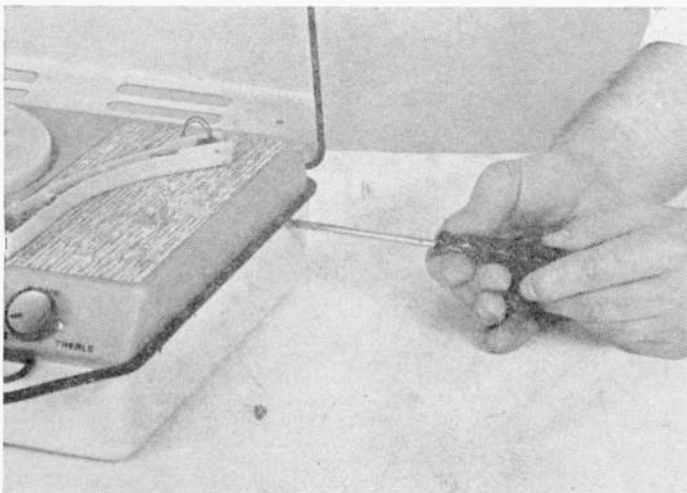

Kiddie phonos vary widely in general mechanical layout and construction, but this General Electric player is not unlike several other brands that have been on the market at one time or another. Disassembling this unit required unplugging line cord from socket at rear, then removing series of Phillips-head screws with a screwdriver.

# Kiddie Phono Repair

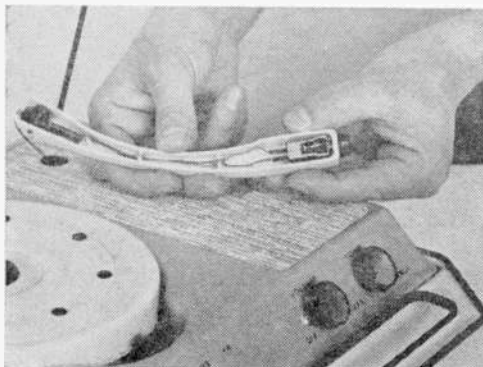

Cartridge and tone arm easily fall prey to injury (note absence of tone-arm base in player above). Needle should almost always be renewed with exact replacement, as should both tone arm and cartridge, if condition warrants.

gory. This can easily be accomplished by removing the pin or E-ring from the turntable, carefully pulling the turntable from the spindle, then cleaning the underside of the turntable as well as the motor shaft and idler assembly with a suitable solvent—a small bottle of GC carbon tetrachloride being a good choice. Use the cleaner sparingly on rubber parts, and be certain to clean the rim of the turntable thoroughly (see photo at top of facing page).

A new needle (now generally referred to as a *stylus*) should put the arm-and-cartridge

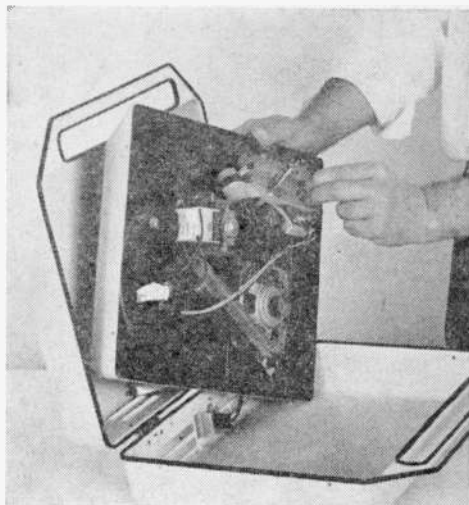

Amplifier/speaker section of kiddie phono generally contains one or two tubes in an AC/DC circuit. Inoperative amplifier usually stems from burned-out tube; damaged speaker often proves to be the cause of distorted sound.

combo back in like-new condition unless either or both has been damaged. If they have, it's usually best to replace both with a new arm-and-cartridge assembly as shown in the photos.

As for the amplifier and speaker, burned out tubes and punctured speaker cones account for something like 90% of kiddie phono troubles in this area. Effecting a cure is almost child's play—plug in a new tube or toss in a new speaker, and you'll have every reason to expect that the set will play like new again.—Ron Mitchell

After carefully noting wiring of leads running into amplifier from cartridge, leads were unsoldered, then single hex nut was unscrewed to permit removal of tone-arm assembly. Since new tone arm was virtual duplicate of damaged unit, fitting it in place called for little more than a reversal of disassembly procedure.

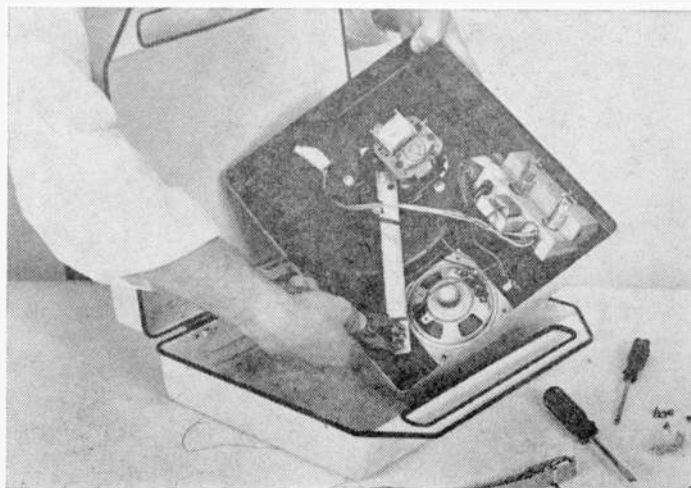

# How to get into one of today's hottest money-making fields—servicing 2-way radios!

More than 5 million two-way transmitters have skyrocketed the demand for service men and field, system, and R & D engineers. Topnotch licensed experts can earn \$12,000 a year or more. You can be your own boss, build your own company. And you don't need a college education to break in.

HOW WOULD YOU LIKE to start earning \$5 to \$7 an hour...\$200 to \$300 a week...\$10,000 to \$15,000 a year? One of your best chances today, especially if you don't have a college education, is in the field of two-way radio.

Two-way radio is booming. Today there are more than five million two-way transmitters for police cars, fire trucks, taxis, planes, etc. and Citizen's Band uses—and the number is growing at the rate of 80,000 new transmitters per month.

This wildfire boom presents a solid gold opportunity for trained two-way radio service experts. Most of them are earning \$5,000 to \$10,000 a year more than the average radio-TV repair man.

## Why You'll Earn Top Pay

One reason is that the U.S. doesn't permit anyone to service two-way radio systems unless he is licensed by the FCC (Federal Communications Commission). And there aren't enough licensed electronics experts to go around.

Another reason two-way radio men earn so much more than radio-TV service men is that they are needed more often and more desperately. A two-way radio user *must* keep those transmitters operating at all times, and *must* have them checked at regular intervals by licensed personnel to meet FCC requirements.

This means that the available licensed expert can "write his own ticket" when it comes to earnings. Some work by the hour and usually charge at least \$5.00 per hour, \$7.50 on evenings and Sundays, plus travel expenses. Others charge each customer a monthly retainer fee, such as \$20 a month for a base station and \$7.50 for each mobile station. A survey showed that one man can easily maintain at least 15 base stations and 85 mobiles. This would add up to at least \$12,000 a year.

## How to Get Started

How do you break into the ranks of the big-money earners in two-way radio? This is probably the best way:

1. Without quitting your present job,



He's flying high. Before he got his CIE training and FCC License, Ed Dulaney's only professional skill was as a commercial pilot engaged in crop dusting. Today he has his own two-way radio company, with seven full-time employees. "I am much better off financially, and really enjoy my work," he says. "I found my electronics lessons thorough and easy to understand. The CIE course was the best investment I ever made."

learn enough about electronics fundamentals to pass the Government FCC License. Then get a job in a two-way radio service shop and "learn the ropes" of the business.

2. As soon as you've earned a reputation as an expert, there are several ways you can go. You can move out, and start signing up and servicing your own customers. You might become a franchised service representative of a big manufacturer and then start getting into two-way radio sales, where one sales contract might net you \$5,000. Or you may be invited to move up into a high-prestige salaried job with one of the major manufacturers.

The first step—mastering the fundamentals of Electronics in your spare time and getting your FCC License—can be easier than you think.

Cleveland Institute of Electronics has been successfully teaching Electronics by mail for over thirty years. Right at home, in your spare time, you learn Electronics step by step. Our AUTO-PROGRAMMED<sup>2</sup> lessons and coaching by expert instructors make everything clear and easy, even for men who thought they were "poor learners." You'll learn not only the fundamentals that apply to all electronics design and servicing, but also the specific procedures for installing, troubleshooting, and maintaining two-way mobile equipment.

## Your FCC License...or Your Money Back!

By the time you've finished your CIE course, you'll be able to pass the FCC

License Exam with ease. Better than nine out of ten CIE graduates are able to pass the FCC Exam, even though two out of three non-CIE men fail. This startling record of achievement makes possible our famous FCC License Warranty: you'll pass the FCC License Exam upon completion of your course or your tuition will be refunded in full.

Find out more. Mail coupon for two FREE books, "How To Succeed In Electronics" and "How To Get A Commercial FCC License."

### ENROLL UNDER NEW G.I. BILL

All CIE courses are available under the new G.I. Bill. If you served on active duty since January 31, 1955, or are in service now, check box in coupon for G.I. Bill information.

### Cleveland Institute of Electronics

1776 E. 17th St.,  
Cleveland, Ohio 44114

Please send me without cost or obligation:

1. Your 44-page book "How To Succeed In Electronics" describing the job opportunities in Electronics today, and how your courses can prepare me for them.
2. Your book on "How To Get A Commercial FCC License."

Name \_\_\_\_\_

Address \_\_\_\_\_

City \_\_\_\_\_

State \_\_\_\_\_ Zip \_\_\_\_\_ Age \_\_\_\_\_

Check here for G.I. Bill information  
Accredited Member National Home Study Council RT-02

**CIE**

**Cleveland Institute of Electronics**

1776 East 17th Street, Cleveland, Ohio 44114

CIRCLE NO. 5 ON PAGE 7 OR 96

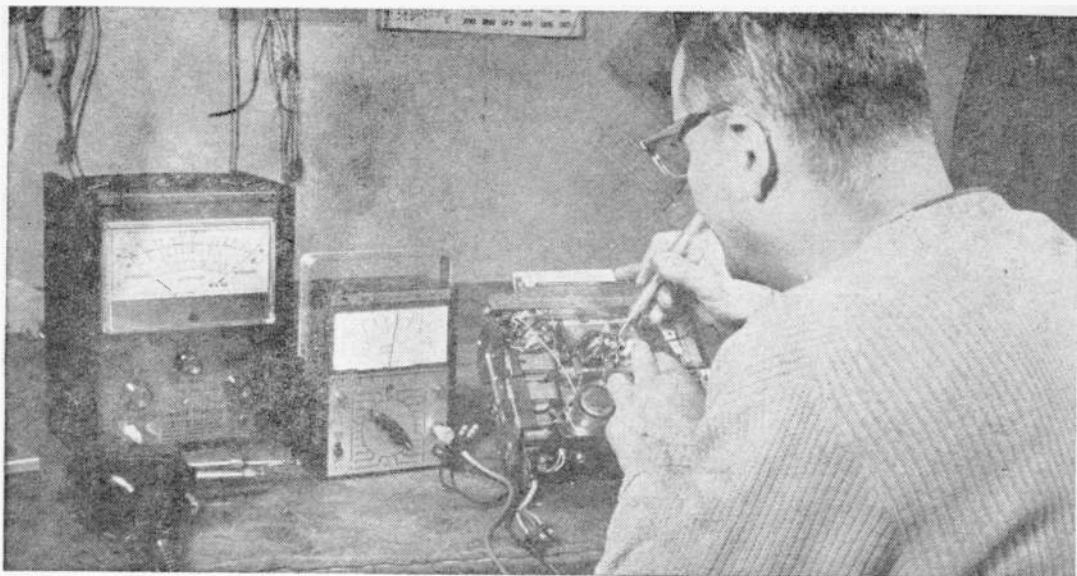

# 8 STEPS TO CAR

**UNCLE SAM** is spending millions to place men on the moon (rumor has it, in fact, that Rosemary's baby is scheduled for a moon landing, though nobody's saying just when). No one's denying that the Apollo missions are expensive and quite complicated electronically. Auto tape player repairs are expensive too, though unlike Apollo missions they needn't be—not if you fix your own.

In the Eight Steps you're about to see, you'll find meat enough to move you well along the way toward truly enjoyable music on the move. Only a few hand tools will be

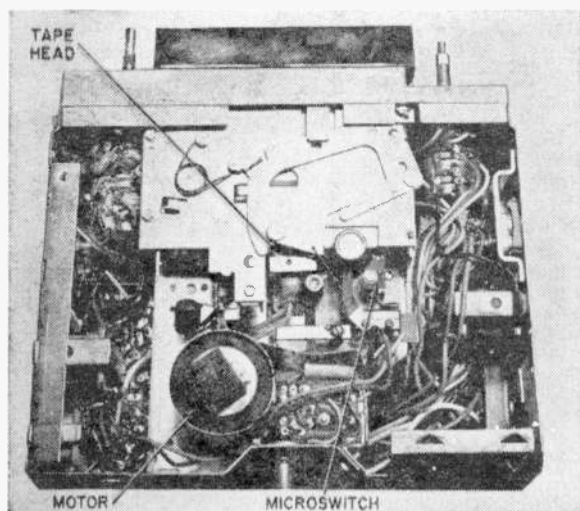

**1** Keep your eyes open as well as your mind when you remove the car tape player from under your dash, to the time you remove the chassis covers on your workbench. Very often a loose connection or screw can be fixed putting the player in tip top playing form. Once the covers are off, do some eyeball poking to turn up the trouble. Remember, most stereo tape player troubles are mechanical. Stop, think and try to isolate the trouble quickly before digging any deeper. And be sure not to misplace any hardware.

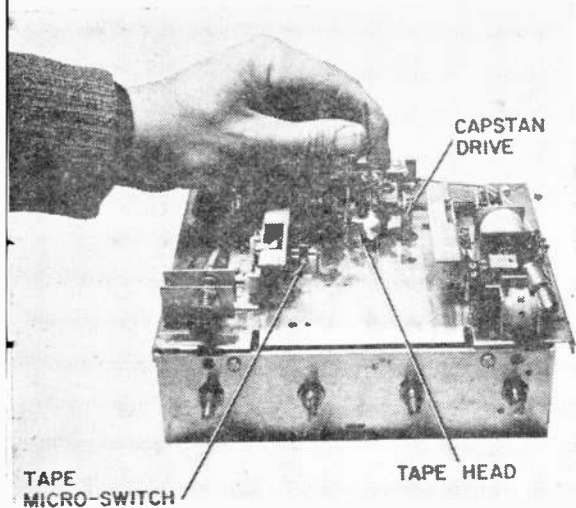

**2** The most common trouble with auto tape machines is excessive dirt and dust. To ensure crisp tape reproduction, keep that tape head clean. A handy gadget to own is a tape head cleaning cartridge. At least once a week insert the cartridge to clean the head. At least once a year, or whenever playback reproduction is not up to par, do a thorough cleaning job. Clean tape head and tape guides with tape cleaning fluid. Apply fluid with a Q-tip. Denatured alcohol can be used. Also, remove tape oxide dust from head and motor capstan drive. Poke around and clean it all up. However, be sure not to throw any tape guides out of position.

by Homer L. Davidson

# TAPE PLAYER REPAIR

needed for most repairs. Just remember to use a pencil-type soldering iron when working in solid-state circuit boards, and don't forget that adage about fools rushing in where angels wouldn't be caught dead. Take your time, take things easy, and think! If you have a signal tracer, VTVM, and/or transistor tester around the shop, by all means drag 'em out and put 'em to work—if you can find work for them. But since most tape player troubles are mechanical in nature, the bulk of the problem rests with you. Ready to take the time to stop, think, and try to isolate that trouble? Then read on.

**3** In many cases, dirt and grease will collect on the motor drive pulley and nearby metal parts. Simply remove all dirt and grease with denatured alcohol. Also, check that capstan flywheel and clean it if necessary. A bright slick-looking flywheel indicates slippage between the drive belt and flywheel. Clean thoroughly. If at all possible, try to find a replacement drive belt. You may have to write to the manufacturer. Power output transistors are installed with hardware that can loosen, causing poor electrical connection. Also, if not seated tightly on their heatsink surface, the power output transistors can overheat and destroy themselves. Be sure they are secured in their sockets.

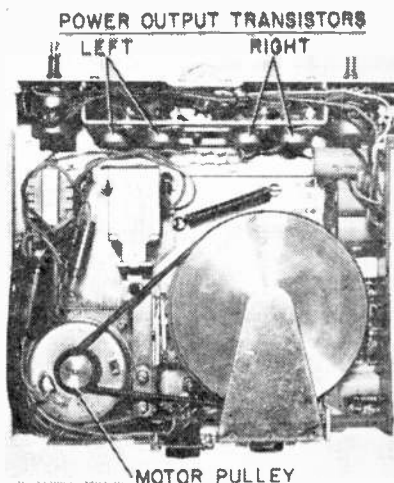

## TAPE PLAYER REPAIR

**4** Excessive tape oxide dust within the flywheel bearing will cause slow and erratic tape speeds. Most capstan flywheels can be removed by pulling out a small keeper pin at the bottom bearing assembly. Now it will be easy to clean all bearing parts and surfaces nearby. Put a drop of oil into both bearings and re-assemble. Let the tape player run for a few minutes on the test bench and check for any oil that may work on the flywheel drive surface. Over lubrication may undo any good achieved.

**5** Does the tape refuse to change to another channel? Or perhaps, the solenoid is working and the channel indicator does not move? To find out what's up, connect power to the unit and listen to determine whether the solenoid is operating or not. A channel change can easily be heard while watching the ratchet. Determine whether the ratchet is turning over a small cam that lifts and lowers the tape head. Eyeballing it here will pinpoint simple mechanical problems that you can adjust to

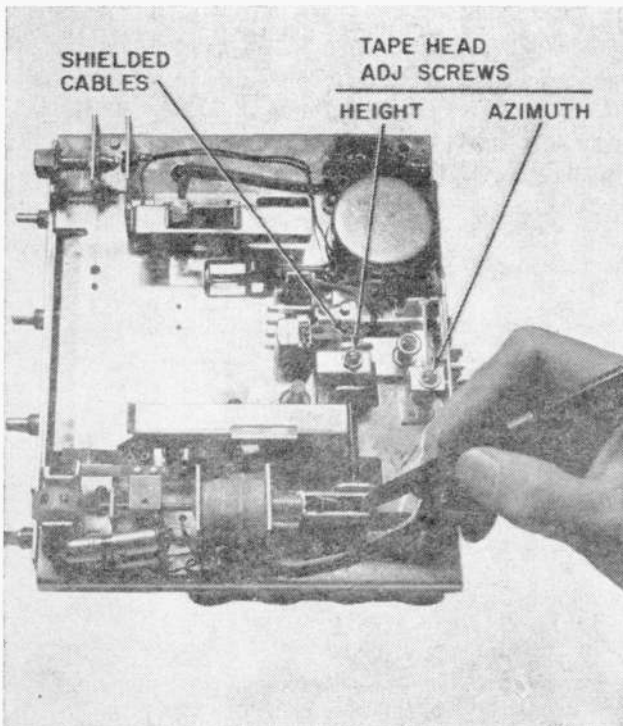
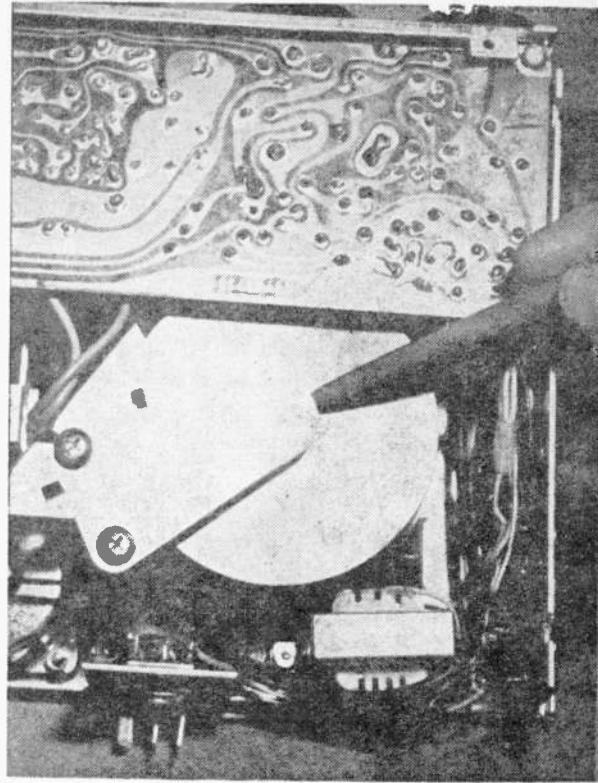

normal operation order. If the solenoid does not operate, it may be shorted out or have an open coil—call your VOM into action. If your playback is erratic or dead, check the shielded cables to the tape head. They can cause lots of trouble. If inspection does not pinpoint the cause of the trouble, you'll need the services of a signal tracer or injector. Be sure the volume control is set wide open.

**6** In case the stereo tape player will not manually change channels, suspect a dirty or broken manual change switch. Momentarily short the two contacts at the back of the change switch. If the solenoid is operating, the tape head will change positions. If not, trace out the wiring and look for a cold solder joint or break. If the switch is loose, it will promote frayed and broken wires. Try to determine cause of failure to prevent its recurrence.

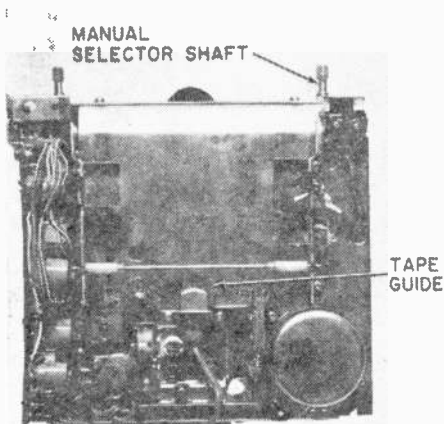

**7** Generally, when the tape becomes wound up into the capstan drive assembly, suspect a rough capstan drive or a poor cartridge. Do not allow the machine to run when jammed with tape. The motor will overheat. In this particular model, the motor protection resistor in series with the power supply burned out and was replaced. Most values are low—like 2.2 ohms. However, check the unit's schematic diagram to determine correct value and wattage. Of course, overheated motors often become defective and replacement is mandatory.

MOTOR PROTECTION RESISTOR

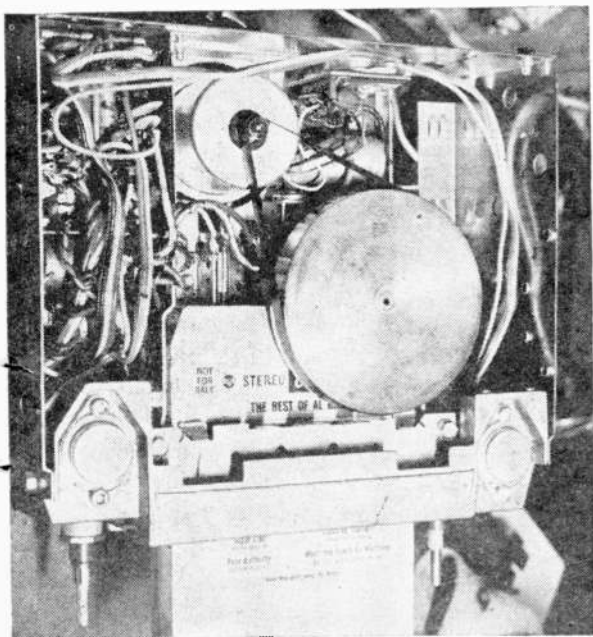
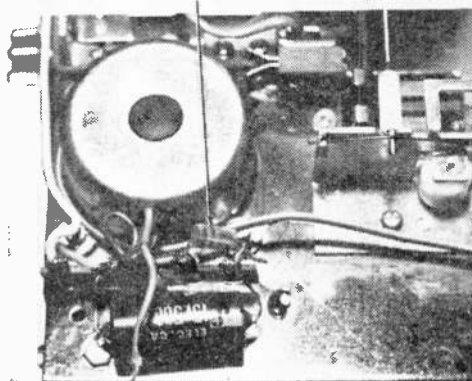

**8** Before clamping the lid on a stereo tape player, give it a good bench preventative maintenance checkup. First, demagnetize the tape head. There are several inexpensive demagnetizers on the market. Second, use a test tape and check both amplifier channels and speakers for proper functioning. If you have the know how and manufacturer specs, check and align the tape head in azimuth and height. Next, install the machine under your dash, make power and speaker connections, snap in a tape cartridge. Now sit back and enjoy good stereo. ■

# YOUR TV SET WILL GET YOU IF YOU DON'T WATCH OUT

by Jackson Kay



**S**creaming sirens and tires tear down the street with skinner lights flashing red. Dark red hulks rumble past your home to a conflagration elsewhere. Lucky? You bet your are if you didn't give your television receiver the care and protection it needs and deserves. Ambulances can give you the same scare action as they whiz by, but they are painted white. No matter what the color, keep these emergency vehicles away from your door by following the safety points and tips that'll keep your TV set safe and operable.

## Location and Protection

- Never place your TV set on an unstable TV cart or stand. Should it fall, pull out the power plug at once and call your TV service technician. Do not move the set!
- Your TV set has slots in the cabinet for ventilation purposes, to provide adequate convection cooling to prevent overheating. Don't cover these slots with cloth, plastic or any other material.
- Never block the bottom ventilation slots of a portable TV set by placing it on a bed, sofa, plush rug, towel, etc.
- Never place your TV set near or on a radiator, heat register, oven, dishwasher, toaster or any appliance that gives off heat.
- Avoid exposing the TV set to rain or extreme moisture as this may result in a fire or shock hazard. Never operate a TV set if liquid has spilled into it. Have your TV service technician check out the set before you turn the power on.
- When installing an outside antenna, use a lightning arrester which is U. L. listed.
- For added protection during a lightening storm, and when the set is to be left unattended for a long period of time, unplug it. Old man weather can zap your house and TV set with lightning or cause extreme power line surges. Either action will cause damage to your set and possibly start a fire.

## Operation and Service

Everyone is a TV set repair expert simply because they own one. Yet everyone has an appendix, but how many friends would you trust to remove yours? Here is some advice on how to operate and service your TV set and stay alive to enjoy it.

● Some sets are equipped with a polarized AC line plug—one blade is wider than the other. This polarized plug will fit into a power outlet only one way. If you have trouble fitting it into a power outlet or require a special polarized extension cord, contact the TV dealer who sold you the set.

- TV sets equipped with a polarized plug or



three-prong plug should not be tampered with to defeat the safety purpose of the specialized plug. Do not replace these plugs with standard two-prong plugs—you'll cause a severe shock hazard in many cases.

- Do not remove the back cover of the TV set as this will expose you to very high voltages. Voltages above 100, 200, 300, even 400 volts are common, not to mention picture tube voltages over 20,000 volts. Remember, 100 volts or more can kill, if not burn or seriously injure your body!

- Never push or poke objects into the TV set through cabinet slots, as it is possible to contact dangerous voltages or short circuits.

- Be sure the TV receiver is turned off before you clean the face of the picture tube. Do not use water or excessive liquids. Do not use scouring powders packaged for sinks—they may scratch the tube.

- Adjust only those controls on the back of the set that are covered in the operating instructions. Mess with anything else and your TV service technician will present you with a larger bill.

- Do not defeat the fuse or circuit breaker by jumping the circuit. When replacing fuses be sure to use the exact replacement.

- Turn the set "off" when it is not being viewed. This procedure will increase the set's useful life.

### Call the Service Technician Now!

- There will be a time when your television receiver needs the expert servicing of a technician. You will know this is a certainty when you're unable to restore normal operation by adjusting the user's controls. When this happens, call your TV service technician.

- It is normal for some TV sets to make popping or snapping sounds, particularly when being switched on or off. If sounds are frequent, call your service technician.

- Always request your service technician verify that the replacements have the same safety characteristics as the original part.

- Never add, or permit a technician to add extension speakers, or jacks for record players or tape recorders to a TV set that has not been designed for this purpose. Such additions may result in an electrical shock hazard.

### Safety First

One good guide by which you should govern yourself when puttering about an apparently defective TV set, is not to perform any adjustment, poking, prying, snooping, cleaning, etc., that you would not permit a six-year-old child do. After all, why is a child's life dearer than yours when TV service technicians are available to do the task efficiently and safely? ■

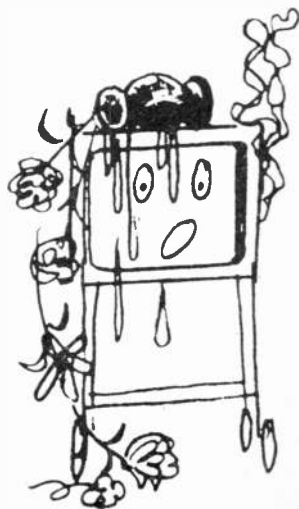
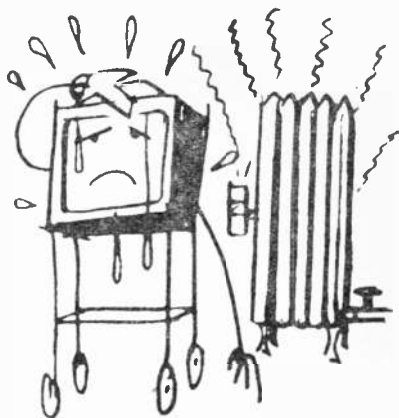

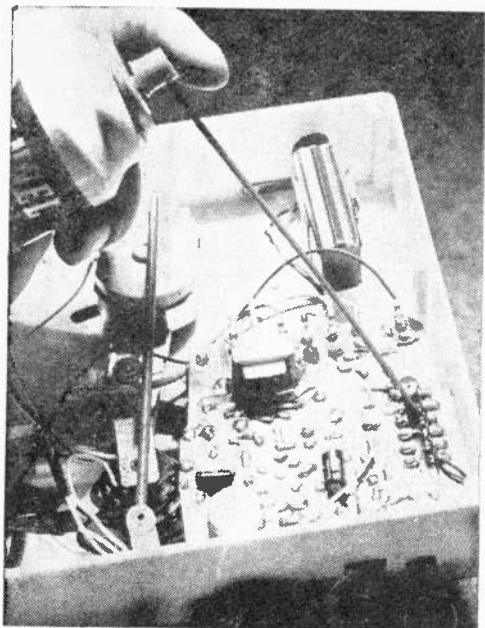

Oil has caused more tape troubles than it has cured, though it can be a godsend if used sparingly. But oil mechanical parts only.

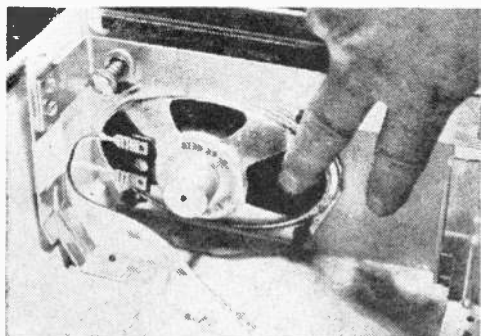

Speaker is often responsible for distorted sound, particularly if finger pressed against cone corrects trouble. Remedy is new speaker.

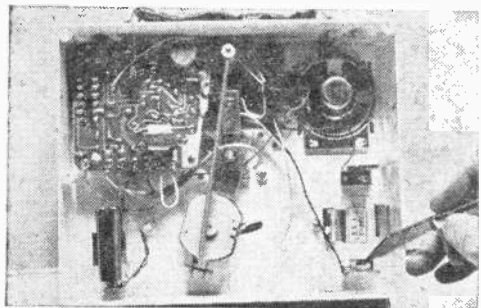

Batteries (if used) should be replaced often and removed whenever recorder is stored. Knife here points to corroded terminals.

# THOSE MINOR TAPE TROUBLES

... and what you  
can do about them

By HOMER L. DAVIDSON

■ Ben Franklin wasn't thinking of tape-recorder repair when he observed that "a penny saved is a penny earned," but the fact is that you *can* cut service calls by making minor recorder repairs yourself. Our photos present a rogue's gallery of common tape-recorder ills, with the suggested remedy indicated in each case. A quick perusal will no doubt reveal what you have long suspected—that the answer to your tape troubles lies right in your own two hands. ■

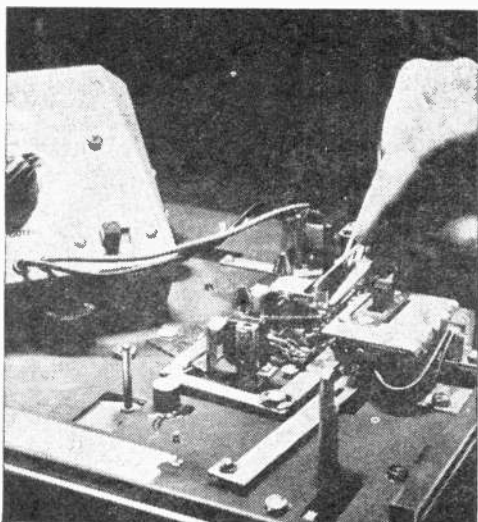

Tubes or transistors are chief reason for loss of record/play functions. Audio generator should quickly pinpoint defective one.

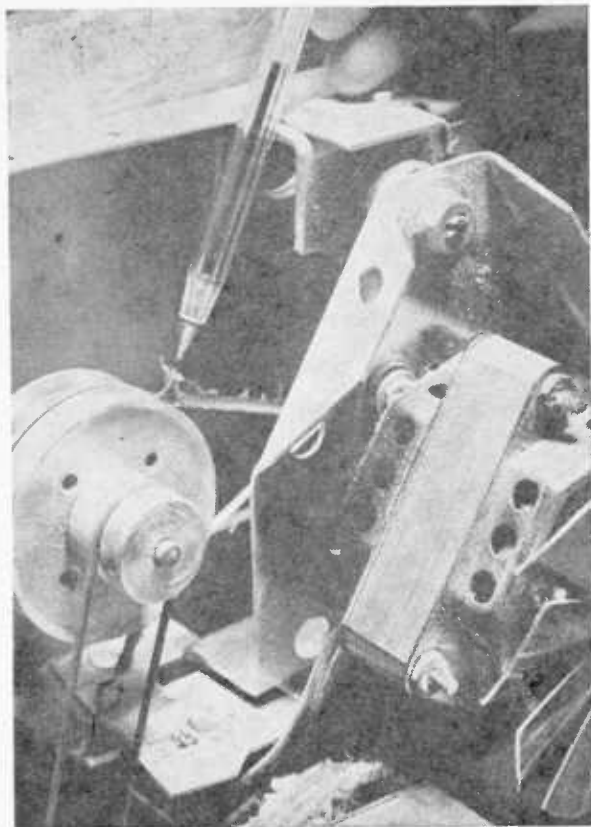

Drive belt may be culprit in recorder with too-slow tape speed. Clean belt with fluid; be certain idler pulley(s) are well oiled.

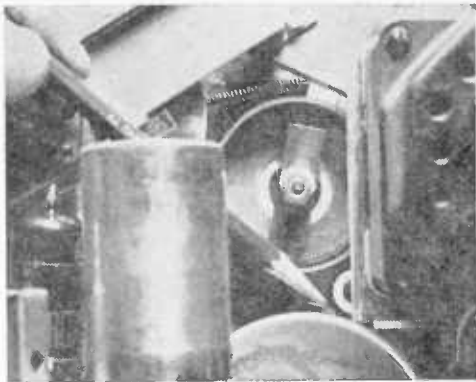

Capstan flywheel, if oily, can result in slippage, as can hardened rubber drive assembly. Remedies: clean flywheel, replace drive

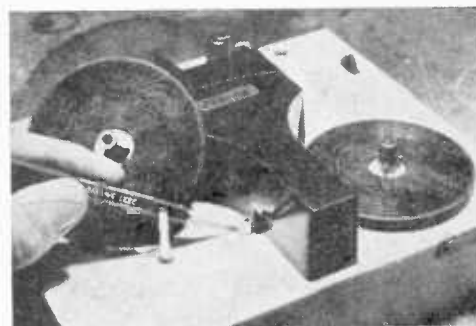

Tape guides and levers can slow tape, even stop recorder if bent or otherwise damaged. To fix, check and correct tape path.

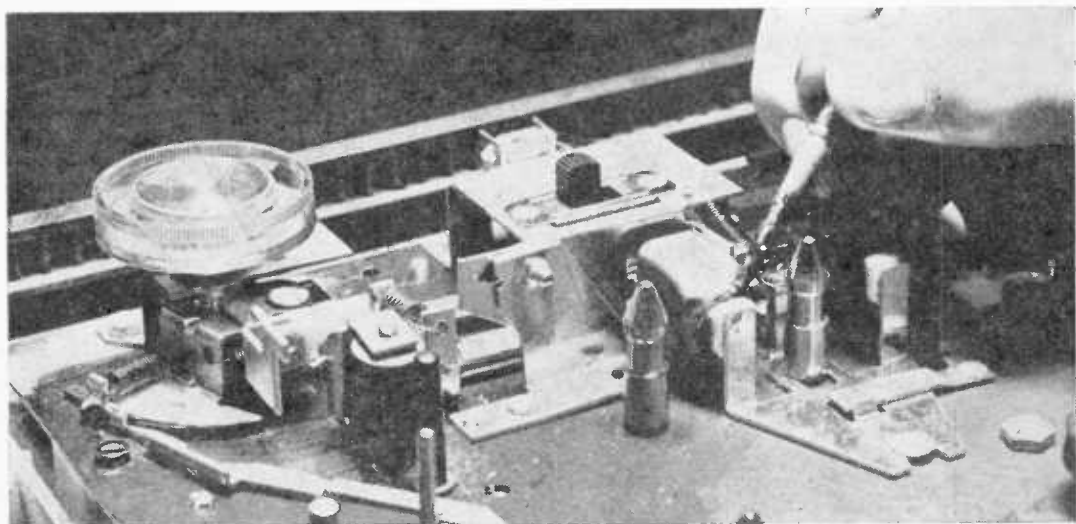

Record/play head holds key to proper operation of any recorder and can be source of weak, noisy, or distorted recordings. Use Q-tip moistened in head cleaner to remove dirt; use demagnetizer to remove residual magnetism and place head in neutral state. (Turn page.)

# TAPE TROUBLES

*Continued*

Rubber pressure roller can result in uneven tape motion, particularly if badly worn (as is roller being held by hand in photo). Since a worn roller cannot be repaired, an exact replacement must be secured from either the manufacturer or his agent.

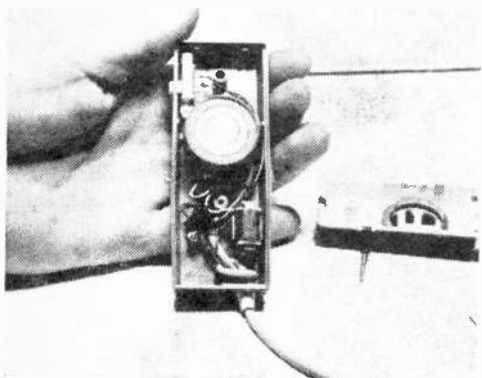
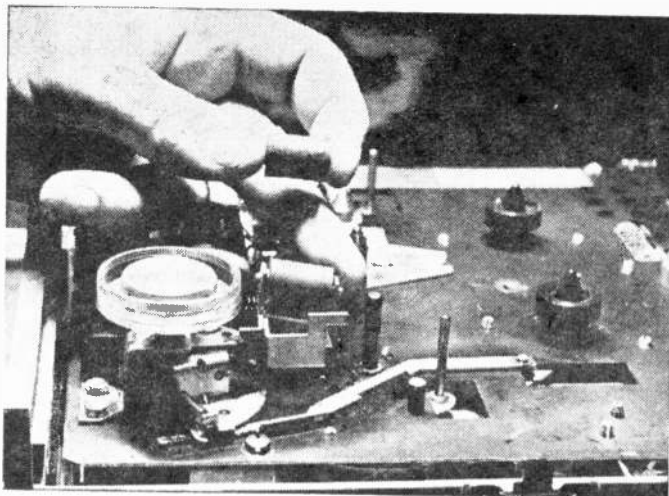

Mike cord can be explanation for intermittent recording, and mike can go completely dead if one or more wires in cable are broken. New cord or mike will solve problem.

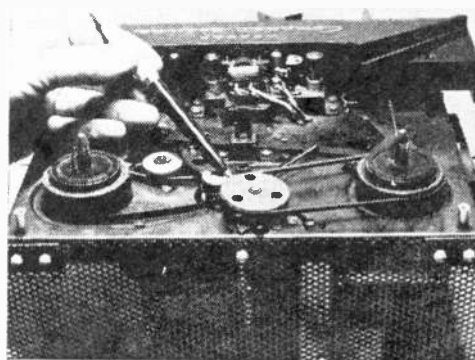

Rewind drive wheel can prevent proper operation during rewind function if it is bent or otherwise defective. In portable units, batteries can also be to blame.

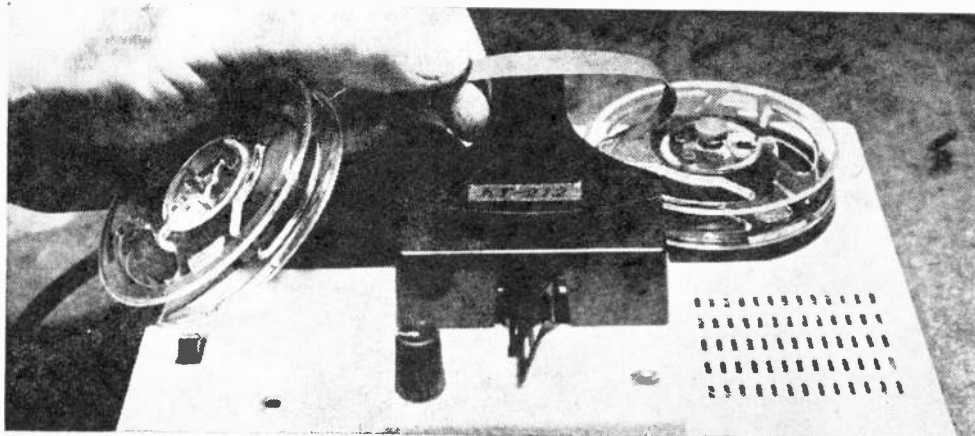

Tape itself holds clue to many a minor trouble. Dull side of tape must face heads if recorder is to function properly; tape must be fully erased if recording is to be clean and unblemished (virgin or bulk-erased tape being the best bet for good recordings).

# GET YOUR CB SIGNAL

## ALL PUT OUT!

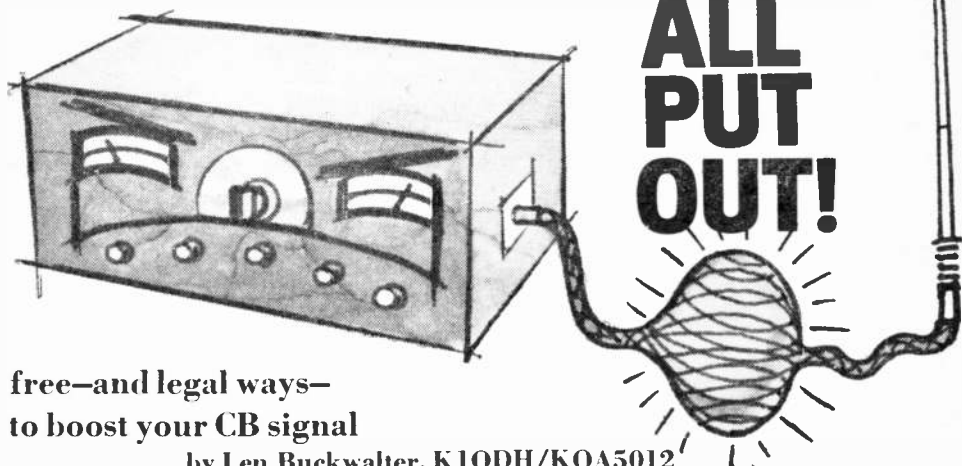

free—and legal ways—  
to boost your CB signal

by Len Buckwalter, K1ODH/KQA5012

**A**n old timer in the radio game once cleared up the mystery of CB antenna matching this way: "Imagine driving a car on an icy road. You gun the accelerator but the rear wheels spin uselessly and you don't go anywhere. Throw sand under the wheels and away you go. What you've done is matched power to load—just like matching a CB rig to an antenna."

There may be little connection between Edsels and electrons, but there's truth to the old timer's analogy. His spinning wheels represent the final radio-frequency amplifier acting as a power generator. Ice represents the load, or CB antenna, while sand is equivalent to a matching device which enables the wheels to bite into the ice—much like an amplifier delivering watts to an antenna. When matching is poor in either case (rig or car) the result is often useless heat.

The need for CB antenna matching springs from the differing impedance of various elements along the line. Measured in ohms, impedance is the AC resistance encountered by the radio signal in going from RF amplifier to transmission line to antenna, and finally to the air. Each element harbors its own characteristic impedance and maximum power transfer won't occur unless all impedances agree—which is to say "matched." What determines impedance

value is often the internal nature of the device. Fortunately, it's possible to tamper with impedances and electronically juggle the numbers. As a rule-of-thumb, a transmitter stage that operates at fairly high voltage and low current displays high impedance. Thus, the final stage of a tube-type CB rig is generally considered high impedance because plate voltage is about 250 and current flow only about 20 milliamperes. These conditions help drive impedance up to thousands of ohms. The impedance of a transistor output, on the other voltage is typically low and current flow high. These shifting possibilities challenge the CB designer, who must build his creations to feed a 50-ohm impedance. Why that figure?

**Picks a Number.** Fifty ohms is a standard value which grew out of fifty-odd years of two-way mobile radio. It's handy for several reasons. One is that a transmission line (connecting rig to antenna) can operate at low impedance, which gives it low operating voltage. The line can safely snake up to a roof or through the car trunk. Also, a standard mobile whip has an impedance of about 50 ohms and there's less of a matching consideration.

As you can see in Fig. 1, the main points for antenna matching start at the RF am-

# CB SIGNAL

plifier final. In this circuit there's a matching device between the output stage and the 50-ohm coaxial cable. The "matcher" is supplied inside the rig by the manufacturer and is usually adjustable by the buyer, but more on this in a moment. The circuit transforms high tube impedance down to the low value of the cable. The second "matcher" is shown as an optional component because, in many instances, coaxial cable hooks directly to the antenna. (Antenna makers also adhere to that 50-ohm value for input impedance of a CB antenna.) An optional matcher, however, could be used between the line and antenna. Some antennas (beams, for example) may need tuning, and accessory antenna matchers are sold for those who want to squeeze the last bit of energy out of the cable running to the antenna.

**Figure 1. Matcher transforms impedance of final RF amp to that of antenna. Optional matcher lowers Standing Wave Ratio (SWR) of voltage within coax cable. Tune both matchers for lowest SWR reading with field strength meter.**

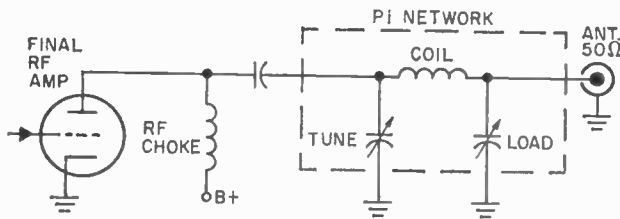
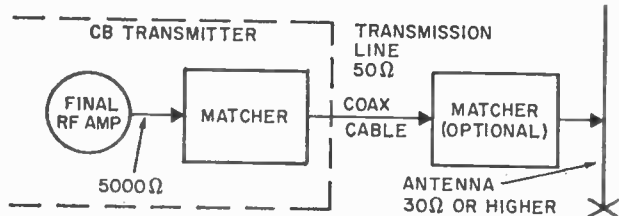

**Figure 2. Schematic of pi-type output impedance matcher found in tubed CB transceivers. Network has two jobs; matching antenna to final RF amp, reducing second-harmonic content in output signal. Adjust load capacitor for lowest SWR.**

**Got a Match.** Unless these major points are matched, maximum power cannot flow. For example, if a high impedance source directly feeds a low impedance load, there'll be a loss because the load acts to short-circuit the energy. If the condition is reversed—low to high connection—then the load can't absorb full power. Further, whenever a bad mismatch occurs, the system suffers "standing waves." These demons develop if power fails to be soaked up by the load. Signals reflect back to the transmitter and cancel part of the power.

Bad mismatch in a solid-state rig can

also blow the final transistors. This often happens as excessive voltages appear at transistor collectors and puncture the semiconductor material. Only through correct antenna matching will the 5-watt CB signal—weak enough to begin with—reach out for maximum range.

**Have Some Pi.** How designers accomplish matching from final amp to the line in a typical rig is shown in Fig. 2. It's the popular pi network formed by two variable capacitors around the final tuning coil. It permits an adjustable match between the tube and a reasonably wide range of impedances in the line. Impedance-transforming action occurs when the capacitors are varied and the output checked on a meter. You tune each control for maximum, being sure to repeat the adjustments several times back and forth to find the combination that produces best power output.

A similar circuit, found in transistorized circuits, is shown in Fig. 3; a double-pi network. The difference is that a tuning ca-

pacitor is joined by two coils with tunable slugs. The combination of components not only resonates the final amplifier to the desired output frequency (27 MHz) but transforms final transistor impedance down to that of the transmission line. A double-pi is used because it provides good opposition to the passage of second-harmonic signals from the final stage. These harmonics fall on 54 MHz and could cause considerable interference to TV channel 2.

In many instances, that's all the matching circuitry you'll find in a CB antenna system. Since line and antenna are each 50 ohms,

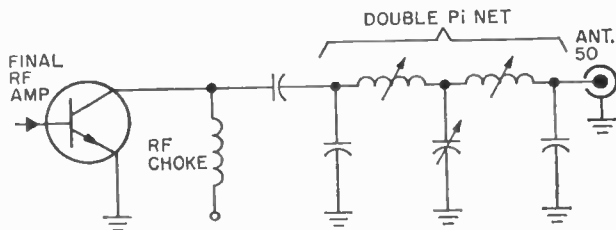

**Figure 3. Schematic of pi-type output impedance matcher found in solid state CB transceiver. As with network found in Fig. 2, double pi network not only lowers impedance of output signal, it also resonates final amp to output frequency on CB band.**

they connect directly together with no further matching. If the transmitter output adjustments are correctly done, the rig should be driving the antenna with maximum energy.

**The Meter Dead-out.** But are the matching controls properly adjusted? Manufacturers usually preset the rig's output controls for a 50-ohm load at the factory, but this might not be the precise value for your installation. The position of an antenna and cable may affect impedance so to be sure antenna adjustments are satisfactory, you'll need some touching up. Some rigs have output indicators (Fig. 4) which tell if the final is putting out maximum signal, but they read indirectly and could be misleading.

A field strength meter (Fig. 5) can more accurately reveal the effect of transmitter adjustments. It's actually a primitive receiver that gives steady indication of carrier strength. Try to place the meter as far as possible from the antenna while taking readings since it's possible to sense magnetic radiation from the antenna, and this energy doesn't contribute much to range. With the rig on, and the mike button keyed, tune the output controls (Fig. 6) for highest field strength. If you have a solid-state rig, don't turn any control more than a turn or so if there's no change in output. You don't want to risk a severe mismatch and possible damage to the semiconductors.

The field-strength meter suffices for tune-up, but an SWR (standing-wave ratio) meter will do an even better job. Its operation is based on the condition that when all components of the system are working at highest efficiency, SWR is lowest. The meter (Fig. 7) is inserted in the line and adjustments made for least SWR reading. When making these adjustments it's a good idea to also monitor relative output on the same meter (either reading is possible). You might mistune the controls enough to knock down RF output and believe efficiency is fine because of low SWR. A constant check on relative output prevents this error.

The SWR meter is also a handy trouble-

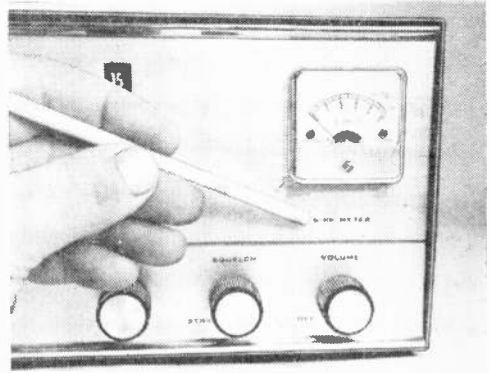

**Figure 4. Indirectly-read S/RF meter can't tell you output SWR. Tune up this kind of rig with aid of field strength meter (FSM).**

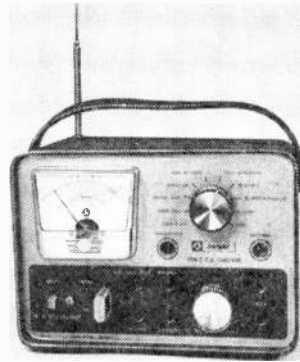

**Figure 5. This mini test lab checks health of entire CB rig from mike connector to antenna. Shown is Knight's Ten-2 CB Checker.**

shooter. If you develop a short circuit in an antenna element or transmission line, the SWR reading will shoot up and spell trouble. A perfect SWR ration is 1-to-1, but this is impossible in practical circuits. Anything below, say, 2-to-1 is acceptable and means that little power is wasted in the system.

**Before the Antenna.** There are a number of accessory antenna matchers on the mar-

# CB SIGNAL

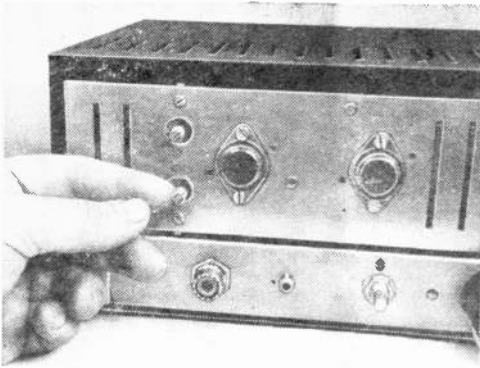

Figure 6. With your rig on, mike button depressed, adjust output loading, tuning controls for highest field, strength reading.

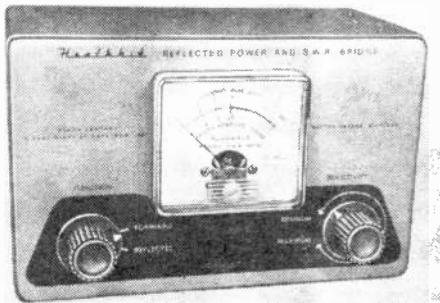

Figure 7. Keep tabs on your CB rig with Heathkit's Model AM-2 Reflected Power and SWR Bridge. Hams also find it useful.

ket and they can be installed by anyone who wants to squeeze the last milliwatt out of his rig (Fig. 8). They are similar to the matching circuits inside the CB rig: usually consisting of tuning capacitors and coils. The difference is that you can install a matcher at the point where the line connects to the antenna.

Inserting a matcher at the output of a transmitter shouldn't be necessary because matching adjustments are already provided by the manufacturer. A good spot for these external matchers is at the base of a mobile antenna (in the trunk, for example). The reason is that mobile whips are rated at 50 ohms, but the car's shape and the height of

the antenna may alter their value. In general, a whip suffers a mismatch because its impedance drops to below that of the coaxial cable when mounted on a car. A matcher can take care of this discrepancy by transforming impedances between line and whip until they agree. This is done by turning the matcher controls while observing either the RF output for maximum or for least SWR indication, as already described.

**Coaxial Cable.** There's a bit of controversy surrounding coaxial cable and how it's matched to the rest of the system. If you purchase the most popular cable—RG/58U—the manufacturer guarantees about 50



Figure 8. Think you can wring more power from your rig with an optional matcher? Here's one made by Gold Line.

ohms impedance. This is implicit in the cable's construction: its center wire and shield act electrically as a series of tiny distributed coils and capacitors. No matter where you cut the cable, it presents a 50-ohm value (at either end). For this reason, a transmission line doesn't have to be tuned or matched, but merely cut to any desired physical length.

Here's where the hassle begins. The cable is 50 ohms—but only if you connect it to 50-ohm devices at both ends. Unless your transmitter and antenna are each operating at 50 ohms, the cable is knocked for an electrical loop and runs at some other impedance. Standing waves created along the mismatched line rock those little coils and capacitors formed by the coaxial conductors. These problems should be cured when you tune the transmitter output controls, adjust the antenna (if possible in your model) or install an antenna-matching box.

Some authorities claim, however, that



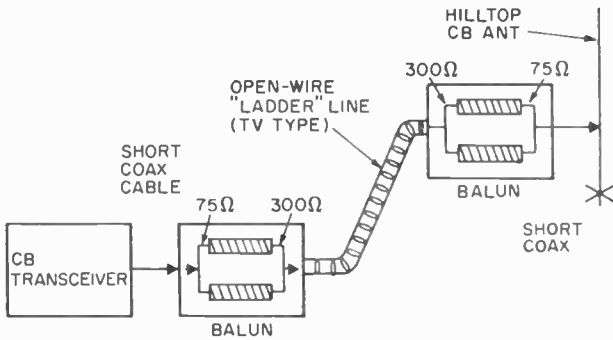

**Figure 9.** Open wire lead-in offers CBER one distinct advantage. Signal losses with this kind of lead-in are very low—hundreds of feet of cable can snake between rig, antenna without CBER encountering extreme signal loss. Only problem with “ladder” line is problem of impedance matching; easily solved with balun coils terminating cable at both ends.

cutting the coaxial cable to a specific length cures some of the loss from cable mismatch in a system that's less than perfect. The cure is based on the fact that a coaxial cable can function as an impedance-matching device when cut to an electrical half-wave length of the signal. To turn this into practical numbers, you'd cut the cable to 11 feet 10 inches—or any multiple of that figure if a longer run is required. The next two length possibilities, for example, would be 23 feet 8 inches, then 35 feet 6 inches. You may not enjoy sensational improvement from this trick, but it should do no harm, and possibly overcome a problem of poor transmitter loading into the coaxial cable because of mismatch.

**Over the Mountain.** The unfortunate CB operator who lives at the bottom of a box canyon or is hemmed in by tall obstacles can leap-frog out of his dilemma by another matching trick. This is the case where you want to run a very long cable to an antenna which clears the obstructions—on an adjacent hill or other high formation. If the run is less than about 200 feet, the easiest way out is to install RG/8U cable. It's 50 ohms, but it operates at less loss per foot than the RG/58U style. But if you must run hundreds of feet, it would probably be cheaper

to try another possibility. It's “open-wire” line; a ladder-like pair of conductors spaced about an inch apart by plastic insulators (the “rungs” of the ladder). This feeder type is sold for TV use on UHF channels because its loss is extremely low. Remember, though, the first limitation of open-wire feeders is that they must be insulated by standoffs all along the way (coax can run anywhere).

The other pitfall is impedance matching. These lines reduce loss by wide spacing and impedances of several hundred ohms. It means you can't connect the feeder directly to a CB rig or antenna since standard ratings are 50 ohms. Yet, if you must run open line to keep cost and losses down, you can transform impedance at either end and come up with a good match. It's done by “balun” coils that are sold for TV tuner repair.

The term “balun” derives from “balanced-unbalanced.” These coils enable you to connect together unbalanced devices (CB rig and antenna) to a balanced device (the open-wire line). Secondly, the baluns provide about a four-to-one impedance transformation to allow these various devices to connect together with no mismatch. We experimented successfully with some inexpensive  
*(Continued on page 92)*

**Figure 10.** Tuning your CB transceiver for maximum watts per mile takes time, knowledge of test gear used. Here's complete test set-up—keep Field Strength Meter as far from antenna as is practicable.

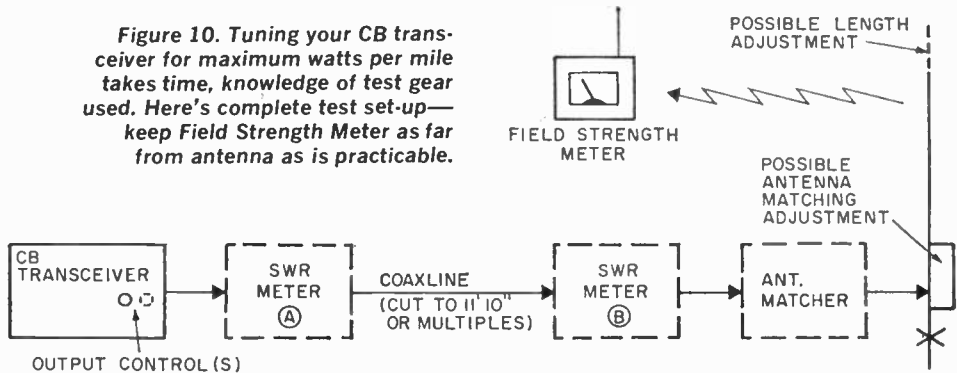

# 11 STEPS TO WALKIE-TALKIE REPAIR

by Homer L. Davidson

**D**on't give up on that sick walkie-talkie! You can fix it yourself by following our 11 steps to CB walkie-talkie repair. You don't have to be a CB expert nor an expert technician to make minor repairs. Most troubles are simple and easy to locate. Only a few hand tools are needed, and five will get you ten they're in your workshop now! Have a little patience and proceed with our step-by-step guide. Remember, most CB troubles are easy to repair. It's finding the trouble that takes knowledge, and this we offer you in steps.

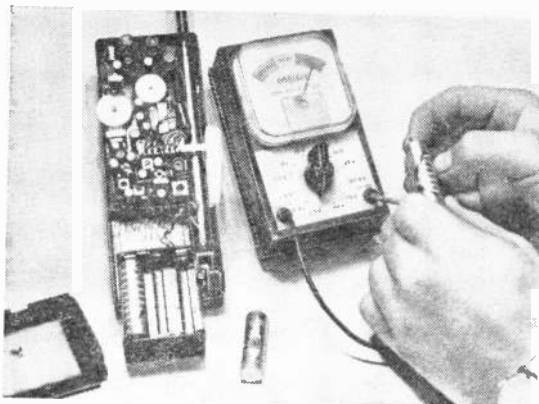

**1** Check those small dry cells first! If you don't have a battery tester, check voltage with the "talk" button depressed. If one or more dry cells are low, replace all. Be sure dry cell contact surfaces are shiny bright or else you lose volts.

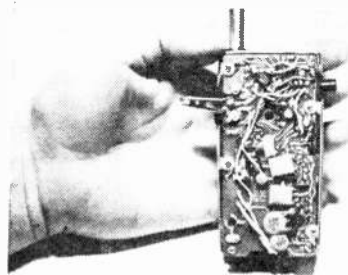

**4** If you can't turn your walkie-talkie on and the batteries are good, then you got switch trouble. The on-off switches in most portables are flimsy and break easily. Use an alligator clip across the switch connections—if this works, a new switch is needed.

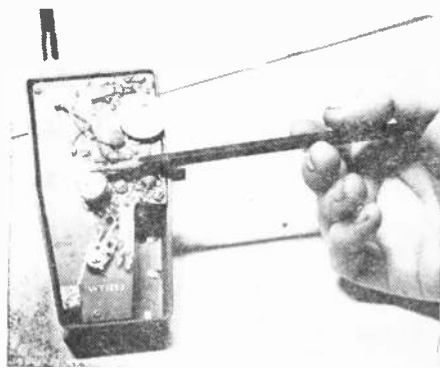

**5** If your unit will not go on the air, then it's time to push, poke, and pull to detect loose components, snapped wires, etc. Poor or marginal connections are responsible for most transmitter problems. Better go back to Step 2 and do some careful inspecting and soldering.

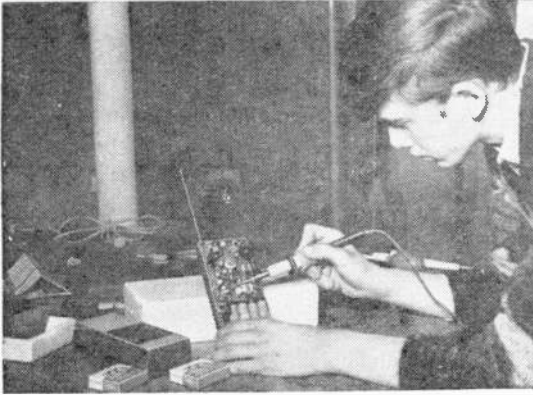

**2** One big headache common to battery equipment is loose battery leads. Use a small-tip, low-wattage solder iron while making repairs. Apply enough heat to make a good solder joint and stop. Nose around for other loose connections or cold solder joints in the printed circuit board. Check switch connections, too!



**3** Walkie-talkie antennas usually break with time because of the abuse they take. Don't toss out the unit because its sky hook snapped. Multi-section antennas are available at most parts suppliers and can be installed in your unit. Be sure to select an antenna that comes close in length to the original. A longer antenna does not mean better reception or more signal out—it may mean poorer operation because of detuning.

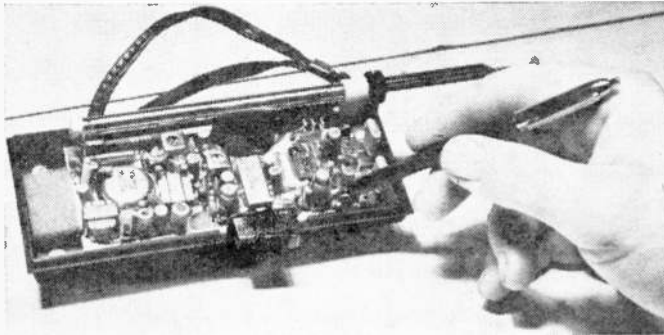

**6** No reception? In super-het models this means trouble in unit's front end as a rule. Check antenna coil for broken leads or loose connections. Travel from antenna to audio section touching transistor leads as you go. As soon as buzz comes from speaker, you know trouble is in previous transistor stage. Check for physical defects and damage before yanking out any transistors.

**7** One good way to get rid of bugs is to spray them dead with electronic Raid. Push-to-talk switches cause a lot of trouble because of dirty contacts. It's not the switch's fault. The unit's low cost prevents use of hermetically-sealed switches, so dirt and dust will louse up the contacts. Use one of the many contact cleaners currently on the market place. A short spray and a dozen switch pushes should clean up any trouble in your rig.

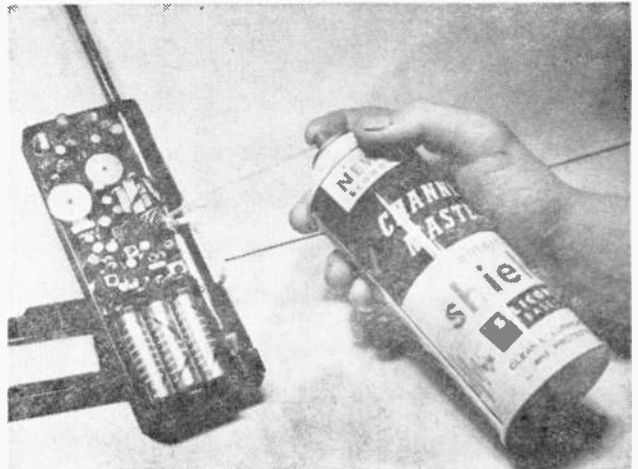

(Turn page)

# WALKIE-TALKIE

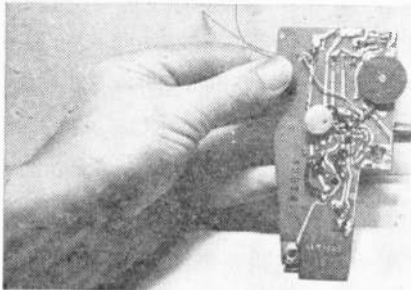

**8** Let's face it, you drop a walkie-talkie and you have to pay the price. In this case it means removing the printed circuit board and patching it up if necessary, not to mention the epoxy work needed on the case.



**9** The sound from walkie-talkies is never hi-fi, but it can get worse with time because dirt, dust, humidity, and what-not tear, jam, warp, etc., the speaker cone. A quick test is to listen to the receiver at low volume—if it still sounds bad, it's time for a new speaker. Most jobs are 8-10 ohm units available from electronic supply houses. Pick a PM speaker replacement with the exact dimensions as the original.

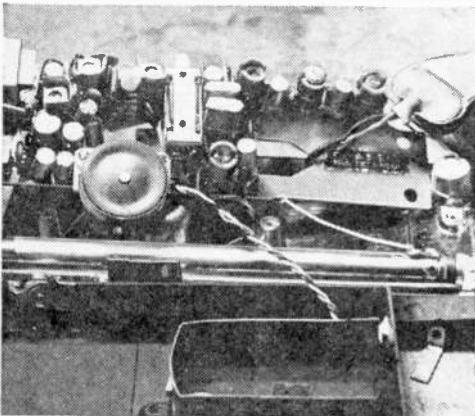

**10** If your receiver looks like it was salvaged from a vacuum cleaner bag, it's due for a thorough cleaning. Here's where old-fashioned GI spit and polish will pay off. Use Q-tips and water-color brushes to wipe and brush away the gook. You'll be surprised at the defects that can be uncovered this way.

**11** If the first ten steps do not get your walkie-talkie on the air, you're in for some dog work. Most rigs come supplied with schematic diagrams—use them to pinpoint troubles. Make resistance measurements and continuity checks. Use the lowest scale setting when possible and likewise for voltage checks. If a transistor tester is available, check each transistor. It's a good idea to compare measurements against your other unit if you own a pair. It's up to you now, we ran out of space.

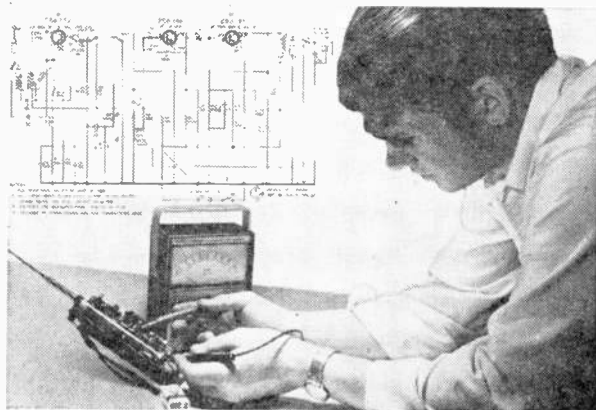

# SUPER-HETER-O-DYNE

WHY THE LAST WORD IN RECEIVERS TERRORIZED THE RED BARON  
by LEN BUCKWALTER, K10DH

**B**ORN out of necessity during World War I, the superheterodyne receiver circuit toppled all existing conventional receiver types on electronics' popularity chart. And to this day, none of the "conventional" radios of that era were able to recapture electronics' limelight. Stranger yet, every branch of electronics is still being swept along Progress' Path by a circuit that—predictably—should have gone the way of the Flivver and Flapper. From military and industrial, to commercial and consumer—everybody who's ever seen a radio, and certainly a television set, has found himself staring face to face with a superheterodyne receiver. Fact is, you'd be hard-pressed to find any up-to-date radio—even the integrated-circuit-and-ceramic-transformer variety—that doesn't somehow utilize the superhet circuit.

After the First World War, the "All-American Five," as it was dubbed, took its place in living room and parlor from coast-to-coast. And it continues to be built today as its inventor generally conceived of it, way back when the circuit was made to track and help locate enemy aircraft spitting fire over French skies.

**Narrow Squeeze.** The superheterodyne found itself ruling the receiver roost largely because it had a redeeming quality no other receiver of that vintage era could boast of. Called *selectivity*, this hitherto unheard-of quality endowed the superhet with the ability

to select the particular station a listener wanted to hear (and later see), and reject all others. Indeed, it was a revolutionary step forward in receiver design. But selectivity was hardly a quality needed back in grandfather's day. Why?

First, grandpop used to listen to signals sent by spark-gap transmitters. The primitive spark signals generated by those common-as-apple-pie transmitters were extraordinarily broad. It was like listening to the lightning crashes you can pick up as you tune across the dial of an AM radio during a thunderstorm. More important, though, there were fewer signals on the air. So, selectivity wasn't too important.

The year 1922 saw the meteoric rise of radio for entertainment and communication. As hundreds of stations took to the air, it became apparent that the primitive receiving gear capable only of broad-bandwidth reception couldn't even begin to handle the impending traffic jam beginning to build on the airwaves. And the problems of receiving but one station, without an electronic cacaphony drowning it out, takes us back even further in electronics' primeval time.

**Cat's Whiskers and TRF.** Digging through to the bottom of the Twentieth Century, we uncover two electronic fossils: the cat's whisker crystal receiver, and tuned radio frequency (TRF) receiver. These were popular predecessors of the superhet circuit.

# SUPERHETERODYNE

The crystal set had the least selectivity of either circuit, and what it did have was obtained mostly from one measly tuning circuit. Consisting of a coil and homemade variable capacitor, these crude tuning devices could barely pick out a desired radio signal and, hopefully, reject all RF intruders trying to elbow their way into the listener's headphone on either side of the signal. The cat's whisker consisted of a strand of fine wire for gently probing, or tickling, the crystal's natural galena surface in order to locate its most sensitive point. Though the cat's whisker detector could extract audio signals from the amplitude-modulated radio frequency signal, the galena detector couldn't help but ruin the radio's selectivity. It loaded the tuning circuit, increasing the listener's chances of picking up stations other than the desired one.

Matters improved with the TRF receiver. It aimed for, and hit, sharper reception dead center, by adding more tuned circuits. This feat wasn't practical with crystal sets, because this circuit's inherent losses ran too high to gain any benefit from any additional coils.

The invention of the triode vacuum tube

gave an engineer the perfect amplifying device. Circuit losses could now be overcome with ease; the TRF took over where the cat's whisker left off, dooming the crystal set to mantelpiece and museum.

Three or four amplified radio-frequency stages were customarily added prior to the TRF's detector, all the while adding to selectivity's cause. However, all wasn't perfect in TRFville.

The amount of noise introduced by the tubes limited the number of TRF stages. So the Silver-Masked Tenor's strains could still be heard with those of the Clicquot Club Eskimos—but not by his choice, or that of the listener.

**Pitching the Low Curve.** The public soon learned that these newfangled TRF receivers weren't exactly the living end. The TRFs, as a rule, failed to perform satisfactorily as frequencies inched higher into kiloHertz land. Seems that as the frequency of the signal went up, the TRF's tuned circuit efficiency for that frequency dropped almost proportionately.

To demonstrate this, look at our example. The bell-shaped curve represents response of a tuned circuit selecting some low-frequency station. The circuit delivers good selectivity, and interference on a slightly higher frequency is rejected.

But examine what happens when a similar

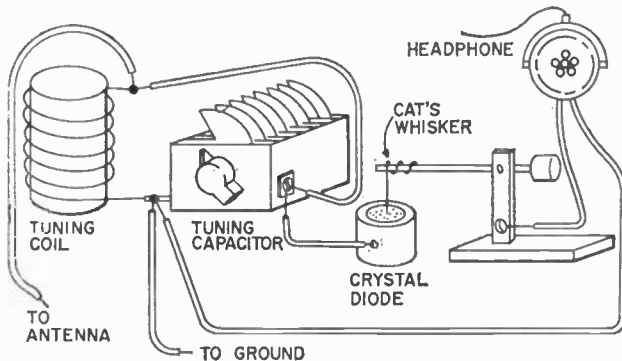

*Schematic representation of crystal radio shows how cat's whisker gently contacted diode surface in order to achieve demodulation of RF signal. Earliest semiconductor diodes made were miniature crystal diode/cat's whisker affairs encased in glass package.*

*Our schematic shows relatively advanced tuned radio frequency receiver. First TRFs had individually adjusted tuning capacitors; ganged units were still to be invented. By adjusting battery voltage 'twixt ground, tuning circuit, radio gain's varied.*

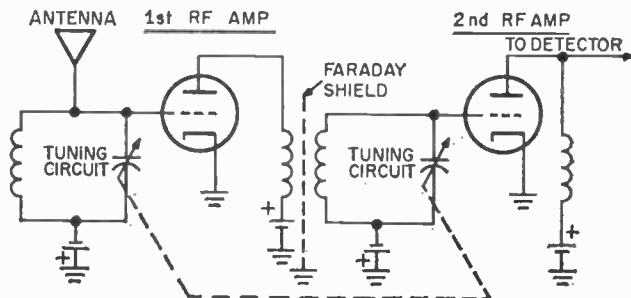

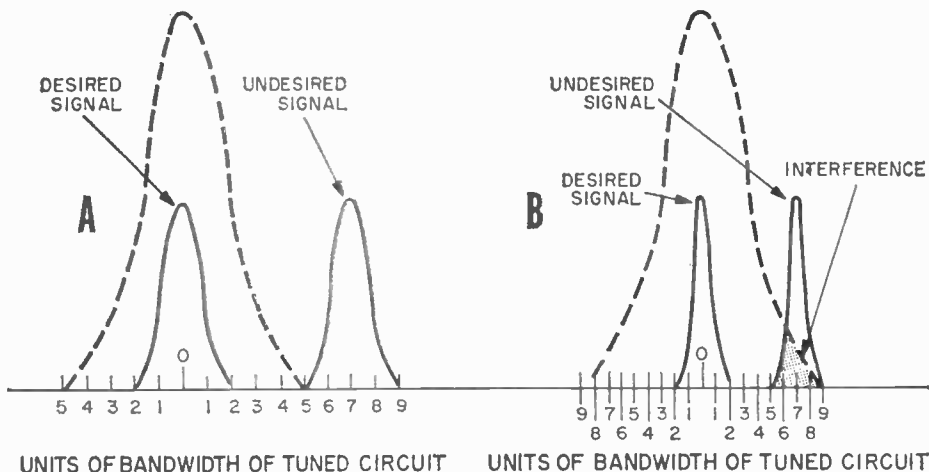

*Tuned-circuit bandwidth varies proportionally with frequency. Tuned circuit A, working at low frequency, rejects unwanted signal. Tuned circuit B, working at high frequency, can't completely reject undesired signal; interference results.*

tuned circuit is operated on a higher frequency. Although the curve's proportions remain the same, it's actually responding to a much greater span of frequencies. Now it's possible for two closely spaced stations to enter the response curve and ultimately be heard in the speaker.

Since tuned circuits grow more selective as frequency is lowered, wouldn't it be to our technical advantage to receive only low-frequency signals? This idea probably oc-

curred to Major Edwin Armstrong, because his invention, the superheterodyne circuit, does just that.

**Superselectivity.** By stepping signals down to a lower frequency than they were originally, the new circuit could deliver neat-as-a-pin selectivity on almost any band. Fact is, this development helped open the high-frequency bands, and by the 1930s virtually every receiver adopted the Major's superheterodyne idea.

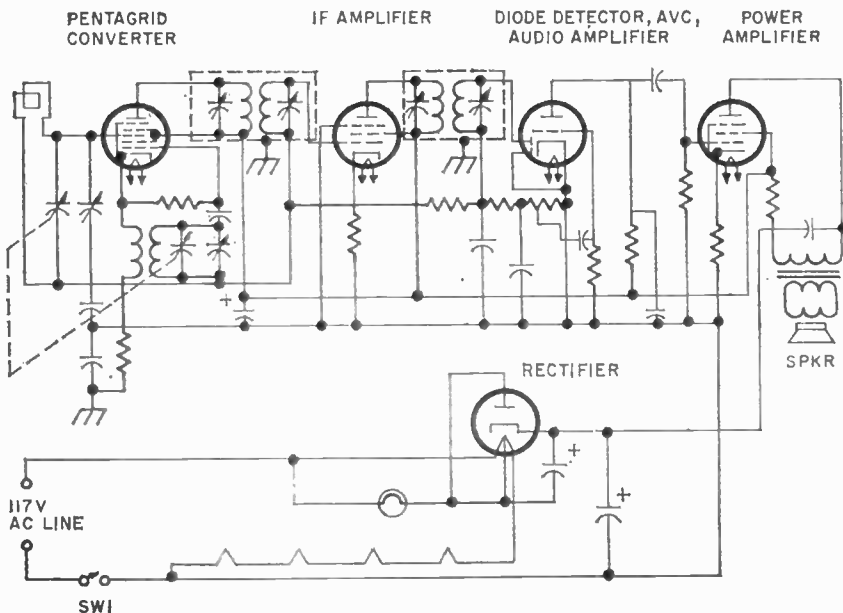

*Schematic of tubed superheterodyne receiver. Virtually all superhets sold commercially are five tube rigs; most are also design-wise electrically and mechanically equivalent.*

# SUPERHETERODYNE

The word "superheterodyne," by itself is revealing. It begins with *super*, for super-sonic, referring to a new signal created within the radio. The generated signal is neither in the audio, nor higher radio-frequency range, but in between. *Hetero* means combining, the *dyne* is force. The newly-created ten-dollar term, *superheterodyne*, neatly sums up this circuit's action.

**Major Blocks.** You can get a good picture of the superhet in its natural habitat if you look at our block diagram. Though our schematic shows a tubed receiver, all equivalent stages tend to do the same job regardless of whether the receiver is transistor or tube. Now that you know what the superhet does and how it looks, let's take a peek at how it works.

For sake of illustration, assume a signal of 1010 kHz in the standard BC band enters the antenna, and from there, is sent down the line to the mixer. But what, you ask, is mixed?

Our frequency mish-mash consists of the different frequencies made up of the desired station on 1010 kHz, and a second signal generated internally by the local oscillator. This oscillator perks at a frequency of 1465 kHz, for reasons which you'll understand in a moment.

True to its name, our mixer combines both signals from antenna and oscillator. And from these two frequencies, it delivers yet another frequency that is the *difference* between them—namely 455 kiloHertz. So far, our superhet circuit changed, or reduced the desired signal to a frequency having an intermediate value. Beating two frequencies together in order to produce a third signal is known by members of the Frequency

Fraternity as mixing, heterodyning, or beating. And some engineers prefer to call the lowly mixer a converter; this term often appears in schematics. But whatever name you throw its way, the result is the intermediate frequency.

There's something else you should know about the intermediate, or IF, frequency. It always remains the same no matter what station you tune to. If you sweep the dial across the broadcast band in one continuous motion, the IF frequency remains constant. How's this accomplished?

It's done by tuning the incoming signal simultaneously with the local oscillator. That's something akin to the mechanical rabbit which paces greyhounds at a race track. In the superhet a ganged tuning capacitor performs this dynamic-duo feat.

Take a close look at the tuning capacitor, and you'll see physically smaller plates assigned to the local oscillator. Since these plates are smaller than the antenna stage capacitor plates, the effect is to lower the capacity, and *raise* the frequency of the oscillator stage. That's how the oscillator stage consistently produces a signal which is 455 kHz above the incoming frequency. But, why bother, you ask?

**More Muscle, Too.** When we convert each incoming station's frequency to the same IF, we gain yet another advantage besides better selectivity. A *fixed-tuned* amplifier always operates at higher efficiency than one which needs to muscle a multitude of frequencies. There are fewer technical bugaboos in a one-frequency amplifier, so our tubes or transistors can operate more effectively at this lower frequency. And last but not least, circuit layout and wiring are less critical. All of this is well and fine, but how do we actually extract our Top-Forty tunes, news, and weather from our super-duper-het?

**Sound Sniffing.** The detector stage recovers original audio voltage from the station's signal. Since we're cranking the RF voltages through a superhet circuit, the RF signal did a quick disappearing act, only to appear as an IF frequency of 455 kHz. Though the original carrier (1010 kHz) is converted downward in frequency to 455 kHz, any audio voltage variations impressed upon the carrier remain the same. So if a musical note of 1000 Hz was sounded back in the radio studio, the note still remains that value in both RF and IF circuits, despite the mixing process.

Like a ladle skimming heavy cream off

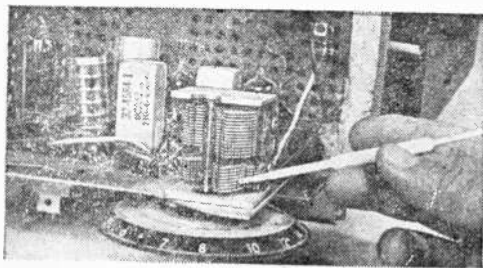

Alignment tool is pointing to oscillator section of superhet tuning capacitor. Smaller, fewer plates mean high oscillator frequency.



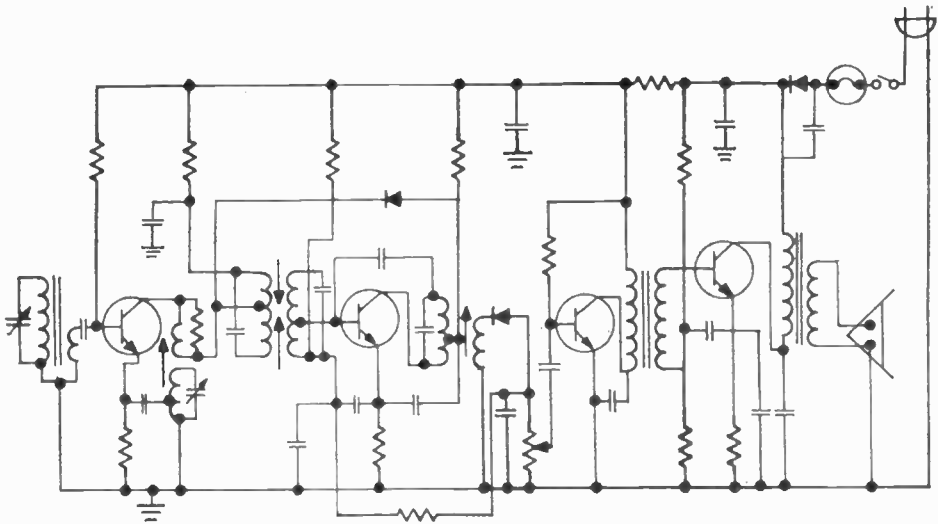

*Our schematic of transistorized superheterodyne receiver is similar in function to tubed superhet found on page 47. Biggest differences between two are semiconductor diodes found in audio detector, AVC loop, power rectifier stages.*

the top of a jug of fresh milk. the detector rectifies either the positive-, or negative-going portion of the carrier, skimming off the audio signals from the carrier. Though audio modulation appears during both positive and negative swings of an amplitude-modulated carrier, only one half of the available signal is used. If both positive and

negative portions of the RF signal were detected simultaneously, the audio signals would cancel each other at the output!

Now let's look at the stages of an ordinary solid-state superhet circuit that might be found in a common table radio or transistor portable.

**Simplified Schematic.** Our diagram is

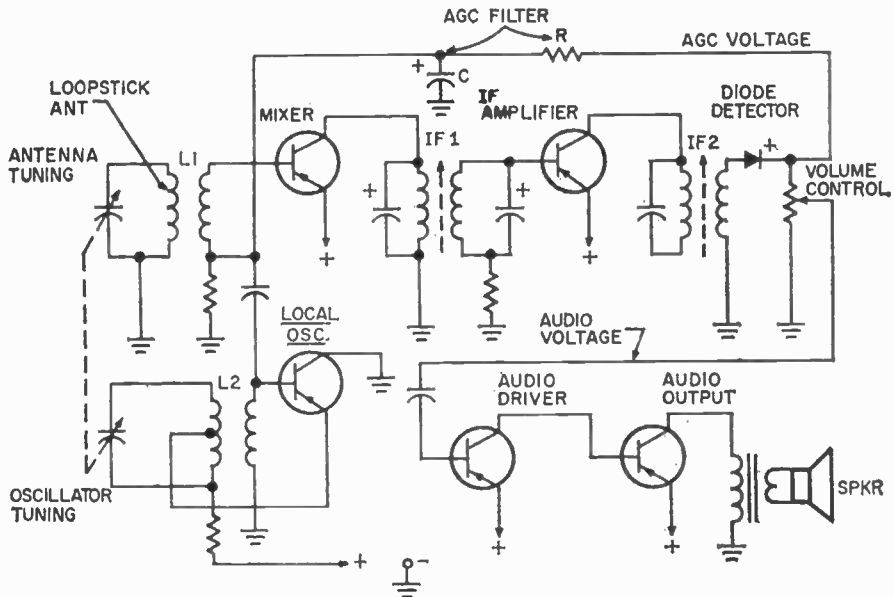

*Most common superhets don't have separate local oscillator, mixer function; schematic above is more typical of BCB set. Communications-type receiver needs added usefulness of separate stages—it's easier to suppress images, input-signal overload this way.*

# SUPERHETERODYNE

pretty typical of transistorized superheterodyne circuits. Of course, there may be variations on this circuit's theme, like addition of an RF amplifier ahead of the mixer to improve sensitivity. The number of IF stages also varies with receiver quality, and specialized items such as filters may appear in ham and SWL rigs.

If you can follow our basic block diagram, you'll have the key to virtually any solid-state superhet. In order to further simplify matters, many resistors and capacitors not essential to our tour through solid-state superhet country have been omitted.

Leading the pack on our superhet speedway is the antenna tuning circuit. Loopstick antenna L1 grabs the RF signal out of the ether, and also serves in partnership with the tuning capacitor in the tuning circuit. You sharpies will also notice that the antenna tuning capacitor is mechanically joined to the oscillator tuning capacitor. (This is represented schematically by a dotted line.) Remember now, we want to develop the IF frequency. This ganged antenna/oscillator capacitor ensures the necessary *tracking* of the local oscillator with the radio-frequency signal.

The oscillator frequency is developed by the oscillator portion of our variable capacitor, and coil L2. In our superhet's schematic, the oscillator signal is capacitively coupled from the oscillator transistor base and sent on its way to the mixer stage. The mixer, therefore, "sees" both oscillator and incoming station frequencies. The electrons from oscillator and antenna circuit get it all together in the mixer's base, producing our intermediate frequency.

If you could look at the mixer's output, you'd see more than just the IF signal. Fact is, the mixer's load contains a jumble of frequency byproducts. As signals combine in this circuit, they add, subtract, and recombine in many ways. It's as if you had to separate the wheat from the chaff with a pair of tweezers!

Only the desired signal emerges from the mixer stage because intermediate-frequency transformer IF1 picks the proper signal to the exclusion of all the others. Now our freshly-created signal passes through a stage of IF amplification, and receiver selectivity is further whipped into shape by the second

intermediate-frequency transformer IF2.

As we've already described, the detection process takes place at the diode, regaining the radio station's original audio signal. This audio voltage is fed from the volume control to both audio stages where they're further amplified and sent to the loudspeaker.

The detector diode doesn't merely extract soul sounds from the ether; it also delivers a second voltage output. Called AGC (Automatic Gain Control), this voltage controls our mixer's amplification, preventing the speaker from blasting when you suddenly tune your radio to a strong station. In our simplified schematic, our AGC voltage is a positive-going voltage which increases proportionately with rising signal strength. But before AGC can control receiver gain, it's filtered for pure DC in a resistor and capacitor network.

Result is a DC signal which can be used to control the gain of the mixer transistor. Thus, if a strong RF signal tries to muscle its way through this stage, the mixer is subjected to a higher bias voltage on its base terminal, which tends to put the brakes on our mixer's gain.

**Pitfalls, Yet.** Let's not lionize the king of receivers, though, for sometimes its growl turns to a puny purr. Biggest problem, and most annoying, is a form of interference peculiar to the superhet known as an *image*. Produced by a mathematical mixup, images are all of those undesired signals finding easy routes to travel through your receiver. Take a look at our image explanation; you'll see the receiver is tuned to a desired signal of 8000 kHz.

The local oscillator generates a frequency  
(Continued on page 91)

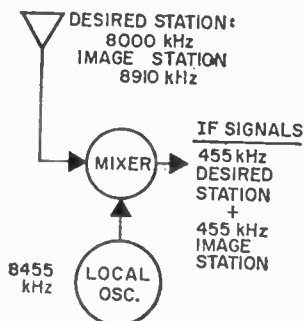

**Mixer is superhet's weakest link as signal handler. Too strong input signal can develop image frequency. Too much local oscillator signal pumped into mixer has same effect.**

# TUNING UP THE ALL AMERICAN 5



By Mannie Horowitz

**M**odern radio as we know it today, is due to one great invention—namely the superheterodyne receiver. Sure people used radios before the circuit was widely adapted. The multi-dial TRF (tuned radio frequency) set was quite popular in the '20's—especially if you could afford one. However, commercial five tube radios as we know them today, originated with the low cost superheterodyne circuit. This circuit has proven itself so fine and effective that it has been adopted for use in practically every FM receiver as well as for the popular five-tube, AM radios flooding this country.

As was the case with the TRF receiver, the RF signal is selected by varying the capacitor in the resonant circuit. This signal

is fed to the first tube, known as the mixer, converter, first detector, or anything else you may wish to call it. Along with this RF signal, a second signal, which is generated in the receiver, is fed to the mixer. The frequency of the signal generated by this local oscillator in the receiver, is 455 kHz above the frequency of the radio station. Thus, if the radio station broadcasts on a frequency of 1100 kHz, the oscillator frequency is set to 1100 + 455 or 1555 kHz. If the radio station broadcasts on a frequency of 880 kc, the frequency of the oscillator is set to 880 + 455 or 1335 kHz. The frequency generated by the local oscillator is varied by a capacitor in the oscillator circuit, as shown in Fig. 1.

It is quite simple to accomplish the varia-

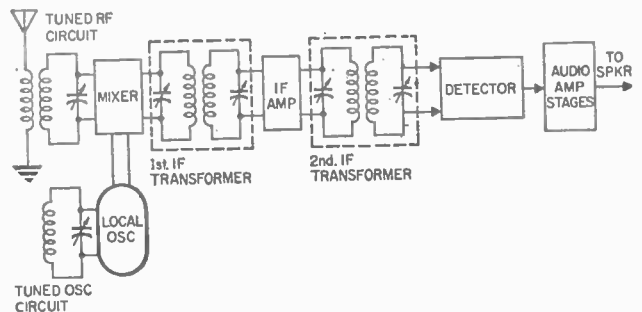

Fig. 1. In the superheterodyne receiver, the incoming RF signal is reduced to an intermediate frequency in the mixer.

# All American 5

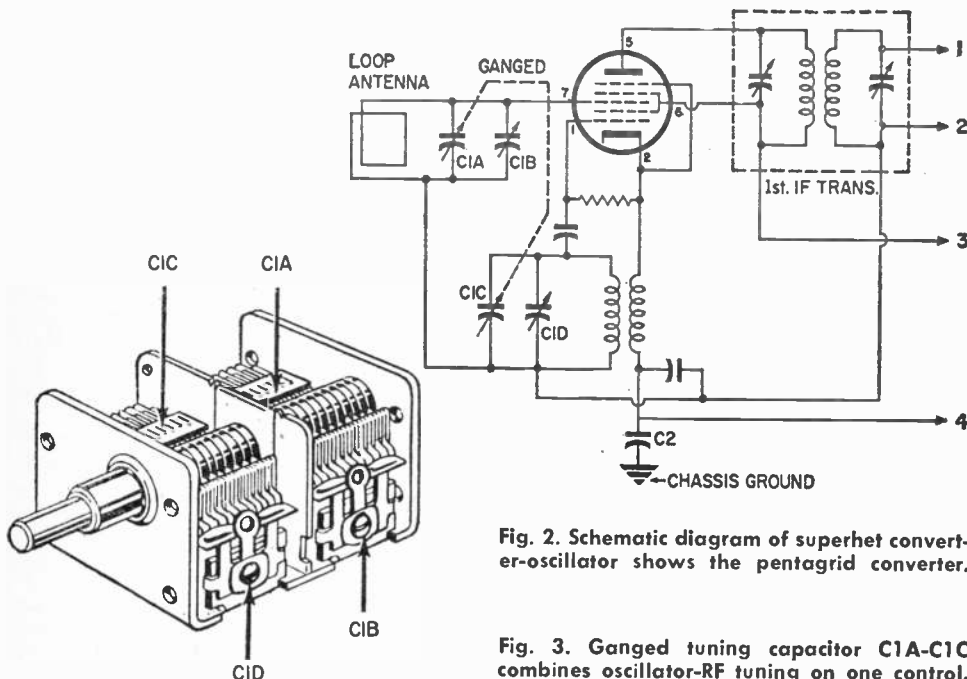

Fig. 2. Schematic diagram of superhet converter-oscillator shows the pentagrid converter.

Fig. 3. Ganged tuning capacitor C1A-C1C combines oscillator-RF tuning on one control.

tion of the oscillator frequency with the variation of the frequency of the resonant circuit in the RF section. The capacitors which tune the oscillator and the RF signal are actuated by one knob. Thus, when a specific station is selected by the RF section of the capacitor, the corresponding oscillator frequency is selected by the oscillator section of the capacitor.

The two signals are combined in the mixer stage. The output from this stage is the 455 kHz difference between the two signals. The 455 kHz difference in frequency is maintained between the oscillator and radio station; thus the difference frequency is available for all radio stations over the tuning range. It should be noted that the audio signal, which was received by the antenna as intelligence riding on top of the RF signal, is now transferred to the 455 kHz signal. It rides on top of this 455 kHz IF or intermediate frequency signal.

**IF Amplifiers.** This 455 kHz signal must now be amplified. The 455 kHz is carefully selected by two IF transformers. Between these two transformers is a stage of IF gain involving a vacuum tube or transistor. This

is not unlike a standard tuned RF stage, except here, only one frequency must be selected and only one frequency must be amplified. This can be done most efficiently.

In the remainder of the unit, the IF signal is detected to separate the audio from the IF carrier, the IF is discarded, the audio is amplified, and sent on to the speaker.

Why the choice of any specific IF frequency, is difficult to determine. It seems that 450 kHz or 500 kHz would be a more logical choice. Is there less interference or better sensitivity using 455 kHz? Or is it just a choice someone made and the number happened to stick? Whatever the reason, the industry has accepted this as the standard. We have no choice but to use this figure when aligning a radio.

**Alignment Requirements.** Although no outline of exact procedures has been described, the above discussion of the superheterodyne radio indicates the alignment requirements. There are two precise factors which must be satisfied.

*First*, the IF transformers must be aligned so that they will pass the 455 kHz IF frequency while rejecting all other signals.

*Second*, the variable capacitor must be adjusted so that the difference in frequency between the RF signal and oscillator is 455 kHz over the entire broadcast band.

Exact procedures using a signal generator and an output meter will be discussed below. However, before this is done, it would be helpful to discuss the circuit of a typical superheterodyne receiver. We will consider the receiver one stage at a time. If you would hook-up the leads (with arrowheads) represented by identical numbers in two successive stages (or two successive schematic figures), you have the schematic diagram of a complete superheterodyne receiver.

**Typical 5-Tube Superhet.** The first tube of the superhet (see Fig. 2) serves several functions. First, it is the oscillator—pins 1 and 2. Then, it receives the RF signal at pin 7. Finally, the two signals mix through the maze of grids to give the final IF frequency—455 kHz at the plate. The first IF transformer is tuned to this 455 kHz. Other RF frequencies that happen to get to the plate circuit are bypassed to ground via the power supply by the action of the 1st IF transformer.

Because these receivers are quite sensitive, the RF signal does not have to be picked up by an antenna on the roof. Instead, a loop antenna at the receiver is usually used. This may consist of several turns of wire on a flat piece of cardboard, or several turns of wire on a ferrite rod. The ferrite material is composed of iron and other metallic oxides combined with ceramic material for rigidity. This ferrite rod is also known as a loopstick.

The loop antenna works in conjunction with capacitor C1A (see Fig. 3) to form a resonant circuit to tune to the radio station. A small variable mica capacitor, C1B, is usually mounted on C1A and connected in parallel with it by the manufacturer of the capacitor. This C1B is used in the alignment procedure. It is known as a trimmer capacitor and is used to trim the combined values of C1A and C1B so that it will resonate at the proper frequency with the loop antenna coil, and at the proper setting of the tuning dial.

The oscillator coil, in junction with C1C and C1D form the resonant circuit to determine the frequency which the oscillator will generate. Capacitor C1C (see Fig. 3) is the main tuning capacitor for the oscillator, and C1D is the trimmer, arranged very

much like the combination discussed above for C1A and C1B in the RF section.

Capacitors C1A and C1C are attached to one shaft. One knob is used to turn both capacitors simultaneously. Screwdriver adjustment screws are set in the variable mica capacitors which are mounted on its respective large air capacitor.

You can usually tell which section of the capacitor refers to the oscillator and which to the RF circuit. The oscillator resonates at a higher frequency than does the RF circuit. Therefore the oscillator section usually has less or smaller plates than does the RF section. This is very much like musical instruments where higher pitched notes come from smaller instruments.

In Fig. 4, a simple IF amplifier stage using the 12BA6 and a second IF transformer, is shown. These are used to amplify the signal from the converter and first IF transformer and provide better selection of the IF frequency. These, in turn, are connected to the detector diodes in the 12AV6, the triode voltage amplifier in the 12AV6 and finally the power amplifier 50C5 which drives the speaker. All this is shown in Fig. 5.

The AC-DC power supply used to provide the necessary DC voltages to operate the radio circuit, is shown in Fig. 6, using a 35W4. Some radios used selenium or silicon rectifiers instead of a tube.

The various interconnections between sections are self-evident. Lead 1 is the link connecting the output from the IF transformer in Fig. 2 to the input of the IF amplifier tube in Fig. 4. Lead 3 in Fig. 2, 4, 5 and 6 is used to interconnect the B+ supply to all stages. Lead 4 in these figures is the common B- ground. (Turn page)

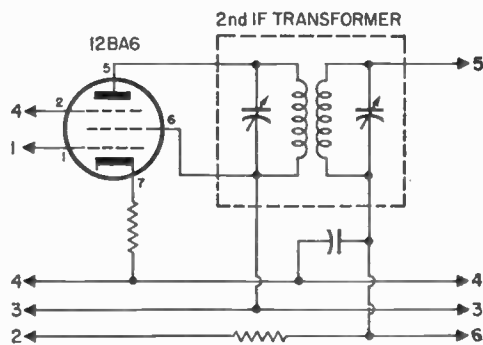

**Fig. 4.** IF amplifier tube 12BA6 boosts signal; second IF transformer increases selectivity

# All American 5

Lead 5 in Figs. 4 and 5 connect the second IF transformer to the detector, while lead 6 connects the audio to the volume control through a resistor.

**Introducing AVC.** Only lead 2 requires some additional discussion. This lead is used to conduct part of the detected signal back, as DC, to the earlier stages. This DC controls the gain of these stages. On strong signals, the gain of the IF and mixer amplifiers is reduced due to this DC. Thus, this lead completes an Automatic Volume Control (AVC) circuit. It sort of equalizes the strength of the final output signal for all stations. In alignment procedures, AVC action is undesirable, for it limits variations in gain at the output. During alignment, the test signal levels are kept low so that AVC action will be negligible.

One other factor should be observed in this circuit. The chassis is not used as a ground for the B-. Because B- is connected to the AC line, grounding the chassis to B- and hence the AC line, can be hazardous. To keep the chassis from floating, it is connected to B- ground through a small capacitor. This is shown as C2 in Fig. 2.

**Aligning Instruments.** Two instruments are necessary in this procedure. One is to be used as a signal source. The second is to be used to measure the output.

In the alignment procedure, three signals should be used. An audio signal should be fed to the audio amplifier section of the receiver (Fig. 5) to be certain that it is operating.

Next, a 455 kHz signal modulated by an audio tone should be fed to the IF stages. The IF stages are adjusted for maximum

output by monitoring the audio signal strength at the speaker.

Finally, two modulated RF signals are required to permit adjustment of the RF and oscillator circuits. One RF signal must be at the high end of the band and the other RF signal must be at the low end of the band.

Several signal generators are available that are capable of producing all these signals. They are shown in the photograph in Fig. 7. The switch positions given in the following text are for the EICO 324 unit which is typical of the units available.

The audio output can be gotten from the two jacks at the lower left hand corner of the unit. The Signal Selector knob is to be set at the "Int. Mod/AF Out" position to get an internally modulated audio output. The "AF Mod/Output" control is used to adjust the amplitude or strength of the modulated audio signal output from the generator. None of the other controls have any effect on the audio. They are concerned only with the RF signal.

The connector at the lower right hand corner of the unit is used for the RF and IF output. The Signal Selector knob is set at its previous position for a modulated output signal. The frequency is selected by use of the Band Selector switch and the rotary frequency control knob. Thus if 455 kHz is required, the Band Selector is set at "B," for this band covers the range from 400 kHz to 1.2 MHz (marked near the tuning scales). The tuning knob is then rotated until 455 kHz appears under the pointer in the window. A similar procedure must be followed for any RF frequency that may be required.

The amount of RF signal output is controlled by the RF Course and RF Fine controls. These are usually kept near minimum during the alignment procedure.

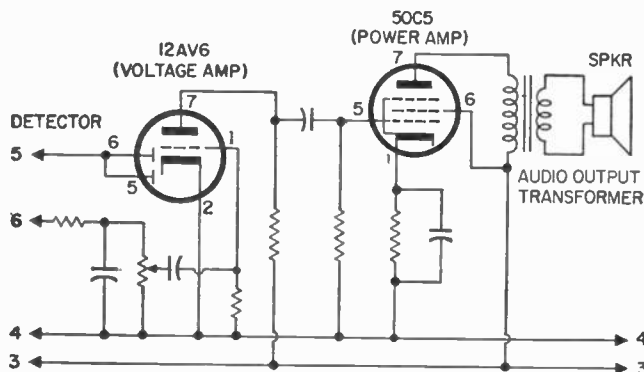
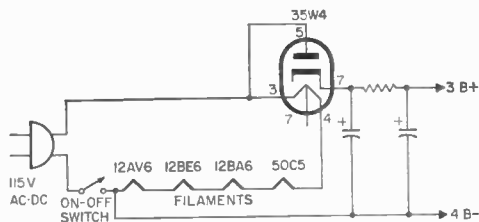

Fig. 5. The audio amplifier section of the receiver combines detection and voltage amplification in the 12AV6 tube, and power amplification in 50C5.



**Fig. 6.** The power supply that provides the DC voltages for receiver utilizes 35W4 diode tube in filtered half-wave rectifier circuit.

Finally, the output from the radio must be monitored in some way or other to perform a proper alignment. The low voltage AC scale on any multimeter can be used to measure the output voltage.

If no meter is available to monitor the output, the signal level may be checked audibly by listening to the speaker and judging the levels.

**The Test Setup.** When the receiver, generator, and meter are interconnected, details and precautions should be carefully observed.

The meter should be connected to the speaker leads in Fig. 6. If one of the speaker leads is connected to a chassis of B- ground, connect the common lead from the meter to this point. If you use the instrument illustrated, it is the lead with the alligator clip.

Connect the AC probe to the remaining lead to the speaker. If the speaker has no grounded leads, the meter may be connected in either direction. If you use a meter which does not have to be connected to the AC power supply, such as a VOM, the leads may be connected in either direction to the speaker.

Now set the Function switch on your meter so that it will read AC. Set the range switch to the lowest range above 1 volt. The output meter is now set up for the entire alignment procedure.

The common from the signal generator must be connected to the B- ground. During the alignment procedure, the signal will be injected from the Audio and RF outputs to various points in the radio. Just where to inject the signal will be discussed in the procedure methods.

Several precautions must be observed when making this setup.

1. Make all connections to the receiver when it is turned off.

2. Excess hum during test may be reduced by reversing the position of the AC power plug in its socket.

3. Never connect an external ground (radiator, water pipe, etc.) to any point on the receiver.

4. In conjunction with caution #3, never place the chassis on a metal bench, steam heat radiator, or any grounded object. If you must use a metal bench, be certain that the power plug is not in the socket or that there is some insulating material between the receiver with the instruments and the table. A large piece of cardboard will do. To avoid shock, do not touch the metal bench and the receiver or instruments simultaneously.

5. To avoid shock when aligning the unit, do not touch any grounded electrical conductors.

6. Use insulated or special aligning tools so that the alignment will not change when you remove the tool from the adjustment screws. A small insulated metal screwdriver may be used.

With this in mind, we can now proceed with the actual alignment procedure.

**Aligning the IF's.** Before touching the IF cans, you must be certain that the audio section is working properly. Connect the top (hot) lead from the audio output of the generator to the hot side of the volume control. This is the top, ungrounded end of the control in Fig. 5. Turn the volume control on the radio and the gain control on the generator to give the maximum output. Now, turn the output level control on your generator down until the sound comes through clean and undistorted to the ear. Note the voltage. During the remainder of the procedure, never let this meter read more than 1/2 this voltage. If it should rise above this value, decrease the output from

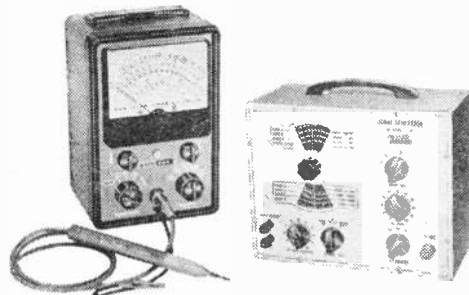

**Fig. 7.** VTVM and signal generator are all you need to align superheterodyne receivers.

# All American 5

the generator with the appropriate control.

Now set the generator to produce a modulated 455 kHz signal. Adjust the modulation control to less than 100% modulation. This is easy with most generators, since they are either not capable of this much modulation or use fixed modulation with no front panel controls.

Connect the RF output from the generator, through a .01  $\mu$ F capacitor, to the grid of the tube preceding the final IF transformer. In Fig. 4, it would be pin 1 of the 12BA6. Adjust the trimmers in the final IF transformer for the maximum output. Keep the oscillator output low enough so that the maximum desirable output voltage level, discussed above, will not be exceeded.

Now, connect the same probe to the RF grid of the converter stage. In Fig. 2, it is pin 7 of the 12BE6. Because of impedance conditions, the level of the output from the generator will probably have to be increased to get a reading on the meter. If no reading can still be made, it will be necessary to temporarily disconnect the tuned RF circuit. This tuned circuit consists of C1A, C1B and the loop antenna in Fig. 2. Now adjust the trimmers in the first IF transformer for the maximum output. Be certain to reconnect RF circuit after alignment is complete.

**RF Alignment.** The big problem with RF alignment is to find a convenient point at which to inject the RF signal.

If there is an antenna terminal, connect the output from the generator to it, through a capacitor. If there is no antenna terminal, as is the usual case, wind several turns of wire into a small coil or "hank." The size is only important in that it should be convenient to place it a few inches away from the flat loop or loopstick antenna, without shifting its position relative to the antenna. A small hank of four loops or turns of ordinary insulated hook-up wire wound in circles of about 3 inches in diameter will do nicely for this coil. The various turns can be held together at several points with masking tape. The masking tape can be used to hold it near the antenna during the alignment procedure.

If you made the RF loop discussed, disconnect both the RF and AF generator leads

from the chassis or B- ground. Connect the two leads from the hook-up wire loop to the RF leads from the generator. Should this loop stop the generator from oscillating (as noted by no output in the receiver) more turns will be required. Just how many turns can be found by trial and error.

If there is an antenna terminal on the receiver, do not disconnect the generator from ground, but connect the RF lead through a 200  $\mu$ F. capacitor to the antenna terminal.

Feed a 1400 kHz modulated signal to the receiver. Set the dial on the receiver to 1400 kHz. Adjust the oscillator trimmer condenser, C1D, for the maximum output.

Now feed a 600 kHz modulated signal to the receiver and set the dial on the radio to 600 kHz. Adjust the oscillator padder condenser,\* if any, for maximum output. If there is no padder condenser, there is usually a screwdriver adjustable slug in the oscillator coil. Adjust this for maximum output.

Next, recheck the 1400 kHz adjustment. Repeat both adjustments (the one at 1400 kHz and the one at 600 kHz) until you get the maximum output and best tracking.

Now that the oscillator section has been adjusted, the RF circuit must be adjusted. Once again, feed a 1400 kHz modulated signal to the receiver. Tune the radio to 1400 kHz. Adjust the RF trimmer condenser (C1B in Fig. 2) for maximum output.

Next, feed the 600 kHz signal to the receiver and set the dial to 600 kHz. Adjust the padder condenser or slug in the antenna coil, if either exists. In some units, it is possible to adjust the position of the coin on the loopstick for maximum output signal. In other units, where no padder facilities exist, the trimmer must be adjusted to give the best maximum output compromise at 600 kHz and 1400 kHz.

If your listening habits favor one end of the band over the other, or one station more than another, it is best to adjust the RF trimmer for the maximum output at the frequency of the favored station.

Repeat the RF alignments at 1400 kHz and 600 kHz until the best compromise is achieved. Alignment is complete when you remove the leads from the signal generator and the RF coil you made. ■

\* Some receivers have a capacitor between the parallel combination of C1C-C1D and the oscillator coil. This is the padder condenser. A padder condenser may be placed in a similar position in the RF circuit.



Teach  
your  
electronic  
pets  
new  
tricks  
with  
our

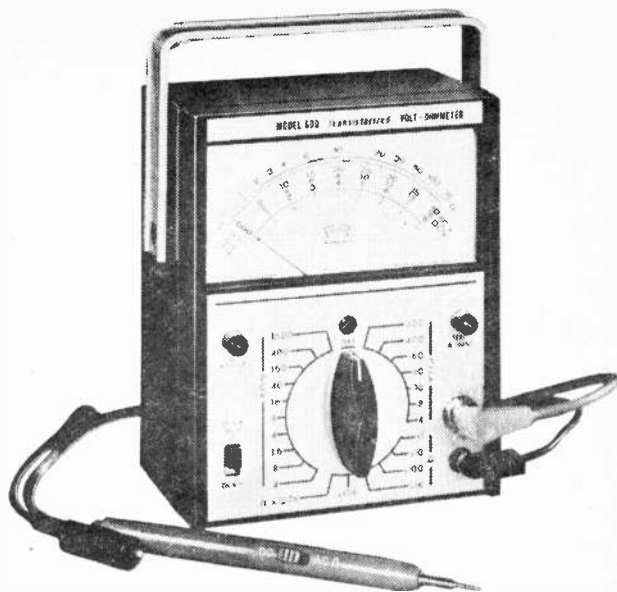

No-Buck

# SEMI CONDUCTOR

## Tester

by Joseph J. Carr

**T**HERE's a semiconductor tester hiding in your workshop. Don't believe us? Mosey up to your trusty multimeter and, presto, it changes, Cinderella style, into a transistor/diode checker! How, you ask, can such a simple device give you the lowdown on a semiconductor's health? Easy! By interpreting the multimeter's ohmmeter scale properly, you can measure diode front-to-back resistance and determine if the diode's leaky. You'll even be able to tell which end is cathode (or anode) when no markings are there to guide you.

Buying transistors by the bagful can be a very profitable way of stocking your supply shelves for those forthcoming projects. On the other hand, lots of those bargain beauties often turn out to be bargain beasties—if they aren't marked by lead function they're as good as worthless. Thing is, you can unravel this mystery with your multimeter. You can even tell whether the unit's npn or pnp. What's more, by carefully tagging each transistor as you go along, you'll know which of those black beauties will perk in RF and audio gear, and which are going to be relegated to power-supply projects.

**Ohmmeter Orientation.** Before jumping into the semiconductor test pool, let's wet our toes with a little ohmmeter theory. Remember how ohmmeters work? A battery inside the multimeter is hooked up in series with the meter movement. Battery current pushes its way through the meter movement into an

*(Continued on page 66)*

# BELL & HOWELL TECHNICAL REPORT

**Subject:** New Home Entertainment Electronics Systems Program

## Competitive Advantages:

- Features first Solid-State Color TV (315-square inch, rectangular screen) Kit for at-home training to build, keep.
- Helps prepare recipient for Color TV Service Business of his own. Covers solid-state circuitry in depth--also other Home Entertainment equipment. Fully updated.
- Provides three additional professional quality kits to assemble, keep, use.

## COMPONENTS:

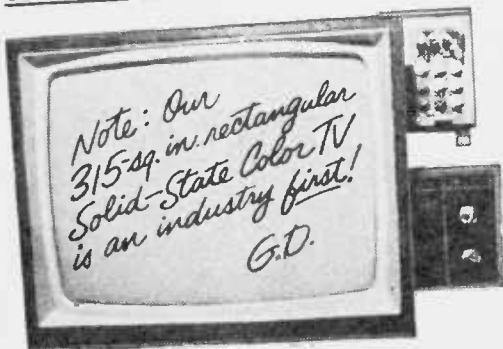

## Specifications:

New 25" diagonal, ultra rectangular screen. 315-sq. inch viewing area. 25,000 volt, solid-state design, w/ 45 transistors, 55 diodes, 2 silicon rectifiers. 4 advanced IC's w/46 transistors, 21 diodes. 2 tubes: picture and high voltage rectifier. Solid-State VHF and UHF tuners. 3-stage solid-state IF. AFT standard. VHF power tuning. Also: "Instant On" circuit, automatic color control, noise limiter.

## Descriptive analysis:

Modular plug-in circuit board design provides for more than 100 advanced solid-state devices. Insures premium color, sound control, exceptional reliability, easy access. Includes Hi-Fi amplifier for sound output, built-in dot generator, tilt-out convergence panel. Handy Volt-Ohm meter permits initial set-up and adjustment plus detailed troubleshooting. 315-sq. inch picture tube face transmits entire image. Push button channel advance. AFT module brings in perfect picture, sound

automatically. Easier to service than older, non solid-state sets. Quality components throughout.

## Electro-Lab-at-Home: Components included:

The Electro-Lab® consists of three units, arriving in 16 shipments which recipient assembles, keeps. All components are professional quality. The circuit DESIGN CONSOLE contains built-in power supply, test light, speaker. Patented Modular Connectors permit plug-in to console to rapidly "bread-board" many different circuits. No soldering or messy un-soldering necessary.

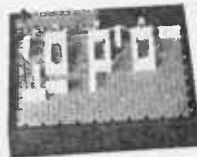

The portable 5-inch, wide-band OSCILLOSCOPE is calibrated for peak-to-peak voltage and time measurements... offers 3-way jacks to handle test leads, wires, plugs. Images on screen are bright, sharp.

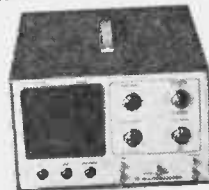

The lightweight TRANSISTORIZED METER combines most desired features of a vacuum-tube voltmeter and a high-quality multimeter. Features a highly sensitive, 4-inch, jewel-bearing d'Arsonval meter movement. Registers current, voltage and resistance on large, easily read dial. CONSENSUS: first class gear.



## Program is designed to give:

- Understanding of electronic circuits in most home entertainment electronic systems
- Ability to analyze and troubleshoot a wide variety of advanced solid-state and other TV circuits
- Capability to understand and use test equipment and procedures with special emphasis on TV testing
- Ability to assemble, test and adjust the solid-state TV kit included with the program

MAIL CARD TODAY FOR ALL THE FACTS  
No Postage Needed →

# Color TV is going Solid-State—here's how to help yourself get ready for it:

There's nothing else like this exciting new program that offers the *first* 315-sq. inch Solid-State Color TV available for at-home training.

As you follow the simple, step-by-step assembly and testing procedures, you will soon become thoroughly familiar with the most advanced solid-state TV circuitry. And you'll help prepare yourself for a profitable Color TV service business of your own—either full or part time.

## Why Color TV pays better.

Today, Color TV is the big seller. And tomorrow, when it goes all solid-state, the man who has mastered this circuitry, will be in demand. This, of course, is where the money is going to be made.

But, this new Bell & Howell Schools program will also give you the in-depth knowledge of the basics as well as TV circuit analysis. You'll get the theory and practical experience you need to handle radios, Hi-Fi's, stereos, tape recorders, B & W television as well as most other home entertainment electronic devices.

## Build, keep your own 25" diagonal Solid-State Color TV Set

Whether you are a beginner, an experienced hobbyist, or a pro working in the field, you are going to be delighted with the performance you get from this new solid-state kit. So proud, you'll want to show it off to your relatives and friends.

The "specs" at left give a few of the facts. But there are many, many features besides these which you will not find in any set on the market today. Send for all the facts and this is the one you'll want.

## You're ready for many kinds of Home Entertainment Equipment

This is a thorough-going program, put together by professionals, with completely up-dated components and materials. When you have completed it, you'll have a new kind of confidence in your ability to tackle almost anything related to electronics in the home. And I can assure that these devices are definitely on the increase!

In addition, you'll have the kind of sound technical background you need for either a career as a technician in the Electronics industry or a business of your own—either full or part time.

Note: TV picture is simulated.

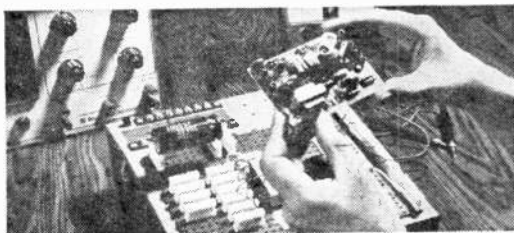

## CONSIDER THESE ADVANTAGES:

Bell & Howell Schools' Electro-Lab-at-Home Plan gives you the most thorough background possible in solid-state Color TV. Everything comes to you by mail. No traveling. You go at your own speed and never miss a paycheck!

When you have completed your program our Lifetime National Placement Service will help you locate in an area that interests you. This service is available at any time—now or in the future.

## Approved for G.I. Benefits.

Our programs are approved for Veterans' Benefits. If you're a Vet, check the space in the card for full details.

## Student Loans now available

If you are a non-veteran and need financial assistance, you may qualify for Student Loans, which are also available.

## Special Help Sessions.

These are scheduled regularly (Saturdays) at seven Bell & Howell Schools and in many other cities. Here you can get expert guidance by top instructors to help you over any rough spots.

Bell & Howell Schools offer you even more. Once you have finished your program at home, you may decide you want more advanced preparation. In this case, you can **earn transfer credits** to any one of our seven schools which are located all across the country.

Mail the postage-free card today for all the facts. There is no cost or obligation of any kind.

DEVRY INSTITUTE OF TECHNOLOGY  
ONE OF THE  
**BELL & HOWELL SCHOOLS**

(TV kit is not available in Canada)



**FREE! MAIL CARD TODAY FOR ALL THE FACTS**  
**No Postage Needed**

# NO-BUCK TESTER

(Continued from page 63)

external circuit, and back to the battery. If we make it hard for current to flow by putting a resistance in series, the meter pointer won't swing as far along the dial. That's why you'll find highly accurate resistors in any multimeter—they limit meter pointer travel so that the pointer always comes to rest at a specific place on the dial. Short an ohmmeter's leads together, and that place, of course, will be zero ohms.

When we connect our multimeter across an external resistance (with the multimeter in the ohms mode), the meter receives even less current than it did before; so there's less swing on the pointer's part.

**Testing Diodes.** Our lives should only be so diode-simple. Diodes are the easiest to test, so we'll tackle them first. Like that famed airplane pilot, Wrong-Way Corrigan, diodes do their thing best in a single direction. We rely on diodes to pass current *unidirectionally*. This unique ability forms the basis for our test. There are four states of being for any diode. They can be open, shorted, leaky, or OK. Before you start testing, it would be wise if you had a sheet of paper and pencil before you to jot down readings.

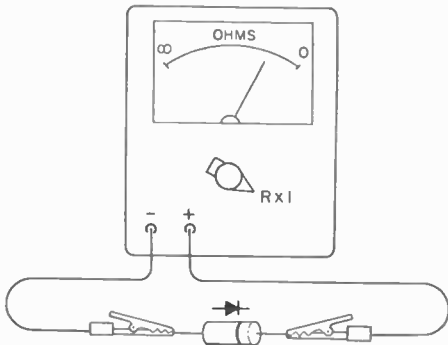

**Place positive multimeter probe on diode lead emerging from banded end. Attach negative probe to unbanded diode lead end. If diode's good, meter pointer will swing upscale.**

With the ohmmeter at Rx1, gently place the probes onto the diode leads. Record your reading—then swap probes and take a second resistance reading. After you take both readings we're ready to interpret what you've found.

Let's assume your first diode under test checked out OK. How'd we know? If the

diode's healthy, one of your resistance readings will be much higher than the other. The actual resistance values aren't important; it's the *ratio* between readings that counts. Consider ten to one (10:1) a normal resistance ratio for small-signal diodes. For instance, if one reading were 500 ohms, then the second reading should fall in the 5000-ohm range (or higher) if we're going to consider this diode OK. You'll find that power diodes yield slightly lower resistance

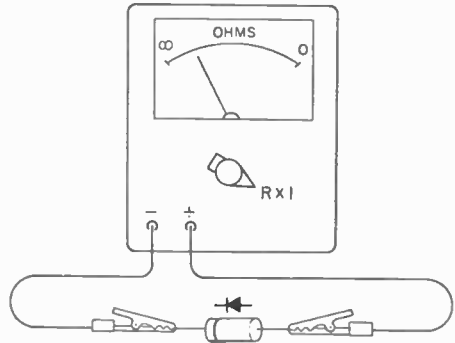

**Negative multimeter probe attaches to banded diode end with positive multimeter probe sitting on other diode end. Resistance ratio is prior reading divided by this reading.**

ratios. Generally, a five to one (5:1) ratio is considered normal because power diodes don't have to be as efficient as small-signal units.

Suppose your first and second readings were almost identical (but not zero ohms). You've got a leaky diode—and for all practical purposes it's as useless as a donkey at a Republican convention. Shorted and open

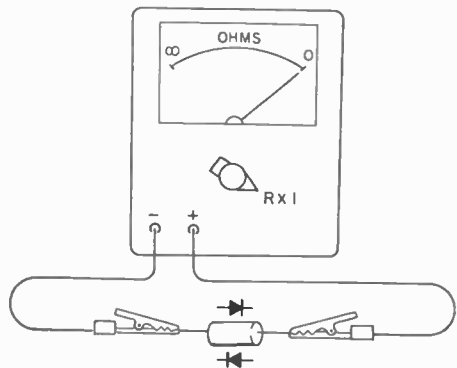

**Here's what dead short looks like. Meter pointer rests at zero ohms with diode affixed to meter probes in either direction. Short can also show as low reading in either direction.**

diodes test exactly as you'd expect them to. The term shorted includes those diodes exhibiting very low resistance values in both directions (50 ohms one way and, say, 75 ohms the other). An open diode wouldn't deflect the meter pointer when tested in either direction.

Last, but not least, you'll want to know which end is cathode or anode on unmarked diodes. Here's where you've got to know relative ohmmeter lead polarities. Take any known quality diode and connect the positive ohmmeter lead to the cathode end. This end always has some kind of band, letter, or mark indicating cathode. Connect the negative ohmmeter lead to the anode and take a resistance reading.

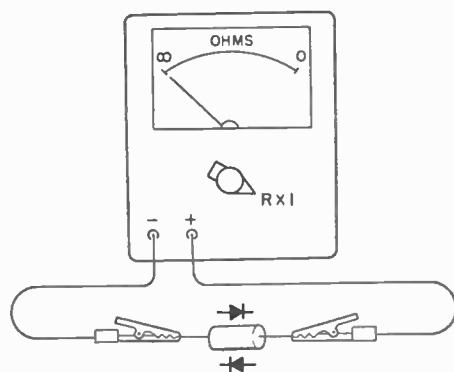

**If meter pointer doesn't budge from infinity, chances are you're looking at open diode. Confirm open condition by testing diode in both directions on Rx100 ohmmeter scale.**

Swap leads—the new reading (ohm-wise) should be lower! The reason's simple enough; when a diode anode is positive with respect to cathode, current flowing through the diode sees less resistance. Now you know that when the positive meter lead's connected to an anode end, resistance readings will be lower. That's how you'll be able to identify any unmarked diode!

There's one more rule you should follow. While testing diodes or transistors, always stick to the same ohmmeter range, whether it's Rx1, Rx10, or Rx100. The Rx1 range should give you sufficient meter pointer deflection. If it doesn't, switch to a higher range. Switching ranges midstream invalidates your readings for that particular semiconductor under test, because you're introducing different currents into it.

**Testing Transistors.** Just as there are thousands of personality types amongst members of the human family, transistor

types can be (and often are) categorized in terms of family behavior—and even sex! Look in any transistor catalog. You'll see that many consecutively numbered transistor types share like characteristics. And while a pnp transistor may not wear eye-lashes and makeup, it exhibits polarity characteristics equal to and opposite that of a like npn transistor.

Let's start by examining a small-signal pnp unit first. The method for checking transistors with a VOM or VTVM is no different than for checking a diode. Perform your tests with the ohmmeter on the Rx1 scale. Connect your negative ohmmeter probe to the transistor base lead. Separately touching the collector and then emitter leads with the positive probe, first you'll detect a high-resistance and then a low-resistance reading. Reversing the procedure (with the positive probe on the base) will show up as low collector resistance reading and high emitter reading.

By now you're wondering what all this resistance hokus-pokus has to do with transistor testing. You've just killed two measurement birds with one stone. First, you found out if the transistor was leaky, shorted, or open between elements. This would become apparent as you made your resistance measurements. Next you either confirmed or discovered the transistor's sex, that is, whether it's pnp or npn.

Suppose the base-emitter junction tests open. This situation is revealed as a very high resistance, whether the positive probe is connected to the base, or the other way

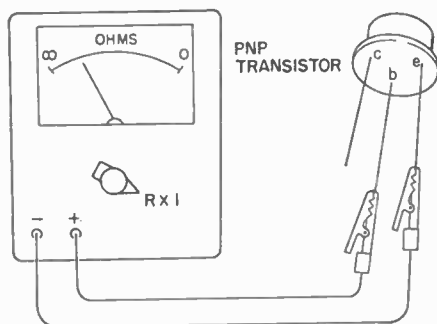

**Base-emitter resistance test for pnp junction transistor; npn transistors show similar result with ohmmeter probes reversed. Be sure you perform test with ohmmeter in Rx1 mode.**

around. If the base-emitter junction tests shorted, you'll see that this condition shows up as a very low resistance, no matter which

# NO-BUCK TESTER

way the ohmmeter probes are placed. Leaky transistors give you a real run for your measurement money. Indicating abnormal base-emitter resistance values, they won't test open or shorted—normal resistance characteristics for that particular transistor family under examination simply won't show.

Finding out whether a transistor's pnp or npn merely amounts to noting lowest resistance values as you check base-emitter junctions. For pnp units, the lowest reading occurs when the positive probe's connected

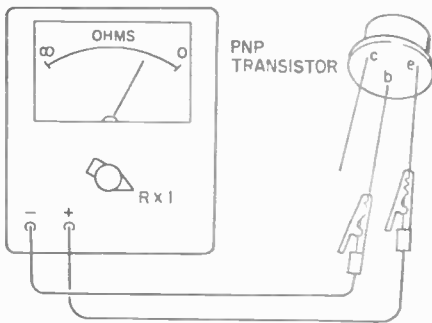

**With positive probe on emitter and negative probe attached to base, meter pointer should deflect upward toward low ohms reading. Be sure to switch probes around for npn unit.**

to the emitter, and the negative lead is hooked to the base. For npn transistors, it's just the opposite. That is, you'll bulls-eye when the ohmmeter positive lead is connected to the base and the negative lead goes to the emitter.

**Explaining the Unknown.** Even if you didn't know that a pnp transistor was under test, you could still play the switch 'n swap ohmmeter lead game. Our procedure isn't more difficult—you'll simply need to pay more attention to your readings. First, mount a transistor to a surface that's easily written on—a piece of paper or cardboard will do. Label each transistor lead X, Y, and Z.

Now pick a lead (say lead X), and attach the positive ohmmeter probe to it. Connect your negative probe to another transistor lead, say lead Y. Take a reading, writing the value recorded between the leads on the paper. Now reverse your ohmmeter probes, taking another set of readings between the

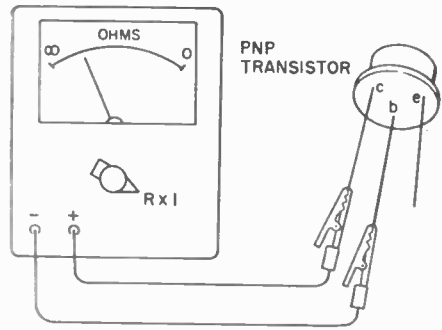

**Base-collector junction test reveals excessive leakage. With multimeter connected as shown, pointer should barely deflect. Transistor's power rating greatly influences leakage value.**

same two transistor leads. Again, write the value between the leads.

Move your ohmmeter probes to a second pair of leads (Y and Z for instance). Repeat the resistance recording operation. Eventually, you'll want a set of values between all transistor leads.

Let's interpret our readings. One set of resistance readings will be almost identical. You've found the emitter and collector—label one lead *E* and the other *C* (for the moment, it's entirely arbitrary which lead receives either letter). Since you've located both emitter and collector it stands to reason that base is your only unmarked lead. Write *B* next to this lead.

Assume, for the moment, that you've got an npn transistor labeled. If your base-emitter resistance reading was lower with the

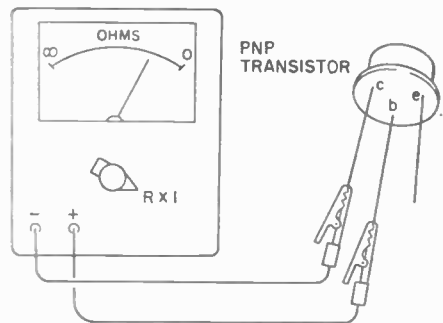

**Leakage reading is also affected by temperature. Therefore, transistor should be at room temperature for leakage test; results'll be deceptive with unit connected as shown.**

positive ohmmeter probe connected to base (base-emitter junction test), and the base-collector reading was higher with the positive

*(Continued on page 91)*

# ERECTING A

# ROOFTOP TOWER

Forget about masts, guy  
—a rooftop TV antenna  
require less money,

**D**o you really want to climb Mount Everest to get good TV reception? Are you waiting for the moment when your mast gets the shakes and comes toppling down during a storm that was never supposed to show up?

If you get the wim-wams thinking about all the complications that might come up when erecting a mile-high TV antenna—or if you've already been through the mill—this guide to erecting a roof-



wires, and dizzying heights  
will take less time,  
and give plenty of zonk!

By Homer L. Davidson

top antenna should give you courage. Actually, it's not as bad as it first seems. If you're willing to sacrifice some height to gain a goof-proof installation, not only will you sleep better at night and feel better in your pocket book, but your neighbors will appreciate a job well done.

We've come up with some groovy photos that show a young fella going about his work. As you can see, he's got a sturdy roof (good shingles and joists), a few tools, and the roof mounting antenna. That's it.

With screwdriver, pliers, and crescent wrench in hand, all you do is select the right tower for your particular receiving area. This depends on the kind of signals you wish to receive (uhf, vhf, FM, etc.), distance from the transmitter, and the obstructions in between. Your local TV shop will probably give you some advice on just what you need.

**Here To Stay.** A rooftop tower has many advantages over a mast. It's easier to install, it has a much better appearance, it's more secure, and you eliminate vibrating guy wires that run endlessly from the

# TV Tower

mast to your house. Very few rooftop antennas blow over during severe storms, so they prevent additional damage to your roof. Should the boom or any of the elements be damaged they can be reached with no trouble at all.

Only a few holes are needed to install the tower on your roof. Before you get started, check and make sure that your antenna will be no higher than other installations in your neighborhood. If necessary, check the local city ordinance for TV antenna installations. Some cities have very exact requirements and even a permit fee. Better to be safe now than sorry later.

Small TV towers come in lengths of 18, 30, and 36 in., as well as 5- and 10-ft. lengths. While they are sturdy and cost little, a tower mounted on a 1½- to 2-story home should provide adequate reception even in a fringe area. If you're really out in the cold, a hi-gain Yagi-type antenna will help to put you in the ball park.

**Selecting a Sight.** Once on the roof, select a likely spot for a three-legged tower. We'll help you out by recommending dead center on the roof peak (you get a ground-plane effect this way that will reduce local RF interference somewhat); just count the total number of shingles and divide by two to reach *Ground Zero*. Mounting the antenna to one side of the roof is possible, but less effective.

Make sure you're clear of tree limbs, etc., and in the line of sight of some TV stations. At all cost, keep away from power lines of any description.

In extreme fringe areas you can mount the tower on the highest part of your roof. But if you've got more than 10 ft. of antenna skyward (extending above the tower), it will have to be guyed properly. Under normal circumstances, however, guy wires shouldn't be necessary. A good rule of thumb is: a 5-ft. mast extended out of a 30- to 36-in. tower; a 10-ft. mast extended out of a 5- to 10-ft. tower.

If you're mounting the tower on a flat surface (with no peak), simply center it by using the roof corners as a guide. A friend can hold the boom at the approximate dead center while you take sightings from alternate corners.

**Mounting Boom.** Before securing the

three-legged tower, check that all three legs are located *over* a roof joist (i.e., supporting beam). The towers have adjustable legs so this is possible. You can locate the joist by taking a hammer and tapping lightly over the surface of the roof. The first solid thump indicates you've got a beam where you need it.

Temporarily place the legs of the tower on the corresponding joists. Place the two adjoining legs (i.e., the two that form the base of the triangle) in the direction where winds are excessive. It's usually north winds or northwesterlies that cause most problems, but it pays to make sure for your particular area.

Level the tower before securing (lagging) it to the joists. A carpenter's level will prove to be a worthwhile investment, but should one be lacking, place the boom on the tower anyway and sight it against house outlines and other reference points. When using a level, level the tower in two opposite directions with the boom installed.

Now you can secure the legs to the joists using the supplied screws. Be sure to place at least two screws in the base of each supporting leg. If they don't go directly into the joist you will have to sound out the joist's location again. Probably a shift of ¼ in. is all that will be needed. Make sure that all screws are flush with the roof surface and as tight as possible.

**Antenna Up and Away.** Remove the antenna from the packing carton and prepare it for mounting. Most TV antennas can be unfolded in a second and the antenna rods will lock into position. Simply push or pull the elements into the correct configuration and clip them into place. You'll find it easier to assemble the antenna on the roof, but take care not to damage shingles while you're working. Wherever you work, leave plenty of space for the job.

To connect the 300-ohm lead-in wire to the assembled antenna, use either small eyelet connectors or form an eyelet with the bare wire. Place the lead under a lock washer, tighten the connection, and place some electrical tape over the antenna terminals. This will insulate the antenna connections from erosion due to wind and moisture.

If the antenna has a fairly long boom, two brace supports should be used to support it. Place a standoff on the front support brace while the antenna is still being prepared for mounting.

**Two Types.** In this installation a uhf *bow-tie* antenna will be mounted below the



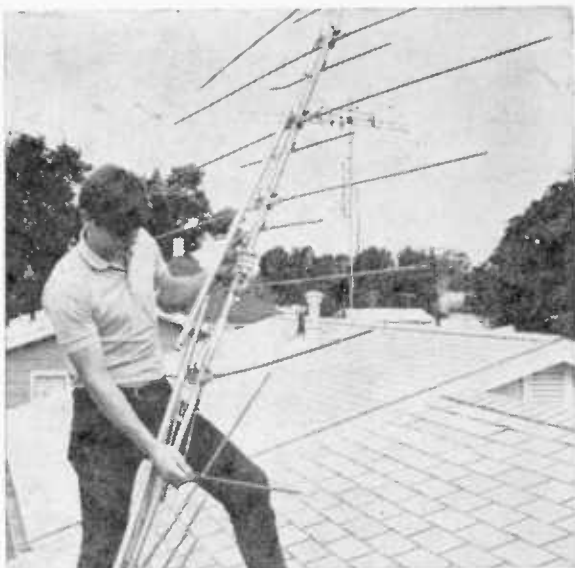

*Before securing tower to roof, place TV mast in position so that tower can be properly leveled (see photo on previous page). Once antenna has been installed, final leveling can be achieved with small set screws on support braces. At least two screws should be used to secure legs to joist. Carefully remove vhf antenna from carton, fold out all elements, check their configuration, and then lock them into place. Hook up lead-in cable to antenna, and with cable in place, mount a standoff on one arm brace to hold it in position. Now that antenna lead-in is installed, mount antenna to 5 or 10 ft. mast. Tighten all bolts and pull up brace supports so that antenna will be level.*

# TV Antenna

all-channel vhf boom. Since the latter is the basic unit it is mounted first. *Remember*—many antennas combine elements for both uhf and vhf reception, so you'll only need the bow-tie (or equivalent) if you're in a fringe area or the uhf signals are not in the same plane with the vhf signals.

Choose the correct length of mast to install in the tower. This will depend on reception requirements (also, check rule of thumb already mentioned for tower measurements). Most likely it will be either a 5- or 10-ft. piece. Bolt the antenna to the mast, level the bay, and tighten the mounting bolts. Pull up the brace supports so the antenna is in a level line and snug up the "U" bolts on the brace. Try not to flatten out any of the aluminum pipe.

Once you've lowered the mast into the tower, you can raise or lower it to get best reception. Rotate it so that the smallest elements on the boom are pointing toward desired stations; in fringe areas this may simply mean *snow-free* reception.

Some receiving areas require a uhf translator antenna. This is usually a bow-tie having several "V" elements and a reflecting screen. Gain is sometimes as high as 12 dB at distances up to 50 miles. If a translator antenna isn't required (as mentioned before), you can forget about the next steps.

Unfold the uhf antenna's mounting elements and bolt them into place. Connect the polyethylene lead-in cable to the antenna terminals and feed it through standoffs down the front of the antenna (or back through the screen). Now mount the bow-tie on the mast with two clamps just below the vhf boom. Point the bows toward the station you want; reflector remains flush behind them.

**Leading Question.** The lead-in cables for both antennas are fed down the mast and tower by way of standoffs (one for each lead). Bring the cables down one leg of the tower, pull them tight, and rotate the twin lead until you have a spiral that's taut so it won't flap in the wind. Crimp the insulating washers in the standoffs to hold the spiral in place. If you've got coax, however, you can tape it to the mast (see section on rotators).

Check to see at what point your leads will come off the roof and start down to the set. Position two screw standoffs here. fasten

down the two leads, and pull them tight. Keep on making a taut spiral with the twin lead as before.

Going across the roof, place a screw standoff every 4 ft. and keep the two leads taut as they are inserted. This should make for a neat installation.

Once the tower legs, screw standoffs, etc., are in place, use plastic roof cement to cover up all the screws for a weather-proof installation. Smear the stuff over any metal part that penetrates the roof's surface.

The antenna leads should now be brought down the side of the house. Place two screw standoffs just under the roof overhang and two more standoffs at the bottom where the leads will be fed into the house proper (through a window or the siding). Again, the leads should be taut, with more standoffs added wherever necessary. Try to keep the cables away from metal rain spouts, power lines, or other obstructions.

**Rotating the Beam.** If an antenna rotator is added to your installation it should be mounted *before* the vhf boom. Place the mast into the tower brace supports and mount the assembled rotator to this piece of pipe. If you use a 10-ft. tower, place the rotator on the tower mast as opposed to the antenna mast. This way it's easier to lower the vhf boom into the rotator assembly.

Connect the 4-, 5-, or 8-wire cable to the rotator. Make a note of the correct terminals for both ends of the cable. Terminal 1 on a flat 4- or 5-wire cable will be silver so start with it. Connect each wire to the rotator and tape the cable to the mounting bracket. The rotator's cable can be brought down either by taping it to the mast or using more standoffs.

Be sure to leave a 1½- to 2-ft. loop in your antenna leads where they run past the rotator. This permits the antenna to turn a full 360 degrees without binding or pulling the leads out of position. Use a standoff above and below the rotator to hold the loop in position. These standoffs should be in position before you tape the rotator cable to the mast. This way you won't pierce these wires with one of the standoffs; this could ground the rotator's cable.

Check the correct direction for the rotator before leaving the antenna in one position. Rotator mechanisms have either a north or south starting position. When the antenna is in its correct starting position, bolt it into place. See if the antenna loop is free so it will rotate through a full 360 degrees. ■

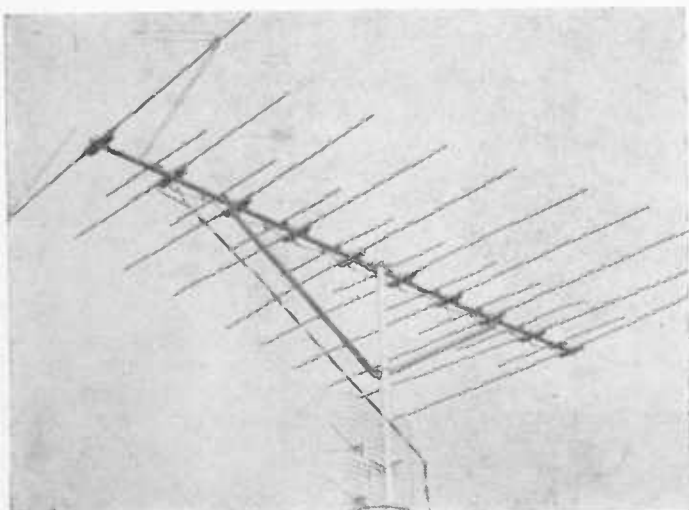

Remove uhf antenna from carton (if needed—see text) and fold out all elements. Remember, if you're going to install a rotator it should be mounted before either the vhf or uhf arrays are bolted to tower's boom. Mount uhf antenna below vhf array and point bow ties towards desired TV stations. Now bring two lead-in cables down mast along one leg of tower. Standoffs should be used to keep leads in position. Loop of 1½ to 2 ft. is necessary to allow rotator to turn full 360 degrees. If you have no rotator, leads may be taut. Use plastic cement to cover all metal surfaces that penetrate roof's surface. At left, both antenna arrays have been mounted on boom and pointed towards major TV stations in area. Final leveling adjustment can now be made.

pico  
giga  
milli  
centi  
kilo  
nano

# DISCOVERING PREFIXES AND EXPONENTS THE PRACTICAL LANGUAGE OF ELECTRONICS

mega  
micro  
deci  
hecto  
atto  
femto  
deka

by Norman Crawford

**A**nyone who's dipped his little toe into electronics is certain to have run across such terms as *microFarad*, *milliHenry*, and *milliAmpere*—not to mention *megaHertz*, *megOhm*, and *kiloHertz*. The prefixes here—*micro-*, *milli-*, *mega-*, and *kilo-*—are an important part of the electronic vocabulary. It follows, then, that anyone who wants to be proficient in electronics will have to develop skill in understanding and using them.

These prefixes are used to change the value of an electronic unit of measure. For example, if you see a resistor with the familiar brown/black/green color code, you *could* call it a 1,000,000 ohm resistor. Thing is, it's usually less awkward to call it a 1-megohm resistor. Putting the prefix *meg-* or *mega-* before the Ohm inflates the value of the unit, Ohm, by 1,000,000 times.

Similarly, one kiloVolt is recognizable as 1,000 Volts, and one kiloHertz as 1,000 Hertz, and so on. These prefixes are usually so automatic with electronics aficionados that they will invariably refer to a millionaire as a guy who has one megabuck!

**The Debit Side.** At the other end of the scale, the *milli-* and *micro-* prefixes are useful for shrinking units. A Farad, for example, is too big a unit to use in everyday electronics. In dealing with the real-life capacitors (the kind you solder into circuits), we normally use a basic unit of *one-millionth* of a Farad—a *microFarad*. The prefix *micro-* cuts up a unit into a million tiny slices, enabling us to use one such slice as a convenient-sized unit. A micro-

Ampere, similarly, is a millionth of an Ampere; a microVolt, one millionth of a Volt.

If you need larger slices, the *milli-* prefix is available, which provides a unit only one-thousandth the size of the basic unit. A milliAmpere, for example, is a thousandth of an Ampere; that is, it takes 1000 mA (milliAmperes) to equal 1 Ampere.

To handle these tiny slices of units, it's wise to spend a few minutes learning *scientific notation*, which is designed to make it easy to handle very large and very small numbers. Once you've mastered this technique, you can manipulate all the various-sized units of electronics as easily as you can add two and two!

Take, for example, the familiar *kiloHertz*, (known until recently as the *kilocycle*). A broadcasting station operating at 840 kHz (kiloHertz) in the broadcasting band is radiating 840,000 cycles of RF energy every second. To change from 840 kHz to 840,000 Hz, you can think of the "kilo-" as being replaced by "x 1000", thus:

840	kilo	Hertz
840	x 1000	Hertz
840,000		Hertz

But you can also write "1000" as "10x10x10". And you can write "10x10x10" as "10<sup>3</sup>". (Ten to the third power, or ten cubed). As we develop these ideas further, you will see how you can simplify greatly your future work in electronics by thinking of the prefix "kilo-" as being replaceable by "x 10<sup>3</sup>", thus:

840 kiloHertz =  $840 \times 10^3$  Hertz

Similarly, a 6.8 megohm resistor, measured on an ohmmeter, will indicate 6,800,000 ohms. In this case, the prefix "meg-" can be replaced by "x 1,000,000":

6.8	meg	Ohms
6.8	x 1,000,000	Ohms
6,800,000		Ohms

But you can write "1,000,000" as "10x 10x10x10x10x10" (six of 'em; count 'em), which is  $10^6$ . Thus, you should learn to mentally replace "meg-" with "x  $10^6$ ", so that 6.8 megOhms becomes a  $6.8 \times 10^6$  Ohms. The 6 is called an *exponent*, and shows how many 10s are multiplied together.

**The Minus Crowd.** What about the "milli-" and "micro-" prefixes? "Milli-", we've said, is one-thousandth; in a way, it is the opposite of the "kilo-" prefix. Make a

mental note, then, that milli- can be replaced with "10<sup>-3</sup>" (read as "ten to the minus three power"), which is  $1/10 \times 1/10 \times 1/10 = 1/1000$ . Similarly, the "micro-" prefix can be considered as the opposite of "meg-", and replaced by  $10^{-6}$ .

The beauty of this approach appears when you are faced with a practical problem, such as, "if 1.2 milliAmperes flows through 3.3 megOhms, what voltage appears across the resistor?" From our knowledge of Ohm's Law, we know that  $E = IR$ ; that is, to get Volts (E) we multiply current (I) times resistance (R). Without the aid of scientific notation, the problem is to multiply 0.0012 Amperes by 3,300,000 Ohms, which is rather awkward to carry out. The same problem, however, is very easy in scientific notation, as can be seen below:

$$\begin{array}{r} 1.2 \times 10^{-3} \\ \times 3.3 \times 10^6 \\ \hline 3.96 \times 10^3 \end{array}$$

Prefix	Pronunciation	Symbol	Exponent	Example
tera-	TEHR-uh	T	$10^{12}$	Frequency of infra red light is approx. 1 teraHertz
giga-	GIG-uh	G	$10^9$	Frequency of TV channel 82 is approx. 1 gigaHertz
mega-	MEG-uh	M	$10^6$	Frequency of typical shortwave broadcast station is approx. 1 megaHertz
kilo-	KILL-oh	k	$10^3$	Top note on a piano is approx. 4 kiloHertz
hecto-	HEK-toh	h	$10^2$	(not often used in electronics)
deka-	DEK-uh	da	$10^1$	(not often used in electronics)
deci-	DESS-ih	d	$10^{-1}$	A decibel is 1/10th bel
centi-	SENT-ih	c	$10^{-2}$	Wavelength of TV channel 82 is approx. 30 centimeters
milli-	MILL-ee	m	$10^{-3}$	Collector current of a typical small transistor is approx. 1 milliAmpere
micro-	MY-kroh	$\mu$	$10^{-6}$	Base current of a typical small transistor is approx. 20 micro-Amperes
nano-	NAN-oh	n	$10^{-9}$	Time for a radio wave to travel 1 foot is approx. 1 nanosecond
pico-	PY-koh	p	$10^{-12}$	Collector-to-base capacity of a good high-frequency transistor is approx. 1 picoFarad
femto-	FEM-toh	f	$10^{-15}$	Resistance of 6 microinches of 0000 gauge wire is approx. 1 femtOhm
atto-	AT-toh	a	$10^{-18}$	6 electrons per second is 1 atto-Ampere

# Prefixes and Exponents

The answer is  $3.96 \times 10^3$  Volts, or 3.96 kiloVolts. We obtained the answer by multiplying  $1.2 \times 3.3$  to get 3.96, and adding the -3 exponent to the 6 exponent to get 3 for the exponent of the answer. The advantage of scientific notation is that the largeness and smallness of the numbers involved is indicated by numbers like  $10^6$  and  $10^{-3}$ , and the largeness or smallness of the answer is found by adding the 6 and the -3.

What about a division problem? For the sake of a good illustrative example, consider the unlikely problem of finding the current when 4.8 megaVolts is applied across 2 kilOhms. The problem is written as:

$$I = \frac{E}{R}$$

$$= \frac{4.8 \text{ megaVolts}}{2 \text{ kilOhms}} = \frac{4.8 \times 10^6 \text{ Volts}}{2.0 \times 10^3 \text{ Ohms}}$$

$$4.8 \div 2 = 2.4$$

$$2.4 \times 10^3 \text{ Amperes} = 2.4 \text{ kiloAmperes}$$

In division, then, finding the size of the answer becomes a subtraction problem, in which the exponent representing the size of the divisor ("bottom" number) is subtracted from the exponent representing the size of the dividend ("top" number).

A more practical division problem answers the question, "what current flows when 5 Volts is applied across 2.5 kilOhms?"

$$I = \frac{E}{R} = \frac{5 \text{ Volts}}{2.5 \text{ kilOhms}}$$

$$= \frac{5.0 \times 10^0}{2.5 \times 10^3} = \frac{5.0 \times 10^0}{2.5}$$

$$= 2.0 \times 10^{-3} \text{ Amperes}$$

$$= 2.0 \text{ milliAmperes}$$

Note that it's perfectly legal to use  $10^0$  (ten to the zero power) to indicate a unit that has no prefix—in other words, one of anything.

**For The Solving.** Here are a few more problems:

1. The inductive reactance of a coil is given by

$$X_L = 2\pi fL$$

What is the reactance of a coil whose inductance  $L = 22$  milliHenries, when an alternating current of frequency  $f = 1.5$  megaHertz is applied to it?

$$X_L = 2 \times \pi \times (1.5 \times 10^6) \times (22 \times 10^{-3})$$

$$= 207.24 \times 10^3 \text{ Ohms}$$

$$= 207.24 \text{ kilOhms}$$

2. An oscillator is connected to a wavelength-measuring apparatus, and the wavelength of its oscillations determined to be 2.1 meters. What is the frequency of the oscillator?

$$F = \frac{\text{speed of light}}{\text{wavelength}}$$

$$= \frac{3.0 \times 10^8 \text{ meters per second}}{\text{wavelength}}$$

$$= \frac{3.0 \times 10^8}{2.1 \times 10^0} = 1.4286 \times 10^8 \text{ Hertz}$$

We wish this answer had come out with a "10<sup>6</sup>", instead of a "10<sup>8</sup>", because we can convert  $10^6$  Hertz directly to megaHertz. However, we can change the answer to  $10^6$ , by shifting the decimal point of the 1.4286. Remember this rule: To lower the exponent, shift the decimal point to the right. (Of course, the opposite rule is also true). Since we wish to lower the exponent by 2, we must shift the decimal point to the right by two places:

$$142.86 \times 10^6 \text{ Hertz} = 142.86 \text{ megaHertz}$$

3. A 3.3 microfarad capacitor is being charged from a 20-volt battery through a 6.8 kilOhm resistor. It charges to half the battery voltage in a time given by

$$T = 0.69RC$$

For the particular values given in the problem, what is the time taken to charge to half the battery voltage?

$$T = 0.69 \times (6.8 \times 10^3) \times (3.3 \times 10^{-6})$$

$$= 15.4 \text{ milliseconds}$$

**Tera To Atto.** Since scientific notation is so potent, you'll probably be interested in the meaning of *all* the prefixes used in the scientific community, not just the four—micro-, milli-, kilo-, and mega—that we've discussed so far. Very common in electronics is the *micro-microFarad*, which is  $10^{-6} \times 10^{-6}$  Farad, or  $10^{-12}$  Farad. This is more commonly known as the *picoFarad*. Similarly, a thousandth of a microAmpere is  $10^{-3} \times 10^{-6}$  Ampere, or  $10^{-9}$  Ampere. This is known as a nanoAmpere. At the other extreme, 1000 megaHertz is called a gigaHertz. See the table of these prefixes on page 62, together with their meanings and pronunciations. (Continued on page 91)

---

# HOW TO CHANGE

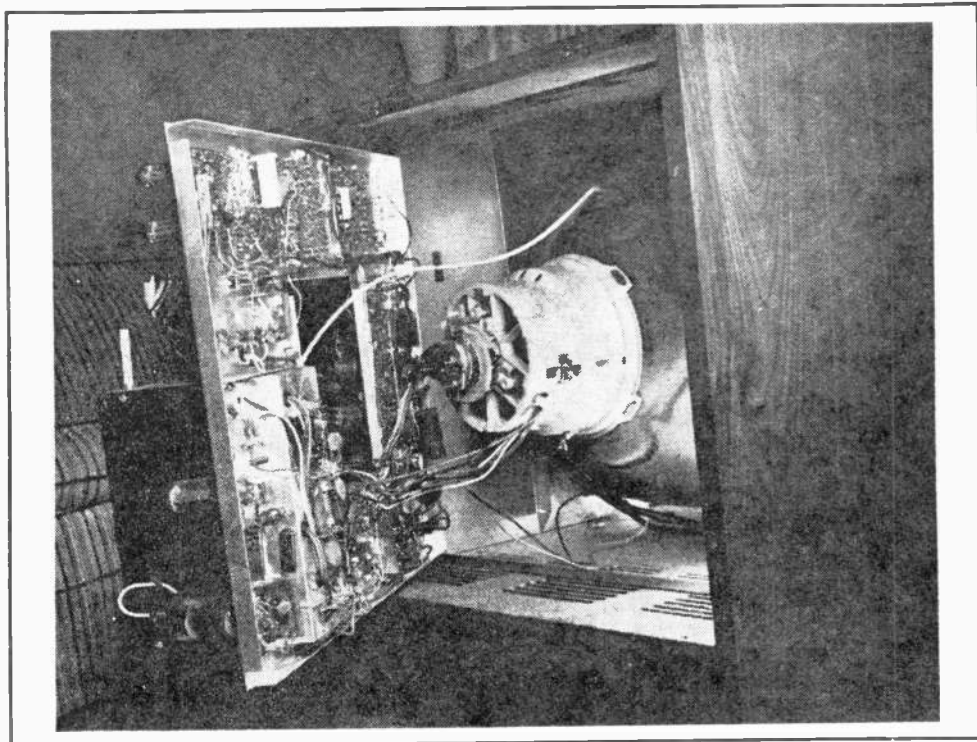

## A COLOR TV TUBE

---

By HOMER L. DAVIDSON

■ When your color picture tube becomes dim and one or two colors are real weak, you can replace that color tube yourself. Follow the photos and text in this article and you can save yourself some dough. This article shows how to replace the round and rectangular color picture tubes. The sizes are 21-inch round, 25-, 23-, and the 19-inch rectangular color CRT's.

The initial preparation consists of taking the TV chassis from the cabinet. First, remove all knobs and the rear cabinet cover from the TV receiver (Fig. 1). Discharge the high-voltage charge of the tube with a long, insulated-handle screwdriver—from anode connection to the TV chassis. Be real careful, and do a good job of grounding out the high-voltage cable. In older TV re-

ceivers, the high-voltage cable must be unfastened from the metal box before you open the lid of the box. This lead will pull out of a pin socket. In newer TV sets, the high-voltage lead unplugs from the glass picture tube. Unbolt the TV chassis and unplug all wires going to the TV chassis.

This includes the picture tube cap or socket, yoke leads, and speaker leads. All the colored wires going to the deflection yoke are marked on the yoke where they are plugged in. There is little danger of getting them wrong when replacing them. Unhook the blue grounding lead from the blue lateral magnet. Unplug the convergence yoke cable from the TV chassis and also loosen the antenna terminal assembly.

Before pulling out the chassis, be sure

**CHANGE COLOR TUBE**

all cables and wires are disconnected. On the older models, pull out the chassis three or four inches and loosen the 1/4-inch metal screw, holding down the small-controls assembly. Slide the assembly back and pull up. Now the chassis is free (Fig. 2).

**The Tube Comes Out.** The cabinet should be turned over on its face before removing the color tube. Be sure to lay a blanket or thick padding upon the floor to keep the cabinet in ship shape. Have a friend (Fig. 3), or the wife, help place the TV cabinet front down upon the padding.

In the older color sets the dynamic convergence magnet assembly (Fig. 4) slides

separately off the neck of the tube. In the rectangular 25-inch sets the yoke assembly also contains the convergence coils and fits tightly against the color tube.

Four nuts hold the picture tube in place—two at the top and two at the bottom. A metal flange surrounds most tubes, near the face of the tube. In the newer color sets, the automatic degaussing coils (ADG) are fastened to this framework. In the 25-inch sets the metal flange must be removed before you can get to the nuts holding the color tube in place.

Now remove the components from the neck of the color picture tube. In case you are not familiar with the location of these components, measure their position (Fig. 5) on the neck of the color picture tube. This procedure is quite helpful when replacing

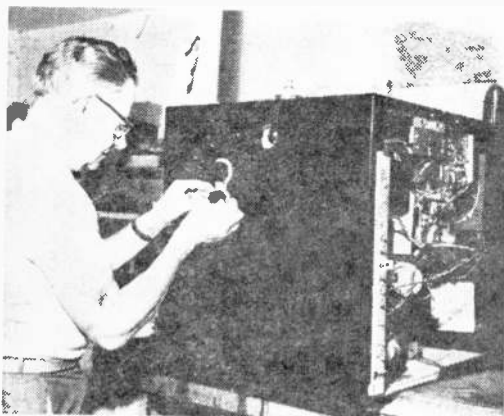

Fig. 1. (top, left) Removing the control knobs.

Fig. 3. (below) Place cabinet face down on folded blanket to protect pic tube and finish.

Fig. 4. (right) Point of pencil indicates the setting of convergence yoke and red band.

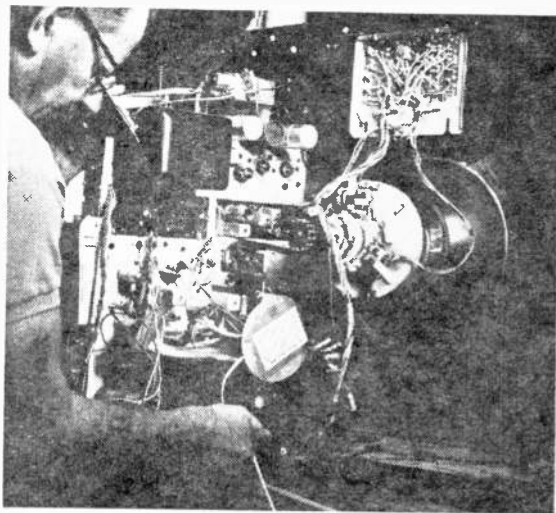
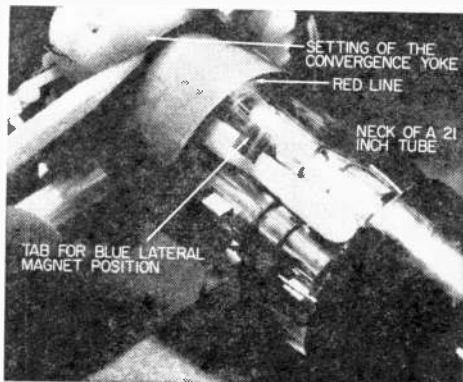

Fig. 2. (above) Don't be afraid to make notes about various connections as you disconnect chassis from CRT and yoke. It can save you a little hunting later.





these components to the neck of the new color tube. *As a safety precaution, wear safety glasses when working close to the picture tube. Do not put pressure on neck of CRT or let tube rest on neck.*

**Clear the Neck.** Place the kinescope face down on a drop cloth or newspaper to protect the face from scratches. Now remove the components from the neck of the tube. When you remove the blue lateral magnet, you will notice that it sets over a tab or clip inside the tube neck (Fig. 6).

In the older sets, the purity ring sets over the red ring marked inside the tube. Note that the blue wires from the convergence assembly (Fig. 7) go to the top of the picture tube over the blue gun, the red wires at the left side, and the green wires on the right going to the green dynamic convergence coils.

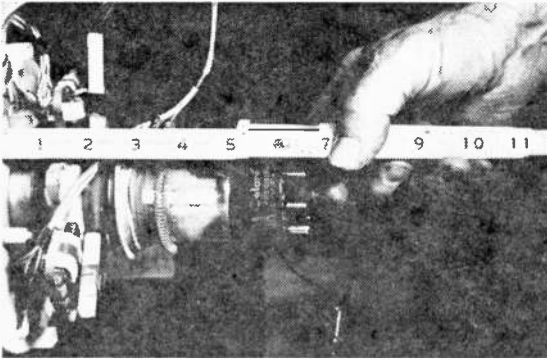
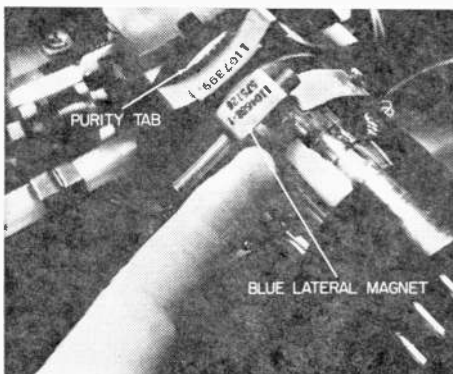

Fig. 5. (top) Be sure to mark down measurements so you can replace the yoke assembly.

Fig. 6. (below) Here author is pointing to blue lateral magnet and the tab inside the neck of the CRT. Tab is not obscured by blue lateral magnet in Fig. 4. By first replacing the components according to the measurements most adjustments are minor.



The large deflection yoke is loosened with a 1/4-inch nutdriver (Fig. 8) and can be lifted off the neck of the tube. It is very heavy; do not drop it! Be especially careful not to rap the CRT with a tool or heavy object. *The CRT must be handled with care since it can implode and cause serious damage to you and the set.*

The masking must be removed from the front edge of the CRT, as in Fig. 9. On the rectangular tubes, a strap with corner flanges must be removed by loosening a side-bracket bolt. Remove the bracket (i.e., masking) assembly from the old CRT and place it upon the new tube.

Be sure the CRT is laying in the same position as mounted in the TV cabinet. Now place the strap in place on the new CRT and tighten up the bracket assembly. Be sure the high-voltage (anode) button is at

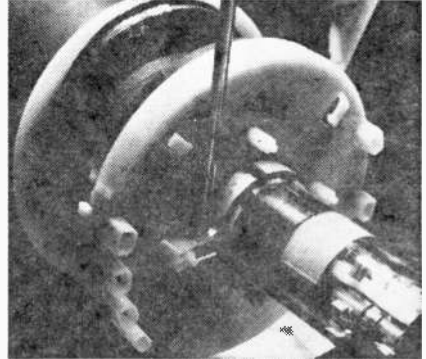
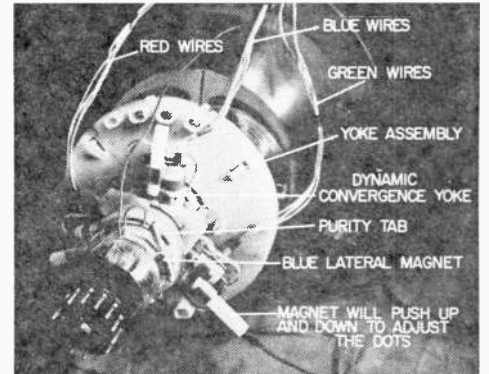

Fig. 8. (above) After yoke assembly has been loosened with nutdriver it can be removed. Assembly is quite heavy—don't drop it.

Fig. 7. (below) All components of the yoke assembly are indicated. Once you can tell the difference between a dynamic convergence yoke and a purity magnet you have an easier job of following these instructions.



**CHANGE COLOR TUBE**

the top of the set on a 25-inch picture tube (Fig. 10). The 23-inch and 21-inch round-CRT anode connections (Fig. 11) are on the side of the tube.

**Reassembly.** Place all components back on the neck of the CRT. Use the previously taken measurement for their approximate position. In the older sets the yoke must be mounted so it will slide back and forward for purity checks. The 25-inch yoke assembly fits snugly against the bell of the tube. This yoke slides back and forward inside of the large yoke assembly. Two small screws are loosened on each side of the plastic yoke assembly.

Tubes that are not bonded have a safety

glass—be sure the glass is clean. Wash it with soap and then rinse with clear water. Make sure there is no lint or dirt on the face of the new CRT (Fig. 12). Seat the tube in its place in the cabinet and bolt it to the front brackets. Replace the metal shield and degaussing-coil assembly, if the set has one.

Now set the cabinet upright and fasten the convergence board in place (Fig. 13). Install the TV chassis and connect all cables. Make certain that all parts are replaced and tightened. Banging against metal parts will sometimes induce magnetism into these parts and a second job of degaussing may be required. Be sure that all cables are connected and in place. Turn on the color receiver and leave it on for 15 to 20 minutes before purity or convergence checks are made.

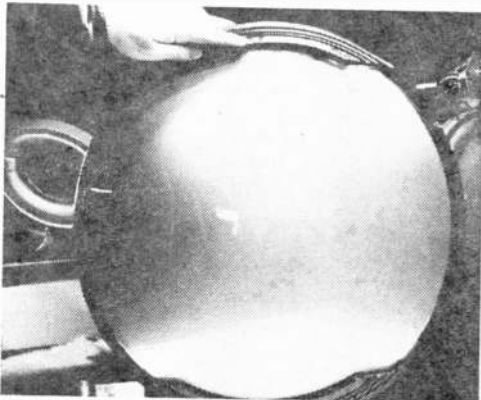
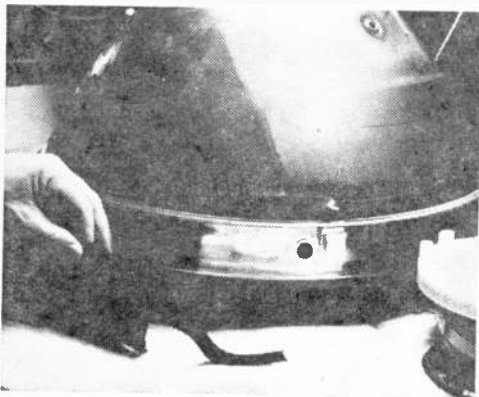

Fig. 9. (top, left) Make careful note of how the front protective mask is removed from CRT to make replacement much easier. Plastic mask on 21-inch CRT must be placed evenly (top, right) before taping in place.

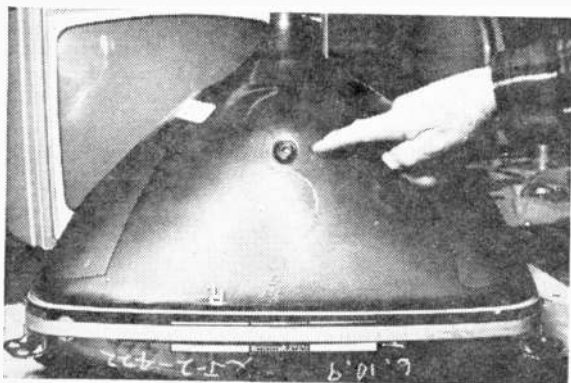

Fig. 10. High-voltage connector is at top of 25-inch CRT's—on side of 19- and 23-inch CRT's. Make sure!

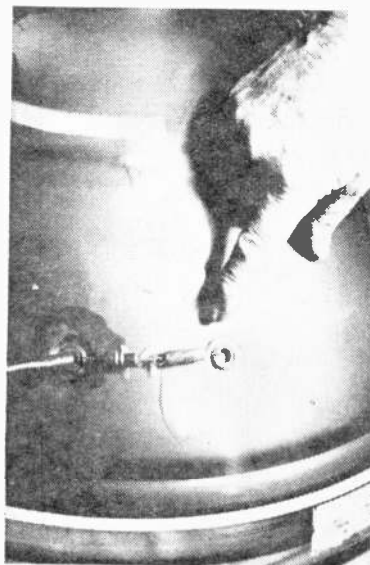

Fig. 11. Resistor, with spring, bridges anode buttons.

**Basic Adjustments.** Color-TV convergence can take time and may require skill. You may want to degauss and converge the color TV yourself, if correct equipment is available. If not, get help from a good reliable color-TV serviceman and pay him to finish the job.

If you want to do it yourself; here goes: Position a degaussing coil near the picture tube (Fig. 14) to completely neutralize any induced magnetism. This step will help insure proper purity and convergence when the picture tube is converged. Hook up the Dot-Bar color generator and let it warm up as the color-TV set warms up. When replacing the CRT, even sets with built-in degaussing coils should be degaussed just as if one was not built into the TV cabinet.

Take a quick look at the TV screen and if there are any color shaded areas the set

should be put through a purity check up.

To start the purity adjustment (Fig. 15), turn off the set and unplug the IF cable going to the tuner. Plug the AC-interlock cord back in, let the receiver warm up, and short out the green and blue grids through a 100K resistor. (There are commercial kinescope grid-shortening switch boxes on the market for just this purpose.) At the moment the screen should be red. Adjust the center purity ring for a center red coloring. Then push the yoke back and forth and adjust the purity ring until the entire screen has an even red tint. The red-, blue-, and green-grid connections are generally on the top of the chassis. These three colored wires go to the picture-tube socket.

If the purity adjustments are done correctly, the green and blue shading will fall in line. It is always best to check each one

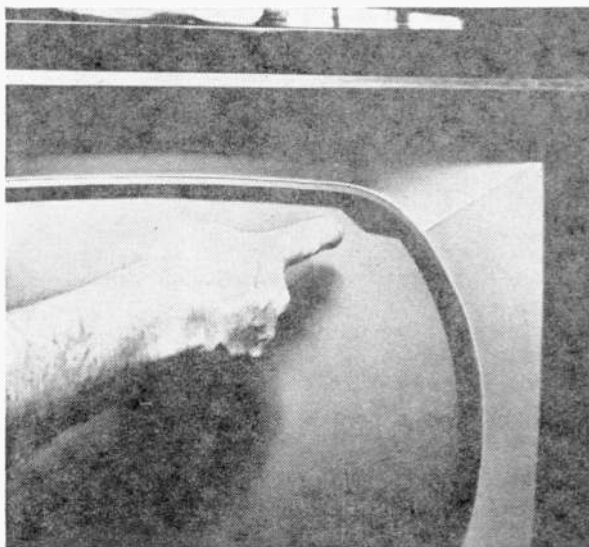
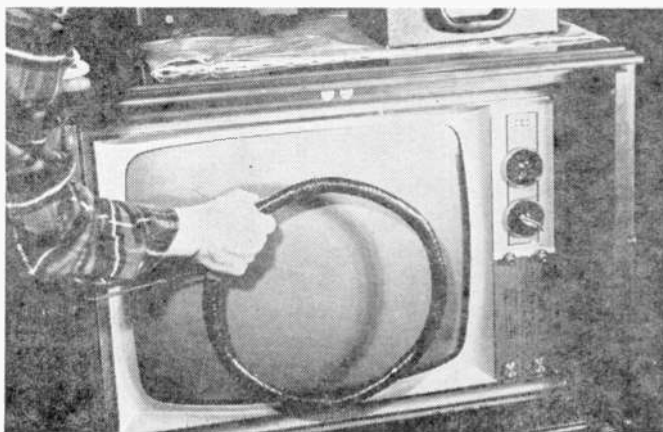

Fig. 12. (top, left) When replacing CRT's that are not bonded, safety glass must be cleaned of fingerprints and lint. Double check mask to make sure it is aligned properly in set.



Fig. 13. (top, right) When convergence board has been reinstalled and all nuts and machine screws have been tightened the chassis can be returned to the cabinet and secured too.

Fig. 14. (right) Degauss the CRT even if there is a built-in degaussing coil.



## CHANGE COLOR TUBE

separately by shorting the other two grids to ground through a 100K resistor. If a little shading persists, try degaussing the CRT again and start over with the red adjustment procedure again.

At this time, check the level of the picture and see if the picture is in focus. Sometimes it is difficult to do a good job of convergence with the set out of focus. When you reset the focus control, convergence dots are way off.

**Getting a Picture.** Convergence is relatively easy on the new color receivers. The older models require patience and plenty of time. Connect the Dot-Bar generator to the antenna terminals. Remove the convergence board from the back of the set and place it on the slots at the top and back of the set. Tighten the two metal screws so the board is solidly in place. Watch the wires that connect the board to the yoke assembly so that they do not get tangled.

If the receiver was in convergence when the color CRT went bad, the dynamic convergence controls will generally need only a touch up. Set the generator to get dots on the CRT screen and check the dots down through the center of the screen. Short out the blue gun with the 100K resistor. Bring the red and green dots together on a center dot. Slide the red and green magnets in on top of one another. Readjust the setting, if needed.

If they won't quite come together, remove

and rotate the red magnet a half turn and reinsert it, and adjust again. Now, once the red and green dots are centered, short the green grid and line up the red and blue dots. (The blue-beam magnet moves the blue dot up and down. The blue lateral-beam moves the blue dot horizontally. Place them on top of one another). Go back and check the red and green guns once again. Check that all three dots are together. You should now have a white dot. The amplitude and tilt controls should not be adjusted unless the dots fail to converge.

Now, step back and take a look at the screen from a distance. Tune in a black-and-white program from a local station and check for color fringing. Generally, the convergence board does not need to be adjusted unless tampered with.

If the dots do not converge at the ends, top, and bottom, the vertical and horizontal adjustments must be made. Use the manufacturer's convergence and adjustment information and follow their alignment procedure. It is best to go over color convergence several times and then get away from the dots. Go back in a few minutes and recheck.

Follow the factory adjustment for black-and-white setup. The newer TV color receivers have a *service-normal* switch mounted at the rear of the chassis. When this control is thrown to the *service* position the raster collapses into a thin white line. You adjust the three screen controls until the vertical line is perfectly white. Now flip the switch to *normal* and the picture is black and white. ■

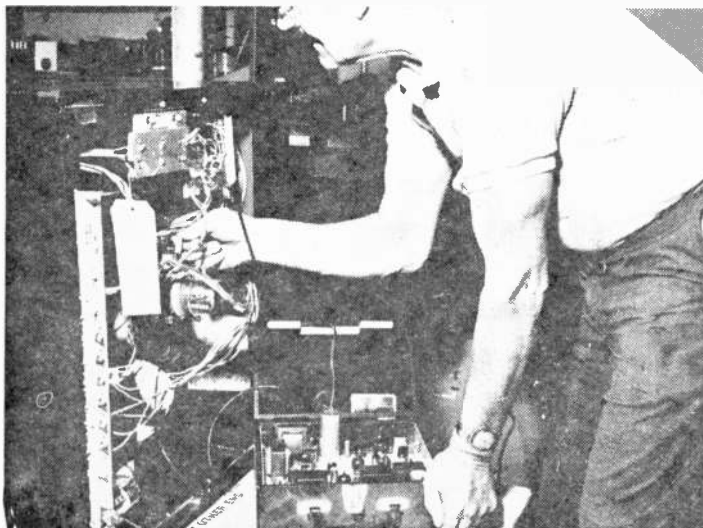

Fig. 15. The last step is the most crucial of all the steps in the replacement of a color CRT. Color purity has a lot to do with the overall enjoyment you get when watching your favorite programs. No one can thrill to faces that are tinged with green, or grass that has a purplish tinge. If you don't have the necessary equipment you can have your local TV service technician do both the color purity and convergence adjustments. Fee is much less than paying for complete job by TV technician.

# Ten timely tips for resistance measurement

By Marshall Lincoln, W7DQX

Resistance measurements must be one of the most misunderstood tasks undertaken by electronic's buffs. Why? Because a good many of us don't really understand how resistance is actually measured.

Since the meter we use can't think for itself, we must use it properly to obtain the correct results. Like all electrical instruments, of course, a meter performs according to electrical laws which cannot be violated. But it may not give us the results we want, or the results we *think we're getting*, unless we use it properly.

**1** For our first tip, all we need do is look at the ohmmeter scale on the face of our handy VOM. Notice how the numbers indicating resistance are squeezed

together near the high end of the scale? Down at the low end, the numbers are spread out where we can easily read them—the number 1 is a fair distance from 2, and 2 is almost as far from 3 and so on.

But up at the high end, we see that 200 is about as close to 500 as 1 is to 2. And 1k and 2k are practically on top of each other.

This compression at the high end of the scale is normal for an ohmmeter, and there's nothing we can do about it. But what we can do is make use of this situation so it works to our advantage.

How? Very simple—just remember to use the right two-thirds or so of the scale, where the numbers are spread out the most, whenever possible. This will allow you to read much more clearly just exactly what calibration is being indicated by the meter needle. If the pointer stops far to the left, where the

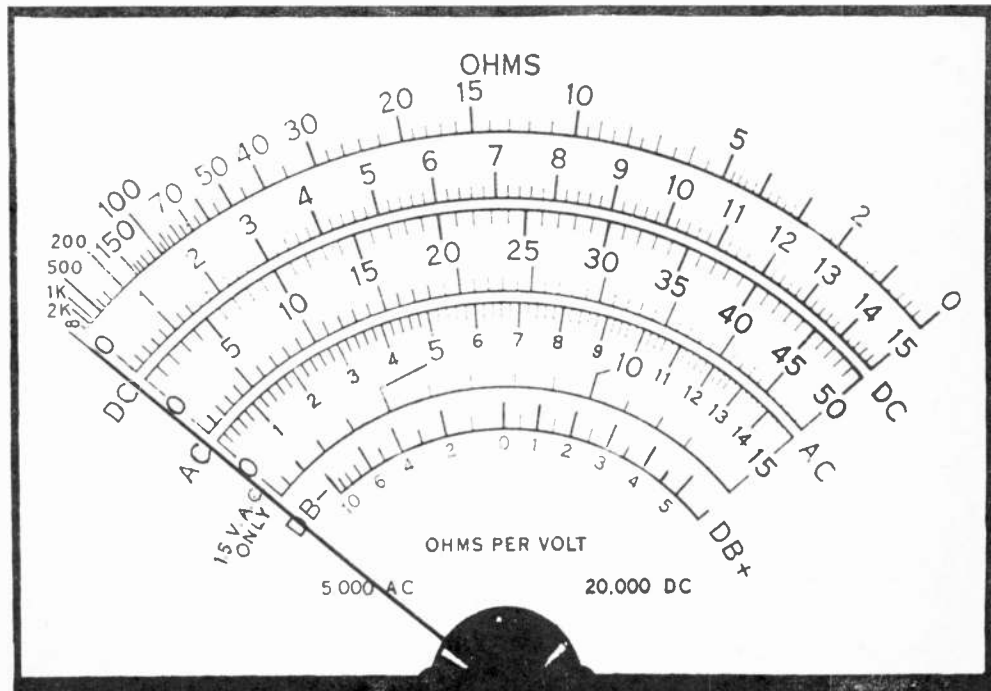

# 10 TIPS

scale calibration is greatly compressed, the thing to do is switch the meter's range switch to a higher resistance range so the needle will drop to a more usable part of the scale. And don't forget to re-check the zero-set adjustment when you do this, since it may need re-setting for the new range.

If you're already using the highest resistance range, then to achieve a more accurate reading you'll have to use a different method for measuring high resistance, as explained in *Tips 8 and 9* which follow.

**2** Our second tip is another simple item often overlooked. Did you ever notice, when holding ohmmeter prods tightly against the leads of a resistor, that the ohmmeter needle couldn't seem to make up its mind just where to stop? Then you probably discovered that as you pressed the test prods tighter against the resistor leads, you got an indication of lower resistance on the meter.

*Ah ha, you thought, there's some corrosion on the resistor leads and I'm pressing the test prod through it and getting better contact with the wire.* This may have been true. But there more probably was another reason for this occurrence, or for the major part of the effect.

It's simply that the meter was measuring not only the resistance of the little resistor you held against the prods, but the resistance of your body as well! When you pressed harder on the prods, you also brought more skin area into contact with them.

So, you should be sure, especially when using a high-resistance range, that you don't touch the metal tip of the test prods. Or if you do touch a prod, touch only one—never both. Use an alligator clip on one lead so

you don't have to hold it in contact with the resistor lead.

On low-resistance ranges, the effect won't be noticeable, since your body resistance is rather high. For this reason, connecting it in parallel with the resistor you're measuring will have little effect.

**3** Another often-overlooked item that can have a large effect on the accuracy of an ohmmeter is the condition of its battery. Every ohmmeter has a small battery inside its case to supply the small current which passes through the resistance being measured. The amount of current which flows gives us the ohmmeter indication.

However, if the battery is weak, the indication may become false if we hold the test prods on the resistor for any length of time. Reason is that the battery voltage may drop during this time. And if the battery voltage changes after we set the meter to zero, we'll get a false meter indication.

There's a simple way to check the battery condition without opening up the meter case and removing the battery. When you touch the prods together and adjust the zero-set knob to prepare to make resistance measurement, hold the prods together for several seconds longer and watch the meter

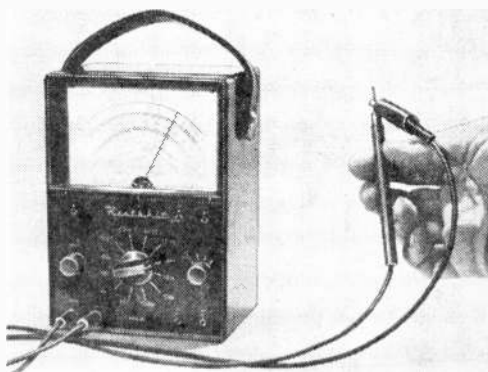

**Above**—Be sure battery in your VOM is putting out enough voltage if you want accurate resistance readings. Keep test leads together for a few seconds to be sure zero setting remains constant. **Left**—Never hold both test probes in your hand when checking resistance, your body resistance in parallel with resistor being measured affects reading.

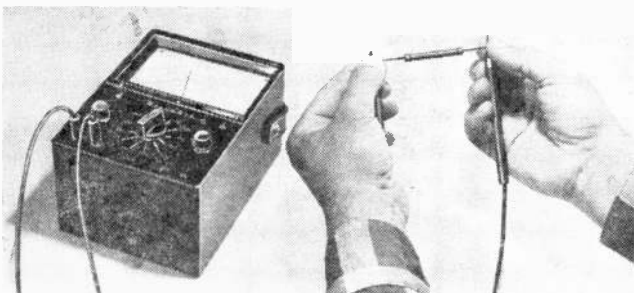

needle closely. If it stays at zero, the battery voltage is holding steady. But if the needle begins to slowly move upscale, the battery voltage is dropping, and the battery should be replaced.

Make a habit of performing this test each time you use your ohmmeter. This way, you'll always know for sure if the battery is in condition to give you accurate measurements.

**4** An ohmmeter can be put to handy use in checking for one of the peskiest of all troubles that may occur in a vacuum tube—an intermittent short between elements. This is a condition that may not show up on a conventional check in a tube tester.

This test is made with the tube plugged into its regular socket in radio or amplifier or whatever. The heater should be lit, but there should be no voltage on either plate or screen. After the tube is thoroughly warmed up, use the ohmmeter to check for continuity between each pair of tube socket terminals in all possible combinations. Be careful, though—don't connect the ohmmeter across the heater pins!

Tap the tube firmly with the rubber eraser on the end of a pencil while making each of these checks, and watch the ohmmeter closely. If there's a momentary flicker of the ohmmeter needle, there is contact between tube elements, and the tube should be scrapped. A stable resistance reading between two tube pins could indicate a resistive short between two tube elements. Then, too, it could merely be caused by a resistor, capacitor, or coil in the circuit. Check the stage's wiring to be sure.

**5** Got a box full of battered and scraggly-looking diodes—and you don't know which ones are good and which ones are open or shorted? Fortunately, there's a quick way to tell. And while you're at it, you can find out the correct polarity of those that have the cathode marking band rubbed off.

To make this simple test, you'll need to know which ohmmeter lead goes to the positive terminal of the ohmmeter battery and which goes to the negative battery terminal. Generally, the ohmmeter in a VOM is wired so that positive (+ or red) jack on the meter case goes to the negative

battery terminal, and the common or negative (– or black) jack goes to the positive battery terminal.

If you have the wiring diagram for the meter, or care to open the case and trace the wiring, you can find out for sure. Or, you can make this check: switch the ohmmeter to a medium range and touch the prods to the leads of a rectifier which you know is good. You'll get the lowest resistance indication when you have the positive lead touching the anode and the negative lead touching the cathode.

To test unknown diodes, connect the ohmmeter to their leads first one way, then the reverse. The two resistance indications you obtain should be considerably different—one should be quite high and the other rather low. If this occurs, you have reasonable assurance the rectifier is good, since it passes current much more readily in one direction than it does in the opposite direction. If you get resistance indications that are nearly the same, the diode is shorted. And should you get indications of a high resistance in both directions, the diode is open. When you get the lower resistance reading, you have the positive ohmmeter lead connected to the anode and the negative lead connected to the cathode.

**6** Transistors also can be checked with an ohmmeter . . . or can they? Yes, they can . . . sometimes. (How's that for a straight-forward answer?)

The reason it's impossible to give an absolute *yes* or *no* is that there are so many types of transistors in the world today. Many of them can be safely checked with an ohmmeter; others, being on the delicate side, can't be. Assuming you want to be perfectly safe, you should never touch an ohmmeter lead to a transistor. But if you follow this precaution, you'll be passing up many golden opportunities to check transistors which can be safely tested with an ohmmeter—if you do it properly.

To determine whether or not to even try it, you'll have to refer to a transistor manual for the particular type of transistor you want to check, then do a few calculations. Always use the lowest ohmmeter range available for the test. This will assure minimum current flowing through the transistor as you make the check.

By knowing the polarity of your ohmmeter battery, as explained in *Tip 5*, you

# 10 TIPS

can determine if each section of the transistor has the proper relationship of low resistance in one direction and high in another. Which way is which will of course be determined by whether you're checking a *pn*p or *n*pn transistor, and which leads you're touching with the ohmmeter prods.

For example, with the positive ohmmeter lead connected to an *n* lead and the negative ohmmeter lead connected to a *p* lead, you'll get a higher resistance indication than with the leads reversed, if all is normal. As with a diode, equal readings would indicate a short, and excessively high readings would indicate an open.

**7** Some rudimentary checks of capacitors can also be made with an ohmmeter. Most common of these is checking an electrolytic capacitor. Even so, you can learn at least a little about the health and well-being of coupling and bypass capacitors as well.

A capacitor, unless shorted or leaking shouldn't conduct current. When an ohmmeter is connected across a capacitor, the battery in the ohmmeter supplies current which charges the capacitor. As this is done, the meter seems to indicate that the capacitor is conducting current. But once the charge begins to build up on the capacitor plates, this charging current drops off.

In the case of an electrolytic capacitor, which has a fairly large capacity, enough current flows when you first connect the ohmmeter prods to the capacitor leads that you will get an indication of very low resistance. This is normal, as long as this resistance indication quickly increases, within a few seconds, to a value of several hundred thousand ohms.

However, if the apparent resistance remains rather low, then the capacitor has excessive leakage and probably should be discarded.

Other types of capacitors, such as coupling capacitors, have much lower capacity. This means that usually you'll get no indication on the meter that the capacitor is charging. Reason is that the capacitor requires so little current to take on a full charge that the ohmmeter battery supplies this current very quickly. The meter movement barely flick-

ers—if it budges at all.

With such capacitors, you should get an indication of infinite resistance with the ohmmeter. If you do get an indication of low or medium resistance, then the capacitor is leaking or shorted, and should be discarded.

**8** By adding a simple external modification to your ohmmeter, you can extend its range upward to accurately measure resistances much higher than what you normally can read on the meter scale.

Fig. 1 shows how this is done. What you do is add a battery and resistor in series with one ohmmeter lead. The positive battery terminal is connected to the negative ohmmeter lead, so that the internal and external battery voltages add. The external battery voltage should be nine times the voltage of the ohmmeter battery; similarly, the external resistor, *R*, should be nine times the total resistance of the ohmmeter high resistance range circuit.

The result of this external range extender will be to multiply the ohmmeter's high range by 10 times. With this hookup, for instance, a resistance which produces an indication on the meter of 2 megohms would actually be 20 megohms.

The exact external battery voltage and resistance needed will vary, depending on the meter you're using. For the Simpson 260 VOM, for instance, the manufacturer gives the values as 67.5 Volts and 1.08 megohms. But keep in mind that other meters may require different values.

To determine what you must add to your meter to use this range extension method, consult the operating manual for the meter. If this fails to cover the matter, write the manufacturer, enclose a copy of the dia-

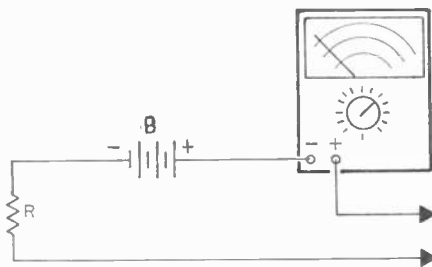

Fig. 1—External battery and resistor are used in this manner to extend range of your VOM for resistance measurements beyond normal range of your test set.



gram in Fig. 1, and explain what you want to do.

In case you find you need a rather peculiar external battery voltage, such as 54 or 13.5 Volts, remember that this doesn't have to be just one battery—you can connect a series of flashlight cells together to add up to the required voltage.

**9** There's an alternate method of accomplishing high-resistance measurements which, unlike Tip 8 just given, doesn't even involve using an ohmmeter. The circuit for this method is shown in Fig. 2.

For clarity, the diagram shows two meters. However, you can use a single VOM to make the two measurements required. The unknown resistance is connected in series with the VOM and with a DC power supply of several hundred volts.

Start with the highest current range your meter offers so as to guard against the possibility of throwing the meter off scale, then switch down to lower ranges until you obtain a usable reading.

After measuring the current flowing through the unknown resistor, you now need to measure the voltage across the resistor. If you use the same VOM to make this voltage measurement, remember to close the circuit where the current meter is shown in the diagram when you remove this meter to connect it across the resistor.

With these two measurements made, apply Ohm's law to determine the value of the unknown resistance. If, for example, you measured 700 volts across the unknown resistor and 10 microamps flowing through it, your calculations would be:

$$R = \frac{E}{I} = \frac{700}{.00001} = 70 \text{ megohms}$$

Before trying this method, be sure you are really dealing with a large amount of DC

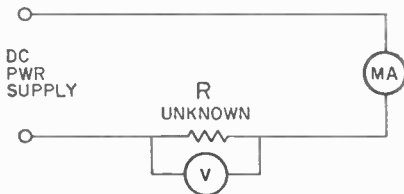

Fig. 2—Here's how to measure high resistance. Using a high voltage source, measure current and voltage and then apply Ohm's Law to calculate resistance value.

resistance. With the voltages you'll have to use, you could easily damage your meter or burn out the unknown component if it turned out to actually have only a medium amount of resistance.

**10** A technique very similar to that illustrated in Tip 9 can be used to measure very low values of resistance using a low voltage. A pair of dry cells connected in series will be fine, though you may get by with a single dry cell if your VOM has a millivolt range.

The test hookup is shown in Fig. 3. In addition to having the unknown resistance connected in series with the current meter and the flashlight cell, there's also a second resistor, about 5 to 10 ohms, in the series loop to limit the current flow. The value of this resistor isn't critical. However, if it's too large, you'll have difficulty getting meter readings large enough to be usable.

First, measure the current in the circuit. Then remove the meter, close the circuit again, and measure the voltage across the unknown resistance. Again, a simple calculation with Ohm's Law gives the value of the unknown resistance.

For example, suppose you got a current indication of 160 milliamperes and measured 0.08 volts across the unknown resistor. The calculation would be:

$$R = \frac{E}{I} = \frac{0.08}{0.16} = 0.5 \text{ ohm.}$$

Since you'll be measuring a pretty small voltage across a tiny resistance, a VOM with a millivolt scale would be handy. However, if your meter doesn't have such a scale, try using two or three dry cells instead of one. This will cause more current to flow, which will increase the voltage drop across the unknown resistance to the point where it should be easier to measure. ■

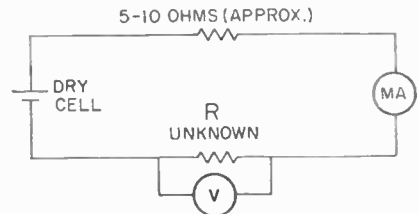

Fig. 3—Very low resistance values require higher current than available from VOM cell; with external source as shown in Fig. 2 read V and A and apply Ohm's Law.

## Something for Everyone

Continued from page 10

waveforms. A readout in the display panel directly above a lighted graticule eliminates all the guesswork and saves valuable time when measuring peak-to-peak voltage. Eight vertical scales ranging from 0.1 to 300 volts give amazingly accurate readings. The Model 1440, a 5-in. DC to 10 MHz recurrent sweep oscilloscope, features sync-separator circuits in TV-H and TV-V positions and a DC amplifier for measurement of AC and DC components. It has front-panel Vectorscope capability, is all Solid State (except for CRT), comes complete with a combination 10 to 1 and direct probe, and has the low profile case design. Operates on 117 VAC, 50 or 60 Hz. The Model 1440 has a user net price of \$299.95. For further information, circle No. 47 on the Reader Service Coupon on page 7 or 96.

### Good Goo

A new one-component liquid adhesive, Perma-bond, bonds rubber, metal, glass, plastics, wood, porcelain and many other materials in 10 to 45 seconds. It is ready to use without catalysts, heat, mixing or solvents. The adhesive has to be



applied to only one surface and one drop covers 1 sq. inch. It flows easily into cracks and crevices.

A compound of Alpha-Cyanoacrylate monomer, Perma-bond is colorless, transparent and impervious to many chemicals and weathering. For more information on prices and quantities, circle No. 46 on the Reader Service Coupon on page 7 or 96.

### For 2 and 4 Channels

An 8-track cartridge player deck which plays both conventional stereo and the increasingly popular four-channel tapes is available from 3M



Company for the car music buff who wants to hear his favorite tapes at home. The Wollensak model 8054 pre-amplified deck hooks into a component stereo system. The unit features fast forward control, channel selector key and automatic programming for stereo or 4-channel playback. The program and track indicators are illuminated. Frequency response is rated at 30-15,000 Hz, signal to noise ratio at 52dB, and wow and flutter at 0.25 per cent. Suggested list price is \$119.95. For complete information, circle No. 45 on the Reader Service Coupon on page 7 or 96.

### Big Boost

Want to make a lot of friends? Then pick up the Heath Company's GP-21 Battery Charger Kit. It's the lifesaver for those run down 12 volt batteries in automobiles, farm equipment and boats. Give your friends a boost, or give yourself one if your battery runs down. The GP-21 features a completely automatic, virtually foolproof design. The user simply plugs the line cord into a standard 120 VAC outlet, hooks up the terminal



cables and leaves. The charger brings the battery to 13.4 volts then shuts itself down, maintaining just enough current to compensate for normal leakage. The connections can be left indefinitely, and the GP-21 is protected against improper connection. At \$29.95 mail order, the Heathkit GP-21 Battery Charger kit includes rust-proof aluminum case, stainless steel hardware and cables. For all the facts on this kit circle No. 36 on the Reader Service Coupon on page 7 or 96.

### Speaker System Kits

Do-it-yourselfers can now assemble their own high-fidelity speaker systems with one of three

new Knight-Kits from Radio Shack. The speaker system kits are easy to assemble using a screwdriver, pliers and soldering iron, and provide a substantial savings over the cost of comparable factory-assembled speaker systems.

Model KG-5120 is an acoustic suspension system with an 8-in. dual-cone woofer and 3½-in. cone-type tweeter, rated at 24 watts peak. Over-

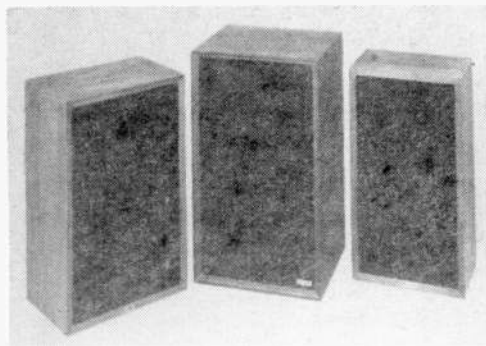

all response is given as 45-18,000 Hz. The book shelf-sized 12x22x8-in. speaker system is priced at \$39.95.

Model KG-5121 is a three-way system with a bass-reflex type enclosure, 10-in. woofer, cone-type 6-in. midrange and 3½-in. tweeter. Response is 40-18,000 Hz. Power capacity, 40 watts peak. Size, 14x22x9-in. Priced at \$49.95.

Top of the new Knight-Kit line is the Model KG-5122, featuring acoustic-suspension design with a 12-in. woofer, 3½-in. compression midrange, and horn-loaded dome radiator tweeter. It has midrange and tweeter level controls at the rear of its 14x24x12¾-in. enclosure. 60 watts peak power capacity. Response is given as 30-20,000 Hz. Price, \$79.95. For more information on these Knight-Kit speaker system kits circle No. 43 on the Reader Service Coupon on page 7 or 96.

### Pollution Detective

Designed especially for ages 8 through young adults, Edmund's comprehensive Pollution Test Kit includes everything needed for testing environmental pollution. An ideal introduction to ecology and good citizenship, the kit contains a multitude of safe chemicals and apparatus for detecting, and in many cases, measuring the degree of pollutants—aldehydes, sulphur dioxide, ozone, carbon monoxide, carbon dioxide—in air,



water and soil. Alkalinity and acidity levels can also be measured.

Available by mail from Edmund Scientific Co. for only \$9.95, the kit also instructs in biodegradables, and promotes anti-litter activity. For more information circle No. 39 on the Reader Service Coupon on page 7 or 96.

### CBer's Safety Triangle

Tests by an independent testing lab and the U.S. Army show the Tri-Vec Safety triangle to be significantly more effective than previously used devices to indicate a car stopped on the road or shoulder. A permanent reflective coating provides high visibility, day or night. Made of high impact molded plastic, the unit has passed wind stability tests of 40mph, yet it is light weight and sets up



or knocks down quickly for easy storage. A study sponsored by the Automotive Safety Foundation revealed that of all basic geometric shapes, the triangle is most quickly identified by the human eye. Tail lights, flares, etc. do not convey an internationally recognized warning signal for disabled vehicles as does the Tri-Vec Safety Triangle which is priced at \$5.25 postpaid. For more information, circle No. 38 on the Reader Service Coupon on page 7 or 96.

### Cheapie Electret

New from Radio Shack is the self-powered Realistic Electret Condenser Microphone designed for voice or music reproduction with the highest quality tape recorders. Its 30 to 15,000 Hz response is said to equal that of professional-type microphones costing several times as much. Due to its extremely low current consumption, a single "AA" size penlight cell will provide more than 10,000 hours, or about one year, of normal use. Although made for use with tape recorders having low-impedance (600 ohm) mike inputs, due to its high sensitivity it can also be used effectively with recorders having high-impedance (up to 20,000 ohm) mike inputs. The Realistic Condenser Microphone is priced at \$24.95, in-

cludes desk stand, floor stand adapter and removable poly-urethane windscreen for protection from wind. For more data, circle No. 37 on the Reader Service Coupon on page 7 or 96.

### Ecology Kit

Smart shoppers with an inclination to do-it-themselves can save on today's most exciting new kitchen appliance—the waste compactor—with the Heathkit Minimizer, available from Heath Company. Selling for \$199.95 mail order, the GU-1800 Minimizer offers all the features found on any other compactor on the market, plus the unique self-service advantage of an easy-to-

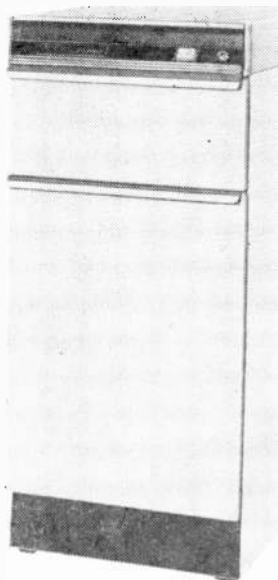

assemble kit. The minimizer compresses all normal household disposables into a neat plastic lined bag. The packing-ram reduces refuse to nearly 1/4 of its original size, so one bag will hold up to a week's trash for an average family of four. Assembly is an easy 6 to 10 hour job. If you want to help keep the country clean, circle No. 44 on the Reader Service Coupon on page 7 or 96.

### Electrostatic Speaker System

Lafayette's bookshelf electrostatic speaker system, Criterion ES85, contains newly designed electrostatic tweeter elements—4 in all—characterized by their ability to reproduce high frequencies with faithfulness, presence, and crystal clarity. The handsome airtight oiled walnut wood enclosure houses an 8-in. low frequency dynamic transducer that reproduces deep bass response down to 45 Hz. A built-in power supply for the tweeter elements conveniently includes a 117 VAC line cord and switch. Current consumption is so low that the speakers may be left plugged in permanently. The electrostatic tweeter elements consists of a movable flat metal diaphragm and a non-movable metal electrode capable of reproducing high frequencies up to 25,000 Hz. An electrical L/C crossover network crosses over at 5,000 Hz and includes a variable high frequency control for adjusting the ESL tweeter output to tailor it to your listening room. Power

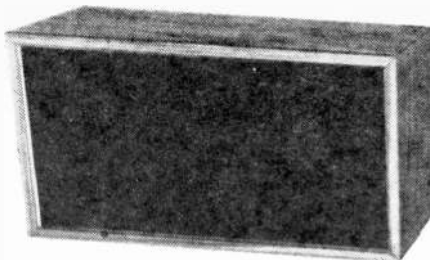

handling capacity 50 watts (minimum, 12 watts). Size: 11 3/4 x 21 3/8 x 8 1/2-in. D. Priced at \$64.95, stock No. 99-02719W. For more information, circle No. 40 on the Reader Service Coupon on page 7 or 96.

### CB Polecat

A new low cost base station antenna, nicknamed Polecat, has been announced by the Antenna Specialists Company. The Model M-417 Polecat features a full 1/2-wavelength (17 foot long) radiator and a Hi-Q phasing coil which produces a VSWR of 1.5:1 or better on all chan-

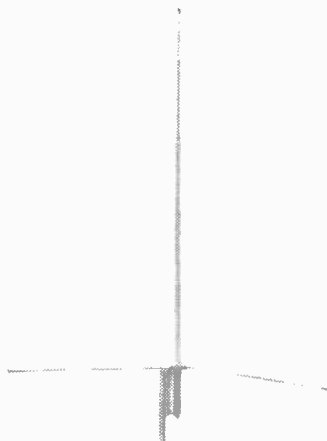

nels. Three 1/4-wave radials result in a low angle of radiation and a 6 dB improvement in signal-to-noise can be expected. The Polecat is priced at \$18.95 suggested retail. Complete details are available from A/S dealers, or by circling No. 41 on the Reader Service Coupon on page 7 or 96.

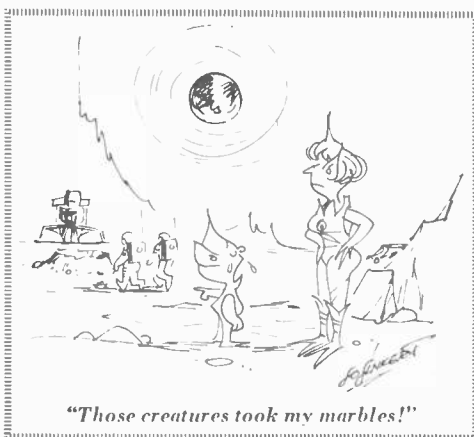

"Those creatures took my marbles!"

## Prefixes and Exponents

*Continued from page 76*

The jargon of electronics which has grown up around these prefixes is just as important as the prefixes themselves. Here are some examples of "jargonized" prefixes as they might appear in speech:

**Puff**—a picoFarad (from the abbreviation, pF)

**Mickey-mike**—A micro-micro Farad (which is the same as a **puff**)

**Meg**—A megohm. Also, less often, a megaHertz.

**Mill**—A milliAmpere

**Megger**—a device for measuring meg-Ohms

**dB** (pronounced "dee-bee"—A decibel, which is one-tenth of a Bel

**Mike**—A microFarad. Also, to measure with a micrometer.

So, if you understand the prefixes and know their corresponding exponents, you'll have command of another set of important tools to help you do practical work in electronics. In addition, you'll be ready for the inevitable wise guy who'll ask if you can tell him the reactance of a 100-puff capacitor at 200 gigaHertz. After calculating the answer in gigaseconds, reply in femtoOhms! ■

## No-Buck Tester

*Continued from page 68*

tive ohmmeter probe base connected (base-collector junction test), you're looking at an npn unit. That's why the emitter and collector were arbitrarily marked—you might have to switch the *E* and *C* around in order for things to make sense.

We won't deny that this process takes a little practice. Therefore, you might want to mount a known transistor to the paper first and experiment with this unit in order to get the hang of things.

As expected, pnp units give opposite resistance readings with this method. Always remember to find the emitter and collector first, and then go ahead and make your

measurements between base-emitter junction, then base-collector junction.

We've gone through a lot of work sorting out good, bad, and indifferent npn and pnp transistors. Was it worth the effort? Our most immediate test result enables us to sort the wheat from the chaff. Good transistors go in one pile, and the others sheepishly slink off to your things-I-wasted-my-money-on collection.

Those transistors with the highest base-emitter resistance ratios happily serve in RF and audio gear. Units with lower ratios perk in power supplies as pass transistors. Those pnp's squeaking along with horrible resistance ratios can be put to work in your next project requiring not-too-critical diodes. Cut off the collector lead; the emitter now serves as the new diode anode with base serving as cathode. ■

## Superheterodyne

*Continued from page 56*

of 8455 kHz, which places it exactly in our IF signal ball park. But note that a second station—a pop fly on 8910 kHz—also happens to be 455 kHz away from the local oscillator. For each oscillator frequency, now there are two station frequencies giving identical IF frequencies. It's up to your receiver to strike out the image station. Otherwise, the RF ball game will turn into a rout!

You might expect the receiver's antenna tuning circuit to completely reject the image signal. After all, it's supposed to be tuned

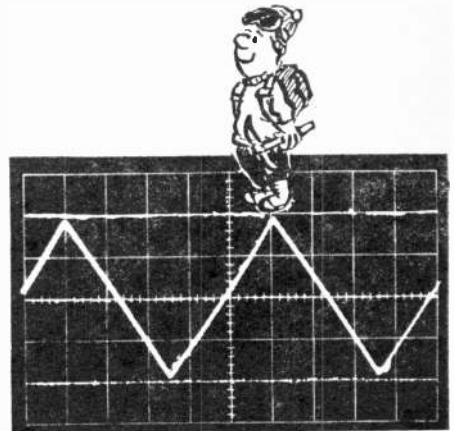

generate a very high IF frequency, positioning any images developed by the mixer well outside the tuning range of the antenna circuit. Looking at our example of a double superhet, you'll see one IF amplifier perking at 5000 kHz and another working on 455 kHz. Now if we receive an incoming signal on 8000 kHz, the local oscillator, now called a high-frequency oscillator, generates a frequency at 13,000 kHz, so the first IF signal works out to 5000 kHz. Your receiver would have to pick up a signal falling on 18,000 kHz to produce any image. Naturally, the image frequency in this instance is significantly removed from the antenna circuit, so the image is greatly attenuated.

While high IF frequencies work well against image interference, they also revive Nagging Problem Number One: the higher the frequency of a tuned circuit, the poorer its selectivity. Since this situation also applies to IF stages, a *second* conversion is required, bringing the first IF signal down to 455 kHz, where we can sharpen our receiver's selectivity curve. That's how the double-conversion receiver solves both image and selectivity hassles. Any ham or

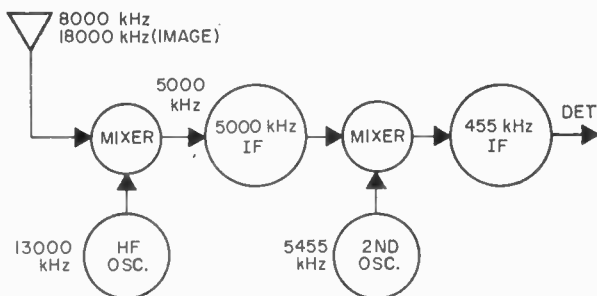

**Any superhet worthy of warming an amateur shack works around image problem with dual conversion. Combination of IFs puts image out of range of either stage.**

SWL rig worthy of an on/off switch is sure to have this feature. But don't think of dual conversion as a receiver cure-all.

Dual conversion is *not* usually found in entertainment receivers—radio broadcast and TV for example, because it's too sharp! High selectivity could easily slice away sidebands in an FM stereo program and kill its multiplexed channel, or rob a TV image of its fine picture detail.

But for all its faults, the basic superhet circuit we've been talking about must be doing something right. Last year over 50 million superhets were sold in the U.S. Not bad for a circuit that might have gone the way of the hip flask, eh? ■

## CB Signal All Put Out

*Continued from page 47*

Saxton Model BC-2 baluns ordered from Lafayette Radio-Electronics. If you try these coils, use the following schematic, supplied in the coil package; "Circuit A—75 ohm to 300 ohm". One pair of coils connects the 75-ohm side to the CB transmitter; the second pair connects the 75 ohms to the antenna base. (Although 75 ohms is specified, the coils operate at very low SWR at CB's 50 ohms.) The system is shown in Fig 9.

**It's Round Up Time.** Finally, whatever matching technique or adjustment you follow in your CB rig, don't run the "ratio race". Although standing waves should have the lowest ratio indicated on an SWR meter inserted in the transmission line, anything below 2-to-1 is all you need for good signals on both transmitting and receiving

sides. An overall look at the major matching points is shown in Fig. 10.

Antenna matching is a must for CBers. Admittedly you can transmit far beyond 150 miles on 5-watts input to your rig's final, but, far too many stations can't get past the next hill because their radiated RF is used to heat up the coax line. Get with it and match up! ■



## Tackle That Totable TV

*Continued from page 30*

the trouble and the tubes are O.K. Check for low grid drive voltage on the output tube and check the associated components. Most width problems are found in the horizontal output sweep circuit (see Fig. 15).

Also look for a brass sleeve (on some portables) around the CRT gun and yoke assembly. Loosen up the yoke assembly screw and pull the brass shim out toward the picture tube socket to increase picture width. On deluxe portables with a horizontal drive control, check that it's set correctly. Try adjusting the control for correct width. Going too far will produce one or two white vertical drive lines from the middle to the left side of the CRT screen, in which case the control should be backed off a bit.

**Horizontal Lines.** Check the horizontal tubes when lines are lying across the CRT and cannot be straightened up with the horizontal hold control (see Fig. 16). If this doesn't do the job, adjust the horizontal frequency coil slug. Set the horizontal hold control in the center of rotation and adjust the horizontal frequency coil slug until the picture locks in. Now switch the channel selector knob to another channel and see if the horizontal circuit stays locked in. If not, it may be necessary to make another fine adjustment of the horizontal frequency coil.

When the horizontal lines will not straighten up or the raster goes into a *Christmas-tree* effect or jagged horizontal lines, check for a defective AFC circuit. In current portables, a duo-diode rectifier with three leads serves as the AFC component as shown in the schematic in Fig. 17.

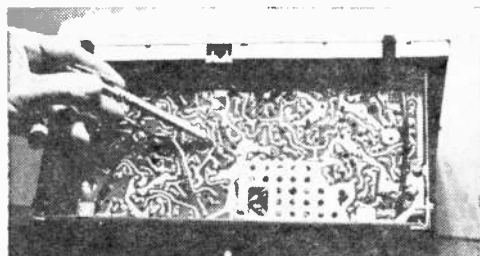

Fig. 24. Last but not least in the stable of portable TV troubles is the printed circuit board. Check it for cracks and cold solder joints in the area of the defective circuit, especially around heavy components.

To remove the duo-diode, cut off the leads about  $\frac{1}{2}$  in. from the PC board. Now you can solder a new AFC diode (or the old one) to these leads. Take a resistance measurement of the duo-diode rectifier; these are usually of the common cathode type (the center terminal is common to the two outside leads). Connect the ground lead from the ohmmeter to the center diode terminal. Now measure the resistance from each outside lead; the reading should be around 20 K. Reversing the ohmmeter leads should produce a zero-ohms reading. A leaky duo-diode will show a low resistance both ways.

A keystone, or triangular, picture is caused by a shorted deflection yoke and can only be remedied by replacing it with a new one. Bending and pulling of the picture can be caused by a defective horizontal oscillator or output tube. Excessive blooming of the picture when the brightness control is cranked up is caused by weak horizontal output or high voltage tube.

**Bright Horizontal Line.** If the picture consists of a single horizontal line, replace the vertical oscillator and multiplier tube. The bright horizontal line indicates the vertical sweep is not operating (see Fig. 18).

If tube replacement does not help, try adjusting the vertical height and linearity controls, or both. It is possible for the vertical height control to have a burnt spot, causing the vertical sweep to collapse. Check for continuity of the vertical output transformer windings. Also check to see if the feedback coupling capacitor shown in Fig. 19 is leaky.

For insufficient height, at top or bottom of the raster, adjust the vertical height and linearity controls. A weak vertical oscillator or output tube can cause this problem, too.

Constant vertical rolling of the picture can often be cured with a new vertical oscillator tube. If the picture is unstable both vertically and horizontally, the fault lies in the sync section. Replace both vertical and sync separator tubes. Some portables have both features in one tube, while others may have these sections in a separate tube or located in one-half of another dual-function tube.

**Snowy Picture.** A picture very light in detail with a lot of snow on the screen as in Fig. 20 is usually caused by a defective RF tube in the tuner. Substitute a new RF, oscillator, and first IF tube and see if the situation improves. *(Continued on 94)*

*Continued from page 93*

Picture still snowy? Then dig into the antenna coils and lead-in connections. Most portable receivers have isolating capacitors in the antenna input terminals. These capacitors protect the antenna coils and tuner.

In case lightning has struck your antenna, you may find one or both of these capacitors blown open. With an ohmmeter, check continuity of both antenna coils. You will find the antenna coils located on top at the rear, or inside, of the tuner cover. Be sure and replace damaged antenna coils with direct factory replacements.

**Stations Won't Stay On Channel.** In case the picture will not stay on channel or becomes snowy when the channel selector is jogged, clean the tuner (Fig. 22) with a good tuner spray lube. With the strip or turret-type tuner, clean the contact points with rag and cleaning solution. Bear down with the clean section of the rag to brighten up the contacts. Apply contact grease over the clean contacts and spray the contact springs located under the tuner drum.

## When Color Won't Stay Put

*Continued from page 22*

compares burst and 3.58 oscillator frequencies and creates the DC correction voltage.

But for comparison action to occur, the diodes in the Phase Detector must be electrically balanced, even when no burst is present. This provides a basis for a simple test. First, place a shorting jumper from grid to ground of the Burst Amp, as shown. This kills any incoming burst which would disturb the test.

Then place a VTVM across the plate of the Phase Detector and to ground. If your circuit is typical of many, you should read approximately  $-28$  VDC at this point. Next measure the diode cathode to ground for a reading of  $+28$  VDC. Voltages in different circuits may vary, but the important feature is that they are typically equal and opposite. This is a good indication of proper balance in the stage. Resistors and capacitors should be checked if voltages are unequal.

**O.K. Phase.** If there's good voltage balance in the Phase Detector, shift attention to the Burst Amplifier. Voltage and resistance checks here stand a good chance of revealing the trouble. If you can't pinpoint the

Many small tuners use a rotating multi-section wafer switch. Spray these contacts and rotate the tuner shaft at the same time. Select a good tuner spray that won't be harmful to plastic parts in the tuner.

**Conclusion.** There are many troubles that can develop in a portable TV. Remember to go slow and easy. Look, listen, and try to isolate which section the trouble is in. Be careful not to break off any control knobs on the rear of the chassis or damage the set in any other way.

You will find that all tubes and parts are quite close together in portables. Some of the tubes and parts are hard to get at, so proceed with caution (see Fig. 23). If the set has been subjected to abuse, don't forget to check the PC board for possible intermittent condition (see Fig. 24). Especially on the earlier sets, PC boards were subject to many problems.

But with care and a little use of the old think tank, most portable TV problems can be easily solved. So, go to it with confidence and save a few bucks while you're at it. ■

culprit, perhaps the incoming burst signal isn't reaching the Burst Amp.

We've shown the source of the burst in Fig. 11. Note that it's from a tap-off point from the Color Amp. If any components between this point and the grid of the Burst Amp are defective, there could be an interruption of the burst signal. So check resistors, capacitors, or coils in this part of the circuit. If you're getting color on the screen, even if it's out-of-sync, chances are the other stages shown in Fig. 11 are functioning. Explanation for this fact is that the color signal must traverse those stages in order to reach the picture tube.

Thus, with little more than a VTVM and a jumper wire, you should be able to track down most troubles in color sync circuits. The simple tests described help locate the general area, or even a particular stage that's upsetting color stability.

If you run into an exotic problem that won't yield to these tests, chances are you'll need an oscilloscope to examine actual signals in transit through color-sync stages.

A typical schematic by RCA is illustrated in Fig. 12. Note that the scope waveforms seen at the bottom correspond to numbered points in the diagram. Both the shape of wave and its P-P (peak-to-peak) voltage are given for comparisons. ■



# CLASSIFIED Market Place

FOR BIGGER PROFITS! NEW CAREER OPPORTUNITIES!  
READ AND REPLY TO THESE CLASSIFIED ADS

Classified Ads 65¢ per word, each insertion, minimum 10 words, payable in advance. For information on Classified ads—to be included in our next RADIO-TV REPAIR—write to C. D. Wilson, Mgr., Classified Advertising, 229 Park Avenue South, New York, N.Y. 10003.

## ADDITIONAL INCOME

MAKE \$1.00 PER SALE selling engraved metal Social Security plates. FREE SALES KIT. Engravplates, Box 10460-7510, Jacksonville, Florida 32207.

## ANTIQUES, ARTS & CURIOS

ANTIQUER—Curios guide book. Complete listing—pricing—of thousands of items. 224 pages. Hundreds of illustrations. \$2.50—Four Seasons, Box 399S, Huntington, N. Y. 11743.

## AUTHOR'S SERVICE

PUBLISH your book! Join our successful authors: publicity advertising promotion, beautiful books. All subjects invited. Send for free manuscript report and detailed booklet. Carlton Press, SMH, 84 Fifth Avenue, New York 10011.

## BOOKS AND PERIODICALS

FOR the best reading in the Mechanical Field—give Science & Mechanics! \$4.00 for year's subscription. Science & Mechanics, 229 Park Avenue South, New York, New York 10003.

1971 CB YEARBOOK—A magazine for the buyers of Citizen's Band Electronic Equipment. Send \$1.25—(includes Postage) to CB Yearbook, 229 Park Avenue South, New York, New York 10003.

ADULTS ONLY!!! FREE ILLUSTRATED "DISCOUNT" CATALOGUE "UNUSUAL". Records—magazines—photos—merchandise. Books—Box 126-SM, Brooklyn 11229.

## BUSINESS OPPORTUNITIES

I MADE \$40,000.00 Year by Mailorder! Helped others make money. Start with \$10.00—Free Proof! Torrey, Box 318-T, Ypsilanti, Michigan 48197.

MAKE Magnetic Signs. Big Profits. Free Information. Universal. Lenora, Kansas 67645.

1000% PROFIT Bronzing Shoes. Free Details. NBC, Box 11069-0, Kansas City 64119.

MAILORDER: How to prepare your own catalog for pennies! Free catalog! Obie-BHC, Brooklyn, New York 11219.

## COINS, CURRENCY & TOKENS

SELLING my barrel of Indian & Lincoln cents (1860's thru 1920's—all mints) at \$10 per pound! Maximum 10 pounds. Sample bag of 20—\$2. Mrs. Penny Fisher, Box 1778-T, Encino, California 91316.

## DO-IT-YOURSELF

PRACTICAL tips for home, garden and workshop are in "1001 How-To Ideas." Send \$1.00 for your copy includes Postage. to 1001 How-To Ideas, 229 Park Avenue South, New York, New York 10003.

## FERROUS SULFATE

(5 GRAINS Each) I have the Amazing Superior Tonic Tablets. The pill that puts Youthful Desire into Aging Bodies. 30 Tablets \$3.00 NINA of GERMANY, 406 S. SECOND St. ALHAMBRA, CALIF. 91802

## INVENTIONS WANTED

WE either sell your invention or pay cash bonus. Write for details. Universal Inventions, 298-14, Marion, Ohio 43302.

## MISCELLANEOUS

DON'T DIE Without a Will! Protect your family! Blank will forms only \$2. Willform, Box 191, Auburn, New York 13021

## MONEYMAKING OPPORTUNITIES

ADDRESSERS needed! Postage, envelopes, etc. furnished! Details \$1.00. NESales-C, P. O. Box 1573, Worcester, Massachusetts 01601.

MAKE Big Money raising chinchillas, rabbits, guinea pigs for us. Catalog 50¢. Keeney Brothers Farms, Inc., New Freedom, Pennsylvania 17349.

MAKE Your Classified Ad Pay. Get "How To Write a Classified Ad That Pays." Includes certificate worth \$2.00, towards classified ad in this publication. Send \$1.25 TO R. S. WAYNER, Science & Mechanics, 229 Park Avenue South, New York, New York 10003.

## PERSONAL

ELIMINATE Debts Without Borrowing! Particulars Free. Helper, 10639 Riverside, No. Hollywood, California 91602.

BEEN Looking for real Chili? Recipe kept secret 23 years. But no longer. So good it is now copyrighted. Details: P. O. Box 3051, Ft. Worth, Texas 76105.

## PHOTOGRAPHY—PHOTO FINISHING & SUPPLIES

SAVE HUNDREDS of Dollars!!! Make your own Densitometer. Free detailed instructions available. Write to: Science & Mechanics Instruments Division, Dept. HW372, 229 Park Avenue South, New York, New York 10003.

## PROFITABLE OCCUPATIONS

CHINCHILLA income guaranteed Terms 25¢—Bulletin \$1.00 Rainbow. 11DC Post Richey, Florida 33578

## REMAILING SERVICE

DALLAS—Fort Worth Remails 25¢ Monthly Rates, Nortex, Drawer 430, Weatherford, Texas 76086

NEW YORK REMAILS 25¢ each. \$3.00 Monthly. Foreign accounts welcome M Cassidy, 2845 University, New York, N.Y. 10468.

## SALESMEN—DISTRIBUTORS

BIG DEMAND ANTICRIME DEVICE—Excellent Profit Potential—free details Sutton, Route 4, Box 143, Lawton, Oklahoma 73501.

## SONGWRITERS

SONGS, Poems Wanted! For Publishing, recording at our expense! Talent, 17-HW, Longwood Road, Quincy, Mass. 02169.

## SPECIAL SERVICES

THERE IS NO CHARGE FOR THE ZIP CODE. PLEASE USE IT IN YOUR CLASSIFIED AD.

## STAMP COLLECTING

FIFTY United States stamps, including 19th Century, 25¢ to approval applicants. Littleflower, P. O. Box 771, Royal Oak, Michigan 48068.

THERE IS NO CHARGE FOR THE ZIP CODE. PLEASE USE IT IN YOUR CLASSIFIED AD.

## TIPS FOR THE HOME, ETC.

PRACTICAL tips for home, garden and workshop are in "1001 How-To Ideas." Send \$1.00 for your copy includes Postage. to 1001 How-To Ideas, 229 Park Avenue South, New York, New York 10003.

## FOR GREATER CLASSIFIED PROFITS, RESULTS AND SAVINGS

Place your ad in one of our SPECIAL COMBINATIONS: Business, Science & Mechanics, or Davis Combination. Each Combination is designed to give your ad the largest audience available. For further information write to R. S. WAYNER, Manager, Classified Advertising, Science & Mechanics, 229 Park Avenue South, New York, N.Y. 10003.

## READER SERVICE PAGE

• The Editor of RADIO-TV REPAIR — 1972 ISSUE offers readers an easy way to get additional information about products and services advertised in this issue. To become proficient in your home and repair projects you must obtain the correct quality parts, knowledge, test gear, tools and many other items. Become a knowledgeable buyer by obtaining information on the products and services mentioned in this issue and keyed with a Reader Service Number, it's yours for the asking. Just follow the instructions below and the literature you requested will be sent to you promptly and at no cost. It will be a pleasure to serve you.

• The coupon below is designed for your convenience. Just circle the numbers that appear next to the advertisement or editorial mention that interests you. Please limit your selections to 20 or less. Then, carefully print your name and address on the coupon. Cut out the coupon and mail to RADIO-TV REPAIR, Box 886, Ansonia Station, New York, N.Y. 10023. Do it today!

Mail Coupon to: This offer expires December 31, 1972

**RADIO-TV REPAIR**

**Box 886 Ansonia Station, New York, N.Y. 10023**

• Okay, I want some information and I want it fast. Please arrange to have the literature whose numbers I've circled at right sent to me as soon as possible. I understand this is a free service; however, I must limit the circled items to 20.

	1	2	3	4	5	6	7	8
	9	10	11	12	13	14	15	16
	17	18	19	20	21	22	23	24
	25	26	27	28	29	30	31	32
	33	34	35	36	37	38	39	40
	41	42	43	44	45	46	47	48

Name \_\_\_\_\_

Address \_\_\_\_\_

City \_\_\_\_\_ State \_\_\_\_\_ Zip \_\_\_\_\_

# 10 Reasons why RCA Home Training is

# your best investment for a rewarding career in electronics:

Transistor experiments  
on programmed breadboard—  
using oscilloscope.



## 1 LEADER IN ELECTRONICS TRAINING

RCA stands for dependability, integrity, and pioneering scientific advances. For over half a century, RCA Institutes Inc. has been a leader in technical training.

## 2 RCA AUTOTEXT TEACHES ELECTRONICS FASTER, EASIER

Beginner or refresher—AUTOTEXT, RCA Institutes' own Home Training method helps you learn electronics faster, easier, almost automatically.

## 3 WELL PAID JOBS ARE OPEN TO MEN SKILLED IN ELECTRONICS

There are challenging new fields that need electronics technicians... new careers in computers, automation, television, space electronics where the work is interesting and earnings can be greater.

## 4 WIDE CHOICE OF CAREER PROGRAMS

Select from a wide choice of career programs, each of which starts with the amazing "AUTOTEXT method of programmed instruction. Check over the attached card.

## 5 SPECIALIZED ADVANCED TRAINING

For those working in electronics or with previous training, RCA Institutes offers advanced courses. No wasted time on material you already know.

## 6 PERSONAL SUPERVISION THROUGHOUT

All during your program of home study, your training is supervised by RCA Institutes experts who become personally involved in your efforts and help you over any "rough spots" that may develop.

## 7 HANDS-ON TRAINING

To give practical application to your studies, a variety of kits are included in your program. You get over 250 projects and experiments and as many as 22 kits in some programs. When completed, they're yours to keep and use on the job.

## 8 FCC LICENSE TRAINING—MONEY BACK AGREEMENT

Take RCA's Communications Career Program—or enter with advanced standing and prepare immediately for your 1st, 2nd, or 3rd class FCC Radio-

telephone License exams. RCA Institutes' money-back agreement assures you of your money back if you fail to pass the FCC exams taken within 6 months after completing the course.

## 9 CONVENIENT PAYMENT PLANS

You get a selection of low-cost tuition plans. And, we are an eligible institution under the Federally Insured Student Loan Program.

## 10 RCA INSTITUTES IS FULLY ACCREDITED

RCA Institutes is an accredited member of the National Home Study Council. Licensed by N.Y. State—courses of study and instructional facilities are approved by the State Education Department.

**Canadians:** These same RCA courses are available to you in Canada. No postage. No customs. No delay. Your inquiry will be referred to our school in Canada.

VETERANS: TRAIN  
UNDER NEW GI BILL

CLASSROOM TRAINING ALSO AVAIL-  
ABLE. FREE CATALOG ON REQUEST.

ACCREDITED MEMBER National Home Study Council

Construction of Oscilloscope.

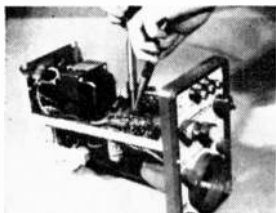

Construction of Multimeter.



# RCA

If Reply Card Is Detached—Send This Coupon Today

## RCA INSTITUTES, INC.

Home Study Dept. 767-202-0  
320 West 31st Street  
New York, N.Y. 10001

Name \_\_\_\_\_

Address \_\_\_\_\_

City \_\_\_\_\_

State \_\_\_\_\_

Zip \_\_\_\_\_

Check here if interested in Classroom Training

# BUILD YOUR OWN RADIO

## and Electronics Circuits

### PROGRESSIVE HOME RADIO-T.V. COURSE

#### Now Includes

- ★ 12 RECEIVERS
- ★ 3 TRANSMITTERS
- ★ SQ. WAVE GENERATOR
- ★ SIGNAL TRACER
- ★ AMPLIFIER
- ★ SIGNAL INJECTOR
- ★ CODE OSCILLATOR

- ★ No Knowledge of Radio Necessary
- ★ No Additional Parts or Tools Needed
- ★ EXCELLENT BACKGROUND FOR TV
- ★ **SCHOOL INQUIRIES INVITED**
- ★ Sold In 79 Countries



Reg. U. S. Pat. Off.

Training Electronics Technicians Since 1946

### YOU DON'T HAVE TO SPEND HUNDREDS OF DOLLARS FOR A RADIO COURSE

The "Edu-Kit" offers you an outstanding PRACTICAL HOME RADIO COURSE at a rock-bottom price. Our Kit is designed to train Radio & Electronics Technicians, making use of the most modern methods of home training. You will learn radio theory, construction practice and servicing. THIS IS A COMPLETE RADIO COURSE IN EVERY DETAIL.

You will learn how to build radios, using regular schematics; how to wire and solder in a professional manner; how to service radios. You will work with the standard type of punched metal chassis as well as the latest development of Printed Circuit chassis.

You will learn the basic principles of radio. You will construct, study and work with RF and AF amplifiers and oscillators, detectors, rectifiers, test equipment. You will learn and practice code, using the Progressive Code Oscillator. You will learn and practice trouble-shooting, using the Progressive Signal Tracer, Progressive Signal Injector, Progressive Dynamic Radio & Electronics Tester, Square Wave Generator and the accompanying instruction manuals.

You will receive training for the Novice, Technician and General Classes of F.C.C. Radio Amateur Licenses. You will build Receiver, Transmitter, Square Wave Generator, Code Oscillator, Signal Tracer and Signal Injector Circuits, and learn how to operate them. You will receive an excellent background for television, Hi-Fi and Electronics.

Absolutely no previous knowledge of radio or science is required. The "Edu-Kit" is the product of many years of teaching and engineering experience. The "Edu-Kit" will provide you with a basic education in Electronics and Radio, worth many times the low price you pay. The Signal Tracer alone is worth more than the price of the kit.

### THE KIT FOR EVERYONE

You do not need the slightest background in radio or science. Whether you are interested in Radio & Electronics because you want an interesting hobby, a well-paying business or a job with a future, you will find the "Edu-Kit" a worth-while investment. Many thousands of individuals of all

ages and backgrounds have successfully used the "Edu-Kit" in more than 79 countries of the world. The "Edu-Kit" has been carefully designed step by step, so that you cannot make a mistake. The "Edu-Kit" allows you to teach yourself at your own rate. No instructor is necessary.

### PROGRESSIVE TEACHING METHOD

The Progressive Radio "Edu-Kit" is the foremost educational radio kit in the world, and is universally accepted as the standard in the field of electronics training. The "Edu-Kit" uses the modern educational principle of "Learn by Doing." Therefore you construct, learn schematics, study theory, practice trouble shooting. It is a closely integrated program designed to provide an easily-earned, thorough and interesting background in radio. You begin by examining the various radio parts of the "Edu-Kit." You then learn the function, theory and wiring of these parts. Then you build a simple radio. With this first set you will enjoy listening to regular broadcast stations. Learn theory, practice testing and techniques. Gradually, in a progressive manner, and at your own rate, you will find yourself constructing more advanced multi-tube radio circuits, and doing work like a professional Radio Technician.

Included in the "Edu-Kit" course are Receiver, Transmitter, Code Oscillator, Signal Tracer, Square Wave Generator and Signal Injector Circuits. These are not unprofessional "breadboard" experiments, but genuine radio circuits, constructed by means of professional wiring and soldering on metal chassis, plus the new method of radio construction known as "Printed Circuitry." These circuits operate on your regular AC or DC house current.

### THE "EDU-KIT" IS COMPLETE

You will receive all parts and instructions necessary to build twenty different radio and electronics circuits, each guaranteed to operate. Our Kits contain tubes, tube sockets, variable electrolytic, mica, ceramic and paper dielectric condensers, resistors, tie strips, hardware, tubing, punched metal chassis, Instruction Manuals, hook-up wire, solder, selenium rectifiers, coils, volume controls and switches, etc.

In addition, you receive Printed Circuit materials, including Printed Circuit chassis, special tube sockets, hardware and instructions. You also receive a useful set of tools, a professional electric soldering iron, and a self-powered Dynamic Radio and Electronics Tester. The "Edu-Kit" also includes Code Instructions and the Progressive Code Oscillator, in addition to F.C.C. Radio Amateur License training. You will also receive lessons for servicing with the Progressive Signal Tracer and the Progressive Signal Injector, a High Fidelity Guide and a Quiz Book. You receive Membership in Radio-TV Club, Free Consultation Service, Certificate of Merit and Discount Privileges. You receive all parts, tools, instructions, etc. Everything is yours to keep.

Progressive "Edu-Kits" Inc., 1189 Broadway, Dept. 515DK, Hewlett, N.Y. 11557

### UNCONDITIONAL MONEY-BACK GUARANTEE

Please rush my expanded "Edu-Kit" to me, as indicated below:

Check one box to indicate choice of model:

- Deluxe Model \$31.95
- New Expanded Model \$34.95 (Same as Deluxe Model Plus Television Servicing Course and valuable Radio & TV Tube Checker).

Check one box to indicate manner of payment:

- I enclose full payment. Ship "Edu-Kit" post paid.
- I enclose \$5 deposit. Ship "Edu-Kit" C.O.D. for balance plus postage.
- Send me FREE additional information describing "Edu-Kit."

Name

Address

City & State

Zip

### PROGRESSIVE "EDU-KITS" INC.

1189 Broadway, Dept. 515DK, Hewlett, N. Y. 11557

### FREE EXTRAS

#### • SET OF TOOLS

- SOLDERING IRON
- ELECTRONICS TESTER
- PLIERS-CUTTERS
- VALUABLE DISCOUNT CARD
- CERTIFICATE OF MERIT
- TESTER INSTRUCTION MANUAL
- HIGH FIDELITY GUIDE • QUIZZES
- TELEVISION BOOK • A RADIO TROUBLE-SHOOTING BOOK
- MEMBERSHIP IN RADIO-TV CLUB
- CONSULTATION SERVICE • FREE AMATEUR LICENSE TRAINING
- PRINTED CIRCUITRY

### SERVICING LESSONS

You will learn trouble-shooting and servicing in a progressive manner. You will practice repairs on the sets that you construct. You will learn symptoms and causes of trouble in home, portable and car radios. You will learn how to use the professional Signal Tracer, the unique Signal Injector and the dynamic Radio & Electronics Tester. While you are learning in this practical way, you will be able to do many a repair job for your friends and neighbors, and charge fees which will far exceed the price of the "Edu-Kit." Our Consultation Service will help you with any technical problems you may have.

### FROM OUR MAIL BAG

J. Statalitis, of 25 Poplar Pl., Waterbury, Conn., writes: "I have repaired several sets for my friends, and made money. The "Edu-Kit" paid for itself. I was ready to spend \$240 for a course, but I found your ad and sent for your Kit."

Gen Valerio, P. O. Box 21, Magna, Utah: "The Edu-Kits are wonderful. I'm sending you the questions and also the answers for them. I have been in Radio for the last seven years, but like to work with Radio Kits, and like to build Radio Testing Equipment. I enjoyed every minute I worked with the different kits; the Signal Tracer works fine. Also like to let you know that I feel proud of becoming a member of your Radio-TV Club."

Robert L. Shuff, 1534 Monroe Ave., Huntington, W. Va.: "I thought I would drop you a few lines to say that I received my Edu-Kit, and was really amazed that such a bargain can be had at such a low price. I have already started repairing radios and phonographs. My friends were really surprised to see me get into the swing of it so quickly. The Trouble-shooting Tester that comes with the Kit is really swell, and finds the trouble, if there is any to be found."

### PRINTED CIRCUITRY

At no increase in price, the "Edu-Kit" now includes Printed Circuitry. You build a Printed Circuit Signal Injector, a unique servicing instrument that can detect many Radio and TV troubles. This revolutionary new technique of radio construction is now becoming popular in commercial radio and TV sets.

A Printed Circuit is a special insulated chassis on which has been deposited a conducting material which takes the place of wiring. The various parts are merely plugged in and soldered to terminals.

Printed Circuitry is the basis of modern Automation Electronics. A knowledge of this subject is a necessity today for anyone interested in Electronics.