

Theory, Design, and Operation of Crystal Receivers

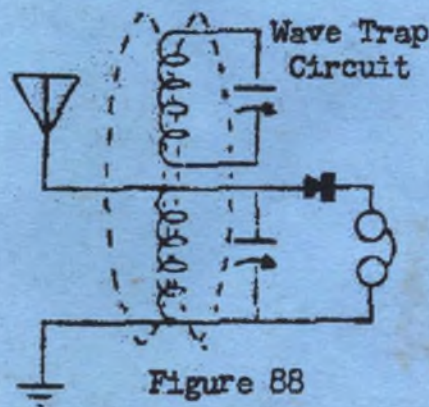

Copyright 1953 by K.G. Kott, W8ROG

Introduction

While packing boxes in my parents attic after their house had been sold, I came across a few copies of this book my father wrote in 1953. Memories of family stories came flooding back about Dad typing the book, pounding away on the old Smith-Corona, Mom proofreading in the late hours of the night. They bought a mimeograph machine and printed each page in the living room and assembled each copy by hand.

I knew all this information shouldn't just gather dust in the attic. With encouragement from Rebecca Anderson Hewes of the Xtal Set Society, I am reprinting the book exactly as it first appeared in 1953. The few remaining copies are so fragile that I wasn't sure if it would withstand being reprinted, but I had to try. People who are crystal experimenters and builders would appreciate seeing it with the hand-typed pages, hand-drawn schematics and charts, rather than computer generated text.

I hope you enjoy this book and it brings you a deeper understanding and appreciation of the magic of crystal sets.

Nancy Kott, WZ8C 1998

Note: the missing pages 25, 28, 31, 34, 37, 40, 43, 46, were blank

The Atomic Theory

Atoms are the building blocks of the universe. The atomic theory states that all matter is made up of atoms, which are the smallest part of an element that can exist. Atoms, in turn, are composed of various energy particles; the most important of these are the electron and the proton. The proton is the smallest charge of positive electricity known. The electron is the smallest charge of negative electricity.

Within the atom, the protons are found concentrated at its center, while the electrons are found not only at its center but also whirling at terrific speeds in orbits around the center, in a manner similar to the planets revolving around the sun in our solar system. Atoms are inconceivably small: 100,000 atoms placed in a line would scarcely measure one-thousandth of an inch.

Every element is made up of a different type of atom. Atoms differ from one another by the number of protons and electrons that compose them. For example, an atom of the lightest element known, Hydrogen, has one proton and one electron. A representation of this atom is shown in Figure 1.

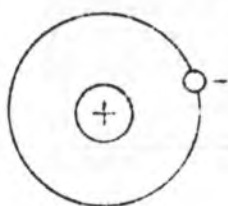

Figure 1

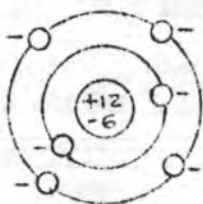

Figure 2

Heavier elements are composed of heavier atoms. Carbon atoms have 12 protons and 12 electrons, as represented in Figure 2. Copper atoms have 29 of each; Mercury atoms, 80; and Lead atoms, 82 of each.

The center, or nucleus, of the atom always carries a positive charge because there are more protons present than electrons.

The field around the nucleus is negatively charged because of the negative charge of the circling electrons. Normal atoms have an equal number of protons and electrons, thus making their overall charge neutral.

Since unlike electrical charges attract each other, the attraction between the nucleus and the orbital electrons restrains them from flying off tangentially into space, just as gravity binds the planets to our solar system. However, if an electron's velocity is increased to the point where its centrifugal force becomes greater than the electrostatic restraining force, the electron will escape from the atom. When an atom loses an electron, its overall charge becomes positive because the protons and electrons no longer balance each other; for the same reason, the atom would become negatively charged should it gain an extra electron.

Potential Difference. The Volt.

The only reason a substance carries an electrical charge, or potential, is that its atoms have either an excess or deficiency of electrons. In the common dry cell, electrons are shifted from one terminal to the other by chemical action occurring within the cell. The terminal from which the electrons are shifted is then left with a deficiency of electrons and is positively charged; and the terminal upon which the excess electrons are

forced acquires a negative charge. This derangement is maintained as long as the cell has chemical life. The difference in potential existing between the two terminals is called VOLTAGE and is measured in the standard unit called the VOLT. Another name for voltage is electromotive force (abbreviated to e.m.f.).

Conductors and Insulators

Some atoms hold their electrons very tightly; materials composed of these atoms are called INSULATORS. Other atoms allow their electrons to escape relatively easily, and materials made from these atoms are called CONDUCTORS. There are various grades of both insulators and conductors, depending upon their atoms' ability to hold or release electrons.

Electrical Current Flow; The Ampere

Copper is a good conductor: its atoms freely release their electrons. If we take a piece of wire and connect it to a cell as shown in Figure 3, the positive terminal of the cell will attract the electrons in the wire;

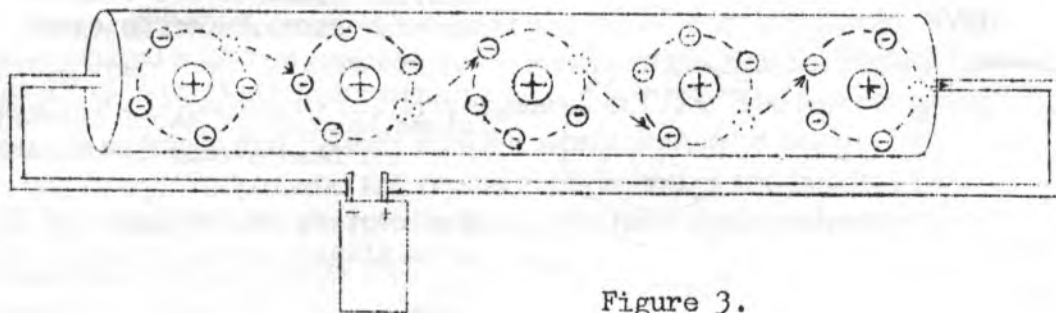

Figure 3.

also the excess electrons at the negative terminal of the cell will rush to replace any electrons that have escaped from their atoms. This results in a drift, or flow, of electrons from the negative terminal to the positive terminal as represented in the enlarged section of the wire in Figure 3. This flow of electrons constitutes an electric current, which is measured in the standard unit called the AMPERE. The enlarged section of the wire portrays a simplified representation of only five of the billions of atoms in the wire. To illustrate the minuteness of the atom and its constituents, it may be interesting to note that 6,250,000,000,000,000,000 electrons must pass any given point along the wire each second to maintain a current flow equal to one AMPERE.

Electrical Resistance. The Ohm

When electrons are forced to flow through a conductor, there occurs a multitude of collisions between the electrons and the atoms, resulting in friction and heat. Depending upon their atomic structure, some materials develop more friction than others. This opposition to the flow of current is called RESISTANCE and is measured in the standard unit called the OHM. For a given amount of current flow, the heat generated is directly proportional to the resistance of the conductor. The resistance of a conductor is directly proportional to its length and inversely proportional to its cross-sectional area.

Resistance is desirable in some circuits to limit or control the flow of current. For this purpose, materials which have high resistivity are made into compact forms called RESISTORS. Their resistance values may be fixed or variable, and range from a small fraction of an ohm to several millions of ohms. Resistance is represented in electrical diagrams by the symbols illustrated in Figure 4.

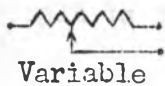

Figure 4

Ohm's Law

Electrical potential is expended in forcing current through a conductor because of the conductor's resistance, just as water pressure is expended in forcing water through a pipe. There exists a definite relationship between the voltage, current, and resistance of a circuit. This relationship may be expressed by three simple formulae which constitute Ohm's Law:

$$(1) \text{ Amperes} = \frac{\text{Volts}}{\text{Ohms}} ; (2) \text{ Volts} = \text{Amperes} \times \text{Ohms} ; (3) \text{ Ohms} = \frac{\text{Volts}}{\text{Amperes}}$$

If any two of these factors is known, the third can be readily found.

Examples of the Use of Ohm's Law

Question: How much current will flow through a 2000 ohm headset if it is connected across a 1.5 volt dry cell?

Answer: $\text{Amperes} = \frac{\text{Volts}}{\text{Ohms}} = \frac{1.5}{2000} = 0.00075$ Amperes of current flow.

Question: If a 6.3 volt radio pilot bulb draws 0.1 amperes, what is the resistance of its filament?

Answer: $\text{Ohms} = \frac{\text{Volts}}{\text{Amperes}} = \frac{6.3}{0.1} = 63$ Ohms of resistance.

Question: How many volts of electromotive force are required to force a current of 10 amperes through a resistance of 5 ohms?

Answer: $\text{Volts} = \text{Amperes} \times \text{Ohms} = 10 \times 5 = 50$ Volts of electromotive force.

The Capacitor, or Condenser

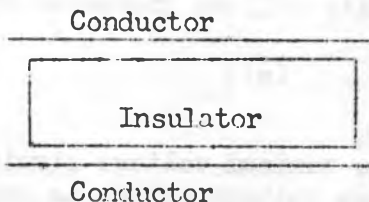

Figure 5

When two conductors are separated by an insulator, as in Figure 5, a capacitor is formed. (The names "capacitor" and "condenser" are used interchangeably.) Now, if we apply a potential across these conductor plates by connecting them to a battery as in Figure 6, the following electron action will simultaneously occur. Electrons in the lower plate will flow to the positive terminal of the battery until the plate reaches the same potential as the

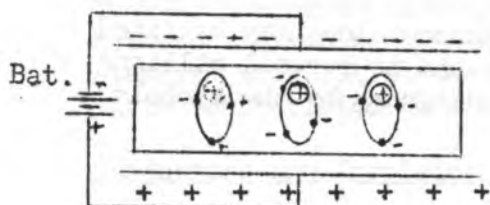

Figure 6

pulled toward the negative plate, and the electrons' orbits are distorted by the attracting force of the positive plate. The condition of Figure 6 exists.

If the battery were suddenly disconnected, we would have the condition of Figure 7. The excess electrons in the upper plate cannot escape, nor

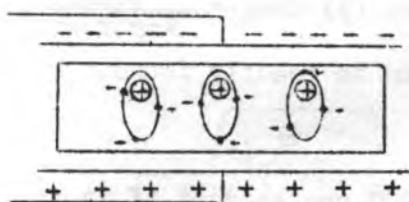

Figure 7

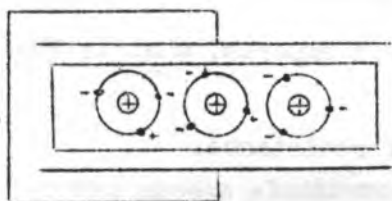

Figure 8

can the lower plate gain electrons; the dielectric remains in the strained condition. Electrical energy is stored in the condenser. Should a conductor be connected between the plates as in Figure 8, the excess electrons of the upper plate will flow to the lower plate until the two plates are of equal potential, and the strained condition of the dielectric would return to normal. The condenser has discharged its electrical energy.

Condensers are rated by the amount of electrical energy they can store. Usually more than one set of plates is used to provide more surface area for the condenser action. The units of capacity used are fractions of the standard unit called the FARAD. A microfarad is one-millionth of a farad; a micromicrofarad is one-millionth of one-millionth of a farad.

The dielectric material is of considerable importance in a condenser for it greatly affects the condenser's ability to store energy. For example, the capacity of a given condenser is approximately doubled if paraffin wax is substituted for air as a dielectric; the capacity will be increased about five times if mica is used.

Condenser Voltage Ratings

The peak voltage rating of a condenser is the maximum voltage strain its dielectric is capable of withstanding. If the peak voltage rating is exceeded, the electron orbits in the dielectric will be strained to the point of rupture causing the dielectric to become a conducting link between the plates and destroying the condenser's ability to store energy. The maximum voltage at which a condenser is designed to operate is called the Working Voltage.

This value is usually marked on the body of paper-dielectric condensers along with the condenser's capacity rating. The working voltage of small mica-dielectric condensers is not marked on the condenser, but it is generally 500 volts. Of course, when working with crystal receivers there is no high voltage present, and the voltage ratings of condensers can be ignored. Figure 9 illustrates the most common types of condensers and their electrical symbols. The color code used to mark the capacity of some types of condensers is included in another part of this book.

Variable Condensers

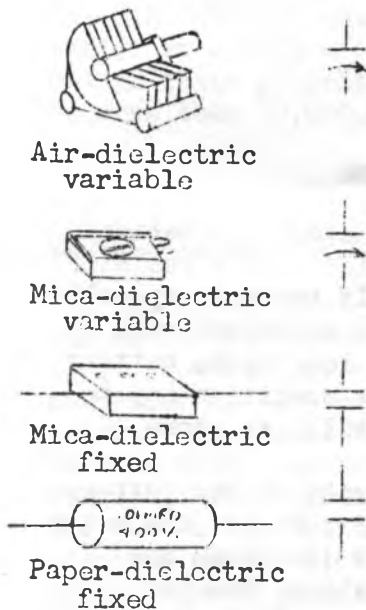

Figure 9

Aside from changing the dielectric material, the capacity of a condenser can be altered by two other methods. Usually in air-dielectric variable condensers, the capacity is varied by turning a shaft to which is attached one set of condenser plates. This changes the amount of plate surface area engaged in the condenser action. When the plates are fully meshed, the effective plate area is maximum and the capacity of the condenser is maximum. When the plates are disengaged, the capacity is very small.

With mica-dielectric variable condensers, the spacing between the plates is varied by means of a compression screw adjustment. When the plates are pressed tightly against the mica-dielectric the capacity is greatest, decreasing as the screw is loosened, allowing the plates to spring apart.

Condensers in Series and Parallel

When two or more condensers are connected in parallel as in (a) of Figure 10, the effect produced is the same as if one larger condenser existed. This is because the surface area of each set of plates, in effect, joins

together to form one larger set of plates as in (b) of Figure 10. The capacity of two or more condensers connected in parallel is equal to the sum of the individual capacities.

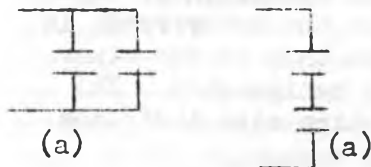

(a)

(b)

$$\text{Capacity (total)} = C_1 + C_2 + C_3 \text{ etc.}$$

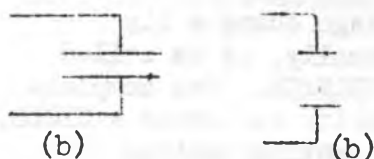

(a)

(b)

When two condensers are connected in series as in (a) of figure 11, the resulting capacity is less than the capacity of either condenser alone. The series connection has the same effect as increasing the spacing between the condenser plates, as in (b), resulting in less total capacity.

When two condensers are connected in series the resulting capacity may be found by the formula:

Figure 10

Figure 11

$$C_{(\text{total})} = \frac{C_1 \times C_2}{C_1 + C_2}$$

Examples:

What is the resulting capacity when a 100mmfd.(micromicrofarad) and a 365 mmfd. condenser are connected in parallel? In series?

Parallel Connection:

$$C_{(\text{total})} = C_1 + C_2 = 100 + 365 = 465 \text{ mmfd.}$$

Series Connection:

$$C_{(\text{total})} = \frac{C_1 \times C_2}{C_1 + C_2} = \frac{100 \times 365}{100 + 365} = 78.5 \text{ mmfd.}$$

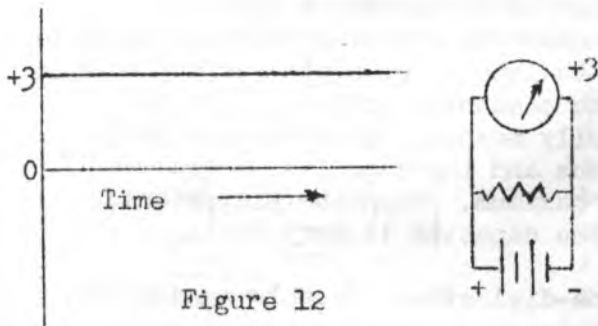

Alternating Voltages

Figure 12 illustrates a battery connected in parallel with a resistor and a voltmeter. If the battery voltage is 3 volts, the voltmeter will read this value as long as the battery is connected. This condition may be illustrated graphically as shown.

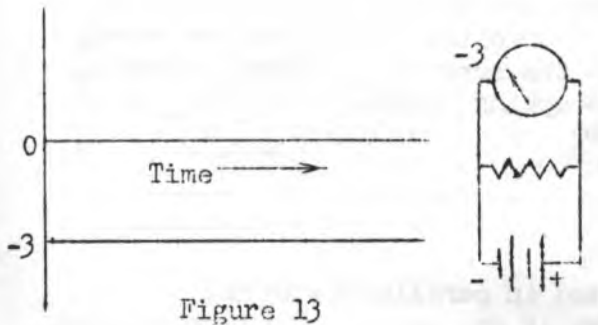

When the polarity of the battery is reversed as in Figure 13, the meter will still read 3 volts since the potential of the battery has not changed, but this time the meter needle will move in the opposite direction to indicate the reversal of polarity. Figure 13 illustrates this graphically.

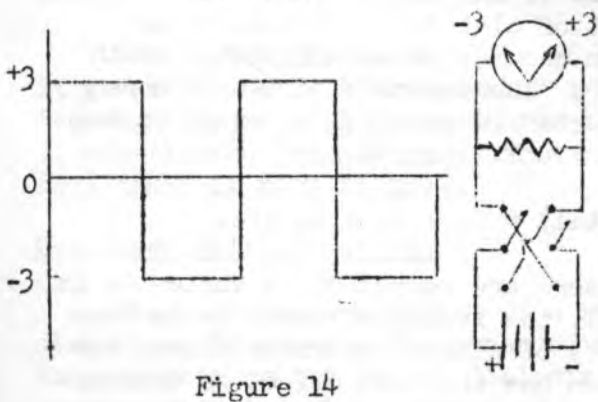

If a polarity reversing switch is connected in the circuit and the polarity of the voltage is changed periodically, the condition of Figure 14 exists. First the meter reads in one direction and then in the other as the switch is manipulated. The graphic illustration also indicates this condition.

When a voltage changes its polarity periodically, it is called an ALTERNATING VOLTAGE. One complete reversal of polarity is termed a CYCLE. Ordinary house-lighting voltage

reverses its polarity 60 times per second; hence it is called 60 cycle power.

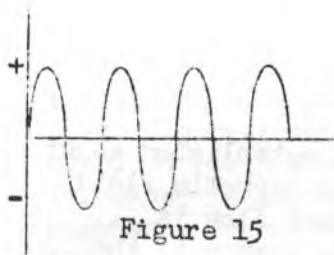

Figure 15

Wave Form

The graphical picture of an alternating voltage is called the WAVE FORM of the voltage. That of Figure 14 is called a SQUARE Wave. Ordinary house-lighting voltage varies as shown in Figure 15; this shape is called a SINE Wave. The electrical energy transmitted from a broadcasting station is

also sine wave in nature.

Frequency

The number of times per second that a polarity change occurs is called the FREQUENCY of the voltage. As mentioned earlier, house-lighting voltage varies at a rate of 60 times, or cycles, per second. Radio frequency waves change their polarity at a much faster rate: from 10,000 cycles (10 kilocycles) to more than 30,000,000,000 cycles per second (30,000 megacycles).

1 kilocycle = 1000 cycles

1 megacycle = 1000 kilocycles, or 1,000,000 cycles.

Capacitive Reactance

We recall that when the capacitor of Figure 6 became fully charged there was no further movement of electrons, and hence there was no further current flow. However, if an alternating voltage is applied across a condenser, the condenser is alternately charged, discharged, and recharged to the opposite polarity in accordance with the alternating polarity of the voltage. The current flow does not come to a halt as it did with the unidirectional current. The higher the frequency of the applied voltage, the faster will be the rate of charge and discharge of the condenser; and the greater will be the electron movement, or current flow. The amount of current flow in an alternating-current capacitive circuit varies directly with the applied frequency. It is to be understood that current actually does not flow through a condenser (this is impossible because of the insulating properties of the dielectric); but the rapid charging and discharging of the condenser allows the current to surge back and forth in the circuit producing the same effect as if the current were flowing through the condenser.

The effect a condenser has on current flow is called CAPACITIVE REACTANCE. Capacitive reactance offers to the flow of current an opposition which decreases with the frequency of the current. At zero frequency (direct current) we have the condition of Figure 6 and a current flow of zero; the condenser is offering an infinite amount of opposition to current flow. At high frequencies, the shifting electrons (Figure 14) are so copious as the condenser charges and discharges that it is almost the same as if the condenser were short-circuited. Capacitive reactance is dependent upon the size of the condenser and the frequency of the current in accordance with the following relationship:

$$\text{Capacitive Reactance (in ohms)} = \frac{1}{6.28 f C}$$

Where: f is the frequency in cycles; and C is the capacity of the condenser in farads.

The Inductor, or Coil

Whenever a current flows through a conductor, there is established about that conductor a magnetic field as shown in Figure 16. This magnetic field represents energy stored around the conductor. If the current flow is interrupted, the magnetic field will collapse and return the energy to the conductor. Such returned energy is usually noticeable in the form of an arc at the switch contacts as the returned energy seeks to dissipate itself. Even in straight, single conductors (such as house wiring) this phenomenon may be noticed. The ability of a conductor to store energy in the form of a magnetic field is called **INDUCTANCE**. The inductance of a length of single conductor can be increased by winding it in the form of a coil as in Figure 17. Now the individual magnetic fields around the conductor join together

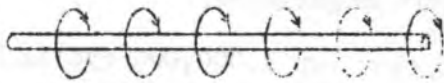
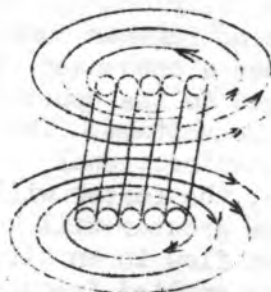

Figure 16

and favor the establishment of a stronger magnetic field. Inductance is expressed in the standard unit called the Henry. A millihenry is one-thousandth of a henry; a microhenry is one millionth of a henry.



(cross-sectional view)

Figure 17

Induced Voltage

Whenever a magnetic field passes through a conductor, a voltage is generated in the conductor. If two conductors are placed parallel to each other and a varying current is passed through one of them, the resulting magnetic field about that conductor will cut through the adjacent wire and induce a voltage in it, even though there is no physical connection between the two wires. This is the principle used in transformers and coupled

radio circuits which will be covered later.

Inductive Reactance

Applying an alternating voltage across an inductance results in the production of a magnetic field which is periodically established, collapsed, and re-established as the polarity of the voltage changes. The inductance offers an opposition to the changing of its magnetic field; this opposition is called **INDUCTIVE REACTANCE**. Unlike capacitive reactance, inductive reactance increases with frequency. The faster the magnetic field is changed, the greater is the opposition that the coil offers to the change. Inductive reactance is expressed in ohms and bears the following relationship to the frequency and inductance of the circuit:

$$\text{Inductive Reactance (in ohms)} = 6.28 f L$$

Where: f is the frequency in cycles;
 L is the inductance in henries.

Impedance

When an alternating current is flowing through a circuit containing a

coil or condenser, or both, the impressed voltage must not only overcome the resistance of the circuit but also the inductive and capacitive reactances which algebraically add to the resistance. The total opposition of the combined resistance and reactance is called the **IMPEDANCE** of the circuit. Impedance is expressed in ohms. As will be shown, inductive and capacitive reactance cancel each other when they are in the same circuit, and should they be of equal value, the only opposition to the flow of current is the resistance of the circuit.

Resonance

If we take the fully charged condenser of Figure 7; but instead of shorting the plates together, we connect them across an inductance, a series of events takes place. When the condenser is connected to the coil as shown

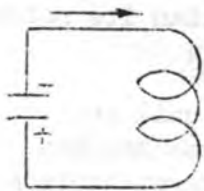

Figure 18

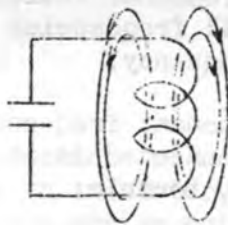

Figure 19

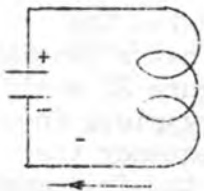

Figure 20

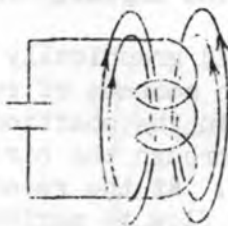

Figure 21

in Figure 18, the electrons in traveling to the lower plate must pass through the coil. The electron flow through the coil stores energy in the form of a magnetic field which remains as long as the current flow continues. When the plates of the condenser reach the same potential the current flow ceases, and at that instant the condition of Figure 19 exists. The condenser charge is neutral, and there is energy stored in the magnetic field of the coil. As soon as the current flow stops, the magnetic field collapses and returns its energy to the circuit. This returned energy forces more electrons into the lower plate and charges the condenser again, but this time it is charged to the opposite polarity. We then have the condition shown in Figure 20. After the complete

collapse of the magnetic field, the condenser again discharges through the coil, this time in the opposite direction. This current flow establishes another magnetic field; see Figure 21. When this field collapses, it recharges the condenser as shown in Figure 18; and the process repeats itself.

This oscillation of current would continue for an indefinite period if it were not for the electron friction, or resistance, of the circuit which gradually dissipates the electrical energy in the form of heat. The frequency at which this oscillation takes place is determined by the size of the capacitor and inductor. The larger the capacitor, the longer it will take to charge and discharge; the larger the inductor, the longer it will take for the magnetic field to build up and decay. Hence, increasing the size of either the capacitor or coil will decrease the frequency of the energy exchange; and decreasing the size of either component will increase the frequency. The frequency at which this energy exchange takes place is called the **RESONANT FREQUENCY** of the circuit. At this frequency, the inductive reactance of the coil and the capacitive reactance of the condenser are equal

and each neutralizes the effect of the other: for if we were to connect an alternating-current generator which has the same frequency as the resonant circuit (as shown in Figure 22) in series with the circuit, the generator would find no opposition to establishing and re-establishing the magnetic field of the coil or to charging and re-charging the condenser because these actions are already being accomplished at that frequency. The generator must merely supply the losses suffered by the circulating current so that it will not decay and stop flowing. Thus, the only opposition offered to the generator voltage would be the electron friction, or resistance, of the circuit. This is true only when the generator voltage has a frequency equal to the resonant frequency of the circuit. If the generator frequency were higher or lower than the resonant frequency, the generator would have to upset the natural tendency for current flow in the circuit and establish its own rate of charging and discharging the condenser and changing the magnetic field of the coil, with no help from the natural resonant action of either component. The circuit offers a high impedance to all frequencies other than its natural resonant frequency.

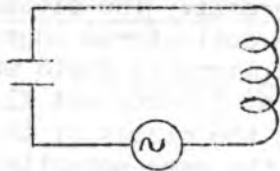

Figure 22

The resonant frequency of a coil and condenser connected as in Figure 22 may be found by the formula:

$$\text{Res. Freq. in cycles/sec} = \frac{1}{6.28\sqrt{LC}}$$

Where L is the inductance in henries, and C is the capacity in Farads.

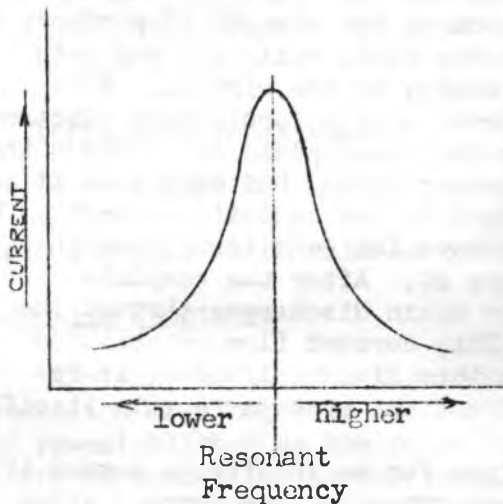

Figure 23

Figure 23 graphically illustrates the relative amounts of current that a generator placed in the position of Figure 22 would force through the circuit at various frequencies. At the resonant frequency the current flow is maximum. As the frequency increases the inductive reactance of the coil becomes predominant and limits the flow of current, while at lower frequencies the capacitive reactance becomes predominant and limits the current flow.

"Q"

The resistance in the resonant circuit plays an important part in determining how sharply the curve of Figure 23 rises and falls. The greater the resistance, or power consumption, the lower will be the current flow at resonance, the the broader will be the curve. The curves of a high-resistance (low Q) and a low-resistance (high Q) circuit are compared in Figure 24. Since nearly all the resonant circuit's resistance is found in the coil and the connecting leads, the sharpness of the curve, or the current flow response at various frequencies, can be estimated by the resistance of the coil. Coils are judged by a "figure of merit" called "Q". The "Q" of a coil is the ratio of its inductive reactance to its resistance:

$$Q = \frac{\text{Inductive Reactance}}{\text{Resistance}}$$

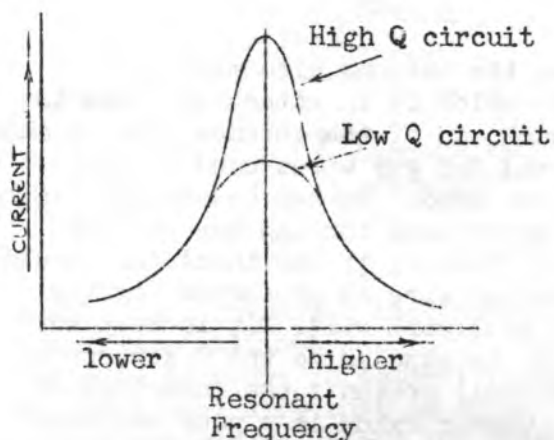

Figure 24

Other factors that affect the Q of a coil will be covered when we discuss coils.

Selectivity

Because a resonant circuit offers a high impedance to all frequencies other than its resonant frequency, the resonant circuit has the property of selectivity. **SELECTIVITY** is the ability to distinguish between, or separate, voltages of different frequencies. Selectivity will be discussed again shortly.

The Antenna

When discussing capacitors we said that a capacitor consisted of two conductors separated by an insulator, or dielectric. Referring to Figure 25, we may see that an antenna system coincides with this definition. The antenna wire is one of the conductors of the condenser, and the ground serves as the other. Air between them is the dielectric. We are correct in expecting that this antenna system can hold an electrical charge, and that it can be charged and discharged just as any other condenser. As a matter of fact,

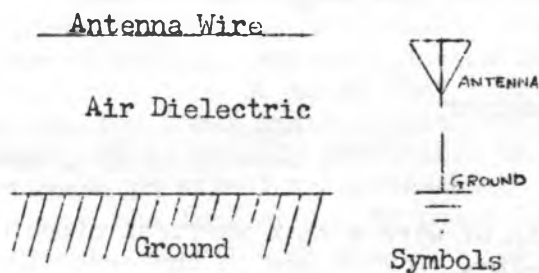

Figure 25

an antenna wire 100 feet long, held 25 feet above the earth has a capacity of nearly 175 micromicrofarads. Our discussion of inductance indicates that this antenna wire also would have some inductance, in this case, approximately 50 microhenries. It is well to bear in mind that this antenna system must exhibit capacitive and inductive reactance since it possesses the properties of capacity and inductance. These reactances must be completely canceled if we wish to capture the

greatest amount of energy from some distant broadcasting station. But, first, let us consider how an antenna receives a radio signal.

When a radio wave emanates from a transmitting antenna, it is made up of an electrostatic field and a magnetic field. Each field contains half of the total energy of the radio wave. The electrostatic field has the ability to produce voltage stresses in space, while the magnetic field generates a voltage in any conductor through which it may pass. Our receiving antenna may be viewed as a device to capture both of these forms of energy. The inductive properties of the antenna responding to the magnetic field, and the capacitive properties responding to the electrostatic field. So now we picture our antenna as a large air-dielectric condenser which transmitting stations all over the world are continually charging for us. We have but to drain off this energy for our own use.

Practical Antennas

In order to form an efficient system, the antenna wire must be completely insulated from any structure to which it is attached. This is accomplished by placing an insulator at each end of the antenna wire as shown in Figure 26. For long lengths of wire, and for guy wires used to support antenna poles, etc, strain insulators may be used. As can be seen in Figure 27, when using strain insulators the two wires loop through one another giving added protection against the antenna falling if the insulator should break. Hard-drawn #10 or #12 enameled copper wire is preferred for the antenna wire, although any insulated wire will work well. It is best to use insulated wire because when copper wire is exposed to the weather the insulation (such as rubber, plastic, or enamel) prevents the formation of copper oxide on the surface of the wire. Copper oxide is a poor conductor and consequently reduces the efficiency of the antenna system. The insulation on the wire does not interfere with the reception of radio signals since they can pass through insulating materials virtually without loss.

(1) The Inverted L Antenna

The most popular type of antenna, and the type that generally gives the best results, is called the Inverted L Antenna. It consists of a horizontal

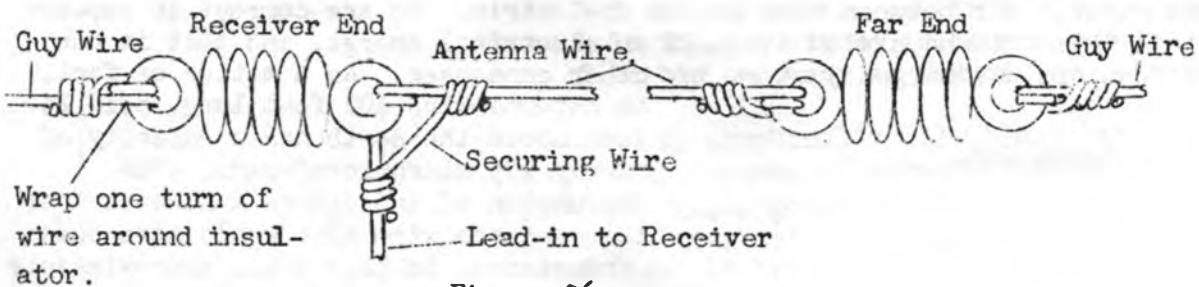
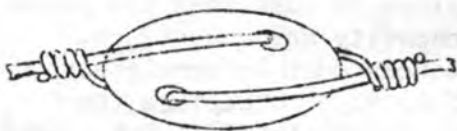

Figure 26



Strain Insulator

Figure 27

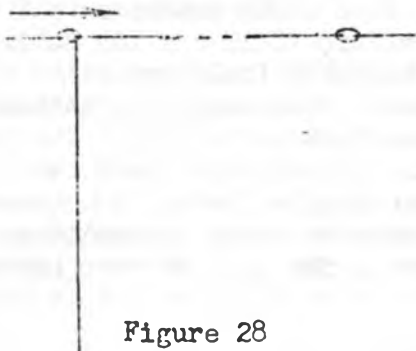

Figure 28

length of wire with a vertical piece of lead-in wire fastened to one end. This gives the appearance of an inverted letter "L" as shown by Figure 28. For maximum efficiency the horizontal portion of the antenna should be made as long and as high as possible, running directly over the earth rather than over trees or houses. The vertical lead-in wire should be kept as short as possible. Horizontal lengths of from 250 to 400 feet and heights of from 40 to 50 feet are not excessive for crystal set use.

The amount of signal pick-up may be further increased by running one or more wires parallel with the horizontal wire as shown in Figure 29. They should not be spaced closer than 2 feet or more than 5 feet apart for best results. The

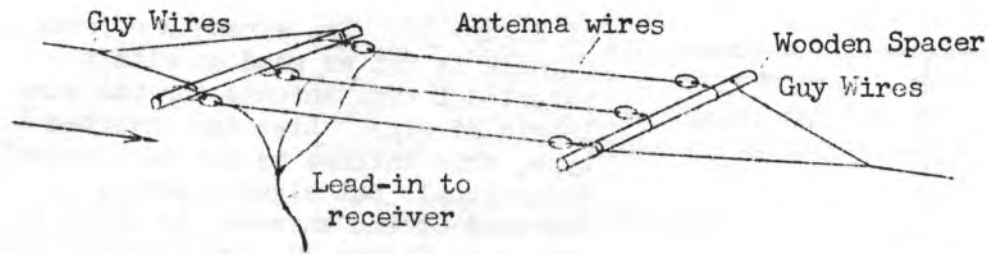

Figure 29

The wires are connected together only at the lead-in end. Adding one additional wire will not double the amount of signal pick-up, but it will produce a definite increase in headset volume; the increase will be less and less with each additional wire that is added so it is not worthwhile to add more than 3 additional wires. Keep the lead-in wire as far as possible from all objects; and, if possible, bring it through the window frame or wall through a glass or porcelain tube.

This type of antenna receives well from all directions; however, it does have a tendency to favor signals coming from the lead-in end, or from the same direction as the arrow shown in Figures 28 and 29.

It must be borne in mind that the only source of power for the conventional crystal set is the antenna system, and that the greatest energy output in the form of sound waves can never exceed the amount of energy picked up by the antenna. However, in the cities, space is limited and an antenna of the dimensions mentioned above is out of the question. Fortunately, cities are usually areas of greater signal strength; and maximum efficiency, although desirable, is not mandatory. Single wire inverted L antennas from 30 to 50 feet long and at house-top level will usually bring in all the local stations with ample volume. When the antenna length is short, it is usually profitable to add at least one parallel member; the increase in signal is noticeable. Three parallel wires which are run so as to give the longest length possible in an attic will very often give good results. With inside antennas the choice of wire is not as important. When wire is exposed to the weather, it should always be covered with an insulation; however, for an inside antenna, any type of copper wire may be used. It is best to keep the wire size #18 or larger, but only a slight difference will be noticed on local stations if the wire used is as small as #32.

Some landlords do not allow the erection of any kind of external antenna; for these locations other antennas will be described. (It is well to remember that a fairly efficient 3 or 4 wire inverted L type antenna made of #32 enameled wire, using rubber bands for insulators, can be erected in a few minutes in an attic or on a flat-top roof--and it will be nearly invisible because of the small diameter of the wire.)

(2) T Type Antenna

If the lead-in wire is connected near the center instead of at the end of the horizontal wire, the inverted L antenna becomes the T type of antenna

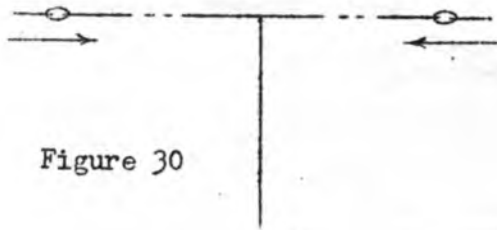

Figure 30

of Figure 30. The strength of received signals is not as good as with the inverted L type antenna for the same length of wire. Like the inverted L type, this antenna is not particularly directional; but signals coming in from the ends of the antenna, as shown by the arrows in Figure 30, are slightly favored.

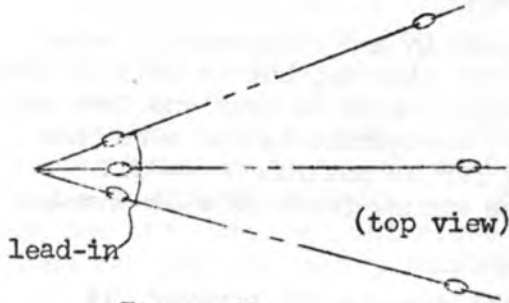

Figure 31

(3) Horizontal Fan Type

When the wires of a multi-wire inverted L type antenna are not kept parallel, but diverge as they leave the lead-in end, the fan shape of Figure 31 is evident. This antenna behaves much like the inverted L type when the angle between the wires is 15° or smaller. The angle between the two outer conductors should not exceed 90° for best results.

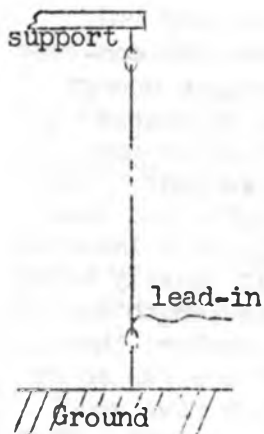

Figure 32

(4) Vertical Type Antenna

The vertical antenna consists of a conductor of any length that runs perpendicular to the earth, as in Figure 32. The vertical antenna is non-directional, that is, it receives equally well from all directions. The difficulty of erecting a support for the high end of the wire makes this type generally undesirable. The vertical antenna has no special advantage other than its non-directional properties, so it is little used for low-frequency receiving purposes.

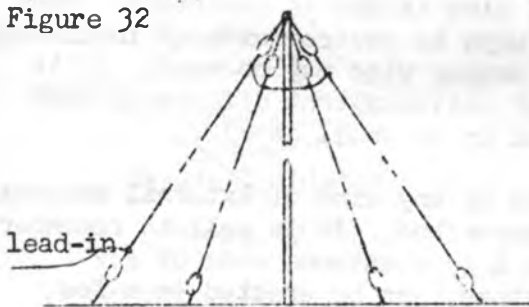

Figure 33

(5) The Umbrella Type Antenna

The umbrella antenna is shown in Figure 33. The wires spread out from the center support as they approach the ground. The angle that the wire makes with the support should not be less than 45° for best results. This antenna is non-directional. It is possible to erect a moderately efficient umbrella antenna all on one's own roof if an 8 or 10 foot support is erected near the center of the roof and the antenna wires are fastened from this support to the corners of the roof. The antenna wires also serve as guy wires for the center support. The higher the center support, the more efficient the system will be. If this is objectionable for reasons of appearance, a centrally located chimney may be used as a support by fastening a piece of wire around it to which insulators are attached as in Figure 34. Of course, an insulator must always be



Figure 34

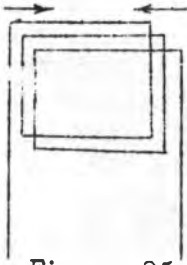

Figure 35

placed at the far end of the wire before it attaches to the corners or edges of the roof. The wire size may be reduced to #20 enameled wire which will be barely visible from a short distance away on ground level. The more wires used, the better will be the results. Six or eight wires are recommended.

(6) The Loop Type Antenna

The loop antenna consists of one or more turns of wire wound in the form of a circle or rectangle; see Figure 35. Actually, it is nothing more than a coil whose physical dimensions are large enough to intercept radio signals. The size of the loop antenna may vary from one foot to several feet across the flat side. The loop antenna is very directional off the ends of the loop as shown by the arrows of Figure 35. Pick-up from the directions off the flat sides of the loop is very small. This makes the loop antenna very useful in separating interfering signals, providing that both stations are not located in the directions off the ends of the loop. In high-signal areas, loop antennas often provide good reception when used with crystal receivers. The loop replaces the coil of the tuning circuit and is tuned with a condenser in a manner to be described later.

To determine if a loop is practicable in your area, a simple test may be

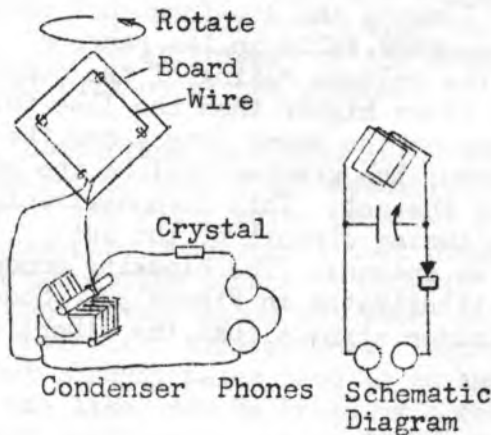

Figure 36

made. Take a piece of thin wood or heavy cardboard about 14 inches square and drive a temporary nail into each corner. Around these nails wind about 15 turns of #18 doorbell wire, or equivalent, as in Figure 36. Tape the wire firmly to the board and remove the temporary nails. Connect this loop to a 365mmfd. tuning condenser, crystal (fixed type preferred), and headset as shown in Figure 36*. Stand the loop on one end and rotate it slowly, at the same time varying the condenser through its tuning range. If any station can be heard well enough to be understood, it is likely that it can be brought in with comfortable headset volume by increasing the size of the loop. Notice the directional properties of the loop,

and make a note of the direction in which it must be pointing to receive the desired station or stations.

The larger the size of the loop, the greater will be the received signal strength. A loop three feet square will frequently provide fair volume in high-signal areas. If reception may be obtained with the small loop when its

((* The beginner should become familiar with the radio supply houses where these parts may be purchased at wholesale prices. A postcard request to Allied Radio Corporation, 833 W. Jackson Blvd., Chicago, Illinois, will bring a free catalog listing hundreds of items & radio parts.))

flat side is approximately parallel with the wall of a room, a large loop may be wound around the edges of the wall, just as the loop was wound around the piece of wood in Figure 36. Three or four turns are usually all that are required with a large wall-type loop. The loop may be wound with smaller wire (#28 or #32) which may be finally cemented in place with small dabs of colorless fingernail polish placed every few inches. If reasonable care is taken in the construction of the wall loop, it will be almost invisible. Loops may be wound around large picture frames, etc, by the same method.

Increasing the number of turns of wire on the loop increases the amount of signal pickup; however, the frequency range of the tuning condenser becomes smaller as the number of turns is increased. So a compromise must be made between volume and tuning range. It is best to have at least 50 to 75 mmfd. of tuning capacity in the circuit even when the loop is designed to receive only one station.

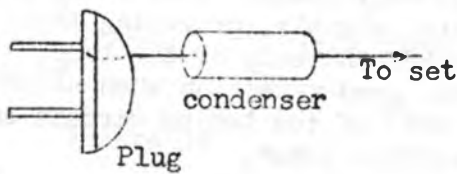

Figure 37

(7) The Power Line Type Antenna

Electric power lines are usually elevated for a long distance before they enter a house, and one of these lines when properly used as an antenna will frequently bring in local stations with

good volume. The power line never should be directly connected to the set, but it should be coupled through a condenser which allows the high-frequency radio waves to pass while at the same time blocking the low-frequency power line voltage. The best size of blocking condenser falls in the range of from 50 to 100 mmfd. In this application, the voltage rating of the condenser is important; and it should be at least 1.5 times higher than the line voltage. A considerable amount of capacity exists between the power lines, and the larger the size of the blocking condenser used, the greater will be the effect of this power line capacity on the tuning of the set. This is undesirable since it reduces the frequency range of the tuning circuit of the set. Only one side of the power line is used as an antenna. The blocking condenser may be connected to a conventional plug as illustrated in Figure 37. Sometimes one side of the power line provides louder signals than the other; try reversing the plug in the receptacle.

(8) Novel Type Antennas

The following types are of little practical use. They are mentioned only because of their novelty.

The Underground Antenna is made by burying a length of insulated wire from six inches to one foot below the ground. Since radio waves penetrate the earth for a short distance, reception may be obtained from such an antenna; however, the signal strength will only be a fraction of the value the same wire would provide if it were elevated only a few feet above the earth.

The Tree Antenna consists of a wire fastened to the top of a tree by means of a metal spike driven into the trunk. This uses the tree as a vertical antenna. Because of the moisture content of the tree, the signal pick-up is sometimes a little greater than if the wire alone were used.

The Balloon or Kite Antenna is a type which has one end of the wire elevated by fastening it to an airborne balloon or kite. Very loud signals are usually picked up by such antennas; but the difficulty of keeping the high end of the wire aloft limits this antenna to the novelty class.

In high signal areas, almost any large piece of metal, such as, bed springs, metal roofs, metal structure of buildings, smoke stacks, fire escapes, fences, metal clothes lines, window screens, and the like, will bring in signals with varying degrees of strength. The poor internal connections and high resistance of most of these items makes their performance unpredictable.

Grounds and Counterpoise

To complete the antenna-system condenser, a connection to the other plate, the earth, may be made in a number of ways. As with the antenna, we must choose the method which best suits our conditions. When a long and efficient antenna is erected, it is foolish not to complete the job with an equally efficient ground connection. Three or four metal rods about 5 feet long and spaced 2 feet apart form an excellent ground connection when driven into moist earth and connected together. If the soil is dry and rocky, better results may be obtained if a counterpoise is used instead of a ground connection. A counterpoise is a wire erected in the same manner as the antenna, except that it is run directly below the antenna at a height of from 6 to 10 feet above the ground. Running more than one parallel wire, as described earlier, increases the efficiency of the counterpoise action just as it increased the signal pick-up of the antenna.

Connecting to a cold water pipe provides a good ground connection when an earth connection is not feasible. Connecting the ground wire to the street-side of the water meter provides a lower resistance path to ground because the various pipe connections that occur on the house-side of the meter are avoided. If a connection cannot be made to this basement water pipe, the connection can be made further along the water line, or even to a steam pipe. The wire from the Power Line type antenna (described earlier) may be tried as a ground if it is not already being used as an antenna. Bed springs, fire escapes, fences, and the like, may be tried as a counterpoise. However, if anything but a direct earth ground is used, try more than one type of ground substitute to make sure that best results are being obtained. Remember, one poor-conducting pipe connection in a cold water system may cause lowered volume if it happens to be in your ground circuit. If any splices are made in either the antenna or ground wires, they should be soldered to keep their resistance to a minimum.

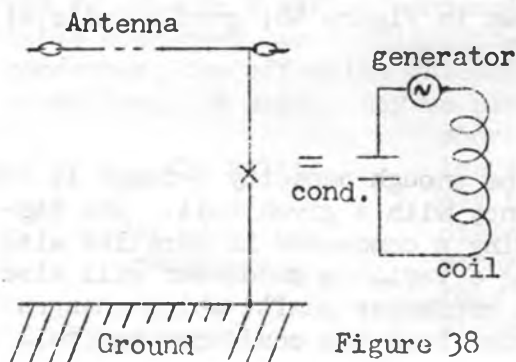

Figure 38

Antenna Tuning

When we connect the antenna and ground connections together, or to some power-consuming device, we have a circuit similar to Figure 38. Capacity exists between the antenna wire and ground (the condenser), the antenna wire has inductance (the coil), and the received energy from the radio stations is represented by the generator. But there

is more than one generator, for there are thousands of radio stations operating at different frequencies; each is acting as a generator in series with our resonant-circuit antenna system. Referring to the graph of Figure 23, we can see that the station which will be successful in producing the largest current in our antenna is that station operating on a frequency to which our antenna system is resonant. Other signal currents will also be produced in the antenna, but they will be weaker because of the reactance offered to them.

The antenna system described on page 12 would have a natural resonant frequency (because of its inductance and capacitance) of about 1700 kilocycles. This means that any station operating on a frequency of 1700 kilocycles

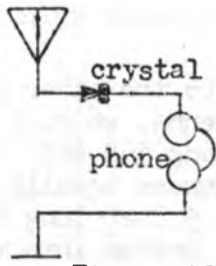

Figure 39

would find it easiest to establish a current flow in our receiving system. Providing this was the only frequency we wished to receive, adding a detector and headset as shown in Figure 39 would complete our receiver. But usually we wish to be able to receive more than one frequency. To do this we must be able to change the amount of inductance or capacity in our antenna system so that the system will become resonant at any frequency which we wish to receive. We have seen that increasing either the capacity or inductance of a circuit lowers the resonant frequency, and that decreasing either of these quantities

raises the resonant frequency. We could tune the antenna system to different frequencies by changing the length of the antenna wire, or by changing its height above ground. But fortunately there are simpler methods available to accomplish the same results.

Variable Inductance Tuning

The simplest practical method of tuning the antenna system is to connect a coil of wire as shown in Figure 40. This added inductance will lower the resonant frequency of the antenna circuit. The amount of inductance possessed by the coil will determine the new resonant frequency. If we pull the coil apart, accordion fashion, the magnetic lines of force will not link together as they did when the coil turns were close together, and the inductance will be decreased (ref. page 9). Thus by varying the spacing between the turns of wire, we can

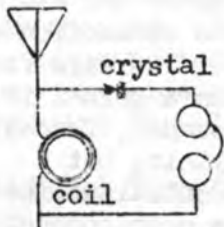

Figure 40

"tune in" any station we choose. The same effect could be accomplished by adding or subtracting turns of wire from the coil. This experiment may be easily tried. A 25 foot roll of doorbell wire just as it comes from the box will

serve as the coil. Simply connect it as shown in Figure 40; good results will be obtained on local stations with almost any antenna.

Variable Capacity Tuning

If the antenna is short, there may not be enough capacity between it and the ground to resonate at the desired frequency with a given coil. The capacity of the circuit can be increased by adding a condenser in parallel with the coil as illustrated in Figure 41. Adding a variable condenser will also allow stations to be tuned in by turning the condenser shaft, which changes the amount of capacity in the circuit. Varying both the condenser and coil

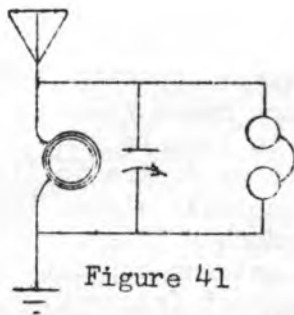

Figure 41

will give a wide tuning range. The resonant frequency will be highest when the inductance and capacity are at a minimum, and lowest when they are at a maximum.

The Series Condenser

When a fixed value of inductance is used, the antenna capacity limits the highest frequency to which the circuit can tune. This is because even though the variable condenser of Figure 41 is turned to a minimum, there still exists the capacity of the antenna system in parallel with the coil. To tune to a higher frequency we must either decrease the inductance of the coil (which we decided was a fixed value in this case) or reduce the effective capacity of the antenna system. We can accomplish the latter by connecting a condenser in series with the antenna. We recall from our discussion of condensers that when two condensers are placed in series, the resulting capacity is less than that of either condenser (ref. page 6). For example, if the antenna system of Figure 42 has a capacity of 150 mmfd. between the points "a" and "g", the effective capacity will be reduced to 75 mmfd. if we connect a 150 mmfd. series condenser as shown in Figure 43.

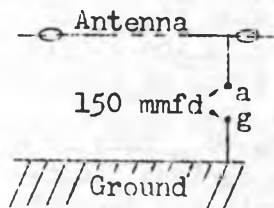

Figure 42

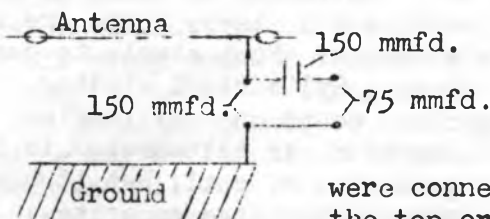

Figure 43

If we were dealing with small condensers, there would be the same resulting capacity if the series condenser

were connected in series with either the top or bottom plate, since in each case it would be in series with the whole condenser as far as the whole circuit is concerned. But

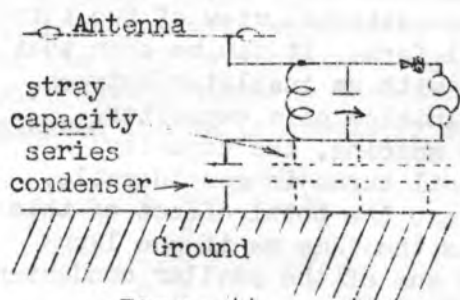

Figure 44

when dealing with the capacity of an antenna system, the stray capacity between the component parts of the set and ground form an effective condenser which would be in parallel with the series condenser if it were placed in the ground lead as in Figure 44, and the decrease in effective antenna capacity would not be as pronounced. In fact, the stray capacity may be so great as to complete the ground connection through its stray capacity effect, and allow strong signals to be

received without an actual physical ground connection. Any type of condenser may be used as a series condenser. Usually a 500 mmfd. mica-dielectric variable condenser, or similar air-dielectric condenser, is used. By varying this condenser, the effective antenna capacity can be changed to suit any tuning conditions. A switch may be placed in parallel with the series condenser to

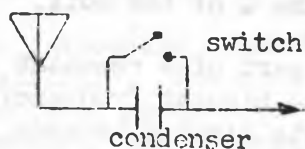

Figure 45

short it out of the circuit when tuning to the lower frequencies where the full antenna capacity may be desirable; see Figure 45. If an air-dielectric condenser is used, a tip of one of the rotor plates may be bent as shown in Figure 46; this will serve the purpose of the switch of Figure 45, automatically shorting out the condenser

tip of rotor plate bent
to contact stator plate
when condenser is turned
to maximum capacity

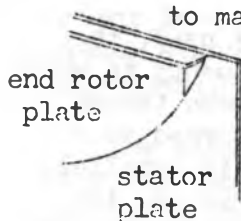

Figure 46

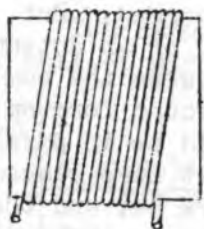
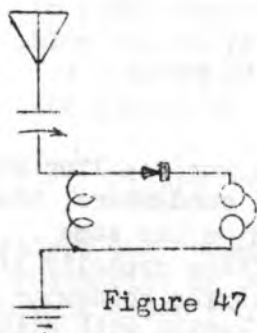

Figure 48

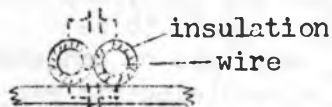

Figure 49

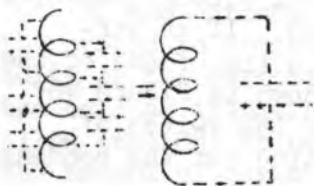

Figure 50

when it is turned to maximum capacity. If a fixed coil is used which has a value of inductance large enough to tune to the lowest frequency to which we desire to listen when using the antenna capacity alone, the addition of a series condenser (Figure 47) to reduce the effective antenna capacity will tune the set to the higher broadcast frequencies, and the parallel condenser of Figure 41 can be omitted.

These are the most common "conventional" methods of tuning a crystal set. Before going into a greater variety of tuning methods, a discussion of coils will prove helpful.

Coils

Coils may be wound in an infinite number of shapes and sizes; there are also many styles of windings. Most simple to describe is the Single Layer, Cylindrical Winding. The turns of wire are close wound on a cylindrical coil form of any diameter, as illustrated in Figure 48. This is a good type of coil, but it has one serious fault--high distributed capacity. Distributed capacity is the name given to the capacity that exists between the turns of wire on the coil. Figure 49 shows an enlarged cross-sectional view of two turns of the wire on the coil form. It can be seen that we have two conductors with an insulator between them, which is our definition of a capacitor. Because of their close spacing, the capacity existing between the coil turns is considerable. As Figure 50 illustrates, the total effect of this distributed capacity is the same as if one large condenser equal to the sum of the smaller condensers was connected across the coil.

The coil form also acts as a dielectric for the distributed capacitors, and for this reason coil forms should be made of a material which does not absorb moisture. If cardboard is used it should be first covered with coil dope or shellac. A coil form which is a poor insulator is also a high-loss dielectric, which will lower the Q of the coil.

When a coil is used as a part of a resonant circuit, it is obvious that the highest frequency to which the circuit can tune is limited because the minimum capacity of the circuit can never become lower than the value of the distributed capacity of the coil.

Special Windings--The Basket Weave

To eliminate the effects of distributed capacity, many types of coil windings have been tried. The object being to find a type of winding which would allow the turns of the coil to be so close together as to provide good linkage of the magnetic lines of force existing about the conductor turns (high inductance), and yet keep the turns far enough apart to keep the distributed capacity small. The types of windings are usually named for their appearance: "Space Wound," "Bank Wound," "Diamond Wound," "Honeycomb Wound," "Spiderweb Wound," and so on. Each type of winding has its advantages and disadvantages. All of these windings will not be given equal consideration here because there exists one type of winding which is superior to the other forms. This is the Basket Weave coil. It is simple to make, yet it has a distributed capacity which is as small as with other types which require a machine to wind them. Furthermore, it is self-supporting, neat appearing, and it has an excellent Q. Since no permanent coil form is required, it can be wound to any diameter with equal facility.

To wind the basket-weave coil, simply draw a circle of the desired diameter on a board and drive an odd number of equally spaced headless nails around the circumference as shown in Figure 51. The winding is started as illustrated, weaving inside and outside of the nails. Figure 52 illustrates the second turn of the coil being wound over the first turn. This procedure is continued until the desired number of turns is completed; then the coil is tied with string at the crossing points between the nails and removed from the form. The winding may be finally held in place by replacing the string with a cement, such as coil dope, or colorless fingernail polish. If reasonable care is exercised, a professional-looking, high-Q coil having low distributed capacity can be turned out without previous experience. The Q of these coils will vary between 200 to 300 depending upon their construction. Q increases with wire size, and it is also the greatest when the diameter of the coil is approximately twice its length. Large coils made with large wire have a higher Q than small diameter, small wire coils. The spacing between the nails should be roughly one-sixth the coil's diameter.

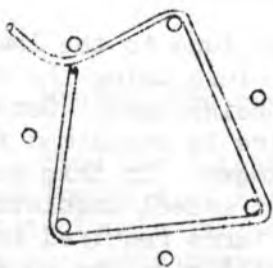

Figure 51

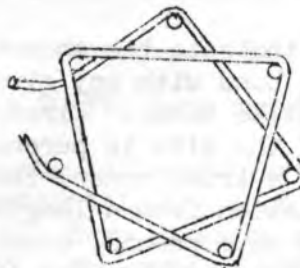

Figure 52

Ferrite Core Coils

Recently a new type of coil with a high-Q Ferrite core has become available. The core of this coil is made from a special metal alloy which is first reduced to finely powdered particles; each of these particles is covered with an insulating material, and then they are compressed together into a solid mass. Because this magnetic metal offers a much lower opposition

to the establishing of magnetic lines of force than does air, a small coil having this material as a core may be made to have the same inductance as a larger coil, and still keep an equivalent Q. The subdivision of the core material is necessary to prevent eddy-current losses. Eddy currents are small power-wasting circulating currents produced in a core by the magnetic field of the coil. Dividing the core into small insulated particles destroys the path for these circulating currents.

An example of this coil is the Grayburne "Ferri-loopstick" which is of the size shown in Figure 53. This coil has an inductance of 245 microhenries with a Q of between 240 to 275. With the conventional 350 mmfd. variable

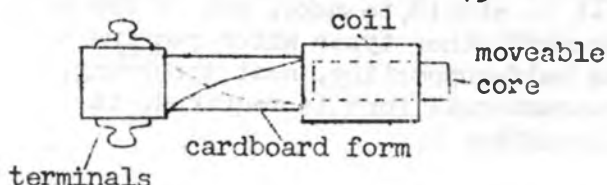

Figure 53

condenser the entire broadcast band can be covered using this coil. The core of the coil is moveable, and by sliding it in and out, the coil's inductance can be varied. Using a small fixed condenser of about 50 mmfd. connected across the coil, the entire broadcast band may be tuned by simply

moving the metal core, thus changing the inductance of the circuit. If the antenna capacity is too great to allow this type of tuning, it can be reduced by using a series condenser as explained earlier.

Practical Coil Winding

For those who wish to wind their own coils, the following charts are included. Although they may appear quite complicated at first glance, they are actually very simple to use. With these charts the experimenter can wind a coil of any practical diameter, with any even size wire from #14 to #28; also he can predict beforehand what the efficiency of the coil will be. The use of these charts is explained by a series of problems, one solved on each chart. These problems are typical, and if a change in wire size is made, the same problem can be solved on any of the other charts.

The charts indicate the amount of turns needed to tune to the lowest end of the broadcast band with any given capacity. But before using the charts three things must be known. First, the size of wire being used. Generally this is known if the wire is purchased; but if the wire is reclaimed from another coil, or a transformer, the size may not be known. In this case, remove the insulation from a length of the wire (except enamel insulation) and wind a few turns on a pencil, counting the number of turns required to make one inch of winding length. The chart of Figure 54 will give the approximate

<u># of Turns/Inch</u>	<u>Wire Size</u>
71	28
58	26
46	24
37	22
29	20
23	18
19	16
15	14

wire size. The counted number of turns will probably not exactly match the figures given here because only the even sizes of wire are given; also, manufacturer's tolerances vary. But using the figure which comes nearest to the count will be sufficiently accurate. The second factor which must be known is the outside diameter of the coil form. This can be easily measured with any scale. The third factor is the total capacity of

Figure 54

the circuit. If the circuit is used in connection with an antenna and ground as in Figure 41, both the capacity of the antenna system and the capacity of the variable condenser add together to form the total capacity (the distributed capacity of the coil is already taken into consideration in the following charts and so it may be ignored). To estimate the value of the antenna capacity, the chart of Figure 55 is given. The figures obtained will be only approximate, but they will serve well enough for most calculations.

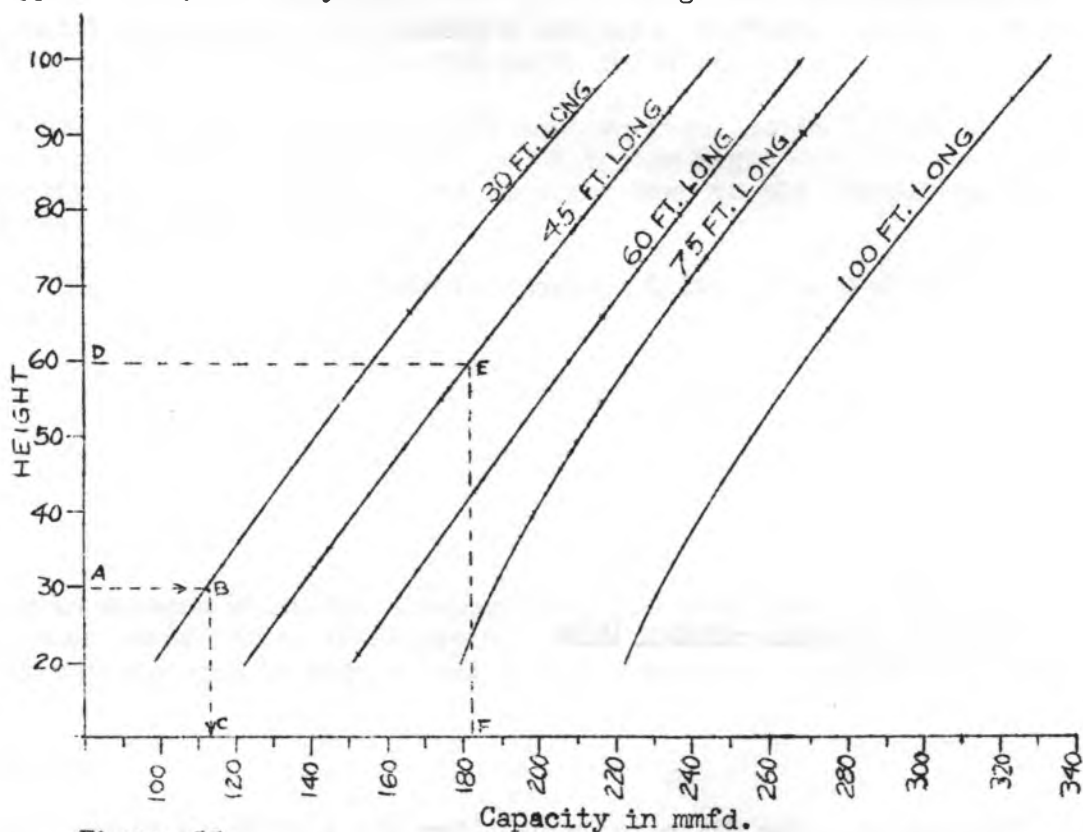

Figure 55

Examples:

Problem: What is the capacity of an antenna 30 ft. long and 30 ft. high?

Solution: Find the height of the antenna on the left hand vertical scale of the graph (point A of Figure 55); draw a horizontal line over to the appropriate length line (30 ft.)(see point B); drop straight down from this point to the lower horizontal scale and read a capacity of 117 mmfd.(point C).

Problem: What is the capacity of an antenna 45 feet long and 60 feet high?

Solution: Locate height of antenna on left hand vertical scale (point D); draw a horizontal line to the 45 ft. length line (point E); drop straight down to the capacity scale and read about 181 mmfd.(point F).

With the wire size, coil diameter, and total capacity of the circuit known, we may now utilize the following charts.

1.

Using an antenna which has a capacity of 200 mmfd., and a 350 mmfd tuning condenser connected as in the circuit of Figure 41, how many turns of #28 enameled wire on a 1 3/4 inch coil form are needed to tune to the broadcast band?

Solution:

The total capacity of the circuit = 200 mmfd. (antenna capacity) + 350mmfd. (tuning condenser capacity) = 550 mmfd. total capacity.

Find the coil diameter on the left hand vertical scale (point "A" of Figure 56). Draw a horizontal line from this point to the right until it meets the 550 mmfd. capacity curve (point "B"); drop straight down to the "Number of Turns" scale and read 56 turns. (point "C").

Since the point "B" falls near the maximum Q line, the Q of this coil should be good.

2.

Using an antenna which has a capacity of 100 mmfd. and a 250 mmfd. tuning condenser connected as in Figure 41, what diameter of coil and how many turns must be used to wind a coil having a maximum Q, using #26 enameled wire?

Solution:

Total circuit capacity = 100 mmfd.(antenna) + 250 mmfd. (condneser) = 350 mmfd.

The point where the "Maximum Q Line" and the 350 mmfd. capacity curve meet is the point of maximum Q for the coil (point E of Figure 57). Moving horizontally to the left of this point, read a coil diameter of approximately 2 1/4 inches; dropping vertically from point E, read that 66 turns are required (point F).

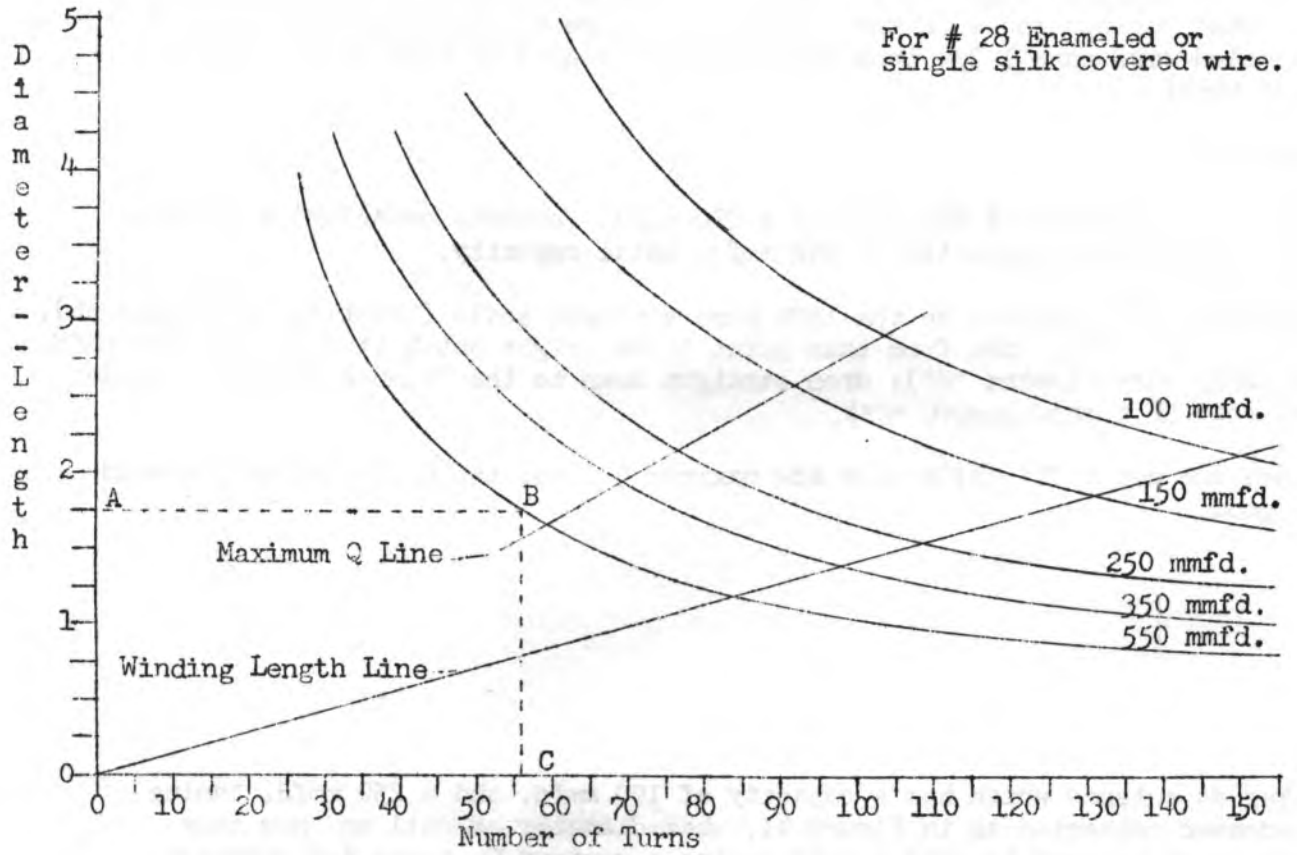

Figure 56

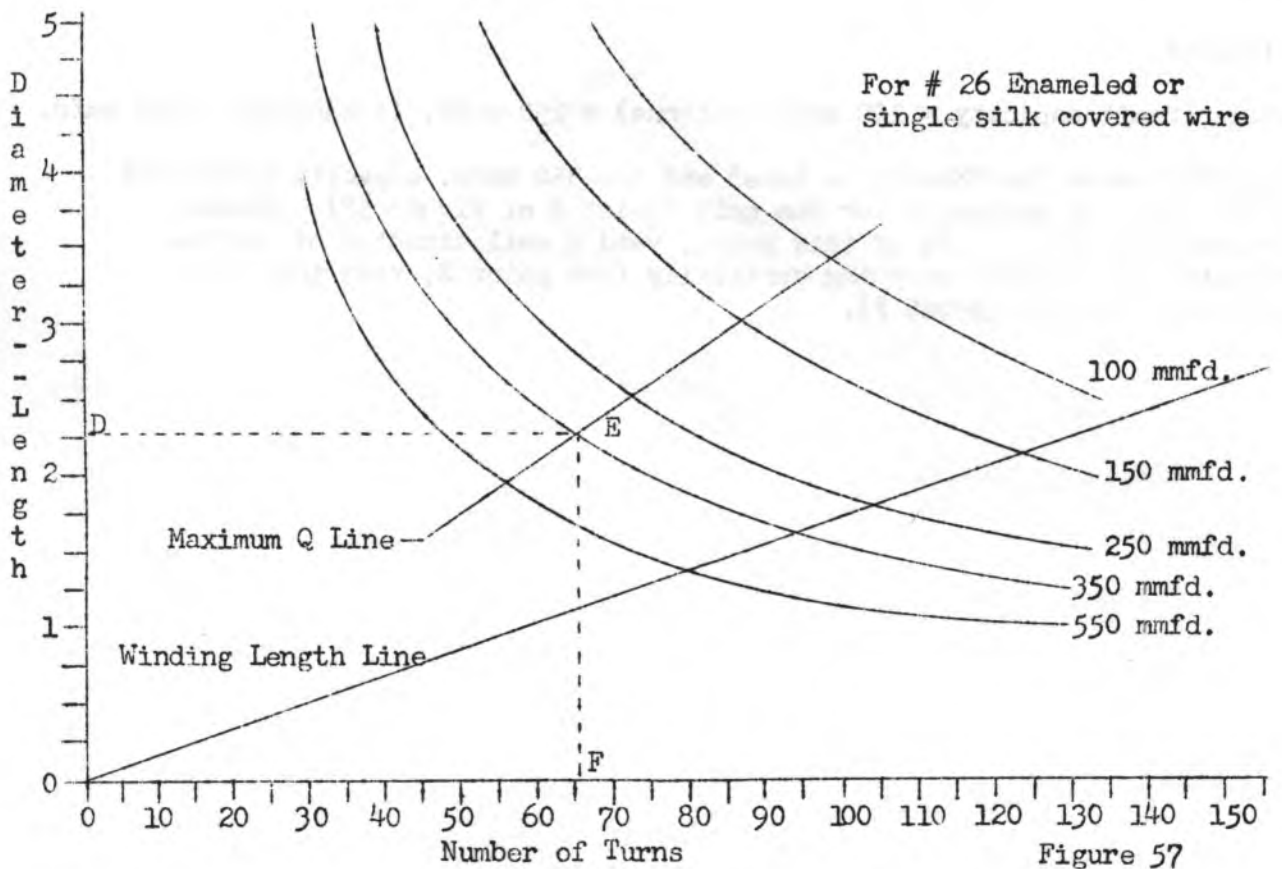

Figure 57

3.

What length of coil form is required for a coil being wound with 92 turns of # 24 enameled wire?

Solution:

Find the number of turns on the "Number of Turns" scale (point G of Figure 58); draw a vertical line up to the "Winding Length Line" (point H); move horizontally to the left of point H to read a winding length of 2 inches. For mounting purposes the coil form should extend at least another $1/4$ inch on each side of the winding, so a coil form of about $2\ 1/4$ inches in length is required.

4.

If the total capacity of the circuit is 300 mmfd. how many turns of # 22 enameled wire are required on a $3\ 1/4$ inch diameter form to tune to the broadcast band?

Solution:

There is no 300 mmfd. capacity curve on the chart; however, solving the problem using the 250 mmfd. curve yields an answer of 67 turns (points I & J of Figure 59), and solving the problem using the 350 mmfd. curve yields an answer of 52 turns (points K & L). Since 300 mmfd. lays half way between the 250 mmfd. and 350 mmfd. curves, the correct number of turns lays half way between 52 and 67 turns, or about 59 turns are required.

To check the Q of this coil, draw a line straight up from the number of turns required (point M) until it strikes the coil diameter line (point N). This point is near the "Maximum Q Line"; hence, the Q of the coil should be good.

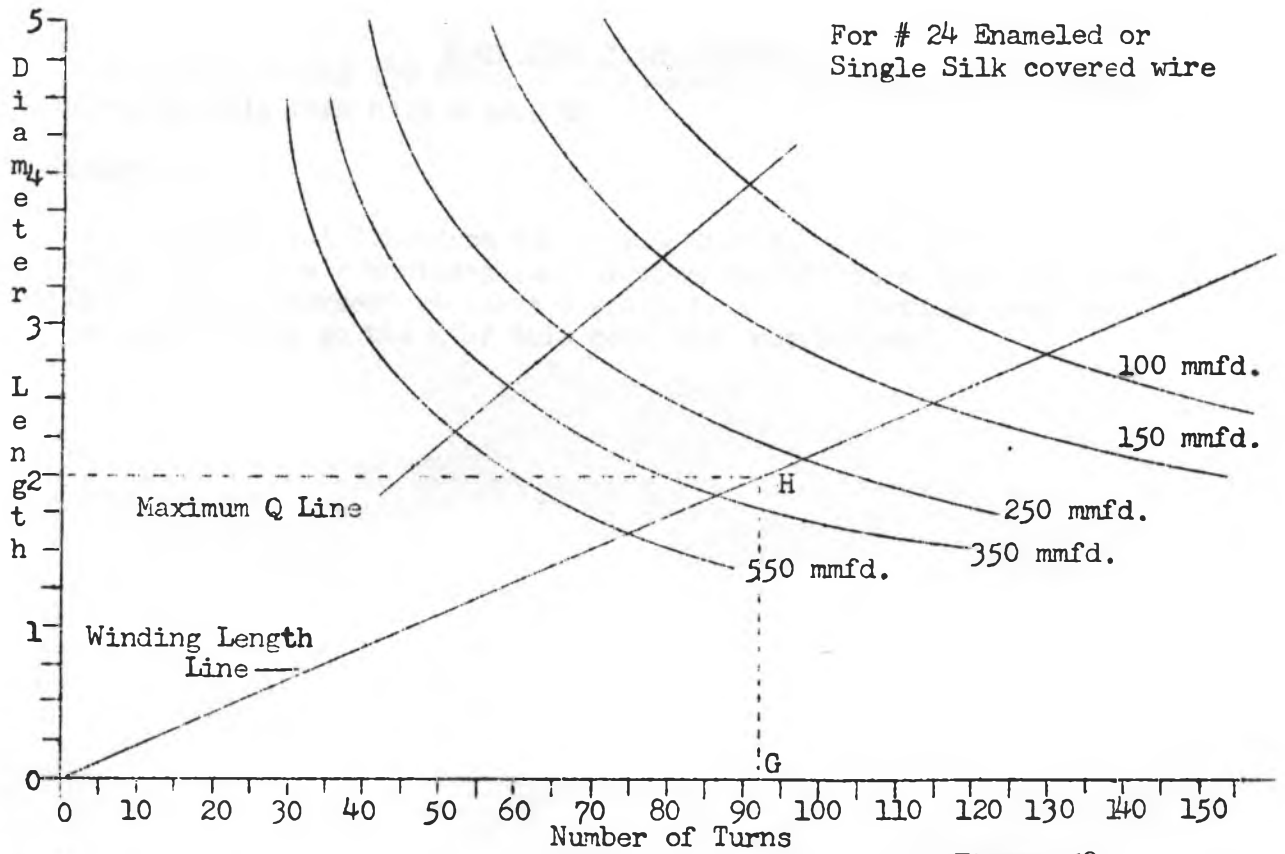

Figure 58

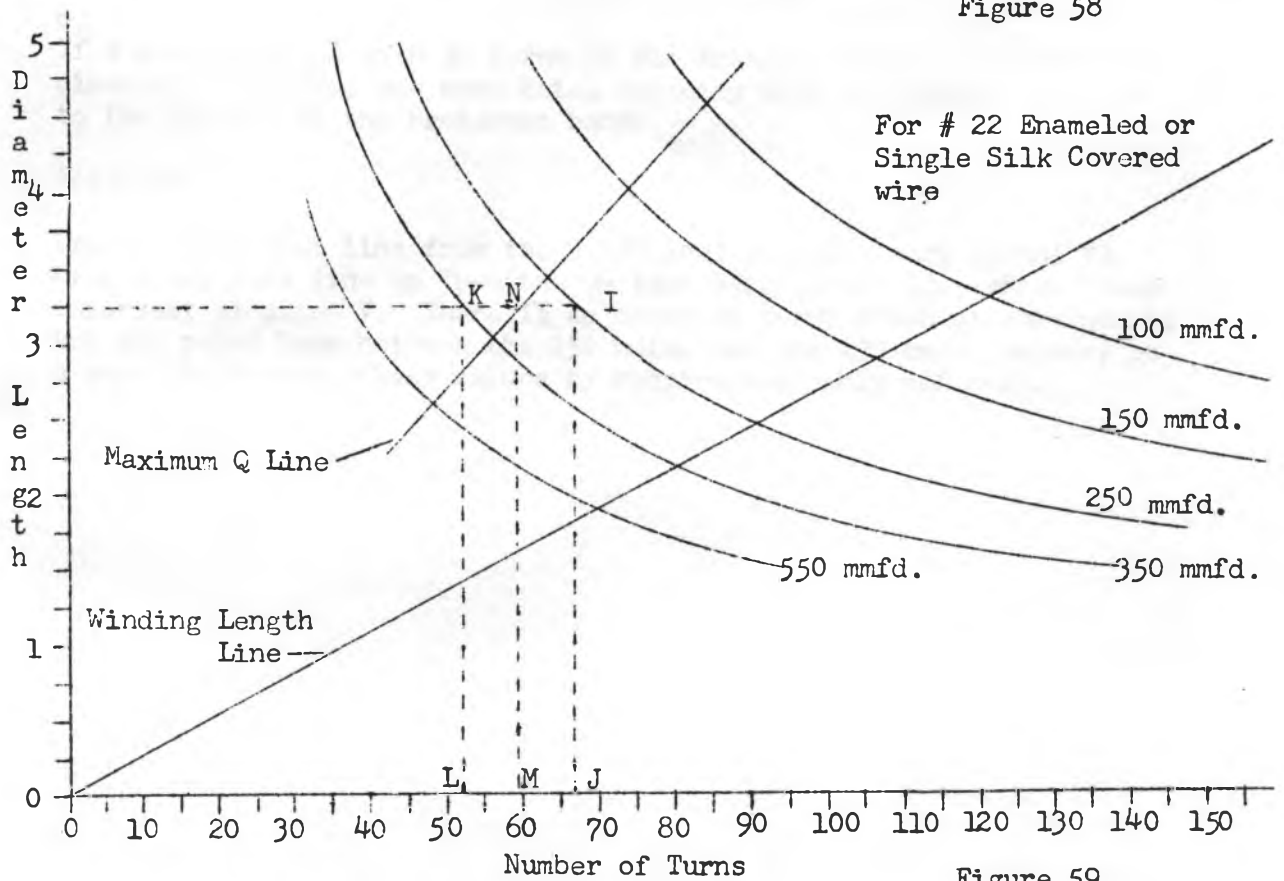

Figure 59

5.

Will a coil having 130 turns of #20 Enameled wire wound on a 2 inch diameter coil form have a good Q?

Solution:

Draw a horizontal line from the 2 inch diameter mark (point P of Figure 60); draw a vertical line up from the 130 turn mark (point R). These lines intersect at point S which is a long distance from the Maximum Q line, so the Q of this coil will not be good.

6.

If a coil is wound with 90 turns of #18 Enameled wire on a 3 1/2 inch diameter coil form, how much total capacity will be required to tune to the low end of the broadcast band?

Solution:

Draw a horizontal line from the 3 1/2 inch diameter mark (point T); draw a vertical line up from the 90 turn mark (point U). These lines intersect at point V. There is no capacity curve drawn at this point; but the point lays between the 150 mmfd. and the 250 mmfd. curves, so a capacity between these values is required--roughly 180 mmfd.

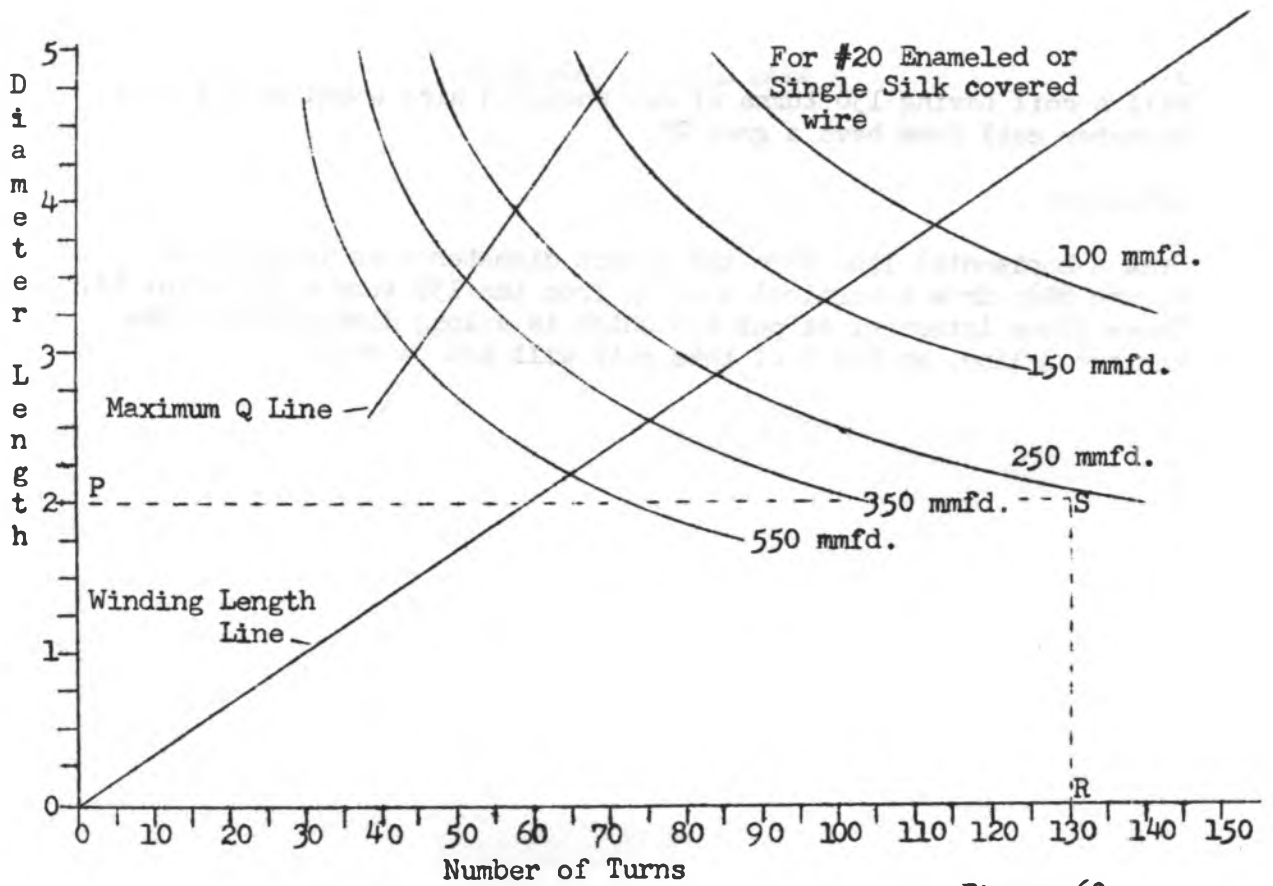

Figure 60

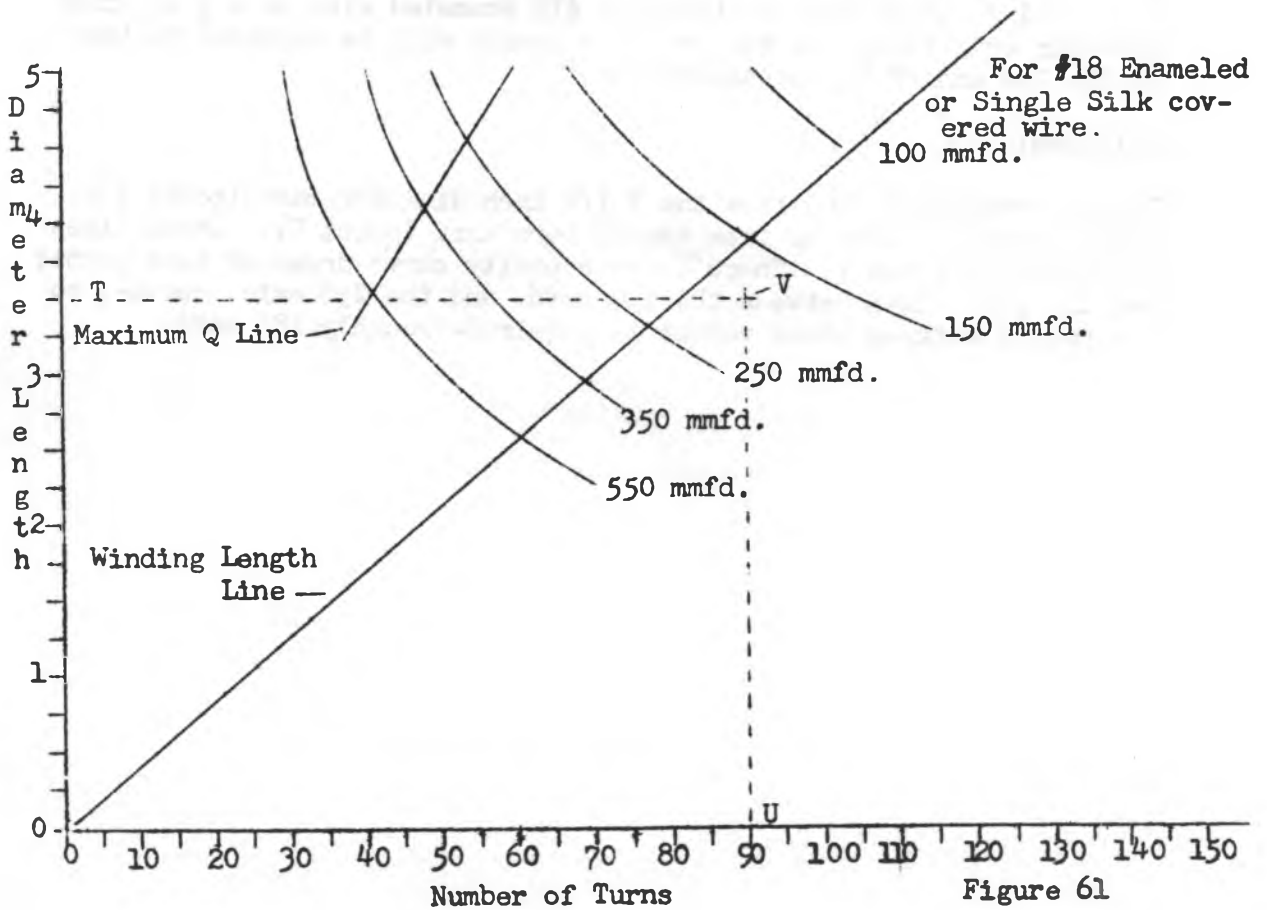

Figure 61

7.

It is desired to wind a coil with #16 Enameled wire on a 2 inch diameter coil form, how many turns should be used to tune to the broadcast band with a total capacity of 550 mmfd.?

Solution:

A line drawn horizontally from the 2 inch diameter mark (point W) does not fall in the range of the capacity curves, which means that it is not practical to wind such a coil for use in a crystal receiver because the Q of the coil would be objectionably low.

8.

How many turns per inch can be close wound with #14 enameled, or single silk covered wire?

Solution:

Draw a horizontal line from the 1 inch mark (point X) to the "Winding Length Line" (point Y); drop down to the "Number of Turns" line and read 15 (Point Z). 15 turns of #14 wire close wound will occupy 1 inch.

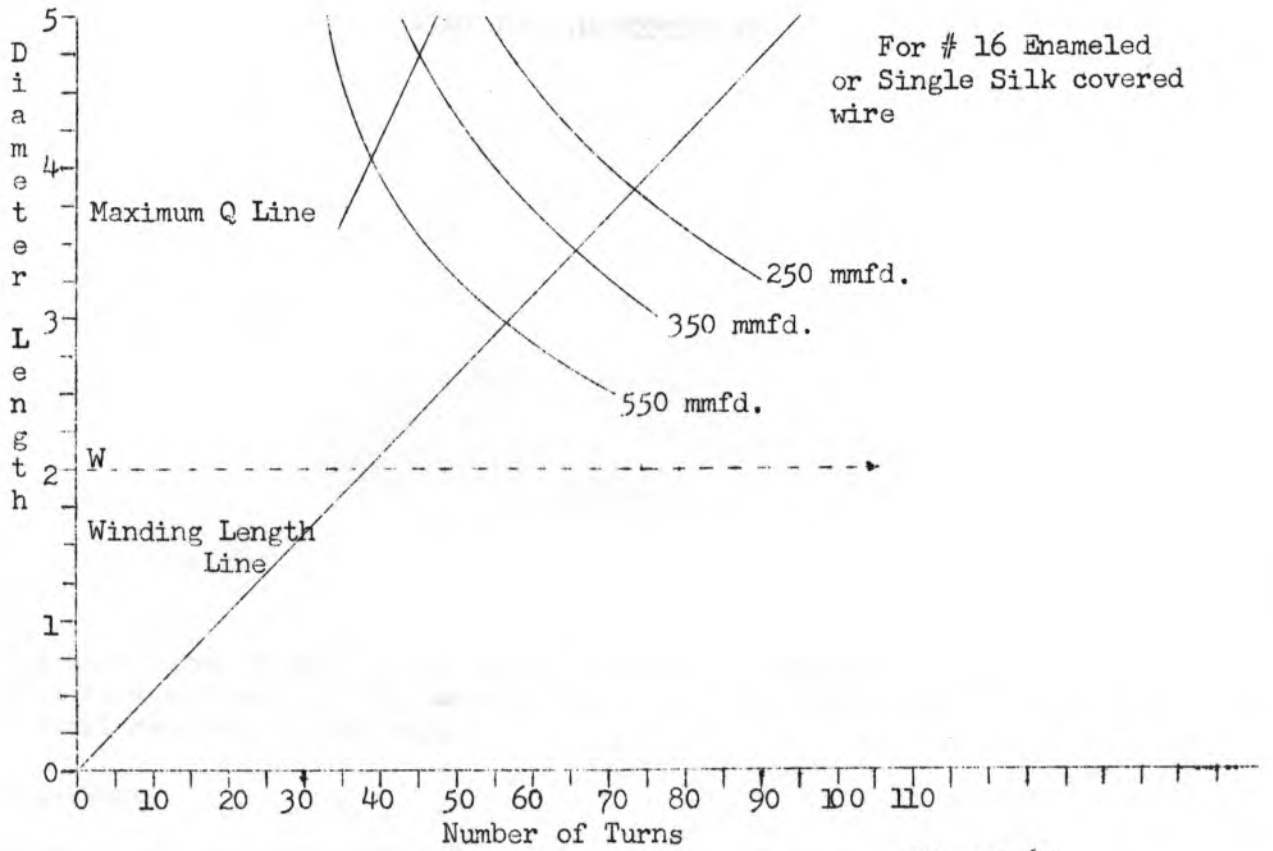

Figure 62

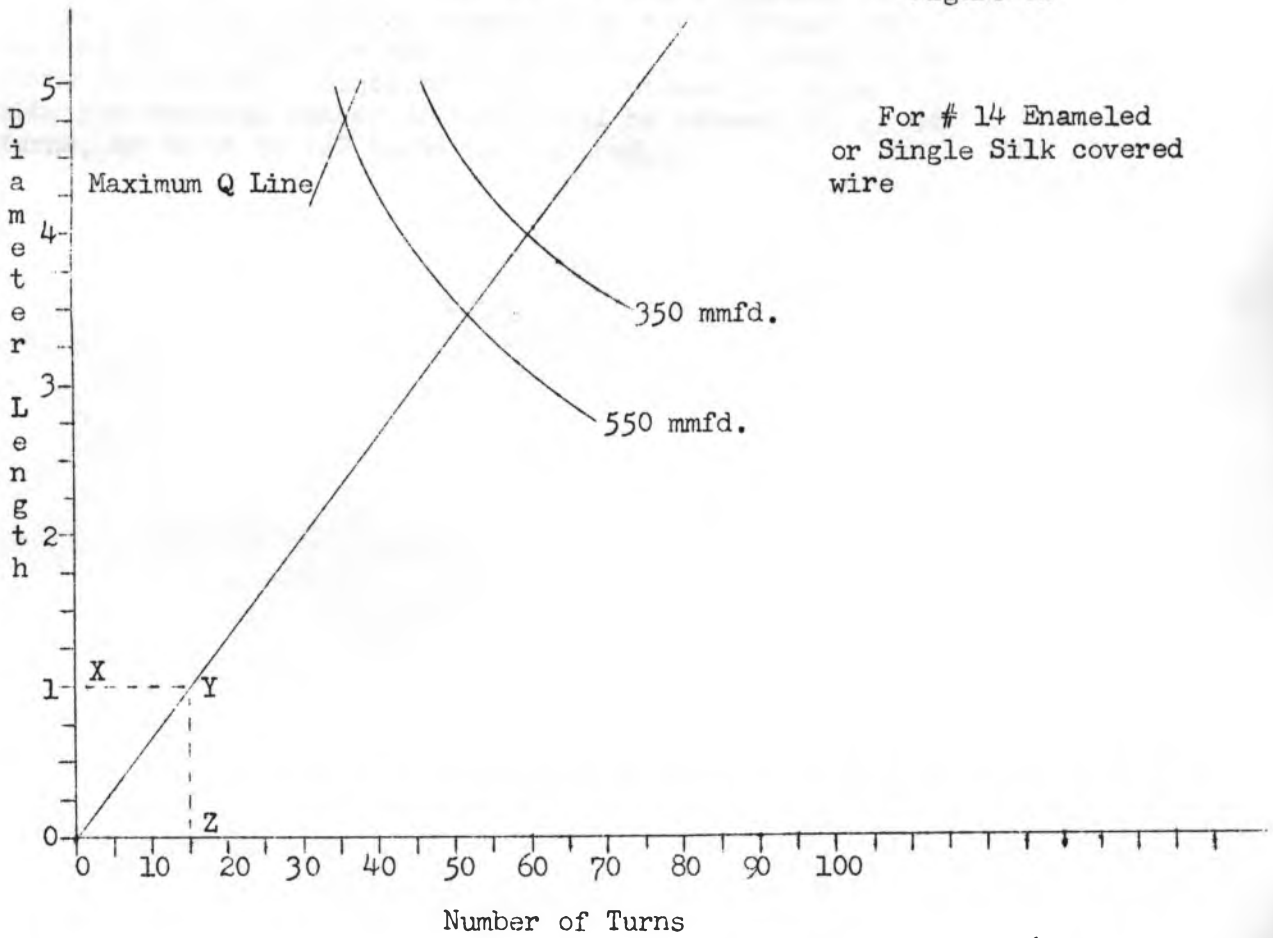

Figure 63

9.

How many turns of #27 double cotton covered wire on a 2 1/2 inch coil form are required to tune to the broadcast frequencies with a total capacity of 350 mmfd.?

Solution:

There is no chart for #27 DCC wire; however, solving the problem for #28 DCC wire yields an answer of 65 turns (Figure 64), and solving the problem for #26 DCC wire yields an answer of 66 turns (Figure 65). Since #27 wire is between the sizes #26 and #28, the required number of turns will be between 65 and 66 turns, or about 65 1/2 turns is required.

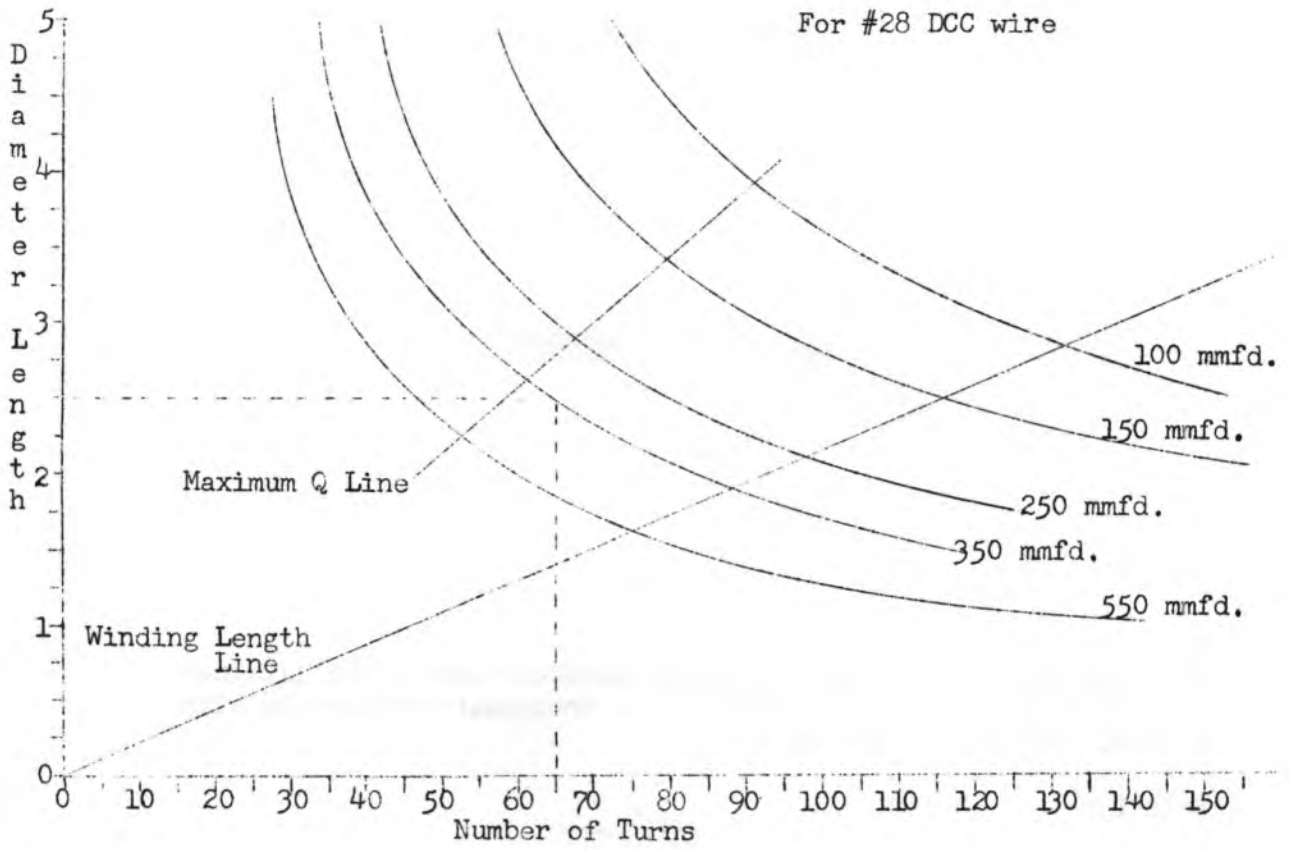

Figure 64

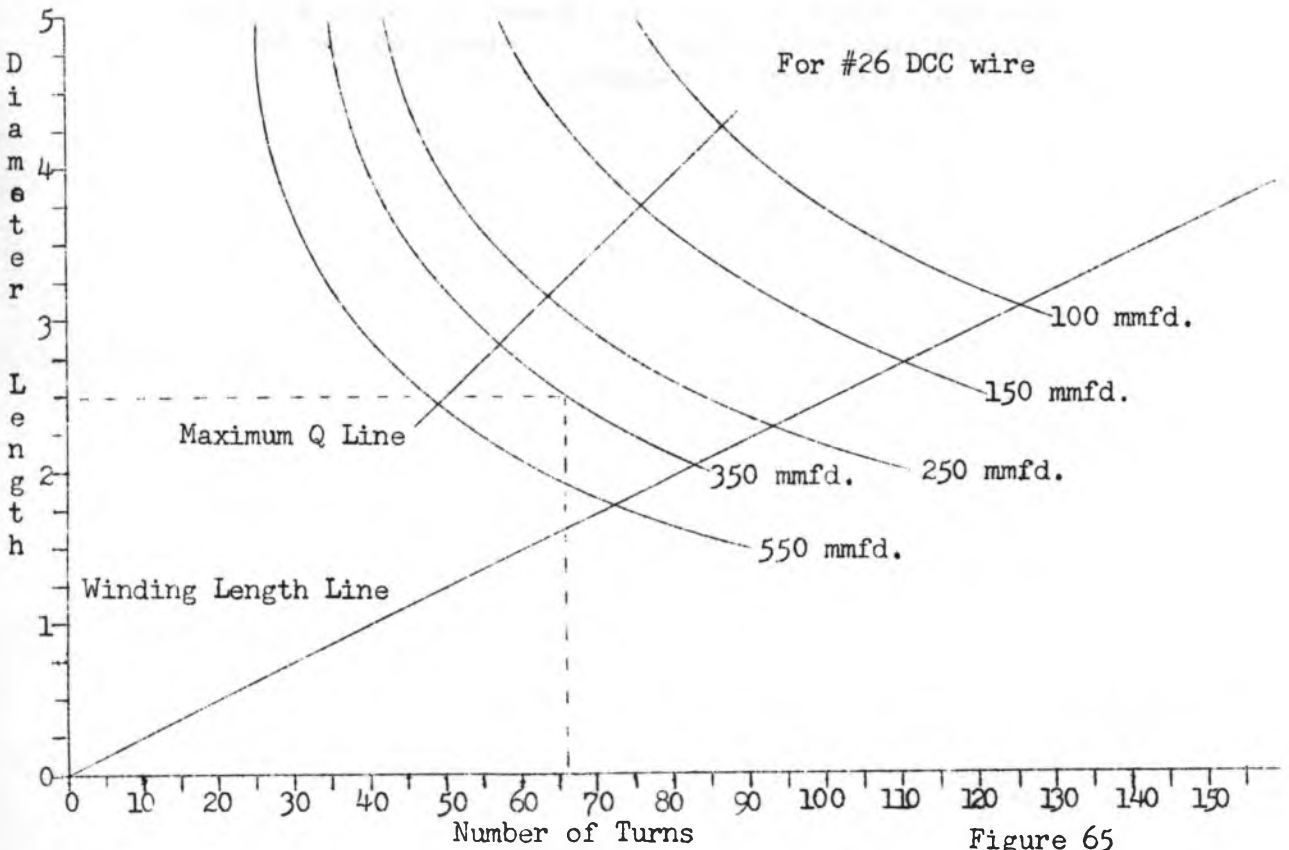

Figure 65

10.

It is desired to wind a basket-weave coil 3 inches in diameter, using #24 DCC wire. If the total capacity of the circuit is 350 mmfd., what number of turns is required?

Solution:

Solving the problem in the manner described earlier results in an answer of 59 turns; however, since the basket-weave coil has less distributed capacity than the single-layer, close-wound coil an additional 10% should be added to the number of turns.

$59 + 5.9 = 64.9$, or 65 turns are required. (See Figure 66).

11.

With a total capacity of 550 mmfd., how many turns are required on a basket-weave coil 4 inches in diameter wound with # 22 DCC wire?

Solution:

Solving the problem in the usual manner results in an answer of 32 turns (Figure 67). Adding 10% to this figure gives approximately 35 turns as the final answer.

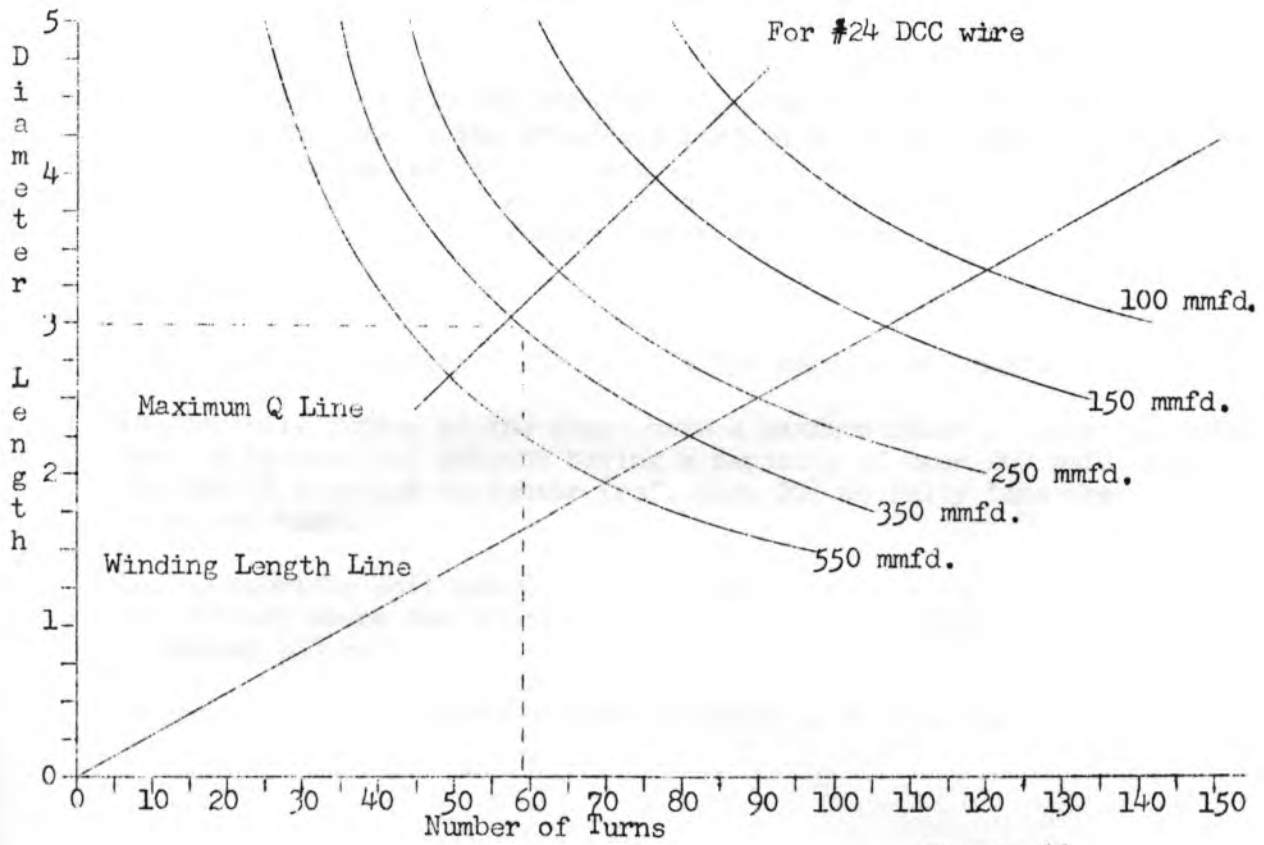

Figure 66

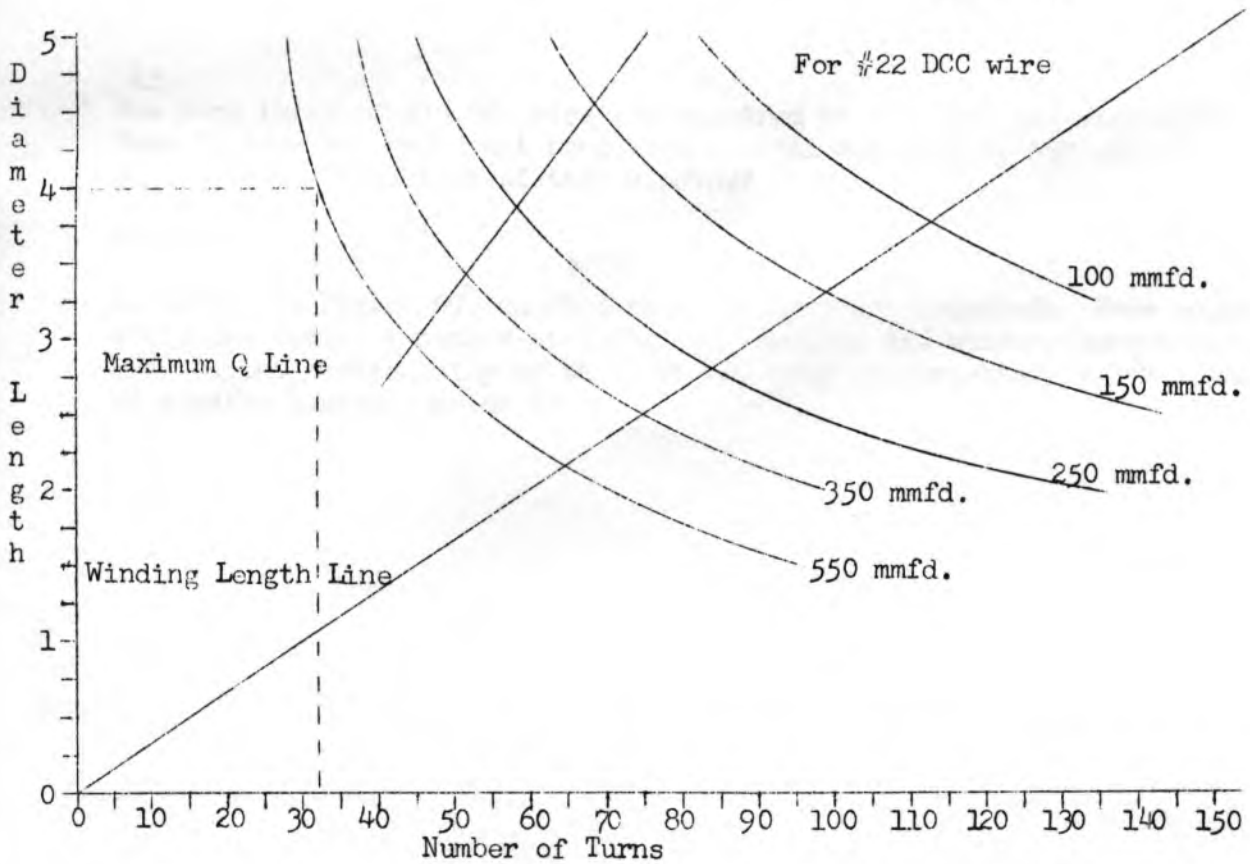

Figure 67

12.

How many turns of #20 DCC wire are required on a 3 inch diameter coil form to tune to the broadcast band with the following circuit components connected as in Figure 41:

Antenna capacity = 257 mmfd.

Tuning Condenser = 350 mmfd.

Solution:

Total circuit capacity = 257 mmfd. + 350 mmfd. = 607 mmfd.

The capacity curves of the chart have a maximum value of only 550 mmfd. This is because any antenna having a capacity of over 200 mmfd. requires the use of a series condenser (ref. page 20) to fully tune the broadcast band.

The appropriate coil can be found by using the 550 mmfd. curve for any circuit where the antenna capacity causes the total capacity to exceed 550 mmfd.

In this case the required number of turns is 48 (see Figure 68).

13.

How many turns of #18 DCC wire are required on a 4 inch diameter coil form to tune the broadcast band with a total capacity of 550 mmfd.? What will be the length of this winding?

Solution:

Referring to Figure 69, we find that 37 turns are required. From point A where the vertical number-of-turns line crosses the winding-length line, draw a line horizontally to the left and read approximately $1 \frac{3}{4}$ inches of winding length. (point B).

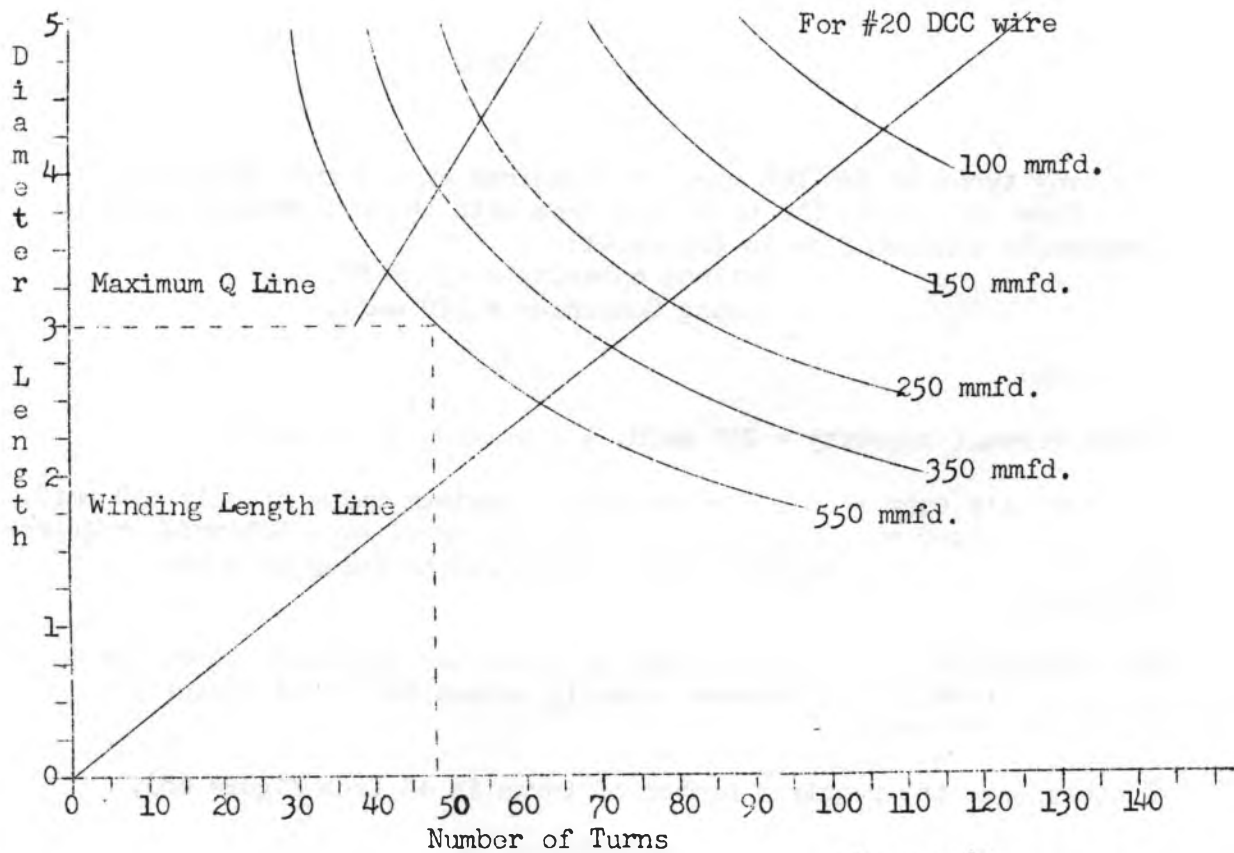

Figure 68

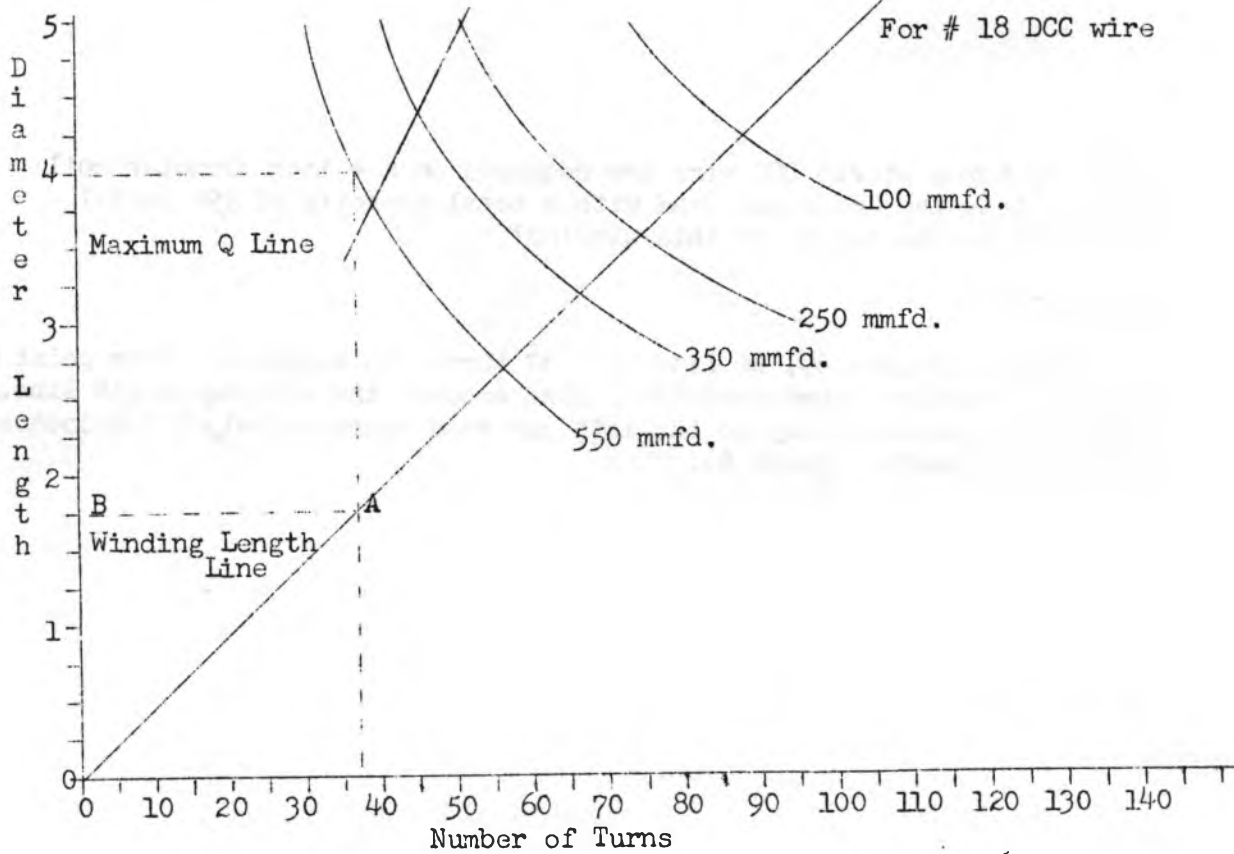

Figure 69

14.

How many turns of #16 DCC wire are required to make a 4 inch diameter basket-weave coil for a circuit having a total capacity of 100 mmfd.?

Solution:

There is no 100 mmfd. curve on the chart (Figure 70) which means such a coil as described above would not be practical for a crystal set circuit.

15.

How many turns of #14 DCC wire are required to make a 4 1/2 inch diameter basket-weave coil for a circuit having a total capacity of 350 mmfd.? Would the Q of this coil be good?

Solution:

Solving in the usual manner on Figure 71 yields an answer of 54 turns. Adding the extra 10% required for basket-weave coils brings the total number of required turns to approximately 59 1/2.

Since point C is some distance from the maximum Q line, the Q of this coil will only be fair.

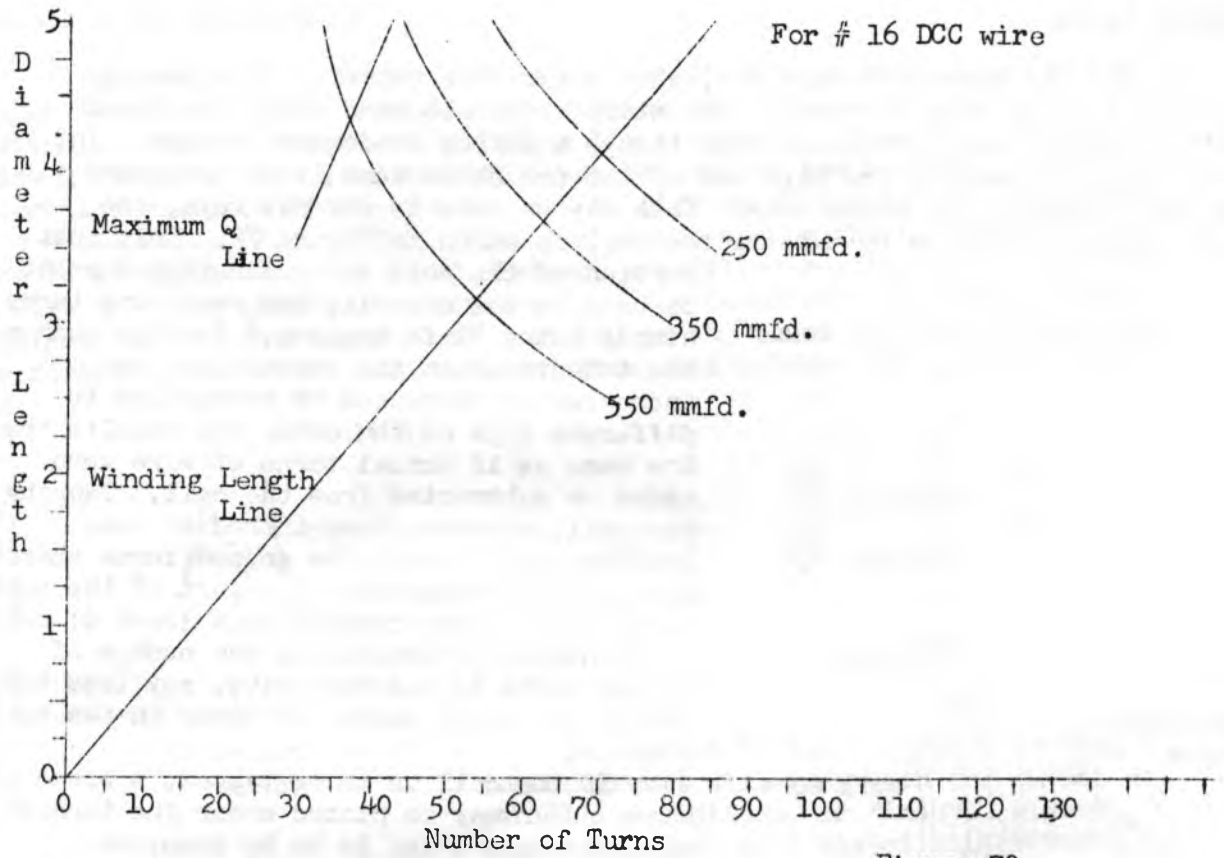

Figure 70

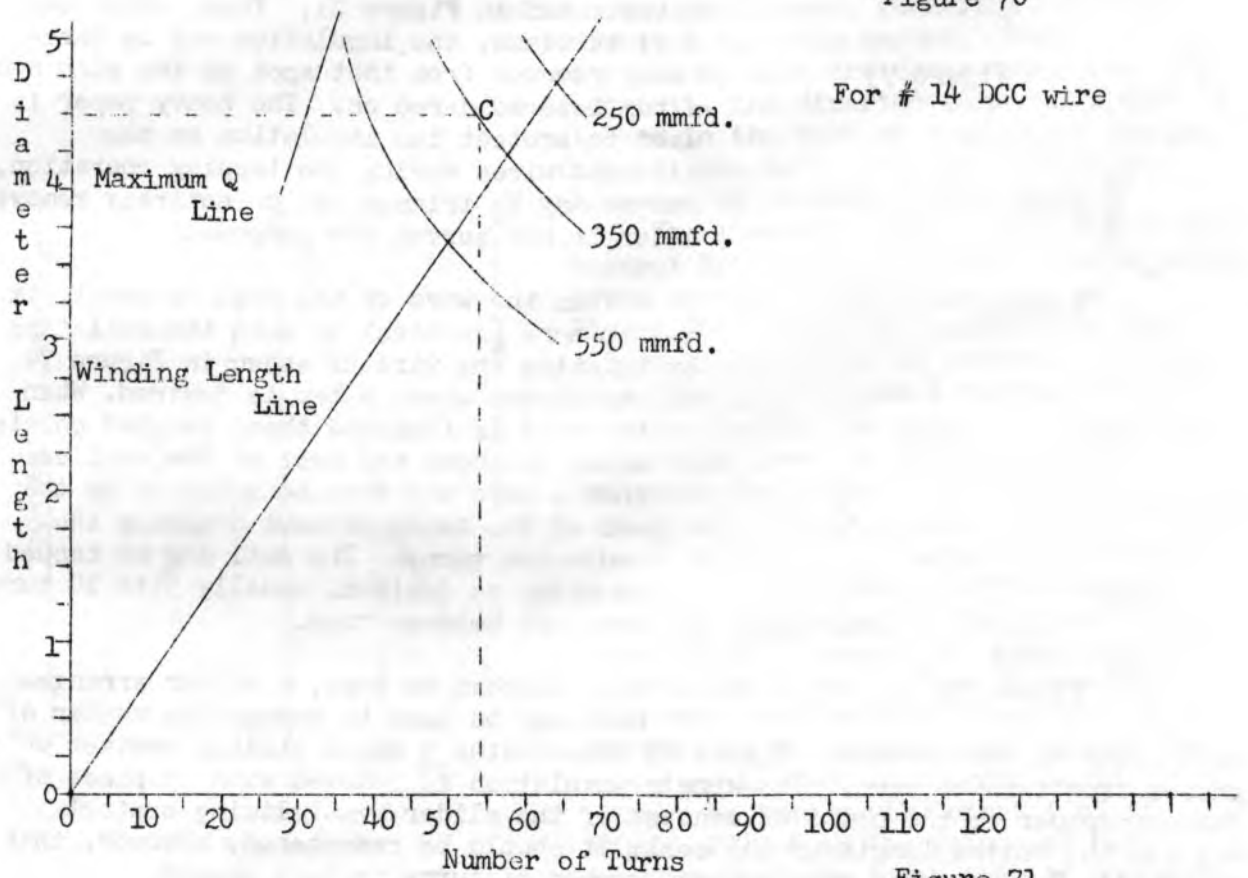

Figure 71

Tapped Coils

Under the average conditions, when a variable capacity in a tuning circuit is less than 350 mmfd, the entire broadcast band cannot be tuned with a given fixed inductance even though a series condenser is used. In this case, to tune to the high end of the broadcast band it is necessary to also decrease the inductance. This may be done in several ways, the most common method is by tapping the coil as shown in Figure 72. Only that portion of the coil above the tapped point is used in the circuit, the remaining turns simply being "left hanging." In this manner the inductance in the circuit can be increased or decreased by connecting to different taps on the coil; the results are the same as if actual turns of wire were added or subtracted from the coil. Tapping the coil, however, does introduce some inefficiency because the unused turns absorb some of the energy from the part of the coil being used. This results in a lower Q; but it is not objectionable if the number of unused turns is not excessive, say less than 30% of the total number of turns on the coil.

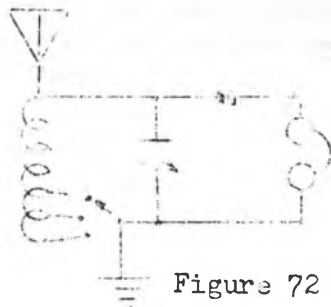

Figure 72

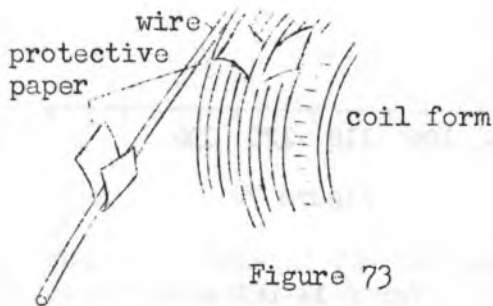

Figure 73



Figure 74

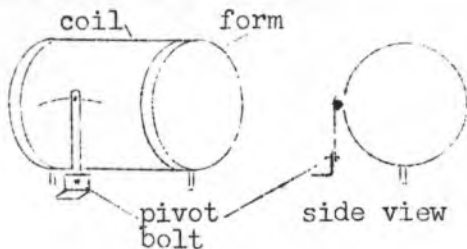

Figure 75

coil turns in the circuit. Figure 75 illustrates a metal sliding contact which passes from turn to turn. The wire's insulation is removed with a piece of fine sandpaper at the point of contact of the slider. A sliding contact may run the entire length of the coil; it should be remembered, however, that the coil's Q is lowered when a large number of turns is left unused.

If the coil is to be tapped, a piece of heavy paper may be placed under the turn of wire on which a tap is to be made, as illustrated in Figure 73. Then, after the coil is wound, the insulation may be carefully removed from that spot on the wire and a tap lead soldered on. The heavy paper is used to protect the insulation on the adjacent wires during the tapping operation, and it may be trimmed off or entirely removed after it has served its purpose.

When the wire of the coil is small, it may be more practical to make the coil taps by twisting the wire as shown in Figure 74 at the places where a tap is desired. When the coil is finished these twisted points stick up above the rest of the coil so that a wire may then be soldered to the end of the twist without damaging the adjacent turns. The coil may be tapped as often as desired, usually 5 to 10 turns are left between taps.

Instead to taps, a slider arrangement may be used to change the number of

Circuit Q and Selectivity

It was explained earlier that Q and selectivity go hand in hand: the higher the Q of a tuned circuit, the greater will be its ability to separate stations. Figure 76 again illustrates the resonance curves for a high Q and a low Q circuit. The Q of circuit B may be low for two reasons. First, the internal resistance of the circuit may be high which limits the current flow to a small value (Figure 77). This resistance may be the resistance of the wire of which the coil is wound. Second, a parallel resistance as illustrated in Figure 78 may divert some current from the tuned circuit elements and dissipate it in the form of heat. As far as the tuned circuit is concerned the result is the same: less current circulates between the coil and condenser.

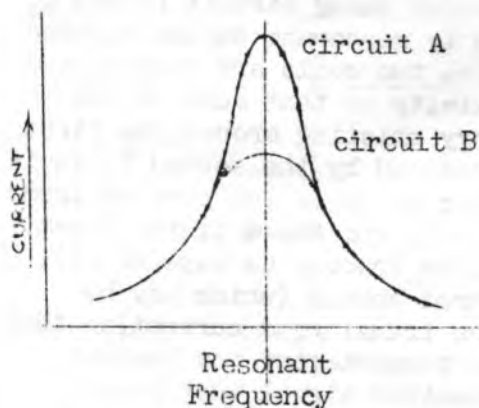

Figure 76



Figure 77

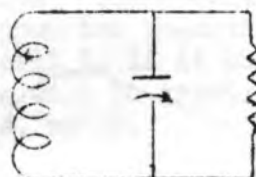

Figure 78

The amount of current diverted from a tuned circuit will vary with the amount of parallel resistance, or "Load". A very high resistance will divert little current, while a low resistance, such as a headset, will divert a sizeable amount. When a detector and headset are connected across a tuned circuit, the diverted current is dissipated in the form of mechanical energy, that is, the moving of the headset diaphragms which produces sound waves.

The lowered Q which results when the headset is added to a tuned circuit often makes station separation difficult. Figure 79 illustrates graphically the relative difference in current developed in a high Q and a low Q circuit for two stations having the same power output and operating near the same frequency. Both circuits are tuned to the station operating at 700 kilocycles, and the 720 kilocycle signal may be considered as the interfering station. Notice that with the high Q circuit the difference in current flow between the two received signals is large ("A" of Figure 79). With the low Q circuit there is little difference in current flow between the two signals, and one signal would be almost as loud as the other ("B" of Figure 79). Also the volume of both stations will be lower than it was when the same signals were received by the

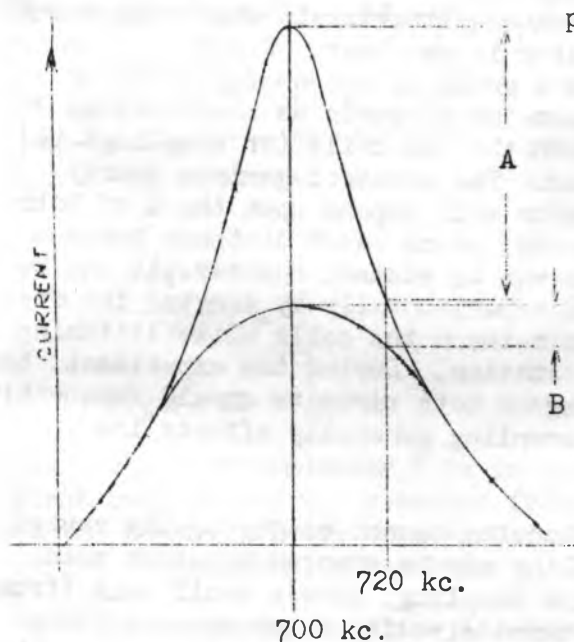

Figure 79

high Q circuit.

Coupled Circuits

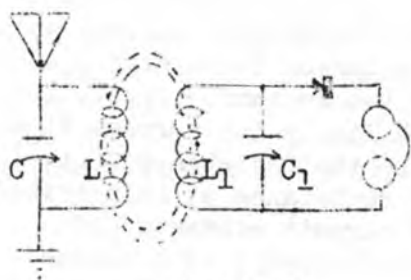

Figure 80

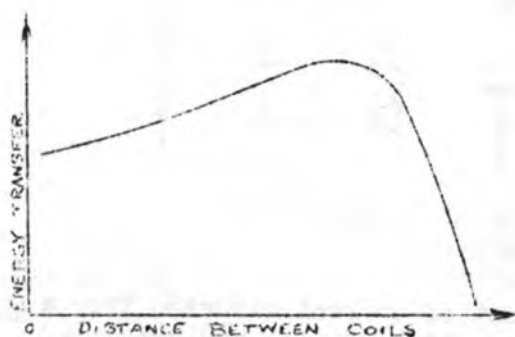

Figure 81

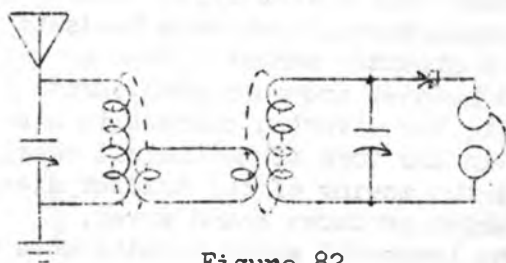

Figure 82

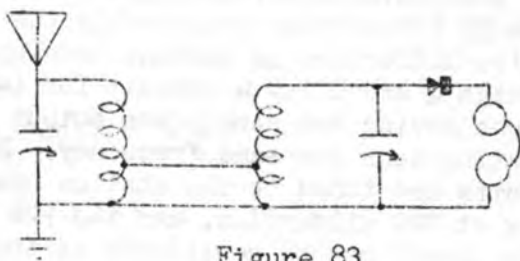

Figure 83

When only one tuned circuit is used it is very likely that interference between stations will result. There are two general ways to improve selectivity; both involve the use of at least two tuned circuits. Figure 80 illustrates one method of improving selectivity. The antenna circuit is tuned to resonance by L and C . Another tuned circuit L_1 and C_1 is also tuned to resonance at the station's frequency. The two coils are then placed in close proximity so that some of the magnetic energy existing around the first coil is intercepted by the second (this is another method of diverting current from a tuned circuit, and the Q of the first circuit will be lowered because of it). The transferred energy (which may be thought of as transferred current) is then passed on to the detector and headset. Since the received signal must pass through both tuned circuits on its way to the headset, greater selectivity will result providing that the Q of the first tuned circuit is not lowered too greatly by the load placed on it by the second tuned circuit.

Care must be taken not to couple the two circuits too closely. A point of optimum coupling exists where the energy transfer is greatest. Figure 81 shows a typical graph of the energy transfer between two circuits as the distance between the two coils (or coupling) is varied. The point of maximum energy transfer will depend upon the Q of both circuits, so no exact distance between coils can be stated; however, it can be found experimentally by varying the distance between the coils while listening to a station. During the experiment, the tuning of both circuits should frequently

be checked since changing the amount of coupling generally affects the circuits tuning.

When the distance between the two circuits cannot be physically varied because of mechanical problems, the coupling may be changed by other means. Figure 82 illustrates a method called Link Coupling. Here a small coil (from 3 to 5 turns) is coupled to each of the tuned circuits which are not otherwise coupled, then the small coils are connected together which provides the link coupling between the two resonant circuits. If the link length is kept under a foot or two in length, the losses of the link will be negligible. A variation of link coupling is shown in Figure 83. In this circuit the coils

are tapped by the connecting wires, and the lower few turns of the tuned circuits themselves are used in place of the link coils. The results are the same as with the circuit of Figure 82.

Another method of coupling two circuits when direct electromagnetic coupling is not feasible is shown in Figure 84.

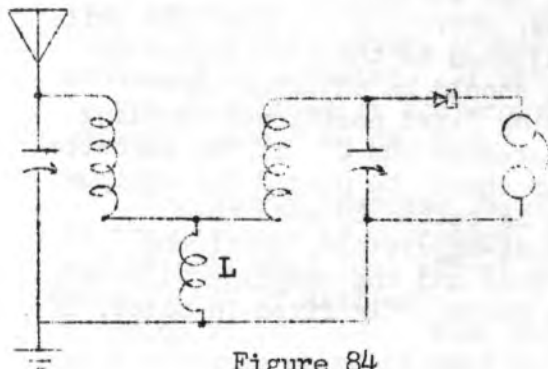

Figure 84

Here the two circuits are coupled by the coil L which is actually a part of both circuits. Current flowing in either circuit must pass through the coil L, and because of this the two circuits are coupled. The amount of coupling depends upon the inductive reactance of the coil L. If it has many turns the coupling will be great; if it has a few turns, small.

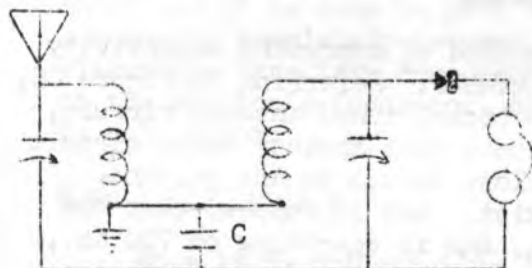

Figure 85

Instead of a coil, a condenser may be used as illustrated in Figure 85. As with the case above, this component is a part of both circuits, and the coupling between the circuits will depend upon the capacitive reactance of the condenser. Since capacitive reactance varies inversely with the condenser's capacity (ref. page 8), a large condenser produces a small amount of coupling and a small condenser produces a large amount of coupling. For the same amount of coupling, the results obtained are identical with those obtained with the circuit of Figure 84.

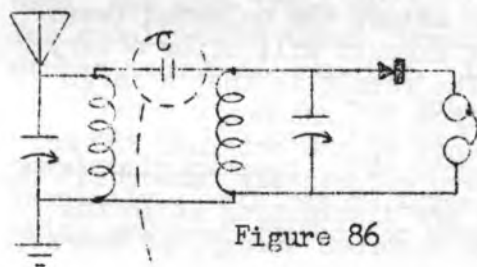

Figure 86



Figure 87

Using either a mutual coil or condenser for coupling changes the resonant frequency of the tuned circuits by an amount proportional to the amount of inductance or capacity which is connected in series with the circuits. For, referring to Figure 84, we can see that the variable condensers are no longer tuning only the main coils but also the mutual inductance coil L; and in Figure 85 we can see that the main tuning condensers are connected with the mutual condenser C

in such a way that condenser C is in series with each of the tuning condensers. The first case lowers the resonant frequency of the circuits; the second raises the resonant frequency, hence retuning of the circuits is necessary if the amount of coupling is changed.

Another method of coupling is shown in Figure 86. This is called capacitive coupling. The size of condenser C determines the amount of coupling. A small condenser is usually all that is needed. In fact, the capacity that exists between a few turns of insulated wire placed over another insulated wire as in Figure 87 will frequently serve as the condenser,

especially if some inductive coupling (from coil to coil) exists also. The larger the size of the coupling condenser, the greater will be the amount of coupling.

All of these types of coupling are simply different methods of doing the same job, that of transferring energy from one circuit to another. The end result of any of these circuits is the same, providing the Q of the coils is the same in each case, and that they are adjusted to the same degree of coupling. In any case, the degree of coupling should be adjusted experimentally for best results. Try to avoid winding fixed positioned coupling windings on a new project; it is difficult to predict the Q 'S of the circuits involved and to accurately tell where the coils should be placed for optimum performance. It is better to make them adjustable, or semi-adjustable, until the circuit can be tried and the coupling adjusted. Then they can be permanently fixed in place, if desired.

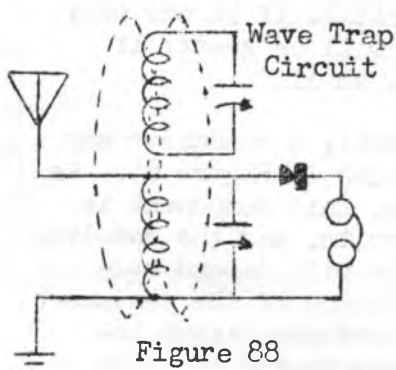

Absorption Wave Traps

The second method of improving selectivity operates in this manner. Referring to Figure 88, we find the conventional tuned antenna circuit, detector, and headset, plus another tuned circuit which is placed close enough to the antenna circuit to allow electromagnetic coupling to exist. Let us suppose that two stations are interfering with each other; again, one is operating on 700 Kc., and the other on 720 Kc. The antenna circuit is tuned to the desired station on 700 Kc., but because of its low Q the station on 720 Kc. is almost as loud as the desired station (ref. page 50). Now if we adjust the unloaded (wave trap) circuit to the interfering frequency, this circuit will offer a very small opposition to a current flow of 720 Kc. The result is that a large 720 Kc. current is induced in the trap circuit from the antenna circuit. The wave trap current is established at the expense of the original 720 Kc. energy received by the antenna; therefore, we have effectively "absorbed" the interfering signal from the antenna circuit and are dissipating it in the form of a current flow in the trap circuit. Such absorbed energy, of course, cannot reach the headset; and the interference is removed.

Because there is no load on the wave trap circuit, its Q is very high; and providing we do not couple it too closely to the antenna circuit so that it becomes loaded down by the headset load, it will tune very sharply. Because it tunes so sharply, it will not absorb the 700 Kc. signal which will be delivered to the headset with normal volume.

Practical Wave Trap Circuits

With the average crystal set having only one tuned circuit, at least one wavetrapp circuit will probably be necessary to separate the stations properly. As many traps as required may be used, each trap circuit will remove one interfering station.

Wave traps must be carefully adjusted if good results are to be obtained. Because of the high Q of these circuits, tuning must be done very slowly; wave

traps tune as sharply as a superhetrodyne broadcast receiver. Until familiarity with the circuit is acquired, wave traps should be adjusted in the following manner. Tune the crystal receiver to the desired station, keeping the wave-trap circuit away from the main tuning coil. This will bring in the desired station and the interfering stations. Next, bring the wavetrap as close as possible to the tuning coil, and slowly tune the wave-trap condenser through its tuning range which should seriously affect the tuning of the receiver, probably tuning different stations in and out as the condenser is adjusted. If the receiver tuning is not affected, the wave trap is not resonating at the proper frequency and the values of inductance and capacity should be checked.

Now slowly increase the distance between the wavetrap and the tuning coil. As the distance is increased, the tuning of the wavetrap will become sharper and it will have less effect on the tuning of the crystal receiver proper, except that it will completely remove any station operating on the frequency to which it is tuned. When properly adjusted, the wave trap will be placed at a distance where it will not affect the regular tuning of the set, and it will be adjusted to the interfering station's frequency (tuning is very sharp and it is easy to pass over the adjustment where the interfering station is completely removed.). If the interfering station cannot be removed, either the wave trap components are not of the proper value to reach resonance at the station's frequency, or the distance (coupling) between the two coils is not proper.

Wave Trap Coupling

When it is not possible to couple the wave traps to the ends of the main tuning coil because space limitations, or because of the type of winding used, the wave traps may be coupled by any of the methods previously described for coupling two tuned circuits together. Care must be taken to get the proper amount of coupling. If the coupling is too close, the wave trap will affect the tuning of the set and perhaps even absorb some of the desired signal; and if the coupling is too loose, the interfering station will not be completely removed. The proper amount of coupling must be adjusted experimentally. Figures 89 through 92 illustrate some of the types of coupling which are best suited for wave trap applications (ref. page 51).

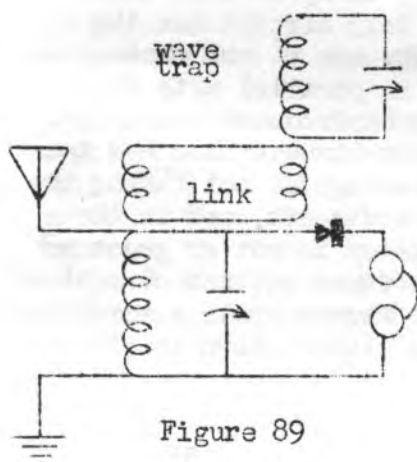

Figure 89

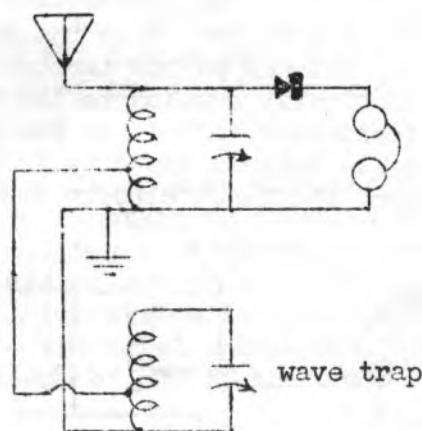

Figure 90

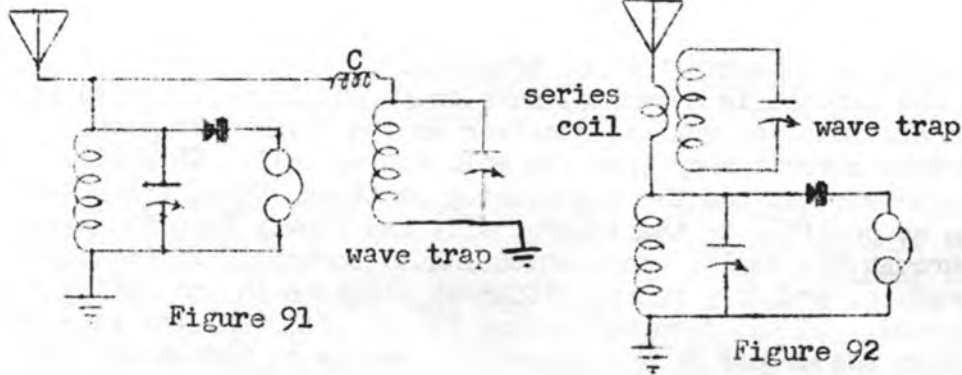

Figure 89 illustrates link coupling. One end of the link may be made by winding 5 turns of insulated wire directly on top of the turns on the wave trap coil, thus providing close coupling of the link to the trap coil. Then the coupling to the set can be varied by positioning the other end of the link (which is another 5 turn coil.) with respect to the antenna tuning coil.

Figure 90 operates in a similar manner. A tap may be made 5 turns from the grounded end of the wave trap coil, then the coupling to the receiver may be varied by moving the tap on the antenna coil.

Figure 91 employs capacitive coupling. The coupling may be varied by changing the amount of capacity "C". A small variable condenser (3 to 30 mmfd.) may be used, or a few twists of insulated wire may be employed. In the latter case, the capacity may be varied by twisting and untwisting the two wires.

Figure 92 uses a 3 to 5 turn coil in series with the antenna to couple energy to the wave trap circuit. The amount of coupling is varied by changing the position of the series coil with respect to the wave trap coil.

Once the wave trap is set, it will remove the station to which it is tuned; therefore, if we should ever desire to listen to that station we must either detune the wave trap, move it away from the main tuning coil (decrease the coupling), or the circuit may be opened by placing a switch in the trap circuit as shown in Figure 93.



Figure 93

Additional Antenna Coupling Circuits

Another method of coupling the antenna to the tuning coil is shown in Figure 94. Here the antenna circuit is not tuned; the energy collected by the antenna passes through a few turns (3 to 15) of wire which are electromagnetically coupled to the tuning coil. This circuit has the advantage of decreasing the effect the antenna capacity has on the tuning; that is, since the antenna capacity is not connected in parallel with the tuning condenser, the tuned circuit has a wider range of frequency coverage.

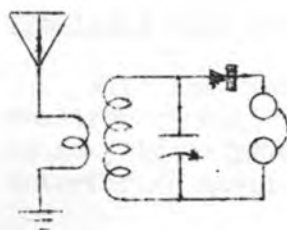

Figure 94

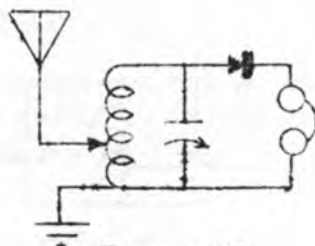
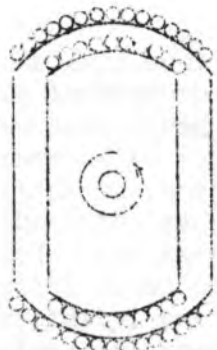

Figure 95

But this circuit also has the disadvantage of not tuning the antenna circuit, and so the efficiency is not as great as when a tuned antenna circuit is used. Figure 95 is a variation of the method shown in Figure 94.

Before leaving the antenna tuning system, we shall discuss one more type of coil which may be used in the antenna circuit.

The Variometer



(cross-sectional view)
Figure 96

The variometer is an inductor whose inductance is changed by the interaction of the fields of two coils placed one inside the other as shown in Figure 96. To understand the operation of the variometer, first consider two separated inductors which are connected in series as shown in Figure 97. The total inductance of the two coils is equal to the sum of the individual inductances. If the two coils are moved into close proximity to each other, the magnetic fields of the coils combine to form an even stronger field; and the total inductance is greater than the sum of the individual inductances (Figure 98). The closer the coupling between the coils, the greater will be the new inductance value.

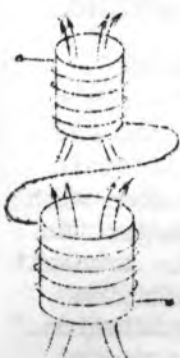

Figure 97

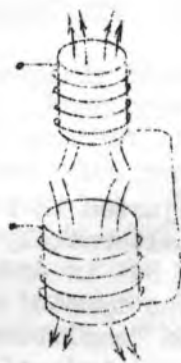

Figure 99

If the coils are again separated and the connections of one of the coils are reversed (or one of the coils is rotated 180°) the total inductance is still equal to the sum of the individual inductances (Figure 99); but now if the coils are coupled together, the two fields will oppose each other and weaken the total magnetic field. The total inductance will then be less than the value of either coil alone (Figure 100).

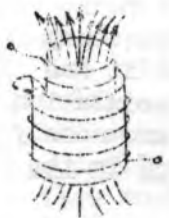

Figure 98



Figure 100

Referring again to Figure 96, the center coil is moveable and may be rotated by turning the center shaft; so the position of the coil and the resulting inductance can be varied. When the two coils are at right angles to each other, the magnetic fields are at right angles, and since the fields are neither aiding nor opposing each other, the condition is the same as when the coils were separated in Figures 97 & 99. Then as the shaft is rotated, the field of the center coil either aids or opposes the field of the stationary coil, giving a

wide variation in inductance value.

A variometer may be made from two coils of such diameter that one coil will slide into the center of the other. Instead of rotating the moveable coil 180° , the field of the moveable coil may be reversed by means of a switch. When the switch is in one position, moving the coils together will increase the total inductance; and when the switch is in the other position, moving the coils together will decrease the total inductance. The switch, of course, merely reverses the connections of one of the coils.

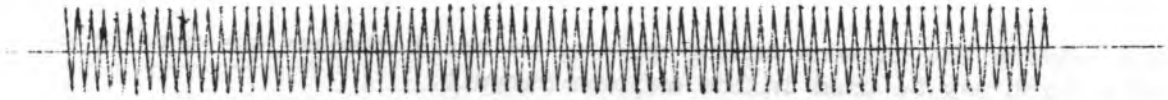

Figure 101



Figure 102

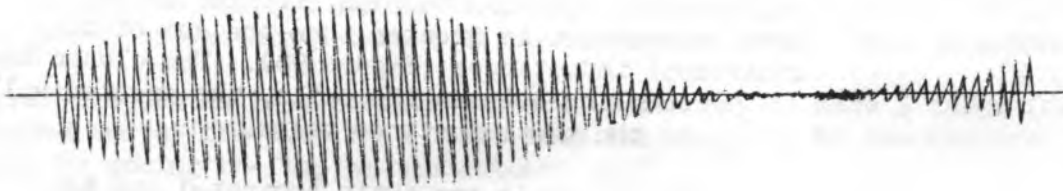

Figure 103

Amplitude Modulation

We have seen that when an antenna circuit is adjusted to resonance with a broadcasting station, the signal from the station alternately charges the "antenna condenser" from one polarity to the other. But in order to transmit intelligence, the radio signal must be modulated. The type of modulation used by low-frequency broadcasting stations is called "amplitude modulation." Amplitude modulation is the process of varying the amplitude of the radio signal (or the power output of the station) in accordance with the frequency of the speech or music being transmitted. Figure 101 illustrates a radio frequency signal before modulation; Figure 102 illustrates a low frequency audio sound wave; and Figure 103 illustrates the radio signal after it has been modulated with the sound wave. How the process of amplitude modulation is accomplished at the radio station does not concern us here; we are mainly interested in the fact that the radio signal does carry intelligence in the form of amplitude variations which we wish to utilize.

The Detector

If a headset were connected across a tuned circuit which is receiving energy from a radio station, as in Figure 104, current would first flow in one direction through the headset and then in the opposite direction as the polarity of the condenser changes. Assuming the station being received is WJR, which operates on 760 Kc., the current flow through the headset would change its direction of flow 760,000 times per second. The diaphragms of the headset would be unable to vibrate at this frequency; and even if they could

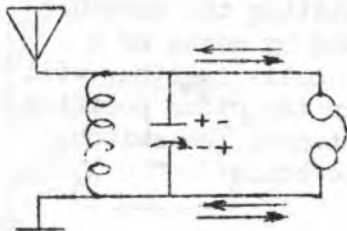

Figure 104

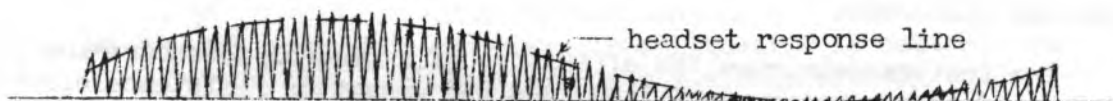

Figure 105

our ears would be unable to hear such a high-frequency sound. In order for us to hear the intelligence that the broadcasting station is transmitting, we must first "rectify" the signal, that is, change it from an alternating current to a direct current. Figure 105 illustrates a radio signal after it passes through a rectifier, or detector. All the current pulses are above the zero axis because the rectifier did not pass the half of the cycle below the axis. The current now flows in only one direction. The headset still could not respond to the individual pulses of current because of their rapidity, but it can respond to an average value as shown by the dotted line along the crest of the peaks in Figure 105. Comparing the headset response line with the original modulating signal (Figure 102), we may see that the headset diaphragms will vibrate at the same frequency as the modulating signal, and that this sound will be reproduced at the receiving end.

Mineral Rectifiers. or Crystals

When properly contacted, certain minerals have the property of acting as a rectifier. When galena (lead sulphide) is touched lightly with a thin wire, the point of contact offers a high resistance to current flowing in one direction and a low resistance to current flowing in the opposite direction through the crystal. This means that a larger current will flow in one direction than it will in the other, and a form of rectification will take place. Although this process of rectification is not perfect, it is sufficiently complete to allow us to use this mineral as a detector in our crystal receivers. Figure 106 illustrates an adjustable, open type galena detector.

Figure 107 is a characteristics curve of a galena crystal. It shows graphically the relative amount of current that will flow through the crystal for different values of input voltage. Illustrated is a typical radio signal voltage, and the resulting current flow. The small peaks of current below the zero current axis indicates that rectification is not complete, and that a small amount of "reverse current" flow is taking place. This reverse current flow must be subtracted from the current peaks above the zero axis if we wish to know the exact amount of effective rectified current obtained.

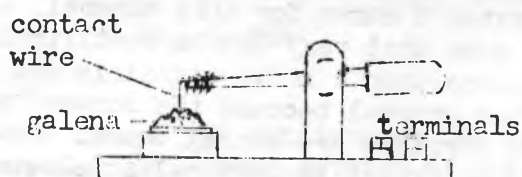

Figure 106

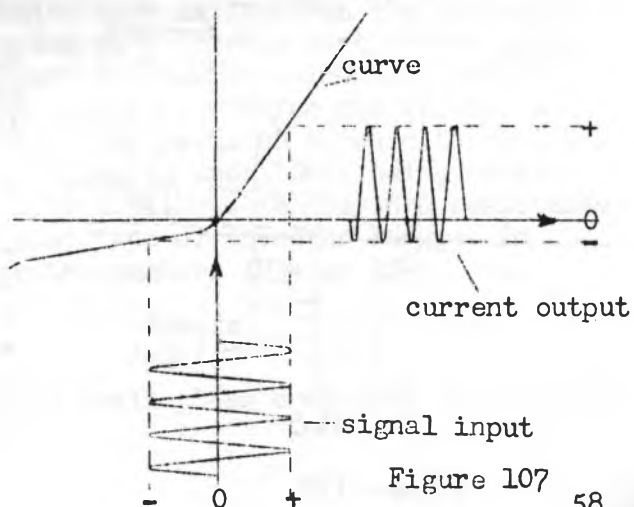

Figure 107

Detector Efficiency

Two factors determine the efficiency of a mineral detector: the ratio of forward to reverse current flow, and the amount of resistance offered to the forward current flow by the crystal. The current ratio is important since the effective rectified current is equal to the forward current minus the reverse current; and the forward-current resistance is important because it determines how much loss the current will suffer in passing through the crystal. Both of these values vary with different crystals, and also with different points of contact on the same crystal's surface. With an open type crystal detector as shown in Figure 106, the contact wire, or catwhisker, is moved from place to place on the crystal until the best spot is found--the spot which gives the greatest signal volume in the headset.

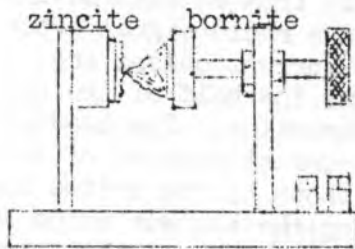

Figure 108

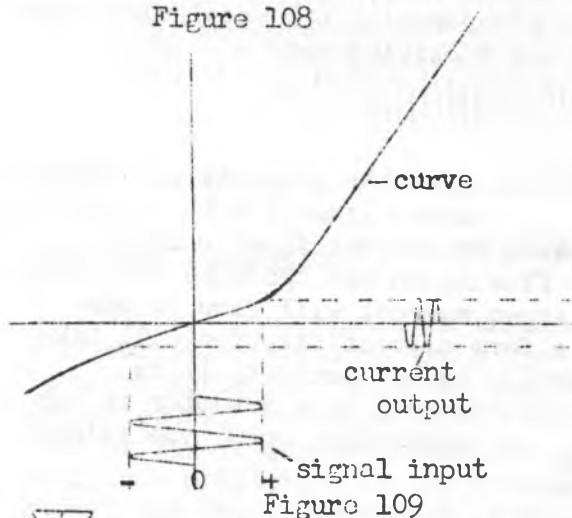

Figure 109

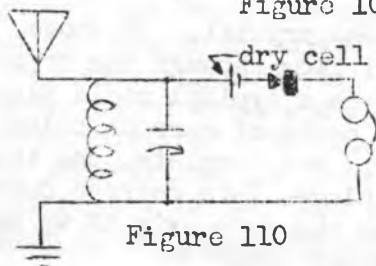

Figure 110

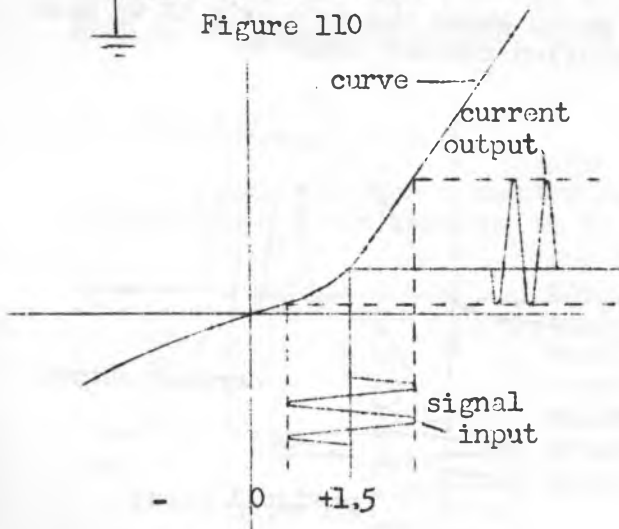

Figure 111

Types of Detectors

Many minerals have been employed as crystal detectors. Silicon, molybdenite, pyrites, carborundum, and combinations of minerals such as antimony and silicon, zincite and bornite (one mineral pressing against the other as illustrated in Figure 108) have been used with success. Actually the characteristic curves of all these crystals is much the same as the one shown in Figure 107, with the exception of carborundum. The most sensitive contact point of a given mineral may not always be found on the crystal's exposed surface, which makes one crystal appear more sensitive than another. Chipping away an unsensitive portion of a crystal may expose a more sensitive area. With regard to the forward-current resistance of these minerals, galena and molybdenite have the lowest. Galena is probably the best all around adjustable detector of the natural mineral group.

When speaking of the characteristic curves of these minerals, we made an exception of carborundum. Figure 109 illustrates a curve for this mineral. It can be seen that very little rectification takes place when a radio signal is fed into this crystal because the forward and reverse currents are nearly equal. However if we "bias" the mineral by placing a dry cell in series with it (Figure 110) there will be the cell's voltage in series with the incoming signal which will shift the signal voltage to a position shown in Figure 111. The signal is now working on

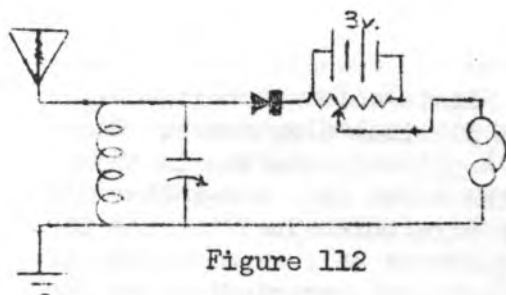

Figure 112

increased. In practice, the bias voltage is varied until the loudest signal is obtained. The battery voltage in no way amplifies the signal, and even with the voltage properly adjusted the carborundum detector is not as sensitive as the galena detector. The forward-current resistance of the carborundum detector is higher than that of other mineral detectors. As a result, when it is connected across a tuned circuit as in Figure 112, it does not load the circuit as much as the

the sharper bend of the curve, and the resulting rectification is better. For this reason a variable battery arrangement is always used with a carborundum detector. Figure 112 illustrates a typical carborundum detector circuit. As the slider on the 5000 ohm variable resistance is moved to the right, the voltage in series with the detector is

increased. In practice, the bias voltage is varied until the loudest signal is obtained. The battery voltage in no way amplifies the signal, and even with the voltage properly adjusted the carborundum detector is not as sensitive as the galena detector. The forward-current resistance of the carborundum detector is higher than that of other mineral detectors. As a result, when it is connected across a tuned circuit as in Figure 112, it does not load the circuit as much as the galena crystal because of its high resistance; this keeps the Q of the circuit high and provides better selectivity. However, the selectivity is gained at the expense of headset volume which is undesirable; it is similar to connecting a resistor in series with a galena detector to decrease the amount of current drawn by the headset. It is the most wasteful method of obtaining selectivity. Always use the most sensitive detector possible, for selectivity can always be obtained by the more efficient methods previously described.

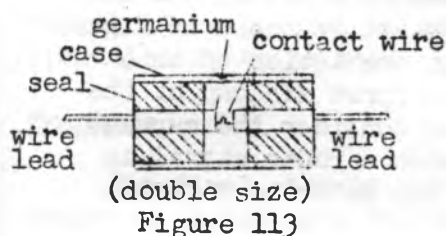

Figure 113

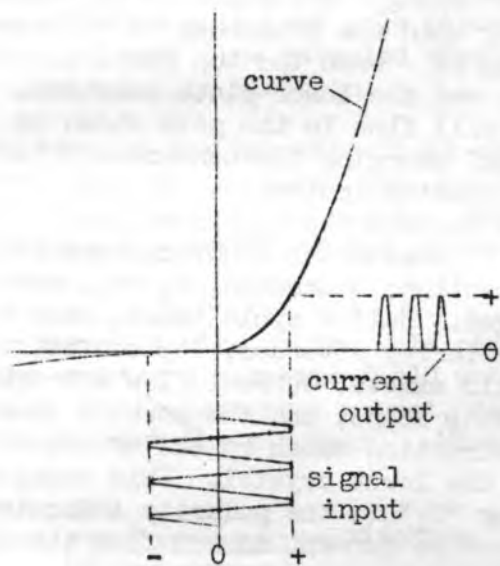

Figure 114

The Germanium Diode

The need for a detector which is superior to those described above became evident during World War II. A considerable amount of research was devoted to the problem, and the answer was found in the Germanium Diode. It consists of a piece of germanium to which a small amount of impurities have been added, and a fine piece of tungsten contact wire. After a sensitive spot is found on the crystal, it is sealed in a plastic cartridge as shown in Figure 113. Figure 114 illustrates a characteristic curve for the germanium crystal. The ratio of forward to reverse current flow is excellent, being better than 1000 to 1, and the forward resistance

is the lowest yet obtainable. It is the best type of detector for use in a crystal set. This crystal is sold under the numbers 1N34 or 1N48.

The Electrolytic Detector

The electrolytic detector consists of a small glass container filled with

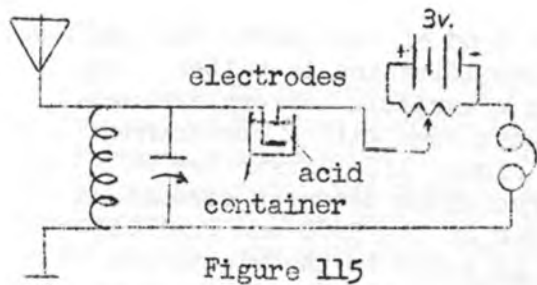

Figure 115

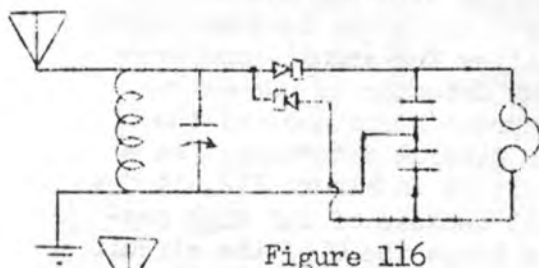

Figure 116

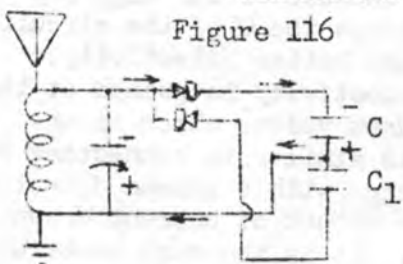

Figure 117

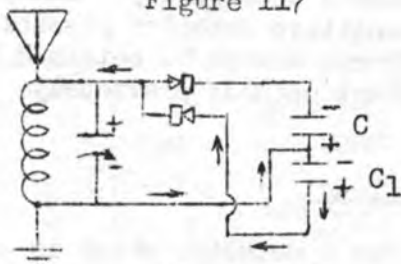

Figure 118

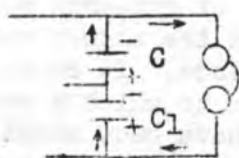

Figure 119

sulphuric or nitric acid which is contacted by two platinum electrodes. One electrode is completely emersed in the acid, while the other is a one-thousandth inch diameter wire which just touches the acid (the adjustment of this electrode is critical). A battery connected across the electrodes as in Figure 115 causes a thin film of bubbles to form around the positive wire, which allows current to pass more easily in one direction than the other. This detector has no advantage over the germanium or galena detectors.

The Voltage Doubler Detector

A voltage-doubler detector which employs two crystals is shown in Figure 116. To explain the action of this detector, let us first disconnect the headset and then consider the current paths present when a radio signal is applied across the detector circuit.

When a signal is received, the tuning condenser changes its polarity at a rate depending upon the frequency of the received signal. When the top plate is negative and the lower plate positive, current will flow in the path shown in Figure 117 charging the condenser "C" to the polarity indicated. Current will not flow through the bottom crystal because it does not conduct current in that direction; therefore, C_1 will not be charged. Half a cycle later, when the signal polarity reverses, the condition of Figure 118 exists. Current flow through the top crystal stops, and the current flows in the direction shown by the arrows through the lower crystal. This charges condenser " C_1 " to the polarity indicated.

Meanwhile, condenser "C" cannot discharge because current cannot flow through the top crystal in the direction required to discharge it.

When the headset is connected across both condensers (Figure 119), it may be seen that the voltages of the two condensers add together to force through the headset a current greater than would be possible if one crystal was used alone. With the conventional single crystal we were using only one half the received signal to drive the headset, but with this circuit we are utilizing both halves of the cycle. One half charges condenser "C", and the other half charges condenser " C_1 "; then the two voltages are added together to drive the headset.

In actual practice, with the headphones connected across the circuit

there is a continuous discharging of the condensers as shown in Figure 119, and when the signal strength is weak the condenser C discharges its feeble amount of energy before condenser C_1 can become fully charged. Likewise, the charge of condenser C_1 leaks off while condenser C is charging, so that the voltages of the two condensers are not present at the same time to add together. The result is that there is no increase in volume with weak signal inputs. However, on strong signals each half cycle charges the condensers to the point that even though the leakage current through the headset still exists, the condensers retain much of their charge during the interval when the other condenser is charging. Thus the voltages can add together and produce a louder signal.

To sum up, in practice, no increase in volume will be noticed on weak stations, but there will be a noticeable increase in volume on any station that can force a large charge into the condensers. Most local stations can meet this requirement if a reasonable length of antenna is used. Any type of crystals may be used, but the fixed type is preferable. It must be remembered that the polarity of the crystals is important in this circuit, for when one crystal is conducting, the other must not conduct if proper operation is to be had.

Headsets

The final step in the process of receiving, that of changing the detected signal into sound waves, is accomplished by the headset. A cross-sectional view of a conventional magnetic headset unit is illustrated in Figure 120. It consists of a strong permanent magnet to the ends of which are attached soft iron pole pieces. Wound around the pole pieces are many turns of very fine enameled wire; placed very near to the pole pieces is a thin metallic diaphragm.

The path of the magnetic field of the permanent magnet is from the north pole, through the north pole piece, diaphragm, and south pole piece back to the south pole of the magnet. The magnetic field pulls the diaphragm so that the normal position of the diaphragm is slightly bent in toward the pole pieces.

The turns of wire on the pole pieces are so wound that a current flow through them creates a magnetic field which either aids or opposes the field of the field of the permanent magnet, depending upon the direction of the current flow through the windings. When the magnetic fields aid each other, the

diaphragm is pulled nearer to the pole pieces because of the stronger magnetic field; and when the field is weak because the fields are opposing each other, the diaphragm springs back to a position further from the pole pieces than it was while under the influence of the permanent magnet alone.

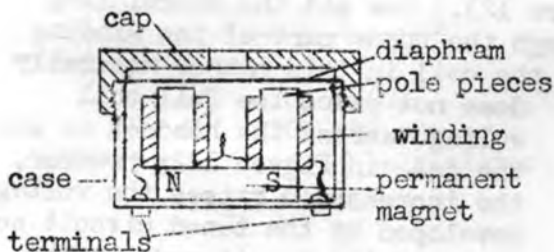

(cross-sectional view)

Figure 120

As the varying signal current passes through the headset windings, the diaphragms vibrate in accordance with the frequency and amplitude of the signal current, and sound waves are produced.

The Crystal Headset

The reproducing mechanism of a crystal headset unit contains a piezo-electric crystal. When electrodes are fastened to a piece of piezo-electric crystal, and a voltage is applied across the electrodes, the crystal will distort from its natural shape in accordance with the amplitude and polarity of the applied voltage. In this manner the crystal vibrates when a signal voltage is applied to the electrodes. The construction of a typical crystal headset unit is illustrated in Figure 121.

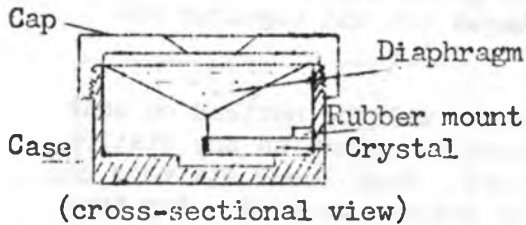

Figure 121

Three corners of a square crystal blank are clamped between rubber mounting pads, and a metal or paper diaphragm of a conical shape is fastened to the remaining corner. As the applied signal voltage causes the crystal to vibrate, the attached diaphragm also vibrates and produces sound waves in the same manner as did the magnetic headset diaphragms.

The crystal headset is far superior to the magnetic headset in both sensitivity and frequency response, or fidelity. The magnetic headset operates efficiently over only a narrow range of frequencies--and even those frequencies frequently suffer distortion when reproduced. But the crystal headset has a very uniform frequency response up to approximately 10,000 cycles per second, and the distortion is far below that of the magnetic headset, being somewhat less than 5%.

The input impedance of the crystal headset is about 5 times that of the common 2000 ohm magnetic headsets, which means a tuned circuit is not as heavily loaded down when crystal headsets are used. A higher Q and increased selectivity results. In general, if a crystal headset is substituted for the ordinary magnetic headset, a marked increase in volume, selectivity, and fidelity will be immediately noticed. After listening to a crystal headset, few will ever wish to return to the muddy sounding magnetic type. Crystal headsets cost about 3 times the price of magnetic headsets, but it is money well spent. The serious crystal fan should not be without them.

Impedance Matching

When a load is connected across a tuned circuit as in Figure 122, current is diverted and the Q of the circuit is lowered. Frequently, with high Q circuits, it is possible to realize a gain in selectivity by connecting the load to a tap on the coil as shown in Figure 123. Now all the circulating current in the resonant circuit flows through the upper part of the winding which results in a higher Q. Tapping down the coil in this manner naturally

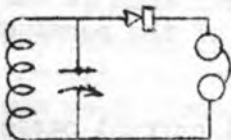

Figure 122

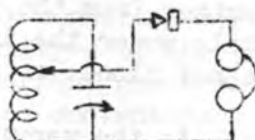

Figure 123

does not place the full coil voltage across the headset as was the case in Figure 122; however, the increased Q raises the voltage developed by the tuned circuit so that, if the tap is made at the proper point, the voltage applied to the headset will be the same in either case. The higher Q resulting from the use of the circuit

of Figure 123 is desirable because of the increase in selectivity. The position of the coil tap varies with the Q of the coil and the impedance of the headset. In practice, it is best to find the proper tap point by experimentation. The tap point should be lowered, turn by turn, until a decrease in volume is noticed, then move the tap back a turn or two so that no loss in volume can be detected. If the coil has a reasonably high Q to begin with, a noticeable increase in selectivity will be obtained.

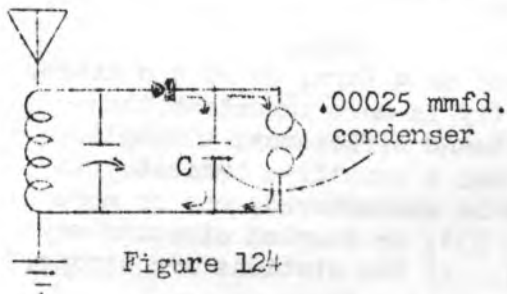

Figure 124

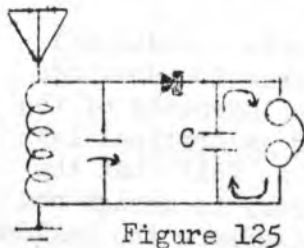

Figure 125

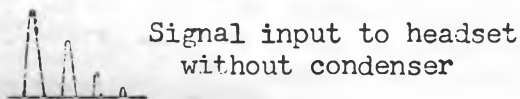

Figure 126

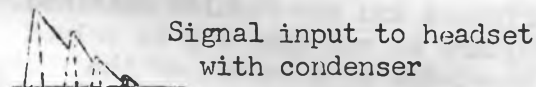
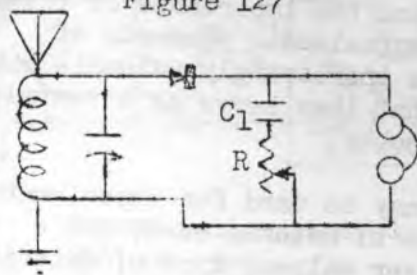

Figure 127



$C_1 = .01$ mmfd.
 $R = 100,000$ ohm
 variable resistor.

Figure 128

The Headset Condenser

Referring to Figure 105, we recall that the detected signal input to the headset is composed of a series of direct current pulses of varying amplitude. If a condenser is placed across the input circuit to the headset as shown in Figure 124, when the signal voltage is applied across the circuit, part of the signal pulse drives the headset and part of it charges condenser "C" to the peak value of the pulse, as shown by the arrows of Figure 124. Then when the voltage of the pulse decreases below its peak value, the condenser discharges through the headset as shown by the arrows of Figure 125. Thus with a condenser there is a more steady delivery of current to the headset; compare Figure 126 and Figure 127. In actual practice, the capacity existing between the wires of the headset performs the function of the headset condenser, and adding additional capacity as in Figure 124 will produce no noticeable effect, unless the condenser is quite large. In the latter case, the high audio frequencies will be reduced in volume and the bass notes will predominate in the headset. This is because the capacitive reactance of a condenser varies inversely with frequency (ref. page 8), and at high audio frequencies a large condenser may offer less impedance to the signal current than the headset does. The condenser then acts as a low-impedance parallel path which will, in effect, bypass the higher frequencies past the headset to ground.

This principle is employed in many tone-control circuits. A variable tone control circuit for a crystal set is shown in Figure 128.

Receiver Design

The circuit elements involved in crystal receiver operation have now been covered, and we are ready to design our own circuit. In designing our receiver we must first decide what our minimum demands from the receiver will be; what extra features, if any, we wish to incorporate; and what amount of money we desire to invest.

For example, if the receiver is to be used on a farm, or at a cottage, several miles from any station, then sensitivity is more important than selectivity. Emphasis should be placed on antenna efficiency, a simple high Q tuned circuit, an efficient detector, and a sensitive headset. In the city where more interference is likely to be encountered, one or more absorption wave traps may be added (ref. page 53), or coupled circuits may be used to improve selectivity (ref. page 51). If the stations are strong, the voltage-doubler detector may be used to good advantage.

The mechanical variations in the construction of chassis layouts and tuning controls are almost without number. Detailed construction drawings will not be given, leaving this phase of the design to the ingenuity of the builder. Greater enjoyment will always be had by building an original layout than by merely following in the steps of another. It is felt that the reader now has a sufficient grasp of the principles necessary to design and build his own set, indeed, the purpose of this book is to advance the builder from a "direction-follower" to a designer. If the previously covered theory has been carefully digested, have no fear that your design will not be at least as good as any design you may see elsewhere; in fact, it will probably be better for your particular location and financial status.

The best method of becoming familiar with crystal receivers is by experimentation. To secure maximum benefits from your experiments it is necessary to keep a record of the tests performed and the results obtained. The mystery surrounding an unexplainable failure at one time may be solved at a later date in the light of increased knowledge if a record of the failure is preserved. Experimental data is invaluable to anyone who wishes to increase his proficiency in the art of radio, and the importance of the methodical recording of this data cannot be overemphasized. Records of experiments (whether successes or failures) become increasingly valuable with the passing of time if for no other reason than that they serve as a reminder of the happy hours devoted to a most interesting hobby.

The reverse side of the sheets of this book may be used for experimental recording space. Record such information as, type of antenna used, the circuit diagram, type of coils being used, condenser values, type of detector and earphones, list of stations received and their location, etc.

Any of the circuits shown in the illustrations of this book will work well as a schematic diagram. Simply refer to the coil design charts for the tuned circuit data. The coil design charts give the designer a wide latitude in the selection of his tuned circuit components. Almost any spare parts and scrap wire can be worked into an efficient tuner if the data given in this book is carefully followed.

But the first step toward success is to make a start. Why not right now?!

The Transistor

The conventional crystal detectors previously described rectify the alternating-current radio signal, but they do not amplify it. However, it has been found that if three contact wires are placed on a special type of

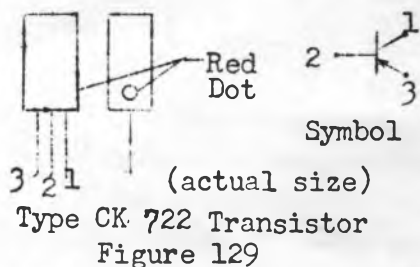

germanium crystal, with signal and battery voltages properly applied, amplification is possible. Such a device is called a Transistor; an example of a readily available transistor is illustrated in Figure 129.

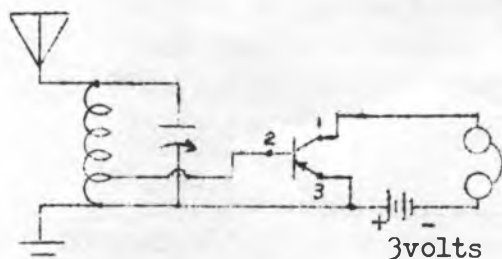

A practical transistor circuit is given in Figure 130. Because of the low input impedance of the transistor, the Q of the coil would be excessively lowered if the transistor were connected directly across the coil, so a tapped coil is used. The adjustment of the tap should be made in the same manner as described under the paragraph on impedance matching (ref. page 63). Because of its amplification properties, the transistor will give greater volume than the conventional crystal. When properly adjusted the volume should be about twice as loud.

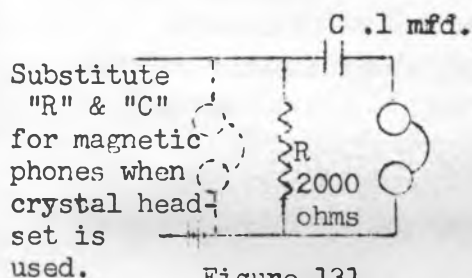

Because battery current should never be allowed to pass through crystal headsets, the resistor "R" and blocking condenser "C" of Figure 131 must be used when crystal headsets are used. The battery current passing through the resistor in series with the transistor develops the amplified signal voltage across it, then the condenser passes the a.c. signal current while at the same time blocking the direct current of the battery through the headset.

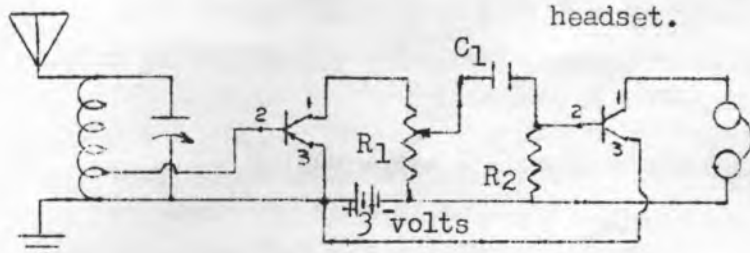

$R_1 = 10,000$ volume control
 $R_2 = 250,000$ ohms
 $C_1 = .1$ mfd.

local stations if a long antenna is used.

Transistors have a very long life, estimated to be from 70,000 to 100,000 hours. The battery drain is very small.

If two 1.5 volt penlight cells are used in the circuit of Figure 130, the expected battery life should be about 200 hours; if they are used in the circuit of Figure 132, about 100 hours. When larger type flashlight cells or #6 dry cells are used, the expected life span will be the shelf life of the battery.

Color Code

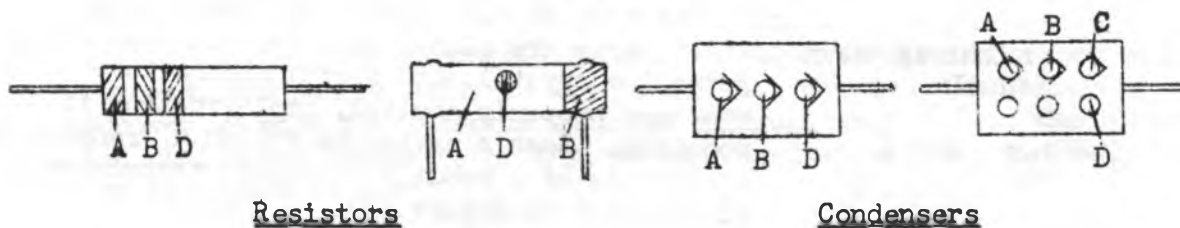

<u>Letter</u>	<u>Meaning</u>	<u>Color</u>	<u>Figure or Multiplier</u>	
A	First Figure	Black	0	1
B	Second Figure	Brown	1	10
C	Third Figure (if used)	Red	2	100
D	Multiplier	Orange	3	1,000
		Yellow	4	10,000
		Green	5	100,000
		Blue	6	1,000,000
		Violet	7	10,000,000
		Gray	8	100,000,000
		White	9	1,000,000,000

Examples:

Question: What is the resistance of a resistor having the following colors:
"A"-Red, "B"-Green, "D"-Yellow?

Answer: Resistance = AB multiplied by D = 25 X 10,000 = 250,000 ohms.

Question: What is the resistance of a resistor having the following colors:
"A"-Brown, "B"-Black, "D"-Black?

Answer: Resistance = AB multiplied by D = 10 X 1 = 10 ohms.

Question: What is the resistance of a resistor having the following colors:
"A"- Black, "B"-Brown, "D"- Black?

Answer: Resistance = AB multiplied by D = 01 X 1 = 1 ohm.

Question: What is the capacity of a condenser having the following colors:
"A"-Red, "B"-Gray, "D"-Brown?

Answer: Capacity = AB multiplied by D = 28 X 10 = 280 mmfd.

Question: What is the capacity of a condenser having the following colors:
"A"-Brown, "B"-Black, "C"-Black, "D"-Brown?

Answer: Capacity = ABC Multiplied by D = 100 X 10 = 1000 mmfd.

Question: What is the capacity of a condenser having the following colors:
"A"-Black, "B"-Orange, "C"-Orange, "D"-Red?

Answer: Capacity = ABC multiplied by D = 033 X 100 = 3300 mmfd.

Anyone can build and enjoy crystal receivers. A few minutes' work brings gratifying results even to the veriest beginner. But as with all hobbies, the novice stage passes, leaving a more critical ear and cultivated taste. Although this book will serve the beginner well, it is primarily dedicated to the latter group who have reached the inevitable conclusion that superior results cannot be obtained without a more extended knowledge of the art. Here is a practical and theoretical presentation. It is a book the beginner can comfortably "grow into."

To achieve optimum results, a crystal receiver must be a carefully designed and individual piece of apparatus. A set that produces satisfactory results on a Minidoka farm may not live up to expectations in a New York apartment house because of the widely different operating conditions. Antenna erection space, distance and direction from radio stations, the operating power of these stations, interference conditions, and other similar factors prescribe exacting standards which our receiver must meet if it is to afford us a full measure of enjoyment. A properly made crystal receiver will provide years of uninterrupted entertainment. The initial investment is low; the maintenance cost, negligible.

In order to design the best receiving equipment for our particular location, let us first briefly review some of the pertinent phases of electronics to provide ourselves with the knowledge required to make intelligent and profitable decisions. A knowledge of fundamental principles is of special importance to the experimenter. It will save hours of fruitless labor; and more important, it will allow you to interpret and explain the results of your experiments. Knowledge and skill ensure success.