

THE
MANUAL
OF
MODERN
RADIO

J. SCOTT-TAGGART

THE MANUAL
OF
MODERN RADIO



JOHN SCOTT-TAGGART



McGraw-Hill Press



BROADCASTING HOUSE, LONDON

Frontispiece

THE MANUAL OF MODERN RADIO

BY

JOHN SCOTT-TAGGART

OF GRAY'S INN, BARRISTER-AT-LAW

FELLOW OF THE INSTITUTE OF PHYSICS

ASSOCIATE MEMBER OF THE INSTITUTION OF

ELECTRICAL ENGINEERS

MEMBRE de la SOCIÉTÉ FRANÇAISE des ELECTRICIENS

etc. etc.

With 541 Diagrams & Forty Plates

LONDON

THE AMALGAMATED PRESS LTD.

THE FLEETWAY HOUSE, FARRINGDON ST. E.C.4

1933

CONTENTS

CHAPTER	PAGE
1. A SIMPLE INTRODUCTION	7
2. AERIAL CIRCUITS	29
3. HOW THE VALVE WORKS	56
4. THE THREE-ELECTRODE VALVE	62
5. HIGH-FREQUENCY AMPLIFICATION	71
6. LOW-FREQUENCY AMPLIFICATION	82
7. MULTI-STAGE L.F. AMPLIFIERS	87
8. REACTION	94
9. RECTIFIERS AND DETECTORS.. .. .	195
10. DECOUPLING, FILTERS AND SMOOTHING DEVICES	118
11. PARALLEL-FED L.F. TRANSFORMERS	143
12. THE SCREEN-GRID VALVE	146
13. THE VARIABLE-MU VALVE	152
14. THE PENTODE VALVE	156
15. PUSH-PULL AMPLIFICATION	164
16. QUIESCENT PUSH-PULL AMPLIFICATION	167
17. CLASS B AMPLIFICATION	170
18. NEUTRALISED CIRCUITS FOR H.F. AMPLIFICATION	174
19. MULTIPLE AMPLIFICATION WITH ONE VALVE	178
20. MULTIPLE REACTION CIRCUITS	181
21. MAINS UNITS AND THE RECTIFICATION OF A.C.	184
22. METAL RECTIFIERS	189
23. METAL RECTIFIERS AS DETECTORS	192
24. VOLUME CONTROL METHODS	195
25. TONE CONTROL SYSTEMS	209
26. PICK-UP CIRCUITS FOR GRAMOPHONES	222
27. AUTOMATIC VOLUME CONTROL	229
28. A.C. VALVES AND THEIR CIRCUITS	250
29. OPERATION OF D.C. MAINS VALVES	267
30. UNIVERSAL MAINS RECEIVERS	268
31. THE SUPERHETERODYNE	270
32. COMMERCIAL SUPERHETERODYNE RECEIVERS	298
33. ULTRA-SHORT-WAVE RECEPTION	304
34. IRON-CORE TUNING INDUCTANCES	306
35. THE METAL VALVE	308
36. ELECTROLYTIC CONDENSERS	310
REFERENCE SECTION	313 to 384

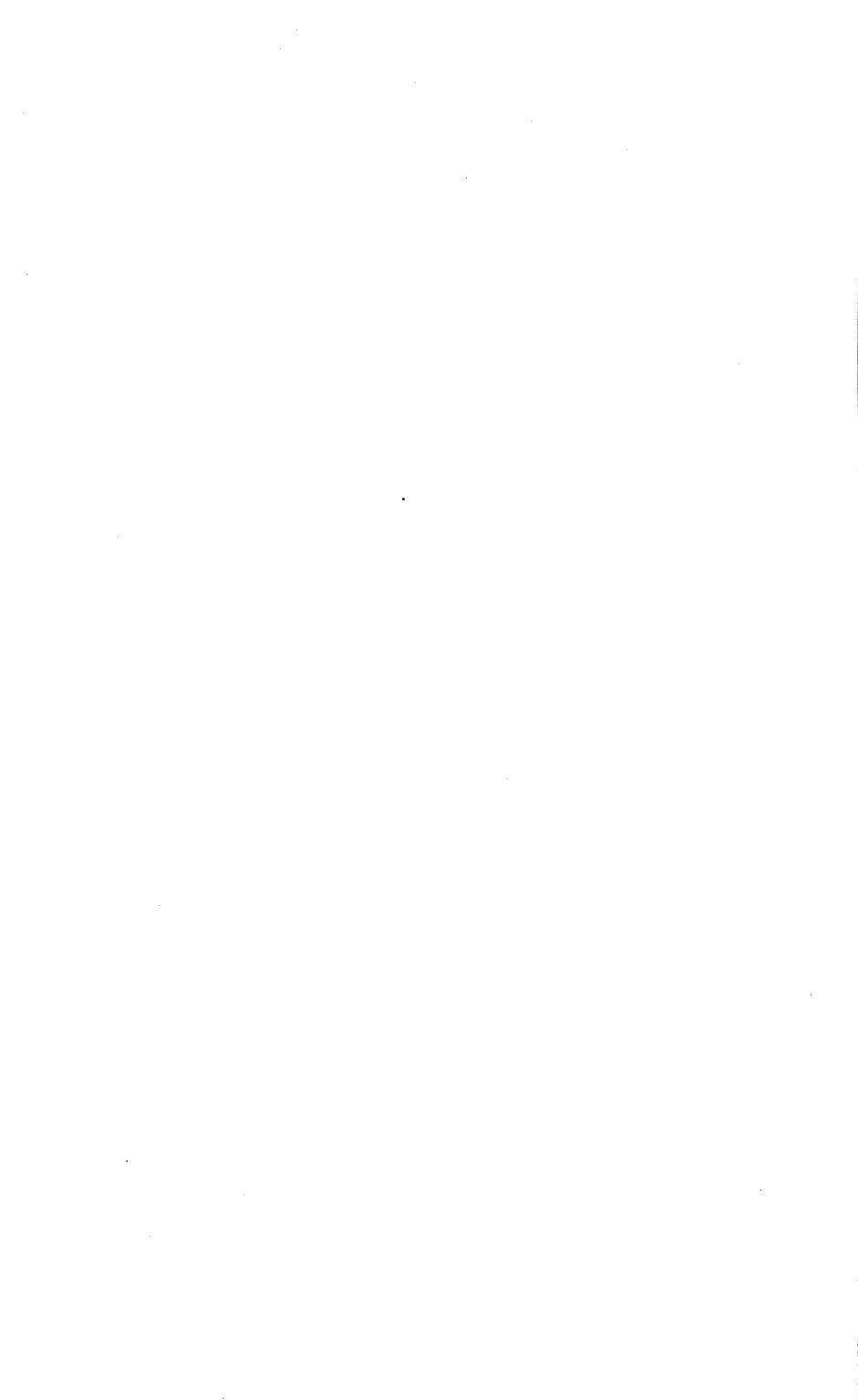

PREFACE

During the last two years, there has been a technical renaissance in radio technology. Progress has been swift, but the literature of the subject—at least, in so far as books are concerned—has lagged behind.

It was with the idea of repairing this omission that it was suggested that the records should be garnered in some permanent form. This volume is the result.

Between the stiff covers of this Manual—its size rather belies its name—will be found a summary, supplemented by criticism when it has been felt necessary, of the whole modern technique of broadcast reception.

No pains have been spared to include every development of recent date or which is credited with being of recent invention. Iron-cored high-frequency inductance coils, Pentagrid valves, electrolytic condensers, metal-rectifier detectors, high-frequency variable-mu pentodes, metal receiving valves, Class B and Q.P.P. amplification are all described. A very comprehensive account is given of the supersonic-heterodyne—the most popular type of commercially-made receiver, and several subjects such as automatic volume control are dealt with more fully, as far as the present writer can judge, than in any other work so far published. Modern progress is exemplified by typical circuits of up-to-date set designs.

The actual printing of this work has been greatly expedited so that the usual long delay between the writing of a book and its publication has been avoided. This has made it possible for the volume to include details of the technique of 1933-1934.

The usefulness of the book, however, does not rest solely on its record of modern radio technology. It is also a text-book on the thermionic valve and should place the reader in a position to understand readily any future developments or present analysis. The very many illustrations should contribute to its value to students.

It has been assumed, in order to widen the scope of the Manual, that the reader knows nothing whatever about radio or even of electricity. Only very occasionally, if he reads from cover to cover, will he have to leave a paragraph to a second reading. The style of writing, it is hoped, has avoided equally the Scylla of ponderousness and the Charybdis of looseness and inaccuracy.

The future of radio reception will be darkened by greater complexity, but the triumph of radio technology will be the more resplendent.

If this Manual of Modern Radio assists readers to understand or grapple with the problems of the present and the complexities of the future, it will have served its purpose.

JOHN SCOTT-TAGGART.

LONDON,

October, 1933.

CHAPTER 1

A SIMPLE INTRODUCTION

How and where to start is a great problem which faces any writer who sets out to explain wireless to the non-technical reader.

My own plan is to explain only sufficient of the basic scientific principles underlying radio to enable the average person to understand the practical operation of wireless receivers. It is my intention in this book to concentrate on the different kinds of circuits, how they may be built up, their advantages and disadvantages, their operation, and their practical embodiment in actual sets. Elementary electrical principles are required to give one an adequate understanding, but a course in physics, chemistry and mathematics is quite unnecessary. It is my intention to explain only sufficient "theory" to enable a reader to proceed to the next stage he has to consider.

There are several facts which no doubt every reader of this book will already know. One, for example, is that there are two kinds of stations in broadcasting. One of these is the transmitting station, which sends out a programme by wireless, and the other is the receiving station in the home, usually with its loudspeaker for providing the entertainment. What is going on at the transmitting station is not known to the layman, except that there is a band or a lecture or someone trying to make a joke. At the receiving end the person ignorant of wireless only knows that there are batteries, wires, an aerial, a loudspeaker and various things that one has to turn. Why these various things are required is unknown, and a few simple explanations are obviously called for.

A broadcast transmitting station sends out music and talks which are received by literally millions of broadcast receiving stations in private homes, but it is clear to everyone that the sound does not come direct, for the simple reason that it is not possible to hear a band, for example, for more than a few hundred yards or, at the most, a mile or thereabouts. Moreover, we know that sound

is greatly obstructed by buildings. The yodellers of Switzerland can communicate over a valley because of the absence of obstacles

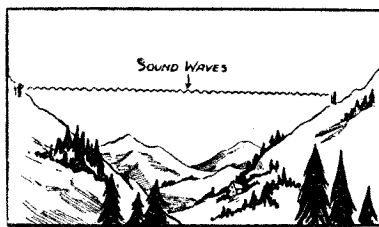

Fig 1—Sound waves will travel long distances if there is no obstruction

between (Fig. 1). If an ordinary person or even a yodeller desires to speak to another person a considerable distance away, he will find it necessary to use some other method than shouting. The telephone is a solution, but not the only one.

In the case of the telephone the sound does not actually travel along some electric wire, although it is possible to carry on a conversation over a distance of, say, one hundred yards by joining two cocoa-tins by a piece of string, one person speaking into his cocoa-tin and the other placing *his* tin over his ear (Fig. 2). This simple form of telephone involves the actual passage of sound along the string, the human voice causing the "transmitter" cocoa-tin to vibrate, these vibrations passing along the string and making the bottom of the other cocoa-tin vibrate in sympathy. These vibrations produce a sound which is identical in form but weaker than the original sound.

Ordinary talking through air is an excellent means of communicating with someone else; it suffers several disadvantages, however. It is not private in the first place; the only way to prevent others from hearing a conversation is to whisper in the ear of the "receiving" person. Even this has its disadvantages in that everyone else's hearing immediately improves. Moreover, one cannot speak except over short distances and even then one neither obtains privacy nor permits it to other people.

If someone is talking in a room, others may be disturbed even though they may not want to listen to what is being said. Ordinary speech, therefore, is broadcast; it is distributed in all directions, not perhaps equally loudly in all directions, but nevertheless in such a way as to make a considerable number of people sit up and take notice. Think how much more useful it would be if we could communicate our thoughts privately to people, and thus obtain secrecy in public at the same time not interfering with the pleasure of other people.

Private direct communication, however, also has its disadvantages. For example, at a public meeting it is very convenient that a single speaker on the platform can be heard by hundreds in the audience. This applies even more so where music is concerned. Broadcast entertainment occurs in every theatre and the medium

through which one hears sound is the air. If a political meeting were held in a hall in which all the air had been removed by a pump, all the people in it would require to have special breathing apparatus providing them with air or oxygen; but although everyone would be able to breathe and see, it would be impossible to hear any remarks by the speaker. Political meetings of this kind would probably do a great deal of good; but, unfortunately, it is too well recognised that air forms a vital link in the chain of communication between speaker and listener. Air is by no means the best conductor of sound, but it possesses one very valuable property and that is that it completely fills empty spaces.

Sound Waves.—How is it that speech can be communicated at all through air? The reason is that when a person talks the vibrations in his throat set up movements of air which are known as waves. When one speaks, the complicated sounds cause a movement of the air outside the mouth. The air, so to speak, is given a nudge. The air around the mouth nudges, in turn, the air in the immediate neighbourhood, and this zone of air passes on the nudge to the air beyond. This process takes a little time, and the nudges—or waves, as they are called—get weaker and weaker. When, however, the waves reach the ear of the person who is listening, the stretched ear-drum of that person is set vibrating by the air in its neighbourhood, i.e., by the sound waves, and the nerves communicating with the brain enable one to “hear.”

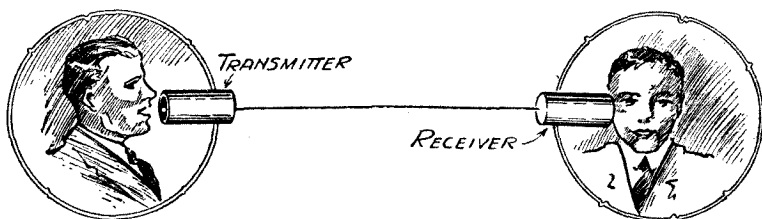

Fig. 2—Sound waves may be sent along a wire for comparatively short distances

Sound travels through air at the rate of about 1,000 ft. per second. It would, therefore, take about five seconds for a sound to reach someone a mile away. All the air in the neighbourhood would be disturbed, and any ear within a mile would be able to hear the sound, although “signals” would be stronger in the direction in which one was shouting.

The action of a sound wave is very similar to that of the ripple of water on a pond produced by dropping a stone in it. When the stone reaches the surface of the water it displaces it; in other words it gives it a nudge, and the displaced water rises up as a ridge which, in collapsing, pushes up another ridge or ripple. The

ripple, therefore, proceeds in an ever-widening circle until it reaches the banks of the pond. The point to notice is that although the ripple is moving outwards from the central point where the stone was dropped, the water in movement at the edge of the pond does not consist of the same particles as the water moved by the dropping of the stone. In other words, although the waves have travelled, the water forming the part of each wave remains more or less in the same place. When talking over a considerable distance it is not the actual human breath that travels but simply the variation in pressure of the air between speaker and listener. If the air between speaker and listener were removed it would not be possible to carry on a conversation because there would be no medium in which the waves could be formed. If, however, the cocoa-tin telephone is arranged between two people, a substitute for the air is obtained and the string or stretched wire, which would be used instead of string, will act as the connecting link, the sound vibrations being communicated through the particles of matter in the string or wire. Quite ordinary conversational tones will be carried by such a primitive telephone over much greater distances than the ordinary voice would carry, and there is the further advantage that the conversation is comparatively private, being confined to the wire or string.

The Telephone.—The electric telephone is, of course, a big advance on the simple cocoa-tin arrangement described. It enables one to communicate over huge distances with a considerable degree of secrecy and privacy; other people are not bothered by the conversation, especially if one is speaking from one of the quasi-Turkish bath cabinets so thoughtfully provided by the Post Office.

A great advantage of the electric telephone is that the speech may be communicated round corners; moreover, weather conditions do not affect the transmission of speech in this way.

How does the electric telephone work? It does so by virtue of an electrical current which is varied in strength by a person speaking into a mouthpiece—or *microphone*, as it is technically termed. The electric current travels along the wire, and at the far end is made to operate an earpiece, or telephone receiver. The microphone consists of a disc of material which is caused to vibrate by the sound waves of the speaker striking it (Fig. 3). The vibration of the microphone *diaphragm*, as the disc is called, produces currents of varying strength which pass along the wires and are made to cause another diaphragm, or disc, to vibrate at the receiving person's telephone. The vibrating of this second diaphragm sets up sound waves which are heard by the second person. Thus

the bulk of the work is done by an electric current which reproduces exactly the same variations as those existing in the sound waves.

The Ether.—When it is desired to communicate a concert or a speech, or other form of amusement or boredom, so that a very large number of people can simultaneously hear, the telephone is no use, because the currents are confined to the wire, and each person's receiver would have to be connected to this wire.

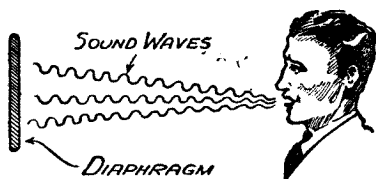

Fig. 3.—Sound waves impinging on a diaphragm which vibrates in sympathy

The expense of doing this would be very great, and the idea of us all having wires to all the broadcasting stations of Europe is too absurd to bear consideration. Fortunately, we have to our hand a medium which pervades everything and which is only too pleased to act as the link between the broadcasting station and a receiving station. This all-pervading medium is not air, but is known as the *ether*. This substance, if it may be so called, permits certain kinds of waves to be formed in it. It ought to be explained that the ether is a most mysterious substance; it cannot be seen and it cannot be weighed; it remains when all matter has been removed from a space and it pervades all matter just as air pervades a sponge when the latter is dry. We may feel more at home with the ether when we realise that it allows light to travel through it, and light is communicated by waves which travel at the rate of 186,000 miles per second. We see the sun because the sun sends light waves to us, the time taken by a wave to reach us being eight seconds. When we see something, it simply means that light waves are reaching our eyes from that object, and the light waves originally probably come either from the sun or from some artificial source of light, such as an electric lamp; the object we are looking at may itself actually radiate light, although this is not usually the case. An example of direct radiation is a coal fire or an electric lamp, whereas an ordinary object, such as a book, or this page before you, reflects light from some other source, and is thus seen.

Air is not necessary for the passage of light, and we can even see better through a vacuum. The space between the earth and the sun, for example, is, for the most part, a vacuum with nothing in it but ether, and it is this ether which allows the passage of light waves.

The sun, of course, can be seen by millions of people at the same time on the earth, but it is not as good a broadcaster as the B.B.C. A wireless transmitting station used for broadcast purposes sends out electric waves through the ether, but these waves really do go in all directions, and may be picked up by anyone within a

certain radius of the station whether he is on the ground, flying in an aeroplane, or below the surface of the ground (although in this latter case the waves are greatly weakened).

Wavelength.—Light waves and wireless waves differ from each other in their properties, and these properties are governed by the length of the wave. Wireless waves are usually from 200 yards long to 2,000 yards long. The length of the wave, it should be explained, is the distance between two equivalent points on two successive waves, e.g., the distance from the crest of one wave to the crest of the next. The length of waves forming light is about $\cdot 00002$ inch. The length of the waves varies with the colour of light; for example, red light has a longer wavelength than violet light, and these longer waves are not so readily interfered with by objects placed in their path. Red light, for example, is more effective for penetrating fog, which consists of particles of moisture which would act as a greater barrier to violet light. The waves usually used for wireless purposes are much more practical for that purpose than light waves since they are not so susceptible to interference by material objects. A thin piece of black paper will stop the passage of an extremely powerful light, but huge buildings often only have a very small effect on wireless waves, especially if there is very little metal in the building.

Why are wireless waves at all necessary? There are several reasons, but the first one that occurs to us is that ordinary sound will not travel the distance and go to the places where we want it. This is a good thing, because otherwise the world would be a very noisy and annoying place to live in, and people would be hearing all kinds of noises which they do not want to hear. Things are bad enough as they are.

It is very important to realise at the very beginning that wireless waves only act as *carriers* of the spoken word or of music. The sound waves produced by musical instruments or by the human larynx are made to vibrate a diaphragm of some kind in a microphone, and this microphone is then used to vary the strength of wireless waves which pass to the receiving station and are there made to cause vibrations in another diaphragm which may be attached to a telephone receiver or a loudspeaker.

Broadcasting, therefore, somewhat resembles the telephone in that electrical means are used. If an electric current could be used instead of wireless waves, it would no doubt be employed for wireless communication. Some of the earlier inventors who tried to communicate from point to point without wires arranged to have two metal plates inserted in the earth at a distance of, say, one mile; they passed an electric current between these plates, and

varied its strength by means of a microphone. The receiving station consisted of a similar set of plates inserted in the ground, and these picked up or tapped some of the transmitted currents. The varying current thus received was made to operate telephone receivers. A similar arrangement was used during the war for communicating between front-line trenches and the rear, but the scheme is not a practical one for general use. For one thing, the range is very strictly limited, whereas wireless broadcasting by means of ether waves can be carried on over ranges of as much as 2,000 miles or—if very short waves are used—over far greater distances.

How the Telephone Works.—A few general words about the operation of the ordinary household telephone would not be out of place at this stage. Fig. 4 shows a simple telephone circuit. There is no great need to go into the theory of electricity at this stage. In the first place, no one knows exactly what electricity is; but we do know what it *does*. A *direct* current of electricity is one which flows in a given direction all the time. Just as water requires some channel or pipe in which to flow if it is to be properly controlled, so in the case of electricity we use metal wires, usually of copper, and allow the current to flow through these. The copper wire is said to be a *conductor* of electricity, while substances which do not permit electricity to flow through them are called non-conductors, or *insulators*. Air, cloth, ebonite, cotton, silk, are all insulators.

The simplest form of electric telephone consists of a microphone, an electric battery for providing the electric current, line wires for connecting the transmitter to the receiver, and a telephone receiver or loudspeaker at the receiving station.

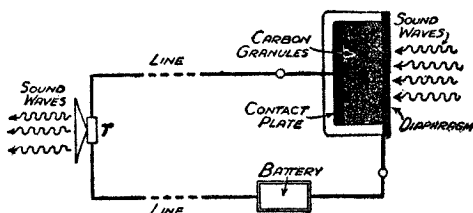

Fig. 4—The simplest electric telephone in which sound waves vary the microphone current

Fig. 4 shows the complete arrangement, the dotted lines representing the line wires through which the electric current flows. The whole arrangement is called a circuit because the electric current from the battery flows through the microphone along one of the line wires, through the telephone receiver T, and back through the other line wire. All the reader needs to know at this stage about the telephone *receiver* is that when a varying current passes through it, it alters the position of the diaphragm which is made to vibrate in accordance with the varying electric current. This vibration will produce

sound waves in the air. The usual *microphone* can be briefly described as a conductor whose conductivity can be varied by sound waves striking it. The result is that the current through the microphone varies in strength according to the nature of the sound waves.

The microphone in a very simple form consists of a kind of pill-box at the bottom of which is a carbon disc or plate to which a wire is connected. The box is then filled with carbon granules or pellets. The top of the box is covered with a thin carbon disc which is called the *diaphragm*. When the microphone is in circuit an electric current flows from the diaphragm through the carbon granules to the contact plate. When sound waves are directed towards the diaphragm the latter will vibrate and will compress the carbon granules. As these are momentarily squeezed closer together, they make firmer contact and a larger electric current flows through them. The word *resistance* is used to describe the opposition which a conductor offers to an electric current. Even the best conductors offer some resistance, and the microphone is really a variable resistance, the value of which is altered when sound waves cause the diaphragm to vibrate.

The current through the telephone receiver T will be a fluctuating one, the fluctuations occurring at the rate of several hundred per second, the exact *frequency* depending upon the note of music or the sound of a particular part of a word in speech.

Wireless Transmission.—In the case of a wireless transmitter and receiver the link between microphone and telephone receiver is the ether and the current from the microphone is changed into electric waves which will traverse the ether between transmitter and receiver. When the wireless waves reach the receiver they set up electric currents which are ultimately arranged to operate a telephone receiver or its modern equivalent—the loudspeaker.

Let us now consider the meaning of the term *alternating current*. It has already been explained that a direct current is one which

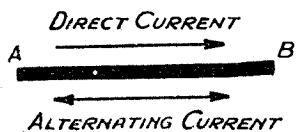

Fig. 5—Illustrating the difference between direct and alternating current in a wire

flows in a given direction; for example, in Fig. 5 a current which flows steadily from A to B along a wire is called a direct current (abbreviated to D.C.). Dynamos, accumulators, dry batteries, are all producers of direct current. If, however, the current—instead of flowing from A to B—first flows in this direction and then reverses and flows from B to A and continues to change direction regularly, this is *alternating current*. The complete flow and reverse flow is called a *cycle of current*, and the number of *cycles per second* is called the *frequency* of the alternating current. The electric mains supply to

most houses in this country consists of alternating current and the frequency is usually 50. This means that the current makes a complete back and forth journey fifty times per second. The flow in one direction is called the *positive half-cycle* while the flow in the opposite direction is called the *negative half-cycle*. Actually the currents due to an A.C. apparatus do not remain at full strength all the time, but wax and wane; for example, the current starts flowing from A to B at weak strength and gradually builds up to a maximum, after which it begins to fall off until it reaches zero. At this point the current reverses and starts flowing from B to A but only gradually at first, building up to a maximum and then falling off to zero again, when the process is repeated in the opposite direction. The current thus reaches a *peak* at each half-cycle.

An alternating current may be illustrated in the manner shown in Fig. 6, where a snake-like curve illustrates two complete cycles of alternating current. The portion of this current above the horizontal line AB represents the flow of current in a positive direction. The line AB really represents a time base, and at any given fraction of a second we can see what is happening to the current flowing through the wire. It will be noticed that I have drawn the alternating current to have a frequency of 50 per second; in other words, for a complete cycle AB to be completed takes $\frac{1}{50}$ th of a second, a half-cycle taking $\frac{1}{100}$ th of a second. The height or depth of the hump indicates the *amplitude* (i.e., strength) of current flowing.

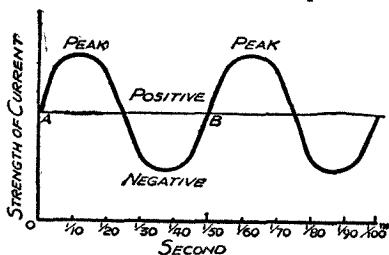

Fig. 6—Two complete cycles of alternating current. The inverted peaks are negative current

High-Frequency Oscillations.—Alternating currents play a great part in wireless transmission and reception, and a very wide range of frequencies is employed. The currents which operate a telephone receiver or loudspeaker, for example, are called low-frequency currents, or audio-frequency signals. The amplitude or strength of the currents will govern the loudness of the signals, while the frequency determines the pitch of the note. A drum, for example, will produce frequencies somewhere around 200 per second, whereas the top note of some musical instrument is equivalent to 15,000 cycles (sometimes called 15 kilocycles).

If the current changes direction very rapidly the currents are said to be of high frequency, or radio frequency, and by this we usually imply currents having a frequency of over 20,000. Actually,

the high-frequency currents used for broadcast transmission usually have a frequency of from 150 kilocycles to 1,500 kilocycles. These high-frequency currents are fed to an aerial and earth and waves are produced in the ether.

Aerial and Earth.—An aerial in its simplest form consists of a length of wire supported as high as may be convenient from masts, towers, trees, etc. Fig. 7 shows a typical aerial supported between two masts and insulated from the masts by insulators at each end.

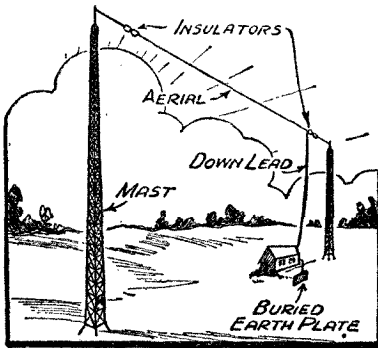

Fig. 7—A transmitting aerial showing how the wire is insulated at each end

These insulators are frequently made of porcelain and are to prevent the leakage of any current from the aerial to the mast. One end of the aerial is shown connected to the transmitting or receiving station, as the case may be, by means of another wire which is known as the down lead which becomes the *lead-in* as the wire enters the building. An aerial at a transmitting station usually only differs from that of the receiving station as regards

its height and size and improved system of insulation. What is known as the *earth* frequently consists of a sheet of metal buried under the ground and having connected to it a wire lead which enters the building where the transmitting or receiving station is situated. When high-frequency currents are fed into an aerial system of this kind the current, when flowing backwards and forwards along the lead-in and aerial proper, will set up an electric strain in the ether which results in waves being radiated from the aerial. These waves may travel hundreds of miles and will influence any aerial and earth system over which they pass.

The ordinary domestic wireless receiving station consists of an aerial, an earth, a wireless receiver and the batteries required to work it. But the actual energy of the incoming signals is derived from the waves which pass over the aerial and set up high-frequency currents in it which are identical in character and frequency to those occurring in the transmitting aerial. The only difference is that the currents are, of course, only a very small fraction of those occurring at the transmitter. It is possible for millions of aerials to pick up a small proportion of the energy transmitted from the broadcasting stations. What we do with these high-frequency currents is for later consideration, but at this stage the reader should note that the strength of the high-frequency current in the aerial is varied

by the microphone, and that the waves radiated produce currents of a complex nature in the receiver. Fig. 8 shows a complete transmitting and receiving system in most simple form. Note that symbols are used to indicate the various parts. No attempt is made at this stage to explain how the microphone alters the character of the oscillations in the transmitting aerial, or how the oscillations in the receiving aerial are made to influence the loud-speaker. The present book is chiefly concerned with what we do with the high-frequency oscillations in the receiving aerial.

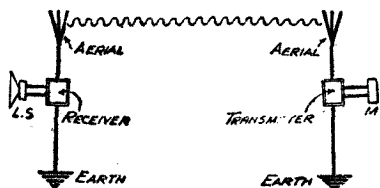

Fig. 8—A skeleton representation of a transmitter sending to a receiving station

Tuning.—Since wireless stations tend to radiate their signals in all directions, we shall have the disadvantages as well as the advantages of broadcast transmission. The disadvantage, of course, is that when there are a large number of stations working together, they will tend to interfere with one another, a receiving station picking up all the different waves at the same time. A great deal of the technique of wireless reception consists in being able to sort out one signal from others, and we speak of a wireless set as being *selective* or else poor in selectivity. There are various methods of obtaining selectivity in a wireless receiver, but the basic one of all is that of tuning.

It has been explained that the high-frequency currents generated in an aerial will send out electric waves. These waves have a length which bears a definite relationship to the frequency of the high-frequency current. For every complete cycle of high-frequency current in the aerial, i.e., a rush of current up the aerial and down again, a single wave is flicked off the aerial and is sent travelling on its way. These waves travel in all directions, much in the same way as a ripple on the surface of a pond will spread until finally it is too weak to be seen. The ripples possess two noticeable features: there is, first of all, the size of the wave or ripple, and then there is the distance between the crest of any two waves. This distance between crests—or, to put it more generally, between any two similar points on two successive waves—is called the *wavelength*.

The speed of waves through ether is the same for all wavelengths, viz. three hundred million metres per second (the metre being the French unit a little larger than a yard). If the frequency of the oscillations in the transmitting aerial (an oscillation being equivalent to a complete cycle) is one million, there will be one million waves established in the ether within one second. The first

wave will have travelled three hundred million metres (since this is the velocity of waves) by the time the last wave is sent out by the aerial. Since there are a million waves in the three hundred million metres, it follows that each wavelength is three hundred millions divided by one million, which equals three hundred metres. Each wave, therefore, takes up three hundred metres in the ether, and this is known as the wavelength of the station. It matters little whether we speak of the wavelength of a wireless station or the frequency.

The actual frequency chosen for wireless transmission does not make a great deal of difference within certain limits. Generally speaking, communication is more reliable on the longer wavelengths above, say, 400 metres, but every wavelength has usually some merit or demerit. There will, however, be no difference in the operation of waves of such lengths as 400 metres and 410 metres.

The problem of selectivity and the prevention of different stations from jamming each other is overcome largely by giving each station a separate wavelength on which to work. That station will then only use high-frequency current of its allotted frequency, and although the ether will be full of waves of all sizes travelling in it, yet a suitably designed receiving station will be able to pick out any wave it desires, and so receive the wireless programme from the particular station required. The farther apart stations

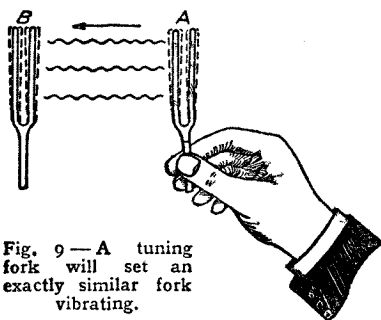

Fig. 9—A tuning fork will set an exactly similar fork vibrating.

are in wavelength, the more easily can they be separated on a wireless receiver.

The system of tuning a wireless set really consists in effectively choosing the particular station required and avoiding the influence of signals on neighbouring wavelengths. The problem is a complicated one, and a final solution has not been attained even after nearly forty years of radio.

The radiation of a particular frequency, and its selection, has a parallel in sound waves. A tuning-fork, for example, is a method of producing sound waves of a given frequency which is marked on the tuning-fork. The strength of the waves will depend on the violence with which the fork is struck, but the frequency will always remain the same. In Fig. 9 are shown two tuning-forks, B and A. The one on the right, A, is first struck, and the sound

waves from A are made to impinge on the fork B. If this fork is one which has been designed for the same frequency as the fork A, then the sound waves will set B vibrating; and if we then stop A from vibrating (e.g., by gripping the prongs firmly), we shall hear the same note being emitted from the fork B. The reason the fork B responds to A is that it is tuned to the same wavelength or frequency. If there were several tuning-forks all close together, and they were all vibrating at different wavelengths, it would be possible to pick up the waves from any of the forks by the use of another fork tuned to the desired wavelength. This is exactly what we do in a wireless receiver, and the equivalent to a tuning-fork is a tuned circuit.

Tuned Circuits.—A tuned circuit consists of an *inductance coil* shunted by a condenser. An inductance coil, or inductance as it is usually called, simply consists of a coil of wire which, when dealing with high frequencies, is usually cylindrical in shape and wound on a former, or cylinder, of insulating material. The wire is insulated with silk or other material, so that the turns may be wound close together without any danger of leakage of current between them. A condenser is also a very simple piece of apparatus, and normally consists of—in its simplest form—two metal plates or sheets placed opposite each other within a short distance, and having between them some insulating material, such as air, waxed paper, mica, glass, etc.

In wireless receivers, the condenser is usually made adjustable, and the plates are capable of being separated to a greater or less extent. There are various ways of making a condenser variable, and the usual one involves rotating a moving vane into or out of a pair of fixed vanes which are connected together. The moving vane is, therefore, the filling in a sort of sandwich. To obtain a "bigger" condenser, several vanes connected together move in or out several fixed vanes, also connected together. Fig. 10 shows a tuned circuit consisting of an inductance coil L and a variable condenser C. On the right of Fig. 10 is a pictorial representation of the circuit, shown symbolically on the left. In the pictorial drawing the inductance is marked L, the fixed plates of the variable condenser are marked F, and the moving plate is M. This terminal (i.e., connecting point) M is on the metal frame of the variable condenser and, through the bearing, is connected to

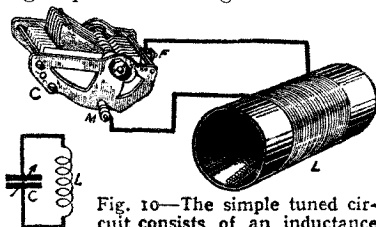

Fig. 10—The simple tuned circuit consists of an inductance and variable condenser

the moving vanes ; the fixed vanes are insulated from the frame. It is only the portion of the moving vanes inside the fixed ones which serve a useful purpose.

It will be noticed from the left-hand circuit of Fig. 10 that the condenser is represented by two straight lines parallel to each other, and the fact that the condenser is variable is made clear by the arrow which crosses the two lines. The condenser serves as a means of storing electricity, and the greater its *capacity* the more electricity will it store. The capacity of a condenser depends on the size of the plates opposite to each other, the distance between the plates and the nature of the insulator between them. The larger the surface area of the opposing plates the greater will be the capacity ; the shorter the distance between the plates the greater will be the capacity ; and the greater the *specific inductive capacity* of the *dielectric* (i.e., the insulator between the plates) the greater the capacity.

Most variable condensers for tuning purposes have air between the plates which, while it does not give a big capacity, makes the condenser more efficient, i.e., have less losses. Fixed condensers for high-frequency purposes usually have mica dielectrics, while condensers for low frequencies usually have a paper dielectric.

In order to avoid having large areas of sheet metal in a condenser, it is customary to use smaller sheets and to arrange them

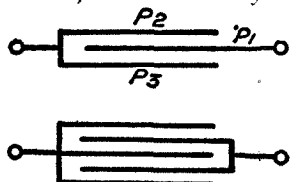

Fig. 11—Condensers with fixed plates intermeshed to increase capacity

sandwich fashion as shown in Fig. 11. In this illustration the top sketch shows three plates, P2 and P3, being joined together, while P1 is placed in between the others. This arrangement, although it only involves a total of three plates, has twice the capacity of an arrangement consisting only of P2 and P1. The lower sketch of Fig. 11 shows a total of five plates and the capacity of this condenser is twice that of the condenser in the upper sketch.

That a condenser will hold electricity may be demonstrated by arranging the circuit shown in Fig. 12, where a battery B of, say, 100 volts *charges* the condenser C when a switch K is closed. By closing a switch we mean that a break in the circuit is closed up so that an electric current can flow. The terms "battery" and "volt" have not been explained, but the reader can assume that a battery is a means of supplying direct current, e.g., for lighting a lamp, and the voltage is the "pressure" that governs the amount of current which is passed through the lamp or other circuit. Voltage is the amount of pressure or electro-motive force in the battery

and it is measured in volts just as length is measured in feet, or weight in tons. The "voltage" of the average flashlamp bulb is four and a half, and the voltage of the mains which supply our electric light is usually about two hundred and twenty volts.

The nature of an electric current, as we shall see later, has suggested the *electron theory* which regards an electric current as made up of the flow of millions of almost infinitesimally small particles called *electrons*, each of which is supposed to be a bit of negative electricity. The terms "negative" and "positive" in electricity mean respectively an excess or shortage of electrons, and the negative pole (i.e., terminal) of a battery will supply large quantities of electrons which will flow through the circuit across the battery terminals and back to the positive terminal of the battery where they are welcomed with open arms owing to the shortage there. A flow of current into the condenser C will therefore be regarded as a flow of electrons from the negative terminal of the battery B

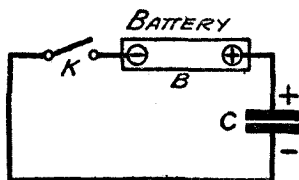

Fig. 12 — Showing condenser charged up by current from battery

to the switch K and along the wire to the bottom plate of C which thus becomes negative, while the upper plate becomes relatively positive. Beyond the initial surge of current into the condenser C, there is no actual passage of direct current through the condenser C. A condenser can thus be charged by direct current, but the insulating material between the plates prevents any direct passage through it.

If we now disconnect the battery B from the condenser C, e.g., by opening the switch K, we can treat the charged condenser C as a source of direct current. It will be found charged to the same voltage as the battery, and if we join the terminals of the condenser C together by wire it will be found that, at the moment of completing the circuit, a spark is obtained and the condenser C is thus discharged. The spark is caused by the impatient electrons jumping the tiny air gap and heating the air white hot. The current is only momentary because a condenser rapidly gives up its charge and it has no way of renewing the charge. A battery, on the other hand, owing to the chemical processes which go on inside it, will maintain its voltage even while current is being withdrawn from the battery.

Let us now charge up the condenser C and then disconnect all apparatus from it. Now connect across it an inductance coil L, as shown in Fig. 13(a). The moment the inductance L is connected across C, the electrons on the bottom plate of the condenser will surge through the inductance L and, owing to the special

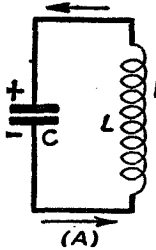

Fig. 13(a)—Condenser discharging through an inductance

property of an inductance coil, the condenser will not only be discharged but there will be an additional spurt of current in the same direction, and this will charge up the condenser in the opposite direction to what it was previously. The result is that we have the condition of affairs illustrated in Fig. 13(b), where the top of the condenser C is

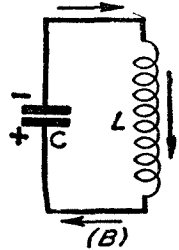

Fig. 13(b)—Condenser discharging in opposite direction

now negative and the bottom positive. When this happens, the condenser decides to discharge itself through the inductance in the opposite direction and the electrons take the path of the arrow. This time, the current again over-shoots itself and charges up the bottom plate of the condenser C. The result of this process, which is repeated several times, is that the condenser produces a series of alternations. These in radio work are generally termed *oscillations* and, in the particular example given, each oscillation will be weaker than the preceding one owing to the various losses in the circuit. Usually the oscillations rapidly die out, but here it is important to notice that although the strength (or amplitude) of the oscillations rapidly decreases, their frequency remains the same. In this respect the tuned circuit reminds one of the swinging of a pendulum. If one has a ball on the end of a piece of string and draws it to one side, the ball will swing to and fro until it finally becomes stationary. The initial amount of energy is dissipated or wasted in overcoming the resistance at the point of suspension and the resistance offered by the air to the moving pendulum. Although the swing of the pendulum becomes shorter and shorter, the time taken for the pendulum to swing from one extreme side to the other side and back again remains always the same. If, however, we increase the length of the pendulum, then the time taken for the oscillation of the pendulum will increase.

The current in an oscillatory circuit behaves in a manner similar to that of a pendulum, or perhaps a better example is a steel blade having a metal bob on the end, as shown in Fig. 14. The blade is springy and is supported at one end on a table. If we pull down the bob and then release it, the steel blade will not only return to its horizontal position but will over-shoot itself and then return. Although the movement of the bob

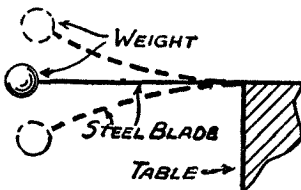

Fig. 14—A steel blade with weight oscillates, if flicked

will become less and less at each swing, the time taken for the swings is constant and the object of these explanations is to emphasise the fact that a tuned circuit has a given frequency irrespective of the strength of the current in that circuit.

The circuit is said to be *resonant* to a given frequency, and it will now be clear to the reader that, if we can feed such a circuit with currents from the aerial of a wireless receiving station, current will be set up in the circuit when it is tuned to a frequency the same as that of the incoming signals. A complete aerial circuit is shown in Fig. 15, the left-hand sketch showing the theoretical circuit while the arrangement (B) is a pictorial equivalent. It will be seen that the tuned circuit is connected between the aerial and earth. The earth in the pictorial circuit is represented by a water-

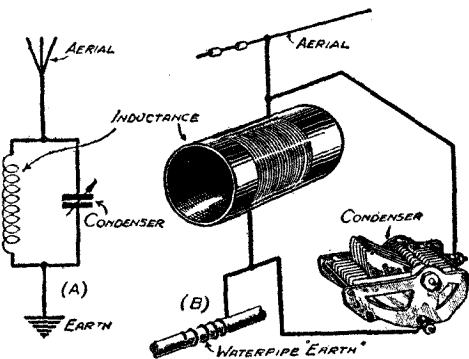

Fig. 15—The simplest tuned aerial circuit consisting of inductance and variable condenser between aerial and earth

pipe, since most people use a water-pipe as the earth connection instead of burying a metal plate in the ground. As a water-pipe is made of lead and ultimately reaches the ground, it is very commonly employed as an earth connection.

The aerial of a wireless receiver is therefore employed as a *collector* of high-frequency energy, the current in the aerial circuit being set up by the passing waves.

Of course, if an aerial were connected straight to earth, currents set up in the aerial by the waves would pass down to earth, but this arrangement provides us with no means of operating our loud-speaker, and, moreover, there is no arrangement for enabling us to tune to any particular wavelength. The important point about a tuned circuit is that it will not respond strongly to any frequency other than that to which it is tuned. A great advantage of the arrangement is that it will strengthen the incoming oscillations by building them up. A child on a swing can start swinging slowly and work up to a very high swing indeed, or a person by giving the child's swing a push at suitable moments can build up big "oscillations" of the swing. There are numerous examples of the effectiveness of a series of regular impulses which accumulate and produce a very strong effect even though the individual impulses

may be quite weak. Most of the bridges across the River Thames have a notice on them instructing officers in charge of troops to give orders to their men to break step; instead of the rhythmic march of a large number of troops causing a vibration which could build up and finally damage the bridge, the soldiers are ordered to break the rhythm by marching as they please so that half of them are putting their left foot forward while the others are putting forward their right foot. As a matter of fact, I have marched large bodies of troops in step across all kinds of bridges for the purpose of seeing whether there was any building-up effect, but I did not notice any special vibration. This reprehensible experiment is perhaps a testimonial to the bridges rather than to my caution. Probably in the cases that have come to my notice the *natural period of resonance* (or natural frequency) of the bridge did not coincide with the frequency of the steps of the men in my charge.

Another example of the building-up effect of resonance is the fracture of a glass by the playing of a violin on a given sustained note to which the glass happens to be tuned. This spectacular experiment is also one I have never seen carried out successfully, although certain articles in a room often vibrate audibly on certain notes and spoil broadcast reception.

Motorists will experience a peculiar form of resonance on certain roads of a bumpy character. When going at a certain speed the rough surface of the road may cause the whole car to bounce on its springs to a most unpleasant degree. This is because the natural frequency of the car on its springs coincides with the jolts given to the car by the irregularities of the road. By increasing the speed of the car it is possible to increase the frequency of the jolts and, since these no longer coincide with the natural frequency of the springs of the car, excessive bounce is removed.

A tuned circuit is, therefore, very valuable in a wireless receiver, since it builds up oscillations of the same frequency as itself, but the built-up effect is not experienced on any other frequency. Hence the arrangement will select any desired station if the operator makes its natural frequency coincide with the frequency of the desired station.

Methods of Tuning.—Both an increase in the value of the inductance coil and an increase in the capacity of the condenser will increase the "wavelength" of the circuit. Or, if you wish to look at it from the point of view of frequency, an increase of inductance or of capacity will produce a decrease in the natural frequency of the circuit.

It is not an easy matter to vary the number of turns of the

inductance and so produce a variation of the *inductance* of the coil. It is much more convenient to tune the circuit by altering the value of the variable condenser. The various ways in which the aerial circuit in the wireless receiver may be tuned are dealt with in a separate chapter and we shall assume for the moment that the arrangement employed consists of an inductance and variable condenser connected between aerial and earth, as shown in Fig. 15. This, as a matter of fact, is not the most selective arrangement, and stations working on wavelengths even considerably different from that to which the circuit is tuned will force themselves into the circuit, even though the resultant oscillations are not as strong as those of the desired station. Under these circumstances *interference* occurs and both stations would be heard, the undesired one coming in as an annoying background to the other.

Detection.—Having obtained our desired oscillations by tuning the inductance and condenser to the desired wavelength, our next problem is to *detect* these currents and to make them audible. At present, they consist of high-frequency currents which may be changing direction a million times per second. No ordinary apparatus will respond to the high frequencies involved at a receiving station. Nor, in fact, is it desirable that they should, because the high-frequency current really represents only the *carrier waves* which carry the *low-frequency* currents produced by the microphone. The electric waves, after all, are merely for the purpose of conveying the rather complex alternating currents of audio-frequency which are produced by speech and music, the maximum frequency of which never exceeds about fifteen thousand per second, and for all practical purposes rarely exceeds eight thousand. It is these variations which are carried on the back, so to speak, of the high-frequency oscillations. At a wireless broadcasting station we generate very high-frequency alternating currents and superimpose on them the audio-frequency currents so as to produce a mixture of the two. This mixture is then fed into the transmitting aerial, and produces waves of a similar mixed character. These waves are capable of traversing great distances, and, when they come to a receiving aerial, set up complex high-frequency oscillations which contain the desired low-frequency currents. Our problem is really to sift out the high-frequency *component* (i.e., part) of the incoming oscillation, leaving the desired audio-frequency current. What we require to do is to distil, so to speak, the mixture and recover the original L.F. (low-frequency) currents which we can then apply to a loudspeaker—usually after magnifying them by means of special apparatus. The process of regaining the original current

produced by speech or music is known as *detection*, and various devices have been used for detecting the signals and making them operate telephones, a loudspeaker, or some other device.

The earliest method of detection consisted of a small spark-gap connected across a tuned circuit. When signals were received, a stream of tiny sparks passed across the gap and messages could be sent in the Morse code by sending out short or long groups of waves. This crude arrangement then gave place to the *coherer*, which consisted of metal filings into which were poked two contacts; an electric current was passed through this heap of filings, but the current was very small indeed under normal conditions. When, however, the incoming oscillations were applied to the filings, they cohered or stuck together, and so provided a much better path for the current from a local battery. The resultant current was passed through a tape machine, which would record dots and dashes. Another scheme consisted in making the high-frequency current demagnetize a moving loop of magnetized iron wire. The process of demagnetization was made to produce a noise in a pair of telephone receivers worn by the operator.

A big step forward was made when the process of *rectification* was applied to the received oscillations. The system of rectification involves the change of alternating current into direct current, and it may be carried out by applying these currents to some form of one-way conductor.

There are several types of one-way conductors or devices which operate in such a way as to give the impression that they are one-way conductors. The earliest device was probably the two-electrode valve, which consists of a metal filament heated to white heat in a vacuum containing also a metal plate to which external connection could be made. This device will allow electrons to flow through the valve from filament to plate, but not in the reverse direction. Full details of this device are given later. A *crystal detector* prior to 1914 (and revived in the early days of broadcasting) was also an extremely popular rectifier, and it was used then to a much greater extent than the valve. Fig. 16 (a) and Fig. 16 (b) show in theoretical form and also pictorially a simple wireless receiver using a one-way conductor such as the crystal.

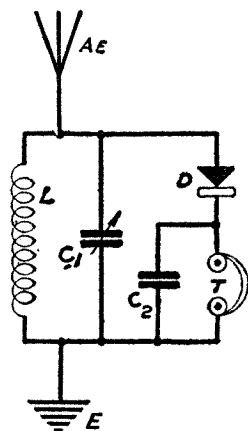

Fig. 16 (a)—A simple crystal-detector receiver

It will be seen that the crystal detector D,

as well as telephone receivers T , are connected across the tuned circuit LCI , while a small fixed condenser, C_2 , is connected across the telephones.

In this arrangement the telephones T constitute the device for turning low-frequency currents into sound, and it would be as

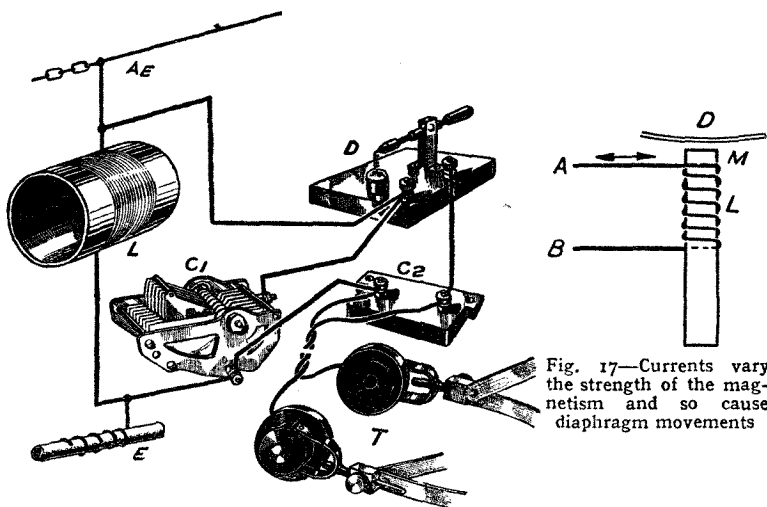

Fig. 16 (b)—Pictorial representation of the simple receiver shown in Fig. 16

well to explain how the telephones operate. Fig. 17 illustrates the simplest form of telephone receiver. It consists of a bar magnet of steel around which is wound a coil L of insulated wire. Close to the end of the magnet is placed a flat disc D of iron, which is supported all round its edge. Under normal conditions the magnet will cause the disc or diaphragm to sag a little in the middle, owing to the attraction between the magnet and the iron disc. If now we pass an electric current through the coil L the strength of the magnetism in the magnet will be either increased or decreased, according to which way round the coil is wound. Let us assume that the magnetism is increased. This will cause the middle of the diaphragm to approach still closer to the end of the magnet. If the current supplied to AB is now reversed, the magnetism will decrease and the magnet will no longer have the same force on the centre of the disc which, therefore, moves farther away from the magnet and tends to become flatter instead of sagging in the middle. It will thus be seen that, by passing an alternating current through the coil round the magnet, the *diaphragm*, i.e., the disc, can be made to move up and down. This movement is usually very small

indeed, but it is quite sufficient to set up sound waves in the air above it and the frequency of these sound waves will be the same as the frequency of the alternating currents applied to AB. We have here, then, a method of converting alternating electric current into sound waves, and the higher the frequency of the current the higher pitched will be the note given off by the diaphragm of the telephone receiver. If the frequency of the alternating current is further raised, a point will ultimately be reached when the device ceases to operate. In the first place the diaphragm cannot be made to move faster than a certain speed of vibration; but, even if it were possible to make the diaphragm vibrate a million times per second, the human ear would not be able to hear the sound vibrations.

In order to operate a telephone receiver (or a loudspeaker—which works on a very similar principle), we require to apply audio-frequency currents, and these are obtained from the complex high-frequency oscillations in the receiving circuit by the one-way detector.

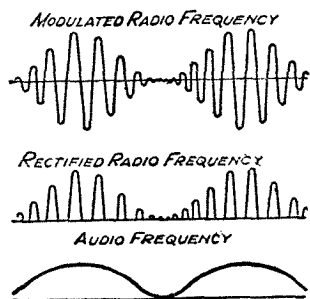

Fig. 18—To illustrate the rectification process in reception

Fig. 18 shows graphically how the one-way rectifier of Fig. 16 works. The top line shows the nature of the alternating current in the tuned receiving circuit. It will be seen that the currents are of radio frequency, but that they vary in amplitude. The currents shown, of course, only represent a very small fraction of a second's-worth, but it will be seen that the amplitude or strength

varies. These currents are applied to the crystal detector D, and the small condenser C₂—like all condensers—allows the passage of the high-frequency voltages so that they are applied across the detector D. This detector only allows those portions of the currents which flow in a certain direction to pass; for example, the detector may only allow positive half-cycles to pass through it, and these currents will flow round the inductance L and into the condenser C₂ and through the telephones T, which act as a discharge path for the condenser C₂. The second line of Fig. 18 shows the unidirectional pulses which occur at a high frequency, but which are all in the same direction. The telephones T will not respond to each individual impulse for reasons already given, but they will respond to the average effects of all these impulses, and the bottom line of the figure shows how these impulses produce an average direct current of low frequency which is capable of operating the telephones and producing a note.

CHAPTER 2

AERIAL CIRCUITS

If we connect a resistance between the aerial and earth, incoming wireless signals which influence the aerial will set up currents of an alternating nature in the aerial system and these currents will travel through the resistance. When a current passes through a resistance, or impedance, a *potential difference* (i.e., difference in electrical pressure measured in volts) is set up across it, and in the present case this will take the form of alternating *electromotive forces* (abbreviated to e.m.fs.). Electromotive force is also much the same thing as "voltage."

In Fig. 19 the e.m.fs. may be "drawn off" at the points AB and made to operate the detector. The pictorial arrangement of Fig. 19 is given in Fig. 20, and in several cases I propose to give

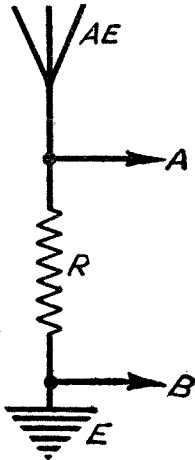

Fig. 19—An aperiodic aerial circuit. Voltages are developed across R. No selectivity is obtainable

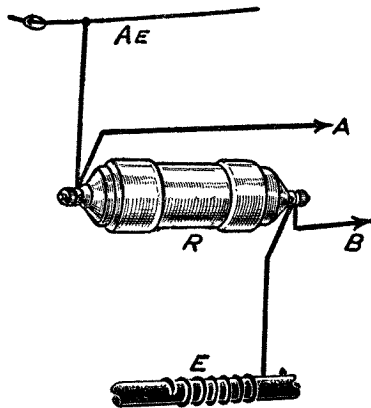

Fig. 20—A pictorial equivalent of the aperiodic aerial circuit. The system is rarely used

pictorial illustrations so that the reader can familiarize himself with symbols as used in circuit diagrams.

The very simple aerial circuit of Fig. 19 is known as an *aperiodic* circuit because the resistance R acts impartially towards all incoming signals, no matter what their wavelength may be. Not only does the resistance R act impartially and therefore prevent the circuit from being at all selective, but this inability to "tune" to a particular station only is combined with the heavy losses of energy due to the resistance itself.

Another form of aperiodic aerial circuit is shown in Fig. 21, in

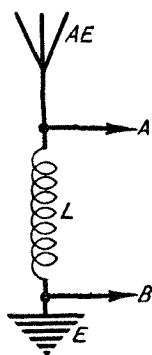

Fig. 21—Use of choke as aperiodic aerial circuit

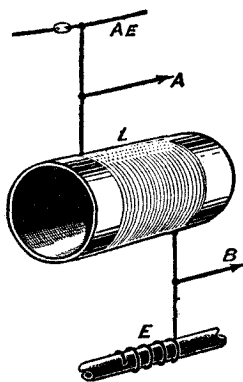

Fig. 22—Pictorial form of circuit on the left

which, this time, an inductance coil L is connected between aerial and earth and the potentials set up across the impedance of this inductance coil may be led away to a detector. By impedance we mean the total opposition offered to alternating currents. The inductance L now acts as a *choke*. It is not selective, but it responds rather differently to different wavelengths. The higher the wavelength the lower will

be the frequency of the alternating currents set up in the aerial circuit, and the e.m.f.s. set up across L will be lower because the impedance (or opposition) will be lower. In the case of short wavelengths, which produce higher - frequency currents, the potentials across L will be greater.

Both arrangements of Fig. 19 and Fig. 21 are occasionally used in wireless receiving sets, but only rarely.

The Tuned Aerial Circuit.—If we connect an inductance coil across aerial and earth and have some means of inductance variation (such as sliding contacts capable of making contact with different turns) we shall be able to *tune* the aerial circuit. This will make it selective to the signals to which the circuit is tuned, and so we can pick up stations at different wavelengths simply by altering the value of the inductance.

It may be wondered where the *circuit* is formed. It consists of the inductance and the capacity formed by the aerial wires and the earth. This is clearly shown in Fig. 23, dotted lines showing the capacity between aerial and earth. The same arrangement is shown more diagrammatically in Fig. 24, where the dotted lines show the condenser effect which represents the aerial to earth

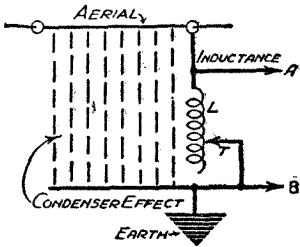

Fig. 23—The tuned circuit is completed by the aerial-earth capacity

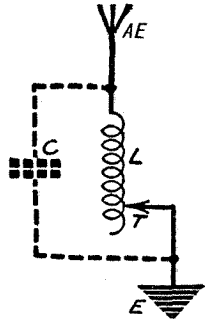

Fig. 24—Dotted lines show the equivalent of the aerial capacity

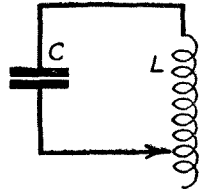

Fig. 25—This is what the aerial circuit virtually is

capacity. The circuit may, in effect, be redrawn more simply as in Fig. 25 where the variable inductance L is shunted by the condenser C to form a single tuned circuit.

There are all sorts of ways of varying the inductance of an inductance coil. A common method is that shown in Fig. 26,

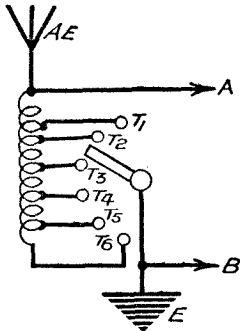

Fig. 26—A rotating contact gives rough tuning by varying the inductance used

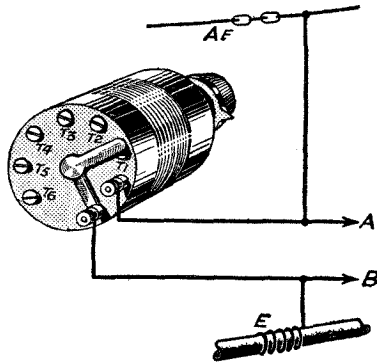

Fig. 27—A pictorial equivalent of the tapped inductance method of aerial tuning

where various tappings T_1, T_2, T_3 , etc., are taken from the coil. These tappings simply consist of wires taken from different points along the coil and connected to metal studs T_1, T_2, T_3 , etc., while the switch arm may be rotated so as to make contact with any individual stud. The amount of inductance included in the aerial circuit is that between AE and the stud used. The remaining portion of the inductance does not affect tuning since no currents pass through it. Actually, this overhanging portion of inductance is a disadvantage and does absorb energy, and it is usual to short-circuit it by connecting stud T_6 to earth.

Fig. 27 shows a pictorial form of Fig. 26. A knob turns a switch arm over various studs connected to tappings on the coil.

The disadvantage of a tapped inductance is that a very large number of tappings would be required to get accurate tuning—in fact, every turn would require a tapping taken from it, and this would mean many studs, perhaps 50 for medium waves and 150 for the longer waveband used in broadcasting. Moving contacts are notoriously unpractical and inclined to be noisy in operation, bulky and difficult to screen. (This last objection will be understood when valve circuits are dealt with later on.) Moreover, tuning on every turn would not be accurate enough.

The Variometer.—A much smoother working device is a *variometer*, which consists of two inductance coils which may be moved with respect to each other so as to produce a variation of inductance. The two coils are connected in series and one is usually rotated so that its magnetic field either opposes or helps the other coil. When a current flows through an inductance, magnetism is produced; a magnetic field (i.e., area) is produced and an alternating current will produce an alternating magnetic field. Now, if a coil of wire is placed in such an alternating magnetic field, alternating currents will be set up. These in turn tend to produce a magnetic field which will influence the original inductance. If an alternating current is passed through two coils *in series* (i.e., so that the current passes through one and then the other) the resultant magnetic fields may help or oppose each other according to the relative positions of the coils; since "inductance" depends on a magnetic field, the inductance will vary.

The variometer scheme of tuning is illustrated in Figs. 28 and 29.

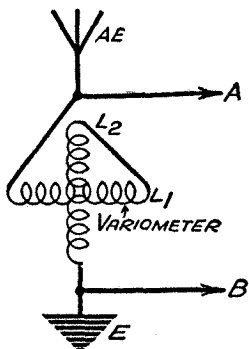

Fig. 28—A variometer gives very accurate aerial tuning

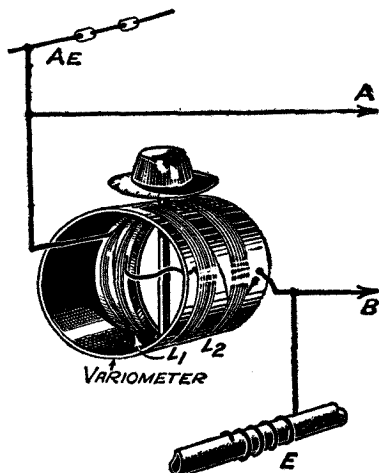
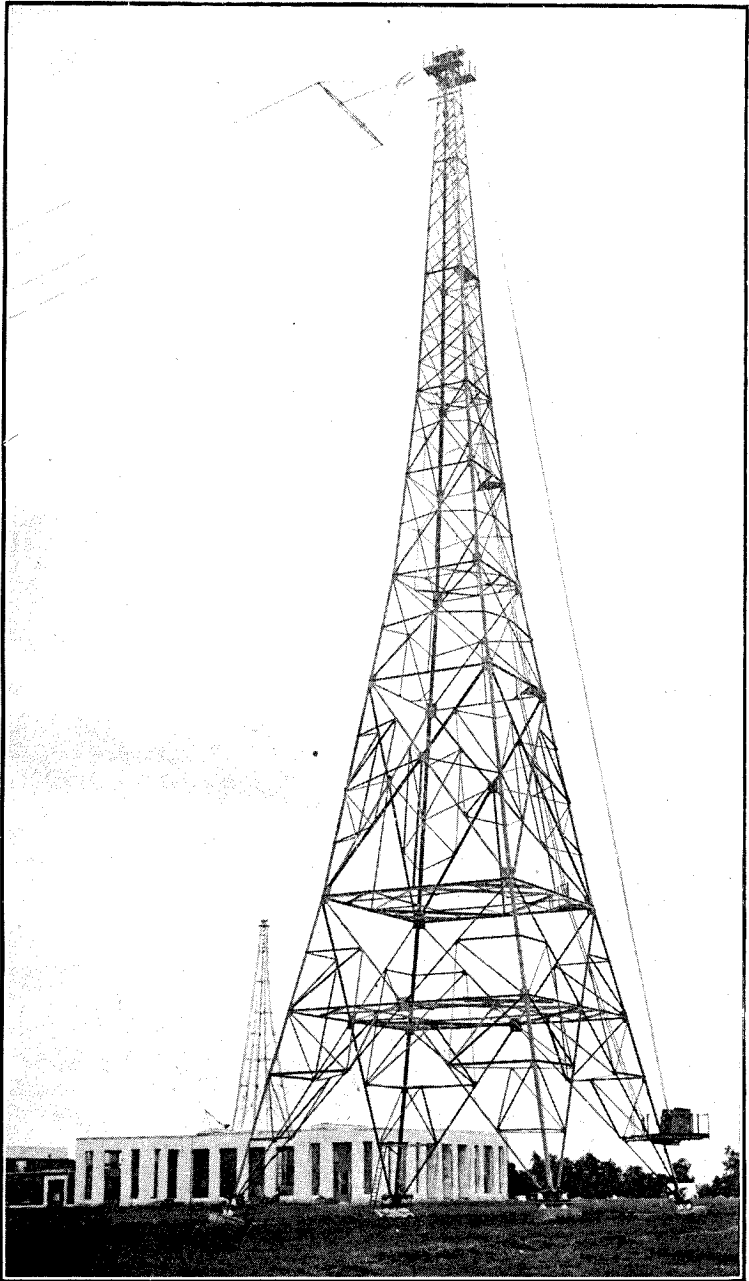
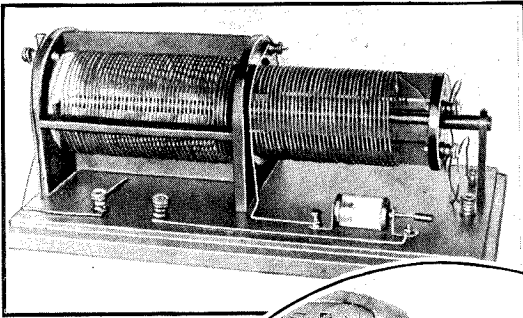

Fig. 29—The variometer here consists of one coil rotating inside another



B.B.C. STATION AT BROOKMANS PARK



EARLY TYPE
OF
TUNING
ARRANGEMENT

A MODERN
AIR-CORE
COIL
WITH
SCREEN
REMOVED

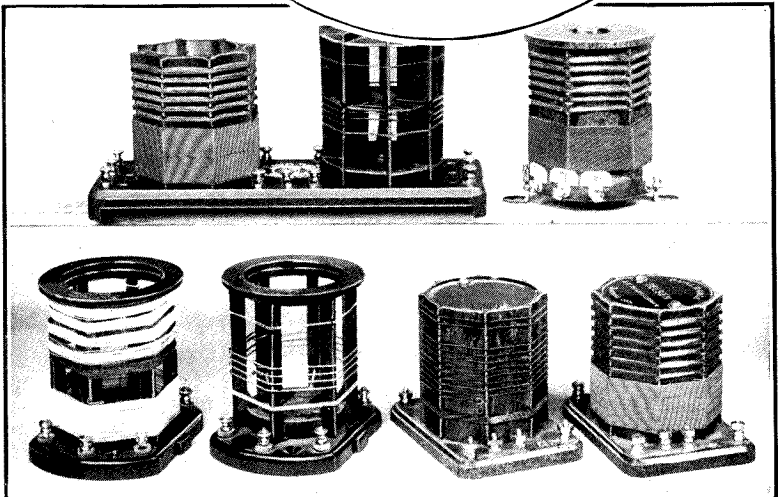
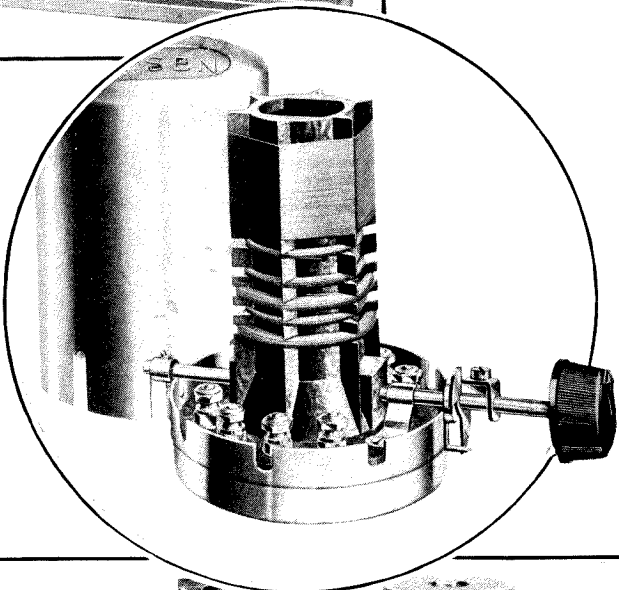

DIFFERENT TYPES OF AIR-CORE COILS

VERY
RECENT
SCREENED
IRON-CORE
COIL

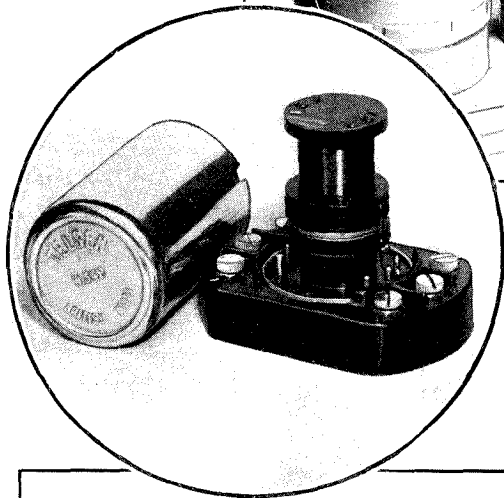
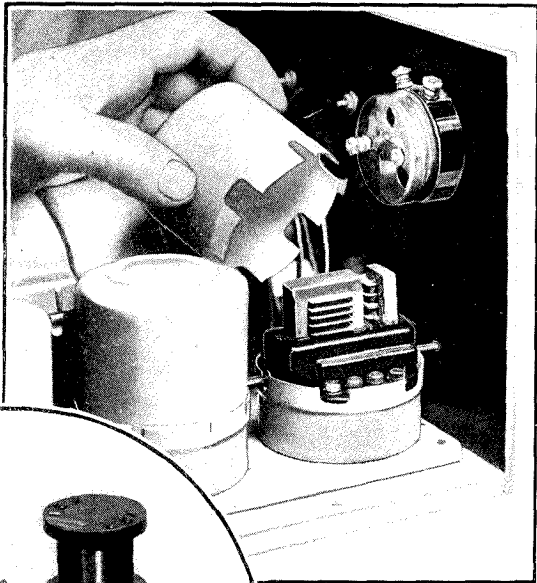

ANOTHER
MODERN
IRON-CORE
COIL

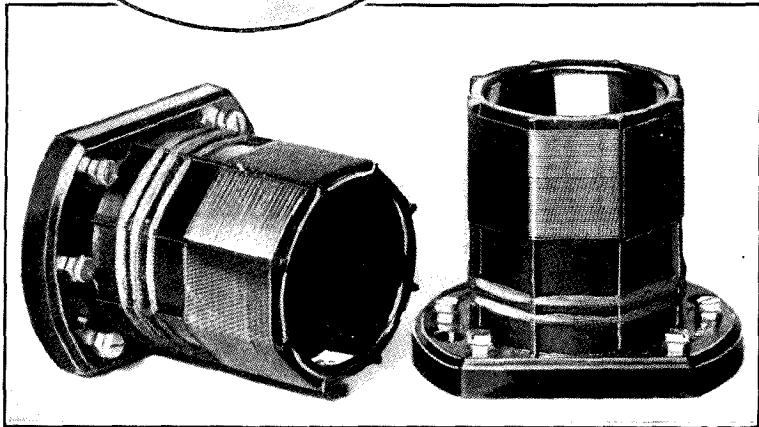

TWO EFFICIENT UNSCREENED COILS

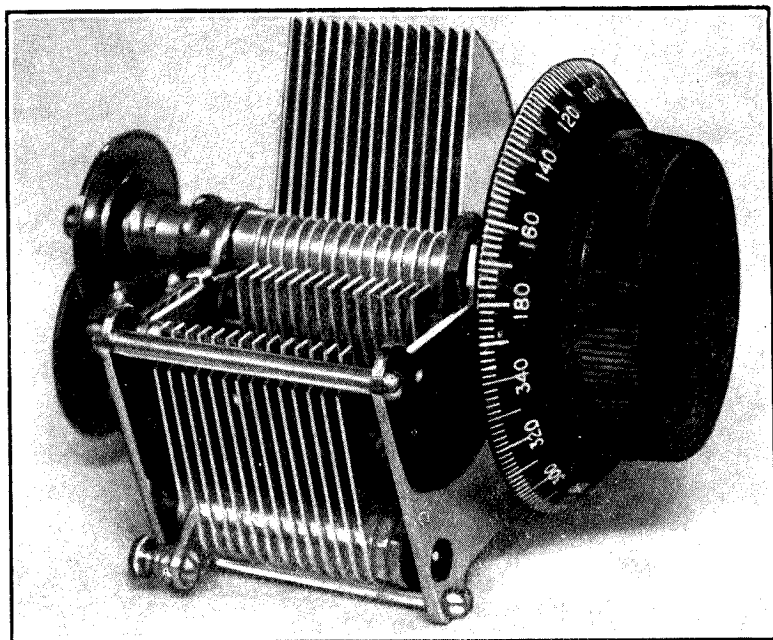

UNSCREENED TUNING CONDENSER

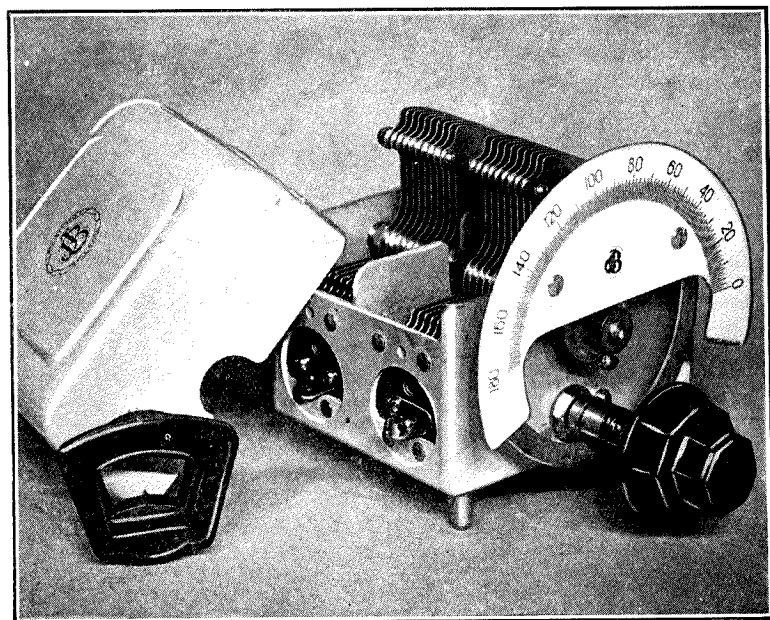

TWO-GANG SCREENED TUNING CONDENSER

The "field" of the *rotor*, or moving coil, can be reversed by turning the coil inside the outer coil.

The disadvantage of the variometer is that it is expensive, has inconvenient moving parts, is bulky, is difficult to screen, and has a high resistance to H.F. currents when the total inductance is at a small value.

All variable inductance methods of tuning also suffer from the great disadvantage that they are dependent upon the aerial capacity for the range of wavelengths to which the set will tune. It is desirable in all modern receivers to be more or less independent of the aerial capacity, which would vary in every home.

The usual method of tuning an aerial circuit is to keep the inductance fixed for a wide range of wavelengths, and to effect a change in tuning by the use of a variable condenser which usually has a maximum capacity of .0005-mfd. The variable condenser may be connected in one of two positions, and these are shown in Figs. 30 and 32.

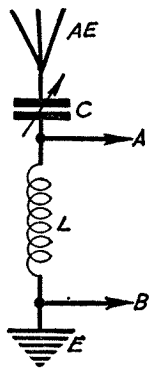

Fig. 30—Tuning with series aerial condenser

In Fig. 30, which is known as the series aerial tuning arrangement, the variable condenser C is connected between the aerial and the top of an inductance coil L, the bottom of which is connected to earth. This circuit really consists of the inductance coil L shunted by two

condensers in series, one of which is the aerial capacity and the other the variable condenser C. By varying C we vary the total capacity across the inductance L, and can therefore tune to the desired wavelength. In the case of high-capacity aerials, the arrangement is capable of giving a fairly wide range of wavelengths, but on a very small aerial the condenser C will not enable large variations of capacity to be effective across L, and the scheme of Fig. 32, which involves a parallel condenser, is more generally used although it suffers somewhat from the disadvantage that the greater the capacity across the inductance L, the lower will be the

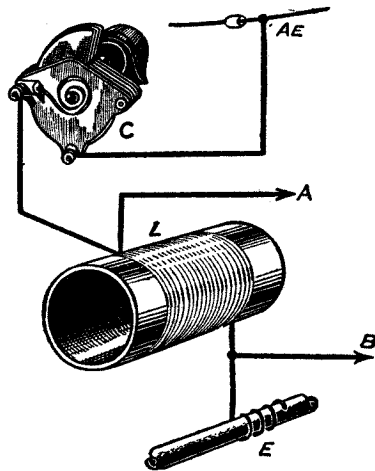

Fig. 31—A pictorial form of the circuit of Fig. 30

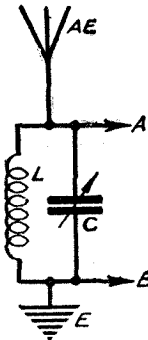

Fig. 32—Parallel aerial condenser tuning method

e.m.fs. drawn from the points A and B. These letters, incidentally, will be used throughout the series of subsequent circuits to show the points on the aerial circuit which are connected to a detector or amplifier arrangement.

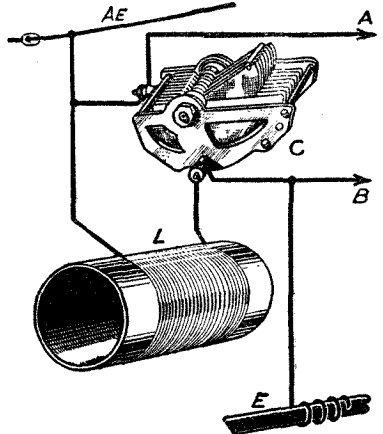

Fig. 33—The same arrangement as Fig. 32, but shown in picture form

In the case of the average aerial, the arrangement of Fig. 32 will give the widest range of wavelengths, but this simple circuit is not, in practice, used to any large extent. The Fig. 34 scheme

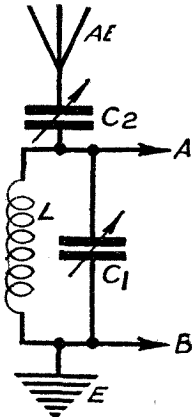

Fig. 34—Use of a small series condenser

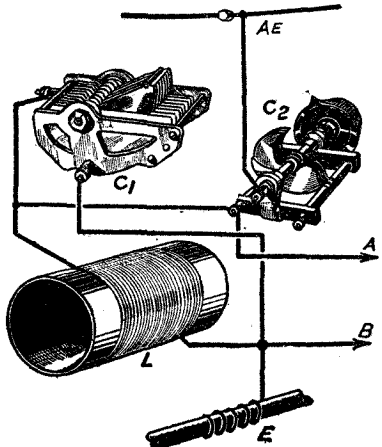

Fig. 35—The Fig. 34 method, which gives greater selectivity, is shown pictorially

will enable a very wide range of wavelengths to be covered, but this time two variable condensers C_2 and C_1 are employed, the former varying the effective capacity of the aerial, while the latter tunes the inductance L in the ordinary way. This arrangement has been used on several of my own receivers, and has two great advantages: one is that by reducing the capacity of C_2 to about $.00004$ mfd., the effective capacity of all aerials is made low. and so

using the set on different aerials alters the tuning to only a small extent, and the condenser C_1 across the coil L enables a very wide range of wavelengths to be obtained (e.g., from 180 metres to, say, 650 metres with a single coil, or with a larger coil a range of, say, 900 metres to 2,000 metres).

Apart from this technical advantage, there is also great merit in that, by reducing the capacity of the condenser C_2 , the aerial load is reduced. The aerial, it should be noted, not only feeds the signals to the tuned circuit, but also acts as a brake on it; any oscillations which are set up in the aerial system have, obviously, to occur in the aerial. By increasing the capacity of C_2 , we increase the strength of the signals received (assuming C_2 has not too large a maximum); but we also increase the aerial load, and this has the effect of making the whole circuit less selective. Tuning is, therefore, broader, and to get more selective results we have to reduce the capacity of C_2 . Of course, the greatest selectivity would occur when C_2 was at zero, equivalent to the aerial being disconnected, in which case the selectivity would simply be that of the circuit $L C_1$; but this arrangement, of course, is not practicable, because no signals would arrive at the tuned circuit.

The condenser C_2 is made variable and, having a low minimum capacity, is thus a convenient method of altering the selectivity of the aerial circuit and adjusting the signal strength. As a volume control it has many advantages.

Instead of making the condenser C_2 variable, it may be fixed (Fig. 36) and left at, say, .0001 mfd., or a lower value. Its selectivity

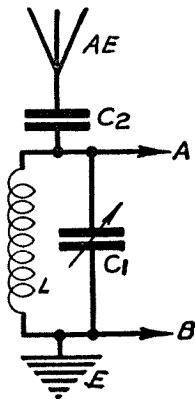

Fig. 36—A small fixed condenser is in series with aerial

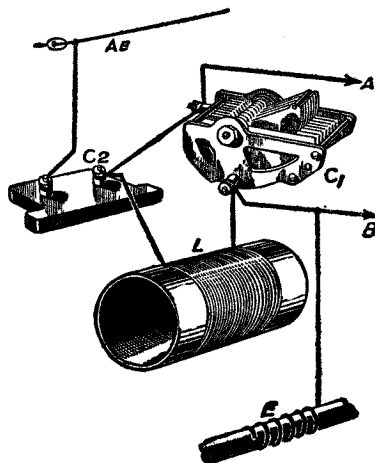

Fig. 37—This is a sketch of Fig. 36 translated into components

is greater than with the Fig. 32 arrangement, a wider range of wavelengths is covered by the condenser C_1 , and the wireless receiver is less dependent on different kinds of aerials.

Aperiodic Aerial Coupling.—A very popular way of applying the incoming signals to the first tuned circuit of the receiver is that shown in Fig. 38. The circuit $L_2 C_1$ consists of an ordinary

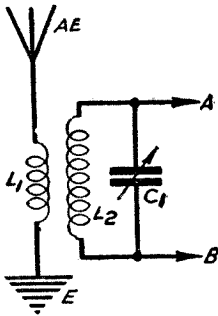

Fig. 38—An aperiodic aerial coupling system. An untuned inductance is coupled to a tuned coil

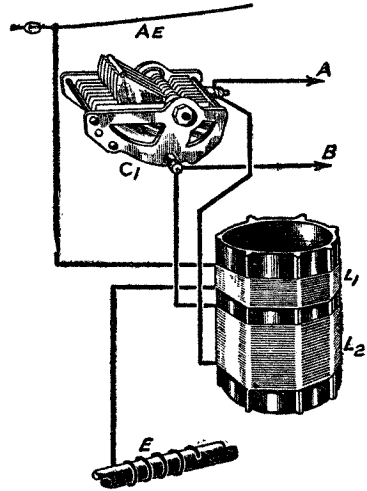

Fig. 39—Pictorial form of the circuit of Fig. 38

inductance tuned by the usual variable condenser. An inductance coil L_1 is included between aerial and earth, and is *coupled* to (i.e., placed near so as to influence) the inductance L_2 —i.e., it is wound over L_2 or close to it, so that its magnetic field influences L_2 . Any oscillations in the aerial circuit are now passed on to the circuit $L_2 C_1$ by the principle of *induction*. The aerial circuit itself is not actually tuned directly, since the inductance L_1 has to suffice for the whole of a waveband (e.g., from 180 to 640 metres, and perhaps for a much wider waveband). The arrangement is called an aperiodic coupling because the coil L_1 is assumed to be aperiodic, and capable of operating quite effectively for different wavelengths. The advantage of the Fig. 38 circuit is that it is substantially independent of aerial capacity, and enables the condenser C_1 to tune L_2 over a very wide range of wavelengths. The scheme has the same advantages as Fig. 34.

These advantages may be accentuated if one can vary the coupling between L_1 and L_2 , and this is usually done by having tappings on the inductance L_1 or making L_1 movable in regard to L_2 (see Figs. 40 and 41). For example, L_1 might consist of a rotor coil

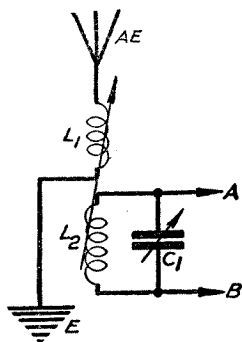

Fig. 40—Variable coupling is effected by moving the aerial coil

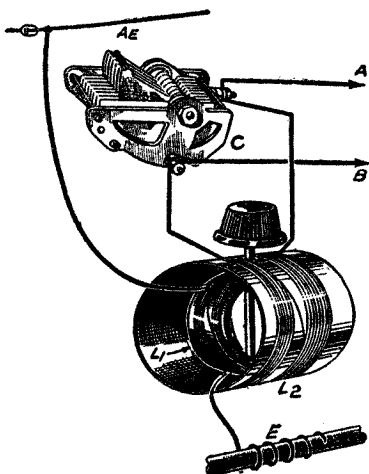

Fig. 41—Usually this is done by rotating the coil inside the other

rotating inside L2. Any degree of coupling from the aerial is thus obtainable. Small coupling, of course, provides greater selectivity and weaker signals. Tight coupling, on the other hand, produces stronger signals but "flatter" tuning (i.e., less selectivity). It should be noted, however, that with reference to both the capacity feed system of Fig. 34 and the aperiodic coupling of Fig. 38 that frequently a tighter coupling ceases to make any increase in signal strength beyond a certain point and, in fact, may be detrimental to signal strength. In the case of weaker couplings, however, it may be definitely stated that an increase of coupling will increase signal strength and vice versa.

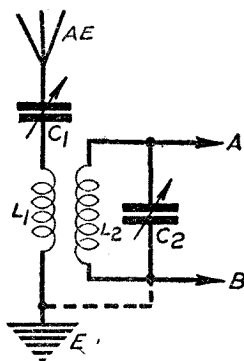

Fig. 42—Here greater selectivity is obtained by varying the feed to L1 by C1

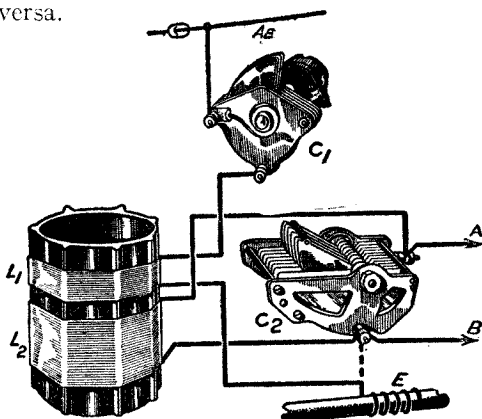

Fig. 43—In practice, the coupling between the tuned circuits is usually fixed

Variable Selectivity.—A certain method of obtaining variable selectivity and signal strength is illustrated in Figs. 42 and 43, where a condenser C_1 has been added to the circuit of Fig. 38. This condenser is usually a "solid dielectric" variable condenser of .0003 mfd. maximum capacity, and its object is to isolate or else to bring into action the aerial to a greater or lesser extent. The effect is not dissimilar to that obtained by moving the coil L_1 way from L_2 , low values of C_1 weakening signal strength but reducing the load imposed by the aerial on the tuned circuit $L_2 C_2$, therefore giving greater selectivity. It is not the object in this arrangement to tune the aerial circuit by means of C_1 ; the aerial circuit still remains aperiodic, and the condenser C_1 may be set at any position between minimum and maximum on any wavelength received. As in all arrangements where there is a series aerial condenser, it will be found that settings corresponding to larger values are necessary when receiving the longer waves.

In coupled circuits such as Fig. 42 it will be usual to "earth" the bottom end of the secondary circuit as shown by the dotted line.

Auto-Coupled Aerial Circuits.—Instead of using a separate inductance coil as a primary, it is possible to tap a single inductance and to connect the aerial to a tapping on the coil. Fig. 44 shows a sample of this arrangement in which the tapping T may be taken to one of several points along the inductance coil. The nearer the tapping T is to the bottom of the coil (i.e., nearest the earth end), the weaker will be the signals, but the less will be the load of the aerial on the circuit $L C$, and the less will be the effect of the aerial on the tuning of $L C$. If the tapping is made to the top of the coil L , the circuit, of course, is no different from Fig. 32, while if the tapping is taken to the bottom of the coil no signals at all would be received. For selectivity, the tapping should be low down; for signal strength, it should be higher up.

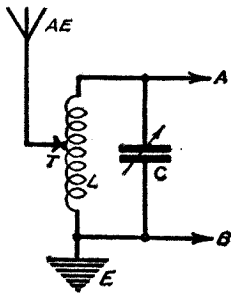

Fig. 44—A tapped aerial circuit gives selectivity

But, as previously explained, there is usually a degree of coupling beyond which it does not pay to increase it. Although, in practice, one may prefer to have a variable tapping, it frequently happens that one has to arrive at a compromise tapping to give the best all-round results for selectivity and sensitivity.

Instead of varying the tapping (such alterations are not very convenient, especially in the case of screened coils—one method being to move a "crocodile clip" contact, as in Fig. 45), a small

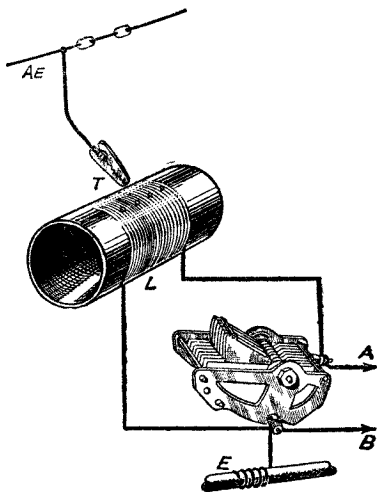

Fig. 45—This is Fig. 44 in pictorial form. A movable clip is used

variable condenser, usually of the solid dielectric type, can be connected in the aerial lead as shown in Figs. 46 and 47. This condenser may be used in conjunction with an average fixed tapping or with a variable tapping, and it provides a smoothly adjustable means of altering the selectivity of the circuit $L C_1$. It acts in a similar capacity to the previously mentioned condensers, and whilst it may alter somewhat the tuning of the circuit $L C_1$, it is not itself intended as a means of tuning, but only of altering selectivity and signal strength. In the case of many commercial coils, a couple of tapings only are provided and taken to terminals.

Use of Differential Condensers.—A refinement in coupling condensers on aerial circuits involves the use of a *differential condenser* of, say, '0001-mfd. capacity. Fig. 48 shows such an arrangement in which C_2 is a "differential," its moving set of plates P_1 being capable

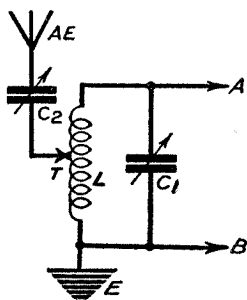

Fig. 46—Combined tapped coil and series feed condenser

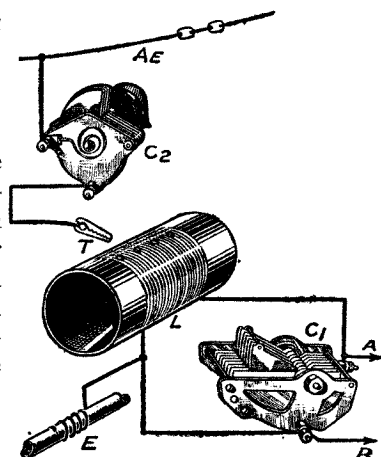

Fig. 47—Pictorial form of Fig. 46. Note solid dielectric condenser

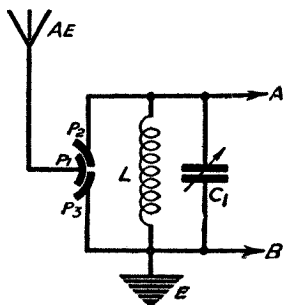

Fig. 48—Use of differential condenser for feeding circuit

of being placed opposite fixed plates P_2 or fixed plates P_3 . In the position opposite P_2 the whole arrangement is identical with Fig. 36. When P_1 , however, is opposite P_3 , the aerial is theoretically disconnected. No signals will now be received by the set except for any high-frequency currents which leak over from P_2 to P_1 . This leakage occurs to some extent in all circuits using differentials.

The disadvantage of an ordinary variable condenser in the aerial lead as a means of varying selectivity is that a reduction of its capacity will alter the tuning of the receiving circuit, since the effective capacity of the aerial is reduced. By the use of the arrangement in Fig. 49, any variation of the fixed plate P_1 is accompanied by bringing into action the condenser C_3 , which is adjusted to have a

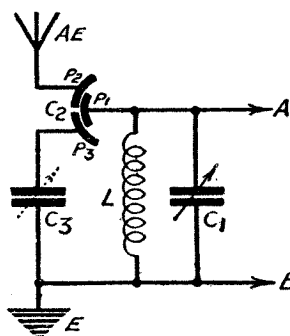

Fig. 49—Differential condenser to avoid altering tuning

capacity equal to that of the aerial. Whatever the position of P_1 may be, the tuning of $L C_1$ will not vary much, because while the aerial capacity may be in process of

reduction, the effectiveness of the capacity C_3 is increased. The arrangement is shown pictorially in Fig. 50, which illustrates the components (i.e., parts) involved.

Waveband Switching.—A variable condenser of .0005-mfd. capacity will only "cover" a certain range of wavelengths, and if we desire longer wavelengths we must increase either the inductance or the maximum of the variable condenser. It is undesirable to increase the condenser capacity because the e.m.fs. established across the inductance decrease as the condenser capacity is increased and the arrangement ceases to become efficient; moreover,

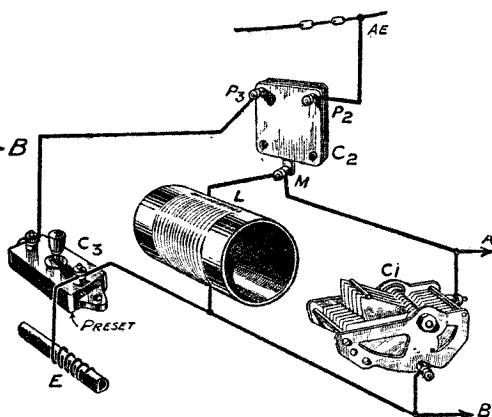

Fig. 50—Pictorial form of Fig. 49. A preset condenser is inserted where shown to replace the aerial capacity

a larger condenser will be necessary, and this is not very practicable as an air dielectric condenser is already large, and there would be the additional difficulty of obtaining a fine adjustment of the condenser for tuning purposes.

When it is desired to cover a band of longer wavelengths, such as from 1,000 to 2,000 metres, it is usual to have a separate inductance which may be switched into circuit in place of the coil used for the medium wavelengths. There are three ways of switching this coil into circuit. It may be (a) connected as an entirely separate coil, the medium waveband coil not being used at all, or (b) it may be connected in series with the medium waveband coil so that the two coils together add up to provide the equivalent of a single large inductance, or (c) the two coils may be arranged so that for long wavelengths the long-wave coil is used alone, whereas when it is desired to switch on the medium waveband the smaller coil is connected in *parallel* with (i.e., across) the long-wave coil. This brings down the total inductance to something less than the smaller of the two coils. Of these three methods the last is, perhaps the most efficient but not the most convenient, and a series arrangement is usually employed, as is illustrated in Fig. 51, and pictorially in Fig. 52, a commercial coil being used. Here we have a switch *S* connected across the inductance *L*₂, which is a separate long-wave

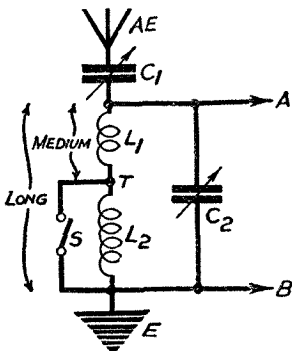

Fig. 51—A simple waveband switch which shorts the long-wave coil

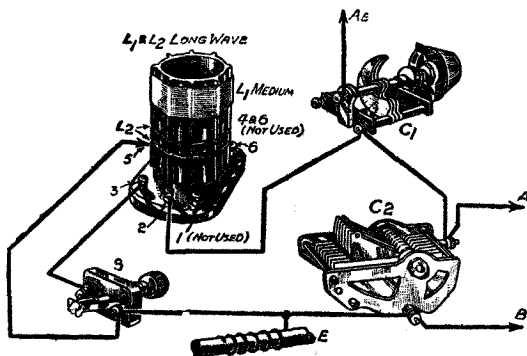

Fig. 52—Illustration of typical commonly-used components wired to conform to Fig. 51

coil usually wound with finer wire than the coil L_1 , which is the medium-wave coil. When the switch S is closed, the long-wave inductance L_2 is short-circuited, leaving the coil L_1 for medium-wave reception. When the switch S is open, the inductance L_2 is in series with L_1 and the set is now tuned to the long waveband.

A similar form of switching is illustrated in Fig. 53 (and pictorially in Fig. 54), a tapping T_1 being now used to obtain greater selectivity on the medium waveband. This tapping may conveniently be half-way along the smaller inductance L_1 . When the switch S is closed, the inductance L_1 is shunted by the condenser C_2 , and selectivity is obtained both by the

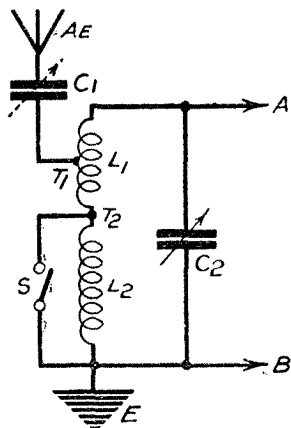
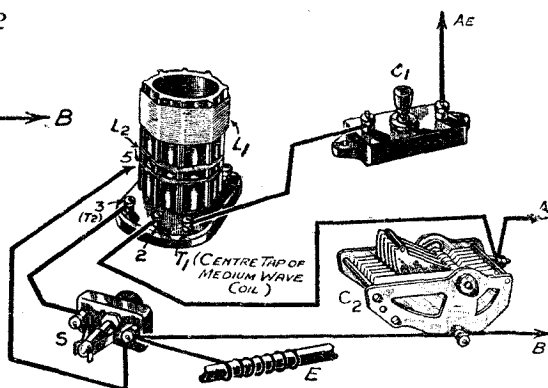

Fig. 53—Selectivity is obtained especially on long waves by C_1

Fig. 54—Pictorial form of the circuit given above



tapping on the coil L_1 and by the use of the variable condenser C_1 , which may be either a preset variable (i.e., semi-variable) or a solid dielectric variable condenser, if it is not desired to use an ordinary air dielectric variable condenser.

Although the tapping T_1 will definitely give greater selectivity on the medium waveband, the position is altered when the coil L_2 and L_1 are used together for the reception of long waves, because now the position of the tapping is equivalent to being very high up on the single long-wave coil, and therefore the degree of selectivity obtainable is less. On the long wavelengths, therefore, most of the selectivity comes from the fact that a condenser C_1 is in the aerial lead. A merit of the Fig. 53 arrangement lies in the fact that the condenser C_1 can be set at approximately the same value for the same amount of selectivity on long and medium wavelengths, whereas in the case of the Fig. 51 circuit it will be found that a larger value of capacity is required for the longer wavelengths

to give a similar compromise between strength and selectivity. The reason for this is that a given capacity in the aerial lead will offer a much higher reactance (i.e., opposition) to the longer wavelengths.

Fig 55 shows the equivalent of Fig. 53 with the switch S closed. It will be seen that we ignore the long-wave inductance which has been short-circuited. Fig. 56 is the Fig. 53 arrangement with the switch open showing the medium and long-wave coils in series.

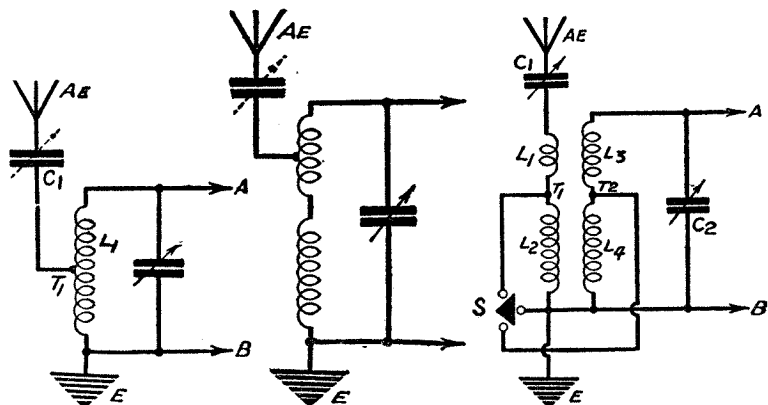

Fig. 55—Equivalent circuit when on medium waves

Fig. 56—Conditions when receiving long waves. Coils are in series

Fig. 57—How a three-point switch is used with H.F. transformer

H.F. Transformer Switching.—A slightly more complicated switching arrangement is necessary when aperiodic transformer coupling is used. Fig. 57 shows how a three-point switch S may be used to short-circuit the long-wave windings simultaneously. The switch consists of three contacts which are brought into contact with each other by the movement of a knob; a push-pull switch is frequently used for this purpose, all three contacts being brought together when the switch is pulled out. (Sometimes one of the contacts is permanently connected to the moving metal part, but this makes no theoretical difference to the circuit.) When the switch is open, the aerial current goes through the condenser C_1 , through the primary inductance L_1 , through the primary inductance L_2 , and so to earth. The secondary inductances L_3 and L_4 are also in series, the inductance L_3 picking up the current from L_1 , while L_4 picks up that from L_2 . The effect, therefore, is the same as if L_1 and L_2 were one single inductance coil coupled to another single inductance coil. This is the arrangement for long-wave reception. When, however, the switch S is closed, the inductance L_2 is short-circuited and L_4 is simultaneously short-circuited. This leaves

simply the inductance L_1 in the aerial circuit and the inductance L_3 in the secondary circuit. The arrangement is now ready for medium-wave reception. It will be noted that the bottom end of the inductance L_4 is connected to earth. It is common practice to connect one side of a secondary circuit to earth and in the present case it enables us to use a three-point instead of a four-point switch. Fig. 58 is a pictorial equivalent of Fig. 57 using a commercial type of coil.

To obtain a proper transfer of energy from the primary to the secondary circuit, more turns are necessary in the primary winding when receiving long wave lengths, but this arrangement is not always used, and a single coil may be employed with quite good effect as a

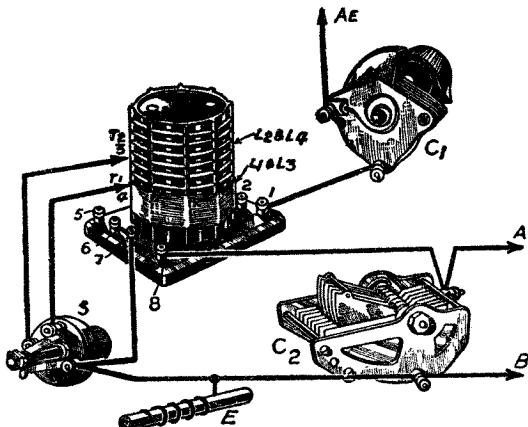

Fig. 58—The above pictorial form of Fig. 57 shows how both long-wave coils are shorted

primary winding, provided it is more tightly coupled to the long-wave secondary than to the medium-wave secondary. Fig. 59 shows a circuit in which the inductance coil L_1 is coupled to both L_2 and L_3 . In practice, L_2 and L_3 are usually wound on a cylindrical former, with the coil L_1 wound in slots between the two windings, so that it will affect both. When the switch S short-circuits the coil L_3 , known as the long-wave winding, the incoming signals only influence the medium-wave winding L_2 . But when the switch S is open, the coil L_1 affects both L_2 and L_3 . These two latter coils are wound in such directions as to help each other and so really form one single coil; so that when receiving long waves, the coil L_1 is virtually coupled to a single long-wave winding. Fig. 60 is a pictorial form of Fig. 59.

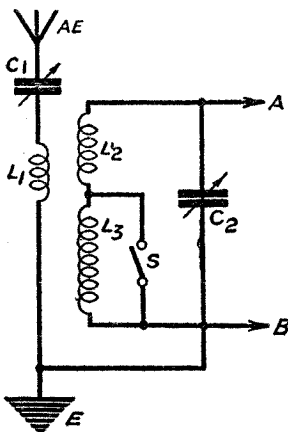

Fig. 59—An aperiodic-coupled circuit with wave-change switch

Special Tapping.

—A simple but effective method of wave-change switching, so as to preserve a middle tapping on both the medium-wave coil and the long-wave coil, is illustrated in Fig. 61. The inductance coils now consist of a winding L_1 which constitutes half the

medium-wave inductance, a long-wave coil L_3 , and another coil L_2 , which represents the other half of the medium-wave coil. The aerial is connected through the condenser C_1 , to the middle point of the inductance L_3 , and this middle point is also connected to one of the points of a three-point switch S , the other two points of which are connected to the ends of L_3 .

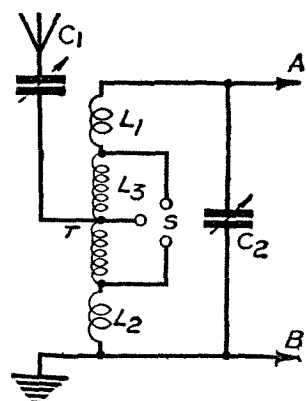

Fig. 61—Scheme for ensuring a middle tapping on both wavebands

medium-wave inductance, a long-wave winding L_3 , and the portion below the tapping T —are short-circuited, so that the aerial is connected to a half-way point between L_1 and L_2 . This, of course, is equivalent to a middle tapping on a single medium-wave coil; the inductance L_3 , being short-circuited, can be ignored. The same idea may be used for "wave-changing" H.F. transformers.

Loose-Coupled Receiving Sets.—The circuits so far considered are simply variations of a single circuit consisting of inductance and capacity, and the maximum selectivity is theoretically only that produced by an inductance and condenser by itself freed from the damping effect of an aerial. Much greater selectivity, however, is obtainable if two tuned circuits are brought together so that

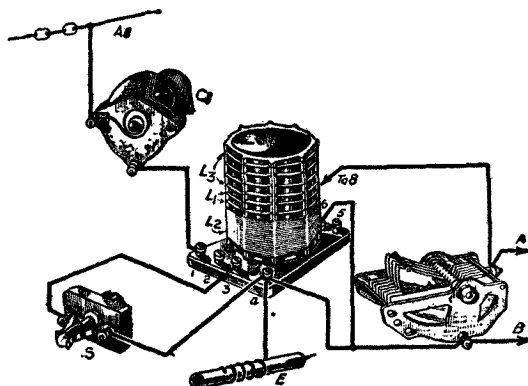

Fig. 60—Pictorial form of the preceding circuit which employs a single aerial coil for both wavebands

each is resonant to the incoming frequency, the first circuit passing on the current to the second.

Fig. 62 shows a simple aerial circuit $L_1 C_1$, with an aerial feed condenser C_3 in the aerial lead. The inductance L_1 is coupled to a secondary inductance L_2 which has across it a variable condenser C_2 . The terminals $A B$ are taken to the detector or amplifier belonging to the remainder of the receiver, with which we are not concerned at this stage. The circuit $L_1 C_1 C_3$ is tuned by means of C_1 , so as to build up oscillations due to the desired waves, and these oscillations going through the

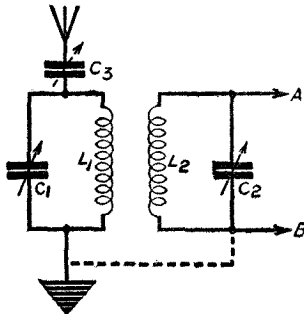

Fig. 62—Loose-coupled input tuner for selectivity

inductance L_1 will set up a fluctuating magnetic field which will influence the inductance L_2 , and set up similar currents in the circuit $L_2 C_2$ —but only provided that circuit is also tuned to the incoming signals. The condenser C_3 may be of the preset

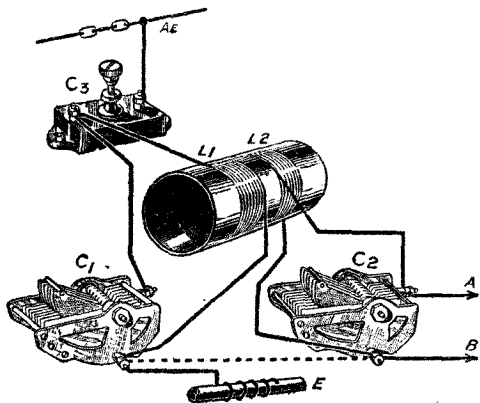

Fig. 63—Components arranged to conform to the Fig. 62 loose-coupled tuner system

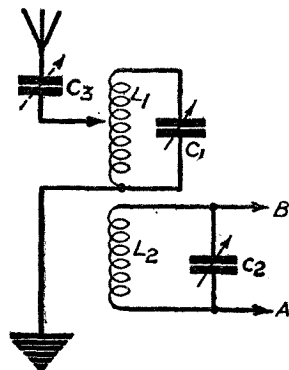

Fig. 63a—Further selectivity is obtained by tapping the aerial coil

type, and the circuit is shown pictorially in Fig. 63.

Resonance Curves.—A very convenient way of illustrating the selectivity of a tuned circuit is by means of a resonance curve. This is obtained by feeding the tuned circuit with high-frequency current, to which the circuit is accurately tuned. The current flowing in the circuit is now measured in some way, and further measurements are taken to find out the strength of the current when the frequency is altered by certain fixed amounts. Fig. 64 and

Fig. 65 show two approximately-drawn resonance curves; the first is for a single tuned circuit and the second for two circuits coupled together.

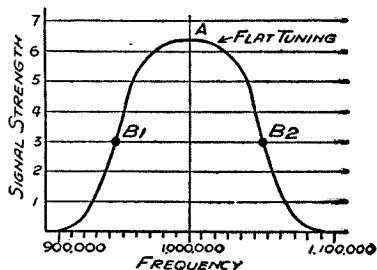

Fig. 64—Resonance curve of single circuit giving poor selectivity

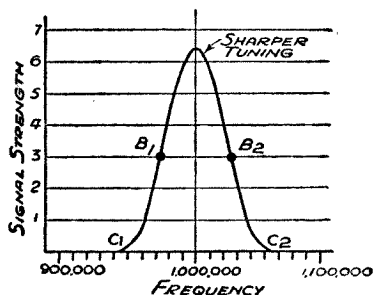

Fig. 65—Curve showing overall selectivity of two tuned circuits

These are not actual resonance curves but are drawn to show approximately what a resonance curve is like. It has been assumed that the incoming frequency is 1,000,000, corresponding to 300 metres. The height of the curve is an indication of the strength of the current flowing in the tuned circuit, or in the case of Fig. 65 of the current flowing in the second tuned circuit. The figures on the left-hand side of each drawing (or *graph*) indicates signal strength, i.e., the current actually flowing in the circuit; but the scale is arbitrary, i.e., it does not represent, say, microamperes, but is just a convenient way of showing different strengths.

The currents supplied are of constant strength, but it is assumed that we have a means of varying their frequency. When the frequency is 1,000,000 the maximum current of just over six is produced in the tuned circuit, and one therefore makes a mark at the point A on the graph. As we increase the frequency in steps we find a falling-off in the current produced in the tuned circuits, and by measuring this current at different frequencies and marking it on the graph we get a down-hill curve. If now we decrease the frequency *below* 1,000,000 we will also get a falling-off in the current set up in the tuned circuit. The reason for the falling-off, of course, is that the circuit is tuned to 1,000,000, and therefore will respond fairly readily to the frequencies very close to it; other frequencies will produce some result because the currents are being forced into the circuit, but the currents will be weaker. The more sharply a tuned circuit is the more it will object to having different frequencies pushed into it, and therefore these currents due to frequencies other than the resonant frequency will be greatly reduced.

By looking at a resonance curve we can see how selective a circuit is, the broader a curve is, the flatter the tuning and the

greater will be the interference experienced. The tuning of a single circuit having a resonance curve similar to that in Fig. 64 is very flat, while a resonance curve such as that of Fig. 65 shows much greater selectivity and less interference from frequencies differing from 1,000,000; the curve has a sharper peak, although the example given does not, even now, show a high degree of selectivity.

The resistance of a tuned circuit causes flat tuning and poor selectivity. By resistance one means various losses which occur in a tuned circuit, and these are principally the high-frequency resistance of the coil and the dielectric losses in the condenser. A nearly perfect inductance coil shunted by a nearly perfect condenser would naturally produce a very sharp curve and give a very high degree of selectivity.

A great deal can be done to sharpen the selectivity of a single tuned circuit, but the use of coupled circuits is a very popular method of sharpening tuning.

In a circuit of the Fig. 62 type, it is some advantage to be able to vary the coupling between L_1 and L_2 , i.e., the primary and secondary winding. The further these coils are apart the less will be the coupling (called *mutual inductance*), and the sharper will be the overall resonance curve of the two circuits. If the coupling between L_1 and L_2 , however, is made too loose, there will be a great loss of signal strength, whereas if they are too tight tuning will be broad, signal strength will fall off, and other complications arise. To get the best selective results the couplings should be as loose as possible without producing excessive reduction of signal strength.

It is not now customary to have an adjustable coupling between L_1 and L_2 , for various practical reasons. One big disadvantage of a variable coupling is that a movement of either coil will alter the tuning of each circuit and a great deal of fiddling becomes necessary in order to tune correctly. It is much more usual to find the two coils fixed at a suitable distance from each other so as to produce a reasonable peak on the resonance curve.

Band-pass Tuning.—Coupled circuits are sometimes called band-pass filters, because the idea is that they shall only pass a certain band of frequencies and that other frequencies will produce no appreciable response. The ideal band-pass tuner would respond equally to a narrow band of frequencies, say 4,500 cycles per second above and below a middle point corresponding to the frequency to which the band-pass tuner is tuned. This effect may be obtained to a certain extent successfully by taking advantage of a peculiar property of a coupled circuit of the kind given in Fig. 62. If L_1 and L_2 are closely coupled it will be found that the resonance curve of the arrangement does not consist of a single

peak, as in Fig. 65, but as a peak with a dent in it, as shown in Fig. 66. There are really two peaks fairly close together. The tighter the coupling between the coils (i.e., the closer they are together) the further apart will be the two humps or peaks, whereas the looser the coupling the closer will be the humps until finally they merge together into one single peak. Between the two extremes of the single peak and the double hump there is an intermediate resonance curve similar to that of Fig. 66, where to all intents and purposes, the resonance curve has a broad peak at the top and steep sides. This means that the so-called *band-pass* arrangement adjusted to give this kind of square peak is responding to 5,000 cycles above or below the incoming frequency.

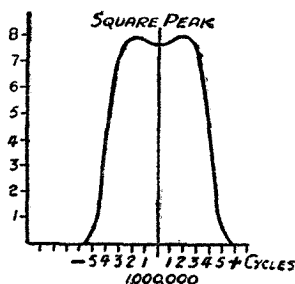

Fig. 66—Suitable coupling produces a band-pass tuning effect.

It might be asked why it is desired to produce a tuner to respond to any frequency but the desired one (in our example 1,000,000). The answer is that the high-frequency current set up by the reception of wireless broadcasting consists of a band of frequencies and not merely the carrier or main frequency. The subsidiary frequencies are called side-bands and are waves of different frequencies. A broadcasting station usually radiates a band of frequencies 10,000 above and below the main carrier-wave frequency. An L.F. note of, say, 3,000 would produce side frequencies of 1,003,000 and 997,000.

If the receiving circuits are so selective that they will only respond to the carrier-wave and frequencies one or two thousand above and below it, then we shall lose the frequencies corresponding to the higher notes in the speech or music being broadcast. Methods may be adopted, however, for using ultra-selective circuits and then compensating for the reduction of the high notes. Meanwhile, however, we will simply consider coupled circuits and band-pass arrangements. The simple double-circuit tuner of Fig. 62 may be modified in a score of different ways, and a few examples of different methods of coupling two tuned circuits will now be given.

Fig. 63a shows the same arrangement as Fig. 62, except that a tapping has been taken off the aerial inductance L_1 and preset condenser C_3 inserted in the aerial lead. It will be obvious that any of the simple aerial circuits previously described may be employed, by simply coupling in some way or another a secondary circuit (sometimes called a closed circuit).

Auto-Couplings.—Instead of having two separate inductances coupled together it is possible to use a single inductance which is common to both aerial and closed circuits, and Fig. 66a shows

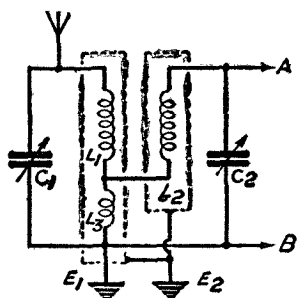

Fig. 66a—Auto-coupling using inductance common to both circuits

an example of this, the inductance L_3 forming part of the aerial circuit $L_1 L_3 C_1$, and also of the closed circuit $L_2 L_3 C_2$. If the aerial current has to pass through L_3 , there are set up potentials across L_3 , and these will energise the closed circuit $L_2 L_3 C_2$. The larger the inductance L_3 the greater will be the coupling effect, and this is equivalent to bringing the two coils in our original circuit closer together. If, however, the inductance L_3 is made smaller, the coupling between the two circuits will be weaker

and therefore the selectivity will be greater and a sharper resonance curve obtained. If the coil L_3 consisted, for example, of only one turn, there would be practically no coupling between the two circuits.

A point should be noted here that the amount of coupling provided by the inductance does not simply depend upon the number of turns of the inductance itself, but upon the frequency of the broadcast signals received. If the incoming signals are of short wavelength and thus produce currents of higher frequency, quite a small inductance coil will provide a strong coupling between the two circuits; but if we now switch the receiver over to the long waves, the same inductance coil will provide less coupling. The reader will appreciate that for a given inductance coil the potentials established across it will be much less the lower the frequency of the current.

In circuits of the Fig. 66a type and, in fact, in nearly all coupled circuits, it is better to *screen* the coils (i.e., cover them with metal canisters which are themselves earthed). This prevents undesired couplings between the coils.

Capacity-Coupled Circuits.—Instead of having a common inductance, we can use a common capacity to couple the two circuits, and Fig. 66b is a typical example of this popular arrangement. Its pictorial equivalent is given in Fig. 66c. It will be seen that there is an aerial circuit $C_3 L_1 C_4 C_1$, and a closed circuit $L_2 C_4 C_2$. These two circuits "share" the condenser C_4 , which has a capacity of about $\cdot 06$ mfd. It is usual to employ a non-inductive condenser in this position to ensure that it will act as far as possible as a capacity.

The three condensers in the aerial circuit all act in parallel with L_1 . First of all, the condenser C_1 is in series with C_4 , these two condensers being theoretically replaceable by a variable condenser of slightly smaller capacity than C_1 . We then have in addition two capacities, viz. C_3 and the capacity of the aerial in series with each other and capable of being replaced by a variable condenser connected in parallel with C_1 . The secondary circuit is likewise theoretically capable of simplification.

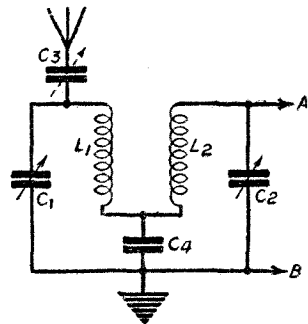

Fig. 66b—Capacity-coupled band-pass arrangement with large condenser common to both circuits. Coils are not coupled

The condenser C_4 has the effect of reducing the maximum capacity of C_2 . Since, however, C_4 has a large capacity, it makes little difference to the tuning range provided by the two variable condensers C_1 and C_2 . Nevertheless, since the aerial currents pass through C_4 , they will set up potentials across it which will energise the closed circuit $L_2 C_4 C_2$. The larger the capacity of C_4 , the weaker will be the potentials established across it and therefore the coupling effect will be reduced. This is equivalent to moving the coils farther apart in the previous *inductively-coupled* arrangement of Fig. 62. If, on the other hand, the condenser C_4 of Fig. 66b is reduced in value, the potentials established across it will be greater at all frequencies and the coupling will be stronger. A reduction of capacity will increase signal strength but reduce selectivity, whereas an increase of capacity will reduce signal strength and improve selectivity. We are here "up against" the usual compromise.

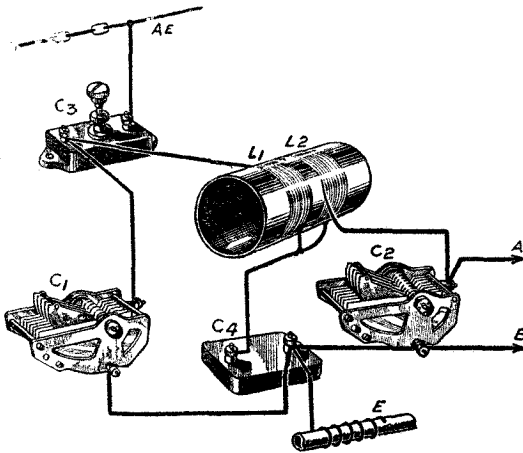

Fig. 66c—Pictorial form of Fig. 66b. A preset aerial condenser gives greater selectivity on the aerial circuit

In all inductively-coupled circuits, whether of the loose-coupled

type using separate coils or the auto-coupled arrangement of Fig. 66a, the effective coupling is greater as the frequency of the signals increases, i.e., for shorter wavelengths. The opposite effect is obtained in capacity-coupled circuits. Assuming we keep the condenser C_4 unaltered, the coupling effect will be less as the frequency is increased and *greater* as the frequency is decreased. In other words, there will be more coupling on the longer waves than on the shorter. It is the exact reverse in the case of the inductively-coupled circuit. It is possible, however, by combining capacity and inductive coupling to make the two effects level out so that the circuit behaves in a similar way whatever the frequency received may be. Some suitable schemes are described later.

Meanwhile, it is interesting to look at Fig. 67, which shows the

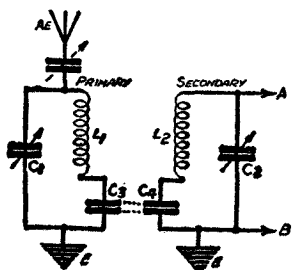

Fig. 67—Shows how capacity-coupled circuit can be resolved into two circuits

Fig. 65 arrangement divided into two separate circuits. This is for the purpose of showing how the condenser C_4 is really part of both of the circuits. The condenser C_4 now becomes C_3 in the aerial circuit, and C_4 in the secondary circuit.

Fig. 68 is another modified capacity-coupled circuit, in which an aerial tapping is employed, while Fig. 69 shows an aperiodic aerial coil L_1 coupled to L_2 . It has already been explained that any kind of aerial circuit may be used

on coupled circuits and the reader should be capable of building up a large variety of circuits.

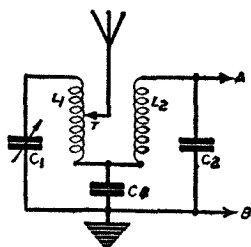

Fig. 68—Capacity-coupled band-pass with tapped aerial coil

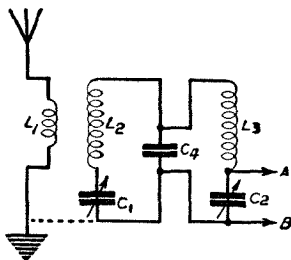

Fig. 69—Here the capacity-coupled band-pass circuit is supplemented by aperiodic aerial coupling

Electrostatic Coupling.—We have so far considered the use of a large capacity common to both circuits, but it is possible to produce capacity coupling by the arrangement shown in Fig. 70, where a very small condenser C_4 , which may have a value of

000005 mfd., is connected across the top ends (i.e., remote from the earth) of the two tuned circuits, the bottom ends of the circuits being joined together by a wire. The potentials established across $L_1 C_1$ are now communicated through C_4 to the circuit $L_2 C_2$, and this arrangement is sometimes known as *electrostatic coupling*.

The greater the capacity of the condenser C_4 the greater will be the coupling between the two circuits, but it is important to screen the primary from the secondary circuit to avoid any stray coupling which would interfere with the coupling effected by C_4 . If we keep C_4 fixed, the coupling between the two circuits will increase with the frequency of the signals to be received. In other words, the coupling will increase as the frequency increases. This is the exact opposite of the effect obtained with the capacity-coupling system of Fig. 66b. It has therefore been suggested that the two systems could be combined together with advantage in a band-pass unit, and this arrangement is shown in Fig. 70 where coupling is carried out both by the larger condenser C_4 and the very small condenser C_3 .

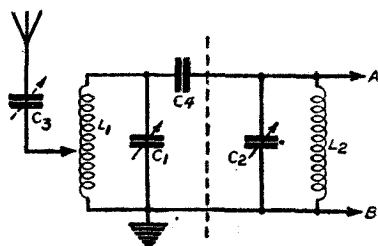

Fig. 70—Electrostatic coupling by means of very small condenser between tops of coils

Mixed Couplings.—Since inductive couplings are most effective on the shorter wavelengths, and the capacity couplings on the longer wavelengths, a simultaneous use of both methods suggests itself and gives good results. It is to be noted that the different degree of coupling is not only noticeable when changing over from the medium waveband to the long waveband of a broadcast receiver, but even as one tunes to a different wavelength on either waveband; thus, the effect at the top end of the tuning condenser will be different from that at the half-way position or at the bottom end. The difference in coupling is particularly a disadvantage in band-pass circuits where it is desired to keep the band of frequencies passed constant at all wavelengths. There has consequently come into wide use mixed couplings in band-pass circuits, and Fig. 71 is a very typical example. Not only are the primary and secondary circuits coupled by means of a condenser C_4 common to both, but the inductance L_1 is coupled to the inductance L_2 . It requires, of course, considerable accuracy in the design of the two couplings to obtain a suitable band-pass effect at different frequencies. Another popular circuit is that of Fig. 72 where the inductive coupling is now obtained by a *link* circuit which consists of two

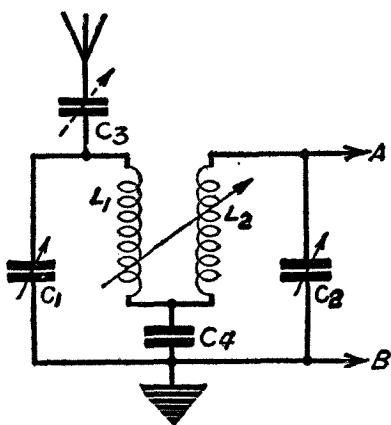

Fig. 71—Mixed band-pass filter. Transfer is by capacity and also by inductive coupling

and C_3 provide the couplings.

Resistance Coupling.—A special form of loose-coupled tuner is illustrated in Fig. 74, the aerial circuit being coupled to the secondary circuit by means of a resistance R of about 100,000 ohms. This is a non-inductive resistance and serves as a means of communicating the potentials established across

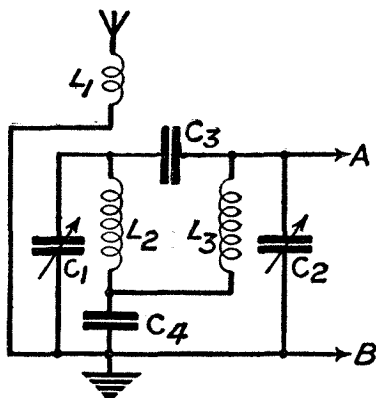

Fig. 73—A mixed capacity-coupled band-pass filter with an aperiodic aerial coupling coil

inductances in series, namely L_3 and L_4 ; L_3 is coupled to L_1 and the currents circulating in L_3 L_4 , which is an aperiodic circuit, are passed on to the secondary circuit by means of a coupling between L_4 and L_2 . It is customary to arrange for the transformer L_1 L_3 to be screened in one metal can, while the transformer L_4 L_2 is enclosed by another screening can.

A mixed capacity band-pass arrangement is shown in Fig. 73, and has been previously described. The condensers C_4

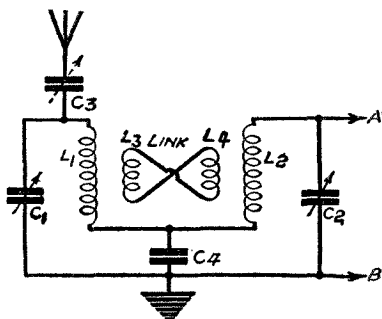

Fig. 72—Another form of mixed band-pass filter, a link providing inductive coupling

L_1 C_1 to the circuit L_2 C_2 . The degree of coupling depends upon the value of the resistance R . The greater this resistance the less will be the coupling, and the more selective the circuit. This arrangement is theoretically independent of frequency for its operation, the coupling being approximately the same for all wavelengths. It is usual in such coupled circuits to enclose the inductances in separate

shielding cans to prevent any coupling other than through the resistance R , because it must be remembered that two coils near to each other will influence each other both inductively and capacitively to some extent. In Fig. 75 a much smaller value of

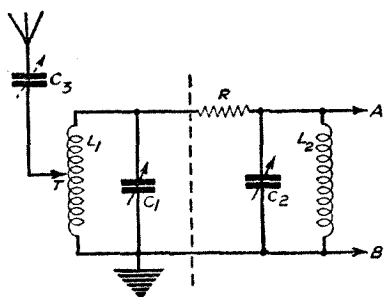

Fig. 74—Resistance coupling is effected by a resistance of about 100,000 ohms

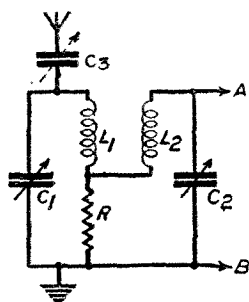

Fig. 75—An unsatisfactory arrangement in which a small resistance is common to both circuits

resistance R produces a coupling effect between the aerial and secondary circuits but the disadvantage of this arrangement is that the resistance R introduces losses into both circuits, thus reducing the selectivity of each circuit. In resistance-coupled circuits, as in all coupled circuits, the tuning will be sharper on the second circuit, while that of the first circuit will be comparatively flat, although it may be greatly improved by lessening the load of the aerial in the various ways already discussed.

CHAPTER 3

HOW THE VALVE WORKS

The whole technique of wireless was changed when the thermionic valve became popular during the war. Actually, however, the valve dates back to 1904, when Fleming applied a bulb containing a filament and a metal plate to the detection of wireless signals.

The word "valve" is a mechanical term which implies that gases or liquids can only flow through it in one direction. The valve of a bicycle tyre, for example, allows the passage of air into the tyre, but not out. It is thus a one-way device, and we have seen that one method of detecting wireless signals is to rectify them so that a varying high-frequency current is changed into an alternating current of low frequency or into a direct current fluctuating at low frequency.

A thermionic valve contains a surface of material which when heated will give off electrons, this surface (or *cathode*, as it is called) being surrounded or having near to it one or more other electrodes usually in the form of metal plates, grids, etc. Different kinds of valves are used for different purposes, and modern radio technology really consists in the various applications of different types to the reception or transmission of wireless waves.

The first type of valve to consider is the two-electrode valve or *diode*, as it is sometimes termed. This was the first type of valve used in radio, and it consists simply of a metal filament or cathode

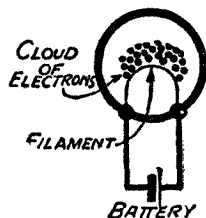

Fig. 76—Filament heated to incandescence and emitting electrons

and an *anode* usually in the form of a metal plate near to but not touching the filament. These two electrodes, the filament and the anode, are placed inside a glass bulb and the air removed. In modern valves a very high vacuum indeed is usually considered desirable and such valves are known as *hard* valves.

Electrons.—Fig. 76 is a theoretical diagram of a filament inside a vacuum, the filament being heated to incandescence, i.e., to red heat or white heat, by means of the current from a

battery. The leads to this battery are taken through the bulb in which the vacuum exists. This arrangement is really an ordinary vacuum lamp but, although we can see the light given off by the filament, something is occurring inside the vacuum which no one can see, but which becomes very important when we take advantage of it. This effect is known as *electron emission*.

All matter is supposed to be built up of atoms, and each atom consists of a central core and usually a considerable number of almost infinitesimally small particles called *electrons*. When a metal is heated there is a great deal of agitation which causes some of the electrons to be shot out of the filament. The hotter the wire the greater will be the emission of electrons. In an ordinary lamp the electrons are of no practical use and either return again to the filament or settle on the inside of the glass bulb. In the ordinary way an electron shot off from the filament will tend to return to it much in the same way as a stone thrown in the air will return to the earth. In Fig. 76 the electrons are shown as a cloud surrounding the filament. Instead of allowing them to go to waste we can collect them by inserting a metal plate inside the bulb close to the filament (as in Fig. 77) and connecting a battery across the

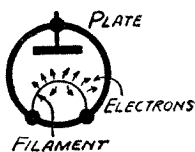

Fig. 77—Showing the introduction of a metal plate

plate and filament so that the plate is made positive with respect to the filament. The plate is now called an *anode*, and in Fig. 78 it will be seen that a flow of electrons

takes place from the filament to the anode round through the battery B₂, through the ammeter M (a direct-current measuring device) and so to the filament.

The flow of the electrons round the circuit constitutes an electric current and, since all electrons are negative charges, any positive potential or voltage on the anode will tend to attract the electrons emitted by the filament, and these attracted electrons will flow round the anode circuit of the valve. The strength of the anode current usually depends upon two things: first, the number of electrons emitted from the filament and, secondly, the voltage of the battery B₂ connected across anode and filament.

If, instead of connecting the positive terminal to the anode of the valve we reverse the battery, making the plate negative, we will have the arrangement shown in Fig. 79, and now the ammeter

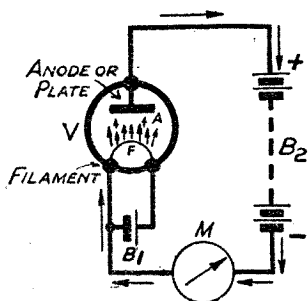

Fig. 78—Anode current is produced by applying a positive voltage to anode

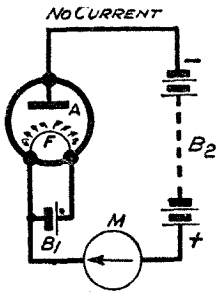

Fig. 79—No anode current is produced if anode is negative

M will register no current at all because the plate instead of attracting electrons will repel them. This is because the plate is negative and the electrons are also negative, and two similar charges will always repel each other. It will thus be seen that the valve containing a plate and incandescent filament will allow an electron current to pass from filament to plate but not from plate to filament. It is thus a valve.

Characteristic Curves.—To understand the operation of a two-electrode valve it is very useful to draw a *characteristic curve* in the form of a graphical representation of the effect of anode voltage on anode current. It has already been explained that as the anode voltage, i.e., the voltage of the battery B2 in Fig. 78 is increased, so will more and more electrons be drawn to the anode and therefore the anode current as measured by M will increase.

Fig. 80 shows a simple characteristic curve of a two-electrode valve. It will be seen that when there is no voltage on the anode there will be no anode current. As the anode voltage increases so does the anode current (shown in milliamperes, i.e., thousandths of an ampere, the unit of current), but a point is ultimately reached when a further increase of anode current produces practically no difference to the anode current.

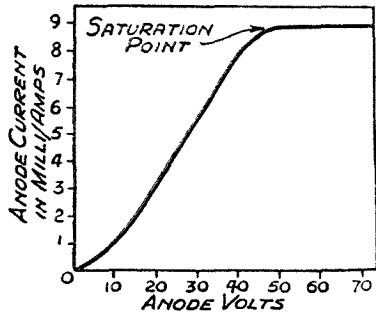

Fig. 80—Characteristic curve of diode showing effect of anode volts on anode current.

This point is known as *saturation point*, and occurs when all, or nearly all, of the electrons emitted from the filament are drawn to the anode. The only way of increasing anode current now is to increase the emission by applying a greater voltage to the filament of the valve and so heating it to a higher temperature.

Space-Charge.—It may be wondered why, when a high voltage is connected across anode and filament of the valve, the full electron emission is not at once passed from filament to anode. The reason is that the cloud of electrons surrounding the filament constitutes a very considerable negative charge which tends to repel any electrons emerging from the filament. The newly-born electrons, so to speak, find in front of them a mass of negatively-charged electrons which tend to repel it, and this repelling effect opposes the attractive force of the positive potential on the anode

By increasing the anode voltage, however, it is possible to counteract the repulsion due to space charge, and so an increased potential on the anode produces a larger anode current.

The unwanted electrons which are repelled by the space charge normally return to the filament ; and a good analogy is illustrated in Fig. 81, which is a mechanical representation of what goes on in the two-electrode valve.

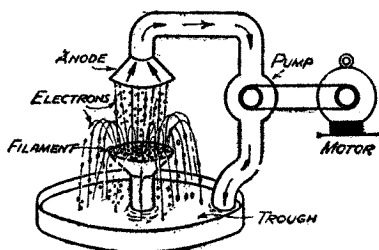

Fig. 81.—Shows a mechanical analogy in which a fountain sprays water

through a rose such as is used on a watering-can. The water is pumped up from a trough by means of a pump (not shown), which corresponds to the filament-heating accumulator of a valve

(usually called a *filament battery*). Above the rose is a funnel connected to a pipe which goes to a motor-driven pump which creates a strong draught of air which sucks up some water sprayed from the rose. This water follows the direction of the arrows and ultimately goes back into the trough. The motor-driven pump corresponds to the anode battery, the rose to the filament, and the funnel to the anode of the valve. It will be seen that the funnel does not suck up all the streams of water, although the greater the force of the motor-driven pump the more water will be sucked up into the funnel. The whole arrangement, therefore, corresponds very closely to what happens in the case of a two-electrode valve.

The Diode as Rectifier.—The *unilateral* conductivity of the valve (i.e., the fact that it conducts current in only one direction) is taken advantage of in various ways in modern wireless receiving apparatus. It is used for rectifying the alternating currents of our electrical mains and providing currents at suitable voltages for working our wireless receivers. It is also used for rectifying the high-frequency currents received in an aerial circuit—or more usually after several stages of magnification by another type of valve.

Fig. 82 illustrates a source of alternating current supply connected across anode and filament of the valve, a direct-current meter M being connected in the circuit. It will be seen that there is a deflection of the needle of the meter M due to the passage of the current through it, but this current will not be absolutely steady

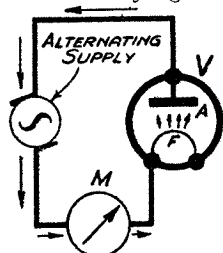

Fig. 82. — Illustrating diode acting as rectifier

and, direct but will consist of a series of pulses all in the same direction. The source of alternating current will make the anode of the valve alternately positive and negative at a frequency of, say, 50 times per second. When the anode is positive, an electron flow takes place from F to A, down through the alternating supply, through M and back to the filament. When, however, the anode is made negative, no current whatever flows in either direction.

To prevent the flow of direct current from being pulsating, we can store the pulses in a reservoir, and a large capacity condenser is

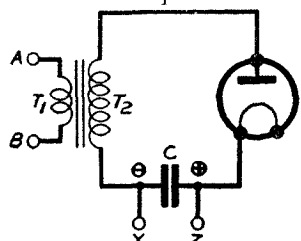

Fig. 83—Use of reservoir condenser to store rectified current

used for this purpose. Fig. 83 shows how a condenser C is charged up by means of a valve rectifier, which is fed with alternating current by means of the transformer T₁ T₂, the terminals A B of which are connected to the mains. By suitably designing the windings T₁ and T₂, any desired voltage may be applied to the valve rectifier. Here again, when the anode is made positive there is a flow of electrons from the filament to the anode round through T₂ and to the left side of the condenser C. The negative half-cycle makes the anode negative, and this produces no current in either direction. The condenser C stores the direct current pulses and lets the current out in a steady stream to the terminals YZ across which the output circuit is connected. The condenser C may have a capacity of 4 mfd. or more, and its action is rather similar to that of a reservoir of water which supplies a constant flow of water for household purposes but receives its own supply from streams and intermittent rainfall. If we had to rely for our water on streams, the supply would be very irregular; but if we allow the streams to run into a reservoir, we shall no longer be living, so to speak, from hand to mouth. A reservoir provides a current even during dry seasons which correspond to the negative half-cycles of alternating current.

High-frequency currents may also be rectified by the valves, and Fig. 84 shows a simple circuit in which the condenser C₂ is charged with rectified pulses of direct current, C₂ feeding the telephones T with current of a similar character to the microphone current at the transmitting station.

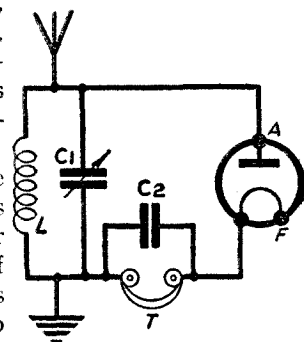

Fig. 84—Diode in use as a wireless detector

A more comprehensive account of the rectifying action of the diode is given in the chapter on detectors. The actual construction of a diode varies considerably with different makes. Fig. 85 shows one with a cylindrical anode. It will be seen that the filament is supported at the top by a spring to keep it tight when it expands under heat and at the bottom by an anchoring wire fixed into the glass *pinch*, as it is called. The anode in the form of a metal cylinder is also supported by a wire which is fixed in the pinch. Three leads go to the electrodes, a small portion of platinum wire being sealed in the pinch between the supporting wires and the leads. The platinum has the same co-efficient of expansion as the glass (i.e., it expands to the same extent with heat), and it is impossible for air to leak through the *seal*. Cheaper substances, usually metallic alloys such as nickel-iron, are commercially used instead of platinum. The portion of the valve which supports the electrode is usually called the *stem* and is made, first of all, from a *funnel* of glass, as shown in Fig. 86 (a). The supporting wires, together with the lead-in wires and the links of platinum, are passed

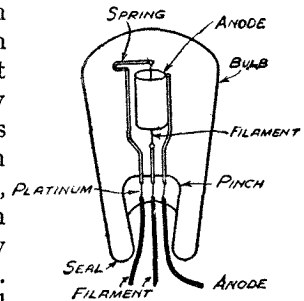

Fig. 85—Shows construction of simple diode valve

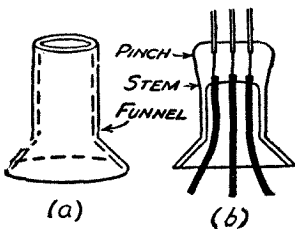

Fig. 86—The supporting wires are embedded in a glass "pinch"

through the funnel, which is then heated till the glass melts, the top of the funnel being then squeezed together, thus forming the pinch.

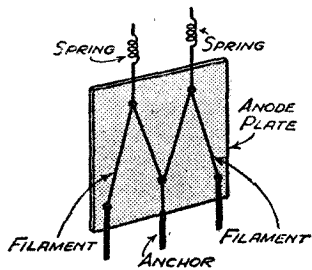

Fig. 87—Most modern valves have flat electrodes and zig-zag filaments

This is shown in Fig. 86(b). The electrodes are then mounted on the supporting wires. Sometimes the anode is in the form of a flat rectangular box in which a W-shaped or V-shaped filament is arranged. Fig. 87 shows one flat side of an anode with a W-shaped (or M-shaped) filament which may have a supporting anchor in the middle and springs to take up the slack when the filament expands due to the passage of a current through it.

Sometimes two diodes are mounted in the same bulb for full-wave rectification, which will be duly explained later.

CHAPTER 4

THE THREE-ELECTRODE VALVE

The two-electrode valve, although applied to wireless in 1904, proved of very little value when one considers the huge strides made when in 1907 Lee de Forest introduced a third electrode into the bulb. The three-electrode valve, or *triode* consists of a cathode, a grid, and an anode. The cathode in the case of battery valves is usually a filament heated by the current from an accumulator, while the grid can take many different forms. In the simplest

case the grid consisted of a zig-zag wire placed between the filament and the plate. Fig. 88 shows the symbol for a three-electrode valve and also the general position of the parts. The electrons pass between the filament and the plate, and in doing so have to travel

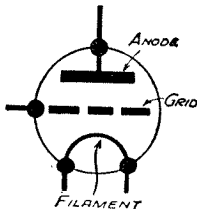

Fig. 88—Method of indicating a three-electrode valve

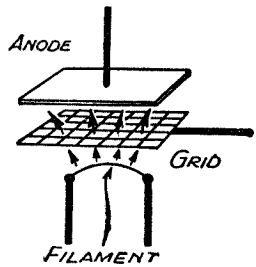

Fig. 89—Open mesh grid which controls electrons

between the wires of the grid.

Fig. 89 shows another arrangement in which the grid consists of a piece of wire gauze between filament and anode. In these arrangements the whole of the electron current does not come under effective control of the grid, and therefore it was proposed at

quite an early stage to form the grid and anode into cylindrical shape concentric, and surrounding the filament (Fig. 90). Most modern three-electrode valves, however, are arranged on the lines of Fig. 91, the filament consisting of a wire M-shaped (or

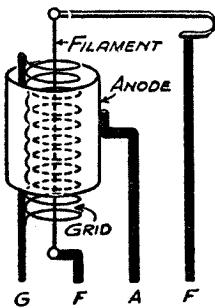

Fig. 90—Construction of cylindrical type of valve.

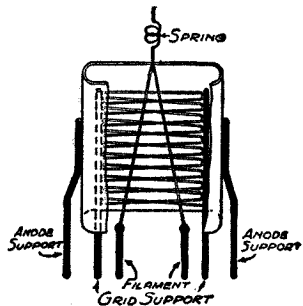

Fig. 91—A more modern construction of valve.

otherwise arranged to present as large a surface as possible) enclosed in a flat rectangular anode, while the grid is of similar general shape. In the case of valves for mains operation the cathode is usually indirectly heated and consists of a tube coated with electron-emitting material and heated by a filament which passes through the centre of the tube. Such valves require a different style of construction, but the general principle of all these valves is the same.

The introduction of the grid was not properly understood at first, but very soon it was realised that it served as a means of controlling the electron current from filament to anode. Fig. 92 shows a complete three-electrode valve circuit in which a battery B_2 of, say, 100 volts is connected across the anode and filament, a milliammeter being connected in the anode circuit so that we can note changes in anode current. The battery B_2 is usually termed the high-tension battery (usually abbreviated to H.T.). The low-tension battery B_1 is usually called the L.T.

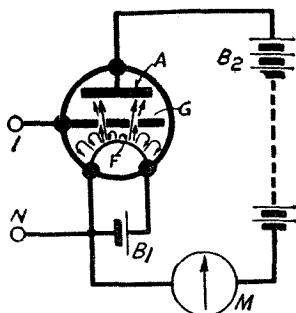

Fig. 92—The grid voltage controls the anode current of the valve

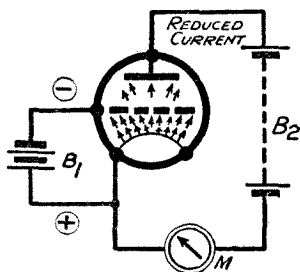

Fig. 93—A negative potential on the grid is reducing the anode current

It will be seen that an electron current is flowing from the filament to the anode and producing a medium deflection of the needle of M ; some of the electrons emitted by the filament are not sufficiently attracted by the anode and the space-charge already explained causes them to return to the filament.

If, now, we connect a battery across the terminals $I N$ of Fig. 92, we shall produce a change in the anode current of the valve, and this change may either be an increase or a decrease and its extent will depend upon the voltage applied across $I N$. In Fig. 93, for example, the battery B_1 is so connected as to produce a negative potential on the grid. This negative potential will repel negative electrons which otherwise would have gone to the anode, and therefore there will be a decrease of anode current. If, as in

Fig. 94, we increase the battery B_1 so that a high negative potential is given to the grid of the valve, all the electrons may be repelled and the anode current will fall to zero. It may be asked why the

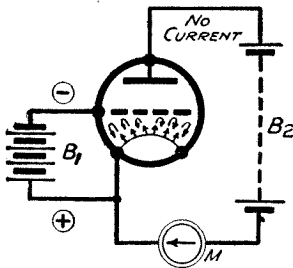

Fig. 94—Anode current cut off by large negative voltage

anode current should fall to zero when there is a strong positive potential on the anode. The explanation is that the grid is nearer to the filament than the anode and that its effect on electrons is therefore very much greater. The comparative effect of a given voltage on the anode and on the grid is known as the *amplification factor* of the valve. Thus, if one volt on the grid produces the same anode current change as ten volts on the anode, then the amplification factor of the valve is ten. By making the grid of very fine mesh and placing it close to the filament, amplification factors running into a thousand or two may be obtained in special valves.

If, instead of applying negative potentials to the grid of the valve, we apply a positive potential as shown in Fig. 95, then the anode current will increase, since the grid is now helping the anode to draw up electrons to it. The electrons, however, do not stop at the grid but shoot through the spaces in it; a few of them do, however, actually stop and set up a grid current which flows in the external circuit from grid to filament.

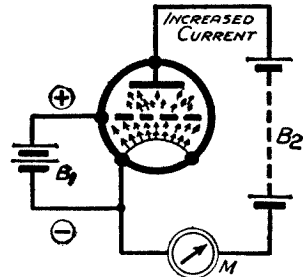

Fig. 95—Positive voltage on grid increases anode current

When, however, the grid is made negative there is no flow of grid current.

GRID VOLTS	ANODE CURRENT
-7	0 Milliampere
-5	4 "
-3	1.3 "
-1	3.6 "
0	5.0 "
+1	6.4 "
+3	8.7 "
+5	9.3 "
+7	9.4 "

Fig. 96—Table showing effect of different grid volts. A curve may be drawn from this

From this table we can construct a characteristic curve or graphical representation of the effect of grid volts on anode current in milliamperes. Such a characteristic curve is shown in

By using a *potential divider* or *potentiometer* (an arrangement using a resistance for adjusting voltage) and varying the voltage of the grid both in a negative and a positive direction, we can take a series of readings of the anode current and prepare a table such as that of Fig. 96.

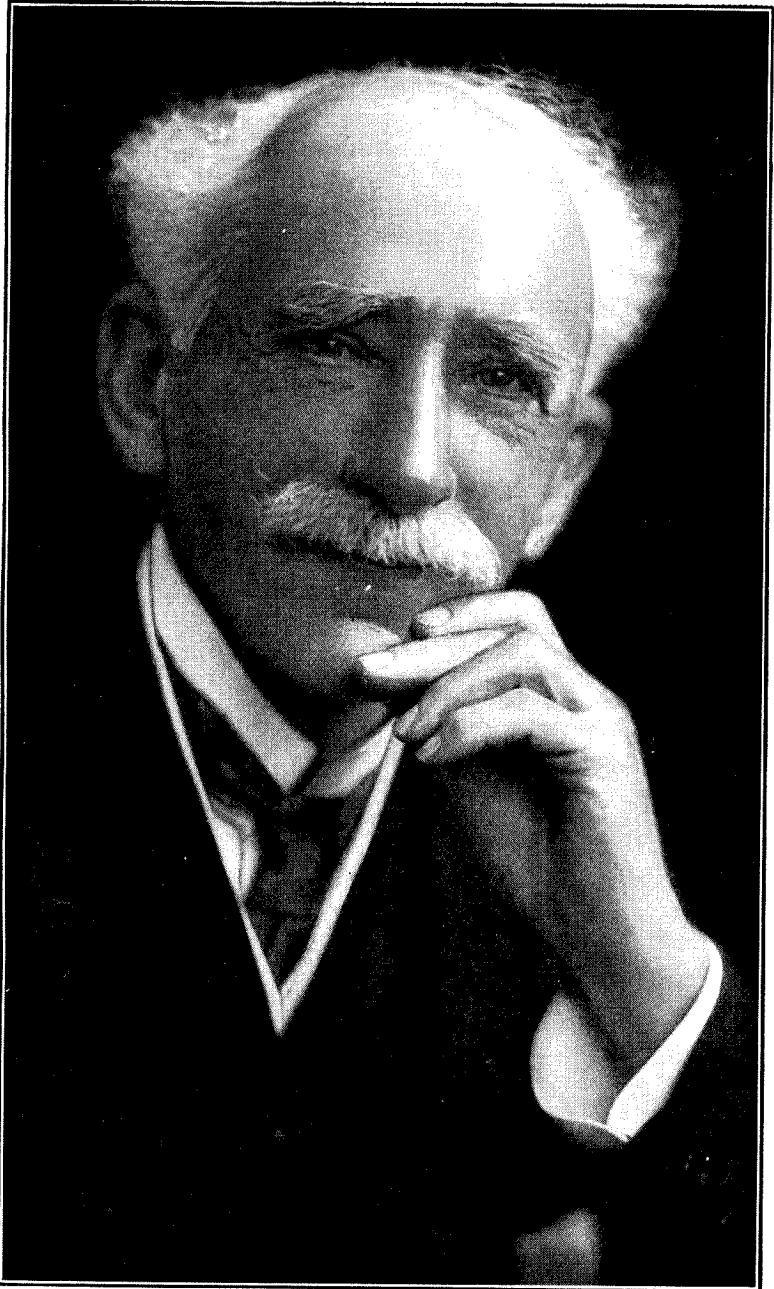

SIR AMBROSE FLEMING—INVENTOR OF THE DIODE VALVE DETECTOR.
Plate 5

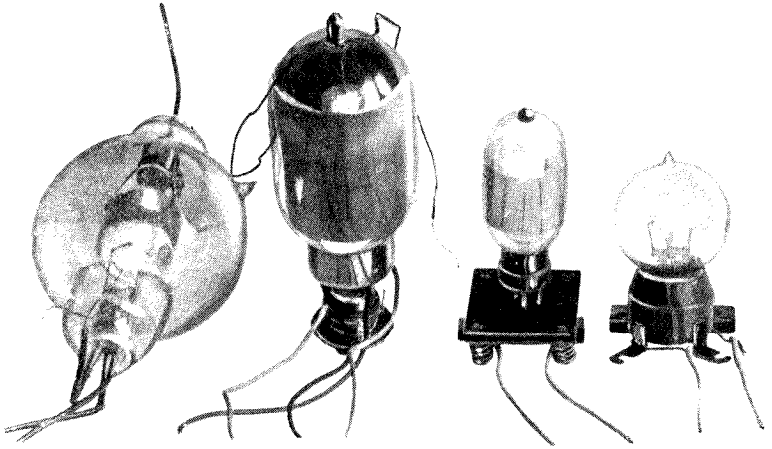

EARLY TYPES OF MARCONI VALVES

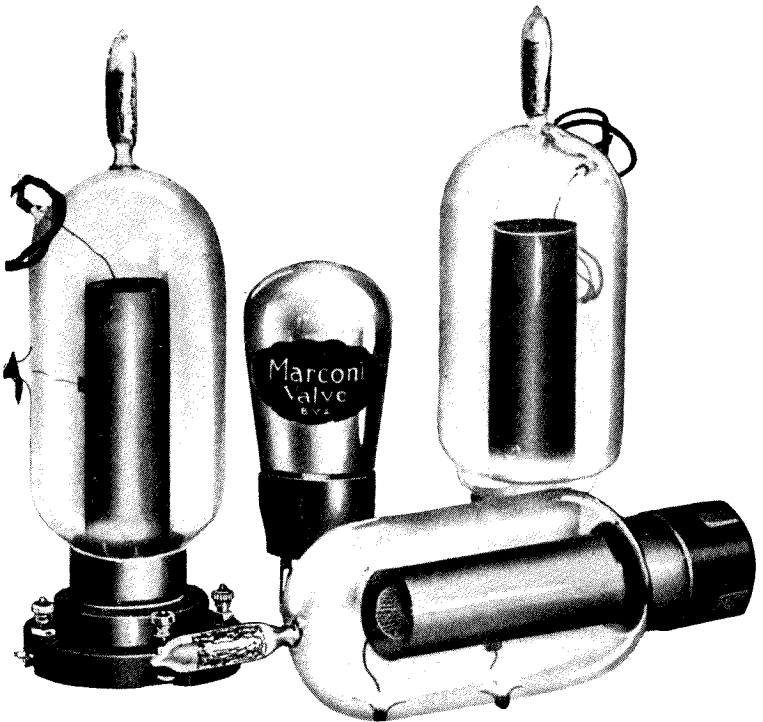

TYPES OF VALVES USED BETWEEN 1914 AND 1916 CONTRASTED WITH A MODERN TYPE

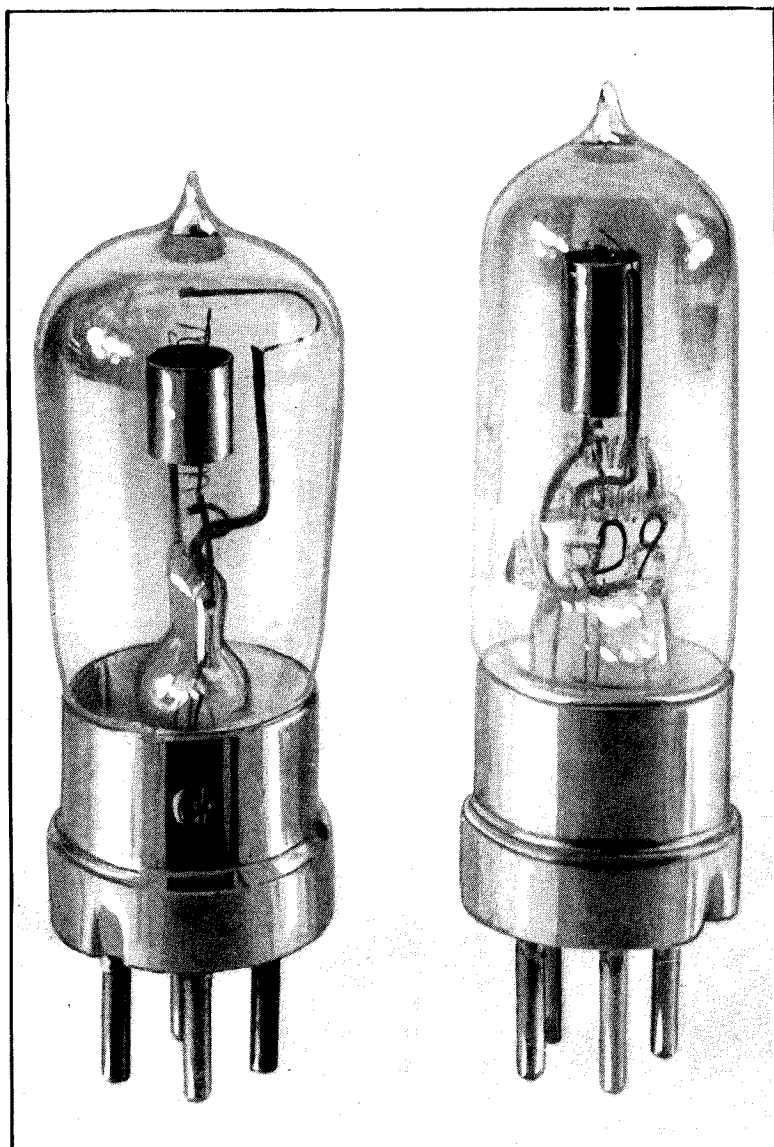

TWO OF THE EARLIER TYPES OF POST-WAR VALVES

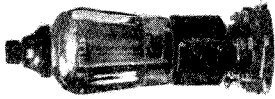

S.G. H.F.

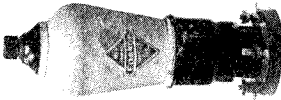

VAR. MU. S.G.

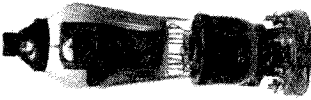

MAINS S.G.

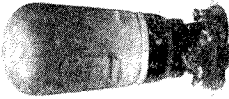

DETECTOR



MAINS DETECTOR



POWER



SUPER POWER

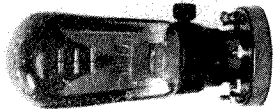

PENTODE

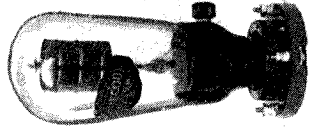

MAINS PENTODE

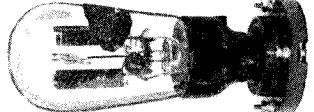

RECTIFIER

A MISCELLANEOUS SELECTION OF MODERN VALVES

Fig. 97, and is useful for illustrating what happens in a triode. It will be seen that the characteristic curve is straight or approximately so as regards its middle portion but at the bottom end it begins to bend as it approaches zero anode current. This is popularly known as the *bottom bend*, while the bend at the top end is known as the *saturation bend*. Saturation occurs in the triode when the grid is helping the anode to draw up a maximum number of electrons, and under these conditions practically the whole of the electrons emitted from the filament are going either to the anode of the grid, and therefore an increase of grid volts will produce no increase in anode current; it will, in fact, ultimately result in a decrease of anode current owing to the grid robbing the anode of some of its supply of electrons. The top bend is, however, of little importance these days. Modern filaments give such a copious emission of electrons that, in any case, saturation is not easily obtained.

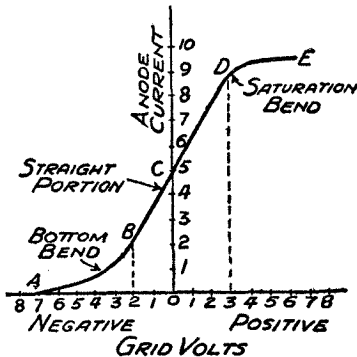

Fig. 97—Characteristic curve of a three-electrode valve

A Mechanical Analogy.—The previous analogy of a motor-driven pump which draws water from a rose, may be applied to the three-electrode valve, and Fig. 98 shows a mechanical arrangement which operates in a manner very similar to that of a three-electrode valve. We have now introduced a propeller or fan which is driven by a belt and may be caused either to produce an up-draught to help the suction exercised by the inverted funnel, or a down-draught which will tend to prevent any water being sucked up the funnel. When an up-draught is produced, this corresponds to a positive potential on the grid of the valve, while the down-draught corresponds to a negative potential on the grid.

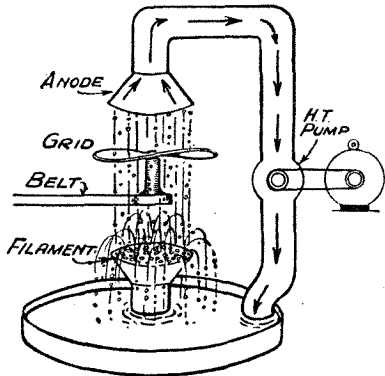

Fig. 98—A mechanical analogy to explain the action of the triode

Space-charge Theory.—The action of the grid may be explained on the space-charge theory which has already been touched upon. In Fig. 99 a cloud of electrons is shown between the filament and

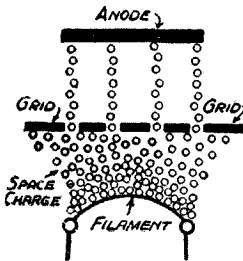

Fig. 99—A cloud of electrons form a space-charge

the anode, this cloud being more concentrated around the filament. The grid is close to this space-charge, and therefore any potentials on the grid will have a large effect on it. When the grid is made negative, more electrons are repelled into the space-charge, and this accentuates the difficulty electrons experience on leaving the filament. To them the anode seems very distant and of little attractive power, while the increased space-charge is very near, and overwhelming in its action. If, however, the grid is given a positive charge, this will attract electrons from the concentrated area and will largely counteract by its positive potential the repelling effect of the negative, space-charge. Different values of grid potentials will cause different variations of effect on the space-charge, and therefore on the current going to the anode.

Low-Frequency Amplification.—One of the earliest circuits used in connection with the three-electrode valve is that illustrated in Fig. 100, in which the rectified currents from the crystal detector *D* charge up a condenser *C*₂ and the fluctuating potentials across this condenser are applied across the grid and filament of a three-electrode valve acting as an amplifier. The varying grid potentials produce exactly similar anode current changes which operate the telephones. It is called an *amplifier* or *magnifier* because small voltage variations will cause large anode current variations, and the device, moreover is a *potential-operated* one; that is to say that the grid-circuit absorbs no energy in the ordinary case, and only requires potential variations to be applied to it. Consequently a 500-kilowatt dynamo giving 10 volts applied to the grid will not produce any greater change of anode current than a small 10-volt battery which could be held in the hand. The arrangement of Fig. 100 operates the valve as a *low-frequency amplifier* or L.F. amplifier. It is also called an *audio-frequency amplifier*, the word "audio" implying sounds one can hear. Fig. 100 is not a practical circuit.

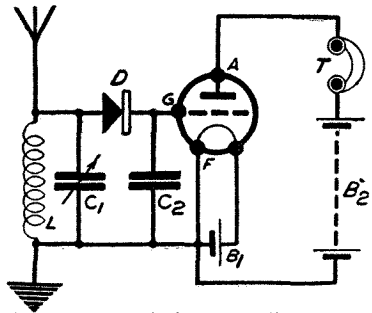

Fig. 100—Crystal detector followed by a simple L.F. amplifying valve

Stepping-up Voltages.—Since it is primarily voltage that counts in a low-frequency amplifier, it is a simple matter to step-up an

alternating current into one of higher voltage, and the circuit of Fig. 101 will give an improvement of several times over that of Fig. 100. In an arrangement such as that of Fig. 101 the low-frequency current variations passing through the primary T_1 of the step-up transformer $T_1 T_2$ produce similar variations of potential across T_2 , and these are applied across the grid and filament of the three-electrode valve.

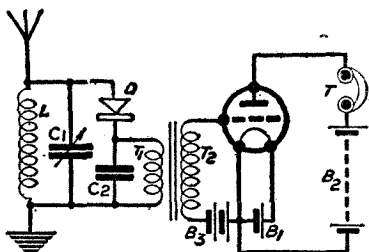

Fig. 101—A step-up transformer increases the voltages applied to the grid

The amount of voltage step-up is approximately the ratio of the turns of T_1 to the number of turns in T_2 . Thus, if T_2 has three times as many turns as T_1 , then the voltage across T_2 will be three times that across T_1 . The actual current in T_2 will, however, be small, since the transformer cannot multiply energy. An improvement feature of the circuit is the battery B_3 which is known as a *grid-bias battery*, and in practice has a value of anything up to 18 volts, according to the type of valve in use. The object of the grid-bias battery is to make the grid normally negative so that no grid current is set up when signals are being amplified.

It has already been explained that when a grid becomes positive a grid current is established and this grid current will introduce a load on the transformer secondary and will not only damp down signals but will cause a distortion effect ; for example, if the grid were normally at zero potential, positive half-cycles applied to the grid would cause electrons to be attracted to it. This would prevent the full positive half-cycle voltage being developed on the grid, although, of course, quite a considerable voltage would be applied to the grid and produce an increase of anode current. The effect of a negative half-cycle, however, would be greater, since no grid current would be set up and the full negative voltage would be developed. It has, therefore, come to be recognised as a first principle of low-frequency amplification that no grid-current shall be permitted, and this is ensured by giving the grid a negative bias (i.e., normal voltage) to start with, and never applying more input volts

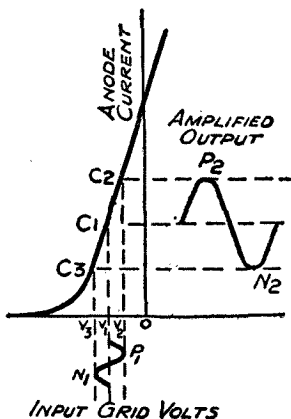

Fig. 102—Pure reproduction requires operation on the straight portion

than the voltage of the grid-bias battery; the grid consequently will never become positive.

The characteristic curve of the triode has already been explained, but it is reproduced in Fig. 102 to show the conditions under which low-frequency amplification takes place. The grid is given a negative bias of V_1 volts, the anode current now being C_1 . If an alternating potential is applied to the grid, the grid will first become more positive (although still negative) and then will become more negative than V_1 . In the figure, the applied alternating current is in the form of a complete cycle, i.e., a positive half-cycle followed by a negative half-cycle. The positive half-cycle at its peak value causes the grid volts to become V_2 , which is less negative than before. This causes a rise in anode current to C_2 . The negative half-cycle now causes the grid volts to become more negative and to reach V_3 . This causes a drop of anode current to C_3 . On the right of the diagram is illustrated an amplified output cycle of alternating current which is exactly the same shape as the input cycle, but larger. No matter what the shape of the input curve may be, the output curve will always be exactly the same, but will be a larger edition of it. The conditions for this state of affairs are that no grid current shall be set up and, secondly, that the used portion of the characteristic curve shall be straight. The portion C_3, C_1, C_2 in the example given is straight, but if we selected a more negative grid bias we should be operating at or near the bottom bend of the characteristic curve; not only would poorer amplification be obtained, but the changes of anode current for a positive half-cycle would be greater than that for a negative half-cycle and consequently the output would be distorted.

Class B Amplification.—The disadvantages of a grid current are very considerable, but by the use of a special transformer of low resistance and designed to supply *power* to the grid circuit of the L.F. amplifier, it is possible to overcome some of the disadvantages of a grid current and a special form of amplification known as Class B has been developed, and involves the establishment of grid current. The technique and theory of Class B amplification is discussed in a separate chapter.

L.F. Output Circuits.—Instead of having telephones in the anode circuit of a valve, we can, of course, use a loudspeaker, and since these are of various types it may be necessary to use a transformer to connect the anode circuit of the

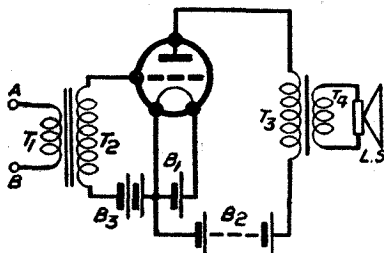

Fig. 103—Use of output transformer to match valve and speaker

valve to the loudspeaker in the most effective way (Fig. 103); the moving-coil type of loudspeaker, for example, requires a step-down transformer, converting the output current into low voltage heavy current electricity. There are various other types of output circuit and these are discussed in a separate chapter on low-frequency amplification.

Multi-Stage Amplification.—In place of a step-down output transformer, one could use a step-up transformer and apply the stepped-up voltages to another low-frequency amplifying valve. This is known as multi-stage amplification and is dealt with in a later chapter.

High-Frequency Amplification.—Since electrons in a valve containing a vacuum respond with extreme rapidity, and since the time taken for the electrons to pass from filament to anode is so very small, it is possible to amplify current of very high frequency indeed without any lag or delay. A positive or negative voltage applied to the grid of a valve, even though it be applied only for a fraction of a second, will produce an instantaneous effect on the anode current; we therefore can obtain effective high-frequency amplification (or *radio-frequency amplification* as it is sometimes called) and so strengthen the oscillations received before they are applied to a detector.

Fig. 104 shows a circuit in which a tuned circuit $L_2 C_2$ is connected in the anode circuit of the valve, while the H.F. potentials across the aerial circuit $L_1 C_1$ are applied across grid and filament; if desired, a grid-bias battery is inserted in the grid circuit to reduce damping. The amplified oscillations flowing in the anode circuit of the valve will energise the circuit $L_2 C_2$, provided this is in tune with the incoming signals. The arrangement not only results in greater high-frequency current but also gives a greater degree of selectivity, as the valve provides a means of coupling the two tuned circuits together. A full consideration of H.F. amplification is given in a separate chapter, and it only need be noted here that several stages of high-frequency amplification can be arranged, usually by connecting the terminals Y Z in Fig. 104 across the grid and filament of a second H.F. valve.

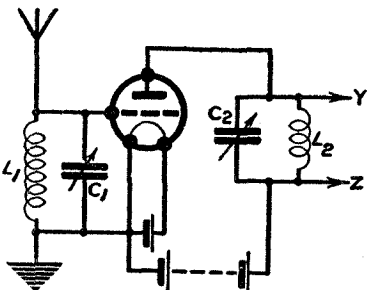

Fig. 104—A high-frequency amplifier using a tuned anode circuit

Relative Merits of H.F. and L.F. Amplification.—It may be wondered why two kinds of amplification are so often used in a

radio receiver. Radio-frequency amplification magnifies the input oscillations before they are applied to a detector, while L.F. amplification is used for amplifying the signals after they have been detected. The latter system is considerably simpler since it involves no tuned circuits, and it is generally employed where a loud signal is desired. On the other hand, H.F. amplification is resorted to when the input signal is not sufficiently strong to operate the detector efficiently and without distortion. All detectors require a certain minimum input signal to operate them effectively; consequently, unless signals produce strong high-frequency oscillations in the aerial circuit, it is customary to amplify them by one or more H.F. valves before applying the current to the detector. An additional advantage of radio-frequency amplification is that it serves as a means for giving greater selectivity. Where the input signals are sufficiently strong, radio-frequency amplification is unnecessary, but it would still probably be resorted to as a convenient means of providing greater selectivity.

The Valve as Detector.—The three-electrode valve has had a great vogue as a detector, although its operation in some cases is really equivalent to that of a two-electrode valve followed by a three-electrode valve L.F. amplifier. The whole question of the valve as a detector is covered by a separate chapter, and the reader is advised to refer to this. Meanwhile, it can be stated that the three-electrode valve can operate as a detector in two main ways: We can apply a steady negative potential to its grid so as to work at the bottom bend of its characteristic curve; this is known as *bottom-bend* rectification. The second and most popular method is called *leaky-grid-condenser* rectification or simply grid-condenser rectification. In a common form of this system a grid condenser of .0001-mfd. capacity is connected between the top end of the tuned circuit and the grid of the valve; a resistance of, say, 1 megohm (one million ohms, the ohm being the unit of resistance) is now connected across the grid condenser or, if more convenient, across grid and the positive side of the filament "battery."

In both methods, the H.T. current in the anode circuit of the valve is varied at L.F. by the incoming signals, the desired audio-frequency currents having thus been "extracted" from the oscillations.

CHAPTER 5

HIGH-FREQUENCY AMPLIFICATION

Aperiodic Couplings.—The oscillations in an aerial circuit are usually weak, and it is clearly advantageous to amplify them by means of a valve which will reproduce the currents exactly in their original form but of greater strength. A three-electrode valve, a screen-grid valve, or an H.F. pentode is usually employed for high-frequency amplification, but whichever is used the circuits are very much the same, and to explain the action of a valve for high-frequency amplification, the three-electrode valve will be assumed to be used in most of the circuits.

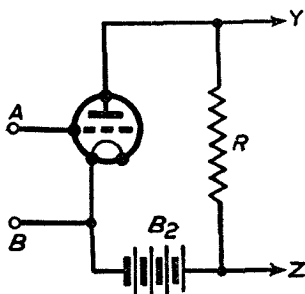

Fig. 105—Varying voltages across A B will establish amplified voltages across R

Let us first consider the simple arrangement of Fig. 105, where the high-frequency currents are fed to the terminals A B which are respectively connected to the grid and filament of the high-frequency amplifying valve. Any of the aerial circuits or preliminary tuning arrangements previously considered may be connected to the terminals A B. In the anode circuit of the valve is connected a resistance R of say 100,000 ohms, and a high-tension battery B₂ of, say, 100 volts. With the grid of the valve at zero potential, there will normally be a steady anode current flowing through the resistance R which will give the terminal Y a steady negative potential with respect to Z; but as we are not concerned with steady potentials but only with high-frequency currents, we can ignore the potential drop across the resistance R for the time being. In any case, its effect can be eliminated by simply connecting a fixed *stopping condenser* between the top of R and the terminal Y.

When the grid of the valve is made positive, there will be an increase of anode current which will flow through R; this will tend to make the terminal Y negative with respect to Z, i.e., still more

negative than it already is. If, however, the grid is given a negative half-cycle, the anode current will decrease, and this means that the normally steady voltage across R will decrease, making Y less negative than it was before. This is equivalent to Y becoming positive with respect to Z . If the grid has H.F. applied to it, there will thus be high-frequency potentials established across Y and Z , superimposed upon the steady potential across R , which can be ignored for our present purpose. If the H.F. potentials applied to A B rise and fall in strength, exactly similar currents but larger ones will occur in the anode circuit of the valve, producing larger e.m.fs. across Y Z .

The amount of amplification will depend upon the type of valve used, the value of the resistance R and the value of the battery B_2 . The whole scheme is not a particularly efficient one for high-frequency amplification, and it is particularly inefficient for amplifying high frequencies corresponding to the lower wavelengths. The reason for this is that there is always some capacity in shunt across the resistance R , such as the self-capacity of the resistance, the capacity of the various leads, and the anode-to-filament capacity of the valve. These various capacities can all be represented by capacity C_2 connected as shown in Fig. 106, and this capacity will have the effect of short-circuiting to a large extent

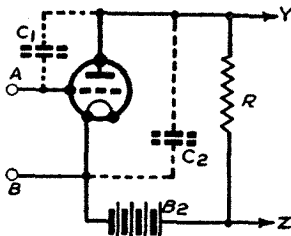

Fig. 106—Various stray capacities affect the efficiency of resistance coupling for H.F.

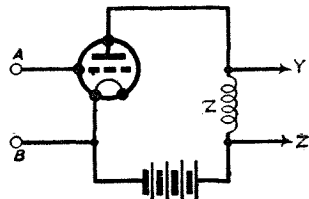

Fig. 107—An H.F. choke coupling system is better, but not efficient

the high-frequency potentials which the valve would otherwise establish across R . The arrangement, however, is aperiodic and capable of operating over a wide band of wavelengths, the best amplification being obtained on the longer waves. There is, however, no benefit such as is obtained from a resonant tuned circuit.

In place of a resistance R , an air-core choke Z may be connected as shown in Fig. 107. The high-frequency currents now pass through the choke Z , which is really an inductance of large value and, owing to its reactance (i.e., opposition effect), potentials are established across it and may be led away from the terminals Y Z . This arrangement is also aperiodic, but the reactance increases with

frequency, so that greater amplification will usually be obtained on the shorter wavelengths. On the other hand, if the choke has self-capacity or capacities vitually across it, the choking effect will be less on the lower wavelengths and amplification may be less. It is possible, incidentally, to connect an air-core choke in series with the resistance to cover a wider range of frequencies.

Aperiodic H.F. Transformers.—Instead of using an H.F. choke, it is possible to arrange an aperiodic output transformer consisting of an inductance coil L_1 coupled to another inductance coil L_2 , as shown in Fig. 108. It is sometimes advantageous to make the coil L_2 with a larger number of turns so that a step-up effect is obtained between L_1 and L_2 . Although this output transformer is aperiodic, it will usually operate best over a limited band of wavelengths

Tuned H.F. Couplings.—Aperiodic H.F. couplings are certainly simple and involve no adjustment, but they are not very popular because the degree of amplification is smaller than that obtained when the output circuit is tuned, and, moreover, one of the advantages of high-

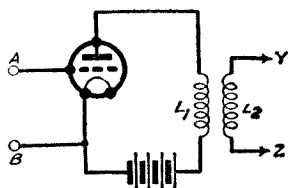

Fig. 108—Sometimes an aperiodic H.F. transformer is used for H.F. amplification

frequency amplification is that it enables an extra tuned circuit to be very simply arranged, and the more tuned circuits there are in a receiver the

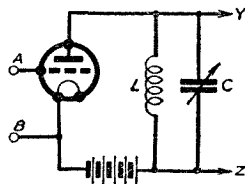

Fig. 109—The tuned anode method of H.F. amplification which gives good results

greater will be the selectivity.

The simplest tuned coupling of all is known as the *tuned anode* coupling, and it is illustrated in Fig. 109, where an inductance L , shunted by a tuning condenser C , is connected between the anode of the valve and the positive of the high-tension battery. The amplified oscillations in the anode circuit of the valve are now used to set up oscillations in the circuit $L C$, and the effect of the resonant circuit is to produce stronger e.m.f.s. across the terminals $Y Z$, which can be connected either to another stage of high-frequency amplification or to some form of detector. A

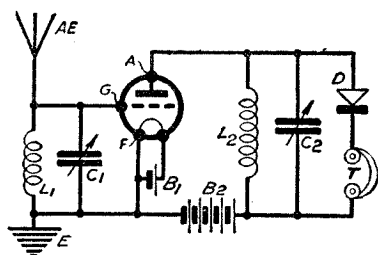

Fig. 110—A complete wireless receiver employing tuned anode H.F. coupling and a crystal detector

to some form of detector. A

complete tuned anode circuit operating a crystal detector is illustrated in Fig. 110 where the tuned aerial circuit is connected across the grid and filament of the valve and a crystal and telephones are connected across the tuned anode circuit.

Tuned Transformer Couplings.—Instead of connecting the tuned anode circuit directly in the anode circuit of the valve, it is possible to couple it by means of a separate inductance, as shown in Fig. 111. Here we have an inductance L_1 , usually of rather smaller size than the inductance L_2 but coupled to it. The coil L_2 is tuned by means of a condenser C to the wavelength to be received, but it is, of course, essential that this be tuned accurately. Usually, the coupling between the inductance L_1 and L_2 is fixed to some efficient value, but by varying the coupling between

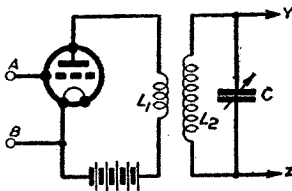

Fig. 111—H.F. intervalve coupling, using an H.F. transformer with aperiodic primary

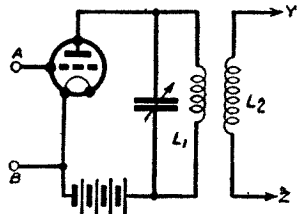

Fig. 112—The primary of the H.F. transformer is here shown tuned

L_1 and L_2 we can vary the degree of amplification given by the valve. If the coupling between L_1 and L_2 is very weak, there will be little amplification, but, on the other hand, the selectivity of the circuit $L_2 C$ will be greater. A loose aerial coupling made for greater selectivity because the aerial load was reduced. In this case, the anode load also decreases the selectivity of the tuned circuit $L_2 C$, the worst condition, of course, being obtained when a tuned anode circuit is employed. It is therefore quite common practice to reduce the anode load by means of a transformer coupling as in Fig. 111, even though there may be some loss of signal strength.

Another transformer-coupled arrangement is illustrated in Fig. 112, where, this time, the primary is tuned while the secondary coil L_2 is coupled to L_1 . Usually the coil L_2 is made so as to have a larger number of turns than L_1 , with the theoretical intention of obtaining a step-up effect. This form of transformer coupling is not used to any large extent.

Tapped Tuned Anode Circuits.—We can reduce the load effect of the anode circuit of the valve (which load could be represented by a resistance); there is no need to include the whole of the tuned anode circuit, but only a portion of it, and this can be carried out

in the manner shown in Fig. 113, where a tapping T is taken on the coil L. The lower the tapping T, the fewer will be the turns of the inductance L directly included in the anode circuit of the valve, and therefore the load will be less. This improves selectivity, but will also reduce signal strength. An additional advantage of the tapping is to render the valve more stable and less likely to oscillate of its own accord, due to unintentional coupling between the tuned circuit associated with the anode circuit, and the grid circuit,

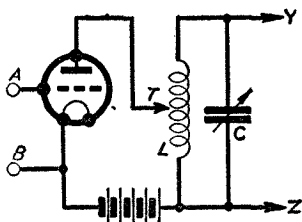

Fig. 113—Tapping the tuned anode circuit gives greater selectivity and stability

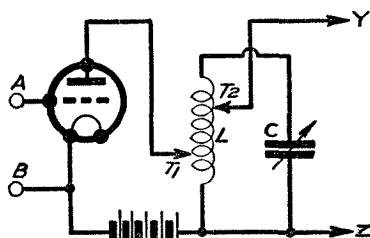

Fig. 114—Tapping the grid circuit results in less grid circuit damping

which should be connected across the terminals A B. This form of instability is due to *inherent reaction*, which is explained later.

In the ordinary way, the terminals Y Z would be connected to some form of detector, such as a crystal or valve, and this detector will usually absorb energy. It will therefore have a damping effect on the tuned circuit L C. The effect would be similar to that obtained by connecting a resistance across the circuit L C. To reduce this damping effect one frequently takes a second tapping T₂ on the inductance L (see Fig. 114), and connects this to the detector, so that only a portion of the inductance L is connected across the energy-absorbing detector. It would appear at first sight that tapping down on the inductance L in this way would reduce the total voltage available to operate the detector, but there is an advantage in that by reducing the load on the circuit L C stronger H.F. oscillations will flow in that circuit. If this happens, the tapping-down on the inductance frequently results in a negligible loss of signal strength while, since a considerable amount of damping is removed from the circuit, selectivity will be much better.

Parallel-fed Tuned Anode.—Instead of connecting the tuned anode circuit direct in the anode circuit of the valve we can arrange for *parallel feeding*. In this case, no direct current flows through the tuning inductance. The direct anode current is made to pass through a resistance or H.F. choke, and the potentials established across this choke are made to energise a tuned circuit. Fig. 115

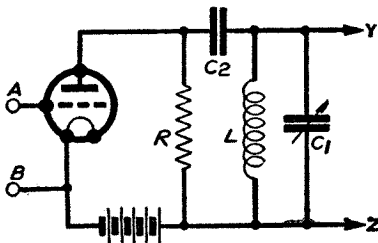

Fig. 115—A parallel-tuned anode circuit, using resistance

shows how a resistance R carries the direct anode current and the e.m.fs. developed across R energise the tuned circuit LCI , a condenser C_2 acting as the coupling condenser. Condenser C_2 prevents any direct current flowing through the coil L but it offers a ready passage to the high-frequency current. The disadvantages of a resistance include the loss of efficiency due to the *stray capacity* across R , which militates against effective amplification of the higher frequencies, and a further disadvantage is that a resistance greatly drops the anode voltage if the resistance is to be at all effective. This in turn requires a much higher value of high-tension battery; this is not always convenient.

A much more technically efficient and commonly used arrangement, especially in connection with screen-grid valves, is illustrated in Fig. 116, where an H.F. choke Z is included in the anode circuit of the valve, while the tuned circuit LCI is coupled to it through a condenser C_2 . Fig. 117 is a slightly modified arrangement. Note the position of the inductance L and the tuning condenser C_1 ; instead of being connected directly across the choke Z , they are

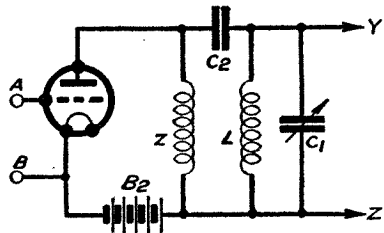

Fig. 116—A theoretical arrangement in which the tuned circuit is fed from a choke

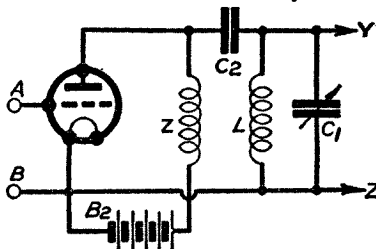

Fig. 117—A practical arrangement which employs an H.F. choke feed system

connected across the anode and filament of the valve. This really means that they are connected across both the choke Z and the high-tension battery. The arrangement has the big advantage that practically no high-frequency current passes through the high-tension battery and the tuning condenser has one side connected to earth. A more familiar drawing of the circuit is shown in Fig. 118. It will be noticed that the second valve is also shown in part, a condenser C_3 and the resistance R providing leaky-grid rectification (described elsewhere).

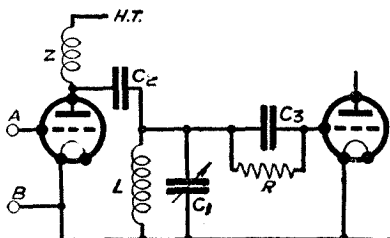

Fig. 118—Parallel-fed tuned anode coupling, sometimes called tuned grid coupling

incorporated, as it were, in the anode circuit is governed by the value of the choke Z , and the capacity of the condenser C_2 . The greater the capacity of C_2 , the closer will be the arrangement to the ordinary tuned anode circuit, and the tighter will be the connection between the anode circuit of the valve and the tuned-anode circuit. The lower the value of the capacity C_2 , the more loosely connected will the tuned circuit be to the anode of the valve and the greater the falling off in signal strength; but on the other hand, since the anode load is reduced, the selectivity will be greater. When trouble is experienced due to a tendency of the H.F. amplifying valve to oscillate (i.e., generate oscillations itself due to inherent reaction), a reduction of the value of the coupling condenser will increase stability.

The parallel-fed tuned-anode circuit is very popular when a screen-grid valve is used, and the connections are shown in Fig. 119,

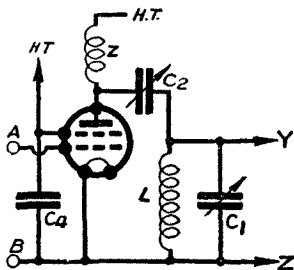

Fig. 119—Use of screen-grid valve in parallel-fed tuned-anode coupling

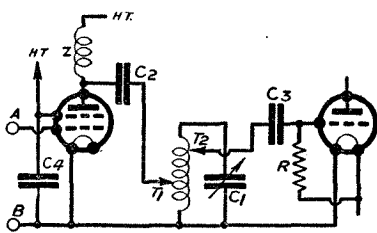

Fig. 120—Use of anode and grid tapping to improve the selectivity

from which will be seen that they are the same as before, except that a positive potential is applied to the screen in the valve. This circuit also shows an adjustable feed condenser C_2 . The use of parallel feeding may be combined with any of the other arrangements described and Fig. 120 shows how a tapped tuned circuit may be employed in conjunction with a choke-fed system where the tapping T_1 is taken down on the inductance to give greater

selectivity and to increase the stability of the circuit, while the second tapping T_2 is taken down on the coil to prevent the grid current from the second valve introducing excessive damping on the tuned circuit and thereby causing lack of selectivity. The condenser C_2 may, of course, be made variable if desired, as was shown in Fig. 119. The usual capacity for this condenser is from .0001 mfd. to .0003 mfd.

Use of Differential Couplings.—A differential condenser consisting of two sets of plates between which a third moving set operates may, with advantage, be used in high-frequency amplifying circuits, and the present writer has developed two methods of doing this. One is illustrated in Fig. 120a, which was used in the

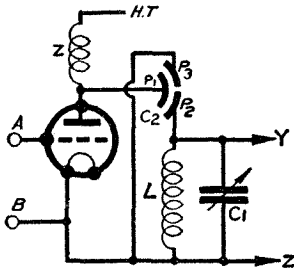

Fig. 120a—Differential anode coupling for greater selectivity and control

“S.T.300,” “S.T.400” and “S.T.500” circuits. The anode of the valve is connected to the moving plates P_1 of the differential C_2 , which has a capacity of, say, .0001 mfd. for each half. One set of fixed plates P_3 is connected to earth, while the other half, P_2 , is connected to the top end of the tuned circuit $L C_1$. When the moving plates, P_1 , are directly opposite P_2 , the whole arrangement works in exactly the same way as the simpler arrangement of Fig. 118. When, however, P_1 is opposite P_3 , the tuned circuit is theoretically completely isolated, and all the high-frequency output from the choke Z goes to earth and is wasted. Actually, in practice, a certain amount of H.F. current does drift over to the circuit $L C_1$, but, generally speaking, by the use of a differential in this way one can control the amount of energy fed into the circuit $L C_1$.

The chief merit of this is not, however, so much as a volume control but as a means of adjusting the stability of the high-frequency amplifying stage, and, far more important still, varying the load of the anode circuit on the tuned circuit $L C_1$. Thus selectivity will improve as P_1 is brought opposite to P_3 , although, simultaneously, there will be some reduction in signal strength. Alteration of the moving plates will cause some alteration of tuning of $L C_1$, and it will be necessary to retune on the condenser C_1 when the differential is altered. It will be noticed that there is not only capacity between P_2 and P_1 and between P_3 and P_1 , but there is a devious capacity of a stepping-stone type between P_2 and P_3 , the moving plates P_1 acting as an intermediate plate. It is as if the capacities P_2 , P_1 and P_1 , P_3 were connected in series and that this composite condenser were connected across $L C_1$. Changes in P_1 will vary the

stepping-stone capacity across $L C_1$. This stepping-stone capacity is absent when P_1 is opposite P_3 or opposite P_2 . It is to be noticed, however, that when P_1 is opposite P_2 there is the additional capacity of the anode of the valve and its associated apparatus, and this tends to make the circuit $L C_1$ tune to a greater wavelength than when P_1 is opposite to P_3 .

If the differential condenser is reversed, as in Fig. 121, so that the moving plate is now connected to the circuit $L C_1$ alterations in tuning can be made less. When P_1 is opposite P_3 there is a capacity across $L C_1$, but this is made equal to the capacity of the anode

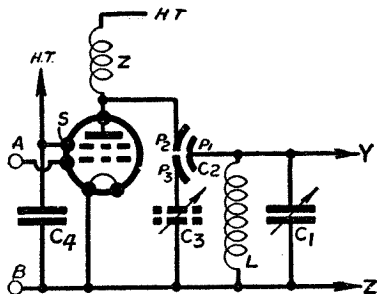

Fig. 121—A reversed form of differential coupling possesses certain advantages

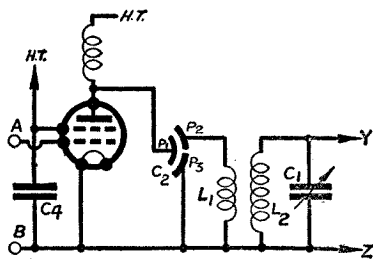

Fig. 122—Use of differential anode coupling with H.F. transformer coupling method

by inserting a preset condenser C_3 between P_3 and earth. The result is, that whichever plates P_1 is opposite, the additional capacity will be the same, and when P_1 is at an intermediate position the two capacities (P_1, P_2 and P_1, P_3) will remain more or less the same. This arrangement, therefore, enables an adjustable degree of coupling to be obtained without alteration in tuning of the circuit $L C_1$.

Fig. 122 shows how a transformer-coupled set may be fed through a differential condenser from a choke. This arrangement produces practically no variation in tuning of the circuit $L_2 C_1$. There is some advantage in providing for a path for the unwanted high-frequency current developed in the anode circuit of a valve, and so the arrangements in Fig. 120 and Fig. 122 are of value. A reverse reaction effect is obtained on a preceding circuit, namely the grid circuit of the high-frequency amplifying valve when there is no tuned circuit associated with a choke in the anode circuit of the valve. This reverse reaction effect, known as Miller Effect, reduces the amplitude of the signals in the grid circuit of the amplifying valve and reduces the selectivity of that circuit.

The arrangement of Fig. 120a is shown applicable to a three-electrode valve, but Fig. 123 shows the arrangement when a screen-grid valve is employed. It will be seen that the arrangement is

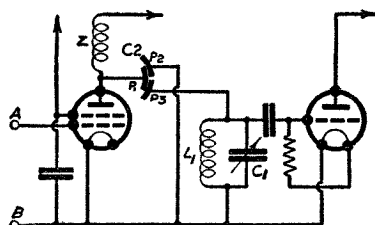

Fig. 123—Screen-grid valve, followed by differential anode coupling

really identical. It does not matter which way the fixed plates of the differential are connected; the only difference will be that the operator of the receiver may have to turn the differential condenser anti-clockwise instead of clockwise in order to obtain the effect he

desires. Usually, one would arrange the connections so that turning the knob to the right will cause an increase of coupling.

Reaction effects may be introduced on any of the tuned anode circuits or other circuits between two valves. (See chapter on reaction.)

Loose-coupled Tuned Circuits Between Valves.—Instead of having a single tuned circuit between a couple of valves, it is possible to obtain all the advantages of greater selectivity by using two tuned circuits, and we have a large variety of arrangements to choose from. These have already been discussed in connection with band-pass circuits and loose-coupled arrangements generally. These were dealt with under the heading of aerial circuits, but the arrangements may equally well be used for coupling an H.F. amplifying valve to either a detector or another H.F. valve. Fig. 124 shows a simple arrangement in which two tuned circuits, $L_1 C_1$ and $L_2 C$, are coupled together by means of the inductances L_1

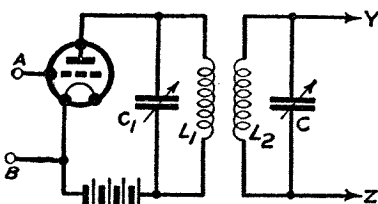

Fig. 124—Loose-coupled tuned circuits between valves give greater selectivity

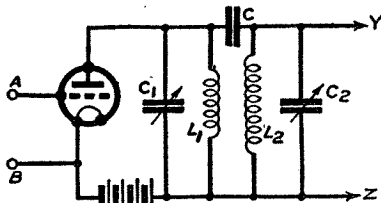

Fig. 125—The tuned circuits are coupled only by a small condenser C

and L_2 which form a transformer. It is usual to make these two inductances the same size and to have the coupling fairly loose. The looser the coupling the greater will be the selectivity, and the reader is referred to previous remarks on loose-coupled circuits. Fig. 125 shows an arrangement where two tuned circuits are coupled together by a very small capacity C , while in Fig. 126 a resistance R of 100,000 ohms is used for coupling the two circuits. In Fig. 127 we have a band-pass arrangement in which a

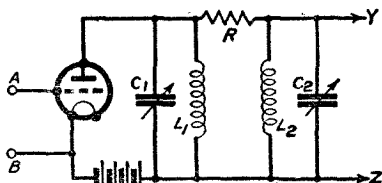

Fig. 126—Use of a resistance of about 100,000 ohms for coupling

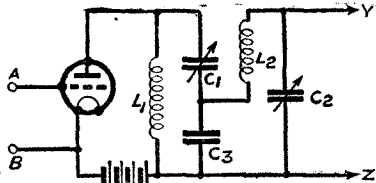

Fig. 127—A large condenser common to both circuits couples the two circuits

condenser C_3 of, say, $\cdot 06$ mfd. capacity, is used for linking the two tuned circuits, while in Fig. 128 a similar effect is obtained by means of a small inductance, L_3 , common to both circuits. All these arrangements will give greater selectivity than a single tuned circuit, and a band-pass effect is easily obtainable with most by suitably adjusting the couplings. For still greater selectivity (sacrificing the band-pass effects)

the couplings should be made still looser. The mixed couplings described in connexion with input circuits may equally well be used in intervalve circuits.

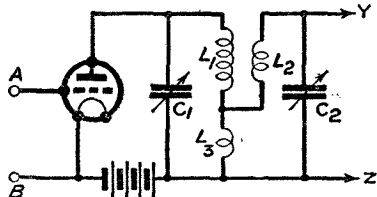

Fig. 128—Inductive coupling is here effected by an inductance common to both circuits

All the above circuits may be used with screen-grid valves, the only alteration to the circuits being the connection of a positive potential to the screen of

the valve. The only reason screen-grid valves are not shown is that they do not affect the explanation of the circuits. It is considered preferable to keep the circuits as simple as possible.

CHAPTER 6

LOW-FREQUENCY AMPLIFICATION

The three-electrode valve is capable of being used for either high-frequency amplification or low-frequency magnification. It is proposed now to consider the various ways in which it can be used for amplifying low frequencies—i.e., those which are produced when an incoming signal is rectified and converted into the kind of current originally produced by speech at the broadcasting station.

Fig. 129 shows a complete low-frequency amplifying outfit. It consists of an input step-up transformer T_1 , T_2 , a grid-bias battery B_1 , a valve, a high-tension battery B_2 , and a loudspeaker L .

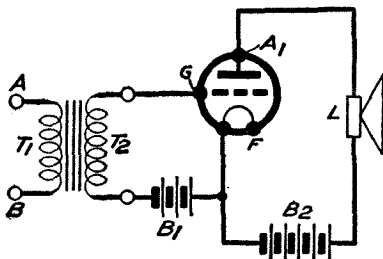

Fig. 129—The simplest form of low-frequency amplifier; note grid-bias battery B_1 .

The grid-bias battery may have a value of anything up to about 16 volts, while the high-tension battery will usually have a voltage of 120.

The currents to be amplified are taken from the detector and applied to the primary T_1 . The secondary T_2 usually has about three times as many turns as T_1

in order to obtain a voltage step-up effect. Since the three-electrode valve works as a potential-operated device, we are not concerned about current in the secondary of the transformer, but are only anxious to obtain high voltages developed across T_2 . The low-frequency variations are applied to the grid G of the valve, and amplified variations of exactly the same character are produced in the anode circuit A_1 , L , B_2 , F of the valve. The object of the grid-bias battery B_1 is to keep the grid G negative, and so prevent any grid currents flowing. The effect of grid currents would be to damp down the input voltages and produce distortion. The valve is operated on the steep, straight portion of its grid-volts/anode-current curve.

Fig. 130 is a small modification in which the grid-bias battery is shown adjustable, and a step-down transformer T_3 T_4 is connected in the anode circuit of the valve. A moving-coil speaker is presumed to be in use, and the purpose of the output transformer is to match the valve and speaker. It is necessary to convert the output currents into signals of exactly similar characteristics, but of lower voltage and higher current values.

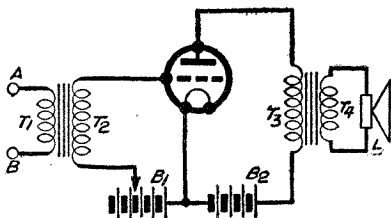

Fig. 130—Shows use of output transformer feeding the loudspeaker

Auto-Transformer Connections.—In place of a step-up transformer having two absolutely distinct windings, it is possible to use an auto-transformer, as shown in Fig. 131. The input signals are fed to the terminals A and B, A being connected to a tapping point T_2 of the choke coil T_1 , T_2 , T_3 . The input currents use the portion of the coil between T_2 and T_3 , but the varying magnetic field influences the whole of the coil which acts as the secondary; a step-up effect is thus obtained, the actual amount of stepping-up depending upon the ratio of the portion T_2 , T_3 to the whole coil T_1 , T_2 , T_3 . Thus, if a tapping T_2 is half-way up, there will be a step-up of 1 : 2. By suitably joining the primary and secondary windings of an ordinary L.F. transformer, it is possible to use it for auto-coupled circuits. Circuits are given later.

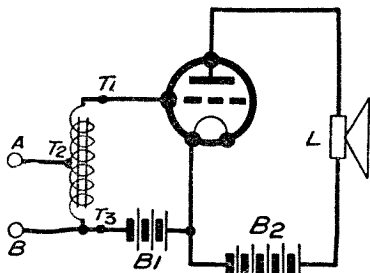

Fig. 131—This illustrates a step-up auto-transformer in grid circuit

tapping T_2 is half-way up, there will be a step-up of 1 : 2. By suitably joining the primary and secondary windings of an ordinary L.F. transformer, it is possible to use it for auto-coupled circuits. Circuits are given later.

Choke Couplings.—Probably the simplest form of feeding the input low-frequency current to the grid circuit of the valve is to employ a choke coil Z , as in Fig. 132. This is an iron-cored choke, (i.e., an inductance coil wound on iron) and the passage of the input currents through it sets up e.m.f.s. across it, and these are communicated to the grid and filament of the

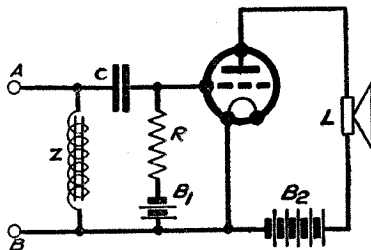

Fig. 132—The grid resistance and condenser C enable bias to be applied

valve. Instead of a grid-bias battery being connected in the usual way so that its potential is communicated to the grid through the choke coil Z , a modified arrangement is illustrated because it is frequently used in technical circuits. A fixed condenser C of large capacity (say, $\cdot 006$ mfd. and upwards) is connected between the top of Z and the grid of the valve. Across the grid and filament of the valve we have a resistance of, say, 100,000 ohms to 1 megohm. The condenser C allows the low-frequency potentials to be communicated to the grid without alteration, but it prevents the choke coil Z short-circuiting the battery B_1 . The object of the resistance R , in this case, is to present a high impedance (i.e., opposition) to the low-frequency current: if R were absent and the battery B_1 were connected across the grid and filament, the L.F. potentials would be short-circuited through the battery B_1 .

In place of the resistance R , one could use a low-frequency choke similar to Z , but of greater inductance; a resistance, however, is cheaper and behaves to all frequencies in very much the same way.

Resistance Coupling.—A third method of feeding low-frequency potentials to the grid of the valve consists in passing them through a resistance, as shown in Fig. 133. The input circuit now consists of the terminal A , the resistance R of about 50,000 to 100,000 ohms, and the terminal B . In passing through R , the currents set up varying potentials across R and these are applied

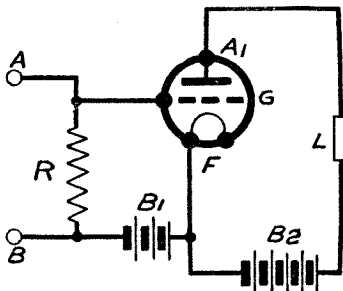

Fig. 133—Simple resistance coupling. The size and direction of B_1 may be modified

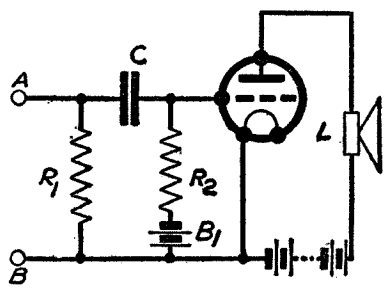

Fig. 134—Use of stopping condenser and grid resistance to ensure correct grid bias

across grid and filament of the valve, the grid-bias battery C_1 being inserted in the grid circuit to give the grid G a suitable negative potential. Without making any appreciable difference to the operation of the circuit, we can modify it in the manner shown in Fig. 134, where a condenser C of $\cdot 006$ mfd. upwards is inserted between the top of R_1 and the grid, a grid resistance R_2 being connected between R_2 and the negative of the grid-bias battery B_1

The object of the grid condenser and grid leak of Fig. 132 and Fig. 134 will be seen when we come to practical receivers. It may be stated here that the object of the condenser C is purely that of a stopping condenser to insulate the grid from any *steady* voltage across R1 and from the high-tension battery positive. It might be thought at first that the resistance R2 would reduce the grid-bias potential applied to the grid of the valve, but when it is remembered that the grid, when negative, takes no current at all since it repels any tendency of electrons to flow to it, there will be no grid currents through R2 to set up a back-e.m.f. across it. The full voltage of the grid-bias battery is, therefore, communicated to the grid of the valve.

Parallel-fed Output.—We have seen the loudspeaker connected directly in the anode circuit of the valve, or connected to it by means of a step-down transformer. A modified form of this latter arrangement is shown in Fig. 135, where the loudspeaker L is connected across a portion of an output choke T. This output choke is now virtually acting as a step-down transformer.

A very common arrangement is the parallel-fed output circuit

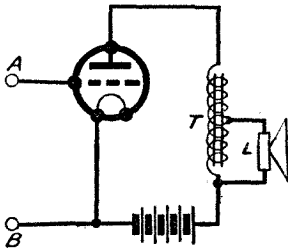

Fig. 135—Tapped output choke equivalent to a step-down auto-coupled transformer

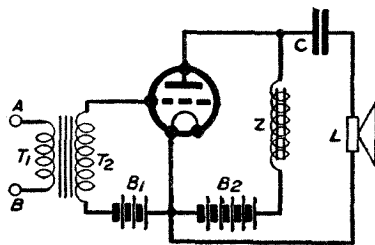

Fig. 136—Parallel-fed output arrangement. No D.C. passes through the loudspeaker

illustrated in Fig. 136. An iron-core L.F. choke coil Z is connected in the anode circuit of the amplifier, a stopping condenser C being connected in series with the loudspeaker L; condenser and speaker are across the choke coil Z. In the figure they are actually connected across the choke coil Z and the high-tension battery B2; this is because the battery possesses a small impedance itself. It is desirable, for several reasons, that one side of the speaker should be at earth; one reason for the Fig. 136 arrangement is that one cannot receive a shock from the H.T. when the speaker terminals are touched. When the whole circuit is not receiving any incoming signals, there is a steady anode current which flows through Z, the H.T. battery and the filament-to-anode path in the valve. No direct current flows through C and the speaker, since C acts as a stopper to direct current. When signals, however, are received,

the choke Z offers a very considerable impedance to the fluctuating currents. These alternating currents find it much easier to pass through the condenser C and the loudspeaker L , so they pass along this easier path and operate the loudspeaker. It is possible to consider the choke Z as providing the alternating potentials which establish a current through the circuit CL . The parallel-fed output circuit prevents any direct current going through the loudspeaker, enables the loudspeaker to be kept at earth potential, and greatly reduces the tendency for fluctuating potentials to be set up across the high-tension battery and influence in an undesirable way the anode voltages of other valves in the receiver.

An extension of the parallel-fed output scheme is shown in Fig. 137, where a tapping T is taken on the choke coil Z and connected to one side of the condenser C . The loudspeaker L is connected between the other side of C and the filament of the valve. The

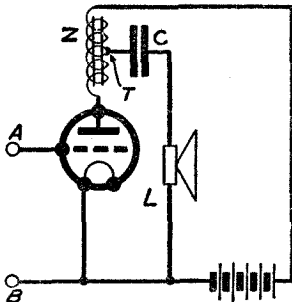

Fig. 137—Tapped output choke which gives step-down effect; speaker is parallel-fed

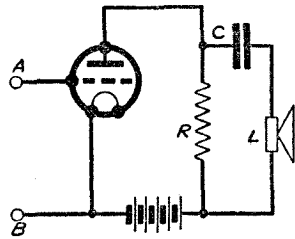

Fig. 138—Resistance-fed loudspeaker. This arrangement possesses several disadvantages

whole of the arrangement now acts as a step-down transformer, with the loudspeaker insulated from the direct voltage of the H.T. battery. Instead of using an output choke for parallel-feeding a loudspeaker, a resistance R may be used, as shown in Fig. 138. This scheme, however, is not popular. It will be appreciated that any resistance in the high-tension battery circuit will tend to reduce the anode voltage of the output valve, whereas an iron-cored L.F. choke of low resistance would have little effect on the anode voltage, but will offer a desirably high impedance to the alternating currents which are being amplified.

CHAPTER 7

MULTI-STAGE L.F. AMPLIFIERS

Resistance-coupled Amplifiers.—Since one valve will amplify, it is a simple matter to apply the output current to another valve acting in a similar way, thus obtaining two stages of amplification. To obtain a practical and convenient circuit a certain amount of thought must be given to the problem. Let us first of all consider a two-valve arrangement using resistance coupling. Fig. 139

shows the anode A_1 of the first valve connected through a resistance R and high-tension battery B_2 to the filament F_1 . By applying the incoming low-frequency signals to the terminals $A B$ we shall get a fluctuating voltage set up across the resistance R ; by connecting the terminals $Y Z$ across the second grid G_2 and second filament F_2 we obtain a

second stage of amplification, the final doubly amplified signals appearing in the loudspeaker L . The disadvantage of this arrangement is that, when no signals are being received, the steady anode current of the first valve flows through the resistance R , thereby setting up a potential difference across R . This steady e.m.f. may be as much as 20 or 30 volts, and is in such a direction that the grid of the second valve is made negative in respect to its filament. This negative potential is far too great to make the second valve operate at a proper position on its characteristic curve, and the circuit is really given to bring out its unpractical nature.

Students who wish to remember how to find out the nature of the potential applied to the second grid, should remember that electrons flow from F_1 of the first valve to A_1 , and round through the resistance R , from top to bottom and back through the H.T. battery. Since the electrons flow from the top

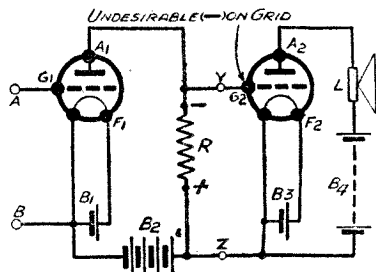

Fig. 139—Theoretical resistance-coupled L.F. amplifier

of R to the bottom of R, it follows that the top of R is negative while the bottom of R is positive, since electrons always flow from negative to positive. When alternating signals are applied to the terminals A B, the steady potential across R will be varied up and down; the grid G1, when positive, produces an increase of anode current and therefore makes the terminal Y more negative with respect to Z. When, however, the alternating signals make the grid of the first valve negative, there will be a decrease in the anode current of the first valve, and therefore there will be fewer electrons flowing through the resistance R. This means that although the terminal Y will still be at a negative potential with respect to Z, it will be less negative than before.

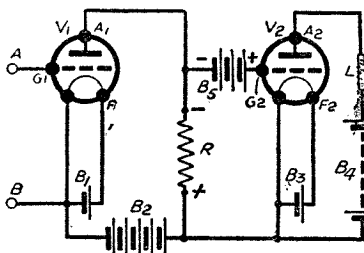

Fig. 140—Use of battery B5 to prevent excessive negative grid voltage

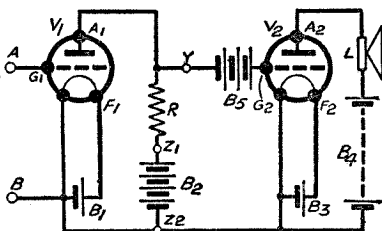

Fig. 141—Insertion of H.T. in position shown requires a grid battery B5

To overcome the disadvantage of a steady voltage drop across the resistance, we can insert a special battery B5, as in Fig. 140, in the grid circuit of the second valve. This is so connected as to oppose the steady voltage across R which tends to make the grid of the second valve too negative. It is, of course, desirable that the battery B5 should be so adjusted that a small suitable negative potential still remains on the grid of the second valve.

Another modification is illustrated in Fig. 141 where the high-tension battery B2 is connected in the first anode circuit. It is also a part of the grid circuit of the second valve. There is now a negative potential, due to R, tending to make the grid G2 negative, but the high-tension battery B2 is tending to make the same grid positive and this voltage is considerably greater than the other, so that when we insert a battery B5 in the grid circuit we must connect it so that its *negative* terminal is connected to G2. The object of putting the high-tension battery in the position shown is partly because the battery has a certain internal resistance of its own, and since e.m.f.s. will be set up across the battery due to alternating potentials on the grid of the valve, we might as well take advantage of them to assist in the amplification. The arrange-

ment, however, is really shown as a step in the simplification of the whole circuit.

It will be seen that there are two accumulators heating the filaments and that there are two high-tension batteries. In practice,

we can combine both accumulators and high-tension batteries and the circuit is now illustrated in Fig. 142. The conditions necessary for using one H.T. and one L.T. battery are (a) that the high-tension battery must be next to the filaments of the valves and (b) that its negative terminal must be connected to the same side of each filament accumulator (in this case the negative side).

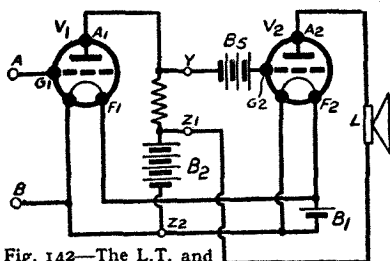

Fig. 142—The L.T. and H.T. batteries are now common; a grid battery remains necessary

In Fig. 142 a battery B5 is still necessary in the grid circuit of the second valve to keep its potential at a suitable value. The arrangement, however, is a nuisance for the following reasons: The use of a large battery involves expense, the battery itself will offer an impedance which may become uncertain after a time owing to the battery getting old, the battery will have a capacity to earth and the resistance R will, therefore, be shunted by an undesirable capacity. The voltage of the battery B5 would also have to be altered as the high-tension battery B2 altered in voltage owing to use, and the difficulty of insulating the battery B5 would present a problem.

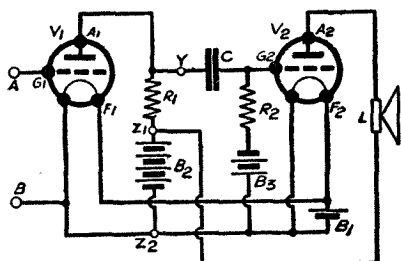

Fig. 143—By using a grid condenser, the steady, undesirable grid voltage is removed

We overcome these disadvantages by using a stopping condenser to prevent the steady voltage (due to the voltage drop across R in opposition to the H.T. voltage), getting to the grid of the second valve which we only want influenced by the alternating current being amplified. Fig. 143 shows a complete and practical example

of a resistance-coupled amplifier. The battery B5 has now been replaced by a stopping condenser C; a grid resistance R2 and grid-bias battery B3 are connected across grid and filament of the second valve. The amplified alternating currents passing through R1 now set up alternating potentials at the point Y and these are readily communicated to the grid G2 of the second valve. The

grid-bias potential from B_3 is communicated through the resistance R_2 (which may have a value of 1 megohm). It is true that this grid resistance R_2 tends to short-circuit to a slight extent any potentials developed across the main resistance R_1 , but as the grid resistance R_2 has a value of 10 to 20 times that of R_1 , the loss is small. The *coupling condenser* C offers a certain reactance (opposition) to the alternating potentials applied to the grid G_2 , but here again the loss is small since we can make the condenser C conveniently large. It might be advisable to point out, however, that the condenser C will offer a greater reactance to lower notes than to the higher frequencies. It is, therefore, possible to obtain a certain amount of *tone control* by reducing the value of the condenser C , thus lessening the amount of amplification of the lower notes.

A more subtle way of looking at the operation of this circuit is to regard the condenser C and the resistance R_2 as being in shunt to the main resistance R_1 and acting as a potential divider across it. There will thus be a drop of L.F. potential across C and across R_2 . Except in the case of very low notes, almost the whole of the potentials will be developed across R_2 which is what we desire. By making C very much smaller, however, a very appreciable potential drop will occur across C when very low frequencies are being amplified and consequently the potentials developed across

R_2 will be correspondingly less. Since it is the potentials across R_2 that are amplified by the second valve, there will thus be a falling off in the low notes.

A more common way of drawing the Fig. 122 circuit is shown in Fig. 144.

Transformer-Coupled Amplifiers.—We can repeat

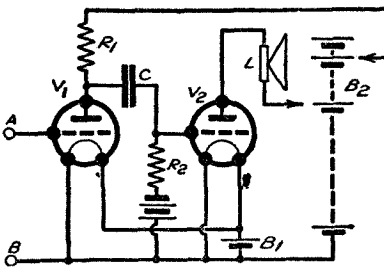

Fig. 144—A complete and practical resistance-coupled low-frequency amplifier

with low-frequency step-up transformers what we have already done with resistance coupling and Fig. 145 shows two valves coupled together by means of a step-up transformer T_1 T_2 having a ratio of, say, 1 : 3. The input signals are fed to the terminals A B of

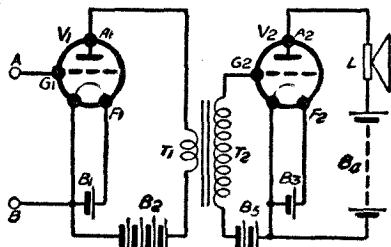

Fig. 145—A theoretical circuit showing step-up transformer for coupling valves

the first valve and produce exactly similar but larger currents

which flow through T1 and are stepped up by the transformer and taken to the grid and filament of the second valve. The second grid is given a suitable negative potential by means of a grid-bias battery B5. The doubly amplified signals appear in the loud-speaker L.

The circuit in practice is simplified as shown in Fig. 146, where a single accumulator B1 feeds both filaments, and a single high-tension battery B2 feeds both anodes.

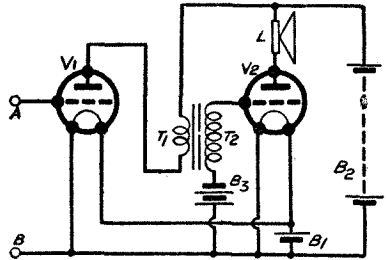

Fig. 146—A single L.T. and a single H.T. battery are now employed

Combining Resistance and Transformer Couplings.—It is possible to use several stages of low-frequency amplification in

which the couplings between the valves are either resistances or transformers. It is, however, most common to find a combination of the two arrangements; the first valve, for example, may be coupled to the next by a resistance, and the second valve coupled to the final output valve by a step-up transformer. Such an

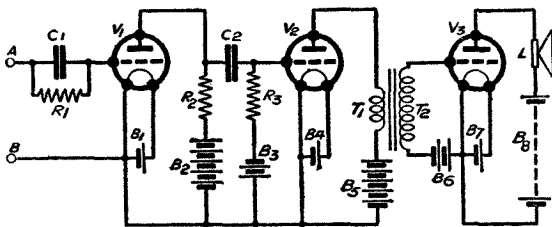

Fig. 147—A combined amplifier using both resistance and transformer methods of coupling the valves

arrangement in simple theoretical form is given in Fig. 147. The first valve V1 in this case is shown operating as a leaky-grid detector, the process being explained in the chapter on

Detection. When high-frequency potentials are communicated to the terminals A B (which could be connected to any of the aerial circuits already discussed), the grid of the first valve becomes negative to an extent which will vary with the modulation (i.e., variation in strength due to speech or music) of the incoming signals. Similar amplified low-frequency currents will flow through the resistance R2, and amplified potentials of varying character will be passed on to the grid and filament of the second valve, which also acts as a low-frequency amplifier. Magnified low-frequency currents will thus flow through T1 and will set up similar e.m.f.s. across the secondary T2. The output valve, V3, acts as a final low-frequency amplifier.

Fig. 148 shows the same circuit simplified, using a single filament accumulator, a single high-tension battery and a single grid-bias

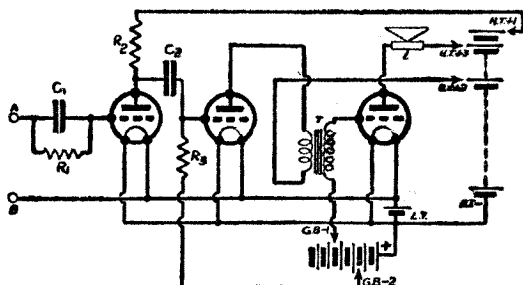

Fig. 148—A single accumulator and H.T. battery are shown in this practical circuit

A first valve for resistance-coupling can have a high amplification factor and fairly high impedance; the signals it will have to handle will be weak. The second L.F. valve will usually have a lower impedance, the grid voltage "swings" being larger.

Some Special Arrangements.—Fig. 149 shows a simple two-valve receiver in which the first valve acts as a detector, and the second as a low-frequency amplifier. (Incidentally, when a three-electrode valve is used as a detector in this way, low-frequency amplification is really occurring in the valve as well.) It will be seen that the terminals A B are connected across an aerial circuit,

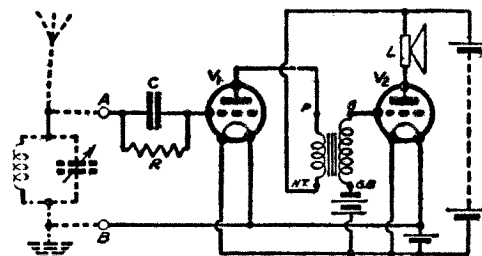

Fig. 149—Simple circuit in which the first valve is detector and the second an L.F. amplifier

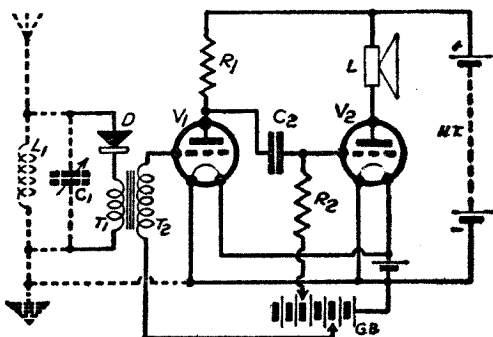

Fig. 150—A crystal detector followed by a stage of resistance-coupled L.F. amplification

battery. Since the different valves may require different anode voltages and different grid-bias potentials, these batteries are provided with tappings in the form of movable plugs fitting into sockets to give different voltages.

and the terminals could be connected across any kind of circuit in which high-frequency oscillations are taking place.

Fig. 150 shows a resistance-coupled amplifier which is fed by a step-up transformer, the primary of which is connected in a crystal detector receiving circuit. Here again

the reader can connect the primary T_1 of the input step-up transformer T_1 T_2 to any source of low-frequency current. It will be noticed that a wire connects the negative of the filament accumulator to earth. This helps to stabilise the valve part of the receiver. The iron core and any shielding cover of the L.F. transformer is also commonly connected to earth.

Fig. 151 is a straightforward two-stage low-frequency amplifier employing two step-up transformers. It may be used for amplifying any low-frequency current whether from a crystal or valve detector. In all L.F. amplifiers of the multi-stage type it will be usual to provide "bigger" valves in the later stages: as these valves are handling amplified currents, the swings of grid voltage will be larger and therefore more negative bias will be required for correct operation.

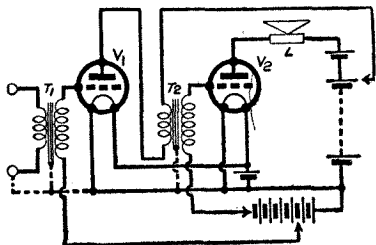

Fig. 151 — A complete two-stage L.F. amplifier. Note separate grid-bias voltages

CHAPTER 8

REACTION

Perhaps the most interesting and certainly one of the most useful applications of the three-electrode valve is its use for producing the effect known as "reaction." This effect consists in taking a portion of the amplified high-frequency currents occurring in the anode circuit of the valve and feeding it back into the grid current so as to strengthen the oscillations already existing there.

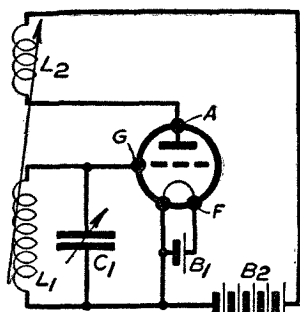

Fig. 152—The simplest reaction method with movable reaction coil

The arrangement of Fig. 152 will make plain what is happening. Across the grid and filament of the valve we have a tuned circuit $L_1 C_1$ in which it is assumed that oscillations are taking place produced, say, by incoming signals. The anode circuit of the valve contains an inductance coil L_2 , and in the ordinary way when the valve is used as an amplifier the high-frequency oscillations in $L_1 C_1$ will be amplified by the valve, and the current passing through L_2 will consist of exactly similar oscillations, both as regards frequency and general character.

They will, however, be of greater amplitude or strength. If now we bring the coil L_2 close to the coil L_1 the strong oscillations in L_2 will induce further oscillations into the inductance L_1 . By arranging the connections to the coil L_2 the right way round, we can ensure that the induced oscillations in $L_1 C_1$ (i.e., those fed into the circuit by L_2) coincide with those already flowing in that circuit. If this is done, the original oscillations will be greatly strengthened. If, however, the inductance coil L_2 (which is known as a *reaction coil*) is coupled the wrong way round relative to L_1 , then the induced oscillations will be in an opposite direction to those taking place in the circuit $L_1 C_1$. This is known as a "reverse" reaction effect, and the oscillations are reduced in strength.

It is important to adjust the coupling between L_2 and L_1 correctly. (The arrow in Fig. 152 indicates that the coils are coupled.) If the coupling is too loose, there will be very little reaction effect, but as we tighten the coupling so does the reaction effect increase, with a consequent increase in current strength. If, however, the reaction coil is brought too close to L_1 , the valve will *oscillate* of its own accord (i.e., the valve will itself begin to generate alternating currents of a frequency determined by the inductance L_1 and capacity C_1). These continuous oscillations, as they are called, will occur independently of any incoming signals, so that even though we remove the original source of oscillation, the valve will continue to oscillate of its own accord.

This property of self-oscillation is extremely valuable and is used by broadcasting stations for the generating of the continuous waves which, after modulation, convey music or speech. In wireless receivers also, oscillating valves are employed, especially in the superheterodyne.

Having obtained the reaction effect, which is adjusted just below the state of self-oscillation, the next question is how to employ the magnified oscillations. We can either use the original tuned circuit $L_1 C_1$ and connect a detector in some way to it, or we can draw off the oscillations from the reaction coil L_2 . We can even tune the reaction coil L_2 by adding a variable condenser across it, although this tends to add complications. It is possible to obtain a reaction effect in scores of different ways, all of them however, having this in common; that energy is transferred from the anode circuit to the grid circuit in such a direction that the oscillations existing there are strengthened.

The most generally-used arrangement employing reaction consists in using a valve simultaneously as a detector and as a means of

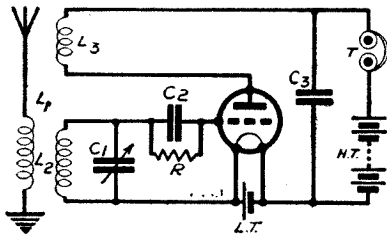

Fig. 153—Complete reaction receiver, the reaction coil being movable with respect to L_2

obtaining reaction, and Fig. 153 shows a simple single-valve receiver working on this principle. An aperiodic aerial coil L_1 is coupled to the closed circuit $L_2 C_1$ of the receiver, which is connected across grid and filament of the valve. The grid circuit contains the grid condenser C_2 and grid leak R to enable the valve to

operate as a detector. The anode circuit of the valve contains a reaction coil L_2 , telephone receiver T , and a high-tension battery $H.T.$ Telephones are used because the signals will not be strong

enough to work a loudspeaker. A condenser C_3 provides an easy path for the high-frequency oscillations, to save them having to go through the telephones T and battery $H T$.

The detector action of the valve has already been mentioned, but it is important to note that although the grid fluctuates at a low-frequency in accordance with the modulation of the music or speech due to the rectification effect, high-frequency potentials are also superimposed on the grid. In the ordinary way these oscillations, if there were no reaction coil, would not be used in any way whatsoever in this circuit; they would, in fact, be a nuisance rather than otherwise. By making them pass through a reaction coil, however, and coupling this coil L_2 in the right direction to L_1 , we are able to strengthen the oscillations in the circuit $L_2 C_1$. It is usual to make the reaction coil rotate inside the coil L_2 , and its correct position is found by actual experiment while listening. If the coupling is too tight the valve will oscillate, there will be violent distortion of the incoming signals and a whistle if the condenser C_1 is varied. Incidentally, this oscillation will cause a great deal of interference to neighbouring receiving sets, since the valve has become a miniature transmitter.

The benefits of reaction are not confined to increasing the signal strength of the oscillation in a tuned circuit. The effect of reaction is equivalent to reducing the resistance of the circuit and a consequent reduction in the losses. Inefficient coils or condensers will introduce damping into the oscillatory circuit, and it is very difficult to reduce the losses beyond a certain limit, and it certainly becomes an expensive matter. It is little wonder, then, that reaction is used to compensate to some extent for the damping of the circuit. The reader will have understood that any reduction in losses, and consequent improvement in efficiency in a tuned circuit, will improve its selectivity. The second and perhaps the most important merit of reaction is that it improves the selectivity of the circuit to which it is applied.

The phenomenon of reaction may be illustrated by considering a pendulum swinging in air. This is illustrated in Fig. 154. The bob of the pendulum is drawn to one side and then released. It will, after a short time, come to rest, the reason being that there is friction at the point of suspension and also considerable resistance offered by the air. If, however, we can compensate for these losses by giving the bob of the pendulum a tap at a suitable moment on every swing, we can keep the pendulum

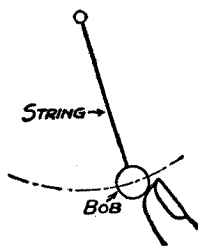
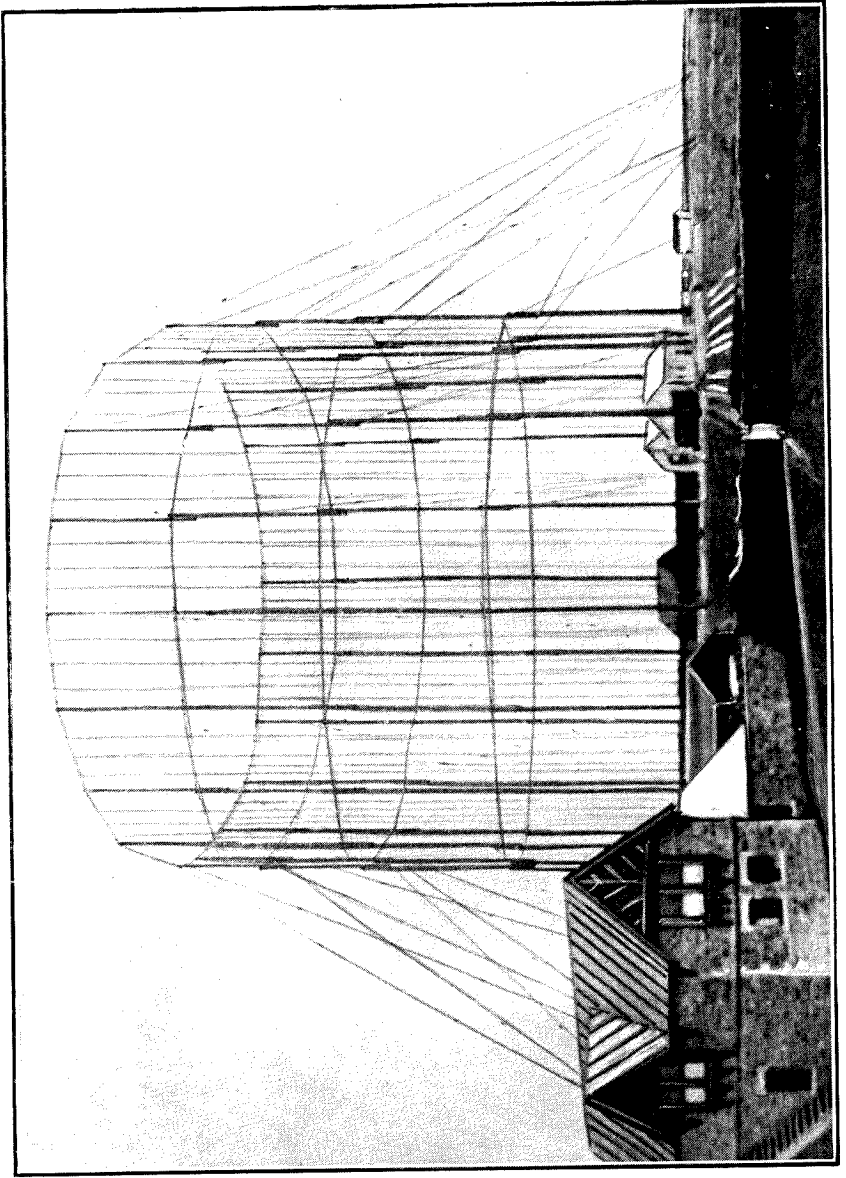

Fig. 154—Keeping a pendulum swinging by correctly-timed taps



MARCHESE MARCONI, G.C.V.O.



THE AERIAL USED BY MARCONI IN HIS FIRST TRANSATLANTIC TESTS

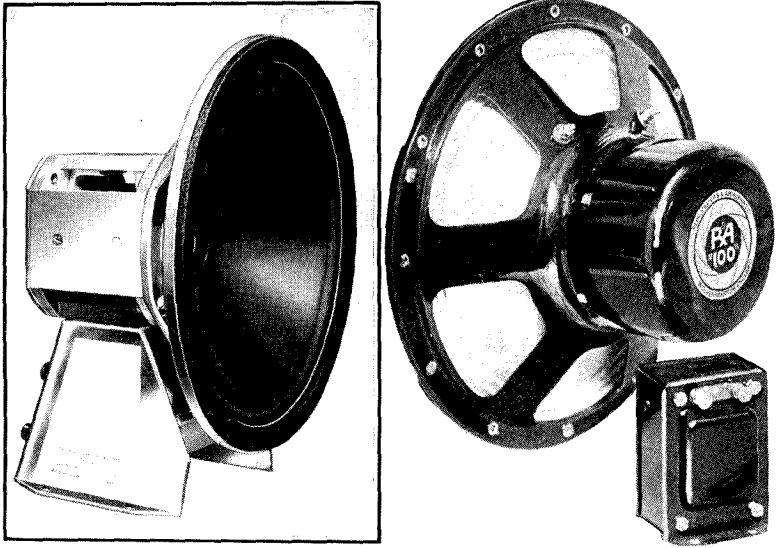

TWO TYPES OF MODERN MOVING-COIL LOUDSPEAKER

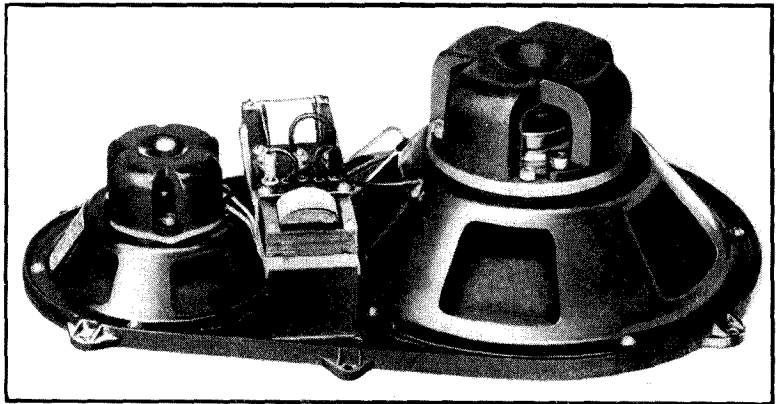

A DOUBLE LOUDSPEAKER, ONE SPEAKER FOR HIGH NOTES AND THE OTHER FOR LOW NOTES

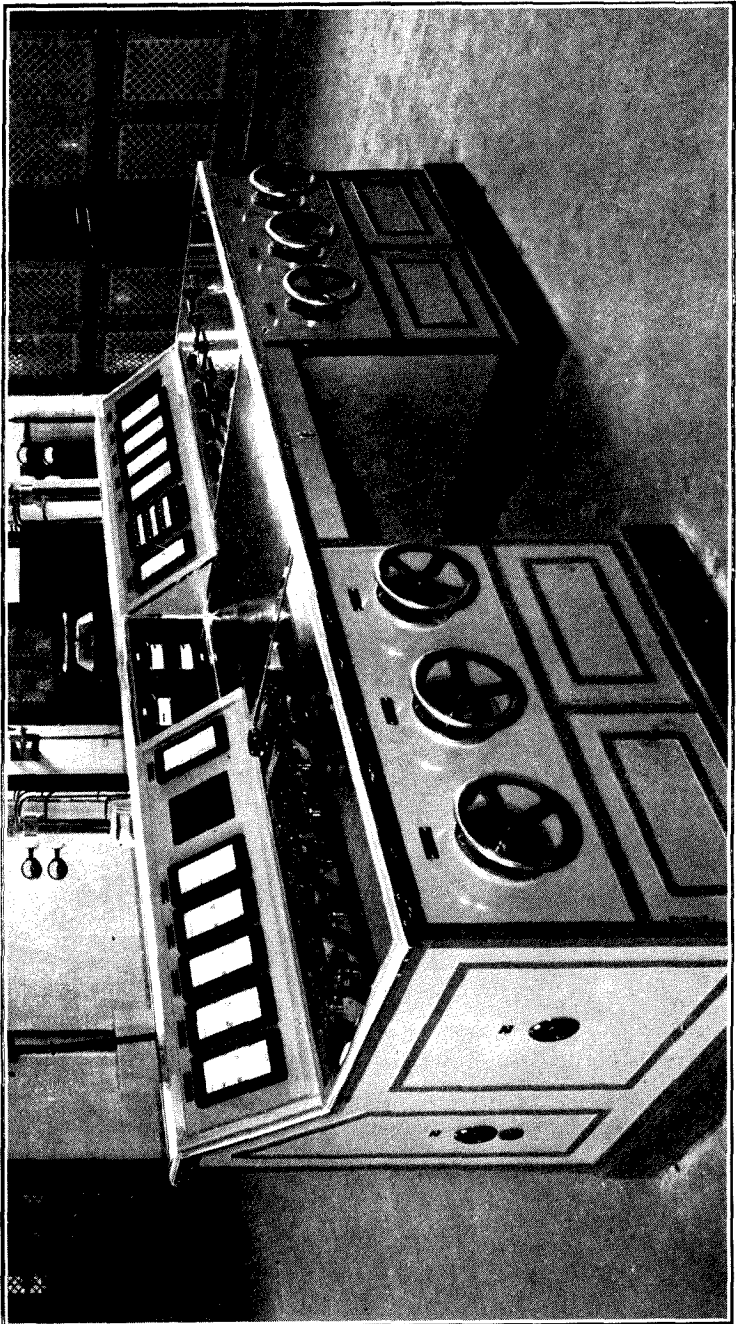

THE TRANSMITTER CONTROL DESK AT THE FRANKFURT-AM-MAIN STATION

swinging for an indefinite period. It is to be noted that these taps must be correctly timed, as it would never do to tap the bob while it was approaching one's finger. Reaction is automatically correctly timed because the valve anode circuit contains oscillations of exactly the same frequency as the original oscillations in the grid circuit, but it is quite possible to reverse the reaction coil or have a wrong connection to it so that the reaction acts in the opposite way and damps down the original oscillation. There are many mechanical analogies for reaction, such as the ordinary steam engine where the flywheel represents an oscillatory circuit. Originally, the steam engine was operated by a small boy who let steam into the cylinder by means of a tap which he turned. The rush of steam pushed the piston out and the flywheel turned round half a turn. The steam was then switched off and the flywheel carried the piston back to its starting point. The steam was then switched on again and the process repeated. The story goes that the boy noted that he had to turn on the steam at a certain particular position of the flywheel and, by connecting a rod between the steam tap and the flywheel, he was able to make the whole engine automatic in operation. The "output circuit" of the steam engine is the flywheel and the input is the steam-tap, and reaction is thus obtained by coupling the output to the input.

A clock having an escapement is also a form of reaction, since the balance wheel arranges to allow the power of the spring to operate at regular intervals to keep the balance wheel working. These analogies, however, correspond to self-oscillation of a valve, whereas in reaction we do not desire the feed-back to be sufficiently great to produce oscillation.

Methods of obtaining Reaction.—Reaction may be obtained in various ways, all of which have this in common: that energy is fed back from the anode circuit to the grid circuit. A reaction coil is the usual method adopted, but here we have many ways of varying the amount of high-frequency current transferred from anode to grid. The system in which the reaction coil itself is moved with respect to the grid circuit inductance is perfectly effective, but the movement of the coil relative to the other tends to produce quite large changes in the tuning of the grid circuit, so that every alteration of the reaction coil requires an alteration in tuning of the circuit. As a matter of fact, a slight readjustment of the tuned circuit is almost inevitable in any form of reaction, but it is desirable to use some form which produces a minimum of change of tuning. A further disadvantage of the moving coil is that it is difficult to screen, and moving parts of this kind are in any case undesirable.

Fig. 155 shows an arrangement by which the reaction coil L_2 is fixed with respect to L_1 , and the resistance R_1 of variable value is connected in the anode circuit. By varying the value of the

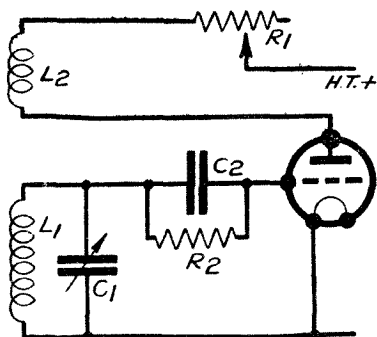

Fig. 155—The reaction is varied by an adjustable resistance in the anode circuit

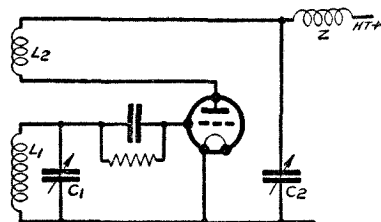

Fig. 156—The variable condenser C_2 modifies the choke effect of Z

resistance R_1 , the H.F. voltage drop across L_2 can be varied; the greater the value of R_1 the less will be the high-frequency current flowing through L_2 , and therefore the less will be the reaction effect. One of the most popular forms of reaction adjustment is that illustrated in Fig. 156. A reaction coil L_2 is fixed in respect to L_1 , but an H.F. choke Z is included in the anode circuit and is shunted by a variable condenser C_2 usually connected from one side of the choke to the filament of the valve. The high-

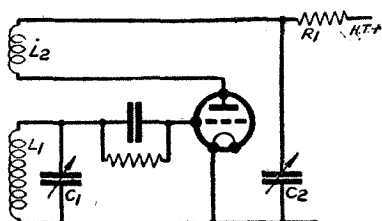

Fig. 157—The impedance of a resistance is counteracted by a variable condenser C_2

frequency current through L_2 is greatest when the condenser C_2 is at maximum. When C_2 is at a minimum, the reaction current has to travel through the choke Z , and this greatly reduces the current through the reaction coil L_2 .

Fig. 157 shows a similar arrangement in which a resist-

ance R_1 is employed for the same purpose.

Choke-fed Reaction Coils.—The system of parallel feeding may be adapted to reaction circuits and Fig. 158 shows an extremely common and popular arrangement in which a choke coil Z is included in the anode circuit. Across anode and filament is connected a small variable condenser C_2 of, say, $\cdot 0001$ to $\cdot 0003$ -mfd. capacity, and a fixed reaction coil L_2 coupled to L_1 . The inductance coil Z will cause any high-frequency currents to prefer to pass

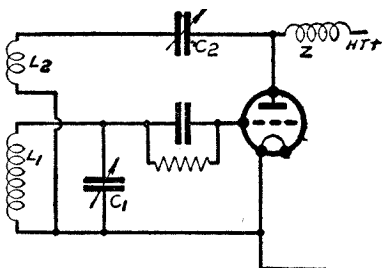

Fig. 158—One of the most popular and successful methods in use to-day

value very little reaction current will travel through L_2 .

Fig. 159 shows a similar arrangement, but this time the reaction condenser C_2 is connected so that one side of it is connected to the filament. This tends to lessen hand-capacity effects, since only one side of the condenser are at H.F. potential, whereas in Fig. 158, both sides of the condenser are at H.F. potential. Fig. 159 will produce spurious undesired oscillations and improper reaction control, unless L_2 is kept near the "earthy" end of L_1 , thus minimising capacity coupling.

through C_2 and the reaction coil L_2 which only has a small inductance; but the amount of high-frequency current fed into the reaction coil L_2 will depend upon the value of the coupling condenser C_2 ; when this is at a maximum, the most H.F. current will pass through the reaction coil. When the reaction condenser C_2 is at a low

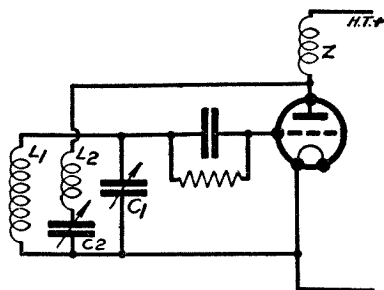

Fig. 159—This is similar to Fig. 158, but hand-capacity effects are reduced

Fig. 160 is the same as Fig. 159, except that a fixed condenser C_3 is now connected across the anode and filament of the valve. This condenser frequently has a value of .0003 mfd., and its object is to by-pass and largely short-circuit the high-frequency potentials produced across the choke Z , when the reaction condenser C_2 is at zero and no reaction current is flowing through L_2 . The reason for

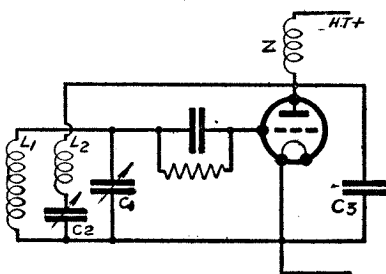

Fig. 160—A condenser C_3 reduces adverse Miller effect when reaction is at zero

passing the H.F. currents to earth when they are not required for reaction purposes is this: Owing to the capacity between grid and anode of the valve inside the valve, the potentials across Z will tend to influence the tuned circuit $L_1 C_1$ in a reverse reaction manner, thus weakening the signals and increasing the

damping of that circuit, thereby impairing the selectivity. This effect is known as the Miller Effect and the condenser C_3 is intended to remove it. The condenser C_3 should not be so large as to starve the reaction coil of current; it may be necessary, in any case, to use a fairly large value of C_2 .

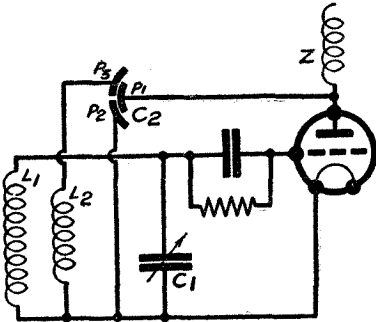

Fig. 161—A differential reaction circuit of great popularity; unwanted reaction currents are earthed

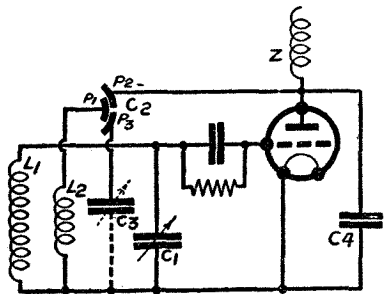

Fig. 162—A special form of differential reaction to avoid mistuning

Use of Differentials for Reaction.—A differential condenser may be used for obtaining reaction, and it may be connected in the manner shown in Fig. 161. Here the plates P_1 may be arranged to come opposite P_2 or P_3 , or in any intermediate position. When opposite P_3 the maximum reaction effect is obtained, while when opposite P_2 no reaction is obtained and the H.F. currents are by-passed to earth as explained in connexion with the condenser C_3 of Fig. 160. At intermediate positions of the moving

vanes, different degrees of reaction may be obtained. A reverse differential may be used in the manner shown in Fig. 162, which is a scheme which has been adopted by the present writer. Here the moving vanes P_1 may be connected to the reaction coil L_2 . It is to be noted that the small preset condenser C_3 is connected

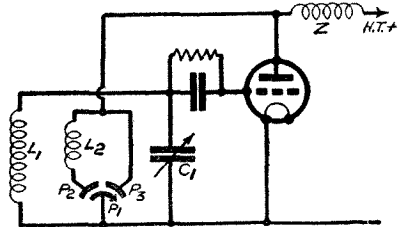

Fig. 163—A differential reaction scheme for reducing hand-capacity effects affecting tuning

Whatever the position of P_1 may be, the capacity connected to the top end of the reaction coil L_2 will be approximately the same. This arrangement causes little alteration to the tuning of the grid circuit. Another use for a differential condenser is illustrated in Fig. 163 where the reaction coil is connected across the fixed plates. The movement

of the rotor vanes varies the coupling between the reaction coil and the choke which feeds it.

Fig. 164 shows how a reaction coil and fixed condenser C_2 provide the reaction, while a condenser C_3 partially short-circuits the choke Z and so controls the amount of high-frequency current fed to the reaction coil.

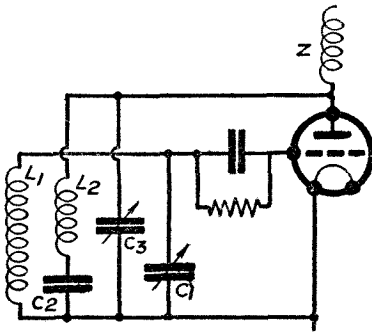

Fig. 164—Parallel-fed reaction coil with choke effect varied by C_3

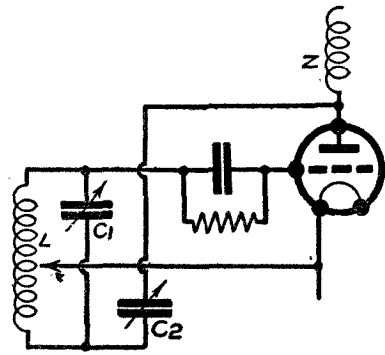

Fig. 165—A single-circuit reaction method. Reaction is applied to one end of coil

Tapped Grid Circuits.—By taking a tapping on the tuned grid circuit feeding the valve, as shown in Fig. 165, it is possible to introduce reaction e.m.f.s. to the far end of the coil (i.e., the bottom end) by means of a variable condenser C_2 . This is a convenient way of feeding reaction in the correct phase (direction) and Fig. 166

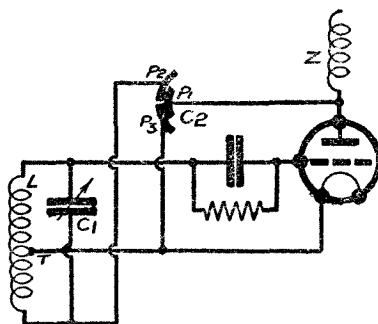

Fig. 166—A modification of Fig. 165 using a differential reaction condenser

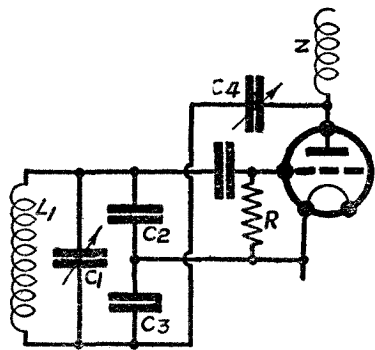

Fig. 167—Instead of a tapping on the coil itself, two condensers are used

shows how a differential condenser may be used to carry out the same operation. In Fig. 167 the input circuit is split by means of two small condensers, this being more or less equivalent to a tapping on the inductance coil.

Use of Variable Resistances.—A variable resistance may be used to vary the amount of reaction applied to a circuit. The resistance may itself add damping to the tuned circuit, thus varying the effectiveness of a fixed amount of reaction, or the resistance may be used for varying the amount of reaction passing through the reaction coil. The first type of circuit is illustrated in Fig. 168 where the fixed amount of reaction is supplied by the reaction coil

L_2 , coupled to L_1 . A resistance R of, say, 30 ohms is inserted somewhere in the tuned circuit. The greater the value of the resistance R the less will be the effect of reaction applied to the circuit L_1, C_1 , whereas if the resistance R is reduced to zero or nearly zero, the valve may be made to oscillate. Instead of using a small value of resistance in series with the tuned circuit a larger resistance may be connected in parallel with it as shown in Fig. 169. These arrangements,

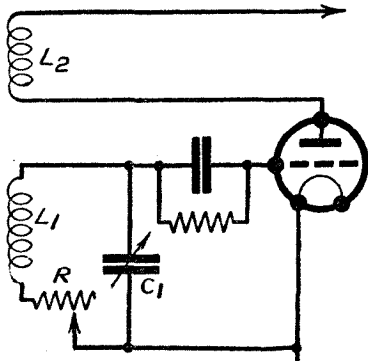

Fig. 168—Excessive fixed reaction is reduced by a resistance

however, are not to be recommended and considerable difficulty would be experienced in obtaining a variable resistance free of self-capacity.

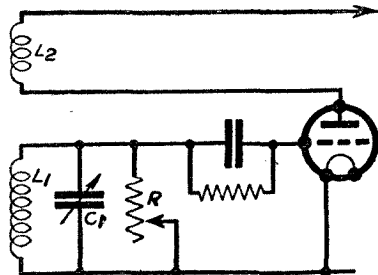

Fig. 169—A parallel variable resistance varies damping of circuit, thus altering reaction

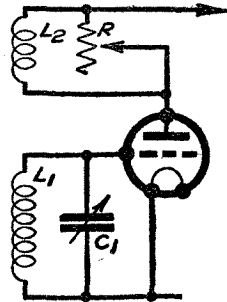

Fig. 170—A fairly practical system of controlling reaction by a variable resistance

A more practicable arrangement is that set out in Fig. 170 in which a resistance R is connected across the reaction coil. Here again, however, the disadvantages almost inseparable from the use of a variable resistance (noisiness, self-capacity, etc.) come into play. It will be appreciated that very smooth reaction is desirable and the variable condenser has proved the most popular way of controlling reaction effects.

Reaction from H.F. Valve.—Although the circuits given are highly economical in the sense that the valve introducing reaction is also used as a detector, these conditions are not essential and reaction may be obtained from a high-frequency amplifying valve by coupling its output to the input in some variable manner. An example of this is illustrated in Fig. 171 where a very small condenser C_4 is used for coupling the anode circuit $L_3 C_2$ to the grid circuit $L_1 C_1$. These arrangements are not generally success-

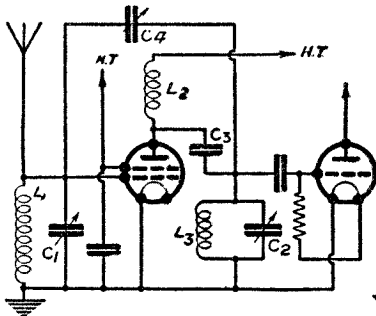

Fig. 171—Reaction may be obtained by capacity coupling between tuned anode and grid circuits

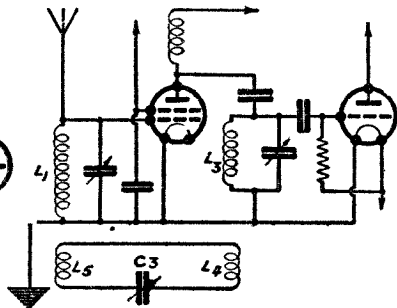

Fig. 172—A link circuit is here used to couple the anode and grid circuits

ful since the whole set is designed to prevent capacity coupling between the anode circuit and the grid circuit. The technique of screen-grid amplification is intended to overcome the natural capacity coupling inside the valve between the metal anode and grid. This coupling has a natural reaction result which will make a set unstable and likely to oscillate of its own accord.

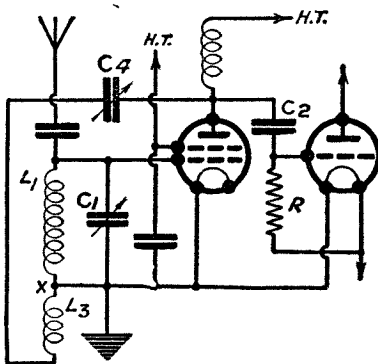

Fig. 173—Aperiodic H.F. amplifier with reaction applied to aerial circuit

An inductive reaction scheme of the kind illustrated in Fig. 172 has been used with success by the present writer. It will be seen that two inductance coils L_4 and L_5 are coupled respectively to the anode inductance L_3 and the grid inductance L_1 . The circuit $L_5 L_4 C_3$ is intended to be aperiodic while the condenser C_3 will vary the strength of the current communicated from the anode circuit to the grid circuit. It is of course essential that the connections to the coils should

be correct, otherwise reverse reaction will be obtained.

A type of circuit popular in portable receivers is that illustrated in Fig. 173 which shows a choke coil connected in the anode circuit of a screen-grid valve. This choke acts as an aperiodic H.F. coupling between the first valve and the detector valve which follows. Reaction may be introduced into the circuit $L_1 C_1$ by means of a small variable condenser C_4 which feeds the reaction coil L_3 . The merit of this arrangement is that high-frequency amplification is still obtained although only a single tuning condenser is employed. The use of a choke in this manner is not as efficient as if a tuned circuit were associated with the anode of the screen-grid valve.

External Reaction.—The reaction effect may be obtained from an entirely separate valve specially arranged for that purpose and Fig. 174 shows a satisfactory arrangement. It will be seen that a tapping on the aerial inductance is taken to the grid of a three-electrode valve whose anode circuit contains a reaction coil L_2 coupled to the aerial inductance L_1 . A grid condenser and grid resistance is associated with the grid of the reaction valve but only as a convenient method of applying a negative potential to the grid of this valve from a grid-bias battery. The ideal conditions are a comparatively tight coupling between the reaction coil and the aerial inductance and a low tapping on the aerial inductance L_1 . This will result in only a small portion of the characteristic curve of the reaction valve being used and greater constancy of reaction will thus be employed, whereas if a large portion of the characteristic curve were used, the amount of reaction applied would probably vary with the signal strength

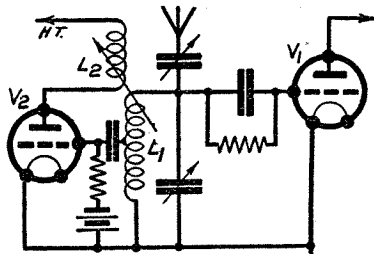

Fig. 174—External reaction is applied by means of a separate valve

CHAPTER 9

RECTIFIERS AND DETECTORS

Most valve detectors to-day operate on the principle of the simple two-electrode valves which in 1904 were first applied to the rectification and detection of wireless signals. A more detailed consideration of this type of valve will therefore not be out of place at the beginning of this chapter.

In Fig. 175 an alternating current is fed by means of a trans-

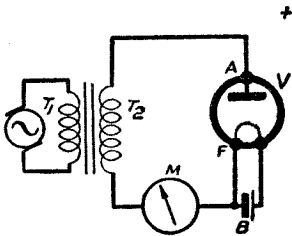

Fig. 175—Alternating current being applied to diode, which rectifies it

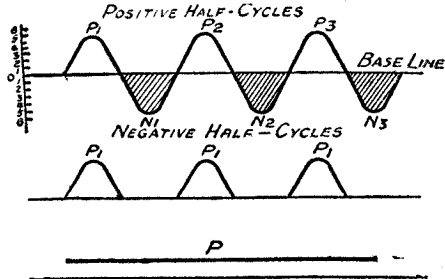

Fig. 176—Graphical representation of the rectification process; only positive half-cycles pass

former T_1 T_2 to the anode A and filament F of the two-electrode valve V. In the anode circuit of the valve is connected a direct-current measuring instrument M. When the filament F is switched off, there will be no current through the meter M, but when the filament is "alight" a reading will be obtained on the meter. The reason for this can be explained by Fig. 176, which shows a number of cycles of alternating current. The positive half-cycles P_1 , P_2 , P_3 will all make the anode of the valve positive, and this potential will attract electrons from around the filament. The negative half-cycles will make the anode negative and this will repel the electrons emitted from the filament. There will thus be no electrons round the anode circuit during the negative half-cycles.

It is assumed that the measuring instrument will only measure a direct current and therefore if the valve conducted both positive and negative half-cycles, these—if following each other rapidly—would neutralise each other in their effect on the meter M.

The negative half-cycles, however, are non-effective. The positive half-cycles have a cumulative effect since they produce a series of pulses through the measuring instrument which responds to them as if there were a fairly steady direct current passing from anode to filament or, in other words, as if there were a steady stream of electrons flowing from the anode through T_2 and through M . This steady current is indicated by P in the third line of Fig. 176.

In place of a measuring instrument, we can use telephone receivers, and instead of the low-frequency transformer $T_1 T_2$ we can employ the input circuit of a wireless receiver containing high-frequency oscillations. A direct current would not, of course, influence telephone receivers, but the high-frequency oscillations from a broadcasting station vary in amplitude, and so produce after rectification a fluctuating current which will produce sounds in the telephone exactly similar to those which modulate at the broadcasting transmitter.

Fig. 177 shows a complete wireless receiver of very primitive

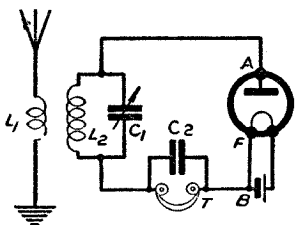

Fig. 177—The Fleming or diode valve circuit used as a wireless detector

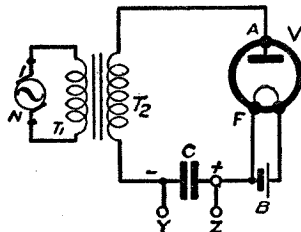

Fig. 178—Complete A.C. rectifier circuit with a reservoir condenser which becomes charged as shown

form. It will be seen that telephones T are included in the anode circuit of the valve, and that the high-frequency alternating current potentials are supplied by the circuit $L_2 C_1$. The condenser C_2 across the telephones allows a passage of high-frequency current to the filament of the valve. It also has an *integrating* effect in that it adds up the little pulses of high-frequency positive half-cycles and gives up to the telephones a pulsating current of low frequency. As we principally use loudspeakers the simple arrangement of Fig. 177, besides being insensitive, will not provide a sufficient power output and one or more stages of low-frequency amplification would be required.

To understand how we can withdraw low-frequency potentials for further amplification, a study of Fig. 178 will repay the reader. Here we have the alternating currents fed to the terminals $I N$, the transformer $T_1 T_2$ passing them on to the anode and filament

of the valve *V*, the condenser *C* allowing the passage of the alternating e.m.f.s. but acting as a bar to the rectified direct currents. When the anode *A* of the valve *V* is made positive, electrons leave the filament *F*, travel to *A*, round through the winding *T*₂, and on to the left-hand plate of the condenser *C*. Unless we discharge the condenser *C* in some way, the electrons will pile up on the left-hand side of this condenser, making the terminal *Y* negative with respect to the terminal *Z*. The condenser *C* will charge up to the peak value of the input voltage.

The unidirectional properties of the two-electrode valve, or diode as it is sometimes called, are illustrated by a characteristic curve showing the relationship between anode current and anode volts. Such a curve is prepared by simply varying the voltage of a battery connected across anode and filament and measuring the change in the anode current as registered by a meter in the anode circuit. The curve is usually nearly straight, although it may have an initial curvature of a concave character at the beginning. This initial curvature was in the earlier days of wireless taken advantage of in the manner shown in Fig. 179, where a potentiometer *R* is

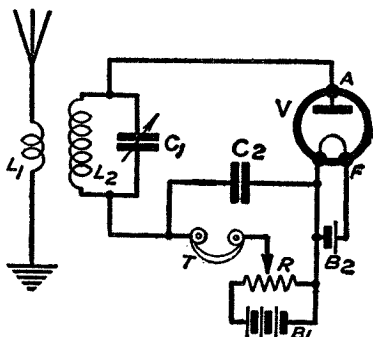

Fig. 179—Fleming valve with positive bias on anode for more sensitive detection

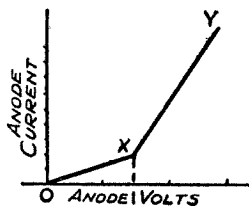

Fig. 180—An exaggerated anode current curve of diode to show rectification at bend

used for the purpose of giving the anode of the valve a small initial positive potential. This causes the valve to operate on the bend *X* of the anode current curve, which has been specially exaggerated in Fig. 180. Positive half-cycles of high-frequency current will cause a larger flow of current through the telephones. Negative half-cycles, however, will produce less effect. The average effect will be an increased current.

Amplifying Rectified Signals.—The condenser which is charged up by the rectification of high-frequency signals, must be discharged in some way, otherwise the valve would cease to act as a rectifier and the voltage output from the device would remain

constant. It is usual to connect a resistance across the condenser which is being charged by the rectified current. Fig. 181 shows a simple rectifier valve V_1 which feeds a condenser C_2 with the rectified current, a leak R being connected across the condenser C_2 . The application of oscillating potentials of varying strength to the anode of the valve will now have the effect of producing low-frequency e.m.fs. across the resistance R , the terminal Y being made negative to a varying extent with respect to the terminal Z . The potentials across the terminals $Y Z$ are now communicated across the grid and filament of a three-electrode valve

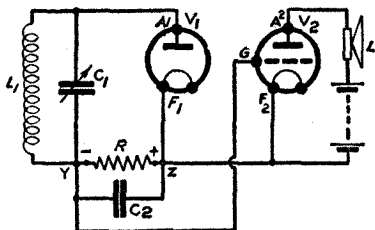

Fig. 181—The L.F. potentials across R are passed on to the L.F. valve

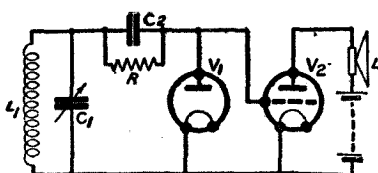

Fig. 182—The connection shown above results in H.F. on the grid of V_2

V_2 which has in its anode circuit a loudspeaker; probably a further stage of amplification would usually be used.

The reader may prefer to regard the resistance R as the apparatus across which the rectified e.m.fs. are developed due to the flow of current through R , the condenser C_2 serving as a by-pass for the high-frequency potentials communicated across A_1 and F_1 , and also serving as a means of integrating and smoothing out the rectified pulses of H.F. into an average low-frequency pulse. Fig. 182 is similar to Fig. 181 except that the resistance R and the condenser C_2 are connected in the lead going to the anode. The anode of the rectifier valve V_1 is connected to the grid of the low-frequency amplifying valve V_2 . The low-frequency potentials established across R or across C_2 (whichever one cares to regard as the essential piece of apparatus) are communicated to the grid of the second valve, but it will be noticed that the tuned circuit $L_1 C_1$ is virtually across grid and filament of the second valve. There is, therefore, across the grid and filament of the valve not only a source of low-frequency potentials, but also a source of high-frequency potentials. This means that the grid of the second valve will certainly attempt to amplify both high- and low-frequencies. This, as a matter of fact, will not matter very much in simple cases, but it is bad practice for high-frequency currents to be produced in the anode circuit of the valve V_2 , although advantage is taken of the fact in many reaction circuits.

The arrangement of Fig. 181 is tainted with the same defect to some extent, because the low-frequency pulses established across R are also mixed with the high-frequency potentials which pass through the condenser C_2 , and, unless this capacity is large, appreciable high-frequency potential differences across the terminals Y and Z are produced.

Whichever connection is used, some form of high-frequency filter is indicated, and Fig. 183 shows how a choke coil L_2 and a

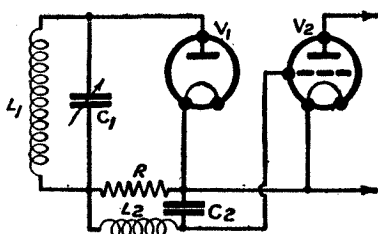

Fig. 183—Use of H.F. choke to keep H.F. from the output L.F.

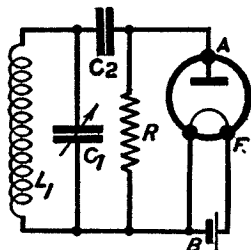

Fig. 184—The output resistance is now in parallel with the input circuit

small capacity C_2 are connected across the leak R so as to filter out the high-frequency currents before they can influence the grid of the second valve. A resistance of, say, 1 megohm is often used in place of the choke. A full explanation of the action of filters of this kind is given in a separate chapter.

Parallel Output.—There is no need for the resistance (across which we are to develop the low-frequency potentials) to be directly in the input circuit to the valve. It may be connected in parallel with it, as shown in Fig. 184. The oscillating currents in L_1 C_1 are now communicated across the anode and filament of the valve through the fixed condenser C_2 . If no leak R were connected across anode and filament, the anode would become more and more negative as it accumulated electrons which could not leak away through the condenser C_2 . Finally, the anode would become so negative that its potential would equal the maximum H.F. potential applied to it and then no more electrons would be drawn up from the filament. If, however, a leak R is connected across anode and filament in the manner shown, the condenser C_2 will discharge through it.

The values of C_2 and R are so chosen that the device remains sensitive as a detector and does not become paralysed. We could connect the top end of R to the grid of a second valve, and the bottom end of R to the filament of a second valve, but we would have the trouble of high-frequency potentials being passed on. If,

however, we use the arrangement illustrated in Fig. 185, we can insert a choke L_2 between the grid of the valve and the leak R . This choke will have the effect of practically preventing any high-frequency potentials being set up across R , especially if R is shunted by a small condenser C_3 ; almost the whole of the H.F. potentials will now be established across L_2 . The

Fig. 185—Another way of keeping the H.F. out of the L.F. circuits

presence of the H.F. choke L_2 does not, however, prevent the resistance R acting as a low-frequency leak and the L.F. potentials established across it can be communicated to the grid of the second valve.

In Fig. 185 a three-electrode valve is shown in use as the rectifier, the anode not being used. It therefore acts as a diode.

Fig 186 shows a similar arrangement in which high-frequency currents are fed to the diode and a variable tapping is taken on the grid leak R which may conveniently have a value of one-half megohm. The second valve V_2 acts as a low-frequency amplifier as does the third valve V_3 which may operate the loudspeaker. The half-megohm leak will serve as a volume control, since any proportion of the L.F. potentials developed across it may be passed on to the grid of the second valve.

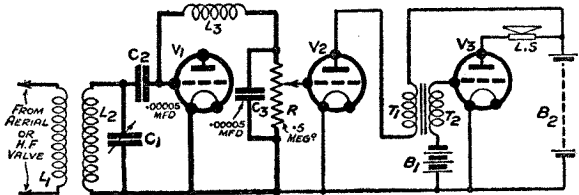

Fig. 186—A practical diode rectifier circuit using three valves, first as detector, second as L.F. amplifier

The second valve V_2 acts as a low-frequency amplifier as does the third valve V_3 which may operate the loudspeaker. The half-megohm leak will serve as a volume control, since any proportion of the L.F. potentials developed across it may be passed on to the grid of the second valve.

Fig. 187 is a slight modification, but still uses a three-electrode valve.

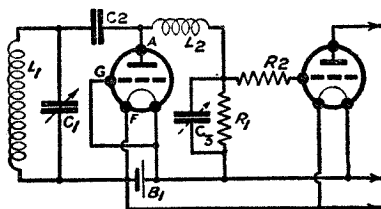

Fig. 187—Another diode detector circuit with H.F. choke and grid stopper

This time the high-frequency potentials are connected across the anode and filament while the grid of the valve is connected to the positive side of the filament battery. A preset condenser C_3 is shown connected across R_1 to enable adjustments to be made to give the best results.

A further refinement is the connection of a resistance R_2 of, say, 100,000 ohms in the grid circuit of the second valve; its object is to act as a further H.F. filter. The operation of such a *grid stopper* is also explained in the chapter on filters.

Full-wave Rectifiers.—Instead of using a single rectifier valve, it is possible to use two so that both half-cycles are utilised, and an arrangement is illustrated in Fig. 188, where a middle tapping T is taken on the inductance L of the tuned circuit. The tapping is taken through the usual leak R to the filament, while the two ends of the inductance L are connected respectively to a couple of anodes A_1 and A_2 in the special valve.

The operation of the full-wave rectifier is briefly as follows: The anode A_1 may be assumed to be given a positive potential due to the high-frequency signals. Simultaneously the anode A_2 will be negative, since the two ends of the inductance L will—at any given instant—be at opposite potentials. The anode A_1 being positive will draw electrons from the filament, and these will flow through the top half of the inductance coil to the tapping T and thence through the leak R to the filament. When the current in the circuit $L C_1$ changes direction, the anode A_2 will become positive, while A_1 becomes negative. The anode A_2 now draws electrons from the filament and these flow to the tapping T and through the resistance R . It will thus be seen that no matter which anode is made positive, a current will flow through the leak making its left-hand side negative with respect to the right-hand side. A choke coil L_2 and condenser C_2 is shown in use for the purpose of filtering out any high-frequency potentials established across the resistance R . A by-pass condenser C_3 connected across R also helps to reduce

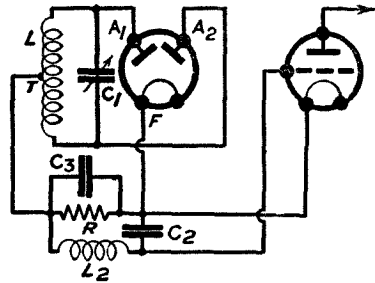

Fig. 188—Full-wave rectifier using a double diode for detection

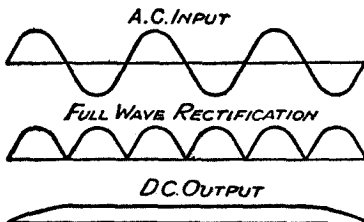

Fig. 189—Graphical representation of full-wave rectification

the H.F. potentials across it. This condenser evens out the rectified impulses into L.F., but if too large, the higher notes of the L.F. currents will themselves be levelled out and lost; we obviously do not seek to produce a steady D.C. output.

Full-wave rectification in which both half-cycles produce a

rectified current is graphically illustrated in Fig. 189, where the top line shows the alternating current input while the second line shows that the bottom half-cycles have now been reversed and appear between two successive positive half-cycles. The third line shows the approximately D.C. output from the arrangement. It will be understood, of course, that in actual practice the high-frequency signals do not take the form of a steady alternating current but vary in amplitude, and so the output instead of being pure D.C. is of a unidirectional character which varies in amplitude at audio frequency: in other words, we obtain low-frequency potential variations which are then amplified by subsequent valves.

Leaky-Grid Rectification.—Although the diode system of rectification is becoming increasingly popular in the more powerful commercial receivers, it has not proved popular with the constructor and amateur because it requires two valves to operate effectively, one being the detector valve and the other an amplifier.

The earliest use of the three-electrode valve was as a detector operating on what is known as the *leaky-grid condenser* system of rectification. The simplest form of this circuit is illustrated in Fig. 190, where a three-electrode valve has telephones connected in its anode circuit and a tuned circuit $L_2 C_1$ connected across grid and filament. In the grid circuit, however, is a condenser C_2 shunted by a resistance R . The grid condenser, as it is called, usually

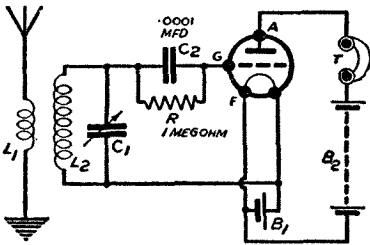

Fig. 190—Circuit for obtaining leaky-grid-condenser rectification in wireless reception

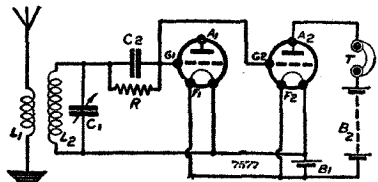

Fig. 191—This represents the Fig. 190 circuit arranged as two valves

has a capacity of from $\cdot 00005$ to $\cdot 0003$ mfd., while the leak R may have a value of from 250,000 ohms to 5 megohms. The arrangement of Fig. 190 really consists of a diode detector followed by a low-frequency amplifier, and Fig. 191 shows how we could get the same effect by the use of two valves. It will be seen that the grid G_1 and filament F_1 of the first valve constitute a diode and that the condenser C_2 and grid resistance serve the same purpose as they do in the ordinary diode detectors just described. The L.F. potentials across the resistance and C_2 are not actually

passed on to the grid and filament of a separate valve as in Fig. 191, but already exist on the grid which controls an electron stream between filament and anode. The grid therefore of a valve operating as a leaky-grid-condenser rectifier is acting partially as an anode for rectifying purposes and partially as a control electrode of a three-electrode valve low-frequency amplifier.

We virtually have two valves in one, and it is little wonder that the scheme has proved extremely popular as a simple, reliable and efficient detector. The arrangement, however, does not lend itself to the rectification of very large high-frequency inputs and moreover suffers from the disadvantage that high-frequency currents

occur in the anode circuit and require filtering out in some way so as to prevent them from becoming mixed up with the subsequent low-frequency stages which are almost invariably employed.

Instead of connecting the leak directly across the grid condenser as in Fig. 190, the scheme of Fig. 191a is very commonly employed and operates on exactly the same principle, the only disadvantage of the Fig. 191a arrangement being that the leak introduces a little more damping

into the tuned circuit. On the other hand, it enables one side of the tuning condenser to be connected to the negative of the L.T., which terminal is usually earthed.

The Westector.—The arrangement of a diode detector followed by a stage of low-frequency amplification is not fundamentally different from the use of a Westector. The Westector is a metal rectifier which is much more robust than a crystal detector, will handle larger inputs, and which gives a rectified output current which is proportionate to the input. A Westector may be connected in the manner shown in Fig. 192. A resistance

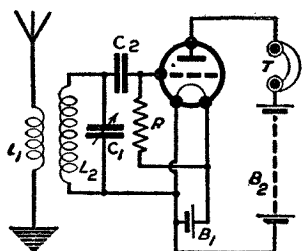

Fig. 191a—The grid resistance is given a parallel connection

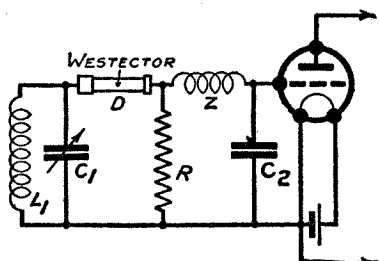

Fig. 192—The Westector—a metal rectifier—is here shown as a wireless detector

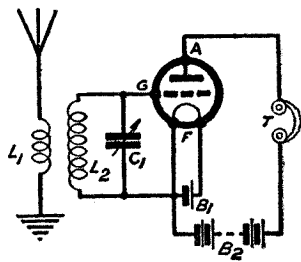

Fig. 193—An unusual valve detector circuit which relies on grid damping

R serves as the output impedance, while an H.F. choke Z and condenser C₂ serve as a filter for cutting out the high-frequency currents which would otherwise influence the grid of the amplifying valve.

Another Form of Valve Detection.—An interesting but little-used system of detection is that illustrated in Fig. 193, where the tuned circuit is connected across grid and filament of the valve. It will be seen that the bottom side of L₂ C₁ is connected to the negative side of the accumulator B₁. The operation of this arrangement is as follows: When the grid of a three-electrode valve is made positive a grid current flows, but when the grid is made negative the grid repels electrons which would otherwise go to it. When high-frequency potentials are applied to the grid and filament of a valve, the positive half-cycles will draw electrons to the grid while the negative half-cycles will have no effect at all. The positive half-

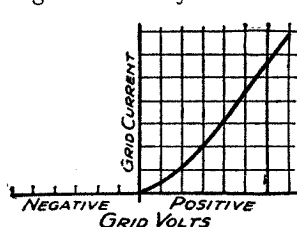

Fig. 194—Grid current curve to explain grid rectification effects

cycles will be damped out to some extent, but the negative half-cycles produce no grid current and so cause a substantial decrease of anode current. Fig. 194 shows what a grid current curve is like, while Fig. 195 shows how the bottom half-cycles of input oscillations are productive of a large drop in anode current while the positive half-cycles only produce a small increase. The average effect therefore, of oscillations applied to the grid and filament of the valve will be a decrease in anode current. There will thus be a rectification effect, as shown in Fig. 195.

Anode-bend Rectification.—The methods of rectification so far considered depend upon the production of rectification effects in the grid circuit, the anode circuit merely serving as part of the amplifying arrangement. By using what is known as *anode-bend* detection (or anode rectification, as it is sometimes called) it is possible to do the whole of the rectification on the anode current curve, relying upon the curvature at certain points of the anode current curve to produce the asymmetrical effect desired. The curve A X B Y C of Fig. 196 is that of a fairly typical three-electrode valve, and it will be seen that while the portion between Y and C is perfectly straight, that between Y and A is concave.

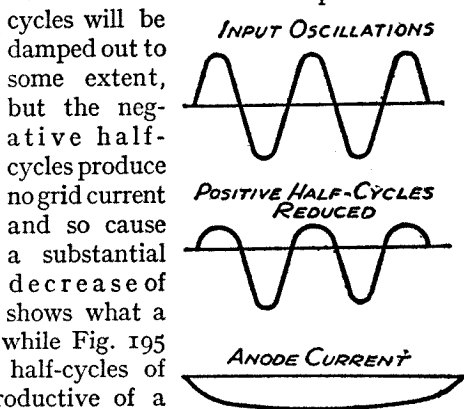

Fig. 195—Graphical representation of grid damping detection

If we arrange a circuit as in Fig. 197 and give the grid G of the valve an appropriate negative potential by means of a grid-bias battery

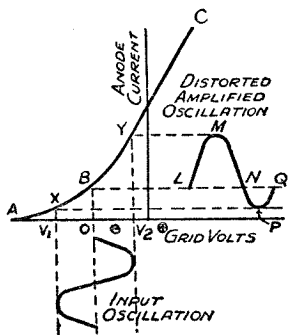

Fig. 196—Characteristic curve showing how anode-bend detection works in a receiver

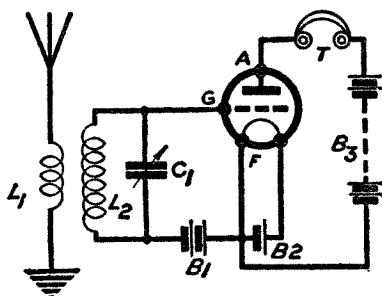

Fig. 197—Typical anode-bend circuit ; an adjustable negative bias is given to the grid

BI, we shall be operating the valve at some such point as B on its characteristic curve, i.e., at what is known as the bottom bend. With this arrangement the input oscillations are in no way altered, since no grid current flows. The positive half-cycles, therefore, remain of the same amplitude as the negative ones and the whole of the rectification effect is obtained on account of the fact that equal potentials in a positive and negative direction produce entirely different changes in *anode* current.

This is very clearly seen in Fig. 196 where the positive half-cycle will carry the operating point to Y on the curve corresponding to a large increase in anode current, whereas a negative half-cycle will only carry the operating point to X, which represents a comparatively small decrease of anode current. The curve L M N P Q has been drawn to show the amplified complete oscillation consisting of a positive and negative half-cycle. It will be seen

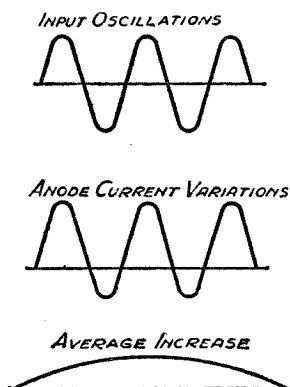

Fig. 198—An approximate graphical representation of anode-bend detection

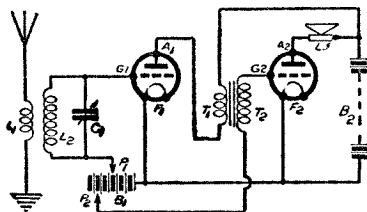

Fig. 199—A complete two-valve receiver circuit using anode-bend rectification

that the positive half-cycle is much greater than the negative half-cycle. The average effect, therefore, of one cycle will be to cause an increase in the anode current. Oscillations will, therefore, be rectified by this arrangement. Fig. 198 shows graphically how an average increase in anode current is produced by a series of input oscillations. The increase of anode current will vary in time with the low-frequency modulations of the incoming high-frequency signals.

Fig. 199 shows a complete 2-valve receiver operating on the anode-bend principle. It will be seen that a single grid-bias battery *BI* serves to provide suitable negative bias both to the grid of the detector valve and to the grid of the L.F. amplifier.

Anode-bend rectification of this kind does not withdraw energy from the tuned circuit *L1 C1*, and therefore imposes no damping on that circuit which consequently provides a high degree of selectivity. Grid-leak rectification, on the other hand, absorbs energy and is less selective. Anode-bend detection, however, is somewhat less sensitive and is generally regarded as giving rather inferior quality as compared, not so much with the ordinary grid-leak rectifier as with power-grid rectification which has become very popular in recent years on more powerful sets.

Anode-bend rectification is not confined to the bottom bend. It is possible to obtain saturation in a valve, especially if the filament current is sufficiently reduced. A curve such as that shown in

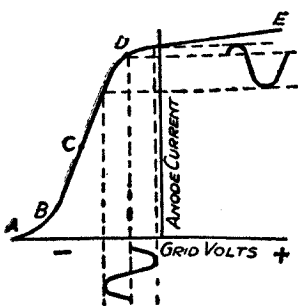

Fig. 200—The upper bend may also be used for rectification

Fig. 200 is thus obtained, the saturation bend *D* occurring at a point equivalent to a small negative potential on the grid. If we work the valve at a point *D* on the bend, the incoming high-frequency oscillations will produce an average decrease of the anode current. Modern valves are usually less sensitive at the upper bend than the lower bend and the lower bend form of rectification possesses the advantage that the anode current is less than that required for upper-bend rectification and leaky-grid-

condenser rectification, where the anode current required may be equal to that of a low-frequency amplifier.

Power Grid Detection.—Power grid detection is a form of rectification usually used when it is desired to obtain a high degree of purity of reproduction combined with the ability to handle large inputs. In power grid detection one employs a high anode voltage usually of about 200 volts, a small grid condenser of, say, .0001-mfd.

capacity and a grid-leak of much lower value than that normally used; the usual value of a grid-leak for power grid detection is 250,000 ohms as against 1 megohm or more for ordinary grid detection. The circuitual arrangement is the same in both cases.

Power grid detection requires substantial inputs, and it is not a very sensitive arrangement; a further disadvantage is that it absorbs considerable energy from the preceding circuit and therefore impairs the selectivity. Power grid detection is now being replaced on many sets by diode detection, the two-electrode valve being frequently arranged in the same valve and using the same filament as another valve used as an L.F. amplifier, such as a pentode or triode. The increasing popularity of automatic volume control calls for larger voltages and these are readily obtainable by using diode rectifiers into which are fed highly amplified high-frequency currents.

Grid Current Curves.—It has been stated that the bottom end of the tuned circuit in a leaky-grid rectifier receiver is connected to the positive side of the L.T. The reason for this is that rectification is most efficient at a bend in the grid current curve. Sometimes the grid current begins at zero grid volts, sometimes when the grid is slightly positive and at other times—as in the case of mains indirectly heated valves—with the grid slightly negative. Sometimes one operates the detector valve at the point where grid current begins but sometimes a little farther up the curve when the rise in grid current begins to become more rapid; in the latter case, the theory of operation may be compared to that of the positively biased diode of Fig. 179.

A grid leak connected to the L.T. positive will pass a small grid current which will produce a negative potential acting in opposition to the larger positive potential; the result is a small suitable positive potential on the grid.

CHAPTER 10

DECOUPLING, FILTERS & SMOOTHING DEVICES

The fact that alternating currents and direct currents behave differently towards different types of apparatus, such as condensers, resistances and inductances, is extremely important and enables many useful effects to be employed in wireless receivers. It is proposed in this chapter to deal with this subject and show how decoupling, smoothing, filtering, etc., are linked by a few elementary principles.

A direct current, such as is provided by a high-tension battery, will pass through a resistance and a potential difference will be established by it across the resistance; a direct current will likewise pass through an inductance but there will be no potential drop across the inductance unless the coil also possesses some resistance which, of course, in practice it always does, although for nearly all purposes in this chapter we can ignore the fact. A direct current will not, however, pass through a condenser at all.

Alternating currents in wireless receivers are nearly always either high-frequency currents due to oscillations in the aerial or else low-frequency currents which are the product of rectifying the high-frequency signals. The L.F. alternating currents are of varying strength and frequency corresponding to the voice or music at the transmitting station. These low-frequency currents may vary in frequency from about 60 per second to 15,000. The high-frequency signals usually used for broadcasting have a frequency of from 150,000 (150 kcs.) to 2,000,000 (2,000 kcs.)

It is important to note how different apparatus acts towards different frequencies. A pure resistance having no inductance and no self-capacity (i.e., no condenser effect across its ends) behaves in much the same way to currents of all frequencies. The condenser, however, while allowing all alternating currents to pass through it, possesses *reactance* which is the opposition in ohms (the unit of "opposition") it offers to alternating currents due to its capacity. The reactance depends partly upon the capacity and partly on the frequency of the currents which we desire to pass through the

condenser. The reactance will be greater the lower the frequency of the currents, and vice versa.

An inductance coil also offers reactance to alternating currents, this reactance being greater the greater the frequency; thus a given inductance will offer greater opposition to high-frequency currents than to currents of lower frequency. Putting it another way, if we pass a given alternating current through an inductance coil, the e.m.fs. set up across it will be greater for a higher frequency than for a lower frequency. This is just the opposite to what happens in the case of a condenser, where the higher the frequency the readier passage does the condenser provide and the lower the potentials established across it.

An inductance coil in practice has a certain amount of self-capacity due to the proximity of turns which provide a leakage path when high frequencies are applied to the coil; the inductance also possesses a certain amount of resistance, as we have seen.

A condenser is also not usually a pure capacity, but provides losses which may be represented by a resistance. The total opposition given by an inductance and by a condenser is in each case usually termed the *impedance* of the coil or of the condenser

Potentiometer Effects.—In Fig. 201 is shown an alternator (i.e., source of alternating current). A feeding alternating current of voltage V to a resistance R and a condenser C . In passing through the resistance, the alternating current sets up a voltage V_1 , but V_2 across the condenser. These two will always equal the voltage of the alternator, but the proportion of the two voltages will depend upon the frequency of the current supplied by the alternator and the value of the resistance and that of the condenser. In Fig. 202 an iron-cored L.F. choke (i.e., one of many turns and therefore of high inductance) L is connected in series with the condenser C ; the choke will “drop” a very considerable voltage V_1 , even to low-frequency current, but it will

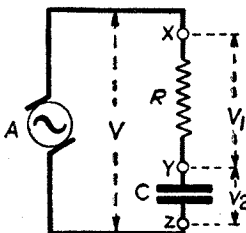

Fig. 201—Potentiometer effect of resistance and condenser in series

always offer a higher reactance to currents of higher frequency (assuming it is a pure inductance). The condenser C , however, will in this, as in the previous case, “drop” a lower voltage as the frequency increases.

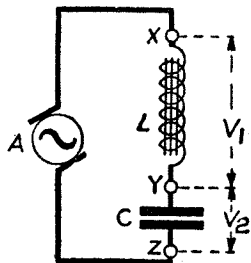

Fig. 202—The total A.C. voltage is divided across the iron-core inductance and the condenser

In Fig. 203 the iron-cored choke is replaced by an air-core H.F. choke, and its action is similar to that of Fig 202. All these circuits are commonly used in wireless receivers, the air-core choke being usually used when high-frequency currents are involved, and the iron-cored chokes when we are concerned with low-frequency

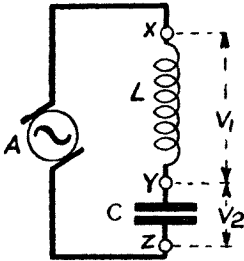

Fig. 203—The voltages across C will be small for high frequencies

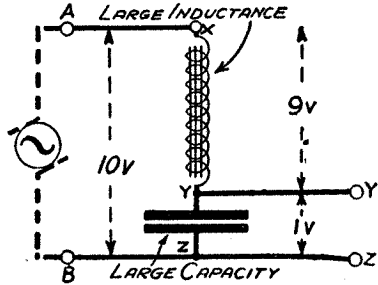

Fig. 204—Most of the alternating current voltages will be developed across the inductance

currents. The recent development of special iron cores for H.F. coils, however, removes the definite distinction. When the choke is illustrated with lines through it, this means it is designed to have a high inductance suitable for L.F. circuits.

Let us first assume that the alternating current is of steady frequency; we shall now consider the effects of different inductances, condensers and resistances. In Fig. 204 a large inductance is connected in series with a large capacity; the large inductance will set up large voltages across itself, while the large capacity will clearly offer a low-reactance path to the alternating current. There will thus be only a small voltage drop across the condenser. If the input voltage is 10 volts we may readily get 9 volts developed across the inductance, and only one volt across the condenser. In Fig 205

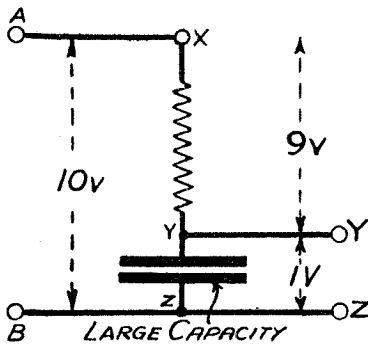

Fig. 205—The voltage across the condenser will be small compared to voltage across resistance

a resistance has been substituted for the inductance, but here again we may easily get 9 volts across the resistance and only 1 volt across the large condenser.

Let us now, however, reverse the conditions and use a small inductance and a small capacity. The small inductance will now offer very little reactance to the alternating current and the voltage may easily be 1 volt as against 9 volts against the small condenser,

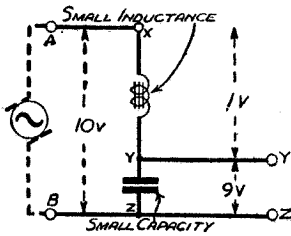

Fig. 206—A small inductance and small capacity will favour low notes

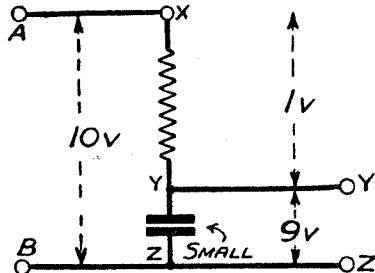

Fig. 207—A resistance and small condenser will give a greater output of low notes

which is now offering a high reactance to the current (Fig. 206). Fig. 207 shows how the use of a small condenser in series with a resistance may result in 9 volts being developed across the condenser as against 1 volt across the resistance. By using different values of resistance and condenser, or inductance and condenser, we can thus divide the input potential in any desired proportion.

Different Effects of L.F. and H.F.—Let us now keep the inductance and condenser unaltered, and simply vary the frequency of the currents applied to them. Fig. 208 shows the same circuit, fed on the left by an L.F. alternator and on the right by an H.F. alternator. The low-frequency currents find it a comparatively easy matter to get through the inductance, and so they only set up 1 volt across it, but when they come to the condenser they find it offers a higher reactance, and so 9 volts are established across the condenser. If now we increase the frequency, it may well be that the inductance now offers a very much higher reactance, while the condenser offers a very much lower one, and the voltages may be reversed so that that across the inductance is now 9 volts and that across the condenser only 1 volt.

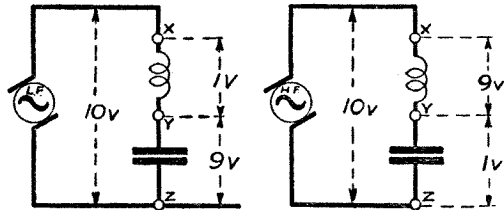

Fig. 208—The identical circuit may give a large or small condenser voltage according to frequency

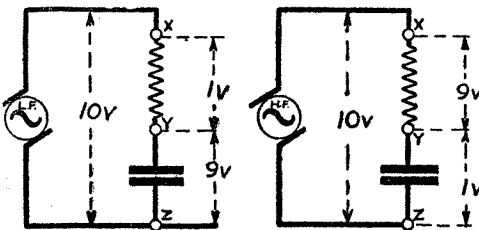

Fig. 209—The same resistance and condenser behave differently to L.F. and H.F.

the voltages may be reversed so that that across the inductance is now 9 volts and that across the condenser only 1 volt.

In Fig. 209 the left-hand circuit shows a low-frequency alter-

nator feeding a resistance and condenser, while on the right is a high-frequency alternator feeding the same values of resistance and condenser. In this case, the resistance does not behave any differently towards high- or low-frequency currents, but the condenser does. In the case of the low-frequency currents, the voltage established across the condenser may be 9 volts, leaving 1 volt for the resistance, while, when high-frequency currents are applied, the condenser offers an easy path and only 1 volt is developed across it, the remaining 9 volts being developed across the resistance. It is to be noted that in all these examples the total voltage applied is 10 volts, and that this is distributed across the inductance and condenser, or the resistance and condenser. The two pieces of apparatus, in fact, operate as a potential divider, the two sets of voltages always adding up to 10.

H.F. and L.F. Filters.—The different behaviour of inductances and condensers to different frequency currents enables us to filter out either the high or the low frequencies where there are two kinds in a receiver. In wireless reception it often occurs that there are present in the set both high-frequency currents (i.e., of radio-frequency) and low-frequency currents (i.e., of audio-frequency).

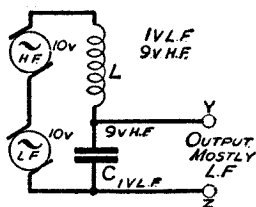

Fig. 210—H.F. is filtered out by this arrangement

Fig 210 is a simple example of a filter which, in this case, is being used to separate a desired low-frequency signal from an undesired high-frequency current. Two alternators, one providing 10 volts of H F. and another providing 10 volts of L F., are connected in series across an air-core inductance coil L, and a fairly large condenser C. Considering the high-frequency currents first, it will be seen

that they will produce a big voltage drop across the inductance L, and a small voltage drop across the condenser C. It is a very simple matter to arrange the values of the inductance and capacity so that this effect is obtained, and it is assumed that the voltage drop across L is 9 volts and that across C is 1 volt. The low-frequency currents, however, behave in an exactly opposite way. The 10 volts of L.F. are now chiefly dropped across the condenser C, there being 9 volts of L.F. and only 1 volt of L.F. across the inductance coil L.

Results of this kind but slightly differing as regards proportions, will be obtained under the following conditions. Let the inductance have a value of 10 millihenries and the condenser a value of .001 mfd. If, now, we apply a low-frequency current of 50 cycles, it will be found that the voltage across the condenser is ten times

that across the inductance. If, now, we substitute a high-frequency current of 500,000 cycles, we will find that the voltage across the condenser is only one-tenth of that across the inductance. These examples show that, in the arrangement given, the output will consist mostly of the low-frequency current, the high-frequency current having been filtered out.

If, however, we desire the high-frequency current and not the low-frequency current, then we must withdraw the currents from across the inductance *L* instead of across the condenser, and then we have the arrangement of Fig. 211. The potentials across *Y Z*

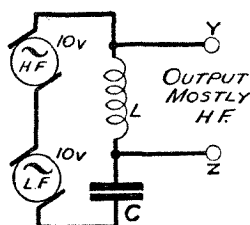

Fig. 211—This particular connection gives an H.F. output

will now be almost entirely due to the high-frequency current, the low-frequency current producing only a small drop in potential across the inductance (which having an air core will have a comparatively low inductance, and therefore small reactance towards L.F.) We can now use either the Fig. 210 or the Fig. 211 arrangement to deliver high-frequencies or low-frequencies at the output terminals.

Although not quite so effective, a resistance and condenser combination will also act as a filter, and an example is shown in Fig. 212. By suitably choosing the values of the resistance *R* and the condenser *C*, it is possible to make the voltage drop across the condenser *C* for high-frequencies only 1 volt as against 9 volts across the resistance *R*. The

condenser *C* will offer a higher reactance to low-frequency currents than to the high, so that we may easily get 9 volts of L.F. across *C* and only 1 volt of L.F. across *R*. The terminals *Y Z* will

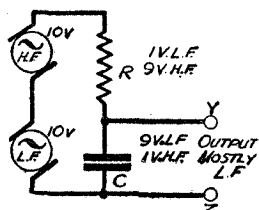

Fig. 212—Connections to give an L.F. output

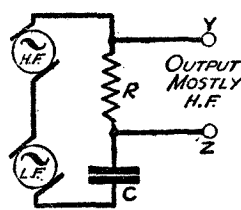

Fig. 213—The same circuit with H.F. output

therefore supply an output consisting chiefly of low-frequency current. Fig. 213 shows the terminals *Y Z* connected across the resistance *R*, and in this case most of the output consists of H.F.

Filtering H.F. from L.F.—A very common circuit in which high-frequency currents are a nuisance in that they get mixed up with the desired low-frequency currents is that shown in

Fig. 214, where a valve detector, working on the leaky-grid principle, is coupled to the next valve through a resistance coupling. When leaky-grid condenser rectification is employed a varying negative charge is developed on the grid at a frequency corresponding to the original low-frequency current used for modulating the transmitting station. But at the same time the grid is having H.F. potentials supplied to it and these will be amplified to some extent by the valve since there is a resistance in the anode circuit. In fact, the resistance is sometimes used for amplifying high-frequency currents, although it is not very efficient—partly because of its self-capacity and the valve capacity which is in parallel with it. Nevertheless, high-frequency currents do get into the anode circuit and tend to be passed on to the next valve. Here they are liable to cause distortion through overloading the next valve when low-frequency currents are to be amplified, and they also tend to cause instability in the receiver as well as *hand-capacity effect* (alteration of tuning, reaction, etc. when the operator's hand approaches a control knob). Also the H.F. currents which drift over may become rectified and produce unwanted L.F. currents.

To get rid of the high-frequency currents before they reach the next valve is our object, and various forms of filters may be employed.

The simplest arrangement of all is to shunt a condenser across the points which are not to receive any high-frequency currents. For example, in Fig. 214 a condenser C_2 of .0003 mfd. is connected

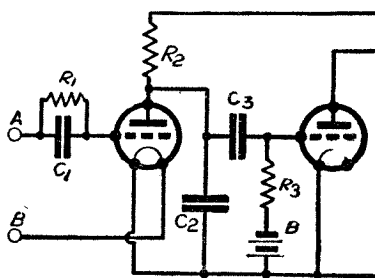

Fig. 214—Use of condenser C_2 to short-circuit undesired H.F. in L.F. amplifier

across the grid and filament of the second valve, or to be a little more accurate, across the resistance R_2 . The fact that this condenser does not actually have its lower side connected to the top end of R_2 does not matter, because *as regards alternating current* the top end of R_2 (which is connected to the high-tension positive) is at the same potential as the filament of the valve. That is

because the passage of alternating current through the high-tension battery produces only small potential differences across it. High-frequency currents which are unintentionally amplified by the first valve will find themselves partially short-circuited by the condenser C_2 . There is, of course, this disadvantage about the condenser C_2 : it will, to some extent, short-circuit the low-fre-

quency currents, but since we have an average frequency of perhaps one thousand per second as compared with the one million per second of the high-frequency current, it will be seen that the condenser will do a good deal to prevent high-frequency currents from going on to the grid of the second valve. It is important not to make the condenser C_2 of too large a capacity, otherwise it will start interfering with signal strength and unduly cutting down the desired low-frequency current. In fact, the condenser C_2 is likely to reduce somewhat the higher musical or speech frequencies. It follows that the condenser C_2 will be more effective for shunting high-frequency currents due to stations on the medium waveband, than those on the long waveband which have a lower frequency.

In order to reduce the undesired high-frequency currents in the L.F. side of the wireless receiver, a choke coil and condenser may be arranged as a filter, as shown in Fig. 215. This is an improvement on the previous figure.

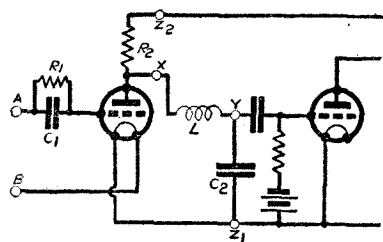

F.g. 215—Use of H.F. choke and condenser C_2 to keep out H.F.

The choke coil L is an air coil inductance and the mixed L.F. and H.F. currents are applied between the points X and Z_1 . The coil L and condenser C_2 may be considered as a potential divider, being virtually across the source R_2 ; the desired L.F. potentials are drawn off the terminals Y and Z_1 . The high-frequency currents, flowing

through L and C_2 , will produce a large voltage across L , while the voltage across C_2 will be small. On the other hand, the low-frequency currents will produce only a small drop across L , and almost a maximum voltage across C_2 . It will thus be seen that across the terminals Y and Z_1 we shall have almost pure L.F.

The arrangement may be redrawn in the form of Fig. 216, where alternators supplying both L.F. and H.F. are connected, as shown across a network (i.e., combination of apparatus offering different paths for current) in which R_2 represents the anode resistance, L the air-core choke, and C_2 what is generally known as a *by-pass* condenser.

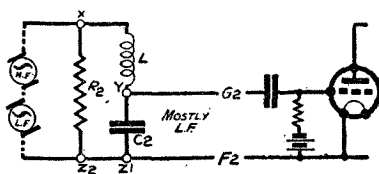

Fig. 216—Network equivalent to the stopper circuit of Fig. 215

As previously explained, the potentials developed across Y and Z_1 will be mostly L.F.

A filtering effect is obtainable even without a special by-pass condenser, and the Fig. 217 arrangement is of interest in this connection. The inductance L is now connected between the anode of the first valve and the grid of the second. The choke L now chokes back the H.F. current while having little effect on those of low-frequency. Putting it another way, we can consider the

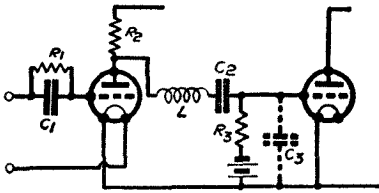

Fig. 217—Sometimes an H.F. choke by itself is used as a stopper

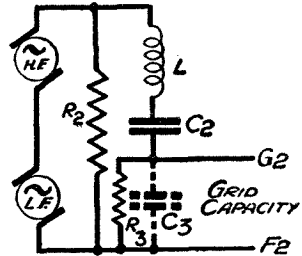

Fig. 218—This shows the network corresponding to the circuit given in Fig. 217

inductance L , the grid condenser C_2 , and the grid resistance R_3 (itself shunted in turn by the capacity between grid and filament inside the valve, and shown as the dotted line condenser C_3) as being a complicated network connected across the resistance R_2 . The arrangement is shown theoretically in Fig. 218. It will be seen that the voltages developed across R_2 are distributed over the inductance L , the condenser C_2 , the resistance R_3 (which is shunted by the grid capacity). Nearly all the high-frequency potentials available will be developed across the inductance L and very little across the terminals G_2 and F_2 . Little H.F. will therefore get to the grid of the second valve. The L.F. currents, however, will produce only a very small voltage drop across L , a comparatively small voltage drop across C_2 (which is of large capacity) but a large voltage drop across R_3 (which has a value probably of 1 megohm). The grid-to-filament capacity of the second valve will have very little effect indeed on the low-frequency currents since the capacity is minute. The arrangement we have just discussed is not as effective a filter as the Fig. 215 arrangement.

H.F. Resistance Stoppers.—A plain resistance of, say, 100,000 ohms may be used as a "stopper" of H.F. One use of such a resistance is shown in Fig. 219, with its corresponding theoretical equivalent Fig 220. Here the high-frequency potentials developed across R_2 are distributed through the resistance R_3 , the large condenser C_2 and the grid resistance R_4 shunted by the grid-to-filament capacity in the valve. This latter, when very high frequencies are involved, is a much readier pass than the grid

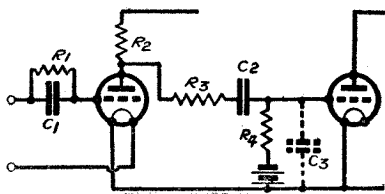

Fig. 219—Use of grid-stopper resistance to keep H.F. from grid of L.F. valve

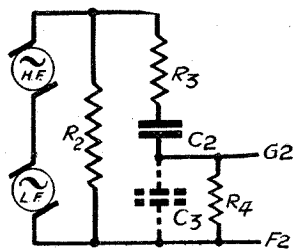

Fig. 220—The network of resistances and capacities equivalent to Fig. 219

resistance R_4 . The theoretical operation of this circuit is similar to that given in connection with the inductive stopper but the results may not be as effective.

The actual position of a choke coil for filtering purposes may be varied and in Fig. 221 the choke L is connected in the grid circuit of the second valve, which is coupled to the first by means of an intervalve L.F. transformer $T_1 T_2$. It has been assumed that high-frequency currents have drifted over into the secondary T_2 of the transformer and, unless we get rid of them in time, they will affect the grid of the second valve. By inserting the choke L in the position shown we shall choke back the H.F. currents. A

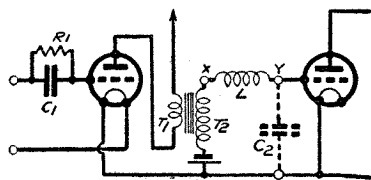

Fig. 221—Showing use of choke as a means of filtering out H.F.

better way of looking at it is to consider the choke L and the grid-to-filament capacity of the valve as being connected across the secondary T_2 . The H.F. and L.F. voltages supplied by T_2 will distribute themselves across the points X and Y and across Y and Z . Because the capacity C_2 (that of the grid in the valve) is very

small and the inductance L also small towards low-frequency currents, we can ignore the effect of the choke on L.F. As regards high-frequency currents, however, most of the potentials will be developed across the inductance and the potentials developed across $Y Z$ by the high-frequency currents will be comparatively small. Hence little H.F. will be applied to the grid. We can accentuate the effect by putting an actual condenser C_2 of small capacity across the grid and filament of the valve. This will make the drop across the terminals $Y Z$ due to high-frequency currents still smaller. The arrangement is shown in Fig. 222, but it is generally unwise to use even a small condenser across grid and filament of the valve because the low-frequency potentials developed across the secondary

of the L.F. transformer will be weakened by the presence of this condenser, especially in respect of the higher musical notes.

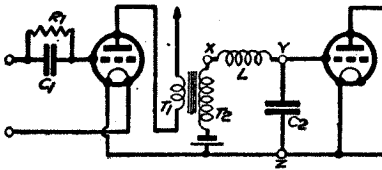

Fig. 222—A condenser C2 increases filter effect but affects top notes of L.F.

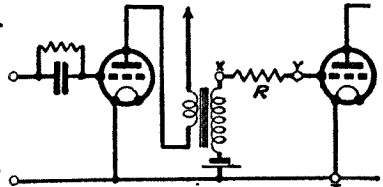

Fig. 223—A grid resistance stopper of 100,000 to 500,000 ohms is popular

A very common arrangement, however, is to include a grid stopper consisting of a resistance R inserted between one end of the intervalve transformer secondary and the grid of the second valve, as shown in Fig. 223. This resistance usually has a value of from 100,000 ohms to 500,000 ohms, and its operation is best understood by regarding it as being in series with the grid-to-filament capacity path and forming (with that capacity) a potential divider across the secondary of the transformer. The greater proportion of the H.F. potentials available is dropped across the resistance R, and less across grid and filament of the valve. On the other hand, the low-frequency potentials are not materially affected. As in all these cases, however, there is some slight cutting down of the top notes on the audio-frequency signals; the grid stopper arrangement is sometimes used when the second valve is a pentode valve, which tends to accentuate high notes. A certain reduction of them is therefore not undesirable.

It is, on the whole, more advisable in the case of L.F. transformers to cut out the H.F. on the primary side and Fig. 224 shows one method of doing this. The choke coil L is connected in the position shown between the anode of the first valve and one side of the primary of the transformer. A condenser C is connected across the primary. Any high-frequency currents from the anode circuit will now pass through L and C, and most of their "force" will be wasted across the inductance L. The high-frequency potentials produced across the condenser C will therefore be small. Exactly the opposite applies, of course, to the desired low-frequency currents. Fig. 224 produces Miller effect and is not advised.

The arrangement may be modified by connecting

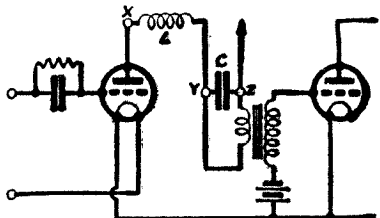
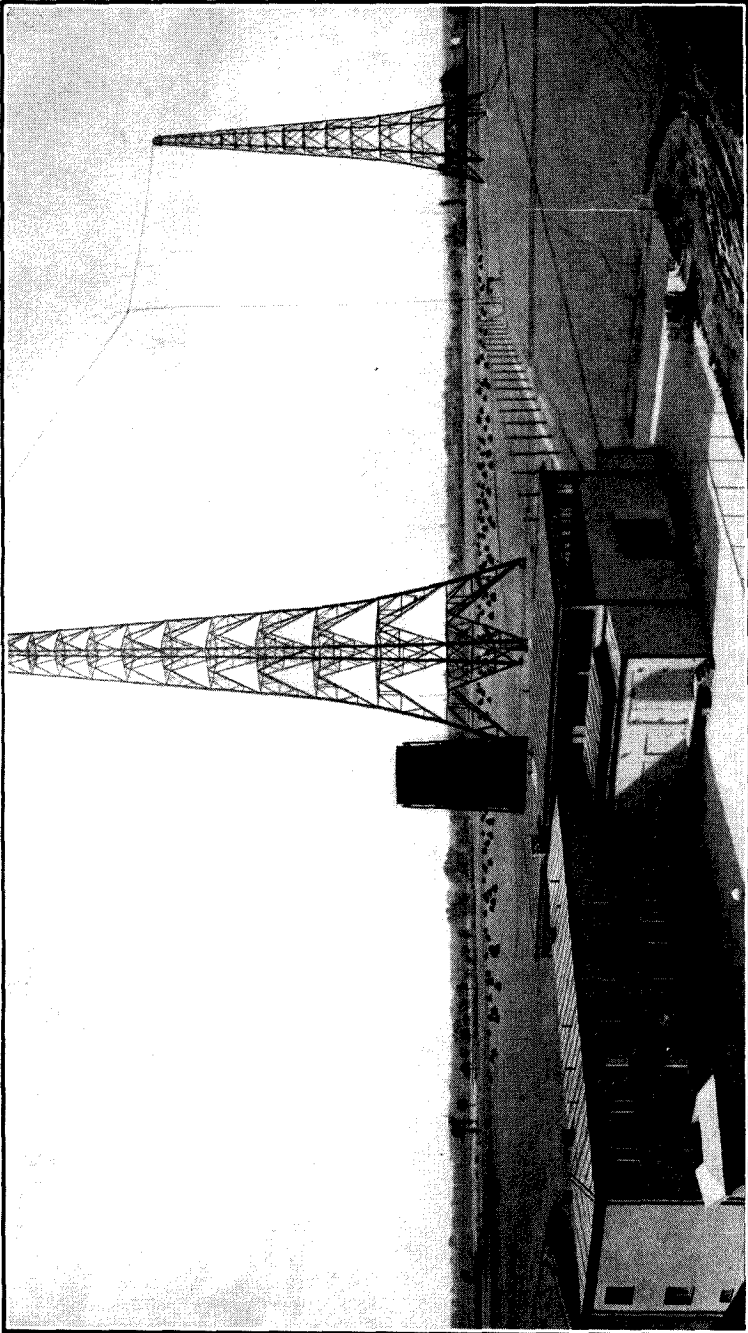
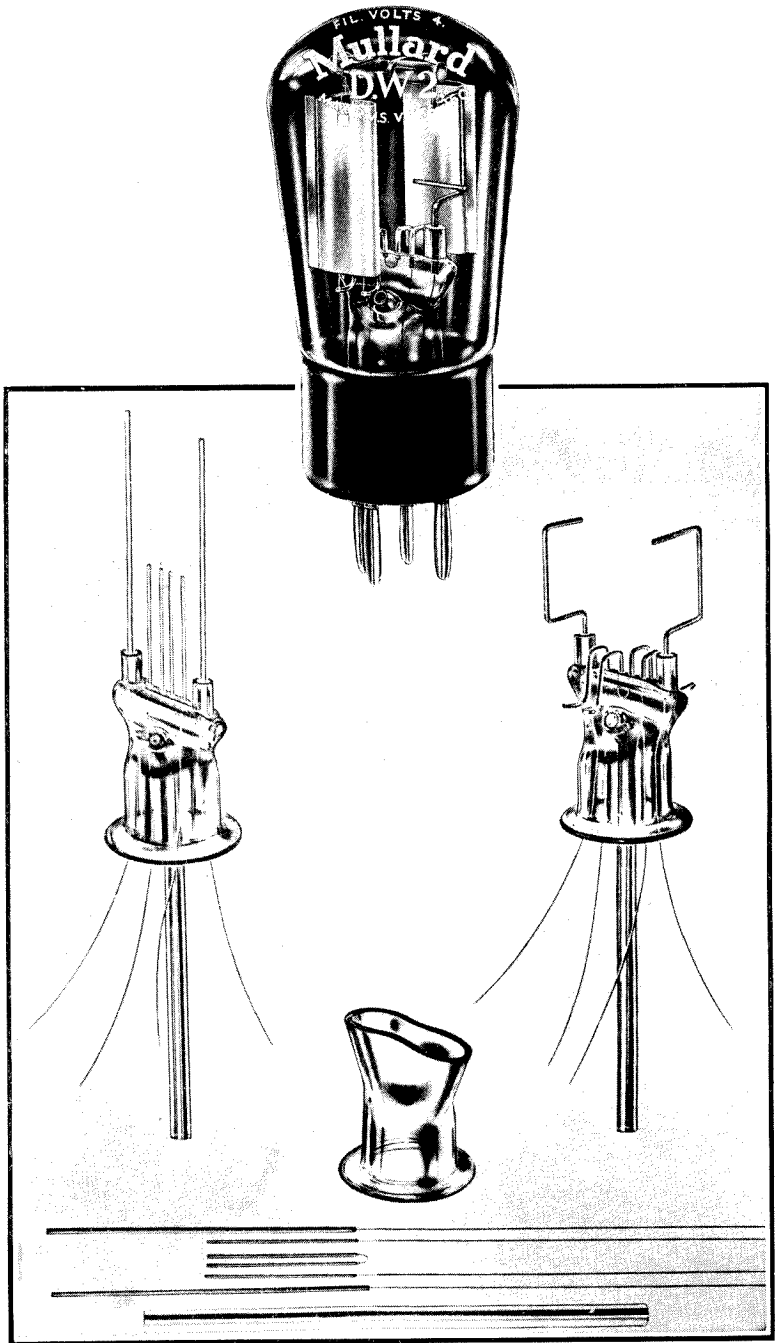

Fig. 224—Here the H.F. choke is directly in the anode circuit



A GENERAL VIEW OF LEIPZIG'S BROADCAST TRANSMITTING STATION



THIS AND THE OPPOSITE PAGE ILLUSTRATE STAGES —

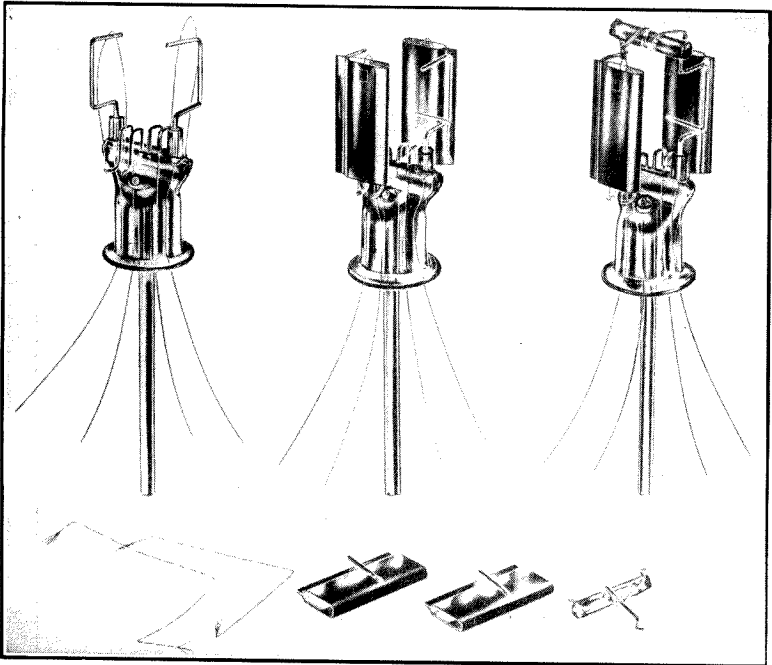
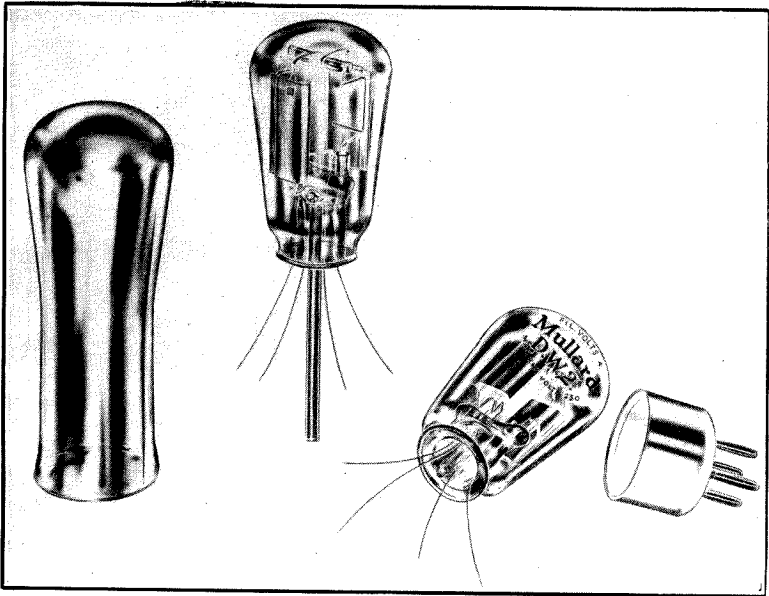

—IN THE MANUFACTURE OF A FULL-WAVE RECTIFIER

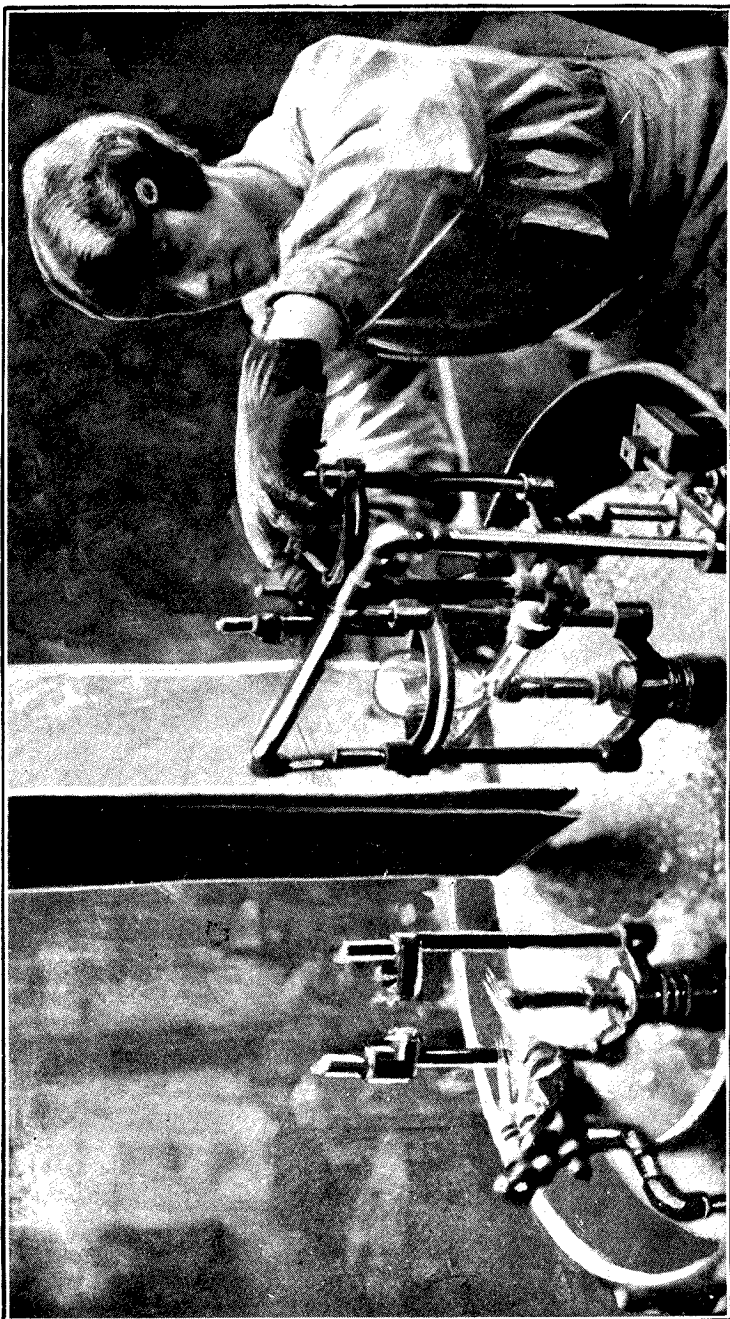

OPERATIVE SEALING THE STEM INTO THE BULB

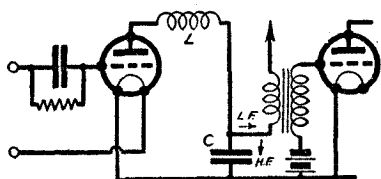

Fig. 225—Use of H.F. choke ; this, however, produces Miller effect

the condenser C straight to the filament of the valve, as shown in Fig. 225. This provides a rather more direct path back to the first filament for the high-frequency currents, whereas in the Fig. 224 arrangement the high-frequency currents pass through the high-tension battery.

Inductance-Resistance Filters.—If an inductance of fairly low value is connected in series with a resistance, the combination will act as a filter if suitable values are chosen. The greater part of the available H.F. potentials appears across the terminals of the inductance and a smaller part across the resistance. The opposite will occur when low frequencies are being dealt with, the voltage developed across the choke being small, while that across the resistance is large. Fig. 226 shows the combined arrangement.

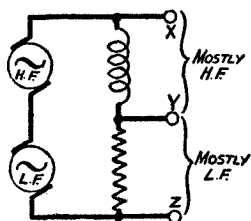

Fig. 226—Theoretical arrangement of inductance-resistance filter

Alternative-Path Filters.—A very commonly employed filtering arrangement consists in providing two paths for the mixed currents and making a particular type of current prefer one path to the other. A good example is illustrated in Fig. 227, where an alternator is supplying current to two paths in parallel.

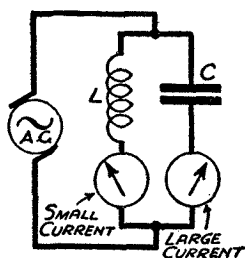

Fig. 227—A.C. prefers large condenser to large inductance

The first path consists of an inductance L and a measuring instrument for indicating the current passing through L. The second path consists of a condenser C which also has in series with it an instrument for measuring the current passing through it. The current supplied by the alternator will now divide up between L and C, and we shall assume in the following description that this circuit is not tuned but simply consists of a choke L and the condenser C. Both the inductance

L and the condenser C will offer a certain amount of reactance to the alternating currents, but if L is large and C is large then the currents will prefer to pass through C instead of going through the choke. In the case of low frequencies it is, of course, possible that the condenser C will offer a higher reactance than would an inductance L, in which case the low frequencies would prefer to

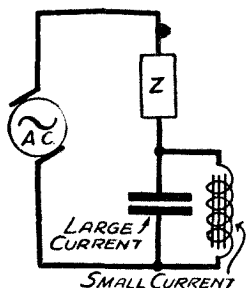

Fig. 228—Shunt effect of condenser across inductance

pass through L . It all depends upon the relative values of L and C , and of the frequency of the applied alternating current. If the inductance is always kept high for the particular frequency desired and the capacity is kept also high, we can say that the alternating currents will always prefer to pass through the condenser. An example of alternative paths is given in Fig. 228, where the alternating current is made to pass through an impedance Z and then has the alternative of passing through either a large condenser or a large inductance, which latter will, if we are dealing with low-frequency currents, be an iron-core choke; the currents will prefer to pass through the condenser.

Alternative paths sometimes consist of a resistance and a condenser; here, again, the preferred path will be the one which offers the least impedance to the particular frequency of the alternating current. (The current, of course, never chooses one path only but divides itself in the preferred proportion. Two paths, even if one is a poor one, enables a greater *total* current to pass through the network. A large resistance and a large condenser ensure that in most cases the alternating currents will prefer to go through the condenser. This is illustrated in Fig. 229.

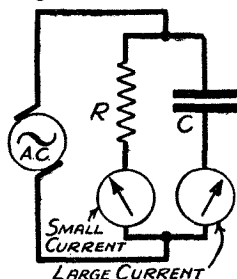

Fig. 229—A.C. will pass through a large condenser in preference to a large resistance

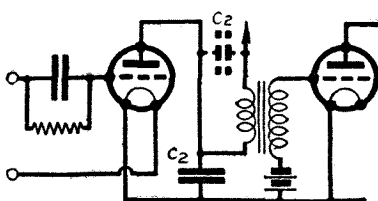

Fig. 230—H.F. currents will prefer to pass through the condenser C_2

In Fig. 230 we have a method for reducing the amount of high-frequency current getting into the inter-valve transformer and so on to the grid of the second valve. The scheme is extremely simple in that the condenser C_2 is connected across anode and filament and forms a by-pass for any high-frequency currents; they prefer to pass through C_2 rather than go through the primary of the inter-valve transformer which acts as a choke. The condenser C_2 , however, must not be of a high capacity, otherwise it will also

by-pass some of the low frequencies; a commonly used value is from .0001 to .0005-mfd. The arrangement is not ideal, however, because the primary of the L.F. transformer does not act as a perfect choke to H.F.; there is a considerable amount of self-

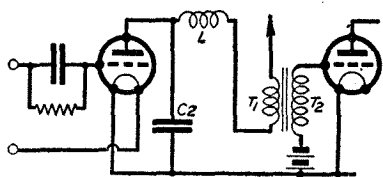

Fig. 231—Practical method of using H.F. choke and by-pass condenser

capacity in the transformer primary, and sometimes a condenser is actually incorporated in the transformer. If we wish to keep H.F. entirely away from the transformer, it is better to insert a high-frequency choke in the manner shown in Fig. 231, where an inductance L is con-

nected between the anode of the first valve and the primary of the L.F. transformer. A condenser C2 is now connected across the anode and filament of the first valve. The H.F. currents now have two paths open to them, one of which is the choke L and the primary of the transformer, and the other is the condenser C2; they naturally choose the latter. Fig. 232 shows the theoretical arrangement of an L.F. alternator and an H.F. alternator, both supplying currents to the network consisting of a condenser C2, choke L, and the primary T1 of the transformer. The condenser C2 passes much H.F. and little L.F., while the inductance L permits little H.F. but much L.F. to pass.

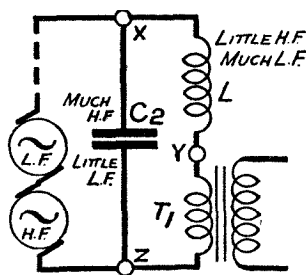

Fig. 232—Theoretical network corresponding to the Fig. 231 arrangement

A further improvement is shown in Fig. 233, where a further filtering process is carried out by a second condenser C3 connected

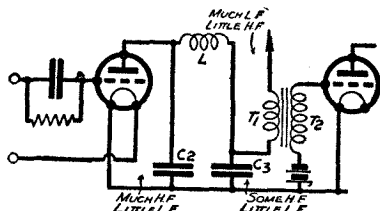

Fig. 233—The best method of keeping H.F. out of L.F. circuits

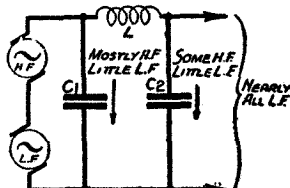

Fig. 234—Theoretical network corresponding to the circuit of Fig. 233

in the position shown. Any small amounts of H.F. current which get through the choke L now pass to the first filament (usually earthed) through the condenser C3, and there is little chance of

H.F. getting into the inter-valve transformer. The complete network is illustrated theoretically in Fig. 234. It will be seen that the condensers C_1 and C_2 pass H.F. but very little L.F. The inductance L and the condenser C_2 act as a potential divider which passes out L.F. with little alteration.

This class of filter is frequently used in resistance-coupled amplifiers, and a good example of such a circuit is given in Fig. 235, where a choke coil L is inserted between the anode of the first valve and the beginning of the coupling resistance R_2 . The junction point between the choke and the resistance R_2 is connected to a condenser C_3 to the earth filament. The connection to the grid of the second valve is made in the usual way. It will be seen

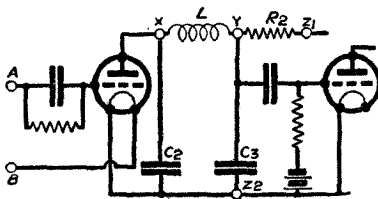

Fig. 235—Use of H.F. choke and condensers in resistance-coupled amplifier

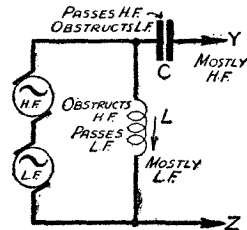

Fig. 236—Simple arrangement for filtering out low-frequency currents

that the H.F. gets two chances of being filtered out in this circuit.

Low-Pass Filters.—We have so far been chiefly concerned with filters which are designed to suppress high-frequency currents and to pass on low-frequency currents or potentials, but sometimes we desire the reverse effect and Fig. 236 shows a simple arrangement.

A high-frequency choke L is connected across the sources of H.F. and L.F., and a condenser C is connected in one lead to the output terminals $Y Z$. The inductance L will allow the low-frequency current to pass through, while obstructing the H.F., which is made to go straight through C . This condenser, however, while it allows the passage of the high-frequency currents, will impede those of low-frequency; terminals $Y Z$ will therefore supply mostly high-frequency currents.

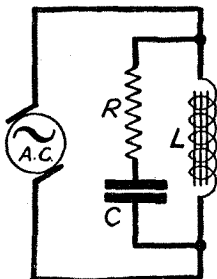

Fig. 237—Arrangement for reducing the higher notes

Sometimes we desire to prevent excessive passage of the higher audio-frequencies through an inductive piece of apparatus, such as a loudspeaker or the choke feeding a loudspeaker, or a transformer used for the same purpose. The arrangement of Fig. 237 is then

commonly employed. Across the iron-core inductance is connected the resistance R (which may have a value of, say, 10,000 ohms) and the condenser C , having a capacity of .01 mfd. Under normal circumstances, the lower frequency currents will prefer to travel through the inductance L rather than through the parallel path $R C$, because R in the first place is high, and C certainly offers a considerable reactance to low-frequency currents. If, however, the frequency supplied by the alternating source rises above a certain frequency it will produce excessive voltages across L ; the safety circuit $R C$ now provides an overflow, because on the higher frequencies the reactance of L becomes so great that the parallel path $R C$ become much more attractive. The arrangement is frequently used as a tone-control for the purpose of cutting down high-note response, especially when pentodes are in use. With these valves, moreover, dangerously high voltages may be set up across the inductance L , and the resistance R and condenser C form a safe alternative path.

A resistance and inductance in parallel would of themselves

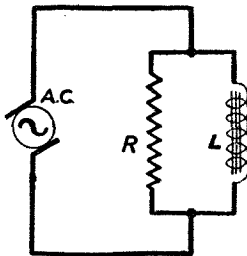

Fig. 238—A resistance alone will reduce high notes

constitute a filter. In the case of low frequencies, the currents would distribute themselves between R and L , as shown in Fig. 238, but most of the currents would probably go through L . As the frequency is made to rise, however, the inductance L offers an increasing reactance and more and more current will tend to pass through R , which continues to offer the same obstruction at all frequencies, and therefore becomes a *relatively* easier path as the alternating frequency rises. The disadvantage of the simple resistance across the inductance is that the resistance will pass current at all frequencies, whereas the addition of a condenser in series with it, as in Fig. 237, prevents excessive currents flowing at low frequencies. A condenser alone in place of the resistance R in Fig. 238 has already been discussed, but as a tone-control device and safety arrangement it suffers from the disadvantage that it permits the passage of high notes all the time. In most tone-control schemes the resistance is a variable one.

Multiple Filters.—Effective filtering may be accomplished by using suitably sized chokes and suitably large condensers, but the former are difficult to make so as to be free from a self-capacity which would minimise their effectiveness, while in many circuits a large condenser cannot be used at all, since it would also cut down the audio-frequency signals. A better solution consists in connecting

filters in series, so to speak, so that after filtering most of the high-frequency currents, the remaining mixture is subjected to a second or third filtering process, each filtering stage cutting out, say, 90 per cent of the H.F. applied to it.

A double filter of this kind is illustrated in Fig. 239, where a

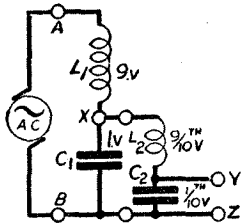

Fig. 239—Use of two filters in series

potential divider filter consisting of an inductance L_1 and condenser C_1 is capable, we can assume, of reducing the H.F. across the condenser C_1 to one-tenth of the total H.F. voltage supplied by the alter-

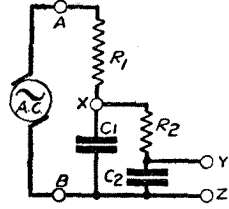

Fig. 240—Two resistance-capacity filters

nator. The terminals of C_1 have connected across them a second inductance L_2 in series with a condenser C_2 , so that this 1 volt of H.F. is further reduced, the final H.F. voltage across C_2 showing only one-tenth of a volt. By the use of two similar filters we have cut down the H.F. to 1-100th of its former value, whereas if low-frequency currents were passed through the filter simultaneously they would only be affected slightly by the second condenser C_2 . This scheme is particularly useful where it is not desired to cut down the audio-frequency currents.

The resistance-capacity filter previously described also lends itself to duplication. Fig. 240 shows a double resistance-capacity filter. If we assume that the condenser C_1 and the resistance R_1 divide up the A.C. potential available so that only one-tenth of it is to be found across the terminals of C_1 , then by adding a similar filter across C_1 we can repeat the process, so that the total A.C. voltage across the output terminals is only 1-100th of the original voltage. This scheme may be used for separating high- and low-frequency alternating currents, but it is largely used for separating D.C. and A.C.

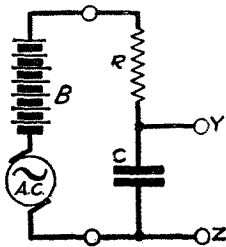

Fig. 241—Separating the A.C. from a D.C. supply

Fig. 241 shows a battery B providing D.C. (direct current) which it is desired to draw off at the terminals YZ . In series with the battery B is a source AC of alternating currents. The problem before us is to get rid of this alternating current and draw off only the D.C. The solution consists in connecting

a resistance R in series with a condenser C . If we make C of large capacity (and we can make it as large as we like, say, 2 mfd. in

this case, since no D.C. can pass) then practically the whole of the A.C. potential is developed across the resistance R , which is "outside" the terminals $Y Z$. Such alternating current as passes through C will produce practically no potential difference across it, with the result that the terminals $Y Z$ will supply almost pure D.C. The most usual example of this filter consists in the D.C. supply system of an A.C. wireless receiver or *mains unit*, where the alternating current from the mains is rectified and produces a direct current output which is not strictly pure, but which has mixed in with it a certain residual ripple of alternating current. It is essential to get rid of this ripple, which will produce a hum in the receiver, and a resistance and a capacity filter is very commonly employed for this purpose.

The disadvantage of a resistance is that not only are the alternating potentials developed across it but there is a certain loss in D.C. voltage across the resistance, since the direct current has to pass through it. A more expensive but more effective arrangement is to use an iron-core inductance in place of the resistance, and if this is wound with reasonably thick wire, the D.C. voltage loss across it will be small while the A.C. potentials developed across it will be large. The arrangement is shown in Fig. 242.

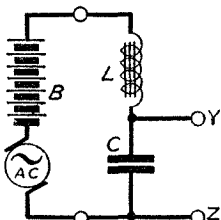

Fig. 242—Use of iron-core choke filter

Fig. 243 shows multiple-filter systems suitable for passing on low frequencies but not high frequencies. In the first case (a) iron-core inductances are shown in use, and large condensers C_1 and C_2 are employed. This filter will only allow the passage of very low frequencies and direct currents. Direct currents will also pass

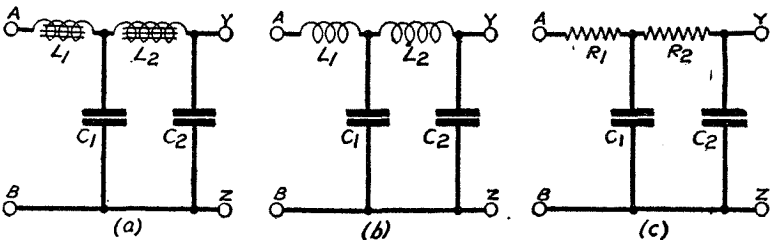

Fig. 243—Three forms of filter which pass on the low-frequencies and tend to "short-circuit" the higher frequencies

through both of the other two filters, although there will be considerable reduction in voltage in the case of the filter (c).

Filter (b) is suitable for discriminating between H.F. and L.F., the latter being allowed to pass through.

The filter (c) is very commonly used for allowing a passage of D.C. but cutting out practically all alternating currents of whatever frequency. Naturally the effectiveness of all these arrangements for given frequencies depends upon the sizes of the condensers and chokes or resistances.

Fig. 244 is a high-pass filter. If mixed H.F. and L.F. currents

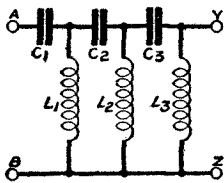

Fig. 244—This combination of condensers and inductances passes on the H.F.

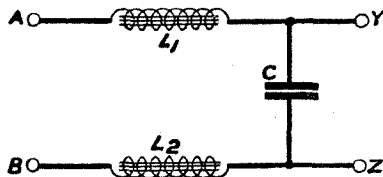

Fig. 245—Use of two L.F. chokes and one condenser for special cases

are applied to A B, the H.F. currents will go through the condensers C_1 , C_2 , and C_3 to Y Z; the low-value inductances will act as chokes to the H.F. but will short-circuit the L.F.

Sometimes it is desirable to include a choke or resistance in each lead instead of only in one lead when desiring to cut out alternating currents. Fig. 245 shows the use of a choke L_1 and a choke L_2 and a capacity C . This is sometimes used for cutting out low-frequency ripple from a D.C. rectifier. The chokes should have little effect on the D.C., but in conjunction with the condenser C , form a potential divider across the alternating current. Some of the potential is developed across L_1 , practically none whatever across C , and the rest across L_2 . The same potential is developed across L_2 as across L_1 , and the effectiveness of the filter is no different than if one inductance only were used having twice the size of L_1 . The arrangement, however, is useful in preventing hum in certain cases where leakage of one kind or another would occur from the terminal Z.

Decoupling.—The word decoupling is used normally to convey the by-passing of alternating currents of high or low frequency to earth instead of letting them pass through an undesirable channel such as a high-tension battery, a grid-bias battery or a mains unit. The currents to be by-passed usually go to earth but not necessarily so. They may go to the filament of the battery valve or the cathode of an A.C. valve, but both are usually connected to earth except, perhaps, for some D.C. potential with respect to earth. We, therefore, speak of "earthing," through a condenser, certain points of a circuit. The symbol for an "earth" is used, but this does not mean a separate earth, but simply an earthed point on the receiver.

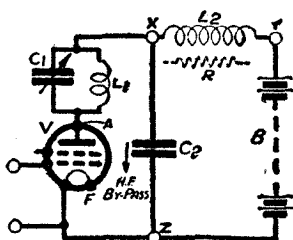

Fig. 246—Decoupling the anode circuit of an H.F. valve

Fig. 246 shows a good example of decoupling to prevent high-frequency currents getting into the high-tension battery. It will be seen that a screen-grid valve is being used as an H.F. amplifier. The anode circuit of the valve contains an inductance L_1 tuned by a condenser C_1 ; in the ordinary way, the top end of the inductance would be connected to the positive of the high-tension battery, which would mean that high-frequency currents in the anode circuit of the valve would pass through the high-tension battery. This is undesirable, because the battery itself has a certain internal resistance, and the high-frequency currents passing through it would set up potential difference across the battery. This is particularly disadvantageous when the high-tension battery, as it usually does, feeds a number of other valves, because it means that high-frequency e.m.fs. are communicated to the other valves and cause instability and other troubles. Another disadvantage of letting the high-frequency currents get into the H.T. battery is that stray couplings occur between the wires going to the battery itself and other parts of the receiver; in fact, H.F. currents would tend to be floating about all round the set, causing instability and lack of selectivity.

We can connect an H.F. choke L_2 and a condenser C_2 of large capacity across the points X and Z. The high-frequency currents will choose the path of least resistance, i.e., through C_2 , and only a small proportion of the high-frequency current will ever get to the high-tension battery.

Actually, in a circuit of this kind the condenser C_2 should be as large as possible, and may have a value of 2 mfd., but as larger condensers are more expensive, condensers of 0.1 mfd. or even 0.01 mfd. would quite effectively decouple the high-tension battery from radio-frequency currents. The condenser should be of such a size that its impedance is not more than one-tenth of that of the choke.

The inductance L_2 should have as little self-capacity as possible, because the self-capacity will itself provide an alternative path in parallel with L_2 , thus reducing the reactance of this path which should really offer as great an obstruction to the H.F. current as possible.

In place of the inductance L_2 , we could use a resistance R (shown in a dotted line), although it has the disadvantage that it will reduce the high-tension voltage on the anode. We can, however,

use quite a small value of resistance with good effect, provided the condenser C_2 is made large. For example, if the resistance had a value of 1,000 ohms it would make little difference to the anode volts of the screen-grid valve. If we make the condenser C_2 of 1-mfd. capacity, the reactance of it will only be $\frac{1}{6}$ th of an ohm when dealing with high-frequency currents corresponding to signals of 300 metres wavelength; it is easy to see that the high-frequency currents will much prefer to pass through a path having an opposition effect of only $\frac{1}{6}$ th of an ohm as compared to 1,000 ohms. In designing any decoupling circuit, it is important to find the reactance of the two paths for the particular frequency of the currents to be decoupled; for example, the decoupling in this case is much more effective for a wavelength of 300 metres than it would be for a wavelength of 1,600 metres.

If we were trying to decouple low-frequency currents of a frequency of, say, 1,000, we should need a choke of much higher value or a resistance of much higher value, say, 20,000 ohms. We could, of course, as an alternative use a much larger condenser, but this is not usually a practical or economical method.

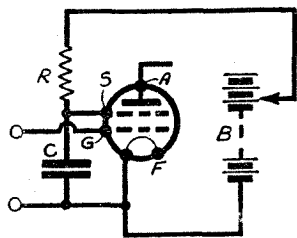

Fig. 247—Decoupling the screen of an S.G. valve

Fig. 247 shows how the screen of a screen-grid valve may be decoupled. If the screen were connected directly to a tapping on the high-tension battery, any high-frequency currents set up in the screen circuit due to high-frequency

potentials on the grid would get into the high-tension battery and perhaps make a nuisance of themselves. Also the screen itself would have its potentials altered at high frequency, even though the voltage variations might only be slight. It is quite common practice to connect the screen to a tapping on the high-tension battery, and to connect a 1-mfd. condenser across screen and filament. This would effectively by-pass any H.F. on the screen, but to make doubly sure, a small resistance R is often connected in the screen circuit; the resistance may have a value of 600 ohms or 1,000 ohms, or, in general, some small value which will not produce an undesirable or excessive drop in H.T. voltage applied to the screen. If a resistance is used, the condenser C may be reduced in value to, say, 0.1 mfd., but it is rather interesting to notice that any variation in H.T. voltage due to the influence of other valves is prevented from influencing the screen if more adequate decoupling is employed. A value of 1,000 ohms and 0.1 mfd. will effectively decouple the screen from any H.F. potentials set up across the H.T.

battery by any other valve in the receiver, but these values will not be sufficient to decouple the screen from *low-frequency* potentials established across the H.T. battery. In fact, in the case of low frequencies below 500 cycles, the decoupling would be poor, and it would be desirable to use a 1-mfd. condenser and perhaps 20,000 ohms for the resistance. This, in turn, would mean that a larger H.T. voltage applied to the battery would be required. It is not customary to decouple an H.F. valve so effectively.

The Fig. 247 arrangement could be modified by substituting a high-frequency choke in place of the resistance R, but such an arrangement can only be used for decoupling high-frequency currents. It may be stated with confidence that where resistances are used for low-frequency decoupling, the same circuit will decouple the high frequencies even more effectively. It is important, however, that for the latter purpose the resistances should provide a path having small self-capacity. Special composition *resistors* are quite satisfactory for high-frequency decoupling.

Eliminating H.F. from Mains.—In the case of mains receivers, it sometimes happens that the mains themselves pick up signals or stray currents of high frequency and these may influence the various circuits of the receiver. These currents may be prevented from getting to the receiver by inserting an air-core choke L in one of the leads and employing a by-pass condenser to provide a short-circuiting path. Such an arrangement is illustrated in Fig. 248,

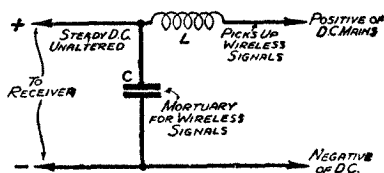

Fig 248—Method of cutting out H.F. picked up by D.C. mains

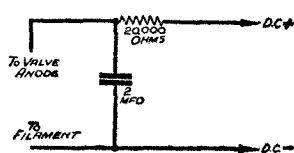

Fig. 249—Another method which however, causes a drop in the H.T. voltage

which is shown applied to D.C. mains. This may be readily explained by using the potential divider theory as applied to L and C. Fig. 249 shows a similar arrangement in which a 20,000-ohm resistance and a 2-mfd. condenser is used for decoupling the receiver on the D.C. supply. This arrangement, incidentally, will smooth out the D.C. supply, cutting down hum. The resistance, however, will also greatly reduce the H.T. voltage. The condenser is sometimes best connected on the other side of the choke in Fig. 248; or a condenser to earth (sometimes a separate outside earth) may be taken from each side of the choke. Sometimes a choke is connected in each lead. If only one choke is used it should be inserted

quite considerable potential fluctuations will occur across the battery, causing a raising and lowering of the H.T. voltage. Since this voltage is supplied to the anodes of the two preceding valves, changes in those two anodes are likely to occur, and these in turn will ultimately cause variations in the grid potentials of the last valve. If these potentials tend to strengthen the original voltage variation on that grid, low-frequency oscillation will occur. If, however, the reaction effect is in a reverse direction, there will be a falling off in signal strength and also distortion. It is therefore desirable to prevent any fluctuation of H.T. voltage getting to the anodes of either valve, and this can be effectively stopped by the use of a decoupling arrangement. In Fig. 250 a decoupling resistance R_4 of 20,000 ohms with a by-pass (or decoupling) condenser C_1 of 2 mfd. is used for decoupling the anode of the first valve, while the anode of the second valve is decoupled by a similar resistance by 20,000 ohms and the condenser C_2 of 2 mfd. Parallel feeding of the loudspeaker of the last valve or decoupling the anode circuit of this valve (though not shown) will also contribute to the stability of the whole arrangement.

It is to be noticed that the resistances of 20,000 ohms tend to cut down the anode voltages of their respective valves. Iron-cored chokes might be used in place of resistances, but they have to be of good quality and are expensive; in addition, they have usually an external field which may give rise to trouble in a compact receiver, although this is not very likely.

To improve the decoupling, if it proves necessary, both resistance and by-pass condenser should be increased in size. Where it is not possible to increase the value of the resistance without unduly decreasing the anode voltage, the condenser should be increased in capacity or multiple filters employed.

Multiple Decoupling.—An example of a multiple decoupling

arrangement is shown in Fig. 251, which has been drawn to illustrate numerous methods of decoupling and filtering. It will be seen that two resistances, R_2 and R_3 , are employed to

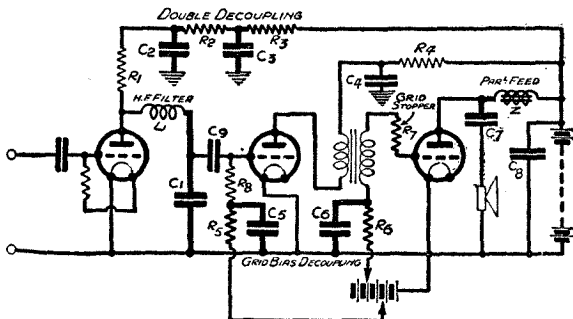

Fig. 251—Very complete decoupling is applied to both anode and grid circuits

decouple the anode of the first valve. The resistance R_1 is the only resistance coupling, while a filter L_1 and C_1 is used to keep out high-frequency currents from the subsequent valves. It will be noticed that the grids of the second and third valves are served from a common grid-bias battery. This battery also may develop a high resistance, this resistance forming a coupling between valves which is liable to set up instability or distortion. We thus find the grid-bias battery sometimes decoupled and the scheme is very common practice in A.C. sets. The grid of the second valve has a grid resistance R_8 for the usual purpose, but in addition there is a grid-bias decoupling resistance R_5 of, say, 50,000 ohms, and a by-pass condenser C_5 of 1-mfd. capacity. A similar resistance R_6 and condenser C_6 is used for decoupling the grid circuit of the last valve. Actually, one may here use very large decoupling resistances, e.g., 1 megohm, since they pass no current; this enables us to use smaller and cheaper condensers, say .01 mfd.

The anode circuit of the second valve is decoupled by a resistance R_4 and a condenser C_4 having values of 20,000 ohms and 2 mfd. respectively. The grid circuit of the last valve has a grid stopper R_7 which is for the purpose of still further preventing any high-frequency currents getting to the grid of the last valve. The anode circuit of the last valve has an iron-core L.F. choke Z (of, say, 50 henries) and a condenser C_7 of, say, 2 mfd., which feeds the loudspeaker. This parallel feeding arrangement prevents the low-frequency current from getting into the high-tension battery, practically all of the alternating current passing through C_7 to the loudspeaker instead of going through the high-tension battery. A final refinement is a condenser C_8 of, say, 2 mfd. or more, connected across the high-tension battery. This further tends to stabilize the voltage of the H.T. battery. The whole circuit should be studied as an example of good decoupling technique in modern receivers.

A useful way of regarding all decoupling arrangements is to consider the system as similar to that of a by-pass arterial road built to divert traffic from the narrow busy street of a town. It is as if the town authority has provided this easy path for motor traffic and made it particularly more pleasant than for motors to pass through the town. For example, if a corporation made no effort to provide a good road through the town and left pot-holes in the main street, it is quite clear that motor traffic would be even keener to take the by-pass way. The more uncomfortable the corporation can make the high street of the town and the smoother they can make the by-pass road, the more readily will traffic use the by-pass route. In decoupling arrangements this is metaphorically what we do.

Auto-Transformers.—A particular advantage of parallel feeding is that the primary winding may be connected in series with the secondary so as to produce an efficient auto-transformer giving a higher step-up ratio. Fig. 253 shows how this is done, and the windings have been shown wound on a common iron-core, because this is what happens in practice. The two fields of the coil assist each other, and the initial voltage across the primary T_1 , which is regarded as 1, is added to the voltage across the T_2 , which is 3, and the $3 + 1$ voltage is now applied to the grid of the second valve. Thus, although the input voltage is 1, the output will be 4, and the transformer has therefore become an auto-transformer, giving a step-up ratio of 1:4. If the normal step-up ratio were 1:8, then the auto-transformer connections would give a ratio of 1:9; in all cases the increase is 1, since the primary is in series with and helping the secondary.

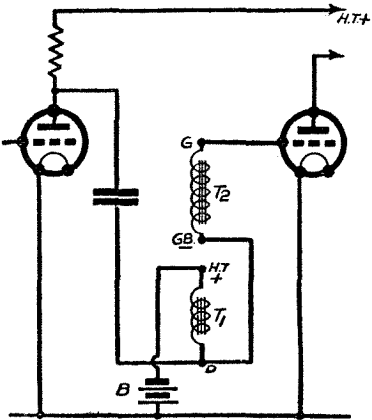

Fig. 254—Windings are now in opposition and give reduced step up

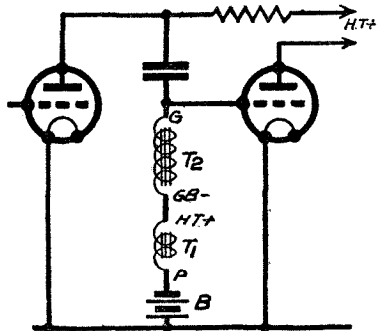

Fig. 255—Windings in series act as choke, giving 1:1 ratio

By altering the connections to the various terminals of the transformer in the manner shown in Fig. 254, the primary voltage will be connected in series with the secondary voltage, but in opposition to it, so that the grid voltage will now be $3 - 1$, which equals 2, and the step-up ratio of the transformer is now only 1:2. In the case of other ratios we simply subtract 1 from the larger figure and this gives the new ratio.

If the primary and secondary are connected in series so as to help each other, and the anode is connected through its condenser to the top end of the combined inductance, as shown in Fig. 255, the whole transformer acts simply as a choke or, if one prefers to consider it as such, as an auto-transformer of 1:1 ratio. It is thus possible to obtain any ratio from 1:1 to 1:4 with an ordinary 1:3 transformer. Actual connections vary with different makes.

High-ratio-ed transformers, unless expensive, suffer from the disadvantage that the primary winding usually has an inadequate inductance, and therefore the whole transformer gives inadequate low-note response.

Decoupling Resistance for Transformers.—The usual arrangement of decoupling a resistance-fed transformer is that illustrated in Fig. 256, while in Fig. 257 a similar arrangement is applied to a choke-coupled L.F. transformer. The choke should

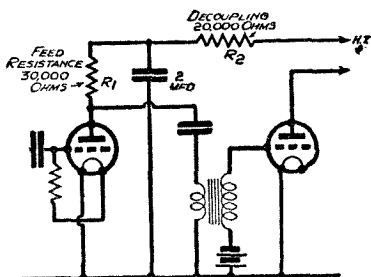

Fig. 256—How a resistance-fed transformer may be decoupled

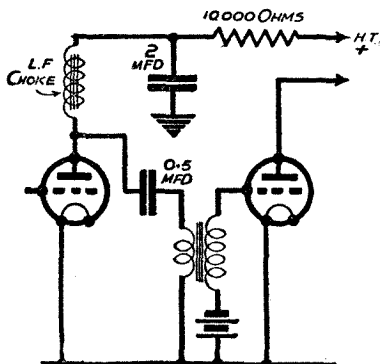

Fig. 257—Method of decoupling a choke-fed L.F. transformer

have a value of at least 100 henries, and the question arises as to whether such a choke is worth while in view of its expense ; an iron-cored transformer having a large current-carrying capacity would probably be as cheap.

Resistance-fed transformers require decoupling in most cases because any alternating-current component in the anode circuit will pass through the primary. In fact, there is the additional disadvantage that the primary and its feed condenser are connected across the main H.T. supply voltage, and if this is irregular any currents which may produce hum will pass through the primary and actually be stepped-up. Fig. 258 obviates this. It will be noticed that the primary T_1 and condenser C are connected across R instead of across anode and filament. The method is improved by inserting a decoupling resistance and condenser in the H.T. lead as usual. Parallel-feeding does not relieve one of the duty of proper decoupling.

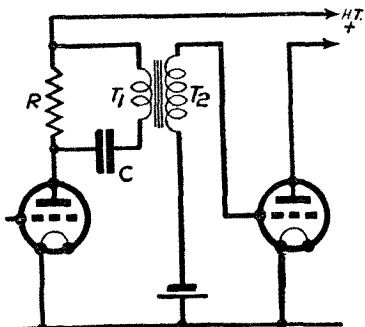

Fig. 258—This connection reduces interaction and hum

CHAPTER 12

THE SCREEN-GRID VALVE

The three-electrode valve was used as a high-frequency amplifier up to about 1926, when a different kind of valve known as the *screen-grid valve* began its slow march to popularity. The *Neutrodyne* system of amplification, invented in this country by the present writer and in America by Hazeltine (who acquired the present writer's patents, which in this country were earlier than his own), did a great deal to extend the life of the three-electrode valve as a radio-frequency amplifier, since it overcame the tendency of the valve to oscillate due to undesired coupling between the anode circuit and the grid circuit when the two circuits were in tune.

This instability is due to an inherent reaction effect which takes place between the anode of the valve and the grid, largely due to the small capacity formed by the metal of the anode and that of the grid. The screen-grid valve was designed to reduce this undesirable capacity and so render unnecessary the more complicated arrangement of the Neutrodyne. Actually the screen-grid valve introduced many other advantageous features, but its origin lay in the desire to prevent the capacity coupling inside the valve. This was done by introducing a fourth electrode in the form of a grid between the normal grid (i.e., the control grid) and the anode. This extra grid acted as an electrostatic shield which prevented any high-frequency potentials on the anode being communicated to the control grid. The screen itself was originally a very fine mesh of gauze, and it takes that form in most modern S.G. (screen-grid) valves.

In the ordinary way not only would such a screen-grid, if connected to the filament, prevent high-frequency feed-back inside the valve, but it would also virtually cut off the effect of the high positive potential on the anode. Instead, therefore, of connecting the screen-grid, as one might at first expect, to earth or to the filament, it is connected to a point on the high-tension battery, normally at about + 75 volts. The effect now is that electrons are drawn up to the screen-grid due to the considerable positive potential

on the latter, and when they reach this screen-grid they are drawn off by the anode. The screen-grid valve is usually operated in such a way that the anode voltage is high enough to draw any electrons which reach the screen, an increase in anode voltage at this point producing little increase in anode current; an effect similar to saturation is thus obtained. The control of the anode current is rather indirect in that the variations of control grid voltage vary the amount of electrons going to the screen-grid, these electrons being then drawn up by the anode from the screen-grid. The screen-grid itself takes a small current (often about half a milliampere), but no use is made of this current.

The screen-grid voltage governs the amount of amplification given by the valve and also the input voltage handling abilities. A reduction of the screen voltage reduces both and consequently tends to make the valve more stable, since a reduction of the anode-to-control-grid capacity is not the only cause of instability in an H.F. amplifier. There are other stray capacity and magnetic couplings which make for instability; a reduction of the degree of amplification of the valve will, in such cases, stabilise the whole circuit. A commonly used form of S.G. valve circuit is that illustrated in Fig. 259, which shows a parallel-fed tuned circuit

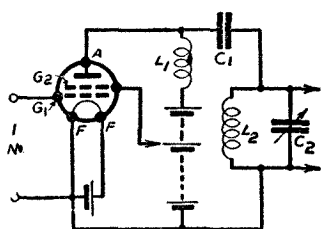

Fig. 259—Simple screen-grid H.F. amplifier

$L_2 C_2$, which may be considered as deriving its energy from the choke L_1 which passes the direct current but which forces most of the oscillations to go through the coupling condenser C_1 to the tuned circuit. The control grid G_1 is next to the filament, while the screen-grid G_2 is next to the anode and is given a positive potential derived from the H.T. battery.

Characteristics of the Screen-Grid Valve.—Fig. 260 shows the characteristic curve of a screen-grid valve illustrating the variation of anode current with anode voltage at fixed control-grid and screen-grid voltages. The control-grid voltage may be zero and the screen voltage 75. It will be seen that the first part of the curve shows an increase of anode current: but when the anode voltage reaches a certain value (about 14 volts), the anode current begins to fall. This is due to what is known as *secondary emission*. The *primary electrons* (ordinary electrons) emitted from the filament strike the anode with sufficient force to knock out electrons from the surface of the anode. These electrons come from the actual atoms of metal or other matter of which the anode

is made, and as many as 20 *secondary electrons*, as they are called, may be knocked out of the anode by the bombardment of each single electron. These secondary electrons emitted from the anode find close to them a screen-grid which has a higher positive potential (75 volts) than the anode (14 or more volts); consequently, they will travel from the surface of the anode to the screened-grid, which is positive with respect to the anode. The number of secondary electrons leaving the anode will become greater than the number of primary electrons striking it; hence the total anode current will begin to fall, and therefore we get the downward sloping part of the characteristic curve in Fig. 260. This portion of the characteristic curve is called the *negative resistance* portion, and the properties of the valve in this condition are extremely interesting,

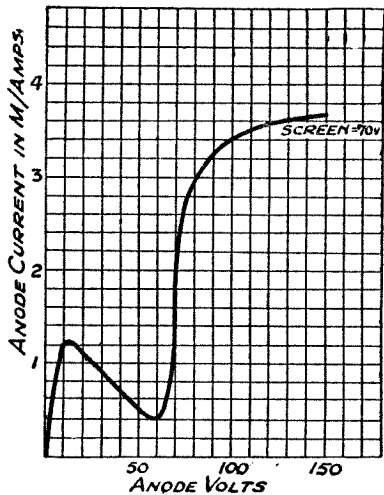

Fig. 260—Characteristic curve of screen-grid valve. Note negative resistance slope

since the anode circuit of the valve is behaving in exactly the opposite way to an ordinary resistance wire, which passes more current as the voltage across it increases.

As far as high-frequency amplification is concerned, however, the secondary emission effect is a definite nuisance, and we do not operate the valve on this portion of the characteristic curve. It will be noticed that when the anode voltage increases beyond that of the screen, the anode curve begins to rise rapidly, and here the explanation is simple. The primary electrons are now increasing and any secondary electrons which are emitted from the anode return to the anode, since the screen-grid is now at a relative lower potential and has lost its attractiveness. The rise in anode current begins to occur before this point because the primary electron current is rising, while the flow of secondary electrons the opposite way is decreasing as the potential of the screen is becoming less positive *relative* to the anode.

In spite of the odd form of the characteristic curve of Fig. 260, the actual operation of the screen-grid valve is extremely simple when the usual voltages are involved, and Fig. 261 is a curve showing the effect of control-grid voltage on the anode current.

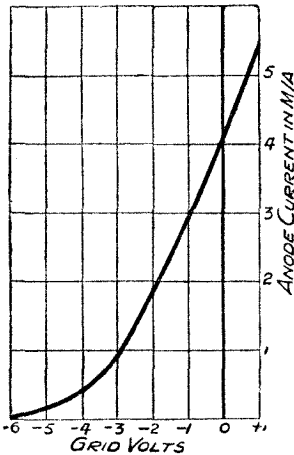

Fig. 261—Shows how the grid-volts/anode-current curve resembles that of triode

This curve is really exactly the same as that of an ordinary three-electrode valve.

The S.G. valve is normally operated on the upper portion of its Fig. 260 curve when the anode is at a higher potential than the screen. Further technical aspects of the curves are discussed in the chapter on pentodes.

Screen-grid valves usually have a high anode impedance and require an efficient tuned circuit to be associated with the anode circuit; the amplification factor, however, of the valve is also very high, and in a properly designed type of circuit, a high degree of magnification is obtainable.

Various refinements can be introduced into the circuit and Fig. 262 shows a simple practical arrangement using a screen-grid valve. The aerial circuit presents no special features, except that a small grid-bias cell B2 of 0.9 volt (a special cadmium cell may be provided to give this voltage) is included in the control-grid circuit of the S.G. valve and a condenser C5, having a capacity of say .01 mfd. or more, is provided as a by-pass for H.F. currents. The object of the grid-bias cell B2 is to prevent grid current and so lessen damping on the tuned grid circuit L1 C1, thus improving selectivity; an additional advantage is that by eliminating rectification in the grid circuit, *cross-modulation* is avoided. (Cross-modulation is interference caused by one station modulating the carrier of another in the receiver.) Whether a grid cell is employed or not is a matter of the valves used, and the makers' recommendations are a guide; the introduction of a grid cell will prove a very considerable saving in H.T. current. Sometimes a 1.5 volt cell may be inserted, but any grid bias will usually reduce the

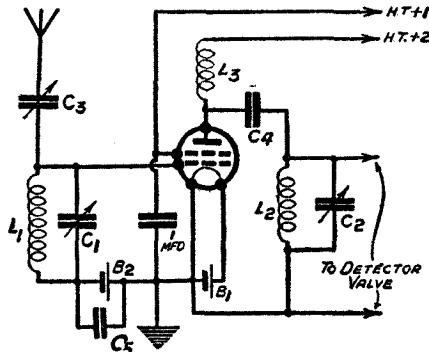

Fig. 262—Choke-fed tuned anode circuit is often used with S.G. valve

amplification. It will be noticed that there is a 1-mfd. condenser connected across the screen and the filament of the valve. This serves to keep the voltage on the screen steady, and prevents high-frequency currents from getting into the leads to the high-tension battery.

A parallel-fed circuit is not the only one that can be used with an S.G. valve, and the tuned anode is very effective. The arrangement is shown in Fig. 263; trouble due to instability, owing to excessive amplification, may occur. Fig. 264 shows a modified

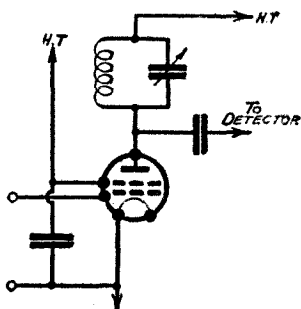

Fig. 263—Plain tuned anode coupling can be applied to S.G. valves

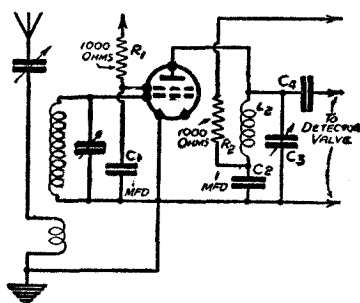

Fig. 264—This improvement keeps one side of C_3 at earth potential

tuned anode circuit in which the variable condenser C_3 instead of being "up in the air" (i.e., at a high-frequency potential in respect to earth) has its moving vanes (i.e., the bottom plate of C_3) connected to earth. It will be noticed that there is a 1-mfd. condenser C_2 shunting the source of H.T., while the resistance R_2 of 1,000 ohms increases the decoupling effect. A similar decoupling resistance R_1 of about 600 ohms or 1,000 ohms is included in the screen-grid circuit of the valve, and serves to assist in keeping the screen-grid voltage constant and to prevent high-frequency currents drifting round the set and to the high-tension battery.

In both these cases the decoupling condensers are given as of 1-mfd. capacity, but lower values can be employed, say 0.1 mfd. It will, however, be noticed that the condenser C_2 in the tuned anode circuit is really part of a single-tuned circuit $L_2 C_3 C_2$, and will therefore affect to some extent the tuning range of the condenser C_3 . It is therefore, desirable that its capacity should be large.

To increase the stability of the circuit, and to improve the selectivity of the anode circuit, it may be desirable to tap down on to the anode inductance, and a variable tapping is provided by T_1 in Fig. 265, where the connection of the anode can be made to

various points on the coil. The lower down on the coil the tapping is made, the greater will be the selectivity, the weaker will be the signal strength and the greater will be the stability of the high-frequency stage. Usually a tapping a quarter way down or half way down the coil is employed. The tapping down, by reducing the load of the anode current, will improve selectivity; to reduce the damping of a subsequent grid-leak detector valve, a second tapping T2 may be arranged.

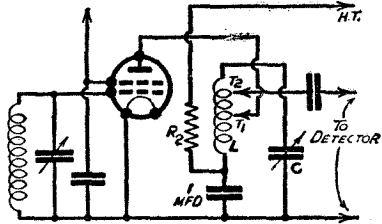

Fig. 265—Anode and grid tapplings on anode coil

A transformer coupling may also be adapted to the S.G. valve, and an example is illustrated in

Fig. 266, the H.F. transformer primary L3 being coupled to the secondary inductance L4. A step-up is usually obtained between these two coils, and the right degree of selectivity and stability is obtained by giving L3 the right number of turns.

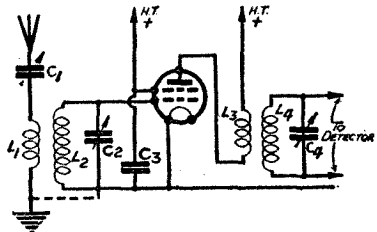

Fig. 266—Use of H.F. transformer with S.G. valve

and intervalve arrangements should be studied, since they can all be applied to an S.G. valve; it may be specially noted that aperiodic H.F. couplings are much more effective with S.G. valves than with triodes, since in the latter case Miller Effect robs the valve of much of its amplification. The anode voltage fluctuations are in the triode arrangements communicated through the capacity inside the valve to the grid in a reverse reaction direction, thus damping down the grid circuit, causing loss of selectivity and signal strength. In the case of the S.G. valve, the screen-grid prevents this effect to a very great extent.

Various S.G. valve circuits figure throughout this book and the chapters on aerial circuits and intervalve arrangements should be studied, since they can all be applied to an S.G. valve; it may be specially noted that aperiodic H.F. couplings are much more effective with S.G. valves than with triodes, since in the latter case Miller Effect robs the valve of much of its amplification. The anode voltage fluctuations are in the triode arrangements communicated through the capacity inside the valve to the grid in a reverse reaction direction, thus damping down the grid circuit, causing loss of selectivity and signal strength. In the case of the S.G. valve, the screen-grid prevents this effect to a very great extent.

Screen-grid valves may be used as detectors and also in special circuits as L.F. amplifiers.

Screen-grid valves may be used as detectors and also in special circuits as L.F. amplifiers.

CHAPTER 13

THE VARIABLE-MU VALVE

Unquestionably, one of the most important valve developments of recent years is what is known as the *variable-mu* valve.

This consists of a special screen-grid valve possessing adjustable *mutual conductance*; that is to say, the change of anode current for a given grid voltage change can be altered, and this is done by the simple expedient of altering the normal grid bias, a reduction producing a decrease of mutual conductance and therefore of the amplification of the valve.

This, of course, occurs with every screen-grid valve, since the *slope* of the grid-volts/anode-current curve becomes less as the grid becomes more negative. The curve, however, becomes too sharp and cross-modulation is likely to result; moreover, the input volts are strictly limited.

Control of Volume.—The object of the variable-mu valve is to enable us to control volume. Various methods of volume-control may be used, but most of them have some quite serious disadvantage. The most obvious way is to reduce the strength of the input high-frequency current, but most methods of doing this result in introducing resistance into the circuit and/or altering the tuning. The latter trouble is particularly serious where ganged condensers are used for tuning several circuits simultaneously with one knob, and the slightest upsetting of the ganging will be disastrous. A method commonly employed is that which reduces the amplification of the screen-grid valve by reducing the screen voltage. This, however, tends to produce overloading of the screen-grid valve. It is only suitable for use when the input signals are weak, when, of course, there is not likely to be the same need for a volume control.

The variable-mu method reduces the amplifying effect of the S.G. valve while enabling very large input voltages to be applied; their *effect* is simply reduced. The variable-mu valve is similar to an ordinary S.G. valve, but the grid wire spacing is modified; frequently the spacing of the grid wires vary, being wide at one point on the grid and tapering to a finer mesh at another. The

result is that by applying an increasing negative potential to the grid, a steep reduction of anode current is first obtained, but the later control corresponding to the greater negative potentials on the grid is more gradual, and it may require very large negative potentials to reduce the flow of electrons which find it so easy to get through the more open spaces in the grid. A photograph of an ordinary S.G. valve appears in this book.

Merits of the Variable-Mu.—Fig. 267 shows the characteristic

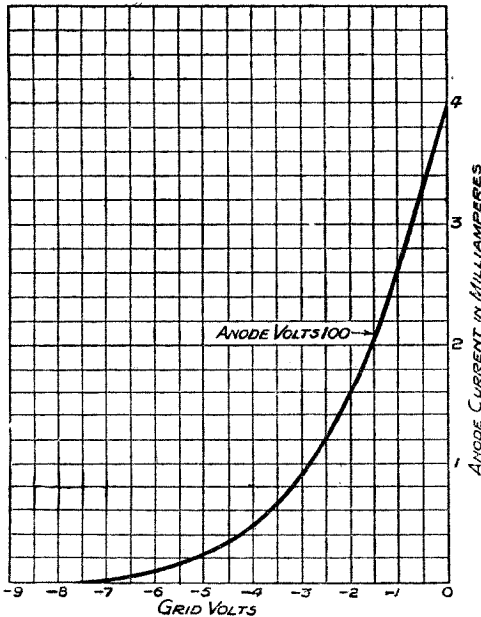

Fig. 267—Typical characteristic curve of a variable-mu S.G. valve

curve of a variable-mu S.G. valve, and illustrates the big change in characteristics in the form of what is sometimes called a *tailing* characteristic. The following are some of the merits which can be claimed for the variable-mu :

(1) Volume control without alteration of ganging.

(2) No introduction of damping into the preceding tuned circuit.

(3) Capable of handling very wide input voltage variations, making the set suitable for "local" or distant reception.

(4) No cross-modulation trouble due to one signal modulating another one, which is likely to occur when the S.G. valve operates near a sharp bend on its characteristic curve.

(5) The reduction of anode current is an economy. In ordinary circuits a reduction of signal strength does not save anode current.

(6) Selectivity is improved due to a reduction of damping of the tuned circuit associated with the anode of the variable-mu valve.

(7) Any tendency to instability of the variable-mu valve can immediately be corrected by increasing the negative potential on its grid, thereby reducing the amplification.

One of the disadvantages, of course, of the variable-mu valve is that a large grid-bias battery is required, a voltage as much as 12

volts being needed in some cases, and 9 volts in others. In many sets a large grid-bias battery is, of course, already in use to bias the grid of the output valve. In the case of the variable-mu arrangement, however, the grid-bias battery has to supply a current, since a potentiometer or potential divider, as it is sometimes called (more logically), is necessary to obtain the adjustable voltage for the control grid (i.e., ordinary grid) of the valve. The potentiometer current requires to be switched off when the set is switched off, and consequently some thought must be given to the switching arrangements, otherwise, of course, the grid-bias battery would run down while the set is not in use.

Fig. 268 shows a complete variable-mu valve amplifying circuit, the voltage for the control-grid being obtained from a sliding contact on the potentiometer resistance R , which can conveniently have a value of 25,000 or 50,000 ohms. The switch S should be opened when the set is switched off, and closed when reception is desired. It will be noted that a condenser of 1 mfd. is connected across the used portion of the resistance R . Actually, this condenser, which is intended to prevent the resistance affecting the H.F. currents and to prevent these latter from going to parts of the circuit where they are not wanted, could be considerably smaller than this, especially if a decoupling resistance were inserted in the lead to the moving contact of the potentiometer.

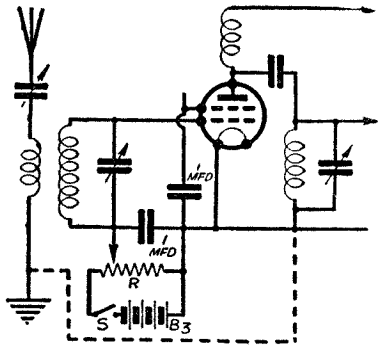

Fig. 268—Potentiometer connections for a variable-mu S.G. valve

The bottom side of the variable condenser, which in practice would be the moving vanes, is not actually at earth potential, but in Fig. 269 is shown an alternative arrangement with the moving plates connected to earth. In this case, the 1-mfd. condenser is really part of the tuned circuit. The

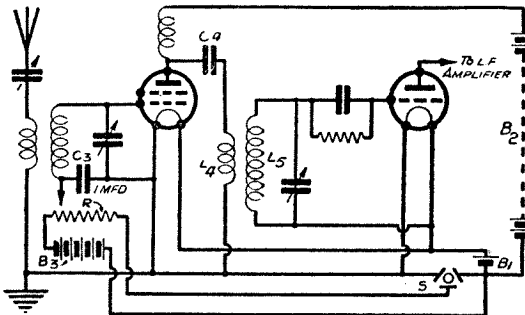

Fig. 269—A three-point switch cuts out potentiometer battery as well as L.T.

chief interest of the Fig. 269 circuit, however, is that it is a complete stage of H.F. amplification, followed by a leaky-grid detector, and that a 3-point switch S switches off the potentiometer battery B3 at the same time as the filament-heating battery B1 is disconnected. A parallel-fed H.F. transformer coupling is illustrated. The screen of the S.G. valve is not shown connected, to simplify the drawing; in this figure, as in Fig. 268, only essentials are drawn.

It may be desirable to keep the tuned circuit intact for ganging purposes, and we can then use the arrangement of Fig. 270,

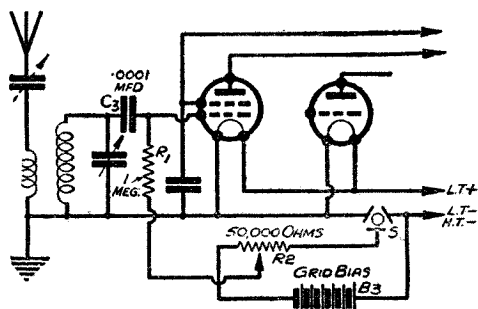

Fig. 270—Parallel system of applying bias to variable-mu valve

where a grid condenser C3 and a grid resistance R1 is used for the purpose of applying grid bias to the control grid. This arrangement must not be confused with leaky-grid detection, because it is nothing of the sort. It is to be compared to the arrangement in a resistance-coupled amplifier where the parallel method is used for applying a negative potential to the grid. The condenser C3 is merely for the purpose of preventing the negative potential supplied by the potentiometer from being short-circuited by the tuning inductance, while the resistance R1 is solely to prevent the short-circuiting of the H.F. potentials supplied to the grid. Actually, this will introduce some small losses into the tuning circuit, but these can usually be ignored. The circuit of Fig. 270 is incomplete and only illustrates those parts of the circuit under discussion.

CHAPTER 14

THE PENTODE VALVE

A valve development of great interest is the *pentode*, a composite word derived from the Greek, and implying that there are five electrodes. These five electrodes are the filament, three grids and an anode. The filament is surrounded by the control-grid, which performs the usual function of a grid in a triode. Around the control-grid is a second grid called the screen-grid (sometimes called the auxiliary grid). This performs some of the functions of the screen-grid of a screen-grid valve. The third grid, which comes between the second grid and the anode, is called the *suppressor grid* or *earth grid*, and its object will be duly explained later.

The pentode is a definite advance in the direction of higher efficiency, although it is not without certain disadvantages of its own. It was chiefly developed as an output valve for receivers, and therefore as an L.F. amplifier. The pentode can be made to give a large output with low values of H.T. voltage and current, and for a given output the sensitiveness of a pentode may be made greater. We can thus see that louder signals are obtainable with a given input signal, or, putting it another way, we can get good loudspeaker signals even though the input is comparatively weak.

A pentode has a higher amplification factor than that of a comparable triode. Hence the pentode is especially useful in portable receivers and in any case where the number of valves must be kept to a minimum and the high-tension current kept low.

The pentode overcomes one of the disadvantages of a triode. This disadvantage may be seen by examining Fig. 271, which shows a three-electrode valve acting as a low-frequency amplifier. A loudspeaker is included in the anode circuit of the valve and, when signals are being received, quite considerable voltages are set up across the loudspeaker

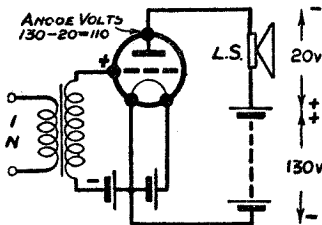

Fig. 271—To explain back-e.m.f. effects of triode

windings. The loudspeaker, in fact, acts as though it were a low-frequency choke having an iron-core, and even though the speaker may not be of this particular type, yet it will probably have a transformer the primary of which will have potentials set up across it when signals are being amplified by the valve. In Fig. 271 it is assumed that the grid is momentarily made positive by a positive half-cycle fed to the grid by the input transformer. This will cause a momentary rise in the anode current of the valve, and this rise of current through the loudspeaker LS will set up a potential difference across it. This potential is such that the top end of the speaker LS in the circuit is made negative with respect to the bottom end, and it is assumed for the sake of this example that the voltage established across the speaker is 20. If, now, the high-tension battery has a value of 130 volts, then the actual voltage on the anode of the valve will be 130 minus 20, which equals 110.

The valve is now not working under the same conditions as at the beginning of the positive half-cycle because the anode voltage is dropping and the grid voltage is rising. The desire of the grid to increase the anode current is being partially, but, of course, only partially, defeated by the drop in anode current. If the grid is being given a *negative* half-cycle the *reduction* in anode current will set up a momentary potential across the loudspeaker of 20 volts, but this time the voltage across the speaker *helps* that of the H.T. battery and produces an increase in the voltage on the anode of the valve; this, in fact, will rise to 130 plus 20, i.e. 150 volts. We do not, however, want the anode voltage of the valve to rise because this will tend to increase the anode current and we are wanting the anode current to be reduced by the negative voltage on the grid.

The sum total effect, then, of an inductive winding in the anode circuit of the valve is that the degree of amplification is reduced.

The screen-grid valve and the pentode will reduce this effect, because even though the anode voltage may change above and below its normal value of, as in this case, 130, the screen-grid prevents the voltage changes on the anode from influencing the conditions on the other side of the screen-grid. The anode current of a pentode consists of electrons which reach the screen-grid. Quite a small anode voltage will collect all these electrons, and the voltage of 130 on the anode is more than enough to draw the electrons which have reached the screen-grid. The anode current is, therefore, more or less at saturation value the whole time, so that changes up or down of anode voltage will produce very little change in anode current.

The way to vary the anode current, of course, is to vary the

number of electrons which reach the screen-grid, and this is carried out by means of the control-grid. It is very important that the reader should realise that, although anode voltage changes make little difference to the anode current, control-grid voltage changes produce quite the normal anode current changes.

The screen-grid, or auxiliary-grid, as it is often called, plays a vital part in the operation of the pentode. If the screen-grid were not given any positive potential at all, but connected direct to the filament, then the full voltage on the anode, say 130 volts, would produce a negligible anode current; the screen-grid would act as an almost impenetrable barrier which would shut off the attractive force of the positive potential on the anode. If, however, the screen-grid is given a high positive potential, the electrons from the filament are brought right up to the screen-grid, and once they are there they are readily attracted to the anode. The screen-grid can, therefore, be regarded as a sort of "decoy duck" which lures on electrons, which then shoot through the open spaces and pass to the anode.

All electrons, however, do not go to the anode. Some of them remain at the screen-grid, forming a screen-grid current. This, however, is not a large one, and nothing whatever is done with it.

We may regard the control-grid as controlling the flow of electrons to the anode indirectly; it varies the flow of electrons to the screen-grid and the screen grid just hands them over to the anode.

The Earth Grid.—We now come to the question of the earth grid or suppressor grid. This is connected inside the valve to the filament (or cathode, as this electrode is called in general terms). It is frequently joined to the middle support between the two V's which make up a W filament. The action of a screen-grid valve has already been explained, and a typical characteristic curve of such a valve showing the connection between anode volts and anode current was reproduced in Fig. 260. There is a certain portion of the curve where an obvious negative resistance effect is being obtained, i.e. where an increase of anode volts produces a decrease of anode current. The pronounced action of secondary emission effect is seen between an anode voltage of 11 and 55, but actually it occurs over a wider range of voltages than this. The negative resistance effect occurs particularly when the anode voltage is less than the screen-grid voltage, and under these conditions secondary electrons knocked out of the metal anode by the primary electrons arriving from the filament decide to leave the anode for the screen-grid, which is at a relatively more attractive positive potential. The anode is now losing more secondary electrons than the number of primary electrons it is gaining, and the result is

that the anode current falls as the anode voltage is increased. When, however, the anode voltage is increased above the screen-grid volts, the secondary electrons which have been deserting the anode decide to return to the anode, which is now more positive than the screen-grid. The upper portion of the characteristic curve, i.e. where the curve at the top begins to bend over to the right, is where we work the ordinary screen-grid valve for high-frequency amplification. We carefully avoid working anywhere near the negative resistance part of the curve, but this does not trouble us, because the anode voltage swings are relatively small.

When the pentode is employed, however, for low-frequency amplification, the anode voltage swings are large and the e.m.fs. across the speaker set up large potential differences across the anode and the screen-grid. This may be understood by reference to Fig. 272, which shows a pentode operating as a low-frequency amplifier. The screen-grid or auxiliary grid G_2 of the pentode is given a positive potential a little less than that of the anode. It will readily be understood that the high voltages developed across the loudspeaker may cause a reversal sign as regards the potential of the screen-grid with respect to the anode. Instead of the anode being positive with respect to the screen-grid it may become

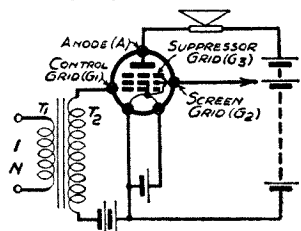

Fig. 272—Suppressor grid prevents negative resistance

negative, or, putting it another way round, the screen may become momentarily positive with respect to the anode. Now, since the anode is being bombarded by electrons sufficiently to produce secondary emission from the anode, the anode may be regarded as a cathode emitting secondary electrons; since the screen-grid is momentarily positive with respect to the anode, secondary electrons will travel from the anode to the screen.

To prevent these secondary emission effects, a suppressor grid is connected between the screen-grid and the anode, and it ensures that, although secondary electrons may be knocked out of the anode, they will never tend to go to the screen-grid, because the suppressor has the same effect as a negative potential on the grid of a three-electrode valve; in other words, the suppressor grid will, while permitting primary electrons to go to the anode, prevent secondary electrons from leaving the anode and going to the screen-grid. What happens may perhaps be more clearly understood by turning Fig. 272 upside down and regarding the anode as the new cathode from which secondary electrons are being emitted.

The prevention of secondary emission currents alters the whole

characteristic curve of the valve, and instead of a portion of the curve showing the presence of negative resistance effects, a curve such as that in Fig. 273 is obtained and it will be seen that over very wide limits of anode voltage there is no change in anode current; even with the anode voltage only a fraction of the screen-grid voltage, there is no negative resistance effect. Wide sweeps of anode voltage are normally possible.

Grid-Volts/Anode-Current Curve.

The reader may be more familiar with the grid-volts/anode-current characteristic curve of a three-electrode valve, and the anode-volt/anode-current curve of Fig. 273 may convey very little information. Actually, the pentode has a grid-volts/anode-current curve which is very similar to that of an ordinary three-electrode valve, and a typical example is reproduced in Fig. 274.

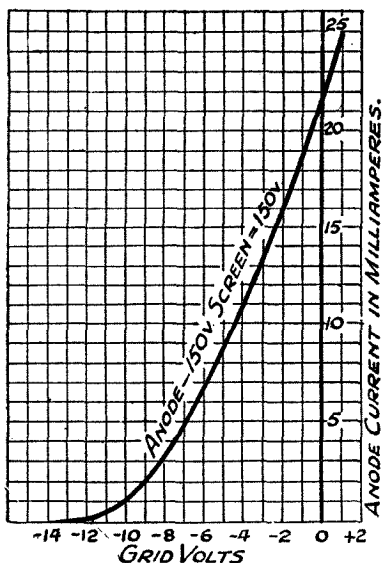

Fig. 274—Shows that grid-volts/anode-current curve resembles that of triode

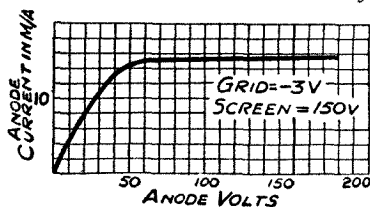
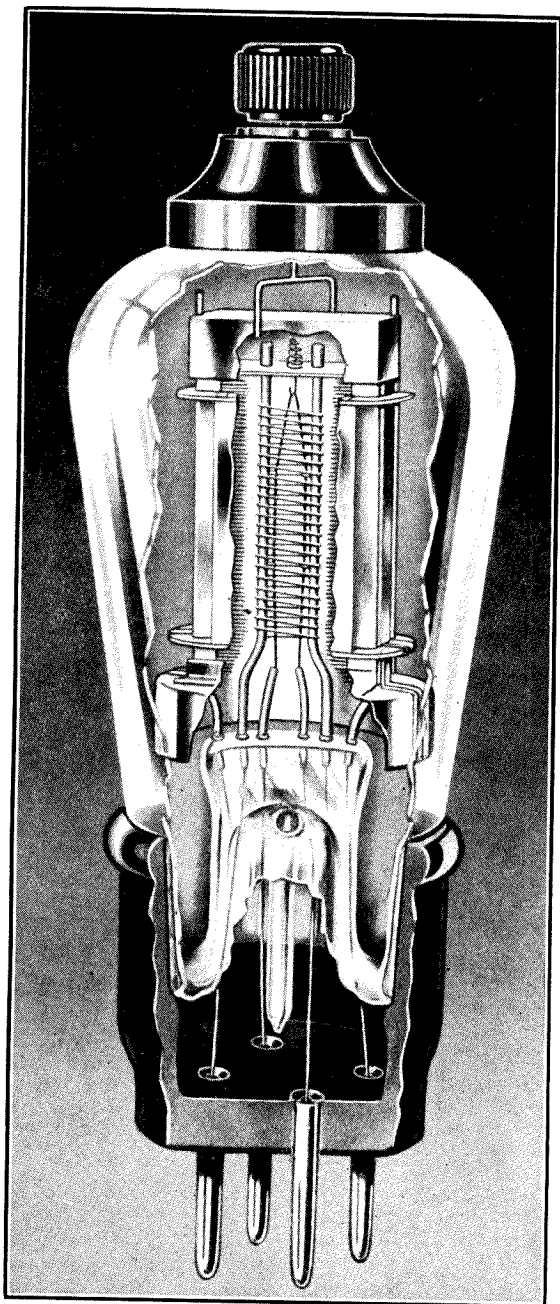

Fig. 273—Characteristic curve of typical pentode valve

It is seen to be very similar to the curve of an ordinary power valve, but the fluctuations in anode voltage do not result in a lower degree of amplification, as would be the case if a power valve were used.

From these explanations it will be seen that the screen-grid in a pentode is not for the purpose of stopping low-frequency oscillation due to capacity coupling between the anode and the control grid. Even in the case of the S.G. valve the screen-grid, although primarily for the purpose of preventing capacity coupling between the anode and control-grid, serves other useful purposes.

There is an increasing tendency to use specially designed pentodes for high-frequency amplification and also for detection when greater outputs are required. As an H.F. amplifier valve the pentode is really operating as a special S.G. valve, and the screening grid is designed with this in view.



MODERN COSSOR SCREEN-GRID VALVE CONSTRUCTION

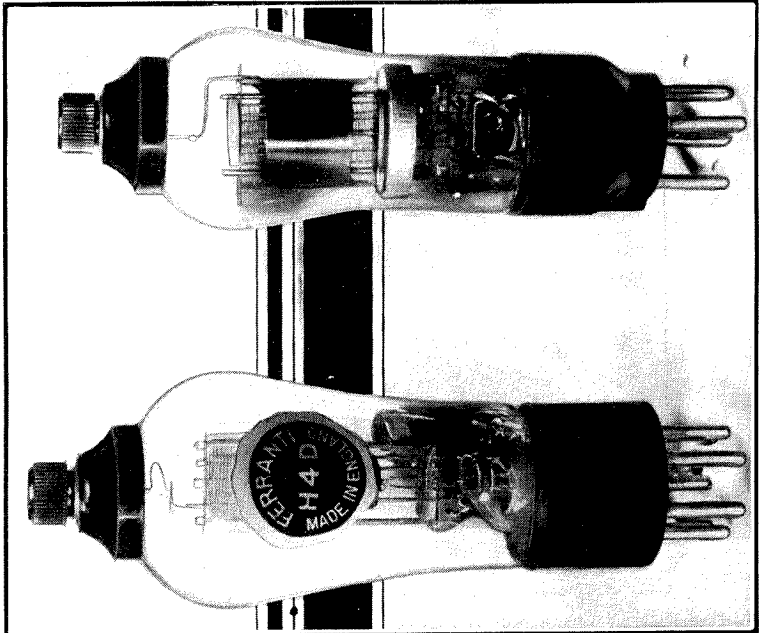
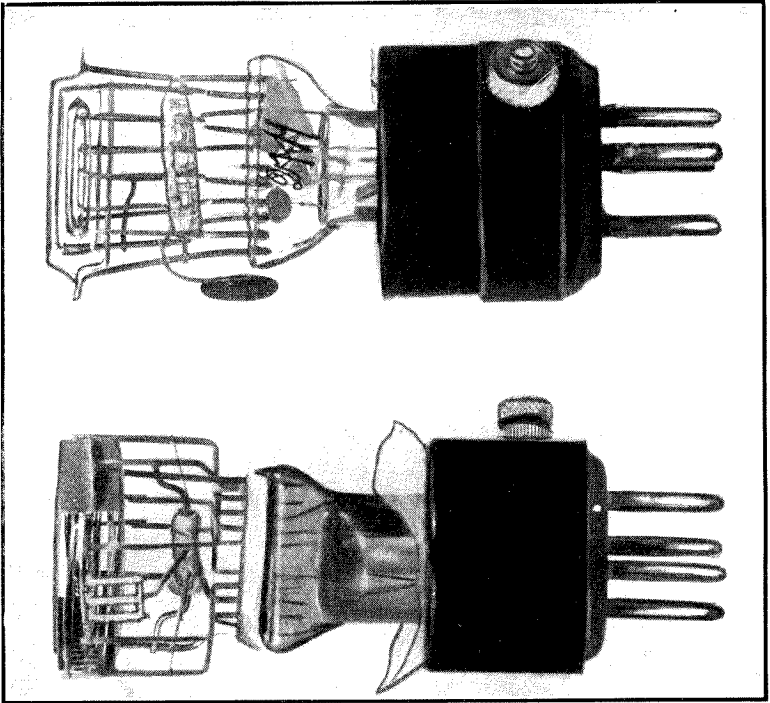

A SELECTION OF VALVES SHOWING CONCENTRIC GRIDS

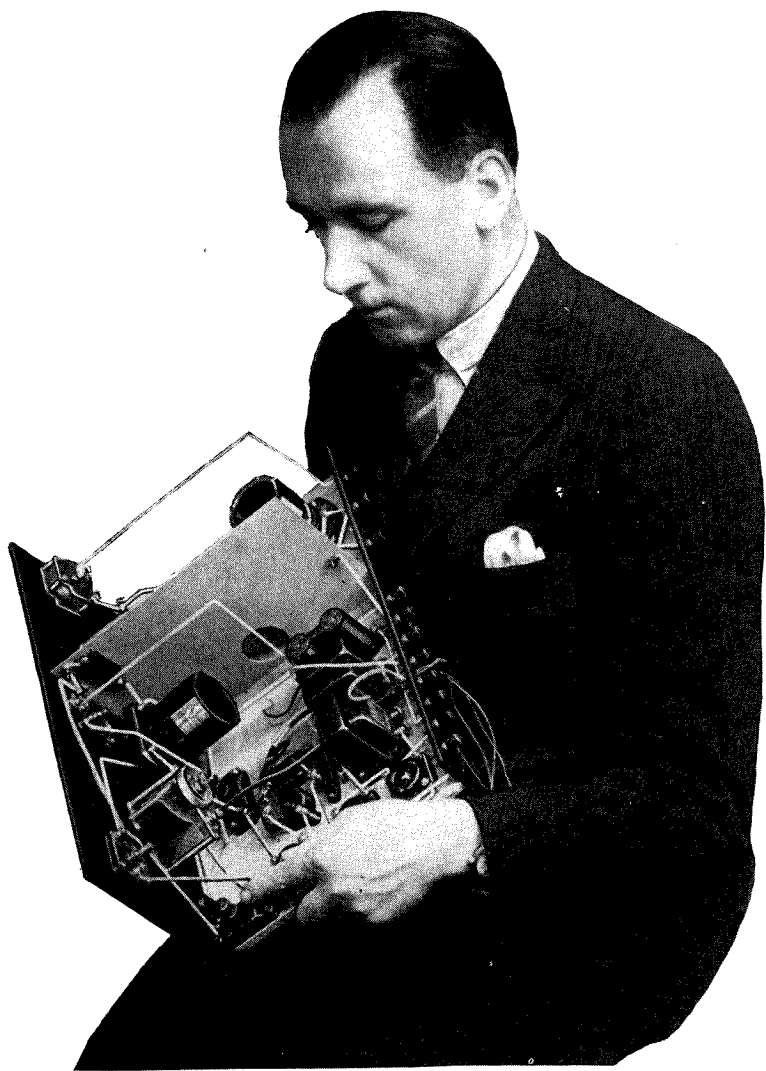

THE AUTHOR IS DEMONSTRATING FEATURES OF A
HOME-CONSTRUCTOR'S DESIGN

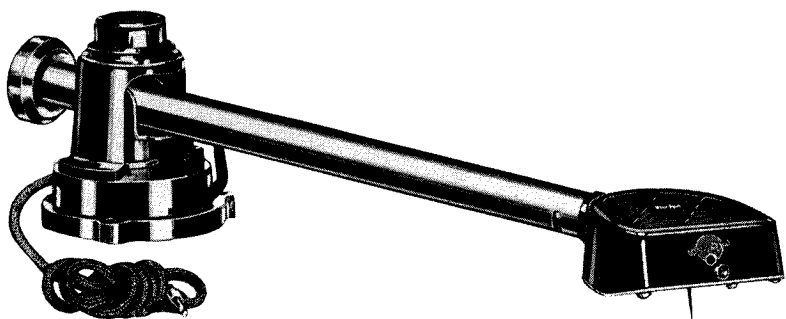

PICK-UP FOR ELECTRIC GRAMOPHONE

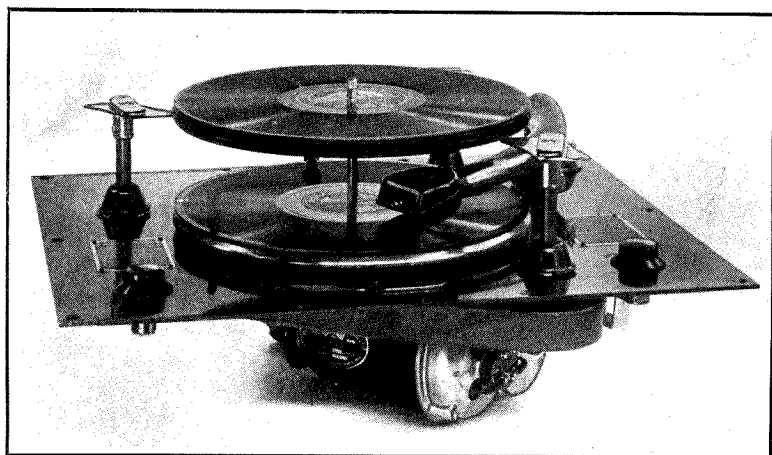

AUTOMATIC RECORD CHANGER

Tone-Correction with the Pentode.—The pentode suffers from a rather important disadvantage in that it accentuates the high notes in speech and music. The reason for this is that since the loudspeaker or its transformer is inductive, the output impedance will rise as the frequency increases. High output impedances are necessary to get the most out of the high-impedance pentode valve, whose anode current keeps approximately constant whatever the external anode impedance may be. More power is thus developed in the loudspeaker on the higher notes, and these are reproduced to an uncomfortable extent, and it becomes necessary to tone them down. Although loudspeakers are sometimes included directly in the anode circuit of a pentode valve, it is more usual to couple the loudspeaker by means of a step-down transformer, or a tapped iron-core choke included in the anode circuit of the valve. The tapped-choke method of coupling is illustrated in Fig. 275, where a 2-mfd. condenser serves as a means of coupling the speaker to the choke while preventing any direct current from flowing through the speaker. The tone-correcting device consists of a condenser of, say, .01 mfd., connected in series with a 30,000-ohm resistance, which may be variable to alter the degree of pruning of the excessively developed top notes. The lower the value of this resistance the greater will be the reduction of the high notes, and vice-versa.

A resistance alone would help to cut down the high notes because these higher-frequency currents will find the choke impedance much greater since the impedance of a choke coil rises with frequency; consequently the higher notes will tend to choose the easier path through the resistance across the choke. A plain resistance, however, would also act as a shunt path for the lower notes; these may be to a considerable extent kept out of the shunt path by inserting a condenser in series with the resistance, this condenser, however, allowing for the passage of the higher frequencies. Owing to the characteristics of the pentode and the fact that very high potentials will be set up across an impedance of high value in the anode circuit, certain precautions must be taken when using pentodes; for example, in Fig. 275 the loudspeaker should not be disconnected while the valve is operating. Nor should one disconnect the H.T. plug, leaving in the screen-grid

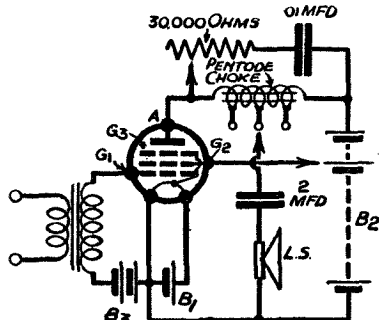

Fig. 275—Tone-corrector circuit applied to output choke

plug, and the grid-bias voltage should not be altered while the H.T. is off. As a matter of fact, however, the tone-control apparatus, if used, will provide a safety path, but in any case it is desirable to avoid doing anything which would establish very high potentials across anode and filament of the valve, as these will tend to break down the insulation of condensers and injure the valve itself.

The idea of having a step-down transformer or a tapped choke in the anode circuit of a pentode is to ensure that the impedance of the anode circuit load has a sufficiently high value; the reader will be aware that to get the maximum power output from any valve the output circuit itself must be *matched* to the impedance of the valve. Under these conditions the maximum output signal volume is obtained from the speaker, and to obtain the best out of a pentode may require a careful choice of the best ratio for a step-down transformer or choke, the latter being regarded as a specialised form of transformer (actually an auto-transformer).

The anode voltage of a pentode is usually the same as or only a little higher than that of the screen-grid. Since secondary electrons from the anode are prevented from going to the screen-grid by the suppressor (or *stopper grid*, as it is sometimes called), there is not the same need as in an S.G. valve for keeping the anode at a potential higher than that of the screen-grid; the electrons, in any case, which reach the screen-grid shoot through it for the most part and reach the anode. In some cases, however, the manufacturers recommend that the anode voltage should be kept a little higher than the screen-grid voltage. The voltage of the screen-grid is then usually dropped by means of a resistor connected between the screen-grid and the H.T. positive; a large-capacity condenser is connected across the screen-grid and filament to keep the screen-grid voltage constant and to effect decoupling.

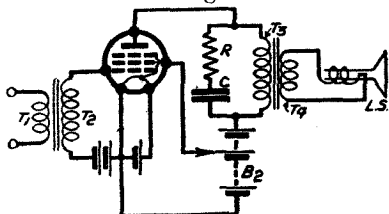

Fig. 276—Use of tone-corrector and step-down output transformer

resistance condenser is now shown connected across the transformer winding T_3 included in the anode circuit of the valve. In Fig. 277 is a circuit which will best be studied on a second reading of this Manual: a mains pentode of the indirectly heated cathode type is shown with the speaker in the anode circuit of the valve, a 15,000-ohm resistance and a .01-mfd. condenser being shunted across the speaker; as a matter of

Fig. 276 shows the use of a step-down transformer for feeding a moving-coil speaker from the anode circuit of a pentode. The tone-correcting

fact, many speakers have transformers incorporated in them, especially if the speaker is of the moving-coil type. A dropping resistance of 7,500 ohms is shown connected to the screen-grid of the valve, while a 2-mfd. condenser is connected between the screen-grid and earth. Self bias is employed, a resistance of, say, 350 ohms being connected between the H.T. negative and the cathode; naturally this value will depend upon the type of valve employed. A grid-bias decoupling arrangement is shown for smoothing out the grid-bias potential; a resistance of 100,000 ohms and a 2-mfd. condenser is arranged as shown.

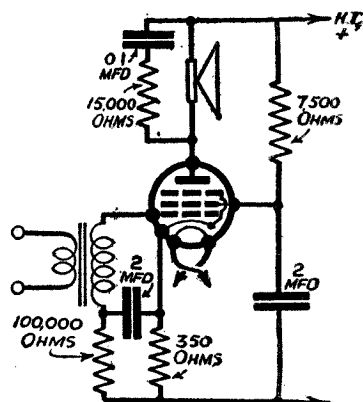

Fig. 277—Typical circuit for using mains pentode; note grid decoupling arrangement

CHAPTER 15

PUSH-PULL AMPLIFICATION

There are various merits in using two valves back-to-back instead of in parallel. The parallel arrangement is equivalent to a larger valve having a lower impedance and greater power—delivering abilities. The use of valves in so-called *push-pull*, however, makes for greater efficiency and the elimination of harmonics resulting from distortion due to curvature of the characteristics of the single valve.

Recent Developments.—Until the last year or two, the usual arrangement of two valves was in the form of an ordinary push-pull amplifier, but more recently specialised push-pull circuits, which have been called Q.P.P. (quiescent push-pull) and Class B, have become popular. We shall first deal with the arrangement shown in Fig. 278, where two valves are operated at or about the middle point of the straight portion of their grid-volts—anode-current curves lying to the left of the grid zero ordinate (the vertical line through zero grid volts).

The valves are operated with negative bias, and the variations of this potential are such that the bottom bend of the curve is avoided and the grids prevented from becoming positive.

The arrangement of Fig. 278 has a middle-tapped secondary on its input transformer and a middle-tapped primary on its output transformer.

It operates as follows: The incoming L.F. currents are fed by means of the step-up transformer T_1 T_2 to the grids of two valves V_1 and V_2 , the grids of both valves being given a suitable negative potential by the grid-bias battery B_1 . The grid bias is

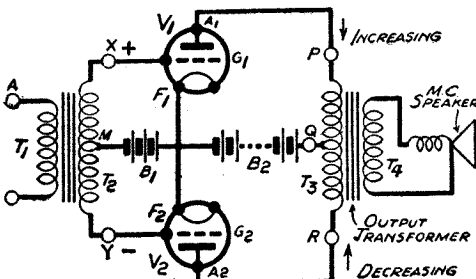

Fig. 278—Simple ordinary push-pull arrangement giving good quality

adjusted so that each valve operates mid-way on that straight portion of its curve lying to the left of zero grid volts. At any given moment the potential at X will be the opposite to that at Y so that whilst the grid of the top valve V1 is becoming increasingly positive with respect to the middle point M and therefore the filament, the grid of the lower valve V2 is becoming increasingly negative. The anode current of the top valve will be increasing while the anode current of the bottom valve will be decreasing. Now, by using a transformer T3 T4 tapped at the middle point Q, in the manner shown, the changes in anode current through the two primaries may be combined so as to produce the same effect on the secondary winding T4, which feeds a loudspeaker. It will be seen that although the current variations through the portions P Q and R Q are exactly opposite, the *direction* of flow differs in each case, so that a rising current in one direction has exactly the same magnetic field effect as a falling current in the opposite direction. This is the push-pull effect and it is not dissimilar to that obtained when a train is equipped with a locomotive in front and one behind. The front engine pulls while the rear engine pushes. Another analogy is that of two men sawing a tree-trunk with a single saw having two handles. One man pushes the saw and the other pulls it, and then the process is immediately reversed and the one who formerly pushes now pulls; this second analogy, of course, is more in keeping with what happens in a push-pull amplifier.

A special point to notice is that the two valves do not take turns in amplifying; they actually are both operating at the same time, but in opposite directions; their output effect, however, are combined to produce a single flow of current first in one direction and then in the other, in the secondary of the output transformer. Fig. 279 shows on the left the curve producing amplification of the positive half-cycle by the upper valve V1; the right-hand curve illustrates the amplification of the same positive half-cycle (which has, so to speak, been turned upside down and so converted into a *negative* impulse by the lower valve V2. The increase of anode current in one valve is combined with

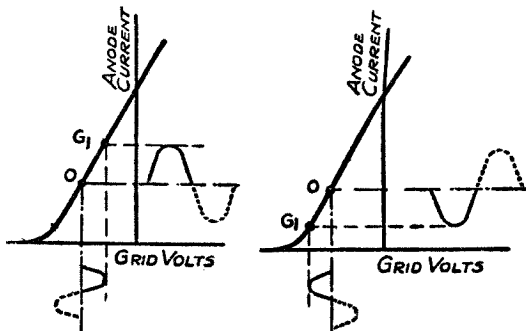

Fig. 279—Ordinary push-pull circuit operates both valves on straight part of curve

the decrease in the other valve by the use of an output transformer having a middle tapping. The current through B2 will be constant.

Unconventional Push-pull Circuits.—Two circuits of unusual type are illustrated in Figs. 280 and 281. They are modifications of the simpler push-pull arrangement in which there is a split input circuit and a similar split output circuit. They may be conveniently studied on a second reading of this manual.

In the case of Fig. 280 which is known in America as the "Capehart" circuit, the input of a pentode output valve is applied only to the grid of one valve, but a portion of the output voltage from this pentode is applied to a second pentode which also feeds the output transformer primary. The tapping of the primary which provides the potential for the grid of the second pentode is so arranged that the voltages on the grid of the second pentode

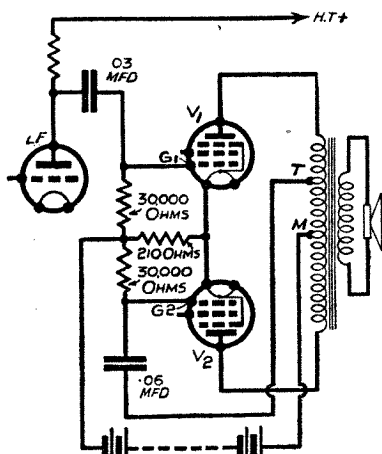

Fig. 280—Special form of push-pull circuit used in U.S.A.

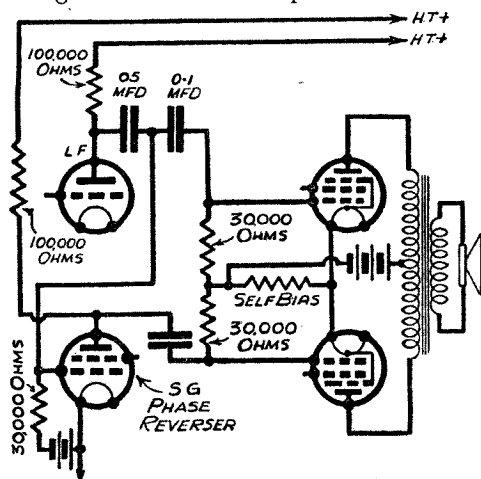

Fig. 281—Another push-pull circuit using a valve for phase reversal

are equal and opposite to the simultaneous voltages on the grid of the first pentode. The scheme, therefore, is a rather complicated way of obtaining a phase reversal. A resistance common to both grid circuits provides a negative bias due to the flow of anode current through it.

An arrangement which has been used by the Columbia and Majestic companies is that shown in Fig. 281, where the phase reversal is obtained by an additional valve which gives an output equal to the input, but of opposite phase; this is simply arranged by making the valve a resistance-coupled arrangement.

CHAPTER 16

QUIESCENT PUSH-PULL AMPLIFICATION

A special form of push-pull amplification has come into recent popularity and is known as Q.P.P. (quiescent push-pull). The word "quiescent" is used to signify that the two valves are normally taking very little H.T. current and that this current only comes fully into action when signals are received. This, of course, is a very valuable feature, principally for those using battery-operated valves, since the heavy drain on H.T. current from an H.T. battery is a highly expensive business. Economy of H.T. current is, therefore, of great importance and the Q.P.P. arrangement consists in operating the two valves, not at the middle point of the steep straight portion of the characteristic curve lying to the left of the grid zero ordinate, but in operating the valves at or about the bottom bend in their characteristic curves. Under these conditions, which are illustrated in Fig. 282, the "rest" current is very small, but when signals are received a rising grid voltage, due to the positive half-cycle, causes an increase in anode current in that valve, while producing only a very small decrease in the other valve. When the input signal changes direction, the first valve is given an increasing negative potential on its grid, but since it is operating at the bottom bend, only a very small decrease of anode current is possible, whereas the other valve is amplifying that half-cycle to the full extent. There is, of course, distortion on the half-cycle which makes the grid negative, but this distortion is cancelled out by the other valve, the general quality of the whole arrangement being good.

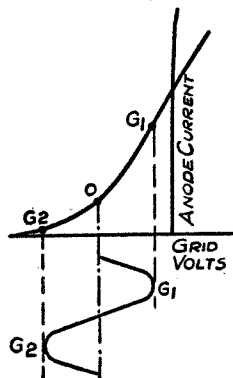

Fig. 282—Q.P.P. circuits operate valves at bottom bend

Two triodes may be used for Q.P.P. amplification, but pentodes, which in themselves are highly efficient, have generally been employed as output valves. They require a tone-correction

circuit consisting of a condenser and resistance, and the complete arrangement is illustrated in Fig. 283.

Practical Points in Q.P.P. Working.—All push-pull circuits tend to produce parasitic oscillations, i.e., continuous oscillations of a frequency different from that of the current to be amplified. These parasitic oscillations cause distortion and an increase in anode current, and it is impossible to get good results unless they are suppressed. Their frequency is usually much higher than that of the signals to be amplified, but they can be effectively prevented in a Q.P.P. amplifier by connecting a resistance of, say, 150,000 ohms between the middle tapping on the input transformer and the filament. A grid-bias battery is used in Q.P.P. working and it will usually have a value of about 18 volts. The valves should be matched, but the actual matching can be very conveniently carried out by altering the auxiliary (i.e., screen) voltage of each valve in turn until the anode current of the valve is about, say, 2 milliamps. (or whatever current corresponds to the bottom bend of the characteristic curve). In Fig. 283 the

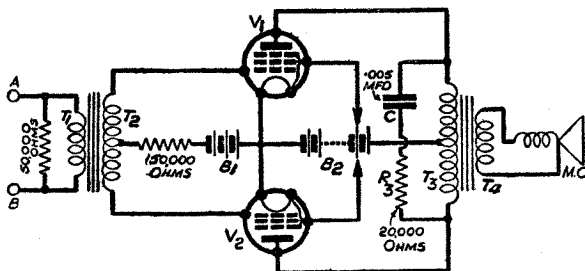

Fig. 283—Two pentodes arranged in quiescent push-pull. Matching of valves is effected by adjusting screen voltages

auxiliary grid in each pentode is shown connected to a separate tapping on the H.T. battery B2, and the valves are matched by moving these tappings. A safety resistance of 50,000 ohms is connected across the primary of the input transformer chiefly with the object of preventing surges of high potential occurring in the whole amplifying system.

It is important at this stage to recognise the difference in operation of ordinary push-pull and Q.P.P. In the latter case, the two valves amplify *in turn*, not simultaneously. It is true that there is a small change in anode current for negative potentials on the grid, but this is a comparatively small change and one we could in ideal circumstances do quite well without.

Some Helpful Analogies.—It is rather useful to consider one or two analogies to show the difference between the two systems.

In the case of the train, both locomotives are helping all the time, but if we were working a Q P P train, the locomotives would work in spurts—the one in front pulling for a short while and then the rear locomotive pushing for a similar short period. In the case of two men sawing a tree trunk, there are two ways they could work: when one was pushing the other could be pulling and vice versa; this would be push-pull. But they could each prefer only to push, the other man momentarily resting without contributing in any way to the movement of the saw. This arrangement would be equivalent to Q.P.P., which is sometimes known as *push-push* amplification because each valve “pushes” in turn, producing a half-cycle of alternating current in the output transformer. The two halves “meet” in the secondary of the output transformer and join up as a complete cycle.

Another analogy which may be of some use is that of a pedal cyclist (see Fig 284). There are two ways he could work a bicycle.

The usual way is to press hard with one foot, say the left, on the pedal which is going down, and just to let the right foot come up of its own accord with the right pedal. This is “Q.P.P.” pedalling,

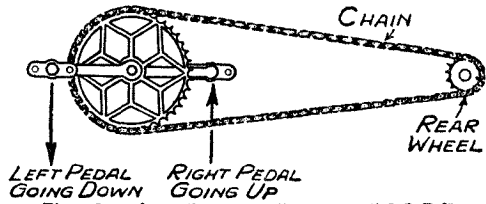

Fig. 284—A cyclist normally uses a “Q.P.P.” system, using pedals in turn

but one can imagine an arrangement where the cyclist's feet are strapped to the pedals so that he may be pressing down on one pedal and pulling up on the other, each leg therefore doing some work in driving the bicycle along. This would be ordinary push-pull.

CHAPTER 17

CLASS B AMPLIFICATION

An even more interesting form of Q.P.P. amplification is that which has come to be known as Class B amplification. In this scheme each valve (which is now usually a triode) operates in turn, the normal steady anode current being very small in comparison to the large currents due to strong signals. The peculiar point about Class B amplification is that the grids of the valves are allowed to become positive. In all other systems it is regarded as highly undesirable that the grid should become positive, because when this occurs there is a substantial load on the secondary of the input transformer, and there is consequently heavy damping of the positive half-cycles. The result is that the degree of amplification is greatly reduced and the positive half-cycles are distorted, since the grid voltage does not rise to the same value in a positive direction as it does in a negative sense. In Class B amplification we deliberately allow grid current to be established, but on account of its deleterious effect we use an input transformer specially designed to supply current as well as voltage. The ordinary step-up transformer used for feeding an ordinary output valve only requires to provide voltage, but a Class B *driver transformer*, as it is known, is a power transformer suitably matched to the current the secondary will take, just as an output transformer matches the output valve anode circuit to a moving-coil speaker. The driver transformer must have a low-resistance secondary and, since it is designed for power purposes, it will usually be a step-down transformer, the primary being connected to the anode circuit of a valve calculated to supply power rather than voltage. Valves of the P.M.2A types are being used as driver valves, although P.M.2 DX types will prove a little more economical in H.T. Prior to the driver valve you will usually have an ordinary step-up transformer, the primary of which is connected to the detector valve.

The simplest circuit arrangement is that illustrated in Fig. 285. The main point to notice is that the grids are kept at zero potential, the characteristic curves of the two valves being similar to that

shown in Fig. 286. At zero volts on the grid the anode current is perhaps only 1.5 milliamps., while it rises to perhaps 20 or 30 milliamps. for large positive grid volts. It is usual to include the

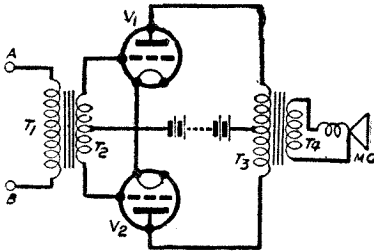

Fig. 285—Simple Class B circuit ; the grids operate at zero volts

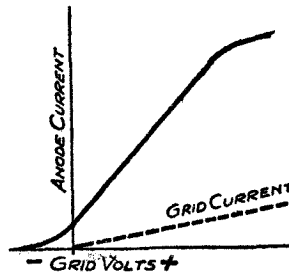

Fig. 286—The curve of a Class B valve lies to the right of zero grid volts

two valves in the same vacuum bulb, this making for better uniformity, better matching and cheaper manufacture, while simplifying set design. The dotted line "curve" in Fig. 286 shows the grid current.

The best combination of valves and transformer ratios, etc., are obtainable from the makers of the valves. A complete circuit, however, is given in Fig. 287, and will serve as some guide to the technique of operating Class B valves. It will be seen that the driver valve V1 has in its grid circuit the ordinary secondary of a step-up transformer. The primary of this transformer is decoupled by the usual resistance and by-pass condenser. The anode circuit of the driver valve contains the primary of the step-down driver transformer T3 and T4, and for safety the anode circuit of the driver valve is also decoupled. The secondary of the driver transformer has a middle tapping as usual, and it will be seen that

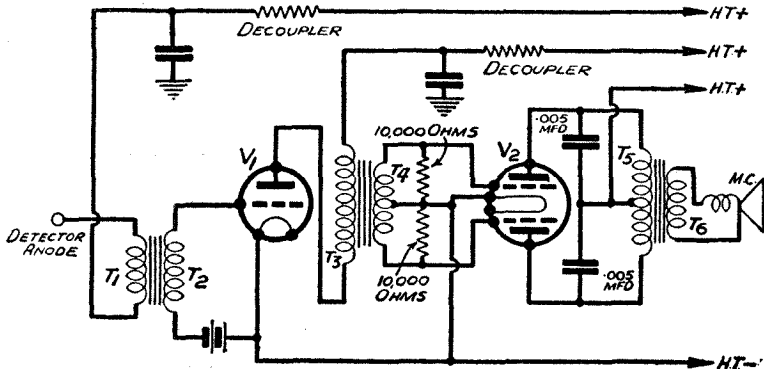

Fig. 287—A complete Class B circuit showing the driver valve V1 and the resistances and condensers for damping parasitics

two resistances, each of 10,000 ohms, are connected between grid and filament in each case. These resistances are for the purpose of preventing parasitic oscillations, and various combinations of condensers and resistances or condensers alone are sometimes found effective to prevent the very real nuisance which may cause fuzziness of tone and an increase in the standing anode current (i.e., the current when no signals are received).

If condensers are embodied, it must be remembered that since a driver transformer is not designed for voltage amplification very much larger condensers will be required for tone-control. Class B valves have a pentode type of characteristic and tend to accentuate the higher notes. There is a great deal to be said for tone-control on the input of a Class B valve, or at any rate at some stage prior to the output circuit of the Class B valve, because any unnecessary signals, whether due to heterodyne whistles or excessive top notes, will result in a waste of H.T. current.

Fixed condensers are frequently connected in the position shown—i.e., between the middle point of the output transformer primary and each anode, but these are usually fitted to prevent parasitics and prevent an excessive rise in output impedance. Sometimes resistances are connected in series with each of the condensers on the output side of the Class B valve. In addition, a condenser is sometimes connected across the two anodes.

Class B valves are generally divided into two categories—those

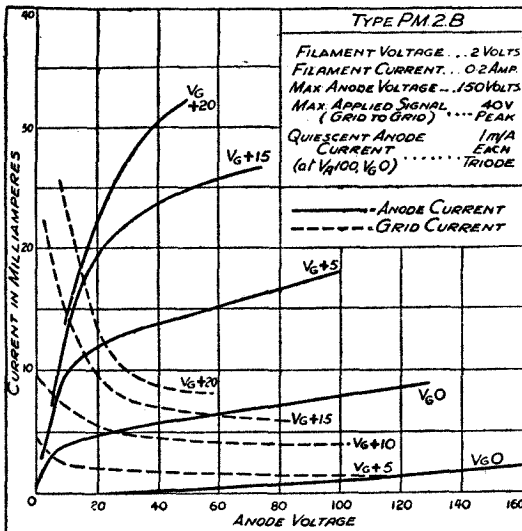

giving about two watts undistorted output, and those giving a little more than one watt; the latter size require less filament current and different types of input and output transformers. It is common practice for component manufacturers to supply transformers and chokes suitable for different types of Class B valve, suitable alternative tappings being

Fig. 288—Characteristic curves of a typical Class B output valve

provided. Some of the valves can be used for medium or high output, but the right driver valves, transformers and H.T. voltages must be used. It is impracticable to give all the various arrangements here.

A characteristic curve for a Class B valve is given in Fig. 288, the P.M.2B being the type of valve whose characteristics are illustrated. The dotted lines represent the grid/current curves.

Class B Output Chokes.—Instead of a transformer having two separate windings, an output choke having a middle tapping is sometimes used for Class B or Q.P.P. amplification, the arrangement being cheaper to manufacture. Different tapings are usually provided, as illustrated in Fig. 288a, so as to suit different speakers and Class B valves. A transformer is used instead of a choke if a moving-coil speaker is not fitted with a transformer. Most speakers are now fitted with special Class B transformers. In

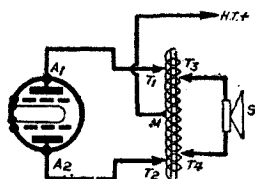

Fig. 288a—An output choke is often used in Class B

Fig. 289, a tone-control arrangement is shown in use to prevent the accentuation of high notes. Other methods and comments on them have already been described.

Finally, in Fig. 290, a seven-pin valve holder is illustrated. This is specially designed for use with Class B and other multi-electrode

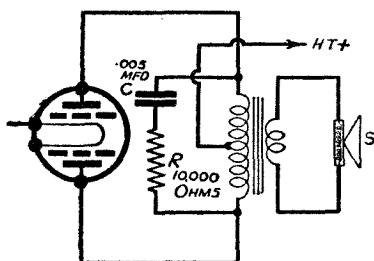

Fig. 289—Class B tends to accentuate high notes, and tone-corrector is shown

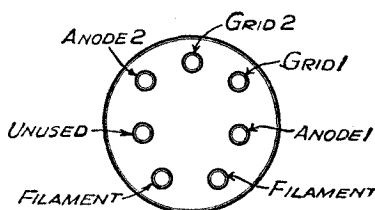

Fig. 290—View of Class B valve-pins, looking from underneath

valves, and the view given is as if looking at the underneath of the valve holder or base of the valve.

Semi Class B.—The Marconi-Osram valve B.21 is a special Class B valve which differs from other types in that the two valves in the bulb do not operate at zero grid bias, but with a bias of about -3 or $-4\frac{1}{2}$ volts. The grids run into grid current during reception, so that the arrangement is a mixture between ordinary Q.P.P. and Class B. Better quality reproduction is claimed, as it is stated that the lower impedance of the valve reduces the danger of quality impairment by transient parasitics

CHAPTER 18

NEUTRALISED CIRCUITS FOR HIGH-FREQUENCY AMPLIFICATION

Before the screen-grid valve became popular, various so-called neutralised circuits were employed in conjunction with ordinary three-electrode valves.

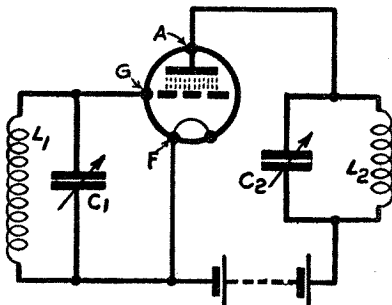

Fig. 291—Capacity coupling inside triode promotes self-oscillation

The disadvantage of these valves was that there was a capacity coupling between input and output circuits, due to the condenser formed by the surfaces of anode and grid inside the valve. This capacity effect is illustrated by dotted lines in Fig. 291, and caused instability and self-oscillation when a tuned circuit was in the grid circuit and a tuned circuit in, or associated

with the anode circuit.

Fig. 292 shows the grid-to-anode capacity represented by the condenser C_2 , while the dotted line condensers C_1 and C_3 represent the grid capacity and anode capacity respectively.

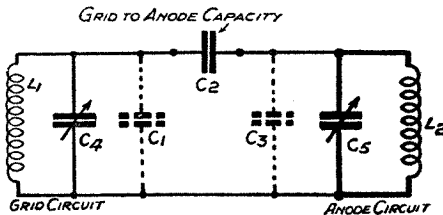

Fig. 292—Theoretical network showing valve capacities

There is obviously a coupling between the two circuits. The method of neutralising the reaction feed-back is to feed back e.m.fs. in opposite phase, so as to wipe out the undesired e.m.fs. communicated from anode to grid through the valve.

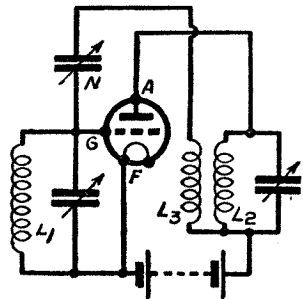

Fig. 293—Use of neutralising winding and condenser

Fig. 293 shows an inductance L_3 wound over or coupled to L_2 , the anode inductance. The top end of L_3 is connected through a very small neutralising condenser N to the grid of the valve ; the other end of L_3 is connected as shown, or to the filament.

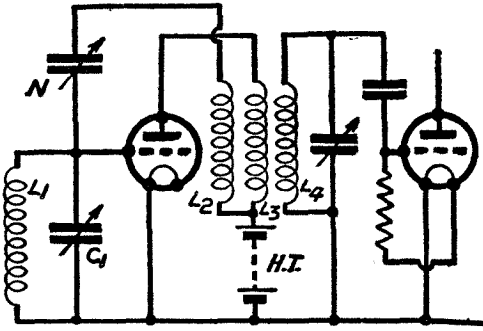

Fig. 294—An H.F. intervalve transformer coupling with neutralising winding

The condenser N , of course, prevents the steady H.T. voltage from affecting the grid, and only H.F. potentials are fed back. The winding L_3 is so wound that the potentials fed back are opposite in phase to those being fed back unintentionally through the valve.

Thus, if the capacity in the valve tends to make the grid positive, the neutralising circuit would tend to make it negative. The condenser N is adjusted so that the negative feedback is just sufficiently strong to wipe out the inherent reaction effect.

The arrangement just described is shown applied to a tuned anode method of H.F. coupling, but the same principle can be applied in several different ways. In Fig. 294, H.F. transformer-coupling is employed, using an aperiodic primary and tuned secondary ; a neutralising winding is coupled to the primary and this neutralising winding feeds back negative reaction.

The necessary phase reversal can be obtained not only by means of a transformer arrangement, but by splitting the anode or grid circuits.

Fig. 295 shows how, by making the H.T. connection to the middle point on the anode tuned circuit, we can obtain a *balanced bridge effect*. The top end of the anode coil L_2 may be momentarily positive, and this potential will induce through the valve capacity and affect the grid circuit.

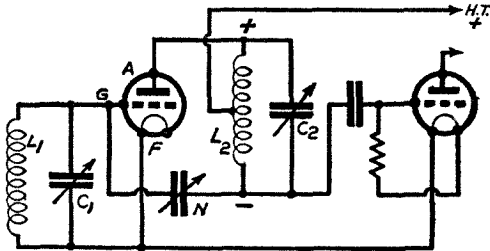

Fig. 295—Tapped anode coil enables valve capacity to be neutralised

Simultaneously, however, an equal and opposite e.m.f. is induced through the neutralising condenser N from from the bottom end of L_2 which is negative.

The variable neutralising condenser has to be very small, of course, since it corresponds to the grid-to-anode capacity of the valve. There are usually other unwanted capacity couplings due to wiring, proximity of components, etc. These tend to increase inherent reaction and the neutralising condenser is used to balance out all the unwanted capacity couplings. The scheme has obvious uses even in screen-grid valve circuits, although capacity couplings are usually reduced to a minimum by screening the components in metal cans connected to earth.

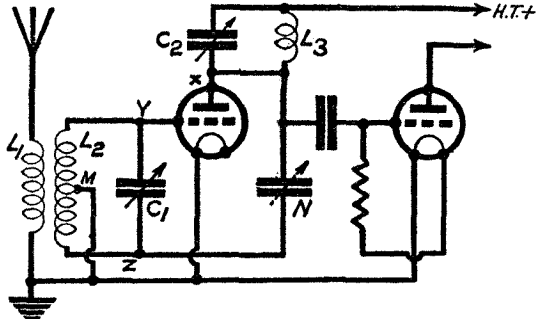

Fig. 296—Tapped grid coil enables neutralising voltages to be fed from anode

In Fig. 296, the opposing e.m.fs. are fed from the anode of the H.F. valve, but are communicated to the bottom end Z of the grid oscillatory circuit $L_2 C_1$, the middle point M of which is joined to the filament. The valve capacity feeds positive reaction to the point Y, while the neutralising condenser N feeds negative reaction to the opposite end of the circuit. The two effects balance out. These various neutralising schemes are specially needed where two or more stages of H.F. are employed, and Fig. 297 shows a typical arrangement.

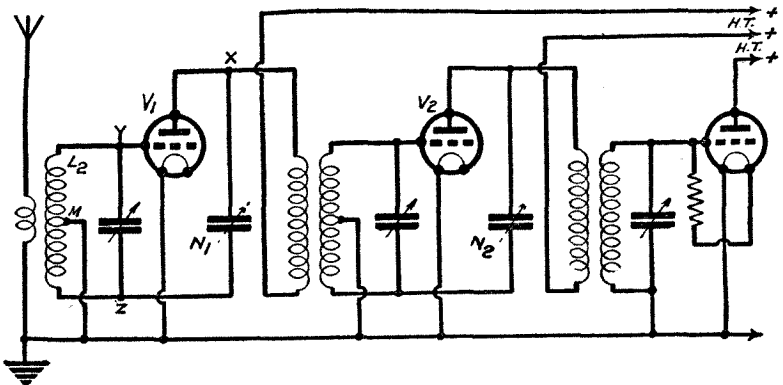

Fig. 297—Multi-stage H.F. amplifier in which each valve is neutralised with the aid of a tapped grid circuit

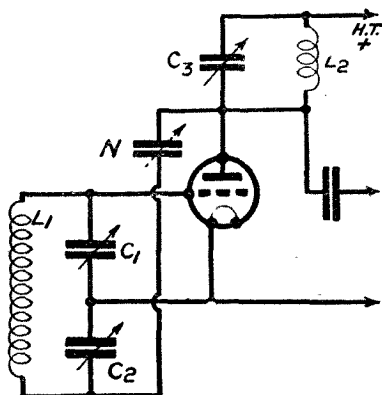

Fig. 298—A special split input circuit prevents parasitics

If the tapings on successive stages are exactly similar, parasitic oscillations may occur owing to the tapped portions forming separate circuits of higher frequency. The use of a tapping point between condensers removes this effect, and a scheme on the lines of Fig. 298 may be employed. The two variable condensers in the grid circuit may be ganged.

crystal detector D and the primary T₁ of the step-up L.F. transformer T₁ T₂. The rectified signals of L.F. are thus fed into the grid circuit and amplified by the valve; the amplified L.F. now works the loudspeaker L S which is in the anode circuit of the valve. There are condensers C₃ and C₂ across T₂ and L S respectively to by-pass the H.F. currents. The loudspeaker does not interfere with the H.F., and the tuned anode circuit does not affect the L.F. circuits which work the speaker.

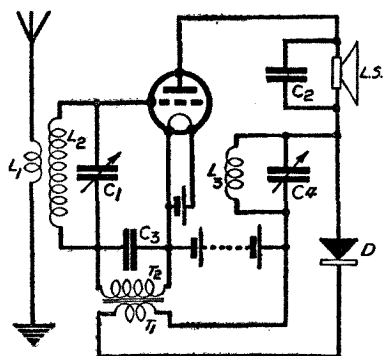

Fig. 300—Crystal detector reflex receiver giving double amplification

The circuit is a good theoretical example of what is called a *reflex* circuit in which the rectified currents are amplified by the valve that amplifies the H.F. signals. The actual circuit is not

the best from a practical point of view.

A valve may be used as a detector, and Fig. 301 shows an H.F. stage using an H.F. transformer to which reaction is applied; the reaction is adjustable by moving the reaction coil, but many modifications are possible. The use of parallel L.F. input is illustrated in Fig. 302; some method of keeping the H.F. out of the

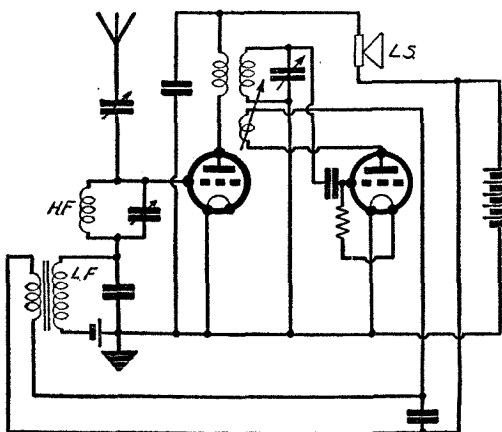

Fig 301—Use of a valve as detector in a reflex receiver

L.F. transformer secondary is required and an H.F. choke Z is shown in use.

Resistance Reflex Circuits.—The present writer has developed various resistance-coupled reflex circuits in which a resistance of about 50,000 ohms is used as the means of feeding the L.F. to the grid of the H.F. amplifier. One of the merits is that there are no L.F. transformers which can oscillate "on their

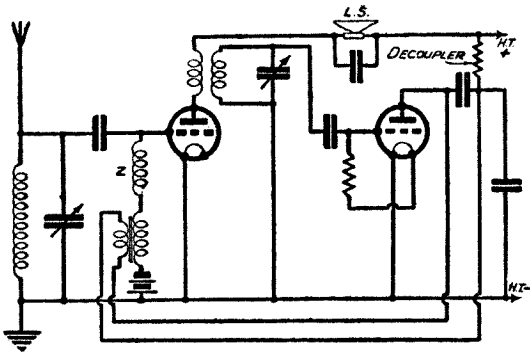

Fig. 302—Another reflex receiver in which, however, the L.F. is fed to the first grid by a parallel circuit

own.” Fig. 303 shows a circuit in which R_1 provides the coupling.

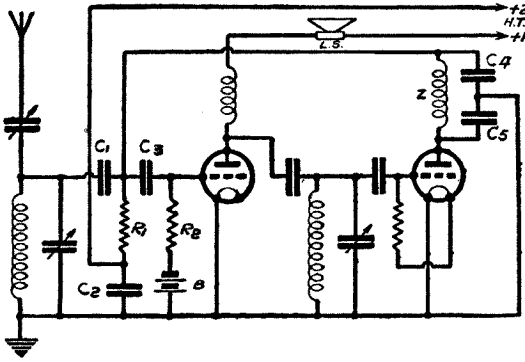

Fig. 303—A reflex receiver in which the L.F. is resistance-coupled

Condensers C_2 and C_3 are large (not less than .01 mfd.). The H.F. choke Z and condensers C_4 and C_5 are to prevent H.F. reaching the grid of the first valve. The resistance R_2 is large (say 1 megohm) and is simply to enable grid bias to be applied to the first valve.

CHAPTER 20

MULTIPLE REACTION CIRCUITS

The merits of reaction as regards the strengthening of signals and the improvement of selectivity are normally only taken advantage of in one circuit. In a simple single circuit receiver where the aerial circuit feeds straight to a detector valve it is common practice to apply reaction to that circuit. Where there is a stage of H.F. amplification the reaction is usually applied to the intervalve circuit, the aerial circuit being left more or less to its own resources.

Sometimes a band-pass circuit is inserted to give greater initial selectivity, but this results in some loss of signal strength—as, in fact, do all usual methods of obtaining selectivity on the aerial circuit.

The compromise between signal strength and selectivity is nowhere more apparent than in the aerial circuit of the average receiver. The present writer has for ten years drawn attention to the merits of applying reaction individually to all the H.F. tuned circuits of a receiver, and various patents have been filed for carrying out these principles.

The application of reaction to an aerial circuit will greatly increase the selectivity of that circuit, which has a large aerial load on it. The usual selectivity schemes involve lightening the load by reducing the amount of coupling to the aerial, e.g., by a series condenser or a loosely coupled H.F. transformer arrangement with aperiodic primary. These methods, when a real improvement in selectivity is obtained, provide the selectivity at the expense of signal strength. At the best, the ultimate theoretical selectivity is no greater than that of a single circuit without aerial and earth. Such a circuit is not selective, as there are substantial losses in the inductance and some in the tuning condenser.

The effect of applying reaction to the aerial circuit is to reduce losses where they chiefly occur in a receiver, to improve selectivity and signal strength simultaneously. The signals are then amplified and applied to a second circuit to which separate reaction is also applied. Reaction could be applied to three or even more circuits

to provide a very high degree of selectivity. Precautions have to be taken to ensure the stability of the set, and the separate reaction on each circuit adds somewhat to the complication of design and operation, and makes it difficult—if not impossible—to simplify control by the use of ganged condensers.

Double Reaction.—Fig. 304 is a double-reaction circuit in which reaction is applied to the aerial circuit by means of the variable condenser C_6 and the reaction coil R_1 . The source of H.F. currents for this reaction is the

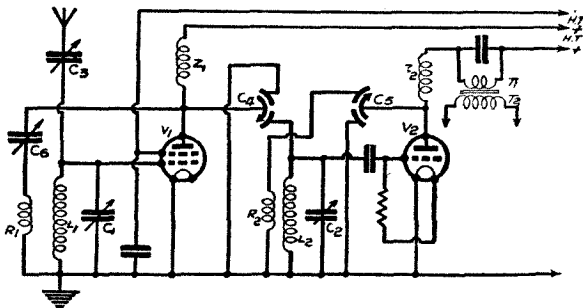

Fig. 304—A double-reaction circuit in which each anode circuit provides reaction

To prevent the correct phase being shifted, the coupling between the valves (the differential condenser C_4 is the agent) is kept small.

Reaction to the parallel-fed tuned anode circuit $L_2 C_2$ is obtained from the second valve, the choke Z_2 providing the currents which are adjusted by means of the differential condenser C_5 .

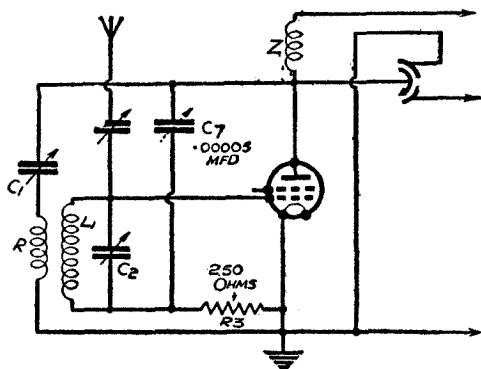

Fig. 305—Showing use of a phase reverser in aerial reaction circuit

It is important that the whole set should be quite stable before reaction is applied to the two circuits. It may be advantageous to apply reverse reaction to the first valve so as to ensure that the S.G. valve is thoroughly stable under all conditions. A small preset condenser C_7 of $.00005$ mfd. and a resistance R_3 of 250 ohms may be used in the

position shown in Fig. 305. The arrangement possesses other merits and has been used in the author's "S.T.500" receiver.

An earlier double-reaction circuit rather less successful in practice is given in Fig. 306. The main reaction control is now C_5 , and

the reaction currents are passed via an adjustable differential condenser C_6 to the aerial reaction coil R_1 and the anode reaction coil R_2 . The amount of reaction may be distributed to the two

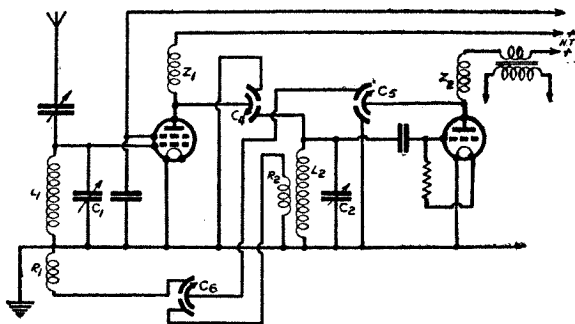

Fig. 306—A reaction distributor system is here illustrated ; reaction is applied to both tuned circuits

circuits. The theory of operation of this circuit is complex, and, although used with success on the present writer's "S.T.400" receiver, is a less practical arrangement than that of Fig. 304.

CHAPTER 21

MAINS UNITS AND THE RECTIFICATION OF A.C.

The earliest use of a two-electrode valve was as a rectifier of alternating currents. These usually have a frequency of 50 cycles in the case of electricity for domestic purposes. Fig. 307 shows a very simple form of rectifier in which a thermionic valve, consisting of an anode and an incandescent filament, allows an electric current to flow only in one direction.

The anode of the valve is made alternately positive and negative, according to which half-cycle of the A.C. supply is affecting it, but only the positive half-cycles produce an electron current, and the resultant electrons charge up the condenser, which is usually called the rectifier condenser, or sometimes the reservoir condenser. The bottom side of this condenser, illustrated in Fig. 307, will become negatively charged, whereas the other side will be relatively positive.

If a load is connected across the terminals H.T.+ and H.T.—, it will be seen that there is a complete circuit. The reservoir usually has a capacity of from 2 mfd. upwards, and it serves a very useful purpose in that it stores the direct current pulses and “irons” out the ripples which would otherwise exist. The condenser will charge up to the peak voltage of the A.C. supply, after which there would be no further current through the valve; but if there is a load across the output terminals of the rectifier system, there will be a constant drain of current from the reservoir which will then be recharged by more current through the valve. The use of reservoirs for evening out a stream of water is very well known, and a condenser serves a very similar purpose, and also provides a path of low reactance for the A.C. potential which has to go to the filament.

With this simple rectifier system there will still be ripples on the

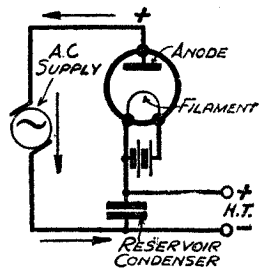

Fig. 307—To explain use of diode as a rectifier

D.C. supply, these occurring as the spurts of electron current enter the condenser. Fig. 308 illustrates clearly when the ripples occur, and the need for some system of smoothing in addition to the rectifier condenser. Elsewhere in this volume there is a full account

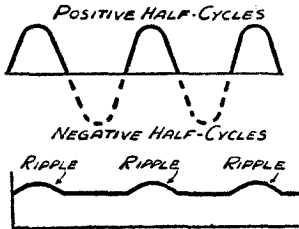

Fig. 308—This illustrates the A.C. ripple obtained with half-wave rectification

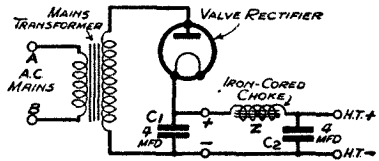

Fig. 309—A simple smoothing circuit comprising choke and condenser

of smoothing devices and filters, and we shall only deal with the matter briefly here. Fig. 309 shows the rectifier arrangement previously described, followed by an iron-core choke Z , and a second condenser C_2 , also of large capacity. The direct current flows from the first reservoir condenser C_1 , through the iron-core choke Z , into the second condenser from which it is drawn off at the terminals H.T. + and H.T. -. No direct current flows through the reservoir condensers unless these are of the electrolytic type, in which case a negligible leakage current flows. The question of the ripples, however, is rather different, because these partake of the nature of an alternating current superimposed on the D.C. This miniature A.C. supply will pass through the choke Z , and then down through the condenser C_2 , back to the other side of C_1 . The choke Z offers a high impedance to the A.C. current, and most of the voltage is established across Z , whereas the condenser C_2 provides a very ready path of low reactance, and consequently only very small voltages are established across this condenser. The arrangement of Z and C_2 forms a potential divider across the condenser C_1 as regards the A.C. ripples, and since we only draw off the D.C. from the condenser C_2 , it will be clear that any A.C. ripple voltages across Z will not affect the receiver, which is being fed with H.T. from the complete rectifying system. There will be some voltage drop through the choke Z as regards the D.C. supply, owing, not to its inductance, but to the ohmic resistance of the choke, and this resistance, therefore, will usually be kept as small as possible, unless one can afford to drop volts across it. In this latter connection, it sometimes happens that we wish to reduce the D.C. voltage, in which case a resistance may even be inserted in series with the choke for that purpose. This also helps to

improve the smoothness of the D.C., since some of the A.C. ripple is developed across the resistance and, therefore, does not reach the set.

Full-Wave Rectifiers.—The half-wave rectifier so far described does not take advantage of the other half-cycle of A.C., and it is, in actual practice, customary to use two rectifiers, which are frequently arranged as shown in Fig. 309a. The same circuit

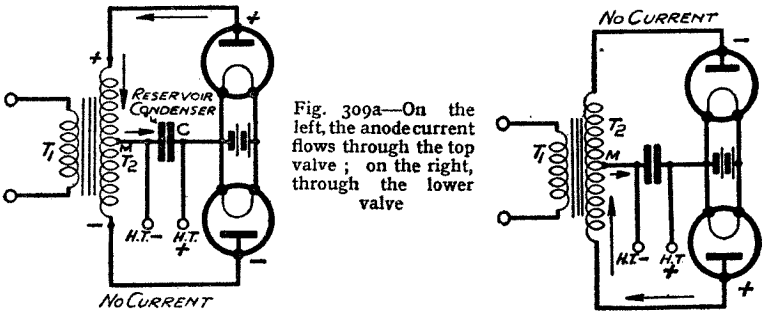

Fig. 309a—On the left, the anode current flows through the top valve; on the right, through the lower valve

is shown operating on different half-cycles. We have a step-up mains transformer T_1 T_2 , the secondary T_2 of which has a middle point M connected through a reservoir condenser to the filaments of two rectifying valves (sometimes combined into one valve by using the same filament for each). The ends of the secondary T_2 are connected to the two anodes of the valves. In this arrangement we can consider the anode of the top valve as being made positive first, as shown in the circuit on the left. This causes the flow of electrons from the filament to the anode, through the top half of T_2 and into the left-hand side of the reservoir condenser, making that side negative. Meanwhile, the other valve has had a negative potential applied to its anode, and this produces no current, so that the lower valve is inoperative. When, however, the voltage from T_2 changes direction, the top valve is inoperative, and the anode of the bottom one becomes positive, as shown in the right-hand figure. This produces an electron current which flows through the bottom of T_2 and also into the left-hand side of the reservoir condenser. The latter is thus affected in the same way, whichever half-cycle is in use, the valves acting alternately and providing a bigger output of D.C. The arrangement, incidentally, makes smoothing easier, since the negative half-cycles on the top line in Fig. 308 are reversed and fill in the gap between the positive half-cycles. There is still a ripple, but it is not so marked, and has twice the frequency and, therefore, produces a greater voltage across any smoothing choke and a lower voltage across

a smoothing condenser; hence existing smoothing arrangements are far more effective for this reason alone.

Smoothing Circuits.—In Fig. 310 a complete smoothing circuit is shown; it consists of a smoothing choke Z and two condensers C_1 and C_2 . A dropping resistance R is included, and may be used for varying the voltage of the D.C. supply. Sometimes this resistance takes the form of the field winding of a mains-energised moving-coil speaker, the D.C. current flowing through the field magnetising the iron magnet of the speaker.

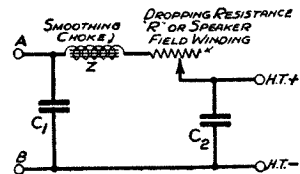

Fig. 310—Use of a resistance for voltage dropping

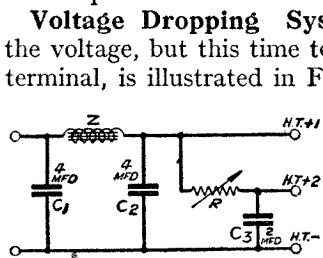

Fig. 311—Use of dropping resistance to provide extra H.T. terminal

is connected between the right-hand side of R and the H.T.—terminal. This assists in further smoothing but is primarily intended as a decoupling device. A *mains unit*, as a separate complete rectifier system is sometimes called, offers a considerable impedance, and thus any fluctuating anode currents due to signals are liable to set up voltage variations which will be communicated to other valves in the receiver and produce coupling effects resulting in low-frequency reaction or reverse battery reaction. The quality of a mains unit is judged, not merely by the supply of D.C., but by the decoupling circuit provided, although, of course, the receiver may have its own decoupling arrangements as well.

Fig. 312 shows another way of providing a variable H.T. voltage; this time a resistance R is used as a potential divider, the sliding contact being connected to the terminal H.T.+2. Instead of a sliding contact, a compression resistance is sometimes used as shown in

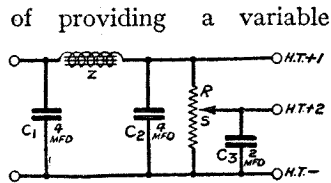

Fig. 312—Use of potentiometer to provide a second H.T. voltage

Fig 313, the resistance R_1 being of this type. The resistance R_2 is fixed, so that the alteration of R_1 results in a different distribution of the voltages, and so causes a variation of the voltage supplied to the terminal H.T.+2. The greater the value of R_1 the lower will be the voltage of H.T.+2.

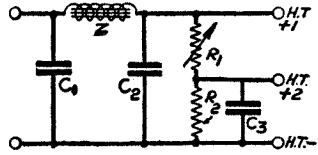

Fig. 313—The second H.T. voltage is varied by R_1

A complete mains unit (sometimes called a *battery eliminator*, or simply an eliminator, when used for supplying the H.T. to battery sets) is illustrated in Fig. 314, and both systems of voltage

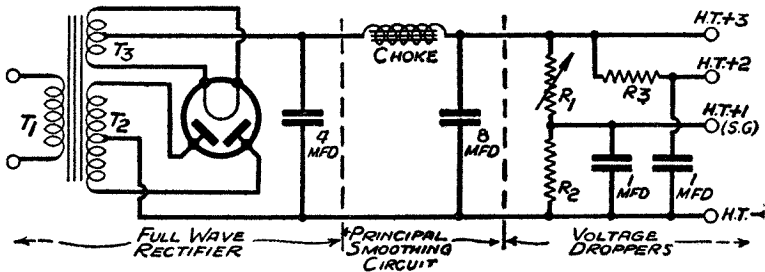

Fig. 314—A complete full-wave rectifier system complete with smoother circuit and extra H.T. terminals

dropping are shown in use. Also, the rectifier valve illustrated contains two anodes but only one cathode. This is a simple arrangement used as an alternative to two separate valves. Note how the circuit may, for clearer understanding, be divided into three parts. A middle tapping is taken from the winding T_3 , which usually provides 4 volts, and which supplies the current to heat the cathode which is shown as a filament. The object of tapping the winding in this way is to reduce hum by making the voltage, with respect to both sides of the filament symmetrical. The cathode is frequently made in the form of a tube covered with some electron-emitting substance and heated by *heater wires*; this type of rectifier is known as the indirectly-heated cathode type, and the cathode is usually connected to one side of the heater filament. The merit of such a valve is that it takes a little time for the current to charge up the condensers; thus, a sudden rush of H.T. to the set is avoided; this is undesirable until the set's own cathodes have warmed up and are emitting electrons.

CHAPTER 22

METAL RECTIFIERS

One of the most fascinating developments of recent years is the metal rectifier, since it is so practical a solution of the problem of rectifying alternating current of low frequency. The metal rectifier is in competition with the thermionic diode for providing the H.T. for mains receivers for use on A.C. mains. The metal rectifier is undoubtedly more of an engineering job than the valve, and it will certainly last many years and perhaps indefinitely, whereas a valve will burn out or lose emission or even fracture. On the other hand, the valve is light in weight, takes up little space, works very well and costs less in the first place.

The so-called metal rectifier is based on the work of Grondahl who, in April, 1926, reported on his work to the American Physical Society. It was found that if a sheet of lead was pressed against the oxidised surface of a sheet of copper, the arrangement allowed current to flow from lead to copper, but not in the reverse direction. The Westinghouse Company has developed a number of commercial types of metal rectifiers which can deal with as much as 80,000 volts or, on the other hand, arranged to give 1,000 amperes at only 12 volts. Their rectifier units (when an H.T. supply is required) are built up of a number of rectifiers in series. The discs of copper, coated with oxide, are threaded together and are fitted with cooling fins which dissipate the heat generated when the unit is in action. The size of the discs depends upon the output current to be delivered, while the voltage the unit is to handle governs the number of the discs. The circuits used in conjunction with metal rectifiers are similar to those employed when a valve or other one-way device is used for rectification, but the copper oxide rectifier lends itself very readily indeed to all kinds of circuits since it is not necessary to provide for filament heating, as in the case of valves.

A simple rectifier circuit is that of Fig. 315, in which a condenser C is charged by the

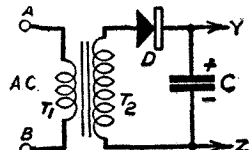

Fig. 315—Simplest metal rectifier system

unidirectional pulses of currents which are allowed to pass through the rectifier D during alternate half-cycles. The current supplied by such a rectifier is not very steady and it becomes necessary to smooth out the ripple. This can be done by chokes or resistances or both, and Fig. 316 shows the use of an iron-cored choke between two reservoir condensers. The theory of choke coils and reservoir condensers for smoothing out a direct current on which a ripple exists has already been explained in this volume. The lower the frequency of the alternating current the more elaborate must the smoothing arrangement be, so that a rectifier unit for 25 cycles is more expensive than one for the standard 50 cycles A.C. The transformer serves as a safe

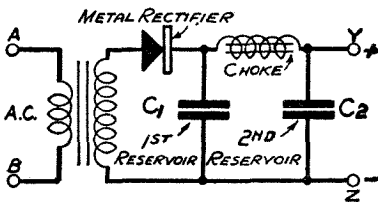

Fig. 316—An iron-cored choke and two condensers provide smoothing

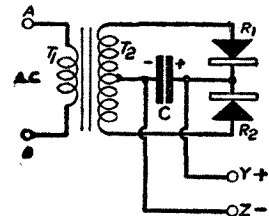

Fig. 317—A full-wave metal rectifier system

means of applying the alternating current to the rectifier and also enables us to obtain any desired high-tension voltage by simply choosing the correct ratio between the turns, so as to produce the desired step-up effect. To provide for different mains voltages it is possible to use a tapped primary winding, thus ensuring that the secondary voltage will be constant.

Full-Wave Rectification.—The arrangement of Fig. 315 is called a half-wave rectifier, while that of Fig. 317 is a full-wave rectifier and employs both half-cycles of alternating current. The secondary T₂ of the transformer T₁ T₂ has a middle tapping taken from it and this is connected to one side of the rectifier condenser C. Two metal rectifiers R₁ and R₂ are so arranged that they work in turn, the arrows showing the passage of electrons which flow into the condenser C the same way, thus charging left-hand side negatively. The disadvantage of this arrangement is that twice the ordinary voltage must be developed across T₂ and greater risks of breakdown are thus incurred.

Rectifiers in Bridge Formation.—The full-wave rectifier system of Fig. 317 possesses the disadvantage that high voltages are required, but by altering the circuit to correspond to Fig. 318 we can arrange that the input transformer supplies only sufficient voltage to make the system comparable to the half-wave rectifier.

Actually four rectifiers are employed in the form of a bridge and the complete circuit includes two rectifiers in series for each half-cycle ; thus, when the top of the bridge is positive and the bottom negative the electron currents will flow from the bottom of the bridge through the rectifier R_4 to the output terminal Z , through the external load to the positive terminal Y and back to the transformer through the rectifier R_3 . When the current in T_2 changes direction, the top of the bridge will be negative and the electron current will then

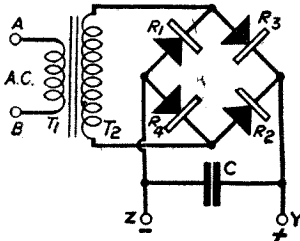

Fig. 318—Metal rectifiers arranged in bridge formation

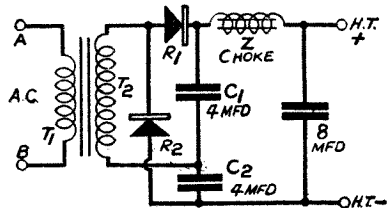

Fig. 319—The most usual arrangement involves voltage doubling

flow through R_1 to Z through the external load to Y and then through R_2 to the bottom of the bridge and so back to T_2 .

Voltage-Doubling Circuit.—Probably the most popular type of rectifier circuit is that shown in Fig. 319, where the alternating voltage supplied by T_2 is not halved as in the full-wave rectifier circuit of Fig. 317 but actually doubled. What we do is to charge up two reservoir condensers C_1 and C_2 , each being fed from a separate rectifier of alternate half-cycles. Thus, there are two rectifier systems, one consisting of R_1 and C_1 , and R_2 and C_2 , each of these condensers is charged to a voltage approximating to the peak voltage of the A.C. (supplied by T_2), and the two condensers act in series resulting in a total voltage approximately twice the peak voltage delivered by T_2 . The rectified output is now smoothed by means of an iron-cored choke Z of, say, 50 henries, and an output reservoir condenser of about 8 mfd.

CHAPTER 23

METAL RECTIFIERS AS DETECTORS

Recent developments of the metal rectifier have enabled this device to be used in wireless receiving circuits. It is, in truth, a "cold valve," and although it will not amplify, it provides an alternative to a diode as a detector in many circuits, especially as the second detector in a superheterodyne receiver. The Westinghouse Company in developing the Westector, as they call their metal rectifier for reception, have found it necessary to reduce the capacity of the rectifier, thus preventing the undesirable shunting of the high-frequency currents; it is also desirable to raise the impedance because radio high-frequency circuits are of relatively high impedance. The device as perfected has the advantage of cheapness, permanence, quiet operation, reliability, and other advantages, which make it a successful competitor with the diode valve in many circuits. Linear rectification is obtainable, and second harmonic distortion is thus removed. The Westector can handle 20 volts of H.F. input when four "sandwiches" (i.e., rectifier units) are connected in series, or 30 to 40 volts when a 6-sandwich rectifier is employed. A single sandwich will rectify without appreciable distortion from $\frac{1}{4}$ volt to 6 volts.

The damping of the Westector is very considerable when, say, medium-waveband signals are being received and there will thus be loss of selectivity, but the same does not apply when dealing with the intermediate-frequency signals of the superheterodyne. In a straight circuit the Westector probably operates best from an H.F. pentode, since the Westector is essentially a power-operated device, and the preceding apparatus must be of a type designed with that fact in mind. The device may be used for half-wave or full-wave rectification, the latter arrangement requiring two rectifiers. Greater damping will be introduced by such a system, but more rectified carrier-wave is obtainable, and this is of advantage on sets using automatic volume control where large voltages are required to control the variable- μ H.F. stage.

Curves of Westector.—A characteristic curve of the Westector

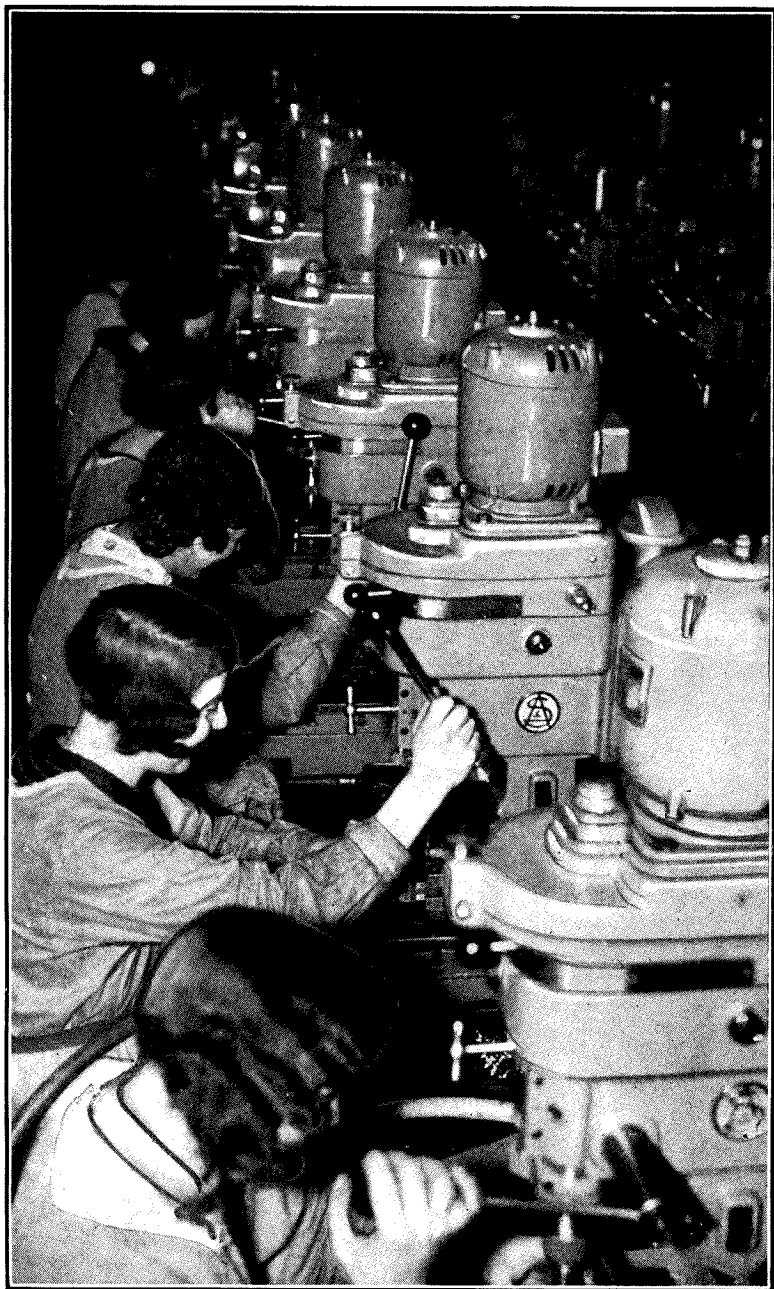

STAMPING OUT PARTS REQUIRED IN VALVE CONSTRUCTION

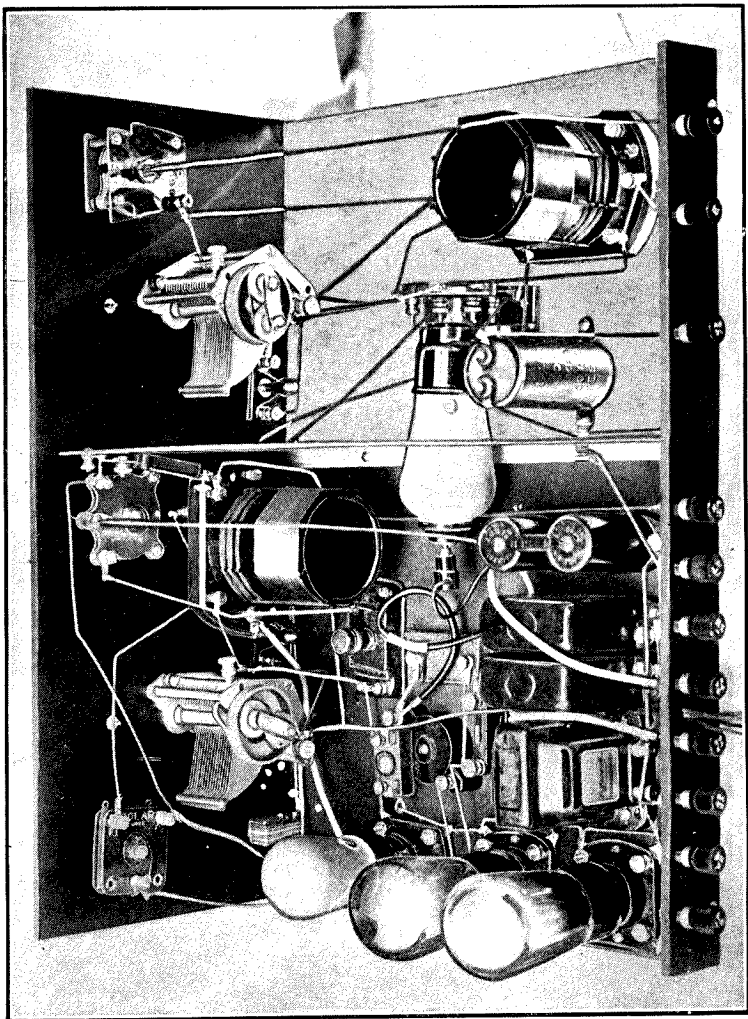

THE REAR VIEW OF ONE TYPE OF HOME-CONSTRUCTOR'S SET

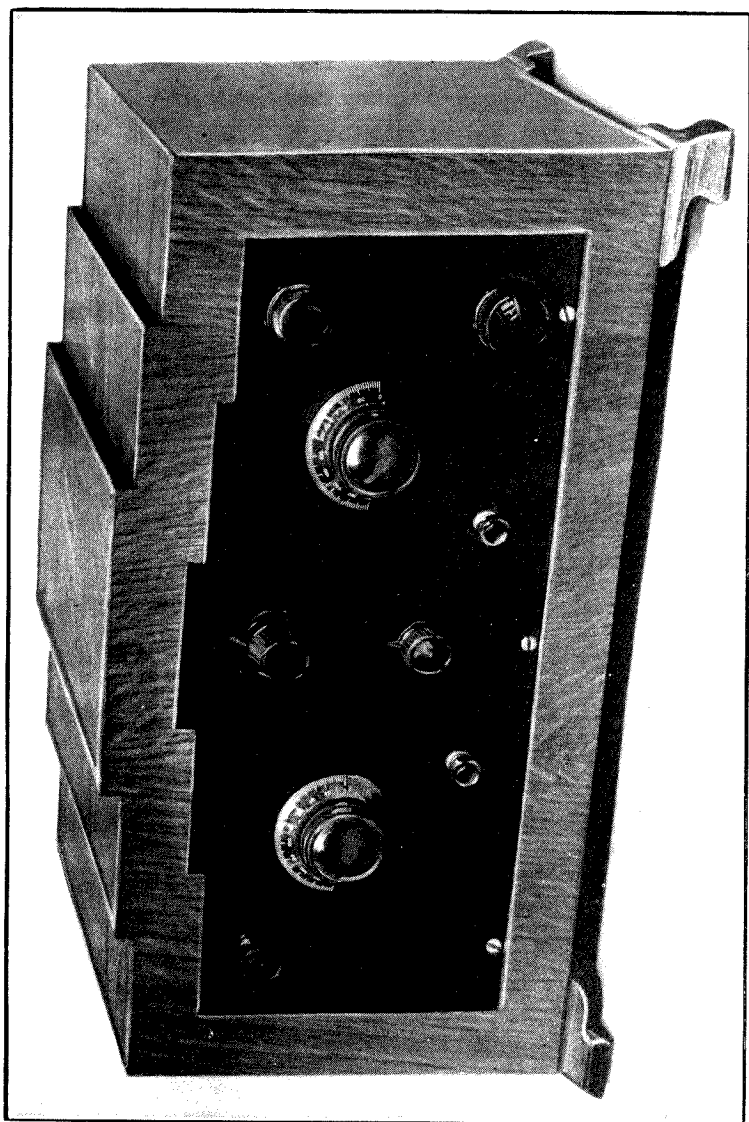

THE FRONT VIEW OF RECEIVER ILLUSTRATED ON PRECEDING PAGE

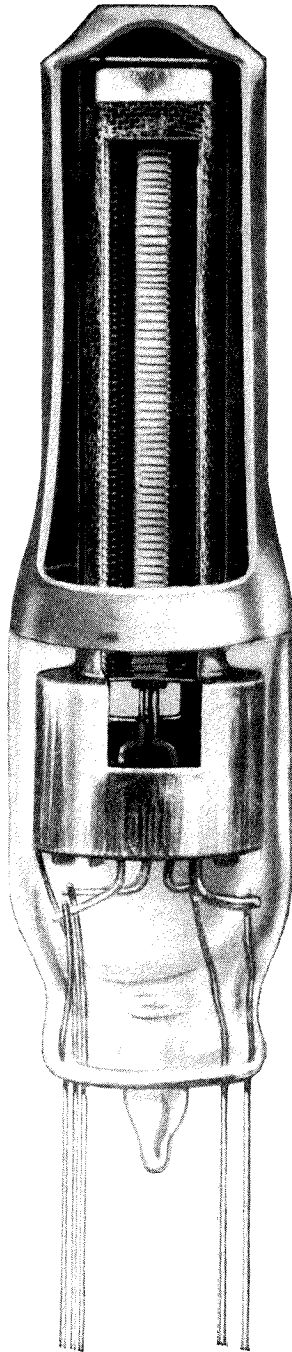

SHOWING CONSTRUCTION OF CATKIN VALVE FOR RECEPTION

is illustrated in Fig. 320. It should be carefully noted that the reverse current (the downward curve to the left) is drawn to an enlarged scale. This curve is for a single Westector disc assembly,

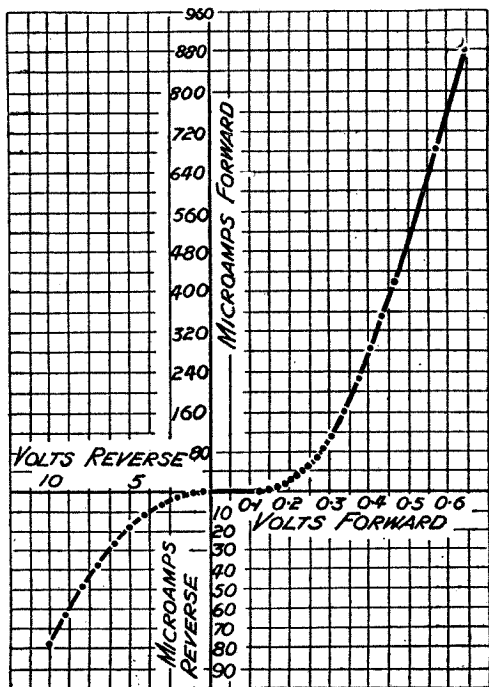

Fig. 320—Curve of Westector ; reverse voltages and currents are on enlarged scale

but it shows the excellent properties of the design. The curve extends beyond the limits shown, but there is no point in extending it to higher currents.

Circuits for the Westector.—Two typical circuits are given to illustrate the use of the Westector, and numerous other circuit arrangements may be obtained on request from the manufacturers.

In Fig. 321, a Westector is shown in use with an L.F. transformer. It is desirable not to include the primary of this transformer in series with the Westector. A parallel-fed scheme is therefore shown, and as a result there is no

D.C. component of the rectified current passing through the primary. This is to prevent a load being thrown on the tuned circuit, and the resistance may conveniently be from 30,000 to 250,000 ohms.

For superheterodyne working, an arrangement similar to that shown in Fig. 322 may be used. In this case, the Westector is being

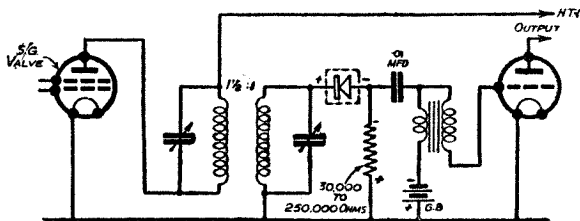

Fig. 321—Westector detector feeding into step-up transformer ; note resistance-feed system

employed as the second detector. To prevent the carrying over of the intermediate frequency, a filter is provided, and the volume control is also shown in the grid circuit of the output valve.

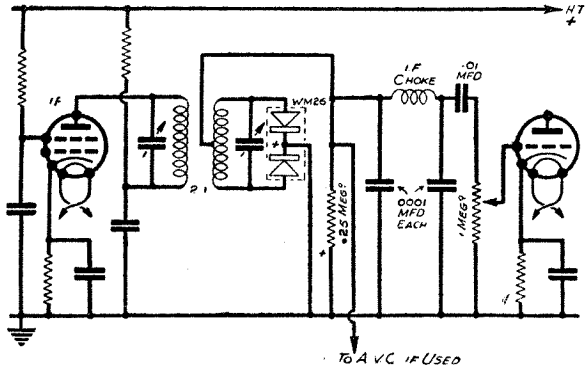

Fig. 322—This circuit involves full-wave rectification and is suitable for super-heterodynes

Anode Current Economiser.—An interesting use of the Westector is as an economiser of H.T. current in battery sets. The scheme is illustrated in one form in Fig. 323. It will be seen that some of the output L.F. currents of a pentode output valve are rectified by a type W4 Westector. The rectified D.C. voltage is smoothed and applied to the grid of the pentode, which is normally highly biased so that the anode current is small. When weak signals are received, the fact that there is considerable negative bias does not matter from a power-handling point of view, as big changes of anode current cannot in any case be required.

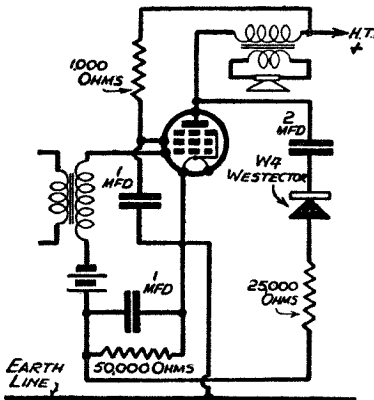

Fig. 323—Economiser circuit; weak signals increase negative grid bias

When signals are strong they require "room" for a big grid swing without distortion, and a large normal diode current. These conditions are obtained by reducing the normal negative bias on the grid. This is done automatically by the signals themselves, because as the signals increase the Westector feeds a *positive* potential in series with the bias; this is equivalent to reducing the normal negative bias.

The same principles have been adopted commercially by using a valve rectifier as an alternative to the metal rectifier. These arrangements should be compared to Class B and Q.P.P. amplification.

CHAPTER 24

VOLUME CONTROL METHODS

General Methods.—The control of volume, i.e. the output from the loudspeaker, may be carried out in a variety of ways. The various methods come under one or other of the following headings :

- (1) Control of H.F. input.
- (2) Alteration of degree of amplification given by H.F. amplifier, i.e. alteration of H.F. amplifying valve characteristics.
- (3) Modification of output circuit of H.F. amplifier.
- (4) Change of detector efficiency.
- (5) Control of L.F. input.
- (6) Alteration of characteristics of L.F. valve.
- (7) Alteration to L.F. output circuit.
- (8) Alteration to circuit immediately preceding the speaker.
- (9) Change of sensitivity of loudspeaker.

The methods (7) and (8) are almost inseparable, since the output circuit of the L.F. amplifier really includes the loudspeaker. Alteration of the sensitivity of the loudspeaker is not carried out on modern receivers. Formerly, one could move the diaphragm further from the magnet.

The degree of amplification given by H.F. or L.F. valves depends, of course, on the nature of their output circuit, and any change in this will probably cause a change in the degree of amplification, but a careful distinction has been made between altering the characteristics of the valves (e.g. variation of grid bias, screen voltage, H.T. voltage and filament emission), and modifying the output circuit.

Let us consider the various methods in the order in which they occur in a receiver. It will be understood that where more than one valve is used for a given purpose, the type of control may be applied to several valves or several circuits associated with the valves ; also, various forms of volume control are frequently combined, e.g. by mechanical ganging or control, or by automatic means such as automatic volume control, where sometimes the

H.F. and L.F. valves have their characteristics altered, or rather their operating conditions.

H.F. Input Control.—The obvious way, and, in fact, one of the most effective for controlling volume, is to provide a means of varying the high-frequency energy in the input circuits of the receiver. Fig. 324 shows how a small condenser in the aerial circuit

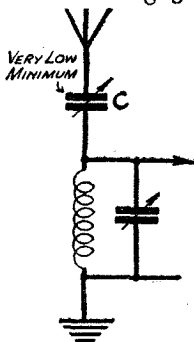

Fig. 324—Series condenser controls volume

(e.g. a .00005-mfd. condenser of low minimum) will reduce volume by cutting down the current in the tuned circuit. A series aerial condenser may at certain values even tend to increase the current in the tuned circuit, but as the value is reduced, the condenser will offer greater reactance to the high-frequency currents, and the latter will be cut down; incidentally, this arrangement, like many others, has advantages and disadvantages and repercussions on the operation of the receiver. The chief disadvantage is that it alters tuning, and this is serious if the circuits are ganged. The merit is that it improves selectivity when the value of the aerial condenser is reduced.

A resistance may also be connected in the aerial circuit as shown in Fig. 325. The greater the resistance, the less will be the signal strength. The arrangement in Fig. 325 may be modified by inserting a series condenser C as shown in Fig. 326. The resistance now has

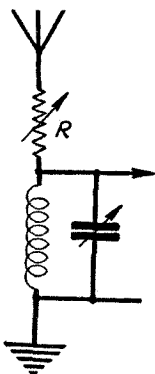

Fig. 325—Series resistance controlling volume

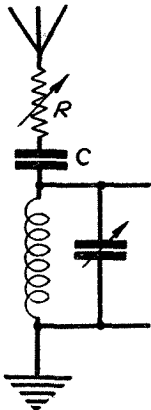

Fig. 326—A fixed condenser is sometimes inserted

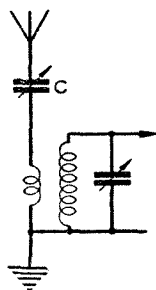

Fig. 327—This arrangement produces little effect on tuning

a similar effect. Fig. 327 shows a variable aerial condenser associated with so-called aperiodic coupling. Once again the effect of C is to alter the reactance; in this position the condenser has only a slight effect on tuning. In Fig. 328 the condenser serves a similar

purpose to that in Fig. 324, but the effect on tuning is less ; usually, however, the condenser C will now have a bigger value, and may still tend to upset tuning. The differential arrangement of

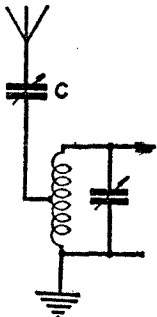

Fig. 328 — Combined tapping and series condenser

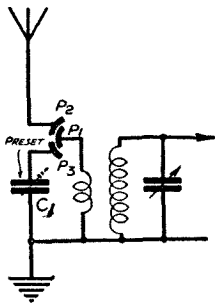

Fig. 329 — Differential condenser reduces mistuning

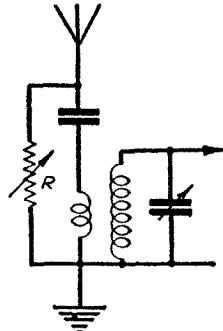

Fig. 330 — Parallel resistance reduces signal strength

Fig. 329, in which the preset condenser C_1 is adjusted to correspond to the capacity of the aerial ; when the moving plates P_1 come opposite to P_2 , signals are loudest. When P_1 is opposite P_3 , signals will be greatly reduced.

A resistance connected across an aerial tuned circuit would introduce very heavy damping and would alter tuning. The arrangement in Fig. 330 is, however, distinctly useful. A series condenser is in the aerial lead, and the variable resistance R is connected across aerial and earth. The arrangement makes little difference to the tuning of the secondary circuit or its damping. The resistance is preferably graded to obey a logarithmic law, so that over the initial adjustment of the control knob the amount of resistance in parallel with the aerial circuit is small. Many receivers apply a local-distance switch which simply puts in circuit a fixed resistance which cuts down the input current when receiving the local station. In all cases, it is desirable that the resistance should be capable of being cut out when desired. A rather different method is used in Fig. 331, where the resistance is connected directly across aerial and earth, and a sliding contact is connected to the H.F. input circuit ; in this case the arrangements of Fig. 326 and Fig. 330 are combined so that a reduction in signal strength is obtained by decreasing the amount of resistance in parallel with the input circuit.

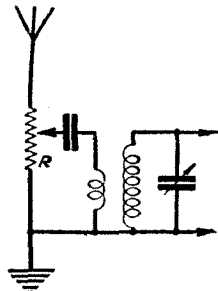

Fig. 331 — Combining series and parallel resistance

An H.F. potentiometer arrangement is sometimes used, and Fig. 332 shows an example. The resistance R , which obviously

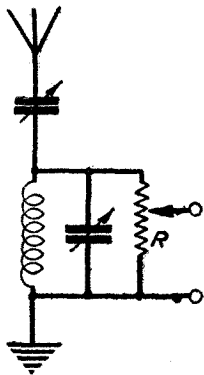

Fig. 332—Use of H.F. potentiometer to control volume

should have a high value (say, 1 megohm) to avoid introducing excessive damping into the tuned circuit, has a sliding contact which is connected to the grid of an amplifying valve. The grid capacity of the valve is removed from the tuned circuit to a greater extent as the slider moves down R , and therefore the arrangement may affect tuning slightly. The damping, however, remains substantially constant. In Fig. 333 a condenser is used to keep the grid-bias battery from short-circuiting through the inductance; the actual capacity of this stopper condenser is of little importance.

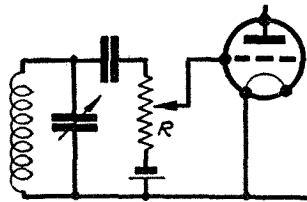

Fig. 333—Use of stopping condenser to prevent shorting bias

A resistance of comparatively low value may be connected across the input winding of an aperiodic transformer arrangement as shown in Fig. 334, to provide volume control. Sometimes a rotating aerial coupler is used as a means of controlling H.F. input. This arrangement can be very successful. It is illustrated in Fig. 335, where the inductance L_1 can be rotated so that the degree of coupling to the inductance L_2 may be varied between maximum and zero. This arrangement, if the coil L_1 is small, makes little alteration to tuning.

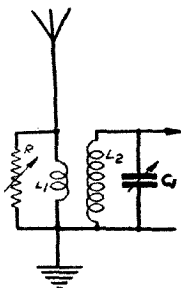

Fig. 334—Variable resistance by-passes H.F. currents

Alteration of Valve Characteristics.—Although reduction of the H.F. input will reduce signal strength, yet another method consists in altering the effectiveness of the H.F. amplifying valve, and this can be carried out by:

- (1) Alteration of filament emission;
- (2) Change of screen voltage of S.G. valve;
- (3) Alteration of control-grid bias of a variable- μ valve.

In Fig. 336 a rheostat is included in one of the leads to the filament. A reduction of emission will reduce the degree of amplifi-

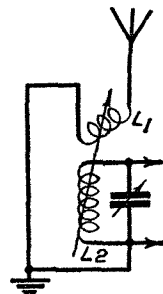

Fig. 335—Variable coupling affects volume

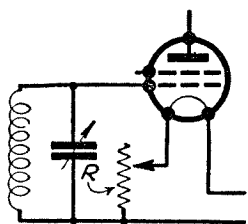

Fig. 336—Reducing filament current reduces amplification of S.G. valve

cation given by the valve. A similar result is produced by reducing the voltage on the screen, and a potentiometer screen-voltage control is shown in Fig 337 ; a condenser C of 1 mfd. is connected across screen and filament for decoupling purposes.

Owing to the use of specially coated filaments, there is a certain delay in the operation of the Fig. 336 arrangement, and a change of volume is not immediately produced by an alteration in filament current ; this is because of the time taken by the coating to increase or decrease in temperature. Another disadvantage, and one which applies to the arrangement in Fig. 337, where the screen voltage is altered, is due to the fact that the reduction of amplification is required when the input signal is too strong. If we reduce the amplification given by the S.G. valve in either manner, the valve will tend to be overloaded, and distortion and cross-modulation will probably result.

The most common method of controlling volume now in use, and perhaps the most effective, is that shown in Fig. 338, where a

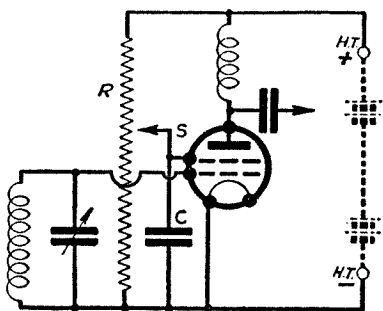

Fig. 337—Potentiometer control of screen of S.G. valve varies amplification

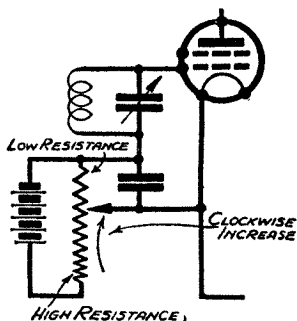

Fig. 338—Use of graded potentiometer with variable-mu S.G. valve

variable negative bias is applied to the control-grid of a variable-mu valve. The principle of operation has been described earlier in connection with this valve. The steepness of the characteristic curve representing grid volts and anode current is reduced by increasing the negative bias on the grid. The system does not alter the tuning or damping of the tuned circuit, but an increase in the negative bias reduces the damping on the tuned circuit associated with the anode of the valve, and therefore increased selectivity may be expected in that circuit. Sometimes the volume control, when at its maximum position (i.e., maximum signal strength), results in

a slight weakening of signal strength. This only applies to the last final slight movement of the control knob, and is due to the establishment of grid current by the incoming signals; this may produce noticeable damping and a reduction of signal strength. Another effect that may be experienced is that, at maximum value, instability may arise owing to the high amplification given by the valve producing high-frequency oscillation. The reduction of signal strength is more commonly to be observed in the case of mains valves where grid current commences earlier (perhaps at -1 volt), but oscillation troubles may occur on any set. A small ballast resistance of fixed value may be included in series with the potentiometer resistance (sometimes the self-bias resistance in the case of indirectly-heated-cathode valves); when the volume-control knob is at maximum (usually fully clockwise) there will then still remain a small negative bias applied to the grid of the valve.

In the case of the variable- μ valve, we want the bias to be highly negative to commence with (i.e. with control knob anti-clockwise), and then for the bias to become less negative as we turn the knob clockwise. The initial changes of resistance are great, whilst for the last half of the movement of the knob, say, we desire a less rapid change of resistance. The resistance wire may be spaced out or wound on a special former of tapered shape, so that if we start with the knob fully clockwise and then turn it slowly anti-clockwise, the resistance increase will start slowly and become progressively more rapid. The potentiometer may be called an inverse log-law potentiometer, considering that in practice we start with the control knob anti-clockwise and bring up signals by clockwise rotation.

In the case of radio-gramophone control where the pick-up voltage is adjusted, the potentiometer is of ordinary log-law type, i.e. the resistance starts small and increases more rapidly as the control knob is turned clockwise.

Combined Input and Bias Control.—Sometimes the high-

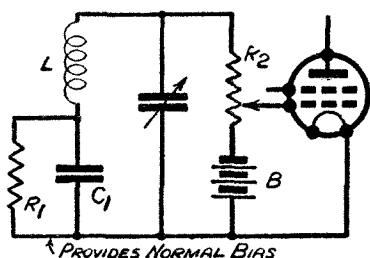

Fig. 339—Combined H.F. potentiometer and variable grid bias

frequency input to an H.F. amplifying valve is varied at the same time as the degree of amplification afforded by the valve is reduced. For example, in Fig. 339 we have a potentiometer R_2 which serves as a means of tapping off various amounts of the available H.F. voltage and also serving as a means of simultaneously varying the grid bias of the variable- μ

valve. The grid bias is provided by the battery B, a switch and decoupling system being omitted for simplicity. Moving the slider down the resistance R2 reduces the H.F. input and increases the negative bias, both effects contributing to a reduction of signal strength. A small resistance R1 and shunting condenser C1 are simply to ensure that the grid will be given a small negative bias even when the full H.F. input is obtained when the moving contact is at the top end of R2.

A somewhat similar arrangement is illustrated in Fig. 340. A self-bias resistance R is now included in the cathode lead of a mains valve, and the slider S varies not only the bias on the grid, but short-circuits to a greater or less extent the input inductance L1. A large fixed condenser could be connected across the slider and the cathode. Sometimes the input is varied simultaneously with the voltage of the screen of an S.G. valve. The objection to reducing the screen voltage alone is now removed as there is no longer the risk of overloading the valve. Ganged control (i.e., mechanically connected) can be used to produce the effect desired.

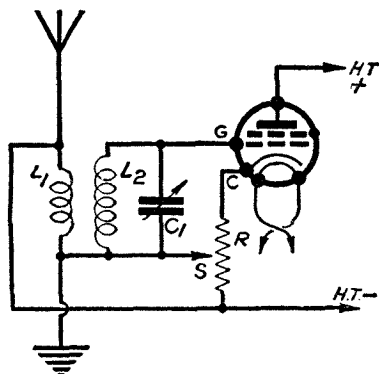

Fig. 340—Another form of combined control as applied to a mains valve

The object in simultaneously controlling the input and the amplification may be either to produce a very effective and drastic control, or else, which is more usual, to reduce the amount of background noise in the receiver. To reduce the input and to leave all the valves amplifying to the full all the small current changes due to valve "noise," extraneous interference, mains hum, etc., is obviously undesirable, and the proportion of background noise should be kept low for weak signals.

H.F. Output Control.—The third method of controlling the

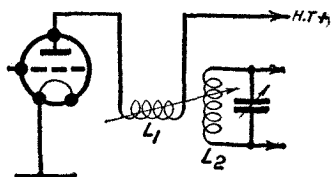

Fig. 341—By an adjustable coupling in the H.F. transformer, volume may be controlled

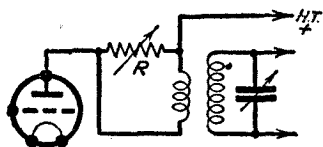

Fig. 342—A variable resistance across the primary will vary the volume

strength of the high-frequency current depends upon altering the nature of the output circuit of the H.F. valve. Fig. 341 shows how, by variably coupling the primary L_1 to the secondary L_2 of an H.F. transformer, the effect may be obtained. In Fig. 342 a variable resistance across the primary will also control the signal strength, a reduction in the value of R producing a weakening in the signals; such a resistance, however, introduces damping into the succeeding tuned circuit. The use of a differential condenser, due to the present writer, is shown in Fig. 343, where the high-frequency output of a screen-grid valve is distributed between the tuned grid circuit of the second valve and the earth. A variation between almost zero and maximum is obtainable by this method, although the particular arrangement shown alters the tuning of the circuit.

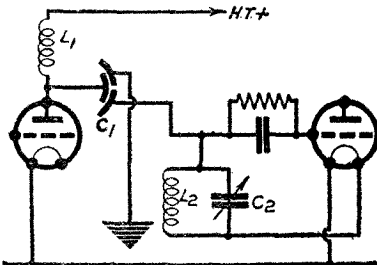

Fig. 343—Use of a differential condenser to vary the volume

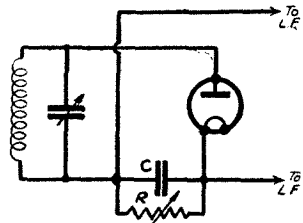

Fig. 344—Output from diode detector is adjustable by a resistance

Controlling the Detector.— Although it is not customary to obtain volume control by varying the efficiency of the detector, yet this method could be adopted if desired, and in Fig. 344 a variable output resistance is included in the circuit of a diode detector. A reduction of this resistance from a normal value of, say, 1 megohm would produce a reduction of signal strength, and when the resistance is zero there would be no output from the detector. This method really comes under the heading of varying the detector output circuit. Fig. 344a shows the output resistance R (of a triode used as a diode) provided with a slider which taps off the desired amount of L.F. Fig. 344b shows a separate potentiometer and a bias battery connected across R . In the case of valves using a control electrode it would be possible to vary the output by altering the H.T. voltage on the anode. This, however, results in alteration of the magnification provided by

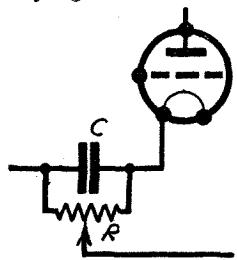

Fig. 344a—Tapping the output from a diode

the valve, rather than an alteration of its true detecting ability. It therefore comes rather under the heading of L.F. volume control, which will now be considered.

Low-Frequency Volume Control.—Where there is no fear of the earlier stages of the receiver being overloaded, volume may be controlled by altering the input to an L.F. valve or by altering the

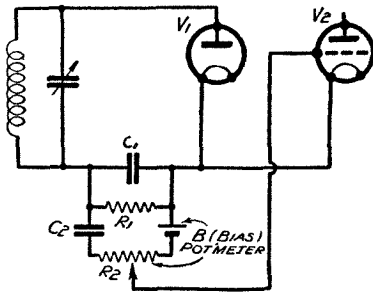

Fig. 344b—A separate potentiometer is here connected across the diode resistance

actual amplification characteristics of the valve, or by altering the output circuit of the valve.

It is not possible to draw a distinction between the output circuit of one valve and the input circuit of the next, but this will not interfere with an explanation of some practical methods of volume control.

In Fig. 345 the anode circuit of a valve, which may either be an L.F. valve or a detector, contains a resistance R which serves as a means of coupling one valve to the next. By altering the value of R the degree of coupling will be changed, a reduction of R resulting in a reduction of signal strength (assuming that the maximum value of R is sufficient to give maximum signal strength). If R were reduced to zero, for example, no signals would be passed on to the next valve. A similar circuit as applied to parallel-fed transformer coupling is illustrated in Fig. 346. Both this and the preceding circuit suffer from the disadvantage that an alteration of the coupling resistance also alters the voltage of the first anode. This would alter the conditions for rectification if the valve is a detector valve, and a particularly serious disadvantage is that if the same valve is being used for providing reaction, the volume control

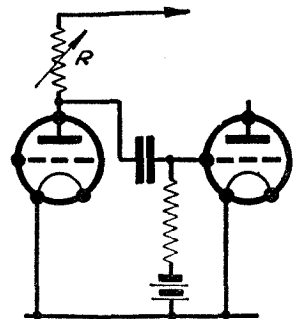

Fig. 345—The output of an L.F. valve controlled by an anode resistance

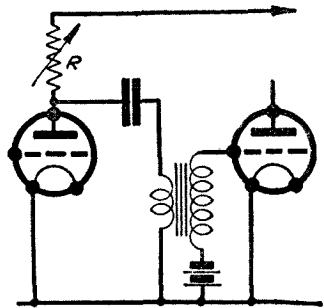

Fig. 346—The variable resistance controls the amplification of this parallel-fed system

will affect the amount of the reaction applied to the preceding tuned circuit. To overcome this difficulty, the arrangement in Fig. 347 may be used. It will be seen that there is a decoupling resistance of 50,000 ohms and an ordinary coupling resistance R ; this latter has a sliding contact which is connected to a large capacity condenser C which is connected to earth, this being equivalent to connecting it to H.T. +, as shown by the dotted line. The condenser C will thus short-circuit, as far as low-frequency currents are concerned, the top portion of the resistance R and the whole of the decoupling resistance. It thus serves not only as

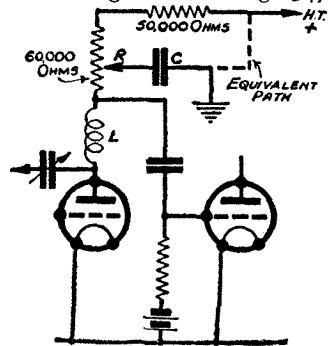

Fig. 347—Amplifier in which a condenser "shorts" part of resistance

a decoupling condenser but as a means of short-circuiting as much of the coupling resistance R as may be desired without altering the steady H.T. voltage on the anode. When the slider is at the bottom of R , no L.F. is passed on to the grid of the next valve, whereas if the slider is at the top of R , the full L.F. voltages across R are communicated to the grid of the next valve. A similar arrangement is applied in Fig. 348 to a parallel-fed transformer coupling, but no reaction choke is shown. The amount of resistance which feeds the L.F. transformer is varied by moving the slider. In both circuits the decoupling resistance may be omitted if the other resistance is large enough, but there is the danger

that the operator will slide the contact to the top end of the resistance, and so cause instability of an L.F. character.

A much simpler form of coupling consists simply in using a

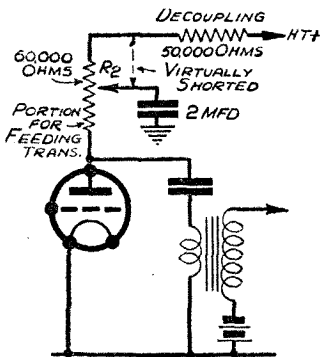

Fig. 348—Slider on R_2 controls amount of amplification

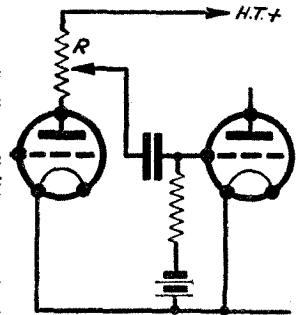

Fig. 349—Potentiometer method of controlling resistance amplifier

potentiometer resistance in the anode circuit of the first valve as shown in Fig. 349.

Since a grid resistance is used in resistance-capacity coupling, the potentiometer arrangement may be used in place of the grid resistance, as shown in Fig. 350, where a sliding contact moves along a

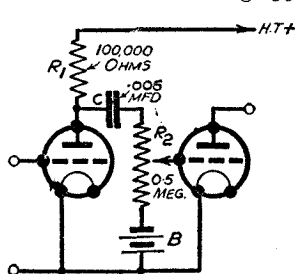

Fig. 350—Grid circuit potentiometer controls volume

resistance of 500,000 ohms.

In Fig. 351 the anode voltage of the first valve is varied by means of an adjustable resistance R , shunted by a large capacity C ; this arrangement is not one which

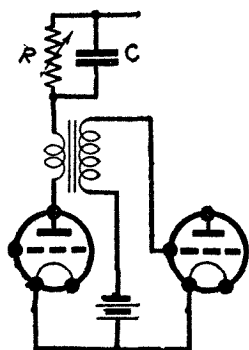

Fig. 351—Anode voltage variation may reduce volume; not a good method

can be recommended, as the characteristics of the valve are altered in such a way as to increase the risk of distortion and overloading. A method which keeps the operating conditions of the valve approximately the same, but alters the amount of L.F. passed on to the next valve, is given in Fig. 352, where the potentiometer

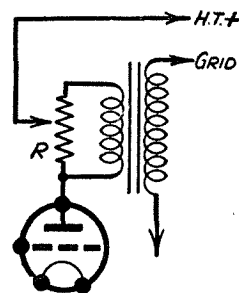

Fig. 352—A potentiometer may be connected to the primary

is connected across the primary of the step-up transformer. A certain amount of tone variation will result from the introduction of the potentiometer, the parallel resistance alone resulting in a diminution of the high

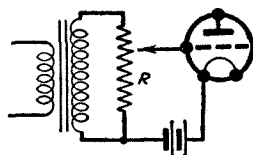

Fig. 353—Commonly used potentiometer arrangement across transformer secondary

notes. In Fig. 353 the potentiometer is this time connected across the secondary of the transformer and a very much higher value of resistance is required in this position than for Fig 352. A value of 1 megohm or $\frac{1}{2}$ megohm is indicated. The introduction of the resistance will produce some reduction in the high notes, but, of course, there may already be an accentuation of these elsewhere in the set (e.g., a succeeding pentode). The position of the slider will vary slightly the tonal result.

Pick-up Volume Control.—As regards the volume control of gramophone pick-ups, the use of a parallel resistance R , as in Fig. 354, is not advised; it will result in a substantial reduction of the high notes, and the potentiometer of Fig. 355 is greatly to be

preferred; it is the standard method of control. The value of the resistance depends upon the type of pick-up employed and the maker's recommendation should be adhered to. The resistance is usually anything from 5,000 ohms to 500,000 ohms. To obtain an even control of volume the resistance should be *graded* to give an approximate log-law effect, i.e. the resistance (from the bottom end of R) should increase slowly as the control knob is turned clockwise, and the amount of resistance corresponding to a given movement of the knob should increase rapidly.

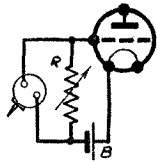

Fig. 354—Unsatisfactory method of reducing pick-up voltage

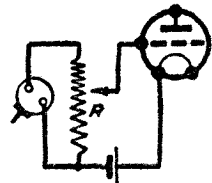

Fig. 355—Graded potentiometer for pick-up volume control

knob is turned clockwise, and the amount of resistance corresponding to a given movement of the knob should increase rapidly.

A Constant Tone Volume Control.—Practically all volume-control arrangements in which a potentiometer is associated with an inductance which is a primary or secondary of the transformer, suffer from the disadvantage that some discrimination against a portion of the musical scale occurs. The arrangement in Fig. 356 has been suggested to overcome this defect and it will be seen that the primary of the step-up L.F. transformer is tapped across the potentiometer R₂; this arrangement, of course, is for parallel-fed transformers.

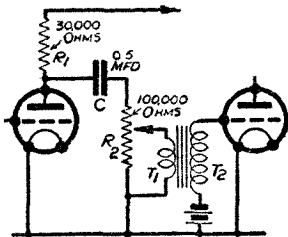

Fig. 356—A special volume control on L.F. circuit

Ordinary volume controls do not allow for the fact that as signals are weakened the low notes and, to some extent, the high notes, produce less effect on the human ear. These notes should therefore be reduced less than the middle register. Fig. 356a shows a large-capacity condenser below R₁. Moving the slider down on R₁

be reduced less than the middle register. Fig. 356a shows a large-capacity condenser below R₁. Moving the slider down on R₁

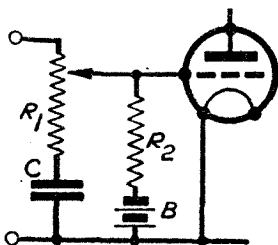

Fig. 356a—This arrangement causes less reduction of bass

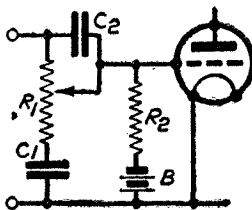

Fig. 356b—A greater proportion of treble and bass are maintained

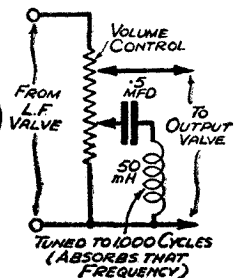

Fig. 356c—An "acceptor circuit" keeps quality good as volume is reduced

will reduce volume, but the greater reactance of C to low frequencies will preserve them to a greater extent than the higher notes.

Fig. 356b is similar, but a condenser C_2 helps to preserve some of the higher notes. The slider therefore affects the middle register chiefly. Another way of reducing the middle register more than the high and low notes is shown in Fig. 356c. A broadly tuned "acceptor" circuit consisting of a 50-mH. coil and a 0.5-mfd. condenser absorbs the middle register, thus weakening it. This effect is small when the main upper slider is at the top of the resistance. As volume is reduced and the upper slider approaches the lower one, the proportion of middle register absorbed increases, which is what we desire to keep the other part of the register loud enough to please the ear. The reader is also referred to the section on pick-ups for further methods.

Control of Diode Output.—A very common method of controlling volume consists in connecting a potentiometer across the load resistance of a diode detector by taking a tapping on the actual load resistance, as in Fig. 357. A refinement is shown in Fig. 358; a

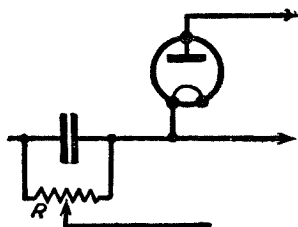

Fig. 357—Output from a diode is controlled by a potentiometer

potentiometer resistance R_2 is connected across the "leak" R_1 , a stopping condenser C_2 being connected in the position shown, while a grid-bias battery B provides the grid of the L.F. valve with a normal negative bias; maximum volume is obtained when the slider is to the left of R_2 .

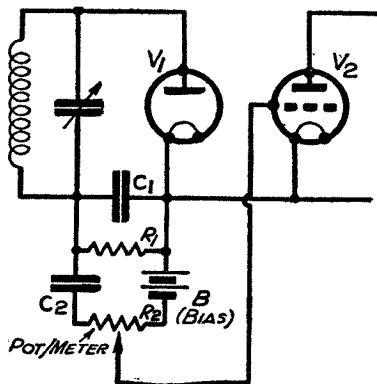

Fig. 358—The battery B provides bias for second valve; C_2 prevents B "shorting"

Variable-Mu L.F. Valve.—An interesting extension of the variable-mu-S.G. valve idea is the variable-mu low-frequency valve developed particularly for use in automatic volume-control circuits. This valve, which may be a triode or pentode, is capable of handling a wide range of input voltages, and a potentiometer is used to bias the control grid (Fig. 359). The "slope" or mutual conductance of the valve can be controlled by the alteration in grid bias, and therefore the degree of L.F. amplification may be adjusted to suit

the volume desired. Excessive input may produce distortion, but within practical limits the arrangement is satisfactory.

Controlling the Loudspeaker.—

Although a control of the current flowing to the loudspeaker comes rather under the heading of the output circuit of an L.F. valve, yet two arrangements, neither of any very great practical value, may be separately considered; that of Fig. 360 consists in shunting the loudspeaker by variable resistance, the value of which would depend upon the impedance of the loudspeaker. A reduction of resistance will reduce the

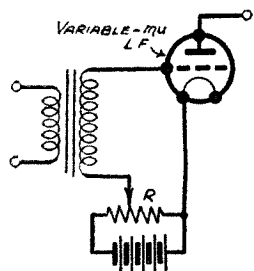

Fig. 359—A variable-mu L.F. valve is shown

signals. In Fig. 361 a resistance is inserted in series with the winding of a moving-coil speaker. An increase in this variable resistance (which may have a maximum value of 50 ohms) will reduce signal strength but tends to accentuate the high notes if the

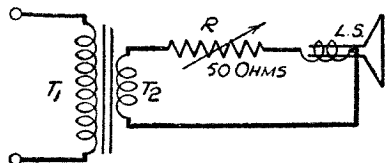

Fig. 361—Output volume is controlled by varying speaker current

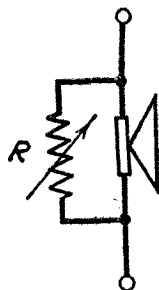

Fig. 360—An unsatisfactory volume control

resistance is made too great, i.e. on weak signals. The

previous arrangement of Fig. 360 is not very satisfactory on account of the fact that, as the higher frequencies due to the higher notes are applied to the system, the rising impedance of the speaker will cause a diversion of current to the resistance and therefore a reduction in the strength of the high notes.

CHAPTER 25

TONE CONTROL SYSTEMS

Simple Loudspeaker Arrangements.—Tone control in wireless receivers is effected by a suitable use of condensers, resistances and inductances. These may be used singly or in various combinations to produce an accentuation of part of the musical scale, or a reduction on a certain band of frequencies.

The following facts should be borne in mind :

- (1) The reactance of a condenser falls as the frequency rises and increases as the frequency falls.
- (2) A resistance behaves in the same manner towards all frequencies (this assumes that the resistance is non-inductive and has no self-capacity).
- (3) An inductance offers a higher reactance as the frequency rises and offers a readier path when the frequency is lowered.
- (4) The extent to which a condenser or inductance carries out its function may be reduced by including a resistance in series with it.
- (5) If an inductance and a condenser resonate to a given frequency they will behave towards that frequency as if they were a simple resistance, but will behave in a more normal manner to other frequencies.

Let us consider the effect of condensers, resistances and inductances in relation to a loudspeaker possessing inductance. If a resistance is connected across the speaker (Fig. 362) the high notes will be decreased. As a resistance behaves in the same way to all frequencies the effect may require explanation. The resistance across the speaker will certainly reduce the low notes as well, but not to the same extent, because we can regard the resistance and the speaker as providing two alternative paths for the current. As the current applied to the speaker rises in frequency so will

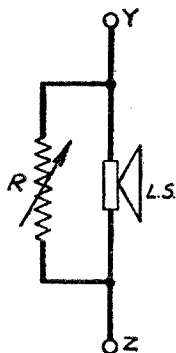

Fig. 362—Variable resistance cuts down "top"

the speaker offer a greater reactance to them and a greater proportion will prefer the easier path, namely, the resistance, which continues to offer only the original amount of opposition. The low notes on the other hand will continue to find it easier to go through the speaker than through the resistance. The result is a reduction of "top" (i.e. the higher notes).

If we connect a condenser across the loudspeaker, as shown in Fig. 363, the lower the frequency applied to the system, the less will

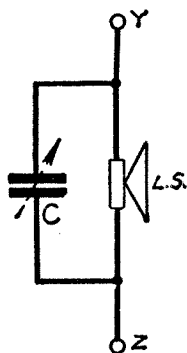

Fig. 363—Condenser across speaker reduces "top"

be the reactance offered by the speaker and the greater will be the reactance offered by the condenser. Most of the low notes will therefore go through the speaker, but, of course, not more than if the condenser were not there; nevertheless, to the low notes the condenser makes little difference, unless of very large capacity. To the high notes, however, the condenser offers a path which becomes easier as the frequency rises. In other words, while the speaker reactance is increasing that of the condenser is decreasing, and therefore the effect of the condenser is to reduce the top notes, and the greater the capacity of the condenser the greater will be the reduction of the high notes.

If, however, we inserted the condenser in series with the speaker—in which case its capacity will have to be large—we get an opposite effect; the insertion of the condenser will affect the low notes more than the high notes. The latter will find it easier to pass through the condenser, but the low notes will find the reactance of the

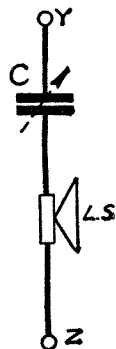

Fig. 364—Series condenser reduces bass

condenser too high for them. This, then, is a method of reducing the bass. The arrangement of Fig. 364 is only possible when the system is fed from an L.F. choke or transformer or resistance, e.g. in parallel-fed systems where no direct current has to pass through the speaker.

An inductance in series with the loudspeaker (Fig. 365) will offer a high reactance to the high notes and allow an easy passage to the low notes. But whereas in Fig. 364, a series condenser if increased in value will increase the low notes more than it will the high, a series inductance if increased in value will reduce the high notes to a greater extent than the low notes. A low-value

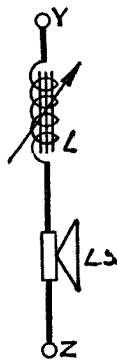

Fig. 365—Series inductance reduces "top"

inductance across the speaker (Fig. 366) will reduce the low notes more than the high since it offers an easier path to the lower frequencies, which are thus reduced in the speaker.

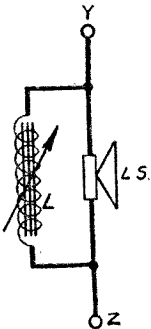

Fig. 366—Parallel inductance reduces bass

Resistance-Capacity Tone Control.—A very common method of altering the tonal response of a circuit is to connect a condenser with a resistance in series with it, across the loudspeaker or other apparatus. Fig. 367 shows the arrangement, the condenser usually being fixed and the resistance variable; the reason for this arrangement is that the variable resistance is cheap, while it is virtually impossible to produce a variable condenser of large capacity.

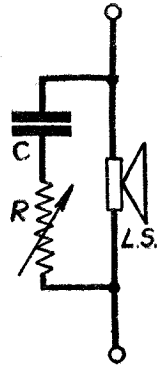

Fig. 367—Common form of tone control

In Fig. 367 the effect of reducing the resistance R is to cut off "top." If R were zero the condenser C would be across the loudspeaker. If the resistance R were infinite, there would be no capacity across the loudspeaker, and therefore there would be no effect on "top." Another way of looking at the subject is to consider why a resistance alone would not do. The reason is that, although a resistance across a loudspeaker will reduce the high notes, yet it will also to an extent reduce the low notes. In the combined arrangement a ready passage is still allowed for the high notes, but the low notes find it difficult to get through C .

A parallel inductance will tend to reduce the bass and accentuate the high notes in comparison.

Variable inductances, specially of the values required for tone control (around 3 henries), are not a practicable proposition and a variable resistance in series with the inductance is customary. A reduction of the resistance R in Fig. 368 results in a greater reduction of low notes than high notes.

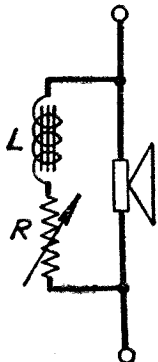

Fig. 368—For reducing bass

If a series condenser is used, the degree of its effectiveness can be controlled by the resistance in parallel with it as shown in Fig. 369. For high values of R the low notes will be greatly reduced, whilst for low values of R they will hardly be affected.



Fig. 369—Also controls bass

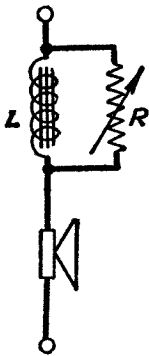

Fig. 370—Increasing R reduces treble

If an inductance is connected in series with the speaker and a variable resistance connected in parallel with the inductance as illustrated in Fig. 370, a high value of resistance will result in a reduction of the top notes, while a low resistance will make little difference to them since they will pass through the resistance R rather than through the inductance L .

Combined Tone-control Systems.—It is frequently convenient to combine devices for reducing either the high notes or the low notes. It should be noted that most control systems operate by virtue of the fact that a reduction in signal strength, either on the high notes or on the low notes, occurs. In Fig. 371 a series inductance and a series condenser are employed; each of these behaves in

an exactly opposite manner towards a rise in frequency, the inductance offering greater and the condenser less reactance. By connecting the junction point between them to a slider on a resistance R , it is possible to vary either the high notes or the low notes, and speech or music may be made shrill (excessive treble) or woofy (lack of top or excess of bass). When the slider is at the top of R , the low notes are reduced because they have to go through the condenser C , which offers considerable opposition. When the slider is at the bottom of R , the high notes are reduced because they now have to go through the inductance L instead of going chiefly through a small value of resistance

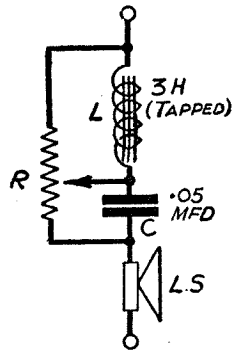

Fig. 371 — Combined tone-control system

(or none at all when the slider is at the top of R).

An arrangement using condensers and resistances only is illustrated in Fig. 372, where a parallel condenser is used for cutting out "top" and a series condenser for reducing bass. If, for example, we reduce the value of the resistance R_1 , the condenser C_1 will be more effective across the loudspeaker and the top notes will be reduced. If, however, we reduce the value of R_2 , the low notes will be strengthened to a greater extent than the high notes.

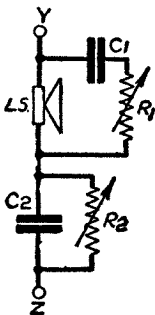

Fig. 372—Bass or treble may be reduced

If the resistance R_2 is increased, the low notes will be kept down (because they have to go through

C_2), while if R_1 is increased the high notes will be increased (because they are not short-circuited as much by C_1). By mechanically ganging the two resistances, the two effects may be made to work together, and Fig. 373 shows an arrangement which has been suggested. A single knob controls two rheostats, the sliding contacts on which are electrically connected. When the slider on R_1 is at the top end, the speaker is shunted by C_1 and the high notes are cut down; simultaneously, the resistance R_2 is cut out of circuit so that the condenser C_2 is short-circuited and the low notes are increased; we therefore get a reduction in "top" and an increase of bass, producing a woofy effect. If we turn the knob so that the slider is at the bottom of R_1 , the top notes are restored; simultaneously, the other slider is at the top of R_2 and the low notes have to struggle through the condenser C_2 , which cuts down their strength. The combined effect is shrill. In an intermediate position of the control knob good average quality is obtainable.

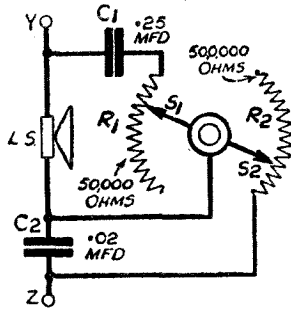

Fig. 373 — Double rheostat affects bass and treble simultaneously

Another circuit of interest is Fig. 374. When the slider is at the left-hand end of R , the low notes are reduced, while if at the other end the condenser C reduces the high notes.

Tone-control of L.F. Transformers.—The principles so far explained may be applied to other parts of a receiving circuit, and it is common practice to apply any tone control at an early stage in the receiver. The object of tone control is not merely to enable the listener to adjust the quality of reproduction to suit his own taste or mood, or the nature of the broadcast transmission, but is often a necessity

owing to the type of receiver employed. The term tone correction is more accurate than tone control in such cases, and the correction is frequently a matter for adjustment when the receiver is first tested; it is not ordinarily altered afterwards. It is, however, always possible to change tone correction into tone control by providing a variable knob on the panel or cabinet of the receiver.

Tone-correction may take the form of increasing the top notes or decreasing the bass; or it may consist in reducing the high-

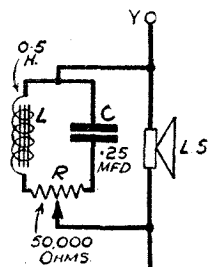

Fig. 374 — Another combined tone-control arrangement

note response on the receiver. Pentodes, for example, and Class B valves tend to accentuate the high notes, and it therefore becomes necessary to reduce the value of these. Heterodyne whistles produce interference of a high-note character, and these may be reduced by suitable tone correction. On the other hand, it is possible that the high-frequency circuits in the set have been made so selective that there is a deficiency of the top notes, and these require to be restored by a special transformer or by a special L.F. inductance coupling between valves, which will amplify the high notes to a greater extent than the lower notes. Sometimes a loudspeaker will resonate and produce a distressing boom effect, either due to the cabinet in which it is housed, or to the construction of the speaker itself. But sometimes inferior components go well together, because one of them may accentuate the high notes and the other respond poorly to them. A curious result then is that a receiver may be built more cheaply to give a result which is as good as that obtainable with the most expensive components. This must not, of course, be taken as an encouragement to buy inferior components indiscriminately.

A condenser is the commonest component in any controlled circuit, and if connected across a resistance or inductance, it will

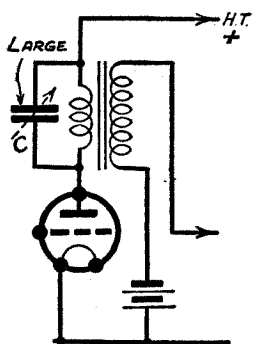

Fig. 375—Reducing "top" by condenser across primary

by-pass the high notes to a greater extent than the low. It is shown in Fig. 375 connected across the primary of the step-up transformer. Its value in this position will have to be much higher than if connected across the secondary, where a value of .0003 mfd. will usually give a very wide range of

response. A preset condenser is suitable for this purpose, as shown in Fig. 376.

In order to obtain the most suitable degree of top-note reduction, a resistance, possibly variable, may be inserted in series with the condenser used for the purpose of cutting off top. The arrangement is shown in Fig. 377 applied to the primary of the transformer. A variable resistance alone is sometimes connected in the manner shown in Fig. 378 and reduces top notes, since it tends to offer an

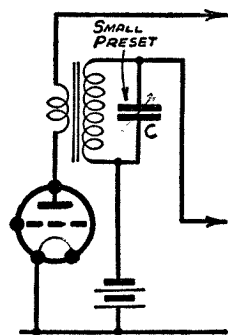

Fig. 376—Reducing treble by condenser across secondary

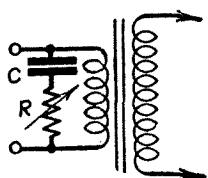

Fig. 377—Resistance and condenser across primary

easier shunt path as the frequency of the current rises. The disadvantage, as already explained, is that it also reduces the low notes to some extent. The advantage of a resistance, however, in some cases is that no awkward resonance effect is

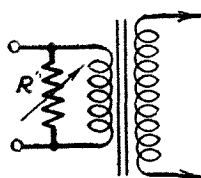

Fig. 378—Plain variable resistance across primary

obtained due to the transformer winding forming a tuned circuit in conjunction with the condenser; such a tuned circuit may produce a sudden increased current when the particular frequency to which it is tuned happens to be applied to it; this effect may be made use of as explained later, but frequently it is highly undesirable; a resistance in series with the condenser, of course, tends to flatten out the effect of resonance apart from other advantages.

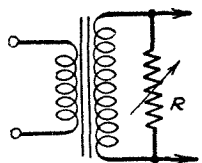

Fig. 379—Variable resistance across secondary

A high resistance may also be connected across the secondary of the transformer as shown in Fig. 379, this also reducing the top notes. The use of a variable condenser alone has already been described in connection with Fig. 376, whereas Fig. 380

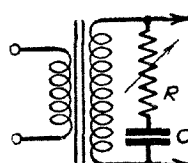

Fig. 380—Resistance varies "top" reduction

shows a condenser and variable resistance connected across the secondary of the step-up transformer.

Application to Resistance-Coupling.—Tone control may be applied to resistance-capacity L.F. coupling, and Fig. 381

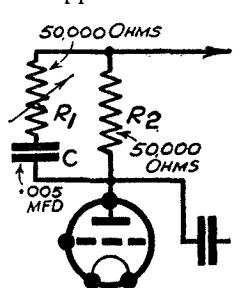

Fig. 381—Tone-controlling a resistance amplifier

shows the use of a variable resistance and fixed condenser connected across the coupling resistance. This arrangement will reduce top note response, while Fig. 382 illustrates the use of an iron-core inductance, and this arrangement will cut off bass to a greater

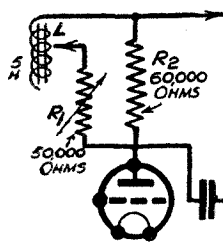

Fig. 382—Reducing the bass in a resistance amplifier

extent than the higher register. The reader is reminded again that many systems of tone control consist in reducing the

amplification of both high and low notes and then discriminating between the two, i.e. a reduction being made greater for one class than the other. Thus the cutting off of top will give the impression of boominess, although the low notes may be no different in strength, or even a little weaker. Similarly, a reduction of the bass will give a shrill effect. Since wireless receivers are very frequently operated below their full output capabilities, any overall reduction in volume by the application of tone correction or control can be reinstated by turning up the volume control.

Tone Correction on Pentodes.—The usual arrangement for tone correcting a pentode is shown in Fig. 383. It serves the purpose of moderating the exaggerated high notes and restoring them to their proper and original proportions. The resistance is an ordinary variable one, and the slider is preferably connected to one end of the resistance, this connection having the advantage that if the slider makes a bad contact at any point on the resistance there is still some resistance in circuit; this makes the arrangement quieter and is of special value in the case of pentode operation where very high voltages are readily produced unless a tone-corrector circuit is employed, and where an accidental open-circuit of the resistance is undesirable.

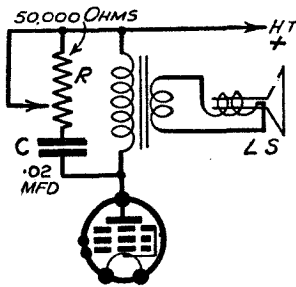

Fig. 383—Tone corrector applied to a pentode

Reduction of Bass.—Bass-note response can be reduced in some circuits in a very simple way. For example, in the case of resistance-capacity coupling, the bass can be kept down by reducing the value of the coupling capacitor C (Fig. 384). This may normally have a value of .006 mfd. and the reduction to .002 mfd. will quite considerably reduce any boominess without materially affecting the treble portion of the register. The theoretical action of this condenser may

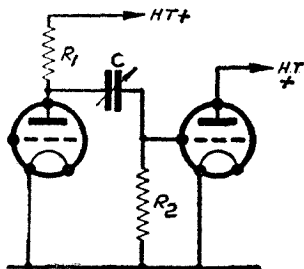

Fig. 384—The coupling condenser C controls the amount of bass

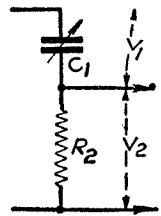

Fig. 385—L.F. potentials developed across C_1 and R_2

be better appreciated by considering Fig. 385. The condenser C_1 and grid resistance R_2 constitute a potentiometer arrangement, the middle point being connected to the grid of the second valve.

The total voltage available remains constant and is supplied by the anode resistance R_1 of Fig. 384. The total voltage will be divided across the condenser C_1 and the resistance R_2 . The voltage V_1 across C_1 will depend upon the reactance of the condenser C_1 and therefore will rise on the low notes. The resistance R_2 remains impartial to all frequencies. If we reduce the value of the condenser C_1 , its reactance to low notes will greatly increase and the voltage V_1 will rise; consequently the voltage across V_2 will drop, since the total voltage available is unaltered. (Or looking at it another way, the reduction of C_1 will reduce the current flowing through R_2 and therefore the voltage across R_2 .) As far as the low notes are concerned, a reduction of C_1 is equivalent to the grid taking a lower tapping on a potential divider and therefore the voltage applied to the grid of the second valve is reduced. The reduction of capacity has much less effect on the high notes.

Use of Reverse Reaction.—An interesting arrangement for the reduction of excessive high notes in a pentode is illustrated in

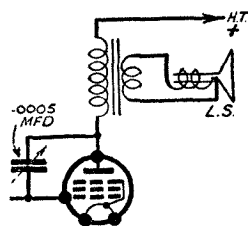

Fig. 386—Use of reverse reaction to reduce "top"

Fig. 386, where a preset condenser of, say, .0005 mfd. is connected across the anode and control-grid. Part of the L.F. voltages developed across the primary of the transformer in the anode circuit of the valve is communicated to the grid in such a way as to oppose the voltages already existing there. This reverse reaction effect (which tends to take place naturally in an ordinary triode valve and is then known as Miller effect) will be much greater for the higher

notes than the lower notes because of the reduced reactance of the condenser to the upper register.

Use of Resonance Effect.—In a parallel-fed L.F. transformer the low notes may be reduced by using a smaller value of coupling condenser. For example, in Fig. 387 the value of the condenser C will govern to quite a considerable extent the amount of bass. The condenser is shown variable, but in this, as in other cases, it must be assumed that where the condenser is of large capacity, other sizes of fixed condenser are substituted.

A very interesting effect occurs when the condenser C and the primary T_1 of the L.F. transformer are made to resonate to a given frequency. Under these circumstances, the current flow is greatly increased and the

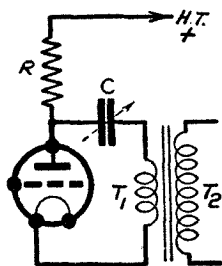

Fig. 387—Feed condenser controls bass response

output voltage from T2 is correspondingly higher. This will only occur round about the resonance frequency, although the effect is not confined solely to the exact frequency but also to neighbouring frequencies. Resonance may be employed to accentuate bass

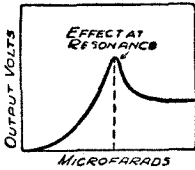

Fig. 388—Resonance increases the bass response

response where this is lacking, and the curve of Fig. 388 shows how an increased response is obtainable if the condenser is suitably chosen to tune the transformer primary to the frequency it is desired to exaggerate, or rather build up to its desired full value.

Pick-up Filters.—Although resonance may be used to boost such frequencies, yet a tuned L F circuit, by being connected in a suitable way, may be used to short-circuit a particular note or a range of neighbouring notes without affecting the general quality of reproduction. For example, a heterodyne whistle may have a frequency of 9,000 cycles per second and a condenser and inductance in series may be joined across certain parts of the receiving circuit with the object of suppressing the whistle by short-circuiting it. A similar arrangement may be used for cutting out the scratch due to the needle rubbing on a gramophone record. A suitable arrangement which has been suggested is that of Fig. 389, where the circuit L C is tuned approximately to the scratch frequency. The resistance R_2 governs the degree to which the tuned circuit operates, while an ordinary

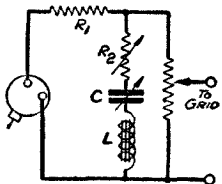

Fig. 389—Scratch filter for pick-up

potentiometer is provided to control the voltages fed to the grid of the amplifying valve.

A much simpler, but less effective arrangement for reducing the high-note response of a pick-up is illustrated in Fig. 390, where a variable resistance R_1 is connected across the pick-up. The other resistance R_2 is the usual potentiometer arrangement.

Tone-Correcting for Ultra-selectivity.—In circuits where the selectivity is very high, the sidebands will be attenuated, and this reduction in strength applies to sidebands corresponding to the higher notes of the transmission. The result is distortion. We can, however, while retaining all the benefits of the selectivity, put the high notes back, either by reducing the low notes and greatly amplifying all the signals, or—still better—by adding an

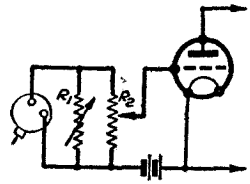

Fig. 390—Another method of reducing scratch

amplifying system which amplifies the high notes to a greater extent than the low notes, and Fig. 391 shows how, by connecting an inductance L in series with a variable resistance R , we can adjust matters so that just the right degree of high-note accentua-

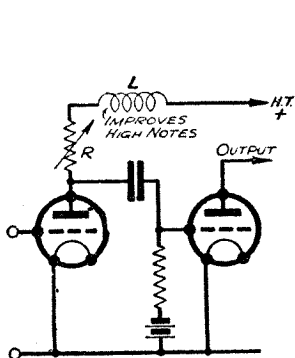

Fig. 391—The inductance produces accentuation of high notes lost by selectivity

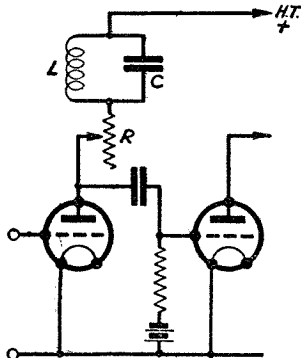

Fig. 392—Use of tuned circuit to give greater amplification of high notes

tion can be provided to compensate for the cutting of the sidebands. A further development of the circuit consists in tuning the inductance L as shown in Fig. 392, a variable resistance R modifying the action of the tuned circuit $L C$.

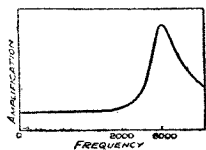

Fig. 393—Resonance effects compensate for reduced "top"

As shown in the curve of Fig. 393, the resonance effect occurs at a certain frequency (about 6,000 in the example given), and up to that value the degree of amplification is rising, whereas after 6,000 the amplification falls off again. This effect is useful because you frequently do not desire frequencies higher than 6,000, owing to

heterodyne whistle and high-note interference. Several tone-corrector L.F. transformers have been placed on the market to give a rising characteristic with a *cut-off* beyond the useful frequency.

An alternative to the Fig. 391 arrangement is that shown in Fig. 394, where the tone-correcting components are included between grid and filament of the second valve.

Tuned Filters to Provide Cut-off.—Filter circuits to provide a cut-off at a given frequency are particularly useful in wireless reception, where it is desired to obtain a straight-line response up to a given frequency, and then a sharp reduction in signal strength after

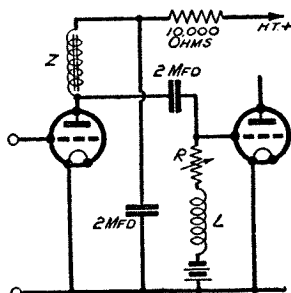

Fig. 394—Tone-corrector circuits as applied to grid circuit

the useful frequency has been reached. In many other cases, it is desirable to provide a rising characteristic (to compensate for high-note loss in selective circuits) and then a cut-off

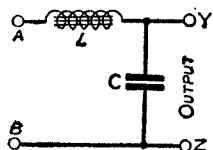

Fig. 395—To explain the cut-off filter

The simplest filter arrangement is that shown in Fig. 395, where an iron-core inductance L and the condenser C are connected in the manner shown. This filter will greatly modify any alternating-current voltages applied to it. If a condenser is simply connected across the output circuit of the valve, the voltage across it will drop steadily as the frequency applied rises. This is shown by the sloping dotted line in Fig. 396. The insertion of the inductance, however, has the effect of retarding the voltage drop, because as the frequency rises the inductance L and condenser C will pass a greater current, since the frequency of the current is approaching the resonance frequency of the two components. When there is actual resonance, i.e., when the input current has the same frequency as that to which the circuit is tuned, there will be a big rise in the current flowing through C , and therefore the voltage across $Y Z$ will tend to rise. The effect is clearly shown in the curve of Fig. 396, where the natural tendency for the voltage to drop is counteracted by the approach to resonance which produces a build-up effect. The curve is, therefore, fairly level until resonance is reached; but if the frequency is increased still further, the voltage increase due to the resonance effect begins to wear off and the actual result of the condenser's position asserts itself, and therefore there is a substantial drop in output volts. This cut-off effect is very useful for cutting out certain classes of interference, including heterodyne whistles, as has been explained. One merit of a frequency cut-off as against an acceptor circuit (a series-tuned L.F. circuit for short-circuiting a particular note) is that there is no necessity for tuning to a particular heterodyne whistle. An acceptor circuit will only cut down one whistle.

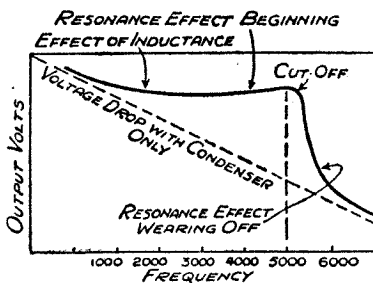

Fig. 396—A cut-off effect is obtained by using resonance phenomena

Multiple Filters.—The simple filter we have just considered is required to be made symmetrical (as in Fig. 397 or Fig. 398) in order to avoid what is known as reflection of the currents when they reach the output apparatus. It is also necessary to ensure

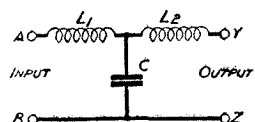

Fig. 397—A symmetrical low-frequency filter

that the input and output apparatus is correctly matched to the filter, but the theory of this subject is outside the scope of the present volume.

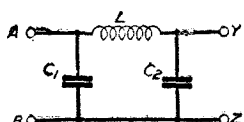

Fig. 398—An alternative symmetrical L.F. filter

Several filters may be connected in series so as to give an even sharper cut-off effect. Fig. 399 shows the arrangement of two filters of the Fig. 397 type. It will be seen that between the con-

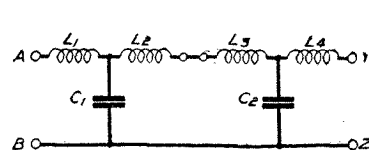

Fig. 399—A sharper cut-off is obtained by using two filters

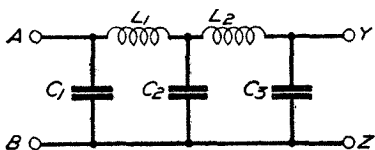

Fig. 400—An alternative series arrangement of L.F. filters

densers are two inductances L_2 and L_3 , which may be replaced by a single inductance of twice the value of each. The arrangement of Fig. 398 may also be duplicated as shown in Fig. 400.

Heterodyne Whistle Eliminator.—A tuned acceptor circuit may be used for the suppression of heterodyne whistles, as already indicated. This circuit simply consists of a condenser and inductance in series, the whole circuit being connected across the apparatus in which the undesired frequency occurs. Since a series resonant circuit may be treated as a plain resistance, the acceptor circuit acts as virtual short-circuit for that particular frequency, but not for any other frequency. In order to obtain the most selective results for a particular frequency, the condenser should be of a low-loss type and the inductance should have a low resistance. A mica preset and a low-loss inductance will be found suitable, and in Fig. 401 representative values are given, the acceptor

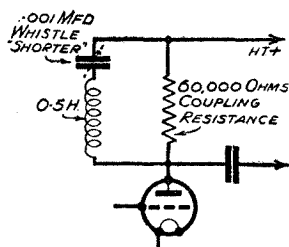

Fig. 401—A tuned acceptor circuit reduces a heterodyne whistle

circuit being connected across the coupling resistance of a resistance-capacity arrangement. The acceptor circuit is sometimes connected across the loudspeaker. Heterodyne whistles are apt to have different frequencies; the filter requires tuning to the particular frequency it is desired to cut out. It is more satisfactory to use a cut-off filter which will cut out all heterodyne whistles above a given frequency, say

4,000 or 5,000 cycles per second.

CHAPTER 26

PICK-UP CIRCUITS FOR GRAMOPHONES

Pick-ups work on various principles, but their object is to provide low-frequency voltage variations which are then applied to one or more L.F. amplifying valves. Sometimes, the first amplifying valve is also the output valve, but usually there will be a stage of L.F. amplification between the pick-up and the output valve. In fact, in the case of a very insensitive pick-up, two stages may precede the output valve.

Electric gramophones working with valve amplifiers are usually associated with a radio receiver, since the low-frequency apparatus and speaker can be used for both purposes. The amplifying system for radio is not necessarily equally effective for gramophone work. For example, there may be a certain amount of tone-correction required on radio owing to loss of strength on sidebands corresponding to the higher notes, due to ultra-selectivity. Such tone-correction may give good results on broadcasting, but it is unnecessary and undesirable in gramophone work. On the other hand, there may be some advantage in providing means for obviating needle scratch, which is a phenomenon of a relatively high audio frequency; low notes are also usually inadequate on many radio-gramophones when playing records, owing to the difficulty of recording this part of the register on the records.

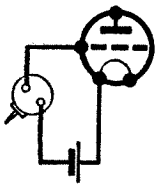

Fig. 402 — Simplest pick-up circuit

These various factors must be borne in mind when designing a circuit for use with a pick-up. The simplest pick-up circuit is that shown in Fig. 402, where a grid-bias battery is connected in the grid circuit containing the pick-up. It is, however, essential to provide volume control, not merely because one desires to adjust the volume and sound, but because it is unlikely that a given pick-up will provide just the right volume with your amplifier system. One can connect a variable resistance across the pick-up, but this is unsatisfactory and will result in distortion. A more satisfactory arrangement is to

connect a potentiometer resistance of, say, 50,000 ohms across the pick-up and to connect the slider to the grid of the amplifying valve (Fig. 403). The actual value of the resistance depends upon the type of pick-up, and the manufacturers' recommendation should be adhered to. Fig. 403 is sometimes modified as shown in Fig. 404; while Fig. 405 keeps one side of the

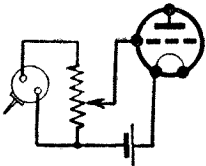

Fig. 403—Pick-up with volume control and bias

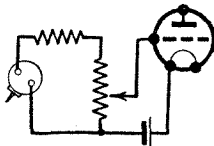

Fig. 404—Use of resistance in series with potentiometer

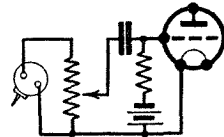

Fig. 405—This enables one side of pick-up to be earthed

pick-up at earth potential, a grid resistance providing the negative bias for the grid of the valve. The condenser is of large capacity (not less than, say, .01 mfd.) and prevents the grid-bias battery from being shorted.

Graded Potentiometers.—To obtain effective volume control, we must arrange matters so that when the volume-control knob is rotated clockwise there is a gradual and evenly distributed increase in volume. We do not, for example, want practically the whole of the control to occur at either extreme position of the control knob. To avoid this, the *graded* potentiometer is used and the resistance should be low at first, and the rate of increase of resistance should be progressive as the knob is turned clockwise. The graded potentiometer is illustrated in Fig. 406, and it is usually made by winding the resistance wire on a tapered former or by using variable spacing between the turns. For gramophone work the initial resistance should be low.

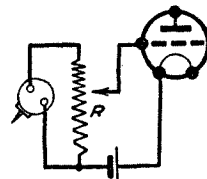

Fig. 406—Logarithmic low-graded potentiometer in use

Tone Control With Pick-ups.—The reduction in the sensitivity of the human ear towards low notes and high notes calls for a special form of volume control which takes into account the falling-off in low notes and to a lesser extent the high notes when volume is reduced.

If, for example, we cut down the volume from an electrical point of view to one-quarter of the original value, the resultant reproduction will not sound satisfactory to the human ear because the low notes will appear to have been attenuated (i.e. reduced) to a

greater extent than the middle register. There will also be some loss, or rather apparent loss, in the high notes, although this is not so marked.

The reader is specially referred to the chapter on tone control. The object of the fixed condensers in the following circuit is to provide adequate low- and high-note response, while the signal strength in the middle register is being reduced. In Fig. 407 a reduction in resistance R_1 will increase signal strength, while increasing the value of R_1 will leave less voltage across the resistance R_2 and condenser C , which, together with R_1 , form a potentiometer. It is not possible with this arrangement to get absolute silence, but this is not really required on a gramophone. The voltage across C in the case of the higher notes will be comparatively small, but the low notes will tend to be accentuated.

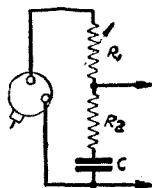

Fig. 407—Volume control for maintaining low notes

To provide for an increase in high-note response when signals are reduced, another condenser may be connected between the

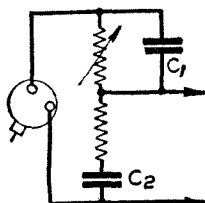

Fig. 408—Condenser C_1 prevents excessive reduction of "top"

side of the pick-up and the grid as shown in Fig. 408. When the upper resistance is increased in value the middle register will be decreased in volume; but the high notes will be communicated direct to the grid through the condenser C_1 , while the condenser

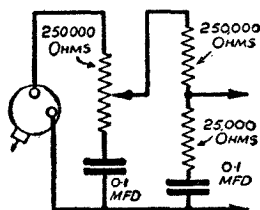

Fig. 409—Another volume control for keeping tone balance

C_2 keeps the low notes at a reasonable level. A rather more elaborate circuit is shown in Fig. 409.

Radiogram Switching.—There are various ways in which a pick-up may be associated with apparatus normally used for radio reception. The switching is usually of a very simple character, and its nature depends upon whether the valve to which the pick-up is connected normally operates as a detector, or as an L.F. amplifier. In nearly all cases it will be used as a detector either on the anode-bend principle or as a leaky-grid condenser rectifier. If the valve is a diode the pick-up would never be associated with it; with an L.F. amplifier the switching arrangement will probably be even simpler than in the case of a detector valve, since the valve is already acting as an L.F. amplifier.



DR. LEE DE FOREST—INVENTOR OF THE TRIODE

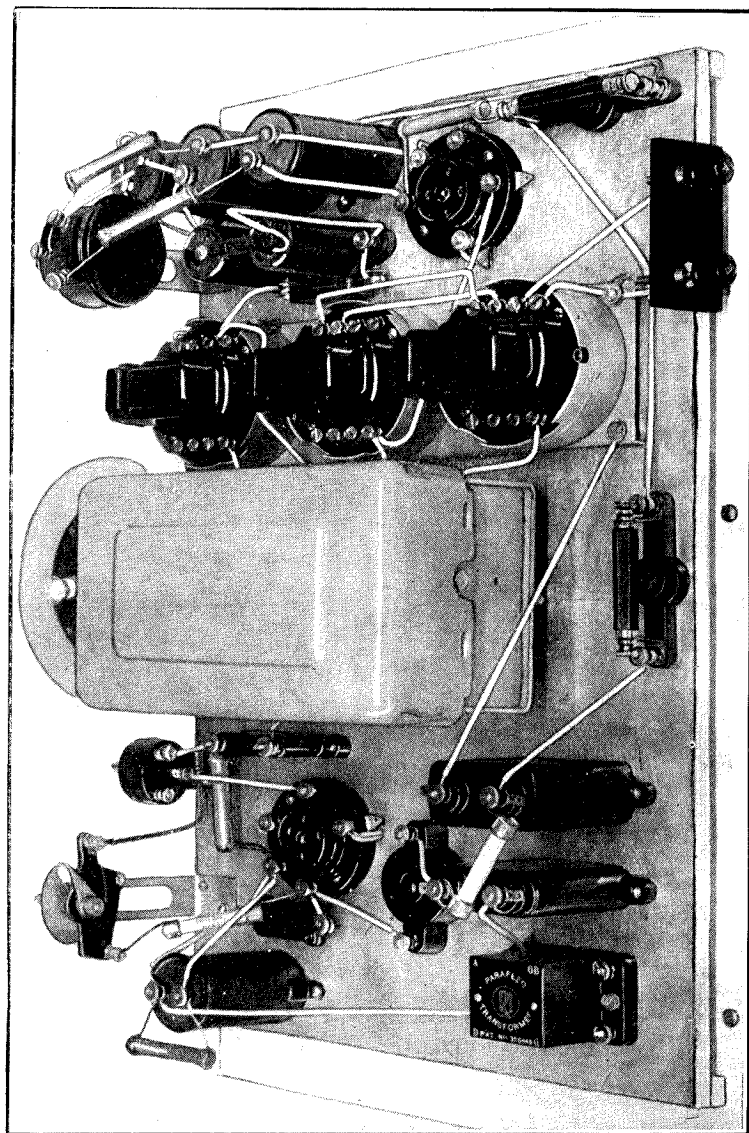

RECEIVER PORTION OF A SINGLE-CONTROL MODERN RECEIVER

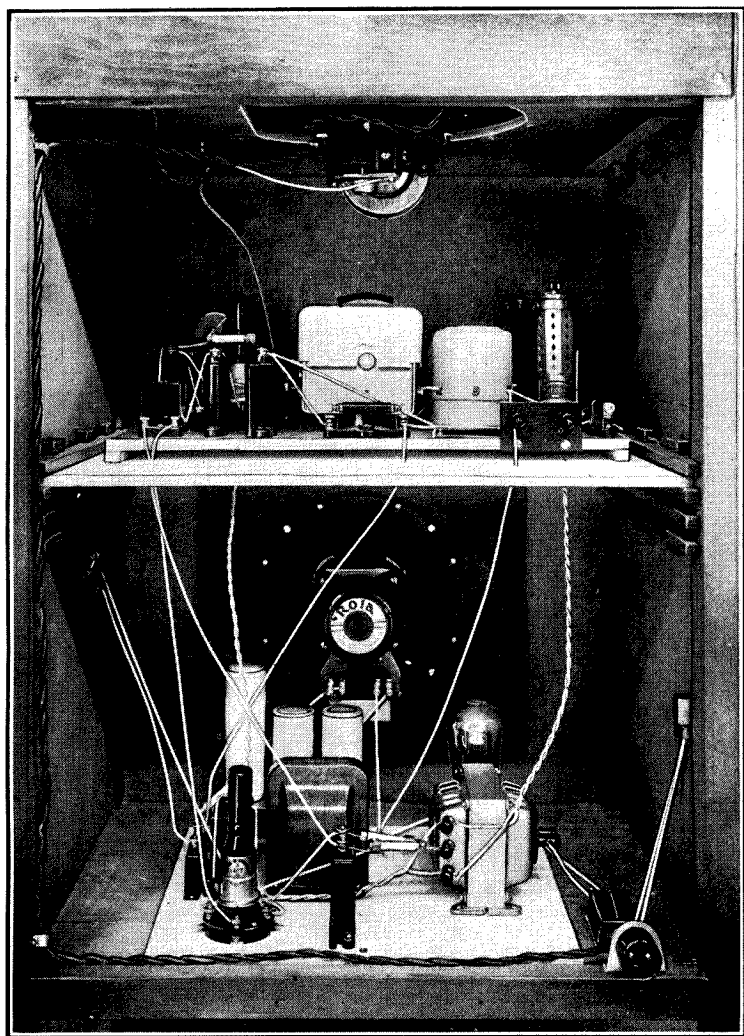

THE COMPLETE A.C. MAINS RECEIVER ARRANGED AS A
RADIO-GRAMOPHONE

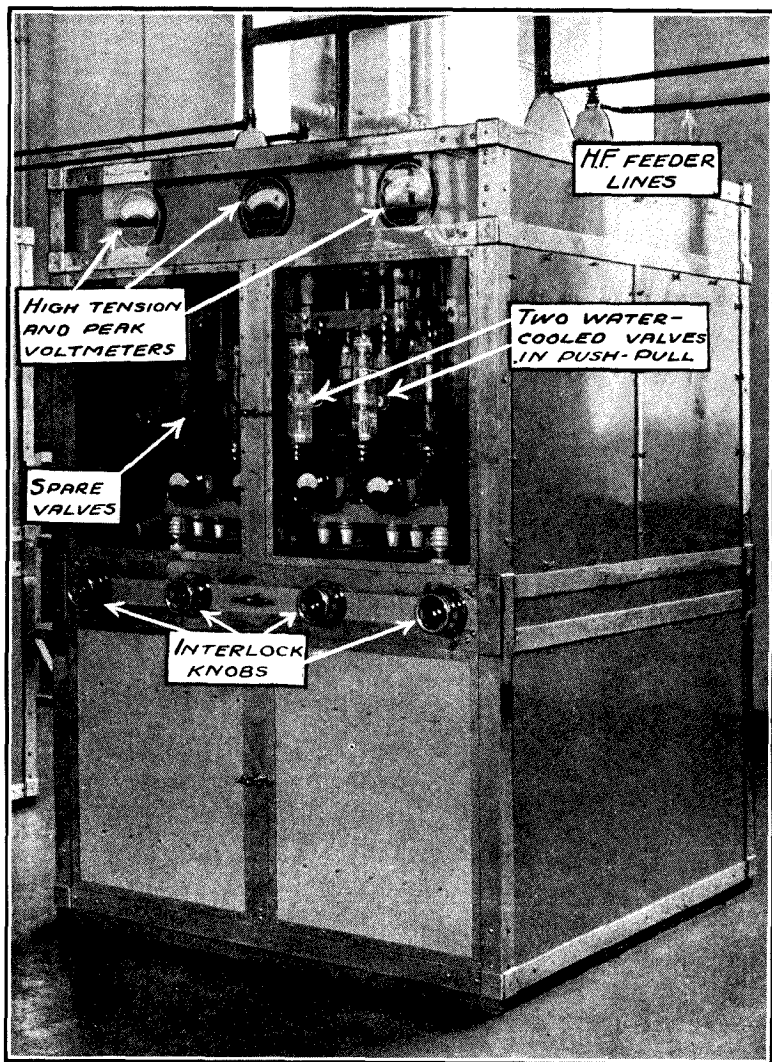

VIEW OF TRANSMITTING APPARATUS

In Fig. 410 the pick-up is connected in series with the tuned grid circuit. It is assumed that anode-bend detection is in use. The arrangement has several disadvantages, one being that the tuning condenser is not at actual earth potential as regards either

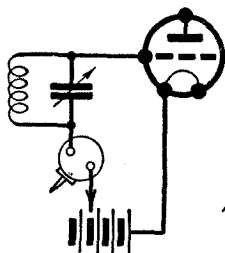

Fig. 410—Pick-up fitted to anode-bend detector

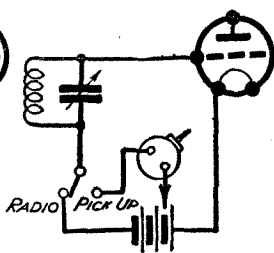

Fig. 411—A much better arrangement with separate bias

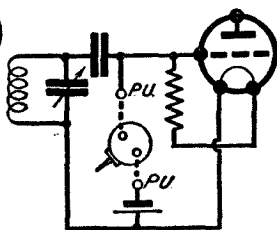

Fig. 412—Suitable for occasional use of pick-up

of its plates. It is also undesirable from the radio point of view to introduce an impedance in the grid circuit; if we shunt the pick-up by a condenser this will probably affect the tone. Moreover, the operator would have to adjust the grid bias to a different value when the pick-up was to be used. In Fig. 411 a switch enables the operator to use different voltages for detection and gramophone reproduction, and incidentally to cut out the pick-up from the circuit when receiving radio.

Probably the commonest circuit for pick-up work is that shown in Fig. 412, where the pick-up is connected to two terminals of the receiver, and the e.m.fs. from the pick-up are applied across grid and filament. The grid condenser is not of a sufficiently high capacity to affect the tonal quality of gramophone reproduction. Since it is not convenient to connect a pick-up every time the gramophone is to be used, a plug and jack system is sometimes used, but an on-off switch, as shown in Fig. 413, is simple but effective.

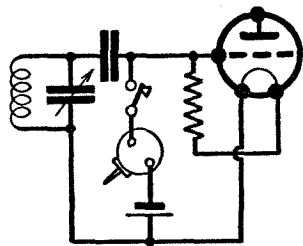

Fig. 413—Simple arrangement for switching-in pick-up

In all these arrangements, however, it will be seen that H.F. currents are being applied to the grid of the valve, and therefore it is liable to receive radio signals at the same time as a record is being played. This can be overcome by detuning the tuned circuit, but even then signals may provide an undesirable background to the gramophone music. Even switching off an H.F. stage may be

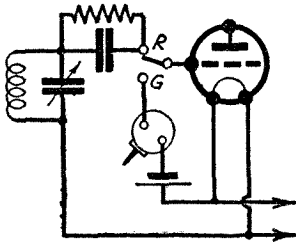

Fig. 414—Change-over radiogram switching system

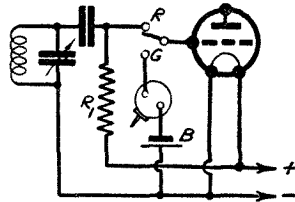

Fig. 415—Similar to preceding circuit, but grid resistance position altered

insufficient to prevent this effect. A two-way switch will usually overcome the trouble, and Fig. 414 shows a simple arrangement where the grid may be connected either to the "radio" terminal or to the pick-up. A modification in which the grid resistance is in a different position is given in Fig. 415, but in both these cases the switch arm, passing between the two contacts, leaves the grid "in the air"—i.e., unconnected to anything. There may be a most unpleasant buzz when switching over, and this may be overcome by leaving a grid resistance permanently across the grid and filament as shown in Fig. 416. The resistance (of, say, 1 megohm) will be of too high a value to affect the tone of gramophone reproduction. An arrangement as applied to A.C. mains valves is given in Fig. 417, where, in addition, a bias resistance R_3 is connected in the cathode lead; this resistance does not affect radio detection because of the presence of the grid condenser C. The potentiometer which has now been introduced is of the graded type, and approximately obeys a logarithmic law.

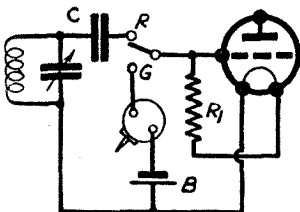

Fig. 416—Grid resistance permanently in circuit prevents noises when changing over

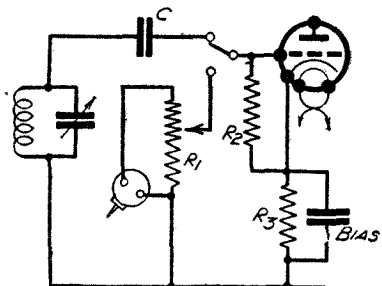

Fig. 417—Pick-up arrangement for use with A.C. mains valves

Shielding Pick-up Leads.—Pick-up leads are very liable to pick up hum—i.e., stray alternating currents; a certain amount of low-frequency instability may also arise owing to low-frequency

reaction. These troubles are usually overcome by shielding the leads between the pick-up and its potentiometer, and also the wire which goes from the potentiometer to the switch and from the switch to the grid of the valve, as shown in Fig. 418. The metal

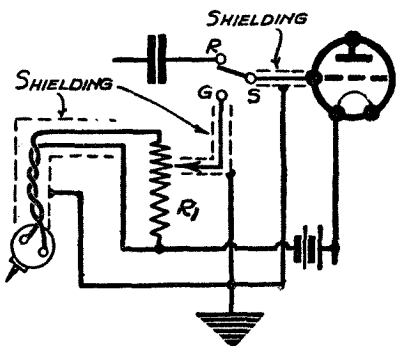

Fig. 418—Screening of the pick-up leads reduces hum and L.F. reaction

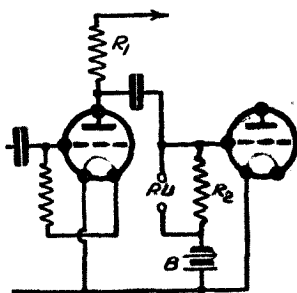

Fig. 419—How a pick-up may be connected to an L.F. valve

casing for all these wires is earthed at one or more points. Sometimes the pick-up is sent out by the manufacturers with the sheath connected to one terminal of the pick-up; this terminal should then be connected to the earth of the receiver.

Pick-up Applied to L.F. Valves.—Where the first valve is a detector and there is a subsequent intermediate stage of L.F. amplification, it will usually be desirable to connect the pick-up in the grid circuit of the L.F. amplifier, and one method of doing this is shown in Fig. 419, where the pick-up is connected across the grid resistance R_2 of the L.F. amplifying valve. It is a circuit in which a detector valve is coupled to the first L.F. valve by resistance coupling, a transformer being then connected in the anode circuit of the first L.F. valve.

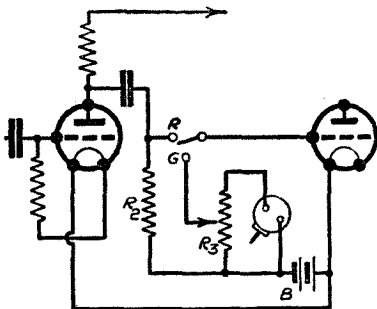

Fig. 420—Switching for a pick-up connected to an L.F. valve

Instead of having terminals to which the pick-up is connected, a switch will usually be employed, and Fig. 420 shows a simple arrangement, while Fig. 421 shows a grid resistance left across grid and filament to prevent noises when switching over from radio to gramophone.

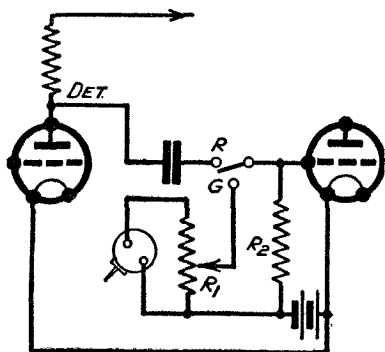

Fig. 421—The grid resistance is left permanently across grid and filament

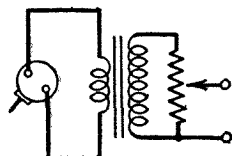

Fig. 422—An L.F. transformer is sometimes used to connect the pick-up to the amplifying valve; the potentiometer may be connected across its secondary

Use of Pick-up Transformer.—Sometimes a pick-up is used in conjunction with a pick-up transformer, as shown in Fig. 422. In such a case the secondary of the transformer may be treated as the pick-up in the various circuits which have been discussed.

CHAPTER 27

AUTOMATIC VOLUME CONTROL

Automatic volume control, or automatic gain control, as it is sometimes called, is a system for keeping the volume from the loudspeaker at a constant level, no matter what the strength of the high-frequency signal strength may be. Manual control—i.e., by hand—is usually fitted even on sets provided with automatic volume control, since although it may be desirable that all stations should come in at the same strength on the loudspeaker, yet one obviously wants to be able to control that strength to suit personal requirements.

The main object of A.V.C. (automatic volume control) is to make it unnecessary to keep altering the manual volume control as one passes from station to station. In the ordinary way, one may readily receive a local station at tremendous strength, while a few degrees away on the dial another station may be comparatively weak. As one tunes still farther round the dial, a very powerful station may produce a most unpleasant blare. There is an obvious advantage if all the stations can be brought in at full loudspeaker strength, but no louder and no weaker. This is done by altering the sensitivity of the whole set, either on the high-frequency or on the low-frequency side, or on both; while in the case of superheterodynes, detectors and intermediate frequency amplifiers may also have their sensitivity adjusted to increase or decrease the sensitivity of the set as may be required.

Another great advantage of automatic volume control is that fading troubles are less. Once a signal begins to fade (a phenomenon due to atmospheric causes outside our control) the input high-frequency currents decrease and A.V.C. then increases the sensitivity of the receiver so that the original strength from the loudspeaker is maintained. Fading is thus robbed of some of its terrors although A.V.C. is not without some disadvantages.

There are three main kinds of A.V.C. :

- (1) Ordinary A.V.C.
- (2) Delayed A.V.C.
- (3) Q.A.V.C. (quiet A.V.C.).

We shall now proceed to discuss these various types of control which are effected almost entirely by the use of resistances and condensers and sometimes special valves or metal rectifiers.

The usual method of A.V.C. consists in varying the degree of amplification of one or more stages of H.F. amplification. This H.F. amplification may be of the original frequency or, in the case of a superheterodyne, of the intermediate frequency; often control of the amplification of both frequencies is effected, and even sometimes of the amplification of the final L.F. valves. It has been seen that a variable-mu S.G. valve will have its mutual conductance and therefore its amplifying powers reduced by an increase of the negative potential on the control-grid. If we can make the high-frequency currents, when they become excessively strong, increase the negative bias on the control-grid of a variable-mu H.F. amplifier, then we have produced A.V.C. Under these conditions an increase in the high-frequency energy supplied to the detector valve of the set will cause an increase of negative bias on the V.S.G. (variable-mu screen-grid valve). This will then cause a reduction of the high-frequency currents applied to the detector.

On the other hand, if there is a weakening of the input current, then the normal negative bias on the V.S.G. will be reduced and the amplification of that valve will be increased, thus maintaining the strength of the H.F. current applied to the detector. It is not a difficult matter to arrange an average volume which one desires and then to allow the A.V.C. action to increase or decrease the strength of H.F. current applied to the detector, so as to keep that volume constant for different strengths of aerial input currents.

It is usual to make the H.F. current do the gain-controlling for the following reasons: We obviously do not want to even up the loud passages and the weak passages unduly. We are solely concerned with the average strength of the high-frequency signals: in other words, of the carrier-wave of the station being received. For a given percentage modulation (the degree to which the carrier is increased and decreased by the music or speech) a strong station will have a stronger carrier-wave. The disadvantage of the method is that two stations may have the same strength of carrier-wave for quite different depths of modulation. Automatic volume control will keep the carrier-waves the same strength, but the signal strength from the loudspeaker will be different in the two cases. The difficulty, however, is not insuperable, and can, in any case, be treated too seriously.

For the proper understanding of A.V.C. it is better for us to appreciate that a modulated carrier wave when applied to a rectifier produces a D.C. component and an A.C. component. There is, in

other words, a direct current which varies in magnitude with the L.F. variations corresponding to the original sound at the transmitting studio. In ordinary practice, we make no use of any direct current component, but the alternating current component is usually amplified and operates the loudspeaker. In A.V.C. we use the D.C. component to provide a comparatively steady D.C. voltage which is applied to the variable- μ H.F. amplifier. The magnitude of this D.C. voltage is dependent on the strength of the incoming carrier wave; it exists even during intervals in the programme, if the carrier is still being received. It is important to see that the voltages used to control the amplifying stages have not mixed up with them the A.C. voltages; it is fortunately a simple matter to filter out these A.C. voltages and by means of decoupling resistances and condensers to prevent undesirable interaction effects.

In Fig. 423 is shown the simplest system of A.V.C. Only the essential parts of the circuit are illustrated. It will be seen that the first valve is an S.G. H.F. amplifier which feeds into the grid circuit of a detector valve. The grid condenser C and leak R are not connected in the more usual position next to the grid but between the bottom side of the tuned grid circuit and the filament or *earth line*. In the leaky-grid condenser system of rectification, the grid and filament of the detector valve operate as a diode. The A.C. low-frequency potential variations occur across the grid leak R , causing the grid voltage to vary at low frequency. These voltage variations are amplified by the valve since the grid is simultaneously the anode of a small diode and also the control electrode of a three-electrode valve L.F. amplifier.

The voltages across the resistance R will be larger the greater the high-frequency currents applied to the detector, and if we can use the D.C. component due to the carrier and feed it to the control-grid of the first valve, we shall get A.V.C. Since the grid current flows from the grid through the resistance R to the filament (reference is now being made to the flow of electron current), the top end of R will be negative with respect to the filament, and the stronger the current the more negative will the top end of R be, and therefore the more negative will the control grid of the first valve become.

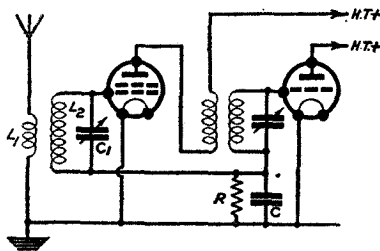

Fig. 423.—A simple circuit to explain automatic volume control

This, of course, is exactly what we want for A.V.C., but in the arrangement of Fig. 423 the L.F. component would also be communicated to the grid of the first valve. Also, there would be complications due to H.F. coupling in the condenser C which is common to both circuits. We certainly do not want any H.F. or L.F. e.m.fs. to be fed into the grid circuit of the first valve. The arrangement of Fig. 424 (this time incorporated in a superheterodyne receiver)

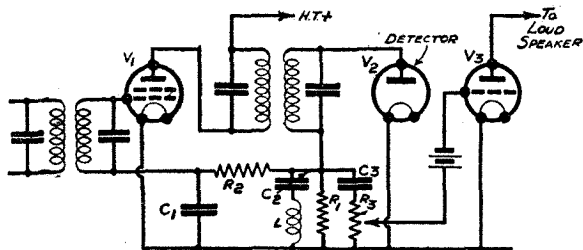

Fig. 424 — A diode detector provides the usual L.F. component and also a D.C. component for A.V.C. purposes

is a good one for explaining how one can remove the objections to the circuit of Fig. 423. In the first place, the detector is now shown as a separate valve, a diode being employed. In the anode circuit of this diode is a resistance R_1 which serves as the origin, so to speak, of all voltages produced through the rectification effect of the detector. By making this resistance high compared with the impedance of the valve, it is possible to convert most of the input signal into volts developed across this resistance. A condenser C_3 and a potential divider R_3 are connected across the main resistance. The condenser C_3 is large enough to allow the ready passage of the alternating current, which it is the first object of the detector to provide. This alternating current flows through the resistance R_3 and establishes L.F. e.m.fs. across it. The sliding contact on R_3 enables different amounts of voltage to be tapped off and supplied to the grid of the valve V_3 which feeds the loudspeaker or other stages of low-frequency amplification. The resistance R_3 , therefore, is a manual volume control device.

To the left of the resistance R_1 is the A.V.C. circuit, which consists essentially of a resistance R_2 of a considerably higher value than R_1 and the condenser C_1 , a large capacity. This condenser C_1 must be of sufficiently large capacity to smooth out any A.C. component, and so the only potentials which are applied to the control-grid of V_1 are the D.C. volts which represent rectified carrier-wave current. The resistance R_2 is essential, because if C_1 were connected across the main resistance R_1 , the desired A.C. component would be flattened out, and moreover the values of capacity and resistance would be unsuitable for effective rectification.

The resistance R_2 , therefore, is given such a value that it assists smoothing and prevents C_1 from interfering with the A.C. volts. To the right of the grid leak R_1 the condenser C_3 acts simply as a stopping condenser which keeps the D.C. component, which we keep separate, out of the grid circuit of the L.F. amplifying valve V_3 .

The operation of this whole circuit is as follows: High-frequency currents (actually of intermediate frequency) are amplified by the first valve and applied to the detector V_2 , which converts them into a steady direct current which is modulated at low-frequency. The low-frequency part goes through the large condenser C_3 and through R_3 , and the potential differences established across R_3 are communicated to the grid of the L.F. valve. Meanwhile, the D.C. component has been smoothed out by the resistance R_2 and condenser C_1 , and is communicated to the control-grid of the variable-mu H.F. amplifier valve V_1 . Strong signals will produce more rectified carrier-wave current, and therefore more negative bias on the variable-mu valve, and thus the H.F. input to the detector will be decreased.

The input circuits shown are tuned circuits with fixed condensers, and represent an intermediate frequency transformer of a superheterodyne, although the general principle may equally be applied to a straight H.F. receiver. It will be noticed that an inductance L and condenser C_2 are connected across the leak R_1 . They form an acceptor circuit and operate as a short-circuit for the intermediate-frequency currents which, of course, are not wanted at this position.

Double-Diodes for A.V.C.—In the case of a single diode detector half-wave rectification is obtained, but we can provide, as in Fig. 425, a valve with a single filament and two anodes, so utilised that a full-wave rectification effect is obtained similar to that described in the chapter dealing with mains units. The middle point of the inductance L_4 in the detector circuit is connected through a leak R_1 and condenser C_1

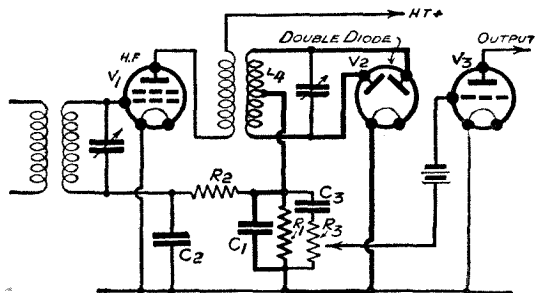

Fig. 425.—A double-diode detector is shown in use for A.V.C. purposes

to the filament. This arrangement provides the voltages both or A.C. and D.C. components; each anode in turn is made

positive, but the resultant electron current will always flow down the resistance R_1 , making the top end negative with respect to the bottom end. The condenser C_3 is a stopping condenser; the potential divider R_3 couples the A.C. component (the actual signals to be heard) to the valve V_3 ; the slider forms a manual volume control for governing the strength of the L.F. voltages applied to the output valve (or L.F. amplifier, as the case may be).

To the left of the condenser C_1 and leak R_1 is a smoothing circuit consisting of the resistance R_2 and the condenser C_2 . The theory of operation of the circuit is similar to the preceding one. The condenser C_1 is small and is for by-passing H.F.

Wunderlich Valve for A.V.C.—A special valve has been developed in America for A.V.C. work, and the circuit is illustrated in Fig. 426. The valve consists of two grids G_1 and G_2 , which are

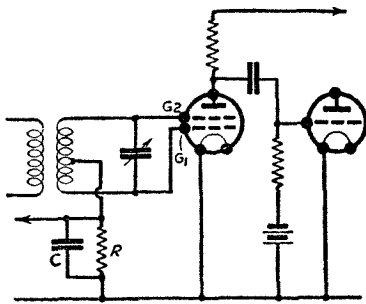

Fig. 426—The Wunderlich valve is a combined double-diode and L.F. valve

interlinked so that each is the same distance from the filament, and between that electrode and the anode. The grids are, therefore, symmetrical, and each end of the tuned circuit is connected to a grid, while the middle point of the inductance is connected through the grid leak R and condenser C to the filament. The operation of the arrangement is as follows:

The two grids and the filament form a full-wave rectifier which supplies a generous rectified current which passes through the resistance R . The result is that a fluctuating potential is set up across R corresponding to the L.F. current from the microphone at the transmitting station, and these L.F. potentials are applied to both grids. As far as L.F. is concerned, therefore, the two grids are given the same potential variation, and as they are interlinked (although not touching, of course) they act in the same way as would a single grid, and produce an amplified low-frequency current in the anode circuit of the valve. The D.C. and A.C. components of the current through R are made use of as follows: The A.C. component produces voltage variations across R which are communicated as just described to the grid, while the D.C. component is smoothed out by the usual resistance and condenser (not shown) before being applied to the grid of a variable- μ H.F. amplifier.

Time Lag in A.V.C.—What we have hitherto spoken of as the smoothing resistance and condenser form an essential link in the A.V.C. arrangement, since not only do they smooth out and provide a steady D.C. component which only varies with the strength of the carrier-wave, but they perform a function of a special kind. It takes time for a D.C. current to flow through a resistance and to charge up a condenser. The larger the value of the resistance and the greater that of the condenser, the longer will it take to charge up the condenser to the voltage of the supply. Likewise, it will take longer for the condenser to discharge through a high resistance than through one of low value. The whole arrangement can be made sluggish, and in A.V.C. systems it is possible to produce a time-lag of from, say, one-twentieth of a second to several seconds. An advantage of a sluggish response to A.V.C. is that when tuning from one station to another equally loud, there is no noisy intermediate position of the dial of the receiver. One of the disadvantages of the simpler forms of A.V.C. is that when one tunes away from a powerful station, the sensitivity of the receiver goes up, since the negative bias on the variable- μ valve is lessened. Two interesting results of this increase of sensitivity are to be observed. In the first place, the tuning of the station which is being left appears flatter, since the receiver, finding that the H.F. currents are weakening, tends to strengthen them by improving the sensitivity of the H.F. stage. Actually, the selectivity of the set is not decreased at all, but only apparently so. It is important, however, to tune an A.V.C. set accurately, and various visual aids have been devised. A more important disadvantage is that in the intervals between stations the set is in its most sensitive condition, and will amplify the mush, background and other noises to a most undesirable extent.

If one provides considerable lag in the action of the A.V.C. arrangement, the operator of the set has tuned in to another station before the receiver has entered into its most sensitive condition, and thus "noise" is not heard between stations.

A disadvantage of lag, however, is that A.V.C. will not then remedy fading, if the fading is of the quick-changing type. Only gradual fading could be corrected. There are other methods of suppressing noise, and so there is no excuse for excessive lag in A.V.C.

Anode-Bend A.V.C.—An anode-bend rectifier may be used for supplying the D.C. voltages for controlling the grid potential of the variable- μ valve. In the previous circuits, the detector valve has provided both the D.C. component for A.V.C., and also has acted as the ordinary detector for providing L.F. current. This

arrangement is not at all necessary, and there are advantages sometimes in using separate valves for the two purposes; and in Fig. 427 V_2 , operating as an anode-bend rectifier, is used to supply

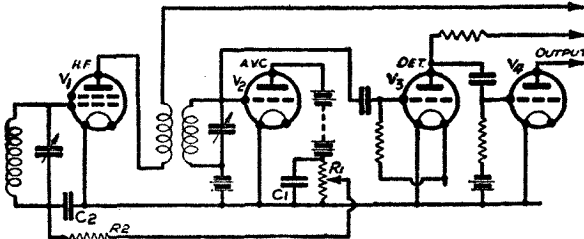

Fig. 427—The A.V.C. valve operates as an anode-bend rectifier and is separate from the detector

a D.C. component to the grid of the H.F. amplifier valve V_1 .

The valve V_2 working at the bottom bend of its curve will pass a larger

average anode current as the H.F. input increases. This increase of current through the resistance R_1 will cause the slider to become negative with respect to the earth line. Consequently a larger negative bias will be given to control-grid of the variable-mu valve V_1 . This will reduce the H.F. currents applied to the A.V.C. and detector valves. An even balance of volume is thus obtainable.

Delayed A.V.C.—The principal disadvantage of ordinary A.V.C. is that the strength of input signals begins to be affected in an adverse manner even when signals are weak. The ideal arrangement is to permit weak signals to be amplified without A.V.C., this latter system acting as a limiting device to prevent signals from exceeding the strength required to give full loudspeaker results.

When A.V.C. only comes into action when the H.F. signals exceed a certain strength we have what is called *delayed* automatic volume control.

A *threshold* value beyond which A.V.C. comes into action is fixed, and a system invented by the present writer (Pat. 172376, 1920) has come into general use; its operation may best be understood by consulting Fig. 428, which shows alternating current being fed into the anode circuit of a diode. This anode circuit contains a D.C. meter and a battery so arranged as to give the anode a normal *negative* bias. The value of this battery is shown as three volts, and the point to notice is that while the peak A.C. voltage is below three volts, there will be no current flowing

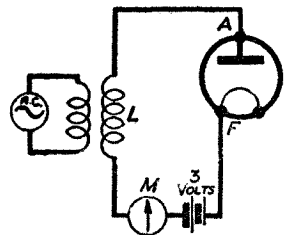

Fig. 428—How a diode with negative bias is conductive for strong signals

through the meter M. When, however, the peak voltage just exceeds the three volts, the anode will begin to become positive with respect to the filament and will draw up electrons which will flow through the valve ; there will be pulses of D.C. through the meter M, which will show an average reading. The valve, therefore, has acted as a non-conductor for voltages below three volts, but has become a conductor for greater voltages. This is because the valve commences to conduct at a voltage of about approximately zero volts on the anode, and this is shown in the curve of Fig. 429. Here are shown complete cycles of alternating current applied to the anode of the diode, which is here supposed to be

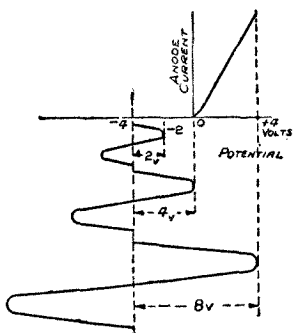

Fig. 429—Graphical explanation of how a diode conducts only strong signals

biased -4 volts. The first cycle has an amplitude of two volts, so that the anode never gets to a higher potential than -2 volts ; therefore there is no current through the valve. When the cycle increases to 4 volts, the maximum potential on the anode is zero, but again there is no current. Any amplitude above 4 volts, however, will establish an anode current, and this is shown by the 8-volt cycle.

its anode circuit, and in Fig 430 is shown a tuned circuit containing H.F. current connected across the anode and filament of a diode, a resistance R and a battery B being connected in series. When the voltage supplied by the circuit LC has a peak value greater than the negative bias supplied by B to the anode of the valve, then and only then will a rectified current pass through R and set up potentials across it which could be utilised for biasing the control-grid of a variable-mu valve.

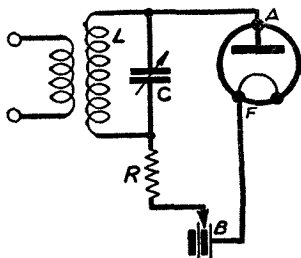

Fig. 430—Output voltages are produced only by strong signals

Instead of a diode, a triode may be used in the manner shown in Fig. 431, where a battery B1 is connected in the grid circuit of the valve so that the potential applied to the grid is more than sufficient to cut off the anode current of the valve. Under these

conditions there will be no potential drop across the resistance R in the anode circuit of the valve. If, however, we now increase the high-frequency potential applied to the grid of the valve, a point will be reached where the H.F. more than overcomes the negative bias on the grid, and the positive half-cycles produce a current which, flowing through R , sets up potentials which may be used for A.V.C. The bend in the curve of a triode, however, is not as sharp as that of a diode.

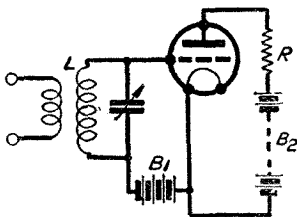

Fig. 431—A triode may be used as a limiter

The above arrangements and their modifications are frequently used to produce a delayed A.V.C. action. The battery is usually replaced by a potentiometer; in the case of indirectly-heated-cathode mains valves, the negative potential is frequently obtained from a self-bias resistance.

Another Sort of A.V.C.—So far, we have considered the use of the high-frequency current only as a means of obtaining A.V.C. But instead of using the rectified carrier-wave (which may have been modulated to different depths in the case of different stations), it is possible to use the actual low-frequency output current to control the amplification of the high-frequency stages. This means that the actual signal working the loudspeaker would be used to control the strength of the high-frequency signals applied to the detector; we are then independent of the depth of modulation.

The obvious apparent disadvantage of the arrangement is that there will be a tendency to level up the strength of sounds and to produce distortion. Loudness of response of a loudspeaker depends on the strength of the current fed into it and its frequency. A true levelling effect in a passage of music would be disastrous, but in actual practice the arrangement does not work out as badly as might be expected. By making the A.V.C. sluggish, individual notes are not affected but only general and sustained signals. This, of course, also brings in its train disadvantages, but the arrangement was at one time in extensive use in America and one method of its application is illustrated in a very simple form in Fig. 432. Here we have an H.F. valve followed by a detector and an output valve. In the anode circuit of the third valve, we have the loudspeaker, but there is also a further circuit consisting of a condenser C_1 and a resistance R_1 ; a diode valve V_4 is connected across any desired amount of the resistance R_1 , while a resistance R_2 is connected in the anode circuit so that a D.C. potential can

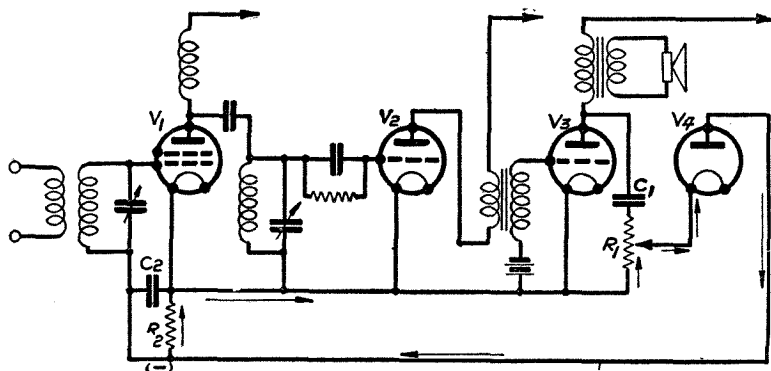

Fig. 432—A special A.V.C. system possessing certain disadvantages ; output volume is governed by signal strength rather than by amplitude of carrier wave

be established across it for the purpose of varying the potential on the control-grid of the first valve. The condenser C2 is for smoothing purposes. The amount of automatic control is governed by the position of the tapping on R1.

Amplifying the D.C. Component.—One of the principal problems in A.V.C. is to provide sufficient volts to control the variable-mu valve. Frequently as much as 20 or 30 volts are required since a local station may be a thousand times as "loud" as a distant station. The choice of system is, therefore, usually governed largely by the ease with which large potentials may be either obtained or dispensed with, and various complicated valves having rather lurid names have come into being, some of them giving excellent results.

Before discussing some of them it is desirable to draw attention to the alternative grid circuit rectifying system illustrated in Fig. 433 and Fig. 434. In previous circuits it has been usual to show the

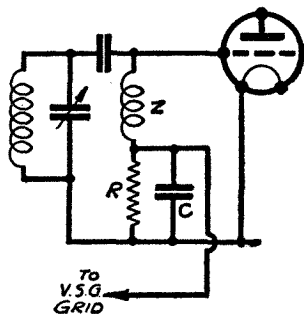

Fig. 433—Output resistance of rectifier may be connected in parallel, as shown

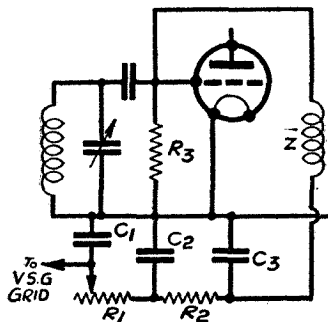

Fig. 434—H.F. and L.F. filters are here provided to ensure D.C. for A.V.C.

grid resistance and condenser in series with the grid circuit, but this is not at all essential, and we can connect a stopping condenser in the grid circuit and then connect the resistance (and if necessary condenser) across grid and filament. Fig. 433 shows the use of a stopping condenser while an H.F. choke is connected in series with R to prevent C short-circuiting the H.F. current supplied by the input circuit. Owing to the rectifier action of the diode, the plate on the right-hand side of the stopping condenser is charged negatively and the electrons flow down to the filament through the resistance R, making the top end of R negative with respect to the bottom end, and thus providing us with a D.C. component or D.C. and A.C. components according to the value of the condenser C.

In Fig. 434 the ordinary A.C. L.F. voltages across R₃ are utilised for A.V.C. The H.F. choke Z and small decoupling condenser C₃ keeps out the H.F. current; R₂ prevents the smoothing condenser C₂ from acting across the original resistance R₃ (in which A.C. voltages must be retained as they are the detector L.F. voltages amplified in the anode circuit of the valve). After C₂ we only want the D.C. component, and R₁ and C₁ ensure that the L.F. component vanishes. We have thus first removed the H.F., then the L.F., and now have the desired D.C.

The Double-Diode Triode.—One of the simpler complex valves for A.V.C. consists of a triode for low-frequency amplification and a double-diode inside the same bulb, a common cathode serving for both valves. Automatic volume control is usually employed when mains valves are used, and an indirectly-heated cathode lends itself to numerous very convenient circuits. It would probably be more convenient to use the word cathode when dealing with A.V.C., and the reader will understand that this term refers to filaments as well.

In order to simplify the subject the diagrams show the circuits with filaments, and, where possible, grid-bias batteries are shown. When A.C. valves are employed, indirectly-heated cathodes and bias resistances will be usual, but the theoretical operation of A.V.C. remains the same.

The combining of the two valves in one bulb makes for economy and saves space. The beginner would do well, however, to realise that the circuits associated with these valves are actually much simpler than they look, and the best procedure is to regard the valves as separate and also to try and separate the rectified current into an A.C. and a D.C. component, the first being used for ordinary L.F. amplification, and the second for A.V.C.

The diode portion of the double-diode triode is screened inside the bulb from the rest of the valve to prevent interaction. It is

obviously desirable to keep the H.F. current out of the L.F. circuit, and there is also the fact that L.F. potentials are established on the anodes of the double-diode, and that these (particularly e.m.fs. corresponding to high notes) may be carried over into the triode anode circuit and so be ultimately effective in the loudspeaker without having passed through the proper channels.

Fig. 435 shows a simple use for the double-diode triode. Here the two anodes A1 and A2 of the double-diode serve as a full-wave rectifier, a middle tapping on the input inductance being connected through the usual grid leak (of $\frac{1}{2}$ megohm) to the cathode. The potentials across this leak have a D.C. and an A.C. component, and the A.C. component is passed through a .01-mfd. condenser to the grid G of the triode valve. The usual resistance and bias is connected across this grid and cathode to give the grid a suitable negative operating potential. The rectified carrier-wave produces the D.C. component, and this is smoothed out by condensers and a resistance, the final potential being communicated to the variable-mu valve or valves.

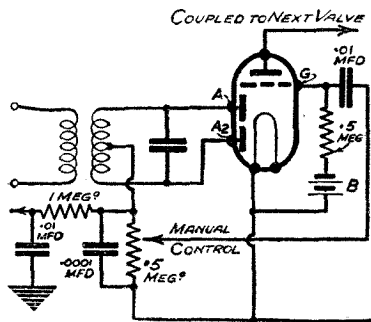

Fig. 435—The use of a double-diode triode for A.V.C. purposes

It will be seen that the chief difference between this arrangement and the Wunderlich valve is that a separate amplifying valve is used.

Delayed A.V.C. with Double-Diode Triode.—A rather more complicated use of the double-diode triode is illustrated in

Fig. 436, where one of the anodes of the double-diode is used for A.V.C., while the other is used as a straightforward diode detector. It will be seen that the anode A2 is connected to the top end

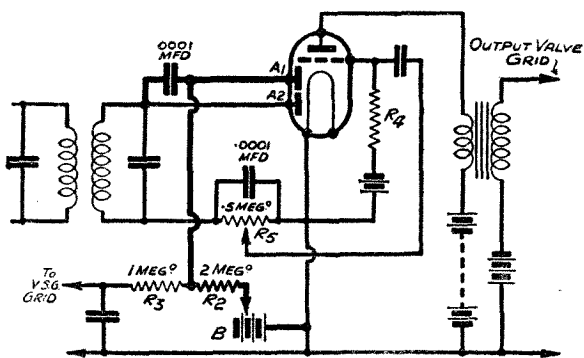

Fig. 436—In this circuit one anode is used for detection and the other for delayed A.V.C.

of the inductance, the bottom end of which is connected to the usual "grid" leak R_5 of, say, 0.5 megohm and "grid" condenser of .0001 mfd. to the cathode. A tapping is taken on the resistance R_5 to the grid of the valve. This is simply the ordinary arrangement of a diode followed by an L.F. amplifier.

The tuned circuit, however, also feeds the anode A_1 through a fixed condenser of .0001 mfd. which serves as a stopping condenser as was explained in connection with Figs. 433 and 434. The anode A_1 is now connected through a resistance R_2 and a bias battery B to the cathode. When the input high-frequency current communicated to A_1 exceeds the negative voltage of the bias battery B , an electron current will flow from the anode A_1 , down the vertical thick line in Fig. 436, through the resistance R_2 and round to the cathode. In doing so, there will be a D.C. component flowing through R_2 , and use of this rectified carrier-wave is made by filtering out the L.F. variations by means of a resistance R_3 and a condenser of, say, .1 mfd. capacity. The D.C. component is then fed to the grid of the variable- μ valve. The circuit is quite simple to understand if one divides it in this manner. The object of the bias battery is to provide an initial voltage on the anode A_1 , so as to produce a delayed A.V.C. action which comes into force only when signals reach a predetermined value. The bias voltage is adjustable, and in practice would be derived from a potential divider (usually a moving contact on a self-bias resistance).

Quiet A.V.C.—It has already been explained that one of the disadvantages of A.V.C. is that during the so-called silent intervals between stations on a tuning dial, the receiver is restored to such a high degree of sensitivity that it picks up all the mush and extraneous interference generally known as "background," and this produces a most distressing noise. We therefore require some means of rendering the set insensitive when changing from one station to another. The trouble is not so bad if the whole sensitivity of the set is reduced, but it can be very annoying. Many sets have been fitted with a switch for reducing the amplification of the set when tuning from one station to another. The equivalent effect, however, can be produced automatically if one arranges that signals below a predetermined strength will produce no result in the loudspeaker. We have already seen that it is desirable that signals below a certain strength should not have their amplification affected by A.V.C. We now see that signals below a still further low level are best not amplified at all, so that the tuning of the receiver may be made much more pleasant and accurate.

One method of Quiet A.V.C. is illustrated in Fig. 437. The arrangement consists, in brief, of a detector which supplies both an A.C.

component and a D.C. component. The D.C. component is smoothed and applied to the grid of a variable-mu valve. It is also applied, however, to a variable-mu *low-frequency* amplifying valve, the grid of which derives its L.F. potential variations from the A.C. component of the rectified current. The idea of a variable-mu L.F. valve is comparatively recent, and in the Q.A.V.C. system here described, its normal operating grid potential is made very much more negative when there is little or no rectified carrier-wave—i.e., when the input H.F. signal is feeble or non-existent (as when tuning between stations). This has the effect of making the whole set very much quieter when a station is not being received.

The method of operation should be clearly seen from Fig. 437. The rectified current from the diode, perhaps conveniently

consisting of the grid and cathode of a triode valve, passes through a resistance R_1 and a resistance R_2 . A connection is taken from the top-end of R_1 through a potential divider system R_3, C_3, R_4 , which

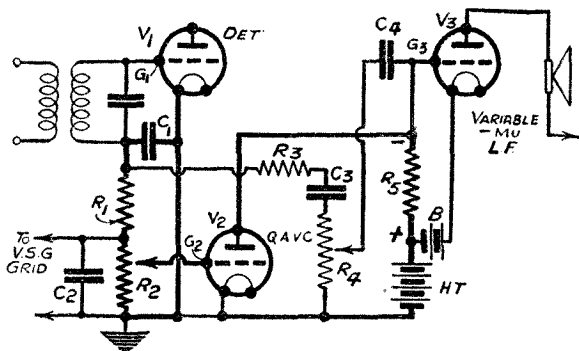

Fig. 437—A quiet A.V.C. circuit in which a separate valve cuts down the amplification of a variable-mu L.F. valve

passes the L.F. component of the rectified current. The required L.F. voltage is tapped off R_4 and fed to the variable-mu L.F. valve, the grid of which is kept at a negative potential by a bias voltage B . The usual grid resistance R_5 , however, not only serves as a means of applying the steady negative bias to the grid, but it is also the anode resistance of a special Q.A.V.C. triode valve. The complete anode circuit of this Q.A.V.C. triode consists of an anode, the resistance R_5 and a H.T. battery. The grid G_2 of the Q.A.V.C. valve is tapped on to the resistance R_2 , which—shunted by the condenser C_2 —has developed across it the D.C. component of the rectified current from the detector valve. In other words, the rectified carrier-wave produces D.C. voltages which are communicated to the grid of the Q.A.V.C. valve in such a way that the stronger the rectified current, the more negative will the Q.A.V.C. valve grid G_2 become. This increased negative potential will cause a decrease of anode current flowing through the

resistance R_5 . This will make the top end of R_5 more positive with respect to the bottom end. In other words, the negative bias on the grid G_3 of the variable- μ L.F. valve will be reduced and the valve will therefore have a greater mutual conductance and amplify better.

The important condition for us to notice, however, is that when the carrier-wave falls off to a low value, or disappears altogether, the grid G_2 of the Q.A.V.C. valve is no longer so negative and there is a big increase of anode current which, passing through R_5 , makes the top of R_5 very much more negative than it was. This means a big negative potential is imposed on the grid G_3 of the variable- μ L.F. valve which is then a poor amplifier. When there is no rectified carrier-wave, the set is very quiet, which is the effect we set out to produce. It is desirable to give the anode G_1 of the diode (the real anode is not used) a negative bias to produce a delayed A.V.C. effect.

An interesting modification of this system consists in feeding a Q.A.V.C. valve in such a way that it is dependent upon a separate and extremely sharply-tuned high-frequency circuit (usually intermediate frequency). When the receiver is tuned to more than a kilocycle off the middle of the carrier-wave of the desired station, the set is silent. This, of course, makes for accurate tuning and good reproduction.

The Double-Diode Pentode.—Perhaps the most interesting of the A.V.C. valves is the double-diode variable- μ pentode. This enables A.V.C. to be obtained even when the difference in

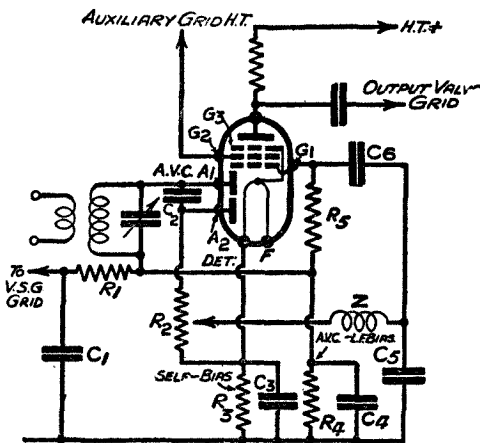

Fig. 438—Double-diode pentode in which the pentode acts as variable- μ L.F. amplifier

microvolts in the aerial circuit differs by as much as 1,000 to 1. The principle of the valve will be easy to understand by those who have followed the description of the last valve arrangement. A circuit using the double-diode variable- μ pentode is shown in Fig. 438. We have, first of all, the ordinary detector circuit, which consists of the anode A_2 and the resistance R_2 . The condenser C_2 is a

stopping condenser, but its capacity must be of the right value as its function is similar to that of a grid condenser for rectification. The L.F. potentials developed across R_2 are communicated to the control-grid G_1 of a variable- μ L.F. pentode amplifying valve (which is in the same bulb as the double-diode rectifier and employs the same cathode). An H.F. choke Z and by-pass condenser C_5 keep the H.F. out of the grid of the pentode, while C_6 and R_5 are simply the usual devices for enabling us to apply a suitable grid bias to the control-grid of the pentode. Now this normal "grid bias" is not stationary; it is made dependent upon the strength of the rectified carrier-wave and we must now turn to the other anode A_1 which produces the rectified currents for the A.V.C. effect. The anode A_1 draws electrons from the filament and these pass through the tuning inductance and thence to the top of R_4 , then through R_4 , then up through R_3 to the cathode. If the H.F. signals are very strong, there will be a large current flowing through R_4 and therefore the grid G_1 of the pentode will be made more negative; since it is a variable- μ pentode, the ordinary L.F. signals will therefore not be amplified as much. We thus obtain an A.V.C. effect in the pentode. In addition, the rectified carrier-wave D.C. potentials may also be fed to the grid of a variable- μ valve used as an H.F. amplifier, the usual resistance R_1 and condenser C_1 being arranged to smooth out any L.F. component.

The resistance R_3 and condenser C_3 in Fig. 438 constitute a self-bias resistance in the cathode lead as is customary in the case of indirectly-heated A.C. valves. The return electron current from the anode passes through R_3 on its way back to the cathode, thus making the foot of R_3 negative with respect to the top of R_3 . It will be noted that the potential drop across R_3 is such as to give the anode A_1 an initial negative bias (via R_4 and the tuning inductance) so that a delayed A.V.C. effect is obtained in a manner already explained.

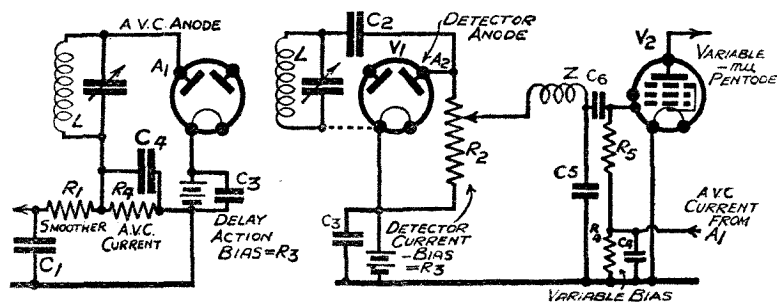

Fig. 439—The double-diode pentode is here resolved into its various functions; one anode provides A.V.C. and the other the usual L.F. potentials

Practical Double-Diode Pentode Operation.—The importance of the “D.-D. Pen.” is such that a further explanation, especially as regards its use in mains valve circuits, is desirable. Let us look first of all at the double-diode portion of the valve. In Fig. 439 are shown how the two anodes operate. The same lettering is applied to components as in Fig. 438. On the left-hand side the anode A₁ is being used for A.V.C. The high-frequency currents from L produce a rectified current which flows through the resistance R₄, a condenser C₄ acting as a by-pass for the H.F. and as a reservoir for the rectified currents. A resistance R₁ and a condenser C₁ act as a filter or smoother circuit to ensure that the rectified carrier-wave produces a pure D.C. potential unaffected by modulations. An explanation is now necessary for the insertion of the bias battery which may be assumed to give the anode A₁ a normal negative potential of say -3 volts. This bias is to effect a delay action. Obviously, it is undesirable to apply an increasing negative bias to the variable-mu H.F. valve of the set when weak signals are being received. They only require to be reduced when they are capable of producing more than ordinary loudspeaker-strength signals. By applying a negative bias to the anode A₁ a rectified current is only set up when the H.F. signals exceed the negative bias on the anode. In this figure the bias is applied by a battery, but in practice a self-bias resistance is used (R₃ in Fig. 438).

The other anode A₂ of the valve operates in the ordinary way as a diode detector, and the right-hand side of Fig. 439 shows the tuned circuit connected across A₂ and the cathode. The dotted line is inserted to replace the actual apparatus which connects the bottom of the inductance L to the cathode; this apparatus, and any voltages set up across it, do not concern us. The condenser C₂, which corresponds to the grid condenser in a simple three-electrode valve detector, insulates the second anode A₂ from any steady voltages. The resistance R₂ corresponds to the usual leak in a diode detector, and a tapping on R₂ enables the required L.F. voltage variations to be applied to the grid of the next valve; in other words, by moving the slider we can provide a manual control of volume. The L.F. variations are passed to the grid of an L.F. amplifier, an H.F. choke Z and condenser C₅ being inserted, if desired, to keep H.F. current out of the L.F. stages. The condenser C₆ is the usual L.F. coupling condenser, and R₅ is the usual grid resistance, but R₄ C₄—which has the A.V.C. current from the anode A₁ passing through it—varies the negative bias on the L.F. valve V₂ (a variable-mu pentode) and thus reduces its amplification when strong signals are received.

The L.F. valve V2 is a variable-mu pentode L.F. amplifier, the amplification of which is adjustable by altering the grid-bias operating point; the rectified D.C. produced by rectifying a carrier-wave is applied to the control grid of the pentode (via e.m.f.s. across R_4) so that the degree of its amplification is reduced when strong signals are received. Thus A.V.C. voltages are both passed forwards to the H.F. stages and backwards to the L.F. stages. This enables signals of very widely varying strengths to be received. This is really essential because in the ordinary way excessive overloading might occur on the L.F. stages. Strong signals are required to produce a large negative bias for cutting down the amplification of the H.F. valve, and these large H.F. voltages applied to the detector anode will tend to overload the L.F. stages; this, of course, only applies when the input signals are very strong, as from a local station, and the ordinary A.V.C. is unable to handle the problem.

The application of some of the principles explained to indirectly-heated cathode valves is illustrated in Fig. 440. It will be seen

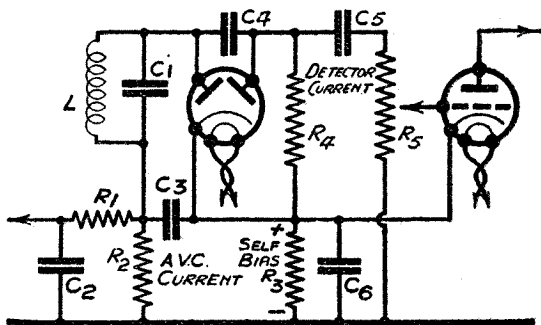

Fig. 440—A mains double-diode triode may be considered as two valves and one theoretical arrangement is given above

that a self-bias resistance R_3 , with its smoothing condenser C_6 , is connected as usual in the cathode lead, and provides a negative bias to the A.V.C. anode of the diode and to the grid of the L.F. amplifying valve. A complete double-diode pentode circuit as recommended by A. C. Cossor is given in Fig. 441 where a pentode output valve is coupled to the D-D. pentode by a resistance coupling of the usual kind. The various functions of the resistances and suitable values for a high-tension line supply of 220 volts are suggested. The portion of the circuit drawn in thicker lines is the one relating to the D-D. pentode and its components.

The anode A_1 is an ordinary rectifier anode for detection. The resistance R_1 and condenser C_2 constitute the usual leaky condenser, while the resistance R_2 is a potentiometer for feeding the control

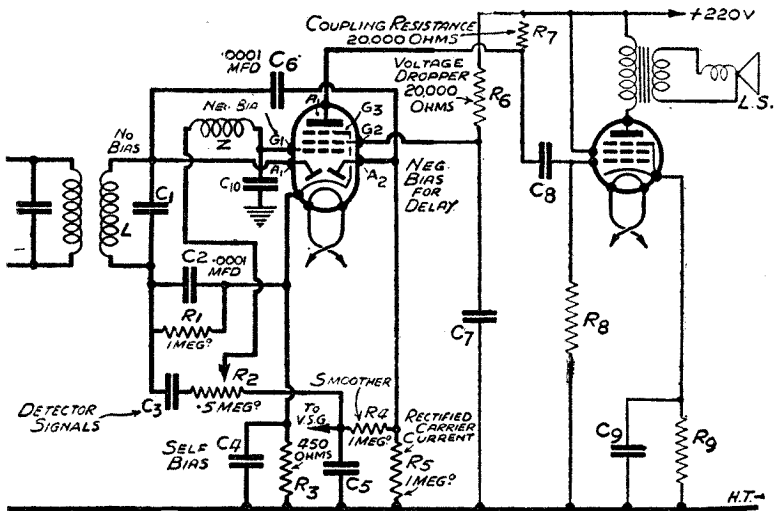

Fig. 441—A complete double-diode pentode A.C. mains valve circuit is illustrated above; the A.V.C. effect is applied to both an H.F. stage and the pentode portion of the valve

grid G1 of the L.F. variable-mu pentode part of the valve. This control grid is given a steady negative potential of about -3.8 volts by the self-bias arrangement R3 C4 connected between the cathode and the earth line. In series with this, is the voltage due to the rectified carrier-wave, which voltage is D.C. and varies with the strength of the input signals when these are above the value of the bias voltage on A2, producing a delay action. The A.V.C. circuit includes the tuned circuit L C1, the condenser C6 and the anode A2. This latter electrode is the H.F. point of the arrangement, while the rectified D.C. goes from the anode A2 through the resistance R5 to the earth line, and then up through the resistance R3 to the valve cathode. This rectified current produces a D.C. potential across R5, making the top end of R5 negative. A smoother circuit consisting of R4 and C5 provides a steady D.C. potential. This, however, will vary with the signal strength of the H.F. currents when these provide a voltage greater than the negative bias applied to A2 by the self-bias resistance R3.

It will thus be seen that the normal operating point of the control-grid G1 of the pentode is governed by the strength of the signals received. The L.F. output of the whole valve therefore depends partly on the input L.F. voltage variations and partly on the strength of the rectified carrier-wave. The coupling arrangements, etc., of the pentode output valve call for no comment as they represent standard practice except for any tone-control connections which may be desired.

The extremely wide range of input H.F. voltages dealt with by the double-diode pentode is illustrated by the curve of Fig. 441a.

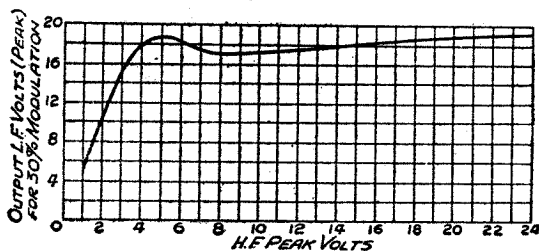

Fig. 441a—The efficacy of the double-diode pentode is illustrated by this curve showing the L.F. output volts for different values of H.F. input peak volts

This figure shows along its base the H.F. input peak voltage, while the vertical scale indicates the L.F. peak volts obtained. It is assumed that the percentage modulation is 30.

The level nature of the output indicates the efficacy of the arrangement.

CHAPTER 28

A.C. VALVES AND THEIR CIRCUITS

Introduction.—At an early date in the history of broadcasting, it was realised that fool-proof operation, economy, and trouble-saving through the working of receivers from the ordinary domestic electric-light mains would prove popular. Since those early days there has been a further appreciation of the superior efficiency of mains over battery valves and the fact that greater power output and quality of reproduction are obtainable, although Class B and similar systems have done much to improve the lot of those who use battery valves.

Apart from convenience and the absence of any necessity to recharge accumulators and replace high-tension batteries, there is very little that the mains-operated valves can do which could not, if expense were no object, be carried out by a battery valve. The circuits, therefore, for the two types of receivers are not dissimilar.

Since most of the mains supply companies provide alternating current for domestic lighting and power, and as the whole country will ultimately be working on A.C., we shall consider first of all valves and circuits intended to work from an A.C. supply which may vary in voltage from 110 volts to 250 volts. Usually the supply voltage varies between 200 and 250, and the frequency is almost standard at 50 cycles, although a lower frequency of 25 cycles is to be found occasionally.

The use of A.C. enables us to obtain any desired high-tension voltage by the simple process of stepping-up the voltage with a mains-transformer, and then rectifying this current for operating the anode circuits of the valves.

The following are the advantages of mains-valve technique :

- (1) Less trouble
- (2) Greater efficiency.
- (3) Better quality of reproduction.
- (4) Higher anode voltages obtainable.
- (5) Owing to higher anode voltages available, grid bias is easily obtained.

- (6) Actual running cost very small. (A complete receiver takes less than an ordinary electric lamp.)
- (7) Since current and voltage considerations do not apply to any extent, extra valves and refinements can be added.
- (8) Radio-gramophones in which the gramophone-motor works off the mains have become very popular.
- (9) Mains-energised loudspeakers can be used and give greater sensitivity, efficiency, and quality.

The introduction of mains valves calls for (1) adequate smoothing-out of any ripples; (2) high insulation; (3) generous decoupling everywhere; (4) greater efficiency of the valves calls for more effective screening of components; (5) avoidance of hum requires special precautions.

Types of Mains Valves.—Mains valves for A.C. working may be of two kinds:

- (1) Directly-heated-filament valves.
- (2) Indirectly-heated-cathode valves.

The first kind were the first used for mains working. Thick filaments are employed so that the alternations produce little effect on the average temperature, and therefore on the electron emission. This type of valve is still sometimes used for rectifying, and also when the valve is for specially high power output; the usual indirectly-heated valve, with its coated cathode, will not stand up to the voltage and current requirements for really large outputs. The chief disadvantage of the directly-heated valve is that it is more likely to cause hum, partly owing to differences in emission and also to the fact that the ends of the filaments are constantly changing voltage; in fact, only the middle of the filament is symmetrical, and connections are usually made to the electrical equivalent of the middle of the filament. Since it is inconvenient to take the middle connection inside the valve, connections are taken to the middle of the transformer winding which feeds the filament, or sometimes to a low-resistance potentiometer connected across the filament. By adjusting the connection to the exact middle of the winding of the potentiometer, most of the hum may be cut out.

Indirectly-Heated Valves.—The indirectly-

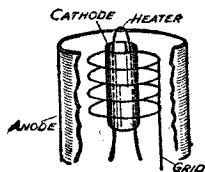

Fig. 442—Arrangement of an indirectly-heated valve

heated valve is almost universally used for broadcast receivers, and is characterised by having a cathode not in the form of a filament but of a metal tube coated with some substance (frequently the oxide of certain alkaline earths) which, when heated to a dull red heat, emits electrons. The tube, or cathode as it is called, is heated by a metal filament which passes

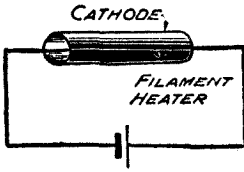

Fig. 442a — The cathode tube is heated by a filament

through its centre. This heater filament usually consists of a hair-pin-shaped wire which is insulated from the cathode. Fig. 442 shows details not of a particular type, but of the general arrangement of the electrodes in an indirectly-heated-cathode valve. In Fig. 442a the tubular cathode, coated with electron-emitting substance, has passing through it a single filament wire heated by current from an accumulator. In practice, of course, it is heated by current from an alternating-current transformer, the voltage usually being 4. It takes some little time, perhaps 15 seconds, for the cathode to attain a normal operating temperature, and this principally accounts for the delay when first switching on an A.C. receiver. The heater current circuit calls for very little comment. All that we are concerned about is that the right voltage is applied to the heater of all the valves in the receiver, and this calls for a correct transformer winding. The only other point of importance is that the insulation between heater and cathode must be high, and that the wiring of the heater induces no hum into other wires.

The cathode, of course, is the important electrode, and it is used in the same way as the filament of a battery valve. As its surface has a large area, it is possible to produce much more efficient valves, since the impedance of the valve can be greatly reduced; the greater the surfaces of anode and cathode, the lower will be the impedance.

Self-Bias.—There is no voltage drop across a cathode, since there is no current flowing through it in the ordinary sense of the term. It is also insulated from the rest of the valve and it is a simple matter to provide *self-bias*.

Self-bias is a name given to the method of obtaining a bias voltage from the flow of anode current. The scheme is not restricted to mains valves, but can also be used in battery valve circuits. In the latter case, however, the scheme is greatly restricted because we cannot usually afford to lose some of the H.T. voltage, and because it is not possible to deal with anything but the total anode current in practice, owing to the fact that all the filaments are connected in parallel and operate off the same accumulator. In the case of mains valves, however, each cathode is an electrode on its own, and there is no need whatever to connect them all together; hence it is possible to connect a resistance in series with a cathode, and to utilise the voltage drop across that resistance—due to the anode current of that particular valve—to provide a negative bias on the grid of that valve.

In Fig. 443 we have a simple L.F. circuit in which a transformer feeds into the grid circuit of an indirectly-heated valve, the output circuit of which contains a transformer fed from an iron-core choke. We are not concerned at present with the circuit, except in so far as grid-bias is obtained, and in Fig. 443 a grid battery is used. Since

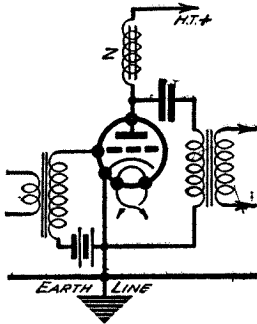

Fig. 443—Indirectly-heated cathode-valve circuit with grid-bias battery

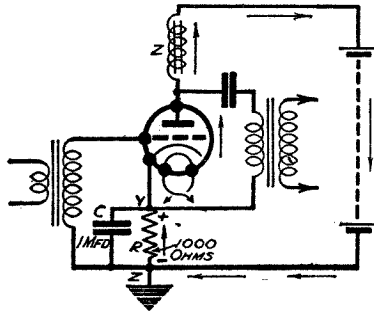

Fig. 444—A self-bias resistance R replaces the bias battery

one of the great charms in mains working is that there are no batteries to replace, a self-bias arrangement is usually employed, and Fig. 444 shows a resistance R in use. The anode current of the valve is shown passing round the circuit in the direction of the arrow. This, of course, is the electron current, and when it reaches the point Z it passes out through the self-bias resistance R to the cathode, and then through the valve to the anode, and so round.

This current may in some cases be definitely of an alternating nature, due to the character of the input signals. In the example given, it was reasonably steady owing to the parallel-feed system of coupling. There will, however, be a certain ripple of an A.C. character but of varying strength according to the audio-frequency signals being amplified; the frequency will also vary, perhaps between 50 cycles and 8,000 cycles. In addition there may be a slight ripple of an A.C. character on the H.T. supply, in spite of effective smoothing. Such a ripple, while perhaps making no difference to results when applied to the anode of a valve, becomes amplified when it is connected to the grid circuit. All these considerations make it desirable that the voltage developed across the grid-bias resistance R should be as steady as possible and therefore a condenser C of 1 mfd. or even 50 mfd. is employed. In a battery set, the filaments are usually all connected to earth, but in a mains receiver, the cathodes are more often than not at some potential (usually positive) with respect to the earth, while they may even be at high frequency potential to earth (e.g., in the case of a superheterodyne mixer valve).

For example, in Fig. 444 the cathode is at a positive potential with respect to earth, but since it is well insulated this is quite in order. The reader should familiarise himself with the idea that the return lead of a grid circuit may be connected to the earth-line and the grid still be negative. This is because the anode current through the valve does not depend upon the potential of the grid with respect to earth, but with respect to the cathode of that valve. If the cathode is positive with respect to earth, and the grid is at the same potential as the earth, then the cathode will be positive with respect to the grid; looking, therefore, at it from the point of view of the grid, the grid will be negative with respect to the cathode. One should consequently always find out not only what apparatus there is in the grid circuit between grid and earth, but between the earth and the cathode of the same valve. Any resistance connected between grid and earth will not alter the grid potential unless there is a current flowing through it. In practice, the potential of the grid is usually derived, as far as D.C. voltages are concerned, from the bias resistance in the

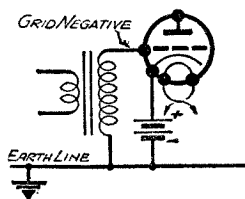

Fig. 445—Explaining how an earthed grid may be negative

cathode lead. To simplify an understanding of how grid potential depends upon the potential between cathode and earth, part of Fig. 443 has been drawn with a bias battery connected between cathode and earth, as shown in Fig. 445. It will be seen that the cathode is positive with respect to earth, while the grid is normally at earth potential. The result is that the grid is negative with respect to the cathode. Since

the cathode is free and insulated, the fact that a point on the grid circuit is earthed makes no difference.

Decoupling Self-Bias.—It is to be noted that the voltage-drop across a resistance in the cathode lead is due to the anode current of that particular valve only. The positive voltage from the high-tension supply is supplied perhaps to several different valves, but the current in each cathode lead will probably be different in each case. If the valve is being used as an L.F. amplifier the current in the cathode lead will, to some extent, be varied at low frequency, and since we do not desire such low-frequency currents to affect the grid of the valve (as otherwise we should obtain a negative reaction effect), we smooth out the voltage-drop across the bias resistance, leaving only the steady D.C. drop, due to the flow of the average anode current for that valve.

The simplest method is to connect a condenser of at least 1 mfd. across the resistance, although an electrolytic condenser of as much as 50 mfd. may be employed. Such a high capacity can

be used since the voltages across the condenser are quite small. The arrangement of the Fig. 444 shows that even though the transformer associated with the anode circuit of the valve is paralleled, there will be some L.F. component in the current passing from Z to Y, and it is necessary to smooth this out with the condenser C. Naturally, this condenser will be more effective for smoothing the higher audio-frequencies. Quite appreciable voltages will be established across C due to the A.C. component in the case of

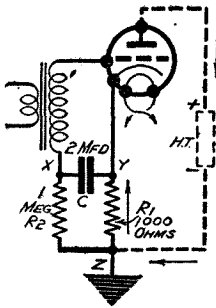

Fig. 446 — Decoupling the self-bias resistance

frequencies below 100, and the effect will be to reduce the degree to which these frequencies are amplified by the valve, owing to reverse reaction effects. If such trouble is experienced, a decoupling arrangement such as that shown in Fig. 446 may be employed for smoothing purposes. The resistance R_1 is now the main supply for the grid-bias voltage, and its value will usually be small (rarely above 1,000 ohms). The resistance R_2 and condenser C connected across R_1 form a potentiometer which taps down in the well-known manner the A.C. component across C, while in no way affecting the D.C. negative potential of the point Z. The potential difference between X and Y is the same as that between Z and Y.

Adjustable Self-Bias.—It frequently happens that advantages are to be gained by having an adjustable grid-bias (e.g., in the case of a variable- μ valve). There are two chief ways of effecting this. One is to vary the value of the bias resistance, as shown in Fig. 447, the decoupling resistance remaining at the same value since it makes no difference to the steady potential on the grid. Obviously when R_1 is at zero, there will be no potential on the grid, while if R_1 is a 1,000 ohms, then the grid voltage will be the voltage-drop due to the anode current flowing through a resistance of 1,000 ohms. The voltage-drop will be obtained by multiplying the value of the resistance by the current flowing through it in milliamperes and dividing the result by 1,000; one milliamperes through 1,000 ohms will produce a bias of -1 volt on the grid. Two milliamperes would produce -2 volts, and so on.

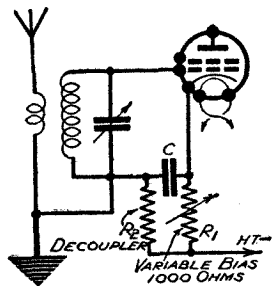

Fig. 447 — Varying the grid voltage by a rheostat R_1

The disadvantage of varying the bias resistance is that the anode

voltage will also be altered, and therefore the anode current. The greater the value of the bias resistance, the greater will be the voltage drop across it, but simultaneously the voltage on the anode of the valve will be decreased, and there will be some falling off in the anode current. This will result in a reduction of anode current. In fact, one of the advantages of a self-bias resistance is that for

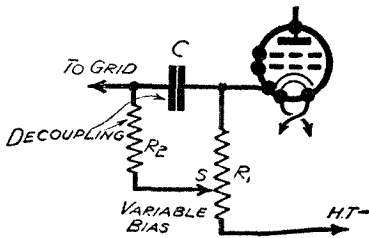

Fig. 448—A slider on the self-bias resistance varies grid voltage

a wide range of anode voltages a suitable negative grid bias will be automatically applied to the grid of the valve. The greater the anode voltage applied by a mains supply rectifier system, the greater will be the anode current, and this will produce a greater negative bias on the grid, which is exactly what we require when using higher anode voltages.

Self-bias is sometimes termed automatic bias for this reason.

A potential divider arrangement, as shown in Fig. 448, keeps the anode voltage constant while enabling any desired grid-bias to be obtained. This arrangement might be used for anode-bend detection, or for altering the voltage on the grid of a variable- μ S.G. valve.

The potentiometer for variable- μ valves is best graded so that near the maximum volume position the resistance covered by the slider is small for a given rotation of the control knob. The amount of resistance should increase rapidly as the knob is turned anti-clockwise to reduce volume. The variable- μ potentiometer is of the inverse log-law type (unsuitable for pick-up circuits).

Auto-Transformer Precautions.—Probably the safest arrangement for an L.F. transformer in a mains set is that illustrated in Fig. 449, which may be modified by decoupling the bias resistance. If, however, an auto-coupled arrangement such as that shown in Fig. 450 is employed, the decoupling arrangement is not advised,

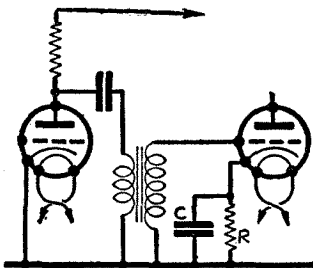

Fig. 449—Showing typical use of a self-bias resistance

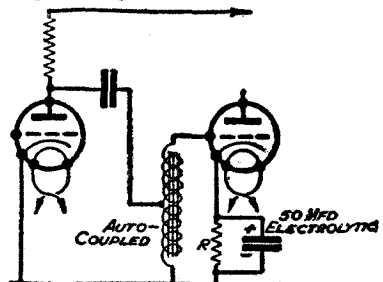
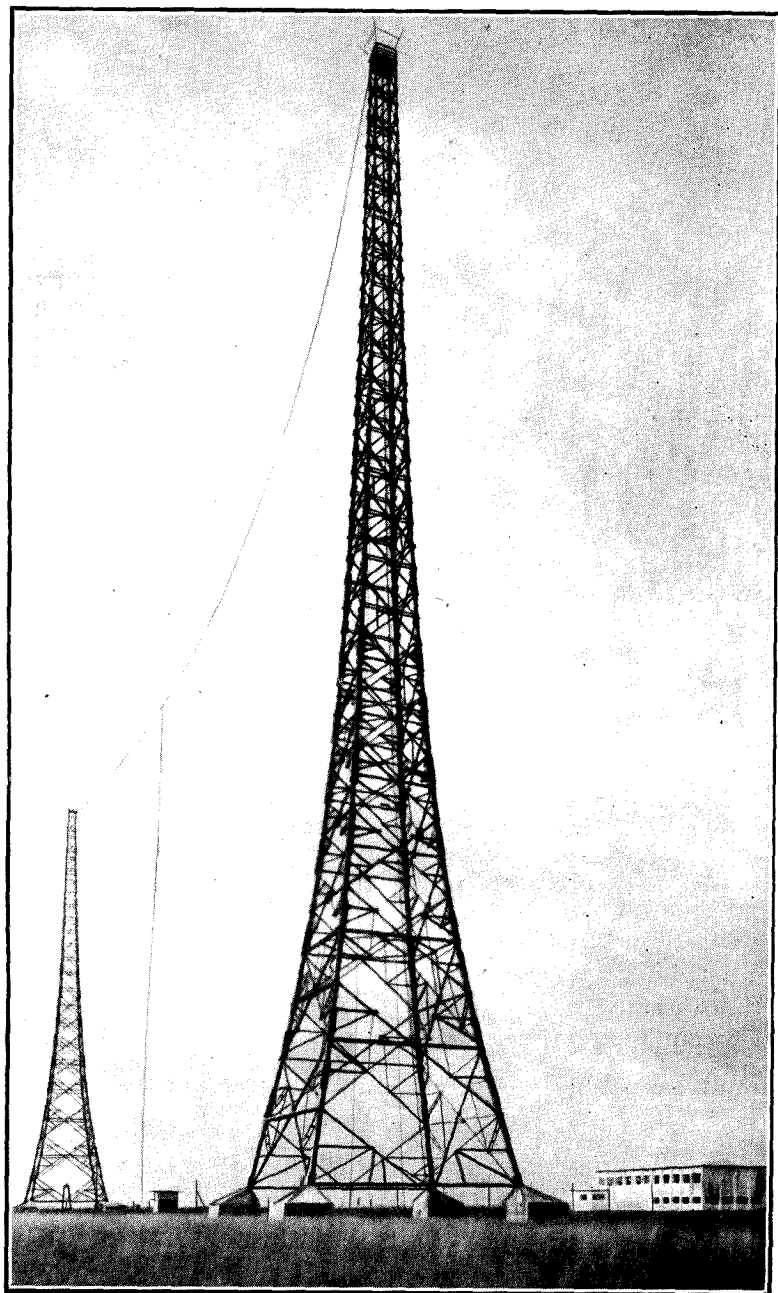

Fig. 450—In auto-transformer connections the above method is advised



GERMANY'S HIGH-POWER STATION AT MUNICH



A DIFFERENTIAL
CONDENSER
WITH SOLID
DIELECTRIC

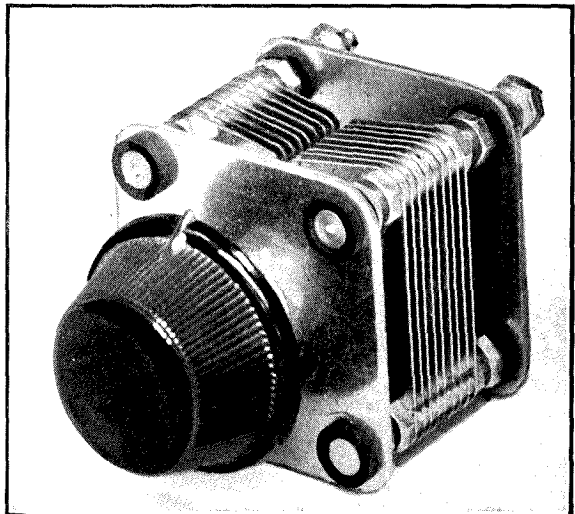

ANOTHER
FORM OF
DIFFERENTIAL
CONDENSER

A COMPACT
SOLID-
DIELECTRIC
CONDENSER

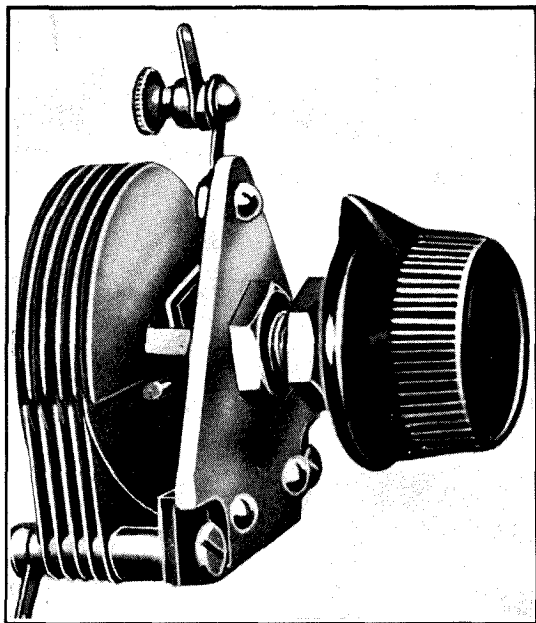

ANOTHER
CONDENSER OF
THE SOLID-
DIELECTRIC
DIFFERENTIAL
TYPE

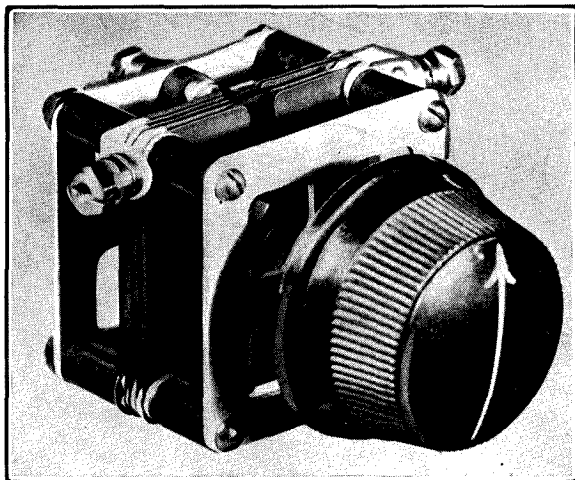



ELECTROLYTIC CONDENSERS CONTRASTED WITH MICA TYPE

because the A.C. voltages would be communicated through the primary winding to the anode and cathode of the preceding valve and would be stepped-up by the transformer. A large fixed condenser, such as an electrolytic of 50-mfd., may be connected in the manner shown in Fig. 450.

Self-Bias for Gramophones.—When it is desired to amplify from a gramophone pick-up, a self-bias resistance and condenser is extremely useful, and Fig. 451 shows a simple typical arrangement. This illustrates a power-grid detector with a switch for bringing into operation a pick-up. It will be noticed that the voltage drop across the bias resistance is not communicated to the grid of the valve because of the 0.001-mfd. grid condenser; when, however, the switch is on "Gram," the bias resistance gives the grid a suitable negative potential. In some cases the bias resistance is short-circuited when receiving radio signals, or a portion of it is short-circuited to enable a different voltage to be applied to the grid for radio detection, e.g., in anode-bend detection; in this latter case, it would be arranged that for gramophone work a

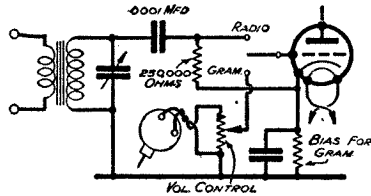

Fig. 451—Showing the use of self-bias in radiogram arrangements

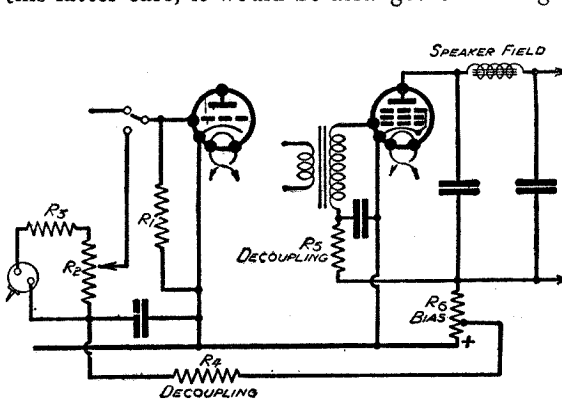

Fig. 452—Skeleton circuit in which negative bias is obtained from a resistance in the common H.T. lead

portion of the bias resistance would be short-circuited, since a smaller negative bias is required for amplification than for anode-bend detection.

The bias in an A.C. set is sometimes obtained by passing the whole of the H.T. current through

a resistance and taking tappings (suitably decoupled) from this resistance. A typical scheme is shown in Fig. 452.

Bias from the Rectifier Unit.—In some cases it is desirable to obtain the bias voltage from the rectifier unit. The desired voltage is then tapped off some resistance in the negative side

of the rectifier system, and this voltage is then smoothed by means of a resistance and condenser in the usual manner. In Fig. 453 the voltage-drop across the field-winding of the moving-coil loud-speaker is used to bias the grid of a pentode having a filament instead of an indirectly-heated cathode. The field-winding may have a D.C. resistance of 2,000 ohms, and consequently there may be a voltage-drop of as much as 100 volts across it. By the use

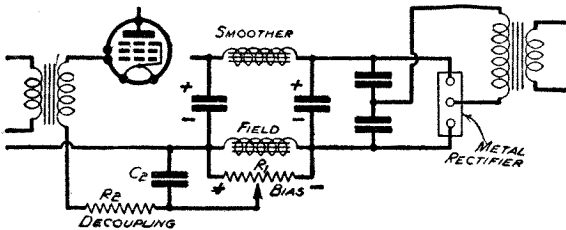

Fig. 453—Negative bias is here obtained from a potentiometer across the field-winding.

of a potentiometer R_1 across the field-winding, it is possible to tap off the desired bias voltage, which is then smoothed by R_2 and C_2 ; a smoothing choke is connected in

the rectifier circuit as shown, but sometimes the field-winding alone is regarded as adequate, although this cannot be regarded as good practice in most cases.

Positive Bias from H.T. Voltage.—The positive voltage of the screens of S.G. valves is obtained usually by a potentiometer arrangement consisting of two resistances in series, the whole being connected across the H.T. supply. The auxiliary grid of a pentode is usually kept at a voltage somewhat less than that of the anode, and a dropping resistance is usually inserted between the maximum H.T. voltage and the auxiliary grid. A condenser of large capacity is usually connected across this auxiliary grid and the cathode for decoupling.

Sometimes the auxiliary grid is fed from a potentiometer system, and such an arrangement is shown in Fig. 454, where a speaker field and two resistances of 10,000 ohms each are all connected in series, and across the maximum H.T. voltage. This arrangement for the speaker field

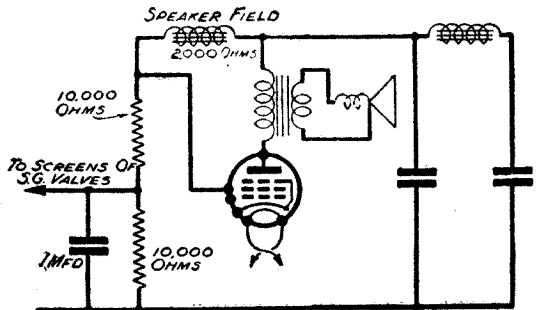

Fig. 454—The positive voltage of the auxiliary grid is obtained from a potential divider consisting of two resistances and a field-winding

is all connected in series, and across the maximum H.T. voltage. This arrangement for the speaker field

is an alternative to connecting it in series with the H.T. supply. The new arrangement prevents us from using the speaker field for smoothing or for additional smoothing purposes. It is being used in the present case as a means of dropping the voltage on the auxiliary grid of the pentode. The point between the two 10,000-ohms resistances is connected to the screens of the S.G. valves, and a 1-mfd. condenser is connected as shown for keeping the voltage constant and for short-circuiting any H.F. currents, and for general decoupling

The object of using a potentiometer for supplying the voltage to the screens of S.G. valves is to keep the screen voltage constant. If a series resistance were employed, an increase in screen current would result in a voltage being established across the resistance, the screen voltage consequently dropping. By the use of a potentiometer across the H.T. supply, and by making the resistances as low as possible consistent with economy of current, screen current changes may be made to have very little effect on the screen voltage.

The importance of keeping the screen voltage constant is to be specially noted in connection with variable-mu S.G. valves, where the control-grid voltage undergoes wide changes with consequent wide changes in screen current. A special resistance network is required for variable-mu working.

Fig. 455 shows a variable-mu H.F. pentode stage with a network of resistances suitable for providing a steady screen voltage and a variable control-grid bias. It will be seen that the current supplied by the H.T. unit takes two paths: one is a simple potentiometer scheme, consisting of the resistance R_3 and the fixed resistances R_2 and R_1 ; the other path is the electron current path through the valve, and the current now flows through R_3 , R_4 , through the valve and back to H.T. positive through the simple decoupling arrangement R_5 . The resistance R_4 , therefore, provides self bias to some extent, while the resistance R_3 also provides a negative bias to the grid. As the sliding contact on R_3 is moved downwards, the bias on the control-grid G_1 is increased, and this increase of negative potential on the grid will cause a decrease of screen current flowing through R_1 . The resultant voltage drop across R_1

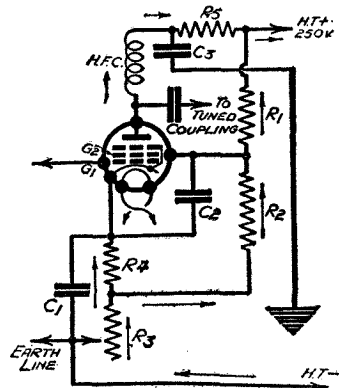

Fig. 455—The network of resistances for a variable-mu H.F. Pentode

(which is not as great as if no potentiometer were used) will cause the screen voltage to become more positive. Simultaneously, however, the downward movement of the sliding contact on R_1 has introduced a greater resistance in series with R_2 and R_1 , thus altering the distribution of the total H.T. voltage; consequently, the potential at the point between R_1 and R_2 (i.e., the

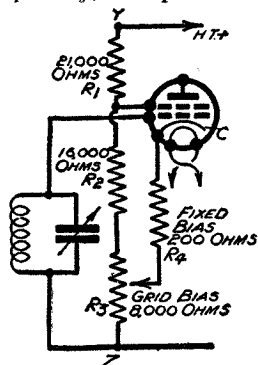

Fig. 456—Resistance network for an A.C. variable-mu S.G. valve

potential of the screen) will fall with respect to the cathode. There are thus two opposing influences, and they are so arranged that the screen voltage is kept constant.

A scheme for use in connection with a variable-mu S.G. valve is that illustrated in Fig. 456, and typical values of resistances are given. It will be seen that a 200-ohm fixed resistance is in series with the cathode; this is a ballast resistance to ensure that a small negative bias will always be on the grid of the valve. The object of this resistance is sometimes to prevent running into grid current at any setting of the potentiometer. This grid current commences in mains valves at about $-1\frac{1}{2}$ volts. Another advantage of a ballast resistance is that when the volume control, which governs the bias on the control grid of the variable-mu H.F. valve, is at maximum, there may be some tendency to self-oscillation, and a ballast resistance may be chosen to have such a value that this self-oscillation is not obtained at any value of the bias potentiometer.

Moving the slider downwards in Fig. 456 will result in a reduction in the negative potential on the grid. This will tend to cause an increase in screen current and, therefore, a drop in screen voltage, due to the passage of the screen current through the resistance R_1 . Simultaneously, however, we have increased the screen voltage with respect to the cathode when we moved the slider down the resistance R_3 . The two effects balance each other out and the screen remains at a constant voltage. Similar compensation occurs also when the slider is moved up the resistance R_3 and the grid is made more negative.

A Simple Mains Valve Receiver.—Probably the best way of explaining the various features of a mains receiver is to take a fairly typical example to show how it embodies various principles. Fig. 457 is a circuit diagram of a certain model in the H.M.V. range of radio-gramophones. At first sight the various resistances and condensers may intimidate the reader. The complete circuit

of Fig. 457 is specially labelled at different points to explain what the various components do. The first valve is a variable- μ S.G., while the second is a triode detector or, if records are being played, an L.F. amplifier. The last valve is a pentode which feeds a moving-coil speaker. The supply of H.T. comes from a full-wave rectifier valve, and the field-winding of the moving-coil speaker is used as the smoothing choke. A tapping on this winding also provides the bias for the grid of the pentode, the usual smoothing resistance and condenser being provided. A "hum-bucking" coil is provided, and is adjusted to produce a reversal of any mains hum, i.e., A.C. parasitic current of mains frequency (usually 50 cycles).

The high-frequency input arrangement consists of a band-pass tuner of the capacity-coupled type with switches for short-circuiting the long-wave winding when receiving stations on the medium waveband. The screen derives its voltages from a potentiometer arrangement across the main supply of H.T. A switch shorting the lower half of the potentiometer will put the S.G. valve out of action and prevent radio signals drifting over when the gramophone is in use.

Note that the volume control is arranged in the manner already explained—i.e., so that the screen voltage is kept constant. The anode circuit of the valve contains a choke for passing on the H.F. to the tuned circuit which is across the grid and cathode of the detector. The anode circuit of the first valve also contains a resistance and condenser for decoupling. This resistance in mains-valve practice usually has a value of 600 ohms or 1,000 ohms, while the condenser may have a value of $\cdot 1$ mfd, or as much as 1 mfd. The object of the resistance and condenser is to prevent any H.F. current from reaching other parts of the set where it is not wanted. Sometimes, however, this decoupling scheme is also used for the purpose of ensuring that the anode voltage of the S.G. valve is kept steady; by keeping any A.C. ripples away from the S.G. valve it is possible to reduce the chance of *modulation hum*—i.e., modulation of the carrier wave of an incoming signal by traces of low-frequency current. This trouble is likely to occur in all cases, and it is impossible to get rid of the effect by ordinary means, if at all. When the decoupling arrangement has also to act as a further smoothing device, higher values of resistance and larger values of decoupling condenser are employed. A low value of resistance is used for H.F. decoupling because even a $\cdot 1$ -mfd. decoupling condenser has quite a negligible reactance to H.F. currents.

Note that two reaction windings are provided, one for the medium and one for the long-wave coil, while the reaction condenser is

arranged so as to reduce hand-capacity effects. A resistance is connected in the position shown when receiving the long waves ; this is to increase the stability of this waveband. It will be seen that in both cases both the anode and grid connections to the coil are tapped down the coil. This increases selectivity and stability.

The bias resistance for gramophone work is short-circuited for radio reception. Note that a potentiometer is connected across the heater connections of the detector valve, and that the cathode is joined to the sliding contact on this potentiometer. Potentiometers for this purpose usually have a resistance of about 30 ohms, and are connected across the 4-volt windings of the mains transformer ; the sliding contact will usually be approximately half-way along the resistance, but an accurate adjustment will be found to reduce hum in many cases. Frequently a potentiometer is dispensed with, and the earth-line of the receiver is connected to a middle tapping on the heater winding of the mains transformer.

The anode circuit of the detector valve contains an H.F. choke inserted for the purpose of feeding the reaction winding. It will be noticed that each end of the choke is connected to the cathode through a condenser. This constitutes an H.F. filter and serves to by-pass H.F. currents in the anode circuit of the valve. These condensers usually have a value of .0005 mfd. each. The one which is connected across anode and cathode passes sufficient H.F. to minimise Miller effect when no reaction is in use ; there is thus no reverse reaction effect due to the capacity coupling between anode and grid inside the valve. The upper of the two filter condensers is intended to short-circuit any H.F. which gets through the H.F. choke. It is highly undesirable that any H.F. should get into the L.F. circuits of the receiver. The L.F. iron-core transformer is parallel-fed by means of a resistance and condenser, and the anode circuit of the second valve contains not only the L.F. coupling resistance, but also two further resistances and two condensers which provide a cheap and effective system of smoothing for the anode circuit of the detector valve.

This extra smoothing is necessary in view of the fact that only the field-winding of the speaker is used for smoothing the H.T. supply. The auxiliary grid of the pentode is given a somewhat lower voltage than the maximum by means of a voltage-dropping resistance, a decoupling condenser being provided in the usual manner. The primary of the speaker transformer has connected across it a condenser which prevents the exaggeration of high notes. In this circuit the student will find that this condenser has connected in series with it a resistance which may be varied to give adjustable tone control.

A practical rather than a technical feature is the connecting of a dial light across the heater winding; this lamp illuminates the dial readings.

Mains Aerials.—The electric-light mains pick up wireless signals since the electric wiring inside the house obviously acts somewhat after the fashion of an indoor aerial, and it is possible to use the mains as an aerial by connecting a condenser across the aerial terminal of the set and one side of the primary of the mains transformer. A mains aerial terminal is provided on the set under discussion, and it is connected, when desired, to the aerial terminal. The condenser has to be flawless as regards insulation; sometimes two condensers are connected in series for extra safety. A typical mains aerial connection is shown in Fig. 458. A safety condenser of $\cdot 01$ mfd. is connected in series with a $\cdot 0005$ -mfd. condenser.

Biasing Two H.F. Stages.—When two stages of H.F. amplification are employed and valves of the variable-mu type are to be

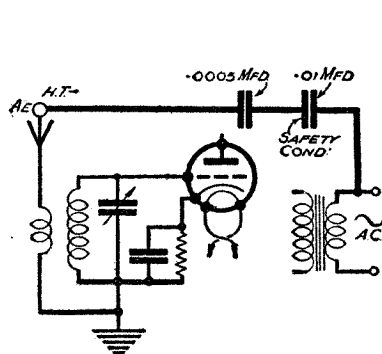

Fig. 458—A condenser (or two for safety) between mains and aerial terminals

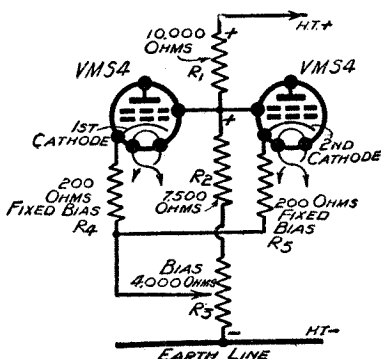

Fig. 459—Resistance network for two variable-mu S.G. valves

used, the resistance network for the various voltages requires modification as regards values since the currents involved vary. We have already seen in Fig. 456 the arrangement for a single valve of the V.M.S.4 type, and a similar Fig. 459 gives the resistances suitable for two V.M.S.4 valves.

Receiver With Two H.F. Stages.—A typical modern receiver circuit using two stages of H.F. amplification is reproduced in Fig. 460, and the resistance network just described is shown in use. The various components are labelled as before to explain their use, but a few comments may be desirable. The resistances R_3 and R_7 are for H.F. decoupling. The 200-ohm resistances in series with each cathode in the case of the H.F. valves is for the purpose

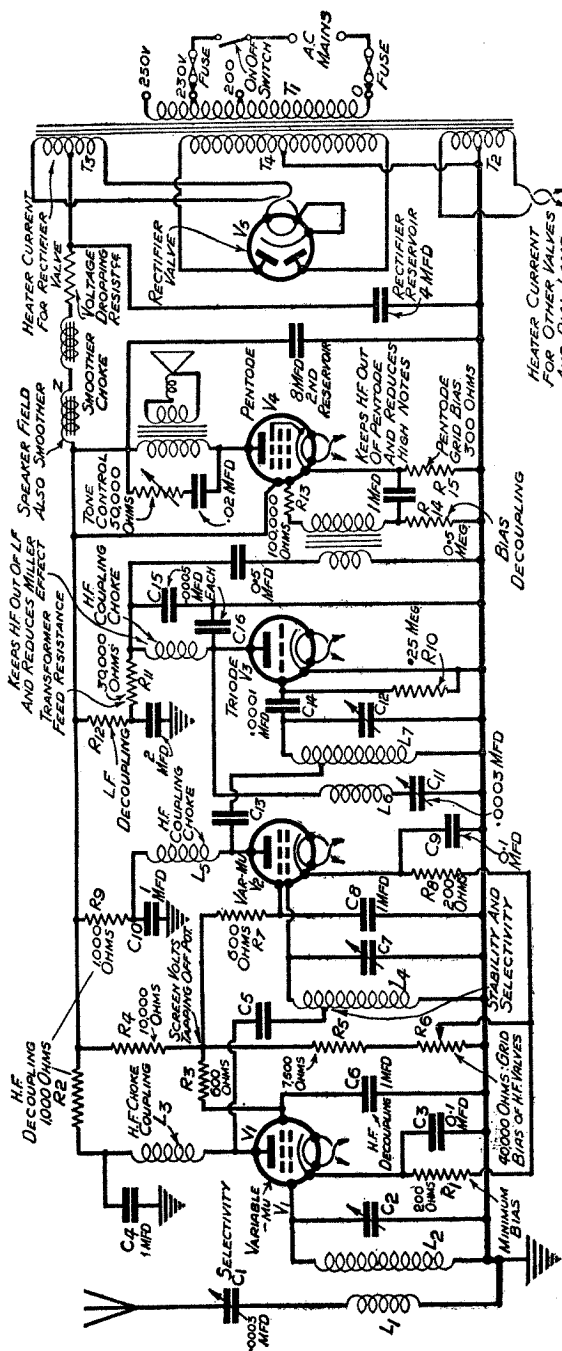

Fig. 460—A commercial type of receiver using five indirectly-heated-cathode A.C. valves and an indirectly-heated-cathode full-wave rectifier; note the potentiometer arrangements for the two variable- μ valves

of ballast, as previously explained. A tone-control resistance is connected in the anode circuit of the pentode, a reduction of the resistance resulting in a reduction of the top notes, of heterodyne whistles and high-tone interference generally. Ample decoupling of the grid circuit of the pentode is provided, and a resistance R_{13} of 100,000 ohms is chiefly to keep H.F. from the grid circuit of the pentode; incidentally, it will reduce to some extent the higher notes of audio-frequency. The smoothing arrangements for the mains unit comprise the speaker-field and also an L.F. choke which should be of a generous character; a voltage-dropping resistance may be included where shown.

The rectifier valve is of the indirectly-heated-cathode type the cathode being connected to one side of the heater wires. The middle point on the heater current winding is connected to the earth-line of the receiver to reduce hum. Various terminals are

provided on the primary of the mains transformer so as to make the set capable of operating on different mains voltages.

S.G. for Anode - Bend Detection.—A mains S.G. valve may be used for anode-bend detection, and one method which has been adopted is that illustrated in Fig. 46r. It will be seen that a coupling resistance of 250,000 ohms is used with a 100,000-ohms stopping resistance for keeping H.F.

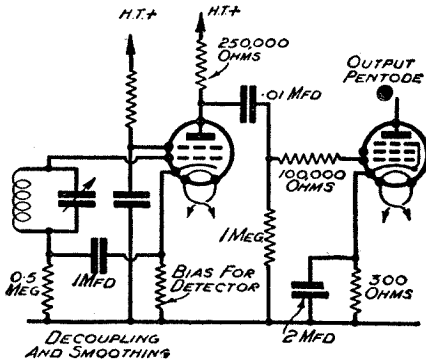

Fig. 46r.—An S.G. valve is used as an anode-bend detector and is resistance-coupled to next valve

out of the grid circuit of the output pentode. Self bias is provided for, giving both grids a negative potential, decoupling being employed in the grid circuit of the detector valve.

CHAPTER 30

UNIVERSAL MAINS RECEIVERS

Owing to the fact that electric light mains are sometimes D.C. and sometimes A.C. the need has sprung up for receivers which, without alteration, can be used on any type of mains supply.

The indirectly-heated valve provides a solution of these difficulties, and Fig. 463 shows a type of circuit which has proved popular in America. The first valve is a variable-mu H.F. pentode with variable grid-bias, a ballast resistance being inserted to prevent

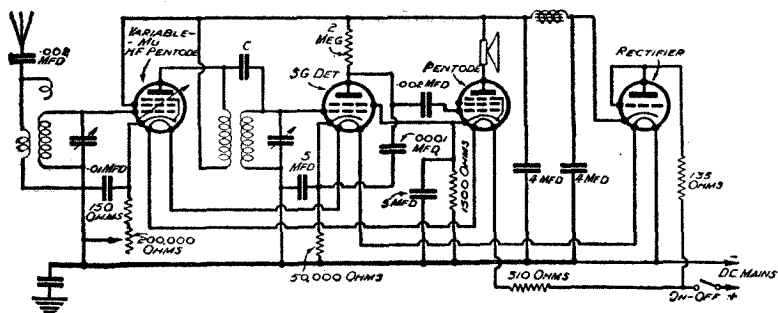

Fig. 463—Simple American universal receiver which can be connected to D.C. or A.C. mains. On D.C. the rectifier valve acts simply as a resistance

the grid reaching a value where grid current commences. The anode is coupled to the grid of the next valve, which is an S.G. detector by means of an H.F. transformer, the secondary of which is tuned. There is also coupling between anode and grid by means of the condenser C, the object of which is to level out the amplification—i.e. to give a fairly constant degree of transference of energy for different wavelengths; the inductive form of coupling is thus supplemented by capacity coupling

The heaters of all the valves, including the indirectly-heated-cathode rectifier are connected in series, an additional resistance of 310 ohms being also connected in series with the heater supply. The value of this resistance will depend upon the mains voltage. The rectifier is of the two-electrode type, the grid and anode of a

three-electrode valve being connected together in some cases. Half-wave rectification is provided and will rather tend to produce hum.

When the set is used for D.C. mains operation, the rectifier valve simply acts as a resistance in series with the anodes of the other valves, the electron currents passing from the cathode to the anode of the rectifier.

The small unfinished coil above the secondary of the input transformer to the set is simply a convenient manufacturing method of applying capacity coupling from the aerial to the grid; the unfinished coil acts as the plate of a condenser.

CHAPTER 31

THE SUPERHETERODYNE

The most popular commercially made receiver to-day is undoubtedly the superheterodyne, because of the great selectivity which may be simply obtained by using the supersonic heterodyne principle.

Before considering the supersonic heterodyne arrangement, the reader should be made familiar with the ordinary heterodyne principle which is used for the reception of continuous waves in wireless telegraph communication. In the ordinary way, the continuous waves (resulting from a continuous H.F. alternating current) produce no sound in a wireless receiver which is designed to receive spark signals or broadcasting. There is, in fact, no *modulation* and the rectified continuous waves simply produce a steady direct current in the output circuit of the detector.

If, however, we apply a local source of continuous oscillations of a frequency slightly different from that of the incoming signals, there will be an "interference" effect causing the continuous oscillations in the receiver circuit to rise and fall regularly. Fig. 464 shows the simplest form of so-called *heterodyne* receiver consisting of a valve detector and a local

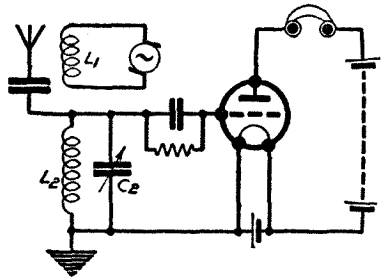

Fig. 464—A heterodyne receiver for the reception of continuous wave Morse

source of oscillations fed by an inductance L_1 into the tuned circuit $L_2 C_2$; in the anode circuit of the detector valve is a pair of telephone receivers. The source of oscillations at this receiving station will consist of an oscillating valve, and the frequency may be altered by varying the setting of a condenser in its grid circuit or anode circuit. Fig. 465 shows a simple arrangement, the anode coil of the oscillator valve being coupled to the inductance in the grid circuit of the detector valve. When the oscillator valve is not working the detector

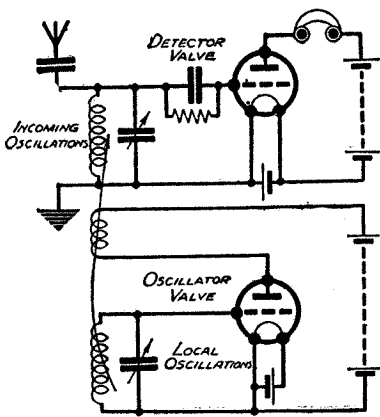

Fig. 465—A local oscillating valve heterodynes incoming continuous oscillations

will not respond to the incoming continuous waves. If, however, the oscillator is working and tuned to a frequency close to that of the incoming signals, a musical note will be heard, and this will be heard in the form of the dots and dashes of the received Morse telegraph signals. If a steady stream of continuous waves is being received there will be a steady musical note heard in the telephones. This is the effect obtained when a broadcast receiver is made to oscillate during an interval in a broadcast programme.

Production of Beats.—If two sets of alternating currents of similar frequency are fed into a circuit, the resultant current will be an alternating one, and its strength will depend upon whether the two sets of alternating current are *in phase* or not. If they are in phase the currents at any given moment will be flowing in the same direction and will help each other; the result is that twice the current is obtained. When, however, such a current is 180 degrees *out of phase* at any given moment the currents in the circuit will be equal and opposite, with the result that there will be no resulting current. When the relationship between the phases is different from the examples given the resultant current will be alternating, but will have a strength depending upon the *phase relationship*.

An entirely different state of affairs arises when one of the frequencies differs from the other. Instead of the result being an alternating current of constant amplitude, *beats* will be formed. Fig. 466 shows in its two top lines the two sets of alternating current. The third line shows the resultant

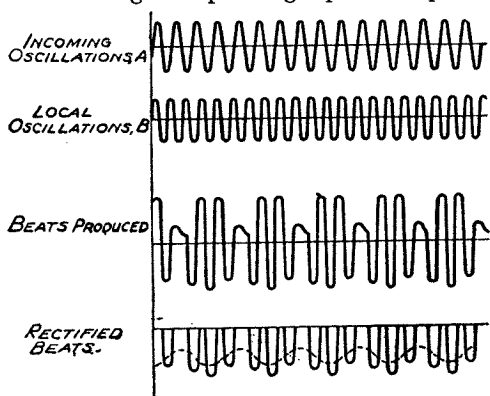

Fig. 466—Graphical representation of the effect of two sets of oscillations of differing frequency

current which, it will be noticed, is alternating in form but rises at regular intervals to peaks which are known as beats, the current falling to a very low value in between the beats. The reason why beats are formed is that the current in the second line will sometimes be helping and at other times opposing the current in the first line.

These beats are similar in form to a modulated oscillating current, and, when rectified, will produce a musical note corresponding to the beat frequency—i.e. the number of beats per second.

In the case of a wireless receiver of the kind shown in Figs. 464 and 465, the local oscillations are forced into the grid circuit, where they mix with the incoming H.F. currents and produce beats which are then rectified by the detector as shown in the fourth line of Fig. 466. Only after rectification do beats produce any effect on the telephones; while unrectified, they still remain H.F. even though the amplitude varies, and H.F. will not affect telephones. The local oscillations can be forced into the receiving circuit because the latter is tuned to a frequency differing only slightly from that of the local oscillations.

Self-Heterodyne Receivers.—In order to economise by one valve, the circuit of Fig. 467 is sometimes used for the reception of continuous wave telegraph signals. It will be seen that the circuit is identical with that of an ordinary reaction receiver suitable for broadcasting, but it is operated in such a way that the valve oscillates; this is made to happen by tightening the reaction coil coupling to the grid circuit inductance. In this type of receiver the variable condenser alters not only the receiving circuit tuning, but the frequency of the local oscillations which are generated by the valve which acts both as oscillator and detector. Actually, the circuit is tuned to produce local oscillations slightly differing in frequency from the incoming signals; consequently, the receiver circuit is slightly mistuned. This, however, does not weaken the incoming oscillation to any great extent, since the difference in frequency is only small (say, 1 kilocycle in the case of C.W. telegraph reception).

Let us now consider the effect of varying the frequency of local oscillations when receiving a continuous wave of, say, 300 metres.

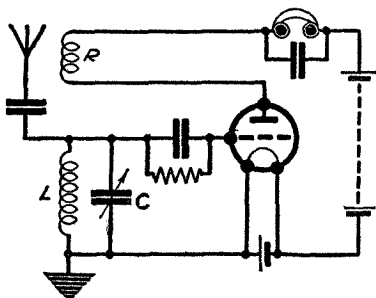

Fig. 467—A simple self-heterodyne receiver; by tightly coupling R to L the valve is made to oscillate

To obtain the frequency from the wavelength one divides 300,000,000 by the wavelength; 300,000,000 divided by 300 is 1,000,000. Therefore the 300-metre signals have a frequency of 1,000,000.

Fig. 468 is a table showing the frequency of the beats produced when incoming signals of different frequencies affect the receiver; the frequency of the local oscillator is kept at 1,000,000.

An incoming signal of 300 metres, corresponding to a frequency of 1,000,000 will clearly produce no beats with a local frequency of 1,000,000, and therefore nothing will be heard in the telephone receivers. If, however, the incoming signal has a frequency of 1,001,000, then the beats produced will have a frequency of 1,001,000 minus 1,000,000, which equals 1,000. The beat-frequency is always equal to the difference in frequency of the two sets of oscillations. It is to be noted that if the incoming frequency is lower—say, 999,000—there would also be a beat frequency of 1,000. The following rule should therefore be remembered: There are always two wavelengths, one above and one below that of the local oscillations, which will produce the same beat note.

In the case of telegraph communications, the operator can adjust the note of the Morse signals simply by altering the frequency of his local oscillator.

Selectivity of the Heterodyne.—The heterodyne is a highly sensitive arrangement, but its great merit lies chiefly not only as a convenient way of receiving continuous waves efficiently, but of providing great selectivity. The reason for the latter effect is that if there are different frequencies being received due to different stations on closely approximating wavelengths, the local oscillator will produce different beat frequencies with each. If the frequency difference between the incoming signals and the local oscillation is 1,000 a beat frequency of 1,000 will be heard. But if the interfering signal has a frequency of, say, 990,000, then the beat

LOCAL FREQUENCY = 1,000,000	
INCOMING SIGNAL FREQUENCY	RESULTANT BEAT FREQUENCY
870,000	130,000
880,000	120,000
890,000	110,000
900,000	100,000
910,000	90,000
920,000	80,000
930,000	70,000
940,000	60,000
950,000	50,000
960,000	40,000
970,000	30,000
980,000	20,000
990,000	10,000
1,000,000	0
1,010,000	10,000
1,020,000	20,000
1,030,000	30,000
1,040,000	40,000
1,050,000	50,000
1,060,000	60,000
1,070,000	70,000
1,080,000	80,000
1,090,000	90,000
1,100,000	100,000
1,110,000	110,000
1,120,000	120,000
1,130,000	130,000

Fig. 468—Beat frequencies produced by different incoming signals

frequency will be 10,000, which will be a very high musical note. The operator would find no difficulty in receiving the desired station in spite of the interference of the much higher note. The human ear, it will be noted, is being used as a selector, and the effect is still more marked when the frequency difference is either very small or very large, because the human ear cannot readily respond to frequencies below 30 per second, or above 30,000 per second.

These limits vary with the individual, his age, etc. Many

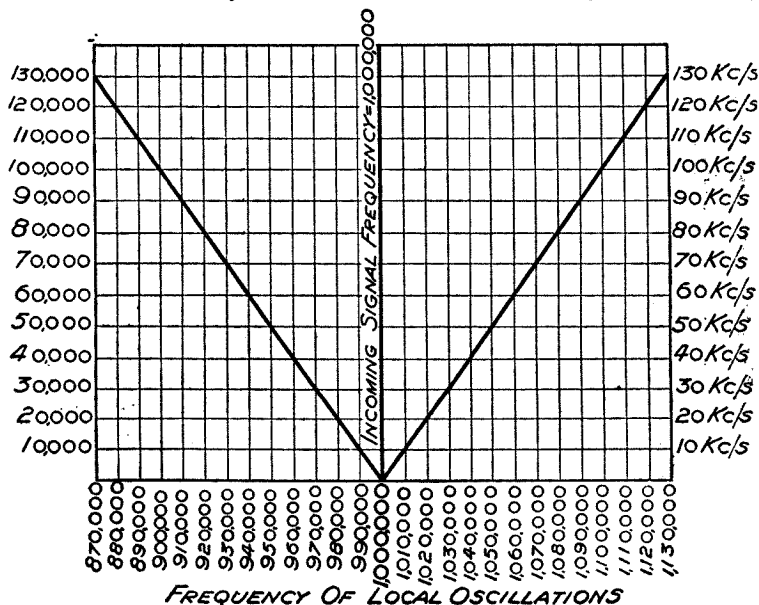

Fig. 469—This shows graphically the effect on the beat frequency produced by adjusting the local oscillator to different frequencies

people, especially elderly ones, would be unable to hear a note having a frequency above 15,000. Obviously, in such cases a normally-interfering signal 15,000 cycles away from the local frequency would produce no effect at all, and would not be heard. A graph showing the effect of varying the local frequency is shown in Fig. 469. The base represents the frequency of local oscillations, while the vertical line on the left shows the resultant beats. The scale on the right is the same as that on the left, only it is shown in kilocycles; this is more convenient than putting all the noughts.

Supersonic Beats. When the beat-frequency is above the audible limit, it is said to be *supersonic*. We have seen that the human ear, by refusing to respond to higher notes than, say, 30,000, assists in achieving wireless selectivity. Electrical apparatus,

however, may be used to assist the human ear in this process of responding only to certain notes. For example, we can feed the beat notes which have now become a form of alternating current of the beat frequency, into a tuned circuit which resonates at the beat frequency. The telephones, or loudspeaker, will be preceded by a filter in the form of a tuned L.F. circuit which will pass out at full strength the beat frequency but will attenuate (i.e., reduce) other frequencies. Since these other beat frequencies are due to the interaction of interfering signals with the local oscillation, wireless selectivity will be greatly enhanced by this form of low-frequency tuning.

In practice, we do not produce a low-frequency beat note and then tune to it. Instead we arrange to make the beat note supersonic. It is a simple matter to make this beat note anything we desire, and we can arrange to make it as high as 100,000 cycles, which corresponds to a wavelength of 3,000 metres. Having obtained this beat frequency, we then apply it to an ordinary high-frequency amplifying system, consisting of valves and tuned circuits resonating at 3,000 metres. It will be seen that interfering signals will produce a different beat note which will be completely "tuned out" by the amplifier circuits.

We had assumed that the incoming signals are of continuous wave-form, and consequently the beat frequency will be also an alternating current having a frequency of 100,000. It is as though we had converted the incoming 300-metre signals into signals of 3,000 metres wavelength. These signals, when rectified by a detector, will produce no audible effect in the telephones or loudspeaker. When continuous waves are being received for telegraph purposes, a second local oscillator is required; this will be tuned to a frequency of, say, 101,000, so as to produce a beat note of 1,000. This is an ordinary L.F. current, and can be amplified by an ordinary L.F. amplifier in the usual way, e.g., by using iron-cored step-up transformers.

The Three Frequencies.—There are three frequencies in any supersonic heterodyne receiver.

(1) The original incoming frequency, sometimes called the *signal* frequency.

(2) The lower frequency caused by mixing local oscillations with the incoming oscillations, and rectifying the result. This is known as the *intermediate* frequency.

(3) The ordinary low-frequency resulting from final detection.

Not only are there three frequencies but there are two detectors, the first being for the purpose of separating the beats, just as we use a detector for separating the desired L.F. modulations from the

modulated high-frequency currents. The second detector is the ordinary normal one for converting the intermediate-frequency signals into L.F. currents, which can operate telephones or a loud-speaker.

Superheterodyne Broadcast Reception.—The use of a second heterodyne is unnecessary when the original oscillations produced in the aerial circuit are due to a broadcast transmitting station. In this case the oscillations are modulated at audio frequency, there being a carrier-wave and sidebands corresponding to the different audio frequencies. The whole of this array of frequencies is heterodyned by a local oscillator, which usually is adjusted 110 kilocycles above the signal frequency. Beats are produced and the mixture is rectified by a valve detector, and the resultant beats, which have an average frequency of 110 kilocycles, are then

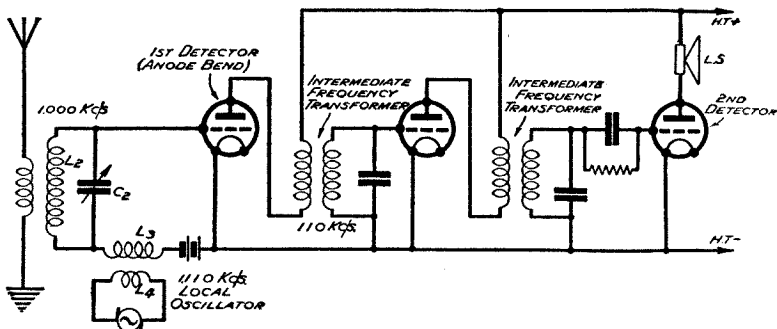

Fig. 470—A complete simple supersonic heterodyne receiver showing the grid injector system and the use of intermediate-frequency circuits

applied to a series of tuned circuits resonating at 110 kilocycles. After amplification, the high-frequency currents, which really correspond to a modulated carrier-wave of 2,727 metres wavelength, are detected in the usual manner by the second detector.

It is not essential that the intermediate-frequency circuit shall be associated with a stage of high-frequency amplification, but at least one valve is usually used for this purpose. Fig. 470 shows a complete, but very simple, superheterodyne circuit for broadcast reception. The local oscillations are fed into the grid circuit of an anode-bend detector by means of the coupling between the inductance coils L_4 and L_3 . It will be noticed that this *injection* takes place into a separate coil outside the tuned circuit; this is because the frequency difference between the local oscillations and the incoming signals is too great to enable one to force the oscillations conveniently into the tuned circuit which would be tuned to the incoming signals.

Let us assume that the incoming signals have a wavelength of 300 metres (1,000 kilocycles). The local oscillations are adjusted to 1,110 kilocycles. The first detector acts as a converter, the mixture between the 1,000-kilocycle signals and the 1,110-kilocycle local oscillations producing beats which, when rectified, will energise the intermediate-frequency (abbreviated to I.F.) circuit which is tuned to the beat frequency, namely, 110 kilocycles. The second valve acts as an amplifier of this intermediate-frequency signal, and the last triode acts as a detector in the ordinary way. Further stages of low-frequency amplification may be employed.

Although the intermediate-frequency transformers are tuned to 110 kilocycles, they must be sufficiently broadly tuned to amplify signals having a frequency at least 5 and perhaps 10 kilocycles on either side of this carrier-frequency; this is because we must keep up the amplification of the sidebands. Frequently, both primary and secondary of the intermediate transformer is tuned, and the whole coupling may be designed to act as a band-pass filter with a flat-topped resonance curve. In practice, the transformers are all matched and adjusted to respond to a fixed frequency, but trimmers are often provided. It is usual to tune to 110 kilocycles. The local oscillator is therefore adjusted so as to produce a beat frequency of 110 kilocycles, when the desired station will be received.

An interfering signal of, say, 1,040 kilocycles will also produce beats with the local oscillator which has a frequency of 1,110 kilocycles. The resultant currents applied to the intermediate-frequency transformer will have a frequency of 1,110 minus 1,040 kilocycles, which equals 70 kilocycles. The intermediate-frequency transformer will reject this frequency, and therefore there will be no interference from it. It will be realised that if the interfering signal has a frequency very close to the original frequency desired, there will be some interference also in the intermediate-frequency stages, but these should be made as selective as possible without causing

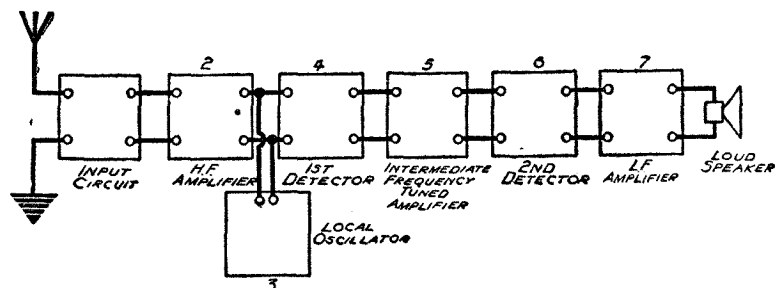

Fig. 471—All superheterodynes have a great deal in common and this schematic diagram shows the constituent parts of a common type of circuit

undue reduction of sidebands, although some pruning of these may be permitted if the subsequent low-frequency circuits are provided with tone correction.

A complete chain of apparatus is illustrated in Fig 471, where boxes represent the different stages in a superheterodyne receiver.

Double Tuning Points.—It is possible to obtain beats of a given frequency at two different settings of the oscillator condenser. Let us suppose that the incoming frequency is 1,000 kilocycles, and the local oscillator is first adjusted to 1,110 kilocycles. This corresponds to a wavelength below that of the incoming signal. The resultant intermediate frequency created will be 110 kilocycles. If we now adjust the local oscillator to have a frequency of 890 kilocycles, the beat-frequency will once more be 110 kilocycles, and therefore the intermediate circuit will pass on this frequency ; in other words, the station will be heard. This means that for any station there are two settings of the local oscillator which will enable the station to be heard. This may cause a great deal of confusion, which can be obviated by keeping the tuning and oscillator condensers more or less in step, while if a single knob is used for controlling both the tuned circuit and the oscillator circuit, no repeat points are obtained.

Added Frequencies.—No mention has yet been made of what occurs when the local oscillations and the incoming oscillations have their frequencies added. Actually two sets of oscillations not only produce oscillations corresponding to a difference in the two frequencies, but also to the addition of them. For example, if the incoming frequency is 1,000 kilocycles and the local oscillator has a frequency of 1,110 kilocycles, not only is a 110-kilocycle signal produced, but also one corresponding to the sum of the two frequencies, viz., 2,110 kilocycles. This corresponds to a wavelength almost half that of the incoming signal and the merits of long-wave amplification as regards sensitivity, ease of handling and selectivity would be lost. No use therefore is made of this very high frequency and it is the signal produced by the difference between the two frequencies that is used in actual practice.

Second-Channel Interference.—It has been explained that there are two oscillator frequencies which will enable a superheterodyne to receive a certain station. It has also been shown that for a given oscillator setting, two different incoming frequencies will give the same intermediate frequency. This means that not only will a desired station produce the beat frequency of, say, 110 kilocycles, but if there is another station whose frequency is 110 kilocycles on the other side of the local oscillator frequency, then that station will also be heard and cause

interference. For example, with the oscillator adjusted to 1,110 kilocycles, the station working on 1,000 kilocycles will be heard. If, however, there is a station working on 1,220, then an intermediate frequency of 110 kilocycles will also be produced by that station. There will thus be serious interference, and this is known as *second-channel interference*. The obvious remedy for this trouble is to introduce a sufficient degree of selectivity in the input H.F. circuit ; consequently, it is common practice to use two or even more signal-frequency circuits on the input side of a superheterodyne. The station producing this kind of interference will be separated from the desired station by twice the intermediate frequency, so that the higher the intermediate-frequency is made, the less chance will there be of second-channel interference. It is common to arrange an intermediate frequency of 110 kilocycles, so that the interfering station will be 220 kilocycles away from the desired station. This is quite a considerable " distance " away and it should not be difficult to arrange a sufficiently high degree of selectivity to prevent weak signals occurring in the grid circuit of the first detector. If, however, a superheterodyne is used near to one of the high-powered Regional stations, one may expect second-channel interference, but only on two stations. A complete remedy lies in the provision of a highly-selective input circuit, sometimes called the pre-selector circuit.

Background Noise.—A superheterodyne tends to produce more background noise than a " straight " set. For example, when a valve oscillates a hissing noise or a breathing sound can be heard, and if this is amplified it will be exaggerated. Excessive intermediate-frequency amplification will tend to increase background noise, while if the signal is increased in the first place before being converted to the intermediate frequency, it is only necessary to pass through one stage of intermediate-frequency amplification. Sometimes the intermediate-frequency is not amplified at all.

Filtering Out the Intermediate-Frequency.—The intermediate-frequency being comparatively low is very liable to get into the L.F. part of the receiver, and it is thus necessary to ensure that there is no drift-over of these currents. The methods adopted are usually the same as those for sifting out H.F. currents in a straight set.

Mixer Circuits.—The conditions required in a superheterodyne frequency converter are :

- (1) That a locally-generated source of constant oscillations should be provided, the frequency being different from that of the incoming signal.

- (2) That the incoming H.F. and the locally-generated H.F. currents should be applied to a rectifier.

Given these two requisites, it will be seen that an extremely large number of schemes can be and have been devised to produce the requisite beats.

Let us consider some of the more important. Fig. 472 shows the signal H.F. currents being fed to the grid of an anode-bend detector,

the source of local oscillations being fed into the grid circuit. This source will be an oscillating valve, the frequency being adjustable.

The valve shown is acting as an anode-bend detector and the anode circuit contains the intermediate-frequency tuned circuit or circuits. Having once obtained the intermediate frequency one can then apply it to a detector or to further H.F. amplifying valves, which will magnify the intermediate frequency with its accompanying sidebands. Fig. 473 shows a similar arrangement in which leaky-grid-condenser rectification is used.

Anode Injection.—Instead of feeding the local oscillations

into a grid circuit, they may be applied to the anode of the first detector valve (Fig. 474), and this has the advantage that the locally produced oscillations do not reach the aerial

circuit, and therefore do not cause interference by radiation. This is particularly the case if an S.G. valve is used as a detector since the screen will prevent coupling with the grid circuit. While on the question of radiation from the aerial, it should be noted that the more selective the input circuits are the less will be the tendency to radiate the local frequency since this differs in frequency from the circuits by, say, 110 kilocycles.

Fig. 475 is similar to Fig. 474, but leaky-grid-condenser rectification

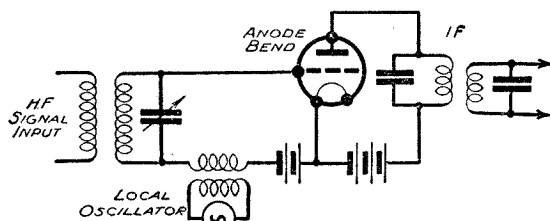

Fig. 472—The grid injector system applied to an anode-bend detector. An I.F. transformer is in the output circuit

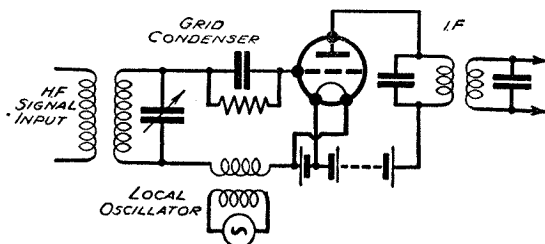

Fig. 473—Application of the grid injector system to a "first detector" operating with grid condenser and leak

is now employed. In this, and in fact all the circuits so far given, the valve may be of the S.G. type, and in fact almost invariably is.

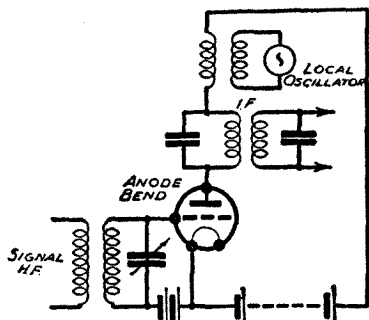

Fig. 474—The anode injector system applied to an anode-bend first detector

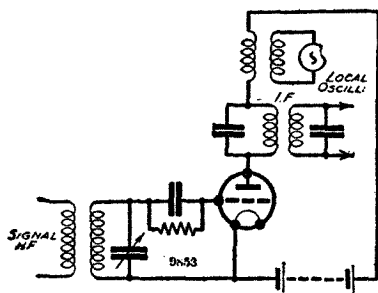

Fig. 475—Applying the anode injector system to a "leaky-grid condenser" first detector

The amount of local oscillator voltage applied may be varied in a number of ways, and a common one is to tap off the required voltage from the tuned circuit of the local oscillator as shown in Fig. 476.

Cathode Injection.—The local oscillations may be injected into the cathode lead of a mains valve, and the arrangement shown in Fig. 477 is very commonly employed, the valve being arranged as an anode-bend detector; a suitable value of self bias is used.

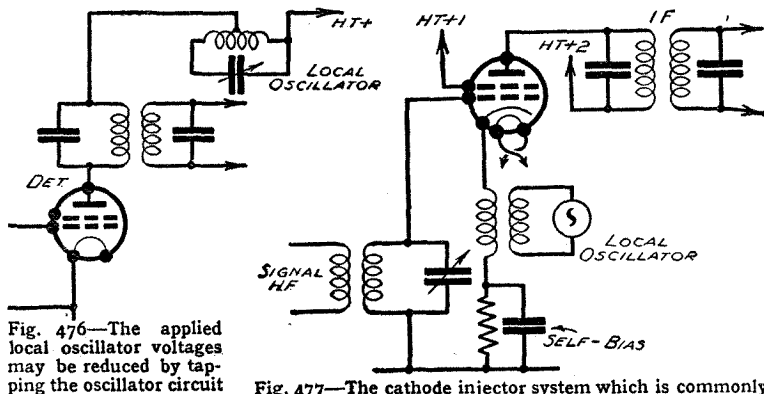

Fig. 476—The applied local oscillator voltages may be reduced by tapping the oscillator circuit

Fig. 477—The cathode injector system which is commonly used in mains valve superheterodynes

Double-Grid Mixer.—A valve containing two grids may be used for mixing purposes, one grid being used for the incoming H F signals, while the other grid has applied to it local oscillations. A typical arrangement is shown in Fig. 478, the negative bias being applied to the ordinary control-grid to make the valve operate as an anode-bend detector.

Autodyne Circuit.—When the detector valve also oscillates the arrangement is sometimes called an Autodyne. Fig. 479 shows a simple arrangement in which reaction is applied to the grid circuit from the anode circuit, the usual H.F. choke being employed. The reaction is adjusted so that the valve oscillates. Actually, the grid circuit is mistuned to the signal. There will be considerable radiation from the

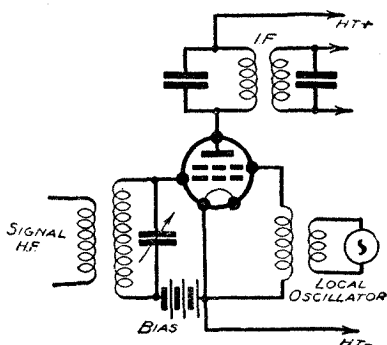

Fig. 478—Double-grid mixer valve circuit ; local oscillations are fed to a separate grid

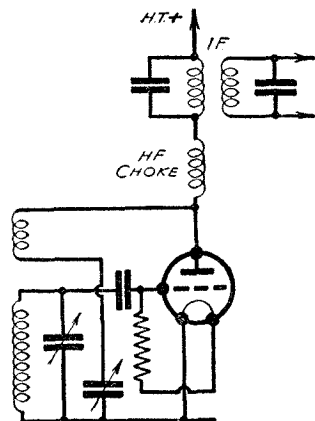

Fig. 479—Self-heterodyne type of superheterodyne frequently used for short-wave reception

aerial with this arrangement, which is popular for the reception of very short waves. The valve creates its own beats which it rectifies and supplies to the intermediate-frequency transformer.

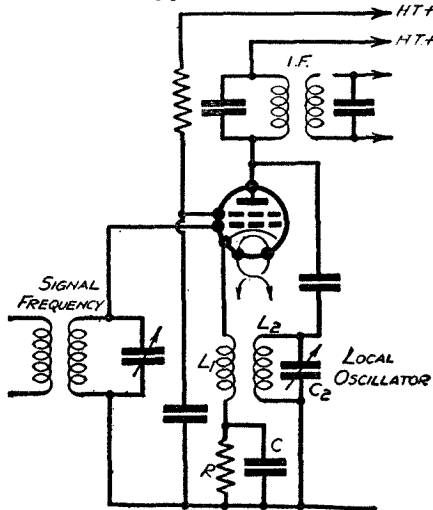

Fig. 480—Self-oscillating detector acts as both a local oscillator and first detector amplifier

An arrangement which is more satisfactory, and which is used for broadcast reception, is that illustrated in Fig. 480 where, in a mains receiver using indirectly-heated valves, the reaction coil is included in the cathode lead. The usual self-bias resistance R and condenser C ensure that the valve operates as an anode-bend detector. The anode circuit of the valve contains not only the primary of the tuned intermediate-frequency transformer, but also the much higher frequency oscillator tuned

circuit $L_2 C_2$. The inductance L_2 is coupled to the reaction coil L_1 , and the S.G. valve therefore operates as an oscillator, the condenser C_2 governing the frequency. These oscillations are naturally also in the grid circuit of the valve and a mixer effect is thus obtained.

An Anode-Injector Superheterodyne.—A typical superheterodyne receiver in which the local oscillations are generated by a triode and fed into the anode circuit of a detector, known as the first detector, is shown in Fig. 481. The anode tuned circuit of the oscillator is connected between the intermediate-frequency transformer primary and the H.T. positive. The input signals to the first detector are derived from a capacity-coupled band-pass tuner; the detector is an S.G. valve operating as a leaky-grid-

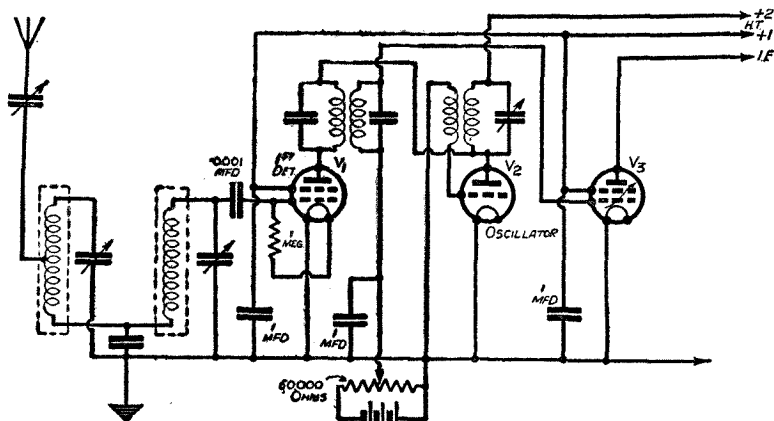

Fig. 481—An anode-injector type of superheterodyne using an S.G. first detector and variable-mu S.G. as intermediate frequency amplifier

condenser rectifier. The I.F. currents in the anode circuit are supplied to a variable-mu S.G. valve which amplifies the intermediate frequency, which is then passed on either to more stages of I.F. amplification, or else direct to a second detector.

In this and certain other superheterodyne circuits which will be described, it is not proposed to give all the stages subsequent to the mixer valve, because they simply consist of one or more stages of I.F. amplification, a second detector (usually a power grid detector, or anode-bend detector, or diode detector), and one or more stages of ordinary L.F. amplification, care being taken to filter out the intermediate-frequency currents and so prevent their entering the low-frequency amplifying circuit. This latter process is more difficult than in the case of separating the ordinary H.F. currents in a straight set, since these currents are of much higher frequency.

Long-Wave Interference.—The intermediate-frequency circuits are usually tuned to somewhere around 3,000 metres. There is always a danger that commercial stations working on such wavelengths will be picked up by the receiver and force themselves into the highly sensitive intermediate-frequency circuits. These

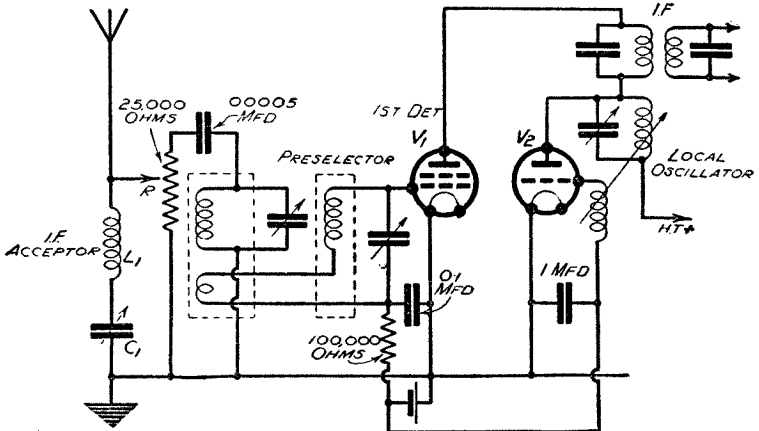

Fig. 482—An acceptor circuit tuned to the same frequency as the I.F. transformers is used to short-circuit interference of I.F. frequency

latter are carefully shielded to prevent direct pick-up, but sometimes it is considered desirable to "short-circuit" the long-wave signals at the beginning of the receiver in such a way that the desired higher frequency signals are not affected.

One method of doing this is shown in Fig. 482, where an acceptor circuit consisting of the inductance L_1 and condenser C_1 is connected across aerial and earth.

This arrangement will virtually short-circuit any signals having a frequency the same as that of the intermediate-frequency circuits of the superheterodyne, while having little effect on the desired signals, the strength of which may be adjusted by means of the potentiometer resistance R .

This circuit shows the use of an inductively-coupled tuner which feeds an S.G. valve, the anode circuit of which contains the I.F. transformer and the tuned anode circuit of an oscillator triode.

An alternative arrangement for keeping out signals having a frequency the same as that of the I.F. circuit is shown in Fig. 483.

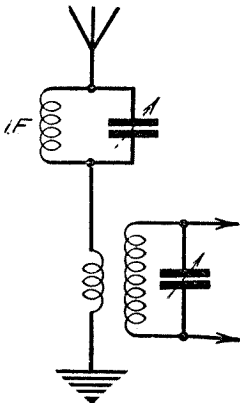

Fig. 483—A series rejector circuit keeps out interference of I.F. frequency

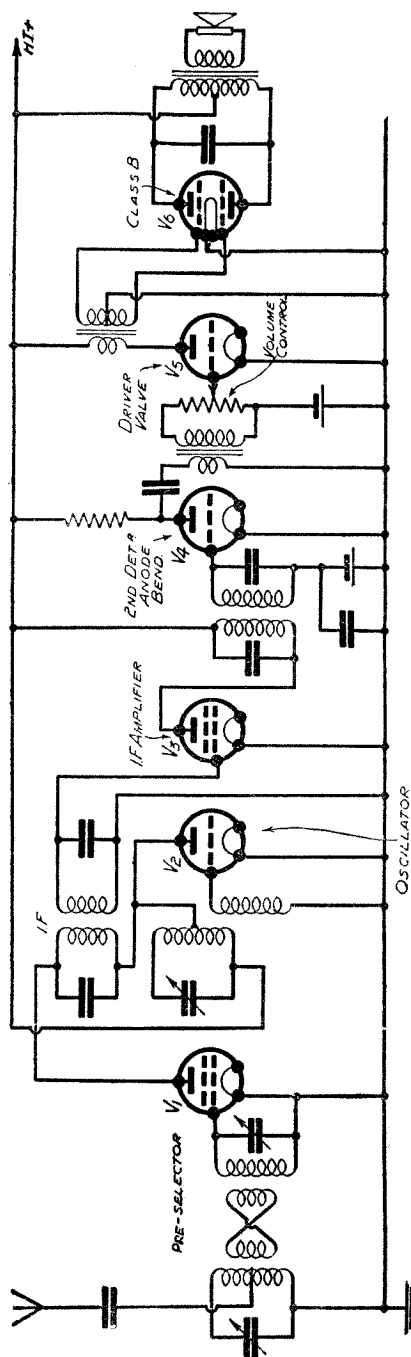

Fig. 485—A skeleton circuit of a Class B superheterodyne ; a loose-coupled input circuit is combined with anode injection from a separate oscillator ; circuitual details are omitted

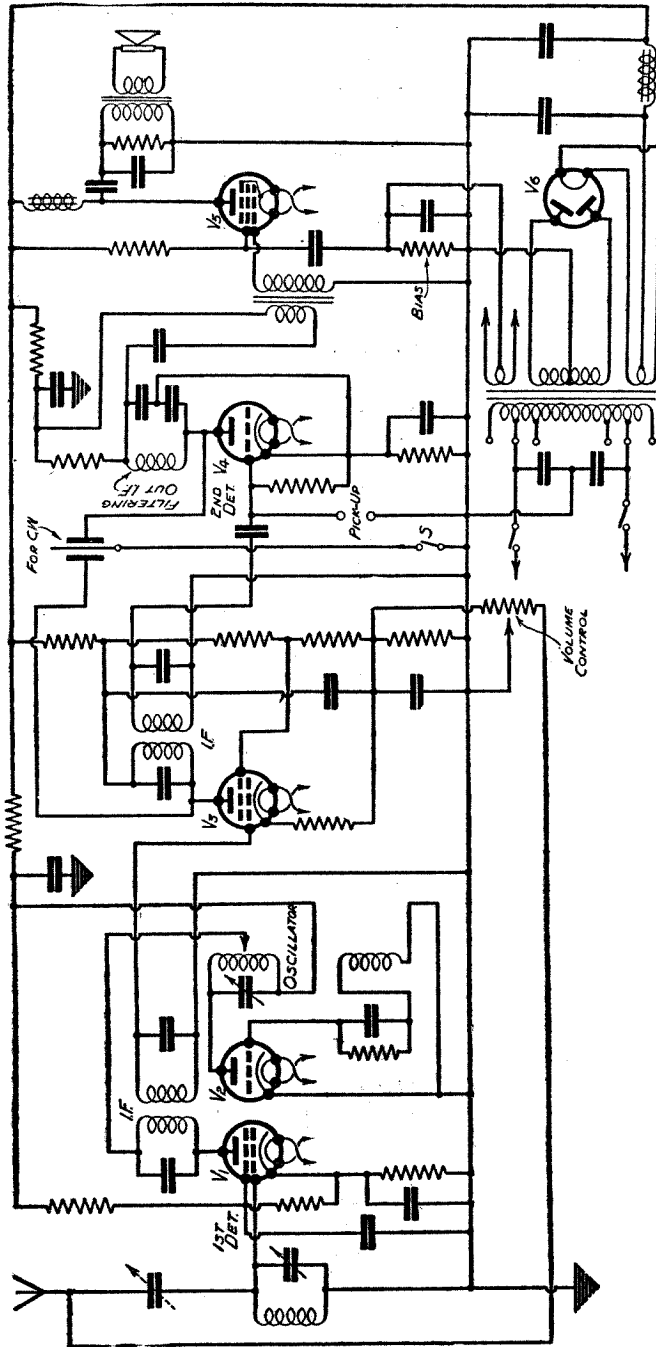

Fig. 486—A commercial mains valve superheterodyne primarily designed for receiving wavelengths below 100 metres. The I.F. circuits may be made to oscillate if telegraph reception is desired.

Mains Superheterodyne for Short Waves.—A superheterodyne receiver using indirectly-heated A.C. mains valves for superheterodyne reception of waves below 100 metres is illustrated in Fig. 486, and has been developed by the G.E.C.; the receiver, however, can also be used for medium-wave broadcast reception. The circuit uses the anode injection system. The volume control varies the bias on the intermediate-frequency amplifier and also "shorts" the aerial circuit to a greater or lesser extent. A pentode output valve is used and it is fed from an S.G. detector, the anode circuit of which can be coupled to the anode of the I.F. amplifier; such capacity-coupling is for the purpose of making the I.F. circuit oscillate and enabling the set to be used for the reception of continuous waves, i.e., for wireless telegraphy reception. The middle

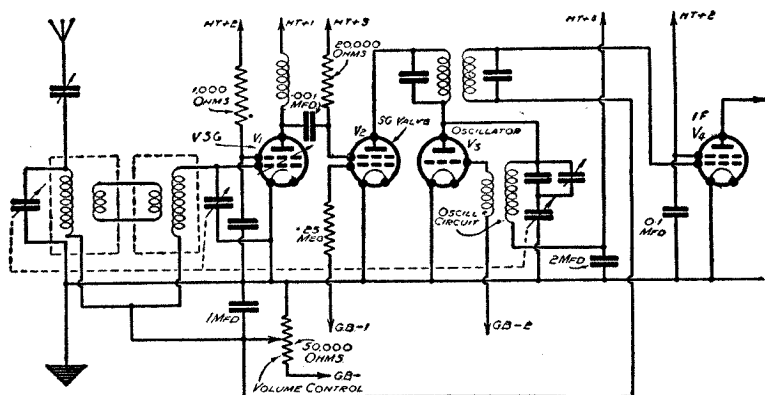

Fig. 487—An interesting circuit in which there is a stage of aperiodic H.F. amplification; the H.F. is applied to the screen of V_2

of the condenser coupling the two anodes can be shorted to earth and this is done when broadcasting is being received. The choke is used for filtering out the intermediate-frequency currents, and the usual condensers are connected to the cathode of the second detector. Note that the primary of the L.F. transformer is parallel-fed and is connected across the feed resistance itself; this reduces hum, since the primary is not connected across the main D.C. voltage of the receiver

Initial H.F. Amplification.—All superheterodynes can be arranged to provide for a stage of H.F. amplification (usually an S.G. valve or variable- μ S.G. or pentode is employed). This will increase selectivity if a tuned circuit is associated with the anode circuit of the amplifier; radiation from the aerial will be reduced and the arrangement is more sensitive.



By courtesy of The Gramophone Co., Ltd.

RADIO—BOTH A LUXURY AND A NECESSITY

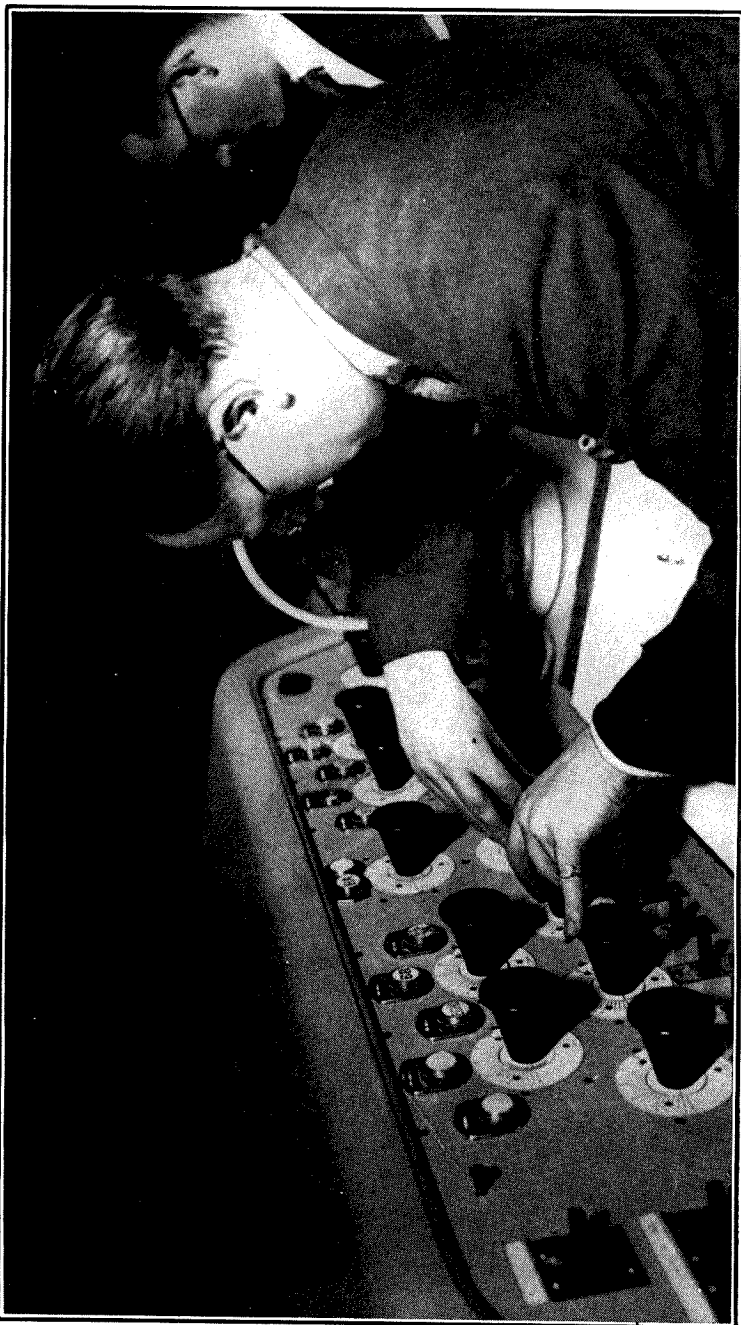

DRAMATIC CONTROL PANEL AT BROADCASTING HOUSE

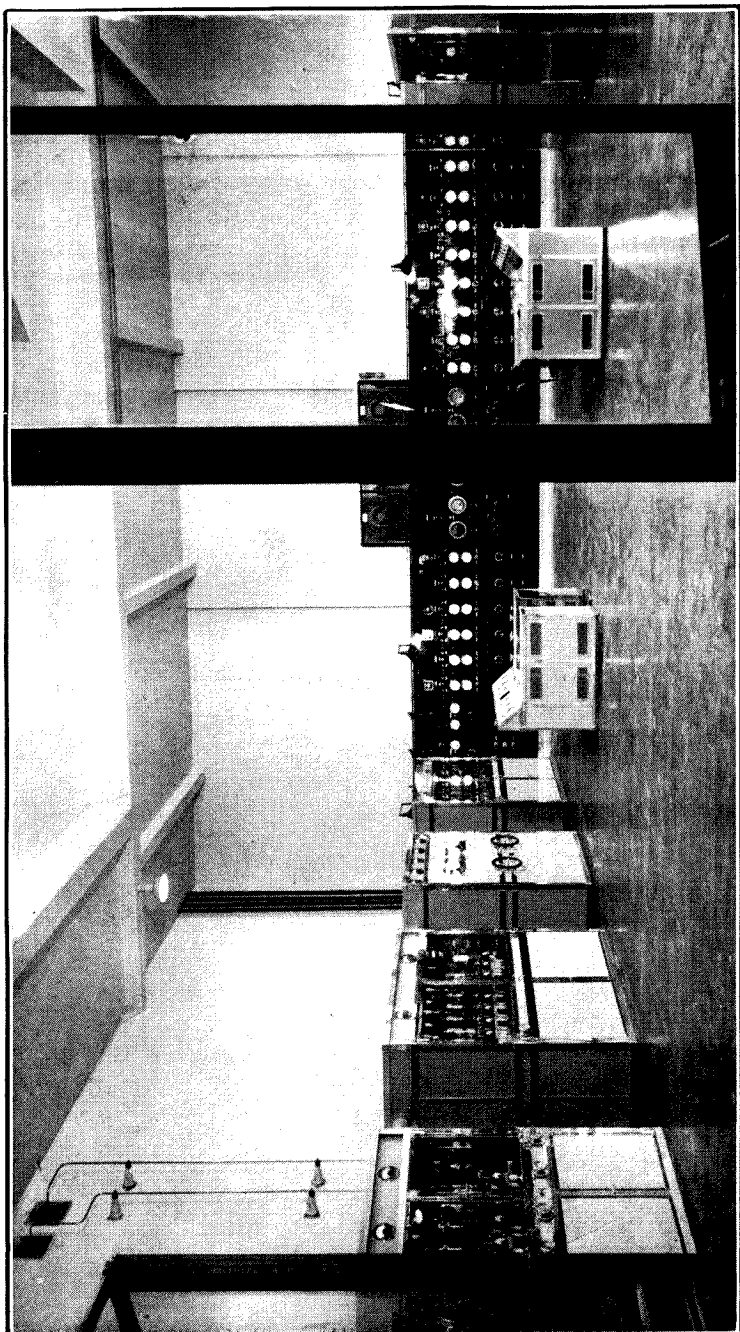

THE INSIDE OF A B.B.C. TRANSMITTER ROOM

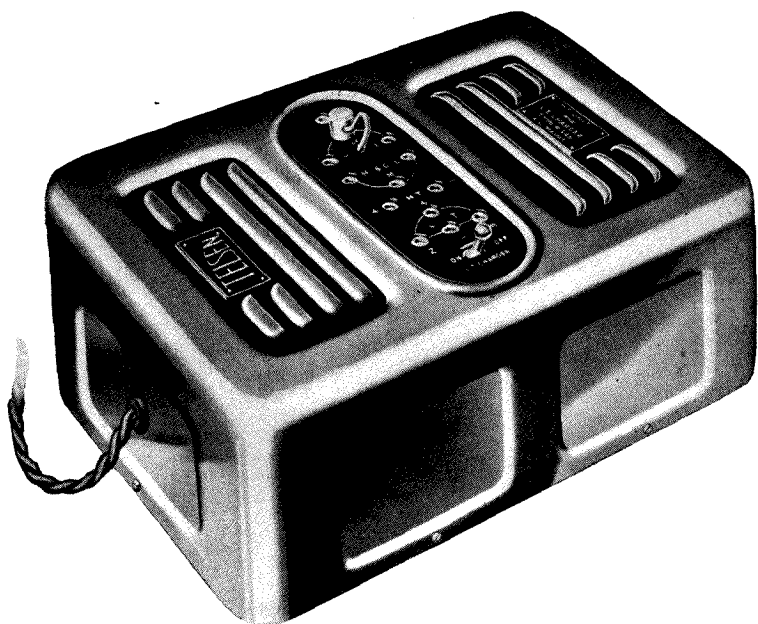

A TYPE OF MAINS UNIT PRIMARILY FOR BATTERY RECEIVERS



ANOTHER MAINS UNIT FOR BATTERY VALVE SETS

The use of an S.G. amplifying valve without a tuned circuit associated with its anode is employed by Telsen. The circuit is given in Fig. 487. It will be seen that the H.F. currents are amplified by the valve V_1 after a pre-selector circuit has been employed. The amplified H.F. voltages are applied not to the ordinary control-grid of a subsequent valve, but to the screen of an S.G. valve. This screen is given a positive potential. The anode circuit of this second valve contains the usual I.F. transformer and the anode circuit of an ordinary triode oscillator, a padding condenser being used, since the whole set is for operation with a single knob.

Cathode Injector Circuit.—

A complete receiver using the cathode injector system of mixing the local oscillations with the incoming oscillations is given in Fig. 488. It will be seen that a triode valve has its grid circuit connected to a coil (which is as small as possible consistent with good results) in the cathode lead of the first detector, which is an S.G. valve operating as an anode-bend detector; the coupling coil is sometimes coupled to the anode coil of the oscillator, and this coil is sometimes used, although in the example given the grid circuit is tuned; these matters are ones of detail. An initial stage of H.F. amplification is shown in this circuit.

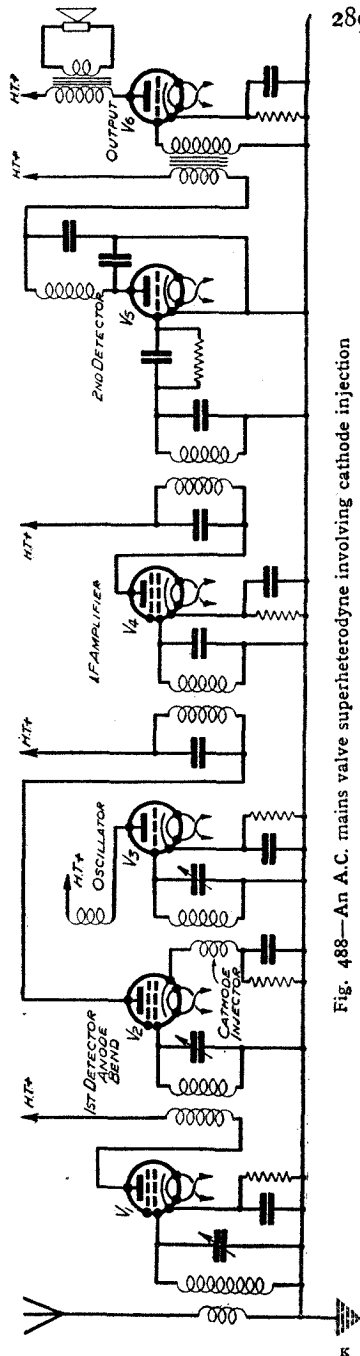

Fig. 488—An A.C. mains valve superheterodyne involving cathode injection

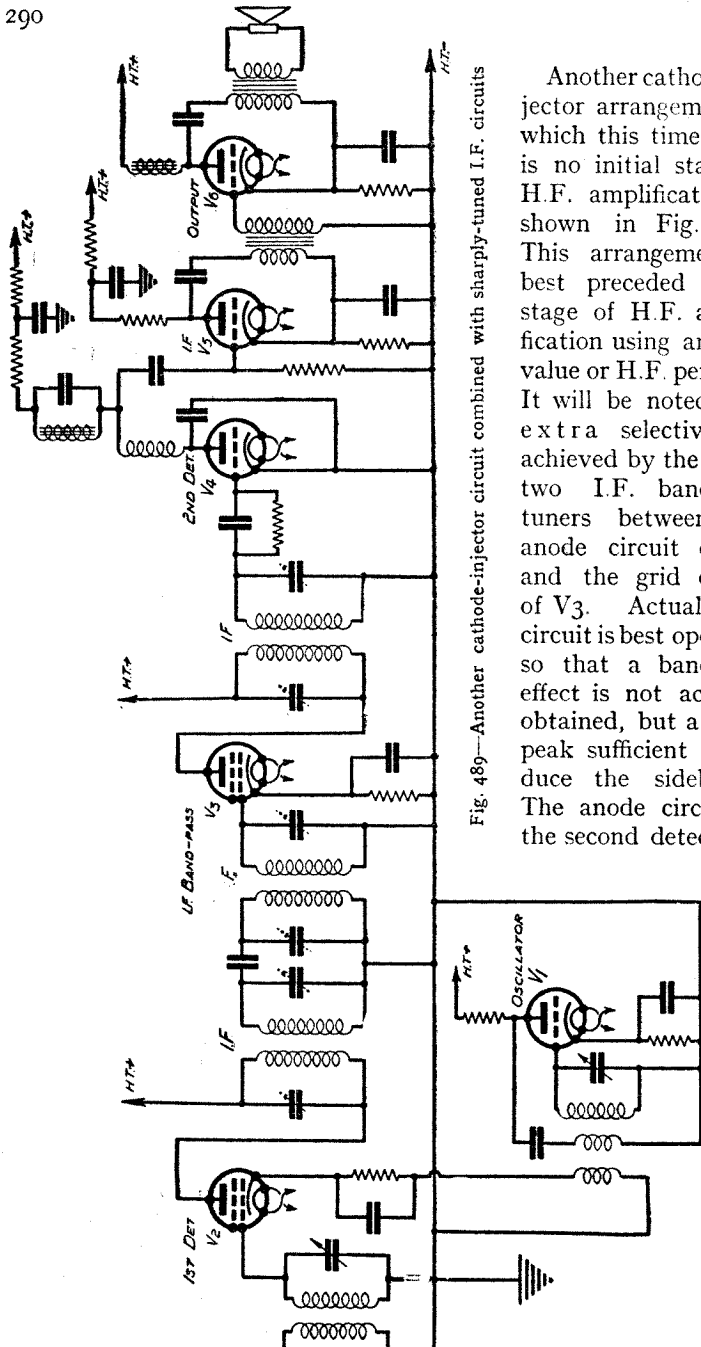

Fig. 489—Another cathode-injector circuit combined with sharply-tuned I.F. circuits

Another cathode injector arrangement in which this time there is no initial stage of H.F. amplification is shown in Fig. 489. This arrangement is best preceded by a stage of H.F. amplification using an S.G. valve or H.F. pentode. It will be noted that extra selectivity is achieved by the use of two I.F. band-pass tuners between the anode circuit of V₂ and the grid circuit of V₃. Actually the circuit is best operated so that a band-pass effect is not actually obtained, but a sharp peak sufficient to reduce the sidebands. The anode circuit of the second detector is

coupled to the L.F. valve by means of a resistance, but a choke tuned by a condenser will serve to produce a rising characteristic which will compensate for any high-note loss which may occur through excessive selectivity in the L.F. circuits. The H.F. choke in the anode circuit of the detector valve and the condenser between anode and cathode is for keeping the intermediate-frequencies out of the L.F. side of the receiver.

Tone Correction in Superheterodynes.— Various tone compensating devices are sometimes used to restore the correct balance of the musical frequencies which may have been mutilated by ultra-selectivity in the preceding circuits. In Fig. 490 is shown a low-frequency coupling arrangement consisting of a tuned iron-cored choke of 0.25 henry, a fixed condenser of .002 mfd. being arranged to resonate around 7,000 cycles. A resistance of 2,000

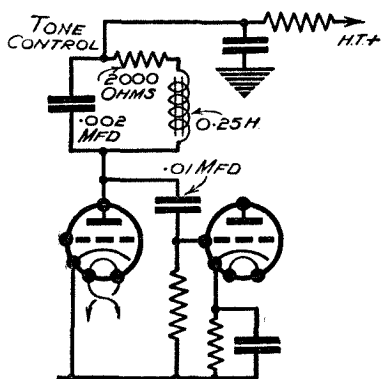

Fig. 490—The L.F. coupling circuit is flatly tuned to produce tone compensation

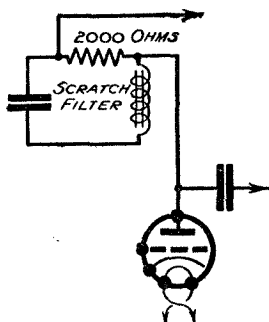

Fig. 491—A change of connections provides a scratch filter but poorer amplification

ohms is connected in series with the tuned circuit to flatten the tuning. It is important to cut out any tone compensator arrangement when playing gramophone records, and the arrangement of Fig. 490 may be used by altering the connections, as shown in Fig. 491, and this may be done by a simple switch. The inductance and condenser now form an acceptor circuit across the coupling resistance of 2,000 ohms, and its frequency reduces needle-scratch. Of course, a resistance of 2,000 ohms for coupling purposes is ordinarily too small, but in the circuit where it was employed there was adequate L.F. amplification for gramophone reproduction.

A Superheterodyne Radio-Gramophone.—A recent design for a superheterodyne radio-gramophone by H.M.V. is given in Fig. 492. This uses the cathode injector system in which the first valve acts as a detector and also oscillator. The H.F. input circuits involve

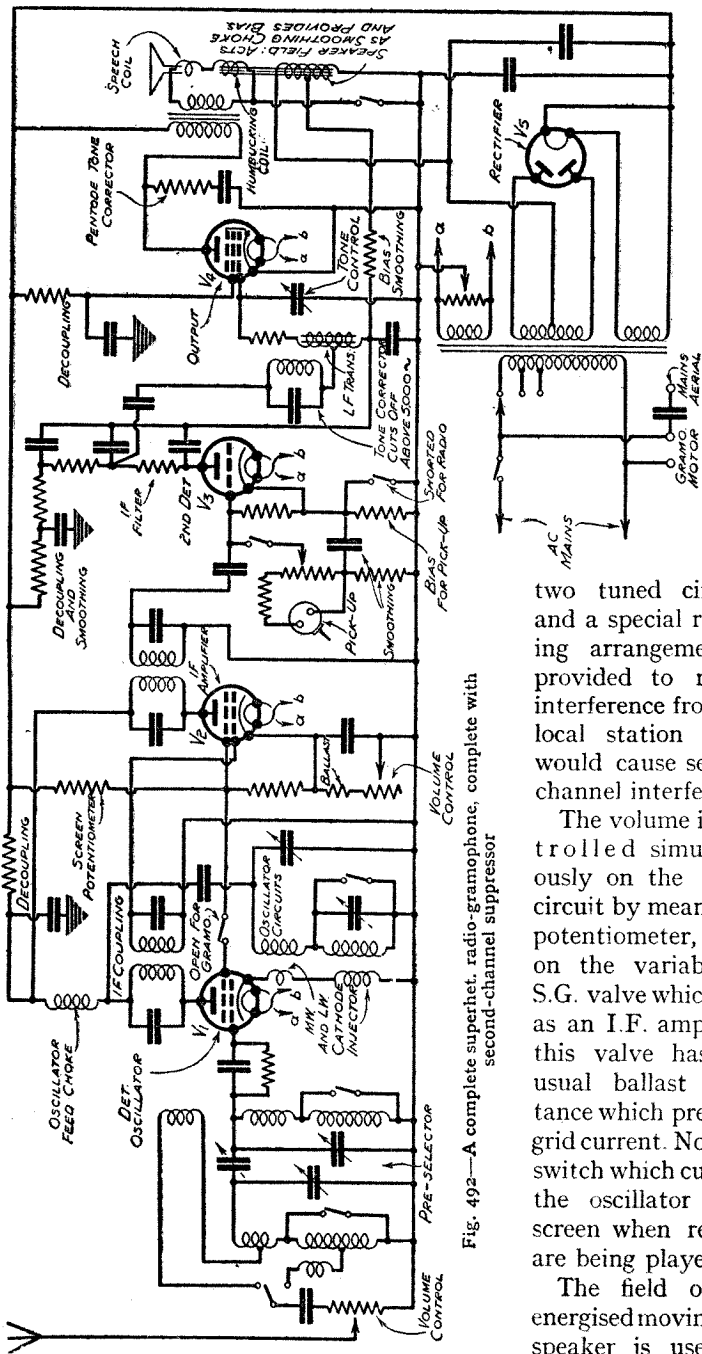

Fig. 492—A complete superhet. radio-gramophone, complete with second-channel suppressor

two tuned circuits, and a special reversing arrangement is provided to reduce interference from the local station which would cause second-channel interference.

The volume is controlled simultaneously on the aerial circuit by means of a potentiometer, and on the variable-mu S.G. valve which acts as an I.F. amplifier; this valve has the usual ballast resistance which prevents grid current. Note the switch which cuts out the oscillator valve screen when records are being played.

The field of the energised moving-coil speaker is used for

smoothing purposes, and also for providing negative bias for the pentode output valve, and this calls for more adequate smoothing in the earlier stages of the receiver; this is carried out by resistances and condensers. The L.F. transformer is of the auto-coupled type, and a tone-corrector, with a cut-off at about 5,000 frequency, is inserted in the position shown, while a tone control consisting of a variable condenser is connected across pentode grid and earth-line, a fixed resistance being connected between the auto-transformer and the

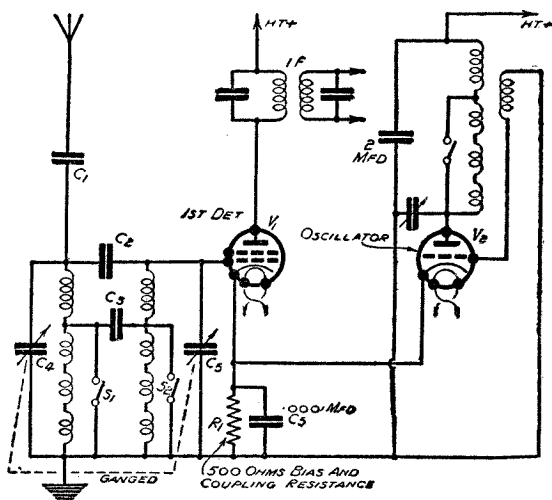

Fig. 493—Cathode resistance method of injection. Note that the capacity across R_1 is much smaller than usual

control-grid of the pentode. A hum-bucking coil is adjusted to neutralise any hum caused by a varying speaker field. The mains aerial terminal is connected to the aerial terminal of the set if an outdoor aerial is not desired. Other features of the receiver are explained by labels on the circuit diagram.

Cathode Resistance Injection.—Although an inductance coil has so far been regarded as a method of coupling an oscillator to the detector, a resistance may be used for this purpose. Fig. 493 shows the resistance R_1 providing bias for the grid of an anode-bend S G detector and also operating as the means of coupling the oscillator to this valve. High-frequency currents are flowing in the anode circuit of the oscillator, and these are passed through the resistance of R_1 , which is in the anode-to-cathode external circuit of the oscillator valve. The pre-selector arrangement provides for capacity coupling between two tuned circuits, a larger condenser C_3 being provided when the long waves are being received.

Autodyne Circuits.—Circuits specially suitable for the reception of the very short waves are given in Figs. 494, 495, and 496. Fig. 494 shows how an S.G. valve is made to oscillate, and thus provide beats which are passed on through an I.F. transformer to an S.G. or other valve.

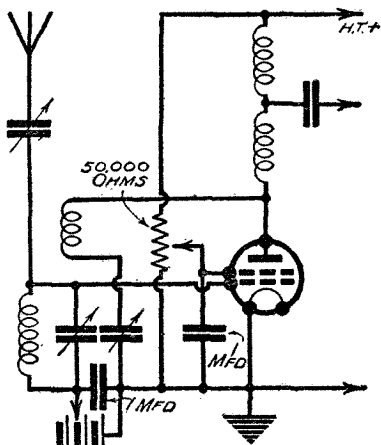

Fig. 494—Superheterodyne adaptor for wavelengths below 100 metres

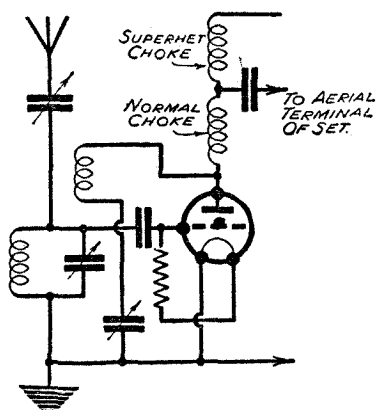

Fig. 495—The simplest method of using an ordinary receiver for superhet. working

The first S.G. valve operates as an anode-bend detector; the connections for the screen are of the simple potentiometer type. Fig. 495 shows a short-wave adaptor which may be connected to an ordinary broadcast receiver.

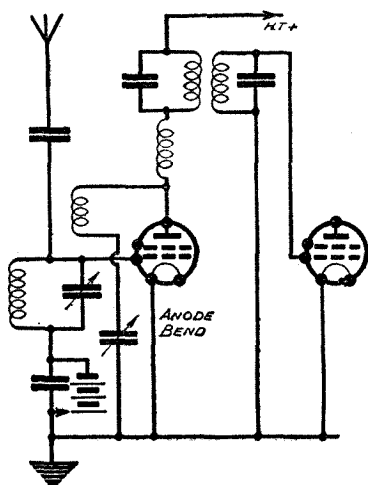

Fig. 496—Use of S.G. valve as first detector; screen connections are not shown

The principle is that the valve acts as an autodyne-superheterodyne producing an intermediate frequency which is fed via the condenser C to the ordinary tuned circuit of the broadcast receiver which is worked preferably on the long waves. The valve, of course, is made to oscillate, and the lower of the two H.F. chokes consists of only a few turns of wire sufficient to choke back enough of the local frequency currents to produce oscillations. Fig. 496 shows a similar arrangement using an S.G. valve operating as an anode-bend detector, whereas Fig. 495

was an ordinary three-electrode valve operating as a leaky-grid condenser rectifier.

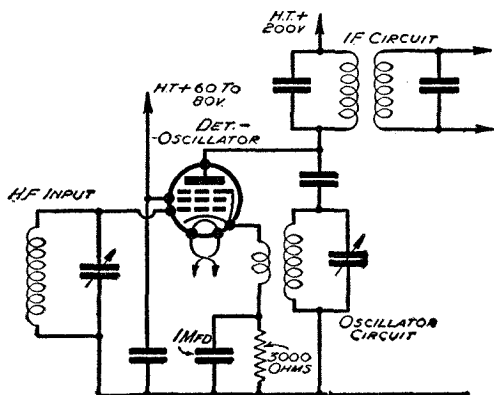

Fig. 497—A self-oscillating H.F. pentode is here used as first detector

H.F. Pentode as Mixer.—The H.F. pentode makes an admirable mixer used as an anode-bend detector, and Fig. 497 shows how it is arranged; it will be seen that the circuits are similar to those employed when an S.G. valve is used as an autodyne mixer with cathode injection.

Cathode Injection in Battery Receivers.

—The filament of a

battery valve may be used in much the same way as a cathode is employed in mains valve technique. In Fig. 498 two coils are inserted, one in each lead of the filament supply. These coils are coupled to an inductance which is associated with the anode circuit of the S.G. valve which acts as a mixer. The two filament coils act as a single coil would act in a mains set of similar type, and the coupling between them and the inductance produces continuous oscillations.

The output choke of the S.G. valve feeds the oscillator anode

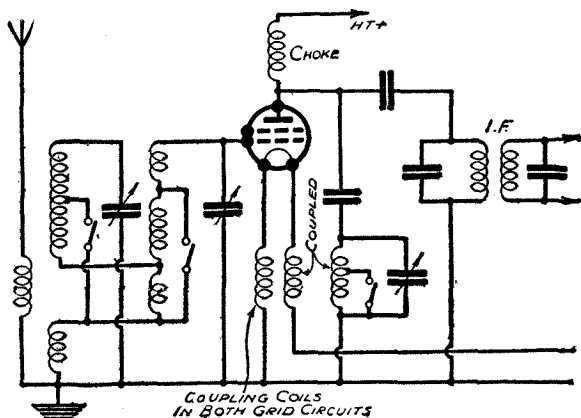

Fig. 498—Cathode injector system applied to a battery valve; coils in filament leads act as reaction coil to produce oscillations

circuit, and also the primary of the tuned I.F. transformer which supplies intermediate-frequency currents which are passed on to subsequent stages in the receiver. The input circuits of Fig. 498 are those of the Colvern Ferrocart band-pass arrangement. The two tuned circuits are coupled together by a common inductance; switching arrangements alter the inductances for medium and long-wave reception.

A Double-Grid Mixer.—A common arrangement of a double-grid mixer circuit is shown in Fig. 499. A stage of H.F. amplification is followed by a double-grid mixer valve, which acts as the first detector working as an anode-bend rectifier. Local oscillations are produced by a triode, the oscillations being fed to the second grid of the valve V_2 . A stage of I.F. amplification is illustrated, but the L.F. circuits have been omitted since they are conventional.

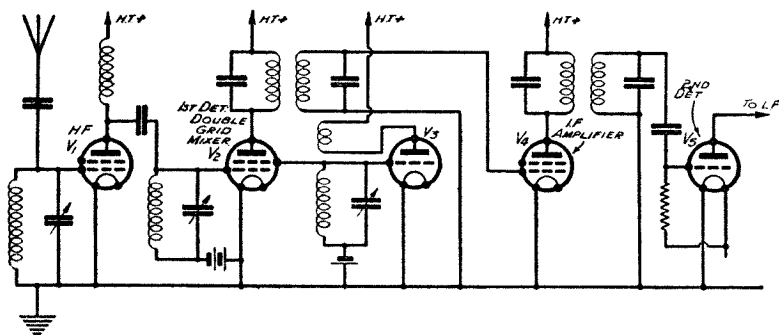

Fig. 499—A double-grid mixer circuit in which a separate oscillating valve feeds the local oscillations to the extra grid of the first detector

The Pentagrid Converter.—A recent multi-grid valve has facilitated superheterodyne reception since local oscillations can very readily be produced in the same valve that is used for rectification; this is carried out without any fear of radiation, and results in more efficient rectification. The Pentagrid and its circuits is illustrated in Fig. 500. It will be seen that there are two screens, one on each side of the main control electrode G_3 . Between the screen nearest the cathode and the cathode itself are two more grids, G_1 and G_2 . The first grid, G_1 , is a control-grid for the oscillator circuit, while the grid G_2 is actually not a grid at all, but consists of two bars forming an anode without interrupting the main flow of electrons. There is, however, sufficient anode current to G_2 to operate the oscillator. The electron current through the valve is varied at the local frequency and the mixing can therefore be regarded as electronic in character. It therefore resembles the

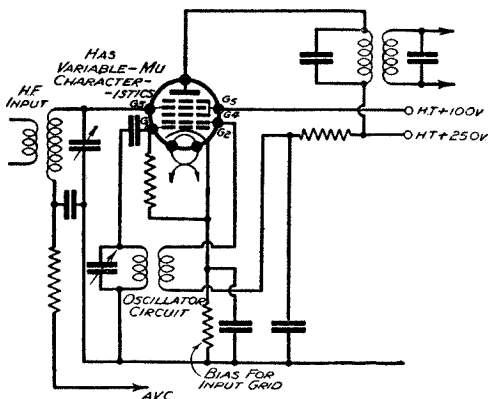

Fig. 500—The Pentagrid valve in which the "grids" nearest the cathode constitute the grid and anode of an oscillator

double-grid arrangement, but the screen below the main control-grid keeps the oscillating part of the valve separate from the main control-grid on the one hand and the main anode on the other.

The valve as a whole has variable-mu characteristics, so that it lends itself to automatic volume control, and the bottom end of the control-grid circuit is connected to the source of A.V.C. voltage.

CHAPTER 32

COMMERCIAL SUPERHETERODYNE RECEIVERS

There are obviously many factors common to all superheterodynes, but individual manufacturers' products vary considerably in detail. Different types of valve are used for the different functions, and sometimes one valve carries out more than one function.

In Fig. 501 an Ekco Superheterodyne is shown. The H.T. is supplied from a metal rectifier, so that in considering the number of valves this factor has to be borne in mind. The input circuit has a simple character, two tuned circuits being magnetically coupled, while a rejector circuit is inserted in the aerial lead to keep out any signals having the same frequency as the intermediate frequency of the set. A separate oscillator valve is provided and it is arranged that its aperiodic grid coil is in the cathode lead of the first detector, which acts as an anode-bend rectifier. The first valve is followed by an intermediate-frequency amplifier of the variable- μ S.G. type, and volume control is effected by means of a potentiometer arrangement which, by altering the self bias of the I.F. valve, reduces the amplification; simultaneously, a lower resistance is connected in shunt with the aerial input, thereby cutting down the input signals. The usual small ballast resistance is connected in circuit.

The next valve is a power grid detector, and a switch is provided for connecting the pick-up in circuit, in which case the self-bias resistance in the cathode lead will give the grid a suitable negative potential.

The iron-cored filter choke in the anode circuit of the second detector keeps the intermediate frequencies from the L.F. circuit, while a switch enables the condenser to be connected across this choke and to reduce top-note response, thereby reducing high-note interference of certain kinds to some extent and for reducing heterodyne whistles; these advantages are combined with a general lowering of the overall tone of the receiver. These remarks apply to all radio receivers where tone-control is fitted.

Bias for the control grid of the directly-heated-cathode pentode output valve is obtained from a resistance connected across the speaker field, which is in the negative H.T. lead.

A Pentode Autodyne Mixer.—The Varley circuit, shown in Fig. 502, presents several interesting features. The first valve is a variable- μ S.G., with a tuned primary on the H.F. transformer connecting it to the control grid of the pentode which follows.

The secondary of the H.F. transformer is aperiodic, and therefore the arrangement is rather different from that usually used in H.F. amplification. The pentode is used as an oscillator as well as a detector. As an oscillator the tuned anode circuit is connected to the anode of the pentode through a coupling condenser. The arrangement is therefore parallel-fed, the primary of the I.F. transformer acting as a choke for the locally-generated oscillations. The control electrode for the oscillating pentode is not the normal grid, but what is ordinarily regarded as the screen, which continues to have a positive potential. The output of the pentode contains the I.F. transformer, the primary of which, however, is not tuned. The remainder of the circuit is quite conventional and consists of a pentode output valve and the usual rectifier arrangement.

An A.V.C. Receiver.—The Murphy A.8 receiver is an 8-valve set in which A.V.C. is employed. It is illustrated in Fig. 503. The aerial input is of a simple character, but a band-pass arrangement is connected between the anode of the first H.F. amplifier, and the second valve which acts as an anode-bend detector. A separate oscillator valve is provided and a cathode injector coupling coil applies the locally-generated oscillations to the grid of the first detector. The output circuit of the detector valve contains the usual I.F. transformer. The I.F. transformers in this set have their windings shunted by resistances to increase the stability. After the valve V_4 there is a second I.F. amplifier, which is not illustrated, but it is identical in operation, although its grid is connected to a different point on the A.V.C. output resistance of the diode detector.

Full-wave rectification is obtained by a double-diode second detector, and the voltages developed across the output load resistance of this detector are communicated to the grid of all the preceding valves, including the first detector. The output potentials are also communicated, although in this case without being smoothed, to a manual volume-control potentiometer connected to the grid of an S.G. valve, acting as an L.F. amplifier. This valve is resistance-coupled to an output pentode.

The heater for this output pentode is provided with turns from a separate winding of the mains transformer. The smoothing arrangements, which consist of the speaker field and also a choke,

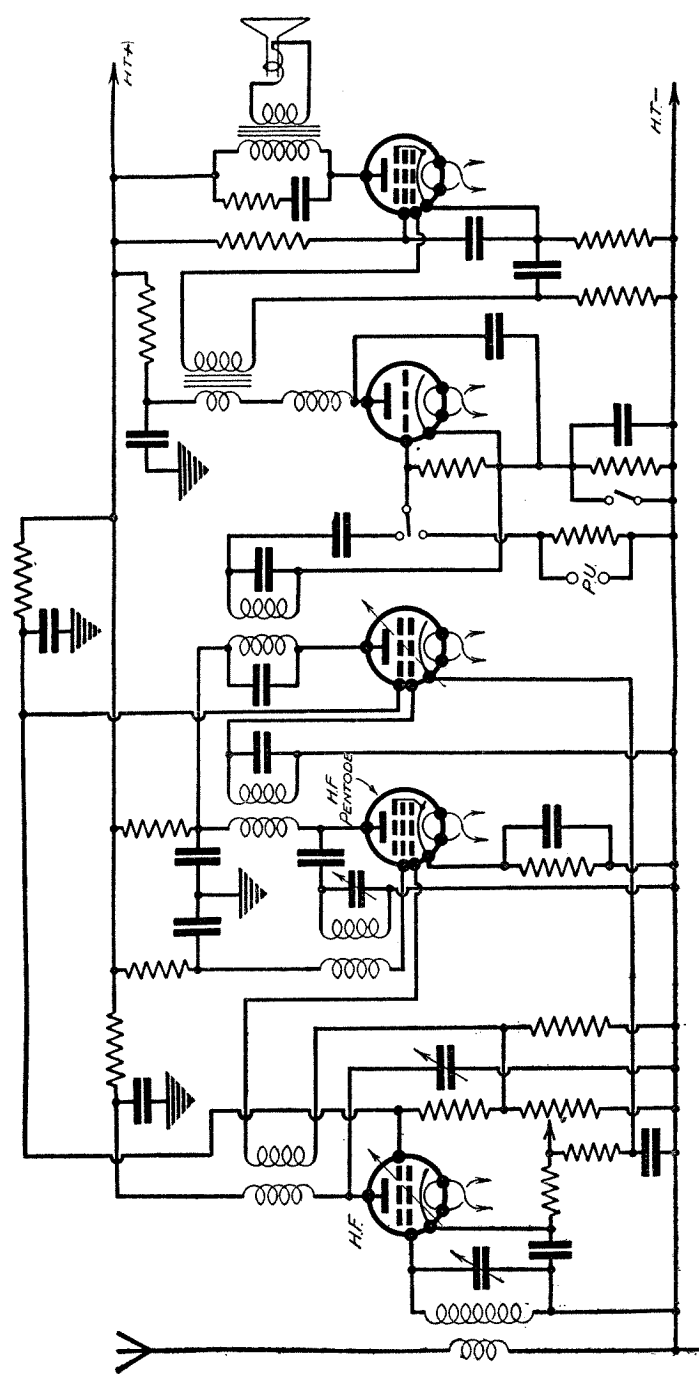

Fig. 502—A stage of H.F. amplification here precedes an H.F. pentode used as a self-oscillating first detector; the reaction coil is connected to the auxiliary grid of the pentode

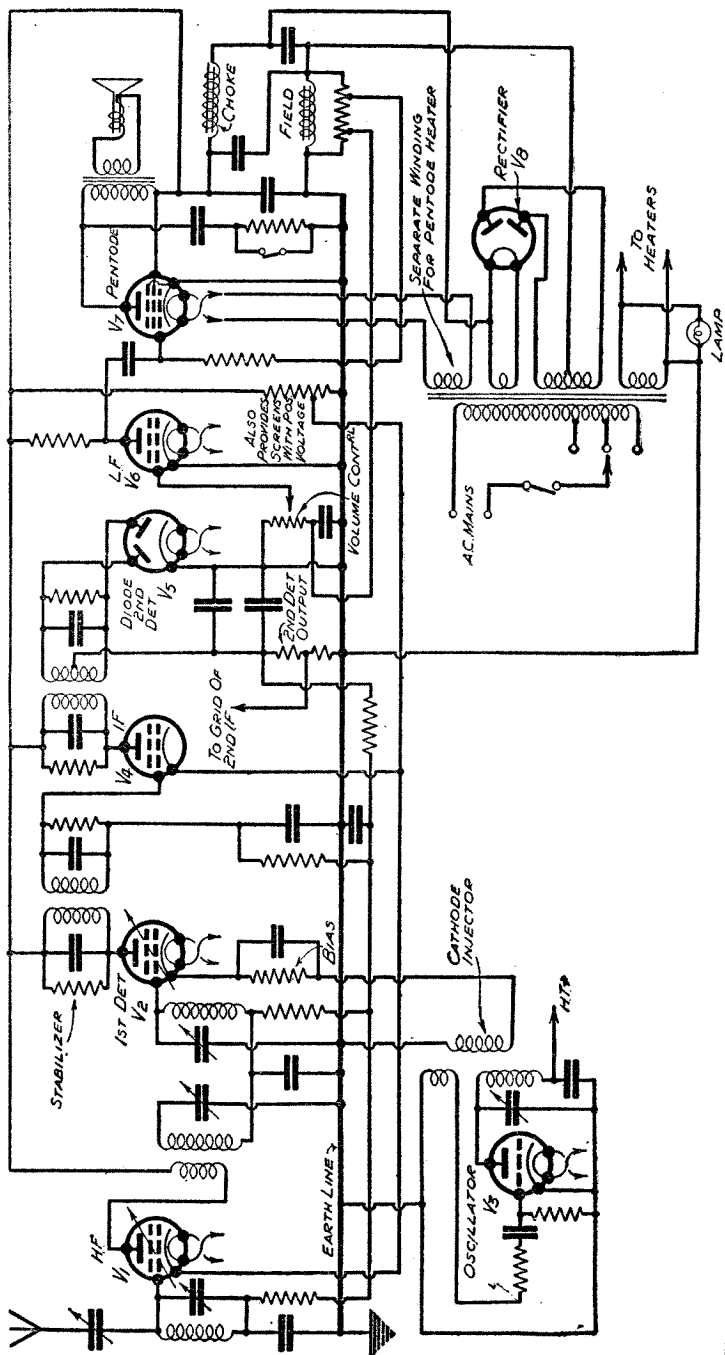

Fig. 503—The general arrangement of the Murphy A.8 receiver. Note the band-pass arrangement between the first two valves and the automatic volume control circuit

are worthy of note ; various voltages are obtained from a resistance across the field, while a bias voltage for the grid of the first H.F. valve of the set and for the screens of the various valves is obtained from a potentiometer resistance connected across the main H.T. voltage.

have been given by J. Dent in the "Wireless World," of June 16, 1933. The inductance L_4 , coupled to the inductance L_5 (which has in parallel with it the condenser C_3), forms the quenching circuit; oscillations are produced having a frequency governed by L_5 and C_3 . This frequency is impressed on the grid of the valve which is producing a reaction effect on the incoming frequency, which may correspond to 5 metres. This circuit will work admirably on a wavelength as low as this. The aerial is coupled to the grid circuit by a single turn.

Simple Super-Regenerative Circuit.—The simplest of all super-regenerative circuits is that illustrated in Fig. 505, where the

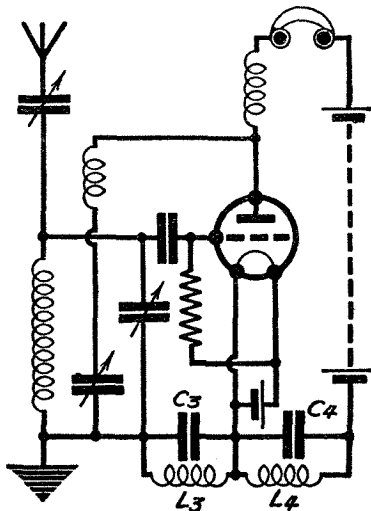

Fig. 505—The simplest type of super-regenerative circuit; the quenching frequency is developed by the circuits L_3C_3 and L_4C_4

grid and anode of a three-electrode valve are coupled together by means of an ordinary reaction coil to produce oscillations at the incoming frequency, and also coupled together by means of two tuned circuits which are tuned to the quenching frequency. These two latter coils, L_3 and L_4 , are tuned by condensers C_3 and C_4 to the desired quenching frequency.

CHAPTER 34

IRON-CORE TUNING INDUCTANCES

The decreasing size of inductance coils necessitated by screening and the close proximity of the different components of a set have made the question of coil efficiency one of great importance. A coil of large diameter wound with Litz wire (which consists of fine insulated wires twisted together in a special way) while giving a low H.F. resistance are quite impracticable in the average receiver.

It has always been known that a higher inductance for a given amount of wire will be obtained by using an iron core. This arrangement is always used when dealing with audio-frequency currents. The fact, however, applies to high-frequency circuits, and various methods have been proposed to increase the magnetic conductivity of the core which would normally consist only of air. The problems to be faced were :

- (1) Increased self-capacity, due to the turns of wire being close to a common metal core.
- (2) Eddy-current losses in the iron core due to currents set up in the core by the current in the windings.
- (3) Hysteresis losses due to different behaviour of an iron core and a changing current.

Instead of using solid iron for the core, which would be quite unsuitable and would result in greater losses instead of fewer, powdered iron was suggested, but the best method of using it has, until recently, not been developed, and considerable difficulty has, in fact, been experienced in obtaining sufficiently finely-divided iron powder. Since suitable powder is now available, it remains to mould this powder in some form suitable for H.F. coils. It may be embodied in wax or other insulating material which will keep the particles apart, and thus prevent eddy-currents being set up.

One commercial form of iron core is known as "Ferrocart," and the core is made as follows: A strip of paper has arranged along it lines of powdered iron, this being effected by moving the strip of paper under a comb, which arranges the powder. The next step is to align all the particles in the same direction, the individual

particles being actually shaped like small sticks. By passing the moving strip of paper (which is covered with some adhesive matter) through the coil of a D.C. solenoid, the various iron particles are all aligned in the same direction, and after this process the strip of paper is dried and subsequently built up into a number of layers which are held together by a binding substance.

Hans Vogt, the inventor, has stated that a further source of loss is avoided by his process; he calls this *capacitive eddy-current loss*, and it is due to each pair of magnetic particles forming a miniature condenser, the insulation between the particles forming the dielectric of this very miniature condenser.

The amount of inductance provided by a given coil wound on an iron core will depend on the size of the core, and a gap is provided and its size varied for the purpose of accurate matching of different coils for ganging purposes. Long-wave coils, owing to their high efficiency, are sometimes wound on open-ended cores consisting simply of a rod of iron-cored material; medium-wave coils usually have closed cores.

Owing to the small size of the coil and also to the fact that their magnetic fields are restricted by the core, there is very little magnetic interaction between coils but capacity coupling can still take place, and therefore iron-core coils still require to be shielded in cans.

CHAPTER 35

THE METAL VALVE

Valves have long been used in which the anode forms the outer coating in place of the usual glass or silica. Such valves lend themselves readily to water-cooling since the water can be applied directly to the anode. Such valves have been designated C.A.T. (cooled anode transmitters). Receiving valves, constructed on the same principle, have been developed by the Marconi-Osram organization, and are called Catkins.

The construction of these is illustrated in these pages. The various supporting wires are firmly held by a steel clamp which surrounds a mica insulator. The general assembly is held with precision by a mica spacing piece, and the whole valve forms a rigid unit which is much more effective for ensuring constancy and uniformity of characteristics. Moreover, the valve is almost unbreakable.

Dielectric losses due to the glass pinch in ordinary valves are reduced by using mica as an insulator, although it is true that the leads which pass through the glass ring at the base of this new valve are separated by glass, but these wires are as far apart as possible.

The absence of a glass bulb prevents the accumulation of unwanted potentials on the inside of the valve due to the accumulation of stray electrons; there is thus no tendency for hum to develop in mains receivers, or certain forms of back-coupling which can be traced to stray electric fields between the bulb and the leads. If the anode is to be screened (as it will usually be in the case of an H.F. valve), a tubular metal cover is provided.

When the anode is exposed, there is no risk of shock as the anode is given a generous coating of enamel. The fact that the anode is exposed to the air will result in a cooler working of both the anode and the grid.

The rigidity of the valve removes the common fault of microphony, which in its most objectionable form consists in the building-up of a howl due to the sound from the speaker causing vibration

of the electrodes of a valve. In the Catkin construction, the valve is fixed in a rubber mounting; there is thus a double insurance against microphony. The valves are smaller in size than the glass equivalents.

An additional advantage of the Catkin is that there is no glass bulb which requires to be deprived of its occluded gas. The various drawings show the construction much more effectively than could any description.

The most interesting feature of the valve from a technical point of view is the junction between the glass portion of the valve and the copper anode. To produce a gas-tight seal of this kind is a highly important development when applied to quantity production.

CHAPTER 36

ELECTROLYTIC CONDENSERS

The electrolytic condenser is one which enables large capacities to be obtained at comparatively small cost and with certain advantages, but also with certain limitations.

Electrolytic condensers are divided into three classes :

- (1) Wet.
- (2) Semi-dry.
- (3) Solid dry.

An ordinary condenser for large capacities consists of two sets of plates, as shown in Fig. 506 (a), where a solid dielectric insulator separates the plate. This dielectric may be waxed paper, mica, or other solid and suitable insulator. The condenser will "pass" alternating current and when connected across a D.C. source it does not matter which way round such a condenser is connected.

The electrolytic condenser differs radically from the ordinary type and both types are shown in Fig. 506. On the left side of (b) is a contact plate which forms contact with a conducting liquid (often containing boracic acid), which is also in contact on the other side with a dielectric insulating film which covers the other plate. The insulating film is extremely thin and consists of a metal oxide. The plate, extreme right, Fig. 506 (b), on which the film exists is usually aluminium, while the film itself is aluminium oxide. Owing to the thinness of the film, there will be a large capacity between the liquid conductor and the aluminium sheet. It is to be specially noted that the conductor is not formed by the left-hand contact plate and the right-hand plate. The two "plates" of the condenser are the liquid and the right-hand metal plate. The left-hand plate is merely to make convenient electrical contact with the conducting liquid.

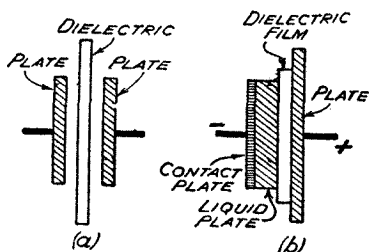

Fig. 506—On the left is an ordinary condenser, while on the right is the electrolytic type

The dielectric strength of the film, i.e., the voltage which the condenser will stand before breaking down, is governed by the general nature and thickness of the film. The aluminium sheet on which the film is formed must always be the positive terminal. This means that the condenser is only suitable for connecting in a position where positive impulses or steady D.C. currents are applied. The condenser is unsuitable for alternating current, although it may be used for smoothing circuits where there is an alternating ripple on a steady direct current which is so applied to the condenser that the aluminium plate is made positive; hence its great utility in mains rectifier circuits.

Electrolytic condensers are marked positive and negative as regards their electrodes and if they are reversed the dielectric film will tend to dissolve and be thus removed. The reverse current which passes through the condenser will also electrolyse the fluid and liberate gases which may burst the container.

Even when connected the right way round, an electrolytic condenser will pass a certain amount of leakage current which may amount to several milliamperes. This leakage current makes no difference to the operation of the condenser as a capacity, and in the position in which the condenser is used, a small leakage effect usually makes no difference. The insulation resistance of the film in a condenser rated at 8 mfd. and suitable for 450 volts amounts to about 2 megohms. The leakage current is not proportional to the voltage applied, but starts very small and then rapidly begins to rise. An ordinary condenser breaks down at some critical voltage, but an electrolytic condenser shows by its leakage current when the maximum limit in voltage is being reached. When the current is exceeded, the condenser heats up and the energy loss increases until the condenser fails. If the excessive voltage is only momentary, the dielectric film is punctured, but the currents which flow form (by electrolytic action) a further coating, and the condenser is therefore healed. Sparking may occur if the condenser is greatly overloaded and the heat generated will result in the evaporation of the liquid in the case of a wet electrolytic condenser. The dry kind of electrolytic condenser, which has a hard, solid dielectric, behaves more like an ordinary condenser as regards sudden breakdown.

When an electrolytic condenser has been standing idle there is quite an appreciable initial spurt of current through the condenser when first connecting up, but this will gradually decrease until the normal leakage value is attained; in the better qualities of electrolytic condenser the excessive leakage current only lasts for less than a minute, but in some of the older types the leakage current

is very heavy and it might take ten minutes before the condenser is healed.

The film on the plate is "formed" by passing a direct current through the condenser, the liquid oxidising the aluminium surface.

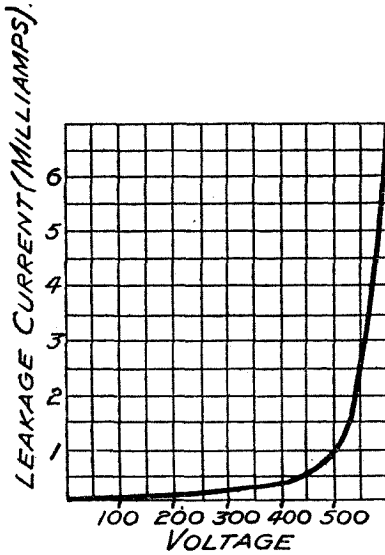

Fig. 507—Curve showing the leakage current for different voltages applied to a certain electrolytic condenser

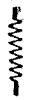



























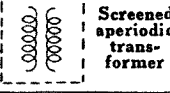





Fig. 507 shows the leakage current for a certain type of electrolytic condenser. The illustrations show the construction and appearance of a modern electrolytic condenser. The manufacturers' instructions regarding mounting the condensers should be observed.

THE END

REFERENCE SECTION

	Page
PRINCIPAL SYMBOLS USED IN RADIO CIRCUITS	314
TABLE OF LOGARITHMS	316
TABLE OF ANTILOGARITHMS	318
TRIGONOMETRICAL RATIOS	320
WIRE TABLES	321
DICTIONARY OF TECHNICAL TERMS USED IN RADIO	324

Principal Symbols used—

	Variable iron-core choke		Fixed resistor		Ganged condensers		Cycle of A.C.
	Condenser		Loud-speaker		Dial light		A.C.
	Variable condenser		Loud-speaker		Crystal or metal rectifier		A.C.
	Preset condenser		Moving-coil speaker		Full-wave metal rectifier		Switch
	Arrow means Moving Vanes		Aerial		Meter		Three-point switch
	Differential condenser		Earth		Meter		Three-point switch
	Variable resistance		Inductance		Fuse		Two-way switch
	Potentiometer		Screened aperiodic transformer		Double fuse		Double-pole double-throw
	Graded resistance		Screened choke or coil		Heater wiring		Full-wave metal rectifier

—in Radio Circuits





































	Triode		Diode		Intermediate-frequency transformer		Tapped inductance
	A.C. triode		A.C. double-diode		Tuned coupled circuits		Inductance coil
	Special A.C. triode		A.C. diode		Tuned secondary transformer		Tapped coil
	Screen-grid valve		Decoupling		Tuned primary transformer		Adjustable inductance
	A.C. screen grid Valve		Pick-up		Preset coupled circuits		Variometer
	Pentode		Earthed shield		Step-down L.F. transformer		Telephone receivers
	A.C. pentode		Cell or battery		Step-up L.F. transformer		Auto-transformer
	Variable-mu S.G.		Tapped battery		Aperiodic transformer		Iron-core choke
	Double diode		Variable battery		Potentiometer		Tapped iron-core coil

TABLE OF LOGARITHMS

	0	1	2	3	4	5	6	7	8	9	1	2	3	4	5	6	7	8	9
10	0000	0043	0086	0128	0170	0212	0253	0294	0334	0374	4	8	12	17	21	25	29	33	37
11	0414	0453	0492	0531	0569	0607	0645	0682	0719	0755	4	8	11	15	19	23	26	30	34
12	0792	0828	0864	0899	0934	0969	1004	1038	1072	1106	3	7	10	14	17	21	24	28	31
13	1139	1173	1206	1239	1271	1303	1335	1367	1399	1430	6	10	13	16	19	23	26	29	
14	1461	1492	1523	1553	1584	1614	1644	1673	1703	1732	3	6	9	12	15	18	21	24	27
15	1761	1790	1818	1847	1875	1903	1931	1959	1987	2014	3	6	8	11	14	17	20	22	25
16	2041	2068	2095	2122	2148	2175	2201	2227	2253	2279	3	5	8	11	13	16	18	21	24
17	2304	2330	2355	2380	2405	2430	2455	2480	2504	2529	2	5	7	10	12	15	17	20	22
18	2553	2577	2601	2625	2648	2672	2695	2718	2742	2765	2	5	7	9	12	14	16	19	21
19	2788	2810	2833	2856	2878	2900	2923	2945	2967	2989	2	4	7	9	11	13	16	18	20
20	3010	3032	3054	3075	3096	3118	3139	3160	3181	3201	2	4	6	8	11	13	15	17	19
21	3222	3243	3263	3284	3304	3324	3345	3365	3385	3404	2	4	6	8	10	12	14	16	18
22	3424	3444	3464	3483	3502	3522	3541	3560	3579	3598	2	4	6	8	10	12	14	15	17
23	3617	3636	3655	3674	3692	3711	3729	3747	3766	3784	2	4	6	7	9	11	13	15	17
24	3832	3820	3838	3856	3874	3892	3909	3927	3945	3962	2	4	5	7	9	11	12	14	16
25	3979	3997	4014	4031	4048	4065	4082	4099	4116	4133	2	3	5	7	9	10	12	14	15
26	4150	4166	4183	4200	4216	4232	4249	4265	4281	4298	2	3	5	7	8	10	11	13	15
27	4314	4330	4346	4362	4378	4393	4409	4425	4440	4456	2	3	5	6	8	9	11	13	14
28	4472	4487	4502	4518	4533	4548	4564	4579	4594	4609	2	3	5	6	8	9	11	12	14
29	4624	4639	4654	4669	4683	4698	4713	4728	4842	4757	1	3	4	6	7	9	10	12	13
30	4771	4786	4800	4814	4829	4843	4857	4871	4886	4900	1	3	4	6	7	9	10	11	13
31	4914	4928	4942	4955	4969	4983	4997	5011	5024	5038	1	3	4	6	7	8	10	11	12
32	5051	5065	5079	5092	5105	5119	5132	5145	5159	5172	1	3	4	5	7	8	9	11	12
33	5185	5198	5211	5224	5237	5250	5263	5276	5289	5302	1	3	4	5	6	8	9	10	12
34	5315	5328	5340	5353	5366	5378	5391	5403	5416	5428	1	3	4	5	6	8	9	10	11
35	5441	5453	5465	5478	5490	5502	5514	5527	5539	5551	1	2	4	5	6	7	9	10	11
36	5563	5575	5587	5599	5611	5623	5635	5647	5658	5670	1	2	4	5	6	7	8	10	11
37	5682	5694	5705	5717	5729	5740	5752	5763	5775	5786	1	2	3	5	6	7	8	9	10
38	5798	5809	5821	5832	5843	5855	5866	5877	5888	5899	1	2	3	5	6	7	8	9	10
39	5911	5922	5933	5944	5955	5966	5977	5988	5999	6010	1	2	3	4	5	7	8	9	10
40	6021	6031	6042	6053	6064	6075	6085	6096	6107	6117	1	2	3	4	5	6	8	9	10
41	6128	6138	6149	6160	6170	6180	6191	6201	6212	6222	1	2	3	4	5	6	7	8	9
42	6232	6243	6253	6263	6274	6284	6294	6304	6314	6325	1	2	3	4	5	6	7	8	9
43	6335	6345	6355	6365	6375	6385	6395	6405	6415	6425	1	2	3	4	5	6	7	8	9
44	6435	6444	6454	6464	6474	6484	6493	6503	6513	6522	1	2	3	4	5	6	7	8	9
45	6532	6542	6551	6561	6571	6580	6590	6599	6609	6618	1	2	3	4	5	6	7	8	9
46	6628	6637	6646	6656	6665	6675	6684	6693	6702	6712	1	2	3	4	5	6	7	7	8
47	6721	6730	6739	6749	6758	6767	6776	6785	6794	6803	1	2	3	4	5	5	6	7	8
48	6812	6821	6830	6839	6848	6857	6866	6875	6884	6893	1	2	3	4	4	5	6	7	8
49	6902	6911	6920	6928	6937	6946	6955	6964	6972	6981	1	2	3	4	4	5	6	7	8
50	6990	6998	7007	7016	7024	7033	7042	7050	7059	7067	1	2	3	3	4	5	6	7	8
51	7076	7084	7093	7101	7110	7118	7126	7135	7143	7152	1	2	3	3	4	5	6	7	8
52	7160	7168	7177	7185	7193	7202	7210	7218	7226	7235	1	2	2	3	4	5	6	7	7
53	7243	7251	7259	7267	7275	7284	7292	7300	7308	7316	1	2	2	3	4	5	6	6	7
54	7324	7332	7340	7348	7356	7364	7372	7380	7388	7396	1	2	2	3	4	5	6	6	7

TABLE OF LOGARITHMS

	0	1	2	3	4	5	6	7	8	9	1	2	3	4	5	6	7	8	9
55	7404	7412	7419	7427	7435	7443	7451	7459	7466	7474	1	2	2	3	4	5	5	6	7
56	7482	7490	7497	7505	7513	7520	7528	7536	7543	7551	1	2	2	3	4	5	5	6	7
57	7559	7566	7574	7582	7589	7597	7604	7612	7619	7627	1	2	2	3	4	5	5	6	7
58	7634	7642	7649	7657	7664	7672	7679	7686	7694	7701	1	1	2	3	4	4	5	6	7
59	7709	7716	7723	7731	7738	7745	7752	7760	7767	7774	1	1	2	3	4	4	5	6	7
60	7782	7789	7796	7803	7810	7818	7825	7832	7839	7846	1	1	2	3	4	4	5	6	6
61	7853	7860	7868	7875	7882	7889	7896	7903	7910	7917	1	1	2	3	4	4	5	6	6
62	7924	7931	7938	7945	7952	7959	7966	7973	7980	7987	1	1	2	3	3	4	5	6	6
63	7993	8000	8007	8014	8021	8028	8035	8041	8048	8055	1	1	2	3	3	4	5	5	6
64	8062	8069	8075	8082	8089	8096	8102	8109	8116	8122	1	1	2	3	3	4	5	5	6
65	8129	8136	8142	8149	8156	8162	8169	8176	8182	8189	1	1	2	3	3	4	5	5	6
66	8195	8202	8209	8215	8222	8228	8235	8241	8248	8254	1	1	2	3	3	4	5	5	6
67	8261	8267	8274	8280	8287	8293	8299	8306	8312	8319	1	1	2	3	3	4	5	5	6
68	8325	8331	8338	8344	8351	8357	8363	8370	8376	8382	1	1	2	3	3	4	4	5	6
69	8388	8395	8401	8407	8414	8420	8426	8432	8439	8445	1	1	2	2	3	4	4	5	6
70	8451	8457	8463	8470	8476	8482	8488	8494	8500	8506	1	1	2	2	3	4	4	5	6
71	8513	8519	8525	8531	8537	8543	8549	8555	8561	8567	1	1	2	2	3	4	4	5	5
72	8573	8579	8585	8591	8597	8603	8609	8615	8621	8627	1	1	2	2	3	4	4	5	5
73	8633	8639	8645	8651	8657	8663	8669	8675	8681	8686	1	1	2	2	3	4	4	5	5
74	8692	8698	8704	8710	8716	8722	8727	8733	8739	8745	1	1	2	2	3	4	4	5	5
75	8751	8756	8762	8768	8774	8779	8785	8791	8797	8802	1	1	2	2	3	3	4	5	5
76	8808	8814	8820	8825	8831	8837	8842	8848	8854	8859	1	1	2	2	3	3	4	5	5
77	8865	8871	8876	8882	8887	8893	8899	8904	8910	8915	1	1	2	2	3	3	4	4	5
78	8921	8927	8932	8938	8943	8949	8954	8960	8965	8971	1	1	2	2	3	3	4	4	5
79	8976	8982	8987	8993	8998	9004	9009	9015	9020	9025	1	1	2	2	3	3	4	4	5
80	9031	9036	9042	9047	9053	9058	9063	9069	9074	9079	1	1	2	2	3	3	4	4	5
81	9085	9090	9096	9101	9106	9112	9117	9122	9128	9133	1	1	2	2	3	3	4	4	5
82	9138	9143	9149	9154	9159	9165	9170	9175	9180	9186	1	1	2	2	3	3	4	4	5
83	9191	9196	9201	9206	9212	9217	9222	9227	9232	9238	1	1	2	2	3	3	4	4	5
84	9243	9248	9253	9258	9263	9269	9274	9279	9284	9289	1	1	2	2	3	3	4	4	5
85	9294	9299	9304	9309	9315	9320	9325	9330	9335	9340	1	2	2	2	3	3	4	4	5
86	9345	9350	9355	9360	9365	9370	9375	9380	9385	9390	1	1	2	2	3	3	4	4	5
87	9395	9400	9405	9410	9415	9420	9425	9430	9435	9440	0	1	1	2	2	3	3	4	4
88	9445	9450	9455	9460	9465	9469	9474	9479	9484	9489	0	1	1	2	2	3	3	4	4
89	9494	9499	9504	9509	9513	9518	9523	9528	9533	9538	0	1	1	2	2	3	3	4	4
90	9542	9547	9552	9557	9562	9566	9571	9576	9581	9586	0	1	1	2	2	3	3	4	4
91	9590	9595	9600	9605	9609	9614	9619	9624	9628	9633	0	1	1	2	2	3	3	4	4
92	9638	9643	9647	9652	9657	9661	9666	9671	9675	9680	0	1	1	2	2	3	3	4	4
93	9685	9689	9694	9699	9703	9708	9713	9717	9722	9727	0	1	1	2	2	3	3	4	4
94	9731	9736	9741	9745	9750	9754	9759	9763	9768	9773	0	1	1	2	2	3	3	4	4
95	9777	9782	9786	9791	9795	9800	9805	9809	9814	9818	0	1	1	2	2	3	3	4	4
96	9823	9827	9832	9836	9841	9845	9850	9854	9859	9863	0	1	1	2	2	3	3	4	4
97	9868	9872	9877	9881	9886	9890	9894	9899	9903	9908	0	1	1	2	2	3	3	4	4
98	9912	9917	9921	9926	9930	9934	9939	9943	9948	9952	0	1	1	2	2	3	3	4	4
99	9956	9961	9965	9969	9974	9978	9983	9987	9991	9996	0	1	1	2	2	3	3	3	4

TABLE OF ANTILOGARITHMS

	0	1	2	3	4	5	6	7	8	9	1	2	3	4	5	6	7	8	9
·00	1000	1002	1005	1007	1009	1012	1014	1016	1019	1021	0	0	1	1	1	1	2	2	2
·01	1023	1026	1028	1030	1033	1035	1038	1040	1042	1045	0	0	1	1	1	1	2	2	2
·02	1047	1050	1052	1054	1057	1059	1062	1064	1067	1069	0	0	1	1	1	1	2	2	2
·03	1072	1074	1076	1079	1081	1084	1086	1089	1091	1094	0	0	1	1	1	1	2	2	2
·04	1096	1099	1102	1104	1107	1109	1112	1114	1117	1119	0	1	1	1	1	2	2	2	2
·05	1122	1125	1127	1130	1132	1135	1138	1140	1143	1146	0	1	1	1	1	2	2	2	2
·06	1148	1151	1153	1156	1159	1161	1164	1167	1169	1172	0	1	1	1	1	2	2	2	2
·07	1175	1178	1180	1183	1186	1189	1191	1194	1197	1199	0	1	1	1	1	2	2	2	2
·08	1202	1205	1208	1211	1213	1216	1219	1222	1225	1227	0	1	1	1	1	2	2	2	3
·09	1230	1233	1236	1239	1242	1245	1247	1250	1253	1256	0	1	1	1	1	2	2	2	3
·10	1259	1262	1265	1268	1271	1274	1276	1279	1282	1285	0	1	1	1	1	2	2	2	3
·11	1288	1291	1294	1297	1300	1303	1306	1309	1312	1315	0	1	1	1	2	2	2	2	3
·12	1318	1321	1324	1327	1330	1334	1337	1340	1343	1346	0	1	1	1	2	2	2	2	3
·13	1349	1352	1355	1358	1361	1365	1368	1371	1374	1377	0	1	1	1	2	2	2	3	3
·14	1380	1384	1387	1390	1393	1396	1400	1403	1406	1409	0	1	1	1	2	2	2	3	3
·15	1413	1416	1419	1422	1426	1429	1432	1435	1439	1442	0	1	1	1	2	2	2	3	3
·16	1445	1449	1452	1455	1459	1462	1466	1469	1472	1476	0	1	1	1	2	2	2	3	3
·17	1479	1483	1486	1489	1493	1496	1500	1503	1507	1510	0	1	1	1	2	2	2	3	3
·18	1514	1517	1521	1524	1528	1531	1535	1538	1542	1545	0	1	1	1	2	2	2	3	3
·19	1549	1552	1556	1560	1563	1567	1570	1574	1578	1581	0	1	1	1	2	2	3	3	3
·20	1585	1589	1582	1597	1600	1603	1607	1611	1614	1618	0	1	1	1	2	2	3	3	3
·21	1622	1626	1629	1633	1637	1641	1644	1648	1652	1656	0	1	1	2	2	2	3	3	3
·22	1660	1663	1667	1671	1675	1679	1683	1687	1690	1694	0	1	1	2	2	2	3	3	3
·23	1698	1702	1706	1710	1714	1718	1722	1726	1730	1734	0	1	1	2	2	2	3	3	4
·24	1738	1742	1746	1750	1754	1758	1762	1766	1770	1774	0	1	1	2	2	2	3	3	4
·25	1778	1782	1786	1791	1795	1799	1803	1807	1811	1816	0	1	1	2	2	2	3	3	4
·26	1820	1824	1828	1832	1837	1841	1845	1849	1854	1858	0	1	1	2	2	3	3	3	4
·27	1862	1866	1871	1875	1879	1884	1888	1892	1897	1901	0	1	1	2	2	3	3	3	4
·28	1905	1910	1914	1919	1923	1928	1932	1936	1941	1945	0	1	1	2	2	3	3	4	4
·29	1950	1954	1959	1963	1968	1972	1977	1982	1986	1991	0	1	1	2	2	3	3	4	4
·30	1995	2000	2004	2009	2014	2018	2023	2028	2032	2037	0	1	1	2	2	3	3	4	4
·31	2042	2046	2051	2056	2061	2065	2070	2075	2080	2084	0	1	1	2	2	3	3	4	4
·32	2089	2094	2099	2104	2109	2113	2118	2123	2128	2133	0	1	1	2	2	3	3	4	4
·33	2138	2143	2148	2153	2158	2163	2168	2173	2178	2183	0	1	1	2	2	3	3	4	4
·34	2188	2193	2198	2203	2208	2213	2218	2223	2228	2234	1	1	2	2	3	3	4	4	5
·35	2239	2244	2249	2254	2259	2265	2270	2275	2280	2286	1	1	2	2	3	3	4	4	5
·36	2291	2296	2301	2307	2312	2317	2323	2328	2333	2338	1	1	2	2	3	3	4	4	5
·37	2344	2350	2355	2360	2366	2371	2377	2382	2388	2393	1	1	2	2	3	3	4	4	5
·38	2399	2404	2410	2415	2421	2427	2432	2438	2443	2449	1	1	2	2	3	3	4	4	5
·39	2455	2460	2466	2472	2477	2483	2489	2495	2500	2506	1	1	2	2	3	3	4	4	5
·40	2512	2518	2523	2529	2535	2541	2547	2553	2559	2564	1	1	2	2	3	3	4	4	5
·41	2570	2576	2582	2588	2594	2600	2606	2612	2618	2624	1	1	2	2	3	3	4	4	5
·42	2630	2636	2642	2649	2655	2661	2667	2673	2678	2685	1	1	2	2	3	3	4	4	5
·43	2692	2698	2704	2710	2716	2723	2729	2735	2742	2748	1	1	2	3	3	3	4	4	5
·44	2754	2761	2767	2773	2780	2786	2793	2799	2790	2812	1	1	2	3	3	3	4	4	5
·45	2818	2825	2831	2838	2844	2851	2858	2864	2871	2877	1	1	2	3	3	3	4	4	5
·46	2884	2891	2897	2904	2911	2917	2924	2931	2938	2944	1	1	2	3	3	3	4	4	5
·47	2951	2958	2965	2972	2979	2985	2992	2999	3006	3013	1	1	2	3	3	3	4	4	5
·48	3020	3027	3034	3041	3048	3055	3062	3069	3076	3083	1	1	2	3	3	3	4	4	5
·49	3090	3097	3105	3112	3119	3126	3133	3141	3148	3155	1	1	2	3	3	3	4	4	5

TABLE OF ANTILOGARITHMS

	0	1	2	3	4	5	6	7	8	9	1	2	3	4	5	6	7	8	9
50	3162	3170	3177	3184	3192	3199	3206	3214	3221	3228	1	1	2	3	4	4	5	6	7
51	3236	3243	3251	3258	3266	3273	3281	3289	3296	3304	1	2	2	3	4	5	5	6	7
52	3311	3319	3327	3334	3342	3350	3357	3365	3373	3381	1	2	2	3	4	5	5	6	7
53	3388	3396	3404	3412	3420	3428	3436	3443	3451	3459	1	2	2	3	4	5	6	6	7
54	3467	3475	3483	3491	3499	3508	3516	3524	3532	3540	1	2	2	3	4	5	6	6	7
55	3548	3556	3565	3573	3581	3589	3597	3606	3614	3622	1	2	2	3	4	5	6	7	7
56	3631	3639	3648	3656	3664	3673	3681	3690	3698	3707	1	2	3	3	4	5	6	7	8
57	3715	3724	3733	3741	3750	3758	3767	3776	3784	3793	1	2	3	3	4	5	6	7	8
58	3802	3811	3819	3828	3837	3846	3855	3864	3873	3882	1	2	3	4	4	5	6	7	8
59	3890	3899	3908	3917	3926	3936	3945	3954	3963	3972	1	2	3	4	5	5	6	7	8
60	3981	3990	3999	4009	4018	4027	4036	4046	4055	4064	1	2	3	4	5	6	6	7	8
61	4074	4083	4093	4102	4111	4121	4130	4140	4150	4159	1	2	3	4	5	6	7	8	9
62	4169	4178	4188	4198	4207	4217	4227	4236	4246	4256	1	2	3	4	5	6	7	8	9
63	4266	4276	4285	4295	4305	4315	4325	4335	4345	4355	1	2	3	4	5	6	7	8	9
64	4365	4375	4385	4395	4406	4416	4426	4436	4446	4457	1	2	3	4	5	6	7	8	9
65	4467	4477	4487	4498	4508	4519	4529	4539	4550	4560	1	2	3	4	5	6	7	8	9
66	4571	4581	4592	4603	4613	4624	4634	4645	4656	4667	1	2	3	4	5	6	7	9	10
67	4677	4688	4699	4710	4721	4732	4742	4753	4764	4775	1	2	3	4	5	7	8	9	10
68	4786	4797	4808	4819	4831	4842	4853	4864	4875	4887	1	2	3	4	6	7	8	9	10
69	4898	4909	4920	4932	4943	4955	4966	4977	4989	5000	1	2	3	5	6	7	8	9	10
70	5012	5023	5035	5047	5058	5070	5082	5093	5105	5117	1	2	4	5	6	7	8	9	11
71	5129	5140	5152	5164	5176	5188	5200	5212	5224	5236	1	2	4	5	6	7	8	10	11
72	5248	5260	5272	5284	5297	5309	5321	5333	5346	5358	1	2	4	5	6	7	9	10	11
73	5370	5383	5395	5408	5420	5433	5445	5458	5470	5483	1	3	4	5	6	8	9	10	11
74	5495	5508	5521	5534	5546	5559	5572	5585	5598	5610	1	3	4	5	6	8	9	10	12
75	5623	5636	5649	5662	5675	5689	5702	5715	5728	5741	1	3	4	5	7	8	9	10	12
76	5754	5768	5781	5794	5808	5821	5834	5848	5861	5875	1	3	4	5	7	8	9	11	12
77	5888	5902	5916	5929	5943	5957	5970	5984	5998	6012	1	3	4	5	7	8	10	11	12
78	6026	6039	6053	6067	6081	6095	6109	6124	6138	6152	1	3	4	6	7	8	10	11	13
79	6166	6180	6194	6209	6223	6237	6252	6266	6281	6295	1	3	4	6	7	9	10	11	13
80	6310	6324	6339	6353	6368	6383	6397	6412	6427	6442	1	3	4	6	7	9	10	12	13
81	6457	6471	6486	6501	6516	6531	6546	6561	6577	6592	2	3	5	6	8	9	11	12	14
82	6607	6622	6637	6653	6668	6683	6699	6714	6730	6745	2	3	5	6	8	9	11	12	14
83	6761	6776	6792	6808	6823	6839	6855	6871	6887	6902	2	3	5	6	8	9	11	13	14
84	6918	6934	6950	6966	6982	6998	7015	7031	7047	7063	2	3	5	6	8	10	11	13	15
85	7079	7096	7112	7129	7145	7161	7178	7194	7211	7228	2	3	5	7	8	10	12	13	15
86	7244	7261	7278	7295	7311	7328	7345	7362	7379	7396	2	3	5	7	8	10	12	13	15
87	7413	7430	7447	7464	7482	7499	7516	7534	7551	7568	2	4	5	7	9	10	12	14	16
88	7586	7603	7621	7638	7656	7674	7691	7709	7727	7745	2	4	5	7	9	11	12	14	16
89	7762	7780	7798	7816	7834	7852	7870	7889	7907	7925	2	4	5	7	9	11	13	14	16
90	7943	7962	7980	7998	8017	8035	8054	8072	8091	8110	2	4	6	7	9	11	13	15	17
91	8128	8147	8166	8185	8204	8222	8241	8260	8279	8299	2	4	6	8	9	11	13	15	17
92	8318	8337	8356	8375	8395	8414	8433	8453	8472	8492	2	4	6	8	10	12	14	15	17
93	8511	8531	8551	8570	8590	8610	8630	8650	8670	8690	2	4	6	8	10	12	14	16	18
94	8710	8730	8750	8770	8790	8810	8831	8851	8872	8892	2	4	6	8	10	12	14	16	18
95	8913	8933	8954	8974	8995	9016	9036	9057	9078	9099	2	4	6	8	10	12	15	17	19
96	9120	9141	9162	9183	9204	9226	9247	9268	9290	9311	2	4	6	8	11	13	15	17	19
97	9333	9354	9376	9397	9419	9441	9462	9484	9506	9528	2	4	7	9	11	13	15	17	20
98	9550	9572	9594	9616	9638	9661	9683	9705	9727	9750	2	4	7	9	11	13	16	18	20
99	9772	9795	9817	9840	9863	9886	9908	9931	9954	9977	2	5	7	9	11	14	16	18	20

TRIGONOMETRICAL RATIOS

Degree.	Radians.	Sine.	Cosine.	Tan.	Cot.		
0	0·0000	0·0000	1·0000	0·0000	∞	1·5708	90
1	0·0175	0·0175	0·9998	0·0175	57·290	1·5533	89
2	0·0349	0·0349	0·9994	0·0349	28·636	1·5359	88
3	0·0524	0·0523	0·9986	0·0524	19·081	1·5184	87
4	0·0698	0·0698	0·9976	0·0699	14·301	1·5010	86
5	0·0873	0·0872	0·9962	0·0875	11·430	1·4835	85
6	0·1047	0·1045	0·9945	0·1051	9·5144	1·4661	84
7	0·1222	0·1219	0·9925	0·1228	8·1443	1·4485	83
8	0·1396	0·1392	0·9903	0·1405	7·1154	1·4312	82
9	0·1571	0·1564	0·9877	0·1584	6·3138	1·4137	81
10	0·1745	0·1736	0·9848	0·1763	5·6713	1·3963	80
11	0·1920	0·1908	0·9816	0·1944	5·1446	1·3788	79
12	0·2094	0·2079	0·9781	0·2126	4·7046	1·3614	78
13	0·2269	0·2250	0·9744	0·2309	4·3315	1·3439	77
14	0·2443	0·2419	0·9703	0·2493	4·0108	1·3264	76
15	0·2618	0·2588	0·9659	0·2679	3·7321	1·3090	75
16	0·2793	0·2756	0·9613	0·2867	3·4874	1·2915	74
17	0·2967	0·2924	0·9563	0·3057	3·2709	1·2741	73
18	0·3142	0·3090	0·9511	0·3249	3·0777	1·2566	72
19	0·3316	0·3256	0·9455	0·3443	2·9042	1·2392	71
20	0·3491	0·3420	0·9397	0·3640	2·7475	1·2217	70
21	0·3665	0·3584	0·9336	0·3839	2·6051	1·2043	69
22	0·3840	0·3746	0·9272	0·4040	2·4751	1·1868	68
23	0·4014	0·3907	0·9205	0·4245	2·3559	1·1694	67
24	0·4189	0·4067	0·9135	0·4452	2·2460	1·1519	66
25	0·4363	0·4226	0·9063	0·4663	2·1445	1·1345	65
26	0·4538	0·4384	0·8988	0·4877	2·0503	1·1170	64
27	0·4712	0·4540	0·8910	0·5095	1·9626	1·0996	63
28	0·4887	0·4695	0·8820	0·5317	1·8807	1·0821	62
29	0·5061	0·4848	0·8746	0·5543	1·8040	1·0647	61
30	0·5236	0·5000	0·8660	0·5774	1·7321	1·0472	60
31	0·5411	0·5150	0·8572	0·6009	1·6643	1·0297	59
32	0·5585	0·5299	0·8480	0·6249	1·6003	1·0123	58
33	0·5760	0·5446	0·8387	0·6494	1·5399	0·9948	57
34	0·5934	0·5592	0·8290	0·6745	1·4826	0·9774	56
35	0·6109	0·5736	0·8192	0·7002	1·4281	0·9599	55
36	0·6283	0·5878	0·8090	0·7265	1·3764	0·9425	54
37	0·6458	0·6018	0·7986	0·7536	1·3270	0·9250	53
38	0·6632	0·6157	0·7880	0·7813	1·2799	0·9076	52
39	0·6807	0·6293	0·7771	0·8098	1·2349	0·8901	51
40	0·6981	0·6428	0·7660	0·8391	1·1918	0·8727	50
41	0·7156	0·6561	0·7547	0·8693	1·1504	0·8552	49
42	0·7330	0·6691	0·7431	0·9004	1·1106	0·8378	48
43	0·7505	0·6820	0·7314	0·9325	1·0724	0·8203	47
44	0·7679	0·6947	0·7193	0·9657	1·0355	0·8029	46
45	0·7854	0·7071	0·7071	1·0000	1·0000	0·7854	
		Cosine.	Sine.	Cot.	Tan.	Radians.	Degree



A DISTINGUISHED TYPE OF MODERN RECEIVER

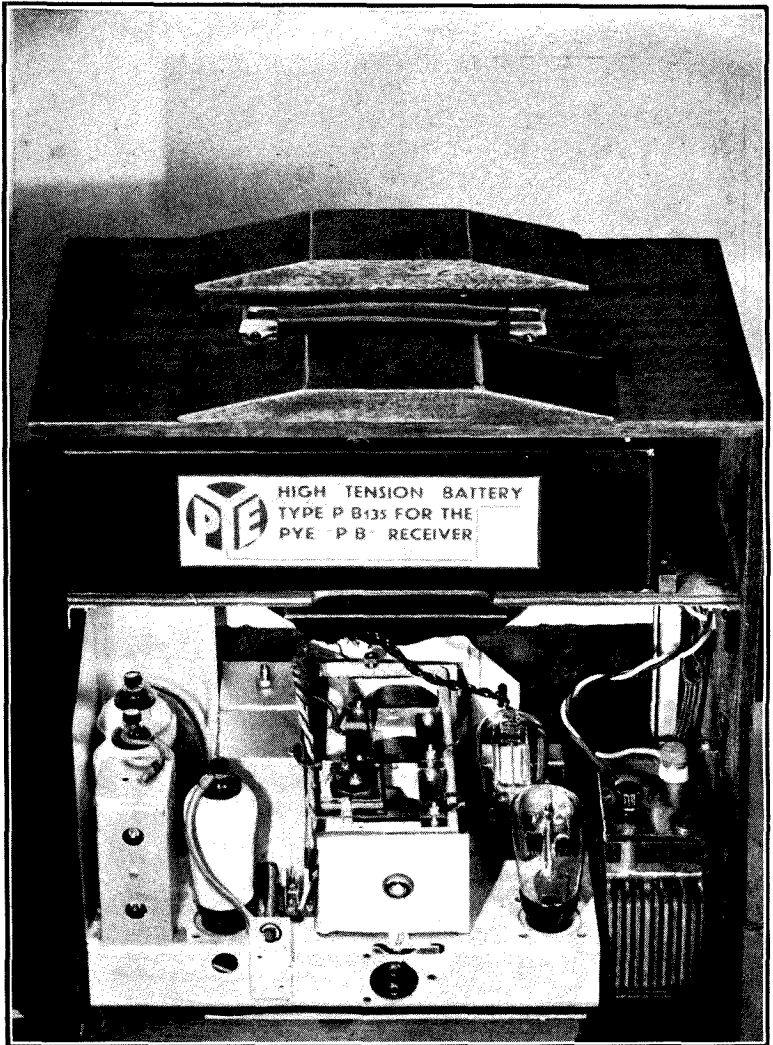

A MODERN BATTERY RECEIVER OF THE SEMI-PORTABLE TYPE

WIRE TABLES

(1) Bare Copper Wire

Diam.	S.W.G.	Section Area.	Ohms per 1,000 yds.	Length per Ohm.	Wt. per 1,000 yds.	Approx. safe Current.
in.		sq. in.		yds.	lbs.	amps.
·128	10	·013	1·87	535	148·8	35
·104	12	·008 5	2·83	353	98·2	28
·080	14	·005 03	4·78	208	58·1	19
·064	16	·003 22	7·46	134·6	37·2	13
·048	18	·001 81	13·27	53·4	20·9	7
·036	20	·001 02	23·6	42·4	1·18	4
·028	22	·000 616	39·0	25·6	7·12	2·5
·002	24	·000 380	63·2	15·8	4·40	1·5
·018	26	·000 254	94·3	10·60	2·94	1·0
·014 8	28	·000 172	139·5	7·18	1·99	·7
·012 4	30	·000 121	199	5·03	1·40	·5
·010 8	32	·000 091 6	262	3·82	1·06	·4
·009 2	34	·000 066 5	361	2·77	·769	·25
·007 6	36	·000 045 4	529	1·89	·535	·15
·006 0	38	·000 028 3	849	1·18	·327	·1
·004 8	40	·000 018 1	1 326	<i>in.</i> 27·15	<i>oz.</i> 3·35	<i>milliamps.</i> 70
·004 0	42	·000 012 6	1 910	18·87	2·32	50
·003 2	44	·000 008 04	2 985	10·77	1·49	30
·002 8	45	·000 006 16	3 899	9·24	1·14	25
·002 4	46	·000 004 52	5 307	6·78	·834	20
·002 0	47	·000 003 14	7 642	4·71	·581	12
·001 6	48	·000 002 01	11 941	3·02	·372	8
·001 2	49	·000 001 13	21 230	1·70	·209	5
·001 0	50	·000 000 78	30 570	1·18	·145	3

(2) Single Cotton Covered Wire

Diam.	S.W.G.	Diam. Overall.	Turns per inch run.	Turns in one sq. in.	Wt. per 1,000 yds.	Yds. per lb.
in.		in.			lbs.	
·128	10	·135 5	7·4	54	150·8	6·63
·104	12	·111 5	9·6	81	99·7	10·3
·080	14	·087 5	11·4	130	59·3	16·9
·064	16	·071 0	14·1	198	38·3	26·1
·048	18	·054 5	18·3	335	21·6	46·3
·036	20	·041 5	24·1	581	12·24	81·7
·028	22	·033 5	29·8	888	7·48	134
·022	24	·027 0	37·0	1 369	4·57	219
·018	26	·023 0	43·5	1 892	3·21	311
·014 8	28	·019 8	50·5	2 550	2·21	452
·012 4	30	·017 4	57·5	3 300	1·58	634
·010 8	32	·015 8	63·3	4 010	1·20	835
·009 2	34	·014 2	70·5	4 970	·781	1 280
·007 6	36	·011 6	86·2	7 430	·619	1 610
·006 0	38	·010 0	100·0	10 000	·392	2 550
·004 8	40	·008 8	112·5	26 600	·255	3 910

(3) Double Cotton Covered Wire

Diam.	S.W.G.	Diam. Overall.	Turns per inch run.	Turns per one sq. in.	Wt. per 1 000 yds.	Yds. per lb.
in.		in.			lbs.	
·128	10	·141	7·1	50·3	152	6·58
·104	12	·117	8·5	72	101	9·09
·080	14	·093	10·75	115	60·2	16·6
·064	16	·075	13·3	177	38·9	25·6
·048	18	·058	17·3	299	22·0	45·4
·036	20	·046	21·7	473	12·6	79·4
·028	22	·038	26·3	692	7·76	129
·022	24	·031	32·3	1 043	4·92	203
·018	26	·027	37	1 400	3·40	294
·014 8	28	·023 8	42	1 790	2·37	422
·012 4	30	·021 4	47	2 210	1·70	587
·010 8	32	·019 8	50·5	2 550	1·32	755
·009 2	34	·018 2	55	3 020	·977	1 024
·007 6	36	·015 6	64	4 010	·677	1 477
·006 0	38	·014 0	71·5	5 110	·437	2 287
·004 8	40	·012 8	78	6 080	·290	3 456

(4) Single Silk Covered Wire

Diam.	S.W.G.	Diam. Overall.	Turns per inch run.	Turns in one sq. in.	Wt. per 1 000 yds.	Yds. per lb. or oz.
in.		in.			lbs.	per lb.
·064	16	·067	15·0	222	37·9	26·4
·048	18	·050	20·0	400	21·3	46·8
·036	20	·038	26·3	692	12·0	83·3
·028	22	·030	33·3	1 090	7·30	137
·022	24	·023 5	42·5	1 810	4·50	222
·018	26	·019 3	51·8	2 680	3·02	332
·014 8	28	·016 1	62·1	3 860	2·05	488
·012 4	30	·013 7	73·0	5 330	1·44	695
·010 8	32	·012 1	82·6	6 820	1·10	912
·009 2	34	·010 5	95·2	9 060	·800	1 250
·007 6	36	·008 9	112	12 540	·551	1 815
·006 0	38	·007 3	137	18 770	·348	2 871
					oz.	per oz.
·004 8	40	·006 1	164	26 900	3·62	276
·004 0	42	·005 2	192	36 860	2·58	387
·003 2	44	·004 4	227	51 530	1·67	599
·002 8	45	·004 0	250	62 500	1·33	752
·002 4	46	·003 6	278	77 300	1·00	1 000
·002 0	47	·003 2	312	97 300	·727	1 375

(5) Double Silk Covered Wire

Diam.	S.W.G.	Diam. Overall.	Turns per inch run.	Turns in one sq. in.	Wt. per 1,000 yds.	Yds. per lb. or oz.
in.		in.			lbs.	per lb.
·064	16	·068	14·7	216	38·3	26·1
·048	18	·051	19·6	384	21·6	46·3
·036	20	·039	25·6	655	12·1	82·5
·028	22	·031	32·2	1 040	7·44	134
·022	24	·025	40·0	1 600	4·59	218
·018	26	·020 5	48·8	2 380	3·08	325
·014 8	28	·017 3	57·8	3 340	2·09	478
·012 4	30	·014 9	67·1	4 500	1·48	675
·010 8	32	·013 3	75·2	5 650	1·13	887
·009 2	34	·011 7	85·5	7 310	·82	1 220
·007 6	36	·010 1	90·1	8 120	·57	1 750
·006 0	38	·008 5	118	13 900	·27	3 760
					oz.	per oz.
·004 8	40	·007 3	137	18 000	3·38	258
·004 0	42	·006 2	161	25 900	2·80	335
·003 2	44	·005 4	185	34 200	1·86	536
·002 8	45	·005 0	200	40 000	1·48	675
·002 4	46	·004 6	217	47 100	1·15	871
·002 0	47	·004 2	238	56 600	·845	1 190

(6) Enamelled Wire

Diam.	S.W.G.	Diam. Overall.	Turns per inch run.	Turns in one sq. in.	Wt. per 1,000 yds.	Yds. per lb. or oz.
in.		in.			lbs.	per lb.
·064	16	·067 5	14·8	219	37·8	26·4
·048	18	·050 7	19·7	388	21·3	46·9
·036	20	·038 7	25·8	666	12·0	83·3
·028	22	·030 5	32·8	1 080	7·30	137
·022	24	·024 3	41·1	1 690	4·52	221
·018	26	·019 8	50·5	2 550	3·03	330
·014 8	28	·016 4	60·1	3 610	2·05	488
·012 4	30	·013 6	73·5	5 400	1·44	694
·010 8	32	·012 0	83·3	6 940	1·09	915
·009 2	34	·010 2	98·0	9 600	·832	1 202
·007 6	36	·008 6	116	13 450	·543	1 840
·006 0	38	·007 0	143	20 450	·340	2 810
					oz.	per oz.
·004 8	40	·005 5	182	33 100	3·49	286
·004 0	42	·004 6	217	47 100	1·43	411
·003 2	44	·003 7	270	72 900	1·56	642
·002 8	45	·003 3	303	91 800	1·195	835
·002 4	46	·002 8	357	127 500	·885	1 128
·002 0	47	·002 3	435	189 000	·613	1 630
·001 6	48	·001 9	526	277 000	·392	2 540
·001 2	49	·001 4	714	510 000	·221	4 510
·001 0	50	·001 2	833	694 000	·154	6 480

DICTIONARY

of

TECHNICAL TERMS

USED IN RADIO

A.

"A" battery.—This is a term used in the U.S.A. to indicate the filament heating battery (i.e. the L.T.).

A.C.—Abbreviation for alternating current.

Absorption wavemeter.—A form of wavemeter consisting of an inductance and condenser which, if worked near a receiving circuit, will absorb energy from it when the wavemeter is tuned to the frequency of the incoming signal; a maximum reduction of signal strength occurs when the wavemeter is tuned to the incoming signal. Sometimes used in conjunction with a lamp or meter for measuring the wavelength in a transmitting station.

A.C. component.—Where there is a direct current and also an alternating current flowing in the same circuit, each is termed a component of the whole current. The alternating current component can frequently be separated from the direct current component by a filter. In valve circuits the A.C. component is usually due to the signals, while the D.C. is the direct current through the valve. The A.C. component may be separated by a parallel-fed system.

A.C. mains.—The supply of alternating current as brought to the house for lighting, heating, etc.

A.C. resistance.—The opposition which a circuit offers to alternating currents. The term impedance is usually used, and includes reactance and ohmic resistance. The A.C. resistance of a valve is more usually termed the impedance. It must not be confused with the direct current resistance of the filament to anode path.

A.C. valve.—General term to describe a valve which operates with A.C. The cathode may be heated directly or indirectly.

Acceptor circuit.—A tuned circuit consisting of an inductance and variable condenser in series, the whole being connected across the two points which it is desired to short-circuit for a given frequency. The acceptor circuit acts as a small resistance towards the frequency to which it is tuned, but offers considerable opposition to all other frequencies.

Accumulator.—A cell or battery of cells of the secondary type which are recharged by direct current and thus restored to their original chemical condition which enables them to deliver a current.

Acoustics.—The science of sound. Is of great importance in the design of studios.

Acoustic waves.—Sound waves. They may be transmitted through solids, liquids, or gases, but not through a vacuum. Sound waves have a velocity of one thousand and ninety feet per second in air, subject to changes of temperature and pressure.

Adaptor.—An arrangement which enables one to apply external apparatus to an existing apparatus such as a receiver. A short-wave adaptor is a simple external addition which may be plugged in or otherwise connected to an existing receiver.

Admittance.—The reciprocal of impedance. It is measured in ohms.

Aerial.—A conductor which is intended to pick up wireless waves. It is usually erected in the form of wires above the earth and is insulated.

Aerial circuit.—The circuit between aerial and earth in a wireless receiver or transmitter. The term is generally also used in connection with the first tuned circuit of a wireless receiver.

Aerial insulator.—The insulator, usually made of porcelain, china, rubber, etc., placed between the aerial wire and its support.

Aerial resistance.—Resistance which the aerial circuit offers to high-frequency oscillations. It is made up of radiation resistance, ohmic resistance, and dielectric loss resistance.

Aerial tuning condenser.—A variable condenser used for tuning the aerial circuit.

Aerial tuning inductance.—Inductance associated with the aerial circuit which is tuned.

Air condenser.—A condenser in which the insulating material or dielectric is air. Such condensers are usually variable.

Air core.—Wireless components of an inductive type, such as chokes, inductances and transformers, are usually wound on formers having air occupying most of the space inside the coil, e.g., an air-core inductance often consists of a coil wound on a cylindrical tube of insulating material, the inside of the cylinder being simply air. Sometimes the space inside the coil is occupied largely or partly by an iron core, in which case it would be called an iron-core coil. Air-core coils, etc., are usually used for high-frequency currents, although the recent developments in special powdered iron coils are tending to displace air-core coils.

- Air gap.**—The space between two electrodes in a lightning arrester, or between the pole pieces of a magnet and the armature. Also the space between the moving coil of a speaker and the magnet.
- Alternating current.**—An electric current which changes direction at regular intervals and with regular changes of magnitude. It starts at zero, builds up to maximum in a certain direction, then falls off to zero again. It then reverses direction, builds up to a maximum and falls to zero. The complete process is repeated a given number of times per second which is known as the frequency.
- Alternator.**—An electrical generator of alternating current. It generally consists of an armature carrying conducting wires connected to slip-rings. The rotation of the armature in a magnetic field produces alternating currents.
- Aluminium rectifier.**—A rectifier consisting of an aluminium cathode and some kind of anode inserted into a liquid electrolyte such as ammonium phosphate. It converts alternating current into D.C. which may be used for charging accumulators.
- Ammeter.**—An instrument which measures the strength of an electric current in amperes.
- Ampere.**—A unit for measuring the flow of electric current. It represents a flow of one coulomb of electricity per second.
- Ampere-hour.**—The number of ampere-hours of an accumulator is a measure of the output it will give. For example, 20 ampere-hours would mean that the accumulator would give one ampere for 20 hours, or $\frac{1}{2}$ an ampere for 40 hours, and so on.
- Amplification.**—The process of increasing the strength or amplitude of electrical variations or, in general, the process of producing a magnified electrical current or voltage.
- Amplification factor.**—The amount of amplification given by an amplifying device. More specifically used in connection with a valve where it represents the theoretical maximum amplification obtainable from that valve. If it takes 10 volts to produce the same change of anode current in a triode as 1 volt on the grid, the amplification factor of the valve is 10.
- Amplifier.**—The complete apparatus which amplifies an electric current or potential. Usually a valve device operating for the magnification of high- or low-frequency currents.
- Amplifier, H.F.**—An amplifier for magnifying high-frequency oscillations. It consists of one or more stages.
- Amplifier, L.F.**—Apparatus for magnifying low-frequency currents such as are obtained after detection.
- Amplitude.**—The maximum value of current or e.m.f. of an electric current; usually used to indicate the maximum strength of an alternative current.
- Anode.**—The positive electrode of a valve, rectifier or other device through which an electric current passes or across which a potential difference is created.

Anode battery.—The high-tension battery used for making the anode positive.

Anode-bend rectification.—The system of rectification or detection which depends upon a change of mean anode current; usually applied to the triode detector, where the grid is biased negatively so that the bottom bend of the grid-volts/anode-current curve is used. Under these conditions, the application of alternating e.m.f.s. to the grid will cause an average increase of anode current.

Anode circuit.—A circuit consisting of the H.T. battery and any other component connected across anode and cathode of a valve.

Anode current.—The current in the anode circuit of a valve.

Anode resistance.—The resistance, if any, in the anode circuit of a valve; usually used for coupling purposes or for decoupling.

Antenna.—Another name for aerial.

Anti-capacity.—Term applied to switches and other components to signify that the self-capacity is small.

Anti-microphonic.—Apparatus so arranged that vibration is reduced or does not affect the operation of the apparatus; usually applied to a valve holder mounted so that it is shock-absorbing.

Aperiodic.—Not responding to any particular frequency; untuned.

Aperiodic aerial circuit.—Usually consists of an inductance coil connected between aerial and earth, this coil being coupled to a tuned circuit.

Aperiodic coupling.—High-frequency coupling between valves; it usually consists of an aperiodic transformer, a resistance, or an H.F. choke.

Armature.—The electrical system of wires arranged on an iron drum rotating in a magnetic field, e.g., in a motor or alternator. Also applied to the iron which vibrates in a magnetic field, e.g., in an electric bell or certain types of loudspeaker.

Astatic.—If a coil is so wound that its external magnetic field is negligible, it is called astatic. Sometimes the coil is wound in two sections, the magnetic fields tending to oppose each other as regards an external point.

Atmospherics.—Waves produced in the ether by some electrical discharge such as lightning. Crashing noises are heard, especially during the summer season; there are many causes of atmospherics, many of which have not yet been fully explored.

Atom.—The smallest quantity of an element which retains its chemical characteristics. Consists of a core or nucleus and one or more electrons.

Attenuation.—The opposite to amplification, i.e., a weakening.

Audibility.—The degree to which sound can be heard.

Audio frequency.—Currents are of audio frequency when they can produce sound waves of a frequency which can be heard by the human ear. The term is an alternative to I.F.

Audio-frequency transformer.—A low-frequency transformer, usually of the iron-cored step-up type used after detection.

Auto-heterodyne.—The method of producing beats in a heterodyne or superheterodyne set which consists in using the valve oscillator as a detector.

Automatic bias.—The method of obtaining grid bias by passing the anode current of the valve through a resistance. An increase of H.T. voltage tends to produce an increase of anode current and this increases the negative bias on the grid, thereby operating the valve at a similar position on its characteristic curve. Usually used with mains valves technique; more usually termed self-bias.

Automatic volume control (A.V.C.).—A system for maintaining the output volume from a receiver at an approximately constant level, to avoid excessive volume on strong signals and to reduce fading.

Auto-coupling.—Where tuned circuits are coupled together, e.g., by means of two inductance coils magnetically coupled, a similar effect is obtainable by making part of each circuit common to the other, e.g., by using part of the inductance of one circuit as part of the total inductance of another.

Auto-transformer.—In the ordinary transformer there are two windings, known as the primary and the secondary. By using a single winding and taking a tapping off it, an auto-transformer is produced and various step-up or step-down effects may be obtained.

A.V.C.—Automatic volume control.

B.

“ B ” Battery.—American term for high-tension battery.

Back-e.m.f.—The opposition to an applied current exercised by the change in the magnetic field created by that current.

Back-lash.—The “ wobble ” or looseness between two mechanical parts, e.g., in a variable condenser. Term usually used to indicate that when reaction is excessive and the valve oscillates, the reaction control has to be turned a considerable degree farther back than one would expect. This effect, sometimes known as “ overlap,” or “ reaction hysteresis,” is due to faulty design or operation.

Baffle.—The board on which a loudspeaker is mounted to prevent the sound waves emitted from the back of the speaker from interfering with those desired from the front of the speaker. Usually consists of a board at least 2 feet square, with a centre hole for the speaker. Sometimes baffle boxes are used.

Balanced armature.—An iron bar pivoted between two magnet poles, one end being attracted while the other is repelled by the magnetic field created by signals passing round coils of wire; used in a balanced-armature loudspeaker.

Ballast resistance.—Additional resistance of small value inserted in the cathode lead of an A.C. valve to prevent the grid bias ever becoming insufficiently negative.

Band-pass filter.—Tuning system consisting of two tuned circuits so coupled that the resonance curve is flat-topped, thus being responsive to a given band of frequencies.

Barretter.—A resistance device for maintaining a current in a circuit at a constant strength; usually in the form taken by an electric lamp.

Battery.—Strictly speaking, two or more cells connected together; generally used to include any kind of accumulator or primary cell.

Battery, dry.—Primary battery in which the chemicals are moist instead of liquid.

Battery eliminator.—A mains unit for delivering the high-tension voltage for a wireless receiver; in the case of an A.C. eliminator, a rectifier of the metal or valve type is used.

Beats.—The result of interference between two frequencies; if the result is rectified a new beat frequency equal to the difference or sum of the individual frequencies is obtained.

Beat reception.—If incoming signals are combined with local oscillations of somewhat different frequency, the resultant beats after rectification will produce currents which may then be treated as the main signal to be received. This method is used in the heterodyne reception of continuous waves, and also in superheterodyne receivers.

Bias.—An initial voltage applied to a valve electrode, usually the grid, which forms the starting point of any applied variation of potential.

Bias battery.—The battery for applying the bias to a valve electrode, usually the grid.

Bias resistance.—The resistance used in self-bias.

Blasting.—Audible distortion due to overloading a valve.

Blattnerphone.—Instrument for recording music and speech on a steel tape which passes under the influence of an electro-magnet energised by the signals to be recorded.

Blocking condenser.—Fixed condenser used for the purpose of stopping the flow of the direct current while permitting the "passage" of an alternating current.

Bright-emitter.—Type of valve in which the filament emits light to a very noticeable extent.

Bulb.—The glass envelope in which a filament or other electrodes are enclosed.

By-pass.—Term usually applied in connection with a fixed condenser connected across certain components in order to permit the passage of alternating currents which are to be prevented from going through the component. An example of a by-pass is the condenser connected across the primary of an L.F. transformer to permit the passage of a high-frequency current.

C.

"C" battery.—American term for grid-bias battery.

Capacity.—The two plates of the condenser are said to possess capacity, and if a source of D.C. is connected across the condenser, it will store electricity. The capacity of a condenser will depend upon the distance between the plates, the plate area, and the dielectric constant of the insulating material between the plates.

Capacity coupling.—The coupling between two circuits which consists of a condenser. Term is usually applied to a coupling between two tuned circuits when the tops of the circuits are coupled by a small condenser, or when the circuits have a large condenser in common; sometimes both methods of capacity coupling are in use simultaneously.

Capacity to earth.—All conductors including aërials, condensers, inductance coils, etc., possess capacity to earth. Even though one end of the conductor may already be earthed, the rest of it will possess some capacity to earth; the effect alters tuning ranges, increases losses and strays, and may cause hum and instability.

Capacity reaction.—Method of obtaining reaction which consists in feeding back e.m.fs. from the anode circuit of a valve to the grid circuit through a condenser; to be contrasted with inductive reaction.

Capacity, specific inductive.—The specific inductive capacity of a dielectric is a measure of its value for increasing the capacity of a condenser. It is the ratio of the capacity with the particular dielectric in question and the capacity of the same condenser with air as dielectric.

Carbon microphone.—A type of microphone, the resistance of which varies owing to sound impinging on a diaphragm which compresses to a varying extent carbon granules.

Carrier.—A current or wave which carries the low-frequency modulating currents from a microphone or similar device. A carrier-wave consists of a wave of a given frequency which is modulated by the speech or music. It is the wavelength of this carrier which is the official wavelength of the transmitting station.

Cascade.—Term indicating the method of connecting wireless devices in series, so that the output of one is applied to the input of a similar arrangement. Cascade amplification involves the amplification of two or more times of a wireless signal, e.g. by means of a high-frequency or low-frequency amplifier.

Cathode.—The negative side of a discharge device is known as the cathode. In a valve the cathode takes the form of a heated filament or a tube coated with electron-emitting material, this tube being then heated by heater wires or a filament passing through the centre of the tube.

Cathode-ray.—A stream of electrons, usually sharply focused, in

a highly evacuated tube. The stream of electrons is usually directed on to a fluorescent screen at the end of the tube. Television methods sometimes employ the cathode-ray system.

Cathode-ray oscillograph.—A special cathode-ray tube so arranged that the visible results on a fluorescent screen indicates the applied current or e.m.f. The control of the beam of electrons is effected by electrostatic or electromagnetic means.

Catkin valves.—Valves with metal anodes which act as the outer envelopes of the valves, and which are designed for wireless reception. The name is derived from C.A.T. It is an abbreviation for Cooled Anode Transmitter. The valves are very robust and the method of construction ensures uniformity.

Catswhisker.—The wire which forms one side of a crystal detector ; this wire presses on the surface of the crystal, a suitable sensitive spot being chosen.

Cell.—Term usually applied to the simple arrangement of two electrodes in an electrolyte, employed in the simple primary or secondary source of electricity ; two or more cells are termed a battery.

Cell, primary.—A general class of cell to which the Leclanché, Daniell, and other types of cell belong. They supply a direct current owing to the chemical action of a liquid and one of the electrodes. They are not charged by passing an electric current through them.

Cell, secondary.—Another term for accumulator.

Cell, cadmium.—A cell which gives a voltage of 0.9 volt. A single cadmium cell is sometimes inserted in the grid circuit of a screen-grid valve to give the grid a suitable negative potential.

Cell, selenium.—The resistance of selenium, a chemical element, varies with the extent to which it is illuminated. The resistance of selenium in darkness is considerable, but falls rapidly with the strength of light falling on it. It is used as a photo-electric cell, especially suitable for automatic signals, railway automatic switching, etc.

Cell, photo-electric.—Usually consists of a glass bulb containing two electrodes, one of which emits electrons when light is shone upon it. The strength of the current through the cell varies with the strength of the light, and the arrangement is extensively used in television systems.

Characteristic curve.—A graphical representation of the relationship between two variable quantities. The term is generally applied to the effect on current in a valve of varying voltages of one of the electrodes. Thus, a curve may be drawn to show the change in anode current produced by altering the anode voltage. The most common characteristic curve is a graph showing the effect of varying the grid voltage on the anode current. Curves, however, may be drawn for the variation of current due to voltages applied to a metal rectifier or a crystal detector.

Charge, electrical.—The surplus or shortage of electrons, giving rise to an unstable electrical condition. A charged body tends to discharge itself when opportunity occurs. The charge may either be positive or negative, according to whether there is a shortage or an excess of electrons on the body. A condenser is said to hold its charge if, after it is charged by connecting a D.C. voltage across it, the voltage remains unimpaired for a long period after the battery or other source of D.C. voltage is removed. The word "charge" is also used to convey the amount of current passed through an accumulator during charging.

Choke.—An untuned inductance coil whose primary function is to offer considerable opposition (reactance) to alternating currents. This reaction is great compared with the ohmic resistance of the wire. The choke will have set up across it a large back e.m.f. Chokes are usually of the high-frequency or low-frequency type. In the former case they are often of the air-cored type, but more recently the successful development of powdered iron cores has resulted in efficient high-frequency iron-cored chokes. The self-capacity of an H.F. choke should be kept extremely small to prevent the by-passing of the high-frequency currents. The low-frequency choke which is wound upon an iron core offers a reactance to low-frequency currents. On this account its self-capacity is of minor importance. It is used for low-frequency coupling between valves, but more commonly for smoothing purposes in mains receivers and units.

Choke-capacity coupling.—The method of coupling valves together by means of a choke. The choke is of high-frequency type, and may be used for the amplification of high-frequency currents, and the screen-grid valve is best used with it. An iron-core choke is also sometimes used in place of an L.F. transformer in low-frequency amplification circuits. In the various choke-coupling systems a blocking condenser is used for connecting the anode of one valve to the grid of the next.

Choke-capacity filter.—The arrangement of a choke and a condenser for filtering out undesired frequencies which will, instead of passing through the choke, prefer to take the easier path through the condenser. The term is also applied to the output circuit of a receiver, in which case the choke is of the iron-cored type and the condenser feeds the loudspeaker. No direct current, therefore, passes through the speaker.

Choke control.—The method of modulating a high-frequency oscillating valve which consists in varying an anode voltage by means of low-frequency potentials established across an iron-cored choke in its anode circuit.

Circuit.—An electrical path, the term being used to include the wires and any apparatus connected by them.

Class "A" amplification.—The ordinary method of low-

frequency amplification in which there is a considerable steady current passing through the valve even when no signals are applied ; the application of signals causes current to rise and fall, the mean current, however, remaining steady. To be contrasted with Class B.

Class B amplification.—A special valve known as a Class B valve is employed, and this valve consists of a common filament, two grids, and two anodes. It really consists of two valves in one bulb, and each grid is given zero potential, or sometimes a small negative potential. Under normal conditions the valve anode current in each case is very small, but when low-frequency signals are applied to the valve the anode current rises in proportion to the applied voltage. There is thus a great economy of anode current, and the valve is a popular method of economising on H.T. current. Alternatively, a large output is obtained for a very small initial anode current. The two valves are arranged in push-pull, the grid of one valve being made positive and the other one is made negative, and vice versa. The output currents of the two anodes are combined by means of a split transformer to operate a loudspeaker.

Close coupling.—The coupling between two coils or circuits is said to be close or tight when there is a large transfer of energy from one circuit to the other. The coupling between two coils is said to be close or tight when one of the coils is very much within the magnetic field of the other, and the mutual inductance is great. This will occur, of course, when the coils are very close to each other.

Closed core.—A core or transformer is said to have a closed core when the external field is very small and there is no gap in the magnetic circuit. When a coil is wound on a ring of iron it is said to have a closed core ; likewise, if it is wound on the cross-bar which goes across a core in the form of a square. Powdered iron H.F. chokes and transformers are sometimes of the closed core type.

Coefficient.—Usually used to indicate the degree to which a certain electrical effect is obtained ; it is usually a ratio.

Coefficient of coupling.—A numerical representation of the amount of coupling between two circuits.

Coherer.—Usually consists of a glass tube containing metal filings which cohere or stick together to a greater or less extent according to any high-frequency current affecting the filings. Under normal conditions the coherer has a high resistance, and will not readily allow the passage of electrical currents. If high-frequency e.m.fs. are applied across the electrodes the filings cohere and the current of electricity from a local battery will pass through the filings and will operate a tape Morse recorder or other device. The coherer was probably the earliest detector used for practical wireless reception.

Condenser.—Consists of a pair or a plurality of pairs of plates, usually in the form of metal sheets separated by an insulating substance known as the dielectric, which may either be solid, such as wax, ebonite, paper, etc., or may consist of a liquid, such as oil. In the case of tuning condensers, the dielectric is usually air. Condensers are of fixed type, in which case the capacity cannot be altered, or “variable.” In the case of a variable condenser, the capacity is adjusted by moving one set of vanes in or out of another set of fixed vanes. The degree to which they overlap or intermesh controls the capacity of the condenser. Solid dielectric condensers are variable condensers in which the moving plates are separated from the fixed plates by means of some solid dielectric such as thin sheets of bakelite; the term solid-dielectric condenser is really misleading, but it is so commonly employed that one understands from it that reference is made to a variable condenser. In fixed condensers, the dielectric is usually mica in the case of small values, and paper in the case of values over about 0.01 microfarad. Electrolytic condensers are of a special type in which a thin insulating film, usually of oxide of aluminium, separates one plate which is aluminium from the other plate which is a liquid in contact with the film. Electrolytic condensers are only suitable for use in connection with direct current or D.C. which has a ripple of A.C. superimposed on it.

Condenser loudspeaker.—If one metal plate is rigidly secured and another plate close to it is free to move, the moving plate may be used as a diaphragm, which will give forth sound if a varying potential is connected across the two plates. A polarising voltage is applied across the plates. This is the principle of the condenser loudspeaker, or electrostatic speaker, as it is sometimes termed. An excellent response to high notes is obtained with this type of speaker.

Condenser microphone.—If two plates of a condenser are so arranged that one of them is rigidly fixed and the other may vibrate, and sound waves impinge on it, a type of microphone is produced. A polarising voltage is applied across it. The vibrations of the diaphragm will result in a change of capacity of the condenser, and for a given quantity of electricity in the condenser different e.m.fs. will be established across it. The variation in voltage produced by a condenser microphone is very small and a considerable degree of amplification is necessary.

Conductance.—The opposite to resistance. The conductance of a circuit is the reciprocal of the resistance. The unit of conductance is the mho, which is the word ohm spelt backwards. If a circuit has a resistance of 1,000 ohms, it will have a conductance of 0.001 mho.

Conductive coupling.—The coupling between two circuits effected by a conducting path. The term is used sometimes

to represent inductive coupling where a single inductance is common to two tuned circuits.

Conductivity.—The facility with which electricity is conducted. The opposite of resistivity, which is more commonly spoken of as resistance.

Conductor.—A substance which allows the passage of electricity. Metals are usually the best conductors, and are almost solely used in electrical apparatus.

Continuous current.—A current which flows in a given direction continuously as distinguished from an alternating current which changes direction. The term is commonly used as a substitute or alternative to direct current (D.C.). The words "continuous current" generally imply that the current not only flows in the same direction all the time but is of constant strength.

Continuous oscillations.—Oscillations which are of alternating current form and of constant amplitude. The usual modern method of producing continuous oscillations is to use a valve. Most of the telegraph communications by radio are effected by means of continuous oscillations producing continuous waves which are radiated from the aerial. The oscillations produced at a broadcast transmitting station when speech or music is not being radiated are of the continuous wave type. The only difference between continuous oscillations and alternating current is the frequency, which is higher in the case of continuous oscillations than in the case of alternating currents of the more usual frequencies.

Continuous waves.—The waves set up in the ether by continuous oscillations.

Control grid.—The main electrode of a valve which affects the passage of electrons between cathode and anode; the input circuit is connected usually across the control grid and the cathode, and the term is used to distinguish this particular grid from the other grids which are sometimes to be found in multi-electrode valves.

Control room.—The room of a broadcasting studio or station where the various electrical circuits from the studio are controlled or connected to the main transmitter apparatus. The term is rather a loose one and may cover a special room at the transmitting station where electrical control of the apparatus is effected.

Control system.—Usually used to designate the method of modulation used at a broadcasting transmitting station.

Converter.—Apparatus for converting one form of electrical current into another: e.g. for converting direct current into alternating current.

The first detector of a superheterodyne which is used for converting the signal frequency into the intermediate frequency is sometimes called the converter, and the conversion factor is a

term used to indicate the efficiency of the valve as a means of converting one type of current into the other.

Copper loss.—The loss of energy due to heat, etc., in the copper wires, etc., of an inductance or electrical apparatus generally.

Correction, tone.—The method of compensating in one part of an apparatus for tonal distortion in another part of the circuit.

Coulomb.—A unit of quantity of electricity. It is the amount of electricity which a condenser of one farad will store when its voltage is raised from zero to one volt. The unit is named after a French scientist of distinction.

Counterpoise aerial.—Such an aerial consists of a large sheet of metal or wire netting or series of wires or even a single wire which is used in place of an ordinary earth. The counterpoise acts as one plate of a condenser the other being the main aerial.

Coupled circuits.—Circuits which are made to influence each other, so that any change of current in one will produce a similar change in the other. The methods of coupling may be inductive or capacitative. In the first case the magnetic field of an inductance coil is made to pass through the whole or a portion of the other inductance. Frequently the two circuits are tuned, in which case they are adjusted to the same frequency. When an alternating current passes through one of the circuits a similar current is set up in the other. Capacity coupling is accomplished by means of a common condenser which forms part of each circuit, or sometimes a small condenser connects the top end of the two inductances which are electrically joined at the bottom.

Coupling.—The interaction between two coupled circuits.

Cross-modulation.—If two stations produce currents in a receiving circuit and the two sets of signals are applied to a valve acting as a detector, cross-modulation may occur, each station modulating the other. The result is a form of interference which no subsequent selectivity can cure. It is experienced when insufficient selectivity is obtained before applying the desired signal to an amplifying valve. If the latter is of the S.G. type, cross-modulation may occur owing to rectification effects in the grid or anode circuits, even though these may not be desired. The remedy for cross-modulation is to reduce the opportunity for rectification to occur, and to improve the selectivity at the very beginning of the circuit.

Crystal control.—The use of a quartz or similar crystal which will vibrate at a given frequency depending upon the dimensions of the crystal. Crystal control is used for the purpose of ensuring that the frequency of a transmitting station is kept constant.

Crystal detector.—Certain kinds of minerals of crystalline form may be used as wireless detectors, and will deliver uni-directional currents when high-frequency currents are applied to them. Some types of crystals have to be used in combination with other

crystals, but usually they may be employed in conjunction with a metal wire known in popular language as a cat's whisker. Some crystal detectors require a battery which, in conjunction with a potentiometer, gives a polarising voltage to the detector, which operates best at a bend in its characteristic curve; a carborundum detector requires such a polarising voltage.

Crystal receiver.—A wireless receiver using a crystal as detector. Such a receiver was commonly used in the early days of broadcast reception, but it is now very rarely employed.

Cumulative grid rectification.—A method of detection in which the application of received signals to the grid of a valve results in the grid becoming increasingly negative due to the rectification effect of the grid circuit. This is sometimes known as leaky-grid condenser rectification, or simply leaky-grid rectification. The damping of positive half cycles (of high-frequency e.m.f.s. applied to the grid of a valve) due to the establishment of a grid current will result in a rectification effect, but this is not cumulative. A more sensitive arrangement is obtained when a grid condenser is inserted in series with the grid. The operation of the method is briefly as follows: The high-frequency potentials are communicated through the grid condenser to the grid, which is normally at such a potential (round about zero volts) that no grid current flows. The application of the high-frequency signals results in the grid becoming momentarily positive whenever the grid is influenced by the positive half-cycle of the incoming signals. When the grid is made positive it draws to itself some of the electrons from the filament, and these charge up the side of the condenser, which is connected to the grid of the valve. The grid, therefore, tends to become increasingly negative, but a leak in the form of a resistance of about 1 megohm is connected across grid and filament, so that the valve does not become inoperative through an excessive negative potential on its grid. The grid to filament path of the three-electrode valve acts in a manner similar to that of a diode Fleming valve, but the grid, however, being placed between filament and anode, not only acts as a small anode itself but also as a control electrode, and any low-frequency potential established on it, owing to its rectifying action, will be the cause of amplified anode-current variations of a similar character.

Current.—Can usually be regarded as the flow of electrons through a conductor. In the case of a modern valve, is it a passage of electrons through a vacuum.

Current density.—An electric current does not flow always in a uniform manner through a conductor. A high-frequency current, for example, tends to distribute itself on the outer skin of a conductor, and therefore Litz wire was developed to make the fullest use of a given weight of copper and to avoid eddy current losses. The amount of current which any conductor will carry

without overheating is laid down in various tables, and the current density or amount of current which is permitted for a given cross-section of wire should not be exceeded.

Cut-off.—When an apparatus fails to respond beyond a certain range of frequencies it is said to have a cut-off. Owing to interference, it is commonly desirable to cut off the response of a wireless receiver at 4,500 cycles, and this may be done by means of special filters or suitable transformers which fail to respond beyond this frequency. Usually the cut-off is not very sharp, but it is sufficiently so to justify the term in many cases. The cut-off may be at the bottom end of the range of frequencies; for example, many transformers reproduce the low notes very ineffectively, and a loudspeaker will do the same if badly designed or used without a baffle.

C.W.—Abbreviation for continuous waves.

Cycle.—A complete back and forth flow of alternating current. In a complete cycle of A.C. the current starts at zero, increases to a maximum in a positive direction, and then—still flowing in the same direction—gradually falls to zero; it then reverses its direction, builds up to a maximum value and then once more falls in strength to zero. The number of cycles per second is the frequency of the alternating current.

D.

Damped oscillations.—Oscillations which become progressively feebler. A pendulum which is set swinging will gradually come to rest, and the oscillations in this case are of a damped character. Damped waves are the waves resulting from damped oscillations, and the signals from a spark station are of this character. Undamped waves are continuous waves.

Damping.—The extent to which the amplitude of the oscillations decreases at every half-cycle. In general, the word is used loosely to indicate a reduction in the amplitude of the oscillations, e.g., by the setting up of the grid current which damps the positive half-cycles.

Db.—Abbreviation for decibel.

D.C.—Direct current.

D.C.C.—Means "double cotton covered," and refers to the insulation covering of a wire.

Dead-end effect.—If an inductance coil is tapped for the purpose of producing a reduced amount of inductance in a circuit the overhanging unused portion of the inductance is known as the dead-end. The main current does not flow through this inductance, but the dead-end nevertheless may have a serious effect on the rest of the circuit, partly because of its capacity and possibilities of absorbing energy. If the dead-end happens to resonate with its own self-capacity or any stray capacity, even more serious trouble may occur. It is usual to arrange the tapping on

the inductance coil so that the dead-end always remains short-circuited, but even then there is a possibility of inefficiency, because the dead-end will remain coupled inductively to the rest of the coil.

Decibel.—One-tenth of a bel. A unit of loss or gain in power. Chiefly familiar as a means of comparing sound levels.

Decoupling.—A term usually used to indicate the method of preventing current flowing through a common circuit which would tend to couple one valve to another, thereby causing instability or distortion. Usual method of decoupling consists in the employment of a resistance and a condenser, the reactance of the condenser being about one-tenth that of the resistance for the frequency to be decoupled. The anode circuit of a valve may be decoupled by connecting a resistance next to the H.T. battery or mains unit and connecting a large condenser of say 1 mfd. across earth and the end of the resistance remote from the battery; alternating current will thus prefer to pass through the condenser rather than through the resistance.

Decrement.—A numerical indication of the extent to which the amplitude of damped waves decreases.

Degree of coupling.—The extent to which coils or circuits are coupled together.

Demodulation.—When a strong wireless signal is being received at the same time as a weaker signal, and the selectivity of the receiver is not such as to separate the stations, the stronger signal will frequently demodulate the weaker, which is then no longer heard. If, however, the stronger station closes down, the weaker station reappears. Sometimes the weaker station, owing to fading phenomena, will increase in strength and become greater than the station which formerly was the stronger; the result will then be that the former strong signal temporarily disappears. A linear rectifier favours the demodulation effect. The word demodulation also is sometimes used to describe the process of separating the low-frequency component from the high-frequency signals, i.e., rectification, but this use of the word is not advised.

Detection.—The process of causing a wireless signal to operate an indicator device at the receiving station. Its modern use, as regards broadcasting, implies the separating out of the low-frequency component which forms part of the modulated high-frequency received signal.

Detector.—The device which carries out the detection process in a wireless receiver. The two most common types of detectors are the crystal and the valve. The metal rectifier is also used sometimes for detection and is especially suitable for super-heterodyne receivers. Valve detectors and metal rectifiers operate on the principle of suppressing to a greater or lesser extent the positive or negative half-cycles of high-frequency

current. The simple diode allows the passage of positive half-cycles but not negative ones, and the average current of the positive half-cycles constitute a low-frequency current, the individual high-frequency pulses being averaged out. In the case of an anode-bend detector, the input e.m.fs. are not altered, but are arranged to produce an asymmetrical effect in the anode circuit of the valve.

Detector valve.—A valve specially designed to act as an efficient detector. Actually, there are so many different ways of using a valve as a detector that the term is meaningless unless the form of detection is specified, e.g., leaky-grid detection or anode-bend detection.

Detuning.—Altering the adjustment of a tuned circuit so that it is off tune with respect to the station to be received. The result will be a weakening of the over-all signal strength, but sometimes this is deliberately done. If the tuning is sharp, the detuning will not only weaken the signal strength but alter the general tone of the speech or music being received. When exactly on tune the low notes will be fully reproduced, while if the circuit is off tune there will be a reduction in the strength of the bass.

D.F.—Direction finding. D.F. apparatus is fitted to many ships and aeroplanes to assist in navigation. The simplest direction-finding apparatus consists of a frame aerial in the form of a vertical loop of one or more wires which may be rotated round a vertical axis. The stronger signals are obtained when the loop is edgewise-on to the distant station.

Diagram.—The so-called theoretical diagram of a wireless circuit is an illustration by means of symbols representing the different components which are joined by lines representing the wires. The symbols used are illustrated in this volume on pages 314 and 315. A pictorial diagram is one in which the components are illustrated pictorially, i.e., as they actually appear.

Diagram, wiring.—A wiring diagram is distinct from a circuit diagram in that it shows the arrangement of the components and wires in an actual set. It is really a working drawing of the apparatus.

Diaphragm.—A thin disc usually of metal or carbon which vibrates at an audible frequency. It may form part of a microphone, and sound waves due to music or speech impinge on it and set it vibrating in sympathy with the sound waves. The vibration of the diaphragm is then made to set up a varying electric current; for example, in the ordinary telephone mouth-piece the diaphragm varies the pressure between carbon granules in the microphone and the resultant varying current is, after passing along the line, made to actuate the telephone receiver at the other end. This receiver also consists of a diaphragm—usually of soft iron, and placed close to the poles of a magnet the magnetism of which is varied by the incoming low-frequency currents.

The varying magnetism affects the magnetic pull on the diaphragm, and therefore the latter vibrates in sympathy with the low-frequency currents. The result is that low-frequency sound waves corresponding to the original voice are set up in the air surrounding the diaphragm, and may be heard by the listener. The diaphragm of a loudspeaker operates in somewhat the same manner, but it is frequently made of paper in the form of a cone.

Dielectric.—The insulating substance which separates the two plates of a condenser. Commonly used dielectrics are air, wax, ebonite, bakelite, mica, paper.

Dielectric coefficient.—The efficiency of any insulator for the purpose of increasing the capacity of a condenser.

Dielectric loss.—The energy lost in the dielectric.

Dielectric strength.—The ability of a dielectric to withstand breakdown when a high voltage is applied to it, as in a condenser.

Difference of potential.—When one part of a circuit has more electrons than another. A state of strain will be set up and electrons will tend to flow from the part where there is a surplus to the part where there is a deficiency. The part of the circuit where there is an excess of electrons is said to be negative in potential with respect to the other part, and a difference of potential is said to be in existence across the points. Difference in potential is measured in volts.

Differential condenser.—A variable condenser having two sets of fixed plates and a set of movable vanes which are always either wholly intermeshed with one set of fixed plates or partly engaging with one set of plates and partly with the other. As the amount of overlap with one set of plates increases, it decreases with the other, i.e., the capacity of one half of the differential increases while the other half decreases. The total capacity of the differential remains approximately the same. The condenser is used for differential anode coupling, differential reaction, and sometimes for the differential feeding of an aerial circuit. There are many applications for such a condenser in modern receiver circuits.

Differential anode coupling.—The method of coupling the anode circuit of a high-frequency amplifier to its associated tuned circuit. A choke coil may be connected in the anode circuit of the valve, and the anode is then connected to the moving vanes of a differential condenser. One set of fixed vanes is connected to one side of the tuned circuit, while the other fixed vanes are connected to earth.

Differential reaction.—The use of a differential condenser for obtaining reaction. The usual method consists in inserting a choke coil in the anode circuit of the detector valve and connecting the anode to the moving vanes of the differential condenser. One set of fixed vanes is connected to earth and the other set to one end of the reaction coil. The reaction current,

therefore, is distributed between earth and the reaction coil, and the distribution is governed by the setting of the reaction knob.

Diode.—A two-electrode valve consisting of a cathode and anode, and particularly useful as a rectifier and a means of obtaining automatic volume control. The diode is used for the rectification of alternating current for supplying the high-tension voltage to wireless receivers, and is also used as a detector for reception especially in super-heterodyne receivers.

Diode rectification.—Diodes may be used for half-wave rectification. If two of them are employed (separately or in one bulb) full-wave rectification may be carried out. In receiving circuits, diodes, of course, do not amplify and therefore, although the quality of reproduction obtained is good, the sensitivity is not as great as that of the triode valve used as a detector.

Direct coupling.—Usually meant to designate a coupling between two coils or circuits which have the same coil or part of a coil common to both circuits. The arrangement of an auto-transformer involves direct coupling, and the method of tapping the aerial or anode to a point on a tuning inductance involves direct coupling.

Direct current.—A current which flows constantly in one direction. A unidirectional current such as that obtained from a battery. The term is usually abbreviated to D.C.

Direct ray.—A wireless receiver sends out waves some of which travel directly to the receiving station and others which travel to the ionised layers in the atmosphere (e.g., the Heaviside layer), and from there become reflected to earth and to the receiving station. The waves which follow the curvature of the earth are known as the direct rays. In daylight the direct ray predominates, but after nightfall the range of a station is greatly increased owing to the great range of the indirect ray.

Directional aerial.—An aerial which transmits or receives signals to or from a certain point.

Direction finder.—An aerial system and wireless receiver for the purpose of finding the direction of a distant wireless station.

Dis.—Abbreviation for disconnection, i.e., a break in a circuit.

Discharge.—When current passes from one charged body to another the resultant current is said to be a discharge, and once the body has been discharged, no more current flows. A condenser may be charged, for example, by placing a battery across its terminals. If the battery is then removed, a spark will occur if a metal rod is placed across the terminals of the condenser, due to the discharge. An accumulator is said to be discharged when it is run down.

Distortion.—The inaccurate reproduction of speech or music, e.g., due to overloading of a valve, unsuitably designed transformers, the establishment of grid current or rectification effects in general. Distortion may arise in numerous ways.

Distributed capacity.—The capacity between turns of an inductance coil, choke, etc. ; for example, any two turns in an inductance coil form a very small condenser, and this effect occurring scores of times increases the natural wavelength of the inductance. The distributed capacity, or self-capacity as it is sometimes called, may be replaced by a condenser connected across the ends of the coil for the purpose of showing the effect of distributed capacity on wavelength. A large distributed capacity results in inefficiency and also limits the wave-range to which the coil will tune with a given value of condenser.

Double diode.—A valve having a single cathode and two anodes. It is equivalent to two separate diodes and is very frequently used for rectifying alternating currents for providing H.T. supply, and is also commonly employed as a detector in multi-valve receivers and for use in connection with automatic volume control.

Double-diode pentode.—A composite valve in which a double diode is combined with a pentode—usually of the variable- μ type. Such a valve (abbreviated to D.D. Pen.) has proved particularly successful as an automatic volume-control device.

Double-diode triode.—A combined valve consisting of a double diode and a three-electrode valve. It is particularly useful in automatic volume-control systems.

Double hump.—Double-hump tuning means that there are two points on the tuning scale where maximum signal strength is obtained. Two tuned circuits when coupled together may be arranged to give a double hump effect, and this is the basis of band-pass arrangement, the two humps being brought close together so that approximately a square peak effect is obtained. Double-hump tuning of an unwanted character may occur through overloading of the detector or through misganging.

Double reaction.—The application of reaction to two different circuits simultaneously, whereby increases in signal strength and selectivity are obtained.

Down-lead.—Wire which comes down from the aerial to the wireless apparatus.

D.P.—Double-pole.

D.P.D.T.—Double-pole double-throw (as applied to a switch).

D.P.S.T.—Double-pole single-throw.

Drive circuit.—In a transmitting system where the high-frequency oscillations are amplified before being applied to the aerial, the original circuit producing the oscillations is sometimes known as the drive circuit.

Driver transformer. The transformer which precedes a Class B valve. It is sometimes provided with different ratio terminals to enable it to match the preceding driver valve and the following Class B valve.

Driver valve.—The valve used before the Class B valve, and which provides the grid of the latter with the necessary e.m.f.s. Since the grids of the Class B valve take a grid current, the driver valve is designed to give a power output rather than mere voltage.

Dry battery.—A battery consisting of a number of dry cells, i.e., primary cells in which the electrolyte is moist and not liquid. A high-tension battery is the commonest form of dry battery used in wireless; a grid-bias battery is also a dry battery.

D.S.C.—Double silk covered; a term applied to the insulation covering of wire.

D.T.—Double-throw.

Dual amplification.—The amplification of two different frequencies in the same valve. A typical case is where a single valve amplifies the high-frequency incoming signals, also the low-frequency currents which result from detection. Sometimes called reflex amplification.

Dull emitter.—A valve in which the filaments glow very feebly and give a copious electron emission at low temperatures.

Dummy aerial.—An artificial aerial which reproduces the electrical characteristics of a normal aerial, but does not radiate.

Duplex telephony.—Telephone system in which speech may be transmitted and received simultaneously, so that the conversation may be heard as if the two people were talking together in the same room.

Dynamic characteristics.—The characteristic curve of a valve in an actual circuit. An ordinary characteristic curve presupposes that the voltage of the anode, for example, remains constant while the grid voltage is changing. In practice, the anode voltage is usually varying at the same time, e.g., in a resistance-coupled amplifier.

Dynamic loudspeaker.—Another name for a moving-coil loudspeaker.

Dynamo.—An electrical machine for producing direct current. A system of wires is revolved in a magnetic field, and by means of a commutator the induced currents are made to flow in the same direction in any external circuit connected across the output terminals of the dynamo.

Dynatron.—A special valve which gives a negative resistance effect due to secondary emission effects. An ordinary three-electrode valve may be used as a dynatron. By applying a larger potential to the grid than to the anode, the anode will lose more electrons by secondary emission than it will gain in primary electrons. Therefore an increasing positive potential on the anode results in a decreasing current. This produces a negative resistance effect, and if an oscillatory circuit is connected in the anode circuit of the valve, oscillations will usually be generated.

E.

Earth.—The connection made to the ground. The earth of a wireless receiver generally consists of a metal plate buried in the ground or a connection to a water-pipe which ultimately goes into the ground. When one speaks of connecting a certain point in a receiver to earth, one means to a point on the set which is at earth potential; a separate earth connection to the ground is not indicated. The metal chassis of a receiver is almost invariably connected to the earth, and therefore any connection to the chassis is an earth connection.

Earth potential.—The potential of the earth is assumed to be zero. In a wireless receiver the chassis, the screens of coils, the iron cores of transformers, etc., are connected to earth to increase stability, reduce hum, and generally to improve the effective working of the receiver.

Ebonite.—An insulating material commonly used in instrument-making. It consists principally of rubber which has gone through a vulcanising process and is sometimes known as hard rubber. Panels and terminal strips for receivers are commonly made of ebonite.

Echo.—The result of reflection of sound waves from the sides of a room or studio. It may be artificially produced electrically. The reflection of wireless rays from ionised layers of the atmosphere is sometimes known as an echo.

Eddy currents.—When metals are in the alternating magnetic field produced by a current flowing through a wire, currents are set up in the metals, and cause a rise in temperature and a general waste of energy. To avoid this, the metal is generally laminated, i.e., arranged in thin strips insulated from one another, thereby preventing the full development of an electric current. The cores of low-frequency transformers are thus laminated. Eddy currents in coil screening canisters, screens etc., are produced by high-frequency currents, and cause serious loss and a reduction in wavelength due to a reduction of inductance. Consequently, metal parts should be kept as far away as possible from coils carrying high-frequency currents. The wire itself through which the currents flow also has set up in it eddy currents, and Litz wire was developed to reduce this effect, while providing a large circuit area for the flow of the current. Iron cores for high-frequency coils are manufactured so as to reduce to a minimum the eddy current losses.

Effective height of aerial.—The effective height of an aerial is not only its average height above the ground, but is governed by the nature of the earth and obstacles under the aerial or near to it. For example, the effective height of an aerial on top of a tall building might only be a few feet.

Effects studio.—The various noises required in a broadcast

drama are artificially produced in most cases, and a special studio for these effects is provided.

Electric field.—The strain in the ether surrounding an electrified body. An electric wave has associated with it an electric field.

Electricity.—An electric current is the flow of electrons, and an electric charge is due to an excess or deficit of electrons.

Electrode.—The conductor inside a thermionic valve, e.g., the anode, grid, or filament. In general, the term is used to designate the conductors between which an electric current passes, whether across a vacuum, through a gas, or through a liquid.

Electro-dynamic microphone.—A microphone in which the currents are produced by sound waves, causing the vibration of a coil of wire in a magnetic field. The coil may be attached to a vibrating diaphragm. The arrangement is really the reverse of a moving-coil speaker.

Electrolysis.—The breaking up of the chemical nature of a solution or liquid generally, and the passage of an electric current through it.

Electrolyte.—The liquid through which an electric current is passed during electrolysis. The term is also applied to the liquid or paste in an accumulator or dry battery, respectively.

Electrolytic condenser.—A condenser which may be of very great capacity for a given dimensional size and which normally consists of a metal plate which is coated with a very thin insulating film which makes contact with the liquid which constitutes the other electrode. Aluminium oxide is the most usual film employed.

Electrolytic rectifier.—An electrolytic cell consisting of two electrodes and a liquid, which permits the passage of a electric current only in one direction. Such a rectifier is frequently used for charging accumulators and the aluminium rectifier is an efficient type.

Electro-magnet.—Consisting only of a coil of wire wound round an iron core. The passage of a current through the coil magnetises the iron. The strength of the magnetism will depend up to a certain limit upon the strength of the current flowing, and when this current stops most of the magnetism disappears.

Electro-magnetic induction.—The effect which sets up a current in a wire when either the wire is moved at right angles to a magnetic field or the magnetic field is moved with respect to the wire.

Electro-magnetic waves.—All waves in the ether such as wireless waves, light and heat are of the same general nature, although their wavelengths differ. The speed of electro-magnetic waves is approximately 186,000 miles per second.

Electro-motive force.—Abbreviated to e.m.f. It is the electrical force which causes electrons to flow round the circuit, and it is produced by the conversion of some other form of energy which

may be chemical, mechanical, thermal, etc. The e.m.f. in a circuit is measured in volts.

Electrons.—These are particles of electricity and correspond to what is sometimes known as negative electricity. An electron is the smallest particle of negative electricity. Every atom of matter has a central core known as the nucleus, which contains protons, and which is associated with one or more electrons. Electrons govern both the chemical nature and the charge of an atom. The electrons which may be added or removed from an atom without altering its chemical properties are the ones we are concerned with in ordinary electrical engineering. A body is said to be negatively charged when it has an excess of these electrons, and positively charged when it is short of electrons.

Electrostatic.—A term used in connection with an electric charge which is at rest. The term, however, is applied to many phenomena involving an apparently incomplete electrical circuit.

Electrostatic loudspeaker.—A condenser loudspeaker in which the two plates form an arrangement which will set up sound waves, due to the vibration of one of the plates on the application of a varying e.m.f. across the speaker.

Electrostatic coupling.—The coupling of two circuits through a condenser. The term is generally used when two circuits are joined together at the bottom of their inductances, and are coupled at the top of the inductances through a small condenser.

E.M.F.—Abbreviation for electro-motive force.

Emission.—The projection of electrons from a cathode. When a wire is heated to incandescence electrons are emitted into the surrounding space, and these electrons in a valve are attracted to a metal plate or anode which is given a positive potential with respect to the filament. The amount of emission depends upon the temperature of the filament, and this filament is sometimes coated with special electron-emitting material such as the oxides of the rarer earth metals. This enables us to work the filament at a lower temperature and yet obtain a copious emission of electrons; consequently there is considerable saving in filament current.

Ether.—All matter is supposed to be permeated by a medium to which the name ether has been given. Its precise nature is not known and in some quarters even its existence is denied. It provides, however, a simple explanation of wave-motion, and wireless waves are supposed to be formed in the ether. Electric and magnetic fields are regarded as strains in the ether.

Eureka Wire.—A special wire of high resistivity consisting of an alloy of copper and nickel. It is extensively used for resistances.

F

Fading.—The reduction in signal strength due to the irregular reflection of wireless waves from the ionised layers of the

atmosphere. Changes in the character of the layers alter the strength of the reflected rays and sometimes these interfere with the direct ray which is also received by the aerial. In the latter case the direct ray may be opposed by the indirect ray and a reduction of signal strength may result. Sometimes the fading takes the form of reduced signal strength, which may occur either for a brief period of time or for a much longer period. The fading may either be slow or rapid and may involve simply a weakening of signal strength or distortion as well. Automatic volume control arrangements reduce the ill-effect of fading of certain kinds, but when serious distortion occurs automatic volume control will be of little or no advantage.

Farad.—A unit of capacity. A condenser is said to possess a capacity of one farad when it will store one coulomb when one volt is applied to the condenser. The usual unit for wireless work is a microfarad, which is a millionth part of a farad. For smaller capacities the unit micro-microfarad is sometimes used (a millionth part of a microfarad).

Feed-back.—The transference of e.m.fs. from one stage in an amplifier to a preceding stage or from the anode circuit of a valve to the grid circuit. If the feed-back tends to increase the original e.m.fs. it is known as reaction, while if the effect is to decrease the original signal it is known as reverse reaction.

Ferrocart coils.—A proprietary brand of iron-core coils. The core takes the form of very small particles of iron insulated from one another. In the Ferrocart system of manufacture the particles are arranged in layers and a magnetic field is used to ensure that the rod-like particles all lie in the same direction.

Field strength.—The signal strength due to a wireless broadcasting station decreases as one goes farther away from the station. The strength is given numerically in millivolts per metre.

Field winding.—The coil which energises an electro-magnet. In wireless it is common practice to energise the magnetic field of a loudspeaker in a mains receiver and the winding which does this is known as the speaker field winding.

Filament.—The thin, heated wire in a valve or electric lamp; in the case of a valve it is the source of electrons; a current is passed through it in order to heat it to the necessary temperature to produce emission.

Filament battery.—The battery which provides the current which heats the filament. The word battery is used to include a single cell accumulator. The filament battery is sometimes known as the L.T. battery (low-tension battery).

Filament circuit.—A circuit consisting of the filament and battery and any rheostat or other component in the circuit.

Filament current.—The current which flows through the filament of the valve.

- Filament emission.**—The extent to which the filament emits electrons.
- Filament resistance.**—As applied to a component it is the resistance connected in series with the filament in some circuits, the resistance being either fixed or variable.
- Filter.**—A special circuit consisting of inductances and resistances and condensers or some of these for the purpose of differentiating between direct current and varying currents or between varying currents of different frequency.
- Fixed inductance.**—An inductance which is not variable.
- Fixed condenser.**—A condenser of fixed capacity which is not adjustable.
- Fixed resistor.**—A resistance which is not variable.
- Flat tuning.**—A tuning arrangement which responds over a wide range of frequencies without serious loss of signal strength.
- Flux density.**—The number of lines of force to a given unit area. A method of measuring the magnetic force through space.
- Forced oscillations.**—Oscillations of a certain frequency which are forced into a circuit not normally resonant to that frequency.
- Former.**—The frame of insulating material on which an inductance coil or resistance is wound, e.g. a tube of impregnated cardboard, paxolin, fibre, ebonite, bakelite.
- Four-electrode valve.**—A valve containing four electrodes. A screen-grid valve is an example, there being a filament, a control grid, a screen-grid and an anode.
- Frame aerial.**—A special aerial consisting of one or more turns of insulated wire wound on a frame about two feet square. The frame is mounted vertically and when pointing edgewise-on to a distant station will receive signals at maximum volume.
- Frequency.**—The number of complete waves or oscillations per second. The alternating current supplied by electric light mains has a frequency of 50 in most cases, the complete back and forth flow of current occurring 50 times per second. The term low frequency is applied generally to frequencies up to about 20,000, i.e. frequencies within the audible limit. High frequency is a term applied to those frequencies which are used for the transmission of wireless signals through the ether by means of waves.
- Frequency distortion.**—Distortion occurring in such a way that the original balance of frequencies is upset. For example, a wireless receiver if made ultra-selective will reduce the higher notes, and the music or speech will therefore be distorted. Some notes may altogether be cut out.
- Frequency modulation.**—Modulation of a transmitted carrier-wave by altering its frequency with the low-frequency microphone current.
- Full-wave detector.**—A detector which responds to both half-cycles of applied high-frequency current.

Full-wave rectification.—A rectifying system in which both half-cycles of alternating current produce an output current; the output current from each half-cycle helps to create a steady D.C. output.

Fuse.—A conductor which ceases to act as such when the current exceeds a certain pre-determined value. A common form of fuse is a wire which melts when the current through it is excessive; this protects any apparatus in circuit from any excess current.

G.

Galvanometer.—An instrument of high sensitivity for indicating the flow of electrical current in a circuit.

Galvanometer, mirror.—A type of galvanometer in which the mirror is caused to rotate, causing the movement of a spot of light along the scale.

Ganged condensers.—Two or more condensers may be mounted on a single spindle so that their capacities are simultaneously varied. This enables two or more circuits to be tuned simultaneously and the condensers are then said to be ganged.

Gap.—The space intentionally arranged to make the magnetic circuit incomplete in a magnetic system; for example, an air gap is frequently provided in a transformer or iron-cored choke.

Generator.—A term generally used to designate an electrical machine for converting mechanical energy into electricity, e.g., an alternator or dynamo. The word, however, is also applied to the valve when used as a generator of oscillations.

German silver.—A metal used for making resistors; it consists of an alloy of copper, nickel and zinc.

Gramophone, electric.—A gramophone which has a pick-up which produces low-frequency alternating e.m.f. when a needle follows the track on a record, these low-frequency e.m.fs. being then applied to a valve amplifier.

Gramophone pick-up.—The apparatus which changes the mechanical vibration of a needle on a rotating record into low-frequency e.m.fs. which are then amplified.

Grid.—One of the electrodes in a valve. In the simple three-electrode valve the grid acts as control electrode, and varying potentials on it will produce different anode currents.

Grid bias.—The steady potential applied to a grid for the purpose of enabling the valve to operate under suitable conditions.

Grid circuit.—The circuit between grid and filament of a valve.

Grid condenser.—A condenser, usually of fixed capacity, which is inserted next to the grid either for the purpose of insulating the grid from any positive potential of the high-tension battery (as in a resistance-coupled amplifier) or to assist in the rectification process when the valve is acting as a detector.

- Grid control.**—A general term to include methods of modulating a valve for telephony transmissions which consist in applying the modulating potentials to the grid.
- Grid current.**—The current which may flow to the grid of a valve from the space inside the valve. Usually the current is an electron current, the electrons coming from the filament. The grid current may be quite appreciable if the grid is made positive. A reverse grid current sometimes flows to the grid when a valve is soft, i.e. when ionisation occurs in the valve.
- Grid leak.**—The resistance, usually having a value of from 100,000 ohms to 5 megohms, connected between the grid and cathode of a valve for the purpose of preventing an excess of electrons accumulating on the grid.
- Grid potentiometer.**—A potentiometer for the purpose of giving an adjustable bias to the grid of a valve.
- Grid rectification.**—Any rectification system which depends upon the establishment of a grid current.
- Grid resistance.**—The resistance connected across grid and cathode. Even when the resistance is connected across a grid condenser it is usually virtually across grid and cathode.
- Ground.**—American term for earth.
- Ground ray.**—The direct ray from a broadcasting station which follows the curvature of the earth and which is to be distinguished from the indirect ray which goes up to the ionised layers in the atmosphere and is then reflected down to earth.

H.

- Half-wave rectification.**—When only half-cycles of alternating current produce a current through a rectifier the system is known as half-wave rectification.
- Hand capacity.**—Hand-capacity effects are due to the fact that the hand used for tuning or for alteration of reaction adjustments, etc., is virtually at earth potential. Hence if it is brought close to any apparatus at high-frequency potential, the effect will be similar to that which would be obtained if a condenser were connected between the point and earth.
- Hard valve.**—A valve in which the vacuum is practically perfect and which operates independently of ionisation effect.
- Harmonics.**—A valve oscillator used either for transmission or as an oscillator in a superheterodyne receiver may generate not only the main or fundamental frequency, but also one or more harmonics which are multiples of the fundamental. If a harmonic has twice the frequency of the fundamental, it is known as the second harmonic; if it is three times the frequency, it is called the third harmonic, and so on.
- Heater.**—The heating element in the form of a filament which passes through the electron-emitting tube which forms the

cathode of an indirectly-heated valve. The heater filament is insulated from the cathode.

Heaviside layer.—A layer of ionised particles of air forming a blanket about 60 miles above the surface of the earth. The ionisation is caused by the sun.

Henry.—A unit of inductance. Although this unit is suitable for low-frequency apparatus, for radio frequencies we use milli-henry (one-thousandth of a henry) or microhenry (one-millionth of a henry).

Hertzian waves.—Wireless waves, the existence of which was proved by Heinrich Rudolf Hertz.

Heterodyne.—The principle of receiving wireless signals which consists in causing interaction between two frequencies close to each other. The heterodyne principle is used for the reception of continuous waves; while the modification of it, known as the superheterodyne, is also employed for broadcast reception.

Heterodyne interference.—Interference due to beats formed in the receiver due to the reception of two stations whose carrier-wave frequencies are close together.

Heterodyne wavemeter.—A wavemeter consisting of an oscillating valve. The correct adjustment is indicated when it is tuned so that the silent interval in the "squeal" is obtained.

H.F.—Abbreviation for high-frequency.

High-frequency.—A rather loose designation of frequencies used for wireless transmission as distinguished from audio-frequencies.

High-frequency amplifier.—The valve apparatus for amplifying the high-frequency oscillations supplied by the aerial circuit.

High-frequency choke.—A choke which offers a high reactance and low self-capacity towards high-frequency currents.

High-frequency resistance.—The resistance offered to the passage of high-frequency currents. It is greater than the normal resistance offered to direct currents.

High-frequency transformer.—The transformer for passing on high-frequency currents; consists usually of two coils coupled together. Sometimes one or other or both of the coils are tuned.

High-pass filter.—A filter for passing high-frequency currents above a certain frequency while repressing frequencies below.

High-tension.—A loose term indicating the source of anode voltage of the valve. In practice, it may vary between 30 volts and 150 volts or 200 volts in most receiving circuits.

High-tension battery.—The anode battery—generally termed the H.T.

Honeycomb coil.—Inductance coil which resembles a honeycomb owing to its cellular construction.

Hot-wire ammeter.—An ammeter for measuring high-frequency currents, these latter being passed through a filament which

sags on being heated, the expansion of the wire causing the rotation of a meter needle.

H.T.—Abbreviation for high-tension; the source of anode voltage applied to a valve.

Hydrometer.—Apparatus for measuring the specific gravity of liquids, especially the acid in an accumulator.

Hysteresis.—The different performance of an apparatus in one direction of alteration of working conditions. For example, magnetic hysteresis represents the different magnetisation effect of iron when the current is increasing or decreasing.

I.

I.C.W.—Abbreviation for interrupted continuous waves.

Impedance.—The opposition to the passage of alternating currents.

In phase.—Alternating currents are said to be in phase when they are in step and assist each other.

Indirectly-heated cathode.—A cathode tube coated with electron-emitting substance and heated by means of heater wires passing through the tube.

Indirect waves.—Wireless waves which are reflected from an ionised layer in the atmosphere.

Indoor aerial.—Aerial erected inside a building.

Induced current.—A varying electric current flowing through a coil of wire will set up a similar but weaker current in any other coil coming within its field of influence.

Inductance.—When an alternating current is passed through a coil of wire an alternating magnetic field is created around the coil, and the lines of force thus created will, as they move (due to the change in the current), cut through the coil itself and set up a back e.m.f. which tends to oppose the change in the current flow through the wire. Thus when the current tends to increase the back-e.m.f. tends to reduce it. The resultant effect is a reduction of the current. Inductance is measured in henries. The word inductance is also used to mean an inductance coil.

Inductance coil.—A coil possessing the properties of inductance.

Inductive coupling.—Coupling effected between two circuits or two coils by arranging that the magnetic field produced by one coil influences the other.

Inductor loudspeaker.—A special loudspeaker in which the diaphragm is connected to an armature which moves between magnet pole pieces and has a large degree of freedom to move.

Insulation.—Certain substances do not permit the flow of electrical currents, and are known as insulators.

Insulation resistance.—Insulators tend, if the voltage applied to them is great enough, to pass a current. The insulation of

different types of apparatus is, therefore, measured by applying a high voltage and measuring the resultant current.

Insulator.—An insulating material used for preventing the leakage of current from conductors.

Inter-electrode capacity.—The capacity between the electrodes in a valve.

Interference.—The disturbance caused to the reception of wireless signals, due to another station, various electrical disturbances (e.g., from lifts, neon signs, etc.) or from atmospherics.

Intervalve coupling.—The method of passing on the output voltages of one valve to the input side of the next valve.

Intervalve transformer.—Term usually applied to low-frequency transformers which couple one valve to the next.

Inverted "L" aerial.—The usual aerial which consists of a horizontal length of wire and a down lead from one end.

Ionisation.—An atom which has lost or gained an electrical charge in the form of electrons is said to be an ion.

J.

Jack.—A combination of contacts which are actuated by inserting a plug, thus opening or closing various circuits.

Jamming.—The interference of one wireless station with another.

K.

Kc.—Abbreviation for kilocycle.

Kc/s.—Abbreviation for kilocycle per second.

Kennelly-Heaviside layer.—Name given to the Heaviside layer in the United States.

Kilocycle.—One thousand cycles.

Kilowatt.—One thousand watts.

Kilowatt hour.—One kilowatt developed for one hour.

Kw.—Abbreviation for kilowatt.

L.

Laminations.—Thin sheets of metal, usually iron, from which a core may be built up; the object is to prevent eddy currents.

Lead.—Connecting wire; term specially used in connection with those wires which go to apparatus outside the set.

Lead-in wire.—The wire connection from an aerial to the receiver.

Lead-in tube.—A tube of insulating material, e.g. ebonite, which is usually fixed through the framework of a window; the lead-in wire passes through this tube.

Leak.—An undesired loss of electric current usually due to faulty insulation. The word is also used as an alternative to grid-leak.

Leaky-grid detection.—The method of detection, which consists in the use of a grid condenser and a grid leak.

Leclanché cell.—A primary cell having a carbon positive electrode and a zinc negative electrode. Sal-ammoniac is used as an electrolyte, with a depolarising agent such as manganese dioxide is used.

L.F.—Abbreviation for low frequency.

Lightning arrester.—A component consisting of two electrodes placed close together and connected across aerial and earth. The idea is that charges on the aerial will pass through the arrester and thus save the receiver from damage.

Lightning switch.—A switch connected preferably outside the house to earth the aerial when the latter is not in use.

Linear amplification.—Correct amplification in which the output currents of the amplifier are proportional to the input e.m.fs.

Linear rectification.—Rectification where the output is directly proportional to the input.

Lines of force.—The lines along which electric or magnetic forces act.

Link circuit.—A circuit which couples two other circuits.

Linkage.—When lines of force of a magnetic field pass through a coil, linkage is effected. Coils are magnetically linked, when the field of one coil passes through the turns of the other.

Load.—When an electrical apparatus is providing current which does work the apparatus is said to be on load.

Loading coil.—To increase the wavelength of an aerial system, an inductance coil may be added. This is known as a loading coil.

Local oscillations.—Oscillations produced at the receiving station by a local oscillating valve.

Local oscillator.—The oscillator valve and its circuit which are required for heterodyne or superheterodyne reception.

Log.—Abbreviation for logarithmic or logarithm.

Log-law.—Components such as condensers, resistances, etc., where the value changes logarithmically with the angle of movement, are called log-law components.

Log-law condenser.—Usually a variable air condenser in which the movement is proportional to the logarithm of the capacity.

Log-law potentiometer.—A potentiometer in which the change of resistance obeys a log-law.

Long waves.—It is customary to refer to the wave band covering from about 1,000 metres to 2,000 metres as the long waves.

Loop aerial.—A frame aerial of one or more turns.

Loose coupling.—Two circuits are said to be loosely coupled when the transference of energy between them is small.

Loudspeaker.—A reproducing apparatus which gives forth sound corresponding to the low-frequency currents fed to it, at such a strength that it can be heard by several people in a room.

Low frequency.—The term is loosely used to indicate frequencies below about 20,000.

Low-frequency amplification.—Amplification of low-frequency alternating currents.

Low-frequency amplifier.—An amplifier for amplifying L.F.

Low-frequency transformer.—An iron-cored transformer used in low-frequency circuits. It is usually of the step-up type.

Low-pass filter.—A filter arrangement designed to pass frequencies below a certain predetermined value.

Low tension.—Voltage of low value, with special reference to the filament battery.

Low-tension battery.—The name commonly given to the accumulator or battery which heats the filament of a valve.

L.T.—Abbreviation for low tension.

M.

Magnetic field.—A magnet has a sphere of influence which is called its field.

Magnetron.—A valve in which the flow of electrons is controlled by magnetic force.

Mains unit.—A rectifier unit primarily for supplying the H.T. voltage to battery sets.

Manganin.—An alloy developed for use as a resistance.

Man-made static.—A name sometimes given to the kind of interference which is produced by machinery and appliances.

Mansbridge condenser.—A small condenser of large capacity usually formed of tinfoil and paper made into a roll.

Mast.—The vertical erection which supports an aerial; it may be made of wood or steel.

Matching.—To make the most effective use of a valve, it should be matched with the apparatus which follows. Or, alternatively, the output apparatus should be adjusted so that it matches the valve; a good example is the matching of a loudspeaker to the output valve.

Medium waves.—Waves which have a wavelength of between 200 and 600; the description, however, is only a popular one.

Megger.—A measuring instrument which gives a direct reading of resistance; particularly useful for measuring high resistances.

Megohm.—One million ohms.

Mercury arc.—A lamp or discharge device in which a pool of mercury forms the negative electrode.

Metal rectifier.—The usual name given to a rectifier consisting of an oxidised metal plate in contact with a lead plate.

Metallised valve.—A valve which is provided with a metal coating over its glass bulb.

Mfd.—A popular but unauthorised abbreviation for microfarad.

Mho.—Unit of conductivity.

Microammeter.—A meter for measuring microamperes.

Microampere.—Microampere.—A millionth of an ampere.

Microhenry.—A millionth of a henry.

Microhm.—A millionth of an ohm.

Micro-microfarad.—A millionth of a microfarad.

Microphone.—An apparatus which translates sound waves into electrical current of similar frequency.

Microphone amplifier.—An amplifier which magnifies the current from the microphone.

Microphonic.—A wireless receiver or valve is microphonic when vibrations produce an effect on the current through the receiver valves. The usual effect is to produce noisiness in the loud-speaker, due, for example, to vibration of the electrodes in a valve.

Microphony.—The troublesome condition set up by a microphonic valve or receiver.

Micro-ray.—Extremely short wireless waves which may be focused very readily and are subject to many of the limitations of light.

Milliammeter.—An instrument for measuring milliamperes.

Milliampere.—A thousandth of an ampere.

Millivolt.—A thousandth of a volt.

Millivoltmeter.—A voltmeter for measuring millivolts.

Modulation.—The variation of a high-frequency current by an other current usually of audible frequency.

Morse code.—A signalling code which consists of letters sent as dots and dashes, each letter being represented by a dot or a dash or a combination of dots and dashes.

Motor-boating.—The phenomenon of low-frequency oscillations due to interaction, usually in the low-frequency side of a receiver.

Moving-coil loudspeaker.—A loudspeaker in which the input currents are passed through a light coil of wire fixed to the centre of a diaphragm and moving in a strong magnetic field. The result is a vibration of the moving coil, and this is communicated to the diaphragm, which radiates sound waves.

Moving-coil instruments.—Measuring instruments are usually of two kinds: the moving-iron type and the moving-coil variety. In the moving-coil type the input current passes through a very light suspended coil of wire, which moves in a strong permanent magnetic field, with the result that the coil moves the pointer of the meter.

Moving-coil microphone.—A microphone in which the diaphragm causes a coil of wire to move back and forth in a strong permanent magnetic field; this movement sets up currents in the coil which are then used as the microphone currents.

Moving-iron loudspeakers.—In this type of speaker the diaphragm or cone is connected to an iron armature which is in the magnetic field of an electro-magnet energised by the input.

Moving-iron instruments.—In this type of meter a piece of iron is fixed to the pointer and the iron is repelled by an electro-magnet energised by the currents to be measured.

Multiple amplification.—The use of a single valve for amplifying different currents simultaneously, as in a reflex circuit.

Multiple reaction.—The application of reaction to two or more tuned circuits in a receiver.

Multi-mu valve.—A variable-mu valve.

Multi-stage amplification.—The use of two or more valves for amplification.

Mutual conductance.—A measure of the change in anode current for a change of one volt in the grid voltage, the anode voltage remaining constant.

Mutual inductance.—The degree of coupling between two inductance coils.

Mutual induction.—The coupling between two inductance coils.

N.

Natural frequency.—The frequency of a circuit containing inductance and capacity. It is the resonance frequency.

Natural wavelength.—An aerial possesses a natural wavelength due to its own inductance and capacity. The natural wavelength of an inverted "L" aerial is about four times the length of the aerial.

Negative charge.—The negative charge on a body is due to the excess of electrons on it.

Negative ion.—A negatively-charged atom.

Negative pole.—The negative terminal or electrode.

Negative resistance.—If a current is passing through an ordinary resistance an increase in voltage across it will cause an increase of current. Such a resistance is known as a positive resistance, but certain devices such as the negatron, the dynatron, and certain combinations of valves, act in the opposite way, the current falling as the voltage increases.

Negatron.—A special valve invented by the present writer for giving a negative resistance effect.

Neon lamp.—An electric lamp containing two electrodes in a bulb filled with neon gas which has been rarefied. If the voltage across the electrodes is sufficiently high, a glow discharge occurs through the gas.

Neutralising coil.—A coil connected in series with a moving coil in a moving-coil speaker in order to neutralise the effect of the ripple of the direct current energising the field magnet.

Neutralising condenser.—A small condenser for the purpose of balancing out or neutralising stray capacities.

Neutrodyne receiver.—A proprietary name for receivers developed by Professor Hazeltine or the Hazeltine Corporation.

Nichrome wire.—A resistance wire made of an alloy of nickel-chromium-steel. Can be heated to a bright red without oxidising.

Nodon valve.—A type of electrolytic rectifier of alternating

current. The cathode consists of aluminium in a solution of ammonium phosphate. The anode is usually of lead.

Non-conductor.—An insulator.

Non-inductive.—An apparatus is non-inductive when its inductance is zero or very small compared to its resistance or capacity.

Non-inductive condenser.—A condenser which has very little inductance.

O.

Ohm.—Unit of resistance.

Ohmic resistance.—Resistance of a circuit to direct current.

Ohm's law.—The relation between current, e.m.f. and resistance.

Open circuit.—A break in a circuit.

Open core.—A core which does not produce a closed magnetic circuit, an air gap being provided.

Oscillation constant.—The square root of the inductance multiplied by the capacity of a circuit.

Oscillations.—The back and forth currents produced by or set up in an oscillatory circuit.

Oscillator.—Generator of oscillations.

Oscillator valve.—The valve in a superheterodyne receiver which generates the local oscillations.

Out of phase.—Term applied when two or more electrical quantities are out of step.

Output.—The final power delivered by or voltage developed by an electrical apparatus.

Output choke.—A low-frequency choke connected in the anode circuit of the last valve of the receiver.

Output transformer.—Couples the last valve to the loud-speaker.

Output valve.—The last valve in a wireless set.

Overlap.—See backlash.

P.

Parallel.—Apparatus is connected in parallel when the current to it divides itself between the two paths.

Parallel feed.—The method of feeding a transformer or inductance coil which provides a choke or resistance path for the direct-current component.

Parasitics.—Spurious oscillations generated by an amplifying valve. The word is also applied sometimes to atmospherics.

P.D.—Potential difference.

Peak.—The maximum value of an alternating current or voltage. In general the maximum value of a variable quantity.

Pentode.—A five-electrode valve containing a cathode, a grid, a screen-grid, a stopper-grid and an anode.

Pentode, H.F.—A pentode valve for high-frequency amplification. It is intended to replace the screen-grid valve.

Pentode output choke.—An L.F. output choke with tapplings suitable for matching a loudspeaker to a pentode valve.

Periodicity.—Frequency.

Permanent magnet.—A magnet which retains its magnetism.

Permeability.—The facility with which a substance permits the passage of the lines of force of a magnetic field.

Permeability tuning.—The method of tuning a circuit which consists in varying the value of the inductance by altering the amount of iron core affecting the inductance.

Phones.—Telephone receivers.

Photo-electric cell.—Usually a type of valve containing a cathode and anode, the cathode radiating electrons when light is shone on to it.

Pick-up.—See gramophone pick-up.

Plate.—The anode of a valve.

Polarisation.—The effect of bubbles of hydrogen which collect on the positive plate of a primary cell, and which reduce the effectiveness of it.

Positive.—Deficient in electrons.

Positive electrode.—An electrode which is given a positive potential; the anode in a valve.

Positive ion.—Atom positively charged.

Pot magnet.—A pot-shaped magnet chiefly used in the construction of certain moving-coil loudspeakers.

Potential.—Degree of electrification.

Potential difference.—A difference of potential occurs between two points when there is a shortage or excess of electrons at one of the points.

Potential divider.—A system in which a given potential difference may be split up into two parts.

Potentiometer.—Usually a wire resistance connected across a or source of e.m.f., a sliding contact being made on the resistance so that any desired potential difference may be tapped off.

Power.—The rate of doing work.

Power amplifier.—An amplifier for providing large outputs as in public address systems.

Power grid detection.—A power type of diode detection in which the anode is also the control electrode of a triode. The reproduction is more or less distortionless.

Power valve.—A triode designed as the output valve of a receiver.

Preset.—A component which is semi-variable, i.e., only varied upon occasions. A preset condenser usually consists of plates which may be screwed together or apart to vary the capacity.

Primary.—In a transformer having two windings the primary is the one to which the input currents are fed; they are then induced into the secondary.

Primary cell.—Usually consists of two electrodes immersed in a chemical solution. The battery is renewed not by recharging, but by replacing the electrodes and the liquid electrolyte.

Push-pull amplification.—Method of amplification which consists in using two valves or their equivalent so that the anode current in one valve is increasing while that in the other valve is decreasing. See also Quiescent push-pull.

Q.

Quiescent aerial.—A method of telephony transmission in which the oscillations in the aerial have a low value when there is no speech or music.

Quiescent push-pull (abbreviated to Q.P.P.).—An arrangement of push-pull amplification in which the grids are normally biased so that the anode current flowing is normally very small, and the valves are working at the bottom bends of their characteristic curves.

R.

Radiation.—The emission of waves from an aerial.

Radio frequency.—High frequency.

Radio-frequency amplifier.—A high-frequency amplifier.

Radio-frequency choke.—A choke for high-frequency work.

Radio-frequency transformer.—A transformer designed to operate on the frequency used for radio transmissions and reception.

Radiogram.—An abbreviation for radio-gramophone.

Radio-gramophone.—A combination of a wireless receiver and a gramophone.

Ratio of transformation.—The ratio of primary turns to secondary turns in a transformer.

Reactance.—The opposition offered to the flow of alternating current by a pure inductance or a pure capacity.

Reaction.—The strengthening of input e.m.fs. by feeding back the output current of an amplifying device such as a valve.

Reaction coil.—An inductance which is coupled to a tuned circuit for the purpose of introducing reaction into it.

Reaction condenser.—A variable condenser for the purpose of controlling the amount of reaction introduced into a circuit.

Rectification.—The conversion of an alternating current into a direct current.

Rectified current.—The direct current resulting from rectification.

Rectifier.—The device which converts alternating currents into direct current.

Rectifying valve.—A valve which acts as a rectifier.

Reflection.—The turning back of wireless waves which reach an ionised layer of the atmosphere is termed reflection.

Reflex circuit.—A circuit in which a valve amplifies two or more different frequencies simultaneously, e.g., the H.F. currents and the L.F. currents obtained after detection.

Regeneration.—Another term for reaction.

Regulation.—The ability of a source of electric current to supply a heavy drain of current without appreciable loss of voltage.

Rejector circuit.—A low-loss circuit consisting of an inductance and a condenser which is tuned to a frequency which it is desired to reject.

Remote control.—A device for controlling a wireless receiver at a distance.

Resistance.—The opposition offered to a current by a conductor.

Resistance-capacity coupling.—A method of high-frequency or low-frequency amplification in which the changing current through a resistance sets up e.m.fs. across the resistance which are communicated to the next valve.

Resistor.—A fixed resistance.

Resonance.—A circuit is resonant to a given frequency when its inductance and capacity are such that the maximum current flows in the circuit.

Resonance curve.—A curve showing the current developed in a tuned circuit when different frequencies are applied.

Response curve.—Usually the curve showing the nature of the output of electrical apparatus for different frequencies.

Retroaction.—Another term for reaction.

Rheostat.—A variable resistance for the purpose of controlling the magnitude of an electric current.

R.M.S.—Root mean square value of alternating currents.

Root mean square.—An alternating current varies in magnitude all the time, but we can take its average effect for half a cycle. The r.m.s. value represents the average value.

S.

Saturation.—The iron core of a transformer or choke is saturated when an increase of current through the primary of the transformer or through the choke will not increase the extent to which the core is magnetised.

Saturation in a valve.—The current through a valve reaches saturation when all or nearly all the electrons emitted from the cathode are going to the anode or other electrodes.

Saturation bend.—The bend in the characteristic curve which indicates that saturation is being reached.

Scanning.—The process of breaking up a picture into small particles for transmission by television.

Scanning disc.—A rotating disc used in television for scanning.

S.C.C.—Single cotton covered; reference is to the insulation coverings on a copper wire.

- Screen.**—A metal shield which interrupts electrostatic or electromagnetic lines of force.
- Screen-grid valve.**—A four-electrode valve having a filament or cathode, a control-grid, a screen-grid between the control grid and the anode, and an anode.
- Screening.**—The different components in a wireless receiver are frequently screened from each other by metal plates or cans to prevent interaction and the influencing of one component by the field of another.
- Secondary battery.**—An accumulator.
- Secondary electrons.**—The electrons which are emitted from a metal surface which is bombarded by primary electrons.
- Secondary winding.**—The winding of a transformer into which currents are induced by the first or primary winding.
- Selectivity.**—A term used to indicate the power of a wireless receiver or circuit to differentiate between wireless signals of different frequency.
- Self bias.**—The method of obtaining bias for the grid of a valve, which consists in passing an anode current through a resistance.
- Self capacity.**—The incidental capacity of a component such as an inductance where there is a capacity effect between the turns.
- Self oscillation.**—A term usually used to indicate the oscillation of a valve due to coupling between its anode and grid circuits.
- Series condenser.**—A condenser which is inserted in series with the aerial lead of a wireless receiver for the purpose of reducing the aerial capacity and increasing the selectivity of the set.
- Series connection.**—The arrangement of components end-to-end so that the current through one passes through the next.
- Series-parallel switch.**—A switch which enables apparatus to be connected either in series or in parallel.
- S.G.**—Abbreviation for screen-grid.
- Sharp tuning.**—High selectivity.
- Short-circuit.**—The cutting-out of a component due to the usually accidental touching of wires which provides a shortened route for the current.
- Short waves.**—A vague term indicating waves below about 200 metres.
- Side-bands.**—A wireless transmission consists of a carrier-wave which is modulated by the low-frequency microphone currents. These are of different frequency, and the waves transmitted from the transmitting aerial consist not only of the carrier wave but of side-band waves which have a frequency equal to the carrier wave plus or minus the microphone frequency.
- Skip distance.**—Owing to the nature of the reception of short waves from the ionised layers of the atmosphere, short waves are frequently not capable of being received at certain distances.
- S.L.F.**—Straight-line frequency. An abbreviation used in connection with variable condensers for tuning purposes.

Smoothing circuit.—A combination of one or more condensers and a resistance or choke or several chokes and resistances for the purpose of smoothing-out the ripple on the supply of D.C.

Soft valve.—A valve which contains a certain amount of gas.

Space-charge.—A charge in space of a cloud of electrons near the filament of a valve.

Square-law condenser.—A variable condenser in which the movement of the moving vanes is directly proportional to the change in wavelength. The change in capacity of the condenser obeys a square law.

S.S.C.—Abbreviation for single silk covered.

Stopping condenser.—A blocking condenser; i.e., one whose purpose is to prevent the passage of direct current while permitting alternating e.m.fs. to be communicated through it.

Step-down transformer.—A transformer in which the secondary winding has fewer turns than the primary.

Step-up transformer.—A transformer in which the secondary winding has more turns than the primary.

Storage battery.—Accumulator.

Straight-line-frequency condenser.—A variable condenser which, for a given angular movement of the moving vanes, will produce the same change in frequency of a tuned circuit.

Stray capacities.—The various unintended capacities between components and between wires and between these and earth.

Sulphating.—The white formation of lead sulphate which occurs on accumulator plates when they have been neglected.

Superheterodyne.—A receiver in which the incoming signals are combined with local oscillations of a slightly different frequency.

Super-power valve.—An output valve capable of handling a comparatively high power.

Supersonic.—A frequency above the audible limit (usually about 20,000).

Switch.—An apparatus for altering the connections of a circuit.

T.

T Aerial.—An aerial in the shape of the letter T, the down lead being taken from the middle of the aerial.

Tapping.—A connection taken from a point between the ends of an inductance, resistance, etc.

Telephone receivers.—The receiving end of an ordinary telephone. Sometimes two of these receivers are used together in the form of a headgear.

Telephone condenser.—A condenser connected across the telephone receiver terminals.

Television.—The science of seeing by wireless or by electricity generally.

Tetrode.—A valve having four electrodes.

Thermionic current.—The electron flow through a vacuum.

- Thermionic emission.**—The emission of electrons from a cathode.
- Thermionic valve.**—A valve in which electrons are emitted from the cathode.
- Thoriated filament.**—A filament usually made of tungsten metal containing a percentage of thorium.
- Three-electrode valve.**—A thermionic valve usually having a filament or cathode, a grid and an anode ; a triode.
- Tight coupling.**—Coupling between two circuits to produce a strong transference of energy.
- Topping-up.**—The process of adding distilled water to an accumulator to compensate for evaporation.
- Toroidal coil.**—A coil wound in the shape of a ring ; it has no external field.
- Transformer.**—An apparatus for changing the character of an electric current of alternating wave-form so that the output current is at a different voltage and current than the input current, no moving parts being involved. Sometimes, however, the transformer may be of the 1 : 1 type, in which case the output current and voltage is similar to that fed into the primary of the transformer.
- Transmitter.**—The apparatus at a transmitting station.
- Trickle charger.**—An apparatus for charging accumulators at home when they are not in use.
- Trimmer.**—An adjustment for causing small variations (of a preset character) of inductances or condensers. The trimmer is generally a small preset condenser used for ganging condensers.
- Triode.**—A three-electrode valve.
- Tuned anode.**—A tuned circuit consisting of an inductance and variable condenser associated with the anode of a high-frequency amplifying valve.
- Tuned circuit.**—A circuit containing inductance and capacity, the frequency of the circuit being adjustable.
- Tuning coil.**—The inductance in a tuned circuit.
- Tuning condenser.**—A variable condenser used for tuning.
- Tuning note.**—A low-frequency signal sent out before a programme begins, to enable receivers to be tuned in.
- Two-electrode valve.**—A valve containing a cathode and an anode ; commonly called a diode.

U.

- Ultra-short waves.**—The description usually applied to wavelengths below 10 metres.
- Undamped oscillations or waves.**—Continuous oscillations or waves.
- Unidirectional conductor.**—A conductor such as a rectifier which allows current to flow only in one direction.

Unilateral conductivity.—Permitting the passage of current only in one direction.

V.

Vacuum tube.—A bulb devoid of air and containing two or more electrodes ; a thermionic valve.

Vacuum valve.—Another term for thermionic valve.

Valve voltmeter.—A valve which is used for measuring voltages ; the voltage to be measured is usually applied to the grid of the valve, while a meter is included in the anode circuit.

Variable condenser.—A condenser consisting of two (or more) vanes, the position of which may be altered to vary the capacity.

Variable inductance.—A coil whose inductance can be varied.

Variable- μ valve.—A valve whose mutual conductance can be adjusted. It is thus possible to vary the amount of amplification given by the valve. The method is frequently applied to screen-grid valves and pentodes, and is used to vary the amplification of both H.F. and L.F. amplifying valves.

Variometer.—A variable inductance arrangement usually consisting of two inductance coils in series, one coil rotating inside the other, so that its field opposes or assists the field of the other coil, thus decreasing or increasing the total inductance.

Velocity of waves.—Speed with which waves travel ; wireless waves travel at the rate of 300,000,000 metres per second, or 186,000 miles per second.

Vernier.—A term loosely applied to any fine adjustment of a variable condenser, etc.

Volt.—Unit of electromotive force.

Voltage amplification.—The ratio of output e.m.f. to input e.m.f. of an amplifier.

Voltage drop.—The reduction in voltage due to the passage of currents through apparatus which opposes its flow.

Voltmeter.—An instrument for measuring voltage.

Volume control.—An adjustable control for altering volume from a loudspeaker ; any device such as a potentiometer for varying amplification.

W.

Wander plug.—A terminal contact connected at the end of a wire and used for tapping off voltages from a battery.

Water-cooled valves.—A valve usually of the transmitting type which is kept cool by the aid of water.

Watt.—A unit of electrical power. A watt is equal to one volt multiplied by one ampere.

Wave.—The disturbance in the ether which enables wireless communication to be carried on.

Wave-form.—The outline of a curve representing the nature of a variation of current or voltage, or of a wave.

Wavelength.—All waves in the ether travel at the same speed, which is 300,000,000 metres per second. The wave thrown off from an aerial may be formed at almost any rate desired, this being the frequency of the wave. The greater the frequency the smaller will be the length of the wave, and vice versa.

Wavemeter.—Instrument for measuring wavelength.

Wavetrap.—A tuned circuit used in connection with an aerial circuit for the elimination of undesired frequency signals.

Wipe-out.—The overloading of a valve by a very strong signal which thus prevents the reception of a weaker signal; the term is sometimes also used to indicate the blotting-out of other signals by extremely strong signals in the neighbourhood of an transmitting station.

INDEX OF DIAGRAMS

CHAPTER 1—A SIMPLE INTRODUCTION.

FIG. No.		PAGE
1	Sound waves will travel long distances if there is no obstruction	8
2	Sound waves may be sent along a wire for comparatively short distances	9
3	Sound waves impinging on a diaphragm, which vibrates in sympathy	11
4	The simplest electric telephone in which sound waves vary the microphone current	13
5	Illustrating the difference between direct and alternating current in a wire	14
6	Two complete cycles of alternating current. The inverted peaks are negative current	15
7	A transmitting aerial, showing how the wire is insulated at each end	16
8	A skeleton representation of a transmitter sending to a receiving station	17
9	A tuning fork will set an exactly similarly fork vibrating	18
10	The simplest tuned circuit consists of an inductance and variable condenser.	19
11	Condensers with fixed plates intermeshed to increase capacity	20
12	Showing condenser charged up by current from battery	21
13a	Condenser discharging through an inductance	22
13b	Condenser discharging in opposite direction	22
14	A steel blade with weight oscillates, if flicked	22
15	The simplest tuned aerial circuit consisting of inductance and variable condenser between aerial and earth	23
16a	A simple crystal detector receiver	26
16b	Pictorial representation of the Fig. 16 receiver shown	27
17	Currents vary the strength of the magnetism and so cause diaphragm movements	27
18	To illustrate the rectification process in reception	28

CHAPTER 2—AERIAL CIRCUITS.

19	An aperiodic aerial circuit. Voltages are developed across R. No selectivity is obtainable	29
------------	--	----

FIG. No.	PAGE
20... A pictorial equivalent of the aperiodic aerial circuit ..	29
21... Use of choke as aperiodic aerial circuit	30
22... Pictorial form of circuit on the left	30
23... The tuned circuit is completed by the aerial-earth capacity	31
24... Dotted line shows the equivalent of the aerial capacity	31
25... This is what the aerial circuit virtually is.. .. .	31
26... A rotating contact gives rough tuning	31
27... A pictorial equivalent of Fig. 26	31
28... A variometer gives very accurate aerial tuning	32
29... It consists of one coil rotating inside another	32
30... Tuning with series aerial condenser	33
31... A pictorial form of the circuit of Fig. 30	33
32... Parallel aerial condenser tuning method	34
33... Fig. 32, but shown in picture form	34
34... Use of a small series condenser	34
35... The Fig. 34 method is shown pictorially	34
36... A small fixed condenser is in series with aerial	35
37... This is a sketch of Fig. 36 translated into components ..	35
38... An aperiodic aerial coupling system	36
39... Pictorial form of the circuit of Fig. 38	36
40... Variable coupling is effected by moving the aerial coil ..	37
41... Usually this is done by rotating the coil inside the other ..	37
42... Here greater selectivity is obtained by varying the feed ..	37
43... The coupling between the tuned circuits is usually fixed ..	37
44... A tapped aerial circuit gives selectivity	38
45... This is Fig. 44 in pictorial form. A movable clip is used ..	39
46... Combined tapped coil and series feed condenser	39
47... Pictorial form of Fig. 46. Note solid dielectric condenser ..	39
48... Use of differential condenser for feeding circuit	39
49... Differential condenser to avoid altering tuning	40
50... Pictorial form of Fig. 49	40
51... A simple waveband switch "shorts" the long-wave coil ..	41
52... Commonly used components wired to conform to Fig. 51 ..	41
53... Selectivity is increased especially on long waves by C1 ..	42
54... Pictorial form of the circuit given above	42
55... Equivalent circuit when on medium waves	43
56... Conditions when receiving long waves. Coils are in series ..	43
57... How a three-point switch is used with H.F. transformer ..	43
58... Pictorial form of Fig. 57	44
59... An aperiodic coupled circuit with wave-change switch	44
60... Pictorial form of the preceding circuit	45
61... Scheme for ensuring a middle tapping on both wavebands ..	45
62... Loose-coupled input tuner for selectivity	46
63... Components arranged to conform to the Fig. 62 loose-coupled tuner system	46
63a .. How further selectivity is obtained	46
64... Resonance curve of single circuit giving poor selectivity ..	47
65... Curve showing overall selectivity of two tuned circuits. ..	47
66... Suitable coupling produces a band-pass tuning effect. ..	49
66a .. Auto-coupling using common inductance	50
66b .. Capacity-coupled band-pass arrangement	51
66c .. Pictorial form of Fig. 66b	51
67... Capacity-coupled circuit can be resolved into two circuits ..	52
68... Capacity-coupled band-pass with tapped aerial coil	52

FIG. No.	PAGE
69... Here the capacity-coupled band-pass circuit is supplemented by aperiodic aerial coupling	52
70... Electrostatic coupling by means of very small condenser	53
71... Mixed band-pass filter	54
72... Another form of mixed band-pass filter	54
73... A mixed capacity-coupled band-pass "filter" with an aperiodic aerial coupling coil	54
74... How resistance coupling is effected	55
75... An unsatisfactory arrangement in which a small resistance is common to both circuits	55

CHAPTER 3—HOW THE VALVE WORKS.

76... Filament heated to incandescence and emitting electrons	56
77... Showing the introduction of a metal plate	57
78... Anode current is produced by applying a positive voltage	57
79... No anode current is produced if anode is negative ..	58
80... Characteristic curve of diode	58
81... A mechanical analogy in which a fountain sprays water	59
82... Illustrating diode acting as rectifier	59
83... Use of reservoir condenser to store rectified current ..	60
84... Diode in use as a wireless detector	60
85... Shows construction of simple diode valve	61
86... The supporting wires are embedded in a glass "pinch" ..	61
87... Most modern valves have flat electrodes	61

CHAPTER 4—THE THREE-ELECTRODE VALVE.

88... Method of indicating a three-electrode valve	62
89... Open-mesh grid which controls electrons	62
90... Construction of cylindrical type of valve	62
91... A more modern construction of valve	62
92... The grid voltage controls the anode current of the valve	63
93... A negative potential on the grid is reducing the current	63
94... Anode current cut off by large negative voltage	64
95... Positive voltage on grid increases anode current	64
96... Table showing effect of different grid volts.. .. .	64
97... Characteristic curve of a three-electrode valve	65
98... A mechanical analogy to explain the action of the triode	65
99... A cloud of electrons form a space charge	66
100... Crystal detector followed by L.F. amplifying valve ..	66
101... A step-up transformer increases the voltages	67
102... Pure reproduction requires operation on the straight portion	67
103... Use of output transformer to match valve and speaker ..	68
104... A high-frequency amplifier using a tuned anode circuit ..	69

CHAPTER 5—HIGH-FREQUENCY AMPLIFICATION.

105... Varying voltages across A B will establish amplified voltages across R	71
106... Various stray capacities affect the efficiency	72
107... An H.F. choke coupling system is better but not efficient	72
108... Sometimes an aperiodic H.F. transformer is used	73
109... The tuned anode method of H.F. amplification	73
110... Receiver employing tuned anode H.F. coupling	73
111... Using an H.F. transformer with aperiodic primary	74
112... The primary of the H.F. transformer is here shown tuned	74

FIG. No.	PAGE
113.... Tapping the tuned anode circuit gives greater selectivity	75
114.... Tapping the grid circuit results in less grid circuit damping	75
115.... A parallel-fed tuned anode circuit, using resistance ..	76
116.... The tuned circuit is fed from a choke	76
117.... Arrangement which employs an H.F. choke feed system	76
118.... Parallel-fed tuned anode coupling	77
119.... Use of screen-grid valve in parallel-fed coupling	77
120.... Use of anode and grid tapplings to improve the selectivity	77
120a.... Differential anode coupling for greater selectivity, etc. ..	78
121.... A revised form of differential coupling	79
122.... Differential anode coupling with H.F. transformer	79
123.... Screen-grid valve, followed by differential anode coupling	80
124.... Loose-coupled tuned circuits between valves	80
125.... The tuned circuits are coupled only by a small condenser C	80
126.... Use of a resistance of about 100,000 ohms for coupling ..	81
127.... Condenser common to both circuits couples the two ..	81
128.... Coupling effected by inductance common to both circuits	81

CHAPTER 6—LOW-FREQUENCY AMPLIFICATION.

129.... The simplest form of low-frequency amplifier	82
130.... Shows use of output transformer feeding the loudspeaker	83
131.... This illustrates a step-up auto-transformer in grid circuit	83
132.... The grid resistance and condenser C enable bias to be applied	83
133.... Simple resistance coupling	84
134.... Use of condenser and grid resistance	84
135.... Tapped output choke	85
136.... Parallel-fed output arrangement	85
137.... Tapped output choke which gives step-down effect ..	86
138.... Resistance-fed loudspeaker	86

CHAPTER 7—MULTI-STAGE L.F. AMPLIFIERS.

139.... Theoretical resistance-coupled L.F. amplifier	87
140.... Use of battery B ₅ to prevent excessive grid voltage	88
141.... Insertion of H.T. in position shown requires a grid battery	88
142.... The L.T. and H.T. batteries are now common	89
143.... How the steady, undesirable grid voltage is removed	89
144.... A complete and practical resistance-coupled L.F. amplifier	90
145.... A theoretical circuit showing step-up transformer	90
146.... A single L.T. and a single H.T. battery are now employed	91
147.... A combined amplifier	91
148.... A single accumulator and H.T. battery are shown in this practical circuit	92
149.... The first valve is detector and the second L.F. amplifier	92
150.... A crystal detector followed by a stage of resistance-coupled L.F. amplification	92
151.... A complete two-stage L.F. amplifier	93

CHAPTER 8—REACTION.

152.... The simplest reaction method with movable reaction coil	94
153.... Complete reaction receiver	95
154.... Keeping a pendulum swinging by correctly timed taps ..	96
155.... The reaction is varied by an adjustable resistance	98
156.... The variable condenser C ₂ modifies the choke effect of Z	98

INDEX OF DIAGRAMS

373

FIG. No.	PAGE
204.... Most of the alternating current voltages will be developed across the inductance	120
205.... The voltage across the condenser will be small compared to voltage across resistance.. .. .	120
206.... A small inductance and small capacity favour low notes	121
207.... A resistance and small condenser will give a greater output of low notes	121
208.... Large or small condenser voltage according to frequency	121
209.... The same resistance and condenser behave differently to L.F. and H.F.	121
210.... H.F. is filtered out by this arrangement	122
211.... This particular connection gives an H.F. output	123
212.... Connections to give an L.F. output	123
213.... The same circuit with H.F. output	123
214.... Use of condenser C ₂ to short-circuit undesired H.F. ..	124
215.... Use of H.F. choke and condenser C ₂ to keep out H.F. ..	125
216.... Network equivalent to the stopper circuit of Fig. 215 ..	125
217.... Sometimes an H.F. choke by itself is used as a stopper ..	126
218.... The network corresponding to the circuit given in Fig. 217	126
219.... Use of grid-stopper resistance to keep H.F. from grid ..	127
220.... The network equivalent to Fig. 219	127
221.... Showing use of choke as means of filtering out H.F. ..	127
222.... A condenser C ₂ increases filter effect but affects top notes	128
223.... A grid stopper of 100,000 to 500,000 ohms is popular ..	128
224.... Here the H.F. choke is directly in the anode circuit ..	128
225.... Use of H.F. choke ; this, however, produces Miller effect	129
226.... Theoretical arrangement of inductance-resistance filter..	129
227.... A.C. prefers large condenser to large inductance	129
228.... Shunt effect of condenser across inductance	130
229.... A.C. will pass through a large condenser in preference to a large resistance	130
230.... H.F. currents will prefer to pass through the condenser C ₂	130
231.... Practical method of using H.F. choke and by-pass ..	131
232.... Theoretical network corresponding to Fig. 231	131
233.... The best method of keeping H.F. out of L.F. circuits ..	131
234.... Network corresponding to the circuit of Fig. 233	131
235.... Choke and condensers in resistance-coupled amplifier ..	132
236.... Simple arrangement for filtering out L.F. currents	132
237.... Arrangement for reducing the higher notes	132
238.... A resistance alone will reduce high notes.. .. .	133
239.... Use of two filters in series	134
240.... Two resistance-capacity filters	134
241.... Separating the A.C. from a D.C. supply	134
242.... Use of iron-core choke filter	135
243.... Three forms of filter which pass on the low-frequencies	135
244.... This combination takes in the H.F.	136
245.... Use of two L.F. chokes and one condenser for special cases	136
246.... Decoupling the anode circuit of an H.F. valve.. .. .	137
247.... Decoupling the screen of an S.G. valve	138
248.... Method of cutting out H.F. picked up by D.C. mains ..	139
249.... Another method which, however, causes a drop in the H.T. voltage	139
250.... A three-valve circuit in which two circuits are decoupled	140
251.... Decoupling is applied to both anode and grid circuits ..	141

FIG. No.	PAGE
CHAPTER 11—PARALLEL-FED L.F. TRANSFORMERS	
252....Simple parallel-fed transformers using an anode resistance	143
253....Auto-transformer giving greater "step-up"	143
254....Windings are now in opposition	144
255....Windings in series act as choke, giving 1 : 1 ratio	144
256....How a resistance-fed transformer may be decoupled	145
257....Method of decoupling a choke-fed L.F. transformer	145
258....This connection reduces interaction and hum.. .. .	145
CHAPTER 12—THE SCREEN-GRID VALVE	
259....Simple screen-grid H.F. amplifier	147
260....Characteristic curve of screen-grid valve; note negative resistance slope	148
261....Shows how the curve resembles that of triode	149
262....Choke-fed tuned-anode circuit is often used with S.G. valve	149
263....Plain tuned-anode coupling can be applied to S.G. valves	150
264....This improvement keeps one side of C ₃ at earth potential	150
265....Anode and grid tappings on anode coil	151
266....Use of H.F. transformer with S.G. valve.. .. .	151
CHAPTER 13—THE VARIABLE-MU VALVE	
267....Typical characteristic curve of a variable-mu S.G. valve	153
268....Potentiometer connections for a variable-mu S.G. valve	154
269....A three-point switch cuts out potentiometer battery	154
270....Parallel system of applying bias to variable-mu valve	155
CHAPTER 14—THE PENTODE VALVE	
271....To explain back e.m.f. effects of triode	156
272....Suppressor grid prevents negative resistance	159
273....Characteristic curve of typical pentode valve.. .. .	160
274....Grid-volts-anode-current curve resembles that of triode	160
275....Tone-corrector circuit applied to output choke	161
276....Use of tone-corrector and step-down output transformer	162
277....Typical circuit for using mains pentode	163
CHAPTER 15—PUSH-PULL AMPLIFICATION	
278....Ordinary push-pull arrangement giving good quality	164
279....Ordinary push-pull circuit operates both valves on straight part of curve	165
280....Special form of push-pull circuit used in U.S.A.	166
281....Another push-pull circuit using a valve for phase reversal	166
CHAPTER 16—QUIESCENT PUSH-PULL AMPLIFICATION	
282....Q.P.P. circuits operate valves at bottom bend	167
283....Two pentodes arranged in quiescent push-pull.. .. .	168
284....A cyclist normally uses a "Q.P.P." system	169
CHAPTER 17—CLASS B AMPLIFICATION	
285....Simple Class B circuit; the grids operate at zero volts	171
286....The curve of a Class B valve lies to the right of zero volts	171
287....A complete Class B circuit showing the driver valve	171
288....Characteristic curves of a typical Class B output valve.. .. .	172
288a....An output choke is often used in Class B	173
289....Class B tends to accentuate high notes	173
290....View of Class B valve-pins, looking from underneath	173

FIG. No.	PAGE
CHAPTER 18—NEUTRALISED CIRCUITS FOR HIGH-FREQUENCY AMPLIFICATION	
291.... Capacity coupling inside triode promotes self-oscillation	174
292.... Theoretical network showing valve capacities	174
293.... Use of neutralising winding and condenser	174
294.... H.F. intervalve transformer with neutralising winding ..	175
295.... Tapped anode coil enables valve capacity to be neutralised	175
296.... Tapped grid coil enables neutralising voltages to be fed from anode	176
297.... H.F. amplifier in which each valve is neutralised	176
298.... A special split input circuit prevents parasitics	177
CHAPTER 19—MULTIPLE AMPLIFICATION WITH ONE VALVE	
299.... Simple reflex circuit which amplifies H.F. and L.F. ..	178
300.... Reflex receiver giving double amplification	179
301.... Use of a valve as detector in a reflex receiver	179
302.... Another reflex receiver	180
303.... A reflex receiver in which the L.F. is resistance-coupled	180
CHAPTER 20—MULTIPLE REACTION CIRCUITS.	
304.... A double-reaction circuit	182
305.... Showing use of a phase reverser in aerial reaction circuit	182
306.... A reaction distributor system is here illustrated	183
CHAPTER 21—MAINS UNITS AND THE RECTIFICATION OF A.C.	
307.... To explain use of diode as a rectifier	184
308.... The A.C. ripple obtained with half-wave rectification ..	185
309.... Smoothing circuit comprising choke and condenser ..	185
309a .. On the left, the anode current flows through the top valve; on the right, through the lower valve	186
310.... Use of a resistance for voltage dropping	187
311.... Dropping resistance to provide extra H.T. terminal ..	187
312.... Use of potentiometer to provide a second H.T. voltage ..	187
313.... The second H.T. voltage is varied by R ₁	188
314.... A complete full-wave rectifier system	188
CHAPTER 22—METAL RECTIFIERS.	
315.... Simplest metal rectifier system	189
316.... Choke and two condensers provide smoothing	190
317.... A full-wave metal rectifier system	190
318.... Metal rectifiers arranged in bridge formation	191
319.... The most usual arrangement involves voltage doubling	191
CHAPTER 23—METAL RECTIFIERS AS DETECTORS.	
320.... Curve of Westector	193
321.... Westector detector feeding into step-up transformer ..	193
322.... This circuit involves full-wave rectification	194
323.... Economiser circuit; weak signals reduce grid bias ..	194
CHAPTER 24—VOLUME CONTROL METHODS.	
324.... Series condenser controls volume	196
325.... Series resistance controlling volume	196
326.... A fixed condenser is sometimes inserted	196
327.... This arrangement produces little effect on tuning ..	196

FIG. No.	PAGE
328....Combined tapping and series condenser	197
329....Differential condenser reduces mistuning	197
330....Parallel resistance reduces signal strength	197
331....Combining series and parallel resistance	197
332....Use of H.F. potentiometer to control volume	198
333....Use of stopping condenser to prevent "shorting" bias ..	198
334....Variable resistance by-passes H.F. currents	198
335....Variable coupling affects volume	198
336....Reducing filament current reduces S.G. amplification ..	199
337....Potentiometer control of screen of S.G. valve	199
338....Use of graded potentiometer with variable-mu S.G. ..	199
339....Combined H.F. potentiometer and variable grid bias ..	200
340....Another form of combined control	201
341....Volume may be controlled by an adjustable coupling ..	201
342....Resistance across the primary will vary the volume ..	201
343....Use of a differential condenser to vary the volume ..	202
344....Output from diode detector is adjustable by a resistance	202
344a .. Tapping the L.F. output from a detector	202
344b .. A separate potentiometer across the diode resistance ..	203
345....The output of an L.F. valve controlled by an anode resistance	203
346....The variable resistance controls the amplification	203
347....A condenser "shorts" part of resistance	204
348....Slider on R ₂ controls amount of amplification.. .. .	204
349....Potentiometer method of controlling resistance amplifier	204
350....Grid circuit potentiometer controls volume	205
351....Voltage variation may reduce volume—not a good method	205
352....A potentiometer may be connected to the primary ..	205
353....Commonly used potentiometer arrangement	205
354....Unsatisfactory method of reducing pick-up voltage ..	206
355....Graded potentiometer for pick-up volume control	206
356....A special volume control on L.F. circuit	206
356a .. This arrangement causes less reduction of bass	206
356b .. A greater proportion of treble and bass are maintained..	206
356c .. An "acceptor circuit" keeps quality good	206
357....Output from a diode is controlled by a potentiometer ..	207
358....The battery B provides bias for second valve	207
359....A variable-mu L.F. valve is shown	208
360....An unsatisfactory volume control	208
361....Output volume is controlled by varying speaker current	208

CHAPTER 25.—TONE CONTROL SYSTEMS.

362....Variable resistance cuts down "top"	209
363....Condenser across speaker reduces "top"	210
364....Series condenser reduces bass	210
365....Series inductance reduces "top"	210
366....Parallel inductance reduces bass.. .. .	211
367....Common form of tone control	211
368....For reducing bass	211
369....Also controls bass	211
370....Increasing R reduces treble	212
371....Combined tone-control system	212
372....Bass or treble may be reduced	212
373....Double rheostat affects bass and treble simultaneously ..	213
374....Another combined tone-control arrangement	213

FIG. No.	PAGE
375... Reducing "top" by condenser across primary	214
376... Reducing treble by condenser across secondary	214
377... Resistance and condenser across primary	215
378... Plain variable resistance across primary	215
379... Variable resistance across secondary	215
380... Resistance varies "top" reduction	215
381... Tone-controlling a resistance amplifier	215
382... Reducing the bass in a resistance amplifier	215
383... Tone corrector applied to a pentode	216
384... The coupling condenser C controls the amount of bass ..	216
385... L.F. potentials developed across C ₂ and R ₂	216
386... Use of reverse reaction to reduce "top"	217
387... Feed condenser controls bass response	217
388... Resonance increases the bass response	218
389... Scratch filter for pick-up	218
390... Another method of reducing scratch	218
391... The inductance produces accentuation of high notes ..	219
392... Tuned circuit to give greater amplification of high notes	219
393... Resonance effects compensate for reduced "top"	219
394... Tone corrector circuits as applied to grid circuit	219
395... To explain the cut-off filter	220
396... A cut-off effect is obtained by using resonance phenomena	220
397... A symmetrical low-frequency filter	221
398... An alternative symmetrical L.F. filter	221
399... A sharper cut-off is obtained by using two filters	221
400... An alternative series arrangement of L.F. filters	221
401... A tuned acceptor circuit reduces a heterodyne whistle ..	221

CHAPTER 26—PICK-UP CIRCUITS FOR GRAMOPHONES.

402... Simplest pick-up circuit	222
403... Pick-up with volume control and bias	223
404... Use of resistance in series with potentiometer	223
405... This enables one side of pick-up to be earthed	223
406... Logarithmic low-graded potentiometer in use	223
407... Volume control for maintaining low notes	224
408... Condenser C ₁ prevents excessive reduction of "top" ..	224
409... Another volume control for keeping tone balance	224
410... Pick-up fitted to anode-bend detector	225
411... A much better arrangement with separate bias	225
412... Suitable for occasional use of pick-up	225
413... Simple arrangement for switching-in pick-up	225
414... Change-over radiogram switching system	226
415... Similar to preceding, but resistance position altered ..	226
416... Grid resistance prevents noises when changing over ..	226
417... Pick-up arrangements for use with A.C. mains valves ..	226
418... Screening of the pick-up leads reduces hum	227
419... How a pick-up may be connected to an L.F. valve	227
420... Switching for a pick-up connected to an L.F. valve ..	227
421... Resistance permanently across grid and filament	228
422... An L.F. transformer is sometimes used to connect the pick-up to the amplifying valve	228

CHAPTER 27—AUTOMATIC VOLUME CONTROL.

423... A simple circuit to explain automatic volume control ..	231
424... A diode detector provides for A.V.C. purposes	232

FIG. No.	PAGE
425....A double-diode detector is shown in use for A.V.C. ..	233
426....A combined double-diode and L.F. valve	234
427....The A.V.C. valve operates as an anode-bend rectifier ..	236
428....How a diode with negative bias is conductive	236
429....How a diode conducts only strong signals	237
430....Output voltages are produced only by strong signals ..	237
431....A triode may be used as a limiter	238
432....A special A.V.C. system possessing certain disadvantages	239
433....Output resistance of rectifier may be connected in parallel	239
434....H.F. and L.F. filters to ensure D.C. for A.V.C.	239
435....The use of a double-diode triode for A.V.C. purposes ..	241
436....One anode used for detection. The other for delayed A.V.C.	241
437....A quiet A.V.C. circuit	243
438....Double-diode pentode acts as variable- μ L.F. amplifier	244
439....Double-diode pentode resolved into its various functions	245
440....A mains double-diode triode may be considered as two valves, and one theoretical arrangement is given ..	247
441....Complete double-diode pentode A.C. valve circuit ..	248
441a ..Curve showing the L.F. output volts for different values of H.F. input peak volts	249

CHAPTER 28—A.C. VALVES AND THEIR CIRCUITS.

442....Arrangement of an indirectly-heated valve	251
442a ..The cathode tube is heated by a filament.. .. .	252
443....Indirectly-heated-cathode valve circuit with grid-bias ..	253
444....A self-bias resistance R replaces the bias battery	253
445....Explaining how an earthed grid may be negative	254
446....Decoupling the self-bias resistance	255
447....Varying the grid voltage by a rheostat R ₁	255
448....A slider on the self-bias resistance varies grid voltage ..	256
449....Showing typical use of a self-bias resistance	256
450....In auto-transformer connections the above method is advised	256
451....Showing the use of self-bias in radiogram arrangements	257
452....Skeleton circuit in which negative bias is obtained from a resistance in the common H.T. lead	257
453....Negative bias is here obtained from a potentiometer ..	258
454....The positive voltage of the auxiliary grid is obtained from a potential divider.. .. .	258
455....Network of resistances for variable- μ H.F. pentode ..	259
456....Resistance network for an A.C. variable- μ S.G. valve ..	260
457....A complete radio-gramophone using mains valves.. .. .	261
458....A condenser between mains and aerial terminals	264
459....Resistance network for two variable- μ S.G. valves	264
460....A commercial type of receiver using five indirectly-heated- cathode A.C. valves and full-wave rectifier	265
461....An S.G. valve used as an anode-bend detector	266

CHAPTER 29—OPERATION OF D.C. MAINS VALVES.

462....Simple circuit showing indirectly-heated-cathode D.C. mains valve	267
---	-----

CHAPTER 30—UNIVERSAL MAINS RECEIVERS.

463....Simple American universal receiver which can be connected to D.C. or A.C. mains	268
---	-----

FIG. No.

PAGE

CHAPTER 31—THE SUPERHETERODYNE.

464....	A heterodyne receiver for the reception of Morse	270
465....	A local oscillating valve heterodynes continuous oscillations	271
466....	Two sets of oscillations of differing frequency	271
467....	A simple self-heterodyne receiver	272
468....	Beat frequencies produced by different incoming signals	273
469....	This shows graphically the effect on the beat frequency produced by adjusting the local oscillator.. .. .	274
470....	A complete simple supersonic heterodyne receiver showing the grid injector system	276
471....	This schematic diagram shows the constituent parts of a common type of superheterodyne circuit	277
472....	The grid injector system applied to an anode-bend detector. An L.F. transformer is in the output circuit ..	280
473....	Another application of the grid injector system	281
474....	Anode injector system applied to anode-bend first detector	281
475....	Applying the anode injector system to a "leaky grid condenser" first detector	281
476....	The applied local oscillator voltages may be reduced by tapping the oscillator circuit	281
477....	The cathode injector system which is commonly used in mains-valve superheterodynes	281
478....	Double-grid mixer valve circuit	282
479....	Self-heterodyne type of superheterodyne	282
480....	Self-oscillating detector	282
481....	An anode-injector type of superheterodyne using an S.G. first detector and variable-mu S.G.	283
482....	An acceptor circuit tuned to the same frequency as the L.F. transformers is used to short-circuit interference ..	284
483....	A series rejector circuit keeps out I.F. interference ..	284
484....	A superheterodyne circuit which lends itself well to single-control tuning	285
485....	A skeleton circuit of a Class B superheterodyne	286
486....	A commercial mains valve superheterodyne primarily designed for receiving wavelengths below 100 metres	287
487....	An interesting circuit in which there is a stage of aperiodic H.F. amplification, the H.F. is applied to the screen of V ₂	288
488....	An A.C. superheterodyne involving cathode injection ..	289
489....	Another cathode injector circuit combined with sharply tuned I.F. circuits	290
490....	The L.F. coupling circuit is flatly tuned to produce tone compensation	291
491....	A change of connections provides a scratch filter ..	291
492....	Superhet radiogram with second channel suppressor ..	292
493....	Cathode resistance method of injection	293
494....	Superheterodyne adaptor for wavelengths below 100 metres	294
495....	The simplest method of using an ordinary receiver for superhet working	294
496....	Use of S.G. valve as first detector	294
497....	A self-oscillating H.F. pentode is here used as first detector	295
498....	Cathode injector system applied to a battery valve ..	295
499....	A double-grid circuit in which a separate valve feeds oscillations to the extra grid of first detector	296
500....	The Pentagrid valve in which the "grids" nearest the cathode constitute the grid and anode of an oscillator ..	297

FIG. No.	PAGE
CHAPTER 32—COMMERCIAL SUPERHETERODYNE RECEIVERS.	
501....A commercial type of superheterodyne for broadcast reception. Note the rejector circuit	299
502....A stage of H.F. amplification here precedes an H.F. pentode used as a self-oscillating first detector; the reaction coil is connected to the auxiliary grid of the pentode ..	301
503....The general arrangement of a Murphy A.S. receiver. Note the band-pass arrangement between the first two valves and the automatic volume control circuit	302
CHAPTER 33—ULTRA-SHORT-WAVE RECEPTION.	
504....An ultra-short-wave receiving circuit of the super-regenerative type. The reaction valve acts as its own quencher and wavelengths of 5 metres may be received..	304
505....The simplest type of super-regenerative circuit; the quenching frequency is developed by the circuits L ₃ C ₃ and L ₄ C ₄	305
CHAPTER 36—ELECTROLYTIC CONDENSERS.	
506....On the left is an ordinary condenser, while on the right is the electrolytic type	310
507....Curve showing the leakage current for different voltages applied to a certain electrolytic condenser	312

GENERAL INDEX

A.C. component.....	231	Band-pass circuits.....	48
A.C. valves.....	250	— link.....	54
Acceptor circuit.....	233, 284	— mixed.....	54
Aerial.....	16	Beats.....	271
Aerial circuits.....	29	Bias, from mains unit.....	257
Alternating current.....	14	— self.....	201, 252, 254, 256
Amplification factor.....	64	Bottom bend.....	65, 115
Amplifier.....	66	— — rectification.....	70
Anode.....	56	Capacity coupling.....	51, 53
Anode-bend A.V.C.....	235	Carrier-wave.....	230
— current economiser.....	194	Cathode.....	56
— detection.....	114	— indirectly-heated.....	251
— detector (S.G.).....	266	— injection.....	281, 289, 295
— injection.....	280	— resistance injection.....	293
Aperiodic aerial circuits.....	30	Catkin.....	308
— H.F. amplifier.....	71	Characteristic curve.....	58
— transformer.....	73	— class B valve.....	172
Auto-coupled aerial circuit	38	— pentode.....	160
— band-pass.....	50	— S.G. valve.....	148
Autodyne superhet.....	282, 294	— Westector.....	193
Automatic bias.....	252, 256	Choke-fed H.F. stage..	72, 104
— volume control.....	229	— reaction.....	98
Auto-transformer for L.F.		Choke H.F. amplification....	72
amplification.....	83, 144	Class B amplification....	68, 170
Auxiliary grid.....	263	— superhet.....	285
A.V.C., delayed.....	236	Combination volume control	
— distortion in.....	238	200, 201
— quiet.....	242	Commercial superheterodyne	
— receiver.....	300	receivers.....	298
Background noise 201, 235,		Component, A.C.....	231
.....	242, 279	— D.C.....	231
Ballast resistance.....	260		

- Condenser..... 19
 — coupling..... 90
 — electrolytic..... 310
 — non-inductive..... 50
 — variable..... 19
 Constant-tone volume control..... 206
 Crystal detector..... 26
 Cut-off..... 219

 D.C. component..... 231
 — valves..... 267
 De Forest..... 62
 Decoupling..... 118, 136
 — self-bias..... 254
 Delayed A.V.C..... 229, 236, 241
 Detectors 25, 105, 113
 — diode..... 59
 diaphragm..... 27
 Differential aerial coupling 39
 — anode coupling..... 78
 — reaction..... 100
 Diode..... 56, 59
 — limiter..... 236
 — output control..... 207
 Directly-heated A.C. valve 251
 Distortion..... 68, 124
 — in A.V.C..... 238
 Double diode..... 233
 — — pentode..... 244
 — — triode..... 240
 Double grid valve mixer 281, 295

 Earth 16
 — grid..... 158
 — line..... 231, 254
 Economiser of anode current 194
 Eddy currents..... 306
 Electrolytic condenser..... 310
 Electrostatic coupling..... 53
 Electrons 21, 56
 Emission..... 57
 External reaction..... 104

 Fading..... 230, 235
 Field winding..... 262
 Filament..... 56
 — battery..... 59

 Filter 109, 110, 118
 Full-wave H.F. rectification 111
 — L.F. — 186
 Funnel..... 61

 Ganged volume control..... 201
 Grid..... 62
 Grid-bias battery..... 67
 Grid current..... 67, 114
 — leaky 70, 112
 — stopper..... 111
 Graded potentiometer 206, 223

 Half-cycle..... 15
 Half-wave rectification..... 184
 Hand-capacity effects..... 124
 Hard valve..... 56
 Heater filament..... 252
 — winding..... 263
 Heterodyne 270
 — whistle eliminator..... 221
 High-frequency amplification
 69, 71
 — oscillations..... 15
 — pentode..... 295
 — stopper..... 126
 — transformer..... 43
 High-note loss..... 111
 High-pass filter..... 136
 High-tension battery..... 63
 — current economiser..... 194
 Hum..... 201, 226, 262, 308
 Hum-bucking coil..... 262
 Hysteresis 306

 Impedance..... 119
 Indirectly-heated cathode 63, 251
 Inductive coupling..... 36
 Instability..... 75, 77
 Integrating effect..... 106, 108
 Intermediate frequency 230
 — — filter..... 284
 Inverse log-law..... 200
 Iron-core coils..... 306

 Leak..... 113
 Leakage current..... 311
 Leaky-grid rectification 112, 70
 Limiter..... 236

- Link band-pass..... 54
 Long-wave interference..... 284
 Loose-coupled H.F. amplifier..... 80
 Loudspeaker current control 208
 Low-frequency amplification
 66, 82
 — choke coupling..... 83
 — reaction..... 226
 — volume control..... 203
 Low-pass filter..... 135

 Mains aerial..... 264
 Mains hum..... 201, 226, 262, 308
 — units..... 184
 Manual control..... 246
 Metal rectifiers..... 189
 Metal valve..... 308
 Microphone..... 13
 Microphony..... 308
 Miller effect..... 79, 100, 263
 Mixed band-pass..... 54
 Mixer methods..... 279
 Mixer valve..... 295
 Modulation..... 95
 — hum..... 262
 — percentage..... 230
 Multi-stage L.F. amplifier 69, 87
 Multiple amplification..... 178
 — filters..... 133
 — reaction..... 181
 Mush..... 235

 Needle scratch..... 222
 Negative..... 21
 Neutralised circuits..... 174
 Neutrodyne..... 174
 Non-inductive condenser.... 50

 Occluded gas..... 309
 Oscillation..... 95
 Output circuits..... 68

 Padding condenser..... 285
 Parallel-fed grid-leak..... 113
 — L.F. output..... 85
 — tuned anode..... 75
 Pentagrid..... 296

 Pentode..... 156
 — H.F..... 259
 — mixer..... 295
 Percentage modulation..... 230
 Phase..... 101
 Pick-up circuits..... 222
 — filter..... 218
 — transformer..... 228
 — volume control..... 206, 223
 Pinch..... 61
 Positive..... 21
 — bias for S.G. screen..... 258
 Potential divider..... 64
 Potentiometer..... 64
 — for gramophone..... 200, 206
 — — S.G. screens..... 258
 — — variable- μ 200
 Power-grid detection..... 116
 Push-pull amplification..... 164
 — quiescent..... 167

 Q.A.V.C..... 242
 Quenching..... 304
 Quiescent push-pull (Q.P.P.) 167
 Quiet automatic volume
 control..... 242

 Radio-frequency amplifica-
 tion..... 69
 Radiogramophone..... 291
 — switching..... 292
 Reactance..... 118
 Reaction..... 94
 — differential..... 100
 — inherent..... 75
 — multiple..... 181
 Rectification..... 26, 105, 184
 — bottom-bend..... 65, 70, 115
 — diode..... 59, 184
 — saturation bend..... 116
 Rectifiers, metal..... 189
 — as detectors..... 192
 Reflex circuits..... 178
 Rejector circuit..... 284
 Resistance amplification,
 H.F..... 71
 — — L.F..... 84
 — fed H.F..... 75
 Resistance-coupled tuned
 circuits..... 55

Resonance.....	23	Thermionic.....	56
Reverse reaction.....	263	Threshold.....	236
S.G. valve.....	79	Time-lag.....	235
Saturation.....	65	Tone control.....	90, 206, 209
— bend.....	116	— correction... 161, 218, 222, 291	
Screened coils.....	50	— of pentode.....	161
Screen-grid.....	79, 146	Triode.....	62
— reaction.....	103, 104	Tuned anode coupling.....	73
— valve as anode-bend de-		— circuits.....	19
tector.....	266	— grid coupling.....	77
— variable- μ	152	— H.F. —.....	73
Seal.....	61	Tuning.....	17
Second-channel interference	278	Two-electrode valve.....	56
— suppression.....	292	Ultra-short wave reception	304
Selectivity of superhet.....	273	Unidirectional conductor....	107
Self-bias.....	252	Universal valves.....	268
— decoupling.....	254	Valve.....	56
— gramophone.....	257	— as detector.....	70
Self-capacity.....	119, 306	— capacity.....	103
Self-heterodyne.....	272, 294	— construction.....	61
Shielding pick-up leads.....	226	— noise.....	201
Single-dial superheterodyne	285	Variable condenser.....	19
Smoothing circuits.....	118, 187	Variable- μ S.G. valve.....	199
Smoothing choke.....	262	— H.F. pentode.....	259
Sound waves.....	8	— L.F.....	207, 208, 243
Space-charge.....	58, 65	— mains valve.....	260
Stem.....	61	Variable resistance reaction	102
Step-up transformer.....	67	Visual tuning.....	235
Stepping-stone capacity.....	78	Voltage dropping.....	187
Stopping condenser.....	71	Volume control 195, 198, 199,	
Stray capacity.....	76	203, 206, 207
Superheterodyne.....	270	Wave-band switching.....	40
Super-regenerative circuit....	304	Wavelength.....	12
Supersonic.....	274	Waves, wireless.....	12
Suppressor grid.....	159	— sound.....	8
Switching, radiogram.....	224	Westector.....	113, 192
Tapped tuned anode.....	74	— circuits.....	193
Telephone.....	10	Wunderlich valve.....	234, 241
— receiver.....	12		

