

# RAYTHEON



price 50 cents



*Excellence in Electronics*

# **RADIO AND TELEVISION TUBE DATA**

No patent liability is assumed with  
respects to the use of circuits and tube  
information contained in this booklet

First Printing  
November, 1957

**RAYTHEON MANUFACTURING COMPANY**

*Receiving and Cathode Ray Tube Operations*

55 CHAPEL STREET, NEWTON 58, MASSACHUSETTS

FRANKLIN PARK (CHICAGO), ILL.  
9501 Grand Ave.

ATLANTA 6, GA.  
1150 Zonolite Rd., N.E.

LOS ANGELES 7, CALIF.  
2419 South Grand Ave.

TABLE OF CONTENTS

	PAGE
Foreword . . . . .	3
Key to Symbols and Abbreviations Used in Data Chart .	4
Tube Data — Types Listed in RETMA Numerical Sequence — Designs — Electrical Characteristics — Basing Connection Reference . . . . .	5-48
Panel Lamp Data . . . . .	49
Tube Outline Drawings . . . . .	50-51

NOTE

The data contained herein is compiled as a Raytheon service to the field. It is not intended to indicate type availability.



The Raytheon recipe for quality and reliability in radio and television tubes is compounded of these rare but essential ingredients:

**Experience** — the Raytheon reputation for *Excellence in Electronics* had been painstakingly built long before the word “electronics” became significant. Few if any manufacturers have put in the years of intensive tube development and research that are back of every Raytheon Tube.

**Proved Performance** — user confidence in Raytheon Tubes is based not on promises but on the sure knowledge of their past performance in actual service. That is why so many of the leading makers of radio and television receivers have standardized on Raytheon Tubes, and why radio and television service-dealers are so ready to stake their own reputations for quality and service on a recommendation of Raytheon Tubes to their customers.

**Quality Control** — Raytheon technical superiority and production craftsmanship is nowhere more emphatically in evidence than in its tube manufacturing, assembly inspection and testing operations. From inspection of incoming raw materials right through to the finished product the most rigid quality standards are strictly maintained. As a result of this constant effort to achieve the ultimate in quality control, users of Raytheon Tubes find that they not only meet but exceed the performance and life expectations that past experience has led them to expect.

Today, as always, Raytheon Tubes symbolize *Excellence in Electronics*.

---



## BEFORE USING THE TUBE DATA CHART

Please read the following notes carefully. They explain the symbols and abbreviations which are used.

The following system for describing the type of base and for referring to the base connection diagram is used in the column headed "Basing Data":

The symbol at the left of the hyphen refers to the base connection diagram.

The symbol at the right of the hyphen indicates the type of base and the number of contact pins in accordance with the following:

First Letter — D = Duo-decal  
 G = Magnal  
 H = Diheptal  
 M = Miniature Base  
 O = Octal Base  
 L = Locking Base  
 R = Radial  
 S = Standard Base

Second Letter — B = Button Base (a shell is not incorporated)  
 M = Medium Shell (bakelite)  
 S = Small Shell (bakelite)  
 W = Wafer Base (metal tube or bantam tube with metal shell)  
 GT = Intermediate (bantam) Shell (bakelite)  
 J = Jumbo Shell

Numeral indicates the number of pins in base.

"B" after numeral indicates bayonet pin in base.

Examples:

4C-SS4B Diagram 4C, standard small shell with bayonet, 4 pin.  
 6G-SM6 Diagram 6G, standard medium shell, 6 pin.  
 7Q-OW7 Diagram 7Q, octal wafer base, 7 pin.

The column headed "Max Size View" shows the number of the tube outline drawing which gives dimensions.

# Heater center tap permits operation at half voltage and twice current.

\* Indicates that capacitance is measured with standard tube shield connected to cathode. In the case of a metal type, the metal shell is connected to cathode.

"C" after figure in "Mutual Conductance" column indicates that value is for conversion transconductance. (Used for converter types only.)

"S" after figure in "Plate Volts" column indicates that value shown is anode supply voltage and that it is applied through the indicated value of G, resistor.

Capacitances shown for converter types are for the mixer section only.

Values of Plate Ma., Screen Ma., and Output Watts for push-pull operation are for two tubes, and value of load resistance is from plate to plate.

Values of Grid Volts for filament type tubes are measured from the negative filament terminal.

Values of Cutoff Bias are approximate.



TYPE	DESIGN	CATHODE HTR OR FIL			BASING DATA	MAX SIZE VIEW	CAPACITIES			USED AS	PLATE VOLTS	GRID VOLTS	SCR VOLTS	PLATE MA	SCR MA	AMP FACT	PLATE RESIS OHMS	MUT COND mmho	OUT PUT WATTS	LOAD RESIS OHMS	CUT OFF VOLTS	TYPE
		TYPE	VOLTS	AMPS			G-P mmfds	IN mmfds	OUT mmfds													
00A	TRIODE	FIL	5.0	.25	4D-SM4B	14AB	8.5	3.2	2.0	DETECTOR	45	0	1.5		20	30000	666				00A	
01A	TRIODE	FIL	5.0	.25	4D-SM4B	14BA	8.1	3.1	2.2	AMP CL A	135	-9	3		8	10000	800				01A	
0Y4 0Y4G	GAS DIODE	COLD			4BU-OW5 4BU-OSS	8BB 7AA				HALF-WAVE RECTIFIER	MAX PEAK INVERSE = 300 volts			MAX I <sub>o</sub> = 75 mada, MIN I <sub>o</sub> = 40 mada							0Y4 0Y4G	
0Z4 0Z4G	TWIN DIODE	COLD			4R-OW6 4R-OT5	8BB 7AA	GAS FILLED			FULL WAVE RECTIFIER	300 RMS MAX		90 ma MAX 30 ma MIN		TUBE DROP 24v						0Z4 0Z4G	
0Z4A/1003	TWIN DIODE	COLD			4R-OW6	8CA	GAS FILLED			FULL WAVE RECTIFIER	265 RMS MAX 365 RMS MAX		85ma MAX — 30ma MIN. TUBE DROP 24v 85ma MAX — 30ma MIN. TUBE DROP 24v		CONDITION I = SINGLE TUBE OPERATION (Applies to above) CONDITION II = RESISTANCE PARALLEL OPERATION (Applies to above)						0Z4A/1003	
1A3	DIODE	HTR	1.4	0.15	5AP-MB7	5AC				DETECTOR	117 MAX		0.5 MAX									1A3
1A4P	PENTODE	FIL	2.0	.06	4M-SS4	12DA	.007*	5.0*	12*	AMP CL A	180	-3	67.5	2.3	0.8	1MEG	750			-15	1A4P	
1A4-T	TETRODE	FIL	2.0	.06	4K-SS4	12DA	.012*	4.6	11	AMP CL A	180	-3	67.5	2.3	0.7	720	.96MEG	750			-15	1A4-T
1A5GT	PENTODE	FIL	1.4	.05	6X-OGT7	9DB				POWER AMP CLASS A	90 85	-4.5 -4.5	90 85	4.0 3.5	0.8 0.7	3 MEG .3 MEG	850 800	.115 .100	25000 25000			1A5GT
1A6	HEPTODE	FIL	2.0	.06	6L-SS6	12DA	.25*	10.5	9.0	OSC SECT MIXER	135S 180	.05MEG -3	67.5	2.3 1.3	2.4	GRID #2 RES. .5 MEG 300C		.02 MEG			-22.5	1A6
1A7G 1A7GT	HEPTODE	FIL	1.4	.05	7Z-OS8 7Z-OW8	9ED 9CA	.30*	6.5*	11*	OSC SECT MIXER	90 90	.2 MEG 0	45	1.2 0.55	0.6	.6 MEG	250C				-3	1A7G 1A7GT
1AB5	PENTODE	FIL	1.2	0.13	5BF-L8	9AA	0.025	2.8	4.2	VOLTAGE AMP	150	-1.5	150	6.8	2.0	.125MEG	1350				-23	1AB5
1AB6	HEPTODE	FIL	1.4	.025	7DH-MB7	5AC	.36	7.6	8.4	MIXER SECT. OSC. SECT.	85 35	0 .027MEG	64.5 1.5	0.65 1.5	0.17	OSC	1 MEG 300C	GRID CURR = 85ua				1AB6
1AC6	HEPTODE	FIL	1.4	.05	7DH-MB7	5AC	.36	7.5	8.4	MIXER SECT. OSC. SECT.	85 30	0 .027MEG	60 1.65	0.65 1.65	0.14	OSC	1 MEG 325C	GRID CURR = 130ua				1AC6
1AE4	PENTODE	FIL	1.25	.1	6AR-MB7	5AC	.008*	3.6*	4.4*	RF AMPLIFIER	90	0	90	3.5	1.2	.5 MEG	1550				-5	1AE4
1AF4	PENTODE	FIL	1.4	.025	6AR-MB7	5AC	.008*	3.8*	7.6*	RF AMPLIFIER	90	0	90	1.65	0.5	1.8 MEG	950				-3.5	1AF4
1AF5	DI-PENT	FIL	1.4	.025	7DJ-MB7	5AC	.2*	2.5*	4.3*	DET-AMPLIFIER	90	0	90	1.1	0.4	2 MEG	600				-3.5	1AF5
1AG4	PENTODE	FIL	1.25	.04	1D	3BA				POWER AMP	41.4	-3.6	41.4	2.4	0.6	.18MEG	1000	.035	12000			1AG4
1AH4	PENTODE	FIL	1.25	.04	1A	3BA	.01	3.5	4.5	RF AMPLIFIER	45	.5MEG	45	0.75	0.2	1.5MEG	750				-3	1AH4

SEE PAGE 4 FOR DATA CHART REFERENCE NOTES

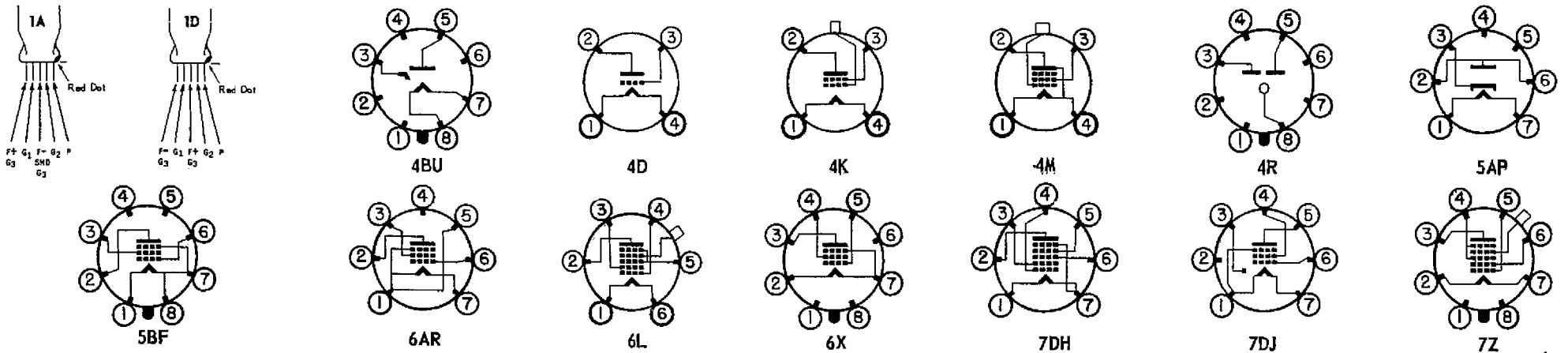



TYPE	DESIGN	CATHODE HTR OR FIL			BASING DATA	MAX SIZE VIEW	CAPACITIES			USED AS	PLATE VOLTS	GRID VOLTS	SCR VOLTS	PLATE MA	SCR MA	AMP FACT	PLATE RESIS OHMS	MUT COND mmho	OUT PUT WATTS	LOAD RESIS OHMS	CUT OFF VOLTS	TYPE	
		TYPE	VOLTS	AMPS			G-P mmfds	IN mmfds	OUT mmfds														
1AJ4	PENTODE	FIL	1.4	.025	7ZP-MB7	5AC	.01	3.3	7.8	RF AMPLIFIER	90	0	90	1.65	0.55	1MEG	750				1AJ4		
1AJ5	DI-PENT	FIL	1.25	.04	1E	3BA	.1	1.7	2.4	DET-AMPLIFIER	45	5MEG	45	1.0	0.3	.3MEG	425				1AJ5		
1AK4	PENTODE	FIL	1.25	.02	1A	3BA	.01	3.5	4.5	RF AMPLIFIER	45	5MEG	45	0.75	0.2	1.5MEG	750			-3	1AK4		
1AK5	DI-PENT	FIL	1.25	.02	1E	3BA	.01	2.0	2.7	DET-AMPLIFIER	45	5MEG	45	0.5	0.2	4MEG	280				1AK5		
1AX2	DIODE	FIL	1.4	.65	9Y-MB9	5CB				HW RECTIFIER	PEAK INVERSE = 25000 volts; I <sub>o</sub> = 300ua max.												1AX2
1B3GT/8016	DIODE	FIL	1.25	0.2	3C-OGT6	9ED			1.5	HALF-WAVE RECT	MAX PEAK INVERSE = 30000 volts    MAX AVE I <sub>o</sub> = 2 macc												1B3GT/8016
1B4/951	PENTODE	FIL	2.0	.06	4M-SS4	12DA	.007*	5.0	11	AMP CL A	180 90	-3 -3	67.5 67.5	1.7 1.6	0.6 0.7	1.5MEG 1MEG	650 600			-8 -8	1B4/951		
1B5/25S	DUO-DI TRIODE	FIL	2.0	.06	6M-SS6	12BA	3.6	2.0	3.0	AMPLIFIER CLASS A	135	-3		0.8		20	35000	575			1B5/25S		
1B7G 1B7GT	HEPTODE	FIL	1.4	.1	7Z-OS8 7Z-OW8	9ED 9CA	.34*	7.0*	7.5*	OSC SECT MIXER	90 90	.2MEG 0	45	1.6 1.5	1.3	.5MEG	350C			-14.5	1B7G 1B7GT		
1B8GT	DI-TRI PENTODE	FIL	1.4	0.1	8AJ-OS8	9CA				TRI CL A PENT CL A	90 90	0 -6.0	90	0.15 6.3	1.4	66	0.24MEG 1150	275 1150	.210	14000	1B8GT		
1C3	TRIODE	FIL	1.4	.05	5CF-MB7	5AC	1.8*	0.9*	4.2*	AMP CL A	90	-3		1.4		14.5		760			1C3		
1C5GT	PENTODE	FIL	1.4	.1	6X-OGT7	9DB				POWER AMP CLASS A	90 83	-7.5 -7	90 83	7.5 7.0	1.6 1.6	180 165	.12MEG .11MEG	1550 1500	.240 .200	8000 9000	1C5GT		
1C6 1C7G	HEPTODE	FIL	2.0	.12	6L-SS6 7Z-OS8	12DA 12CA	.3* .26*	10 10*	10 14*	OSC SECT MIXER	180S 180	.05MEG -3	67.5	3.3 1.5	2.0		GRID #2 RES. .7MEG	325C	.02 MEG		-14	1C6 1C7G	
1C8	HEPTODE	FIL	1.25	.04	8CN	3AA	.25*	6.5*	4.0*	CONVERTER	30	0	30	0.32	0.75		.3MEG	100C			1C8		
											OSC GRID RES = .1 MEG, OSC GRID CURR = 30ua												
1D5G-P	PENTODE	FIL	2.0	.06	5Y-OS7	12CA	.007*	5.0*	11*	AMPLIFIER CLASS A	180 90	-3 -3	67.5 67.5	2.3 2.2	0.8 0.9	750 425	1MEG .6MEG	750 720			-15 -15	1D5G-P	
1D5GT	TETRODE	FIL	2.0	.06	5R-OS7	12CA	.012*	4.6*	11*	AMP CL A	180	-3	67.5	2.3	0.7		.96MEG	750			-15	1D5GT	
1D7G	HEPTODE	FIL	2.0	.06	7Z-OS8	12CA	.30*	10*	14*	OSC SECT MIXER	180S 180	.05MEG -3	67.5	2.3 1.3	2.4		GRID #2 RES. .5MEG	300C	.02 MEG		-22.5	1D7G	
1D8GT	DI-TRI PENTODE	FIL	1.4	.1	8AJ-OGT8	9EA				TRI CL A PENT CL A	90 90	0 -9	90	1.1 5.0	1.0	25	43500 .2MEG	575 925	.200	12000	1D8GT		
1E4G	TRIODE	FIL	1.4	.05	5S-OS7	9FC	2.4	2.4	6.0	AMPLIFIER CLASS A	90 90	-3 0		1.4 4.5		14.5 14.5	19000 11200	760 1300			1E4G		
1E5G-P	PENTODE	FIL	2.0	.06	5Y-OS7	12CA	.007*	5.5*	12*	AMPLIFIER CLASS A	180 90	-3 -3	67.5 67.5	1.7 1.6	0.6 0.7	975 600	1.5MEG 1MEG	650 600			-8 -8	1E5G-P	
1E7G	TWIN PENTODE	FIL	2.0	.24	8C-OS8	12BA				CL A 1 SECT CL A 2 SECT	135 135	-4.5 -7.5	135 135	7.5 14	2.2 4.0		.26MEG	1425	.290 .575	16000 24000	1E7G		
1F4 1F5G	PENTODE	FIL	2.0	.12	5K-SM5 6X-OM7	14BA 14BA				PUSH-PULL PR AMP CL A CL AB 2 TUBE	135 180	-4.5 -7.5	135 180	8.0 19	2.4 5.5		.20MEG	1700	.310 1.25	16000 20000	1F4 1F5G		
1F6 1F7G-II	DUO-DI PENTODE	FIL	2.0	.06	6W-SS6 7AD-OS8	12DA 12CA	.007* .01*	4 3.8*	9 9.5*	AMPLIFIER CLASS A	180	-1.5	67.5	2.2	0.7		1MEG	650			-12	1F6 1F7G-II	
1G4GT	TRIODE	FIL	1.4	.05	5S-OGT7	9DB				AMP CL A	90	-6		2.3		8.8	10700	825			1G4GT		
1G5G	PENTODE	FIL	2.0	.12	6X-OM7	14BA				POWER AMP CLASS A	135 90	-13.5 -6	135 90	8.7 8.5	2.5 2.5		.16MEG .13MEG	1550 1500	.550 .250	9000 8500	1G5G		
1G6GT	TWIN TRIODE	FIL	1.4	.1	7AB-OGT8	9DB				CL A 1 SECT CL B 2 SECT	90 90	0 0		1.0 2.0		30 45000	675			.675	12000	1G6GT	
											MAX SIG PLATE CUR = 14ma												

SEE PAGE 4 FOR DATA CHART REFERENCE NOTES



TYPE	DESIGN	CATHODE HTR OR FIL			BASING DATA	MAX SIZE VIEW	CAPACITIES			USED AS	PLATE VOLTS	GRID VOLTS	SCR VOLTS	PLATE MA	SCR MA	AMP FACT	PLATE RESIS OHMS	MUT COND mmho	OUT PUT WATTS	LOAD RESIS OHMS	CUT OFF VOLTS	TYPE
		TYPE	VOLTS	AMPS			G-P mmfds	IN mmfds	OUT mmfds													
1H4G	TRIODE	FIL	2.0	.06	SS-OS6	12BA	5.0*	3.0*	3.0*	AMP CL A CL B 2 TUBE	180 157.5	-13.5 -15	3.1 1.0		9.3	10300	900	(SEE TYPE 30 2.1)	8000	ALSO)	1H4G	
1H5GT	DI-TRI	FIL	1.4	.05	5Z-OW7	9CA				VOLTAGE AMP	90	0	0.15		65	.24MEG	275				1H5GT	
1H6G	DUO-DI TRIODE	FIL	2.0	.06	7AA-OS8	12BA	3.6*	2.0*	3.0*	AMPLIFIER CLASS A	135	-3	0.8		20	35000	575				1H6G	
1J5G	PENTODE	FIL	2.0	.12	6X-OM7	14BA				PR AMP CL A	135	-16.5	135	7.0 2.0	100	.1 MEG	1000	.45	13500		1J5G	
1J6G	TWIN TR	FIL	2.0	.24	7AB-OS8	12BA				CLASS B TWO SECT	135 138	0 -6		10 NO SIG 0.2 NO SIG			2.2 1.6	10000 10000			1J6G	
1L4	PENTODE	FIL	1.4	0.05	6AR-MB7	5AC	0.008	3.6	7.5	AMP CL A	90 90	0 0	90 67.5	4.5 2.9	2.0 1.2	.035MEG 0.6 MEG	1025 925			-8 -6	1L4	
1L6	HEPTODE	FIL	1.4	.05	7DC-MB7	5AC	.3	7.4	12	CONVERTER	90	0	45	0.5	0.6	.65MEG	300C		G <sub>2</sub> = 90 V I <sub>c2</sub> = 1.2ma	-3	1L6	
1LA4	PENTODE	FIL	1.4	.05	5AD-L8	9AC				POWER AMP CLASS A	90 85	-4.5 -4.5	90 85	4.0 3.5	0.8 0.7	.3 MEG .3 MEG	850 800	.115 .100	25000 25000		1LA4	
1LA6	HEPTODE	FIL	1.4	.05	7AK-L8	9AC	.40	7.7	8.0	OSC SECT MIXER	90 90	.2 MEG 0	45	1.2 0.55	0.6	.6 MEG	250C			-3	1LA6	
1LB4	PENTODE	FIL	1.4	.05	5AD-L8	9AC				PR AMP CL A	90 45	-9 -4.5	90 45	5.0 1.6	1.0 0.3	.2 MEG .3 MEG	925 650	.200 .035	12000 20000		1LB4	
1LB6	HEPTODE	FIL	1.4	0.05	8AX-L8	9AC	0.20	8.0	7.0	MIXER SECT OSC SECT	90 OSC Grid Volt = 0	0 67.5	67.5 45	0.40 2.2	2.2	2 MEG	100C		Peak OSC Grid Voltage Applied to Grid #3 = 10 min Volts	-4.5	1LB6	
1LC5	PENTODE	FIL	1.4	0.05	7AO-L8	9AC	0.007	3.2	7.0	AMP CL A	90 45	0 0	45 45	1.15 1.10	0.20 0.25	1.5MEG 0.7MEG	775 750			-3 -3	1LC5	

SEE PAGE 4 FOR DATA CHART REFERENCE NOTES

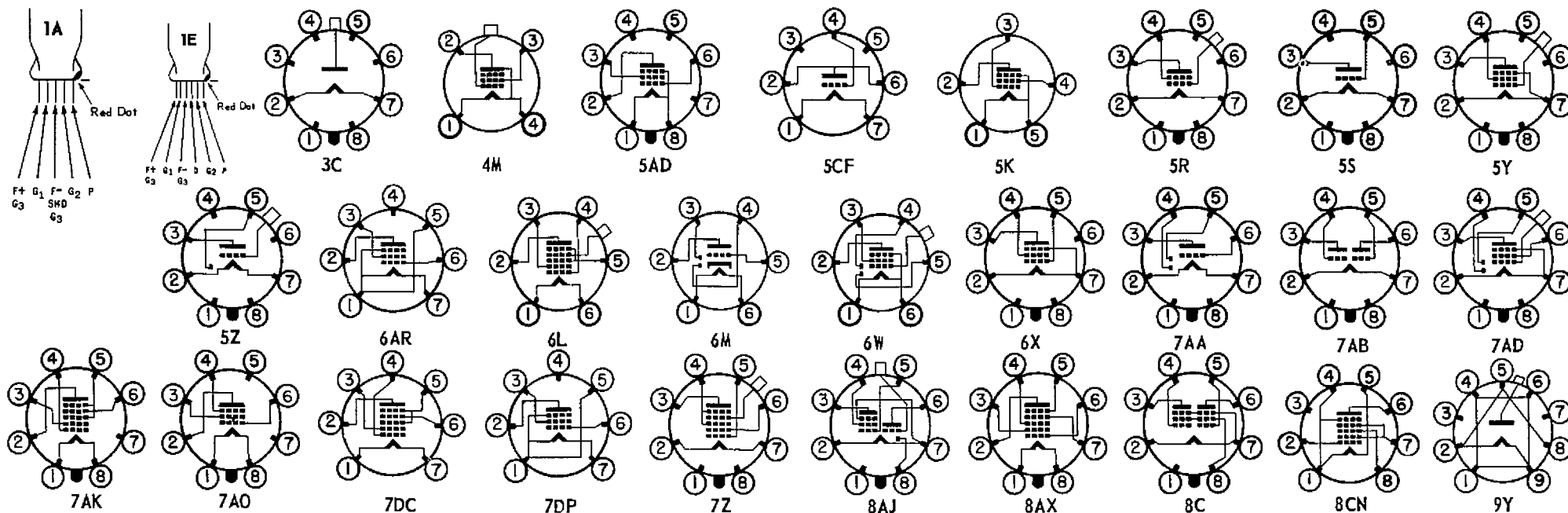





TYPE	DESIGN	CATHODE HTR OR FIL			BASING DATA	MAX SIZE VIEW	CAPACITIES			USED AS	PLATE VOLTS	GRID VOLTS	SCR VOLTS	PLATE MA	SCR MA	AMP FACT	PLATE RESIS OHMS	MUT COND mmho	OUT PUT WATTS	LOAD RESIS OHMS	CUT OFF VOLTS	TYPE	
		TYPE	VOLTS	AMPS			G-P mmfd	IN mmfd	OUT mmfd														
1LC6	HEPTODE	FIL	1.4	0.05	7AK-L8	9AC	0.28	9.0	5.5	MIXER SECT OSC SECT	90 45	0 .2 MEG	35 1.4	0.70		.65MEG	275C				-3	1LC6	
1LD5	DI-PENT	FIL	1.4	0.05	6AX-L8	9AC	0.20	3.2	6.0	AMP CL A	90 45	0 0	45 45	0.60 0.12	0.10	0.95MEG 0.90MEG	600 550					1LD5	
1LE3	TRIODE	FIL	1.4	0.05	4AA-L8	9AC	1.7	1.7	3.0	AMP CL A	90 90	-3 0		1.4 4.5	14.5 14.5	19000 11200	760 1300					1LE3	
1LF3	TRIODE	FIL	1.4	0.05	4AA-L8	9AC	1.7	1.7	3.0	VOLTAGE AMP	90	-3		1.4	14.5		760					1LF3	
1LG5	PENTODE	FIL	1.4	0.05	7AO-L8	9AC	0.007	3.2	7.0	VOLTAGE AMP	90	0	45	1.7	0.4	1MEG	800				-10	1LG5	
1LH4	DI-TRI	FIL	1.4	.05	5AG-L8	9AC				AMP CL A	90	0		0.15	65	.24MEG	275					1LH4	
1LN5	PENTODE	FIL	1.4	.05	7AO-L8	9AC	.007	3.4	8.0	AMP CL A	90	0	90	1.6	0.35	880	1.1 MEG	800				-4.5	1LN5
1N5GT	PENTODE	FIL	1.4	.05	5Y-OW7	9CA	.007*	3.0	10.0	AMP CL A	90	0	90	1.2	0.3	1160	1.5 MEG	750				-4	1N5GT
1N6G 1N6GT	DI-PENT	FIL	1.4	.05	7AM-OS8 7AM-OW8	9FC 9DB				PR AMP CL A	90	-4.5	90	3.4	0.7		.3 MEG	800	.10	25000			1N6G 1N6GT
1P5GT	PENTODE	FIL	1.4	.05	5Y-OW7	9CA	.007*	3.0	10.0	AMP CL A	90	0	90	2.3	0.7		.8 MEG	750				-12	1P5GT
1Q5GT	BEAM PWR AMP	FIL	1.4	.1	6X-OGT7	9DB				POWER AMP CLASS A	90 85	-4.5 -5.0	90 85	9.5 7.0	1.3 0.8		2200 1950	.27 .25	8000 9000				1Q5GT
1R4/1294	DIODE	HTR	1.4	0.15	4AH-L8	9AC				DETECTOR	MAX PLATE = 117 volts (RMS)					MAX I <sub>o</sub> = 1madc					1R4/1294		
1R5	HEPTODE	FIL	1.4	.05	7AT-MB7	5AC	.4	7.0	7.0	OSC SECT MIXER	90 0	0	67.5 1.7	1.4	3.0	OSC GRID CUR --.25 .5 MEG	MA 300C					-15	1R5
1S4	PENTODE	FIL	1.4	.1	7AV-MB7	5AC				PR AMP CL A	90 45	-7 -4.5	67.5 45	7.4 3.8	1.4 0.8	.1 MEG .1 MEG	1575 1250	.270 .065	8000 8000				1S4
1S5	DIODE PENTODE	FIL	1.4	.05	7DI-MB7	5AC				DETECTOR AMP CL A	67.5	0	67.5	1.6	0.4	.6 MEG	625						1S5
1SA6GT	PENTODE	FIL	1.4	0.05	6BD-OW8	9BC	0.01	5.2	8.6	AMP CL A	90 45	0 0	67.5 45	2.45 1.10	0.68 0.30	0.8 MEG 0.7 MEG	970 750					-5.5 -3.5	1SA6GT
1SB6GT	DI-PENT	FIL	1.4	0.05	6BE-OS7	9DB	0.25	3.2	3.0	DET AMP CL A	90 45	0 0	67.5 45	1.45 0.6	0.38 0.16	0.7 MEG 0.9 MEG	665 500						1SB6GT
1T4	PENTODE	FIL	1.4	.05	6AR-MB7	5AC	.01	3.6	7.5	AMP CL A	90 45	0 0	67.5 45	3.5 1.7	1.4 0.7	.5 MEG .35MEG	900 700					-16 -10	1T4
1T5GT	BM PWR	FIL	1.4	.05	6X-OGT7	9DB				PR AMP CL A	90	-6	90	6.5	0.8		1150	.17	14000				1T5GT
1U4	PENTODE	FIL	1.4	0.05	6AR-MB7	5AC	0.008	3.6	7.5	VOLTAGE AMP	90	0	90	1.6	0.5	1 MEG	900					-4	1U4
1U5	DI-PENT	FIL	1.4	0.05	6BW-MB7	5AC				DET-AMP	67.5	0	67.5	1.6	0.4	0.6 MEG	625						1U5
1U6	HEPTODE	FIL	1.4	.025	7DC-MB7	5AC	.4*	8.0*	12*	OSC SECT MIXER SECT	90 90	.2 MEG 0	45	1.1 0.55	OSC GRID CURR = .035ma .6 MEG	275C						-3	1U6
1-V	DIODE	HTR	6.3	.3	4G-SS4	12BA				H W RECT	325 RMS MAX					45 DC MAX TUBE DROP 20v AT 90ma DC					1-V		
1V2	DIODE	FIL	0.625	.3	9U-MB9	5BB				H W RECTIFIER	MAX PEAK INVERSE = 7500 V; MAX I <sub>o</sub> = 550ua										1V2		
1V6	TRIODE PENTODE	FIL	1.25	.04	1F	3BA	1.2 .05	4.0 3.2	1.9 2.4	TRIODE SECT PENTODE SECT	45 45	1 MEG 5 MEG	45	0.4 0.4	0.15	OSC GRID CURR = 12ua 1 MEG	200C					-3.5	1V6
1W4	PENTODE	FIL	1.4	.05	5BZ-MB7	5AC	.1*	3.6*	7.0*	POWER AMP	90	-9	90	5.0	1.0	.25MEG	925	.2	12000				1W4
1W5	PENTODE	FIL	1.25	.04	8CP-	3AA	.01*	2.3*	3.5*	RF AMPLIFIER	67.5	0	67.5	1.85	.75	.7 MEG	735					-5	1W5

SEE PAGE 4 FOR DATA CHART REFERENCE NOTES



TYPE	DESIGN	CATHODE HTR OR FIL			BASING DATA	MAX SIZE VIEW	CAPACITIES			USED AS	PLATE VOLTS	GRID VOLTS	SCR VOLTS	PLATE MA	SCR MA	AMP FACT	PLATE RESIS OHMS	MUT COND mmho	OUT PUT WATTS	LOAD RESIS OHMS	CUT OFF VOLTS	TYPE
		TYPE	VOLTS	AMPS			G-P mmfds	IN mmfds	OUT mmfds													
1X2	DIODE	FIL	1.25	.2	9Y-MB9	5CA				HW RECTIFIER	MAX. PEAK INVERSE = 15,000 V; MAX I <sub>o</sub> = 1ma										1X2	
1X2A	DIODE	FIL	1.25	.2	9Y-MB9	5CA				HW RECTIFIER	MAX. PEAK INVERSE = 20,000 V; MAX I <sub>o</sub> = 1.1ma										1X2A	
1X2B	DIODE	FIL	1.25	.2	9Y-MB9	5CA				HW RECTIFIER	MAX. PEAK INVERSE = 22,000 V; MAX I <sub>o</sub> = 0.5ma										1X2B	
1Z2	DIODE	FIL	1.5	0.3	7CB-MB7	5CB				HALF-WAVE RECT	MAX. PEAK INVERSE = 20,000 MAX I <sub>o</sub> = 2 madc										1Z2	
2A3	TRIODE	FIL	2.5	2.5	4D-SM4	16AA				PR AMP CL A PUSH-PULL CL AB 2 TUBE	250 300 300	-45 -62 SELF	60 80 80		4.2 800	5250	3.5 15 10	2500 3000 5000			2A3	
2A4C	GAS TRI	FIL	2.5	2.5	5S-OS7	12BA				THYRATRON	200 RMS MAX			100 DC MAX TUBE DROP 12v					-9	2A4C		
2A5	PENTODE	HTR	2.5	1.75	6B-SM6	14BA	TRIODE CONNECTION			PR AMP CL A CL AB 2 TUBE	250 350	-20 -38	31 48		6.8 2600		.85 13.0	4000 6000			2A5	
2A6	DUO-DI TRIODE	HTR	2.5	.8	6G-SS6	12DA	1.7	2.0	3.5	AMPLIFIER CLASS A	250	-2		0.9		100	91000	1100			2A6	
2A7 2A7S	HEPTODE	HTR	2.5	.8	7C-SS7 7C-SS7	12DA	.3*	8.5	9.0	OSC SECT MIXER	250S 250	.05MEG -3	100	4.0 3.5	2.7		GRID #2 RES .02 MEG .36MEG 550C			-35	2A7 2A7S	

SEE PAGE 4 FOR DATA CHART REFERENCE NOTES

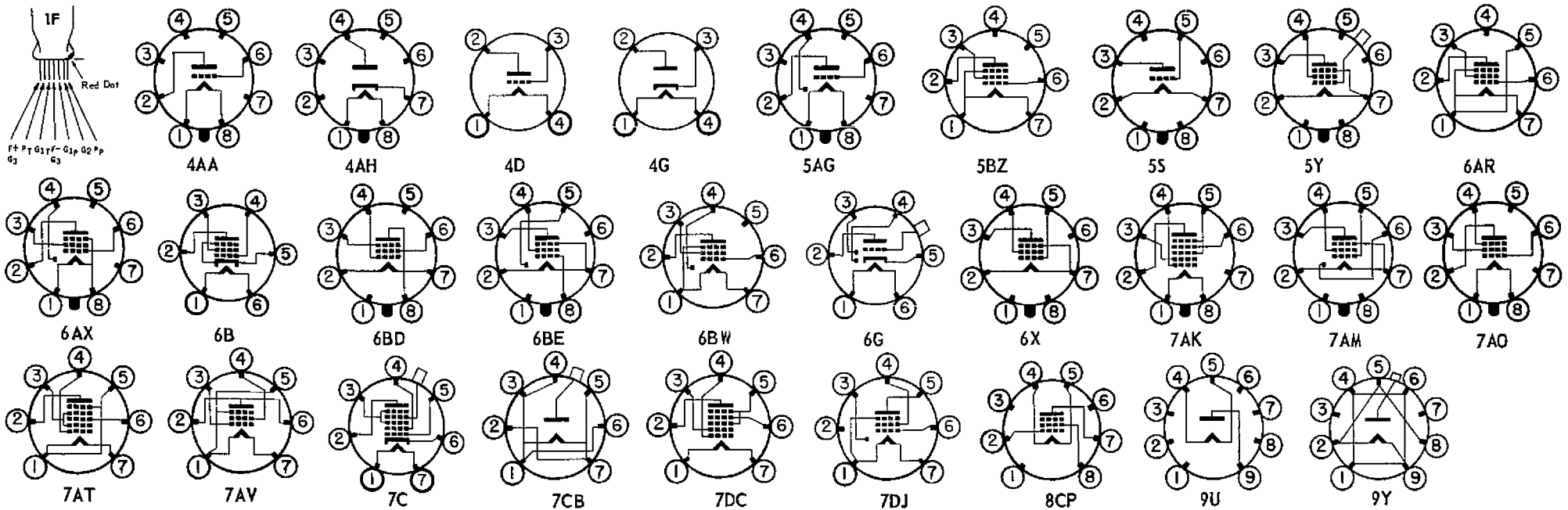



TYPE	DESIGN	CATHODE HTR OR FIL			BASING DATA	MAX SIZE VIEW	CAPACITIES			USED AS	PLATE VOLTS	GRID VOLTS	SCR VOLTS	PLATE MA	SCR MA	AMP FACT	PLATE RESIS OHMS	MUT COND mmho	OUT PUT WATTS	LOAD RESIS OHMS	CUT OFF VOLTS	TYPE
		TYPE	VOLTS	AMPS			G-P mmfds	IN mmfds	OUT mmfds													
2AF4 2AF4A	TRIODE	HTR	2.35	0.6	7DK-MB7	SAC 5AA	1.9	2.2	.45	UHF OSCILLATOR	80 Rk 150		16		15	2270	6600				2AF4 2AF4A	
2B3	DIODE	FIL	1.75	0.25	8HC-OGT8	9EC				HIGH VOLTAGE MAX PEAK INVERSE = 27000 volts						MAX Io = 50 ma					2B3	
2B7 2B7S	DUO-DI PENTODE	HTR	2.5	.8	7D-SS7 7D-SS7	12DH 12DH	.007*	3.5	9.5	AMPLIFIER CLASS A	250 100	-3 -3	125 100	9.0 5.8	2.3 1.7	.65MEG .30MEG	1125 950			-21 -17	2B7 2B7S	
2BN4	TRIODE	HTR	2.3	0.6	7EG-MB7	5AC	1.2	3.2	1.4	RF AMPLIFIER	150	Rk 220		9		6300	6800				2BN4	
2C50	DOUBLE TRIODE	HTR	12.6	0.3	8BD-OGTR	9BC				DISCRIMINATOR	200	-11		18		3450	2900				2C50	
2CY5	TETRODE	HTR	2.4	0.6	7EW-MT	5AA	0.03	4.5	3.0	CL A AMP	180	-1.0	180	10	1.5	0.1MEG	8000			-6	2CY5	
2E5	ELEC RAY	HTR	2.5	.8	6R-SS6	12BA				TUNING IND	250	THRU 1 MEG, TARGET 250v, GRID 0v FOR 90°							-8v FOR 0°		2E5	
2E31 2E32	PENTODE	FIL	1.25	0.05	1A	3BA	0.018	4.2	4.0	VOLTAGE AMP	22.5	0	22.5	0.4	0.3	0.35MEG	500			-2.0	2E31 2E32	
2E35 2E36	PENTODE	FIL	1.25	0.03	1A	3BA	0.2	2.7	5.7	POWER AMP	22.5	0	22.5	0.27	0.07	0.22MEG	385	.0012	0.15 MEG		2E35 2E36	
2E41 2E42	DIODE PENTODE	FIL	1.25	0.03	1B	3BA	0.10	2.7	4.3	DET-AMP	22.5	0	22.5	0.35	0.12	0.25MEG	375				2E41 2E42	
2G21 2G22	TRIODE HEPTODE	FIL	1.25	0.05	1C	3BA	0.065	3.5	3.6	TRIODE OSC HEPT MIXER	22.5 22.5	0	22.5	1.0 0.2	0.3	0.5 MEG	60C			-3.5	2G21 2G22	
2S/4S	DUO DIODE	HTR	2.5	1.35	5D-SS5					DETECTOR						40 APPROX PER PLATE AT 50v DC					2S/4S	
2T4	TRIODE	HTR	2.35	0.6	7DK-MB7	5AA	1.7	2.6	.40	UHF OSCILLATOR	80 Rk 150			18		13		7000			2T4	
2V2	DIODE	FIL	2.5	0.2	8FV-OM8	11BC				HIGH VOLTAGE MAX PEAK INVERSE = 33000 volts						Io = 2ma DC MAX					2V2	
2W3GT	DIODE	FIL	2.5	1.5	4X-OW5	9BC				H W RECT	350 RMS MAX			55 DC MAX								2W3GT
2X2A	DIODE	HTR	2.5	1.75	4AB-SS4	12DA				H W RECT	4500 RMS MAX			7.5 DC MAX								2X2A
2Y2	DIODE	HTR	2.5	1.75	4AB-SS4	12DA				HALF-WAVE RECT						MAX PEAK INVERSE = 12000 volts	MAX Io = 5madc				2Y2	
3A2	DIODE	HTR	3.15	0.22	9DT-MB9	5CB			1.0	HALF WAVE RECTIFIER						MAX PEAK INVERSE = 18000 volts	MAX AC	Io = 1.5ma			3A2	
3A4	BM PWR	FIL	1.4	0.2	7BB-MB7	5AC	0.2	4.8	4.2	PR AMP CL A	150 135	-8.4 -7.5	90 90	13.3 14.8	2.2 2.6	0.10MEG 0.09MEG	1900 1900	700 600	8000 8000		3A4	
3A5	TWIN TRIODE	FIL	1.4 or 2.8	.22 .11	7BC-MB7	5AC	3.2L 3.2R	0.9L 0.9R	1.0L 1.0R	H F AMP	90	-2.5		3.7		15	8300	1800				3A5
3A8GT	DI-TRI PENTODE	FIL	1.4 or 2.8	.1 .05	8AS-OGT8	9EB	2.0 .012	2.6* 3.0	4.2 10*	TRI CL A PENT CL A	90 90	-FIL -FIL		0.20 1.5	0.5	.20MEG .8 MEG	325 750				3A8GT	
3AF4A	TRIODE	HTR	3.2	0.45	7DK-MB7	5AA	1.9	2.2	.45	UHF OSCILLATOR	80 Rk 150			16		15	2270	6600			3AF4A	
3AL5	DOUBLE DIODE	HTR	3.15	0.6	6BT-MB7	5AA				DETECTOR						MAX PEAK INVERSE = 330 volts					3AL5	
3AU6	PENTODE	HTR	3.15	0.6	7BK-MB7	5AC	.0035	5.5	5.0	RF AMPLIFIER	250	-1		7.6		1.5MEG	4450				3AU6	
3AV6	DBLE DI TRIODE	HTR	3.15	0.6	7BT-MB7	5AC	2.0	2.2	0.8	DETECTOR AVC RECTIFIER AF AMPLIFIER	250	-2		1.2		100	62500	1600				3AV6

SEE PAGE 4 FOR DATA CHART REFERENCE NOTES



TYPE	DESIGN	CATHODE HTR OR FIL			BASING DATA	MAX SIZE VIEW	CAPACITIES			USED AS	PLATE VOLTS	GRID VOLTS	SCR VOLTS	PLATE MA	SCR MA	AMP FACT	PLATE RESIS OHMS	MUT COND mmho	OUT PUT WATTS	LOAD RESIS OHMS	CUT OFF VOLTS	TYPE
		TYPE	VOLTS	AMPS			G-P mmfds	IN mmfds	OUT mmfds													
3B2	DIODE	HTR	3.15	0.22	8GH-OJ8	12HE			1.8	HW RECTIFIER	MAX PEAK	INVERSE = 35000 volts			MAX AVG. I <sub>o</sub> = 1.1ma						3B2	
3B5GT	BM PWR	FIL	1.4 or 2.8	0.10 or 0.05	7AQ-OGT7	9DB	PARALLEL FIL SERIES FIL			PR AMP CL A	45 67.5	-4.5 -7	45 67.5	4.4 6.7	0.3 0.5		0.1 MEG 0.1 MEG	1400 1500	.070 .180	8000 5000		3B5GT
3B7/1291	TWIN TRIODE	FIL	1.4	.22	7BE-L8	9AC	2.6L 2.6R	1.4L 1.4R	1.8L 2.6R	AMP OSC CLASS B	135 90	0	19 10.4		20 20		1900 1850	1.5 1.0	16000 8000		3B7/1291	
3BA6	PENTODE	HTR	3.15	0.6	7BK-MB7	5AC	.003S	5.5	5.0	RF-IF AMPLIFIER	250	Rk 68	100	11		1.5MEG	4400				3BA6	
3BC5	PENTODE	HTR	3.15	0.6	7BD-MB7	5AC	.030	6.5	1.8	RF AMPLIFIER	125	Rk 125				0.5MEG	6100				3BC5	
3BF6	HEPTODE	HTR	3.15	0.6	7CH-MB7	5AC	.05			MIXER-OSCILLATOR	250		100	3		1MEG	475				3BF6	
3BN4	TRIODE	HTR	2.8	0.45	7EG-MB7	5AC	1.2	3.2	1.4	RF AMPLIFIER	150	Rk 220		9	43	6300	6800				3BN4	
3BN6	GATED BM	HTR	3.15	0.6	7DF-MB7	5AD				DISCRIMINATOR	80	INPUT SIG CENTER FREQ. = 10.7 MC FREQ. DEV. = ± 75 kc									3BN6	
3BU8	TWIN PENTODE	HTR	3.15	0.6	9EG-MR9	5BC	1.9			SYNC-AGC	100	-10	67.5	2.2	3.3		180			-4.5	3BU8	
3BY6	PENTAGRIDS	HTR	3.15	0.6	7CH-MB7	5AC	0.08			GATED AMPLIFIER	250		100	6.5			1900				3BY6	

SEE PAGE 4 FOR DATA CHART REFERENCE NOTES

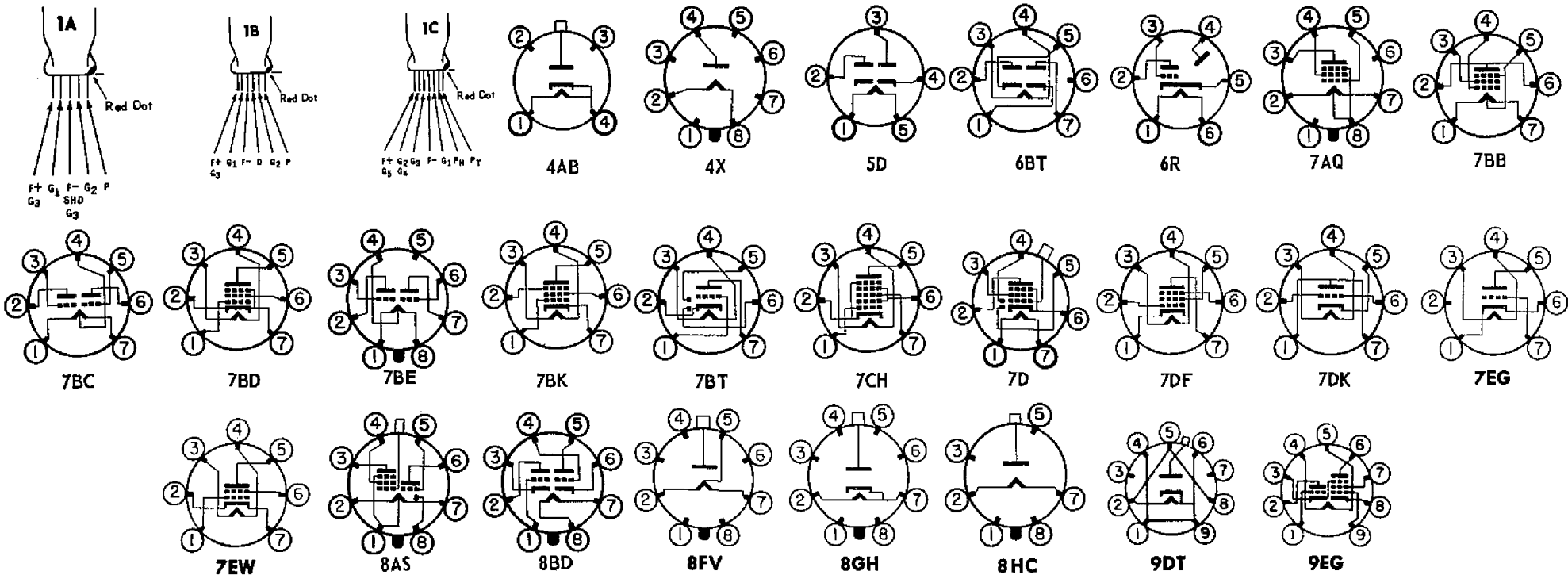



TYPE	DESIGN	CATHODE HTR OR FIL		BASING DATA	MAX SIZE VIEW	CAPACITIES			USED AS	PLATE VOLTS	GRID VOLTS	SCR VOLTS	PLATE MA	SCR MA	AMP FACT	PLATE RESIS OHMS	MUT COND mmho	OUT PUT WATTS	LOAD RESIS OHMS	CUT OFF VOLTS	TYPE			
		TYPE	VOLTS			AMPS	G-P mmfds	IN mmfds														OUT mmfds		
3BZ6	PENTODE	HTR	3.15	0.6	7CM-MB7	5AC	0.025	7.0	2.0	AGC IF AMPLIFIER	125		125	14		0.26MEG	8000				3BZ6			
3C2	DIODE	FIL	3.15	0.21	8FV-OM8	12JD			1.4	HIGH VOLTAGE MAX PEAK INVERSE = 33 kv						MAX I <sub>o</sub> = 80 ma					3C2			
3C5GT	BM PWR	FIL	1.4 or 2.8	0.1 0.05	7AQ-OGT7	9DB	PARALLEL FIL SERIES FIL			PR AMP CL A	90 90	-9 -9	90 90	6 6	1.4 1.4		1550 1450	.240 .260	10000 10000			3C5GT		
3C4	PENTODE	FIL	1.4	.05	6BX-MB7	5AC	.3	4.9	4.4	POWER AMP	85	-5.2	85	5.0	1.1	.125MEG	1350	.2	13000			3C4		
3C6	TWIN TRIODE	FIL	1.4 2.8	0.1 0.05	7BW-L8	9AC	PARALLEL FIL SERIES FIL			VOLTAGE AMP	90 90	0 0		4.5 4.5		14.5 14.5	11200 11200	1300 1300				3C6		
3CB6	PENTODE	HTR	3.15	0.6	7CM-MB7	5AC	0.025	6.5	2.0	IF AMPLIFIER	125		125	13		0.28MEG	8000					3CB6		
3CF5	PENTODE	HTR	3.15	0.6	7BD-MB7	5AC	0.03	6.5	1.9	RF AMPLIFIER	125		125	11	2.3	0.3MEG	7600					3CF5		
3CF6	PENTODE	HTR	3.15	0.6	7CM-MB7	5AC	0.02	6.5	2.0	RF AMPLIFIER	200	Rk 180	150	9.5	2.8	0.6MEG	6200			-6.5		3CF6		
3CS6	HEPTODE	HTR	3.15	0.6	7CH-MB7	5AC	0.05	5.5	7.5	CL A AMPLIFIER	100	-1.0	30	.75	1.1	1MEG	1500			-2.5		3CS6		
3CY5	TETRODE	HTR	2.9	0.45	7EW-M7	5AA	0.03	4.5	3.0	CL A AMPLIFIER	180	-1.0	180	10	1.5	0.1MEG	8000			-6		3CY5		
3D6/1299	BM PWR	FIL	1.4 or 2.8	.220 .110	6BA-L8	9AC	PARALLEL FIL SERIES FIL			PR AMP CL A	150 135	-4.5 -4.5	90 90	9.8 9.8	1.0 1.2		2400 2400	.600 .500	14000 12000			3D6/1299		
3DK6	PENTODE	HTR	3.15	0.6	7CM-M7	5AC	0.02	6.3	1.9	IF AMPLIFIER	125	Rk 56	125	12	3.8		9800			-6.5		3DK6		
3DT6	PENTODE	HTR	3.15	0.6	7EN-MB7	5AC	0.02	6.1	5.8	DETECTOR	150	Rk 560	100	1.1	2.1	0.15MEG	800			-4.5		3DT6		
3E5	BM PENT	FIL	1.4 2.8	.05 .025	6BX-MB7	5AC	PARALLEL FIL SERIES FIL			POWER AMP	90 90	-8 -8	90 90	6.0 5.5	1.5 1.5	.14MEG .12MEG	1200 1100	.2 .175	8000 8000			3E5		
3E6	PENTODE	FIL	1.4 2.8	0.1 0.05	7CJ-L8	9AC	.007	5.5	8.0	VOLTAGE AMP	90 90	0 0	90 90	4.2 2.9	1.7 1.2	0.25MEG 0.325MEG	2000 1700	PARALLEL FIL SERIES FIL	-5.5 -4.0			3E6		
3LE4	BM PWR	FIL	1.4 or 2.8	0.1 0.05	6BA-L8	9AC	PARALLEL FIL SERIES FIL			PR AMP CL A	90 90	-9 -9	90 90	10.0 8.8	2 1.8	0.10MEG 0.11MEG	1700 1600	.325 .300	6000 6000			3LE4		
3LF4	BM PWR	FIL	1.4 or 2.8	0.1 0.05	6BA-L8	9AC	PARALLEL FIL SERIES FIL			PR AMP CL A	90 90	-4.5 -4.5	90 90	9.5 8.0	1.3 1.0	0.75MEG 0.80MEG	2200 2000	.270 .230	8000 8000			3LF4		
3Q4	BM PWR	FIL	1.4 or 2.8	0.1 0.05	7BA-MB7	5AC	PARALLEL FIL SERIES FIL			PR AMP CL A	90 90	-4.5 -4.5	90 90	9.5 7.7	2.1 1.7	0.10MEG 0.12MEG	2150 2000	.250 .240	10000 10000			3Q4		
3Q5GT	BM PWR	FIL	1.4 or 2.8	.1 .05	7AQ-OGT7	9DB	PARALLEL FIL SERIES FIL			PR AMP CL A	90 90	-4.5 -4.5	90 90	9.5 8.0	1.3 1.0	.075MEG .08 MEG	2200 2000	.270 .230	8000 8000			3Q5GT		
3S4	PENTODE	FIL	1.4 or 2.8	.1 .05	7BA-MB7	5AC	PARALLEL FIL SERIES FIL			POWER AMP CLASS A	90 90	-7 -7	67.5 67.5	7.4 6.1	1.4 1.1	.1 MEG .1 MEG	1550 1425	.270 .235	8000 8000			3S4		
3V4	PENTODE	FIL	1.4 2.8	0.1 0.05	6BX-MB7	5AC	0.20	5.5	3.8	POWER AMP	90 90	-4.5 -4.5	90 90	9.5 7.7	2.1 1.7	0.1 MEG 0.12MEG	2150 2000	0.27 0.24	10000 10000	Par Fil Ser Fil	3V4			
4A6G	TWIN TRIODE	FIL	2.0 or 4.0	.12 .06	8L-OS8	12BA				CL A 1 SECT CL B 2 SECT	90 90	-1.5 -1.5		1.1 1.1	20 MAX SIG	26600 PLATE CUR	750 -10.8ma	1.0	8000			4A6G		
4AU6	PENTODE	HTR	4.2	0.45	7BK-MB7	5AC	0.0035	5.5	5.0	VOLTAGE AMP	250	-1	150	10.8	4.3	1MEG	5200			-6.2		4AU6		
4BC5	PENTODE	HTR	4.2	0.45	7BD-MB7	5AC	0.02	6.6	3.1	CL A AMP	100 250	Rk 250	100 150	4.7 7.5	1.4 2.1	.6 MEG .8 MEG	4900 5700			-5 -8		4BC5		
4BC8	DOUBLE TRIODE	HTR	4.2	0.6	9AJ-MB9	5BB	1.4	2.5	1.3	CASCADE AMPLIFIER	150	Rk 220		10		35	6200			-13		4BC8		
4BN6	GATEDBM	HTR	4.2	0.45	7DF-MB7	5AD				DISCRIMINATOR	80	INPUT SIG CENTER FREQ = 10.7 Mc FREQ. DEV = ± 7.5 kc												4BN6
4BQ7A	DBLE TRI	HTR	4.2	0.6	9AJ-MB9	5BB	1.5	2.85	1.35	RF AMPLIFIER	150	Rk 220		9		39	6100	6400			-10		4BQ7A	
4BS8	DBLE TRI	HTR	4.2	0.6	9AJ-MB9	5BB	1.15	2.6	1.2	CASCADE AMPLIFIER	150	Rk 220		10		36	5000	7200			-7		4BS8	

SEE PAGE 4 FOR DATA CHART REFERENCE NOTES

TYPE	DESIGN	CATHODE HTR OR FIL			BASING DATA	MAX SIZE VIEW	CAPACITIES			USED AS	PLATE VOLTS	GRID VOLTS	SCR VOLTS	PLATE MA	SCR MA	AMP FACT	PLATE RESIS OHMS	MUT COND mmho	OUT PUT WATTS	LOAD RESIS OHMS	CUT OFF VOLTS	TYPE
		TYPE	VOLTS	AMPS			G-P mmfd	IN mmfd	OUT mmfd													
4BU8	TWIN PENTODE	HTR	4.2	0.45	9FG-MB9	5BC	1.9			SYNC- AGC	100	-10	67.5	2.2	3.3		180			-4.5	4BU8	
4BX8	DBLE TRI	HTR	4.5	0.6	9AJ-MB9	5BB	1.4	2.4	1.25	CASCADE AMPLIFIER	65	-1.0		9	25		6700			-7	4BX8	
4BZ7	DBLE TRI	HTR	4.2	0.6	9AQ-MB9	5BC	0.007	7.2	3.7	RF AMPLIFIER	150	Rk 220		10	38	5600	6800			-11	4BZ7	
4BZ8	DBLE TRI	HTR	4.2	0.6	9AJ-MB9	5BB	1.15			CASCADE AMPLIFIER	125	Rk 100		10	45	5600	8000			-13	4BZ8	
4CB6	PENTODE	HTR	4.2	0.45	7CM-MB7	5AC	0.025	6.5	2.0	IF AMPLIFIER	125	125		13		0.28MEG	8000				4CB6	
4CE5	PENTODE	HTR	4.2	0.45	7BD-MB7	5AC	0.03	6.5	1.9	RF AMPLIFIER	125		125	11	2.3	0.3 MEG	7600				4CE5	
4CX7	DBLE TRI	HTR	4.2	0.6	9FC-MB9	5BB	1.2	2.4	1.3	CASCADE AMPLIFIER	150	Rk 220		9	39		6400			-10	4CX7	
4CY5	TETRODE	HTR	4.5	0.3	7EW-M7	5AA	0.03	4.5	3.0	CL A AMPLIFIER	180	-1.0	180	10	1.5	0.1 MEG	8000			-6	4CY5	
4DK6	PENTODE	HTR	4.2	0.45	7CM-M7	5AC	0.02	6.3	1.9	IF AMPLIFIER	125	Rk 56	125	12	3.8		9800			-6.5	4DK6	
4DT6	PENTODE	HTR	4.2	0.45	7EN-MB7	5AC	0.02	6.1	5.8	DETECTOR	150	Rk 560	100	1.1	2.1	0.15MEG	800			-4.5	4DT6	
5AM8	DIODE PENTODE	HTR	4.7	0.6	9CY-MB9	5BB	0.015	6	2.6	DET-AMP	200	Rk 120	150	9.5	3	0.3 MEG	5800			-9	5AM8	
5AN8	TRIODE PENTODE	HTR	4.7	0.6	9DA-MB9	5BB	1.5 0.04	2.0 7.0	0.27 2.3	AMPLIFIER	300	Rk 180		13		5750	3300				5AN8	
5AQ5	BEAM PENTODE	HTR	4.7	0.6	7BZ-MB7	5AD	0.17	8.0	11.0	POWER AMP	250	-12.5	250	45	4.5	52000	4100	4.5	5000		5AQ5	
5AS4	DBLE DI	FIL	5.0	3.0	5T-OM5	16AA				FW RECTIFIER	MAX PEAK INVERSE = 1550 volts			MAX I <sub>o</sub> = 1 amp							5AS4	

SEE PAGE 4 FOR DATA CHART REFERENCE NOTES

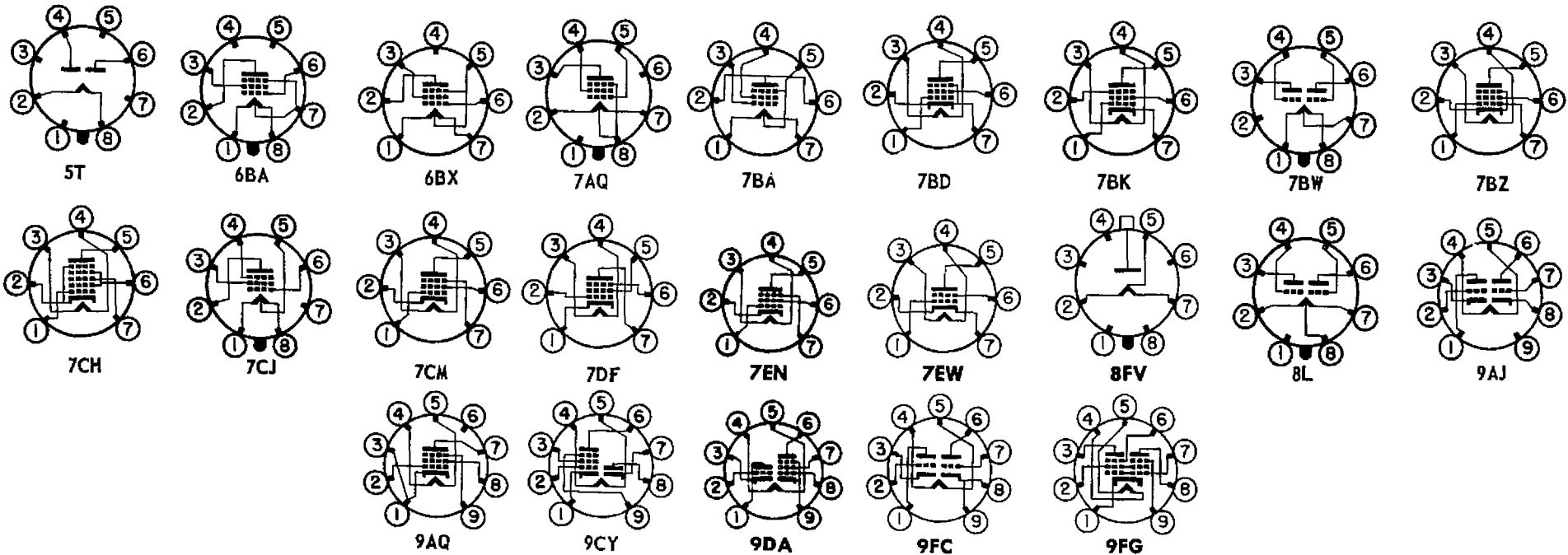



TYPE	DESIGN	CATHODE			BASING DATA	MAX SIZE VIEW	CAPACITIES			USED AS	PLATE VOLTS	GRID VOLTS	SCR VOLTS	PLATE MA	SCR MA	AMP FACT	PLATE RESIS OHMS	MUT COND mmho	OUT PUT WATTS	LOAD RESIS OHMS	CUT OFF VOLTS	TYPE			
		HTR OR FIL	TYPE	VOLTS			AMPS	G-P mmfds	IN mmfds														OUT mmfds		
5AS8	DIODE PENTODE	HTR	4.7	0.6	9DS-MB9	5BB	0.02	2.4	7.0	DET-AMP	200	Rk 180	150	9.5	3		0.3 MEG	6200			-8	5AS8			
5AT8	TRIODE PENTODE	HTR	4.7	0.6	9DW-MB9	5BB	1.5	2.0	0.5	OSCILLATOR MIXER	100 250	150 Rk 200	8.5 7.7	1.6	40	0.75MEG	5800 4600				-10	5AT8			
5AU4	DBLE DI	FIL	5.0	4.5	5T-08	12EE				FW RECTIFIER	MAX PEAK INVERSE = 1400 volts MAX I <sub>o</sub> = 1075 ma														5AU4
5AV8	TRIODE PENTODE	HTR	4.7	0.6	9DZ-MB9	5BB	1.5 0.04	2.0 7.0	0.34 3.0	AMPLIFIER	200	-6	150	13 9.5	2.8	19	0.3MEG	3300 6200				-19 -8	5AV8		
5AW4	DBLE DI	FIL	5.0	4.0	5T-OM5	16AA				FW RECTIFIER	MAX. PEAK INVERSE = 1550 V; MAX I <sub>o</sub> = 250ma														5AW4
5AX4GT	DBLE DI	FIL	5.0	2.5	5T-OGT5	9DB				FW RECTIFIER	MAX. PEAK INVERSE = 1400 V; MAX I <sub>o</sub> = 175ma														5AX4GT
5AZ4	DOUBLE DIODE	FIL	5.0	2.0	5T-L8	9AD				FULL-WAVE RECT	MAX. PEAK INVERSE = 1400 volts MAX I <sub>o</sub> = 125 madc														5AZ4
5B8	TRIODE PENTODE	HTR	4.7	0.6	9EC-MB9	5BB	1.7 0.05	1.9 6.0	1.4 2.6	OSCILLATOR MIXER	200 200	-6	150	13 9.5	2.8	19	0.3MEG	3300 6200				-19 -8	5B8		
5BE8	TRIODE PENTODE	HTR	4.7	0.6	9EG-MB9	5BB	1.8 0.04	2.8 4.4	1.5 2.6	OSCILLATOR MIXER	150 250	Rk 68	110	18 10	3.5	40	0.4MEG	8500 5200				-12 -10	5BE8		
5BK7A	DBLE TRI	HTR	4.7	0.6	9AJ-MB9	5BB	1.9	3.0	1.1	RF AMPLIFIER	150	Rk 56		18		43	4600	9300				-11	5BK7A		
5BQ7A	DBLE TRI	HTR	5.6	0.45	9AJ-MB9	5BB	1.5	2.85	1.35	RF AMPLIFIER	150	Rk 220		9		39	6100	6400				-10	5BQ7A		
5BR8	TRIODE PENTODE	HTR	4.7	0.6	9FA-MB9	5BB	1.8 0.015	2.5 5.0	0.4 2.6	OSCILLATOR MIXER	150 250	Rk 68	110	18 10	3.5	40	0.4MEG	8500 5200				-12 -10	5BR8		
5BT8	DBLE DI PENTODE	HTR	4.7	0.6	9FE-MB9	5BB	0.04	1.3 7.0	3.0 2.3	DET-AMP	200	Rk180	150	9.5	2.8		0.3MEG	6200				-8	5BT8		
5BZ7	DBLE TRI	HTR	5.6	0.45	9AQ-MB9	5BC	0.007	7.2	3.7	RF AMPLIFIER	150	Rk 220		10		38	5600	6800				-11	5BZ7		
5CG8	TRIODE PENTODE	HTR	4.7	0.6	9FA-MB9	5BB	1.5	2.6	0.05	OSCILLATOR MIXER	100 250	Rk 200	150	8.5 7.7	1.6	40	0.75MEG	5800 4600				-10	5CG8		
5CL8	TRIODE TETRODE	HTR	4.7	0.6	9FX-MB9	5BB	1.8 0.028	2.7 5.0	0.4 2.0	OSCILLATOR MIXER	125	-1.0	125	15 12	4.0	40	0.1 MEG	8000 5800				-9 -10	5CL8		
5CM8	TRIODE PENTODE	HTR	4.7	0.6	9FZ-MB9	5BB	1.9 0.02	1.6 6.0	0.22 2.6	IF AMPLIFIER	250 200	-2	150	1.8 9.5	2.8	100	0.6 MEG	2000 6200				-8	5CM8		
5J6	TWIN TRIODE	HTR	4.7	0.6	7BF-MB7	5AC	1.6	2.2	0.4	OSCILLATOR	100	-1		8.5		38	6000	5300					5J6		
5R4G	DBLE DI	FIL	5.0	2.0	5T-OM5	16AA				FW RECTIFIER	MAX. PEAK INVERSE = 2800 V; MAX I <sub>o</sub> = 250ma														5R4G
5R4GY 5R4GYA	TWIN DIODE	FIL	5.0	2.0	5T-OM5	16AA 12GE				FULL WAVE RECTIFIER	1000 RMS MAX COND IN 150 DC MAX TUBE DROP 50v AT 175ma DC 950 RMS MAX CHOKE IN 175 DC MAX														5R4GY 5R4GYA
5T4	TWIN DIODE	FIL	5.0	2.0	5T-OW5	10A				FULL WAVE RECTIFIER	450 RMS MAX COND IN 225 DC MAX TUBE DROP 45v AT 225ma DC 550 RMS MAX CHOKE IN 225 DC MAX														5T4
5T8	TRIP-DI-TRI	HTR	4.7	0.6	9E-MB9	5BB	2.4	1.5	1.1	DET-AMP	250	-3		1.0		70		1200					5T8		
5U4G 5U4GA 5U4GB	TWIN DIODE	FIL	5.0	3.0	5T-OM8	16AA 11ABD 12GD				FULL WAVE RECTIFIER	450 RMS MAX COND IN 225 DC MAX TUBE DROP 58v AT 225ma DC 550 RMS MAX CHOKE IN 225 DC MAX														5U4G 5U4GA 5U4GB
5U8	TRIODE PENTODE	HTR	4.7	0.6	9AE-MB9	5BB	1.8 0.01	2.5 5.0	1.0 2.6	TRIODE SECT PENTODE SECT	150 250	Rk 56 Rk 68		18 10	3.5	40	0.4MEG	8500 5280				-12 -10	5U8		
5V3	DBLE DIODE	FIL	5.0	3.8	5T-OM8	12GD				FW RECTIFIER	MAX PEAK INVERSE = 1400 volts; MAX I <sub>o</sub> = 350 ma														5V3
5V4G 5V4GA	TWIN DIODE	HTR	5.0	2.0	5L-OM5	14BA 12GB				FULL WAVE RECTIFIER	375 RMS MAX COND IN 175 DC MAX TUBE DROP 23v AT 175ma DC 550 RMS MAX CHOKE IN 225 DC MAX														5V4G 5V4GA

SEE PAGE 4 FOR DATA CHART REFERENCE NOTES

TYPE	DESIGN	CATHODE HTR OR FIL			BASING DATA	MAX SIZE VIEW	CAPACITIES			USED AS	PLATE VOLTS	GRID VOLTS	SCR VOLTS	PLATE MA	SCR MA	AMP FACT	PLATE RESIS OHMS	MUT COND mmho	OUT PUT WATTS	LOAD RESIS OHMS	CUT OFF VOLTS	TYPE
		TYPE	VOLTS	AMPS			G-P mmfds	IN mmfds	OUT mmfds													
5V6GT	BEAM POWER AMP	HTR	4.7	0.6	7S-OW7	9DB				CI A AMP	250	-12.5	250	45	4.5		52000	4100	4.5	5000		5V6GT
5W4 5W4GT	TWIN DIODE	FIL	5.0	1.5	5T-OW5 5T-OGT5	8FA 9DB				FULL WAVE RECTIFIER	350 RMS MAX COND 500 RMS MAX CHOKE	IN 100 DC MAX IN 100 DC MAX	TUBE DROP 45v AT 100ma DC									5W4 5W4GT
5X3	TWIN DI	FIL	5.0	2.0	4C-SM4	14BA				F W RECT	1275 RMS MAX COND	IN 30 DC MAX	TUBE DROP 45v AT 100ma DC									5X3
5X4C	TWIN DI	FIL	5.0	3.0	5Q-OM8	16AA				F W RECT	450 RMS MAX COND 550 RMS MAX CHOKE	IN 225 DC MAX IN 225 DC MAX	TUBE DROP 58v AT 225ma DC									5X4C
5X4GA	TWIN DI	FIL	5.0	3.0	5Q-OM8	12GD				F W RECT	450 RMS MAX COND 550 RMS MAX CHOKE	IN 250 DC MAX IN 250 DC MAX	TUBE DROP 44v AT 225ma DC									5X4GA
5X8	TRIODE PENTODE	HTR	4.7	0.6	9AK-MB9	SBB	1.4 0.06	2.6 4.5	1.0 1.2	TRIODE SECT PENTODE SECT	100 250	Rk 100 Rk 200	150	8.5 7.7	1.6	40	0.65MEG	5800 4600		-10 -8		5X8
5Y3GT 5Y3GA 5Y4C 5Y4GT 5Y4GA	TWIN DIODE	FIL	5.0	2.0	5T-OM5 5T-OM5 5Q-OM8 5Q-OS6 5Q-OM8	9DB 12GD 14AA 9DB 12GD				FULL WAVE RECTIFIER	350 RMS MAX COND 500 RMS MAX CHOKE	IN 125 DC MAX IN 125 DC MAX	TUBE DROP 60v AT 125ma DC									5Y3GT 5Y3GA 5Y4C 5Y4GT 5Y4GA
5Z3	TWIN DI	FIL	5.0	3.0	4C-SM4	16AA				F W RECT	450 RMS MAX COND 550 RMS MAX CHOKE	IN 225 DC MAX IN 225 DC MAX	TUBE DROP 58v AT 225ma DC									5Z3
5Z4 5Z4GT	TWIN DIODE	HTR	5.0	2.0	5L-OW5 5L-OGT5	8FA 9DB				FULL WAVE RECTIFIER	350 RMS MAX COND 500 RMS MAX CHOKE	IN 125 DC MAX IN 125 DC MAX	TUBE DROP 20v AT 125ma DC									5Z4 5Z4GT
6A3	TRIODE	FIL	6.3	1.0	4D-SM4	16AA	16	7	5	PR AMP CL A PUSH-PULL CL AB 2 TUBE	250 325 325	-45 -68 SELF	60 80 80		4.2	800	5250	3.2 15 10	2500 3000 5000			6A3

SEE PAGE 4 FOR DATA CHART REFERENCE NOTES

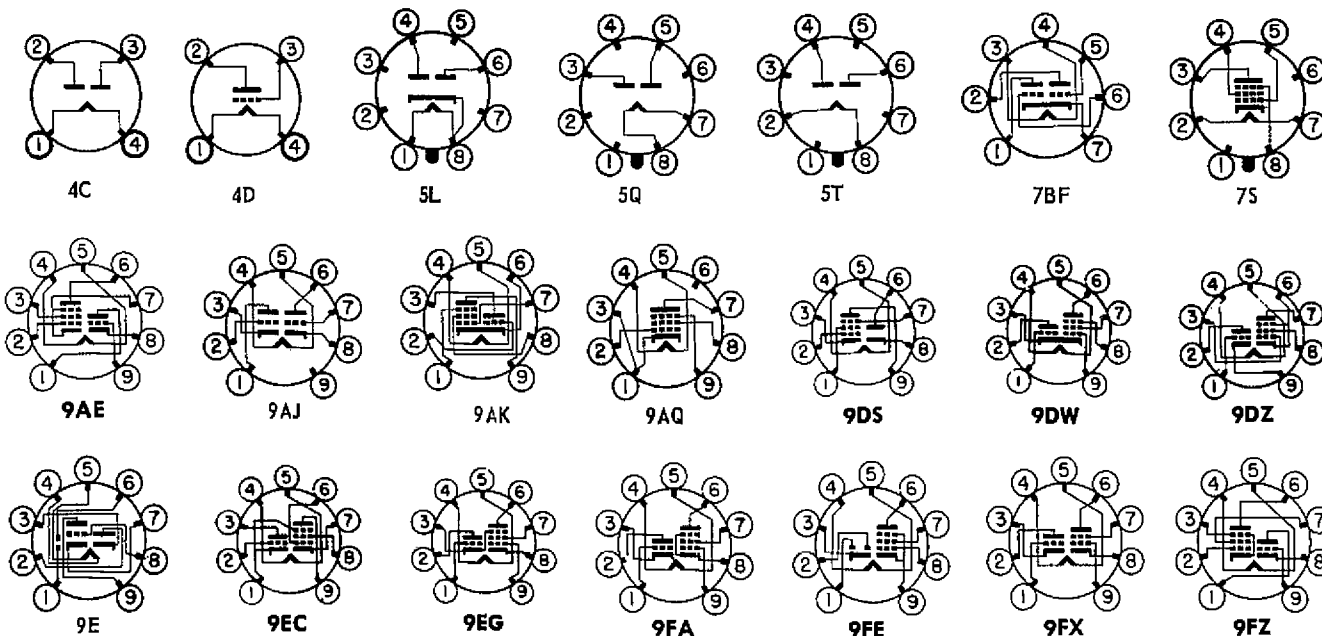





TYPE	DESIGN	CATHODE HTR OR FIL			BASING DATA	MAX SIZE VIEW	CAPACITIES			USED AS	PLATE VOLTS	GRID VOLTS	SCR VOLTS	PLATE MA	SCR MA	AMP FACT	PLATE RESIS OHMS	MUT COND mmho	OUT PUT WATTS	LOAD RESIS OHMS	CUT OFF VOLTS	TYPE
		TYPE	VOLTS	AMPS			G-P mmfds	IN mmfds	OUT mmfds													
6A4/LA	PENTODE	FIL	6.3	.3	5K-SM5	14BA				PR AMP CL A PUSH-PULL CL AB 2 TUBE	180 250	-12 SELF	180 230	22 32	3.9 700	100 45500	2200	1.4 4.2	8000 16000		6A4/LA	
6A5C	TRIODE	HTR	6.3	1.25	6T-OM8	16AA	16	7	5	PR AMP CL A PUSH-PULL CL AB 2 TUBE	250 325 325	-45 -68 SELF		60 80 80		4.2 800	5250	3.75 15 10	2500 3000 5000		6A5C	
6A6	TWIN TRIODE	HTR	6.3	.8	7B-SM7	14BA	(SEE TYPE 6N7G ALSO)			AMP CL A TRI IN PAR'L	294 250	-6 -5		7 6		35 35	11000 11300	3200 3100			6A6	
6A7 6A7S 6A8 6A8C 6A8GT	HEPTODE	HTR	6.3	.3	7C-SS7 7C-SS7 8A-OW8 8A-OS8 8A-OW8	12DA 8DA 12CA 9CA	.3* .03 .26* .26*	8.5 12.5 9.5* 9.5*	9.0 12.5 12* 12*	OSC SECT  MIXER	250S 100 250 100	.05MEG .05MEG -3 -1.5	100 50	4.0 2.0 3.5 1.1				GRID #2 RES. 02 MEG 550C 360C			-35 -20	6A7 6A7S 6A8 6A8C 6A8GT
6AB4	TRIODE	HTR	6.3	.15	5CE-MB7	5AC	1.5*	2.4	1.4	RF AMPLIFIER	100 250	-1 -2		3.7 10		54 55		4000 5500			-6 -12	6AB4
6AB5/6N5	ELEC RAY	HTR	6.3	.15	6R-SS6	9FD				TUNING IND	135 THRU .25 MEG, TARGET 135v, GRID 0v FOR 90°, -10.0v FOR 0°											6AB5/6N5
6AB6G	DUO TRIODE	HTR	6.3	0.5	7AU-OS7	12BB	DRIVER TRIODE OUTPUT TRIODE			DIR C/P'D AMP	250 250	0 +		5 34		72	4000	1800	3.5	8000		6AB6G
6AB7/1853	PENTODE	HTR	6.3	.45	8N-OW8	8BB	.015	8	5	HIGH FREQ AMPLIFIER	300 300	-3 -3	200 300	12.5 3.2	3.2	.7 MEG	5000			-15 -22.5	6AB7/1853	
6AB8	TRIODE PENTODE	HTR	6.3	.3	9AT-MB9	5BC	.2 1.0	4.6 2.3	4.7 1.1	TRIODE SECT PENTODE SECT	100 200	-2 -7.7	200	4 17.5	3.3	18	.15MEG	1350 3400	1.4	11000		6AB8
6AC5G 6AC5GT	TRIODE	HTR	6.3	.4	6Q-OS6 6Q-OGT6	12BA 9DB	ONE 76 DRIVER TWO 76 DRIVERS			DIR C/P'D AMP PUSH-PULL CL B 2 TUBE	250 250 250	SUPPLIED BY DRIVERS 0			32 64 5	125	36700	3400	3.7 9.5 8	7000 10000 10000		6AC5G 6AC5GT
6AC6GT	DUO TRIODE	HTR	6.3	1.1	7W-OGT7	9DB	DRIVER TRIODE OUTPUT TRIODE			DIR C/P'D AMP	180 180	0 +		7 45		54	18000	3000	3.8	4000		6AC6GT
6AC7/1852	PENTODE	HTR	6.3	.45	8N-OW8	8BB	.015	11	5	HIGH FREQ AMPLIFIER	300 300	SELF SELF	150 300	10 THRU .06 MEG	2.5	1.0MEG	9000	160 OHM	-BIAS RES REMOTE			6AC7/1852
6AD4	TRIODE	HTR	6.3	.15	8DK	3AA	.7*	1.9*	2.2*	OSC-AMP	100	RK820		1.4		70	.035MEG	2000				6AD4
6AD5G	TRIODE	HTR	6.3	0.3	6Q-OS6	12BA	3.3	4.1	3.9	AMP CL A	250	-2		0.9		100	66000	1500				6AD5G
6AD6G	TWIN ELEC RAY	HTR	6.3	.15	7AG-OW7	9BA				TUNING INDICATOR	TARGET 150v CONTROL ELECTRODE 75v AT 0°, 8v AT 90°, -50v AT 135° TARGET 100v CONTROL ELECTRODE 45v AT 0°, 0v AT 90°, -23v AT 135°											6AD6G
6AD7G	TRIODE PENTODE	HTR	6.3	.85	8AY-OM8	14BA	TRIODE SEC PENTODE SEC			AMP CL A PR AMP CL A	250 250	-25 -16.5	250	3.7 34	6.5	6	19000 80000	325 2500	3.2	7000		6AD7G
6AD8	DBLE DI PENTODE	HTR	6.3	.3	9T-MB9	5BC	.002	4.0	4.6	DET-AMP	250	RK 225	85	6.7	2.3	1 MEG	1100			-15		6AD8
6AE5GT	TRIODE	HTR	6.3	.3	6Q-OGT6	9DB				AMP CL A	95	-15		7		4.2	3500	1200				6AE5GT
6AE6G	DUO TRIODE	HTR	6.3	.15	7AH-OS7	12BA				CONTROL FOR 6AD6G-6AF6G	250 250	-1.5 -1.5		6.5 4.5		25 33		1000 950	PLATE R PLATE L	-35 -9.5		6AE6G
6AE7GT	TWIN TRIODE	HTR	6.3	.5	7AX-OGT8	9DB				DRIVER 1 SEC TRIODE	250	-13.5		5		14	9300	1500				6AE7GT
6AF4 6AF4A	TRIODE	HTR	6.3	.225	7DK-MB7	5AC 5AA	1.9	2.2	.45	UHF OSC	80	RK 150		16		15	2270	6600				6AF4 6AF4A
6AF5G	TRIODE	HTR	6.3	.3	6Q-OS6	12BA				AMP CL A	180	-18		7		7.4	4900	1500				6AF5G

SEE PAGE 4 FOR DATA CHART REFERENCE NOTES



TYPE	DESIGN	CATHODE HTR OR FIL TYPE		VOLTS	AMPS	BASING DATA	MAX SIZE VIEW	CAPACITIES			USED AS	PLATE VOLTS	GRID VOLTS	SCR VOLTS	PLATE MA	SCR MA	AMP FACT	PLATE RESIS OHMS	MUT COND mmho	OUT PUT WATTS	LOAD RESIS OHMS	CUT OFF VOLTS	TYPE
		G-P	IN					OUT															
6AF6G	TWIN ELEC RAY	HTR	6.3	.15	7AG-OS7	9FA					TUNING INDICATOR	TARGET 135v	CONTROL ELECTRODE 81v AT 0°	0v AT 100°									6AF6G
6AG5	PENTODE	HTR	6.3	0.3	7BD-MB7	5AC	0.025	6.5	1.8		AMP CL A	250	-2	150	7	2	0.8MEG	5000			-8	6AG5	
6AG7	PENTODE	HTR	6.3	.65	8Y-OW8	8FA	.06*	13.0*	7.5*		AMP CL A	300	-3	150	30	7	0.13MEG	11000	3	10000	-8	6AG7	
6AH4GT	TRIODE	HTR	6.3	.75	8EL-OS6	9DB	4.2*	7.5*	3.2*		VERTICAL AMP	250	-23		30			4500			-40	6AH4GT	
6AH5C	PWR AMP	HTR	6.3	0.9	6AP-OM8	16AA					PR AMP CL A	350	-18	250	54	2.5	33000	5200	10.8	4200		6AH5C	
6AH6	PENTODE	HTR	6.3	0.45	7BK-MB7	5AC	0.02	10	3.6		VOLTAGE AMP	300	Rk 160	150	10	2.5	0.5MEG	9000			-7	6AH6	
6AH7GT	TWIN TRI	HTR	6.3	.3	8BE-OGT8	9BC	2.2(1)	3.2(1)	3.0(1)		CL A 1 SECT	250	-9		12		6600	2400			-30	6AH7GT	
							3.0(2)	2.9(2)	2.6(2)			100	-3.6		3.7		10300	1550			-8.5		
6AJ4	TRIODE	HTR	6.3	.225	9BX-MB9	5BA	2.8*	4.6*	1.4*		RF AMPLIFIER	125	RK 68		16			10000				6AJ4	
6AJ5	PENTODE	HTR	6.3	0.175	7BD-MB7	5AA	0.01	4.1	2.0		VOLTAGE AMP	28	Rk 200	28	3.0	1.2	90000	2750				6AJ5	
6AK5	PENTODE	HTR	6.3	0.175	7BD-MB7	5AA	0.01	4.3	2.1		AMP CL A	180	-2	120	7.7	2.4	0.69MEG	5100			-12	6AK5	
6AK6	PENTODE	HTR	6.3	0.15	7BK-MB7	5AC	0.12	3.6	4.2		POWER AMPLIFIER	180	-9	180	15	2.5	400	.19MEG	2300	1.1	10000		6AK6
											135	-6	135	11.5	2.0	360	.17MEG	2100	0.6	12000			
6AK8	TRIPLE DIODE-TRI	HTR	6.3	.45	9E-MB9	5BC	.04	1.9	1.6		AMP CL A	100	-1		0.8			1300				6AK8	
											250	-3		1.0				1200					
6AL5	DOUBLE DIODE	HTR	6.3	0.3	6BT-MB7	5AA			3.2		DISCRIMINATOR	MAX INVERSE = 330v		MAX I <sub>o</sub> = 9made PER PLATE								6AL5	
6AL6G	BEAM PWR AMP	HTR	6.3	.9	6AM-OM7	16BA					POWER AMP CLASS A	250	-14	250	72	5	22500	6000	6.5	2500		6AL6G	
											250	SELF	250	75	5.4	170	OHM BLAS RES		6.5	2500			

SEE PAGE 4 FOR DATA CHART REFERENCE NOTES

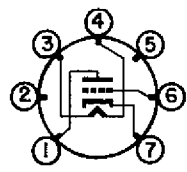

5CE

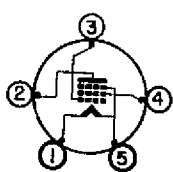

5K

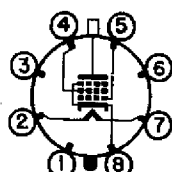

6AM

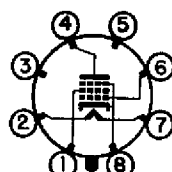

6AP

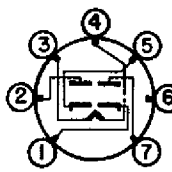

6BT

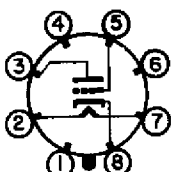

6Q

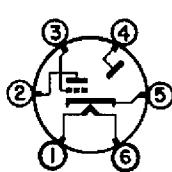

6R

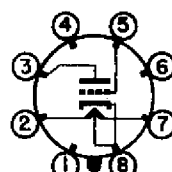

6T

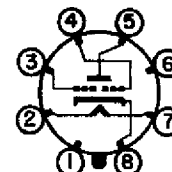

7AG

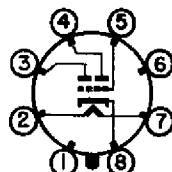

7AH

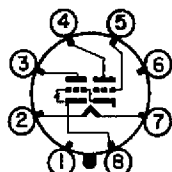

7AU

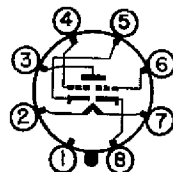

7AX

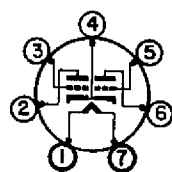

7B

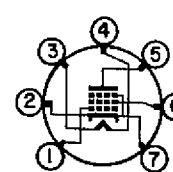

7BD

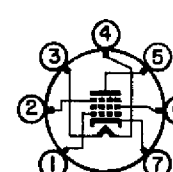

7BK

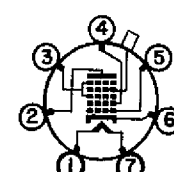

7C

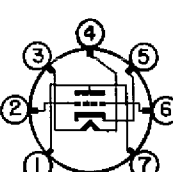

7DK

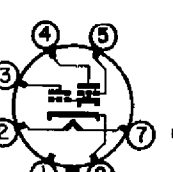

7W

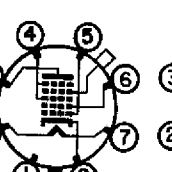

8A

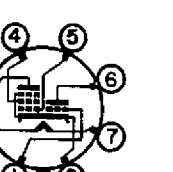

8AY

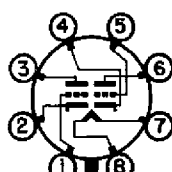

8BE

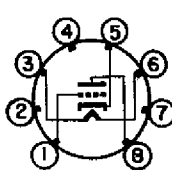

8DK

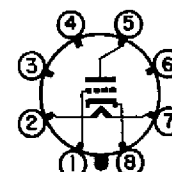

8EL

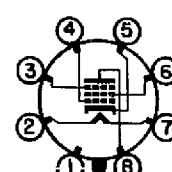

8N

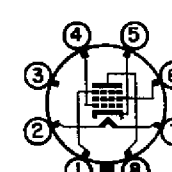

8Y

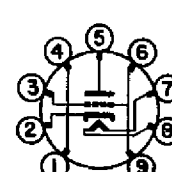

9BX

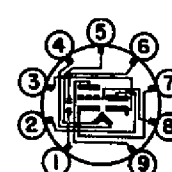

9E

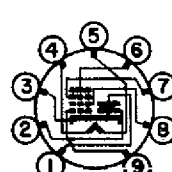

9AT

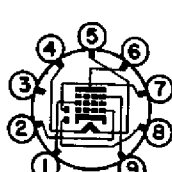

9T



TYPE	DESIGN	CATHODE HTR OR FIL			BASING DATA	MAX SIZE VIEW	CAPACITIES			USED AS	PLATE VOLTS	GRID VOLTS	SCR VOLTS	PLATE MA	SCR MA	AMP FACT	PLATE RESIS OHMS	MUT COND mmho	OUT PUT WATTS	LOAD RESIS OHMS	CUT OFF VOLTS	TYPE			
		TYPE	VOLTS	AMPS			C-P mmfds	IN mmfds	OUT mmfds																
6AL7GT	ELEC RAY	HTR	6.3	0.15	8CH-OGT8	9DA				TUNING IND	TARGET = 315v, GRID = 0v, RK = 3300 ohms													-7	6AL7GT
6AM4	TRIODE	HTR	6.3	.225	9BX-MB9	5BA	2.8*	4.6*	.16	UHF MIXER	150	RK 100		7.5		85		9000			-5	6AM4			
6AM8 6AM8A	DIODE PENTODE	HTR	6.3	.45	9CY-MB9	5BB 5BB	.015	6	2.6	DET-AMP	200	RK 120	150	9.5	3		.3 MEG	5800			-9	6AM8 6AM8A			
6AN4	TRIODE	HTR	6.3	.225	7DK-MB7	5AA	1.7	2.9	.25	UHF MIXER	200	RK 100		13		70		9000				6AN4			
6AN5	PENTODE	HTR	6.3	0.45	7BD-MB7	5AC	0.075	9.0	4.8	POWER AMP	120	RK120	120	35	12		12500	8000	1.3	2500	-20	6AN5			
6AN6	QUAD DIODE	HTR	6.3	0.20	7BJ-MB7	5AC				RECTIFIER	MAX INVERSE = 210v MAX Io = 8madc PER DIODE														6AN6
6AN8 6AN8A	TRIODE PENTODE	HTR	6.3	0.45	9DA-MB9	5BB 5BB	1.5 0.04	2.0 7.0	0.27 2.3	AMPLIFIER	300	Rk 180		13		19	5750	3300				6AN8 6AN8A			
6AQ4	TRIODE	HTR	6.3	.3	7DT-MB7	5AC	2.5	8.5	.2	RF AMPLIFIER	250	-1.5		10		100		8500				6AQ4			
6AQ5 6AQ5A	BEAM PENTODE	HTR	6.3	0.45	7BZ-MB7	5AD 5AD	0.17	8.0	11.0	POWER AMP	250	-12.5	250	45	4.5		52000	4100	4.5	5000		6AQ5 6AQ5A			
6AQ6	DOUBLE DI-TRI	HTR	6.3	0.15	7BT-MB7	5AC	1.8	1.7	1.5	DET-AMP	250	-3		1		70		1200				6AQ6			
6AQ7GT	DOUBLE DI-TRI	HTR	6.3	0.3	8CK-OGT8	9DB	3.0	2.8	3.2	DET-AMP	250	-2		2.3		70		1600				6AQ7GT			
6AR5	PENTODE	HTR	6.3	0.4	6CC-MB7	5AD				POWER AMP	250	-18	250	32	5.5		68000	2300	3.4	7600		6AR5			
6AR7GT	DBLE DI PENTODE	HTR	6.3	.3	7DE-OW8	9CB	.003	5.5	7.5	DET-AMPLIFIER	250	-2	100	7.0	1.8		1.2MEG	2500			-25	6AR7GT			
6AR8	SHEET BEAM	HTR	6.3	0.3	9DP-MB9	5BC				SYNCH DETECTOR	SPECIAL CIRCUIT FOR COLOR TV														6AR8
6AS4GT	DIODE	HTR	6.3	1.2	4CG-OS6	9DB				DAMPER	MAX PEAK INVERSE = 5500 V; MAX Io = 125ma														6AS4GT
6AS5	BEAM PENTODE	HTR	6.3	0.8	7CV-MB7	5AD	0.6	12	6.2	POWER AMP	150	-8.5	110	35	2			5600	2.2	4500		6AS5			
6AS6	PENTODE	HTR	6.3	0.175	7CM-MB7	5AA	0.01	3.9	3	VOLTAGE AMP	120	-2	120	5.2	3.5			3200			-10	6AS6			
6AS7G 6AS7GA	DBLE TRI	HTR	6.3	2.5	8BD-OM8	16AA 12ED				POWER AMP	135	Rk 250		125		2.1		7500			Each Unit	6AS7G 6AS7GA			
6AS8	DIODE PENTODE	HTR	6.3	0.45	9DS-MB9	5BB	0.02	2.4	7.0	DET-AMP	200	Rk 180	150	9.5	3		0.3 MEG	6200			-8	6AS8			
6AT6	DOUBLE DI-TRI	HTR	6.3	0.3	7BT-MB7	5AC	2.1	2.3	1.1	DET-AMP	250	-3		1		70		1200				6AT6			
6AT8	TRIODE PENTODE	HTR	6.3	0.45	9DW-MB9	5BB	1.5	2.0	0.5	OSCILLATOR MIXER	100 250	150	Rk 200	8.5 7.7	1.6	40	0.75MEG	5800 4600			-10	6AT8			
6AU4GT 6AU4GTA	DIODE	HTR	6.3	1.8	4CG-OS6	9FB 9FB				DAMPER	MAX PEAK INVERSE = 4500 V; MAX Io = 175ma														6AU4GT 6AU4GTA
6AU5GT	BM PENT	HTR	6.3	1.25	6CK-OS6	9DB	.5	11.3	7.0	HORIZ. AMP	315	Rk 80	150	59	9							6AU5GT			
6AU6 6AU6A	PENTODE	HTR	6.3	0.3	7BK-MB7	5AC 5AC	.0035	5.5	5	VOLTAGE AMP	250	-1	150	10.8	4.3		1 MEG	5200			-6.2	6AU6 6AU6A			
6AU8	TRIODE PENTODE	HTR	6.3	0.6	9DX-MB9	5BC	2.2 0.046	2.8 7.0	0.32 2.6	AMPLIFIER	150 200	Rk 150 Rk 82	125	8.5 15	3.4		8200 150000				-6.5 -8	6AU8			
6AV4	DBLE DI	HTR	6.3	.95	5BS-MB7	5AD				FW RECTIFIER	MAX PEAK INVERSE = 1250 V; MAX Io = 90ma													6AV4	
6AV5GA	BM PENT	HTR	6.3	1.2	6CK-OM6	11AB	0.5	14	7.0	AMPLIFIER	250	-22.5	150	57	2.1		14500	5900			-43	6AV5GA			

TYPE	DESIGN	CATHODE			BASING DATA	MAX SIZE VIEW	CAPACITIES			USED AS	PLATE VOLTS	GRID VOLTS	SCR VOLTS	PLATE MA	SCR MA	AMP FACT	PLATE RESIS OHMS	MUT COND mmho	OUT PUT WATTS	LOAD RESIS OHMS	CUT OFF VOLTS	TYPE
		HTR	VOLTS	AMPS			G-P mmfd	IN mmfd	OUT mmfd													
6AV5GT	BM PENT	HTR	6.3	1.2	6CK-OGT6	9DB				HORIZ. AMP	200	0	125	66	12							6AV5GT
6AV6	DOUBLE DI-TRI	HTR	6.3	0.3	7BT-MB7	5AC	2.1	2.3	0.9	DET-AMP	250	-2		1.2		100		1600				6AV6
6AW7GT	DOUBLE DI-TRI	HTR	6.3	0.3	8CQ-OW8	9BD				DET-AMP	100	0		1.4				1200				6AW7GT
6AW8 6AW8A	TRIODE PENTODE	HTR	6.3	0.6	9DX-MB9	5BC 5AD	2.2 0.036	3.2 10.0	0.32 3.6	SYNCH SEP. AMPLIFIER	200	-2	150	4.0 13.0	3.5	70	0.4MEG	4000 9000			-5 -10	6AW8 6AW8A
6AX4GT	DIODE	HTR	6.3	1.2	4CG-OS5	9DB				DAMPER	MAX PEAK INVERSE = 4000 V; MAX I <sub>o</sub> = 125ma										6AX4GT	
6AX5GT	DBLE DI	HTR	6.3	1.2	6S-OS6	9DB				FW RECTIFIER	MAX PEAK INVERSE = 1250 V; MAX I <sub>o</sub> = 150ma										6AX5GT	
6AX6G	DBLE DI	HTR	6.3	2.5	7Q-OM7	14BA				FW RECTIFIER	MAX PEAK INVERSE = 1250 V; MAX I <sub>o</sub> = 250ma										6AX6G	
6AX7	DOUBLE TRIODE	HTR	6.3	0.3	9A-MB9	5BB	1.7	1.6	0.46	VOLTAGE AMP	250 100	-2 -1		1.2 0.5		100		1600 1250				6AX7
6AX8	TRIODE PENTODE	HTR	6.3	0.45	9AE-MB9	5BB	0.006	2.5	1.0	SYNC SEP AMPLIFIER	150 250	Rk 120	110	18 10	3.5	40		8500 4800			-12	6AX8
6AZ5	DBLE DI	HTR	6.3	.15	8DF	3AA				DETECTOR	MAX PEAK INVERSE = 420 V; MAX I <sub>o</sub> = 8ma										6AZ5	
6AZ8	TRIODE PENTODE	HTR	6.3	0.45	9ED-MB9	5BB	1.7 0.02	2.0 6.5	1.7 2.2	OSCILLATOR AMPLIFIER	200 200	-6	150	13 9.5	3.0	19	0.3MEG	3300 6000			-19	6AZ8
6B4G	TRIODE	FIL	6.3	1.0	5S-OM8	16AA	16	7	5	PR AMP CL A PUSH-PULL CL AB 2 TUBE	250 325 325	-45 -68 SELF		60 80 80		4.2	800	5250	3.2 15 10	2500 3000 5000		6B4G
6B5	DUO-TRI	HTR	6.3	.8	6AS-SM6	14BA	DRIVER TRIODE OUTPUT TRIODE			DIR C'P'D AMP 2 TUBES CL A	325 325	0 +		9 51				See Type 6N6G Also 13.5 10000				6B5

SEE PAGE 4 FOR DATA CHART REFERENCE NOTES

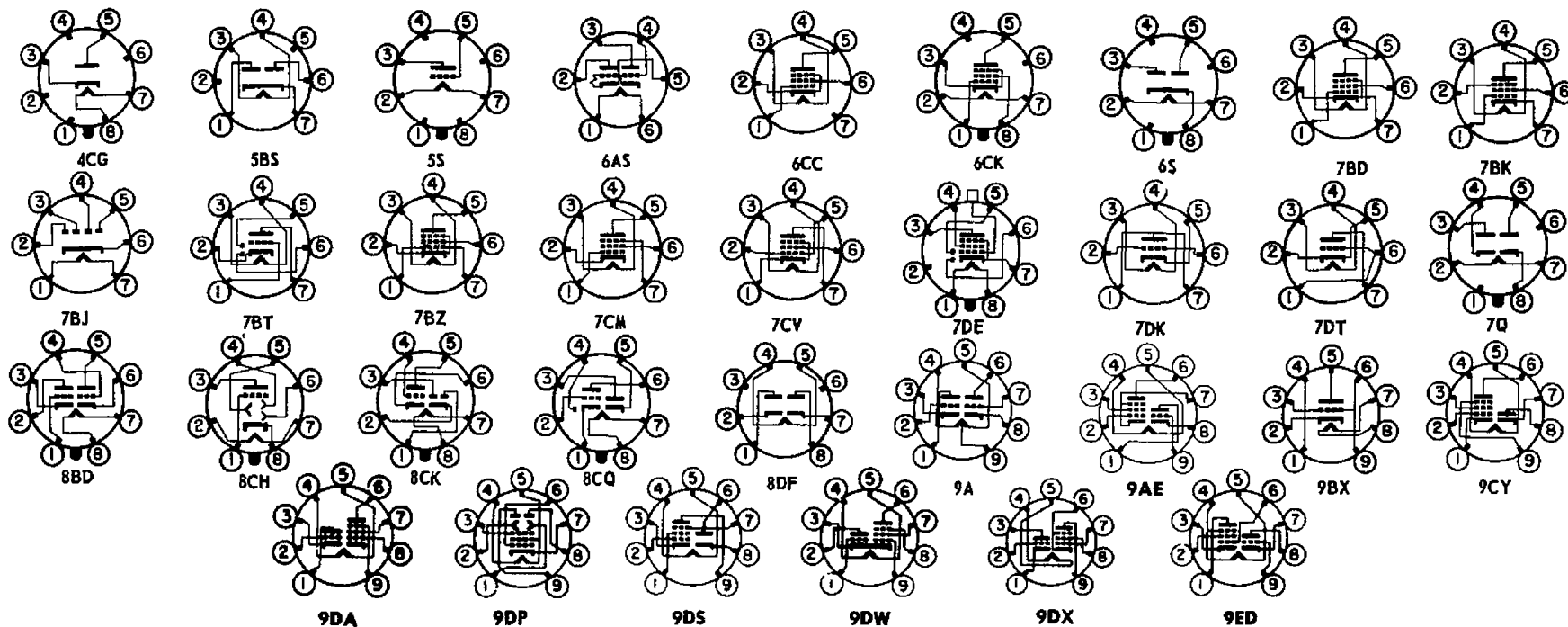

TYPE	DESIGN	CATHODE HTR OR FIL			BASING DATA	MAX SIZE VIEW	CAPACITIES			USED AS	PLATE VOLTS	GRID VOLTS	SCR VOLTS	PLATE MA	SCR MA	AMP FACT	PLATE RESIS OHMS	MUT COND mmho	OUT PUT WATTS	LOAD RESIS OHMS	CUT OFF VOLTS	TYPE				
		TYPE	VOLTS	AMPS			G-P mmfds	IN mmfds	OUT mmfds																	
6B6G	DUO-DI TRIODE	HTR	6.3	.3	7V-OS7	12CA	1.3	2.7	4.5	AMPLIFIER CLASS A	250	-2		0.9		100	91000	1100				6B6G				
6B7 6B7S	DUO-DI PENTODE	HTR	6.3	.3	7D-SS7 7D-SS7	12DA	.007*	3.5	9.5	AMPLIFIER CLASS A	250 100	-3 -3	125 100	9.0 5.8	2.3 1.7	.6MEG .3MEG	1125 950			-21 -17		6B7 6B7S				
6B8 6B8G 6B8GT	DUO-DI PENTODE	HTR	6.3	.3	8E-OW8 8E-OS8 8E-OW8	8DA 12CA 9CB	.005 .01* 0.005*	6 3.6* 4.5*	9 9.5* 10*	AMPLIFIER CLASS A	250 100	-3 -3	125 100	10 5.8	2.3 1.7	.6MEG .3MEG	1325 950			-21 -17		6B8 6B8G 6B8GT				
6BA6	PENTODE	HTR	6.3	0.3	7BK-MB7	5AC	.0035	5.5	5.0	VOLTAGE AMP	250	Rk 68	100	11	4.2	1 MEG	4400			-20		6BA6				
6BA7	PENTA-GRID	HTR	6.3	0.3	8CT-MB9	5BC	0.19	9.5	8.3	CONVERTER	250	-1.0	100	3.8	10.0	1 MEG	950C			-20		6BA7				
6BA8 6BA8A	TRIODE PENTODE	HTR	6.3	0.6	9DX-MB9	5BC 5BC	2.2 0.04	2.5 10.0	0.4 3.6	AMP CL A	200 200	-8	150	8.0 13.0	3.5	18	0.4MEG	2700 9000		-16 -10		6BA8 6BA8A				
6BC4	TRIODE	HTR	6.3	0.23	9DR-MB9	5AA	1.6	2.9	0.26	RF AMPLIFIER	150	Rk 100		14.5		48	4800	10000		-10		6BC4				
6BC5	PENTODE	HTR	6.3	.3	7BD-MB7	5AC	.02*	6.6*	3.1*	CL A AMP	100 250	Rk 180 Rk 180	100 150	4.7 7.5	1.4 2.1	.6MEG .8MEG	4900 5700			-5 -8		6BC5				
6BC7	TRIPLE DI	HTR	6.3	.45	9AX-MB9	5BB				FM DETECTOR	MAX I <sub>o</sub> = 12ma per plate														6BC7	
6BC8	DOUBLE TRIODE	HTR	6.3	0.4	9AJ-MB9	5BB	1.4	2.5	1.3	CASCADE AMPLIFIER	150	Rk 220		10		35		6200			-13		6BC8			
6BD4 6BD4A	BEAM TRIODE	HTR	6.3	0.6	8FU-OJ6	12HE 12HE	1.0	3.8	0.04	VOLTAGE REGULATOR	MAX DC PLATE = 27000 volts; MAX I <sub>o</sub> = 1.5 ma															6BD4 6BD4A
6BD5GT	BM PENT	HTR	6.3	.9	6CK-OGT6					HORIZ. AMP	MAX I <sub>k</sub> = 100ma; MAX PEAK POS. PLATE SURGE = 4000 V															6BD5GT
6BD6	PENTODE	HTR	6.3	0.3	7BK-MB7	5AC	0.004	4.3	5.0	VOLTAGE AMP	250	-3	100	9	3	0.8MEG	2000			-35		6BD6				
6BD7	DBLE DI TRIODE	HTR	6.3	.23	9Z-MB9	5BC	1.3	2.4	1.3	DET-AMPLIFIER	250	-3		1.0		70		1200				6BD7				
6BE6	HEPTODE	HTR	6.3	0.3	7CH-MB7	5AC	0.3	7.2	8.6	CONVERTER	250	-1.5	100	3	7.1	1 MEG	475C			-30		6BE6				
6BE8	TRIODE PENTODE	HTR	6.3	0.45	9EG-MB9	5BB	1.8 0.04	2.8 4.4	1.5 2.6	OSCILLATOR MIXER	150 250	Rk 68	110	18 10	3.5	40	0.4MEG	8500 6200			-12 -10		6BE8			
6BF5	PENTODE	HTR	6.3	1.2	9BZ-MB9	5AD	.65	14	6	VERT. AMP	225	Rk 1200	TRIODE 20 CONN.		6.7		4200					6BF5				
6BF6	DOUBLE DI-TRI	HTR	6.3	0.3	7BT-MB7	5AC	2	1.8	1.4	DET-AMP	250	-9		9.5		16		1900				6BF6				
6BG6G	BEAM PENTODE	HTR	6.3	0.9	5BT-OM6	16CA	0.5	11	6.5	DEFLECT AMP	MAX PEAK POS. PLATE SURGE = 6000v, MAX I <sub>b</sub> = 100ma														6BG6G	
6BG6GA	BEAM PENTODE	HTR	6.3	0.9	5BT-OM6	12JE	0.5	11.0	6.5	DEFLECT AMP	MAX PEAK POS. PLATE SURGE = 6000 volts MAX I <sub>b</sub> = 100 ma														6BG6GA	
6BH5	PENTODE	HTR	6.3	.2	9AZ-MB9	5BC	.002	4.9	5.5	RF AMPLIFIER	250	-2.5	100	6.0	1.7	1.1MEG	2200			-18		6BH5				
6BH6	PENTODE	HTR	6.3	0.15	7CM-MB7	5AC	.0035	5.4	4.4	VOLTAGE AMP	250	-1	150	7.4	2.9	1.4MEG	4600			-7.7		6BH6				
6BH8	TRIODE PENTODE	HTR	6.3	0.6	9DX-MB9	5BC	2.4 0.046	2.6 7.0	0.38 2.4	AMPLIFIER	150 200	-5	125	9.5 15.0	3.4	17	5150	3300 7000			-14 -8		6BH8			
6BJ5	BM PENT	HTR	6.3	.64	6CH-M57	5AD				POWER AMP	250	-5.0	250	35	5.5		40000	10500	4	7000		6BJ5				
6BJ6	PENTODE	HTR	6.3	0.15	7CM-MB7	5AC	.0035	4.5	5	VOLTAGE AMP	250	-1	100	9.2	3.3	1.3MEG	3800			-20		6BJ6				
6BJ7	TRIPLE DIODE	HTR	6.3	.45	9AX-MB9	5BB				DC RESTORER	MAX PEAK INVERSE = 330 V; MAX PEAK PLATE CURR PER PLATE = 10ma DC OUTPUT CURRENT PER PLATE 1.0ma DC														6BJ7	
6BJ8	DBLE DI TRIODE		6.3	0.6	9ER-MB9	5AD	2.6	2.8	0.38	OSCILLATOR	90	0		13.5		22	4700	4700			-7		6BJ8			

TYPE	DESIGN	CATHODE HTR OR FIL			BASING DATA	MAX SIZE VIEW	CAPACITIES			USED AS	PLATE VOLTS	GRID VOLTS	SCR VOLTS	PLATE MA	SCR MA	AMP FACT	PLATE RESIS OHMS	MUT COND mmho	OUT PUT WATTS	LOAD RESIS OHMS	CUT OFF VOLTS	TYPE
		TYPE	VOLTS	AMPS			G-P mmfds	IN mmfds	OUT mmfds													
6BK4	BEAM TRIODE	HTR	6.3	0.2	8GC-QT8	12HE				VOLTAGE REGULATOR	MAX DC PLATE = 25000 volts; MAX I <sub>o</sub> = 1.5 ma										6BK4	
6BK5	BM PENT	HTR	6.3	1.2	9BQ-MB9	5BC	.6	13	5.0	POWER AMP	250	-5.0	250	35	3.5	.1MEG	8500	3.5	6500		6BK5	
6BK6	DBLE DI TRIODE	HTR	6.3	.3	7BT-MB7	5AD				DET-AMP	100 250	-1 -2		0.5 1.2		100 100	80000 62500	1250 1600			6BK6	
6BK7	TWIN TRIODE	HTR	6.3	.45	9AJ-MB9	5BB	1.9	3.0	1.1	RF AMPLIFIER	100 150	Rk 120 Rk 56		9.0 18		37 40	6100 4700	6100 8500		-9 -12	6BK7	
6BK7A	TWIN TRIODE	HTR	6.3	.45	9AJ-MB9	5BB	1.8	3.0	1.0	RF AMPLIFIER	150	Rk 56		18		43	4600	9300		-11	6BK7A	
6BK7B	TWIN TRIODE	HTR	6.3	0.45	9AJ-MB9	5BB	1.8	3.0	1.0	RF AMPLIFIER	150	Rk 56		18		43	4600	9300		-11	6BK7B	
6BL4	DIODE	HTR	6.3	3.0	8GB-OJ8	12ED	11.5	16	5	HW RECTIFIER	MAX PEAK INVERSE = 4500 volts; MAX I <sub>o</sub> = 200 ma										6BL4	
6BL7GT	DBLE TRI	HTR	6.3	1.5	8BD-OS8	9DB	4.2*	5.0*	3.4*	VERT. AMP	250	-9		40		15		7000		-25	6BL7GT	
6BM5	BM PENT	HTR	6.3	.45	7BZ-MB7	5AD	.5	8.0	5.5	POWER AMP	250	-6	250	30	3		60000	7000	3.5	7000	6BM5	
6BN4	TRIODE	HTR	6.3	0.2	7EG-MB7	5AC	1.2	3.2	1.4	RF AMPLIFIER	150	Rk 220		9		43	6300	6800			6BN4	
6BN5	PENTODE	HTR	6.3	0.2	9CR-MB9	5AD	0.2	4.3	5.1	AMPLIFIER	225	Rk 360	225	26	4.1	11		3200	2.8	9000	6BN5	
6BN6	GATED BM	HTR	6.3	.3	7DF-MB7	5AD				DISCRIMINATOR	80	INPUT SIG. CENTER FREQ. = 10.7 Mc; FREQ. DEV = ± 75 Kc										6BN6
6BN7	DOUBLE TRIODE	HTR	6.3	.75	9AJ-MB9	5BC	3 .7	1.6 1.4	5.5 .3	SECTION 1 SECTION 2	250 120	-15 -1		24 5		12 28		5500 2000		-35 -7	6BN7	
6BN8	DBLE DI TRIODE	HTR	6.3	0.6	9ER-MB9	5AD	2.5	3.6	0.32	AMPLIFIER	250	-3		1.6		70	28000	2500		-5.5	6BN8	
6BQ6G 6BQ6GA 6BQ6GTA 6BQ6GTB	BM PENT BEAM PENTODE	HTR HTR	6.3 6.3	1.2 1.2	6AM-OS7 6AM-OGT6	12CA 11BB 9EC 9EC	.6 0.6	15 15	7.5 7.5	HORIZ AMP POWER AMPLIFIER	60 250 250	0 -22.5 -22.5	150 150 150	225 55 55	25 2.1 2.1		20000 20000 18000	5500 5500 6000		-46 -46 -46	6BQ6G 6BQ6GA 6BQ6GTA 6BQ6GTB	

SEE PAGE 4 FOR DATA CHART REFERENCE NOTES

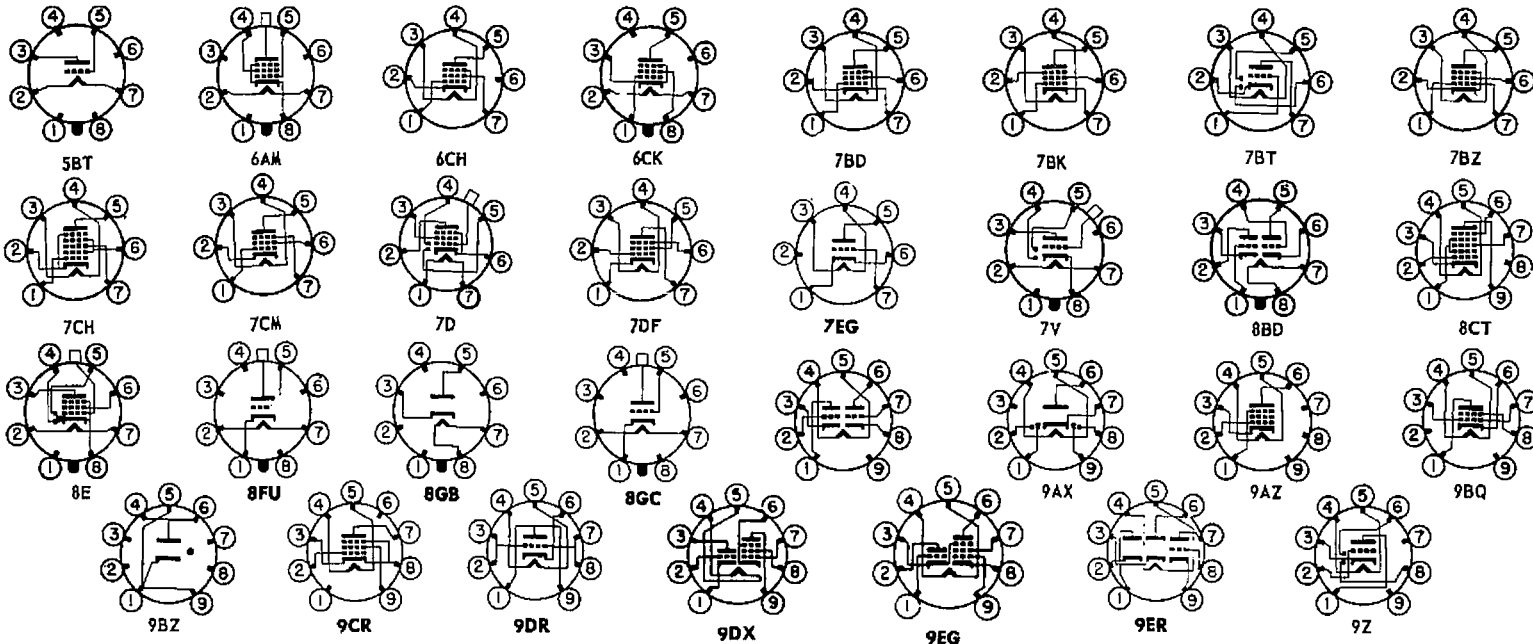

TYPE	DESIGN	CATHODE HTR OR FIL			BASING DATA	MAX SIZE VIEW	CAPACITIES			USED AS	PLATE VOLTS	GRID VOLTS	SCR VOLTS	PLATE MA	SCR MA	AMP FACT	PLATE RESIS OHMS	MUT COND mmho	OUT PUT WATTS	LOAD RESIS OHMS	CUT OFF VOLTS	TYPE
		TYPE	VOLTS	AMPS			G-P mmfds	IN mmfds	OUT mmfds													
6BQ6GT	BM PENT	HTR	6.3	1.2	6AM-OGT7	9EC	.95	14	9.5	HORIZ AMP	250	Rk 43	140	99	11.5	MAX PEAK POS. PLATE SURGE = 5500 V				6BQ6GT		
6BQ7	DBLE TRI	HTR	6.3	.4	9AJ-MB9	5BB	1.15	2.55	1.3	RF AMPLIFIER	150	Rk 220		9		35	5800	6000			-10	6BQ7
6BQ7A	DBLE TRI	HTR	6.3	.4	9AJ-MB9	5BB	1.5	2.85	1.35	RF AMPLIFIER	150	Rk 220		9		39	6100	6400			-10	6BQ7A
6BR8	TRIODE PENTODE	HTR	6.3	0.45	9FA-MB9	5BB	1.8 0.015	2.5 5.0	0.4 2.6	OSCILLATOR MIXER	150 250	Rk 68	110	18 10	3.5	40	0.4MEG	8500 5200			-12 -10	6BR8
6BS8	DOUBLE TRIODE	HTR	6.3	0.4	9AJ-MB9	5BB	1.15	2.6	1.2	CASCADE AMPLIFIER	150	Rk 220		10		36	5000	7200			-7	6BS8
6BT6	DBLE DI TRIODE	HTR	6.3	.3	7BT-MB7	5AD				DET-AMPLIFIER	100 250	-1 -3		.8 1.0		70 70	54800 58000	1300 1200				6BT6
6BT8	DBLE DI PENTODE	HTR	6.3	0.45	9FE-MB9	5BB	0.04	1.3 7.0	3.0 2.3	DET-AMP	200	Rk 180	150	9.5	2.8		0.3MEG	6200			-8	6BT8
6BU4	TRIODE	HTR	6.3	0.45	8GC-OM8	12JE	0.03	2.0	8.0	VOLTAGE REGULATOR		-8.4				1515	8.2MEG	185				6BU4
6BU5	BEAM PENTODE	HTR	6.3	0.15	8FP-OM8	11BD	0.024	3.0	0.9	VOLTAGE REGULATOR	20000	-2.4	70	1.0	0.4						-6.5	6BU5
6BU6	DBLE DI TRIODE	HTR	6.3	.3	7BT-MB7	5AD				DET-AMPLIFIER	250	-9		9.5		16	8500	1900				6BU6
6BU8	TWIN PENTODE	HTR	6.3	0.3	9FG-MB9	5BC	1.9			SYNC AGC	100	-10	67.5	2.2	3.3			180			-4.5	6BU8
6BV7	DBLE DI PENTODE	HTR	6.3	.8	9BU-MB9	5BC	.5	11.5	9.5	DET-AMPLIFIER	180 250	-4 -5	180 250	20 38	3.5 6.0		.13MEG .1 MEG	8000 10000	2.0 4.0	8000 8000		6BV7
6BV8	DBLE DI TRIODE	HTR	6.3	0.6	9FJ-MB9	5BB	2.0	3.6	0.4	SYNC DETECTOR	200	Rk 330		11		33	5900	5600			-11	6BV8
6BW4	DBLE DI	HTR	6.3	0.9	9DI-MB9	5AD				FW RECTIFIER	MAX PEAK INVERSE = 1275 volts MAX I <sub>o</sub> = 350 ma										6BW4	
6BW6	BM PENT	HTR	6.3	.45	9AM-MB9	5BC				POWER AMP	180 250	-8.5 -12.5	180 250	29 45	3. 4.5		58000 52000	3700 4100	2.0 4.5	5500 5000		6BW6
6BX6	PENTODE	HTR	6.3	.3	9AQ-MB9	5BC	.007	7.2	3.4	RF AMPLIFIER	170	-2	170	10	2.5		.4MEG	7200				6BX6
6BX7GT	DBLE TRI	HTR	6.3	1.5	8BD-OS8	9DB	4.0	4.8	1.2	VERT. AMP	100 250	0 Rk 390		80 42		10	1300	7600				6BX7GT
6BX8	DBLE TRI	HTR	6.3	0.4	9AJ-MB9	5BB	1.4	2.4	1.25	CASCADE AMPLIFIER	65	-1.0		9		25		6700			-7	6BX8
6BY5G	DBLE DI	HTR	6.3	1.6	6CN-OM7	14BA				DAMPFER	MAX PEAK INVERSE = 3000 V; MAX I <sub>o</sub> = 175ma										6BY5G	
6BY6	PENTAGRID	HTR	6.3	0.6	7CH-MB7	5AC	0.08			GATED AMPLIFIER	250	100		6.5				1900				6BY6
6BY7	PENTODE	HTR	6.3	.3	9AQ-MB9	5BC	.007	7.2	3.7	RF AMPLIFIER	250	-2	100	10	2.5		.5MEG	6000				6BY7
6BY8	DIODE PENTODE	HTR	6.3	0.6	9FN-MB9	5AD	0.0035	5.5	5.0	DETECTOR AMPLIFIER	100 250	Rk 150 Rk 68	100 150	5.0 10.6	2.1 4.3		0.5 MEG 1.0 MEG	3900 5200			-4.2 -6.5	6BY8
6BZ6	PENTODE	HTR	6.3	0.3	7CM-MB7	5AC	0.025	7.0	2.0	AGC IF AMPLIFIER	125	125		14			0.26MEG	8000				6BZ6
6BZ7	DBLE TRI	HTR	6.3	.4	9AJ-MB9	5BC	1.15	2.5	1.35	RF AMPLIFIER	150	Rk 220		10		38	5600	6800			-11	6BZ7
6BZ8	DBLE TRI	HTR	6.3	0.4	9AJ-MB9	5BB	1.15			CASCADE AMPLIFIER	125	Rk 100		10		45	5600	8000			-13	6BZ8

SEE PAGE 4 FOR DATA CHART REFERENCE NOTES

TYPE	DESIGN	CATHODE HTR OR FIL			BASING DATA	MAX SIZE VIEW	CAPACITIES			USED AS	PLATE VOLTS	GRID VOLTS	SCR VOLTS	PLATE MA	SCR MA	AMP FACT	PLATE RESIS OHMS	MUT COND mmho	OUT PUT WATTS	LOAD RESIS OHMS	CUT OFF VOLTS	TYPE			
		TYPE	VOLTS	AMPS			G-P mmfds	IN mmfds	OUT mmfds																
6C4	TRIODE	HTR	6.3	0.15	6BG-MB7	5AC	1.6	1.8	1.3	H-F POWER TRIODE	250 100	-8.5 0		10.5 11.8		7700 6250	2200 3100					6C4			
6C5 6C5GT	TRIODE	HTR	6.3	.3	6Q-OW6 6Q-OW6	8CA 9BC	2.0 2.2*	3.0 4.4*	11 12*	AMPLIFIER CLASS A	250	-8		8	20	10000	2000					6C5 6C5GT			
6C6	PENTODE	HTR	6.3	.3	6F-SS6	12DB	.007*	5.0	6.5	AMPLIFIER CLASS A	250 100	-3 -3	100 100	2.0 2.0	.5 .5	1.5MEG 1 MEG	1226 1185			-7 -7		6C6			
6C7	DUO-DI TRIODE	HTR	6.3	.3	7G-SS7					AMP CL A	250	-9		5.5	20	16000	1250					6C7			
6C8G	TWIN TR	HTR	6.3	.3	8G-OS8	12CA				CL A 1 SECT	250	-4.5		3.2	36	22500	1600					6C8G			
6CA5	BM PENT	HTR	6.3	1.2	7CV-MB7	5AD	0.5	15	9	AF AMPLIFIER	125	-4.5	125	36	4.0	15000	9200		4500			6CA5			
6CA7	BM PENT	HTR	6.3	1.5	8ET-OGT8		1.0	15.5	7.2	POWER AMP	250	-14.5	150	70	10	18000	9000	8				6CA7			
6CB5 6CB5A	BEAM PENTODE	HTR	6.3	2.5	8GD-OJ8	16BA 12HD	0.8 0.4	24 22	10 10	HORIZ DEFLECT AMPLIFIER	MAX PEAK POS PLATE PULSE = 6800 volts														6CB5 6CB5A
6CB6 6CB6A	PENTODE PENTODE	HTR HTR	6.3 6.3	.3 0.3	7CM-MB7 7CM-MB7	5AC 5AC	.02 0.025	6.3 6.3	1.9 2.0	RF PENTODE IF AMPLIFIER	200 125	Rk 180 125	150	9.5 13	2.8	.6MEG 0.28MEG	6200 8000				-8		6CB6 6CB6A		
6CD6G 6CD6GA	BM PENT BEAM PENTODE	HTR HTR	6.3 6.2	2.5 2.5	5BT-OM6 5BT-OM8	16CA 12JE	1.0 1.1	2.6 22	10 8.5	HORIZ AMP HORIZ DEFLECT AMPLIFIER	430 175	Rk 270 -30	165 175	112 75	14 5.5	MAX PULSE PEAK POS PLATE = 6000 V			7200 7700		-55		6CD6G 6CD6GA		
6CE5	PENTODE	HTR	6.3	0.3	7BD-MB7	5AC	0.03	6.5	1.9	RF AMPLIFIER	125		125	11	2.3	0.3MEG	7600						6CE5		
6CF6	PENTODE	HTR	6.3	0.3	7CM-MB7	5AC	.02	6.3	1.9	RF AMPLIFIER	200	Rk 180	150	9.5	2.8	.6MEG	6200				-6.5		6CF6		
6CG6	PENTODE	HTR	6.3	.3	7BK-MB7	5AC	.008	5.0	5.0	RF AMPLIFIER	250	-8	150	9.0	2.3	.72MEG	2000				-24		6CG6		
6CG7	TWIN TRIODE	HTR	6.3	0.6	9AJ-MB9	5AD	4.0	2.3	2.2	OSCILLATOR	250	-8		9	20	7700	2600				-18		6CG7		

SEE PAGE 4 FOR DATA CHART REFERENCE NOTES

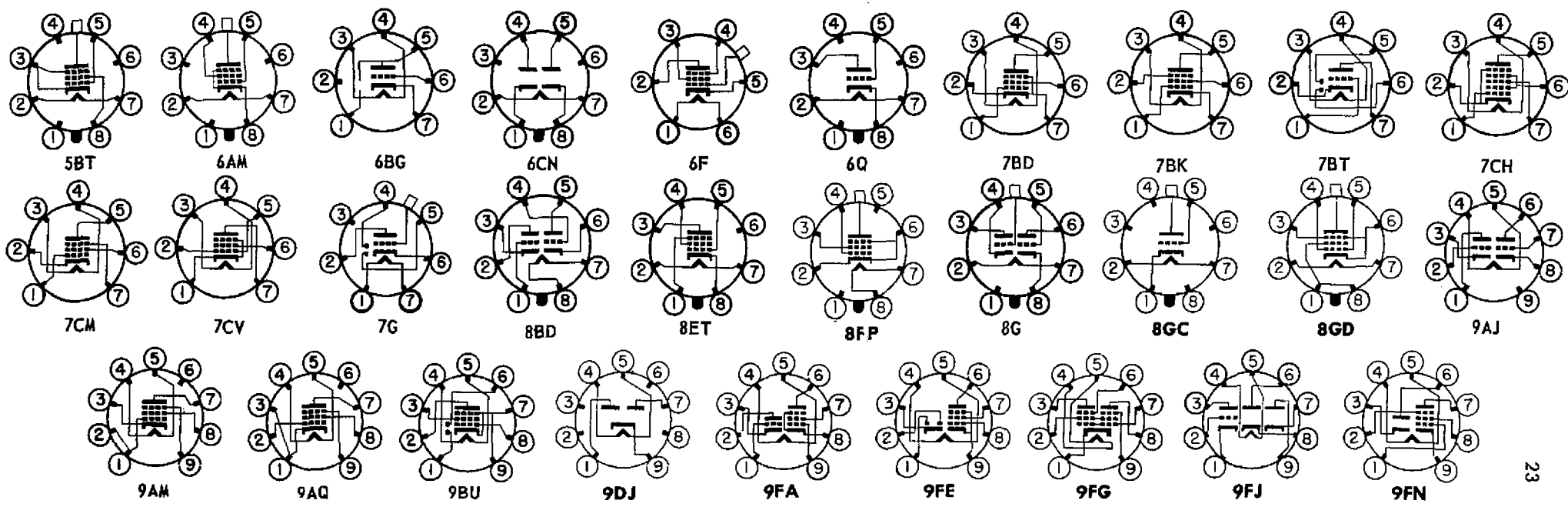



TYPE	DESIGN	CATHODE HTR OR FIL			BASING DATA	MAX SIZE VIEW	CAPACITIES			USED AS	PLATE VOLTS	GRID VOLTS	SCR VOLTS	PLATE MA	SCR MA	AMP FACT	PLATE RESIS OHMS	MUT COND mmho	OUT PUT WATTS	LOAD RESIS OHMS	CUT OFF VOLTS	TYPE
		TYPE	VOLTS	AMPS			G-P mmfds	IN mmfds	OUT mmfds													
6CG8 6CG8A	TRIODE PENTODE	HTR	6.3	0.45	9FA-MB9	5BB 5BB	1.5	2.6	0.05	OSCILLATOR MIXER	100 250	Rk 200	150	8.5 7.7	1.6	40	0.75MEG 4600			-10	6CG8 6CG8A	
6CH6	PENTODE	HTR	6.3	.75	9BA-MB9	5BC				RF AMPLIFIER	250	-4.5	250	40	6.0		50000	11000			6CH6	
6CH8	TRIODE PENTODE	HTR	6.3	0.45	9FT-MB9	5BB	0.025	7	2.25	OSCILLATOR AMPLIFIER	200 200	Rk 180	150	13 9.5		19				-19 -8	6CH8	
6CJ6	PENTODE	HTR	6.3	1.05	9AS-MB9	5CD	.8	14.7	6.0	CL A AMPLIFIER	250	-38.5	250	32	2.4		15000	4600			6CJ6	
6CK6	PENTODE	HTR	6.3	.71	9AR-MB9	5BD	.1	11.2	6.6	CL A AMPLIFIER	250	-5.5	250	36	5		.13MEG	10000			6CK6	
6CL5	BM PENT	HTR	6.3	2.5	8GD-OM8	12JE	0.7	20.0	11.5	AMPLIFIER	175	-40	175	90	7.0		6000	6500		-75	6CL5	
6CL6	PENTODE	HTR	6.3	.65	9BV-MB9	5BC	.12	11	5.5	CL A AMPLIFIER	250	-3	150	30	7		.15MEG	11000	2.8	7500	6CL6	
6CL8	TRIODE TETRODE	HTR	6.3	0.45	9FX-MB9	5BB	1.8 0.028	2.7 5.0	0.4 2.0	OSCILLATOR MIXER	125	-1.0	125	15 12	4.0	40	0.1MEG	8000 5800			-9 -10	6CL8
6CM6	BM PENT	HTR	6.3	.45	9CK-MB9	5BC	.7	8	8.5	VERT. AMP	MAX PEAK POS. PLATE = 2000 V MAX PLATE DISS. = 8 WATTS; MAX PEAK I <sub>k</sub> = 120ma										6CM6	
6CM7	DOUBLE TRIODE	HTR	6.3	0.6	9ES-MB9	5AD	3	3.5	0.4	OSCILLATOR AMPLIFIER	200 250	-7 -8				21	10500	2000 4400			6CM7	
6CM8	TRIODE PENTODE	HTR	6.3	0.45	9FZ-MB9	5BB	1.9 0.02	1.6 6.0	0.22 2.6	IF AMPLIFIER	250 200	-2	150	1.8 9.5	2.8	100	0.6MEG	2000 6200			-8	6CM8
6CN7	DBLE DI TRIODE	HTR	6.3	0.3	9EN-MB9	5BB	1.8	1.5	0.5	DETECTOR	100 250	-1.0 -3.0		0.8 1.0		70	54000 58000	1300 1200			6CN7	
6CQ6	PENTODE	HTR	6.3	.2	7DR-MB7	5AC	.01	7.0	4.5	RF AMPLIFIER	250	-5	100	4.9	1.25			2500			-34	6CQ6
6CR6	DIODE PENTODE	HTR	6.3	0.3	7EA-MB7	5AA				DET-AMP	250	-2	100	9.5	3.0			1950			-40	6CR6
6CR8	TRIODE PENTODE	HTR	6.3	0.45	9GJ-MB9	5BB	1.6	2.0	1.4	IF AMPLIFIER	125	-2	125	12 13	3	22	0.3MEG	4000 7700			-6.5	6CR8
6CS5	BM PENT	HTR	6.3	1.2	9CK-MB9	5BC	0.5	15	9	AMPLIFIER	110	-7.5	110	50	10		13000	8000		2000	6CS5	
6CS6	HEPTODE	HTR	6.3	.3	7CH-MB7	5AC	.05	5.5	7.5	CL A AMPLIFIER	100	-1.0	30	.75	1.1		1 MEG	950			-2.5	6CS6
6CS7	TWIN TRIODE	HTR	6.3	0.6	9EF-MB9	5AD	2.6	1.8	0.5	OSCILLATOR AMPLIFIER	250	-8.5 -10.5		10.5 19.0		17.0 15.5	7700 3450	2200 4500			-22	6CS7
6CS8	TRIODE PENTODE	HTR	6.3	0.45	9FZ-MB9	5BB	1.6	1.9	0.26	IF AMPLIFIER	125	-2	125	12 13	3	22	0.3MEG	4000 7700			-6.5	6CS8
6CU5	BEAM PENTODE	HTR	6.3	1.2	7CV-MB7	5AD	0.7	13.2	8.6	POWER AMPLIFIER	120	-8	110	50	8.5		10000	7500		2500	6CU5	
6CX7	DOUBLE TRIODE	HTR	6.3	0.4	9FC-MB9	5BB	1.2	2.4	1.3	CASCADE AMPLIFIER	150	Rk 220		9		39		6400			-10	6CX7
6CY5	TETRODE	HTR	6.3	0.2	7EW-M7	5AA	0.03	4.5	3.0	CL A AMP	180	-1.0	180	10	1.5		0.1MEG	8000			-6	6CY5
6D6	PENTODE	HTR	6.3	.3	6F-SS6	12DB	.007*	4.7	6.5	AMP CL A	250 100	-3 -3	100 100	8.2 8.0	2.0 2.2		.8MEG .25MEG	1600 1500			-50 -50	6D6
6D7	PENTODE	HTR	6.3	.3	7H-SS7					AMP CL A	250 100	-3 -3	100 100	2.0 2.0	.5 .5		1.5MEG 1 MEG	1226 1185			-7 -7	6D7
6D8G	HEPTODE	HTR	6.3	.15	8A-OS8	12CA	.2*	8.0*	11*	OSC SECT MIXER	250S 250	.05MEG -3	100	4.3 3.5	2.6		GRID #2 .4MEG	RES. .02 MEG 550C			-35	6D8G
6DA6	PENTODE	HTR	6.3	0.2	9BA-MB9	5BB	0.002	5.5	5.1	RF AMPLIFIER	250	0	100	9		19	1MEG	3600			6DA6	
6DA7	DOUBLE TRIODE	HTR	6.3	1.0	9EF-MB9	5BC	2.3 6.9	2.0 5.5	0.415 0.82	OSCILLATOR AMPLIFIER	250 150	-8 -17.5		9.0 40		20 6.3	7700 1100	2600 5700			-42	6DA7
6DB5	BM PENT	HTR	6.3	1.2	9GR-MB9	5BC	0.5	15	9	POWER AMP	110	-7.5	110	50	10		13000	8000		2000	6DB5	

TYPE	DESIGN	CATHODE HTR OR FIL			BASING DATA	MAX SIZE VIEW	CAPACITIES			USED AS	PLATE VOLTS	GRID VOLTS	SCR VOLTS	PLATE MA	SCR MA	AMP FACT	PLATE RESIS OHMS	MUT COND mraho	OUT PUT WATTS	LOAD RESIS OHMS	CUT OFF VOLTS	TYPE
		TYPE	VOLTS	AMPS			G-P mmfds	IN mmfds	OUT mmfds													
6DB6	PENTODE	HTR	6.3	0.3	7CM-MB7	5AC	0.0035	6.0	5.0	DEMODULATOR	150	-3.0	150	5.8		50000	2050			-6.5	6DB6	
6DC6	PENTODE	HTR	6.3	0.3	7CM-MB7	5AC	0.02	6.5	2	PF AMPLIFIER	200	Rk 180	150	9	3	0.5MEG	5500			-12.5	6DC6	
6DE6	PENTODE	HTR	6.3	0.3	7CM-MB7	5AC	0.025	6.5	2.0	CL A AMP	125	Rk 56	125	15.5	4.2	0.25MEG	8000			-9	6DE6	
6DG6GT	BM PENT	HTR	6.3	1.2	7S-OM7	9BC				POWER AMP	110	-7.5	110	50	10	13000	8000				6DG6GT	
6DK6	PENTODE	HTR	6.3	0.3	7CM-M7	5AC	0.02	6.3	1.9	IF AMPLIFIER	125	Rk 56	125	12	3.8		9800			-6.5	6DK6	
6DN6	PENTODE	HTR	6.3	2.5	5BT-OM8	12JE	0.8	22	11.5	POWER AMP	125	-18	125	70	6.3	4000	9000			-36	6DN6	
6DQ6A	BEAM PENTODE	HTR	6.3	1.2	6AM-OM7	12JC	0.55	15	7	POWER AMP	250	-22.5	150	75	2.4	20000	6600			-46	6DQ6A	
6E5	ELEC RAY	HTR	6.3	.3	6R-SS6	9FD				TUNING IND	250 THRU 1 MEG. TARGET 250v, GRID 0v FOR 90°, -8v FOR 0°										6E5	
6E6	TWIN TRI	HTR	6.3	.6	7B-SM7	14BA	PUSH-PULL			CL A 1 SECT CL A 2 SECT	250 250	-27.5 -27.5		18 36		6	3500	1700	1.6	14000		6E6
6E7	PENTODE	HTR	6.3	.3	7H-SS7					AMP CL A	250 100	-3 -3	100 100	8.2 8.0	2.0 2.2	.8 MEG .25MEG	1600 1500			-50 -50	6E7	
6F5 6F5GT	TRIODE	HTR	6.3	.3	5M-OW5 5M-OW5	8DA 9EA	2.0 2.0*	6.0 6.0*	12 12*	AMPLIFIER CLASS A	250 100	-2 -1		0.9 0.4		100 100	66000 85000	1500 1150			6F5 6F5GT	
6F6 6F6G	PENTODE	HTR	6.3	.7	7S-OW7 7S-OM7	8FA 14BA	PENTODE CONNECTION			PR AMP CL A PUSH-PULL CL AB 2 TUBE	285 250 375 315	-20 -16.5 -26 -24	285 250 250 285	38 34 34 62	7 6.5 5 12	78000 80000	2550 2500	4.8 3.2 18.5 11	7000 7000 10000 10000		6F6 6F6G	
6F7 6F7S	TRIODE PENTODE	HTR	6.3	.3	7E-SS7 7E-SS7	12DA	2.0 .008*	2.5 3.2	3.0 12.5	TRI CL A PENT CL A	100 250	-3 -3		3.5 6.5		8 900	16000 .85MEG	500 1100	(SEE 6P7G ALSO)		-35	6F7 6F7S
6F8G	TWIN TR	HTR	6.3	.6	8G-OSS	12CA	4.0L 3.6R	3.2L 3.0R	3.2L 3.8R	AMP CL A ONE SECT	250 90	-8 0		9.0 10.0		20 20	7700 6700	2600 3000			6F8G	

SEE PAGE 4 FOR DATA CHART REFERENCE NOTES

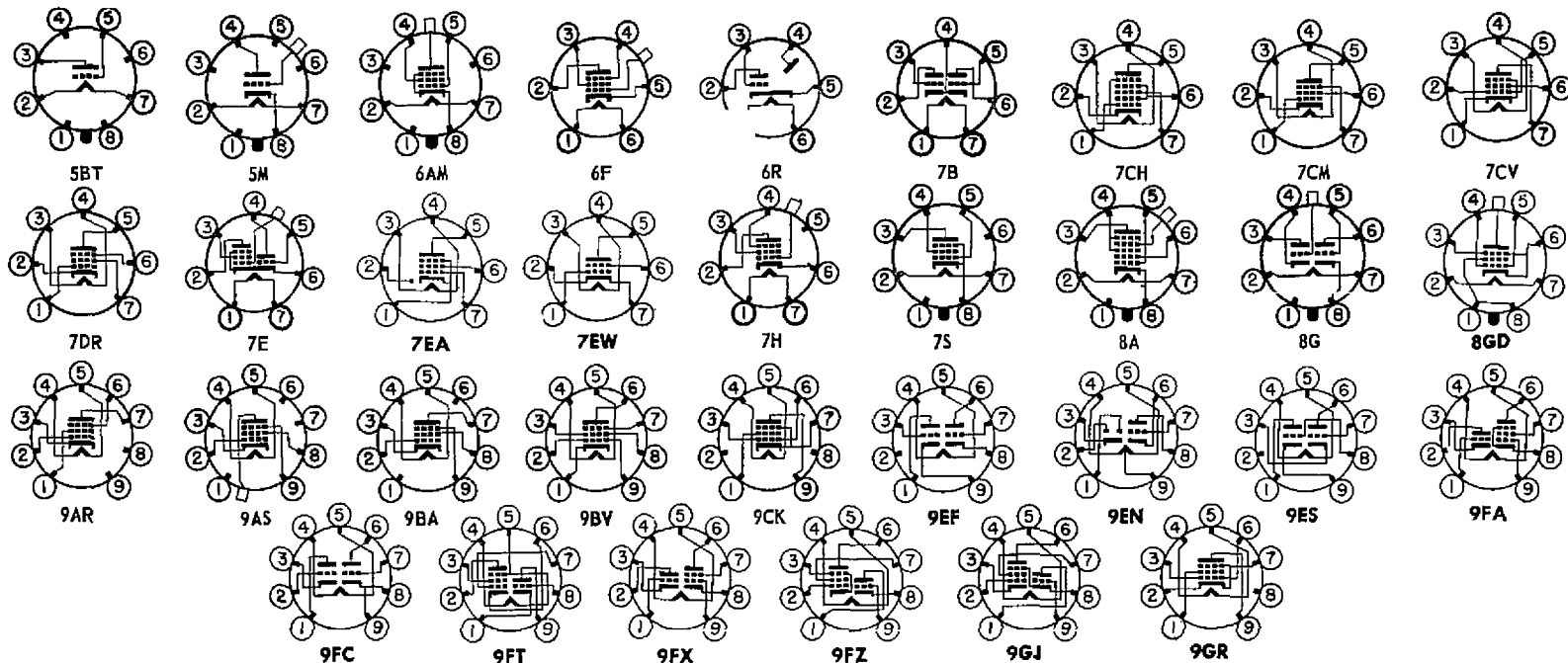



TYPE	DESIGN	CATHODE HTR OR FIL			BASING DATA	MAX SIZE VIEW	CAPACITIES			USED AS	PLATE VOLTS	GRID VOLTS	SCR VOLTS	PLATE MA	SCR MA	AMP FACT	PLATE RESIS OHMS	MUT COND mmho	OUT PUT WATTS	LOAD RESIS OHMS	CUT OFF VOLTS	TYPE
		TYPE	VOLTS	AMPS			G-P mmfds	IN mmfds	OUT mmfds													
6G5/6H5	ELEC RAY	HTR	6.3	0.3	6R-SS6	12BA				TUNING IND	250 THROUGH 1 MEG., TARGET 250 volts, GRID 0v FOR 90°, -22v FOR 0°											6G5/6H5
6G6G	PENTODE	HTR	6.3	.15	7S-OS7	12BA				POWR AMP CLASS A	180 135	-9 -6	180 135	15 11.5	2.5 2.0	400 360	.18MEG .17MEG	2300 2100	1.1 0.6	10000 12000		6G6G
6G6GT	PENTODE	HTR	6.3	.15	7S-MB9	9DB				PWR AMPLIFIER	180	-9	180	15	2.5		.175MEG	2300	1.1	10000		6G6GT
6H4GT	DIODE	HTR	6.3	.15	5AF-OGT5	9DB				DETECTOR	100	MAX		4 MAX		1000 AT .25ma					6H4GT	
6H6 6H6G 6H6GT	TWIN DIODE	HTR	6.3	.3	7Q-OW7 7Q-OS7 7Q-OW7	8BA 12BA 9BC	.1PP .1PP .1PP			DETECTOR	150	MAX		8 MAX EACH DIODE								6H6 6H6G 6H6GT
6J4	TRIODE	HTR	6.3	0.4	7BQ-MB7	5AC	0.24	5.5	4	VOLTAGE AMP	150	Rk 100		15		55				12000		6J4
6J5 6J5GT	TRIODE	HTR	6.3	.3	6Q-OW6 6Q-OW6	8BB 9BC	3.4 3.8*	3.4 4.2*	3.6 5.0*	AMPLIFIER CLASS A	250 90	-8 0		9.0 10.0		20 20	7700 6700	2600 3000				6J5 6J5GT
6J6	TWIN TRIODE	HTR	6.3	0.45	7BF-MB7	5AC	1.6	2.2	0.4	OSCILLATOR	100	-1		8.5		38	6000	5300				6J6
6J6A	TWIN TRIODE	HTR	6.3	0.45	7BF-MB7	5AC	1.6	2.2	0.4	OSCILLATOR	100	-1		8.5		38	6000	5300				6J6A
6J7 6J7G 6J7GT	PENTODE	HTR	6.3	.3	7R-OW7 7R-OS7 7R-OW7	8DA 12CA 9CA	.005 .005* .005*	7 4.6* 4.6*	12 12* 12*	AMP CL A PENT CONN TRI CONN	250 100 250	-3 -3 -8	100 100	2.0 2.0 6.5	0.5 0.5		1.5MEG 1.0MEG 10500	1225 1185 1900			-7 -7	6J7 6J7G 6J7GT
6J8G	TRIODE HEPTODE	HTR	6.3	.3	8H-OS8	12CA	.01*	4.6*	10.5*	OSC-TRIODE MIXER HEPT	250S 250	.05 MEG -3	100	5.0 1.2	2.9	TRIODE PLATE RESISTOR .02 MEG 4 MEG 290C					-20	6J8G
6K5G	TRIODE	HTR	6.3	.3	5U-OS7	12CA	2.0	2.4	3.6	AMP CL A	250	-3		1.1		70	50000	1400				6K5G
6K6GT	PENTODE	HTR	6.3	.4	7S-OGT7	9DB				POWER AMP CLASS A	315 250	-21 -18	250 250	25.5 32	4.0 5.5		75000 68000	2100 2300	4.5 3.4	9000 7600		6K6GT
6K7 6K7G 6K7GT	PENTODE	HTR	6.3	.3	7R-OW7 7R-OS7 7R-OW7	8DA 12CA 9CA	.005 .007* .005*	7 5* 4.6*	12 12* 12*	AMPLIFIER CLASS A	250 280 100	-3 -3 -1	125 100 100	10.5 7.0 9.5	2.6 1.7 2.7		.6 MEG .8 MEG .15MEG	1650 1450 1650			-52.5 -42.5 -38.5	6K7 6K7G 6K7GT
6K8 6K8G 6K8GT	TRIODE HEXODE	HTR	6.3	.3	8K-OW8 8K-OS8 8K-OW8	8EA 12CA 9CB	.03 .08* .08*	6.6 4.6* 4.6*	3.5 4.8* 4.8*	OSC-TRIODE MIXER HEX	100 250 100	.05MEG -3 -3	100 100	3.8 2.5 2.3	6.0 6.2		.6 MEG .4 MEG	3000 350C 325C	(TRIODE GRID 0v)		-30 -30	6K8 6K8G 6K8GT
6L5G	TRIODE	HTR	6.3	.15	6Q-OS6	12BA	2.7*	3*	5*	AMP CL A	250	-9		8		17	8900	1900			-20	6L5G
6L6 6L6G 6L6GA	BEAM PWR AMP	HTR	6.3	.9	7S-OW7 7S-OM8 7S-OM7	10AA 16AA 14BA				POWER AMP CLASS A PP CL A PP CL AB PP CL AB 2	350 250 270 360 360	-18 -14 -17.5 -22.5 -22.5	250 250 270 270 270	54 72 134 88 88	2.5 5.0 11 5 5		33000 22500 23500	5200 6000 5700	10.8 6.5 17.5 26.5 47	4200 2500 5000 6600 3800		6L6 6L6G 6L6GA
6L6GB	BEAM PENTODE	HTR	6.3	0.9	7AC-OM7	12GD	0.9	11.5	9.5	POWER AMP	SEE 6L6GA											6L6GB
6L7 6L7G	HEPTODE	HTR	6.3	.3	7T-OW7 7T-OS7	8DA 12CA	.001 .005*	7.5 6*	11 10*	AMP CL A MIXER	250 250	-3 -6	100 150	5.3 3.3	6.5 9.2	670 670	.6 MEG 1 MEG	1100 350C	G3 AT G3 AT	-3v -15v	-15 -45	6L7 6L7G
6M3	DIODE	HTR	6.3	3.0	8GU-OGT8	12CB	17.5	3.3	19.5	DAMPER	MAX PEAK INVERSE = 6000 volts MAX I <sub>o</sub> = 320 ma											6M3
6M5	PENTODE	HTR	6.3	.71	9N-MB9	5BD	1.0	10	6.2	PWR AMPLIFIER	250	Rk 170	250	36	5.2		.04MEG	10000	3.9	7000		6M5
6M8GT	DI-TRI PENTODE	HTR	6.3	0.6	8AU-OGT8	9EB	2.5 0.015	3.7 5.2	4.3 1.0	CL A TRIODE CL A PENTODE	100 100	-1 -3	100	0.5 8.5	2.7	100	91000 0.2MEG	1100 1900			-35	6M8GT
6N4	TRIODE	HTR	6.3	0.2	7CA-MB7	5AA	2.3	3.1	0.55	VOLTAGE AMP	180	-3.5		12		32		6000				6N4
6N5	ELEC RAY	HTR	6.3	0.15	6R-SS6	12BA				TUNING IND	135 THROUGH 0.25 MEG. TARGET 135 volts, GRID 0v FOR 90°, -12v FOR 0°											6N5
6N6G	DUO TRI	HTR	6.3	.8	7AU-OM7	14BA	DRIVER TRIODE OUTPUT TRIODE			DIR C'P'D AMP	300 300	0 +		8 45			24000	(SEE TYPE 6B5 ALSO)		2400 4 7000		6N6G

TYPE	DESIGN	CATHODE HTR OR FIL			BASING DATA	MAX SIZE VIEW	CAPACITIES			USED AS	PLATE VOLTS	GRID VOLTS	SCR VOLTS	PLATE MA	SCR MA	AMP FACT	PLATE RESIS OHMS	MUT COND mmho	OUT PUT WATTS	LOAD RESIS OHMS	CUT OFF VOLTS	TYPE	
		TYPE	VOLTS	AMPS			G-P mmfds	IN mmfds	OUT mmfds														
6N7 6N7G	TWIN TRIODE	HTR	6.3	.8	8B-OW8 8B-OM8	8FA 14BA	(SEE TYPE 6A6 ALSO)			POWER AMP CL B 2 SECT	300	0		35								6N7 6N7G	
6N8	DI-PENT	HTR	6.3	.3	9T-MB9	5BC	.002	4.0	4.6	RF-AM AMP	250	-2	85	5	1.75	1.6MEG	2200					6N8	
6P5G 6P5GT	TRIODE	HTR	6.3	.3	6Q-OS6 6Q-OGT6	12BA 9DB	2.6*	3.4*	5.5*	AMPLIFIER CLASS A	250 100	-13.5 -5		5 2.5		13.8 13.8	9500 12000	1450 1150				6P5G 6P5GT	
6P7G	TRIODE PENTODE	HTR	6.3	.3	7U-OS8	12CA	2.0* .008*	3.5* 3.5*	3.0* 12*	OSC-TRIODE MIXER PENT	100 250	-3	100	2.4 2.8	0.6							(SEE TYPE 6F7 ALSO)	6P7G
6Q5G	GAS TETRODE	HTR	6.3	0.6	6Q-OS8	12BA	2.8	1.7	2.0	THYRATRON	MAX PEAK FORWARD = 650 volts MAX PEAK ANODE CURRENT = 300 ma										6Q5G		
6Q7 6Q7G 6Q7GT	DUO- DIODE TRIODE	HTR	6.3	.3	7V-OW7 7V-OS7 7V-OW7	8DA 12CA 9CA	1.5 1.3 1.6*	5.5 2.7 2.2*	5.0 4.5 5.0*	AMPLIFIER CLASS A	250 100	-3 -1.0		1.0 0.8		70 70	58000 58000	1200 1200					6Q7 6Q7G 6Q7GT
6R6G	PENTODE	HTR	6.3	0.3	6AW-OS6	12CA	0.007	4.5	11	AMPLIFIER TELEVISION CIRCUITS	250	-3	100	7.0	1.7	1160	0.8MEG	1450			-42.5	6R6G	
6R7 6R7GT	DUO DI TRIODE	HTR	6.3	.3	7V-OW7 7V-OGT7	8DA 9EA	2.5	5.5	4.0	AMPLIFIER CLASS A	250	-9		9.5		16	8500	1900	.28	10000			6R7 6R7GT
6R8	TRIPLE DI TRIODE	HTR	6.3	.45	9E-MB9	5BB	2.4	1.5	1.1	DET-AMPLIFIER	250	-9		9.5		16	8500	1900	.300	10000			6R8
6S4 6S4A	TRIODE	HTR	6.3	.6	9AC-MB9	5BC 5BC				VERT AMP	250	-8		26		16	3600	4500				6S4 6S4A	
6S6GT	PENTODE	HTR	6.3	0.45	5AK-OGT5	9EC	0.01	7.0	4.6	VOLTAGE AMP	250	-2.0	100	13	3	0.35MEG	4000				-30	6S6GT	
6S7 6S7G	PENTODE	HTR	6.3	.15	7R-OW7 7R-OS7	8EA 12CA	.005 .008*	6.5 4.4*	10.5 8.0*	AMPLIFIER CLASS A	250 135	-3 -3	100 67.5	8.5 3.7	2.0 0.9	1 MEG 1 MEG	1750 1250				-38.5 -25	6S7 6S7G	

SEE PAGE 4 FOR DATA CHART REFERENCE NOTES

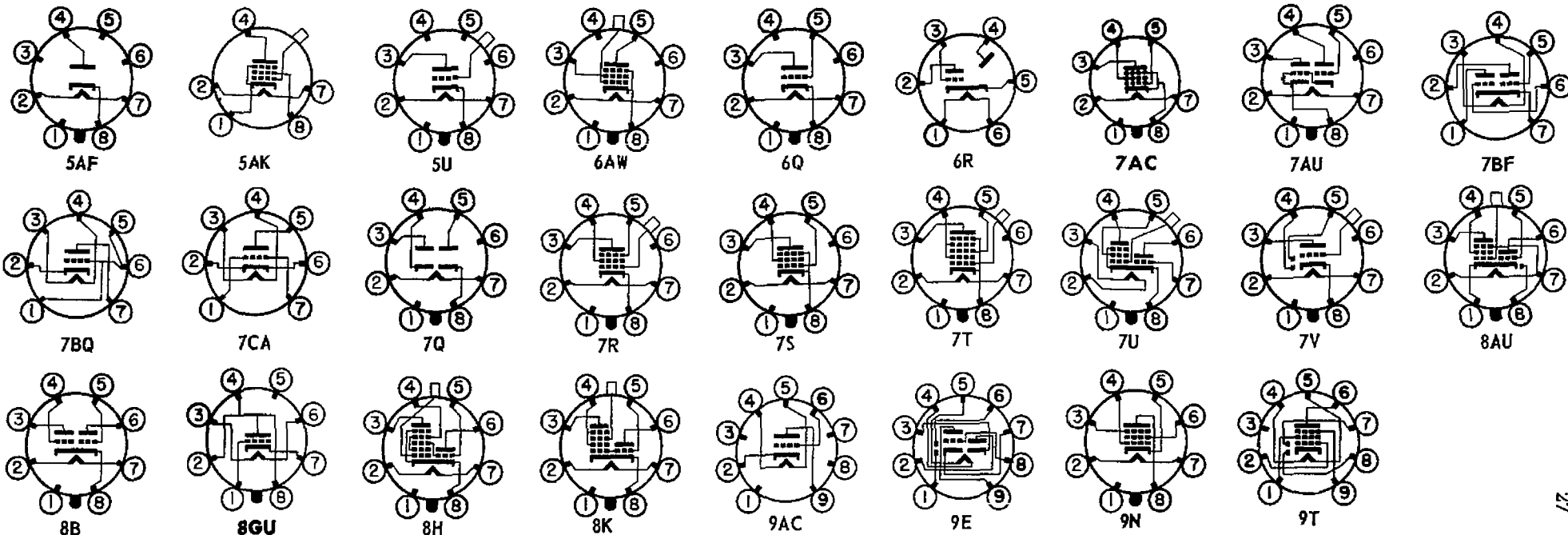



TYPE	DESIGN	CATHODE HTR OR FIL			BASING DATA	MAX SIZE VIEW	CAPACITIES			USED AS	PLATE VOLTS	GRID VOLTS	SCR VOLTS	PLATE MA	SCR MA	AMP FACT	PLATE RESIS OHMS	MUT COND mmho	OUT PUT WATTS	LOAD RESIS OHMS	CUT OFF VOLTS	TYPE
		TYPE	VOLTS	AMPS			G-P mmfd	IN mmfd	OUT mmfd													
6S8GT	TRIP-DI- TRI	HTR	6.3	0.3	8CB-OGT8	9EC				DET-AMP	250	-2.0		0.9		100						6S8GT
6SA7 6SA7GT	HEPTODE	HTR	6.3	.3	8R-OW8 8AD-OW8	8BB 9BC	.13 .20	9.5 11.0	12 12	OSC SECT MIXER	OSC GRID RES 250	-2	100	0.2 3.5	MEG	OSC GRID CUR 1.0 MEG	450C				-35	6SA7 6SA7GT
6SB7Y 6SB7GTY	PENTA- GRID	HTR	6.3	0.3	8R-OW8 8R-OGT8	8BB 9BC	0.13	9.6	9.2	CONVERTER	OSC GRID RES = 20000 OHMS 250	-1.0	100	3.8	10	OSC GRID CURR = 0.35 ma 1 MEG	950C				-20	6SB7Y 6SB7GTY
6SC7 6SC7GT	TWIN TRI	HTR	6.3	.3	8S-OW8 8S-OW8	8BB 9DB				CL A 1 SECT	250	-2		2		70	53000	1325				6SC7 6SC7GT
6SD7GT	PENTODE	HTR	6.3	.3	8N-OW8	9BC	.0035	9.0	7.5	AMP CL A	250 100	-2 -2	100 100	6.0 5.7	1.9 2.0	1.0MEG .25MEG	3600 3350				-11 -11	6SD7GT
6SE7GT	PENTODE	HTR	6.3	0.3	8N-OW8	9BC	0.005	8.0	7.5	AMP CL A	250	-1.5	100	4.5	1.5	1.0MEG	3100				-5	6SE7GT
6SF5 6SF5GT	TRIODE	HTR	6.3	.3	6AB-OW6 6AB-OGT6	8BB 9DB	2.6 2.6*	4.2 4.2*	3.8 3.8*	AMPLIFIER CLASS A	250 100	-2 -1		0.9 0.4		100 100	66000 85000	1500 1150				6SF5 6SF5GT
6SF7	DIODE PENTODE	HTR	6.3	.3	7AZ-OW8	8BB				AMP CL A	250 100	-1 -1	100 100	12.4 12.0	3.3 3.4	.7 MEG .2 MEG	2050 1975				-35 -35	6SF7
6SG7	PENTODE	HTR	6.3	.3	8BK-OW8	8BB				AMP CL A	250 100	-1 -1	125 100	11.8 8.2	4.4 3.2	.9 MEG .25MEG	4700 4100				-14 -11.5	6SG7
6SH7GT	PENTODE	HTR	6.3	0.3	8BK-OW8	9BC	0.003	8.5	7.0	AMPLIFIER CLASS A	250 100	-1 -1	150 100	10.8 5.3	4.1 2.1	0.9MEG 0.35MEG	4900 4000				-5.5 -4	6SH7GT
6SJ7 6SJ7GT	PENTODE	HTR	6.3	.3	8N-OW8 8N-OW8	8BB 9BC	.005	6.0	7.0	AMPLIFIER CLASS A	250 100	-3 -3	100 100	3.0 2.9	0.8 0.9	1.5MEG 0.7MEG	1650 1575				-9 -9	6SJ7 6SJ7GT
6SK7 6SK7GT	PENTODE	HTR	6.3	.3	8N-OW8 8N-OW8	8EA 9BC	.003 .005*	6.0 6.5*	7.0 7.5*	AMPLIFIER CLASS A	250 100	-3 -1	100 100	9.2 13.0	2.6 4.0	0.8MEG .12MEG	2000 2350				-35 -35	6SK7 6SK7GT
6SL7GT	TWIN TR	HTR	6.3	0.3	8BD-OGT8	9DB				CL A 1 SECT	250	-2		2.3		70	44000	1600				6SL7GT
6SN7GT	TWIN TR	HTR	6.3	.60	8BD-OGT8	9DB	4L 4R	3.2L 3.8R	3.4L 3.6R	CL A 1 SECT	250 90	-8 0		9 10		20 20	7700 6700	2600 3000				6SN7GT
6SN7GTA 6SN7GTB	DOUBLE TRIODE	HTR	6.3	.6	8BD-OS8	9DB 9DB	4.0	3.0	1.2	VERT. OSC-AMP	90 250	0 -8		10 9		20 20	6700 7700	3000 2600			-18	6SN7GTA 6SN7GTB
6SQ7 6SQ7GT	DUO-DI TRIODE	HTR	6.3	.3	8Q-OW8 8Q-OW8	8BB 9BC	1.8	4.2	3.4	AMPLIFIER CLASS A	250 100	-2 -1		0.9 0.4		100 100	91000 110000	1100 900				6SQ7 6SQ7GT
6SR7 6SR7GT	DUO-DI TRIODE	HTR	6.3	.3	8Q-OW8 8Q-OGT8	8BB 9DB	2.0 2.3*	3.4 3.5*	2.8 3.8*	AMP CL A	250	-9		9.5		16	8500	1900				6SR7 6SR7GT
6SS7 6SS7GT	PENTODE	HTR	6.3	0.15	8N-OW8 8N-OGT8	8BB 9BB	0.004	5.5	7.0	AMPLIFIER CLASS A	250 100	-3 -1	100 100	9.0 12.2	2.0 3.1	1.0MEG 0.12MEG	1850 1930				-35 -35	6SS7 6SS7GT
6ST7	DUO-DI TRIODE	HTR	6.3	0.15	8Q-OW8	8BB	1.5	2.8	3.0	AMP CL A	250	-9		9.5		16	8500	1900				6ST7
6SU7GTY	DOUBLE TRIODE	HTR	6.3	0.3	8BD-OGT8	9BC				VOLTAGE AMP	250	-2		2.3		70		1600				6SU7GTY
6SV7	DIODE- PENTODE	HTR	6.3	0.3	7AZ-OW8	8BB	.004	6.5	6.0	DET-AMP	250	-1	150	7.5	2.8	1.5MEG	3600				-7.0	6SV7
6SZ7	DOUBLE DI-TRI	HTR	6.3	0.15	8Q-OW8	8BB	1.1	2.6	2.8	DET-AMP	250	-3		1.0		70		1200				6SZ7
6T4	TRIODE	HTR	6.3	.225	ZDK-MB7	5AA	1.8	2.4	.45	UHF OSC	80	Rk 150		18		13		7000			-15	6T4
6T5	ELEC RAY	HTR	6.3	0.3	6R-SS6	9FD				TUNING IND	250 THRU 1 MEG, TARGET 250v, GRID 0v FOR MIN, -22v FOR MAX											6T5

SEE PAGE 4 FOR DATA CHART REFERENCE NOTES

TYPE	DESIGN	CATHODE HTR OR FIL			BASING DATA	MAX SIZE VIEW	CAPACITIES			USED AS	PLATE VOLTS	GRID VOLTS	SCR VOLTS	PLATE MA	SCR MA	AMP FACT	PLATE RESIS OHMS	MUT COND mmho	OUT PUT WATTS	LOAD RESIS OHMS	CUT OFF VOLTS	TYPE
		TYPE	VOLTS	AMPS			C-P mmfds	IN mmfds	OUT mmfds													
6T7G-6Q6G	DUO-DI TRIODE	HTR	6.3	.15	7V-OS7	12CA	1.3	2.7	4.5	AMPLIFIER CLASS A	240 135	-3 -1.5	1.2 0.9		65 65	62000 65000	1050 1000					6T7G-6Q6G
6T8 6T8A	TRIP-DI-TRI	HTR	6.3	0.45	9E-MB9	5BB 5BB	2.4	1.5	1.1	DET-AMP	250	-3	1.0		70		1200					6T8 6T8A
6U3	DIODE	HTR	6.3	.9	9BM-MB9	5BD				DAMPER	MAX PEAK INVERSE = 4000 V; MAX I <sub>o</sub> = 180ma										6U3	
6U4GT	DIODE	HTR	6.3	1.2	4CG-OGT5	9DB				DAMPER	MAX PEAK INVERSE = 3850 V; MAX I <sub>o</sub> = 138ma DC										6U4GT	
6U5/6G5	ELEC RAY	HTR	6.3	.3	6R-SS6	9FD				TUNING IND	250 THRU 1 MEG TARGET 250v, GRID 0v FOR 90°, -22v FOR 0° 100 THRU .5 MEG TARGET 100v, GRID 0v FOR 90°, -8v FOR 0°										6U5/6G5	
6U6GT	BEAM PWR AMP	HTR	6.3	.75	7S-OGT7	9DB				POWER AMP CLASS A	200 110	-14 -10.5	135 110	55 44	3 4	20000 10000	6200 5600	5.5 2.0	3000 2000			6U6GT
6U7G	PENTODE	HTR	6.3	.3	7R-OS7	12CB	.007*	5*	9*	AMP CL A	250 100	-3 -3	100 100	8.2 8.0	2.0 2.2	.8 MEG .25MEG	1600 1500				-50 -50	6U7G
6U8 6U8A	TRIODE PENTODE	HTR	6.3	.45	9AE-MB9	5BB 5BB	1.8* .01*	2.5* 5.0*	1.0* 2.6*	TRIODE SECT PENT SECT	150 250	Rk 56 Rk 68	18 10		40	.4 MEG	8500 5200				-12 -10	6U8 6U8A
6V3	DIODE	HTR	6.3	1.75	9BD-MB9	5CC				DAMPER	MAX PEAK INVERSE = 6000 V; MAX I <sub>o</sub> = 135ma DC										6V3	
6V4	DBLE DI	HTR	6.3	.6	9M-MB9	5BD				FW RECTIFIER	MAX PEAK INVERSE = 980 V; MAX I <sub>o</sub> = 90ma										6V4	
6V5GT	BEAM PENTODE	HTR	6.3	0.45	6AO-OGT8	9DB	0.6	9.0	10.0	POWER AMP	315	-13	225	35	6.0	77000	3750	5.5	8500			6V5GT
6V6 6V6GT	BEAM POWER AMP	HTR	6.3	.45	7S-OW7 7S-OW7	8FA 9DB				AMPLIFIER CLASS A PP CL AB	315 250 250 285	-13 -12.5 -15 -19	225 250 250 285	34 45 70 70	2.2 4.5 5.0 4.0	77000 52000 60000 65000	3750 4100 3750 3600	5.5 4.5 10 14	8500 5000 10000 8000			6V6 6V6GT
6V6GTA						9DB			2 TUBES													6V6GTA

SEE PAGE 4 FOR DATA CHART REFERENCE NOTES

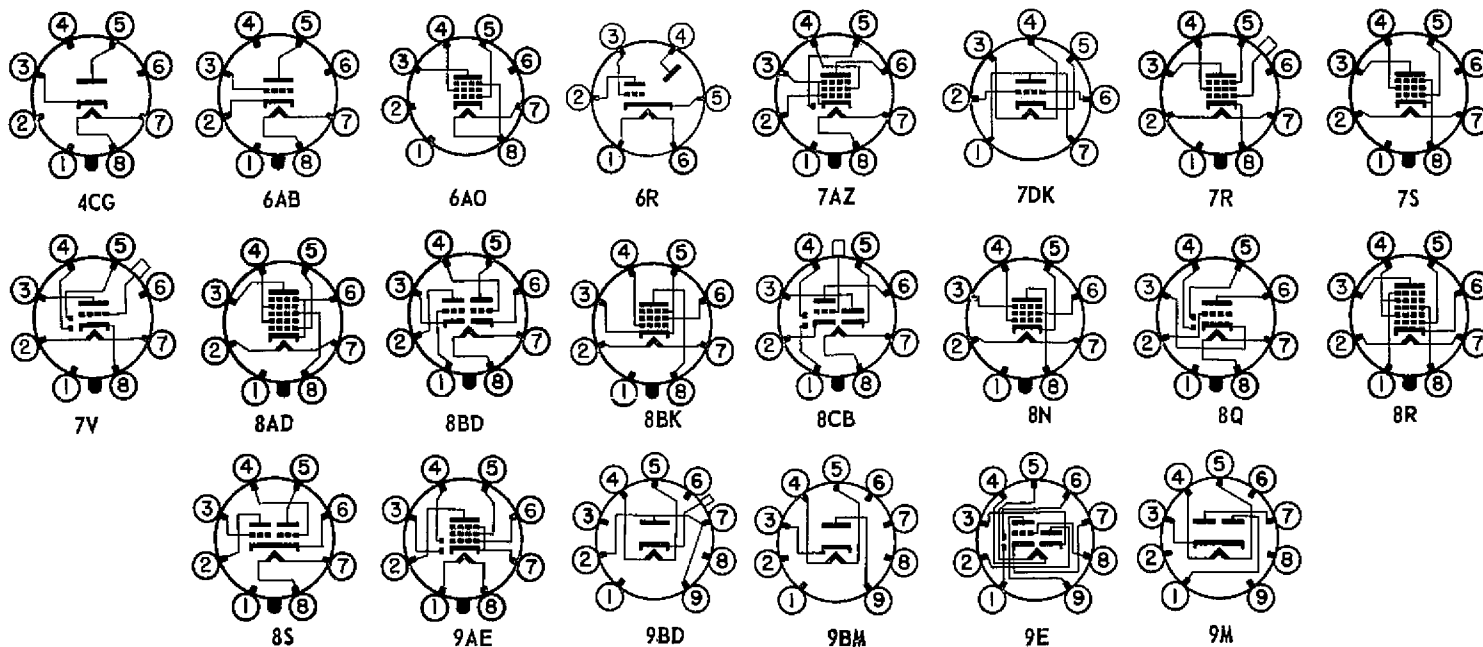



TYPE	DESIGN	CATHODE HTR OR FIL			BASING DATA	MAX SIZE VIEW	CAPACITIES			USED AS	PLATE VOLTS	GRID VOLTS	SCR VOLTS	PLATE MA	SCR MA	AMP FACT	PLATE RESIS OHMS	MUT COND mmho	OUT PUT WATTS	LOAD RESIS OHMS	CUT OFF VOLTS	TYPE
		TYPE	VOLTS	AMPS			G-P mmfds	IN mmfds	OUT mmfds													
6V7G	DUO-DI TRIODE	HTR	6.3	.3	7V-OS7	12CA	1.7	2.0	3.5	AMPLIFIER CLASS A	250 180	-20 -13.5		8 6		8.3 8.3	7500 8500	1100 975	.35 .16	20000 20000		6V7G
6V8	TRIPLE DI TRIODE	HTR	6.3	.45	9AH-MB9	5BB				DET-AMPLIFIER	100 250	-1 -3		.8 1.0		70 70	54000 58000	1300 1200				6V8
6W4GT	DIODE	HTR	6.3	1.2	4CG-OGT6	9DB				HW RECTIFIER	MAX PEAK INVERSE = 1250 volts, MAX I <sub>o</sub> = 125 ma										6W4GT	
6W5G	TWIN DI	HTR	6.3	.9	6S-OS6	12BA				FULL WAVE RECTIFIER	325 450	RMS MAX COND IN 90 DC MAX TUBE DROP 24v AT 90ma DC RMS MAX CHOKE IN 90 DC MAX										6W5G
6W6GT	TETRODE PWR AMP	HTR	6.3	1.25	7S-OGT7	9DB				AMPLIFIER CLASS A	135	-9.5	135	58	2.8	215	24000	9000	3.3	2000		6W6GT
6W7G	PENTODE	HTR	6.3	.15	7R-OS7	12CA	.007*	5.0*	8.5*	AMP CL A	250	-3	100	2.0	0.5		1.5MEG	1225			-7	6W7G
6X4	DOUBLE DIODE	HTR	6.3	0.6	5BS-MB7	5AD				FW RECTIFIER	MAX PEAK INVERSE = 1250 volts, MAX I <sub>o</sub> = 70 ma										6X4	
6X5 6X5GT	TWIN DIODE	HTR	6.3	.6	6S-OW6 6S-OGT6	8FA 9DB				FULL WAVE RECTIFIER	325 450	RMS MAX COND IN 70 DC MAX TUBE DROP 22v AT 70ma DC RMS MAX CHOKE IN 70 DC MAX										6X5 6X5GT
6X8 6X8A	TRIODE PENTODE	HTR	6.3	.45	9AK-MB9	5BB 5BB	1.4 0.6	2.6 4.5	1.0 1.2	TRIODE SECT PENTODE SECT	100 250	Rk 100 Rk 200		8.5 7.7	1.6	40	.65MEG	5800 4600			-10 -8	6X8 6X8A
6Y3G	DIODE	HTR	6.3	0.7	4AC-OS6	12CA				HW RECTIFIER	MAX PEAK INVERSE = 14000 volts, MAX I <sub>o</sub> = 7.5 ma										6Y3G	
6Y5	TWIN DIODE	HTR	6.3	.8	6J-SS6	12BA	(MERCURY VAPOR)			FULL WAVE RECTIFIER	325 450	RMS MAX COND IN 60 DC MAX TUBE DROP 20v AT 60ma DC RMS MAX CHOKE IN 60 DC MAX										6Y5
6Y6G 6Y6GA	BEAM PWR AMP	HTR	6.3	1.25	7S-OM7	14BA 12GD				POWER AMP CLASS A	200 135	-14 -13.5	135 135	61 58	2.2 3.5		18300 9300	7100 7000	6.0 3.6	2600 2000		6Y6G 6Y6GA
6Y7G	TWIN TRIODE	HTR	6.3	.6	8B-OS8	12BA				CL B AMP 2 SECTIONS	250 180	0 0		10.6 7.6	NO SIG NO SIG				8 5.5	14000 7000		6Y7G
6Z5	TWIN DIODE	HTR	12.6 or 6.3	.4 .8	6K-SS6	12BA				FULL WAVE RECTIFIER	325 450	RMS MAX COND IN 60 DC MAX TUBE DROP 20v AT 60ma DC RMS MAX CHOKE IN 60 DC MAX										6Z5
6Z7G	TWIN TRIODE	HTR	6.3	.3	8B-OS8	12BA				CL B AMP 2 SECTIONS	180 135	0 0		8.4 6.0	NO SIG NO SIG				4.2 2.5	12000 9000		6Z7G
6ZY5G	TWIN DI	HTR	6.3	.3	6S-OS6	12BA				FULL WAVE RECTIFIER	325 450	RMS MAX COND IN 40 DC MAX TUBE DROP 18v AT 40ma DC RMS MAX CHOKE IN 40 DC MAX										6ZY5G
7A4	TRIODE	HTR	6.3	.3	5AC-L8	9AC	4	3.4	3.0	AMPLIFIER CLASS A	250 90	-8 0		9 10		20 20	7700 6700	2600 3000				7A4
7A5	PENTODE	HTR	6.3	.75	6AA-L8	9AD				POWER AMP CLASS A	125 110	-9 -7.5	125 110	44.0 40.0	3.3 3.0		17000 14000	6000 5800	2.2 1.5	2700 2500		7A5
7A6	DUO-DI	HTR	6.3	.15	7AJ-L8	9AC	.05PP			DETECTOR	150	RMS MAX			8 DC MAX			TUBE DROP 11v AT 16ma DC				7A6
7A7	PENTODE	HTR	6.3	.3	8V-L8	9AC	.005	6.0	7.0	AMP CL A	250 100	-3 -1	100 100	9.2 13.0	2.6 4.0	1600 1600	.8 MEG .12MEG	2000 2350			-35 -35	7A7
7A8	OCTODE	HTR	6.3	.15	8U-L8	9AC	.15	7.5	9.0	OSC SECT MIXER	250S 250	.05MEG -3	100	4.2 3.0	3.2		GRID #2 RES .7 MEG	550C	.02 MEG		-30	7A8
7AB7	PENTODE	HTR	6.3	0.15	8BO-L8	9AB	.06	3.5	4.0	VOLTAGE AMP	250	-2	100	4.0	1.3		.05MEG	1800			-9	7AB7
7AD7	PENTODE	HTR	6.3	0.6	8V-L8	9AD	.03	11.5	7.5	VOLTAGE AMP	300	Rk 68	150	28	7.0		0.3MEG	9500				7AD7
7AF7	DOUBLE TRIODE	HTR	6.3	0.3	8AC-L8	9AC	2.3	2.2	1.6	VOLTAGE AMP	100	0		10.8		17		2600				7AF7
7AG7	PENTODE	HTR	6.3	0.15	8V-L8	9AC	0.005	7.0	6.0	VOLTAGE AMP	250	Rk 250	250	6.0	2.0		>1MEG	4200			-10	7AG7

SEE PAGE 4 FOR DATA CHART REFERENCE NOTES

TYPE	DESIGN	CATHODE HTR OR FIL			BASING DATA	MAX SIZE VIEW	CAPACITIES			USED AS	PLATE VOLTS	GRID VOLTS	SCR VOLTS	PLATE MA	SCR MA	AMP FACT	PLATE RESIS OHMS	MUT COND mmho	OUT PUT WATTS	LOAD RESIS OHMS	CUT OFF VOLTS	TYPE
		TYPE	VOLTS	AMPS			G-P mmfds	IN mmfds	OUT mmfds													
7AH7	PENTODE	HTR	6.3	0.15	8V-L8	9AC	0.005	7.0	6.5	VOLTAGE AMP	250	Rk 250	250	6.8	1.9	1MEG	3300			-20	7AH7	
7AJ7	PENTODE	HTR	6.3	0.3	8V-L8	9AC	0.007	6.0	6.5	VOLTAGE AMP	250	-3.0	100	2.2	0.7	>1MEG	1575			-8.5	7AJ7	
7AK7	PENTODE	HTR	6.3	0.8	8V-L8	9AD	0.7	12	9.5	GATING TUBE	150	0	90	40	21	11500	6500				7AK7	
7AU7	TWIN TRIODE	HTR	7.0	0.3	9A-MB9	5BB	1.5	1.6	0.4	AMPLIFIER	250	-8.5		10.5	17	7700	2200			-24	7AU7	
7B4	TRIODE	HTR	6.3	.3	5AC-L8	9AC	1.6*	3.6*	3.4*	AMP CL A	100 250	-1 -2		0.5 0.9	100 100	85000 66000	1175 1500				7B4	
7B5	PENTODE	HTR	6.3	.4	6AA-L8	9AD				POWER AMP CLASS A	315 100	-24 -7	250 100	25.5 9.0	4.0 1.6	75000 .1 MEG	2100 1500	4.5 .35	9000 12000		7B5	
7B6	DUO-DI TRIODE	HTR	6.3	.3	8W-L8	9AC	1.5	3.0	3.0	AMPLIFIER CLASS A	250 100	-2 -1		0.9 0.4	100 100	91000 110000	1100 900				7B6	
7B7	PENTODE	HTR	6.3	.15	8V-L8	9AC	.007	5.0	6.0	AMP CL A	250 100	-3 -3	100 100	8.5 8.2	1.7 1.8	.7 MEG .3 MEG	1700 1675			-40 -40	7B7	
7B8	HEPTODE	HTR	6.3	.3	8X-L8	9AC				OSC SECT MIXER	250S 100 250 100	.05MEG .05MEG -3 -1.5	100 50	4.0 2.0 3.5 1.1	2.7 1.3	GRID #2 RES .02 MEG .36MEG .6 MEG	550C 360C			-35 -20	7B8	
7C4/1203A	DIODE	HTR	6.3	0.150	4AH-L8	9AC	0.8	2.2	3.0	DETECTOR	117 MAX			5 MAX							7C4/1203A	
7C5	BEAM PWR AMP	HTR	6.3	.45	6AA-L8	9AD				AMPLIFIER CLASS A PP CL AB	315 250 250 285	-13 -12.5 -15 -19	225 250 250 285	34 45 70 70	2.2 4.5 5.0 4.0	77000 52000 60000 65000	3750 4100 3750 3600	5.5 4.5 10 14	8500 5000 10000 8000		7C5	
7C6	DUO-DI TRIODE	HTR	6.3	.15	8W-L8	9AC	1.4	2.4	3.0	AMPLIFIER CLASS A	250 100	-1 0		1.3 1.0	100 85	.1 MEG .1 MEG	1000 850				7C6	

SEE PAGE 4 FOR DATA CHART REFERENCE NOTES

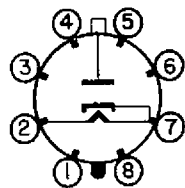

4AC

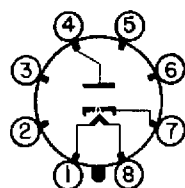

4AH

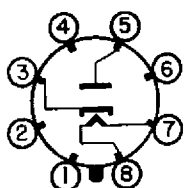

4CG

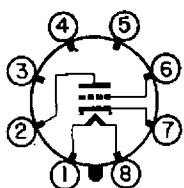

5AC

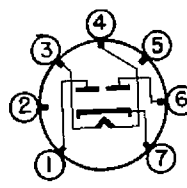

5B5

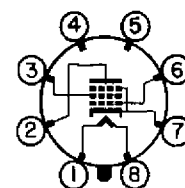

6AA

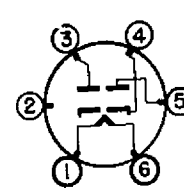

6J

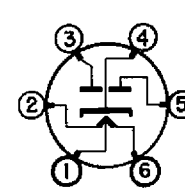

6K

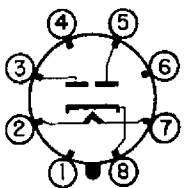

6S

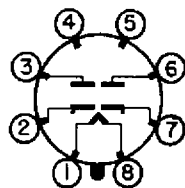

7AJ

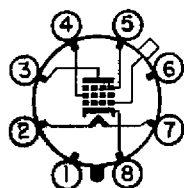

7R

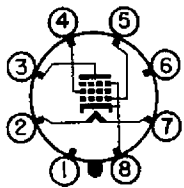

7S

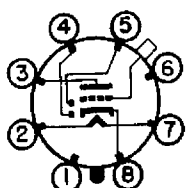

7V

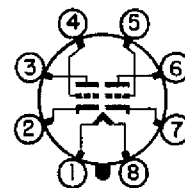

8AC

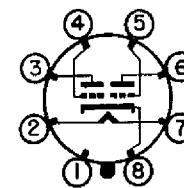

8B

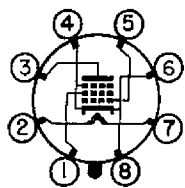

8B0

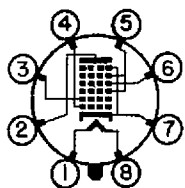

8U

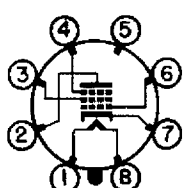

8V

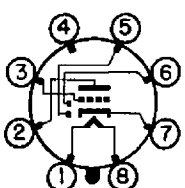

8W

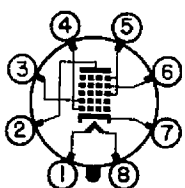

8X

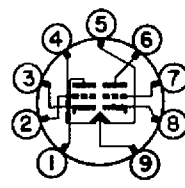

9A

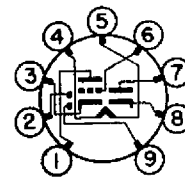

9AH

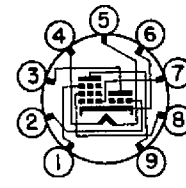

9AK





TYPE	DESIGN	CATHODE HTR OR FIL			BASING DATA	MAX SIZE VIEW	CAPACITIES			USED AS	PLATE VOLTS	GRID VOLTS	SCR VOLTS	PLATE MA	SCR MA	AMP FACT	PLATE RESIS OHMS	MUT COND mmho	OUT PUT WATTS	LOAD RESIS OHMS	CUT OFF VOLTS	TYPE		
		TYPE	VOLTS	AMPS			G-P mmfd	IN mmfd	OUT mmfd															
7C7	PENTODE	HTR	6.3	.15	8V-L8	9AC	.007*	5.5*	6.5*	AMPLIFIER CLASS A	250	-3	100	2.0	0.5		2 MEG	1300			-7	7C7		
7E5/1201	TRIODE	HTR	6.3	.150	8BN-L8	9AC	1.5	3.6	2.8	AMPLIFIER	180	-3.0		5.5		36	12000	3000				7E5/1201		
7E6	DUO-DI TRIODE	HTR	6.3	.3	8W-L8	9AC	1.5	3.0	3.4	AMP CL A	250	-9		9.5		16	8500	1900				7E6		
7E7	DUO-DI PENTODE	HTR	6.3	.3	8AE-L8	9AC	.005*	4.6*	4.6*	AMPLIFIER CLASS A	250 100	-3 -1	100 100	7.5 10.0	1.6 2.7		.7 MEG .15MEG	1300 1600			-42.5 -36.0	7E7		
7F7	TWIN TR	HTR	6.3	.3	8AC-L8	9AC				CL A 1 SECT	250	-2		2.3		70	44000	1600				7F7		
7F8	DOUBLE TRIODE	HTR	6.3	0.3	8BW-L8	9AB	1.2	2.8	1.4	VOLTAGE AMP	250	Rk 500		6.0		48		3300			Each Unit	7F8		
7G7/1232	PENTODE	HTR	6.3	.45	8V-L8	9AC	.007*	9.0*	7.0*	AMP CL A	250	-2	100	6.0	2.0		.8 MEG	4500			-6	7G7/1232		
7G8	DOUBLE TETRODE	HTR	6.3	0.3	8BV-L8	9AB	0.15	3.4	2.6	VOLTAGE AMP	250	-2.5	100	4.5	0.8		.225MEG	2100			Each Unit	7G8		
7H7	PENTODE	HTR	6.3	.3	8V-L8	9AC	.007*	8.0*	7.0*	AMP CL A	250 100	-2.5 -1	150 100	9.5 8.2	3.5 3.3		.8 MEG .25MEG	3800 3800			-19 -12	7H7		
7J7	TRI HEX	HTR	6.3	.3	8BL-L8	9AC	.01*	5.5*	7.5*	OSC-TRIODE MIXER HEX	250S 250	.05MEG -3		5.4 1.3			TRIODE PLATE RESISTOR 1.5MEG	.02 MEG 300C			-20	7J7		
7K7	DUO- DIODE PENTODE	HTR	6.3	.3	8BF-L8	9AC				AMPLIFIER CLASS A	250	-2		2.3		70	44000	1600				7K7		
7L7	DUO- DIODE PENTODE	HTR	6.3	.3	8V-L8	9AC	.01*	8.0*	6.5*	AMP CL A	250 100	-1.5 -1	100 100	4.5 5.5	1.5 2.4		1MEG .1MEG	3100 3000			-5 -5	7L7		
7N7	TWIN TRIODE	HTR	6.3	.6	8AC-L8	9AD	3.0L* 3.0R*	3.4L* 2.9R*	2.0L* 2.4R*	CL A 1 SECT	250 90	-8 0		9 10		20 20	7700 6700	2600 3000				7N7		
7Q7	HEPTODE	HTR	6.3	.3	8AL-L8	9AC	.2*	9.0*	9.0*	OSC SECT MIXER	OSC 250	GRID RES - -2	.02 MEG 100	3.5	8.5		OSC GRID CUR - 1.0MEG	5ma 550C			-35	7Q7		
7R7	DUO-DI PENTODE	HTR	6.3	.3	8AE-L8	9AC	.004	5.6	5.3	AMP CL A	250 100	-1 -1	100 100	5.7 5.5	1.7 2.0		1.0MEG .35MEG	3200 3000			-20 -16	7R7		
7S7	TRI HEX	HTR	6.3	0.30	8BL-L8	9AC	0.04	5.5	9.0	OSC-TRIODE MIXER HEX	250S 250	.05MEG -2		5.0 1.7			TRIODE 2 MEG	PLATE RESISTOR 600C	.02 MEG		-21	7S7		
7T7	PENTODE	HTR	6.3	0.3	8V-L8	9AC	0.005	7.5	5.5	AMP CL A	250 100	-1 -1	150 100	10.8 5.3	4.1 2.1		0.9MEG 0.3MEG	4900 4000			-5.5 -4.0	7T7		
7V7	PENTODE	HTR	6.3	0.45	8V-L8	9AC	0.004	9.5	6.5	HIGH FREQ AMPLIFIER	300	-2	150	9.6	3.9		.3MEG	5800			-6	7V7		
7W7	PENTODE	HTR	6.3	0.45	8BI-L8	9AC	0.0025	9.5	7.0	HIGH FREQ AMPLIFIER	300 300	-2 -2	150 300	10.0 THRU .04 MEG	3.9		.3MEG	5800			-6 -14	7W7		
7X7	DOUBLE DI-TRI	HTR	6.3	0.3	8BZ-L8	9AD				DET-AMP	250	-1		1.9		100		1500				7X7		
7X6	DBLE-DI	HTR	6.3	1.2	7AJ-L8	9AD				FW RECTIFIER	MAX PEAK INVERSE = 700 V; MAX I <sub>b</sub> = 150ma													7X6
7Y4	TWIN DI	HTR	6.3	.5	5AB-L8	9AC				FW RECTIFIER	325 RMS MAX COND IN 60 DC MAX TUBE DROP 20v AT 60ma DC 450 RMS MAX CHOKE IN 60 DC MAX													7Y4
7Z4	TWIN DI	HTR	6.3	0.90	5AB-L8	9AD				FW RECTIFIER	325 RMS MAX COND IN 100 DC MAX TUBE DROP 40v AT 60ma DC 450 RMS MAX CHOKE IN 100 DC MAX													7Z4
8AU8	TRIODE PENTODE	HTR	8.4	0.45	9DX-MB9	5BC	2.2 0.046	2.8 7.0	0.32 2.6	AMPLIFIER	150 200	Rk 150 Rk 82	125	8.5 15	3.4		8200 150000				-6.5 -8	8AU8		
8AW8A	TRIODE PENTODE	HTR	8.4	0.45	9DX-MB9	5AD	2.2 0.04	3.2 10.0	0.32 3.6	SYNCH SEP AMPLIFIER	200	-2	150	4.0 13.0	3.5	70	0.4MEG	4000 9000			-5 -10	8AW8A		

SEE PAGE 4 FOR DATA CHART REFERENCE NOTES

TYPE	DESIGN	CATHODE HTR OR FIL			BASING DATA	MAX SIZE VIEW	CAPACITIES			USED AS	PLATE VOLTS	GRID VOLTS	SCR VOLTS	PLATE MA	SCR MA	AMP FACT	PLATE RESIS OHMS	MUT COND mmho	OUT PUT WATTS	LOAD RESIS OHMS	CUT OFF VOLTS	TYPE
		TYPE	VOLTS	AMPS			G-P mmfds	IN mmfds	OUT mmfds													
8BA8 8BA8A	TRIODE PENTODE	HTR	8.4	0.45	9DX-MB9	5BC 5BC	2.2 0.04	2.5 10.0	0.4 3.6	AMP CL A	200 200	-8	150	8.0 13.0	3.5	18	0.4MEG	2700 9000			-16 -10	8BA8 8BA8A
8BN8	DBLE DI TRIODE	HTR	8.4	0.45	9ER-MB9	5AD	2.5	3.6	0.32	AMPLIFIER	250	-3		1.6		70	28000	2500			-5.5	8BN8
8CG7	TWIN TRIODE	HTR	8.4	0.45	9AJ-MB9	5AD	4.0	2.3	2.2	OSCILLATOR	250	-8		9		20	7700	2600			-18	8CG7
8CM7	DOUBLE TRIODE	HTR	8.4	0.45	9ES-MB9	5AD	3	3.5	0.4	OSCILLATOR AMPLIFIER	200 250	-7 -8				21	10500	2000 4400				8CM7
8CN7	DBLE DI TRIODE	HTR	8.4	0.225	9EN-MB9	5BB	1.8	1.5	0.5	DETECTOR	100 250	-1.0 -3.0		0.8 1.0		70	54000 58000	1300 1200				8CN7
8CS7	TWIN TRIODE	HTR	8.4	0.45	9EF-MB9	5AD	2.6	1.8	0.5	OSCILLATOR AMPLIFIER	250	-8.5 -10.5		10.5 19.0		17.0 15.5	7700 3450	2200 4500			-22	8CS7
8SN7GTB	DOUBLE TRIODE	HTR	8.4	0.45	8BD-0S8	9DB	4.0	3.0	1.2	VERTICAL OSC-AMP	90 250	0 -8		10 9		20 20	6700 7700	3000 2600			-18	8SN7GTB
9AU7	TWIN TRIODE	HTR	9.4	0.225	9A-MB9	5BB	1.5	1.6	0.4	AMPLIFIER	250	-8.5		10.5		17	7700	2200			-24	9AU7
9BM5	BM PENT	HTR	9.5	.3	7BZ-MB7	5AD	.5	8.0	5.5	POWER AMP	250	-6	250	30	3		60000	7000	3.5	7000		9BM5
9BW6	BM PENT	HTR	9.45	.3	9AM-MB9	5BC				POWER AMP	250	-13	250	34	2.2		77000	3750	5.5	8500		9BW6
9CL8	TRIODE TETRODE	HTR	9.5	0.3	9FX-MB9	5BB	1.8 0.028	2.7 5.0	0.4 2.0	OSCILLATOR MIXER	125	-1.0	125	15 12	4.0	40	0.1MEG	8000 5800			-9 -10	9CL8
9U8A	TRIODE PENTODE	HTR	9.45	0.3	9AE-MB9	5BB	1.8 0.01	2.5 5.0	1.0 2.6	TRIODE SECT PENTODE SECT	150 250	Rk 56 Rk 68		18 10	3.5	40	0.4MEG	8500 5200			-12 -10	9U8A
10	TRIODE	FIL	7.5	1.25	4D-SM4	16AA	7	4	3	POWER AMP CLASS A	425 350	-39 -22.0		18 10		8 8	5000 6000	1600 1330	1.6 0.4	10200 13000		10

SEE PAGE 4 FOR DATA CHART REFERENCE NOTES

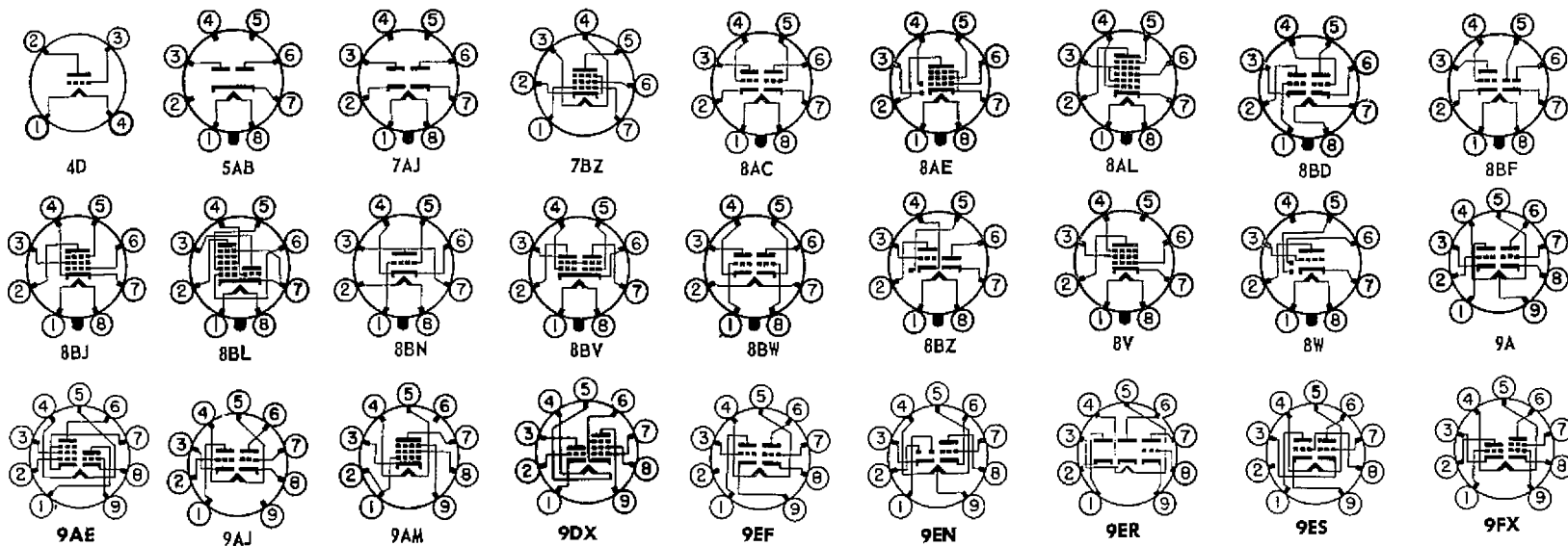



TYPE	DESIGN	CATHODE HTR OR FIL			BASING DATA	MAX SIZE VIEW	CAPACITIES			USED AS	PLATE VOLTS	GRID VOLTS	SCR VOLTS	PLATE MA	SCR MA	AMP FACT	PLATE RESIS OHMS	MUT COND mmho	OUT PUT WATTS	LOAD RESIS OHMS	CUT OFF VOLTS	TYPE		
		TYPE	VOLTS	AMPS			G-P mmfds	IN mmfds	OUT mmfds															
10CL8	TRIODE PENTODE	HTR	10.5	0.3	9DA-MB9	5BB	1.6 0.04	2.4 7.0	0.20 2.2	OSCILLATOR AMPLIFIER	250 135	Rk 100	13.5	7.3 11.5	3.2	53	0.2MEG	4400 8000			-10 -6	10CL8		
10DA7	DOUBLE TRIODE	HTR	10.5	0.6	9EF-MB9	5BC	2.3 6.9	2.0 5.5	0.415 0.82	OSCILLATOR AMPLIFIER	250 150	-8 -17.5		9.0 40		20 6.3	7700 1100	2600 5700			-42	10DA7		
12A	TRIODE	FIL	5.0	.25	4D-SM4B	14BA	7.5	4.0	3.0	AMPLIFIER CLASS A	180 135	-13.5 -9		7.7 6.2		8.5 8.5	4700 5100	1800 1650	.285 .130	10650 9000		12A		
12A4	TRIODE	HTR	12.6#	.3	9AG-MB9	5BC	4.9	6.7	3.8	VERT. AMP	MAX PEAK POS. PLATE = 1000 V; MAX DC CATHODE CURR. = 30ma MAX PLATE DISSIPATION = 6.5 watts													12A4
12A5	PENTODE	HTR	12.6#	.3	7F-SS7	12BA				POWER AMP CLASS A	180 100	-25 -15	180 100	45 17	8 3		35000 50000	2400 1700	3.4 .08	3300 4500		12A5		
12A6GT	BEAM PWR AMP	HTR	12.6	0.15	7S-OGT7	9DB	0.6	9.0	9.0	AMPLIFIER CLASS A	250	-12.5	250	30	3.5		3000	3.0	7500			12A6GT		
12A7	DIODE PENTODE	HTR	12.6	.3	7K-SS7	12DA				H W RECT AMP CL A	125 RMS MAX 135	-13.5	135	30 DC MAX 9	2.5	100	TUBE DROP 15v AT 60ma DC .1 MEG 975	.55	13500			12A7		
12A8GT	HEPTODE	HTR	12.6	.15	8A-OW8	9CA	2.6*	9.5*	12*	OSC SECT MIXER	250S 100 250 100	.05MEG .05MEG -3 -1.5	100 50	4.0 2.0 3.5 1.1	2.7 1.3		GRID #2 RES .02 MEG .36MEG 550C .6 MEG 360C			-35 -20	12A8GT			
12AB5	BM PENT	HTR	12.6	0.225	9EU-MB9	5AD	0.7	8.0	8.5	POWER AMP	250	-12.5	250	47	7		50K	4100		5000		12AB5		
12AC6	PENTODE	HTR	12.6	0.15	7BK-MB7	5AC	0.005	4.3	5.0	AMPLIFIER	12.6	0	12.6	550	28		0.5MEG	730			-5.2	12AC6		
12AD6	HEPTODE	HTR	12.6	0.15	7CH-MB7	5AC	0.25	8.0	5.5	OSCILLATOR MIXER	12.6	0	12.6			9		3800			-4.0	12AD6		
12AD7	DBLE TRI	HTR	12.6	0.225	9A-MB9	5BB	1.8	1.6	0.45	PREAMP	250	-2		1.25		100	62500	1600				12AD7		
12AE6	DI TRI	HTR	12.6	0.15	7DT-MB7	5AC	2.0	1.8	1.1	DET-AMP	12.6	0	12.6	750		15	15000	1000				12AE6		
12AF6	PENTODE	HTR	12.6	0.15	7BK-MB7	5AC	0.006	5.5	4.8	RF AMPLIFIER	12.6	0	12.6	0.8	0.3		0.3MEG	1250			-2.7	12AF6		
12AG6	HEPTODE	HTR	12.6	0.15	7CH-MB7	5AC	0.065	7.5	5.5	CONVERTER	12.6	0	12.6	0.55	1.4		300				-2.0	12AG6		
12AH7GT	TWIN TR	HTR	12.6	.150	8BE-OGT8	9BC	3.0L 2.2R	2.9L 3.2R	2.6L 3.0R	CL A 1 SECT	250 100	-9 -3.6		12 3.7		16 16	6600 10300	2400 1550			-30.0 -8.5	12AH7GT		
12AH8	TRIODE HEPTODE	HTR	12.6#	.15	9BP-MB9	5BC		1.7 5.0	.7 8.0	TRIODE SECT HEPTODE SECT	100 250	.047MEG -3	100	2.6	4.4		550C				-22	12AH8		
12AL5	DOUBLE DIODE	HTR	12.6	0.15	6BT-MB7	5AA			3.2	DISCRIMINATOR	MAX PEAK INVERSE = 330 volts, MAX I <sub>o</sub> = 9 ma dc PER PLATE													12AL5
12AQ5	BM PENT	HTR	12.6	.225	7BZ-MB7	5AD	.35	8.3	8.2	POWER AMP	180 250	-8.5 -12.5	180 250	29 45	3 4.5		58000 52000	3700 4100	2.0 4.5	5500 5000		12AQ5		
12AS5	BM PENT	HTR	12.6	.4	7CV-MB7	5AD	.6	12	6.2	POWER AMP	150	-8.5	110	35	2			5600	2.2	4500		12AS5		
12AT6	DOUBLE DI-TRI	HTR	12.6	0.15	7BT-MB7	5AC	2.1	2.3	1.1	DET-AMP	250 100	-3 -1		1.0 0.8		70 70	1200 1300					12AT6		
12AT7	DOUBLE TRIODE	HTR	12.6#	0.15	9A-MB9	5BB	1.45	2.5	0.45	VOLTAGE AMP	250 100	-2 -1		10 3.7		55 54	5500 4000			-12 -6	12AT7			
12AU6	PENTODE	HTR	12.6	0.15	7BK-MB7	5AC	.0035	5.5	5.0	VOLTAGE AMP	250 100	-1 -1	150 100	10.8 5.2	4.3 2.0		1 MEG 0.5MEG	5200 3900			-6.2 -4.2	12AU6		
12AU7	DOUBLE TRIODE	HTR	12.6#	0.15	9A-MB9	5BB	1.5	1.6	0.5	VOLTAGE AMP	250 100	-8.5 0		10.5 11.8		17 19.5	2200 3100					12AU7		
12AU7A						5BB																12AU7A		
12AV5GA	BM PENT	HTR	12.6	0.6	6CK-OM6	11AB	0.5	14	7.0	AMPLIFIER	250	-22.5	150	57	2.1		14500	5900			-43	12AV5GA		

SEE PAGE 4 FOR DATA CHART REFERENCE NOTES

TYPE	DESIGN	CATHODE HTR OR FIL			BASING DATA	MAX SIZE VIEW	CAPACITIES			USED AS	PLATE VOLTS	GRID VOLTS	SCR VOLTS	PLATE MA	SCR MA	AMP FACT	PLATE RESIS OHMS	MUT COND mmho	OUT PUT WATTS	LOAD RESIS OHMS	CUT OFF VOLTS	TYPE				
		TYPE	VOLTS	AMPS			G-P mmfds	IN mmfds	OUT mmfds																	
12AV6	DOUBLE DI-TRI	HTR	12.6	0.15	7BT-MB7	5AC	2.1	2.3	0.9	DET-AMP	250 100	-2 -1	1.2 0.5		100 100		1600 1250					12AV6				
12AV7	TWIN TRIODE	HTR	12.6#	.225	9A-MB9	5BB	1.9	3.1	.5	AMP CL A	100 150	Rk 120 Rk 56	9 18		37 41		6100 8500			-9 -12		12AV7				
12AW6	PENTODE	HTR	12.6	0.15	7CM-MB7	5AC	0.025	6.5	1.5	VOLTAGE AMP	250 100	Rk 200 Rk 100	150	7.0 5.5	2.0 1.6		0.8MEG 0.3MEG	5000 4750			-8 -5		12AW6			
12AX4GT 12AX4GTA	DIODE	HTR	12.6	.6	4CG-OS6	9DB 9DB				DAMPER	MAX PEAK INVERSE = 4000 V; MAX I <sub>o</sub> = 125ma														12AX4GT 12AX4GTA	
12AX7	DOUBLE TRIODE	HTR	12.6#	0.15	9A-MB9	5BB	1.7	1.6	0.46	VOLTAGE AMP	250 100	-2 -1	1.2 0.5		100 100		1600 1250						12AX7			
12AY7	DOUBLE TRIODE	HTR	12.6#	0.15	9A-MB9	5BB	1.3	1.3	0.6	VOLTAGE AMP	250	-4	3.0		40		1750						12AY7			
12AZ7	TWIN TRIODE	HTR	12.6#	.225	9A-MB9	5BB	1.9	3.1	.5	AMP CL A	100 250	Rk 100 Rk 200	3.7 10		60 60		4000 5500			-5 -12		12AZ7				
12B4 12B4A	TRIODE	HTR	12.6#	.3	9AG-MB9	5BC 5BC	4.3	6.4	7.0	VERT. AMP	MAX PEAK POS. PULSE PLATE = 1000 V; MAX PLATE DISS. = 6 WATTS															12B4 12B4A
12B8GT	TRIODE PENTODE	HTR	12.6	.3	8T-OGT8	9EB	2.3 0.15	5.0 5.2	6.3 9.6	AMP TRIODE CLASS A AMP PENT CLASS A	100 90 100 90	-1 0 -3 -3	0.6 2.8 8 7		110 90 360 360	73000 37000 .17MEG .20MEG	1500 2400 2100 1800			-2.5 -2.5 -42.5			12B8GT			
12BA6	PENTODE	HTR	12.6	0.15	7BK-MB7	5AC	.0035	5.5	5.0	VOLTAGE AMP	250 100	Rk 68 Rk 68	100 100	11.0 10.8	4.2 4.4		1.5MEG 0.25MEG	4400 4300			-20 -20		12BA6			
12BA7	PENTA-GRID	HTR	12.6	0.15	8CT-MB9	5BC	0.19	9.5	8.3	CONVERTER	250 100	-1 -1	100 100	3.8 3.6	10 10.2		1 MEG 0.5MEG	950C 900C			-20 -20		12BA7			

SEE PAGE 4 FOR DATA CHART REFERENCE NOTES

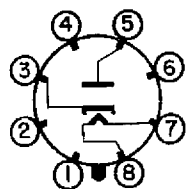

4CG

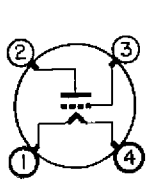

4D

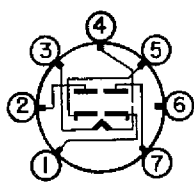

6BT

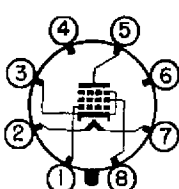

6CK

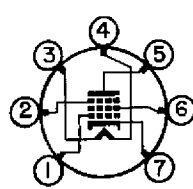

7BK

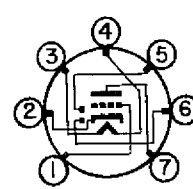

7BT

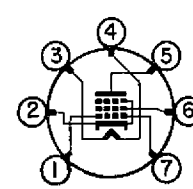

7BZ

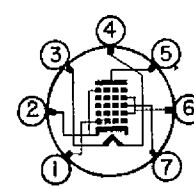

7CH

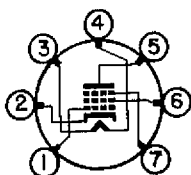

7CM

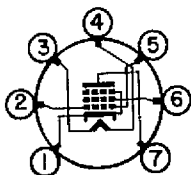

7CV

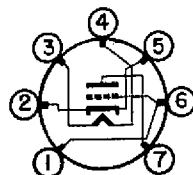

7DT

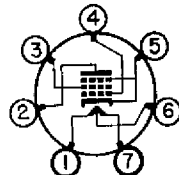

7F

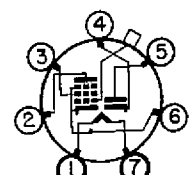

7K

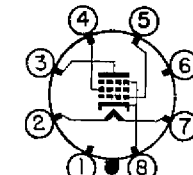

7S

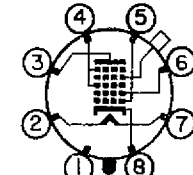

8A

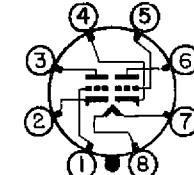

8BE

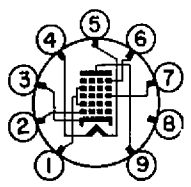

8CT

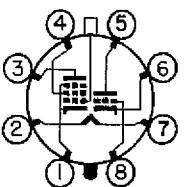

8T

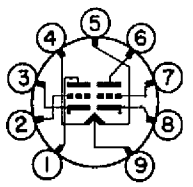

9A

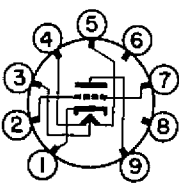

9AG

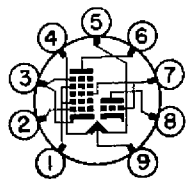

9BP

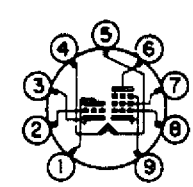

9DA

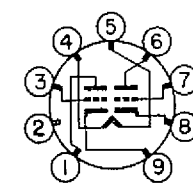

9EF

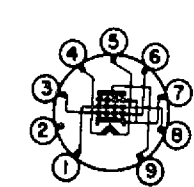

9EU



TYPE	DESIGN	CATHODE HTR OR FIL			BASING DATA	MAX SIZE VIEW	CAPACITIES			USED AS	PLATE VOLTS	GRID VOLTS	SCR VOLTS	PLATE MA	SCR MA	AMP FACT	PLATE RESIS OHMS	MUT COND mmho	OUT PUT WATTS	LOAD RESIS OHMS	CUT OFF VOLTS	TYPE
		TYPE	VOLTS	AMPS			G-P mmfda	IN mmfda	OUT mmfda													
12BD6	PENTODE	HTR	12.6	0.15	7BK-MB7	5AC	0.004	4.3	5.0	VOLTAGE AMP	250 100	-3 -1	100 100	9 13	3 5	0.8MEG 0.15MEG	2000 2550			-35 -35	12BD6	
12BE6	PENTA- GRID	HTR	12.6	0.15	7CH-MB7	5AC	0.3	7.2	8.6	CONVERTER	250 100	-1.5 -1.5	100 100	3 2.8	7.1 7.3	1 MEG 0.5MEG	475C 485C			-30 -30	12BE6	
12BF6	DOUBLE- DI TRI	HTR	12.6	0.15	7BT-MB7	5AC	2	1.8	1.4	DET-AMP	250	-9		9.5			1900				12BF6	
12BH7 12BH7A	TWIN TRIODE	HTR	12.6#	.3	9A-MB9	5BC 5BC	2.4	3.3	.8	VERT. AMP	MAX PEAK POS. PULSE PLATE = 1500 V; MAX PLATE DISS. = 3.5 WATTS										12BH7 12BH7A	
12BK5	BM PENT	HTR	12.6	0.6	9BQ-MB9	5BC	0.6	13	5.0	POWER AMP	250	-5.0	250	35	3.5	0.1MEG	8500	3.5	6500		12BK5	
12BK6	DBLE DI TRIODE	HTR	12.6	.15	7BT-MB7	5AD				DET.-AMP	100 250	-1 -2		.5 1.2			1250 1600				12BK6	
12BN6	GATED BM	HTR	12.6	.15	7DF-MB7	5AD				DISCRIMINATOR	80	Input sig. center freq. = 10.7 Mc; Freq. Dev. = ± 75 kc										12BN6
12BQ6GA 12BQ6GTA	BEAM PENTODE	HTR	12.6	0.6	6AM-OGT6	11BB 9EC	0.6	15	7.5	POWER AMPLIFIER	250	-22.5	150	55	2.1	20000	5500			-46	12BQ6GA 12BQ6GTA	
12BQ6GTR						9EC										18000	6000				12BQ6GTR	
12BR7	DBLE DI TRIODE	HTR	12.6	0.225	9CF-MB9	5BB	1.9	2.8	1.0	CL A AMP	250	Rk 200		10		60	10900	5500		-12	12BR7	
12BT6	DBLE DI TRIODE	HTR	12.6	.15	7BT-MB7	5AD				DET.-AMP	100 250	-1 -3		.8 1.0		70 70	1300 1200				12BT6	
12BU6	DBLE DI TRIODE	HTR	12.6	.15	7BT-MB7	5AD				DET.-AMP	250	-9		9.5			1900	.300	10000		12BU6	
12BV7	PENTODE	HTR	12.6	6.3	9BF-MB9	5BC	0.055	11.0	3.0	AMPLIFIER	250	Rk 68	150	27	6.0	10000	85000	13000		-12	12BV7	
12BW4	DBLE DI	HTR	12.6	0.45	9DJ-MB9	5AD				FW RECTIFIER	MAX PEAK INVERSE = 1275 volts					MAX I <sub>o</sub> = 35					12BW4	
12BY7 12BY7A	PENTODE	HTR	12.6#	.3	9BF-MB9	5BC 5BC	.055	11.1	3	VIDEO AMP	250	Rk 68	150	25	6	90000	12000			-10	12BY7 12BY7A	
12BZ7	TWIN TRIODE	HTR	12.6#	.3	9A-MB9	5BC	2.5	6.5	.7	AMP CL A	250	-2		2.5		100	3200				12BZ7	
12C5	BM PENT	HTR	12.6	0.6	7CV-MB7	5AD	0.5	13	6.5	POWER AMP	110	-7.5	110	50	8.5	14000	7500	1.9	2500		12C5	
12C8	DUO-DI PENTODE	HTR	12.6	.15	8E-OW7	8FA	.005	6	9	AMPLIFIER CLASS A	250 100	-3 -3	125 100	10 5.8	2.3 1.7	.6 MEG .3 MEG	1325 950			-21 -17	12C8	
12CA5	BM PENT	HTR	12.6	0.6	7CV-MB7	5AD	0.5	15	9	AF AMPLIFIER	125	-4.5	125	36	4.0	15000	9200		4500		12CA5	
12CM6	BM PENT	HTR	12.6	.225	9CK-MB9	5BC	.7	8	8.5	VERT. AMP	MAX PEAK POS. PLATE = 2000 V; MAX PEAK I <sub>k</sub> = 120ma MAX PLATE DISS. = 8 WATTS										12CM6	
12CN5	PENTODE	HTR	12.6	0.45	7CV-MB7	5AD	0.25			IF AMPLIFIER	12.6	0	12.6	4.5	3.5	40000	3800				12CN5	
12CR6	DI PENT	HTR	12.6	0.15	7EA-MB7	5AC				DET-AMP	250	-2	100	9.6	2.6	0.8MEG	2200			-32	12CR6	
12CS5	BM PENT	HTR	12.6	0.6	9CK-MB9	5BC	0.5	15	9	AMPLIFIER	110	-7.5	110	50	10	13000	8000		2000		12CS5	
12CS6	HEPTODE	HTR	12.6	0.15	7CH-MB7	5AC	0.05	5.5	7.5	CL A AMP	100	-1.0	30	0.75	1.1	1MEG	950			-2.5	12CS6	
12CT8	TRIODE PENTODE	HTR	12.6	0.3	9DA-MB9	5BB	2.2 0.044	2.4 7.5	0.19 2.4	AMPLIFIER	150 200	Rk150	125	9.0 15.0	3.4	40	0.15MEG	4900 7000			-6.5 -8	12CT8
12CU5	BM PENT	HTR	12.6	0.6	7CV-MB7	5AD	0.7	13.2	8.6	POWER AMPLIFIER	120	-8	110	50	8.5	10000	7500		2500		12CU5	
12D4	DIODE	HTR	12.6	0.6	4CG-OGT8	9DB		6.0	8.0	HW RECTIFIER	MAX PEAK INVERSE = 4400 volts					MAX I <sub>o</sub> = 155 ma					12D4	
12DB5	BM PENT	HTR	12.6	0.6	9GR-MB9	5BC	0.5	15	9	POWER AMP	110	-7.5	110	50	10	13000	8000		2000		12DB5	

SEE PAGE 4 FOR DATA CHART REFERENCE NOTES

TYPE	DESIGN	CATHODE HTR OR FIL			BASING DATA	MAX SIZE VIEW	CAPACITIES			USED AS	PLATE VOLTS	GRID VOLTS	SCR VOLTS	PLATE MA	SCR MA	AMP FACT	PLATE RESIS OHMS	MUT COND mmho	OUT PUT WATTS	LOAD RESIS OHMS	CUT OFF VOLTS	TYPE
		TYPE	VOLTS	AMPS			G-P mmfds	IN mmfds	OUT mmfds													
12DQ6A	BM PENT	HTR	12.6	0.6	6AM-OM7	12JC	0.55	15	7	POWER AMP	250	-22.5	150	75	2.4	20000	6600			-46	12DQ6A	
12E5GT	TRIODE	HTR	12.6	0.15	6Q-OGT6	9BC	2.8	3.8	2.6	AMP CL A	250 100	-13.5 -5		5.0 2.5		13.8 13.8	9500 12000	1450 1150				12E5GT
12F5GT	TRIODE	HTR	12.6	.15	5M-OW5	9EA	2.0*	6*	12*	AMPLIFIER CLASS A	250 100	-2 -1		0.9 0.4		100 100	66000 85000	1500 1150				12F5GT
12F8	DBLE DI PENTODE	HTR	12.6	0.15	9FH-MB9	5BB	4.5	3.0	0.06	VOLTAGE AMP	12.6	0	12.6	1.0	0.38	0.3MEG	1000			-5	12F8	
12G4	TRIODE	HTR	12.6#	.15	6BG-MB7	5AD	3.4	2.4	.9	AMP CL A	90 250	0 -8		10 9		20 20	3000 2600			-7 -18	12G4	
12G8	DBLE TRI	HTR	12.6	0.4	9CZ-MB9	5BC				AF DRIVER	12.6	0			22	8500	2600	2000			12G8	
12H4	TRIODE	HTR	12.6	0.15	7DW-MB7	5AC	3.4	2.4	0.9	AMPLIFIER	250	-8		9	20		2600			-18	12H4	
12H6	DUO DI	HTR	12.6	0.15	7Q-OW7	8BA	3.0	3.4	0.10	DETECTOR	150	MAX		8 MAX EACH DIODE								12H6
12J5GT	TRIODE	HTR	12.6	.15	6Q-OW6	9DB	3.8*	4.2*	5.0*	AMPLIFIER CLASS A	250 90	-8 0		9.0 10.0		20 20	7700 6700	2600 3000				12J5GT
12J8	DUO DIODE TETRODE	HTR	12.6	0.35	9GC-MB9	5BB				AMPLIFIER	12.6	0	12.6	14	3	4000	5400		2000			12J8
12K5	TETRODE	HTR	12.6	0.45	7EK-MB7	5AD				POWER AMP DRIVER	12.6	-2.0	12.6	85	35	100000			800			12K5
12J7GT	PENTODE	HTR	12.6	.15	7R-OW7	9CA	.005*	4.6*	12*	AMP CL A PENT CONN TRI CONN	250 100 250	-3 -3 -8	100 100	2.0 2.0 6.5	0.5 0.5	20	1.5MEG 1.0MEG 10500	1225 1185 1900			-7 -7	12J7GT
12K7GT	PENTODE	HTR	12.6	.15	7R-OW7	9CA				AMPLIFIER CLASS A	250 250 100	-3 -3 -1	125 100 100	10.5 7.0 9.5	2.6 1.7 2.7	.6 MEG .8 MEG .15MEG	1650 1450 1650			-52.5 -42.5 -38.5	12K7GT	

SEE PAGE 4 FOR DATA CHART REFERENCE NOTES

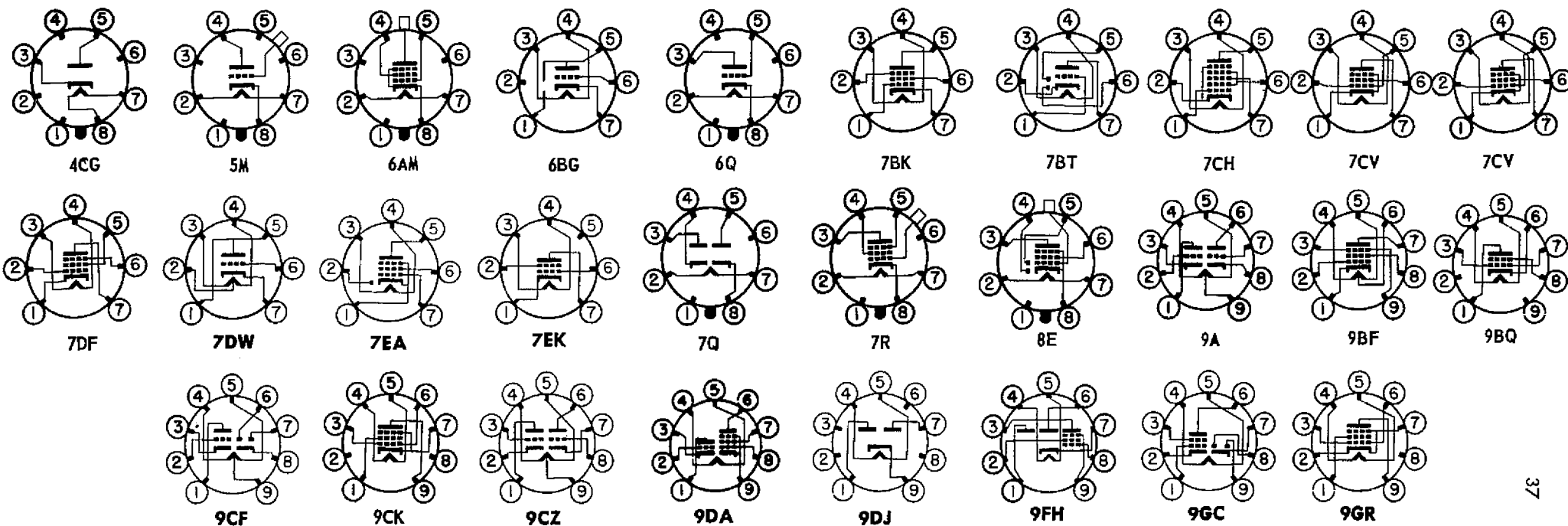



TYPE	DESIGN	CATHODE HTR OR FIL			BASING DATA	MAX SIZE VIEW	CAPACITIES			USED AS	PLATE VOLTS	GRID VOLTS	SCR VOLTS	PLATE MA	SCR MA	AMP FACT	PLATE RESIS OHMS	MUT COND mmho	OUT PUT WATTS	LOAD RESIS OHMS	CUT OFF VOLTS	TYPE
		TYPE	VOLTS	AMPS			G-P mmfds	IN mmfds	OUT mmfds													
12K8GT	TRIODE HEXODE	HTR	12.6	.15	8K-OW8	9CB	.08*	4.6*	4.8*	OSC TRIODE MIXER HEX	100 250 100	05MEG —3 —3	100 2.5 2.3	3.8 6.0 6.2		.6 MEG .4 MEG	3000 350C 325C	(TRIODE GRID 0v) —30 —30			12K8GT	
12L6GT	BEAM PWR AMP	HTR	12.6	0.6	7S-OGT7	9DB				CL A AMP	200	—8.0	110	50	1.5	35000	8250	4.3	3000		12L6GT	
12L8GT	TWIN PENTODE	HTR	12.6	0.15	8BU-OGT8	9DB	0.7	5.0	6.0	POWER AMP CLASS A	180	—9	180	13	2.4	0.16MEG	2150	1.0	10000		12L8GT	
12Q7GT	DUO-DI TRIODE	HTR	12.6	.15	7V-OW7	9CA	1.6*	2.2*	5*	AMPLIFIER CLASS A	250 100	—3 —1.0	1.0 0.8		70 70	58000 58000	1200 1200				12Q7GT	
12R5	BM PENT	HTR	12.6	0.6	7CV-MB7	5AC	0.55	13	9.0	POWER AMP	110	—8.5	110	40	3.3	13000	7000			—22	12R5	
12S8GT	TRIP-DI TRI	HTR	12.6	0.15	8CB-OGT8	9EC				DET-AMP	250 100	—2 —1		0.9 0.4		100 100	1100 900				12S8GT	
12SA7 12SA7GT	HEPTODE	HTR	12.6	.15	8R-OW8 8AD-OW8	8BB 9BC	.13 .20	9.5 11.0*	12 12.0*	OSC SECT MIXER	OSC 250	GRID RES —.02 MEG —2	100 3.5	8.5		OSC GRID CUR —.5ma 1.0MEG	450C			—35	12SA7 12SA7GT	
12SC7	TWIN TRI	HTR	12.6	.15	8S-OW8	8BB				AMP CL A 1 SECT	250	—2		2		70	53000	1325			12SC7	
12SF5 12SF5GT	TRIODE	HTR	12.6	.15	6AB-OW6 6AB-OGT6	8BB 9DB	2.6 2.6*	4.2 4.2*	3.8 3.8*	AMPLIFIER CLASS A	250 100	—2 —1		0.9 0.4		100 100	66000 85000	1500 1150			12SF5 12SF5GT	
12SF7 12SF7GT	DIODE PENTODE	HTR	12.6	0.15	7AZ-OW8 7AZ-OGT8	8BB 9BC	0.004	5.5	6.5	AMP CL A	250 100	—1 —1	125 100	12.4 12	3.3 3.4	0.7MEG 0.2MEG	2050 1975			—35 —35	12SF7 12SF7GT	
12SG7	PENTODE	HTR	12.6	0.15	8BK-OW8	8BB	0.003	8.5	7.0	AMP CL A	250 100	—1 —1	125 100	11.8 8.2	4.4 3.2	0.9MEG 0.25MEG	4700 4100			—14 —11.5	12SG7	
12SH7	PENTODE	HTR	12.6	0.15	8BK-OW8	8BB	0.003	8.5	7.0	AMP CL A	250 100	—1 —1	100 100	10.8 5.3	4.1 2.1	0.9MEG 0.35MEG	4900 4000			—5.5 —4	12SH7	
12SJ7 12SJ7GT	PENTODE	HTR	12.6	.15	8N-OW8 8N-OW8	8BB 9BC	.005	6.0	7.0	AMPLIFIER CLASS A	250 100	—3 —3	100 100	3.0 2.9	0.8 0.9	1.5MEG 0.7MEG	1650 1875			—9 —9	12SJ7 12SJ7GT	
12SK7 12SK7GT	PENTODE	HTR	12.6	.15	8N-OW8 8N-OW8	8BB 9BC	.003 .005	6.0 6.5	7.0 7.5	AMPLIFIER CLASS A	250 100	—3 —1	100 100	9.2 13.0	2.6 4.0	0.8MEG .12MEG	2000 2350			—35 —35	12SK7 12SK7GT	
12SL7GT	TWIN TRI	HTR	12.6	0.15	8BD-OGT8	9DB				CL A 1 SECT	250	—2		2.3		70	44000	1600			12SL7GT	
12SN7GT	TWIN TRI	HTR	12.6	0.3	8BD-OGT8	9DB	4L 4R	3.2L 3.8R	3.4L 2.6R	CL A 1 SECT	250 90	—8 0		9 10		20 20	7700 6700	2600 3000			12SN7GT	
12SQ7 12SQ7GT	DUO-DI TRIODE	HTR	12.6	.15	8Q-OW8 8Q-OW8	8BB 9BC	1.8	4.2	3.4	AMPLIFIER CLASS A	250 100	—2 —1		0.9 0.4		100 100	91000 110000	1100 900			12SQ7 12SQ7GT	
12SR7 12SR7GT	DUO-DI TRIODE	HTR	12.6	.15	8Q-OW8 8Q-OGT8	8BB 9DB	2.3*	3.5*	3.8*	AMP CL A	250	—9		9.5		16	8500	1900			12SR7 12SR7GT	
12SW7	DBLE-DI TRI	HTR	12.6	0.15	8Q-OW8	8BB	2.4	3.0	2.8	DET-AMP	250 26.5	—9 0		9.5 1.1		16 17	1900 1100				12SW7	
12SX7GT	DOUBLE TRIODE	HTR	12.6	0.3	8DB-OGT8	9DB	3.6	2.8	1.2	VOLTAGE AMP	250 26.5	—8 0		9.0 1.8		20 21	2600 1800				12SX7GT	
12SY7 12SY7GT	PENTA- GRID	HTR	12.6	0.15	8R-OW8 8AD-OGT8	8BB 9BC	0.13 0.2	9.5 11	12 12	CONVERTER	250 28	—2 —1	100 28	3.5 0.5	8.5 1.8	1 MEG	450C 250C				12SY7 12SY7GT	
12U7	DBLE TRI	HTR	12.6	0.15	7CK-MB9	5BB	1.5	1.6	0.40	CL A AMP	12.6	0	12.6	1.0		20	12500	1600			—1.5	12U7
12V6GT	PENTODE	HTR	12.6	.225	7S-OGT7	9DB	.7	9	7.5	POWER AMP	180 250 315	—8.5 —12.5 —13	180 280 315	29 45 34	3 4.5 2.2	50000 50000 80000	3700 4100 3750	2.0 4.5 5.5	5500 5000 8500		12V6GT	
12X4	DBLE DI	HTR	12.6	.3	5BS-MB7	5AD				FW RECTIFIER	MAX PEAK INVERSE = 1250 V; MAX I <sub>o</sub> = 70ma DC										12X4	
12Z3	DIODE	HTR	12.6	.3	4G-SS4	12BA				HW RECTIFIER	235 RMS MAX			55 DC MAX			TUBE DROP 17v AT 110ma DC					12Z3

SEE PAGE 4 FOR DATA CHART REFERENCE NOTES

TYPE	DESIGN	CATHODE HTR OR FIL			BASING DATA	MAX SIZE VIEW	CAPACITIES			USED AS	PLATE VOLTS	GRID VOLTS	SCR VOLTS	PLATE MA	SCR MA	AMP FACT	PLATE RESIS OHMS	MUT COND mmho	OUT PUT WATTS	LOAD RESIS OHMS	CUT OFF VOLTS	TYPE
		TYPE	VOLTS	AMPS			G-P mmfds	IN mmfds	OUT mmfds													
14A4	TRIODE	HTR	12.6	0.15	5AC-L8	9AC	4.0	3.4	3.0	AMP CL A	250 90	-8 0		9 10		20 20	7700 6700	2600 3000				14A4
14A5	PENTODE	HTR	12.6	0.15	6AA-L8	9AD				POWER AMP CLASS A	250	-12.5	250	30	3.5		50000	3000	2.5	7500		14A5
14A7/12B7	PENTODE	HTR	12.6	.15	8V-L8	9AC	.005*	5.5*	7.0*	AMP CL A	250 100	-3 -1	100 100	9.2 13.0	2.6 4.0	1600 1600	.8 MEG .12MEG	2000 2350			-35 -35	14A7/12B7
14AF7	TWIN TRI	HTR	12.6	0.150	8AC-L8	9AC	2.3L 2.3R	2.2L 2.2R	1.6L 1.6R	CL A 1 SECT	250 100	-10 0		9.0 10.8		16 17	7600 6500	2100 2600				14AF7
14B6	DUO-DI TRIODE	HTR	12.6	0.15	8W-L8	9AC				DETECTOR AMPLIFIER	250 100	-2 -1		0.9 0.4		100 100	91000 110000	1100 900				14B6
14B8	HEPTODE	HTR	12.6	0.15	8X-L8	9AC	0.20	10	9.0	OSC SECT MIXER	250S 250	.05MEG -3	100	4.0 3.5	2.7		GRID #2 RES .02 MEG .36MEG	550C			-35	14B8
14C5	BEAM PWR AMP	HTR	12.6	0.225	6AA-L8	9AD				PR AMP CL A CL AB 2 TUBE	315 285	-13 -19	225 285	34 70	2.2 4		77000 65000	3750 3600	5.5 14	8500 8000		14C5
14C7	PENTODE	HTR	12.6	0.15	8V-L8	9AC	0.007	6.0	6.5	AMP CL A	250 100	-3 -1	100 100	2.2 5.7	0.7 1.8		1 MEG 0.325MEG	1575 2275			-9 -9	14C7
14E6	DUO-DI TRIODE	HTR	12.6	0.15	8W-L8	9AC				AMP CL A	250 100	-9 -3		9.5 3.9		16 16.5	8500 11000	1900 1500				14E6
14E7	DUO-DI PENTODE	HTR	12.6	0.15	8AE-L8	9AC	0.005	4.6	5.3	DETECTOR AMPLIFIER	250 100	-3 -1	100 100	7.5 10	1.6 2.7		0.7 MEG 0.15MEG	1300 1600			-42.5 -36	14E7
14F7	TWIN TRI	HTR	12.6	0.15	8AC-L8	9AC				CL A 1 SECT	250 100	-2 -1		2.3 0.65		70 70	44000 62000	1600 1125				14F7
14F8	DOUBLE TRIODE	HTR	12.6	0.15	8BW-L8	9AB	1.2	2.8	1.4	VOLTAGE AMP	250	Rk 500		6.0	48			3300				14F8

SEE PAGE 4 FOR DATA CHART REFERENCE NOTES

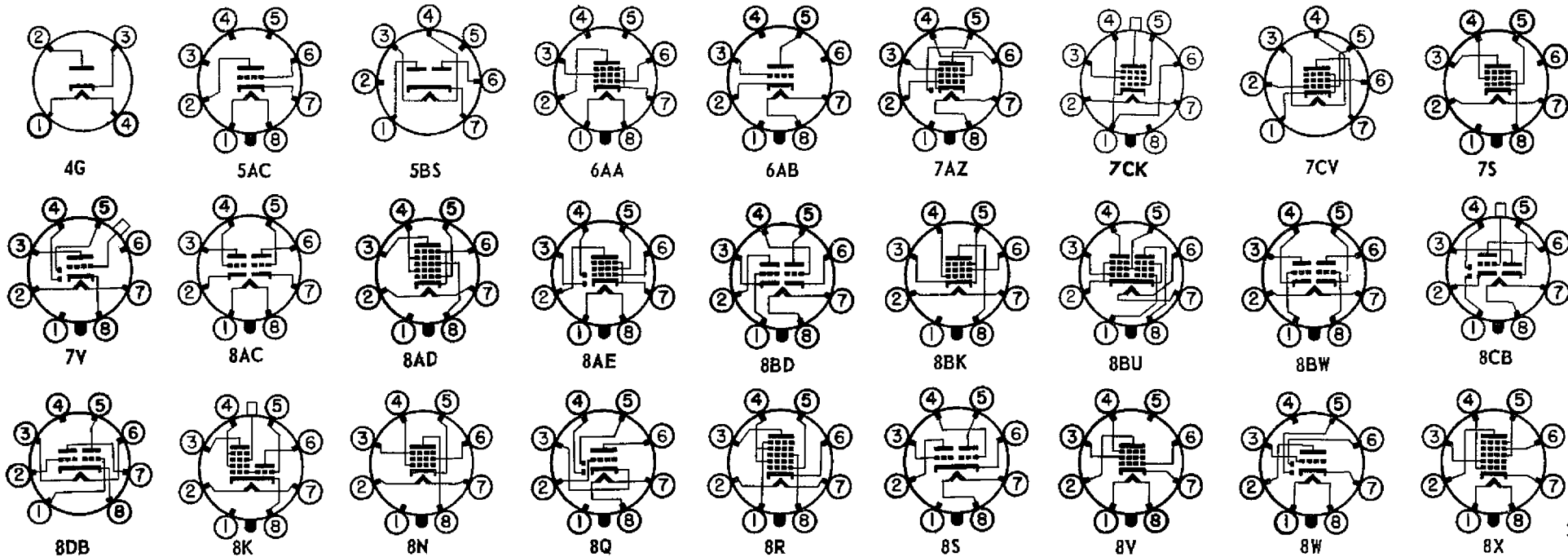





TYPE	DESIGN	CATHODE HTR OR FIL			BASING DATA	MAX SIZE VIEW	CAPACITIES			USED AS	PLATE VOLTS	GRID VOLTS	SCR VOLTS	PLATE MA	SCR MA	AMP FACT	PLATE RESIS OHMS	MUT COND mmho	OUT PUT WATTS	LOAD RESIS OHMS	CUT OFF VOLTS	TYPE
		TYPE	VOLTS	AMPS			G-P mmfds	IN mmfds	OUT mmfds													
14H7	PENTODE	HTR	12.6	.15	8V-L8	9AC	.007*	8.0*	7.0*	AMP CL A	250 100	-2.5 -1	150 100	9.5 8.2	3.5 3.3	.8 MEG .25MEG	3800 3800			-19 -12	14H7	
14J7	TRI HEX	HTR	12.6	0.15	8BL-L8	9AC	0.01	5.5	7.5	OSC-TRIODE MIXER HEX	250S 250	.05MEG -3	100	5.4 1.3	2.9	TRIODE PLATE RESISTOR 1.5MEG	300C			.02 MEG -20	14J7	
14N7	TWIN TRI	HTR	12.6	0.30	8AC-L8	9AD	3.0R 3.0L	2.9R 3.4L	2.4R 2.0L	CL A 1 SECT	250 90	-8 0		9 10		20 20	7700 6700	2600 3000			14N7	
14Q7	HEPTODE	HTR	12.6	0.15	8AL-L8	9AC	.2	9.0	9.0	OSC SECT MIXER	OSC GRID RESIS —.02 MEG 250 —2	100	3.5	8.5	OSC GRID CUR—.5ma 1.0MEG	550C					-35	14Q7
14R7	DUO-DI PENTODE	HTR	12.6	0.150	8AE-L8	9AC	0.004	3.6	5.3	AMP CL A	250 100	-1 -1	100 100	5.7 5.5	1.7 2.0	1.0MEG 0.35MEG	3200 3000			-20 -16	14R7	
14S7	TRI HEX	HTR	12.6	0.15	8BL-L8	9AC	0.02	5.0	8.0	OSC-TRIODE MIXER	250 250	-2	100	5.0 1.8	3.0	TRIODE PLATE RESIS .02 MEG 1.25MEG	525C			-21	14S7	
14V7	PENTODE	HTR	12.6	0.225	8V-L8	9AC	0.004	9.5	6.5	HI FREQ AMP	300	-2	150	9.6	3.9	.3 MEG	5800			-6	14V7	
14W7	PENTODE	HTR	12.6	0.225	8BJ-L8	9AC	0.0025	9.5	7.0	AMP CL A	300 300	-2 -2	150 300	10.0 THRU .04 MEG (OTHER VALUES SAME AS ABOVE)	3.9	.3 MEG	5800			-6 -14	14W7	
14X7	DBLE-DI TRI	HTR	12.6	0.15	8BZ-L8	9AD				DET-AMP	250 100	-1 0		1.9 1.2	100 85		1500 1000				14X7	
14Y4	TWIN DI	HTR	12.6	0.3	5AB-L8	9AD				F W RECTIFIER	325 RMS MAX COND IN 60 DC MAX 450 RMS MAX CHOKE IN 60 DC MAX										14Y4	
15	PENTODE	HTR	2.0	.22	5F-SS5	12DA	.01*	2.4	7.8	AMPLIFIER CLASS A	135 67.5	-1.5 -1.5	67.5 67.5	1.85 1.85	0.3 .3	600 450	.8 MEG .63MEG	750 710			15	
15A6	PENTODE	HTR	15	.3	9AR-MB9	5BD	.1	10	7	VIDEO AMP	180	-2.9	180	36	4.6	.1 MEG	10000				15A6	
15A8	TRIODE BM PENT	HTR	15.0	0.6	8GS-OGT8	9EC	3.4 0.7	2.6 11.0	0.9 5.0	OSCILLATOR AMPLIFIER	110	-7.5	110	45	4.0	13000	7300				15A8	
16A5	PENTODE	HTR	16.5	.3	9BL-MB9	5BD	1	11	5.9	POWER AMP	200	-13.9	180	45	8.5	24000	7600	4.2	4000		16A5	
17AX4GT	DIODE	HTR	16.8	0.45	4CG-OS5	9DB				DAMPER	MAX PEAK INVERSE = 4000 volts;		MAX I <sub>o</sub> = 125 ma								17AX4GT	
17AV5GA	BM PENT	HTR	16.8	0.45	6CK-OM6	11AB	0.5	14	7.0	AMPLIFIER	250	-22.5	150	57	2.1	14500	5900			-43	17AV5GA	
17C5	BM PENT	HTR	16.8	0.45	7CV-MB7	5AD	0.5	13	6.5	POWER AMP	110	-7.5	110	50	8.5	14000	7500	1.9	2500		17C5	
17CA5	BM PENT	HTR	16.8	0.45	7CV-MB7	5AD	0.5	15	9	AF AMPLIFIER	125	-4.5	125	36	4.0	15000	9200		4500		17CA5	
17CU5	BM PENT	HTR	16.8	0.45	7CV-MB7	5AD	0.7	13.2	8.6	POWER AMP	120	-8	110	50	8.5	10000	7500		2500		17CU5	
17DQ6A	BM PENT	HTR	16.8	0.45	6AM-OM7	12IC	0.55	15	7	POWER AMP	250	-22.5	150	75	2.4	20000	6600			-46	17DQ6A	
17H3	DIODE	HTR	17.5	0.3	9FK-MB9	5BC	5.5	4.0	2.0	DAMPER	MAX PEAK INVERSE = 2000 volts;		I <sub>o</sub> = 75 ma MAX								17H3	
17L6GT	BEAM PWR AMP	HTR	16.8	0.45	7S-OGT7	9DB				CLASS A AMP	200	-8.0	110	50	1.5	35000	8250	4.3	3000		17L6GT	
17R5	BM PENT	HTR	16.8	0.45	7CV-MB7	5AC	0.55	13	9.0	POWER AMP	110	-8.5	110	40	3.3	13000	7000			-22	17R5	
17Z3	DIODE	HTR	17	.3	9CB-MB9	5CD				HW RECTIFIER	MAX PEAK INVERSE = 4500 V;		MAX I <sub>o</sub> = 150ma DC								17Z3	
18A5	BM PENT	HTR	18.5	0.3	6CK-OGT6	9BD	0.7	13	7.0	POWER AMP	200	-17	125	40	1.1	4.6	27000	4800			-36	18A5
19	TWIN TR	FIL	2.0	.26	6C-SS6	12BA				CLASS B TWO SECT	135 135	0 -6		10 0.1	NO SIG NO SIG			2.1 1.6	10000 10000		19	
19AQ5	BM PENT	HTR	18.9	.15	7BZ-MB7	5AD				POWER AMP	180 250	-8.5 -12.5	180 250	29 45	3 4.5	58000 52000	3700 4100	2.0 4.5	5500 5000		19AQ5	
19AU4 19AU4GTA	DIODE	HTR	18.9	0.6	4CG-OS6	9FB 9FB				DAMPER	MAX PEAK INVERSE = 4500 volts;		MAX I <sub>o</sub> = 175 ma								19AU4 19AU4GTA	

SEE PAGE 4 FOR DATA CHART REFERENCE NOTES

TYPE	DESIGN	CATHODE			BASING DATA	MAX SIZE VIEW	CAPACITIES			USED AS	PLATE VOLTS	GRID VOLTS	SCR VOLTS	PLATE MA	SCR MA	AMP FACT	PLATE RESIS OHMS	MUT COND mmho	OUT PUT WATTS	LOAD RESIS OHMS	CUT OFF VOLTS	TYPE
		HTR OR FIL TYPE	VOLTS	AMPS			G-P mmfds	IN mmfds	OUT mmfds													
19BG6G	BEAM PENTODE	HTR	18.9	0.3	5BT-OM6	16BA	0.65	11	6.5	DEFLECT AMP	MAX PEAK	POS PLATE SURGE = 6000 volts; MAX Ib = 100 ma										19BG6G
19BG6GA	BM PENT	HTR	18.9	0.3	5BT-OM6	12JE	0.5	11.0	6.5	DEFLECT AMP	MAX PEAK	POS PLATE SURGE = 6000 volts; MAX Ib = 100 ma										19BG6GA
19C8	TRIPLE DI TRIODE	HTR	18.9	.15	9E-MB9	5BB				AMP CL A	100	-1	.5		100		1250				19C8	
19J6	DOUBLE TRIODE	HTR	18.9	0.15	7BF-MB7	5AC	1.5	2.0	0.4	CONVERTER	150	Rk 810	4.8			10200	1900C				19J6	
19T8	TRIP-DI TRI	HTR	18.9	0.15	9E-MB9	5BB	2.4	1.5	1.1	DET-AMP	250 100	-3 -1	1.0 0.8		70 70		1200 1300				19T8	
19V8	TRIPLE DI TRIODE	HTR	18.9	.15	9AH-MB9	5BB				AMP CL A	100 250	-1 -3	.8 1.0		70 70		1300 1200				19V8	
19X3	DIODE	HTR	19	.3	9BM-MB9	5CC				HW RECTIFIER	MAX PEAK INVERSE = 4000 V; MAX Io = 180ma DC										19X3	
19X8	TRIODE PENTODE	HTR	18.9	.15	9AK-MB9	5BB	1.4 .9	2.0 4.3	.5 .7	TRIODE SECT PENTODE SECT	150 150	Rg = 2700 -3.5	13 150	6.2	(250 MC OSC) 1.8		2100C		(MIXER)		19X8	
19Y3	DIODE	HTR	19	.3	9BM-MB9	5BD				HW RECTIFIER	MAX PEAK INVERSE = 700 V; MAX Io = 180ma DC										19Y3	
20	TRIODE	FIL	3.3	.132	4D-SS4	9FC	4.1	2.0	2.3	PR AMP CL A	135	-22.5		6.5		3.3	6300	525	.11	6500	20	
21A6	PENTODE	HTR	21.5	.3	9AS-MB9	5CD	.4	14.3	6.5	AMP CL A	180	-23	180	45	3		6500				21A6	
22	TETRODE	FIL	3.3	.132	4K-SM4	14CA	.02*	3.3	12	AMP CL A	135	-1.5	67.5	3.7	1.3	.33MEG	500				22	
24A 24S	TETRODE	HTR	2.5	1.75	5E-SM5 5E-SM5	14CA	.007*	5.3	10.5	AMPLIFIER CLASS A	250 180	-3 -3	90 90	4 4	1.7 1.7	630 400	.6 MEG .4 MEG	1050 1000			24A 24S	
25A6 25A6G 25A6GT	PENTODE	HTR	25	.3	7S-OW7 7S-OM7 7S-OW7	8FA 14BA 9DB				AMPLIFIER CLASS A	160 135 95	-18 -20 -15	120 135 95	33 37 20	6.5 8 4		42000 35000 45000	2375 2450 2000	2.2 2.0 0.9	5000 4000 4500	25A6 25A6G 25A6GT	

SEE PAGE 4 FOR DATA CHART REFERENCE NOTES

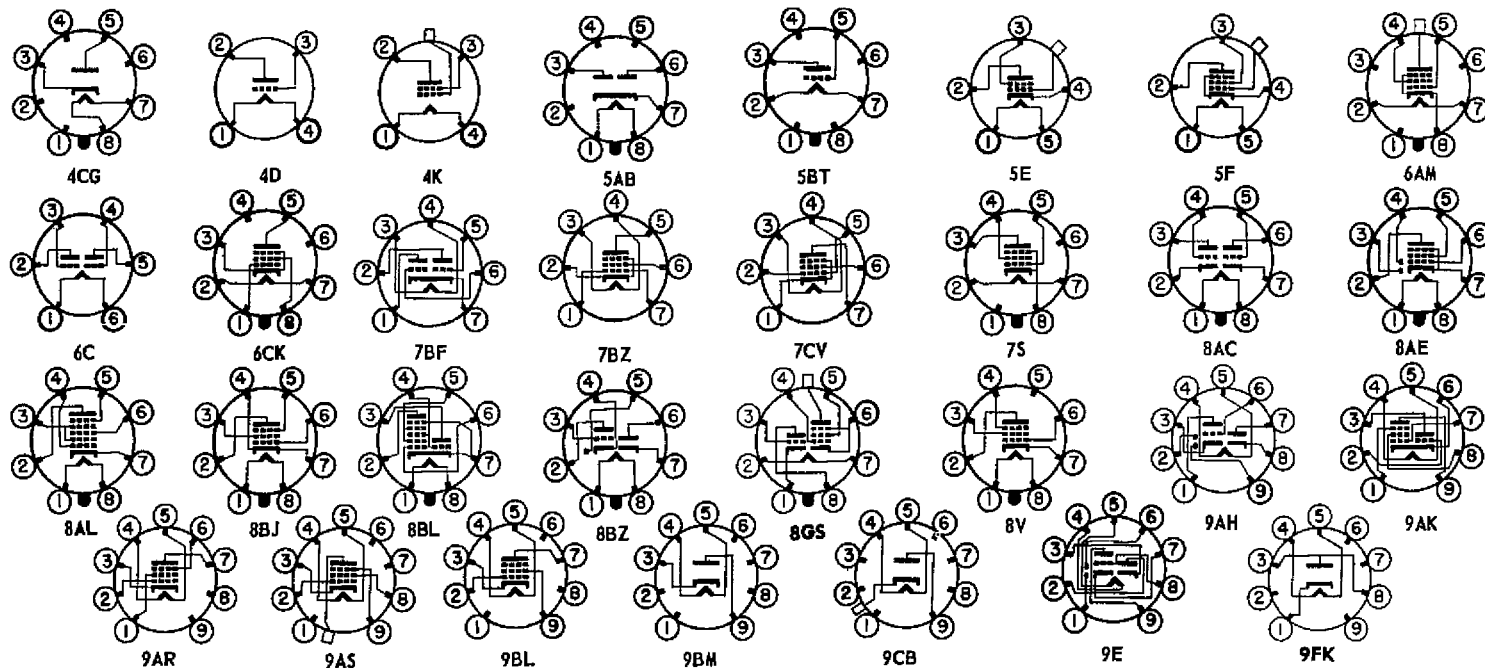

TYPE	DESIGN	CATHODE HTR OR FIL			BASING DATA	MAX SIZE VIEW	CAPACITIES			USED AS	PLATE VOLTS	GRID VOLTS	SCR VOLTS	PLATE MA	SCR MA	AMP FACT	PLATE RESIS OHMS	MUT COND mmho	OUT PUT WATTS	LOAD RESIS OHMS	CUT OFF VOLTS	TYPE
		TYPE	VOLTS	AMPS			G-P mmfds	IN mmfds	OUT mmfds													
25A7GT	DIODE PENTODE	HTR	25	.3	8F-OGT8	9DB				H W RECT AMP CL A	117 100	RMS MAX -15 100	75 DC MAX 20.5 4		90	TUBE DROP 23v AT 50000 1800	150ma .77	DC 4500			25A7GT	
25AC5GT	TRIODE	HTR	25	.3	6Q-OGT6	9DB	6AE5G DRIVER			DIR C'P'D AMP	110	FROM DRIVER 45						2	2000		25AC5GT	
25AV5GA	BM PENT	HTR	25.0	0.3	6CK-OM6	11AB	0.5	14	7.0	AMPLIFIER	250	-22.5	150	57	2.1	14500	5900			-43	25AV5GA	
25AV5GT	BM PENT	HTR	25	.3	6CK-OGT6	9EA				HORIZ AMP	MAX PEAK POS. PLATE SURGE = 5500 V MAX I <sub>k</sub> = 100ma										25AV5GT	
25AX4GT	DIODE	HTR	25	.300	4CG-OS5	9DB				DAMPER	MAX PEAK INVERSE = 4000 V; MAX I <sub>o</sub> = 125ma.										25AX4GT	
25B5	DUO-TRI	HTR	25	0.3	6D-SS6	14BA	DRIVER TRIODE OUTPUT TRIODE			DIR C'P'D AMP 2 TUBES CL A	180 180	-20 +		5.8 46.		15200	2300	3.8	4000		25B5	
25B6G	PENTODE	HTR	25	.3	7S-OM7	14BA				POWER AMP CLASS A	200 135 105	-23 -22 -16	135 135 105	62 61 48	1.8 2.5 2.0	18000 15000 15500	5000 5000 4800	7.1 4.3 2.4	2500 1700 1700		25B6G	
25B8GT	TRIODE PENTODE	HTR	25	.15	8T-OGT8	9EB				CL A TRIODE CL A PENTODE	100 100	-1 -3	100	0.6 7.6	2.0	113 .08MEG .19MEG	1500 2000			-2.5 -41	25B8GT	
25BK5	BM PENT	HTR	25	.3	9BQ-MB9	5BC	.6	13	5	POWER AMP	250	-5	250	35	3.5	.1 MEG	8500	3.5	6500		25BK5	
25BQ6GT	BM PENT	HTR	25	.3	6AM-OGT7	9EC	.95	14	9.5	HORIZ. AMP	MAX PEAK POS. PLATE SURGE = 5500 V MAX PLATE DISS = 12 WATTS										25BQ6GT	
25BQ6GA 25BQ6GTB	BM PENT	HTR	25.0	0.3	6AM-OGT6	11BB 9EC	0.6	15	7.5	POWER AMP	250	-22.5	150	55	2.1	20000 18000	5500 6000			-46	25BQ6GA 25BQ6GTB	
25C5	BM PENT	HTR	25	.3	7CV-MB7	5AD				POWER AMP	110	-7.5	110	49	4	10000	7500	1.9	2500		25C5	
25C6G	BW PWR	HTR	25	.3	7S-OM7	14AA				POWER AMP CLASS A	200 135	-14 -13.5	135 135	61 58	2.2 3.5	18300 9300	7100 7000	6.0 3.6	2600 2000		25C6G	
25C6GA	BM PENT	HTR	25.0	0.3	7S-OM7	12GD				CL A AMP	200	-14	135	66	9	18300	7100	6	2600		25C6GA	
25CA5	BM PENT	HTR	25.0	0.3	7CV-MB7	5AD	0.5	15	9	AF AMPLIFIER	125	-4.5	125	36	4.0	15000	9200		4500		25CA5	
25CD6G 25CD6GA 25CD6GB	BM PENT BEAM PENTODE	HTR	25 25.0	.3 0.6	5BT-OM6 5BT-OM8	16CA 16CA 12JE	1.0 1.1	2.6 22	10 8.5	HORIZ. AMP HORIZ. DEFLECT AMPLIFIER	430 175	Rk 270 -30	165 175	112 75	14 5.5	MAX PULSE PEAK POS. PLATE = 6000 V					25CD6G 25CD6GA 25CD6GB	
25D8GT	DIODE TRIODE PENTODE	HTR	25	0.15	8AF-OGT8	9DB	2.5 0.015	3.7 5.2	4.5 10	DETECTOR CL A TRIODE CL A PENTODE	100 100	-1 -3		0.5 8.5		100	91000 0.2MEG	1100 1900			-35	25D8GT
25DN6	PENTODE	HTR	25.0	0.6	5BT-OM8	12JE	0.8	22	11.5	POWER AMP	125	-18	125	70	6.3	4000	9000			-36	25DN6	
25DQ6	BM PENT	HTR	25.0	0.3	6AM-OM7	12JC	0.55	15	7	POWER AMP	250	-22.5	150	75	2.4	20000	6600			-46	25DQ6	
25F5	BM PENT	HTR	25.0	0.15	7CV-MB7	5AD				CL A AMP	110	-7.5	110	37	7.0	16000	5800		2500		25F5	
26E6G	BM PENT	HTR	26.5	0.3	7S-OGT8	11AA				POWER AMP	200	-19	135	66	9	18000	7100	6	2600		26E6G	
25L6 25L6GT	BEAM PWR AMP	HTR	25	.3	7S-OW7 7S-OGT7	8FA 9DB				POWER AMP CLASS A	110 200	-7.5 -8.0	110 110	49 50	4 1.5	10000 35000	8200 8250	2.1 4.3	2000 3000		25L6 25L6GT	
25N6G	DUO- TRIODE	HTR	25	0.3	7W-OM7	14BA	DRIVER TRIODE OUTPUT TRIODE			DIR C'P'D AMP	180 180	-20 +		5.8 4.6		35	15200	2300	3.8	4000		25N6G
25U4GT	DIODE	HTR	25	.3	4CG-OGT5	9DB				DAMPER	MAX PEAK INVERSE = 3850 V; MAX I <sub>o</sub> = 138ma DC										25U4GT	
25W4GT	DIODE	HTR	25	.3	4CG-OGT6	9DB				DAMPER	MAX PEAK INVERSE = 1250 V; MAX I <sub>o</sub> = 125ma DC										25W4GT	
25W6GT	BM PENT	HTR	25	.3	7S-OGT7	9DB				VERT. AMP	MAX PEAK POS. PLATE = 1200 V; MAX PEAK I <sub>k</sub> = 140ma										25W6GT	
25X6GT	TWIN DIODE	HTR	25	0.15	7Q-OGT7	9DB				H W RECT V DOUBLER	250 125	RMS MAX RMS MAX	60 DC MAX 60 DC MAX			TUBE DROP 25v AT 120ma DC					25X6GT	
25Y4GT	DIODE	HTR	25	0.15	5AF-OGT7	9DB				H W RECT	125	RMS MAX	75 DC MAX			TUBE DROP 18v AT 125ma DC					25Y4GT	
25Y5	TWIN DIODE	HTR	25	.3	6E-SS6	12BA				H W RECT V DOUBLER	250 117	RMS MAX RMS MAX	85 DC MAX 85 DC MAX			(EXPORT TYPE)					25Y5	

TYPE	DESIGN	CATHODE HTR OR FIL			BASING DATA	MAX SIZE VIEW	CAPACITIES			USED AS	PLATE VOLTS	GRID VOLTS	SCR VOLTS	PLATE MA	SCR MA	AMP FACT	PLATE RESIS OHMS	MUT COND mmho	OUT PUT WATTS	LOAD RESIS OHMS	CUT OFF VOLTS	TYPE		
		TYPE	VOLTS	AMPS			C-P mmfds	IN mmfds	OUT mmfds															
25Z4GT	DIODE	HTR	25	0.3	5AA-OGT7	9DB				H W RECT	125 RMS MAX		125 DC MAX									25Z4GT		
25Z5 25Z6 25Z6GT	TWIN DIODE	HTR	25	.3	6E-SS6 7Q-OW7 7Q-OGT7	12BA 8FA 9DB				H W RECT V DOUBLER	235 RMS MAX 117 RMS MAX		75 DC MAX 75 DC MAX									25Z5 25Z6 25Z6GT		
26	TRIODE	FIL	1.5	1.05	4D-SM4	14BA	8.1	3.5	2.2	AMP CL A	180	-14.5		6.2		8.3	7300	1140				26		
26A6	PENTODE	HTR	26.5	0.07	7BK-MB7	5AC	.0035	6.0	5.0	VOLTAGE AMP	250 26.5	Rk 125 0	100 26.5	10.5 1.7	4.0 0.7		1 MEG 0.25MEG	4000 2000			-25 -8	26A6		
26A7GT	DBL BEAM PENTODE	HTR	26.5	0.6	8BU-OGT8	9FB	1.2	16	13	POWER AMP	26.5	-4.5	26.5	20.5	5.5		2500	5500	0.2	1500		26A7GT		
26BK6	DBLE DI TRIODE	HTR	25	.07	7BT-MB7	5AD				DET-AMP	100 250	-1 -2		.5 1.2		100 100			1250 1600			26BK6		
26C6	DBLE-DI TRI	HTR	26.5	0.07	7BT-MB7	5AC	2	1.8	1.4	DET-AMP	250 26.5	-9 0		9.5 1.1		16 17			1900 1100			26C6		
26CG6	PENTODE	HTR	26.5	.07	7BK-MB7	5AC	.008	5	5	AMP CL A	250	-8	150	9	2.3		.72MEG	2000				26CG6		
26D6	PENTA- GRID	HTR	26.5	0.07	7CH-MB7	5AC	0.3	7.5	14	CONVERTER	250 26.5	-1.5 -0.5	100 26.5	3.0 0.45	7.8 1.6		1 MEG	475C 270C			-30 -6	26D6		
26Z5	DBLE DI	HTR	26.5	.2	9U-MB9	5BB				FW RECTIFIER	MAX PEAK INVERSE = 1250 V; MAX I <sub>o</sub> = 120ma DC													26Z5
27 27S	TRIODE	HTR	2.5	1.75	5A-SS5 5A-SS5	12BA	3.3	3.5	3.0	AMPLIFIER CLASS A	250 135	-21 -9		5.2 4.5		9 9	9250 9000	975 1000				27 27S		
28D7	TW PENT	HTR	28	0.40	8BS-L8	9AD				PR AMP CL A	28	-3.5	28	12.5	1.0		3000	3000	.1	4000		28D7		
28Z5	TWIN DI	HTR	28	0.24	6BJ-L8	9AD				FULL WAVE RECTIFIER	325 RMS MAX COND IN 100 DC MAX 450 RMS MAX CHOKE IN 100 DC MAX													28Z5

SEE PAGE 4 FOR DATA CHART REFERENCE NOTES

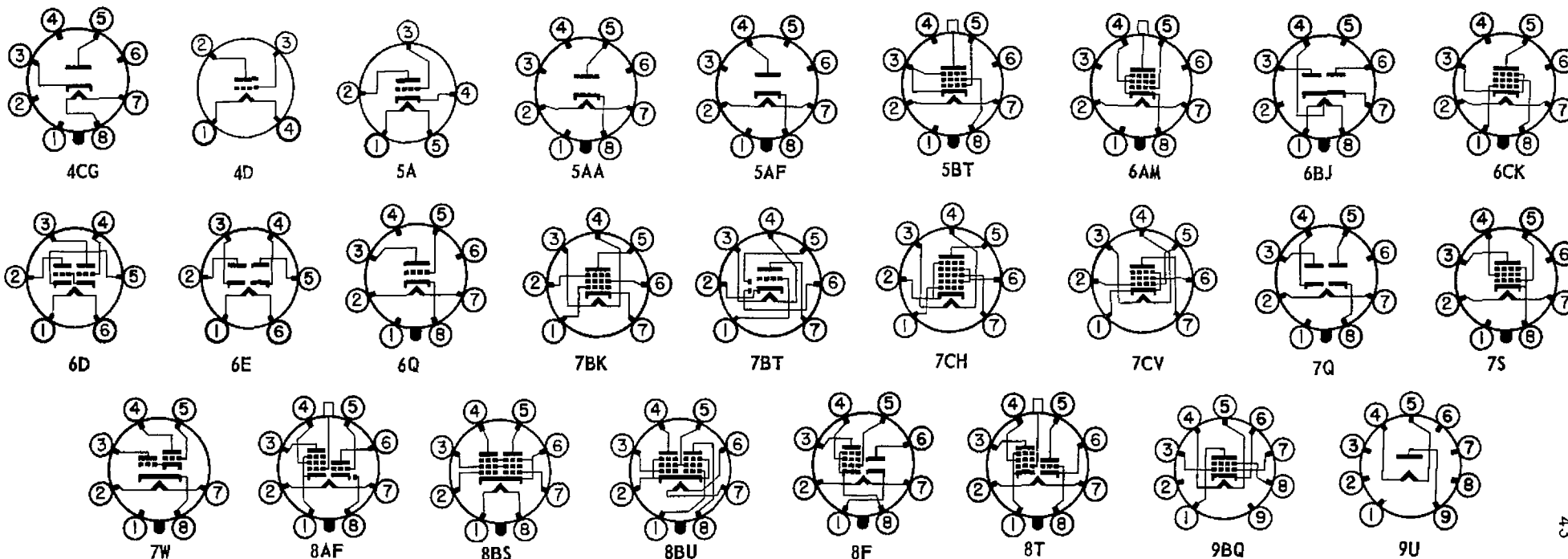



TYPE	DESIGN	CATHODE			BASING DATA	MAX SIZE VIEW	CAPACITIES			USED AS	PLATE VOLTS	GRID VOLTS	SCR VOLTS	PLATE MA	SCR MA	AMP FACT	PLATE RESIS OHMS	MUT COND mmho	OUT PUT WATTS	LOAD RESIS OHMS	CUT OFF VOLTS	TYPE
		HTR OR FIL TYPE	VOLTS	AMPS			G-P mmfds	IN mmfds	OUT mmfds													
30	TRIODE	FIL	2.0	.06	4D-SS4	12BA	6.0	3.7	2.1	AMP CL A BIAS DET	180 180	-13.5 -18		3.1 0.2	9.3 WITH NO SIGNAL	10300	900	(SEE 1H4G ALSO)			30	
31	TRIODE	FIL	2.0	.13	4D-SS4	12BA	5.7	3.5	2.7	AMPLIFIER CLASS A	180 135	-30 -22.5		12.3 8	3.8 3.8	3600 4100	1050 925	3.75 .185	5700 7000		31	
31BX7GT	TWIN TRIODE	HTR	31.5	.3	8BD-OS8	9DB	4.2	4.4	1.1	VERT. AMP	MAX PEAK POS. PLATE PULSE = 2000V MAX PLATE DISS. = 10 WATTS; PEAK I <sub>k</sub> = 180ma										31BX7GT	
32	TETRODE	FIL	2.0	.06	4K-SM4	14CA	.015*	5.3	10.5	AMPLIFIER CLASS A	180 135	-3 -3	67.5 67.5	1.7 1.7	0.4 0.4	780 610	1.2MEG .95MEG	650 640			32	
32L7GT	DIODE BM PWR	HTR	32.5	.3	8Z-OGT8	9DB				H W RECT POWER AMP CLASS A	125 RMS MAX 110 -7.5 110 90 -7 90			60 DC MAX 40 3 27 2			15000 17000	6000 4800	1.5 1.0	2500 2600	32L7GT	
33	PENTODE	FIL	2.0	.26	5K-SM5	14BA				POWER AMP CLASS A	180 135	-18 -13.5	180 135	22 14.5	5 3	90 70	55000 50000	1700 1450	1.4 0.7	6000 7000	33	
34	PENTODE	FIL	2.0	.06	4M-SM4	14CA	.015*	6.0	11.5	AMPLIFIER CLASS A	180 67.5	-3 -3	67.5 67.5	2.8 2.7	1.0 1.1	620 224	1 MEG 0.4MEG	620 560		-22.5 -22.5	34	
35/51 35S/51S	TETRODE	HTR	2.5	1.75	5E-SM5 5E-SM5	14CA	.007*	5.3	10.5	AMPLIFIER CLASS A	250 180	-3 -3	90 90	6.5 6.3	2.5 2.5	420 305	0.4MEG 0.3MEG	1050 1020		-40.0 -40.0	35/51 35S/51S	
35A5	BM PWR	HTR	32	.15	6AA-L8	9AD				POWER AMP CLASS A	110 200	-7.5 -8.0	110 110	40 41	3.0 2.0		14000 40000	5800 5900	1.5 3.3	2500 4500	35A5	
35B5 35C5	BEAM PENTODE	HTR	35	0.15	7BZ-MB7 7CV-MB7	5AD	0.4	11	6.5	POWER AMP	110	-7.5	110	41	7			5800	1.5	2500	35B5 35C5	
35CD6GA	BM PENT	HTR	35.0	0.45	5BT-OM6	16CA	1.0	2.6	10	HORIZ AMP	430	R <sub>k</sub> 270	165	112	14	MAX PULSE PEAK POS PLATE = 6000 v			35CD6GA			
35L6GT	BM PWR	HTR	35	.15	7S-OGT7	9DB				POWER AMP CLASS A	110 200	-7.5 -8.0	110 110	40 41	3.0 2.0		13800 40000	5800 5900	1.5 3.3	2500 4500	35L6GT	
35W4	DIODE	HTR	35	0.15	5BQ-MB7	5AD				H W RECTIFIER	MAX PEAK INVERSE = 330 volts, MAX I <sub>o</sub> = 90 ma dc										35W4	
35Y4	DIODE	HTR	35	0.15	5AL-L8	9AD				H W RECT LAMP TAP	235 RMS MAX 100 DC MAX or 60 DC MAX WITH 6.3v - 150ma PANEL LAMP TUBE DROP 18v AT 200ma DC										35Y4	
35Z3	DIODE	HTR	32	.15	4Z-L8	9AD				H W RECT	235 RMS MAX			100 DC MAX			TUBE DROP 20v AT 200ma DC			35Z3		
35Z4GT	DIODE	HTR	35	.15	5AA-OGT6	9DB				H W RECT	235 RMS MAX			100 DC MAX			TUBE DROP 18v AT 200ma DC			35Z4GT		
35Z5GT	DIODE	HTR TAP	35 7.5	.15 .15	6AD-OGT6	9DB				H W RECT LAMP TAP	235 RMS MAX			100 DC MAX OR 60 DC MAX WITH 6.3v - 150ma PANEL LAMP			TUBE DROP 18v AT 200ma DC			35Z5GT		
35Z6G	TWIN DIODE	HTR	35	.3	7Q-OM7	14BA				H W RECT V DOUBLER	235 RMS MAX 117 RMS MAX		110 DC MAX 110 DC MAX			TUBE DROP 20v AT 220ma DC			35Z6G			
36	TETRODE	HTR	6.3	.3	5E-SS5	12DA	.007*	3.7	9.2	AMP CL A BIAS DET	250 250	-3 -8	90 90	3.2 0.1	1.7 WITH NO SIGNAL	595 55MEG	1080				36	
37	TRIODE	HTR	6.3	.3	5A-SS5	12BA	2.0	3.5	2.2	AMP CL A BIAS DET	250 250	-18 -28		7.5 .2	9.2 WITH NO SIGNAL	8400	1100				37	
38	PENTODE	HTR	6.3	.3	5F-SS5	12DA	.3	3.5	7.5	POWER AMP CLASS A	250 135	-25 -13.5	250 135	22 9	3.8 1.5	120 120	.1 MEG .13MEG	1200 925	2.5 0.55	10000 13500	38	
39/44	PENTODE	HTR	6.3	.3	5F-SS5	12DA	.007*	3.5	10	AMPLIFIER CLASS A	250 90	-3 -3	90 90	5.8 5.6	1.4 1.6	1050 360	1.0MEG .38MEG	1050 950		-42.5 -42.5	39, 44	
40	TRIODE	FIL	5.0	.25	4D-SM4	14BA	8.8	3.4	1.5	AMP CL A	180	-3		0.2		30	15MEG	200	PL RESISTOR .25MEG		40	
41	PENTODE	HTR	6.3	.4	6B-SS6	12BA				POWER AMP CLASS A	315 250	-21 -18	250 250	25.5 32	4.0 5.5		75000 68000	2100 2300	4.5 3.4	9000 7600	41	

SEE PAGE 4 FOR DATA CHART REFERENCE NOTES





TYPE	DESIGN	CATHODE		BASING DATA	MAX SIZE VIEW	CAPACITIES			USED AS	PLATE VOLTS	GRID VOLTS	SCR VOLTS	PLATE MA	SCR MA	AMP FACT	PLATE RESIS OHMS	MUT COND mmho	OUT PUT WATTS	LOAD RESIS OHMS	CUT OFF VOLTS	TYPE				
		HTR OR FIL	AMPS			G-P mmfds	IN mmfds	OUT mmfds																	
50AX6G	DBLE DI	HTR	50	.3	7Q-OM7	14BA				FW RECTIFIER MAX PEAK INVERSE = 1250 V; MAX I <sub>o</sub> = 125ma DC															50AX6G
50B5 50C5	BEAM PENTODE	HTR	50	0.15	7BZ-MB7 7CV-MB7	5AD	0.5	13	6.5	POWER AMP	110	-7.5	110	50	8.5		14000	7500	1.9	2500		50B5 50C5			
50BK5	BM PENT	HTR	50.0	0.15	9BQ-MB9	5BC	0.6	13	5.0	POWER AMP	250	-5.0	250	35	3.5		0.1MEG	8500	3.5	6500		50BK5			
50C6G	BM PWR	HTR	50	.15	7S-OM7	14BA				POWER AMP CLASS A	200 135	-14 -13.5	135 135	61 58	2.2 3.5		18300 9300	7100 7000	6.0 3.6	2600 2000		50C6G			
50C6GA	BM PENT	HTR	50.0	0.15	7S-OM7	12GD				CL A AMP	200	-14	135	66	9		18300	7100	6	2000		50C6GA			
50CD6G	BM PENT	HTR	50	.3	5BT-OM6	16CA	1	2.6	10	HORIZ AMP	MAX PEAK POS. PLATE PULSE = 6000 V MAX PLATE DISS. = 15 WATTS; MAX I <sub>b</sub> = 170ma DC														50CD6G
50L6GT	BM PWR	HTR	50	.15	7S-OGT7	9CB				POWER AMP CLASS A	110 200	-7.5 -8.0	110 110	49 50	4 1.5		10000 35000	8200 8250	2.1 4.3	2000 3000		50L6GT			
50X6 50Y6GT	TWIN DIODE	HTR	50	.15	7AJ-L8 7Q-OM7	9AD 9DB				H W RECT V DOUBLER	235 RMS MAX 117 RMS MAX		75 DC MAX 75 DC MAX		TUBE DROP 22v AT 150ma DC						50X6 50Y6GT				
50Y7GT	DOUBLE DIODE	HTR	50	0.15	8AN-OGT8	9DB				VOLT. DOUBLER MAX RMS PLATE VOLTAGE = 117v PER PLATE, MAX I <sub>o</sub> = 75ma PER PLATE											50Y7GT				
50Z6G	DOUBLE DIODE	HTR	50	0.3	7Q-OM7	14BA				VOLT. DOUBLER MAX RMS PLATE VOLTAGE = 125v PER PLATE, MAX I <sub>o</sub> = 150ma											50Z6G				
50Z7G	TWIN DIODE	HTR	50	.15	8AN-OS7	12BA				H W RECT V DOUBLER LAMP TAP	117 RMS MAX 117 RMS MAX 2.5v - 150ma PANEL LAMP		65 DC MAX 65 DC MAX		TUBE DROP 21v AT 130ma DC						50Z7G				
52	2 GRID TRIODE	FIL	6.3	.3	5C-SM5	14BA	G2 TIED TO P G1 TIED TO G2			PR AMP CL A CL B 2 TUBE	110 180	0 0		43 3 NO SIGNAL	5.2	1750	3000	1.5 5	2000 10000		52				
53	TWIN TRIODE	HTR	2.5	2.0	7B-SM7	14BA				POWER AMP CL B 2 SECT	300	0		35 MAX SIG PL CUR - 70ma (SEE TYPE 6A6 ALSO)			10	8000		53					
55 55S	DUO-DI TRIODE	HTR	2.5	1.0	6G-SS6 6G-SS6	12DA	1.7	2.0	3.5	AMPLIFIER CLASS A	250 135	-20 -10.5		8 3.7	8.3 8.3	7500 11000	1100 750	.3 .075	20000 25000		55 55S				
56 56S 56AS	TRIODE	HTR	2.5 2.5 6.3	1.0 1.0 .3	5A-SS5 5A-SS5 5A-SS5	12BA	3.2	3.2	2.2	AMPLIFIER E CLASS A BIAS DET	250 100 250	-13.5 -5 -20		5 2.5 0.2 WITH NO SIGNAL	13.8 13.8	9500 12000	1450 1150				56 56S 56AS				
57 57S 57AS	PENTODE	HTR	2.5 2.5 6.3	1.0 1.0 .4	6F-SS6 6F-SS6 6F-SS6	12DB	.007*	5.0	6.5	AMPLIFIER CLASS A	250 100	-3 -3	100 100	2 2	0.5 0.5	1500 1185	1.5MEG 1.0MEG	1224 1185		-7 -7	57 57S 57AS				
58 58S 58AS	PENTODE	HTR	2.5 2.5 6.3	1.0 1.0 .4	6F-SS6 6F-SS6 6F-SS6	12DB	.007*	.50	6.5	AMPLIFIER CLASS A	250 100	-3 -3	100 100	8.2 8	2 2.2	1280 375	.8 MEG .25MEG	1600 1500		-50 -50	58 58S 58AS				
59	PENTODE	HTR	2.5	2.0	7A-SM7	16AA	PENT CONN G <sub>2</sub> , G <sub>3</sub> TO PL 2 TUBES G <sub>3</sub> TO P			PR AMP CL A TRI CONN PR AMP CL B G <sub>1</sub> TO G <sub>2</sub>	250 250 400 300	-18 -28 0 0	250	35 26 26 NO SIGNAL 20 NO SIGNAL	9 6	100 2300	40000 2500	2500 2600	3 1.25 20 15	6000 5000 6000 4600		59			
70A7GT	DI BEAM PR AMP	HTR	70	.15	8AB-OGT8	9DB				H W RECT PR AMP CL A	125 RMS MAX 110 -7.5 110		70 DC MAX 40 3 80		TUBE DROP 14v AT 120ma DC 5800 1.5 2500						70A7GT				
70L7GT	DIODE BM PWR	HTR	70	.15	8AA-OGT8	9DB				H W RECT PR AMP CL A	125 RMS MAX 110 -7.5 110		70 DC MAX 40 3		TUBE DROP 20v AT 140ma DC 15000 7500 1.8 2000						70L7GT				
71A	TRIODE	FIL	5	.25	4D-SM4B	14BA				POWER AMP CLASS A	180 90	-40.5 -16.5		20 10		3 3	1750 2170	1700 1400	.79 .125	4800 3000		71A			
75 75S	DUO-DI TRIODE	HTR	6.3	.3	6G-SS6 6G-SS6	12DA	1.7	2.0	3.5	AMPLIFIER CLASS A	250	-2		0.9		100	91000	1100				75 75S			

SEE PAGE 4 FOR DATA CHART REFERENCE NOTES

TYPE	DESIGN	CATHODE HTR OR FIL			BASING DATA	MAX SIZE VIEW	CAPACITIES			USED AS	PLATE VOLTS	GRID VOLTS	SCR VOLTS	PLATE MA	SCR MA	AMP FACT	PLATE RESIS OHMS	MUT COND mmho	OUT PUT WATTS	LOAD RESIS OHMS	CUT OFF VOLTS	TYPE
		TYPE	VOLTS	AMPS			G-P mmfds	IN mmfds	OUT mmfds													
76	TRIODE	HTR	6.3	.3	5A-SS5	12BA				AMPLIFIER CLASS A BIAS DET	250 100 250	-13.5 -5 -20		5 2.5 0.2 WITH NO SIGNAL	13.8 13.8	9500 12000	1450 1150					76
77	PENTODE	HTR	6.3	.3	6F-SS6	12DA	.007*	4.7	11	AMPLIFIER CLASS A	250 100	-3 -1.5	100 60	2.3 1.7	0.5 0.4	1.5MEG 0.6MEG	1250 1100			-7.5 -5.5	77	
78	PENTODE	HTR	6.3	.3	6F-SS6	12DA	.007*	4.5	11	AMPLIFIER CLASS A	250 250 100	-3 -3 -1	125 100 100	10.5 7.0 9.5	2.6 1.7 2.7	.6 MEG .8 MEG .15MEG	1650 1450 1650			-52.5 -42.5 -38.5	78	
79	TWIN TR	HTR	6.3	.6	6H-SS6	12DA				CL B AMP 2 SECTIONS	250 180	0 0		10.6 NO SIG 7.6 NO SIG				8 5.5	14000 7000		79	
80	TWIN DI	FIL	5.0	2.0	4C-SM4	14BA				FULL WAVE RECTIFIER	350 FMS MAX COND IN 125 DC MAX TUBE DROP 60v AT 125ma DC 500 RMS MAX CHOKE IN 125 DC MAX										80	
81	DIODE	FIL	7.5	1.25	4B-SM4	16AA				H W RECT	700 RMS MAX 85 DC MAX TUBE DROP 91v AT 170ma DC										81	
82	TWIN DI	FIL	2.5	3.0	4C-SM4	14BA (MERCURY VAPOR)				FULL WAVE RECTIFIER	450 RMS MAX COND IN 115 DC MAX TUBE DROP 15v 550 RMS MAX CHOKE IN 115 DC MAX										82	
83	TWIN DI	FIL	5.0	3.0	4C-SM4	16AA (MERCURY VAPOR)				FULL WAVE RECTIFIER	450 RMS MAX COND IN 225 DC MAX TUBE DROP 15v 550 RMS MAX CHOKE IN 225 DC MAX										83	
83V	TWIN DI	HTR	5.0	2.0	4AD-SM4	14BA				FULL WAVE RECTIFIER	375 RMS MAX COND IN 175 DC MAX TUBE DROP 23v AT 175ma DC 500 RMS MAX CHOKE IN 175 DC MAX										83V	
84/6Z4	TWIN DI	HTR	6.3	.5	5D-SS5	12BA				FULL WAVE RECTIFIER	325 RMS MAX COND IN 60 DC MAX TUBE DROP 20v AT 60ma DC 450 RMS MAX CHOKE IN 60 DC MAX										84/6Z4	
85	DUO-DI TRIODE	HTR	6.3	.3	6G-SS6	12DA	1.7	2.0	3.5	AMP CL A	250 180	-20 -13.5		8 6		8.3 8.3	7500 8500	1100 975	.35 .16	20000 20000		85

SEE PAGE 4 FOR DATA CHART REFERENCE NOTES

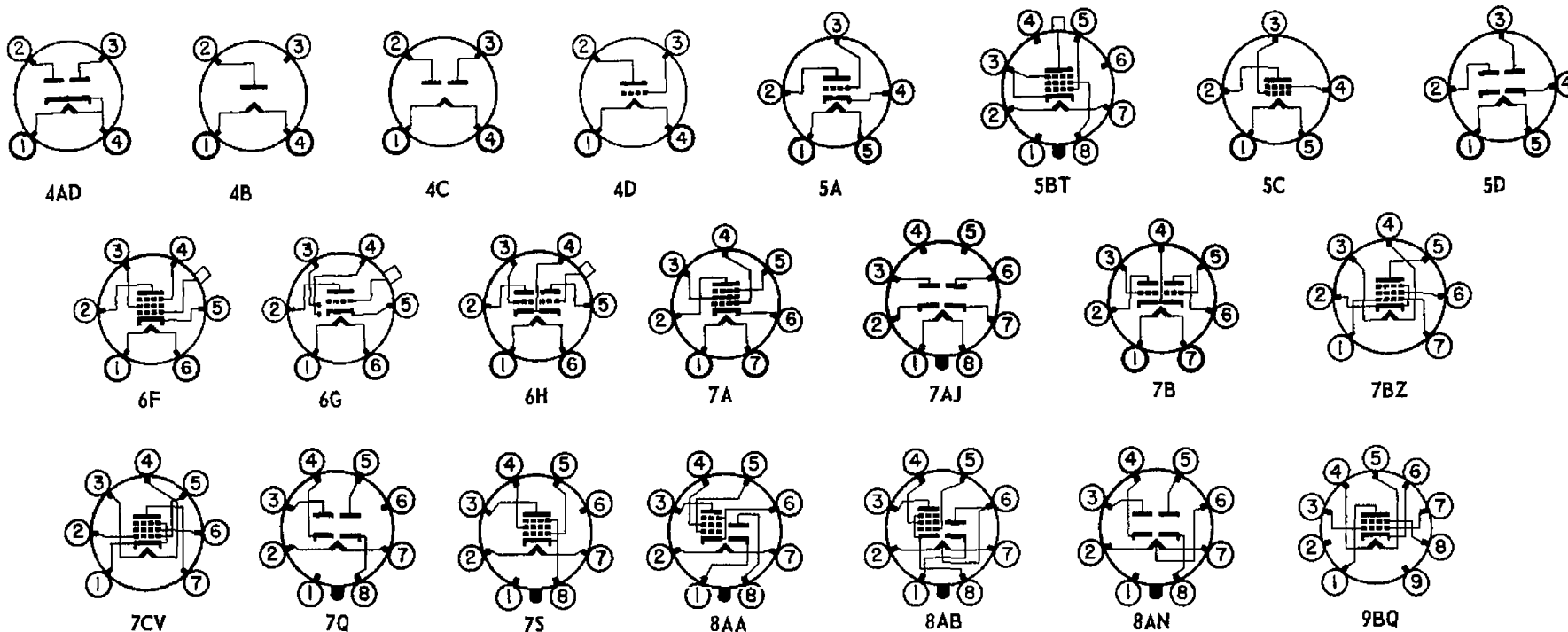



TYPE	DESIGN	CATHODE HTR OR FIL			BASING DATA	MAX SIZE VIEW	CAPACITIES			USED AS	PLATE VOLTS	GRID VOLTS	SCR VOLTS	PLATE MA	SCR MA	AMP FACT	PLATE RESIS OHMS	MUT COND mmbo	OUT PUT WATTS	LOAD RESIS OHMS	CUT OFF VOLTS	TYPE
		TYPE	VOLTS	AMPS			G-P mmfds	IN mmfds	OUT mmfds													
85AS	DUO-DI TRIODE	HTR	6.3	0.3	6G-SS6					AMP CL A	250	-9		5.5		20		1250				85AS
89	PENTODE	HTR	6.3	.4	6F-SS6	12DA	G <sub>3</sub> TIED TO K G <sub>1</sub> TIED TO G <sub>2</sub>			PENT PR AMP CLASS A CL B 2 TUBE	250 135 180	-25 -13.5 0	250 135	32 14 6	5.5 2.2 NO SIGNAL	125 125	70000 92500	1800 1350	3.4 0.75 3.5	6750 9200 9400		89
V99 X99	TRIODE	FIL	3.3	.063	4E-SV4 4D-SS4	8AA 9FC	3.3	2.5	2.5	AMP CL A BIAS DET	90 90	-4.5 -10.5		2.5 0.2	6.6 WITH NO SIGNAL	15500	425					V99 X99
117L/ M7GT	DI BEAM PR AMP	HTR	117	.09	8AO-OGT8	9DB				H W RECT PR AMP CL A	117 RMS MAX 105 -5.2 105		75 DC MAX 43 4						TUBE DROP 16v AT 160ma DC 17000 5300 0.85 4000			117L/ M7GT
117N7GT	DI BEAM PR AMP	HTR	117	.09	8AV-OGT8	9DB				H W RECT PR AMP CL A	117 RMS MAX 100 -6 100		75 DC MAX 51 6.0						TUBE DROP 16v AT 150ma DC 16000 7000 1.2 3000			117N7GT
117P7GT	DI BEAM PWR AMP	HTR	117	0.09	8AV-OGT8	9DB				H W RECT PR AMP CL A	117 RMS MAX 105 -5.2 105		75 DC MAX 43 4						TUBE DROP 16v AT 50ma DC 17000 5300 0.85 4000			117P7GT
117Z3	DIODE	HTR	117	0.04	4CB-MB7	5AD				H W RECTIFIER	MAX PEAK INVERSE = 330 volts, MAX I <sub>o</sub> = 90 madc											117Z3
117Z4GT	DIODE	HTR	117	0.04	5AA-OGT6	9DB				H W RECT	117 RMS MAX		90 DC MAX						TUBE DROP 22.5v AT 180ma DC			117Z4GT
117Z6GT	TWIN DIODE	HTR	117	.075	7Q-OGT7	9DB				RECTIFIER V DOUBLER	235 RMS MAX 117 RMS MAX		60 DC MAX 60 DC MAX						TUBE DROP 15.5v AT 125ma DC			117Z6GT
182B/482B	TRIODE	FIL	5.0	1.25	4D-SM4	14BA				PR AMP CL A	250	-35		18		5		1500				182B/482B
183/483	TRIODE	FIL	5.0	1.25	4D-SM4	14BA				PR AMP CL A	250	-58		20		3		1500				183/483
485	TRIODE	HTR	3.0	1.25	5A-SS5	12BA				AMP CL A	180	-10		5.2		12.8		1300				485
950	PENTODE	FIL	2.0	.12	5K-SM5	14BA				PR AMP CL A	135	-16.5	135	7.0	2.0	100	.1 MEG	1000	.45	13500		950
BA	TWIN DI	COLD			4J-SM4	19BA	GAS FILLED			F W RECT	350 RMS MAX			350 DC MAX			TUBE DROP 80v					BA
BH	TWIN DI	COLD			4J-SM4	14AA	GAS FILLED			F W RECT	350 RMS MAX			125 DC MAX			TUBE DROP 90v					BH
BR	DIODE	COLD			4H-SM4	12AA	GAS FILLED			H W RECT	300 RMS MAX			50 DC MAX			TUBE DROP 60v					BR
XXD	TWIN TRIODE	HTR	12.6	.15	8AC-L8	9AC	2.3	2.2	1.6	AMP CL A 1 SEC	250 100	-10 0		9 10.8		16 17	7600 6500	2100 2600				XXD
XXL	TRIODE	HTR	6.3	.3	5AC-L8	9AC	2.0	3.4	2.6	AMP CL A	250 100	-8 0		8 10		20 25	8700 7000	2300 3600				XXL

SEE PAGE 4 FOR DATA CHART REFERENCE NOTES

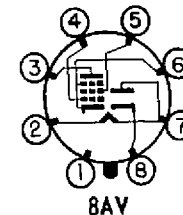
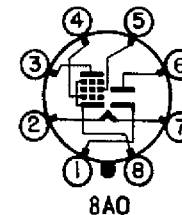
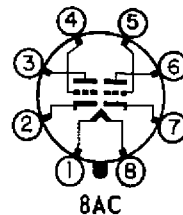
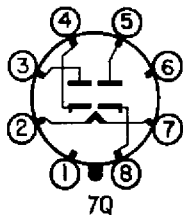
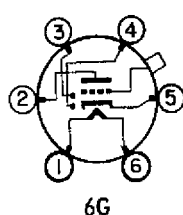
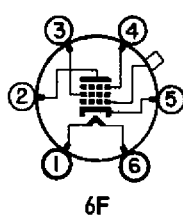
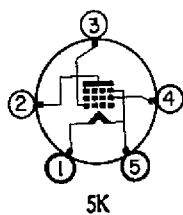
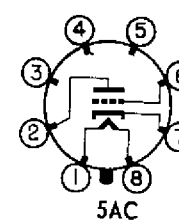
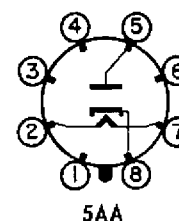
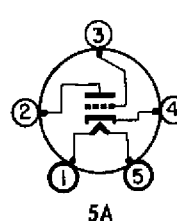
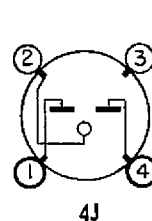
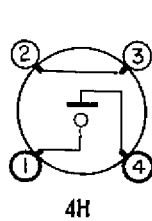
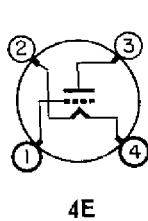
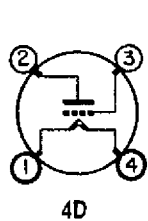
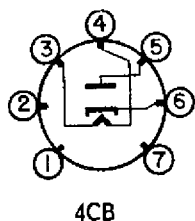



## PANEL LAMPS

Raytheon Dependable Panel Lamps are of the highest quality and are designed especially to meet the requirements of the renewal market.

TYPE NO.	VOLTS	AMPS.	APPROX. CANDLE POWER	BULB	BASE	BEAD COLOR	LIGHT CENTER LENGTH	MAX. OVERALL LENGTH	TYPE NO.
40	6-8	0.15	0.5	T-3¼	Min. Screw	Brown	¾"	1½"	40
40-A	6-8	0.15	0.5	T-3¼	Min. Bayonet	Brown	¾"	1½"	40-A
41	2.5	0.5	0.5	T-3¼	Min. Screw	White	¾"	1½"	41
42	3.2	0.5	0.75	T-3¼	Min. Screw	Green	¾"	1½"	42
43	2.5	0.5	0.5	T-3¼	Min. Bayonet	White	¾"	1½"	43
44	6-8	0.25	0.8	T-3¼	Min. Bayonet	Blue	¾"	1½"	44
45	3.2	0.5	0.75	T-3¼	Min. Bayonet	Green	¾"	1½"	45
46	6-8	0.25	0.8	T-3¼	Min. Screw	Blue	¾"	1½"	46
47	SAME CHARACTERISTICS AS 40A. WITH WHICH IT IS INTERCHANGEABLE								47
48	2.0	0.06	0.03	T-3¼	Min. Screw	Pink	¾"	1½"	48
49	2.0	0.06	0.03	T-3¼	Min. Bayonet	Pink	¾"	1½"	49
49-A	2.1	0.12	0.07	T-3¼	Min. Bayonet	White	¾"	1½"	49-A
50	6-8	0.2	1.0	G-3½	Min. Screw	White	¾"	1½"	50
51	6-8	0.2	1.0	G-3½	Min. Bayonet	White	½"	1½"	51
55	6-8	0.4	1.5	G-4½	Min. Bayonet	White	½"	1½"	55
291	2.9	0.17	—	T-3¼	Min. Bayonet	White	¾"	1½"	291
292	2.9	0.17	0.3	T-3¼	Min. Screw	White	¾"	1½"	292
292-A	2.9	0.17	0.3	T-3¼	Min. Bayonet	White	¾"	1½"	292-A
1490	3.2	0.16	—	T-3¼	Min. Bayonet	White	¾"	1½"	1490

Note: The color of the bead inside the lamp bulb may be used to identify the more common Raytheon types. This information is shown in the column headed "Bead Color."

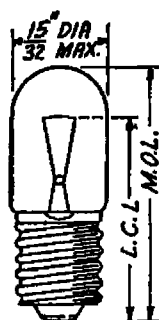

40  
41  
42  
46  
48  
292

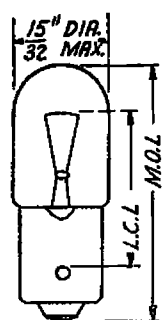

40A  
43  
44  
45  
49  
49A  
291  
292A  
1490

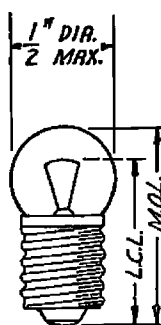

50

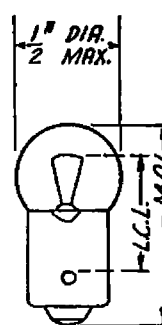

51

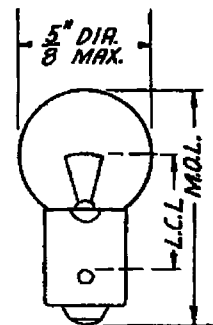

55

3AA

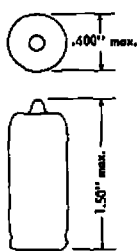

3BA

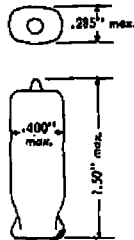

5A

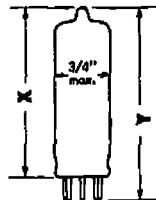

5B

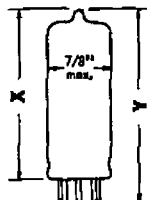

5C

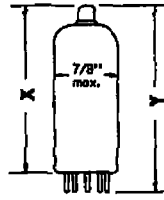

7AA

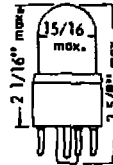

8AA



8B

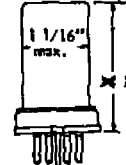

8CA

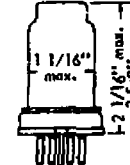

	X	Y
5AA	1 1/2	1 3/4
5AB	1 3/8	1 5/8
5AC	1 1/4	2 1/4
5AD	2 3/4	2 5/8

	X	Y
5BA	1 1/2	1 3/4
5BB	1 5/8	2 3/8
5BC	2 1/4	2 5/8
5BD	2 3/4	3 1/8

	X	Y
5CA	2 7/8	2 11/16
5CB	2 7/8	2 13/16
5CC	2 3/4	3 1/4
5CD	2 11/16	3 3/8

	X	Y
8BA	1 1/4	1 5/8
8BB	2 1/4	2 5/8

8DA



8EA

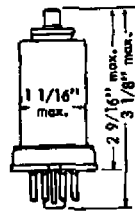

8FA

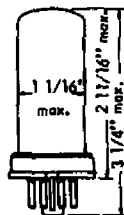

9A

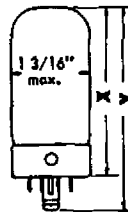

9B

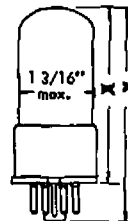

9C

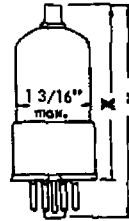

9D

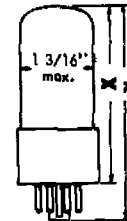

9E

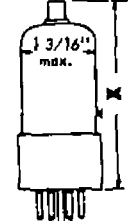

	X	Y
9AA	1 1/2	2 1/2
9AB	1 3/4	2 3/4
9AC	2 1/4	2 5/8
9AD	2 5/8	3 1/2

	X	Y
9BA	2 5/8	2 7/8
9BB	2 1/2	3 1/4
9BC	2 3/4	3 5/8
9BD	2 7/8	3 3/8

	X	Y
9CA	2 3/4	3 3/4
9CB	3	3 3/8

	X	Y
9DA	2 1/2	3 1/8
9DB	2 7/8	3 3/8

	X	Y
9EA	2 3/4	3 15/16
9EB	2 15/16	3 1/2
9EC	3 1/8	3 11/16
9ED	3 3/8	4 3/8

9F

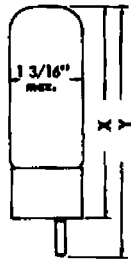

	X	Y
9FA	1 3/4	2 5/8
9FB	3 1/4	3 13/16
9FC	3 3/4	4
9FD	3 3/4	4 1/4

10AA

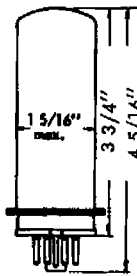

11A

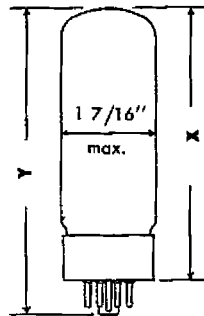

	X	Y
11AA	2 1/8	3 1/2
11AB	3 3/8	3 3/8
11AD	4 1/8	4 3/8

11B

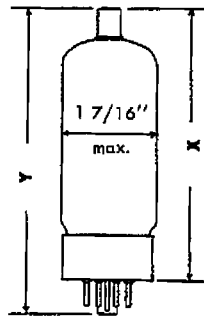

	X	Y
11BB	3 1/2	4 1/4
11BC	3 3/4	4 3/4
11BD	4 1/4	5

12AA



12B

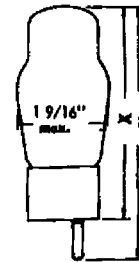

	X	Y
12BA	3 3/8	4 3/8
12BB	3 1/2	4 3/4

12C

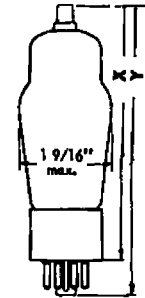

	X	Y
12CA	3 3/8	4 1/2
12CB	4 1/8	4 3/8

12D

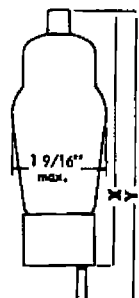

	X	Y
12DA	3 3/8	4 1/2
12DB	4 3/8	4 1/2

12E

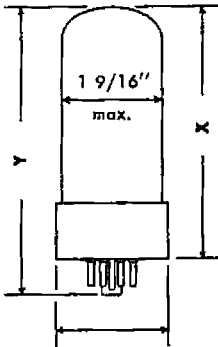

	X	Y
12ED	4 1/8	4 3/8
12EE	4 3/8	5

12G

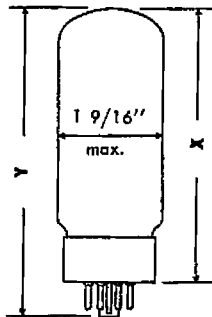

	X	Y
12GB	3 3/8	3 3/8
12GD	4 1/8	4 3/8
12GE	4 3/8	5

12H

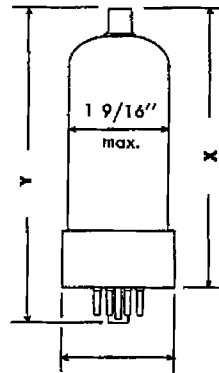

	X	Y
12HD	4 1/4	5
12HE	4 3/4	5 3/4

12J

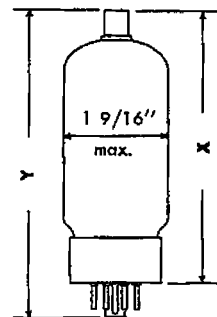

	X	Y
12JC	3 1/2	4 1/4
12JD	3 3/4	4 3/4
12JE	4 1/4	5

14A

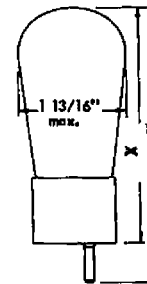

	X	Y
14AA	3 3/4	4 3/8
14AB	4 1/8	4 1/4

14BA

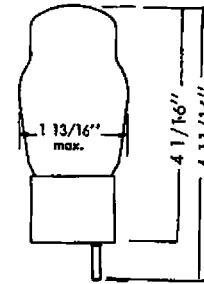

14CA

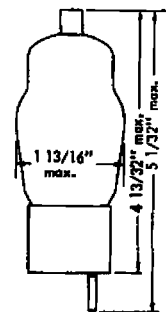

16AA

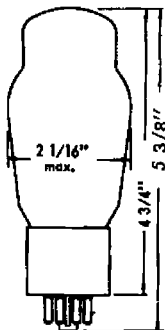

16BA

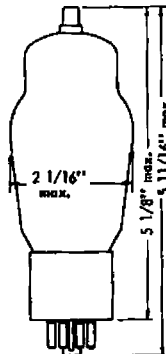

16CA

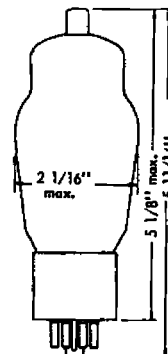

19AA

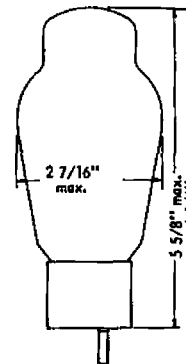

19BA

