

Wireless Telegraphy

Its History, Theory and Practice

BY

A. FREDERICK COLLINS

Published by the

McGraw-Hill Book Company
New York

Successors to the Book Departments of the

McGraw Publishing Company

Hill Publishing Company

Publishers of Books for

Electrical World

The Engineering and Mining Journal

The Engineering Record

Power and The Engineer

Electric Railway Journal

American Machinist

NEW YORK

McGRAW PUBLISHING COMPANY

1905

Wireless Telegraphy

Its History, Theory and Practice

BY

A. FREDERICK COLLINS



NEW YORK
McGRAW PUBLISHING COMPANY

1905

TK5741
C7

GENERAL

McU

Copyrighted, 1905
by the
MCGRAW PUBLISHING COMPANY
NEW YORK

PREFACE.

Nearly a decade has now elapsed since the wireless telegraph made its spectacular appearance on the horizon of progressive achievement, and in these passing years it has come to be a factor of the first magnitude in the scheme of social and commercial economics which forms the foundation of our complex mode of living.

As an example of occult manifestations by the most subtle of nature's forces it stands vividly at the head of this class of phenomena, and the skilled labor it has called forth, that longer distances might be bridged, greater accuracy assured, swifter working effected, and, above all, the correlation of the invisible and elusive waves which would render selectivity a concrete fact, may in a small measure be determined by a perusal of these pages.

Since it frequently happens that didactic treatises fall into the hands of the untaught and the simplest of texts are sometimes found useful by the most highly trained specialist, it was proposed that all the various phases of the subject under consideration should receive due attention and, by connecting them in series, a complete and logical account would necessarily follow and one that would bring the state of the art down to the present time.

For this reason a brief historical retrospect takes precedence at the beginning of nearly every chapter, and then, in order to fulfil in sequence the conditions cited above, the theoretical deductions, experimental physics and finally the practical workings are given, and it is believed that by pursuing this course of treatment the book will find a hitherto unoccupied niche in the bibliography relating to wireless telegraphy.

In conclusion I wish to acknowledge my indebtedness to my friend, Dr. James E. Ives, for many consequential details herein enumerated, and which should, in virtue of his wide experience in the analysis and synthesis of electric wave action, make these portions invaluable to the student as well as to the advanced worker; and my thanks are also due to my brother, Dr. T. Byard Collins and to my wife, both of whom have greatly assisted in its preparation by reading the proofs and checking up the data.

A. FREDERICK COLLINS.

New York City, April, 1905.

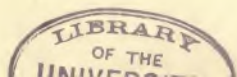

CONTENTS.

CHAPTER I.

ETHER

	PAGE.
HISTORICAL	1
THEORETICAL	5
Function of the Ether	5
Constants of the Ether	10

CHAPTER II.

WAVE MOTION

THEORETICAL	11
Molecular Undulations	11
Transverse Vibration	13
Light Wave Length	14
Reflection	16
Refraction	16
Polarization	17

CHAPTER III.

ELECTRIC WAVES

HISTORICAL	20
EXPERIMENTAL	21
Hertz's Apparatus	28
Reflection	29
Rectilinear Propagation	30
Refraction	30
Polarization	32
Free Electric and Sliding Half-Waves	33

CHAPTER IV.

DISRUPTIVE DISCHARGE

HISTORICAL	36
PHYSICAL	38
Forms of Discharges	38
Discharge Through Dielectrics	39
Color, Size and Shape of Discharges	40
Striking Distance	42
Action of Ultra Violet Light	44
Direct and Alternating Current Effects	45

CHAPTER V.
ELECTRIC OSCILLATIONS

	PAGE.
HISTORICAL	47
THEORETICAL	48
Low Frequency Currents	48
High Frequency Currents	49
Analogue of Electric Oscillations.....	49
Properties of Electric Oscillations.....	50
Transformation	52
Rate of Radiation of Energy.....	53
Decrement of Oscillations	54
Skin Effect in Oscillators	55

CHAPTER VI.
OSCILLATORS

PHYSICAL	56
Oscillators	56
Oscillator Systems	56
Hertz's Oscillator	57
Righi's Oscillator	58
Lodge's Oscillator	58
Multiplex Oscillator	59
Dumbbell Oscillator	59
Bose's Oscillator	60
Experimental Oscillator	60
Marconi's Oscillator	61
Open and Closed Systems	61
Symmetrical and Dissymmetrical Systems	63

CHAPTER VII.
CAPACITY, INDUCTANCE, AND RESISTANCE

HISTORICAL	64
Capacity	64
Inductance	65
Resistance	66
THEORETICAL	66
Capacity Defined	66
Inductance Defined	67
Resistance Defined	68
Effect of Constants on Oscillations.....	69
Formulæ for Calculating Constants.....	70
Calculation of Oscillator Dimensions.....	71
Measurements	71
Capacity	72
Capacity of an Aerial.....	74
Inductance	75
Inductance of an Aerial	76
Resistance	77

CHAPTER VIII.
MUTUAL INDUCTION

HISTORICAL	78
THEORETICAL	80
Induced Currents	80

	PAGE.
Primary and Secondary Currents.....	82
Theory of the Induction Coil	83
Permeability	83
Hysteresis	84
Mutual Induction	84
Function of the Condenser.....	85
Optimum Capacity	87
Calculating the Potential of a Coil.....	88
Forms of Coils	89

CHAPTER IX.

INDUCTION COILS

HISTORICAL	92
PRACTICAL	95
Primary Coils	96
Secondary Coils	97
Insulation	99
Assembly of Parts.....	100
Sources of E. M. F.	100
Selection and Care of a Coil.....	100
Types of Coils	102
Ordinary Coil	102
Modern Coil	102
Foote Pierson Pelta Coil	103
Lodge Muirhead Coil	103
Kinraide Coil	103
Braun-Siemens and Halske Coil	103
Slaby-Arco Coil	103
Fessenden Coil	104
Queen & Co. Meter Spark Coil.....	105

CHAPTER X.

INTERRUPTORS

PRACTICAL	107
Single Vibrating Interruptor	108
Double-Contact Interruptor	109
Double Spring Interruptor	110
Independent Interruptor	111
Mechanical Reciprocating Interruptor.....	112
Mechanical Rotating Interruptor	113
Mercury Turbine Interruptor	114
Electrolytic Interruptor	116
Liquid Interruptor	119
Rotary Interruptor	120
Disruptive Discharge Interruptor	121
Rotary Converter Interruptor.....	122
Mercury Vapor Interruptor	125

CHAPTER XI.

OSCILLATING CURRENT GENERATORS

PRACTICAL	127
Holtz-Toepler Machines	128
Fleming Transformer	130
Tesla Oscillator	130
Elihu Thomson Apparatus	134

CHAPTER XII.

ELECTRIC WAVE ACTION

	PAGE.
HISTORICAL	136
THEORETICAL	136
EXPERIMENTAL	140
Branly's Experiments	140
Koepsel's, Guthe's and Tommasina's Researches	142
De Forest and Smyth's Investigations	143
Testing the Coherer	143

CHAPTER XIII.

ELECTRIC WAVE DETECTORS

PRACTICAL	145
Calzecchi Tube	145
Hertz Resonator	145
Branly Radio-Conductor	145
Lodge Coherer	147
Other Detectors	147
Marconi Coherer	149
Experimental Coherer	150
Slaby-Arco Coherer	150
Braun	151
Blondel Regenerable Coherer	153
Schaffer Anti-Coherer	153
Branly Tripod Coherer	154
Castelli Coherer	154
Fessenden Magnetic Detector	154
Marconi Magnetic Detector	155
DeForest Electrolytic Responder	157
Lodge Mercurial Coherer	158
Marconi Magnetic Detector (Second Form)	159
Fessenden Hot-Wire Barretter	160
Fessenden Liquid Barretter	161
Testing Boxes or Buzzers	162

CHAPTER XIV.

TRANSMITTERS

HISTORICAL	163
PRACTICAL	164
Classification of Transmitters	165
Marconi Transmitter (First Form)	166
Marconi Transmitter (Second Form)	166
Lodge Transmitter	167
Slaby-Arco Transmitter (First Form)	168
Slaby-Arco Transmitter (Second Form)	169
Guarini Transmitter (First Form)	171
Guarini Transmitter (Second Form)	173
Marconi Transmitter (Third Form)	174
Braun Transmitter	175
Marconi Transmitter (Fourth Form)	176

	PAGE.
Popoff-Ducretet Transmitter	178
DeForest Transmitter	178
Fessenden Transmitter	179
Branly-Popp Transmitter	180
Cervera Transmitter	182
Lodge-Muirhead Transmitter	182
Bull Transmitter	183
Marconi Cableless Transmitter	184

CHAPTER XV.

RECEPTORS

HISTORICAL	185
PRACTICAL	186
Classification of Receptors	186
Popoff Receptor	187
Marconi Receptor (First Form)	188
Marconi Receptor (Second Form)	190
Lodge Receptor	191
Slaby-Arco Receptor	191
Braun Receptor	192
Marconi Receptor (Third Form)	194
Guarini Automatic Repeater	195
Marconi Receptor (Fourth Form)	197
Fessenden Receptor	198
Popoff-Ducretet Receptor	200
DeForest-Smythe Receptor	201
Cervera Receptor	202
Branly-Popp Receptor	203
Lodge-Muirhead Receptor	204
Bull Receptor	207
Marconi Cableless Receptor	207

CHAPTER XVI.

SUBSIDIARY APPARATUS

PRACTICAL	210
KEYS	210
Marconi Key	210
(a) Braun Key	211
(b) Braun Key	211
Ducretet Key	212
Fessenden Key	213
DeForest Key	213
Lodge-Muirhead Key	214
Lodge-Muirhead Buzzer	215
CONDENSERS	216
Tesla Oil Condenser	216
Braun Cylindrical Condenser	216
Adjustable Mica Condenser	217
TRANSFORMERS	218
Braun High-Frequency Transformer	218
Marconi Low Potential Transformer	219

	PAGE.
DE-COHERERS	220
Marconi Tapper	221
Braun Tapper	222
Guarini Tapper	223
Collins Magnetic De-Coherer	223
RELAYS	223
Ordinary Relays	223
Polarized Relays	224
INDICATORS	226
Morse Register	227
Telephone Receivers	228
Siphon Recorders	229
TUNING COILS	230
CHOKING COILS	231
POLARIZED CELLS	231
SCREENING CASES	232
ALPHABETIC CODES	232

CHAPTER XVII.

AERIAL WIRES AND EARTHS

HISTORICAL	234
THEORETICAL	234
PRACTICAL	238
Methods of Suspension	239
Forms of Aerials	240
Lodge Capacity Aerial	241
Guarini Sheathed Aerial	241
Jegou Differential Aerial	241
Marconi Aerial (Second Form)	242
Slaby-Arco Direct Earthed Aerial	243
Braun Artificial Earth	244
DeForest Mast and Aerial	244
Fessenden Wave Chute	245
Kite-Sustained Aerials	247
Marconi Cableless Station Aerial	252

CHAPTER XVIII.

RESONANCE

HISTORICAL	258
THEORETICAL	259
EXPERIMENTAL	261
Simple Resonance	261
Sympathetic Resonance	262
Determination of Periodicity	264
Apparatus for Plotting Resonance Curves	265
Relation of Co-efficients to Resonance	265
Tuning Closed to Open-Oscillator Circuits	267
Tuning Resonator Circuits	267
Resonance in Wireless Telegraphy	268

CONTENTS.

xi

CHAPTER XIX.

SYNTONIZATION

	PAGE.
HISTORICAL	269
PRACTICAL	270
Lodge Tuned System	270
Slaby-Arco Multiple System	272
Marconi Syntonic System (First Form)	273
Marconi Syntonic System (Second Form)	274
Braun Resonance System	274
Fessenden Selective System	275
Tesla Duplex System	276
Stone Multiplex System	277
Bull Synchronized System	280

CHAPTER XX.

WIRELESS TELEPHONY

Conductivity Method	286
Inductivity Method	286
Electric Wave Method	287
Bell Radiophone	287
Ruhmer Photo-Electric Telephone	288
Collins Wireless Telephone	292



CHAPTER I.

ETHER.

To understand the fundamental principles involved in transmitting electric waves without connecting wires we are confronted at the very outset with the postulates of that branch of physics dealing with transcendental matter.

By transcendental matter we mean the substance of which the ether is composed and we cannot, by any known physical method, determine its constituency, although this has been attempted. By the term electric waves we differentiate waves emitted by electricity and electricity itself.

HISTORICAL.

For at least a thousand years B.C. philosophers advanced the hypothesis of a medium in the form of a substance or attenuated fluid filling interstellar space and all space in masses and between molecules and atoms not otherwise occupied by gross matter. These speculations, though not verified by experiment, were advanced for the purpose of satisfying the demand occasioned by a particular phenomenon, for it frequently occurred that an explanation or a theory would be found wanting, if not, indeed, utterly untenable, without assuming the existence of a connecting medium; other thinkers advocated a universal ether in virtue of the requirements of their metaphysics, as, for instance, where its presence was deemed a necessary factor in the extension of matter, or the postulate that all space must be filled with something, since nature and a vacuum are incompatible.

Oppositely arrayed were those who proclaimed that matter could act on other matter through space without intervening matter to transmit the energy, i.e., action without physical contact; and by them this was considered a rational philosophy. Without the evidence of an experimental nature to justify the claims of either

faction, the problem remained practically unsolved throughout all the succeeding centuries until the dawn of the nineteenth, when the cloud of obscurity overhanging it began to rise.

The question was, from its incipency, a constant theme for discussion and bitter debate, and even in 1650, when Sir Isaac Newton evolved his theory of universal gravitation, there were still the opposition parties, who were now resolved into the Cartesians, or followers of Descartes, who resisted the onward wave of "action at a distance," and the Newtonians, who believed that intervening matter was not essential to the transmission of energy from one body to another removed by distance. This was a rather curious phase of the discussion, for it would seem from Newton's own letters that he was quite firm in his belief of the actual existence of this attenuated, subtle substance, notwithstanding his followers were opposed to it.

Nearly one hundred years after, or in the middle of the eighteenth century, Father Boscovitch promulgated his doctrinal theory that the laws governing all matter, including their inherent characteristics of physics, chemical affinity, electricity, and magnetism, could be explained by mutual attractions and repulsions, but to fire he gave a special attribute—that of an essence—to account for unfamiliar phenomena. During the next fifty years the erratic philosophy of the priest had become almost universally accepted as the final solution of action at a distance through absolute vacuum, or, as Sir William Thompson, now Lord Kelvin, tersely puts it, "matter acting where it is not," so that the dissolution of the ether was thought by scientists to be complete and the question forever settled, and this in the face of the fact that Christian Huygens, a Dutch mathematician and physicist, had in 1678 worked out his undulatory theory of light and an ether by which he was enabled to account for all its various phenomena. Huygens's is the only tenable theory in the revelations of modern science, but it was shelved for that of Boscovitch and was doomed to obscurity until the wheel revolved and it again came uppermost when that eminent experimentalist, Michael Faraday, in 1845, made a series of tests in an effort to prove that the laws which govern light as elucidated by Huygens—in whose undulatory theory he had the utmost confidence—were the same as those of magnetism. This he successfully accomplished by the rotation of the plane of polarized light under the action of

magnetism, the transparent glass employed for the purpose being quite heavy and of his own manufacture.

This discovery did not lead to such important practical results in applied science as some of Faraday's earlier discoveries, but it has been of infinitely greater scientific value in establishing the unity of an all-pervading medium, ether, upon which is based the complete evidence that electricity and magnetism are propagated by, in, and through the same substance which transmits the undulatory waves of light as Huygens had proposed nearly two hundred years before. It is true that earlier in the nineteenth century, before Faraday's experimental researches, a reaction had partially set in regarding the merits of Boscovitch's action at a distance and Huygens's luminiferous ether; and the latter, which had been so utterly rejected the preceding century, was now to have an inning and the former's pseudo-tenets relegated to the dead past. But it was Faraday's results that encouraged belief in the existence of an ether, and it has grown stronger through the deductions based upon his experiments by others who have repeated or enlarged upon them, and the impetus Faraday gave to the Huygens theory has changed in the last fifty years the trend of scientific opinion completely from action at a distance to that of matter acting only where matter is. Now also was Descartes and his law of vortices in the ascendancy after having lain dormant for many years.

The empirical evidence Faraday accumulated was entirely sufficient for the complete acknowledgment of the existence of an ether, and that electricity, magnetism, and light were propagated by and through the same medium, but by many of his contemporaries his classical experiments were not accepted without the proverbial grain of salt. A few years later Faraday had a champion who developed his electro-magnetic theory of light mathematically and with such consummate skill and precision that they have not only withstood the test of time, but every crucial test which has been applied to them, and every discovery bearing on the subject has proven the correctness of their views.

In 1861 James Clerk-Maxwell systematized Faraday's conception, which is now known as the Faraday-Maxwell electro-magnetic theory of light, which means, in its simplest form, that light, electricity, and magnetism are transmitted by the same ether through which they travel with an identical rate of speed. Maxwell, by a

system of Le Grange's co-ordinates, determined accurately the relations between the various phenomena it included. The number of converts to the doctrine of transcendental matter were now greater than had been made in all the preceding centuries, for Maxwell's equations gave a tangibility to the subtle substance such as it had never known before. There were those of course who still refused to be convinced and who still clamored for such proof as could only be obtained by decisive experiment.

The deductions of Maxwell were now taken up eagerly and analyzed by such eminent scientists as von Helmholtz, Kelvin, and many others, all of whom, starting with the well-known laws of light, electricity, and magnetism, were led to conclude from their own results the correctness of the Faraday-Maxwell theory, and the final analysis of all tended to prove the actuality of one ether. This was sufficient to account for all the varied phenomena such as the rectilinear propagation of light, radiant heat, electrokinetics, and the curved lines of magnetic force.

The name of the lamented Heinrich Hertz should have been added to those above written, for it remained for him alone to establish experimentally the proof of Maxwell's deductions. His methods, like Faraday's, were physical rather than theoretical. The tremendous amount of labor involved in probing for the truth about ether, and the infinite pains required to obtain absolute, undeniable proof of it, may be understood by looking backward again to the laborious task Faraday performed in showing experimentally that the undulatory theory of light and his own curved lines of force were related, and that, therefore, the ether transmitting them must be the same. Maxwell then assumed the arduous duties entailing the verification of Faraday's researches mathematically, and finally Hertz utilized the equations of Maxwell and reversed the order of Faraday's experiment demonstrating the existence of stationary electric waves and that the time constant of their propagation in ether was identical with that of light. This he did in 1888 at Karlsruhe, Germany, and his experiments, simple as the laws governing the action of the electric waves they represent, and as grand in their sublimity as the scientific world has ever known, settled conclusively and finally the existence of an ether and laid the foundation for a commercial enterprise that has so recently startled the world in wireless telegraphy.

THEORETICAL.

Hertz, in his great work, "Electric Waves," has thoroughly sifted the various viewpoints assumed by recent scientists for an ether fulfilling all the functions required of it, and concludes with a concise statement showing the difference in the views held by Maxwell and those of Helmholtz. According to Helmholtz the attractions between two separate bodies A and B, Fig. 1, is based upon two factors, the first by direct action between A and B, represented by the arrows, and second by

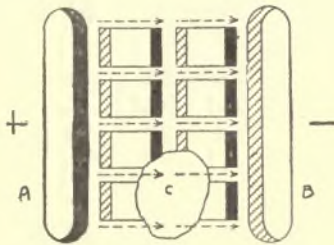

FIG. 1.—POLARIZATION OF ETHER.
(According to Helmholtz.)

the changes in the ether represented by the intervening rectangles. Supposing that the black portion of A is positively charged, the force exerted directly on B will be negative, as indicated by the ruled portion; the intervening matter, be it the ether or other substance shown by the rectangles, will be polarized,

that is, the portions nearest A will be negative and the opposite sides will be positive, and these forces acting and reacting on the subsequent matter on reaching B charge it negatively. According to Poisson this polarization of the ether is of a magnetic nature, and upon this deduction he developed his theory of static magnetism; Mosotti assumed them to be electrical, and Helmholtz, combining these two hypotheses, formulated a theory embracing all the phenomena of electro-magnetism. This theory postulates that if from the space C the ether be removed, forming an absolute vacuum, the positive and negative forces will continue to exist as shown by the arrows, but, since there is no matter, polarization cannot take place.

Maxwell, according to Hertz, agrees with Helmholtz in that the polarizations of the ether are actually present, but not that these polarizations are due to the force of A acting on B, and Maxwell does not assume that the distant forces exist, hence A and B represent nothing, and that the polarization is the only factor present, as shown in Fig. 2, and it is this cause to which we may trace all the effects of molecular and transcendental matter we are acquainted with. It will be seen that if all the ether is removed from the space C, Fig. 2, according to Maxwell, not only would the polarizations not be manifested, but the electro-magnetic forces

producing them would also not be present. This is Maxwell's theory upon which he based his system of equations, and this is the theory Hertz employed, with some few practical modifications,

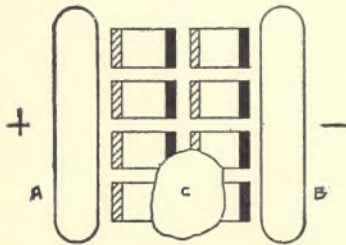

FIG. 2.—POLARIZATION OF ETHER.
(According to Maxwell.)

in his experiments. Faraday laid the corner-stone for this evolution of etheric polarizations. Maxwell was the architect who drafted the plans for its consummation, but Hertz was the builder, and when he had finished his grand work the first absolute proof of a material ether rose before men, a mighty masterpiece; so complete

were his classical investigations that Ernest Haeckel, the great evolutionist, proclaimed that there would now be just as much reason to deny the existence of molecular matter as to deny the existence of the more subtle transcendental ether, and he lamented the fact that, as there were metaphysicians who denied the molecular theory of matter, as Berkeley and Hume, there were still a few philosophers of the abstract who denied the existence of ether.

Hertz commenced his researches in 1879, when the Berlin Academy of Science offered a prize for the solution of a problem showing polarizations in a non-conductor or dielectric to be the result of electro-magnetic induction, but it was not until 1886 that he was able to see his way clear to solving it. These remarkable achievements will be fully treated in the succeeding chapters, for Hertz's work embraces a whole series of exceedingly vital propositions, among them being the proof of the electro-magnetic theory of light, the proof of the existence of an ether, the discovery of stationary electric waves, the mode of producing electric waves by means of a spark-gap, and the manifestation of electric waves by means of a detector, all of those enumerated, but especially the two latter discoveries, forming the basis of the subject herein treated, wireless telegraphy. The sum of the knowledge advanced by all the workers has given us the following conception of what ether is, its functions, and we already know some of its uses.

But, after all is said, it must not be supposed that the nature of ether is really known; for that matter, we do not know positively the real nature of molecular matter, but we do know many of the laws governing the latter and some of the laws of the former, and

with these for the present we must be content. Slowly but surely our knowledge of the laws of both are being enlarged and new laws are occasionally discovered or more accurately determined, and all this is of the greatest importance. As we have seen, the views of those thinkers who have bended their energies toward a possible solution of the ether mystery do not always coincide; more frequently they appear to contradict each other, so that one is at a loss to choose between them, but the following points will serve to show the trend of scientific opinion.

Starting out with the now universally accepted idea that a cosmic ether pervades all space not otherwise taken up by molecular matter, and accepting Maxwell's postulates as gospel truths, we are next confronted with the question of its structure. By some it is believed to be a homogeneous corpuscular body, while others conceive it to be a continuous substance. By those who hold to the *continuous* theory, it is pointed out that the opposite theory of etheric corpuscles is defective, for it must then be supposed that there is another ultra-etheric medium between the corpuscles and so on to infinity.

In behalf of the corpuscular theory, it has been advanced that the corpuscles of ether, though of a uniform size, need not necessarily be spherical, but of any shape permitting them to conform to each other without leaving any intermediate space. The net product would be then, to all intents and purposes, a continuous substance. The consistency of ether calls for another subdivision of opinion, for by some it is considered gaseous, by others a liquid, and again by some others a solid. Again, probably it is none of these, though each in turn serves as an analogue for its actions. In popular lectures it is often likened to a jelly, and, though crude, this offers a very good illustration of the elasticity and incompressibility of the ether.

As a substance it is so high in the scale of matter that we cannot *sense* it, nor have we any instruments sensitive enough to recognize it. A conception may be obtained from Faraday's¹ statement relative to the fourth state of matter. In 1816 he was conducting his researches along these lines, and the expression he employed may assist in elucidating the vast difference between gross matter and ethereal matter; he said, speaking of radiant matter: "If we conceive a change as far beyond vaporization as that is above fluidity, and

¹Dr. Bence Jones's *Life and Letters of Faraday*.

then take into consideration also the proportional increased extent of alterations as the changes rise, we shall, perhaps, if we can form any conception at all, not fall short of radiant matter; and as in the last conversion many qualities were lost, so here many more would disappear. As we ascend from the solid to the fluid and gaseous states physical properties diminish in number and variety, each state losing some of those which belong to the preceding state; when solids are converted into fluids all varieties of hardness and softness are necessarily lost. Crystalline and other shapes are destroyed. Opacity and color frequently give way to a colorless transparency and a general mobility of particles is conferred. Passing onward to the gaseous state, still more are the evident character of bodies annihilated. The immense differences in their weight almost disappear, the remains in the difference in color that were left are lost. Transparency becomes universal. They now form but one set of substances and the varieties of density, hardness, opacity, color, elasticity, and form which render the number of solids and fluids almost infinite are now supplied by a few slight variations in weight and color."

How true is this of molecular and transcendental matter! It is evident if we could conceive a matter as many times removed from radiant matter as the latter is from solids we would have a substance almost as far beyond our analytical powers as ether itself. The distinction that some physicists have made between ether and molecular matter is to class the former as imponderable and the latter as ponderable; this is evidently erroneous, for, though the specific gravity of ether is so slight as to be beyond the sensibility of the most delicate testing instrument, yet as a substance it must have weight, and this has been computed—from the energy of the light waves through it¹—to be approximately over fifteen trillion times lighter than the air, or, in popular language, a sphere of ether the size of our earth would weigh only 250 pounds.

Maxwell has estimated its density to be $\frac{936}{1,000,000,000,000,000,000}$ that of water, and its rigidity to be $\frac{1}{1,000,000,000,000}$ that of steel. Having density and weight, ether and matter have, essentially, properties in common with each other, and this is the more easily understood if we consider Lord Kelvin's hypothesis of matter.

An atom of gross matter, according to this beautiful deduction,

¹Lebedew, Experiments on Radiation Pressure.

had not always a distinct entity, but originated in a minute portion of the ether attaining a whirling motion, and in virtue of the vortex so formed it became a particle of rigid matter—an entity in itself. Although the ether is extremely tenuous, the vortex motion will give it all the physical properties of matter such as rigidity, stability, density, and weight.

As an analogue of the ether metamorphosed by vortex motion into an atom of matter, vortex rings formed of smoke in the air may be given, as they are familiar objects and may be easily produced. It must be remembered, however, that smoky air rings are excessively crude when compared with ether vortex rings or atoms, for the air is a very imperfect medium, whereas ether is absolutely perfect; for this reason air-vortex rings increase in size and decrease in energy and ether-vortex rings remain absolute and constant, and so, when once set in motion become atomic matter, and, when thus transformed, cannot, by any method known to man, be destroyed.

As Oliver J. Lodge says, this ether offers practically one continuous substance which can vibrate as light, which may be sheared into positive and negative electricity, which in whirls constitutes atomic matter, which transmits energy by polarization instead of impact and is the primary cause of every action and reaction of which matter is capable.

In however many respects physicists may disagree as to the nature of ether, they stand a unit in agreeing that it is in a state of continual unrest. According to Plato ether derives its name from the Greek term, signifying perpetual motion. Likewise are these thinkers agreed as to the ether's incompressibility, which may be regarded as infinite, although, according to Fresnel, in the presence of gross matter there is an attraction between the ether and the atoms of matter, readily accounted for in the light of Kelvin's hypothesis, which results in some of the ether forming a closer affinity for, or clinging to and surrounding each individual atom like the sugar coating of a pill. This is what Nikola Tesla terms *bound ether*, and is a part of the atom to which it adheres and travels about with it.

The relation of bound ether to electricity does not particularly concern wireless telegraphy—that is another question—but it is the radiation of waves emitted by electricity through and by *free ether* that here claims our attention. Lodge thinks it probable that negative and positive electricity jointly may make up the ether and

that the ether may be divided into positive and negative electricity. As an illustration of this shearing process, let A, B represent the ether; then, if it is sheared, as shown diagrammatically in Fig. 3, by

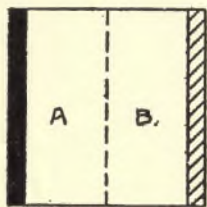

FIG. 3.—SHEARING THE ETHER (According to Lodge).

the dotted line dividing it into two portions, A will be positive and B negative electricity. Although Erlung asserts ether to be a perfect conductor, it is more reasonable to suppose that it is a perfect non-conductor, for, according to Maxwell, conductors must be opaque, while, as Lodge points out, the ether is absolutely transparent.

The constants of the ether, while far from being determined with exactness have been determined with sufficient accuracy, for practical purposes. For instance, the velocity of propagation of waves in the ether has been found to be about 168,000 miles per second.

CHAPTER II.

WAVE MOTION.

THEORETICAL.

In beginning the study of electric waves it is very important to have clearly in mind the essentials of undulatory or wave motion. Undulations may be divided into two classes (a) molecular wave motion in gross matter imported by the impact of one molecule on another, and (b) etheric wave motion caused by transverse vibrations in the ether.

MOLECULAR UNDULATIONS.

The first principles of physics illustrate the simplest form of wave motion of the first class in the following familiar scene. Standing on the shore of an ocean and gazing on the gigantic waves impelled with mighty force toward the shore, the mind is easily led to believe that the incoming waves are carrying great masses of water, but let a boat or a bit of wood float upon its surface and it will be seen to rise on the wave crest and fall on the wave valley, but making no progress in a horizontal line or toward the shore. It is evident, then, that it is not the mass of water that forms the actual onward movement, but that it is the particles of water of which it is composed. These waves transmit energy and wave motors are constructed to utilize the force so sent on from one wave to another. Waves may travel great distances but the motion of each particle of water is exceedingly limited.

Another illustration that gives an exceedingly clear idea of wave motion and one that has long been in favor among physicists is the simple wave motion shown in a rope. This idea has recently been brought to a high degree of perfection by Dr. M. I. Pupin as an analogue showing the constants of long electrical current waves for long distance telephone transmission. Fig. 4 shows the undulatory or wave motion of a rope. The distance between 1 and 2 or 3 and

4 is termed a wave length; 1 and 2 are the nodes or null points of the waves caused by the crest of one wave intersecting the valley of another wave; the vertical distance between 3 and 6 and 4 and 5 determines the amplitude of the wave.

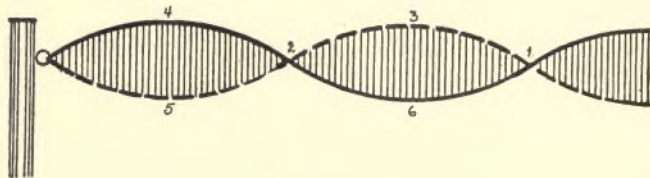

FIG. 4.—WAVE MOTION OF A ROPE.

Next higher in the scale are sound waves; again the cause of sound is the molecular vibration or the impact of one molecule on another, as a bell ringing or a whistle blowing. The vibrating molecules of the bell or whistle impinge upon the nearest molecule of air and these in turn pass the motion onward by impact until they reach the ear or other receiving apparatus or until the transmitted energy is lost by diffusion. Sound is thus propagated through the air and may be transmitted through any elastic medium or substance as a body of water or mercury.

The motion of air molecules is backward and forward in the line of propagation, by longitudinal vibrations or end thrusts. Sound, like all waves of the first class, cannot be transmitted through a vacuum, i.e., where the air has been exhausted, and the ether has nothing to do with its motion. Sound waves travel in free air with the velocity of, approximately, 1,120 feet per second, and the wave length may be found by dividing the velocity by the number of vibrations. The particles or molecules forming sound waves, like those of water or the rope do not travel but remain practically stationary.

If the waves are permitted to continue only a given distance and are then reflected back on themselves so that the line of reflection is in the line of propagation, the wave crests and valleys or nodal points may be easily distinguished. The waves are then called stationary waves.

Heat offers a connecting link between the first and second classes of wave motion, for it may be transferred from one molecule to another like sound, while it possesses the added property of

communicating to the ether, by its vibratory atoms, waves that travel with the velocity of light, and which are propagated by the ether; this is called radiant heat. Radiant heat waves differ from those set up in the air, for ether in a space where there is no atomic or molecular matter present, transmits waves with greater ease than the bound ether of the air. The sun offers a good illustration of the transference of radiant heat from one body to another irrespective of the temperature of the intervening medium.

TRANSVERSE VIBRATIONS.

Having now the fundamental principles of wave motion set up by molecular impact, the next stepping-stone to electric waves is by a familiar knowledge of the laws of light which belong to the second class of wave motion, and these will serve to explain largely the nature of electric waves. The only difference between luminous, radiant heat and electric waves is a variation of the wave lengths.

Though electric and molecular undulatory motion are similar, in that both travel in straight lines, there is yet a vast difference between them, for in molecular matter the wave is caused by a to and fro movement of the molecules, or by end-thrusts as at A, Fig. 5, and ether waves vibrate across the line of propagation as at B,

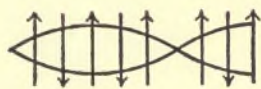
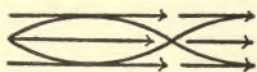

FIG. 5.—LONGITUDINAL IMPACT WAVE.

FIG. 6.—TRANSVERSE POLARIZATION WAVE.

Fig. 6. Waves in gross matter are by longitudinal impact, those of ether are transversal by polarization.

The history of light waves follows coincidentally that of ether, and, in fact, all other phenomena, for there were two theories advanced, both of which had their champions. The corpuscular or emission theory found favor with Newton, who believed light to be a form of segregated matter, each particle being smaller than the atom and that these were projected with enormous velocity from a body having luminous properties. Tyndall proved this theory untenable by demonstrating that a body having a weight of one grain

would acquire the momentum of a cannon ball traversing its course at the rate of 1,000 feet per second, whereas the most delicate test he could apply showed that light does not possess mechanical force.¹

Huygens advanced, in opposition to the above, the undulatory or wave motion theory of light, and this was finally proven experimentally by Young and Fresnel. Accepting now, Huygens's undulatory theory and Young's transverse vibrations of light waves and the Faraday-Maxwell electro-magnetic theory of light, that ether waves are propagated with finite velocity, and that regardless of their length the velocity remains identical, we have the laws of electric waves well within our grasp. The speed of light has been determined by several different methods and is found to be practically 186,500 miles per second. As early as 1676 Römer calculated the velocity by the interval between two successive eclipses of the satellites of Jupiter. Bradley devised a method by the aberration of light. Fizeau measured the velocity directly in a most convincing manner in 1849, with results closely coinciding with Römer and Bradley. Foucault² developed a method in 1850 depending upon the Wheatstone revolving plane mirror, which had been invented prior to that time to prove that time was required for the spark of a disruptive discharge to take place. One of the first reasons advanced for an ether was that light, however great its velocity, required a given length of time to travel. Without entering into a detailed description of the properties of light waves—these may be found in any treatise on light—mention will be made of a few of those by which Hertz was enabled to compare and so determine the nature of his electric waves. These are reflection, refraction, absorption, polarization and the final test for wave motion—interference, developed by Young in 1801 for light. Whatever is said about light waves here may be taken, not only as analogous but as applying directly to electric wave phenomena.

LIGHT WAVE LENGTHS.

A body emitting light produces waves of a length capable of affecting the optic nerve, though the range of wave lengths the eye is capable of receiving is not great, being from 271 ten-millionths

¹Lebedew on Mechanical Force of Light.

²Römer's, Bradley's, Fizeau's and Foucault's methods are fully described in *Ency. Brit.*

of an inch, which is red light, to 165 ten-millionths of an inch or violet light. This is the visible spectrum, and it is interesting to note, in view of what has been said concerning transverse vibrations of light, that the physiological structure of the retina of the eye, as revealed by the microscope, is made up of minute elevations at right angles to the surface of the retina and in the line of wave propagation as shown in Fig. 7. To any one who has seen the

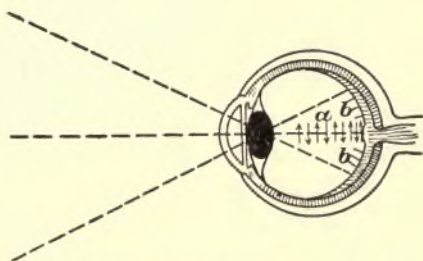

FIG. 7.—LIGHT WAVES IMPINGING ON RETINA OF THE EYE.

spectrum and given a thought to it, the idea must have occurred as to what is above and below the visible portion, and it is true that at both ends there are invisible waves, some being much too short and others a great deal too long to impress the sense of sight.

Thus from some sources, especially from the electric arc and from sunlight, a radiation or stream of waves proceeds, called ultra-violet light, or, more properly, ultra-violet radiation, since all waves not visible to the eye should be designated as radiations. The wave length of the ultra-violet radiation is in the neighborhood of 140 ten-millionths of an inch; the eye failing to be impressed with wave lengths so exceedingly minute, recourse must be had to something that will be sensitive to their presence and the action of a photographic plate answers admirably, for when exposed to the spectrum it shows a color band far above that of the violet seen by the eye; likewise will a plate record the presence of transverse waves so very short it is doubtful if they have ever been measured correctly, although it is supposed that the period of vibration is some 300 quadrillions per second.

So exceedingly penetrating are these transverse vibrations that they will pass through wood, paper and sheets of metal, as light waves pass through glass. These are the most rapid vibrations of which we have absolute knowledge.

At the opposite end of the visible spectrum are the radiant heat waves, and these, although emitted by luminous bodies, are much longer than the retina of the eye is capable of sensing. From radiant heat waves the length of the invisible ones gradually increases until those are reached with which we have to deal, namely, electric waves. Light waves and other radiations have a rectilinear motion, or travel in straight lines when propagated through a medium of uniform composition and density, and it has been shown that the ether absolutely fulfills these conditions.

REFLECTION.—Reflection of light and other ether waves is simply a change in the direction of the waves, or, in other words, the waves are thrown back by some physical surface, usually a polished mirror of metal or glass, thus changing the original direction, though the medium through which they are propagated remains the same. The law of reflection for ether waves is that the direction in which the rays fall upon the reflecting surface—called the angle of inci-

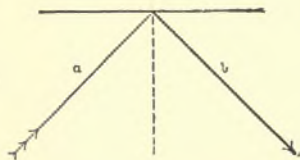

FIG. 8.

ANGLES OF INCIDENCE AND REFLECTION.

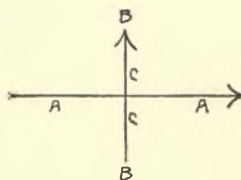

FIG. 9.

WAVE FRONT GRAPHICALLY ILLUSTRATED.

dence a Fig. 8—is exactly equal to the reflection of the waves, called the angle of reflection b .

REFRACTION.—The refraction of light is a bending of a luminous ray formed of waves, when it passes from one medium to another as from air into glass. The refraction of a ray of light through a glass prism, Fig. 9, is made clear when it is understood that the velocity of light is less in glass than in air. Since ether waves are due to transverse vibrations, they are therefore perpendicular to the wave front;

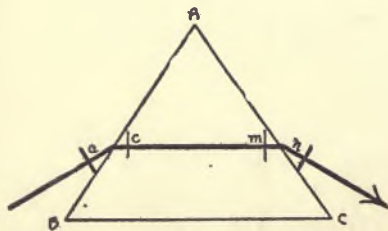

FIG. 10.—LIGHT WAVE THROUGH PRISM.

for instance, let AA represent the direction of the light or electric

wave, BB the transverse vibration, then the surface of the wave CC would be the wave front. When a wave reaches the side of the prism AB, Fig. 10, the lower end of the wave front *a*, strikes and enters the glass first. This end of the wave moves more slowly in the bound ether of the glass, while the upper end of the wave *a* is still in the free ether outside the glass. The lower end of *a*, is so greatly retarded in its propagation, that when the whole wave has entered the prism, the wave front is rectified as shown at *c*. The wave front being perpendicular to the path causes a change in the direction, and the wave now travels in a straight line until the top of the wave front strikes AC, the surface of the prism, as shown at *m*. The upper end of the wave emerges first into the free ether and travels much more rapidly than the other end of the front which is still impeded by the bound ether of the glass. When the wave finally emerges from the glass as shown at *n*, a second change is involved in the direction of its propagation and it is now refracted from the perpendicular.

POLARIZATION.—Another remarkable property of light and one with which we shall have to deal later in electric waves is polarization. Silvanus P. Thompson has offered an exceptionally clear description of what polarization really means.¹ Light from the sun or any luminous body, he says, is non-polarized, that is, it consists of vibrations which are not especially directed up and down, right or left or in any given order. Natural light is not only made up of many different wave lengths, representing so many different colors, but it consists of waves whose transverse vibrations are all jumbled up, that is, not polarized in any particular direction. As a mechanical analogue of polarization Thompson used an india-rubber cord passing through a wooden box, with vertical partitions, Fig. 11; these partitions limit the motion of the cord and allow only the vertical waves to pass through, irrespective of the direction of the vibration of the cord. The waves that have passed through the box are said to be plane polarized, i.e., all are in the same plane. If the box is turned over on its side, Fig. 12, it will now transmit only horizontal waves.

If a second box is used and the first one, P, is placed with its partitions vertical, it will polarize the waves vertically, and as these waves reach the box marked A, also having similar partitions, the waves will get through both boxes and are polarized in the vertical

¹Thompson on "Light."

plane. But if the first box, P, is set vertically, and the second box, A, horizontally, Fig. 13, P will polarize the waves vertically, but the box, A, called the analyzer, prevents the waves from passing through it. However the polarizer P is placed it will polarize the waves, but if the analyzer A is turned at right angles to P, the waves will be cut off.

To recapitulate, when the polarizer and analyzer are parallel, the waves—plane polarized—pass through; but when the polarizer and analyzer are crossed, the waves are cut off. Hence by turning round the analyzer to such a position that it cuts off the waves, the

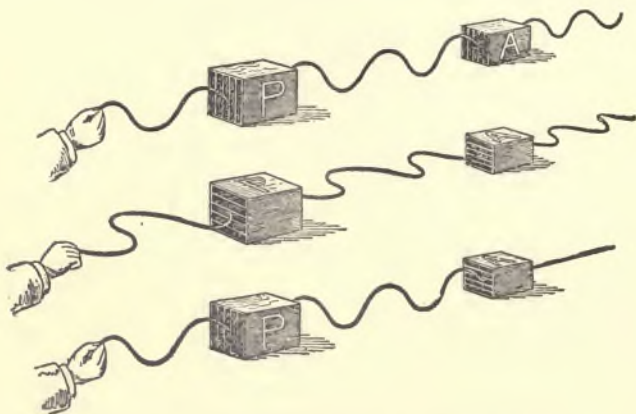

FIGS. 11, 12, AND 13.—ANALOGUE OF WAVE MOTION.

direction of the waves emanating from the polarizer may be easily determined. Now light and electric waves may be plane-polarized, by means of suitable apparatus, in a similar manner to that just described.

There is a gem, called tourmaline, which when cut into thin slices has the property of polarizing light waves. If waves of light are allowed to pass through a tourmaline plate it acts on them like the polarizing box P, Figs. 11, 12 and 13, on the cord. A tourmaline plate is shown in Fig. 14. As the waves from light

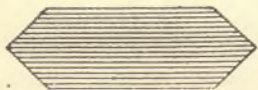

FIG. 14.—TOURMALINE PLATE

pass through the plate they are polarized. Now if a second plate of tourmaline is introduced and placed in the line of direction of the light waves and parallel to the first plate, a stream of light waves will pass through both plates, and to the unaided eye it could not be detected that the waves had

been polarized. Fig. 15 shows such an arrangement, with mixed waves entering the polarizing plate P, the waves rectified after emanating from the plate and passing through the analyzer A. S is the source of light, and all waves entering the polarizing plate

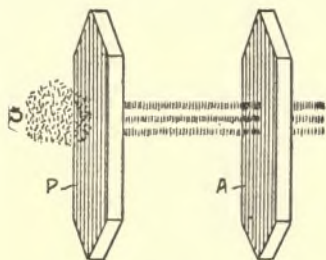

FIG. 15.—TOURMALINE PLATES. TRANSPARENT TO LIGHT WAVES.

are parallel with the axis of the plate P; these are readily transmitted, but all waves in any other direction are extinguished. The waves entering the second tourmaline crystal A, the vibrations of which are parallel with its lines, pass between them and through the crystal easily. But if the analyzing crystal A is placed at right angles to the polarizer P,

Fig. 16, the waves cannot pass, for the microscopic lines of the tourmaline cut off the light vibrations and destroy the waves.

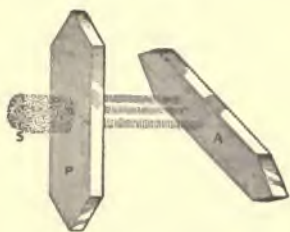

FIG. 16.—TOURMALINE PLATES. ANALYZER AT RIGHT ANGLES TO POLARIZER.

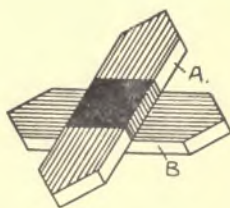

FIG. 17.—TOURMALINE PLATES. OPAQUE TO LIGHT WAVES.

Thus, if the crystals P and A are held before the eye as in Fig. 17, it will appear perfectly dark, showing that no waves are passing through. If the axes of the tourmaline crystals are arranged at an angle of 45° the light is only partially cut off as in Fig. 18.



FIG. 18.—TOURMALINE PLATES CROSSED AT 45° .

These are the first principles of reflection, refraction and polarization of light and other waves in ether, but what has been said is merely the beginning, the statement having been carried only to the extent necessary to elucidate the experiments of

Hertz on the action of electric waves.

CHAPTER III.

ELECTRIC WAVES.

HISTORICAL.

The term, electric radiation, was first employed by Hertz to designate waves emitted by a Leyden jar or oscillator system of an induction coil, and since the discovery of these radiations by that brilliant young scientist of Karlsruhe, in 1888, they have been called almost universally, Hertzian waves.

In this year, coincidentally, Lodge investigated the theory of the lightning rod,¹ and as a necessary part of his work he made a large number of experiments with disruptive discharges from small Leyden jars and noted that the resultant manifestations were electric waves in neighboring wires.

Professor Fitzgerald, of Dublin, had; several years prior to Hertz's discovery, theoretically demonstrated the existence of electric waves and attempted to produce them, but without practical results. Hertz, however, had no knowledge of the work of Lodge and Fitzgerald until after he had announced his own discoveries. One of the nearest approaches to the discovery of electric waves in space before Hertz, was made by Prof. Joseph Henry, of Washington, when he succeeded, by means of a spark from a frictional machine on an upper floor of his house, in magnetizing needles in the cellar beneath at a distance of 30 feet with two floors and ceilings intervening.² Here were the elusive electric waves, but the knowledge of the electro-magnetic theory of light was yet to be elucidated by Faraday, and as Hertz pointed out, even though it had been enunciated by Maxwell, this special and surprising property of the electric spark could not have been foreseen by any theory.

Silvanus Thompson, in 1876, produced electric radiations by an apparatus quite like the one Hertz employed twelve years later, but he failed to grasp the great underlying principle in-

¹Lodge Lightning Guards.

²Memoirs of Joseph Henry.

volved—that the effects obtained were the evidence of electric waves transversing space in exactly the same manner as light waves. The cause of the electric waves as well as the effect produced by them must have come under the observation of experimentalists time and again, sometimes both together, as when Henry and Thompson noted them, but more often the effect was observed without the cause being suspected. As long ago as 1866 A. S. Varley, of England, applied for a patent on a lightning bridge based on the principle of the cohesion of carbon or metallic powder. Calzecchi-Onesta, of Italy, observed this “coherer action” in 1885, but he attributed it to induction.

It remained for Hertz to make known the real nature of the phenomenon, that others before him had merely speculated upon. Since his time the subject has been a favorite one with investigators and has received the attention of such eminent scientists as De la Rive, Lodge, Poynting, Bjerknes, Heaviside, Poincaré, J. J. Thomson, Lebedew and Fleming, all of whom have contributed important results to the accumulation of facts. The workers who have utilized these thoughts are many, and the analyses, opinions and practical results will be treated of in the unfolding of this and the succeeding chapters.

EXPERIMENTAL.

When the oscillations of a disruptive discharge occur, a displacement or strain in the ether in the form of a wave is produced similar to the strain in an elastic solid. The ether resists by its elasticity the emitted wave and when the polarizations producing it cease, the ether resumes its normal state. To produce a wave there must be an expenditure of energy, and the law governing the conservation of energy requires that the strained ether in being restored shall be supplied with some other form of energy to take its place. This law is fulfilled by the creation of magnetic flux or lines of force in a direction at right angles to the wave. When the magnetic lines of force disappear they give rise in their place to electric waves, and when the waves vanish they again produce the magnetic flux and so on. For this reason all ether waves are electromagnetic in character.

An analogue of the electric wave and its accompanying magnetic action and reaction may be found in the sound wave. A bell,

when struck, gives rise to an elastic strain, and the strain in disappearing creates velocity by setting the air particles into motion and thus produces the strain energy in a kinetic form, by causing another strain in the opposite direction to the first.

For the production of electric waves Hertz used a simple device, which, according to his terminology is called an *oscillator*. It is shown diagrammatically in Fig. 19; *a a* are two polished brass

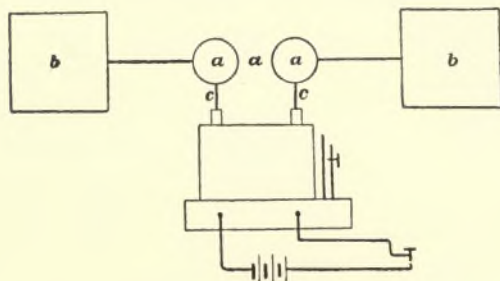

FIG. 19.—HERTZ OSCILLATOR WITH INDUCTION COIL.

spheres; *b b*, the oscillator plates, the distance between them being 60 cm.; *c c* are wires connected with the terminals of the secondary of a large induction coil or other source of high-tension electro-motive force. As the disruptive discharge breaks through the air gap *d* electric radiations in the form of waves traveling with the finite velocity of light and all other ether waves emanate from not only the spark, but the entire oscillator system.

The waves emitted by the oscillator system of the coil used by Hertz were several meters in length. To detect them Hertz employed a modified form of Reiss micrometer spark gap detector, Fig. 20, to which he gave the name of *resonator*, for he found that

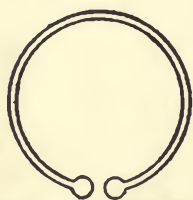

FIG. 20.—HERTZ RESONATOR.

the best results were obtained when its natural period of vibration was in tune or syntonized with the oscillations and waves producing it. The resonators Hertz employed were of several forms, but for the first of his experiments in electric radiations the resonator was circular with a diameter of 35 cm. In his earliest experiments Hertz used a rectangular form of resonator. To one side of the oscillator he attached the resonator by a wire at a dissymmetrical point as in Fig. 21A, or as in Fig. 21B; when the primary spark passes at λ , secondary sparks will also pass in the

gap of the resonator, but if the wire attached to the resonator is at a point symmetrical to the spark gap, Fig. 21C, then no secondary sparks will pass in the micrometer gap, though the most vigorous primary sparking may be taking place in the oscillator. According to Fleming this is due to the inductance of the wire of which the resonator is composed.¹ Hertz found that

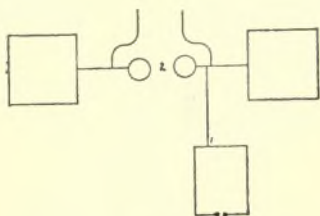

FIG. 21A.—RESONATOR ATTACHED TO OSCILLATOR AT UNSYMMETRICAL POINT.

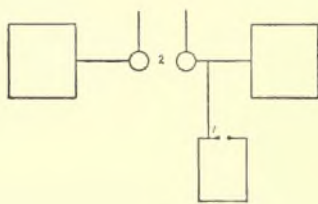

FIG. 21B.—OSCILLATOR WITH RESONATOR ATTACHED AT UNSYMMETRICAL POINT.

without the wire connecting the resonator and oscillator secondary sparks could still be obtained, see Fig. 21D, and that the energy set in motion by the spark of the coil was propagated through space to the resonator in the form of electro-magnetic waves. Fleming concluded that in this case the electric displacement as he calls it, or electric wave, on arriving at the resonator fills its spark gap and

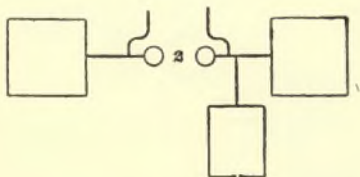

FIG. 21C.—RESONATOR ATTACHED TO OSCILLATOR AT A SYMMETRICAL POINT.

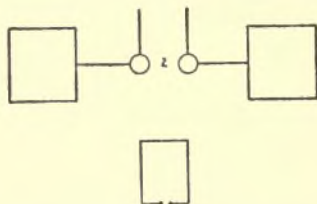

FIG. 21D.—OSCILLATOR WITH FREE RESONATOR.

creates an alternating displacement and an alternating potential difference between the terminals. When this reaches a certain amplitude the minute air insulation breaks down and a small spark is produced between the ball terminals of the resonator.

However this may be, it is substantially the method by which Hertz discovered electric waves and found that they may be propagated in space or guided by wires, but in either case the time constant of their velocity remained unchanged. When the waves emitted by an oscillator are transmitted through a dielectric without the aid of guiding wires, they travel in straight lines and at right

¹Fleming, *Journal of the Society of Arts*, January, 1901.

angles to the plane of the oscillator, shown by the dotted lines, Fig. 22. If the resonator f is placed in such a position that its plane is horizontal to the oscillator plates $b b$, as shown, sparks will pass in the air-gap of the resonator if it is held at proper distance from the sparks of the oscillator where the electric waves originate,

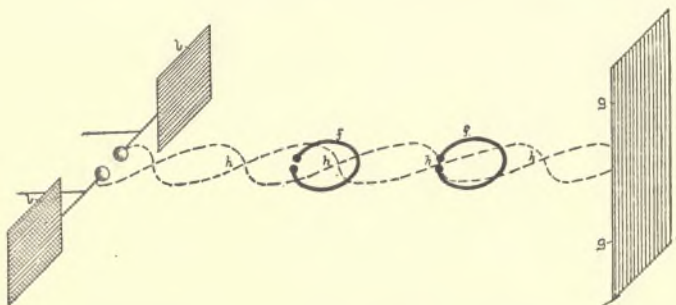

FIG. 22.—PRODUCTION OF STATIONARY ELECTRIC WAVES.

or equal to a wave length, if measured from the point of its greatest amplitude; $g g$, is a metallic plane mirror for reflecting and producing stationary waves; now with the resonator in the same plane but at a greater distance away, at h, h, h or h no spark will pass in the resonator, for here the nodal points have been reached. Hertz concluded that the length of the waves could be determined absolutely by observing the point where the spark in the resonator is the brightest, this being its greatest amplitude of vibration or by noting the null points where the spark is extinguished. However, Sarasin and De la Rive, in 1891, ascertained that the wave length was variable and that the nodal points changed position, upon enlarging or reducing the size of the resonator and that the wave length was approximately equal to four times the diameter of the resonator.¹ These investigators also ascertained that the size of the oscillator plates affected the secondary sparks or the position of the resonator but very little.

By placing the resonator in other planes different phenomena are exhibited. Fig 23 shows the resonator a in a plane parallel with the oscillator; if the spark-gap is at the top of the resonator or turned around until at the bottom, sparks at the oscillator will produce secondary sparks in the gap; but let the resonator assume a position in which it is at right angles to the oscillator plates, as

¹Sarasin and De la Rive, *Comptes Rendus*, March, 1901.

at *b*, then no sparks will pass, though the gap may be turned completely around.

In the original experiments conducted by Hertz a large sheet of zinc was used for the purpose of reflecting the radiations Fig. 22, *g g*, and producing stationary waves which might be measured. When the sparks pass in the micrometer gap of the resonator

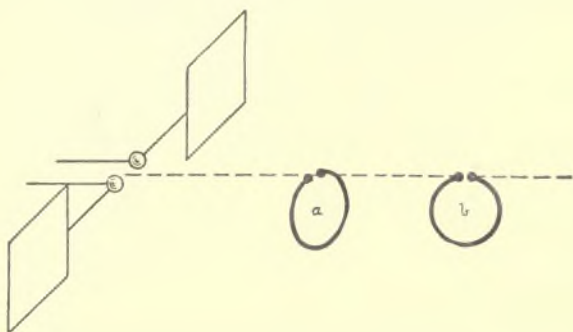

FIG. 23.—OSCILLATOR AND RESONATOR IN DIFFERENT PLANES.

we have an exhibition of electrical resonance, for the detector acts as a closed circuit conductor of such dimensions that the electric waves are propagated through it at the same rate as those emitted by the oscillator; when this is the case the detector is said to be in sympathy with the oscillator system, just as a tuning fork vibrating in air and sending out waves of a given length are reproduced by a second tuning-fork of the same size, tone and pitch as the first. After Sarasin and De la Rive's discovery relating to the effect the size of the resonator had upon the wave length it was believed that the oscillator system emitted waves of many lengths, just as white light is made up of an admixture of many wave lengths and that the resonator responded to the wave length that was in tune with it. Another view that gained considerable credence is that the sparking in the micrometer gap of the resonator was not due to stationary waves set up in space, but that the period of oscillation or wave length corresponded to the resonator itself. However, it is now generally accepted that the theory Hertz first advanced—that electric waves are actually present and that the resonator gives the value of these wave lengths direct—is the correct one and the approximate estimates the experimenter gave concerning their length, vibration and velocity have been determined more accurately since then and confirm his results almost identically.

In the following as well as the preceding experiments it is assumed that the oscillator system produces electric waves of a given length, and thus differs from a luminous body emitting light waves, for in the first the waves are of a single definite value and in the second all the various wave lengths are sent forth which constitute the visible spectrum and many wave lengths of the invisible spectrum. The micrometer spark-gap resonator differs materially from the eye as a detector of ether waves, for the organ of sight is capable of discerning a great many short wave lengths from the deep red to the violet of the spectrum, but the circuit of the Reiss detector is limited to waves of a definite length like that of a tuning fork.

To many, doubtless, there may appear to be a considerable divergence in the nature of electric and light waves, but this disparity is exactly in accordance with Maxwell's electro-magnetic theory of

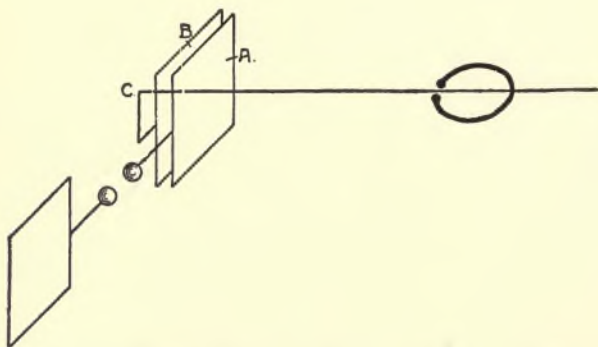

FIG. 24.—MEASUREMENT OF ELECTRIC WAVES IN A WIRE.

light; it is the frequency of vibration and length of wave that differentiates them, making it possible for some waves to do things which other waves cannot do. As water may be made into a solid by freezing, a liquid at normal temperatures, or into steam by heating, yet, after all, it is H_2O . So is it with ether wave lengths; all have properties in common and each has its especial attributes. One of the properties of electric waves is that they travel with equal facility and velocity in open or closed-wire circuits or in space, whether the medium intervening is a dielectric or the ether alone. The method of measurement Hertz devised for ascertaining the wave length in a wire is shown in Fig. 24, the plate *B* is parallel with *A*, but is not in contact with it, the distance

may be 6 or 8 cm., and between the two may be a dielectric of air or any other substance; from B , a wire 1 mm. in thickness extends to C , and then, describing a curve, the wire is carried above the spark-gap and for some distance through the air, perpendicular to the plane of the oscillator plates, say 15 or 20 meters. Now if the resonator is placed in such a position that its plane includes the wire, sparks will appear in the micrometer spark-gap and are very bright when the detector is near the oscillator but decrease noticeably as the end of the wire C is reached.

Between the ends of the wire at given distances that are approximately equal, the secondary sparks decrease as the nodal points are reached and cease sparking almost entirely when at 0; if the wire C is cut through at a node, it does not oppose in the least the propagation of the waves through it.

Another and most easily accomplished method for obtaining the wave length in wires was used by Hertz in his analysis of the mechanical action of electric waves in wires. This was Herr E. Lecher's arrangement,¹ and is shown in Fig. 25; AA^1 is the oscil-

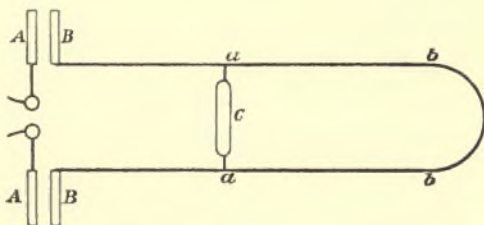

FIG. 25.—LECHER'S ARRANGEMENT OF WIRES.

lator, as described in preceding experiments. Opposite the plate, $A A^1$, the plates $B B^1$ were placed at a distance of 10 cm., with the air as a dielectric between the two sets of plates. From $B B^1$ two parallel wires, 6.8 meters long and 30 cm. apart extend into space and are connected together at $b b'$; a low vacuum tube C —as a Geissler tube—is arranged with sliding contacts $a a'$; when the tube slides over the wires it will be found to become luminous in some portions and to remain dark in others.

Other methods have been devised, the detector consisting of a Langley bolometer, or a Kelvin quadrant electrometer and Trowbridge and Duane used a modified form of the Lecher scheme,

¹E. Lecher, *Wiedemann's Annalen*, vol. 41, 1890.

but in all cases the experiments have practically agreed and show that the velocity of electric waves over wires is identical to that of electric waves in space, the wires acting only as a guide for the waves.

Knowing the method of determining experimentally the length of electric waves and that wave propagation in ether is 186,500 miles per second,¹ the frequency or period of oscillation may be found by dividing the length of the wave by the velocity in miles per second. The greater the self-induction or electrical inertia of a Leyden jar or oscillator system of an induction coil and the greater the capacity of the jar or system the larger the lineal dimensions of the wave will be. Immediately after Hertz had proven that electrical oscillations of high frequency generated electric waves in space he arranged the proper apparatus for concentrating the action and ascertaining if a further relationship existed between the waves he had discovered and those of light.

THE HERTZ APPARATUS.—In his experiments with electric radiations in free air Hertz employed a shorter wave length than in those described, wherein the wave action was manifested in wires. He used a small induction coil giving a maximum spark of $4\frac{1}{2}$ cm. in length, but the spark-gap was cut down to 5mm. when the tests were under way.

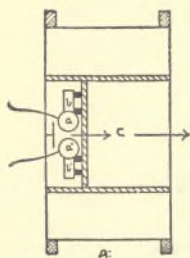

FIG. 26a.
HERTZ OSCILLATOR AND RESONATOR.

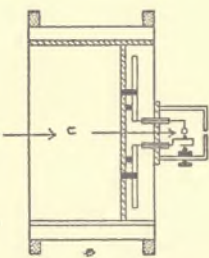

FIG. 26b.

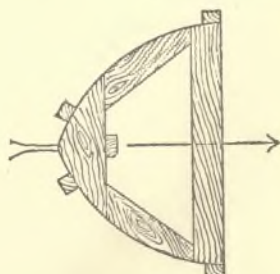

FIG. 26c.
WOOD FRAME SUPPORTING REFLECTORS.

The oscillator balls *a á*, Fig. 26*a*, were connected with the brass rods *b b* 3 cm. in diameter and 13 cm. in length, each. These were attached to a parabolic mirror *c* made of planished sheet zinc supported by a wooden framework, Fig. 26*c*. The oscillator system was

¹There is, doubtless, a slight variation in the velocity of ether wave lengths, but it is so small as to be extremely difficult of experimental proof; for instance, it is believed that red waves of light travel slower than other wave lengths, and the Franklin Institute has been offering a prize for many years for conclusive experimental proof that it is so.

held in place by means of four sticks of sealing wax. The terminals of the coil led to the spark-gap spheres direct and the coil itself was arranged back of the reflector. It was supplied with current from three storage batteries.

The resonator is shown in Fig. 26*b*; it is of the open circuit type, in contradistinction to the spark-gap resonator Hertz chiefly employed in his earlier experiments, made in the form of a circle. It consisted in this case of two straight pieces of wire 50cm. long and 5mm. in diameter, separated at their ends 5cm., from which two smaller wires at right angles with the vertical wires and parallel to each other were arranged with a micrometer spark-gap, formed of a brass sphere at the top and a pointed screw below. The resonator was arranged within a parabolic reflector of similar construction, to that described for the oscillator. As Hertz pointed out in his paper on Electric Radiation,¹ and Fleming by his later apparatus has proven, there can be a considerable modification, as to form and size, without interfering with the successful working of the tests.

REFLECTING ELECTRIC WAVES.—By placing the concave, parabolic zinc reflectors back of the oscillator system and resonator,

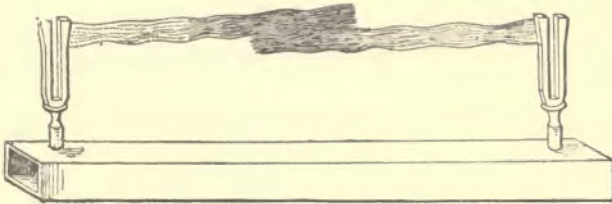

FIG. 27.—SOUND AUGMENTATION BY RESONANCE.

having the axis of their oscillators in the focal line of the mirrors, it was found that there is no manifestation behind or on either side of the mirrors. Here we have an example of a shadow cast by the electric wave. When the mirrors were placed so that their apertures face each other, as in Figs. 26, the waves were reflected from the polished surface and were found to reinforce the advancing waves like the condensation of air between two tuning forks, as in Fig. 27. At other points again the two sets of waves weaken one another like the rarefaction of sound waves as indicated in Fig. 28; in this way the nodal points and wave crests may be distinguished

¹Wiedemann's *Annalen*, vol. 36, p. 769.

easily. Again, if the detector and oscillator reflectors are arranged as shown at Fig. 29, *A* and *B*, no sparks will pass in the resonator

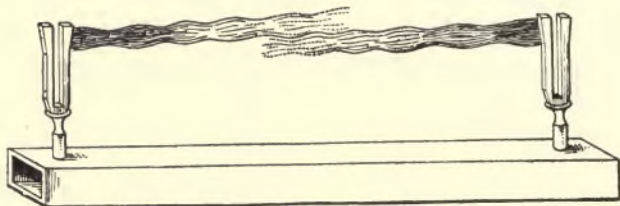

FIG. 28.—RAREFACTION OF SOUND BY INTERFERENCE.

until the plane sheet of metal *C* is set in such a position that the

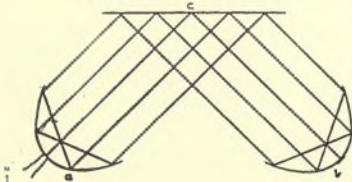

FIG. 29.—REFLECTING ELECTRIC WAVES.

right angle was obtained to reflect the waves from the oscillator into the aperture of the receiving mirror, and a variation of this angle was sufficient to change the direction of the waves, and thereby cause the sparks to disappear.

RECTILINEAR PROPAGATION.—Among the many tests Hertz applied to demonstrate that electric waves travel in straight lines, one was to place a sheet of zinc between the oscillator and resonator in the position shown in Fig. 29, or between the two mirrors. With the plane sheet of metal in place the sparks in the resonator disappear, or if a person crosses the path of the waves the sparking ceases in the detector spark-gap, showing that the waves were intercepted. Electric waves pass through all insulators and are intercepted by all conductors except in the case of liquids, which conduct in virtue of their electrolytic properties, but otherwise follow the law of insulators, all this being in accordance with Maxwell's fundamental law.

REFRACTION.—To ascertain if the electric waves were refracted when they pass from the air into another insulating medium, Hertz constructed a huge prism by chipping a cube of pitch until the desired angles were obtained. This pitch prism had a refracting angle of 30° and by its use the experimenter was able to discern a refraction of 22° . With Fleming's apparatus¹ it is quite easy to exhibit the power of insulators to refract the waves with a prism of

¹Fleming, on Electric Waves, *Journal of the Society of Arts*, January 18, 1901.

much smaller dimensions than Hertz used. Fleming's apparatus consists of two metal boxes, Fig. 30, placed with their open ends towards each other and about 50cm. apart. At *A*, Fig. 30, is the oscillator. The boxes are made of sheet zinc.¹ From the sides of the

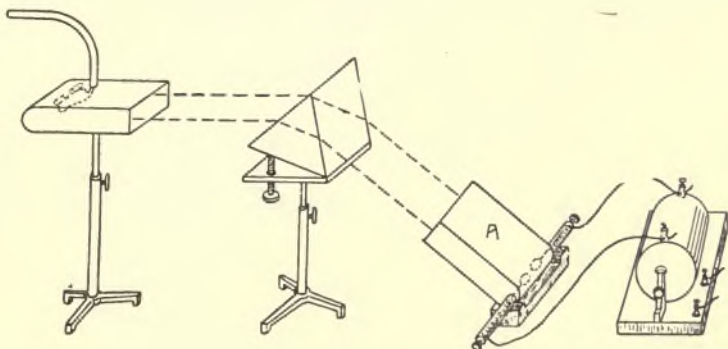

FIG. 30.—REFRACTION OF ELECTRIC WAVES.

box protrude zinc tubes and inside of these are ebonite or other insulating tubes, containing brass rods 8 or 10cm. in length and terminating in brass balls forming the spark-gap; the balls are adjusted to give a spark 1mm. in length. To the opposite ends of the brass rods are long spirals² of gutta-percha covered wire filling up the rest of the tube. The outer ends of these spirals are connected with the secondary terminals of the induction coil; when the apparatus is in operation sparks pass between the oscillator balls, and the electric waves resulting emanate from the aperture of the box.

The box containing the detector is exactly like the one described containing the oscillator system; instead of the resonator Hertz employed, Fleming uses a later product of science, a coherer of simple form, with nickel filings. The coherer is inside the receiving zinc box and the wires connecting with it are brought out through a metal tubing, this precaution being necessary to prevent extraneous waves from manifesting themselves therein. This tube with the inner insulating conductor leads to another metal box containing a bell, relay and battery, as in the ordinary wireless signal apparatus described in a later chapter.

Now if the emitting and receiving boxes are set up with their

¹Zinc is usually employed because it is very much cheaper than copper, and is not magnetic, as sheet tin (iron) would be.

²The object of the spirals is to increase the self-inductance of the oscillator system.

apertures at such an angle that the electric waves emerging from the oscillator system do not pass into the aperture of the receiving box, the detector system is not affected, but on introducing a prism of pitch, glass, wood or paraffin, so that it is in the path of the electric waves, it is bent out of its course and is refracted into the opening of the receiving box. The object in using paraffin or pitch for the prisms is that the length of the waves under investigation being greater than where light is used, a much larger prism is needed than may be readily obtained in glass. Any insulating substance having a homogeneous structure may be used with equal advantage. Fleming has concentrated the electric waves by means of a plano-cylindrical lens of paraffin. The apparatus may also be used in all the experiments made by Hertz in which he employed the large zinc reflectors.

POLARIZATION.—Hertz sought for and found a method to ascertain if electric waves consisted of transverse vibrations like light. This he did by polarization. He arranged the mirror *A*, Fig. 31,

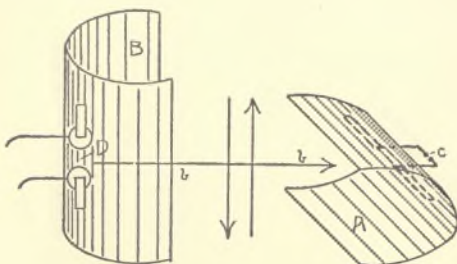

FIG. 31.—POLARIZING ELECTRIC WAVES.

with the enclosed detector so that it could be revolved about the axis of the electric ray *b b*; both the resonator *C* and the mirror *A* were in the horizontal plane to the emitter *D* and the horizontal mirror *B*; when the foci *A* and *B* are at right angles to each other



FIG. 32.—POLARIZER FOR ELECTRIC WAVES.

the mirrors perform the same functions as an optical polarizer and analyzer, or the crystals of tourmaline or the boxes with the partitions offered as an analogue for polarization. Another mode of polarizing the electric wave, and a close counterpart to the Thompson rope analogue, is by means of a wooden frame with parallel wires arranged 3cm. apart, Fig. 32.

If this screen is interposed with the wires perpendicular to the

electric ray, as in Fig. 33, the waves pass and produce a spark in

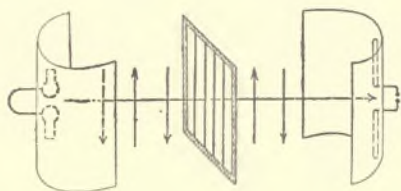

FIG. 33.—PLANE POLARIZED WAVES.

the detector, but if the screen is set up so that the wires will be at right angles to the wave front, the ray is stopped completely, as at Fig. 34.

If the receiving mirror is again placed as at Fig. 31, and the wire screen inclined at an angle of 45° to the horizontal, then sparks may be seen in the detector. Here, then, is another and most striking similarity between the action of light and electric waves. Electric waves may be of any length from 10,000 miles, produced by the lightning flash and having a period of approximately 18 oscillations per second, down through radiant heat, the visible spectrum, to the invisible ultra-violet radiation, having a wave length of 185 ten millionths of an inch with 1500 trillion oscillations or vibrations per second.

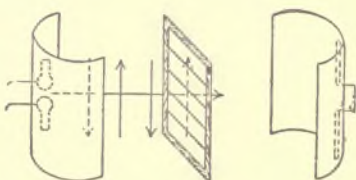

FIG. 34.—POLARIZER AT RIGHT ANGLES TO WAVE FRONT.

Lebedew and Fleming have produced electric waves so short as to be measured by the ten-millionths part of an inch; so short they could be seen, in fact, they were light waves, and reversed, light waves are, as we know, electro-magnetic waves.

In all the experiments cited the production of the electric waves was due to the surging of electric oscillations through the oscillator system seeking to find its potential level, and this was caused by the disruptive discharge breaking down the air-gap.

FREE ELECTRIC AND SLIDING HALF-WAVES.—To account for the phenomena of electric wave propagation over great distances where the curvature of the earth intervenes between the oscillator and resonator, two theories have been advanced. The first is that of the rectilinear propagation of free electric waves and the second is that of sliding half-waves.

Blondel,¹ Taylor² and Fessenden³ have evolved the sliding half-

¹Syntomy in Wireless Telegraphy. Archives, Academy of Sciences Aug. 16, 1898. Blondel.

²London Electrical Review, May 12, 19, 1899. Taylor.

³Transactions Am. Inst. Elec. Engs., Nov. 1889. See also Fessenden's work in Wireless Telegraphy; Collins; Elec. World and Eng. Sept. 19, 1903.

wave theory which, briefly described, is as follows: In wireless telegraphy, where the oscillator and resonator systems have earthed terminals and high aerial wires, the spark-gap is located very closely to the surface of the earth, as shown in Fig. 35. It is contended

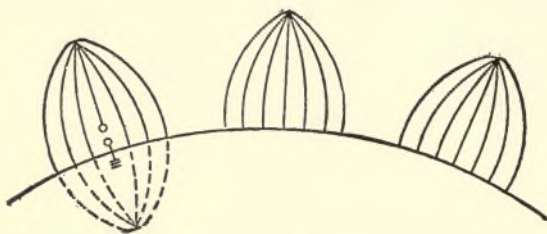

FIG. 35.—PROPAGATION OF SLIDING HALF-WAVES.

that the vertical wire of such an oscillator is the only portion of it capable of emitting electric waves, in which case they must of necessity be in the nature of half-waves, since the earthed arm of the oscillator is so short when compared with the opposite or aerial arm that it is of little consequence. Under these conditions the lower half of the wave would be represented as a reflection or an image shown by the dotted lines. These half-waves being detached, slide over the surface of the earth with the wave front perpendicular to its surface. The half-waves sliding over the surface of the water or earth follow its contour, just as electric waves follow a bent wire, so that it matters but little whether or not the sending and receiving stations are in a direct visual line.

The author has held to the theory of free electric wave propagation, since there is no experimental proof that a spherical electric wave can be divided and maintain its integrity or an electric wave can be formed so that one-half of it is real and the other half imaginary. In the free electric wave theory, it is assumed that spherical waves, like light waves, are emitted and these on reaching

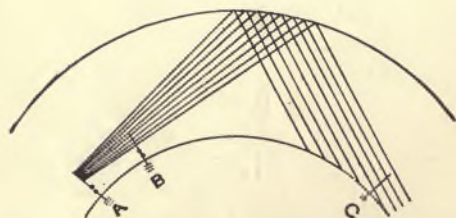

FIG. 36.—PROPAGATION OF FREE ELECTRIC WAVES.

the higher strata of rarefied air, which becomes a conductor of current electricity, and also a non-conductor of electric waves are then reflected, as indicated in the diagram, Fig. 36, when the radiations impinge on the

resonator system of the receiver. Where the distance between the sending and receiving stations is not great and the instruments are in a direct visual line with each other as *A B*, the action is of course direct and without the losses due to diffusion and absorption. The former theory of sliding waves, minus that dealing with half-waves, is based upon Hertz's deductions as set forth in his paper on "Propagation of Electric Waves by Means of Wires,"¹ and the latter theory upon his investigations of free electric waves as described in his paper on "Electric Radiation."²

¹Hertz, Electric Waves. Trans. by Jones.

²Hertz, Electric Waves.

CHAPTER IV.

DISRUPTIVE DISCHARGE.

HISTORICAL.

The phenomenon of an electric spark springing across an air-gap, or a disruptive discharge, was probably the first electrical disturbance witnessed by man to which he gave a thought. When the Traustrian of the Post-Glacial Age saw the terrific zigzag lightning shattering the air in discharging from a cloud to the earth or to another cloud he sought shelter within his cave and thought long and hard, within the limits of his ability. But he wrestled with the subject in vain.

That was half a million years ago at least, and the query originating in the brain of this prehistoric being was not answered until Franklin established the electrical nature of the display, and therefore its identity, when he flew his kite in 1750 in Philadelphia.

The disruptive discharge had been produced and noted as early as 1602 by von Guericke, and by Newton in 1643, and again by Hawksbee in 1705, but the sparks they observed were so minute as to be barely visible to the unaided eye, and as they appeared to be of the same origin as heat, the name of *electrical fire* was given to them. During the succeeding forty years many other experimenters produced and witnessed the sparks as they restored the electrical equilibrium of the charged objects, but nothing more was added of importance to the knowledge until the invention in Leyden, Germany, in 1745, of a jar or phial whereby the electricity could be accumulated and preserved in considerable quantities. This served to stimulate interest in the study of electricity in general and of the disruptive discharge in particular. To whom the honor is due of inventing the Leyden jar is not known with certainty, but it has for its claimants three distinguished investigators of that period; these were Kleist, a monk, Cuneus, a philosopher, and Musschenbroek, a professor.

To Sir William Watson, however, as much credit is due as to

the original inventor, for it was he who conceived the idea of coating the inner and outer surfaces of the Leyden jar with tin-foil as well as to be the first to observe the spark upon its discharge.

Allemand, of Leyden, and Franklin were the first to explain the action of the spark and the jar as an accumulator of electricity. For nearly another century the observers of disruptive discharges were confined to electrostatic sparks produced by frictional machines and jars, in fact, until a new and better way was opened by Faraday's discovery of the induction of electric currents in 1831. This led to the modern induction coil, brought to such a high degree of perfection by Ruhmkorff, of Germany, in 1850; it was now possible to obtain a continuous series of disruptive discharges between the secondary terminals. In the next few years the striking or explosive distance, as the distance through which the spark passes in a dielectric is termed, was greatly increased and a coil constructed by Mr. Apps, of England, for Mr. Spottiswoode, gave a spark 42 inches in length, the longest on record for many years.

While the instrument makers were devising more efficient apparatus for the production of disruptive discharges the scientists were engaged in examining their nature. In 1842 Joseph Henry suggested that the spark was not a unit in itself but that each spark consisted of a number of minute sparks; in 1850 Lord Kelvin mathematically demonstrated it, and in 1859 Fedderson experimentally proved it by analyzing it with a revolving mirror.

While improvements were in order during the next twenty years, the striking distance of the Spottiswoode coil had not been duplicated, the limit having seemingly been reached. Elihu Thomson, in 1877, produced, by means of a high frequency apparatus invented by him, sparks 64 inches in length.

In 1880 Trowbridge succeeded in obtaining disruptive discharges measuring 7 feet in length, and these spark lengths were later eclipsed by Tesla, with a similar high frequency, high-potential discharge¹ of an explosive length so great that the word spark became a misnomer when applied to it; it was in fact a miniature bolt, resembling in every particular the tortuous path of ramified lightning.

¹Tesla Lecture before the American Institute of Electrical Engineers.

PHYSICAL.

The simplest method for obtaining a disruptive discharge is by means of the electrophorus, an electrostatic induction apparatus. After the hard-rubber plate A, Fig. 37, is charged by a brisk rubbing

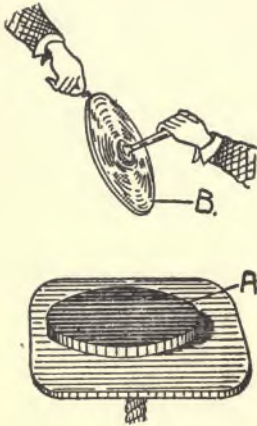

FIG. 37.—ELECTROPHORUS.

with a piece of flannel or cat's skin, the metal disc B is touched with the finger causing the — electricity to be dissipated and the cover or disc B to be charged with + electricity. On the disc being lifted and the knuckle presented, as shown, the difference of potential will be sufficient to cause the breaking down of the air-gap and consequently the passing of the spark. Frictional electric and other plate machines follow practically a similar course in charging and discharging, but to retain or store the electricity recourse must be had to the Leyden jar. To discharge the jar the finger or other negatively electrified body may be brought closely to or in contact with it. The physiological effect of a discharge, even from a small jar, is a "shock," and, if sufficiently intense, is painful; in cases where the heart is weak it is dangerous. To avoid the unpleasant sensation described, a discharger, Fig. 38, is employed. It usually consists of two pieces of brass wire, hinged together with a pair of insulated handles and the terminals fitted with brass spheres of small diameter. The outer coating of tinfoil should be in contact with one arm of the discharger first.



FIG. 38.—DISCHARGER.

FORMS OF DISCHARGES.

There are many different forms of discharge between the terminals of a jar or induction coil, and with the increase in frequency and potential there is a corresponding increase in variety. The three principal ones are the *disruptive*, *convective*, and *conductive* discharge. The convective discharge may be seen glowing from the positive terminal of a frictional machine or an induction

coil, and is caused by the electrification of the air particles, which on being charged are projected by repulsion into the surrounding space, still carrying the charge; in Geissler tubes and other tubes containing residual atmosphere, as the low vacuum Crookes tube, the convective discharge is easily produced and may be closely followed. When a wire joins the opposite terminals of a jar or coil and the potentials are equalized by discharging the current through it, a *conductive* discharge results, the phenomenon being identical to the discharge through a wire from one terminal of a battery to the other. When the potential difference is great enough to break down the air, or other dielectric separating the terminals, a surging takes place through the insulating medium before it is restored, the visible effect of which is manifested in the spark. This is the *disruptive discharge* and is the most suitable discharge for the emission of electric waves.

The initial energy of the disruptive discharge depends on at least four factors, and according to Jaumann upon five. The first and most important of these is, of course, the potential at the electrodes or terminals of the secondary coil, and these usually consist of metal spheres, Fig. 39; in wireless telegraph practice these spherical electrodes are called the *oscillator balls*. If the potential difference is sufficiently divergent and the quantity of induced

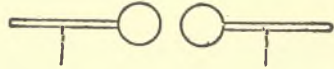

FIG. 39.—USUAL FORM OF SPARK-GAP.

current great enough, the spark is so intense that it will disrupt the dielectric placed between the terminals. A charge is often so excessive in a Leyden jar that the mechanical strain of the glass separating the coatings of tinfoil causes it to give way and the discharge piercing it breaks the vessel. With a 9 or 10 inch heavy spark from a coil, cubes of glass three inches in thickness are easily shattered.

DISCHARGE THROUGH DIELECTRICS.

Disruptive discharges through fluid and solid dielectrics, as oils and glass, have been tested, with the object of increasing their wave emitting properties, but while the break is more sudden, there is a corresponding decrease of energy available for sending out the electro-magnetic waves; at the present time nearly, if not all, the best wireless telegraph systems are using the air as a dielectric, for,

as Lodge clearly puts it, the air constitutes a self-mending partition and upon the passage of every spark it is instantaneously as good as new again. This holds good for oil, which has been used, and is now occasionally, for it does offer a higher insulation than does air, before the break, but this good feature is largely counteracted by the greater resistance offered during the passage of the spark. What the exact resistance of oil, air or other dielectric is at the moment of disruption is not known, but in any case, the value cannot be great. One good feature of the oil dielectric is that it effectually prevents the oscillator balls from tarnishing. In Fig. 40 is shown a spark-gap formed in a dielectric of oil.

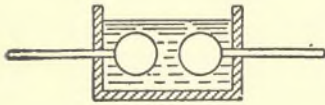

FIG. 40.—SPARK-GAP FORMED OF OIL.

When a spark takes place in oil it is of a greenish-white color. Bisulphide of carbon and spirits of turpentine are excellent liquid dielectrics, and in these the spark is very bright; in alcohol it is red; by submerging the oscillator balls in water and having a very short striking distance, the spark may be had with little difficulty.

COLOR, SIZE AND SHAPE OF DISCHARGES.

The best practical guide to the working efficiency of a wireless telegraph transmitter is by making careful observations of the color, size, shape and sound of the disruptive discharge. To determine the effect of the disruptive discharge on the air, de Nikolarene arranged between two ebonite rings a layer of cotton-wool, and this he placed in the path of the spark; after discharging through it the cotton-wool was found to be compressed on either side forming a canal 6mm. wide.¹ The explosive effect of a disruptive discharge is of electro-static origin rather than due to heat; with a large coil provided with an ordinary mechanical interrupter the spark is brilliant in color, zigzag in form, and produces a sharp crackling sound, but if the induction coil is equipped with an electrolytic interruptor of the Wehnelt type or a mercurial turbine interruptor the discharge loses these characteristics and presents instead an arc, less brilliant in color and giving forth a hissing sound. The second factor on which the effectiveness or inefficiency of an electric wave emitter depends, relates to the form and dimensions of the

¹*Journal de Physique*, August, 1899.

terminals or oscillator balls. Where two points are employed, as in Fig. 41a, and are separated just beyond the striking distance, a luminous convective discharge, called a brush discharge, takes place from the positive terminal especially, and if the points are so adjusted that an occasional spark will pass, the brush will be seen to act as a path for the latent sparks. While streams of electrified air precede the disruptive discharge in any case, yet where it is so pronounced as to be visible it detracts largely from its wave emitting qualities, probably by a lowering of the specific resistance of the air.

Where a point and a disk *b*, Fig. 41, form the terminals of the air-gap the brush discharge is brighter than with two points, and

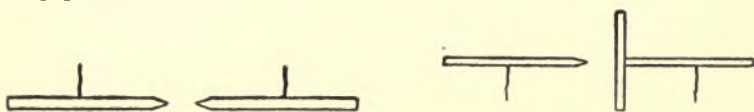

FIG. 41a.—SPARK-GAP WITH POINTED ELECTRODES.

FIG. 41b.—SPARK-GAP WITH POINT AND DISK.

unless the normal striking distance is considerably cut down the disruptive discharge is quite difficult to obtain. With a point and a sphere, *c*, Fig. 41, the brush loses its visible properties where small coils are used and is faintly luminous with larger coils, but

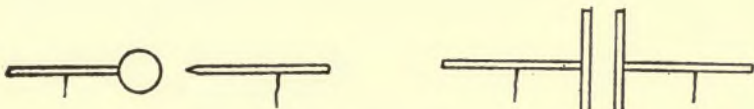

FIG. 41c.—SPARK-GAP WITH POINT AND BALL.

FIG. 41d.—SPARK-GAP BETWEEN DISCS.

the disruptive discharge is persistent. With two disks, *d*, Fig. 41, there is a convective discharge around the periphery of each unless they are carefully rounded, and, when the sparking distance is at its maximum, the disruptive discharges constantly shift from one position to another. From these facts it is clear that to obtain the best results the terminals or electrodes should offer no sharp edges or points to assist a convective discharge, and so spheres of metal are the usual form, the disruptive discharge breaking down the air-gaps between the peripheral portions offering the shortest striking distance. It was believed, until quite recently, that the length of the electric waves depended largely upon the size of the electrodes or oscillator balls, but it has since been determined that the wave lengths vary with the inductance and capacity of the

oscillator system, and that the length of the waves is influenced by the oscillator spheres only in so far as their size alters the capacity of the system.

After what has been said, it is self-evident that the spark depends largely upon the distance between the oscillator balls or terminals. When the striking distance represents the maximum capacity of the coil the sparks are long, ribbon-like, and attenuated, as shown in Fig. 42, which is a photograph of a 42-inch spark, from a meter



FIG. 42.—42-INCH SPARK.

spark coil made by Queen & Co., for the Japanese government for cableless telegraphic communication between Corea and Japan. When the air-gap is cut down to 32 inches, the spark passes between the terminals in the form of a pencil of light of gigantic proportions, Fig. 43, with a wavy luminous effect, giving forth a blue blaze of electrical energy and capable of emitting waves of great penetrative power.

STRIKING DISTANCE.

It is necessary, in order to obtain the greatest efficiency in the production of electric waves, to cut down the length of the spark-gap until the striking distance is approximately forty times less than the maximum distance through which the disruptive discharge takes place;¹ this, in the case of the 42-inch spark, would give a working value of $1\frac{1}{4}$ inch, or, with a standard 10-inch coil, a working spark of one-quarter inch. This ratio varies with the frequency and potential of different coils, and in very small coils the discharge may give the best results when the terminals are separated one-tenth of the total striking distance. The heavy disruptive discharge shown in Fig. 43 is termed usually a "fat" spark, and a good heavy spark is the first requirement for the wireless transmission of intelligence.

¹This refers only to the usual high tension induction coil.

The fourth factor in the initiation of the disruptive discharge depends on the nature, pressure and temperature of the gas or medium in which the spark takes place and need not be discussed



FIG. 43.—32-INCH SPARK.

here, since, as has been pointed out, air and oil furnish the best practical dielectric for the spark-gap.

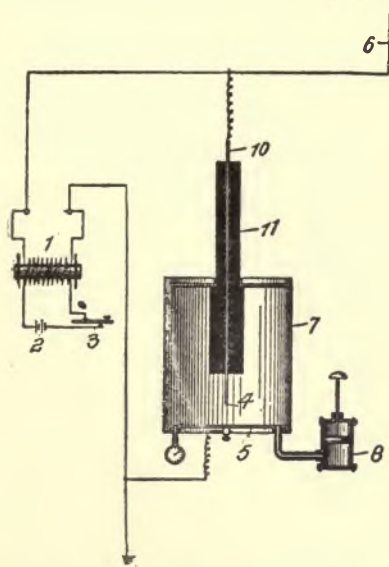

FIG. 44.—COMPRESSED AIR SPARK-GAP.

A clever device invented by Fessenden, the purpose of which is to maintain a certain definite relation between the inductance, capacity and resistance without regard to the potential employed, is shown in Fig. 44. The disruptive discharge takes place in air under pressure, the spark being formed in the gap between the point 4 and the plate 5. In using this apparatus the terminals are adjusted to about one-quarter of an inch apart when using a 12-inch coil. By increasing the pressure the dielectric strength of the air is increased and the spark-potential can be raised to almost any amount without any material loss in the power of the oscillator, as indicated by the line *a*, Fig. 45, whereas in air under ordinary pressure it is found

that no matter how high the potential is raised, practically no increase in efficiency is obtained higher than is given with a spark length, as indicated by the line *b*. The horizontal line *c* indicates

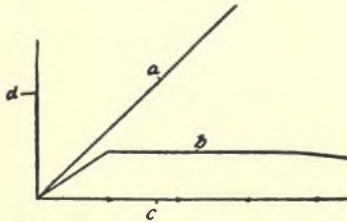

FIG. 45.—SPARK POTENTIAL CURVE.

the potential of the spark in inches, and the vertical line *d* represents the radiation.

In relation to Jaumann's assertion, that the spark is affected by a variation of the magnetic field, it will be omitted, as his theory is not sufficiently established to assist in any way the improvement in the working qualities of the spark.

ACTION OF ULTRA-VIOLET LIGHT.

The curious observation that the disruptive discharge of one induction coil possesses the property of increasing the length of the spark of a second induction coil was made by Hertz, who traced the phenomenon through a long series of splendid experiments and finally determined that it was caused by the ultra-violet radiation falling on one of the oscillator spheres. In these investigations Hertz¹ found that the electric spark itself was richest in emitting the invisible ultra-violet rays, but that the flame of a candle if held near one terminal of the spark-gap was sufficiently productive to cause sparking when the striking distance was otherwise too great to permit the spark to pass.

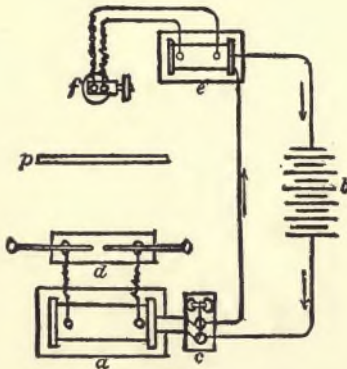

FIG. 46.

The apparatus employed by Hertz in his photo-electric researches is illustrated in Fig. 46. An ordinary induction coil *A* is connected with the oscillator system *B*; a second and smaller induction coil *C* having a very small spark-gap at *D* was set in a plane parallel with the larger coil, so

that the emitted waves from both oscillators will receive the waves. The primaries of both coils were connected in series with a common source of E. M. F., and with an interruptor *f* common to both

¹Wiedemann's *Annalen*, vol. 31.

coils. When the spark-gap *B* was screened from that of *D* by a sheet of glass, the sparks discharging across the latter became very much smaller and this effect led Hertz to conclude that it was not the visible waves of light that produced this property, but the extremely rapid invisible ultra-violet waves.

The electric arc light is, next to the disruptive discharge, the most effective method of producing sparks or increasing them. Hertz states that if the oscillator balls are drawn so far apart that sparks cannot pass and an arc light is started at a distance of from 1 to 4 meters, the sparks begin to pass and cease when the arc light is cut out. By means of an aperture held in front of the arc light he was enabled to separate the ultra-violet radiation from the visible luminous rays of the glowing carbons, and found that the ultra-violet radiation was the direct cause.

In wireless telegraphy any cause having a tendency to abnormally increase the length of the spark, likewise decreases the efficiency of the electric wave emitting system, and, therefore, the ultra-violet radiation falling upon the oscillator balls is detrimental to the proper working of the apparatus. Lodge has secured patents in the United States and England for excluding these radiations, which he does by means of colored glass encasing the oscillator balls.

Sparks of an irregular form may be traced to an uneven distribution of the metal vapor from the electrodes, and is caused largely by unclean terminals; the oscillator balls should be kept perfectly clean and should be polished frequently. Since the disruptive discharge is electrolytic in character, different metals have been tested with a view of ascertaining the most consistent terminals; spheres of copper and aluminium have been found to yield the best results, although brass terminals are almost universally employed.

DIRECT AND ALTERNATING CURRENT EFFECTS.

An intermittent arc formed between metals resulting from the break of contact either by a direct or alternating current suffices to produce electric waves of considerable intensity, and if in the proximity of a sensitive coherer will affect it. While conducting some experiments in New York City, the author had to contend with the sparking of a trolley as it passed an uneven juncture in the conductor. Although the distance was nearly one hundred feet, yet

every spark cohered the filings. Another source of trouble from extraneous sparking by direct currents is due to the relay and tapper contacts breaking the battery circuits of the receiving devices. The remedy for these untoward effects is the employment of choking coils. To test the striking distance best adapted for a given coil as an electric wave emitter, a Reiss micrometer spark-gap detector is the most convenient. By setting the detector and radiator or oscillator system in the same horizontal plane and observing the secondary sparks while adjusting the oscillator balls, the brightness of the detector sparks as well as their length will be found to indicate clearly when the maximum value of spark-length has been obtained. With a disruptive discharge of the proper density and length, powerful oscillations may be easily set up in an open circuit radiator and electric waves capable of intense penetration traversing long distances may be produced.

CHAPTER V.

ELECTRIC OSCILLATIONS.

HISTORICAL.

In the historical retrospect of electric oscillations two classes are observed: (1) that of commercial low frequency alternating currents produced by moving coils of wire in a magnetic field, and (2) the surging of high frequency, high potential currents through a low resistance as the oscillator system of a coil or jar.

In Gilbert's *Annalen der Physik*, published in 1806, the phenomenon of the "back-stroke" in lightning discharges is spoken of as a common occurrence. But the first suggestion that the disruptive discharge was caused by the to and fro motion of the electric current was distinctly expressed by Félix Savart, of France, who was perplexed by the irregularity of the magnetization in small needles when affected by the discharge of a Leyden jar.¹

Joseph Henry contributed a paper to the Philosophical Society in June, 1842, on his investigations of some anomalies in ordinary electrical induction. He repeated Savart's experiments with No. 3 and 4 sewing needles, subjecting them to a magnetizing helix, and found the polarity always conformable to the direction of the discharge and that when very fine needles were employed an increase in the force of the electricity produced changes in polarity. This puzzling phenomenon was finally cleared up by the important discovery that an electrical equilibrium was not instantaneously effected by the spark, but that it was attained only after several oscillations of the current.

Henry himself says: "The discharge is not correctly represented by the single transfer from one side of the jar to the other; we must admit the existence of a principal discharge in one direction and then several reflex actions backward and forward, each more feeble than the preceding, until the equilibrium is obtained."²

¹Brewster's *Edinburgh Journal of Science*, October, 1826.

²Proceedings American Philosophical Society, June, 1842.

Five years later, in 1847, Helmholtz communicated his views, which were evidently independent of those of Henry. In his paper, *Ueber die Erhaltung der Kraft*, Helmholtz suggested the electric oscillations and said he assumed the discharge of a jar not a simple motion of electricity in one direction, but a backward and forward motion between the coatings of oscillations which become continually smaller until the entire *vis viva* is destroyed by the sum of the resistances,¹ and again, five years later (in 1852), Lord Kelvin, deduced the phenomenon mathematically, the results coinciding almost exactly with Savart, Henry and Helmholtz. Faraday arrived at the same conclusion experimentally by decomposing water with an ordinary frictional electric machine, and showed that hydrogen and oxygen rose in a mixed condition from either electrode, and that this was due to electric oscillations of the discharge. In 1859 Fedderson proved the oscillatory nature of the electric discharge by observing the spark in a Wheatstone revolving mirror, as first suggested by Lord Kelvin. Photographic proof of the oscillations has not been wanting in recent years. Vernon Boys, in 1890,² made some exceedingly fine photographs of the principal and supplementary sparks of the discharge, each of which left a well-defined and separate record on the negative. Trowbridge obtained photographic proof that the long seven-foot sparks were oscillatory. Some very interesting photographs of electric oscillations have been made by Dr. E. W. Marchant with a revolving mirror, with and without iron cores in the coils. Many facts have been added within the past two years, and the laws governing the emission of electric waves are, for the most part, quite well known.

PRACTICAL.

LOW FREQUENCY CURRENTS.—In commercial alternating current generators the current flow reverses direction from 50 to 300 times per second. By increasing the number of polar projections or the speed of the armature, or both, a higher frequency may be obtained, but the limit is soon reached. In telephone circuits the frequency of reversal may be 1,000 or more per second. These are simple periodic currents having characteristic curves. A low fre-

¹Scientific Memoirs of Helmholtz; edited by Tyndall, 1853.

²Proceedings Physical Society, London, 1890.

quency alternating current requires the element of time for the maximum positive to change to the maximum negative potential, and *vice versa*; the e. m. f. and current strength are kept at a constant value by the generator, hence the constants usually follow some smooth curve, as in Fig. 47.

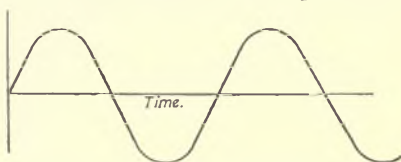

FIG. 47.—ALTERNATING CURRENT CURVE.

HIGH FREQUENCY CURRENTS.—To obtain electric waves an alternating current of exceedingly high frequency having a period of reversal many times greater than can be produced by mechanical means must be employed. There is but one method known to science by which electric oscillations of the requisite frequency for the emission of electric waves may be had. This is by discharging a condenser or oscillator system through a circuit of small resistance and allowing the maximum positive and negative charges to restore the electrical equilibrium through a disruptive discharge, this forming at the moment the spark passes a conductor of low resistance, there is then set up in the oscillator system high frequency currents, the duration of which may be measured by the ten and hundred thousandths part of a second. In this case depending on the capacity, inductance and resistance of the circuit the current will oscillate to and fro several times before it is finally damped out by the sum of the resistances.

Alternating and oscillating currents, of whatever frequency, are governed by the electrical dimensions of the oscillator system, and these factors, i.e., ohmic resistance, inductance, and electrostatic capacity, all tend to slow down the frequency. Ohm's law does not apply to the circuit, but its value largely depends on the frequency with which the reversals take place, and, in circuits containing iron upon the e. m. f. By increasing the frequency of the current the ohmic resistance decreases in value while the inductance and capacity increases. In oscillator systems where high-frequency currents are induced by a disruptive discharge the effect of resistance is usually so small as to be negligible.

ANALOGUE OF ELECTRIC OSCILLATIONS.—A mechanical analogue, designed by Fleming,¹ illustrates the electric action taking place in an oscillator system at the moment of discharge; it is shown in Fig. 48. It consists of a glass tube bent in the form of

¹Fleming, Cantor Lecture, Jan., 1901, Society of Arts, London.

a U; it is partially filled with mercury, which is so displaced that there is a difference of level between the parallel tubes *a* and *b*; gravitational force is therefore exerted upon the two columns of mercury, tending to cause the high and low levels to equalize. If this force is allowed to act slowly the mercury will find its normal

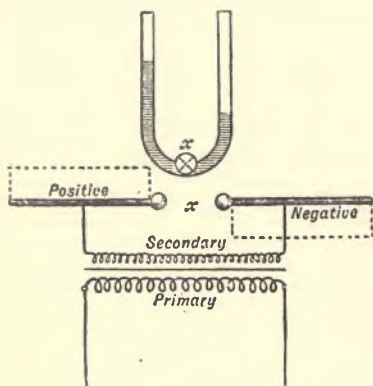

FIG. 48.—ANALOGUE OF ELECTRIC OSCILLATIONS.

level without oscillation. But if the force is allowed to act suddenly, the mercury, in virtue of its density, flows beyond the normal level, indicated by the dotted line, and then returns, its inertia causing several oscillations of the fluid metal before coming to rest. If the tube is rough inside, the friction offered to the mercury has a *damping* effect and permits only one or two oscillations to take place; in electric oscillations the inductance of the system has the effect of slowing down the oscillations. The resistance offered to the flow of the mercury by the abraded surface of the tube, or in other words, the friction, corresponds to the ohmic resistance of the circuit; the denser the liquid in the tube the less appreciable will be the effect of the friction, likewise the higher frequency of the discharge the less the ohmic resistance of the circuit affects the oscillations.

If the glass tube contains air above the mercury and the ends are hermetically sealed, the air will be compressed by the impact of the mercury and acts similarly to the electrical capacity of the oscillator system. It is evident that to produce oscillations in a mechanical body, as mercury in the U-tube system, the first requisite is that of density, so that when the mercury is displaced it will tend to return to the level from which it started and will oscillate to and fro in accordance with this tendency. For obtaining the best results in electric oscillations the system must be composed of metallic bodies having electrical capacity and the system must have the coefficient of inductance and possess low resistance.

PROPERTIES OF ELECTRIC OSCILLATIONS.—The frequency of oscillation attained by a high potential current through the dis-

level without oscillation. But if the force is allowed to act suddenly, the mercury, in virtue of its density, flows beyond the normal level, indicated by the dotted line, and then returns, its inertia causing several oscillations of the fluid metal before coming to rest. If the tube is rough inside, the friction offered to the mercury has a *damping* effect and permits only one or two oscillations to take place; in electric oscillations the inductance of the system

ruptive discharge of a Leyden jar may range approximately from 1,000,000 to 10,000,000 per second. The decadent reversals in oscillator systems may be ten times less than in the case of the jar. By properly arranging the capacity and inductance of a system the number rate may be as slow or as rapid as desired, depending, as we have seen, on the coefficients of the circuit, i.e., capacity, inductance and resistance. The number of complete oscillations or swings for each initial discharge depends absolutely on these factors. The rapidity of each successive discharge depends on the arrangement of the oscillator system or circuit in which the current flows. In a Leyden jar only one series of oscillations can be had upon discharge, unless there is provided some method for recharging the jar, as a frictional machine or an induction coil. In non-syntonic systems of wireless telegraphy the period of oscillation need not be

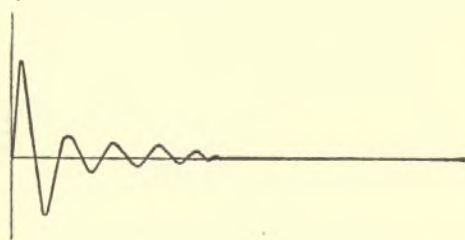

FIG. 49.—STRONGLY DAMPED OSCILLATIONS.

given special attention, since the length of wave emitted may be any one of a number of lengths, but the important feature is the arrangement of the emitter or oscillating system. A system may be a good oscillator and a poor radiator or a poor oscillator and a good radiator. As an illustration, the long vertical aerial wire which forms one arm of the oscillator system may produce only two or three oscillations before the damping coefficient causes the surging current to fall to 0 as shown in Fig. 49, owing to its large capacity.¹ On the other hand, a closed circuit, such as is employed in Lodge's syntonic jars,² is a very persistent oscillator, and is shown graphically in Fig. 50;

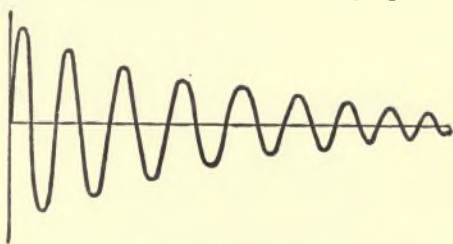

FIG. 50.—FEEBLY DAMPED OSCILLATIONS.

but as a radiator it is very feeble, for its energy is not quickly dissipated by conversion into electric

¹Marconi Society of Arts, London, May 15, 1900.

²Lodge, *The Work of Hertz*.

waves as in the case of an open circuit oscillator, and so thirty or forty oscillations may take place in the system before the energy is damped out. The value of the damping coefficient has been determined mathematically by Herr

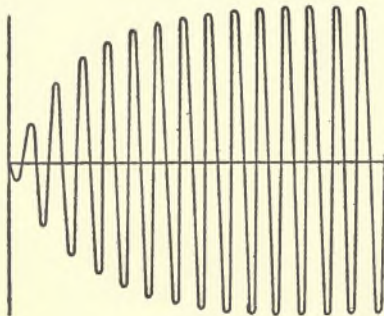

V. Bjerknæs¹ from the calculations of an electrometer inserted in the micrometer air-gap of a Reiss detector.² If the oscillator of a closed system is in sympathy or tune with a Reiss micrometer detector the persistency of oscillation in the detector will be very great as the curve, Fig. 51,

FIG. 51.—AMPLIFIED ELEC. OSCILLATIONS.

shows. TRANSFORMATION.—Another property invested in electric oscillations is that of transformation or conversion; just as low potential commercial alternating currents may be stepped-up or stepped-down, so, also, may oscillating currents be transformed into a higher or lower potential; the principles of alternating current transformation are well known and consist in passing a current through a primary coil which causes the space between the turns of wire to become alternately charged and discharged with magnetic flux, the coil and core thus being magnetized in opposite directions; this reversal of magnetism of the core induces an e. m. f. in the secondary coil, increasing or decreasing the potential according to the relative number of turns of wire wound on the primary and secondary coils, the frequency remaining the same. This is likewise true of electric oscillations.

To increase the frequency of the oscillations the disruptive discharge must be resorted to. Before the spark passes in an oscillator system the frequency of the current is the same as the frequency of the vibrations of the interruption where a direct current is employed, or the alternations of current in the secondary equals that in the primary circuit where a primary alternating current is used. This frequency is enormously increased when the spark takes place, converting the period of reversals from a few hundreds per second to hundreds of thousands per second. A higher potential may be

¹Bierknæs, *Wiedemann's Annalen*, 44: 1891.

²See Chapter II of Hertz' *Electric Waves*.

produced by connecting the secondary terminals of the coil *I* in parallel with a number of condensers, *L L L L*, or Leyden jars having the sparks in shunt, as shown in Fig. 52, so that the inside coatings of both series of jars are connected by both terminals of the secondary coil and the outside coatings are connected with a few turns of coarse wire forming the primary *P*; if now a second frame is wound with a larger number of turns of fine wire, and this secondary transformer is placed parallel to that of the first coil the potential of the oscillatory current will be very greatly increased; if a Leyden jar *M* is introduced in the secondary circuit and a spark-gap arranged at *F*, a second disruptive discharge will occur and the frequency obtained by the spark *S* will also be increased many fold, and a high-potential, high-frequency current results. The Tesla-Thompson effects are produced in this way, and

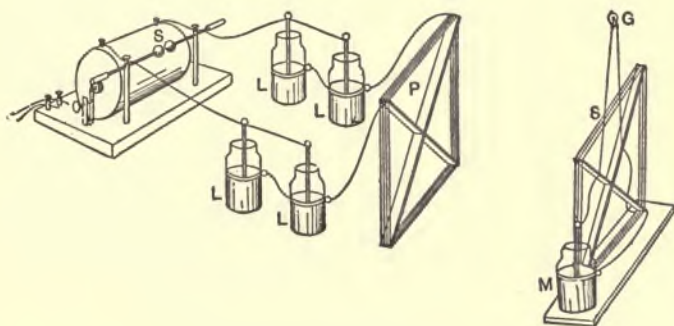

FIG. 52.—TRANSFORMER FOR OSCILLATIONS.

it is evident that any potential and any frequency may be easily produced.

RATE OF RADIATION OF ENERGY.—The rate at which an open circuit oscillator emits its energy in the form of electric waves is enormous, as the following deduction of Hertz will show. By employing a dumbbell oscillator 30 cm. in diameter connected with a spark-gap of 1 cm. by means of two rods each 50 cm. in length he was enabled to charge the system to a potential difference of 36,000 volts. Just before it breaks down the air-gap of the charged oscillator represents an amount of energy equal to $\frac{5}{16}$ of a joule. At the moment the spark passes the electric charge is set in motion in the oscillator and it radiates energy in each half of an

oscillation equal to 2,400 ergs or $\frac{24}{10^8}$ joules as indicated by the formula

$$\frac{\pi^4 Q^2 l^2}{3\lambda^3}$$

where Q is the charge of each sphere, l the length of the connecting rods, and λ the length of the wave emitted, which for the size of the oscillator employed was ascertained to be 480 cm.

If each half oscillation radiates energy equal to $\frac{24}{10^8}$ joules, then in 11 half oscillations or $5\frac{1}{2}$ complete cycles half of the electrical charge of the oscillator will have been emitted, and it is evident that before the 10 complete cycles are completed practically all the energy will have been transformed into electric waves. Fleming shows that since the length of the wave is 480 cm. and the velocity of propagation is 3×10^{10} cm. per second, the period of time occupied by ten oscillations is sixteen hundred millionths of a second, and in this exceedingly short space of time the oscillator has emitted energy equal to about $\frac{54}{10^4}$ of a joule, or at a rate of almost 45 horse-power. As an illustration of the rate at which the oscillator would have to be supplied with energy to keep up with its enormous output so that the emission of the waves would be continuous, it may be stated that 25,000 foot-pounds per second would be required, an amount equal almost to that required to light 500 16-candle-power 100-volt incandescent lamps simultaneously.

But, as a matter of fact, the oscillator system of an ordinary wireless telegraph system sends out trains of electric waves with long intervals between them, while the secondary is charging the oscillator preparatory to sending out another train of waves.

DECREMENT OF ELECTRIC OSCILLATIONS.—The decrement of electric oscillators, or the rate of damping in open circuit oscillators, showing the ratio of amplitude for each successive oscillation, has been determined by Plank and others. From the formula

$$\sigma = \frac{16\pi^4 l^2 C}{3\lambda^3}$$

in which C is the capacity of the oscillator, l the length of the connecting rods, and λ the length of the wave, it will be seen that large capacities, large inductances, or both, are essential for prolonging the oscillations.

SKIN EFFECT IN OSCILLATORS.—An interesting experiment by Hopkins and Wilson in 1895 showed that in a conductor of iron or other metal a magnetic field produced by a magnetizing force required a large time value for the flux to reach the centre. If the conductor exceeded a certain diameter and was placed in a magnetic field, which constantly and rapidly changed polarity, the magnetism would not extend to the centre.

An analogous effect is produced¹ when a high-frequency current surges to and fro in an oscillator system; when such a condition prevails the current penetrates the metal only a fraction of a mm., and this is termed the skin effect. In an experimental investigation of the skin effect in oscillators Chant² tested both cylindrical and spherical oscillators. In these forms he compared their metallic shells with those made of solid metal, and found oscillator doublets made of gold leaf equally as efficient as those in the solid form. In 1886 Lord Rayleigh³ gave a mathematical formula for computing the effective resistance and the effective inductance per unit of length of a circular section of wire when traversed by an alternating current of known frequency.

¹Fleming, *Journal of the Society of Arts*, 1900.

²Chant, *American Journal of Science*, 1901.

³Self-Induction and Resistance of Straight Conductors. *Phil. Mag.*, 1886.

CHAPTER VI.

OSCILLATORS.

PHYSICAL.

DEFINITION OF OSCILLATOR.—The term oscillator, in wireless telegraphy, is applied to any electrically charged body where the charge moves to and fro at a high rate of alternation in restoring the potential level or electric equilibrium. Here the body has a maximum and a minimum charge at two different points at the same instant.

OSCILLATORS.—There are an almost infinite number of sizes and forms of oscillators, ranging from the sun, which is the largest, down to the smallest particle of matter, be it atom or corpuscle. The sun, considered as an oscillator, emits electro-magnetic waves of such great length that they have never been observed experimentally, although the wave length has been determined by calculations from the size and conditions of it as an electrically charged sphere, producing oscillations of a definite frequency, and, therefore, waves of given length. The atom charged with electricity, when disturbed by heat, impact, or other means, agitates its potential level, and, being so very minute, the oscillation is quickened until, for the sake of clearness, it is now termed vibration and produces electro-magnetic waves that are visible, or light waves.

Between the sun as a mass and an atom of matter, all other charged bodies, when the charge is disturbed, produce oscillations differing in degree in the period of each reversal of the charge. To produce definite oscillations for wireless telegraphy, an apparatus must be employed for charging a body to its maximum potential and then setting the charge into motion; this is accomplished by means of an oscillator.

OSCILLATOR SYSTEMS.—In the discharge of a Leyden jar it was shown that the difference of potential was equalized through the spark-gap, the wire or tongs forming the conductor connecting the inside and the outside of the jar. This constitutes the oscillator

system of a Leyden jar. In the discharge of an induction coil the oscillator system is a modification of the jar just cited, but arranged to suit the exigencies of the case. The oscillator system employed by Hertz consisted, as has been shown, merely of two brass

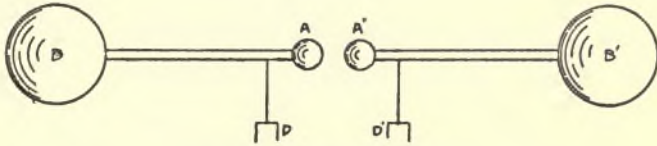

FIG. 53.—OSCILLATOR SYSTEM.

spheres, A, A' , Fig. 53, two larger metal spheres, B, B' , connected with the brass wires and rods, C, C' ; D, D' are the binding posts of the secondary terminals of the induction coil, and do not form a part of the oscillator system proper, but are merely the connection between it and the secondary coil, for the purpose of charging the system with electricity to a high potential. Thus the dividing line between the secondary of the induction coil or transformer and the oscillator system is the binding posts. To obtain the best results with the minimum amount of energy, much effort has been spent not only on the oscillator system as a whole, but on individual parts of it; the following represent the different forms as used by Hertz and by his successors to the present time.

HERTZ'S OSCILLATOR.—Another form of oscillator, shown in Fig. 54, was devised by Hertz for his first experiments. The spheres B and B' may be replaced by any shape or size having capacity, though Hertz favored the adjustable oscillator shown in Fig. 54,

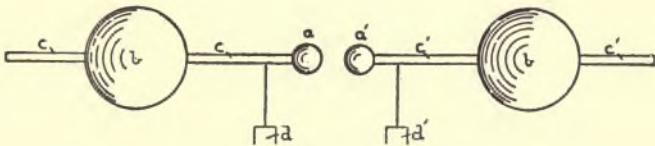

FIG. 54.—HERTZ'S ADJUSTABLE OSCILLATOR.

where B and B' are arranged to slide on the rods C and C' permitting the value of inductance and capacity to be varied at will and the system thus tuned or syntonized with the resonator or spark-gap detector. In the Hertz oscillator the spheres were of sheet zinc 30 cm. in diameter, the spark-gap balls 3 cm. in diameter connected

with rods 50 cm. long. This form is called the Hertz dumb-bell oscillator.

RIGHI'S OSCILLATOR.—Auguste Righi in his photo-electric researches devised the oscillator shown in Fig. 55. It consisted of

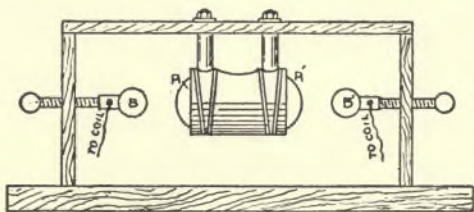

FIG. 55.—RIGHI'S OSCILLATOR.

two large spheres, A, A' , with a spark-gap between them 1 mm. in length and two secondary terminal spheres, B, B' , a cm. from A and A' respectively. In this oscillator two sets of electric waves are emitted, those emanating from the large spheres A, A' and those emitted from the smaller spheres B, B' , including the rods leading to the secondary terminals C, C' . Both of these sets of oscillators are, of course, in alignment with the oscillator system, that is, the surging takes place along the line of propagation.

LODGE'S OSCILLATOR.—Another form of oscillator devised by Lodge is shown in Fig. 56, and is similar to Righi's, but has

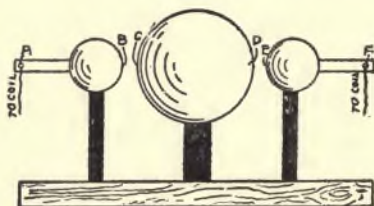

FIG. 56.—LODGE'S OSCILLATOR.

only one central sphere, instead of two, which is much larger and is supported between two smaller spark balls in close proximity on either side. When the disruptive discharge current oscillates through the system represented diagrammatically by the letters $A B C D E F$, waves are emitted by the system from A to F , but a secondary definite charge surges from side to side on the ball $C D$, sending out another train of waves with considerable vigor, but the oscillations die out quickly, since it is readily seen that such a charged body is a good radiator for the electric waves. Two or three oscillations only will take place in the ball when the charge

will have been dissipated in the form of electric waves, reaching the vanishing point or zero in finite time theoretically, but practically in a very small fraction of a second. From tests of capacity and inductance it has been deduced that the wave length produced by these charged metal spheres is about one and one-half times the diameter of the sphere.

MULTIPLEX OSCILLATOR.—M. Albert Turpain¹ describes an oscillator for emitting an octave of electric waves or waves of different lengths simultaneously. Fig. 57 shows the arrangement for producing multiplex waves, or, as Turpain terms it, a multiplex oscillator. Before the laws of the coefficients were

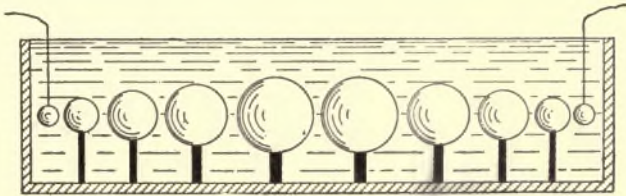

FIG. 57.—MULTIPLEX OSCILLATOR.

interpreted by J. J. Thomson, Lamb and Lodge, the supposition relating to wave lengths radiated by an oscillator was that they were of many and varying lengths, like the composite wave lengths of light, producing white light, but it was finally determined that waves of a given length only were emitted by an oscillator of specific proportions. The monochromatic oscillator may therefore be compared to an octave of musical notes, each producing a distinct wave length. In the monochromatic or multiplex oscillator there are a number of spherical metal shells of different diameters, each of which is supported on an ebonite or other dielectric and the whole immersed in an oil chamber. When the disruptive discharge takes place through the system, the oscillatory charge of each of the spheres radiates a train of electric waves of a definite length. These waves may be detected and picked out, or selected by means of a Hertz resonator at short distances; and this offers a good illustration of selective or syntonic signaling.

CONTINUOUS DUMB-BELL OSCILLATOR.—Another form of dumb-bell oscillator without the usual air-gap is shown in Fig. 58; it may be charged and the charge caused to oscillate as in the

¹Les applications Pratiques des ondes electriques, Turpain.

spherical oscillator of Lodge, i.e., by having the terminals of the



FIG. 58.—DUMB-BELL OSCILLATOR.

secondary coil end in small brass balls, oppositely disposed, and with the oscillator between them.

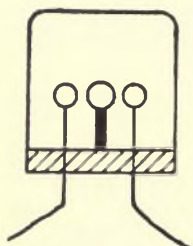

FIG. 59.—
BOSE'S OSCILLATOR

BOSE'S OSCILLATOR.—Prof. J. Chandler Bose designed an oscillator for producing exceedingly short wave lengths. It is illustrated in Fig 59, and consists of a small ball of platinum 2 mm. in diameter supported between two smaller balls of the same metal; it is really a miniature form of Lodge's oscillator, previously described. With this oscillator Bose has polarized the electric waves by means of asbestos, epidote and other fibrous minerals.

EXPERIMENTAL OSCILLATOR.—An oscillator for experimental work, emitting 300 million waves per second, each having a length of one meter, is shown in Fig. 60. It consists of two identical arms, *A*, *B*, each of which has a sphere 8 cm. in diameter at the end and

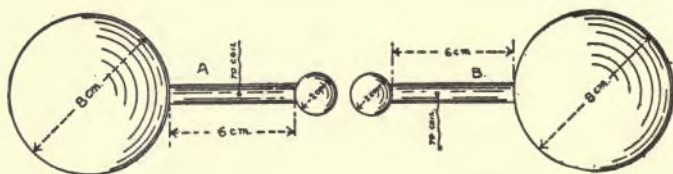

FIG. 60.—EXPERIMENTAL OSCILLATOR.

connected with spark-gap balls by a brass bar 1 cm. in diameter and 6 cm. in length; the spark-gap balls measure 2 cm. in diameter each, and, used with a 15-cm. spark-coil should be set 8 mm. apart. With a larger coil they should be set farther apart, and used with a smaller coil the gap should be correspondingly decreased.

Instead of employing the large spheres for the oscillators, it is often more convenient to use circular disks of sheet metal, or square or oblong plates may be used. The formulæ for obtaining the specific inductive capacity and its permeability or inductance of these values will be found in the following chapter. Leaving the experimental forms of oscillators, we now come to those designed for practical work in wireless telegraphy, or that class found neces-

sary for radiating waves to great distances, or at least to such distances as are required for commercial purposes.

MARCONI'S OSCILLATOR.—To Marconi belongs the credit for having been the first to discover the requirements necessary to fulfill these exacting conditions. The simplest form of practical oscillator for wireless telegraphy is shown in Fig. 61. It consists merely of a vertical wire, fifty or one hundred feet in length, and extending into the air, the lower terminal of which is connected with the spark-ball 2; a second spark-ball, 3, separated a few mm. from the first, forms the spark-gap 4, and from this a wire leads to the earth at 5.

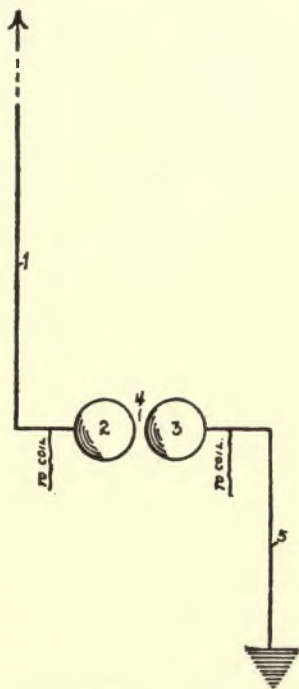

FIG. 61.—MARCONI RADIATOR.

OPEN AND CLOSED OSCILLATOR SYSTEMS.—All the oscillator systems described above are known as *open-circuit oscillator systems*, that is to say, they have a free period of oscillation, and therefore radiate waves with great energy, though the oscillations are quickly damped out. There is another class of oscillators termed *closed-circuit oscillator systems*, in which the period of oscillation

is limited to the size of the circuit; if this has a natural period equal to that of the impressed oscillations these will be prolonged for a considerable length of time before the energy is dissipated; closed-circuit oscillators are, therefore, very feeble emitters of electric waves.

Lodge in his researches on the lightning rod¹ devised many experiments; one especially is of interest here, bearing as it does on the action of closed circuits forming oscillator systems. In Fig. 62 is shown the oscillator system of Lodge's syntononic jars; 1 is an ordinary Leyden jar, the inner coating of which is connected to one ball, forming the spark-gap 2; a circuit, rectangular or of other

¹The Lightning Rod. O. J. Lodge.

suitable shape and dimensions, leads from the upper ball and terminates in a connection with the outside coating of the jar. If the jar is now charged and then allowed to discharge through

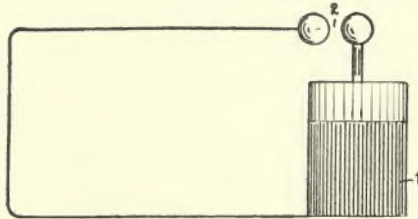

FIG. 62.—CLOSED CIRCUIT OSCILLATOR.

the spark-gap 2 and the circuit of wire, the oscillations will be very persistent in the circuit, surging to and fro many times before reaching 0, and emitting waves that have but little penetrative power, for, as previously pointed out, such a closed circuit spends its energy in oscillation instead of in radiation.

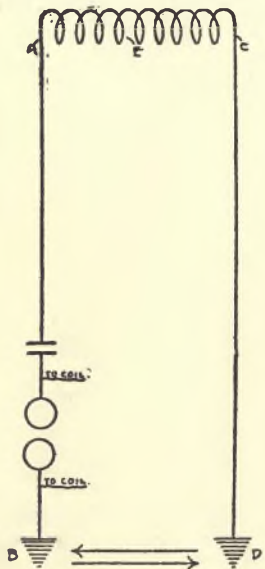

FIG. 63.—
SLABY'S
CLOSED
EMITTER.
CIRCUIT

Slaby, during his early experiments, employed an oscillator system in his transmitting apparatus for practical wireless telegraphy which was similar to the Lodge syntonic emitter jar, except that its proportions were much larger and its energy supplied by a very large induction coil. An inductance coil, *E*, Fig. 63, was added at the top for the purpose of conducting away and dissipating all electric waves of a length greater than those required to fulfill the law of harmonics represented by the terminal of the vertical wire *A*, and the earthed end, *B*. It will be seen that a practically closed circuit was formed between *A B C D*, the earth closing the circuit between *B* and *D*. Slaby has now abandoned this form for an open oscillator system, based on the original single vertical wire.

Nevertheless, in wireless telegraphy where syntonization or a tuned system is desired, it is quite advantageous to operate with closed-circuit oscillators, and Marconi in his recent attempts to produce a commercial syntonic system has evolved from the simple

Leyden-jar circuit of Lodge an apparatus so constructed as to effect a compromise between the open-circuit and the closed-circuit oscillator, producing in turn an emitter having an intermediate amplitude between the severely damped oscillation of the open-circuit system and the prolonged period of oscillation of the closed-circuit system, thus yielding trains of waves of considerable penetrative power. In nearly all commercial systems now in actual use, one terminal or arm of the oscillator is earthed. Lodge deemed the earth connection unnecessary, and deduced the conclusion that if the spark-gap was elevated midway between the oscillator arms, and these were mutually balanced in capacity and inductance, the resultant effect would be equal in efficiency to that of a grounded open-circuit system. This oscillator will be described under the head of Syntonization, Chapter 19.

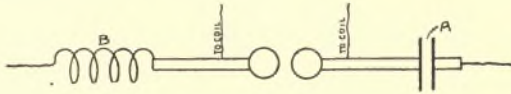

FIG. 65.—DISSYMMETRICAL SYSTEM.

SYMMETRICAL AND DISSYMMETRICAL OSCILLATOR SYSTEMS.—Oscillators, where the arms are balanced equally in resistance, inductance and capacity, as in the open-circuit type of Hertz, are termed symmetrical systems. Where the coefficients vary in value in the opposite arms of the same system, they are termed dissymmetrical systems. All commercial systems are dissymmetrical, since the arm connected with the earth is loaded with an additional capacity by the condenser action of the earth itself. This may be attributed to two factors; (1) the capacity of the earth slows down the oscillations, and (2) Hertz has shown that by physically altering the coefficients of capacity and inductance,¹ in accordance with Lord Kelvin's deductions², a harmonic relation or syntonization could be effected between the emitter and detector systems, due to resonance, and thereby increasing the efficiency very materially. The diagram Fig. 65 illustrates a dissymmetrical oscillator, having a Leyden jar or glass-plate condenser, *A*, inserted in one arm and an inductance coil, *B*, in the opposite arm. Variations of capacity and inductance may be made to fulfill any condition which may arise in practice required by the law of resonance.

¹ Hertz's *Electric Waves*.

² Kelvin, *Transient Electric Currents*, 1853.

CHAPTER VII.

CAPACITY, INDUCTANCE, AND RESISTANCE.

HISTORICAL.

HISTORY OF CAPACITY.—In 1776 Coulomb, whose name has since been given to the unit of electrical quantity, proved by a series of brilliant tests, based on the two-fluid hypothesis of electricity, that the action of an electric charge varies in the inverse ratio as the square of the distance. He likewise investigated theoretically and experimentally the distribution of electricity on the surface of spheres. In 1782 Laplace and Biot enlarged upon these researches, deducing important mathematical conclusions. Poisson next brought the subject under analysis based on the two-fluid hypothesis to a higher degree of perfection. In 1828 Green¹ extended the analysis of Poisson and Laplace and mathematically evolved the electrostatic theory based on the law of Coulomb. Faraday in 1837, with his intuitive insight, concluded that the dielectric through which induction takes place was polarized and that the strain or stress was transmitted between the positive and negative charged bodies by the polarized atoms of the dielectric. This strain is often seen in the piercing of the glass dielectric of the Leyden jar, as well as in the residual charge of the glass.

Green's theorems and Faraday's deductions were enlarged and improved upon in 1845 by Lord Kelvin, who, with great mathematical power, showed how the electrostatic strain of a dielectric was in absolute accord with the theory announced by Green. Following Kelvin are the researches of Maxwell. In 1873, in his *Electricity and Magnetism*, he fully elucidated his beautiful theory of the action of a dielectric medium which is contained in the proposition that in transparent media whose magnetic inductive capacity is very nearly that of unity the dielectric capacity is equal to the square of the index of refraction for light of infinite

¹Green's Application of Mathematical Analysis to Electricity and Magnetism.

wave length. Hertz determined experimentally that by varying the capacity the electric oscillation could be modified and therefore the length of the wave emitted.

HISTORY OF INDUCTANCE.—The history of self-induction, or, as it is now termed, inductance, extends only to Henry's time. Joseph Henry observed the phenomenon and published an account of it as early as 1832.¹ The remarkable fact that a long conductor had an intensifying influence on the current, and especially if the wire was wound in the form of a spiral and interposed in the circuit, Henry attributed to the long wire becoming charged with electricity which by its reaction on itself projects a spark when the connection is broken¹. The same discovery was made a year or two later by Fleeming Jenkin, who communicated to Faraday the fact that he was able to obtain shocks when he included the coil of an electro-magnet in the circuit, though no appreciable effect was obtained when the coil was removed. In 1834 Faraday published in the *Philosophical Magazine* the result of his researches on self-induction, and asserted that the same law was in evidence when a simple coil of wire without a magnetic core was substituted for the electro-magnet, and that a similar effect, though less pronounced, was obtained when a very long straight wire was employed. Faraday believed that self-induction was due to magnetism, and that the current in rising in the circuit produced a number of lines of magnetic force which opposed that of the battery and caused the current to rise slowly. He believed also that, when the current begins to decrease, the number of lines of force begins to decrease and the e. m. f. of induction is called forth, which tends to prolong the current, weakening the e. m. f. at starting and exalting it at stopping. Edlund investigated the integral e. m. f. of inductance on making and breaking the circuit and found that they were equal. Maxwell treated the subject exhaustively from a mathematical standpoint, and introduced a convenient method for showing the effects and measuring the inductance by using a Wheatstone bridge. Helmholtz was the first to treat the subject experimentally and mathematically. Lord Kelvin published his deductions in the *Philosophical Magazine* in a paper entitled "On Transient Electric Currents," in which he discussed the discharge of the Leyden jar and elucidated other important phenomena. For instance, he recognized the influence which the electro-dynamic capacity, or,

¹*Philosophical Magazine*, November, 1832.

as we now term it, inductance, of the oscillator had upon the discharge, and he established an equation of energy which expresses the fact that the energy of the charged body at any instant is partly dissipated as heat in the discharging circuit and partly conserved as current energy in that circuit. Hertz, in his paper, "Very Rapid Electric Oscillations,"²¹ considers the theory of Kelvin, Helmholtz and Kirchhoff, in which the inductance is considered in electro-magnetic measure, and capacity, in electrostatic measure and applied them to actual cases of experimental research.

HISTORY OF RESISTANCE.—Before the year 1827 the nature of the electric current was expressed in terms of *intensity* and *quantity*. In 1827 Ohm enunciated his great law relating to the resistance of a circuit to a steady direct current, which, fully stated, is $I = \frac{E}{R}$. The verification of Ohm's theory of the electric current and improvements in instruments for measuring resistance are largely due to Wheatstone, Kelvin, Matthieson, and others. In 1841 Joule established the law relating to the heat evolved per second with the current strength and the resistance of the wire, which may be stated by the formula $H=RI^2t$. The experiments of Joule were carefully repeated to insure accuracy by Becquerel, Lenze and Botts.

THEORETICAL.

DEFINITION OF CAPACITY.—In the succeeding explanations, formulæ and examples, the term *capacity* will be understood to mean electrostatic capacity, unless otherwise designated. The electrostatic capacity of an oscillator system is the quantity of electricity which will raise its potential to a definite amount. A gas-tank may be taken as an analogue for an electric oscillator. The electricity will produce in an oscillator system a difference of potential depending on its size, form, and the electrical pressure exerted upon it at the terminals of the secondary coil charging it. The capacity represented by K , of a conductor, condenser, or oscillator is directly proportional to the quantity of electricity Q , which it will hold at a given potential V ; or, $K = \frac{Q}{V}$; or the quantity of electricity to charge an oscillator to a given potential is

¹Hertz' Electric Waves.

²Kirchhoff in 1849 was the first actually to measure the resistance of a circuit, which he did by a comparison of a resistance with a coefficient of mutual induction, the time measurement being that of the period of oscillation of a galvanometer.—*Encyc. Brit.*

equal to the capacity of the oscillator multiplied by the potential through which it is raised, or $Q = KV$.

The charging of the oscillator is the first effect of the high-potential current producing a distribution over the surface like the charge of a condenser. The capacity depends on the length and surface of the oscillator, its proximity to other conducting bodies, and its relative distance from the earth. The capacity retards the frequency of oscillation because the charge must be neutralized at each disruptive discharge before the oscillatory current can exert a reflex action in the opposite direction.

UNIT OF ELECTROSTATIC CAPACITY.—The *coulomb* is the unit of electrical *quantity* and is equal to (1) the charge contained in one *farad* capacity when subjected to a pressure of one volt, or (2) the quantity passing in one second through a resistance of one ohm under an e. m. f. of one volt, or (3), the quantity of electricity conveyed by one ampere of current in one second. The *farad* is the unit of capacity and represents a surface of such dimensions that one coulomb will produce a potential of one volt. The *microfarad*, or one one-millionth of a farad, is used in ordinary measurements, since the farad is too large for practical purposes.

DEFINITION OF INDUCTANCE.—Self-induction, or inductance, is that property of an electric current which finds its material counterpart in inertia. A current in a conductor or an electric charge of an oscillator requires a definite time to start¹; again, when a current is flowing in a wire or a charge oscillating in a system, time is again required for the flow to cease or the charge to fall to zero. In virtue of this quality of inductance, the oscillation of an electric charge causes a magnetic field to be formed by the absorption of electric energy. The inductance of an oscillator depends on (1) the form or shape of the system; (2) the magnetic permeability of the space surrounding the oscillator system—this is usually the air, representing unity; and (3) the magnetic permeability of the oscillator itself. In high-potential, high-frequency currents like those due to a disruptive discharge, inductance becomes a most potent factor and causes the current to act, with relation to time, like a heavy body under the starting action of any force. The electro-magnetic energy present in any given circuit is equal to one-half of the square of the current multi-

¹Lodge's Modern Views of Electricity.

plied by the inductance. The oscillating current, then, is the factor representing force, hence inductance must be represented by the dimension of length; *the practical unit of inductance* corresponds, therefore, to a length equal to the earth's quadrant, or 10^9 cm., and was formerly called a quadrant or secohm, but is now known as a *henry*; the absolute unit of inductance corresponds to one cm.

Usually oscillators are formed of some metal or metals that have no magnetic properties; they are likewise usually exposed in free air, which has a constant magnetic permeability; where the inductance is constant, its value depends only on the size and shape of the oscillator system. In this limiting case the total inductance of the oscillator is proportional to the magnetizing force and the magnetic resistance. In the construction of oscillators for high frequencies, flat strips of copper may be used to advantage, as it has been shown that a form of this type is a good emitter, since it offers a greater surface for absorption to the air than a round conductor having an equal cross-section. When the geometric form of an oscillator remains unchanged, as it does in all practical cases, and the lines of magnetic force pass through homogeneous dielectrics, as the air, and uniform diamagnetic metals, of which the oscillators should be made, the *inductance is constant*. The magnetic permeability of a body depends on its conductivity to the lines of magnetic forces. The ratio between the intensity of magnetic induction and the force producing the magnetization may be stated thus: $\mu = \frac{B}{H}$, where μ is the permeability, B the produced magnetization, and H the magnetizing force. The permeability of oscillators, assuming them to be made of non-magnetic metals, is practically that of air, and as the magnetization increases the magnetic permeability decreases.

DEFINITION OF RESISTANCE.—The law of resistance stated by Ohm for direct steady currents is that the resistance equals the e. m. f. divided by the current, or $R = \frac{E}{I}$, or, $I = \frac{E}{R}$. The unit of resistance is the ohm, and a resistance of one ohm would limit the current flow to one coulomb per second when the e. m. f. is equal to one volt. Another law must be recognized in the action for alternating currents of high frequency, as these do not follow absolutely the laws of resistance for low-voltage direct currents; the second law is known as Joule's law, and asserts that the heating power of a current is proportional to the product of

the resistance and the square of the current strength. In limited cases Ohm's and Joule's laws agree; but as Lodge has pointed out,¹ in cases of varying magnetic induction, some of the energy is stored, all is not dissipated, and the two definitions do not agree. An oscillator in action dissipates a very small part of the current as heat, and a much larger portion in the form of waves radiated into space. Both the heat dissipation and the electric radiation are included in the law of resistance.

THE EFFECT OF CAPACITY, INDUCTANCE, AND RESISTANCE ON ELECTRIC OSCILLATIONS.—Lord Kelvin has given in his paper, "Transient Electric Currents,"² an equation showing that the rate of release of energy of a charged jar is at any instant equal to the dissipation of energy in the discharge circuit, or, as it is now termed, the oscillator system, added to the rate of change of the kinetic energy in the circuit. Kelvin's deductions were based on the experimental evidence of the action of a Leyden jar, but the equations hold good for the oscillator systems of induction coils as well. Let the capacity of a jar or oscillator be expressed by C , its resistance by R , its inductance by L , the quantity of electricity in the condenser at any time t by q , and the current in the oscillator circuit by I , then by the following differential equation we have the above stated thus:³

$$-\frac{d}{dt} \left(\frac{1}{2} \frac{q^2}{C} \right) = \frac{d}{dt} \left(\frac{1}{2} LI^2 \right) + RI^2.$$

$$\text{or } L \frac{dI}{dt} + RI = -\frac{1}{C} \int I dt.$$

$$\text{or } \frac{d^2q}{dt^2} + \frac{R}{L} \frac{dq}{dt} + \frac{1}{LC} q = 0.$$

$$\text{or } TT_{\ddot{q}} + T_{\dot{q}} + q = 0,$$

where T is written for $\frac{L}{C}$, TT , for CR , and q and \ddot{q} for the first and second time derivatives of q . The solution of the above equation enables the value of the quantity of electricity or the charge of the jar or in the system to be found at any instant. It is evident that the constants may be so proportioned that the discharge may describe a smooth curve in reaching zero, or the discharge may describe a curve which is periodic and alternate until it reaches

¹Lodge's Modern Views of Electricity.

²*Philosophical Magazine*, 1853.

³Fleming, *Journal of the Society of Arts*, 1900.

zero. The two solutions of the equation are shown graphically in rectangular cöordinates in Figs. 66 and 67. Fig. 66 represents the

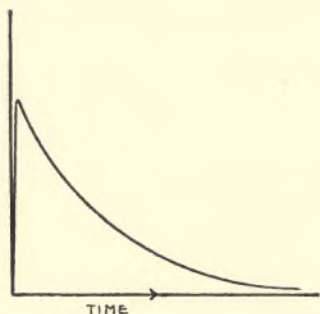

FIG. 66.—DISCHARGE THROUGH A LARGE RESISTANCE.

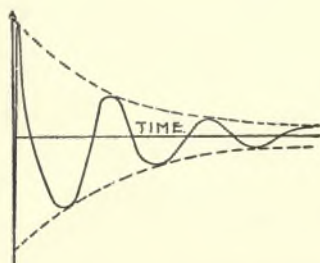

FIG. 67.—DISCHARGE THROUGH A SMALL RESISTANCE.

discharge through a large resistance and Fig. 67 the discharge through a small resistance.

FORMULÆ FOR CALCULATING THE CONSTANTS.—For the practical determination of the constants governing the period of oscillation, recourse may be had to the following formulæ. Let

K = capacity.

R = resistance.

L = inductance.

n = number of oscillations per second.

Then oscillations will occur if

$$R < \sqrt{\frac{4L}{K}}$$

and will not occur if

$$R > \sqrt{\frac{4L}{K}}$$

In this latter case a unidirectional current will reach zero gradually.

The frequency of oscillation of the charge of the oscillator may be obtained from the formula :

$$2\pi n = \sqrt{\frac{1}{KL} - \frac{R^2}{4L^2}}$$

In practice the resistance is usually very small and may be considered negligible; and, therefore, making $R = 0$ in the above, we have

$$n = \frac{1}{2\pi\sqrt{LK}}$$

FORMULÆ FOR CALCULATING CONSTANTS OF OSCILLATORS.—Since K , L and R depend on the size and shape of the oscillator, it is often necessary to construct an oscillator for producing oscillations of a definite frequency. In this case let

l = length of rod (*a a* Fig. 68).

d = diameter of rod,

r = radius of spheres (*b b'* and *c, c'*.)

s = distance from center to center.

then

$$L = 2l \left(\log_{10} \frac{4l}{d} - 1 \right).$$

and
$$K = \frac{1}{2} r \left(1 + \frac{r}{s} \right).$$

Where the capacity areas are of other forms than the sphere the value of K is for a

thin circular disk, $\frac{2}{\pi}$ radius.

thin square “ 0.36 side of a square.

thin oblong “ slightly greater than square of same area.

MEASUREMENTS.—It is quite difficult to measure the inductance and capacity of oscillator systems by comparison with standardized

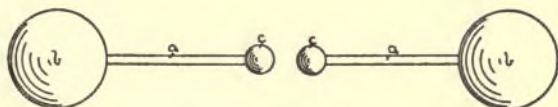

FIG. 68.—CONSTANTS OF OSCILLATOR.

units of these quantities since K and L are usually of a very small value. The resistance of the system may be easily measured, however small its value, but where R is small it may be neglected in calculations for ascertaining the frequency of oscillation. In all measurements, as in deductions, the oscillator system is understood to include the connecting wires leading to the binding posts. In measuring oscillators such as spheres or isolated systems the terminals of the testing instruments should be placed in contact with the opposite peripheral surfaces. In discontinuous oscillators, i.e., where a spark-gap intervenes, as in the Hertzian type, the constants of each arm may be measured from the terminals leading to the binding posts of the secondary coil, and each arm may be measured separately or the gap bridged by causing the spark-gap balls to form a contact.

CAPACITY.—There are several excellent methods for measuring electrostatic capacity; among those usually employed are the direct deflection method, the divided discharge method, and the Grott, Siemens and Thomson methods; the least difficult way, though not the most accurate, is by the direct-deflection method, where the discharge from an unknown capacity is compared with the discharge from a condenser of known capacity.

MEASUREMENT OF CAPACITY—If the inductance is small compared with the capacity, as in the case of a plate condenser, the *bridge method* may be used. If the inductance cannot be neglected in comparison with the capacity, as in the case of some Leyden jars, the ballistic galvanometer method must be used.

In the *bridge method*, the arrangement must be as shown in Fig. 69, where C_1 is the condenser of unknown capacity; C_2 , a

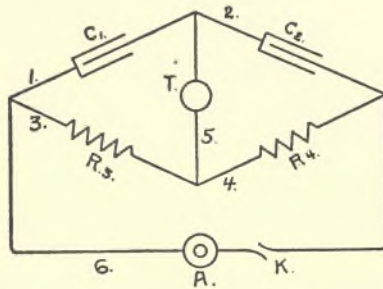

FIG. 69.—BRIDGE FOR CAPACITY MEASUREMENTS.

standard condenser; R_3 , a constant non-inductive resistance of suitable magnitude; R_4 , a variable non-inductive resistance; A, a source of periodic current; T, a telephone receiver, and K, a key to open and close the circuit. R_3 and R_4 can conveniently be the fixed and variable resistances of a Wheatstone bridge of the box form. The commercial alternating 110-volt current can be used to supply periodic current if proper precautions are taken to prevent too large a current passing through the bridge. This current should not exceed a tenth of an ampere, otherwise there will be danger of burning out the resistance coils of the box. The desired result may be obtained satisfactorily and safely by the method of the potentiometer. This arrangement is shown in Fig. 70, where m_1 and m_2 are the alternating current mains and r a resistance of 100 ohms or more. The sixth arm of the bridge is, in this case, attached

to the two points *a* and *b* of the resistance. In this way any desired difference of potential can be obtained.

If a small induction coil is used to generate the periodic current, the secondary of the coil is inserted in place of *A* in Fig. 69.

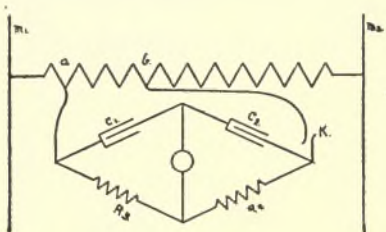

FIG. 70.—POTENTIOMETER METHOD.

In either case to determine the unknown capacity, the resistance, R_4 must be varied until no sound is heard in the telephone, when the circuit is closed by the key, *k*. Sometimes it is impossible to get rid of the sound entirely. In this case that value of R_4 must be taken which makes the sound a minimum.

When this value of R_4 has been found we have the well-known relation,

$$\frac{C_1}{C_2} = \frac{R_4}{R_3}$$

that is

$$C_1 = \frac{R_4 \times C_2}{R_3}$$

That is, the unknown capacity is equal to the standard capacity

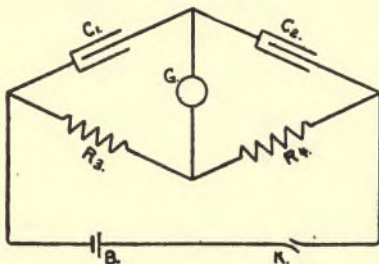

FIG. 71.—DIRECT CURRENT METHOD.

multiplied by the variable resistance and divided by the constant resistance.

If it is inconvenient to use a periodic current and telephone, a battery, *B*, and galvanometer, *G*, may be used as shown in Fig. 71.

A value of R_4 , is then found such that on opening and closing the key, k , there is no deflection of the galvanometer.

In the *ballistic galvanometer method*, the condenser to be measured, C_1 , is put in series with a battery, B , a galvanometer, G , and a key, k_1 ; see Fig. 72. A second key, k_2 , is put around the

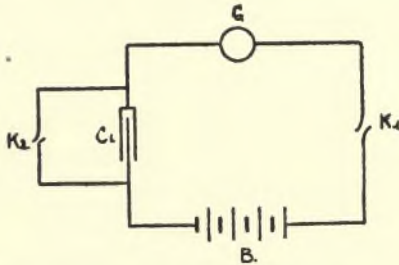

FIG. 72.—BALLISTIC GALVANOMETER METHOD.

condenser C_1 , so that it may be discharged when desired.

In making the measurement, the deflection d_1 is noted when the key k_1 is *opened*. C_1 is now replaced by the standard condenser C_2 and the deflection d_2 is noted. When we have

$$\frac{C_1}{C_2} = \frac{d_1}{d_2}$$

$$\text{or } C_1 = \frac{C_2 \times d_1}{d_2}$$

CAPACITY OF AN AERIAL.—In the following diagram, Fig. 73

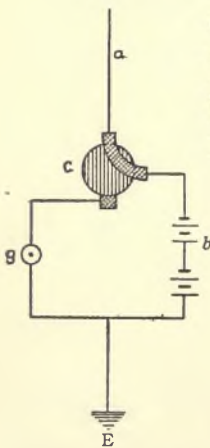

FIG. 73.—CAPACITY OF AN AERIAL.

a , is the antenna;
 c , a commutator (rotating);
 g , a galvanometer;
 b , a battery;
 E , the earth plate.

The antenna is charged n times a second by the rotating commutator c from the battery b . After every charging it is discharged through the galvanometer g . The n discharges a second through the galvanometer produce a steady deflection on the galvanometer, the value of which in terms of amperes can be determined by calibrating the galvanometer. Call this current value of the deflection A ; we then have

$$I = nq.$$

where q is the quantity of electricity sent into the aerial by one charging for in one second the total quantity sent into the aerial, or what is the same thing, discharged through the galvanometer, is $n \times q$. But this is the mean current through the galvanometer. But $q = CV$ where C is the capacity of the aerial and V the potential of the battery. Therefore we have

$$I = nCV$$

$$\text{or } C = \frac{I}{nV}$$

This is in absolute units. To convert it into practical units we must multiply by 10^6 . Then we have

$$C = \frac{I \times 10^6}{nV}$$

where C = capacity in microfarad,

I = current in amperes,

V = potential in volts.

This is a simple and satisfactory method.

MEASUREMENT OF INDUCTANCE.—The inductance of a single loop of wire, or of a small coil, may be determined by comparison with a standard inductance in much the same way as a capacity, by the bridge method. It is necessary in this case, however, to insert an auxiliary non-inductive resistance, r , either into arm 1 or arm 2 of the bridge. See Fig. 74, where

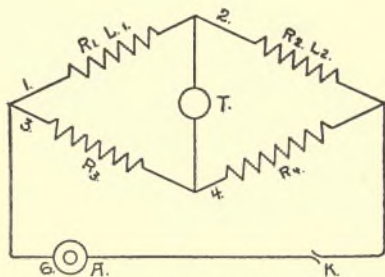

FIG. 74.—BRIDGE FOR INDUCTANCE MEASUREMENTS.

L_1 is the unknown inductance to be measured;

R_1 , its resistance;

L_2 , the known standard inductance;

R_2 , its resistance;

R_3 , a non-inductive constant resistance;

R_4 , a variable resistance.

In order that there shall be a complete balance between the four arms, that is, that there shall be no sound in the telephone, we must have the resistances of the four arms proportional to each other, and at the same time the inductances must be proportional to the resistances, that is, we must have

$$\frac{R_1+r}{R_2} = \frac{R_3}{R_4}$$

and

$$\frac{L_1}{L_2} = \frac{R_3}{R_4}$$

This result is obtained by alternately varying r and R_4 until there is no sound in the telephone. When this is the case, we have

$$L_1 = \frac{L_2 \times R_3}{R_4}$$

If it is not convenient to use a telephone and periodic current, a galvanometer and battery may be used as in the case of the condenser.

INDUCTANCE OF AN AERIAL.—It is obvious that aerials cannot be measured directly by the bridge method suggested by Maxwell, since both ends of the conductor must be connected in the bridge. It is possible, however, to measure the inductance of either single, multiple or other form of aerial indirectly, by measuring its capacity and its wave-length and then calculating its inductance from the formula

$$\lambda = 2\pi v \sqrt{LC}$$

where

λ = wave length of the aerial.

v = velocity of light.

L = inductance of the aerial.

C = capacity of the aerial.

solving for the inductance L we get

$$L = \frac{\lambda^2}{4\pi^2 v^2 C}$$

so that if the wave length λ and the capacity C of the aerial can be obtained, the inductance L may be also ascertained.

The capacity may be measured by the method described above and the wave-length can be found by one of several methods; of the latter a very excellent one, based on the phenomena of resonance, is due to Drs. de Forest and Ives, and is described in the *Electrical World and Engineer*, for June 4, 1904.¹ *Vol 43, p 1074*

¹On a New Standard of Wave Length. By Dr. James E. Ives.

RESISTANCE.—The most convenient arrangement for measuring resistances is the Wheatstone bridge, the connections and circuits of which are given in the diagram Fig. 75. The four arms constituting the parallelogram $A B R$ and X are arranged so that when a current from the battery flows through the circuit and the needle of the galvanometer shows no deflection the arms $A R$ and $B X$ neutralize each other and equilibrium is obtained. For calculations lower than the actual lowest value of the variable resistance R i.e., 1 ohm, the bridge arm A is given a value of 1,000 ohms and that of B 1 ohm. If an oscillator having a very low resistance is to be measured it is connected to the terminals of the X arm; a 5-ohm plug is removed from the variable resistance, let it be sup-

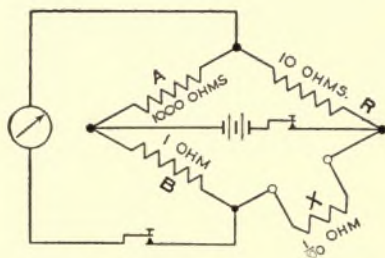

FIG. 75.—RESISTANCE MEASUREMENTS.

posed that the needle is deflected several degrees; this shows too small a resistance in the variable resistance compared with the unknown resistance. Next, unplug 10 ohms, making a total of 15 ohms in the variable resistance; the needle now swings to +, showing the resistance too high; replace the 5-ohm plug and the needle remains on the O division of the galvanometer, indicating that the arms are balanced and that the resistance of X is $\frac{1000}{1000} = 1000$ ohm.

CHAPTER VIII.

MUTUAL INDUCTION.

HISTORICAL.

Mutual induction, or the action of a current in one conductor on another or second current by the mutual interaction of their magnetic fields, was discovered by Faraday. The first remarkable experiment which finally enabled Faraday to make this sweeping observation was the discovery of Oersted in 1819 that a current of electricity produced a magnetic field. He found that when a wire through which a current was flowing was held parallel to an ordinary compass needle, the needle would be deflected at right angles to the direction of the flow of the current. In 1820 Davy and Arago discovered, independently, the method of magnetizing iron by passing a current through a wire coiled around it. Ampere was the first to give these observations a theoretical value.

In a communication dated 1825, Sturgeon described his electro-magnet¹, consisting of a piece of heavy iron wire bent into a U-form, having a copper wire wound around it loosely in eighteen turns, and connected to a battery. In 1828 Henry exhibited a small electro-magnet closely wound with silk-covered copper wire one-thirtieth inch in diameter. The first experiment illustrating the phenomena of mutual induction was made by Faraday in 1831, the apparatus consisting of a spool of wood on which were wound two coils of wire parallel with each other. In the circuit of one coil was interposed a galvanometer; in the circuit including the opposite coil was a battery and a key to make and break the circuit. When the key was pressed in the first circuit the galvanometer showed the passing of a current in the second circuit, but in the opposite direction to that in the primary coil; and when the circuit of the latter was broken, the needle was again deflected in the opposite direction. In either case the induced current had only a momentary duration. To explain this action of one current upon another, Faraday

¹Memoirs of Joseph Henry.

evolved his curved lines of force. Lenz in 1833 deduced his law for the determination of the direction of currents produced by mutual induction from the theory of Ampere; this law follows coincidentally the principles of Faraday. Henry in 1840 investigated the nature of mutual induction, devising for the purpose a series of three coils, and named the current obtained in the second coil a "*current of the second order*;" that in the third coil, a "*current of the third order*," *et cetera*, producing successive induced currents up to the *seventh order*. Becquerel described in detail Henry's researches on mutual induction in his work, *Electricity and Magnetism*.¹ Ritchie also conducted some experiments in mutual induction about the same time. From the laws of Lenz, Neumann in 1845 developed the mathematical theory of the action of one linear current on another. In 1846 Weber verified mathematically and experimentally the law of induction and improved upon the galvanometer for the purpose of testing his conclusions. The first attempt to ascertain the absolute value of a current in the secondary circuit was made by Kirchhoff in 1849. The first application of the induction coil to practical purposes was probably made by DuBois-Reymond, who introduced the automatic make and break about the year 1850; with this coil he made his famous electro-physiological experiments. Wagner subsequently improved upon the interrupter, using an independent electro-magnet in the form of a horseshoe to interrupt the primary circuit. A year later Helmholtz worked out the theory of induced currents in a number of limiting cases, as did Felici in 1852. In 1853 Fizeau made the modern induction coil what it is by his application of the condenser in the primary circuit. In 1855 Foucault designed the interrupter which bears his name. To Ritchie is due the credit of having devised the method of building up the secondary coil, by winding a number of layers and then joining them together, insulating the segments from each other. Ruhmkorff, a German mechanic, residing in Paris, constructed induction coils having the greatest degree of efficiency and added the commutator for reversing the current. Finally, in 1864, Maxwell, with his wonderful conception and grasp of electromagnetic phenomena, deduced the principles of the electric field, including not only mutual induction, but every phase of statical and dynamical electricity, on which, as a whole, he constructed the electro-magnetic theory of light.

¹Traité expérimental de l'électricité et magnétisme, vol. 5.

INDUCTION.—When a current of electricity flows through a closed circuit there is produced outside the conductor a field of magnetism and if the conductor is wound in a coil the number of lines of magnetic force is greatly increased. If the theory is accepted that magnetism is merely electricity in rotation, constituting a whirl in the dielectric medium, it is easy to account for the phenomenon of induction. As analogues of electrodynamic induction those of static induction and magnetic induction may be given. To electrify a body by *static induction* it is not necessary that it be brought into actual contact with the charged body; for instance, let *A*, Fig. 76, be a body charged with positive electricity and let *B* be a pith ball suspended near it. The charge of *A* polarizes the

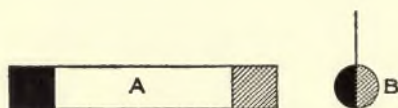

FIG. 76.—STATIC INDUCTION.

dielectric, in this case the air, separating the two bodies, and the side of *B* nearest *A* will be charged negatively and the opposite side of *B* positively. This effect produces electric separation by induction. In *magnetic induction* all the characteristics of a rotational current, or a magnetic field due to a current flowing through a helix of wire may be exhibited; in other words, the curved lines of force of both are similar in every respect. If the pole of a permanent steel bar magnet, *A*, is brought near the end of a bar of soft iron, *B*, Fig. 77, the iron becomes a temporary magnet without actual physical contact with the permanent magnet by induction, and with its poles oppositely disposed to those of the permanent magnet. If a sheet of glass or paper is placed over the steel or

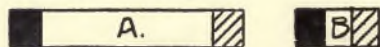

FIG. 77.—MAGNETIC INDUCTION.

iron magnets and iron filings are sprinkled on its surface, the particles will arrange themselves in the direction of the lines of magnetic force extending far beyond the ends of the magnets and showing by these curved lines of force the strains and stresses set up in the surrounding space.

An apparatus for detecting and determining the direction of

an induced current is shown in Fig. 78. The circuit *A* includes the battery 1 and the key 2; a second circuit *B* is so arranged that

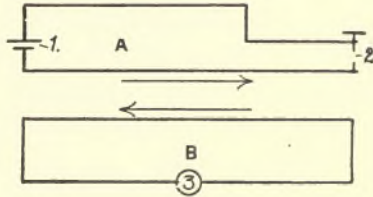

FIG. 78.—INDUCED CURRENTS.

a part of its conductor is parallel with a portion of the circuit *A*. In the circuit *B* is placed a galvanometer or telephone receiver, 3. Now, if the key 2 is made to close the circuit *A*, and the current flows in the direction of the arrow, then a momentary current will be set up in *B* in the opposite direction, and when the current *A* is broken a second momentary current will flow in the reverse direction in *B*. This is due to the fact that on closing the circuit *A* it is instantly surrounded by electricity in rotation or curved magnetic lines spreading out in circles or tubes of force, as shown in Fig. 79, some of which are large enough to inclose the coil *B*;

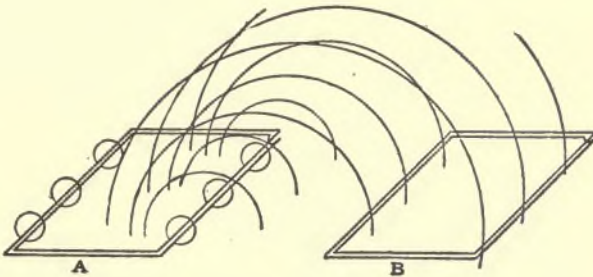

FIG. 79.—MAGNETIC LINES OF FORCE.

at the instant the lines from the first circuit thread through the second coil an e. m. f. proportional to the rate at which they link with the second circuit *B* causes the momentary current to be set up or induced. If the circuit is composed of many turns of wire instead of a single conductor, and again if the circuits are enlarged, the effective distance at which the currents will be induced is proportionately increased. This is the method

by which Sir William Preece was enabled to obtain indications at a distance of eight miles, and was the method he was engaged upon when Marconi succeeded in interesting him in his spark-gap and coherer system.

The practical applications of electro-magnetic induction have not been in the extension of the distance between the inducing and the induced currents, but rather in their proper relations, as in the case of transformers and induction coils. Another phase of electro-magnetic induction is called into action when a soft iron core is inserted in a coil of wire; in this case it will be magnetized by the magnetic lines of force. The degree to which the iron will become magnetic is termed its permeability; new properties are now acquired through the result of this combination, i.e., an iron core inserted in a magnetic field causes the lines of force to be greatly intensified and the inductance produced by the turns of wire acting on each other, as well as the mutual induction exerted by one coil of wire on another, especially if the secondary coil consists of many turns, is greatly increased.

PRIMARY AND SECONDARY CURRENTS.—The coil shown in Fig. 80 is one constructed by Faraday, and is the basis of the modern

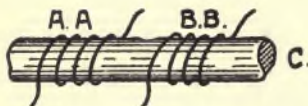

FIG. 80.—FIRST INDUCTION COIL.

induction coil, although the evolution of the latter was more directly due to Henry than to Faraday. The primary winding, *AA*, is formed of wire of large cross-section, and the secondary coil *BB* of wire of small cross-section well insulated, and a soft iron core, *C*; the relative values of the e. m. f. impressed on the inductor or primary coil and that produced in the secondary coil is called the *ratio of transformation*. This ratio is directly proportional to the number of turns of the inductor and secondary, except for a very small loss in transformation; therefore the energy at the terminals of a secondary coil is very nearly equal to that impressed on the primary circuit. As an illustration, suppose the number of turns on the secondary coil to be 1,000, and that on the primary 10, then the increase in e. m. f. is 100 times that of the primary or inductor, but the current or quantity of electricity will be proportionately less. This ratio is called the *coefficient of transformation*.

THEORY OF THE INDUCTION COIL.—In treating of the several elementary principles involved in the action of induction coils, the effect of the magnetic field will be considered first.

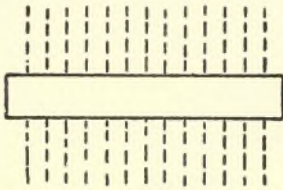

FIG. 81.—THE INDUCTOR.

ELECTRO-MAGNETIC INTENSITY.—

In the inductor, which is a simple solenoid or helix, with an air core, represented in longitudinal section, Fig. 81, the current flowing through a single turn of the coil induces at its centre a magnetic field which may be thus expressed :

$$H = \frac{2\pi I}{10r}$$

where I is the strength of the current in amperes and r the radius of the core. In a long inductor the magnetic field within it is uniform except near the ends, and its intensity is

$$H = \frac{4\pi nI}{10}$$

where n is the number of turns in the inductor per unit of its length. This is the intensity of the magnetizing force or the number of lines per unit of area that exist at any point, and is represented by **H**.

PERMEABILITY.—Iron possesses the essential property for the formation of the lines of magnetic force; it is therefore desirable that soft iron cores be employed in induction coils to obtain the maximum effect of magnetization.

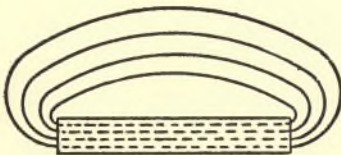

FIG. 82.—MAGNETIC LINES IN CORE.

The number of lines of force per square cm. in the core is represented by **B**. The flow of magnetic lines of force is concentrated in the iron core, as shown in Fig. 82. Since there is a very great difference in the degree to

which various substances are susceptible to magnetization, air has been taken as the standard or unit. The ratio of the magnetization produced to the magnetizing force is represented by μ , that is,

$$\mu = \frac{B}{H}$$

μ is called the permeability of the substance. Non-magnetic metals and insulators are considered to have practically the permeability

of air. Iron possesses a permeability 100 to 10,000 times greater than that of air. As the magnetization of the core increases, its permeability decreases so that a core may soon be completely saturated with magnetism and additional magnetizing force will have no further effect. In soft iron the limit of magnetic saturation is about 60,000 lines of force per square cm. of cross-sectional area.

HYSTERESIS AND EDDY CURRENTS.—When the currents of an inductor are operated intermittently as by an interrupter of an induction coil there is a retardation or lagging of the magnetizing and demagnetizing effects in the iron core due to molecular stress; this is called hysteresis, and Ewing¹ has found that the permeability of an iron core is greater when the magnetizing force is decreasing than when it is increasing, and thus some work must be done, and this takes the form of heat; the curve, Fig. 83, indicates this difference.

MUTUAL INDUCTION.—The total induction developed in a secondary composed of a single turn of wire wound on a closed magnetic circuit, as shown in Fig. 84, is (see Lodge²) independent of

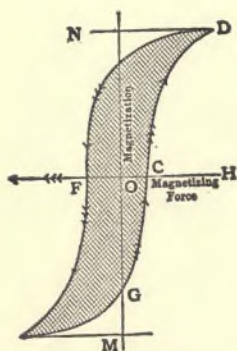

FIG. 83.—HYSTERESIS CURVE.

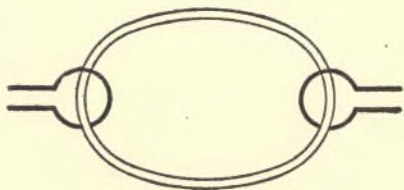

FIG. 84.—MUTUAL INDUCTION.

its size or form; if the secondary is wound with n' turns of wire the total induction is, of course, n' times this. The total induction Φ , or the number of lines of force cutting the secondary coil is equal to

$$\frac{4\pi\mu nn' AI}{10 l}$$

where μ is the permeability of the core, n' the number of turns of wire in the primary, A the area of the cross-section of the primary

¹Ewing, On the Magnetization of Iron in Strong Fields. *Proceedings Royal Society*, March 24, 1887.

²Lodge's *Modern Views of Electricity*, Page 389.

in square centimeters, I the current in amperes, and l the length of the primary coil in centimeters. This formula indicates that the induction is mutually reactive, and may be simply expressed by $\frac{MI}{10}$, the mutual induction between the primary and secondary coils being represented by M , or

$$M = \frac{4\pi\mu nn'A}{l}$$

When an alternating or interrupted current flows in the primary an e. m. f. is produced in the secondary proportional to the rate at which the lines link with it from the primary thus,

$$e = \frac{d\phi}{dt},$$

and the potential e of the induced current in the secondary coil depends on two factors, namely, the number of turns of wire in the secondary and the rate of alternation or interruption, of the current in the primary, or,

$$e = \frac{d\phi}{dt} = M \frac{dI}{dt} = \frac{4\pi nn'A}{10l} \frac{dI}{dt}.$$

These are the fundamental principles underlying the construction of transformers, and it is evident that as high a potential as desired may be obtained by increasing the number of turns of wire on the secondary.

FUNCTION OF THE CONDENSER.—The differentiating feature of induction coils from those termed transformers lies in the employment of an interrupted current and a condenser in shunt with the make and break device. The theory of induction coils having these additional factors is quite complicated, involving new and complex phenomena, which render the construction of coils from predetermined calculations exceedingly difficult, if not, indeed, impossible.

Fig. 85 shows diagrammatically an induction coil in which an interrupter is connected in series with the primary winding and a condenser in shunt with the interrupter; the inductance of the primary coil is represented by L_1 , the inductance of the secondary by L_2 , the e. m. f. by E , the capacity of the condenser around the make and break by C_1 . The object of the condenser is to produce a greater difference of potential at the terminals PP' by permitting the primary current to charge the condenser while the break is taking place at the interrupter X ; the more quickly the break

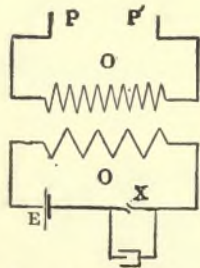

FIG. 85.—THE INDUCTION COIL.

takes place the smaller the capacity of the condenser C may be. Lord Rayleigh has shown¹ that if the primary circuit is severed by a pistol-shot, the conditions approach very closely the ideal break, i.e., absolute instantaneousness, and when this ideal point is reached the condenser may be eliminated entirely, as there is no time for the potential of the primary to rise to a value where it produces an abnormal spark, in which case the current, instead of being broken, is still conducted across the gap by the rarefaction of the air due to the heating effect of the spark itself. When these conditions prevail the current is prevented from dropping from its maximum to its minimum value in the shortest possible time and the potential difference in the secondary coil is likewise diminished.

In all interrupters the period required to effect the break is exceedingly large, compared with zero, whether they are of the vibrating, turbine or electrolytic type and a condenser of the proper proportions is a necessity. Dr. James E. Ives has shown² that when the primary circuit is thus slowly broken the current in the

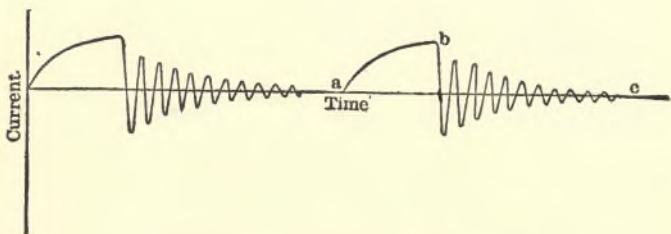

FIG. 86.—OSCILLATING CURRENT DISCHARGE.

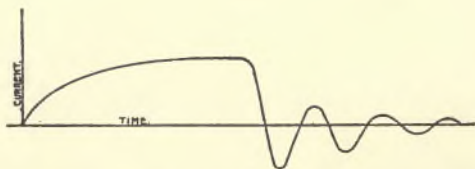

FIG. 87.—CONDENSER DISCHARGE IN THE PRIMARY CIRCUIT.

primary becomes alternating, as indicated in the curve, Fig. 86, as a resultant alternating current action of the condenser. Fig. 87 is the discharge curve of a direct current through the primary circuit followed by the oscillatory discharge of the condenser; the period of

¹*Philosophical Magazine*, Vol. II., 1901, page 581.

²Ives, *Physical Review*, vol. 15, 1902.

alternation of the current in the primary circuit may be ascertained by the formula,

$$T_1 = 2\pi\sqrt{L_1C_1}$$

The capacity should be reduced to as small a value as will prevent excessive sparking; if a greater capacity is employed than is needed to fulfill this requirement the secondary spark will be diminished and its efficiency decreased instead of increased. The *optimum capacity*, as Johnson has termed the capacity giving the longest spark, depends chiefly on the inductance and resistance of the primary coil. The potential difference of the secondary coil depends on the mutual inductance of the primary and secondary coils and the relative values of capacities of the primary and secondary coils; the primary capacity is the capacity of the condenser, and the secondary has a distributed capacity resulting from the turns of wire wound closely together.

Now let V_2 equal the potential of the secondary I_0 , the initial primary current, M the mutual inductance of the primary and secondary, C_2 the distributed capacity of the secondary, L_1 the inductance of the primary coil, L_2 the inductance of the secondary coil, and C_1 the capacity of the condenser, then the potential at the terminals of the secondary may be found by the equation

$$V_2 = \frac{I_0 M}{L_2 C_2 - L_1 C_1} \left(\sqrt{L_2 C_2} \sin \frac{t}{\sqrt{L_2 C_2}} - \sqrt{L_1 C_1} \sin \frac{t}{\sqrt{L_1 C_1}} \right).$$

In this equation the damping factor due to the resistance of the coils is neglected. In the primary, as well as in the secondary coil, oscillating currents are set up, having a period in the primary given by

$$T_1 = 2\pi\sqrt{L_1 C_1},$$

and in the secondary by

$$T_2 = 2\pi\sqrt{L_2 C_2}.$$

The distributed capacity of the secondary is so small that it may be neglected. The expression for the secondary potential then becomes

$$V_2 = \frac{I_0 M}{\sqrt{L_1 C_1}} \sin \frac{t}{\sqrt{L_1 C_1}}$$

Again, in properly constructed coils practically all the magnetic lines of force of the primary cut the secondary when the primary circuit is interrupted and

$$M = \sqrt{L_1 L_2}$$

and the equation reduces to

$$V_2 = I_0 \sqrt{\frac{L_2}{C_1}} \sin \frac{t}{\sqrt{L_1 C_1}}$$

which is the difference of potential at the terminals of the secondary; it is this factor upon which the length of the disruptive discharge depends. Its maximum value is given by

$$V_2 \text{ max} = I_0 \sqrt{\frac{L_2}{C_1}}$$

It is obvious, therefore, that the maximum potential difference of the secondary is the resultant of (a) the value of the current in the primary before interruption, (b) the inductance of the secondary coil, and (c) the capacity of the condenser. The potential difference of the secondary varies directly as the initial primary current, as the square root of the inductance of the secondary and as the square root of the reciprocal of the primary capacity. In order to ascertain the maximum difference of potential of a coil of any size it is only necessary to know the initial primary current I_0 , the inductance of the secondary coil L_2 , and the capacity of the condenser around the break C_1 , as indicated by the formula last given.

Klingelfuss has deduced the following laws, which hold for coils of all sizes up to 100 cm. spark-length¹: (a) the length of the disruptive discharge is directly proportional to the number of turns of wire on the secondary coil; (b) the e. m. f. induced in the primary is proportional to the primary current; and (c) the e. m. f. induced in the secondary is likewise proportional to the primary current. In coils having iron cores the permeability and

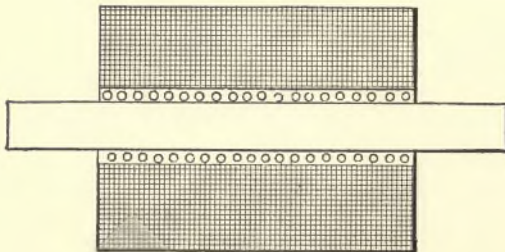

FIG. 88.—STRAIGHT CORE COIL.

consequently the inductance vary with the strength of the current; the inductance may be determined by ascertaining its value with a small current and then with a large current, and taking the mean

¹Annalen der Physik, 5: p. 837, 1901.

value as the normal. Coils of various forms have been experimented with, but those shown in Figs. 88 and 89 have been found

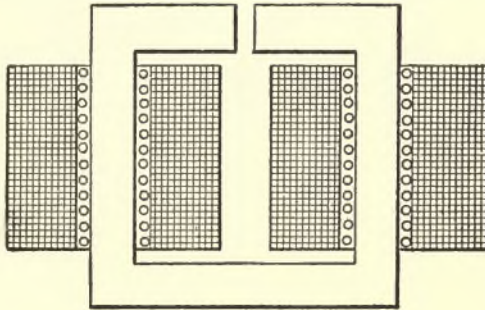

FIG. 89.—HORSESHOE TYPE OF COIL.

to be the most efficient. Klingelfuss in testing the relative values of varying number of turns of wire on the secondary coil obtained the curves shown in Fig. 90; I is the curve obtained with the horseshoe

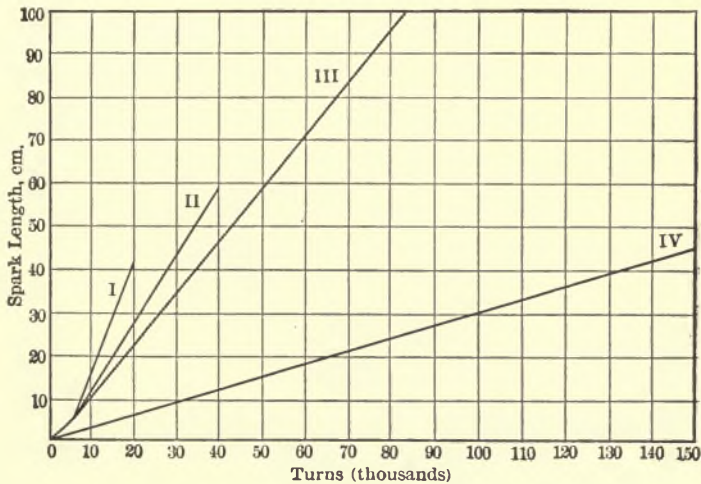

FIG. 90.—EFFECT OF VARYING SECONDARY TURNS.

type of coil; II the results for a straight coil with a core of large cross-section; curve III was obtained with a straight coil having a core with a square cross-section, and IV by a large coil giving a 45 cm. spark. From these curves plotted by Klingelfuss it appears that the horseshoe type of coil is the most efficient, but is not

practicable for high potentials, as the sparks take place across the air-gap of the magnet.

The curves, Fig. 91, are due to Ives, and show that when the iron in the core is increased the potential of the secondary rises very

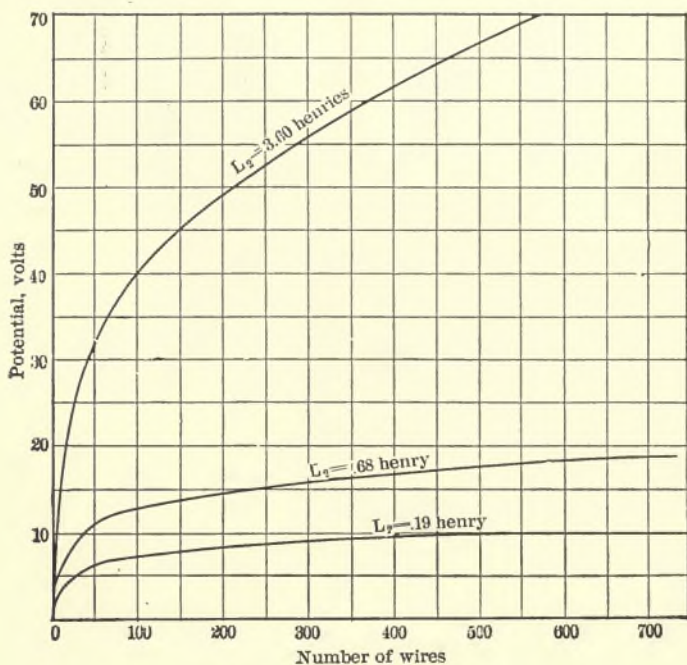

FIG. 91.—EFFECT OF IRON IN CORE.

rapidly at first and more slowly afterward. The curves, Fig. 92, showing the effect of varying the capacity around the break, are by Mizuno, and demonstrate graphically the value of increasing the capacity of the condenser to the critical point of optimum capacity, when the disruptive discharge is of maximum length, and that any increase of capacity above this value tends to decrease the spark-length. The phenomenon of distributed capacity of the secondary coil is difficult of elucidation, as well as the law of the break of the primary current, but while these and other obscure factors are yet without the pale of mathematics, the theory of the induction coil with all its complexities are fairly well evolved, and from the foregoing formulæ and equations the determination of the elements

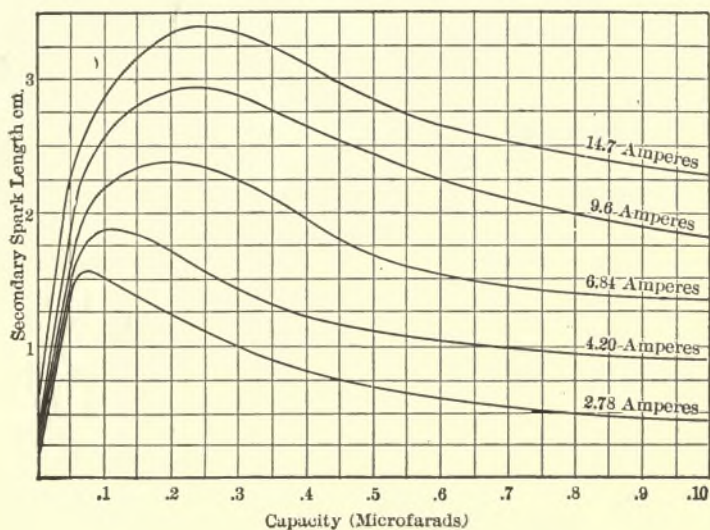

FIG. 92.—EFFECT OF CAPACITY AROUND BREAK.

and constants of induction coils may be obtained with a reasonable degree of accuracy.



CHAPTER IX.

INDUCTION COILS.

HISTORICAL.

While Faraday's ring is the prototype of the modern induction coil, the development of the latter seems to have been more directly due to Henry's flat spirals. Sturgeon made some experiments with coils with and without iron cores in 1836, and in the same year an important advance was made by Prof. S. S. Page, of Washington, when he interrupted the battery circuit by a rapidly revolving spur wheel,¹ and later made and broke the circuit by drawing one end of the battery wire over a file. The primary and secondary coils of Henry and Page were made continuous, that is, a thick wire was first wound into a helix, and then soldered to one terminal of this was a long thin secondary. Callan, in 1836, describes the construction of his coil as being made of two separate insulated wires, one thick and the other thin, wound on an iron core together, but the peculiar construction lies in the fact that the secondary or thin wire was joined to the end of the thick wire, so that they formed one circuit, as in the case of Henry and Page. Callan also devised an "electro-magnetic repeater," or "vibrating contact breaker," for interrupting the circuit. Sturgeon, the inventor of the electro-magnet, investigated the influence of electrical currents on soft iron as regards the thickness of the metal requisite for the full display of magnetic action. Sturgeon applied to his coil a make and break arrangement consisting of a wire dipping into a cup of mercury and operated by a revolving cam and lever producing 36 breaks per second; this he subsequently changed for a disk and obtained 540 breaks per second; he then placed a solid iron core in the coil and obtained powerful shocks. After some trials he substituted a bundle of fine iron wires for the solid core and obtained much better results. Bachhoffer also noted the

¹Silliman's American Journal of Science, October, 1836.

same conditions. Sturgeon's coil was an advance over those made at that time, and the general form he gave it has been retained to the present day.

Callan, in a paper dated September 11, 1837, and printed in Sturgeon's *Annals of Electricity*, says: "In making electro-magnets (coils) which are to be connected for the purpose of obtaining increased electric intensity care must be taken *not to solder* the thin to the thick wire, but to leave both ends of the wire projecting." In a note he recommends that for lecture purposes the thick wire and the thin wire should be wound on separate spools, so to Callan we owe, not only this form, but an induction coil having a primary of thick wire and a secondary of fine wire. In this year Barker designed a make and break device in the form of a star arranged so that the projections dipped into a vessel of mercury, and this has ever since retained the name of Barker's wheel. About this time Bachhoffer states that he applied to his coil a self-acting contact-breaker, and this is the earliest reference to an automatic interrupter. Callan advanced the idea of connecting the secondary circuits of a number of coils in parallel and Fleming credits him with the knowledge at that date of adding up the electro-motive forces of a number of distinct coils.¹ In a paper of 1837 Callan contributed another great improvement in the method of constructing induction coils; this consisted of increasing the insulation of the secondary by drawing the wire just prior to winding through a hot bath of melted resin and beeswax, which mode is still in use. To Poggendorf we are indebted for the invaluable suggestion of winding a large number of thin flat coils, after insulating them, so that there could be no great difference of potential between the immediate coils, and then connecting them in series.

Callan constructed one of the largest coils, up to the advent of wireless telegraphy, ever built. It was completed in 1863 and gave a spark of 15 inches in length. It is still preserved in Maynooth College, England. In 1837 Page invented his rocking-magnet interruptor. By many he is credited with the discovery of the divided coil. In 1838 he constructed a most efficient coil operated by an automatic make and break formed of a vibrating spring dipping in a cup of mercury. He noted the untoward effect of the spark at the point of break, due to the continued passage of the current

¹ Fleming's *Alternate Current Transformer*, Vol. II.

caused by the mercury vapor, and remedied this by flowing the surface of the mercury with oil. Page was likewise the first physicist to show that the secondary discharge of an induction coil was similar in every respect to a static discharge, and that electrostatic tensions could be obtained, Leyden jars charged, the leaves of an electroscope diverged and many other phenomena produced heretofore observed only with electrostatic machines. Page also noted that the spark could be lengthened by heating the air between the oscillator balls, and obtained a spark $4\frac{1}{2}$ inches in length with a discharge giving normally a maximum spark of $\frac{1}{4}$ inch in the air. He observed also the phenomenon that the spark of a primary circuit, when broken, was extinguished by introducing the terminals between the poles of a powerful magnet when the spark was blown out with a loud report.

Wagner and Neef improved upon Page's mercurial break in 1840 by designing the now familiar vibrating armature with platinum contacts. With this invention the induction coil was practically completed with the exception of the condenser. In 1851 Ruhmkorff greatly improved the efficiency of the coils by carefully insulating the secondary from the primary by means of a glass tube and with glass disks at either end to hold the wire in place. He provided also the commutator for reversing the current, and together with his improvements of the vibrating interruptor he became famous as a maker of induction coils, and to-day his name stands as a symbol for high-tension coils. The last important and one of the greatest improvements was made by Fizeau¹ by the addition of the condenser. Ruhmkorff at once took up the work and designed condensers especially adapted for the purpose and made them with carefully proportioned dimensions. Ruhmkorff made his condensers of oiled silk or paper with intervening leaves of tinfoil. The condenser thus formed was placed in the base of the coils and the opposite terminals connected to the opposite posts of the interruptor. In 1867 Ruhmkorff constructed his *chef-d'œuvre*, a coil giving sparks 40 cm. in length. M. Jean, an amateur coil builder, devised a method for securing better insulation in 1854. This consisted in immersing the whole coil in a liquid insulator such as oil or turpentine. He also baked and dried the coil to eliminate any remaining moisture previous to immersion and performed the whole process in a vacuum, thus avoiding contact with the air in

¹*Comptes Rendus*, 1853, Fizeau.

the transfer of the coil to the oil. Taking advantage of all these improvements in the building of coils, Alfred Apps, a London maker, constructed the famous Spottiswoode coil¹ giving a spark 42 inches in length.

PRACTICAL.

In the construction of induction coils for practical wireless telegraphy a heavy and continuous secondary discharge is of prime importance. Induction coils for this class of work should be constructed upon lines somewhat different from those usually followed in ordinary coils, that is to say, they need not be wound to obtain excessively high potentials, and the secondary coil should exercise but a slight reaction on the magnetic lines of force, thus offering but little opposing influence to the primary current.

To obtain these desirable features the inductor or primary coil is made quite long and the secondary coil is proportionately shorter and is wound with wire having a much larger cross-section than an ordinary coil, thereby decreasing the losses by ohmic resistance to a minimum, since every turn of wire not absolutely required to obtain potential adds to the total resistance; the use of wire of large cross-section also reduces to a minimum the heating due to alternating secondary currents. The secondary coil should be doubly insulated, thus strengthening the weakest points of the induction coil and rendering its disruption under the heavy demands of commercial wireless telegraph practice practically impossible.

CORES.—The core of an induction coil should be made of carefully annealed Swedish soft iron wires, preferably of No. 18, 20, or 22 B. & S. gauge, cut into suitable lengths and bound into a compact bundle. It has been found that by increasing the diameter of the core in proportion to its length a greater frequency of interruption is possible, which is a great advantage when an electrolytic interruptor is employed in connection with it, since the **BH** curves are described with little retardation even when the frequency of interruption reaches a value of 10,000 per minute; this is due to the decrease of resistance offered by a coil of large cross-section to the flow of the magnetic lines of force through it. This magnetic reluctance,

¹*Philosophical Magazine*, January, 1887, p. 30.

as it is termed, is the divisor where the magneto-motive force is the dividend, and the quotient is the magnetic flux, or it may be expressed thus:

$$\frac{\text{The magnetic flux}}{\text{The reluctance.}} = \text{Magneto-motive force.}$$

The core of the coil should be long and extend from two to six or eight inches beyond the secondary; by this arrangement the number of lines of magnetic force cutting a turn of the secondary is greater at the middle than at the ends, and therefore less wire may be employed in the secondary.¹

PRIMARY COILS.—In large coils the inductance between the local turns of wire is the cause of excessive sparking at the interruptor. To overcome this objectionable feature, the primary coil is made up of a number of turns of small wires, the multiple winding is equal in conductivity to a single wire of large diameter. This gives better results in virtue of a closer winding of the wire on the core. The inductor or primary coil gives the best inductive effects when wound in two layers on the coil. Double-covered cotton or silk magnet wire may be used, and the size depends on the length of the sparks and the kind of discharge desired. In wireless telegraphy where thick discharges are required a correspondingly heavy current must flow through the inductor, and thus a wire of large cross-section should be used. The strength of the disruptive discharge is subject very largely to the degree of magnetization of the coil, and this, by the number of turns of wire on the inductor, providing they are in close proximity to the coils, in virtue of the law of ampere turns, which, simply stated, is that a current flowing through a number of turns of wire is equal to the number of amperes flowing through a single turn multiplied by the number of turns of wire.

In the construction of inductors it is desirable to minimize the inductance of the turns, since the effect of this local self-induction is to produce a retardation of the primary current, therefore wire of large cross-section is employed together with a double layer of wire; if the wire is too large difficulty may be expected in the nature of excessive sparking at the interruptor. For wireless tele-

¹*Physical Review* Ives Vol. XIV., 1902

graph transmitters, makers of coils have found the following sizes of wire suitable for the inductors:

Size of coils in spark length	No. of wire, B & S Gauge
1/2 inch to 1 inch.....	No. 16
1 inch to 2 inches.....	No. 15
2 inches to 4 inches.....	No. 14
4 inches to 8 inches.....	No. 13
8 inches to 12 inches.....	No. 12

The inductor should be wound to occupy nearly the entire length of the coil, and then treated to a coat of insulation.

SECONDARY COILS.—To obtain a heavy and rapid disruptive discharge the secondary coil should be wound with wire having at least fifty per cent. greater cross-section than in ordinary types of induction coils found in the open market, yet the number of turns of wire should remain the same, and to increase the output of a coil thus constructed so that it will give its maximum efficiency the secondary coil should be wound with the least number of turns of wire possible and yet be capable of producing a given length of spark, since every additional turn of wire not absolutely necessary increases its resistance and decreases the amperage of the secondary current without proportionately increasing the length of the spark. Coils for wireless telegraphy are, in consequence, larger than the usual types; but this feature is compensated for in virtue of its giving heavy, white and powerful discharges which are capable of setting up in the radiator system oscillatory currents of great power.

In order to obtain the proper distribution of wire in the secondary the best method is to ascertain the spark length of single coils made of a few turns of wire and placed at intervals along the core and in the magnetic field of the inductor; curves may then be plotted which will give fairly accurate determinations of the proper amount and distribution of wire. The secondaries of induction coils giving 2 inch sparks and under may be wound of continuous wire, layer upon layer, until the proper amount of wire per given spark-length is used; the cheaper coils to be found in the market are built up in this manner. But for effective work in wireless teleg-

raphy the winding of the secondary must be composed of sectional disks. In coils of 1 inch spark-length two or more sections may be employed, and these sections should decrease in thickness, increase in diameter and be added to in number as the size of the coil increases. Sectional disks $\frac{1}{8}$ inch in thickness are the most suitable for coils giving sparks 12 to 18 inches in length.

In winding these sections the wire is drawn through a melted insulating compound composed of three parts of resin and one part of beeswax; the silk insulated magnet wire, with this additional insulating medium still hot upon it, is reeled into a thin flat coil between two brass disks having planed surfaces and carefully adjusted so that each surface shall have the same thickness and approximately the same amount of wire on it. The sectional disks

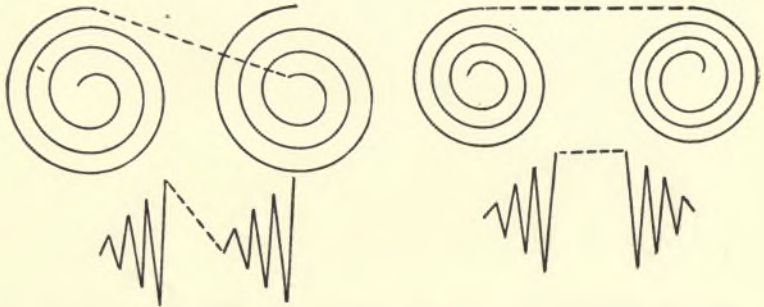

FIG. 93.—CONNECTING DISKS OF SECONDARY.

FIG. 94.—CONNECTING TERMINALS OF SECONDARY DISKS.

are then dried and partially assembled when they are connected in series, as shown in Fig. 93, where the outer terminal of one section is connected with the inner terminal of the next one. A more recent practice is to connect the outer terminals of the first two sections together and then the inner terminals of the next two, as shown in Fig. 94; in the case illustrated in Fig. 93 the terminal of one coil is brought down between the sections in order to make connection with the inner terminal of the next section to it, and this has a tendency to produce short-circuiting and sparking between the individual sections. This is obviated in the latter method, the current flowing in the same direction through all of the sectional disks.

Some makers of induction coils increase the number of turns of wire in the sections which are to occupy the middle of the core, so that it will be much larger and the amount of wire much

greater than at the ends,¹ as shown in Fig. 95. This arrangement brings the greatest number of turns in a position where the magnetic field is at its maximum value. In ordinary induction coils where a long, thin disruptive discharge is desired, the secondary coil is wound with No. 36 to 40 B. & S. magnet wire, but in wireless telegraphy where a heavy spark is essential No. 30 to 34 wire is used. The amount of wire per inch spark for coils up to 6 inches of No. 34 wire is approximately $1\frac{1}{2}$ pounds; for coils larger than 6 inches it is about a pound.

INSULATION.—Where heavy disruptive discharges are required, the insulation of the secondary coil must be carefully considered. It is of prime importance that all the air is removed from the spaces between the turns of wire in the sectional disks and from

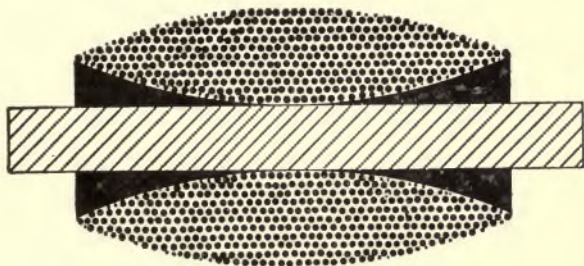

FIG. 95.—CONVEX SECONDARY WINDING.

the interspaces between the sections themselves after assembling. These minute air bubbles weaken a coil and diminish its efficiency, and may in time cause its total disruption, due to electrostatic bombardment of rapidly alternating currents at high potential which develop heat.

To prevent these untoward effects, manufacturers construct what is termed a vacuum secondary; the sectionally wound disks are dried before removal from the winding machine, and after being assembled they are immersed in a melted insulating compound of resin and beeswax; the air is then thoroughly exhausted; when removed the coil is inclosed in a solid mass of air and moisture-proof insulation. Oil is of course the ideal insulation, but it adds bulk to the coil, and there is always danger of leakage, while the process described gives excellent satisfaction and has been adopted by all the leading manufacturers.

¹Electricity: Its Theory, Sources and Application. Sprague.

ASSEMBLY OF PARTS.—After the coil is properly mounted an interrupter and a condenser are necessary adjuncts to complete the equipment. The interrupter should be constructed to operate smoothly and uniformly without regard to the variability of the disruptive discharge while in action. The condenser should be adjustable so that sparking of the interrupter contacts may be reduced to a minimum in accordance with the laws of capacity and inductance already elucidated. Interlocking switches are now placed on large coils, which prevent short circuits, etc. By their use it is impossible for the current to flow through the primary until the interrupter is in operation.

SOURCES OF ELECTRO-MOTIVE FORCE.—Induction coils may be operated by primary cells, storage batteries, or by a direct 110-volt current. In wireless telegraph practice it is preferable to operate coils from 110-volt circuits where practicable, as the increased energy gives a heavier discharge, and therefore more powerful oscillations are set up in the radiator. Where primary batteries are employed a large excess current must be provided, or the discharge will be enfeebled and the coil, whatever its make and rating, will be inefficient. It is not advisable to operate coils on 220-volt circuits, since the reaction on the primary is dangerous alike to the coil and the operator. Where a 220-volt direct current is available a small motor-generator may be installed; that is to say, a direct current motor operating on a 220-volt circuit may be directly connected to a 110-volt dynamo, which supplies energy to the coil, or a motor-generator answering the same purpose may be used. A motor with two windings on its armature, one to take the current at 220 or 500 volts and the other to generate a current of 15 amperes at 20 volts, may also be used. An alternating current cannot be employed directly to operate an induction coil, for the reason that the rate of alternation of the current has a time constant too high to give efficient disruptive discharges without heating the coil. Alternating currents may be used, however, by utilizing in the circuit a Caldwell liquid interrupter or designing the induction coil so that a Grisson converter may be introduced.

SELECTION AND CARE OF A COIL.—In ordering induction coils for wireless telegraphy there are a number of factors to be taken into consideration. Coils are rated by the length of spark they give, and the heavier the discharge the whiter the spark appears. The rating of an induction coil should be made when the coil is operated

normally, and not by the mere length of a single discharge. A coil working with a current of 15 amperes at 20 volts = 300 watts should completely fill a spark-gap one inch long between terminals made of $\frac{1}{2}$ -inch disks. It is often convenient to know the polarity of the secondary discharge. This may be easily ascertained, since the positive terminal is always cold, whilst the negative terminal is hot when the coil is in action. If a Geissler tube is attached to the terminals the positive glows with a purplish red light and the negative with a bluish violet light.

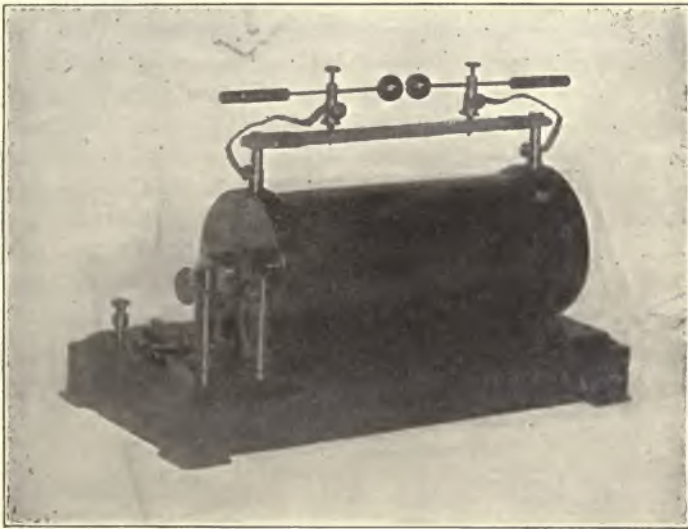

FIG. 96.—ORDINARY INDUCTION COIL.

The proper care must be taken of an induction coil to get the best results, and unless handled with the consideration usually bestowed on other fine mechanical or electrical appliances the results will not be satisfactory. The interruptor should be kept clean and the surfaces of the platinum contacts smooth and parallel with each other; when an adjustable condenser is employed care must be exercised to obtain the proper capacity. If too large or too small a capacity is used the performance of the interruptor will be rendered variable, and excessive sparking will result. One of the most common causes of failure in the operation of coils is, however, directly due to insufficient current; if batteries are utilized as the

source of current it is of vital importance that there should be a very large excess, for effective discharges are only obtained by currents of large amperage.

TYPES OF INDUCTION COILS.—In Fig. 96 is shown a 2" induction coil the secondary of which is formed by winding a continuous wire in several layers around the primary. The layers are insulated from each other by paraffine paper. Coils constructed on this simple plan are made in sizes giving from $\frac{1}{4}$ " spark to a 2" spark. These coils

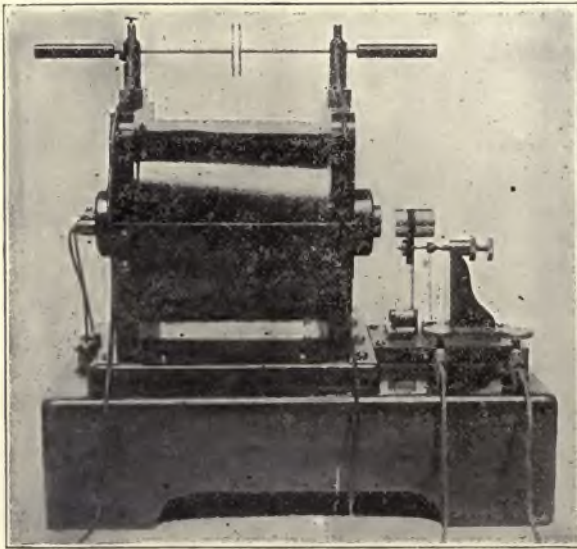

FIG. 97.—MODERN INDUCTION COIL.

are equipped with single vibrating spring interruptors and paper condensers; they give quite satisfactory results for experimental work provided they are carefully handled. By way of comparison, Fig. 97, illustrating a 2" coil of modern design, is given; in this the secondary is built up of disks and insulated with wax and rosin. The interruptor is of the double spring vibrating type and the break is shunted with a mica condenser.

A ten-inch coil built by Foote, Pierson & Co., is shown in Fig. 98. This is equipped with all the latest modern improvements, insuring successful operation under strenuous conditions; it includes

an independent multiple interruptor, interlocking switch, safety-fuse block, adjustable mica condenser, special switches, posts for electrolytic interruptors and a series parallel arrangement of the inductor. Fig. 99 pictures the exterior appearance of the coil used in the Lodge-Muirhead system, the construction of which is similar to that indicated in the preceding portions of this chapter.

The Kinraide coil consists of two separate secondaries with their primaries connected in series. Each secondary has a high and

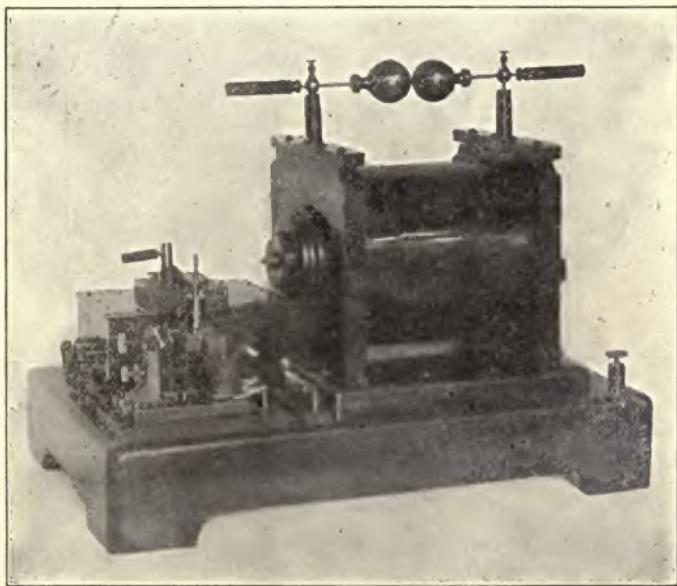

FIG. 98.—FOOTE-PIERSON DELTA COIL.

low potential terminal resulting from the position and method of winding the inductors. The primary of each side is wound outside the secondary winding. The object of this is to overcome the tendency of the secondary to discharge into the primary coil. Fig. 100 represents the coil photographically. The Braun-Siemens and Halske coil, Fig. 101, follows the specifications given for properly designed coils for heavy service, the secondary being wound with wire having 50 per cent. greater cross section, with double the insulation of ordinary coils. The physical characteristics of the Slaby-Arco coils are practically the same as those of the Braun type. In

Fig. 102 a reproduction of a coil designed by Fessenden is given. It will be observed that the core and primary extends on either side

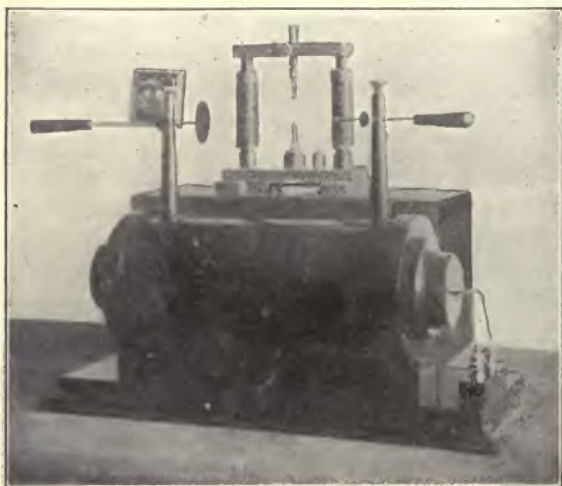

FIG. 99.—LODGE-MUIRHEAD COIL.

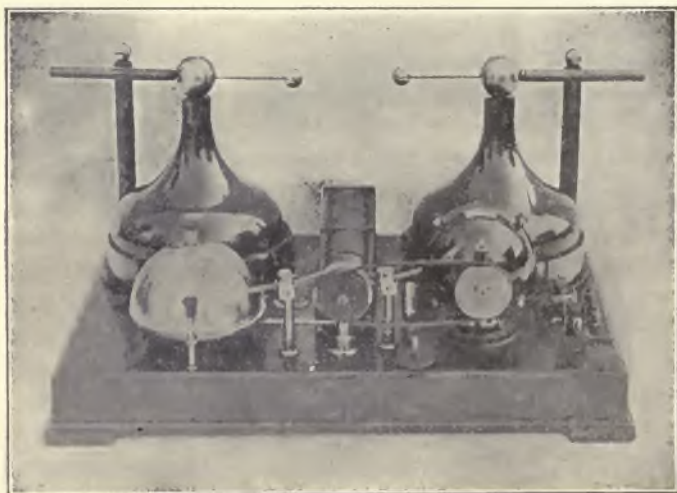

FIG. 100.—THE KINRAIDE COIL.

of the secondary to a distance several times the length of the latter. It has been shown by experiment that additional secondary coils

near the ends of the core enhanced to a very small extent the output of the current of the secondary.

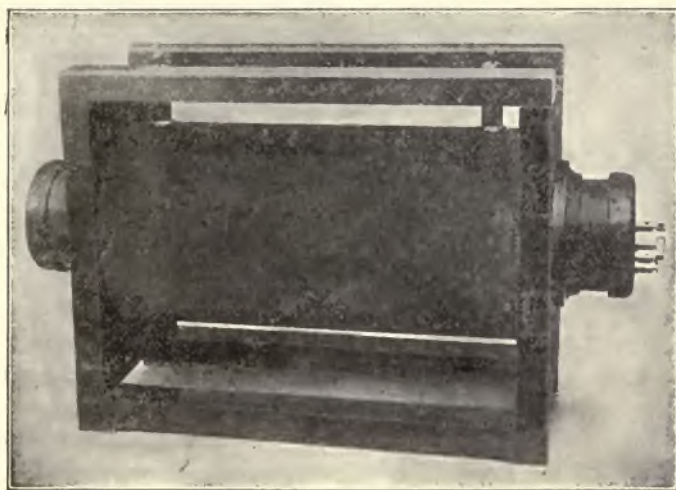

FIG. 101.—BRAUN-SIEMENS AND HALSKE COIL.

The largest induction coils ever made for wireless telegraphy are shown in Fig. 103. Two of these immense coils were built by

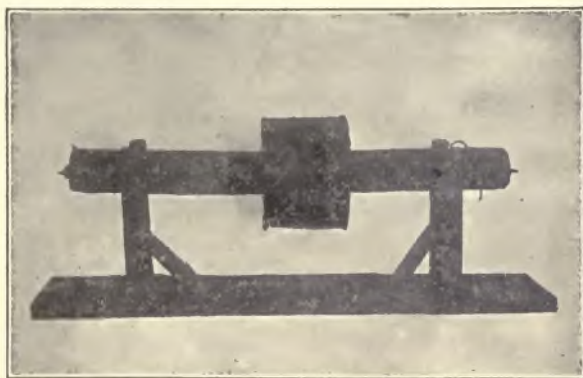

FIG. 102.—FESSENDEN LONG CORE COIL.

Queen & Co., for the Japanese Government. The core of the inductor is formed of iron wires, making a bundle measuring 5 inches in diameter, having a length of four feet and weighing 200 pounds.

This core projects 12 inches beyond either end of the secondary, the latter being divided into two parts, built up of sectional disks and containing 100 miles of fine and carefully insulated magnet wire; when completed the outside of the coils measured 15 inches. The interruptor is driven by an electric motor, actuating heavy pieces of

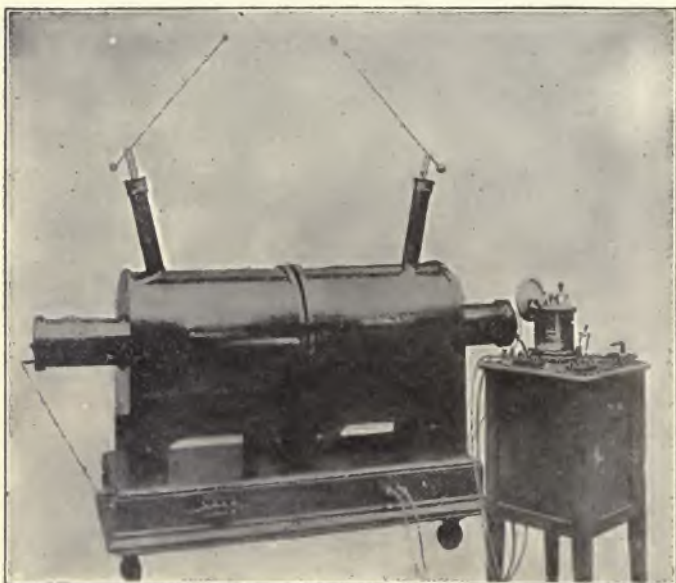

FIG. 103.—QUEEN METER SPARK COIL.

platinum which breaks under oil, while a variable mica condenser is provided to cut down any undue sparking. Either a 110 volt d. c. may be used, or a 25 volt, 20 ampere current from a storage battery when a maximum spark of 42 inches in length or an exceedingly heavy disruptive discharge may be obtained.

CHAPTER X.

INTERRUPTORS.

PRACTICAL.

The evolution of the modern high-class induction coil has called forth much effort and ingenuity in providing a simple method for making and breaking the primary circuit with precision and rapid-



FIG. 164.—SIMPLE VIBRATING INTERRUPTOR.

ity. The requirements of a good interruptor are (1) a break approaching as nearly as possible the ideal, i.e., absolute instantaneousness, (2) high-speed interruptions, (3) arbitrary variability of frequency of make and break at will of the operator, (4) independence of action of the current flowing through the inductor, and (5) capability of carrying large currents. Of interruptors there are four general classes, (a) mechanical vibrating, (b) mechanical

rotating, (c) mercurial turbine, and (d) electrolytic. As to the best type of interruptor there is a wide difference of opinion even among experts, but the mechanical vibrating is the simplest type, easy to keep clean and in adjustment, and therefore extremely suitable for all ordinary classes of work. Where the highest efficiency is desired, as in wireless telegraphy, the mercury turbine or electrolytic types are especially serviceable, and since trained

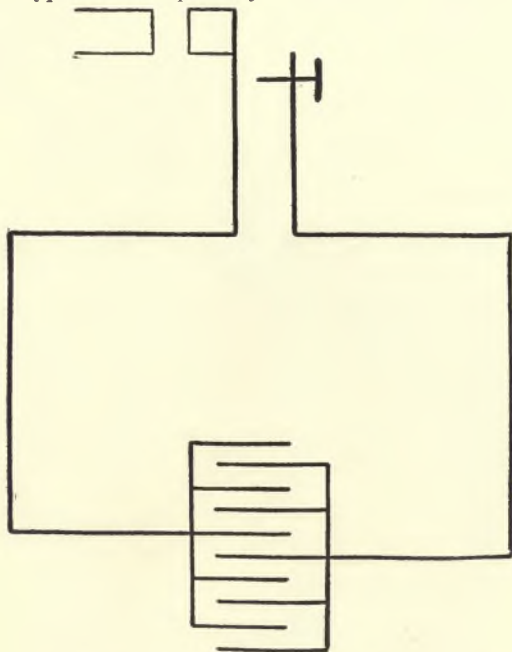

FIG. 105.—CONDENSER SHUNTED AROUND BREAK.

operators are in charge, the care and manipulation of these more complex devices become a secondary consideration.

SIMPLE VIBRATING INTERRUPTOR.—In this type of interruptor the make and break is accomplished by means of a vibrating spring, one end of which is held stationary, while its free end carries an armature magnetically operated by the core of the coil, as shown in Fig. 104. This vibrator is connected in series with the primary coil and the battery, and is so arranged that when no current is flowing through the circuit the spring carrying a movable contact point closes the circuit through a stationary contact point; when the current is permitted to flow through the circuit the core of

the coil is magnetized and attracts the armature, causing the circuit to be broken when the elasticity of the spring pulls the points into contact, closing the circuit again. A condenser is shunted around the break, as per diagram, Fig. 105. This type, known as the Neff hammer interruptor, has been employed on large coils—up to 10 and 12-inch—but is not a very satisfactory device for withstanding the heavy strains to which it is subjected in wireless telegraphy, although it is employed extensively by English makers and was used by Marconi in many of his most successful tests.

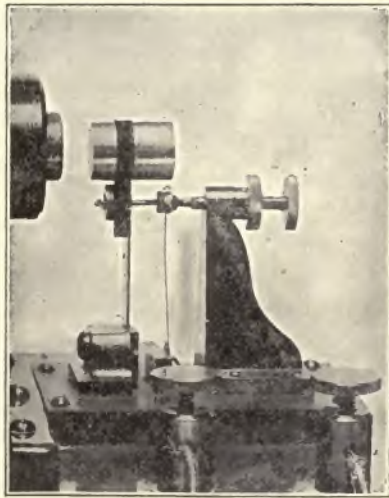

FIG. 106.—DOUBLE SPRING INTERRUPTOR.

This interruptor is almost universally used in coils up to 4 inches. Its periodicity of interruption is variable only through a very limited range of vibration, it has a tendency to stick when heavy currents are used, and its vibrations are sinusoidal, which affects the rate of discharge; oppositely disposed, its frequency is fairly high and may be determined by the musical note it emits. A high or low period of vibration can be arbitrarily given it by the maker by employing a thick, short spring when very rapid movements are desired, or a long, thin spring if a slower rate is necessary, thus obtaining the most suitable value of frequency for the operation of the coil, the range available being from 0 to 2,500 makes and breaks per minute.

DOUBLE-CONTACT INTERRUPTOR.—This is a modified form of the above vibrating type, but has a platinum contact on both sides of the spring, the make taking place as the amplitude of the spring reaches its maximum in both directions, the break as the elasticity of the spring moves toward 0. By this means the frequency of the interruption may be increased to 5,000 vibrations per minute. The greatest difficulty with this form is in its sticking propensities.

DOUBLE-SPRING INTERRUPTOR.—In all single-spring interruptors the movable contact point is secured directly to the spring

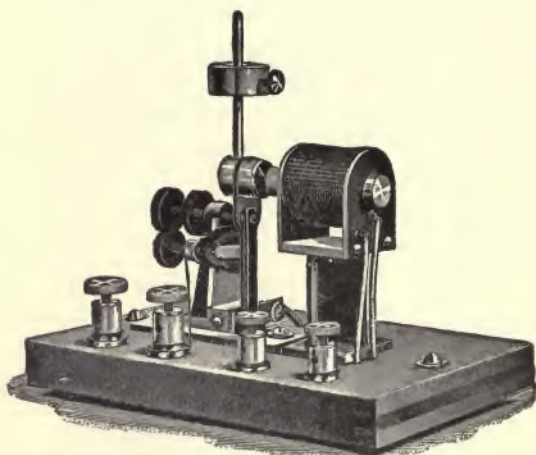

FIG. 107.—INDEPENDENT INTERRUPTOR.

midway between its stationary and its free end; where heavy currents are employed the platinum contacts very often stick, due to the fusing of the points, which on cooling become welded together, rendering the device inoperative. In the double-spring interruptor (Fig. 106) two springs are called into play, the small one carrying a movable platinum contact, projecting through a collar in the large one, which acts as the vibrator spring proper. When the platinum points come in contact with each other the large spring is not arrested in its action, but is carried forward until it reaches its full amplitude, thus giving the contact points the benefit of a long make; when the spring is returning it strikes the collar of the small spring and breaks the contact with all its acquired momentum at full speed.

This is a decided improvement on the simple-spring vibrator, since in the latter the break takes place at the instant the spring begins to move. In the double-spring interruptor the force is sufficient always to break the slight weld at the contact points.

INDEPENDENT INTERRUPTOR.—By the term independent it is to be inferred that this type of vibrator is a complete device in itself, although a subsidiary piece of apparatus of the induction coil. It usually embodies all the improvements of the double-spring interruptor, and, being operated on a shunt, it may be started or stopped at will and the current flowing through the inductor completely made or broken or intermittently interrupted—as the specifications

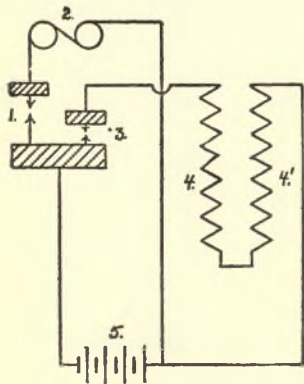

FIG. 108.—CONNECTIONS OF INDEPENDENT INTERRUPTOR.

of some wireless telegraph systems call for—as desired. Fig. 107 is a photograph of a standard independent interruptor, and Fig. 108 shows the connections where an independent vibrator, is employed; 1 represents the contacts for the short circuit; 2 the interruptor magnets; 3 the large contacts for the primary circuit; 4, 4' the primary coil in two layers and 5 the source of e. m. f. Independent interruptors are especially adapted to operate coils on 110-volt circuits. In the type shown a vertical rod is attached to the free end of the large

vibrating spring and carries a sliding weight retained in position by a set screw. By adjusting the weight the period of vibration may be varied within certain limits, offering a decided advantage in adjusting it to the requirements of wireless telegraph transmission. Other features of this interruptor are as follows: its action is independent of the heavy current flowing through the coil, it gives a clean-cut and sharp break, and it cannot stick. An adjustable condenser is very often mounted on the same base with the independent interruptor, and is an important feature where a variable speed takes place, since different periods of interruption require capacities of different value. The magnet of the interruptor should be especially wound for the current with which it is to be operated. The adjustable condensers usually have a total capacity of 4 or 5 microfarads subdivided into fifths, so that

a suitable value may be had for every condition which may arise in using it in connection with the smallest or the largest of coils.

Another improvement in this type of interruptor is to design it with two magnets arranged so that the armature and spring will just clear the inner surfaces of the polar projections of the magnets, as in Fig. 109. This gives the spring an unlimited play, so that its full amplitude may be called into action, making it very positive and powerful.

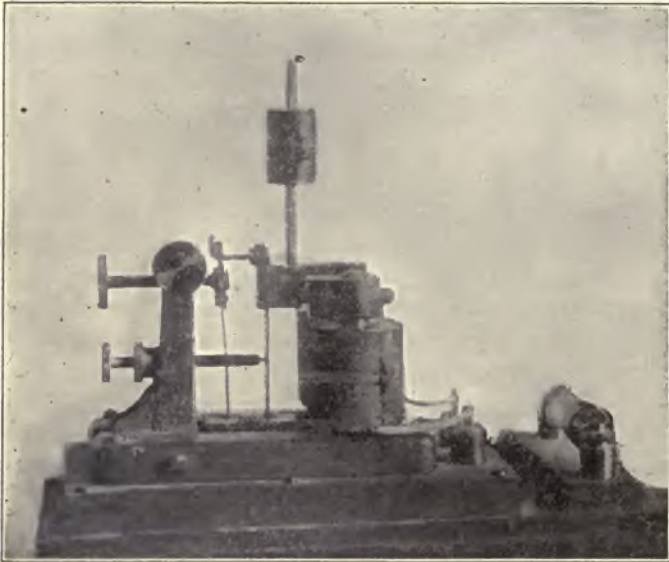

FIG. 109.—DOUBLE POLE INDEPENDENT INTERRUPTOR.

MECHANICAL RECIPROCATING INTERRUPTOR.—In testing the action of interruption on the coefficients of coils experimenters usually employ the simple and efficient method of plunging and removing, by hand, one of the terminals of the inductor into a vessel of mercury which is in circuit with the battery and primary coil. The fundamental feature of a mercurial make and break was utilized by M. Bichat in 1875, who adapted it to a reciprocating mechanism operated by a magnet, as in Fig. 110. It consists of an electro-magnet, *E*, with automatic interruptor, *B*, like a vibrating bell working on a shunt circuit. The armature carries the rod *L*, to which is fastened the contact point *T*. The mercury is represented

by the black space at the bottom of the vessel and is marked —, while the contact point forms the + terminal; the mercury is covered with vaseline to prevent sparking and oxidization.

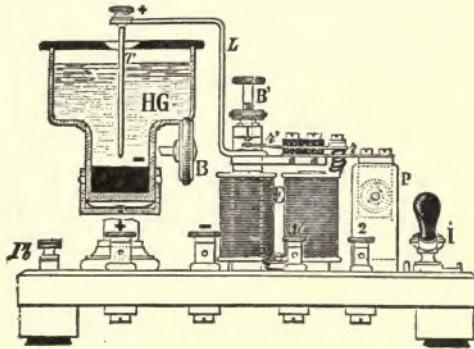

FIG. 110.

MECHANICAL ROTATING INTERRUPTOR.—The mercury type of interruptor designed by Bichat and the rotary type made by Du-

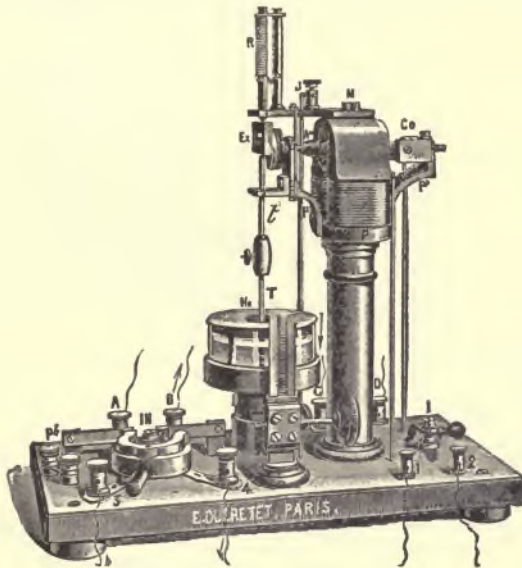

FIG. 111.—ROTATING INTERRUPTOR.

cretet are much used in France. In the latter device the reciprocating motion of the movable contact point is obtained by the ro-

tary action of an electric motor.¹ The motor, *P*, is mounted on an insulated standard. The shaft *Am* of the armature is provided with a cam, *Ex*, operating in a longitudinal slotted plate to which is attached the rod *t* and the collar, *T*, as in Fig. 111, in which the platinum contact point is adjusted; this point makes and breaks contact with mercury in the vessel here, as in Bichat's interruptor.

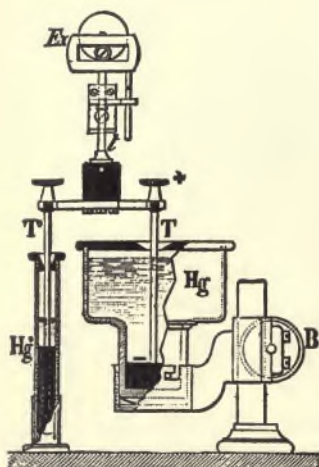

FIG. 112.—SCHEME OF ROTATING INTERRUPTOR.

Covering the mercury is a layer of petroleum or alcohol to prevent sparking. The interruptor has a periodicity of 600 to 800 per minute when operated by the motor. Fig. 112 is a diagram of the interruptor. An adjusting screw, *B*, serves to raise or lower the mercury, giving a longer or shorter period of make, as the case may require. The speed is governed by means of the rheostat, *R*, and its ease of manipulation, reliability, and sharp break make it a serviceable device where low-speed interruptions can be used to advantage.

MERCURY TURBINE INTERRUPTOR.

—The mechanical interruptors described are exceedingly easy to manipulate, require little attention, and are always ready for use, and for these reasons are generally supplied with induction coils for sale in the open market. In wireless telegraph practice better results are obtained with interruptors having a smaller time constant, and which therefore more nearly approach instantaneousness of break. The mercury turbine is a device of this character offering a range of interruption from 10 to 10,000 per minute, with the relative times of make and break under the control of the operator. The cut, Fig. 113, shows the mercury jet interruptor designed by Dr. R. H. Cunningham.² It consists essentially of a hollow spindle containing a steel worm, *P*, revolved by a motor not shown, but belted to it by a pulley at *S*. Mercury is contained in the well below, and when the spindle is rotated the mercury is drawn upward and forced outward through

¹*Comptes Rendus, Academy of Sciences, June 14, 1897.*

²*Electrical World and Engineer, October 12, 1901.*

the lava-tipped-steel tubes, *QQ*, by centrifugal force; the mercury as it is thrown out impinges with great force upon oppositely disposed sectors of sheet iron arranged in pairs, as shown at *I*; these sectors are connected to the terminals *HH*, the circuit being formed between the sectors through the mercury jets, *QQ*. The corners of the sectors are cut off at an angle, the breaks taking place as the impinging jet passes over the portions that are cut away. The

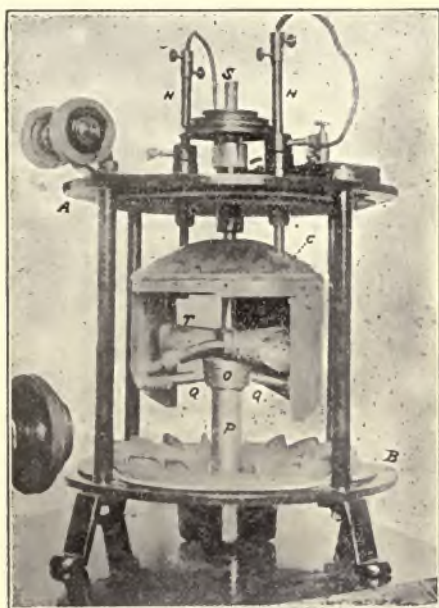

FIG. 113.—MERCURY TURBINE INTERRUPTOR.

terminal rods *HH* may be raised, or lowered, and the length of time required for the contact between the sector and the jet may be varied at will. In the mercury turbine two pairs of sectors are usually employed, which produce four breaks per revolution, but three or more pairs of sectors may be used and the number of breaks per second increased if desired.

The break in this type of interruptor is very sharp, owing to the centrifugal velocity of the jet of mercury as it leaves the edge of the sector, and in the Cunningham interruptor this is accentuated to a further degree by jets of compressed air attached to the mer-

cury jets *QQ*; the air is compressed by two trumpet-shaped pipes, *TT*, attached to the spindle *P*, and as they revolve at a high velocity an air-blast is forced out of their tips. After the mercury has been projected against the sectors it falls back into the cavity ready to be used again. The radial projections on the bottom of this well or cavity prevent the rotation of the mercury. It requires about six pounds of mercury to charge the turbine, and after it has been in operation for a month it should be removed and the parts cleaned by washing in a solution of bichromate of potassium. When

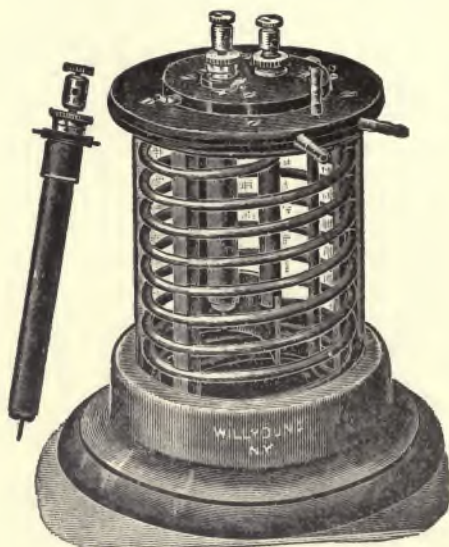

FIG. 114.—COOLING WORM FOR ELECTROLYTIC INTERRUPTOR.

driven by a synchronous motor the crest of each wave flowing in the same direction may be sheared off, and thus any induction coil may be operated by an alternating current and unidirectional disruptive discharges result at the spark-gap. A condenser of small capacity should be shunted across the interruptor to obtain the best results.

ELECTROLYTIC INTERRUPTOR.—In systems of wireless telegraphy, especially those of German manufacture, the Wehnelt electrolytic interruptor has met with favor, and the results attained have been very satisfactory. Interruptors of the electrolytic type consist of a platinum anode having a surface of approximately 4 square mm. and a lead cathode having a surface approxi-

mating 300 square cm., both being immersed in a solution of sulphuric acid 1 part, and water 5 parts. When these electrodes are connected in series with the inductor and a source of e. m. f. having a potential of 40 volts, bubbles of non-conducting gas are formed on the terminal of the platinum anode which interrupts the current; the frequency of the formation and bursting of the bubbles varies directly as the e. m. f. employed, and inversely as the area of the platinum surface.



FIG. 115.—ELECTROLYTIC INTERRUPTOR.

On very large coils this type of interruptor is not theoretically efficient, since a current of 3 or 4 amperes is required, and this causes a loss of 100 to 150 watts, due to the heating of the solution, which if continued affects the rate of interruption, diminishes the sharpness of the break, and sometimes results in absolute failure. For these reasons the solution should be kept at a uniformly low temperature, and in practice this may be accomplished by the use of a cooling worm having a head of water flowing through it; the general arrangement of the worm is shown in Fig. 114, and it may be supplied from the street mains or by using a siphon of rubber tubing. In the Braun-Siemens and Halske type of electrolytic inter-

ruptor the containing vessel is swung in two concentric rings, or gimbels so that its equilibrium may be maintained at all times, and is especially useful for marine work, where the rolling of the boat would affect it; this interruptor is shown in Fig. 115. When an electrolytic interruptor is employed the usual condenser shunted around the make and break is not necessary, as the interruptor itself has a certain inherent capacity due to electrolytic action, and termed

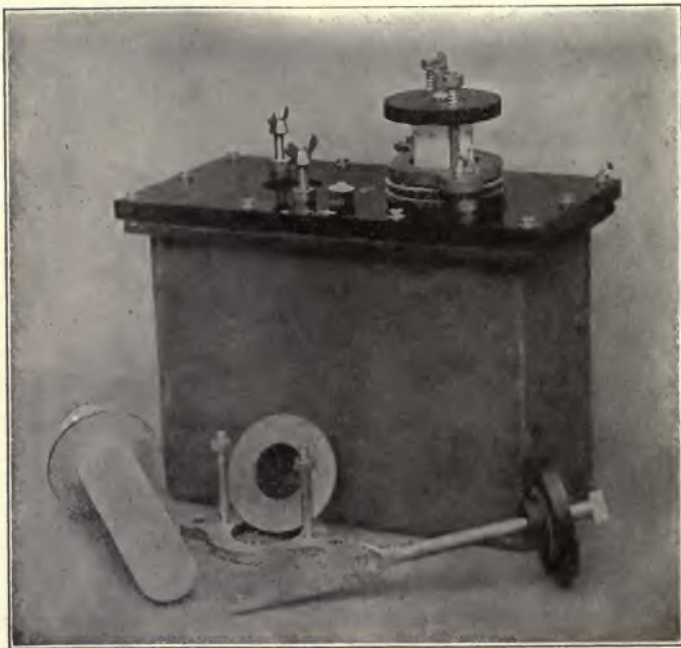

FIG. 116.—DOUBLE ELECTROLYTIC INTERRUPTOR.

electrolytic capacity, which is sufficient to maintain the proper relations of the coefficients. A vent should be provided in the top of the containing vessel and attached to a sponge dampened with water or an alkali solution. Fig. 116 is a double electrolytic interruptor.

An alternating current may be used in connection with an electrolytic interruptor for the negative current impulses have no appreciable effect, while the positive impulses will electrolyze the solution and gas bubbles will be formed as in the case of the ordi-

nary direct current. The platinum point is, however, very rapidly reduced when an alternating current is used, for the negative current acts like a direct current when the platinum point is made the cathode and the lead plate the anode, and its maintenance is therefore quite expensive; but where an alternating current only is available it may, by this method, be pressed into service. In practice at least 40 volts are required to obtain good results, and the rate of interruption is from 1,000 to 10,000 per minute.

LIQUID INTERRUPTOR.—This interruptor is due to Mr. E. W. Caldwell and is essentially electrolytic in action.¹ In this type,



FIG. 117.—LIQUID INTERRUPTOR.

Fig. 117, there are two metal electrodes immersed in a conducting solution or electrolyte; the electrodes are separated from each other by a punctured insulated diaphragm. When in action the current flowing through the circuit has a greater density at the orifice of the diaphragm, with the result that a bubble is formed which interrupts the current; the bubble then collapses, as in the Wehnelt type, only to be formed again, disrupted, and so on. The rapidity with which the make and break takes place varies with the amount of current flowing in the circuit, its inductance, size of the orifice in the diaphragm, the depth of the electrodes in the solution, and several other minor factors. Like other electrolytic

¹*Electrical Review*, New York, May 3, 1899.

interruptors, not less than 40 volts are required to operate it, and an alternating current may be employed if a direct current is not available.

ROTARY INTERRUPTOR.—In all the foregoing interruptors the impulses in the inductor are in the same direction, and unidirectional discharges result between the spark-balls connected to the terminals of the secondary coil. Rapidly alternating currents may, however, be produced by means of the rotary pole-changing interruptor. This is a purely mechanical device driven by a motor and consists of two brass disks or wheels, *Wa*, *Wb*, segments of which are cut out of their peripheries, and these are filled with an insulating compound or with segments of vulcanite, as shown in Fig. 118; the wheels are mounted on shafts, *S S*, and are insulated

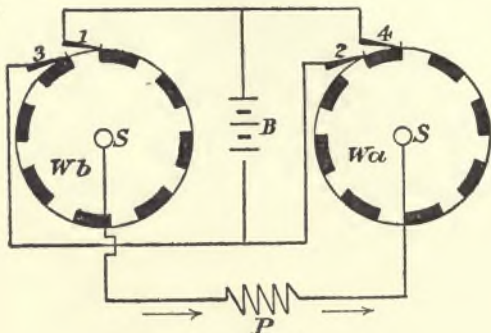

FIG. 118.—ROTARY INTERRUPTOR.

from each other; two pairs of copper or carbon brushes, 1, 3, 2, 4, are arranged to press firmly on the wheels like brushes on the commutator of a dynamo. These brushes are in circuit with the source of e. m. f. *B*, and the wheels are connected in series through the primary *P*, so that when the wheels and brushes are in the position indicated in Fig. 114 a current will flow through the inductor in the direction of the arrow, but upon the movement of the wheels, which operate synchronously, through a degree of arc equal to the peripheral length of a segment a reversal of the poles takes place and the current now flows through the inductor in the opposite direction. In adjusting the brushes care must be exercised that the pair marked 1 and 2 do not touch the brass portion of their respective wheels simultaneously with the brushes 3 and 4, but alternately these should rest on the in-

ulated segments. When the rotary interruptor is in action, as the first pair of brushes, 1, 2, forms contact, the current from the positive pole flows through the disk *Wa* and the inductor *P*, thence through the wheel *Wb* and the brush 1 to the battery. The next instant the brushes 1 and 2 will occupy a position on the insulated segment and 3 and 4 will form contact, when the positive current will flow through the brush 3, traversing the wheel *Wa* and back to

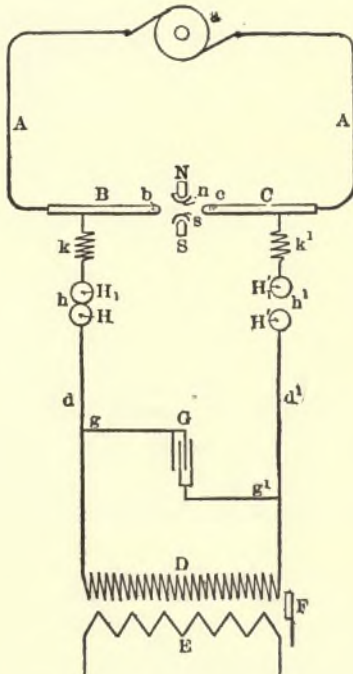

FIG. 119.—DIAGRAM DISRUPTIVE DISCHARGE INTERRUPTOR.

the battery; by this means the current is reversed through the inductor as many times per revolution as there are segments in the wheels; and as these may represent a large number and the speed at which the wheels are rotated may be very rapid, a large number of alternations through the inductor per second may be obtained.

DISRUPTIVE DISCHARGE INTERRUPTOR.—A new type of interruptor, based upon the principle of rendering an air gap conductive by a disruptive discharge, is the invention of Thomas J. Murphy. In the diagram Fig. 119, a direct or alternating current generator *a*, is

connected by *AA*, to the terminals *BC*, forming a spark-plug *ns*; the length of the gap is much greater than the potential developed by *a* can break down. A small induction coil represented by *DEF* having a condenser *G*, shunted across the heads of the secondary, connects to the principal air-gap, *BC*, through the spark-gaps *H HH²H¹*. To prevent the current flowing continuously from *B* to *C* for an indefinite period after the initial resistance of the air has been disrupted by the sparks from the induction coil a magnetic blowout *NS* is mounted with its polar projections at right angles to the carbons, thus forming the arc; the magnetic field reacts on the arc, the disruptive discharge thereby interrupting the current. When in action the generator *a* sends a current into the circuit



FIG. 120.—DISRUPTIVE DISCHARGE INTERRUPTOR.

AA, which traverses the air-gap *BC*, along with the sparks from the induction coil, and there will be as many interruptions of the main current as there are sparks through the gap from the induction coil. This interruptor may be utilized for making and breaking currents having a potential of 500-volts; it operates most efficiently on a 220-volt circuit. A very small induction coil may be employed to primarily disrupt the air. A photograph, Fig. 120, presents a general view of the Murphy interruptor.

ROTARY CONVERTER.—A modified form of the above type of rotary pole changer has been placed on the market by the General Electric Company of Berlin in connection with the Slaby-Arco apparatus. It is known as the Grisson direct-alternating current

¹Murphy High-Potential Interruptor. Collins. *Elec. World and Eng.*, Nov. 28, 1903.

transformer,¹ and; as its name implies, its purpose is to convert a direct current into pure alternating currents in the inductor. Different from the ordinary type of interruptor, the Grisson converter does not interrupt the current when the value of the latter reaches its maximum, and this effectively eliminates the sparking at the brushes B^3 on the segmental wheels U^1U^2 ; heavy currents may be utilized for feeding the inductor in consequence, and the size of the condenser may, therefore, be greatly diminished. In the diagram

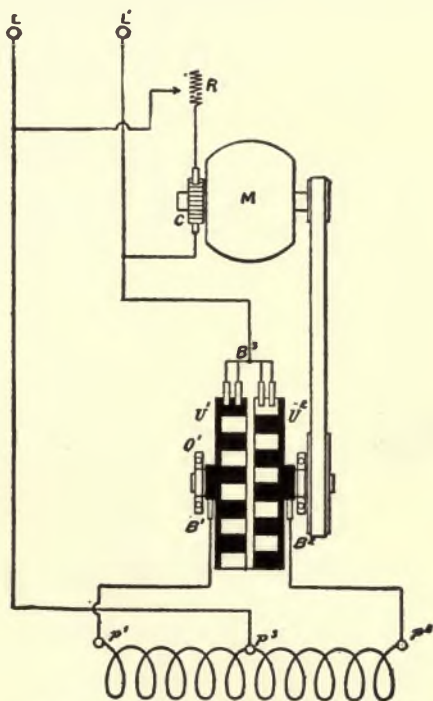

FIG. 121.—DIAGRAM ROTARY CONVERTER.

Fig. 121, it is easy to follow the evolution of alternating currents converted from the direct current; the inductor $P^1P^2P^3$ has, distinct from its terminals P^1P^2 , a third wire connected with a convolution in the middle of the coil at P^3 . A direct current leads through to the terminals $L L^1$; the current leading in to L^1 is divided at the brushes B^3 on the segmental disks U^1U^2 , which are attached to a common shaft and insulated from each other, splitting the direct current from the leads $L L^1$, through the brushes B^3 , forming con-

¹*Scientific American*, June 28, 1902.

tact with the segments of the wheels, reversing the current as the circuit is completed through the inductor. The direct current flows to the inductor P^1P^2 for the period of time the brushes B^3 are in contact with one of the metal segments and one of the insulating segments of their respective wheels when the circuit including the inductor and the source of energy is closed, and the total voltage flows through the inductor; but the instant this critical value is reached the current is reversed in virtue of the change of position of the conducting and insulating segments, and the current is changed in direction in the inductor; the iron core of the inductor reverses its polarity with every alternation of current, and a counter

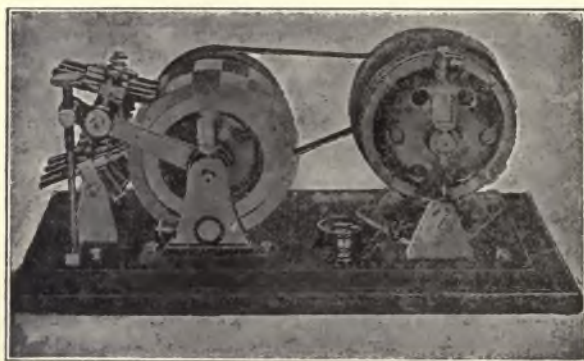

FIG. 122.—ROTARY CONVERTER.

e. m. f. is produced by means of cutting off the current at P^2P^3 in the first circuit, and as one segment approaches and the brushes begin to form contact the opposite segment leaves its brush and the current is reduced to 0; when the first circuit is thus broken the current in the second circuit quickly reaches its maximum value. This converter has a frequency of from 400 to 6,000 alternations per minute, and while this is lower than the periods of electrolytic interruptors, heavier currents may be used. The contact disks are revolved by means of a small motor, M , operated by a shunt from the leads, LL^1 ; C represents the commutator and R a variable resistance for controlling the speed of the disks U^1U^2 , so that the converter has a comparatively wide range of frequency. The Grisson converter is illustrated photographically in Fig. 122.

MERCURY VAPOR INTERRUPTOR.—The foregoing interruptors described are designed to be placed in the primary circuit which includes the inductor of the coil and source of e. m. f. A

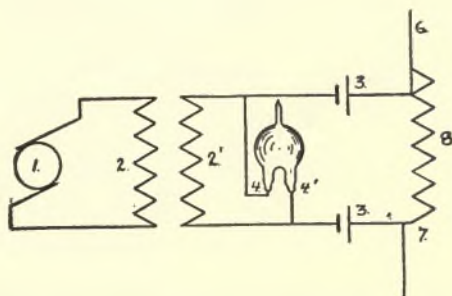

FIG. 123.—DIAGRAM MERCURY VAPOR INTERRUPTOR.



FIG. 124.—MERCURY VAPOR INTERRUPTOR.

new interruptor invented by Peter Cooper Hewitt, is shown in the diagram Fig. 123 and in half tone at Fig. 124,

This interruptor differs from all other types in that it is placed in the secondary circuit, and it not only interrupts the alternating current of high potential, but serves as a modified form of spark-gap. The mercury interruptor is constructed on the same general principles as a mercury vapor lamp and consists of a glass globe with inverted necks, from which the air is exhausted. The necks contain a small quantity of mercury and make connection with wires leading to the oscillator system. In action the negative electrode offers an exceedingly high resistance to the high-potential alternating current until a maximum critical potential difference is reached, when it suddenly breaks down and the current flows through the gaseous conductor with little or no opposition. When the difference of potential between the positive and negative electrodes drops to a minimum critical potential the resistance of the positive electrode is instantly increased to its normally high value. Referring to the diagram, 1 represents an alternating-current generator connected in series with the primary of a step-up transformer; 2' is the secondary winding of the transformer, the terminals of which lead to the condensers 3, 3', with the interruptor 4, 4', 5 in shunt thereto. The condensers are connected with the aerial wire, 6, and the earth, 7, but a closed circuit is obtained by means of a variable inductance, 8. The rapidity of the interruptions depends on the inductance of the coil, 8, and the capacity of the condensers 3, 3'; the discharge from the condensers is oscillating as in the case of the ordinary oscillator with a spark-gap, and the voltage required to operate the interruptor varies from 2,000 to 20,000, the shape and size of the tube and coefficients of the circuit determining the potential required.



CHAPTER XI.

OSCILLATING CURRENT GENERATORS.

PRACTICAL.

One of the fundamental requirements for the successful operation of long-distance wireless telegraphy is a high-frequency, high-potential current. This may be produced by a number of different methods, of which the induction coil, previously described, is the best known; others are the frictional machine, the Tesla oscillator, the Thomson high-frequency apparatus, and the Fleming transformer. Experience has shown that enormously high frequencies and potentials are not so desirable as they were at first believed to be, but that oscillating currents having a periodicity of 100,000 per second and a potential of 25,000 to 50,000 volts give the best results, since the former produces longer wave lengths, which are more penetrating, and the latter backs up the current with sufficient pressure to produce a heavy discharge, this giving rise also to penetrating waves. The frictional machine and the Tesla oscillator are not, therefore, in the present state of the art, satisfactory generators, but the advances in the evolution of wireless telegraphy are so rapid that either of these devices may on the morrow be found useful. A description of these methods is therefore appended.

FRICTIONAL MACHINE.—The frictional machine as invented by Otto Guericke consisted of a globe of sulphur, axially mounted and revolved by a crank; the generation of electricity was effected by the friction of the hand against its surface. A glass globe was substituted by Bose, of Wittenburg, who also applied a smaller wheel with a crank and belted it to the globe to increase its speed; the electricity was collected on a metal tube. The plate glass machine, shown in Fig. 125, was devised in 1787, and comprises a plate glass disk, *A*, revolved on an axis by a crank having an insulated handle. The friction is applied through the rubbers, *D*, pressing against the disk of glass. The disk, rubbers and prime conductor are mounted

on separate glass standards; the prime conductor, *P*, consists of a metal sphere carrying a metal comb extending on either side of the disk.

The lower portion of the glass disk is covered with a silk bag to prevent the leakage of electricity from the plate during its half revolution from the rubbers to the collectors. The rubbers should be coated with an amalgam made of 5 parts of zinc, 3 parts of tin, and 9 parts of mercury melted together, pulverized, and made into a paste with lard. Before the machine is used it should be dried in a warm place to expel all moisture.

In action, the plate glass machine is revolved toward the right, when electricity is generated by the rubbers. When the charged disk comes within the field of the collectors the electricity is accumulated by the prime conductor, thus discharging the glass disk, which

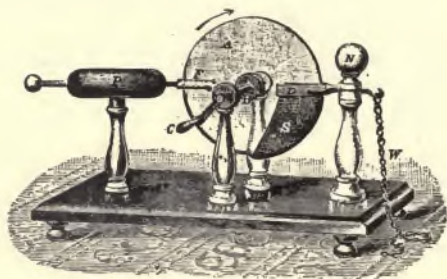

FIG. 125.—FRICTIONAL MACHINE.

becomes negative, due to the loss of its charge. During each revolution of the plate every portion is alternately charged and discharged, the lower half being constantly positive and the other half at zero except its residual charge. The energy generated by a frictional machine is proportional to the surface area of the plate-glass disk. The length of the spark is not a true index of the energy generated, since a short, thick spark may represent more energy than a long, thin one. The greatest objection to the frictional machine is its excessively high potential and proportionately low current strength; coupled with this untoward feature is the variation of spark due to the humidity of the air and other atmospheric conditions. When employed in wireless telegraphy a spark-gap should be provided by mounting a metal sphere on a separate glass standard; the aerial wire is connected to the prime conductor and the opposite side of the spark-gap to the earth.

HOLT-TÖPLER MACHINES.—In 1865 Holtz invented a machine

to generate electricity by its mutual static inductive influence. To operate the machine it was necessary to give it an initial charge from some external source. Töpler improved upon the design by making the machine self-exciting. In the Holtz type, Fig. 126, the plate *A* is mounted axially on a shaft and revolves to the left by means of a small driving wheel, to which a crank is attached. In front of the revolving plate are the collectors *V* and *H* attached to the ebonite disk *M*; the collectors *K* and *L* are insulated by the ebonite rods extending from *M*; these collectors are connected to the Leyden jars, *C*, *D*, and with the adjustable spark-gap *P*, *R*.

The glass plate *B* is fixed on ebonite supports and remains sta-

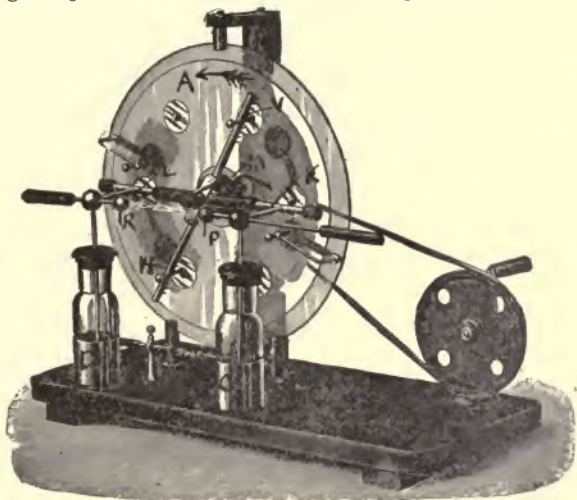

FIG. 126.

tionary. Both the revolving and the stationary glass disks are coated with shellac; the stationary disk has two openings cut in it immediately opposite the combs *K*, *L*; two inductors, *T*, *X*, made of paper, are cemented on its rear surface. The Töpler machine is constructed on the same general principles as that of Holtz, but has cemented on its front surface a number of tin-foil disks or carriers, which form contact with wire brushes as the glass disk revolves; two of these brushes are connected to the stationary plate and two to the uninsulated collectors, thus making the machine self-exciting.

When in action and the plate *A* is revolved, the tin-foil carriers come in contact with the brushes *E*, *F*, opposite brushes touching each opposite pair of carriers successively at the same instant. Electricity is generated by the friction produced and the carriers on

A are charged as well as the inductors on *B*; the instant the carrier is insulated from the inductor by the partial revolution of the plate they act on each other inductively, and the process being continued, the charge multiplies, finally charging the glass disk, which communicates its charges to the Leyden jars. When the potential difference between the inner and outer coatings of the jars becomes great enough through the cumulative action of the charged disks the disruptive discharge takes place between the spark-balls and oscillations surge through the circuit. For wireless telegraph transmission the vertical wire is attached to one side of the spark-gap and the earth terminal to the opposite side as in the case of an induction coil.

FLEMING TRANSFORMER.—This method of producing oscillations is described in connection with the DeForest system of transmission, but is probably due to Dr. Fleming. It consists of an alternating current generator connected in series with the primary winding of an oil insulated transformer; the secondary terminals are connected in series with a battery of Leyden jars or oil condensers having a spark-gap in shunt thereto. When the condensers are charged to their maximum capacity they discharge through the spark-gap, converting the alternating high-potential currents into oscillations of great intensity. This method bids fair to be universally adopted as a means of transformation for sending stations, and possesses many desirable features over the induction coil; among these may be cited that of utilizing any quantity of energy, which in the induction coil is limited by the interruptor. The great Marconi transmitters at Poldhu, Cornwall, England, Glace Bay, Nova Scotia, and South Welfleet, Mass., are equipped with this type of apparatus.

TESLA OSCILLATOR.—In the Tesla oscillator a higher rate of frequency and a higher potential are obtained than by an induction coil or even a static machine. This result is accomplished by stepping up the potential of an ordinary transformer by means of a second transformer coil and stepping up the frequency of oscillation by means of a second disruptive discharge. The Tesla oscillator begins where the Fleming transformer leaves off, while it differs from the Braun system of transformation in that it employs a second spark-gap. A comparison of the diagrams *A*, *B*, *C*, Fig. 127, illustrates the physical difference in the apparatus of Fleming, Braun and Tesla.¹

¹Martin, *Inventions of Nikola Tesla*, 1894, p. 207.

Fleming's method is represented at *A*, Braun's at *B* and Tesla's at *C*. In Braun's method an ordinary induction coil, 1, sparking through the gap 2, is employed though an alternating-current generator could be used to a better advantage; in either case

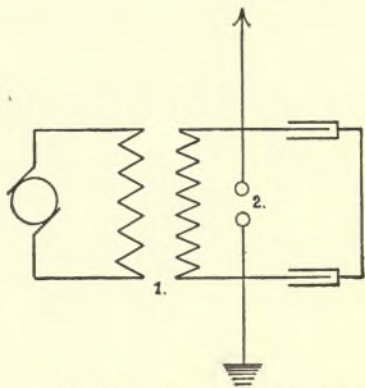

FIG. 127A.—FLEMING OSCILLATOR.

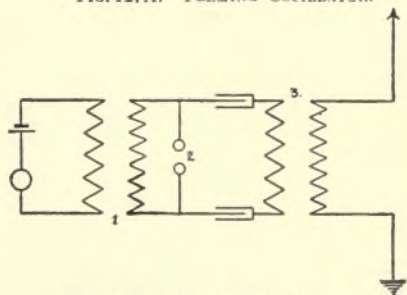

FIG. 127B.—BRAUN OSCILLATOR.

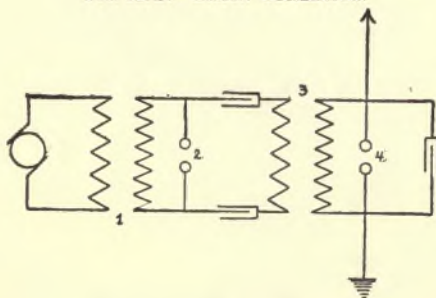

FIG. 127C.—TESLA OSCILLATOR.

the transformer, 3, steps up the potential of the current: the terminals of the secondary lead to the antenna and earth and form an open-circuit oscillator. In Tesla's oscillator after the ordinary high potential is obtained by transformation through the coil, 1,

and a frequency or ordinary periodicity is attained by means of the spark-gap, 2, the oscillatory current is again stepped up by means of the transformer, 3, when the potential may be further increased to a million volts, and by discharging this high-potential current across the spark-gap, 4, the frequency may be further stepped up until it approximates 10,000,000 cycles per second, when

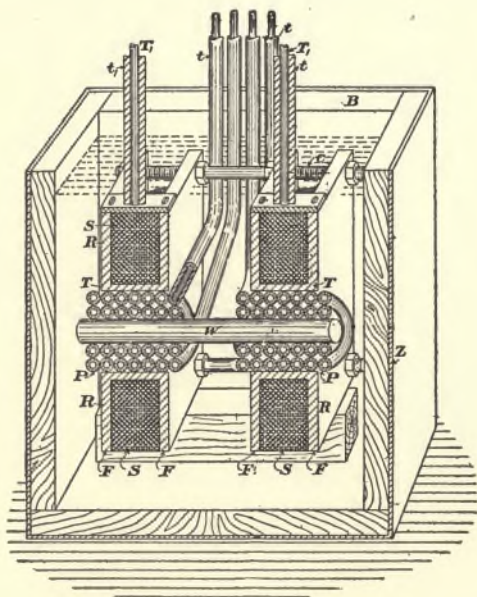

FIG. 128.—TESLA COIL.

the current assumes altogether new properties and produces phenomena new and distinct from that of the induction coil or the static machine, but it has not been proven of value in wireless telegraphy to the present time.

The construction of a Tesla oscillator—that is, the second disruptive discharge-coil—is shown in the sectional drawing Fig. 128. In a box, *B*, of hard wood encased in sheet zinc, the coil is placed. This coil consists of two spools of hard rubber, *R,R*, held apart at a distance of 10 cm. by bolts, *c*, and nuts, *n*, also of hard rubber. Each spool comprises a tube, *T*, having an inside diameter of 8 cm. and 3 mm. thick, the two flanges, *F, F*, 24 cm. square, being screwed thereon, leaving a space between *FF* of about 3 cm. The secondary winding, *s, s*, of the

best rubber-covered wire, has 26 layers of 10 turns each. The two halves of the secondary are wound oppositely and connected in series, the connection between both being made over the primary.

The primary coil, *P P*, is wound in two parts and oppositely upon the wooden spool, *W*, and the four terminals are led out of

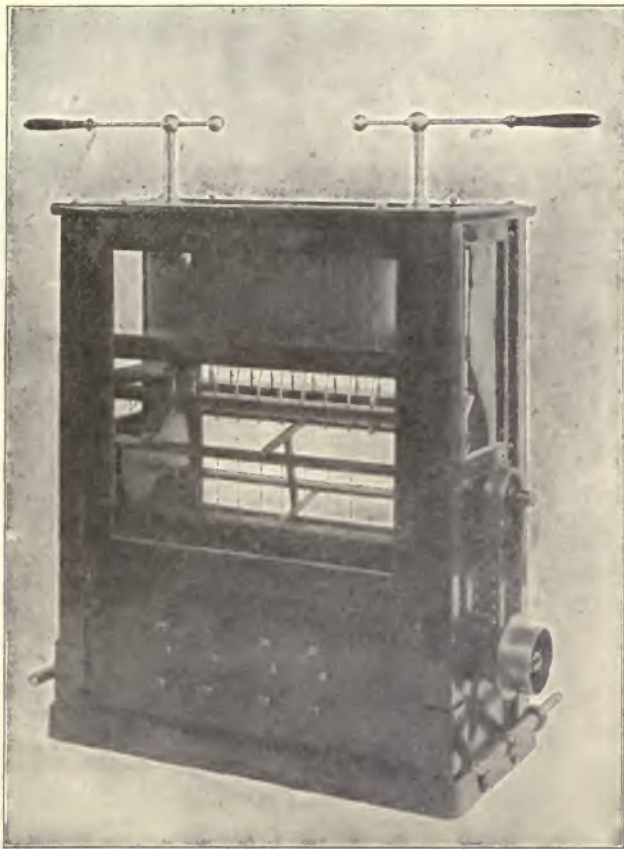

FIG. 129.—ELIHU THOMSON MACHINE.

the oil through rubber tubes, *t, t*, having great dielectric strength. Each half of the primary coil has four layers and 24 turns to the layer; both of these parts are connected in series and the primary and secondary layers are insulated by cotton cloth. The coil is held in position in the oil on wooden supports and there should be at least 5 cm. thickness of oil surrounding it. Either a com-

mercial transformer, as that employed in the Fleming method, or an ordinary induction coil having a spark-gap, may be employed for the primary transformation as desired, although the former gives the most uniform effects.

ELIHU THOMSON APPARATUS.—The photograph, Fig. 129, shows the Thomson machine complete. The machine is composed of a wooden casing, with glass sides and top, part of the ends, however, being made to support the shaft projecting therefrom. There appears to the right of the figure a pulley which is upon the shaft of a small direct-current motor secured to the iron base, and occupying the lower right-hand corner of the case. This motor also bears a pulley with projections or studs carried on its face for engaging with the perforated belt rising from it vertically, and passing over another similar pulley on the connector frame of the shaft, which will be alluded to later. The motor used is bi-polar, having slip rings and taps to its winding for taking off single-phase alternating current.

It is, therefore, not only a motor, but an inverted rotary converter, converting from continuous current to single-phase alternating. The cycles are a little over 25 per second; this, of course, depending on the speed of the motor itself, which in turn may be regulated by the strength of the field of the motor. On the lower left-hand portion of the case is a step-up transformer taking the low voltage current from the motor or rotary converter and transforming it to 15,000 to 20,000 volts in the secondary. This step-up transformer is specially made and insulated securely in the best manner for these high potentials, solid asphalt being employed in insulation. The secondary terminals are led upward within the case to the left, and are connected to two arc-shaped pieces, insulated from each other and arranged to come close to, but not to touch, two pins on the revolving connector frame just below. To the right of these arc-shaped pieces are a set of similar pieces arranged in two series, corresponding to the two terminal pieces and having connections led from them upwardly to the coils of a set of glass condensers. The connections and arc-shaped pieces seen in front are those which correspond to the positive foils, and those at the back would correspond to the negative foils. On the assumption that the arc-shaped piece connected to the secondary of the terminal, and seen in front to the left, is a positive terminal, it is, of course, anomalous to speak of positive and negative terminals in dealing with alternating currents; but the significance of the use of this term will be seen when it is understood that the revolving connector

frame bears connections and pins whereby the terminals of the high-potential secondary are brought into contact with the condenser foils so as to charge these foils to a potential of 15,000 to 20,000 volts definitely as to polarity. This is accomplished by making the connector frame in its rotation synchronous with the rotations of the motor or rotary converter, and giving it a position to afford connection to the condensers when the alternating wave is at or near its maximum in one direction only. When the opposite position is reached, the frame is turned to a position such that no connection can be afforded to the condensers.

The charging of the condenser plates or foils, as above alluded to, takes place through a minute spark-gap between pins upon the connector frame and the stationary arc-shaped pieces connected with the foils. This avoids the noise of mechanical play or rubbing and saves the wear which might otherwise take place. The connector frame, therefore, revolves with entire freedom. It will thus be seen that the connector frame in charging the condensers does so with them in parallel or as one large condenser. The condensers, however, on a semi-revolution of the frame are connected one with the other in series so as to add together the potential.

The same connection is made to the terminals, consisting of slide rods and suitable supports on top of the machine, and bearing brass balls and insulated handles. If there are ten condensers in a set, the multiplying of the potential is, of course, ten times the charge given to each condenser individually, which in the case of 15,000 volts would be 150,000.

As there are ordinarily about 25 revolutions per second, the discharges of the condenser are at that rate, but of course are capable of being varied over a wide range, both in number per second and in intensity.

The machine is well adapted to wireless telegraphy, as it does not reverse its polarity, the vigor of the discharges may be regulated, and its operation is not dependent upon the weather; besides, the machine is portable and can be used whenever a direct current of sufficient voltage is at hand.

It may also be employed, as is evident, simply as a motor by belting from the right-hand pulley and open-circuiting the primary of the terminal. The terminal posts, as seen on the front board, enable various connections to be made whereby the speed and voltage can be controlled.¹

¹Letter from Elihu Thomson to the author, May 20, 1903.

CHAPTER XII.

ELECTRIC WAVE ACTION.

HISTORICAL.

Prior to the time of Hertz's researches in 1888, the effects of electric waves had been observed under varying conditions, but the cause producing such phenomena was purely speculative. The earliest reference to cohesion under electrical influence was made by Guitard in 1850¹ who observed that when air laden with dust was electrified from a point the particles of dust cohered into strings and that the same phenomena occurs in the formation of snowflakes under the action of atmospheric electrification and that small drops of rain are cohered into large drops by the same process, the lightning thus giving rise to the thunder shower. In 1866 Mr. A. S. Varley described his observations on the opposition of a loose mass of dust composed of conducting material to electric currents of moderate tension. Varley made a large number of experiments with lightning bridges based on the principle of a loose contact, but he did not venture an explanation of such action.² In 1879 Prof. Hughes operated a wireless signaling apparatus at a distance of a mile, using his microphonic carbon joint as a detector. Hughes suspected the action to be due to electric waves, but could not prove their existence. In 1884 Dr. Temistocle Calzecchi-Onesti made the first device which has come to be called the coherer,³ and was the first physicist to investigate the variability of conductivity of metal filings under divers circumstances and conditions, and even carried his researches to the point of connecting his tube with the prime conductor of a frictional machine, and in this way obtained a lowering of the resistance of the metal particles; but Calzecchi had no knowledge of electric waves and ascribed the action of cohesion to induction. In 1888 Hertz employed a metal ring for the detection

¹Lodge, *Electrician*, London, Nov. 12, 1897. *Elec. World and Eng.*, May 10, 1902.

²Varley's Paper, British Association (Liverpool meeting), 1870.

³*Nuovo Cimento*. Reprinted in *Elec. World and Eng.*, Dec. 2, 1899.

of the electric waves,¹ and in 1890 M. Eduard Branly read his classical paper on "The Variations of Conductivity under Electrical Influence," being the first to show conclusively, by means of his radio-conductor, that cohesion of metal filings was the effect of impinging electric waves. He also made known the process of restoring the normally high resistance of the filings by percussion.

In 1894 Lodge read a paper before the Electrical Congress "On the Possibility of Transmitting Signals with a Hertz Radiator," employing a device modeled after Onesti's tube and Branly's radio-conductor. In his researches on the phenomena relating to the action of electric waves on metal filings Lodge found that the particles were drawn into contact with each other or cohered, and so he gave to the tube the name *coherer*, which, though not as euphonious as the terminology of Branly, struck the key-note of popular sentiment, and in its new form Lodge's name came to be inseparably linked with it. Lodge was the first to apply the electro-mechanical tapper as a means for automatically decohering the filings, an arrangement which is in general use to-day in wireless telegraphy. Marconi in 1897 improved the coherer to such an extent that in its present form it is at once simple, sensitive, and fairly reliable, and is typical of the evolutionary progress of scientific instruments.

An anomalous class of detectors which have been termed *anti-coherers*, in virtue of their normal resistivity being enormously increased instead of decreased, has been discovered by Herr Schaffer, and still another form which is claimed to be electrolytic in action by Herr Neugschwender. The fundamental principles involved in the foregoing have been arranged in many different forms based on the several theories to be described. Since the action of electric waves is represented by the secondary effect of electric oscillations, other methods of detection have been tried, with varying degrees of success. Henry long ago observed the changes of magnetic polarity in needles inserted in a coil of wire a distance of 30 feet from the emitter.² Elihu Thomson has also suggested the employment of a device constructed on this principle³ of variation of magnetic permeability by the oscillating currents which are set up by the electric waves. Rutherford was the first to actually employ this method successfully, and Marconi has devised a detector based not only upon magnetic permeability of a core of iron by electric oscillations,

¹See Chapter III., Electric Waves.

²See Chapter V., Electric Oscillations.

³*Proceedings Eng. Society, Western Penn. Kintner, 1901.*

but has rendered it much more sensitive and effectual by adding a hysteresis effect. Fessenden has recently evolved a new electric wave detector operated by the current of the oscillations instead of by the voltage, as in foregoing devices, and his barretter,¹ as he terms his detector, is more sensitive than any yet devised for the purpose.

THEORETICAL.

Branly offered several hypotheses to explain the probable mechanical effects produced by coherer action. He did not believe that any displacement of the filings actually takes place on cohesion, especially where the filings are held in position by extreme pressure, or, again, as in the solid coherer mixtures. He thought it possible that there might be a volatilization of the adjoining particles of the filings and thus form a bridge of electrical conductivity. In the mixtures of filings and non-conducting substances he offers the suggestion that a change takes place in the dielectric itself and that the insulating medium is broken down by the passage of minute sparks and that the punctures thus made are coated with a conducting substance. Finally, Branly's theory attributes the coherer action to the gradual breaking down of the dielectric of air insulating the filings, the action being accelerated if the filings are compressed and retarded if the pressure is diminished.

Lodge in studying the nature of metal filings under the influence of electric waves became convinced that the filings were drawn together and cohered and that the particles were welded together, forming practically a continuous conductor. That the primary cause of cohesion is due to a difference of potential set up by the oscillating currents through the resonator circuit is well established. Eccle in his investigations of this subject agrees with Lodge in the matter of cohesion, but assumes that the critical potential difference is established between the opposed plane surfaces of the filings when the distance separating them is small as compared to their own mass. According to Eccle, any particle of matter having the properties of conductivity, which is not spherical in form, and which is free to move in the electric field established between it and its fellows, has the property of exhibiting orientation and thus of setting its longest axis parallel to the field. Accordingly the process of cohesion by electric waves follows this order: (1) the

¹U. S. Patent granted to Fessenden, Aug. 12, 1902.

waves impinge on the resonator system, which (2) produces oscillations in this system, (3) causing a difference of potential between the filings, creating an electric field, and followed (4) by a purely mechanical action or orientation, which results in (5) heat and ends in (6) a welding process or cohesion.

Guthe, in his paper, "The Nature of Cohering Action,"¹ expresses the opinion that the oscillations first heat the juncture of the points of the metal filings where they form contact and that the coherer effect follows. Shaw ascribes the orientation to a molecular change in the metal particles and not to the filings regarded as a mass.¹ Guthe and Trowbridge conclude that the high original resistance of the metal particles is due to the film of oxidization on the surfaces of the filings. Bose's coherer theory supposes the electric mass to act direct on the filings, and that the increase and decrease of resistance under the action of electric waves is a phenomenon of molecular strain and undergoes a physical and a chemical change or modification of its properties in which cohesion is only one aspect.

Haerdon has observed the coherer effect with a microscope and concludes that the action is electrolytic. His coherer consisted of one contact only and was formed of two perfectly joined points. When the incoming waves impinged on the resonator system he observed that the sparks passed from one terminal to the other, carrying minute particles of matter, when a bridge was formed connecting the two points and possessing the property of conductivity until broken down by the usual method of percussion or tapping process.²

In the current operated wave detector of Fessenden, a low heat capacity of the platinum wire must be maintained, so that the conditions are such that the radiating surface is reduced to a minimum; this is the reverse of the action of the bolometer, which has a large heat absorbing and radiating surface compared to its mass; for this reason Fessenden employs a cylindrical wire, since its surface per volume is smallest. The theory of the action of the hot-wire detector involves a new discovery, namely, that "if a conductor having a specific heat-factor of such value that the latent energy required to heat it to a certain excess above the air is small relative to the energy lost by radiation, convection and conduction at that excess temperature during the time of a signal, then it is possible to so arrange the conducting wire in a local continuous current circuit so that when a

¹Philosophical Mag.

²Annalen der Physik.

given amount of current of any periodicity or wave form is caused to flow through the conducting wire there will be a corresponding change of the same magnitude in the local circuit."¹

EXPERIMENTAL.

The exceedingly high resistance of metal filings had been observed long before Branly gave his attention to the subject, as well as the decrease in resistance when pressure is applied; by varying the pressure from zero to infinity the resistance may be made to drop from many megohms to practically that of a solid metal conductor. But not only has pressure the property of decreasing the resistance of metal filings, but electric waves will work a change in the metal filings of a coherer so that from a non-conductor it will become a very good conductor of electric currents. In

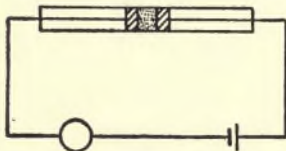

FIG. 130.

INTERNAL COHERER CIRCUIT.

order to test the action of electric waves it is necessary that the coherer should be placed in series with a galvanometer or telephone receiver and a single cell of chloride of silver or other source of e. m. f., as in Fig. 130.

This constitutes a circuit for the passage of the direct current of the cell which is to register the drop in resistance of the coherer, as well as a closed-circuit resonator for the surging of the electric oscillations set up in it by the impinging electric waves. Now if a Leyden jar is discharged a few meters away, there will be instantly a deflection of the galvanometer needle or a click in the telephone. Repeating the spark increases the conductivity of the coherer, and successive sparks sending out trains of waves will break down the resistance finally, which a single spark emitting a train of waves will be unable to do. This is an exceedingly important factor in syntonics wireless telegraphy, and is one of the fundamental principles underlying it.

When a coherer is adjusted to a certain critical sensitiveness, the filings may cohere immediately before the spark passes between the oscillator balls. This may result from two causes, (a) from a train of waves emitted by the mechanical interruptor, or (b) from the low-frequency, high-potential alternations set up in the oscillator

¹U. S. Patent Fessenden. Aug. 12, 1902.

system of the coil and producing a strong electrostatic field. Calzecchi and Branly both found that pulsating and direct currents of high e. m. f. produce cohesion; in the light of recent knowledge it seems that in either case the conductivity of the coherer is increased by the potential difference between the irregularly shaped particles, and this follows the same law as cohesion under the action of electric oscillations. Branly tested the drop in resistance of the following metals¹ during the action of electric waves: iron, copper, brass, zinc, antimony, aluminum, tellurium, cadmium, bismuth, and lead, and determined that the property of cohesion depended largely on pressure and that very fine metal filings after percussion offered an almost perfect barrier to the passage of a feeble direct current; the proper value to insure a maximum sensitiveness may be easily obtained by means of adjustments of the terminal conductor plugs of the coherer. Branly noted that a layer of copper reduced by hydrogen and spread on a sheet of roughened ebonite 2 cm. wide and 7 cm. long and well polished has quite a range of variability. Other substances were also experimented with, including galena, powdered bioxide of manganese mixed with antimony and compressed. Platinized and silvered glass and glass covered with gold, silver and aluminum foil were also susceptible to cohesion, and when iron filings were mixed with colza oil or petroleum they were likewise affected; even solids consisting of iron filings and Canada balsam were reduced in resistance from thousands of ohms to a few hundreds by the disruptive discharge. Rods of solid fused flowers of sulphur and aluminum filings and of solid copper bars oxidized and laid across each other also showed a marvelous decrease in resistivity when the spark passed. The normal resistivity may be restored by percussion, and to accomplish this Branly employed a mechanical tapper, the hammer of which could be regulated. Some substances would retain an increase of conductivity for a period of 24 hours, and in others the normal resistivity would be instantly restored; coherers of this order are designated *auto-coherers*, *self-righting* or *self-restoring coherers*, as fancy dictates. Other substances could be restored to normal resistance by heating. Branly also observed substances in which there was an increase of resistivity under the action of electric waves; antimony and aluminum filings exhibit a marked increase in resistance; these detectors are called anti-coherers, and a kind of platinized glass employed as a coherer

¹*Comptes Rendes*, Vol. III., 785, and vol. 112, p. 90.

would increase and diminish in resistance alternately. Koepsel's researches led him to the conclusion that the harder the metal filings the greater the accuracy in decohering, and therefore recommends highly tempered steel filings. Guthe ascertained that the potential difference increases with the strength of the current until it reaches a certain constant value, when any further increase has no effect on it; this he calls its critical value. Tommasina has made some beautiful experiments in cohesion by electric waves. His apparatus consisted of a nickel-plated brass ball a centimeter in diameter, suspended by a thin wire; a few mm. from the ball and immediately under it a copper disk 15 mm. in diameter was delicately poised on a copper spring. Connected in series with the ball and disk was a battery. Some nickel filings were now placed on the disk, the ball lowered to a point of slightest contact and the current switched through the circuit, when on gently elevating the ball the filings were found to cohere in series, forming a little chain nearly a centimeter in length; with carbon granules, chains 15 mm. in length were obtained.

There are other substances than those tested by Branly which possess the property of responding to electric waves, and among them may be mentioned a preparation of frog's-leg nerve and muscle, as shown by Ritter,¹ and the author has succeeded in showing the "coherer effect" of electric waves acting on the human brain.² These experiments are interesting only from a physiological standpoint. The detection of electric waves by a comparatively new and entirely different process from that of cohesion is the class of detectors based on magnetic permeability. Great results are expected of magnetic detectors by many authorities, for it is reasoned from theoretical considerations that all the energy of the impinging wave may be utilized against the amount merely required to raise the potential to certain value where the insulating films break down and waste the rest of the wave, as in the case of the coherer. The great advantage of this detector is in its self-restoring qualities as well as that its resistance is practically the same at any moment, whereas in a coherer before and after tapping there is always a wide diverging in its resistance, and this effects a considerable variation in the workings of the recorder. It is also claimed that it is more

¹The Works of Hertz and Some of His Successors. Lodge.

²Effect of Electric Waves on Human Brains. Collins. *Elec. World and Eng.* Feb. 22, 1901.

sensitive and much more uniform in action than the coherer, and will, therefore, be of great value in syntonie wireless telegraphy. While this is undoubtedly true, its lack of variability between resistivity and conductivity is decidedly disadvantageous, since a relay, however delicate, cannot be operated with it, and its usefulness is therefore limited to the telephone as an indicator, and in this it acts similarly to a carbon coherer, which is likewise self-restoring, i.e., returns to its normal resistance without tapping.

Dr. Lee DeForest and Mr. E. H. Smythe made an extended investigation into the cause and effect of substances in which the electric oscillations proved a resistance in the detecting medium¹ instead of decreasing it, as in the filings coherer; this responder is not, however, an anti-coherer in a strict sense, but is based upon the disruptive action of high-frequency currents. When two electrodes are slightly separated, and a mixture of oxide of lead and glycerine or other suitable medium is interposed between their opposed surfaces, and are then connected in series with a source of current, minute metallic particles are detached from the anode and thence carried across the gap separating the electrodes to the cathode, where they build up bridges which extend toward and soon reach the anode, bridging the gap, and thus lowering the resistance of the local circuit, as shown in Fig. 131a. These metallic threads deposited by electrolysis are produced by the local current. When the oscillating current is set up by the impinging waves, it breaks down the metallic threads, giving it the appearance indicated in Fig. 131b, segregating and precipitating the metallic particles quite gently, instead of violently disrupting them, though the action is practically instantaneous.



FIG. 131 a.

—ELECTROLYSIS BY DIRECT CURRENT.



FIG. 131b.—

DISRUPTION BY OSCILLATING CURRENTS.

TESTING THE COHERER.—Kinsley suggests the following way for testing a coherer by what he terms the *potential difference* method. He assumes that all metals are equally sensitive and that any degree of sensitiveness may be obtained by applying the requisite pressure to the filings by means of the coherer conductor plugs. When the resistance of the filings

¹*Elec. World and Eng.*, April 11, 1903, p. 613.

is infinitely great, they do not decrease in resistivity gradually, but remain practically constant until the potential difference assumes a critical value, and the resistance then drops, just as in the case of a disruptive discharge between oscillator balls. According to Kinsley, metals oxidizing readily must be much more carefully treated in the construction of coherers than those which do not oxidize so easily. Nickel gives the best results, for the reason that it can be manipulated in the open air and gives a high resistance—and therefore sensitiveness—as required in wireless telegraphy. The voltage for operating a relay through a coherer should not be greater than 0.4 and the current only 0.002 to 0.001 ampere.

The adjustment of a coherer is accomplished by placing it in series with a cell giving the current and voltage just cited and the relay wound to the resistance it is intended to use. The coherer conductor plugs should be withdrawn so that it has a resistance of several megohms. The armature of the relay should have a play of one-tenth mm. and just clearing the poles of the magnets. The tension of the spring should be very slight—merely sufficient to draw the armature away from the magnets when there is no current flowing through the relay coils. The current is now passed through the circuit, the conductor plugs being manipulated to a nicety until the turn of a one-tenth mm. of the adjuster screw of the relay armature causes the latter to be drawn to or from the poles; when drawn from the poles by the adjustment of the conductor plugs the coherer may be said to be roughly correct. Tap the coherer with a pencil while testing to prevent premature cohesion, which is apt to occur either from pressure or from the potential caused by the local battery circuit. Test finally with the spark from a Leyden jar or oscillator system of a coil.

Another method for testing the sensitiveness of a coherer is to place it in a series with a telephone receiver and a source of current having a small e. m. f. By adjusting the coherer plugs while listening to the receiver the characteristic sounds will easily enable the operator to determine when the critical value has been reached; and when the maximum sensitiveness of the coherer is reached the flow of the current is continuously heard. The plugs should now be sealed in the tube. In actual practice coherers may be tested by one of the above methods and then further tested at a distance of 20 or 30 kilometers.

CHAPTER XIII.

ELECTRIC WAVE DETECTORS.

PRACTICAL.

Electric wave detectors were invented before electric waves were known to exist. There are two classes of detectors, i.e., voltage-operated detectors and current-operated detectors. These classes may be subdivided into several distinctive types, the principal ones being the coherer, auto-coherer, hot wire barretter and electrolytic responder. These various detectors will be described in the rotation in which they were made public.

CALZECCHI TUBE.—Calzecchi-Onesti devised a coherer consisting of a tube filled with metal filings to which there was attached

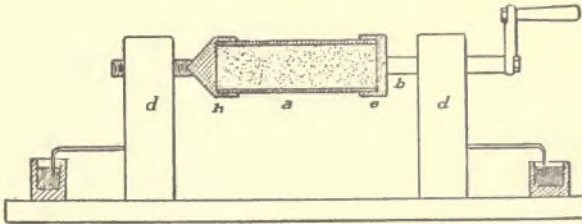

FIG. 132.—CALZECCHI TUBE.

a small crank, Fig. 132, and by turning the crank half a revolution the filings were caused to decohere.¹

HERTZ RESONATOR.—This consisted of a ring with a micrometer spark-gap, as shown in Fig. 20; it has been mentioned throughout this work and will not need further description here. With the wire detectors of Hertz no local batteries were used or additional apparatus to increase or magnify the effects of the waves.

BRANLY RADIO-CONDUCTOR.—Branly's radio-conductor, shown in cross-section, Fig. 133, is an ebonite tube, 1, having one of its

¹*Neuvo Cimento*, 1884.

conductor plugs, 2, arranged like a piston so that a maximum or minimum pressure may be applied to the filings in the cavity, 3;

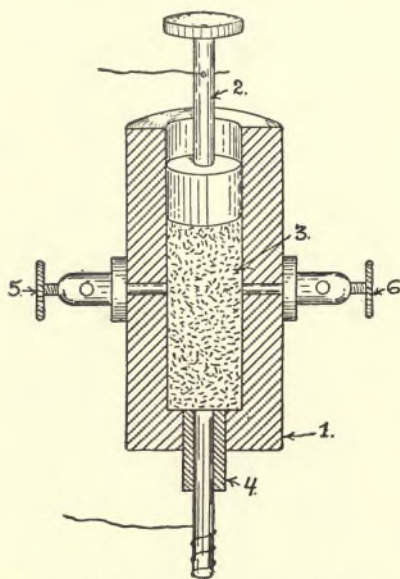

FIG. 133.—BRANLY RADIO-CONDUCTOR.

to complete the circuit the opposite terminal conductor plug, 4, is used; the terminals, 5, 6, in contact with the filings may be employed instead of 2 and 4, by which Branly showed the decrease of re-

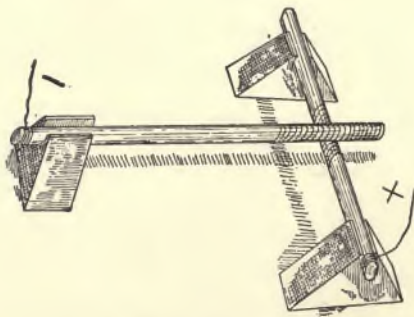

FIG. 134.—OXIDIZED RADIO-CONDUCTOR.

sistance was equal in every direction. A simpler form of radio-conductor was devised by Branly, and is shown in Fig. 134; the arrangement consisted merely of two oxidized copper bars laid at

right angles one upon the other. The author increased the sensitiveness of this arrangement by having the upper rod ground to a knife edge and allowing this to rest lightly on the lower rod.

LODGE COHERER.—Lodge's coherer was an improvement on those

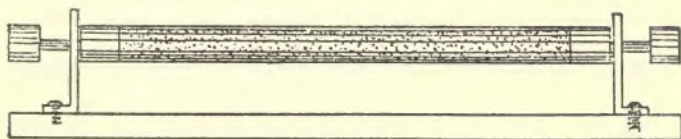

FIG. 135.—LODGE COHERER.

of Calzecchi and Branly in that the tube was mounted with the conductor plugs having a screw adjustment so that the pressure on the filings might be varied between wide limits. Fig. 135 represents the Lodge coherer, half size, that is to say, the original was 12 cm. in length and had a bore of about 8 mm. Two other forms of coherers designed by Lodge are shown in Figs. 136 and 137. In

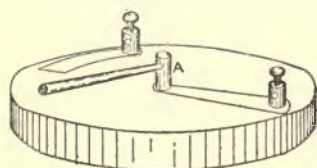

FIG. 136a.—
SINGLE CONTACT COHERER.

Fig. 136 a turn of thin iron wire, *B*, is mounted on an adjustable lever—shown at *A*—and impinges on a small piece of aluminum connected with one of the binding posts and the adjustable wire with the opposite post. The second form is shown in Fig. 137. It also depends on an imperfect electrical contact, and is therefore essentially a coherer. A metal point rests lightly on a metal diaphragm and under the action of the waves the point coheres to the disk, and is made to decohere by means of a small rack.

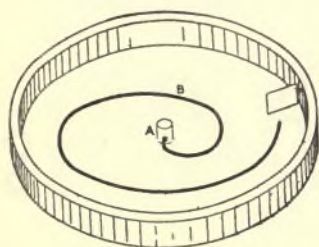

FIG. 136b.—
SINGLE CONTACT COHERER.

OTHER WAVE DETECTORS.—A type of detector based upon the principle that gas possesses greater conductivity when disturbed by electric waves than in its normal state has given rise to the vacuum and trigger tubes for experimental observation. Zehnder's trigger tube, shown half size in Fig. 138, gives better results than an ordinary vacuum tube; the terminals, *A*, *B*, are attached to the resonator plates, and *C* and *D* to a high-potential current which is on the

verge of breaking down the resistance of the tube and causing it to glow; the impinging electric waves supply the additional potential in the form of oscillatory currents and the tube becomes luminous.

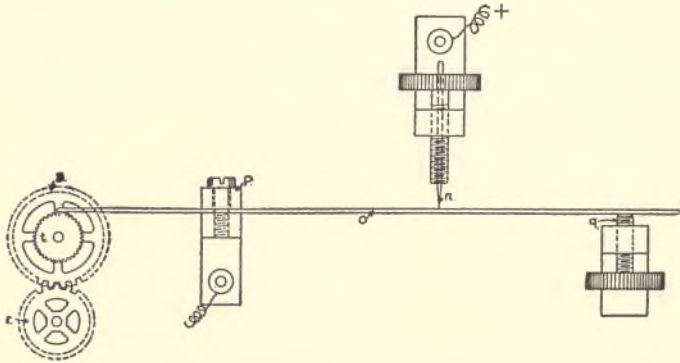

FIG. 137.—POINT AND DIAPHRAGM COHERER.

Fitzgerald employed a sensitive galvanometer as a detector, the field of force created by the oscillations exerted a final influence through

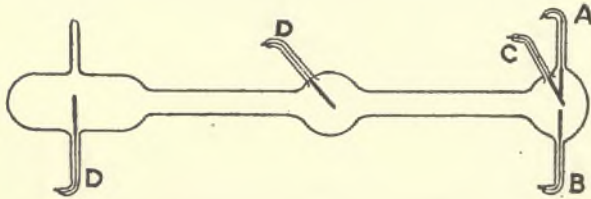

FIG. 138.—ZEHNDER TRIGGER TUBE DETECTOR.

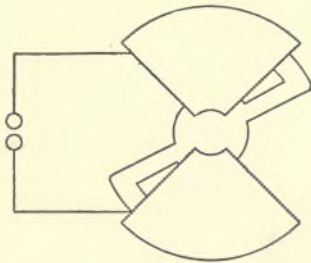

FIG. 139.—
BJERKNES QUADRANT DETECTOR.

the galvanometer system. The thermopile, the thermal joint, the bolometer, and the action of electric waves on wires have been used as detectors by Paalzow and Arons, Rubens and Ritter. Gregory employed a sensitive expansion meter constructed on the principle of a Cardew voltmeter. Bjerknes employed a rectangular form of the Hertz resonator (Fig. 139) tuned to the oscillator, and instead of a spark-gap, one side of an electrometer was connected in;¹ the needle was at 0 potential, and therefore attracted by both quadrants; with this detector Bjerknes plotted

¹Signalling Through Space Without Wires.—Lodge.

curves showing the persistency and damping influence of open and closed resonator systems.

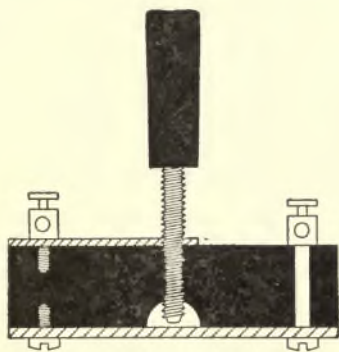

FIG. 140.—
BOLTZMAN AIR-GAP DETECTOR.

Boltzman used a micrometer air-gap connected to an electroscope, as shown in Fig. 140. A current of considerable potential is prevented from discharging across the spark-gap of the electrometer until the thin insulating film of air becomes ionized by the electric waves and allows the current to pass, thus deflecting the leaves of the electroscope. As Lodge has pointed out, with this simple apparatus electric waves could have been easily discovered a hundred years ago. A detector used by

Righi depended for its resistivity on a film of finely divided mercury on a piece of glass and evidently worked on the principle of the air-gap. Popoff, in his meteorological experiments, made a coherer by pasting two strips of platinum foil

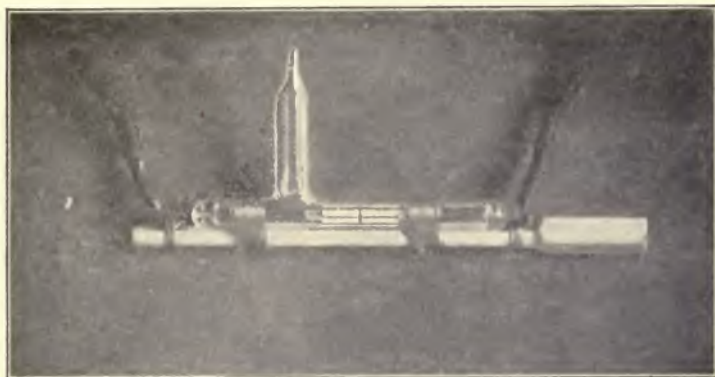

FIG. 141.—MARCONI COHERER.

on the inside of a glass tube; the ends of the strips of foil were brought outside the tube; the filings were placed on the gap between the pieces of foil and filled the tube about half full.

MARCONI COHERER.—Marconi's coherer is an improvement on Lodge's modification of Branly's radio-conductor; he ascertained

and employed the most sensitive and accurate combinations and quantities of metal filings—90 per cent. nickel and 10 per cent. silver—enclosed in a space of 1 square mm. cross-section. His coherer is shown in full size in Fig. 141. With it he has been able to detect signals a distance of 1,099 miles. The terminal conductor plugs are of silver with platinum leads sealed in an exhausted glass tube. The object of creating a partial vacuum in the tube is to prevent the filings from succumbing to oxidization. The conductor plugs are sometimes amalgamated with mercury, but too great a percentage of mercury is fatal to the proper working of the coherer. It is not necessary to exhaust the tube to insure a working coherer within certain limits. A simple coherer for laboratory work is shown in Fig. 143. Two brass conductor plugs, *a*, *a*¹

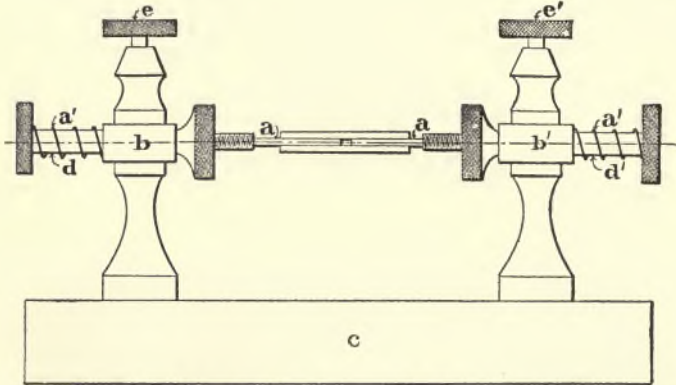

FIG. 143.—EXPERIMENTAL COHERER.

slide freely through the brass standards, *b*, *b*¹, mounted on a piece of hard rubber, *c*; the terminals of the plugs, *a*, *a*¹, are of silver or brass 1 mm. in diameter and sliding nicely in a piece of glass tubing. The plugs *a* and *a*¹ are fitted with a screw adjustment to obtain an inward pressure, the springs *d* and *d*¹ drawing the plugs apart when a higher resistance of the filings is desired. The set-screws, *e*, *e*¹, are provided to secure the plugs when the proper adjustment is obtained. The filings should occupy a space 1 mm. in length and the bore of the glass tube should be about 1 mm. in diameter.

SLABY-ARCO COHERER.—The coherer used in the Slaby-Arco instruments consists of silver conductor plugs with platinum terminals, and the coherer is exhausted for the reasons stated above, as

well as to keep the filings at all times perfectly dry and movable, thus permitting the original grouping of the filings after each percussion. The end surfaces of the conductor plugs are not parallel but wedge-shaped, as in Fig. 144; this "split" or pocket of the coherer allows its sensitiveness to be regulated after the tube is exhausted and sealed. If the position of the tube is such that the narrow part of the split is down, the filings assume a vertical posi-

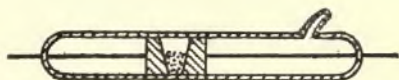

FIG. 144.—SLABY-ARCO COHERER.

tion, the pressure is increased by gravity, and its sensitiveness is at its maximum value. If the broad part of the "split" is down the filings are spread lengthwise, the pressure is diminished, and its sensitiveness decreased. A very sensitive coherer is seldom accurate enough for commercial work, but by this arrangement the proper relations of sensitiveness and accuracy are easily arrived at. The different positions of the coherer are obtained by means of an adjusting pinion and a catch spring. Metal caps are attached to either end of the coherer tube, making the exchange of coherers very easy.

BRAUN COHERER.—The Braun-Siemens and Halske coherer is constructed on original lines. Its essential feature is that it does away with exhausting the tube. Braun contends that experiment had not shown the vacuum tube to be more sensitive than are the unexhausted ones. It is true that the vacuum coherer is exceedingly difficult to keep in adjustment, even transportation sometimes deranging it and when its sensitiveness is lost it is practically worthless. Braun's coherer may be restored to its initial state of sensitiveness with ease; it may be taken apart, cleaned, reconstructed, and adjusted by any practical operator. The conductor plugs are of steel and the filings are of hardened steel after Koepsel's formula. The ends of the conductor plugs forming contact must be highly polished. In sensitiveness it is practically equal to the best vacuum nickel-silver filings coherer and its accuracy greater, that is to say, it is not as susceptible to atmospheric disturbances. Its different parts are shown in Fig. 145.

Braun made the observation that the steel filings coherer does not respond as quickly and is not as accurate when the conductor

plugs become magnetic, but that a certain critical magnetism increases its sensitiveness without decreasing its accuracy. He, therefore, devised a magnetic regulator consisting of a permanent ring magnet and placed near the terminal surfaces of the conductor plugs. By rotating the ring magnet the opposite poles may be brought near the ends of the plugs and the plugs magnetized or de-



FIG. 145.—BRAUN-SIEMENS AND HALSKE COHERER.

magnetized to any extent desired. Nearly all systems of wireless telegraphy employ the regulation coherer, which requires tapping to restore it to its normal state of resistivity, but another sub-class of coherers are made which return to the normal resistance without

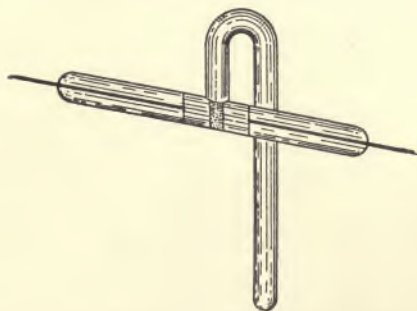

FIG. 146.—BLONDEL REGENERABLE COHERER.

tapping; these are termed self-righting, self-restoring, auto-coherers, or microphone coherers. They are far more sensitive than those requiring percussion, but this is due to the exceedingly high resistance which is a condition required in self-righting coherers. By

increasing the pressure on the filings or granules any self-righting coherer may be transformed into a percussion coherer. Carbon granules are usually employed in self-restoring coherers.

BLONDEL REGENERABLE COHERER.—Blondel's regenerable coherer. Fig. 146, was designed so that the filings in the coherer pocket could be changed, diminished or increased, after the air was exhausted from the tube. The coherer proper is similar to the

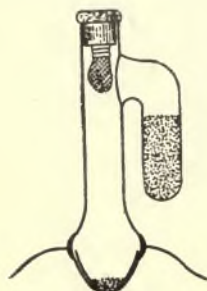

FIG. 147.—
DUCRETET COHERER.

ordinary type, but has the additional U-shaped tube blown immediately over the pocket and at right angles to it. The inverted U-tube, which is much longer at its free end than the arm connected with the pocket, contains an additional supply of metal filings, and by turning the U-tube and the coherer round the axis of the latter, the quantity of filings in the pocket may be varied. Guarini has adopted this form in his repeater system of wireless telegraphy. The Ducretet coherer is similar to the Blondel, but the pocket is V-shaped and the filings are of

hardened steel. It is shown in Fig. 147.

SCHAFFER ANTI-COHERER.—The Schaffer system is character-

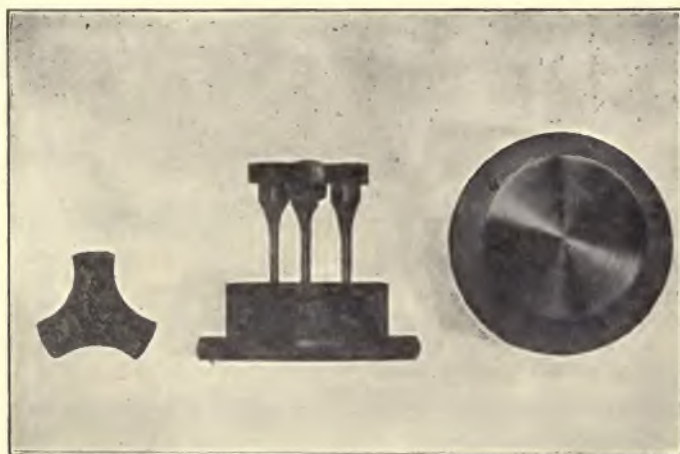

FIG. 148.—BRANLY TRIPOD COHERER.

ized by its use of an anti-coherer. It is made on the principle of the Righi coherer, but is formed of a silver deposit on glass, which is

divided by a minute air-gap made with a razor edge; it is then covered with a film of celluloid.

BRANLY TRIPOD COHERER.—The two most recent coherers are the Branly tripod and the Castelli or Italian Navy self-restoring tube. The new Branly coherer consists of two disks of metal, in one of which are fixed three metal rods forming a little tripod. The points of these rods are rounded and slightly oxidized. These rest on the second disk, which is of polished steel. The degrees of oxidation of the metal points and the polish on the steel disk are an essential factor in the resulting sensitiveness. The thin film of oxide will remain unchanged for several months. Branly devised this form to eliminate the multiplicity of contacts as in the ordinary coherer and which is the principal cause of its uneven variability. Fig. 148 shows its form.

CASTELLI COHERER.—The Castelli coherer is said to have been employed by Marconi in his recent transatlantic cableless tests, and consists of a tube, *A*, Fig. 149, with conductor plugs, *B*, *B*, formed of carbon, a central core of iron, *C*, leaving the dual pockets, *D*, *D*, to receive two drops of mercury. The tube is self-decohering and in practice it insures regularity and rapidity equal to the best auto-coherers.

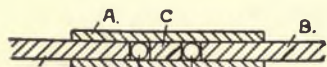

FIG. 149.—CASTELLI AUTO-COHERER.

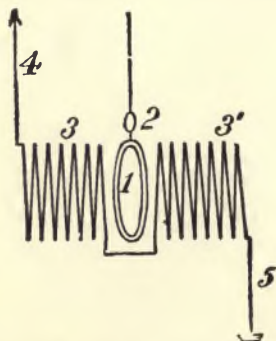

FIG. 150a.—FESSENDEN MAGNETIC DETECTOR. (Side Elevation.)

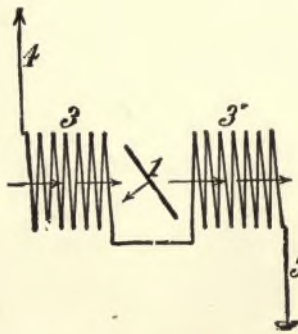

FIG. 150b.—FESSENDEN MAGNETIC DETECTOR. (Top Elevation.)

FESSENDEN MAGNETIC DETECTOR.—Fessenden employed in his earlier experiments a magnetic wave detector,¹ shown diagrammatically in Fig. 150, *a*, *b*. 1 is a small silver ring, with a mirror.

¹*Proceedings Eng. Society Western Penn.* Kintner, March 19, 1901.

2, attached to it, and the system suspended by a quartz fibre; 3, 3' are two coils of wire connected in series, the free terminals, 4 and 5, of which are connected to the vertical wire and the earth. High-frequency oscillations are set up in the coil by the impinging electric waves, the oscillations in the coils producing a magnetic field between them; as these lines cut through the silver ring, currents are induced in it having a tendency to set the ring at right angles to the surface of the coils; this is caused by the field so created tending to equalize the magnetic opposing forces. The slightest movement of the ring and mirror is easily detected and determined by means of a reading telescope and scale. A condenser of proper capacity in parallel with the windings of the coils will increase its action.

That a telephone receiver may be employed instead of the mirror and scale just described, to read the signals, the arrangement

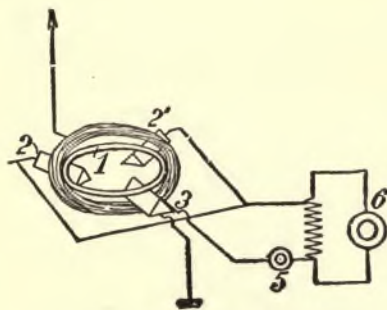

FIG. 151.—
HERTZIAN DETECTOR. (Second Form.)

shown in Fig. 151 was devised; a metal ring, 1, rests lightly on three knife edges, 2, 2', 3; two of these knife edges, 2, 2', are of metal fastened inside the larger ring, and the third knife edge, 3, is of carbon. An alternating current from a dynamo, 6, passes through a non-inductive resistance; from this a lead runs to the knife edges, 2, 2', and an opposite lead connects with the carbon knife edge, 3,

through the telephone receiver, 5. This forms a shunt from the dynamo circuit. The vertical wire is attached to the large ring, and from the carbon knife edge a terminal leads to earth.

MARCONI'S MAGNETIC DETECTOR.¹—As in those above, this detector depends upon the varying magnetic lines of force produced by high-frequency oscillations set up in the detector by waves emitted from a distant point; but there is another factor equally important in this detector, and that is hysteresis, or the **H B** curve which takes place when a piece of iron is magnetized and demagnetized. Since the ascending and descending curves do not coincide, some work must be done; this takes place in the form of heat, and this magni-

¹Journal of the Society of Arts, London. Marconi, 1902.

fies the effects of the oscillations. In construction the magnetic detector is simple; a layer of fine insulated copper wire, Fig. 152, is wound on a core made of thin iron wires. A second layer of fine insulated wire, λ , is wound on the first, forming a secondary coil. The ends of the inner or primary coil are connected with the antenna and ground.

The terminals of the secondary coil are connected in series with a telephone receiver or other suitable receiving device. In Marconi's magnetic detector a horseshoe magnet is caused to revolve before the poles of the iron core by clockwork, and a constant

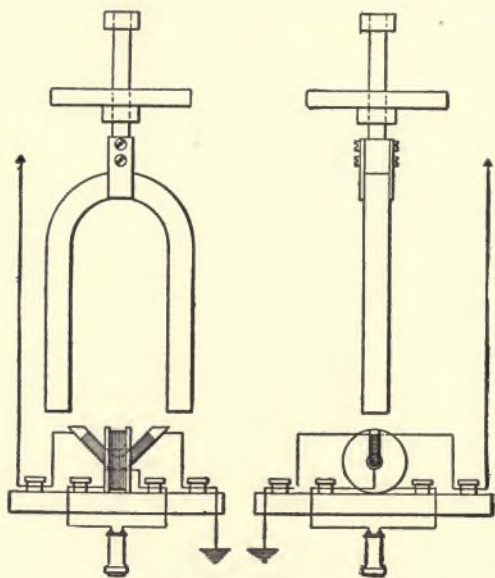

FIG. 152.—MARCONI MAGNETIC DETECTOR. (First Form.)

change occasioned by successive reversals of magnetism is produced. The magnet should be revolved very slowly, half a revolution per second, the speed being changed for different qualities of iron employed. The great advantage of the magnetic detector lies not only in its self-restoring properties, but in its resistance remaining constant during the passage of the oscillation as well as in the intermission. In this respect it will prove extremely advantageous in syntonetic wireless telegraphy. Its disadvantage lies in its limited range of usefulness, since the wide divergence between resistivity

and conductivity necessary in a detector to operate a relay is in the magnetic detector lacking, and accordingly a telephone receiver or other sensitive device must be employed in connection with it.

DEFOREST ELECTROLYTIC RESPONDER.—In the DeForest electrolytic anti-coherer the terminal conductor plugs or elec-

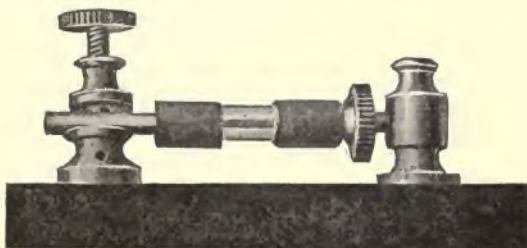

FIG. 153.—DEFOREST ELECTROLYTIC RESPONDER.

trodes employed, Fig. 153, are about an eighth of an inch in diameter and separated one-sixteenth of an inch; the oppositely

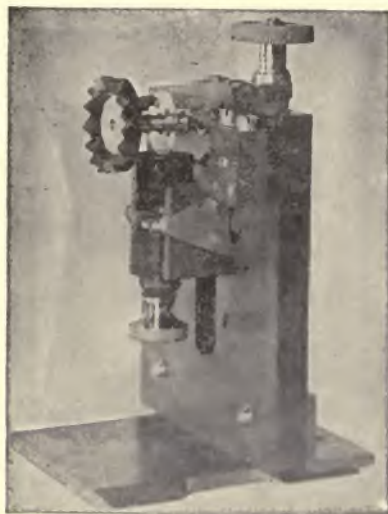

FIG. 154.—LODGE MERCURIAL COHERER.

disposed surfaces may be either smooth or roughened. A screw adjustment is provided for accurately adjusting the sensitiveness of the responder. The complete detector consists of an insulating tube

of glass or ebonite. In the interspace is the sensitive medium composed of rather coarse filings and oxide of lead in equal bulk and made into a paste by the addition of glycerine or vaseline with a trace of water or alcohol. The local current should have a small value—one-tenth to one milliampere—and a variable resistance, ranging from 0 to 15,000 ohms, is included in the circuit to obtain the proper relation of current to resistance.

LODGE MERCURIAL COHERER.—A new form of mercurial coherer brought out by Lodge is shown in Fig. 154 photographically, and in Figs. 155, *a*, *b*, in cross-section and plan and possesses several new features. It is sensitive enough for wave detection at long distances, having a variability ranging from maximum resistivity to maximum conductivity equal to the best filings coherer and

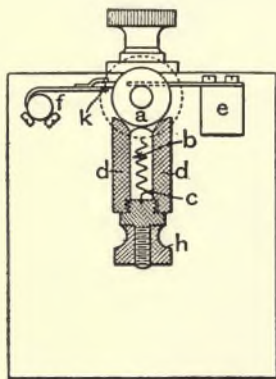

FIG. 155a.—
CROSS-SECTION LODGE COHERER.

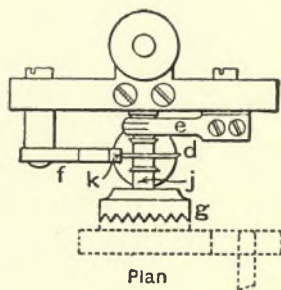

FIG. 155b.—
PLAN OF LODGE COHERER.

without the disturbing element of mechanical decohesion of the latter. The Lodge coherer is devised so that fresh and uniformly exposed surfaces are constantly in action for the process of cohesion. This is accomplished by causing a small steel disk to revolve continuously in contact with a column of mercury, between which is interposed a thin film of oil. When in action, the instant cohesion is effected between the molecules of the solid and fluid metals disruption is produced by the partial revolution of the disk when freshly exposed surfaces are brought into position ready for the next impulse. In Figs. 155 the rotary wheel is indicated by *a*; an amalgamated platinum wire spiral, *b*; *c* is the connection between the wire *b* and the binding post, *h*; *dd* is a trough of mer-

cury, the copper brush, *e*, making contact with the axle, *j*, to which the disk is fastened; a spring, *f*, having a small piece of felt, *k*, attached rests lightly on the disk, keeping its surface clean and dry. The disk is revolved by gears of ebonite operated by clockwork which also actuates a syphon recorder. The coherer is connected directly in circuit with the syphon recorder; without the interven-

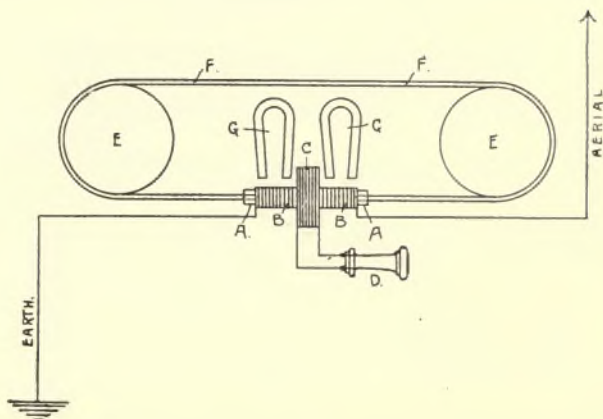

FIG. 156.—MARCONI COMMERCIAL MAGNETIC DETECTOR.

tion of a relay or other device, the local current should be kept from 0.03 to 0.5 volts; when the potential difference exceeds this the film of oil will be broken down and the recorder set in motion.

MARCONI MAGNETIC DETECTOR (SECOND FORM).—This is the commercial form of magnetic detector now employed by Marconi. It consists of a small glass tube, *AA*, on which is wound a primary made of a single layer of wire, *BB*, the terminals leading to the aerial and earth wires respectively, as shown in Fig. 156. A second coil of wire, *C*, is slipped over the primary and the terminals of this connect with a telephone receiver, *D*; two grooved wheels, 4 inches in diameter, are connected by a flexible band formed of a number of thin iron wires, *FF*, which is made to travel through the glass tube by means of a spring motor enclosed in a case.

Two steel horseshoe magnets, *GG*, are placed closely to the moving band of wire and adjusted until the maximum effect is obtained. When oscillations are set up in the resonator which includes the primary coil, *BB*, they change the magnetic intensity of the moving band of iron wire and thus currents are set up in the coil, *C*, and

the telephone receiver, *D*. The magnetic detector is shown photographically in Fig. 157.

FESSENDEN HOT-WIRE BARRETTER.—A current-operated wave



FIG. 157.—MARCONI MAGNETIC DETECTOR.

detector¹ that is more rapid and sensitive than a filings coherer, and one which does not require tapping, is the invention of Fessenden. It is shown in detail in Fig. 158, and consists of a short loop of silver wire, 1, having a diameter of .002 and having a platinum core .00006 of an inch in diameter, the terminals being fastened to the leading-in wires, 6, 6, which are sealed in the glass tube, 3. The tip of the loop is immersed in nitric acid and the silver is dissolved away, leaving a minute platinum surface exposed; this is done in order that the conductor losses will exceed the radiation losses, and to further decrease the loss of radiation by heat the loop is enclosed in a silver shell, 5, 5; the bulb is then exhausted to further increase the effectiveness of the detector.

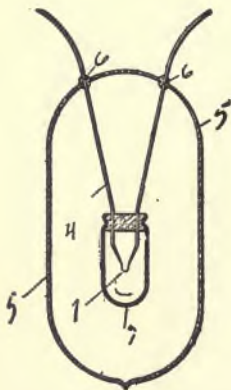

FIG. 158 — FESSENDEN HOT-WIRE BARRETTER.

¹U. S. Patent. Fessenden, N. 706,744, Aug. 12, 1902.

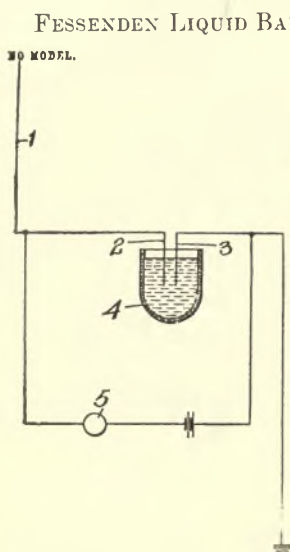

FIG. 159a.—FESSENDEN LIQUID BARRETTER.

A liquid barretter or current-actuated detector may be constructed in different forms,¹ the simplest being shown in Fig. 159a; in this case the loop of a metal barretter is cut and the terminals thus formed, 2 and 3, are immersed in nitric acid, when its sensitiveness is increased and it will act even more efficiently than before. This barretter may be connected either directly or indirectly with the vertical wire and ground as desired. Another method

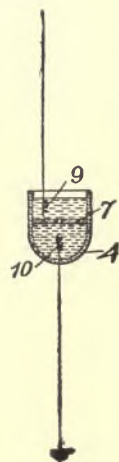

FIG. 159b.—FESSENDEN LIQUID BARRETTER.

of constructing a liquid barretter consists in forming a minute hole through a diaphragm, 7, Fig. 159b, conveniently done

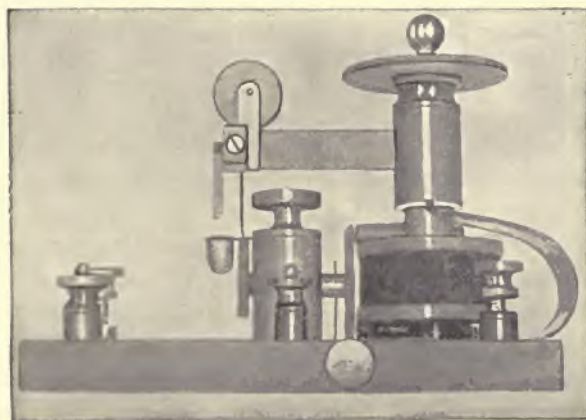

FIG. 160.—FESSENDEN LIQUID BARRETTER.

by drawing down a very thin capillary tube to about .003 of an

¹U. S. Patent 727,331. Receiver for Electromagnetic Waves. Fessenden, May 5, 1903.

inch internal diameter, cementing it into a hole in the center of a thick glass disk, and then grinding off the ends of the glass tube until they are flush with the surface of the diaphragm. The diaphragm is so arranged in a suitable vessel, 4, as to form a partition between two portions of the solution in the cup or holder, shown at *b*, so that they are separated except by the thin column of the liquid contained in the capillary tube which joins the barretter. There are several modifications of these detectors, but in every case the vital principles, i.e., "a receiver having a small heat capacity and consisting of a small quantity of liquid," are the same. The regulation type of Fessenden barretter is shown in the photograph, Fig. 160.

TESTING BOXES OR BUZZERS.—Makers of wireless telegraph apparatus furnish with each set a testing box designed for the use of the operator so that he may instantly ascertain if his coherer and relay are in working order and properly balanced for the reception of messages. With each wireless receptor a half dozen or more coherers are supplied and, assuming these to have been tested to insure sensitivity and accuracy, it is only necessary for the operator to adjust the relay to the resistance of the detector and the current of the cell included in the local circuit. This adjustment is made by a milled screw of the relay which determines the movement of the armature. To learn the degree of adjustment required the buzzer is employed.

In a box a buzzer and a dry cell are inclosed and these are connected in series with a push button arranged on top. When the test is to be made, the box, which measures approximately 3 x 4 x 6 inches, is grasped with both hands at the ends, bringing the push button directly under the thumb. The box is held immediately in front of and from 4 to 12 inches away from the coherer; the button is pressed intermittently, which actuates the buzzer, and the slight sparks produced between its contacts suffice to send out waves which, if the coherer and relay are operative, will cause the instrument to respond and its action may therefore be depended upon for distances up to 40 miles.

CHAPTER XIV.

TRANSMITTERS.

HISTORICAL.

The history of wireless telegraph transmitters for commercial purposes is necessarily brief. In 1896 Marconi constructed the first practical system for the generation and transmission of electric waves¹ to a distance. He immediately proceeded to England, where he applied for a patent. Lodge had made, prior to Marconi's application of the spark-gap principle, some purely experimental tests,² but after its actual application to telegraphy he again took up the subject, and, recognizing the value of a properly proportioned oscillator in connection with a resonator, he devised and patented an apparatus³ in 1897 which he exhibited at the Royal Society Conversazione in 1898.

Slaby and Arco of Charlottenburg, Germany, deduced certain conclusions and formulated theories for an improved transmitter employing a closed circuit oscillator, and this was described by them before the Allgemeine Electricitäts Gessellschaft, Berlin, in 1904.⁴

Marconi constructed an improved transmitter for emitting electric waves of a predetermined length, and read a paper on his method before the Royal Institution in 1902.⁵ Braun followed with his compound-circuit oscillator, in which the earth is eliminated as a factor in transmission of electric wave energy, the text of which he made public in 1902.⁶ A new transmitter, previously described, was designed by Fleming for utilizing a low-frequency, high-potential alternating current and by stepping it up by means of an oil-insulated transformer, its potential was raised

¹Marconi's British Patent. Date of application June 2, 1896; Granted July 2, 1897.

²Exhibited at the Royal Institution, June 1, 1894.

³British Patent to Lodge granted May 10, 1897.

⁴Syntonized and Multiplex Spark Telegraphy, Dec. 22, 1900.

⁵Progress of Electric Space Telegraphy. Royal Institution, June 13, 1902.

⁶Braun, Siemens and Halske Wireless Telegraph System: *Elec. World and Eng.*, June 14, 1902.

sufficiently to charge a series of condensers, which were then discharged through a spark-gap as usual, and in this manner a disruptive discharge was obtained without the induction coil and its interruptor. Fessenden had issued to him a series of United States patents in August, 1902,¹ involving many new principles, the *chef-d'œuvre* of which is a method for distributing capacity and inductance instead of localizing these coefficients of the oscillator as in previous systems; for carrying this method into practice a tuning-grid was designed rendering inductance coils and condensers no longer necessary. John Stone Stone has had issued to him a large number of patents embracing a method for impressing oscillations on a radiator system and emitting the energy in the form of waves of predetermined length whatever may be the electrical dimensions of the oscillator; and finally Anders Bull has invented an electro-mechanical transmitter² the purpose of which is to automatically send out prearranged series of wave impulses for selective wireless messages.³

PRACTICAL.

In the analysis of transmitters it will be observed that there are three systems of circuits; i.e., (1) a low-voltage direct or alternating current circuit, which includes a source of e. m. f., a key, and the primary of an induction coil; (2) a low-frequency, high-potential circuit, which connects the secondary of the induction coil with the spark-gap of the high-frequency or wave-emitting circuit—these are termed *internal circuits*—and (3) a high-frequency, high-potential circuit or *oscillator or radiator system*, as shown in Fig. 161. In some of the later transmitters there are more than

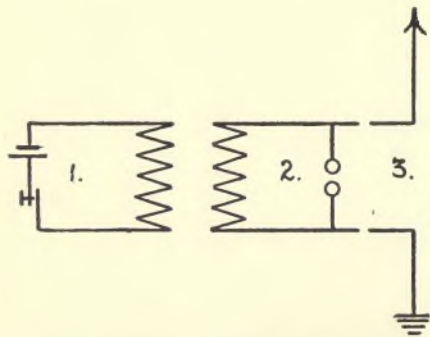

FIG. 161.—SYSTEM OF TRANSMITTING CIRCUITS.

¹Fessenden, Wireless Telegraph Patents, Aug. 23, 1902. *Elec. World and Eng.*

²See Chapter XVIII. Syntonization.

³*Scientific American*, Mar. 21, 1903.

three circuits, but those indicated in Fig. 161 are the fundamental circuits and additional ones represent transforming circuits either for frequency or potential.

CLASSIFICATION OF TRANSMITTERS.—Transmitting apparatus may be divided into two general classes:

- A.—Non-syntonized transmitters;
- B.—Syntonized transmitters;

and these classes may be further subdivided as follows:

- C.—Oscillators for high-frequency currents;
- D.—Oscillators for low-frequency currents;

Class C may be again divided into two sub-classes:

- E.—Oscillators with grounded arms;
- F.—Oscillators with ungrounded arms;

and these classes and sub-classes may comprise the following features:

- a.—Generators of the induction coil type;
- b.—Generators of the transformer type;
- c.—Spark-gap connected in series with its aerial wire and ground;
- d.—Oscillators operating through transformers;
- e.—Oscillators with open circuits;
- f.—Oscillators with closed circuits;
- g.—Oscillators with compound circuits;
- h.—Oscillators with non-tuned circuits;
- i.—Oscillators with tuned circuits;
- j.—Transmitters electrically syntonized, and
- k.—Transmitters mechanically syntonized.

Letters in the text are not indicated in the diagrams, since these do not relate to the specific parts of the emitter, but to the nature of the apparatus. The word *tuned* designates an oscillator so proportioned that its electrical dimensions correspond exactly to the frequency of the oscillations set up in it, and the term *syntonized* indicates that the coefficients of the oscillator are of the same value as that of the resonator operated in conjunction with it.

In all cases the circuits of the oscillator systems will be shown diagrammatically and drawings of the internal circuits will be given where the plans have been available.

MARCONI TRANSMITTER (FIRST FORM).—In the provisional British Patent applied for by Marconi entitled *Transmitting Electrical Signals*, and dated June 2, 1896, two forms of transmitters are covered in the specifications. In the first form, shown in Fig. 162,¹ the diagram indicates that the apparatus is non-syn-tonized (A) and the oscillators are not grounded (F); it is operated by an induction coil (*a*); the oscillator is of the closed-circuit type (*f*) and is non-syn-tonized (*h*). The feature of this transmitter is the placing of the oscillator balls forming the spark-gap in the focus or focal line of a parabolic mirror—as in Hertz's experiments—di-

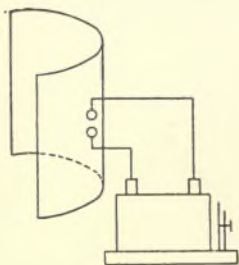

FIG. 162.—MARCONI TRANSMITTER. (First Form.)

rected toward the receiver. In this transmitter there is no vertical wire or earthed terminal. The distance to which messages could be sent was so limited that the method is not now employed.

MARCONI TRANSMITTER (SECOND FORM).—The second form of transmitter devised by Marconi is embodied in the patent specification above referred to and involves the fundamental principles utilized in all transmitters employing a disruptive discharge. It consists of a non-syn-tonized radiator (A) for high-frequency currents (C), having one arm grounded (E); it is operated by an induction coil (*a*) with its oscillator balls connected with an aerial wire and ground (*c*), forming an oscillator of the open-circuit type (*e*), which is non-tuned (*h*). The internal and oscillator circuits are shown in Fig. 163 diagrammatically, and photographically in Fig. 164. This is the first recorded instance of an aerial wire and a grounded terminal being connected in series with a spark-gap, and constitutes an invention.

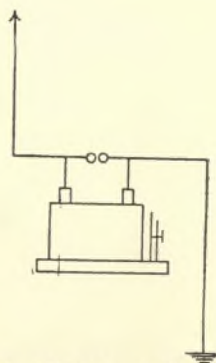

FIG. 163.—MARCONI TRANSMITTER. (Second Form.)

¹Paper by Marconi on Wireless Telegraphy. *Inst. of Elec. Eng.*

LODGE TRANSMITTER (FIRST FORM).—In a British patent granted to Lodge, May 10, 1897, and one issued to him in the



FIG. 164.—MARCONI SYSTEM.

United States for a similar device dated August 16, 1898, is described for the first time a syntonized system (B) utilizing the

coefficients of capacity, inductance, and resistance. In the Lodge transmitter, Fig. 165, a radiator consisting of a pair of capacity areas, 1, 1', made of plates of metal in the form of cones and having a definite and uniform capacity are connected with syntonizing inductance coils, 5, 5', made of a single layer of wire or metal ribbon providing the necessary inductance to effect the proper balance for a given capacity, and oscillations of a given periodicity are thus set up. The disruptive discharge takes place at 3 and the oscillations are prolonged to a certain extent; condensers, 4, 4', are inserted in the oscillator circuit, rendering the

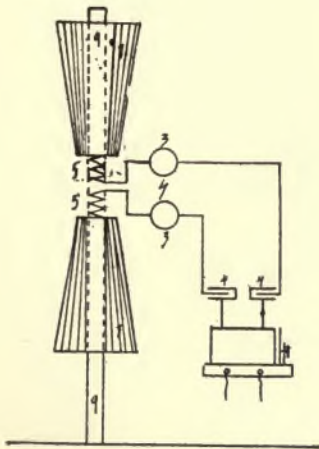

FIG. 165.—LODGE TRANSMITTER.
(First Form.)

condensers, 4, 4', are inserted in the oscillator circuit, rendering the pro-

cess of tuning easier of accomplishment. The internal circuit includes a battery, a key, and the primary of an induction coil. The frequency of the oscillations may be varied by increasing or decreasing the size of the apparatus, and therefore the values of inductance and capacity. This places the apparatus in the class of syntonized transmitters (B) and having an oscillator for high-frequency currents (C) with ungrounded arm or terminal (F); the different parts of the transmitter are characterized by an induction-coil generator (*a*) supplying energy to an open-circuit oscillator (*e*) and having tuned (*i*) and syntonized circuits (*j*).

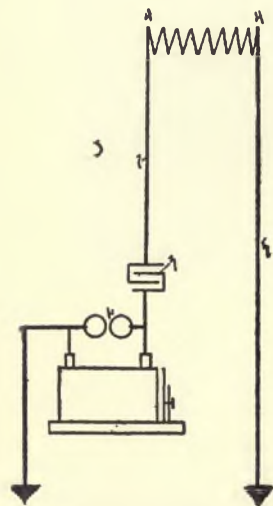

FIG. 166.—SLABY-ARCO TRANSMITTER. (First Form.)

SLABY-ARCO TRANSMITTER (FIRST FORM).—The transmitter of Dr. A. Slaby and Count Arco, shown in diagram in Fig. 166, was the first form devised by them. One arm of the oscillator is grounded; a spark-gap, 2, and a condenser, 3, are in series with the aerial wire, 1, with a choke coil, 4, intervening between the aerial wire, 1, and the return conductor, 5, which also leads to earth; the vertical wire, 4, is tuned to the frequency of the oscillations set up in it and the wire, 5,

should be one-fourth the length of the emitted wave; then if oscillations of any other frequency than those producing complete waves or four times the length of the vertical wire occur, they will either find their greatest amplitude in the coil, 4, or be dissipated in the earth at 5, and in either case they will fail to emit effective waves. The internal circuits are not shown. The oscillator system described was designed as a sytonic transmitter (B) utilizing high-frequency oscillations (C) and having grounded arms (E); it is operated by an induction coil (*a*), and the oscillator spheres are in series with the aerial wire and ground (*c*) as is the return conductor connected through the inductance coil forming a closed circuit (*f*), the whole producing a tuned system (*i*). The difficulty with this transmitter

lies largely in placing the choke-coil, 4, between the aerial wire, 1, and the return conductor, 5, since it has been shown that a closed circuit is a very feeble emitter.

SLABY-ARCO TRANSMITTER (SECOND FORM).—The new form devised by Dr. Slaby and his collaborator, Count Arco, contain the principles of a new theory evolved by them.¹ The internal circuits are shown graphically in Fig. 167, in which 1 represents the

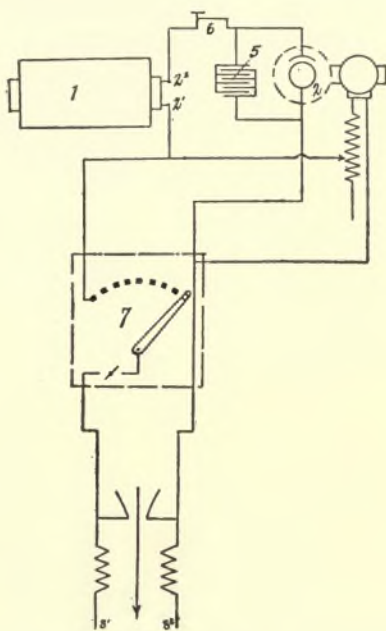

FIG. 167.—INTERNAL CIRCUITS SLABY-ARCO TRANSMITTER.

inductor of a Ruhmkorff coil connected with a mercury turbine interrupter, 2, driven by a small motor, 3, the number of revolutions being regulated by the resistance, 4. Connected in parallel with the turbine is a high-potential condenser, 5, a Morse key with magnetic blowout, 6, to prevent the fusing of the platinum contacts by heavy currents, and a resistance, 7, for regulating the current flowing in the inductor. The terminals 8, 8', connect the inductor with the source of current. A conductor represented by the arrow leads to earth and forms a lightning arrester to protect the

¹Syntonization. Chapter XIX.

apparatus from lighting should it strike the aerial, and is also useful in equalizing the high differences of potential between the apparatus and the ground. The oscillator system consists of the second-

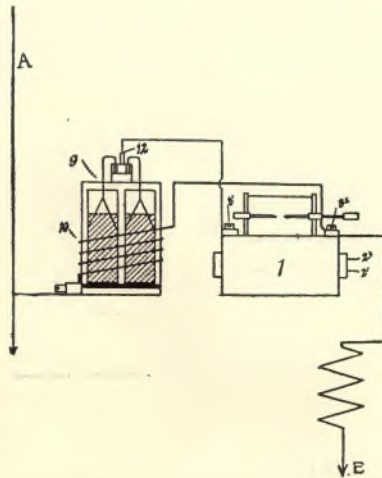

FIG. 168.—EXTERNAL CIRCUITS SLABY-ARCO TRANSMITTER.

ary terminals of the induction coil, 1, Fig. 168; the oscillator balls forming the spark-gap, 2, are immersed in oil, and the terminals are connected with the binding post, and one of these in turn is connected with the aerial wire, A, through a battery of Leyden jars, 9, and the tuning coil, 10. A well-insulated wire connects the spark-gap with the plug-plate, 12, which forms contact with the battery of Leyden jars, consisting of three, seven, or fourteen jars placed in a cylindrical pasteboard box with the tuning coil wound on the outside as shown; Fig. 169 shows a simple diagrammatic arrangement of the oscillator system with the spark-gap, 2, connected with the earth at 3; the aerial wire, 4, leads to the earth, 7, through the tuning coil, 5, the battery of Leyden jars, 6, connecting with

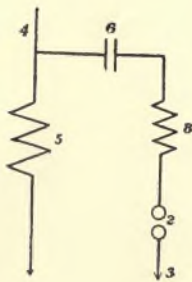

FIG. 169.—GRAPHIC REPRESENTATION OF SLABY-ARCO TRANSMITTER.

the aerial wire, 4, on one side and the inductance, 8, and spark-gap, 2, on the opposite side. The transmitter is of the

syntonized class (B), with oscillator for high-frequency currents (C), which is grounded (E); its generator is an induction coil (a) oscillator (g) and having tuned (i) and syntonized circuits (j).

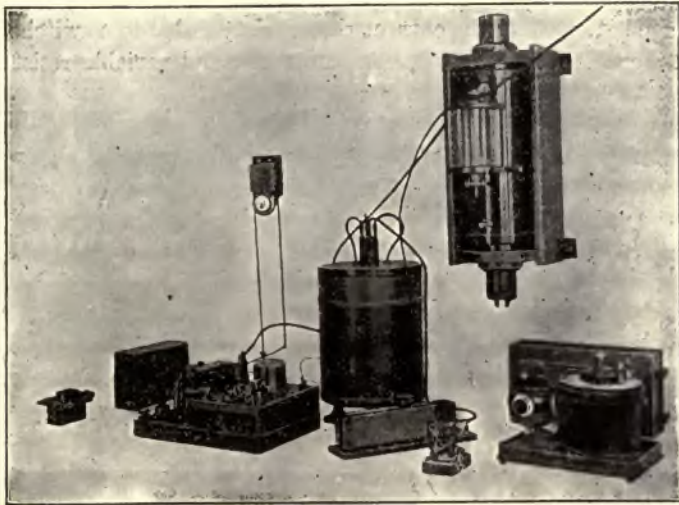

FIG. 170.—SLABY-ARCO SYSTEM.

its oscillator is connected with the aerial wire and ground (c), and is a compound circuit (g) formed of an open-circuit oscillator (e) and a closed oscillator system (f), both of which are tuned to the period of oscillation (i) and syntonized with its complementary resonator system (j). The complete apparatus is shown in Fig. 170.

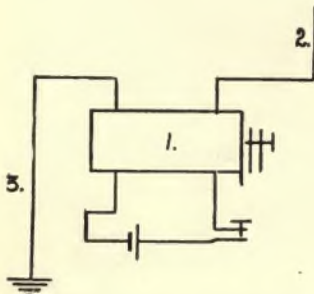

FIG. 171.—GUARINI TRANSMITTER.
(First Form.)

GUARINI TRANSMITTER (FIRST FORM).—A new form of wireless telegraph transmitter employing alternating currents of low frequency and high potential was tried by Emile Guarini Foresio, of Brussels, Belgium, in his experiments in repeating wireless messages, and is in several respects similar to the one

patented by Edison in 1888. This transmitter consists of an ordinary induction coil, 1, Fig. 171, with a mechanical interruptor. The oscillator, or more properly alternating system for radiating the en-

ergy, is connected direct to the terminals of the secondary coil and includes an aerial wire, 2, and the earthed terminal, 3; there is no spark-gap, but in other respects it follows closely the design of oscillators of the open-circuit type. The coil is operated by a 12-cell storage battery, and the current thus derived is led to a switchboard and thence through a voltmeter, ammeter, and variable resistance,



FIG. 172.—GUARINI TRANSMITTER. (First Form.)

to the primary winding of the induction coil. Since there is no spark-gap, there can be no high-frequency currents, but instead, there is a surging of the current through the aerial and ground wires the frequency of which is low, taking place synchronously with the make and break of the interrupter when the transmitter

is in action. This transmitter was employed by Guarini at his Brussels Station. It is shown in Fig. 172. It will be seen that it is a non-syn-tonized transmitter (A) having an oscillator for low-frequency currents (D), and utilizing the earth (E); it is operated by an induction coil (a) and its radiator is connected with the opposite terminal (c); it is of the open-circuit type (e), non-tuned (h).

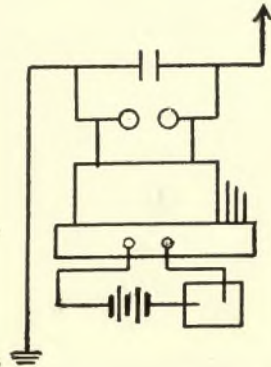

FIG. 173.—GUARINI TRANSMITTER. (Second Form.)

GUARINI AUTOMATIC TRANSMITTER (SECOND FORM).—The transmitter Guarini employed in his repeater is similar to Marconi's second form, but has a condenser placed parallel with the spark-gap to diminish the normal length of the spark and obtain a heavier discharge. The diagram, Fig. 173, depicts the general arrangements. The induction coil gave a maximum spark of 25



FIG. 174.—GUARINI REPEATING TRANSMITTER.

cm. with a current of 3 amperes and 30 volts, but during the operation of the transmitter the spark was cut down to 5 mm. Classified,

this transmitter is non-syntonized (A), and has a high-frequency oscillator (C) with a grounded arm. It likewise is operated with an induction coil (a) and its oscillator is in series with its aerial wire and ground (c); it is of the open-circuit type (e), non-tuned (h), and non-syntonized. Fig. 174 shows the automatic repeater in half tone.

MARCONI TRANSMITTER (THIRD FORM).—In a selective system patented by Marconi and described by Fleming in the *Journal of the Society of Arts*, January 4, 1901¹, and shown schematically in Fig. 175, the inventor has introduced a compound open and closed circuit oscillator system which produces the maximum penetrative efficacy of the emitted wave with its maximum persistency of oscillation. Marconi employs two copper cylinders instead of the usual aerial wire. The interior cylinder, 1, is connected to the earth at 3; surrounding the cylinder 1 is a cylinder, 2, having a larger diameter and mounted in such a manner that an air-space insulates them from each other. The exterior cylinder is connected to one side of the spark-gap, 4, and the interior cylinder to the opposite side of the spark-gap; the cylinders represent a definite capacity which is balanced by the variable inductance, 5. In action this transmitter resembles a Leyden jar of gigantic capacity and having a closed circuit; when a disruptive discharge takes place between the spark-balls, 4, the high-frequency currents flow through the compound circuits, surging many times before they are damped out by transformation into electric waves which retain in a small measure the strength of those propagated by the open-circuit oscillator, and this factor added to the persistency of the emitted waves places it in the class of syntonized transmitters having oscillators for high-frequency currents (C) with a grounded arm (E); in this transmitter an induction coil (a) is used with the oscillator connected in series with the ground (c), the system combining an open circuit (e) with a closed circuit (f), forming a compound oscillator (g). The oscillator is tuned (i) and syntonized (j)

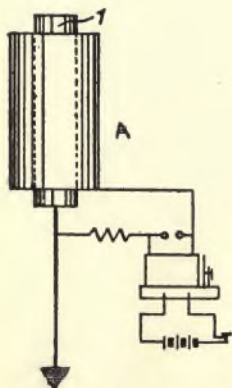

FIG. 175.—MARCONI TRANSMITTER. (Third Form.)

Fig. 175.—MARCONI TRANSMITTER. (Third Form.)

¹Elec. World and Eng., Nov. 9, 1901. Syntonic Wireless Telegraphy.

BRAUN TRANSMITTER.—A diagrammatic arrangement of the transmitter designed by Braun is shown in Fig. 176. It consists of the internal circuits, A, including the primary and secondary windings of the inductor and the open and closed oscillator circuits, B. In the internal circuit a modified Wehnelt electrolytic interruptor designed by Simon is used, or where a low-voltage current only is available a mercury turbine interruptor is employed. A special key is inserted in the primary circuit capable of breaking up a current of 50 amperes into dots and dashes without danger. The secondary terminals, 2, are connected to either side of the spark-gap. The closed-circuit oscillator consists of a series of miniature Leyden jars arranged in two sets of twenty tubes each and connected in series with the spark-gap and primary

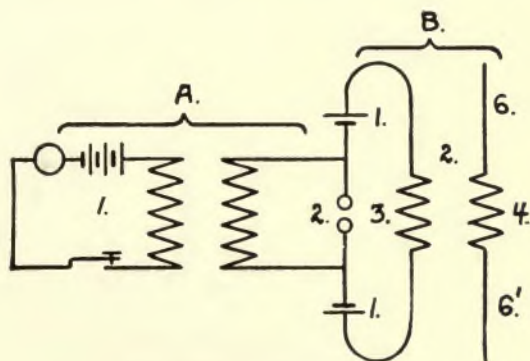

FIG. 176.—BRAUN TRANSMITTER.

winding of a transformer which also acts as an inductance. The secondary of the transformer is connected with two conductors, 6, 6', both of which are one-fourth the length of the emitted wave, the whole forming an open-circuit oscillator one of which serves as the aerial wire emitting long powerful waves.

The lower conductor, 6', is usually wound in a coil, but having the same electrical dimensions as the aerial wire, and in order to eliminate the earth as a factor this conductor is attached to a capacity area such as a metal cylinder.¹ When in action the persistent oscillations produced in the closed oscillator circuit are transformed to any potential desired through the transformer, setting up in the open-circuit oscillator system a practically constant amount of

¹Aerial Wires and Earths.

energy, giving rise, therefore, to pure sine waves. This transmitter is of the syntonized class (B) with high-frequency circuits (C), which are not grounded (F); an induction coil (*a*) is used to transform the current in the first cycle of operations. A distinct open-circuit (*e*) and a closed-circuit (*f*) forms a compound circuit

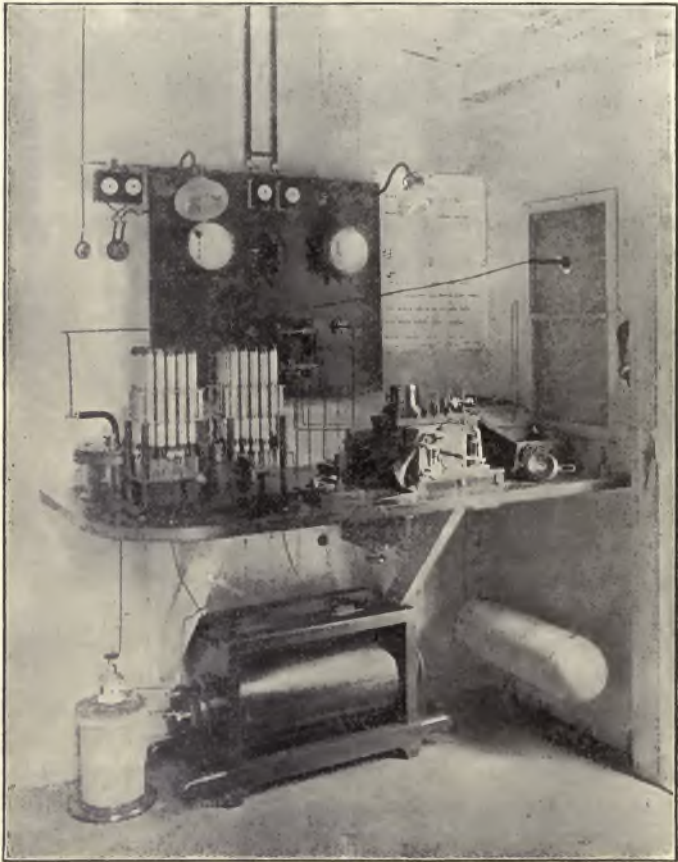

FIG. 177—BRAUN-SIEMENS AND HALSKE SYSTEM.

oscillator (*g*), the operation taking place through a transformer (*d*), and these are tuned (*i*) and syntonized (*j*) for selective signaling. A photographic view of the Braun-Siemens and Halske system is given in Fig. 177.

MARCONI TRANSMITTER (FOURTH FORM).—The fourth system devised by Marconi to solve the problem of syntononic wireless telegraph-

raphy resulted in the arrangement shown in Fig. 178. In assembling the apparatus for fulfilling the conditions required by theory it is necessary that the closed-circuit (B) and the open-circuit (C) should be tuned to the same period of oscillation—or, as Marconi terms it, octaves. Unless these conditions of the coefficients are fulfilled the different periods of the (B) and (C) oscillators will set up currents each of a different frequency and phase, with the result that these will conflict, and in so doing energy will be wasted and enfeebled waves will result.

The object of the variable inductance A in the open-circuit, then, and the condenser, *e*, is to enable the adjustment of the two circuits so that they will have the same natural periods and the currents in them will be in the same phase. The classification of this transmitter places it in

the syntonistic class (B), having oscillators for high-frequency currents (C) with one arm grounded (E). An induction coil (*a*) is

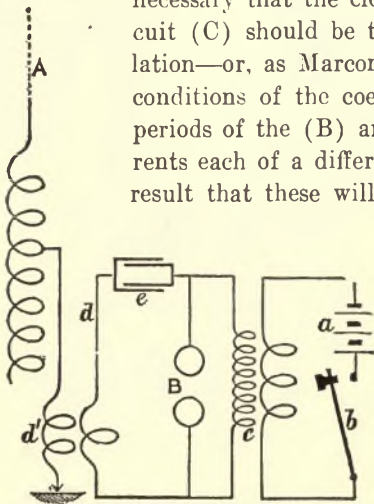

FIG. 178.—MARCONI TRANSMITTER. (Fourth Form.)

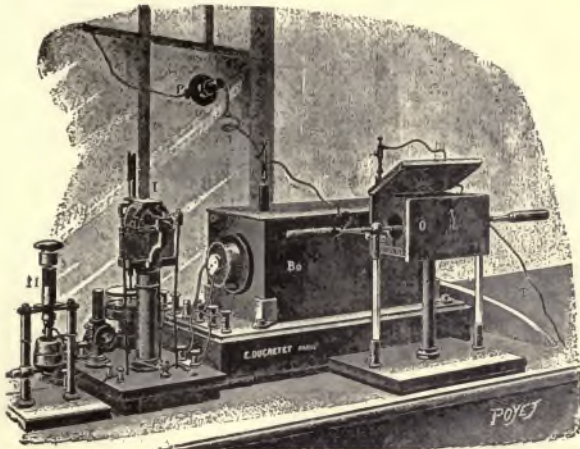

FIG. 179.—POPOFF-DUCRETET TRANSMITTER.

used to charge the oscillator, which is connected in series with the radiator and ground (*c*); the open-circuit (*e*) and closed-circuit

(*f*) oscillators operate through a transformer (*d*), forming a compound circuit (*g*). The oscillators are tuned (*i*) and the trans-

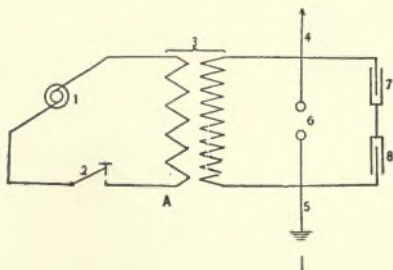

FIG. 180.—DE FOREST TRANSMITTER.

mitter synchronized (*j*) for actuating a complementary synchronized receiver.

POPOFF-DUCRETET TRANSMITTER.—The transmitter designed by Ducretet as the complementary apparatus for Popoff's receptor is shown in Fig. 179 and is of the ordinary induction coil, open-circuit oscillator type, similar to Marconi's second form of sending instrument. The spark-gap is inclosed in the box, *o*, the induction

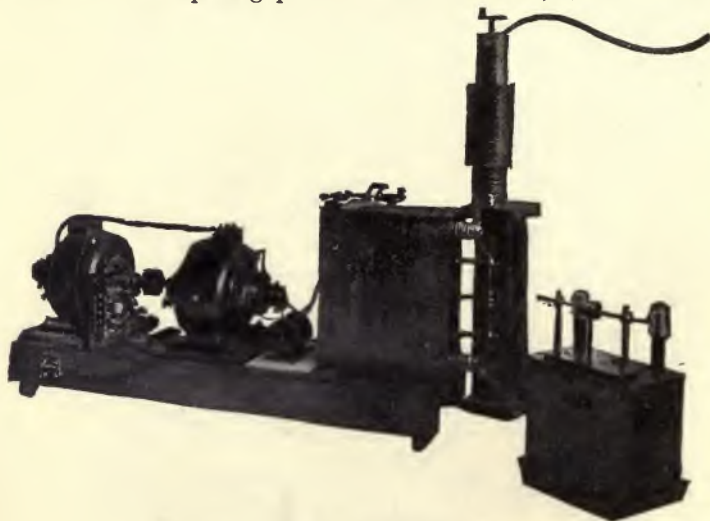

FIG. 181.—DE FOREST TRANSMITTER.

coil is represented at *Bo*, the motor operated mercurial break at *I*, and the key for making and breaking the primary coil at *M*.

DEFOREST TRANSMITTER.—The DeForest transmitter is shown

in diagram in Fig. 180 and in half-tone in Fig. 181. The transmitter is based on Fleming's design and employs a primary alternating current instead of a direct current, and a transformer instead of an induction coil. In Fig. 180 an alternating-current generator, 1, working at 500 volts, supplies energy to an oil-insulated transformer, 3, which converts it to a pressure of 25,000 volts at the secondary terminals; a key, 2, serves to break up the primary current into the Morse code; the terminals of the secondary connect with the spark-gap, 6, of the oscillator system, which comprises the vertical wire, 4, the earthed terminal, 5, and the condensers, 7, 8; in action the

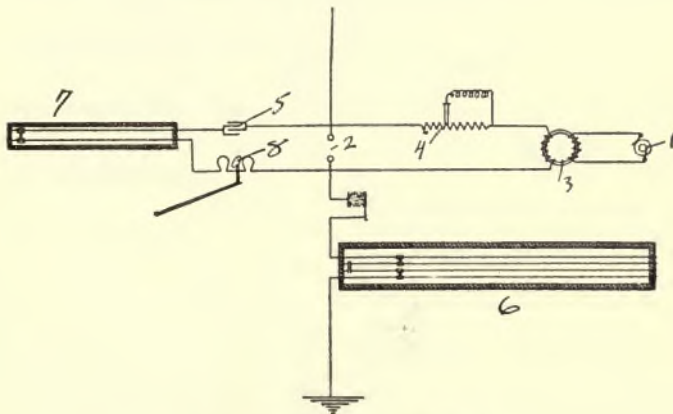

FIG. 182.—FESSENDEN TRANSMITTER.

high-potential currents charge the condensers 7, 8, and these discharge through the spark-gap, 6. This scheme eliminates the interruptor of the induction coil type of generators and gives a heavy discharge between the spark-balls. This transmitter is in the non-synchronized class (A) with a high-frequency oscillator (C), and grounded arm (E); generator of the transformer type (b) and oscillators connected with the aerial wire and ground (c) having an open circuit (e) and non-tuned circuit (h). It is at once a simple and a powerful radiator of electric waves.

FESSENDEN TRANSMITTER.—Fessenden has invented a transmitter that is constructed with special reference to tuning, speed in transmission and economy of operation. It is shown in the diagram Fig. 182 and in the photograph 183. In the diagram 1 represents a source of e. m. f., 2, a spark-gap, 3, an induction coil which is kept constantly in action; 4, a non-inductive resistance, 5, a con-

denser, 6 and 7, tuning grids formed of one or more movable contacts to each pair of wires which are immersed in oil. The tuning grid embodies novel features, combining as it does a variable inductance and capacity without resorting to either coils or condensers; the

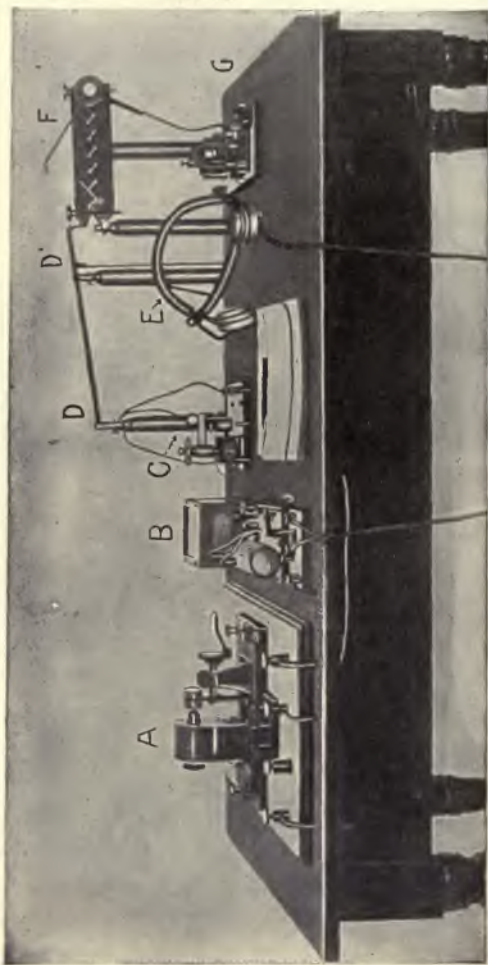

FIG. 183.—FESSENDEN SYSTEM.

grid is simply formed of parallel wires, the oil having a high dielectric capacity. As it is a syntonie emitter, it belongs in the (B) class, and has a high-frequency oscillator (C) with grounded arm (E); an induction coil generator (a) supplies a high-potential current to the oscillator in series with aerial and ground wire (c), forming an open-current system (e) tuned (i) and syntonized (j). By adjusting the grid any frequency of oscillation within range of the instrument may be obtained.

POPP - BRANLY
TRANSMITTER.
—The transmitter designed by M. Vic-

tor Popp and Prof. Eduard Branly, of Paris, is shown in Fig. 184; it consists of an induction coil placed end-on in a case with the secondary terminals leading to a spark-gap as shown; one side of the spark-gap is connected to the aerial wire and the opposite side

leads to earth. The terminals of the primary coil are connected to a mercury turbine interruptor operated by a small motor. The

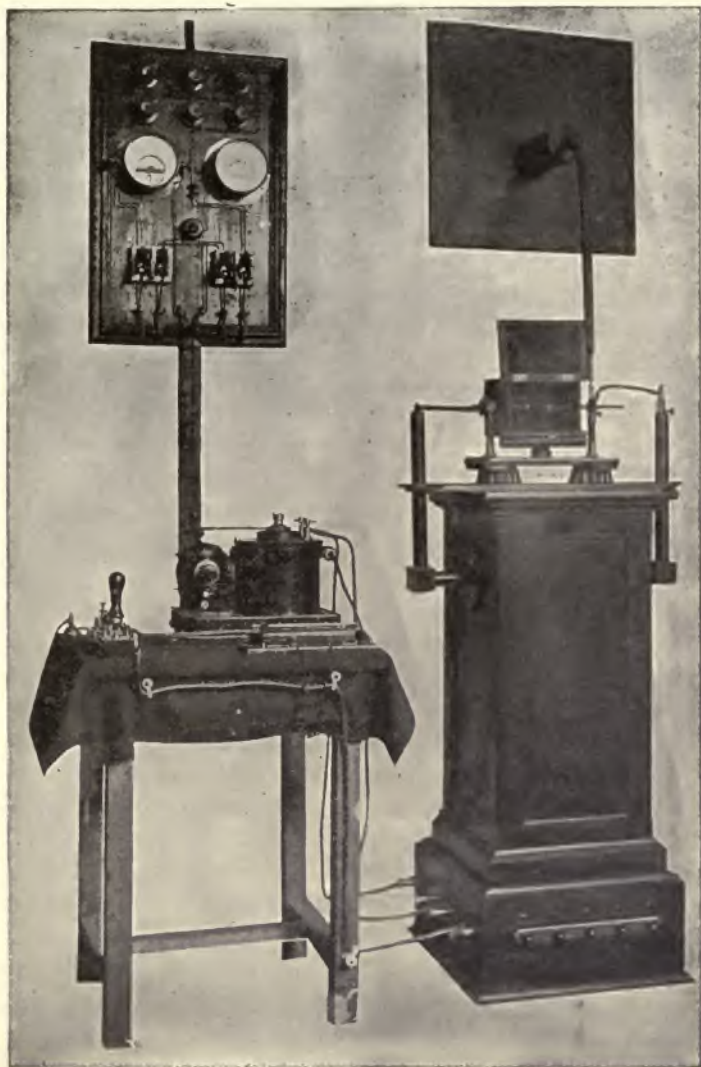

FIG. 184.—POPP-BRANLY TRANSMITTER.

transmitter is of the non-syntonized type (A) with oscillator for high-frequency currents (C) having a grounded arm (E). Its

generator is an induction coil (*a*), the spark-gap of which is connected with an aerial wire and ground, forming an open-circuit oscillator (*e*), which is non-tuned (*h*).

CERVERA TRANSMITTER.—A transmitter designed by Senor Julio Cervera Bavaria¹ for the Spanish government is shown diagrammatically in Fig. 185; its chief

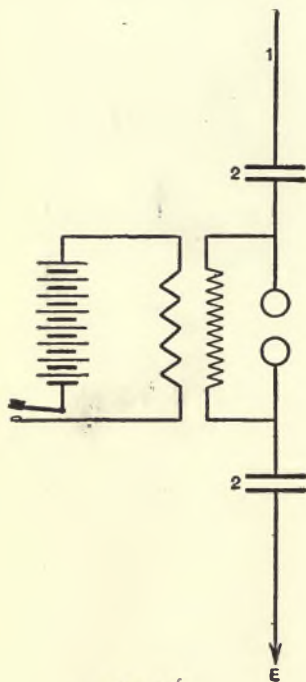

FIG. 185.

feature is an oscillator system in which the radiating wire is of exceedingly small diameter, the capacity of which is increased by connecting in series, on opposite sides of the spark-gap condensers, 2, 2'; it has been shown that a fine wire will radiate all the energy it can be supplied with. A switch is provided for throwing in the condensers when the transmitter is in operation and cutting them out when the receiver is connected to the aerial and ground wire. A keyboard similar to a typewriter keyboard was used in conjunction with the transmitter, and when a key, corresponding to the letter to be sent, is depressed, dots or dashes in the Morse code resulted and the impulses they represent were transmitted. It is a simple non-sintonized emitter (A) with high-frequency oscillator (C), and having a grounded terminal (E); an induction coil (*a*) charges the oscillator formed of a spark-gap connected in series with its vertical wire and ground (*c*), constituting an open-circuit system (*e*), non-tuned (*h*) and non-sintonized.

LODGE-MUIRHEAD TRANSMITTER.—In the new Lodge-Muirhead commercial system² two forms of oscillator systems have been used and these are modifications of Lodge's original transmitter. In Fig. 186 a spark-gap, *s*, is connected in series with the aerial wire *a*, and having a variable capacity in the form of a condenser interposed

¹*Electrician* (London), April 18, 1902. Wireless Telegraphy in Spain. Guarini.

²*Elec. World and Eng.* Lodge-Muirhead System, Collins, Aug. 1, 1903.

at x ; the opposite arm includes the inductance coil, i , a condenser, x , and grounded terminal, E ; this system may be supplied with energy by means of an ordinary induction coil or the condensers may be charged by the secondary current of a commercial transformer, when they will discharge through the spark-gap. The compound oscillator system, Fig. 187, comprises an open and closed circuit; the aerial wire, a , in this case is connected with the earth through the primary of a high-potential transformer and a condenser x ; the secondary coil forms a closed circuit in which is included a pair of oppositely disposed condensers and the primary of an induction coil or a transformer operated by a commercial

FIG. 186.—LODGE-MUIR-HEAD TRANSMITTER. (First Form.)

alternating current; the oscillator spheres are in shunt with the closed circuit. The system shown in Fig. 186 is syntonized (B) with oscillator for high-frequency currents (C), and has one arm grounded; a generator of the induction coil type (a) or of the transformer type (b) may be used; the aerial wire and ground are connected with the spark-gap, c , forming an oscillator of the open-

circuit type (e), which is tuned (i) and syntonized (j). The compound oscillator is in the (B) class, i.e., syntonized with high-frequency oscillator (C), which is grounded (E); an induction coil (a) or transformer (b) may be employed, and the spark-gap, aerial wire, and ground are in series (c), forming an oscillator of the compound type (g), operating through a transformer (d); both the open-circuit oscillator system (e) and the closed-circuit system (f)

are tuned (i) and syntonized (j). A Morse key, automatic machine, and perforator are used in connection with the low-tension circuits, and the local circuit includes a "buzzer," the purpose of which is to open and close the primary circuit of the induction coil so that a definite frequency is obtained. The photograph, Fig. 188, is an excellent illustration of the Lodge-Muirhead system.

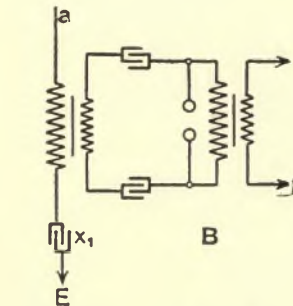

FIG. 187.—LODGE-MUIR-HEAD TRANSMITTER. (Second Form.)

BULL TRANSMITTER.—The Bull transmitter¹ is an electro-mechanical device designed especially for selecting wireless telegraphy. Its oscillator is of the non-syntonized class (A), designed for high-frequency currents (C), and has a grounded arm (E), as in other simple systems. It employs an induction coil (*a*) energizing the aerial wire and earthed terminal, forming the oscillator (*c*), which is of the open-circuit type (*e*), non-tuned (*h*), but with its mechanical devices the transmitter is mechanically syntonized.

MARCONI TRANSATLANTIC CABLELESS TRANSMITTER.—The first cableless signal transmitted across the Atlantic Ocean was emitted by an enormous plant developing energy equivalent to twenty-five

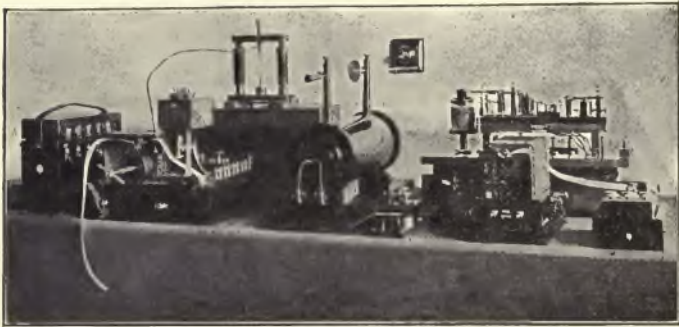

FIG. 188.—LODGE-MUIRHEAD SYSTEM.

horse power and installed at Poldhu, Cornwall, England. The commercial cableless station erected at Tablehead, Glace Bay, Nova Scotia, is equipped with a generator connected to a forty horse-power engine and the one at South Wellfleet, Mass., develops one hundred horse-power. In these great transmitters the engines are coupled with alternating-current dynamos generating electricity at a pressure of 2,000 volts, which is then converted by oil-insulated transformers to a potential of 100,000 volts; a battery of oil condensers is constantly charged by this high-voltage current, and these discharge through a spark-gap formed by the terminal of the aerial and the ground wire. Thus the designing of long-distance transmitters has been resolved into a comparatively simple engineering task involving the transformation of low-potential, low-frequency currents into high-potential, high-frequency oscillations.

¹Syntonization, Chapter XIX.

CHAPTER XV.

RECEPTORS.

HISTORICAL.

The first complete receiving and indicating device for electric waves was not applied to wireless telegraphy, but for meteorological determinations. In 1888 Hertz obtained calculations at a distance of a few feet with his ring detector. Lodge in 1894 showed how a coherer connected with a galvanometer could be used as a receiver when placed a distance of 500 feet from the source of the waves. Prof. Popoff, of Cronstadt, designed a receptor for the study of atmospheric electricity in 1895, and this arrangement forms the earliest record of the application of an aerial wire or antenna connected with a detector and the earth. Prof. Rutherford, of Montreal, in 1896, constructed a magnetic detector and with suitable auxiliary appliances forming a receptor obtained signals at a distance of 2,500 feet.

In his experiments in Italy, Marconi in 1895 employed a coherer with one of its conductor plugs connected with an elevated capacity, the opposite terminal of the detector being earthed.¹ The first tests by Marconi, in England, in 1896, were, however, executed without recourse to the antenna and earthed wire, but by concentrating the received waves in the focus of a parabolic mirror containing the detector. From the records it seems that Marconi was the pioneer in utilizing the Morse register in combination with a detector and relay. The history of wireless telegraph receptors is analogous to that of transmitters, since in nearly every case inventors of transmitters designed complementary apparatus for the reception and indication of the waves; thus Lodge gave to the world the first syntonistic receptor or resonator simultaneous with his tuned transmitter (1898), the result being a complete syntonistic system of wireless telegraphy. Upon the discovery that carbon and some of the metals were self-restoring, the telephonic receptor came into use.

Wireless Telegraphy, Marconi. *Institution of Elec. Engs.*, March 2, 1899.

The Slaby-Arco and Braun systems of Germany, the Popoff-Decretet of France, and other makers use this type of detector in combination with telephone receivers for portable receptors. Fessenden's barretter is an auto-detector, as is the DeForest electrolytic responder. Marconi's cableless stations are equipped with telephonic receptors, and the signs of the time point to its ultimate adoption as the successor of the Morse register type. An electro-mechanically operated receptor for wireless telegraphy has been constructed by Anders Bull and is the latest addition to the art.

PRACTICAL.

The term receptor will be used where it is intended to designate a complete receiving apparatus. Receivers refer to individual parts of receptors such as telephone receivers, *et cetera*. Receptors comprise two principal circuits, i.e., (1) a milli-ampere, low-voltage direct-current circuit shown at 1, Fig. 189, operating a relay or telephone receiver, *a*, by means of the cell, *b*, through the detector, *c*, and (2) a high-frequency circuit which includes the aerial wire, *2*, detector, *2'*, and grounded terminal, *2''*; upon this circuit the electric waves impinge, when they are transformed into electric oscillations. The first is termed an *internal circuit*, and the second a *resonator system*. There may be one or more internal circuits and more than one resonator system, but the two circuits indicated in the diagram are the principal ones.

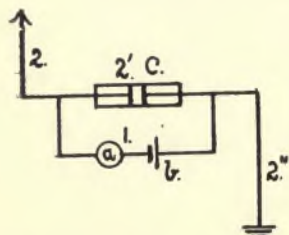

FIG. 189.—SYSTEM OF RECEIVING CIRCUITS.

CLASSIFICATION OF RECEPTORS.—Receptors may be divided into the following classes:

- A.—Non-syntonized receptors.
 - B.—Syntonized receptors.
- And these classes may be again indicated thus:
- C.—Resonators with grounded arms.
 - D.—Resonators with ungrounded arms.
 - E.—Receptors with visual recorders.
 - F.—Receptors with telephonic receivers.

These classes may consist of the following appliances:

- a.—Detectors operated by voltage.
- b.—Detectors operated by current.

- c.*—Resonators connected in series with antennæ and grounds.
- d.*—Resonators operating through transformers.
- e.*—Resonators of the open-circuit type.
- f.*—Resonators of the closed-circuit type.
- g.*—Resonators of the compound-circuit type
- h.*—Receptors with non-tuned circuits.
- i.*—Receptors with tuned circuits.
- j.*—Receptors electrically syntonized.
- k.*—Receptors mechanically syntonized.

Combinations of these various factors make up a great variety of receptors differing widely in detail, arrangement and specific purpose, yet all are dependent on the same sources of energy for their operation.

POPOFF RECEPTOR.—The receptor designed by Popoff in 1895 consisted of a coherer, 1, Fig. 190, one terminal of which was con-

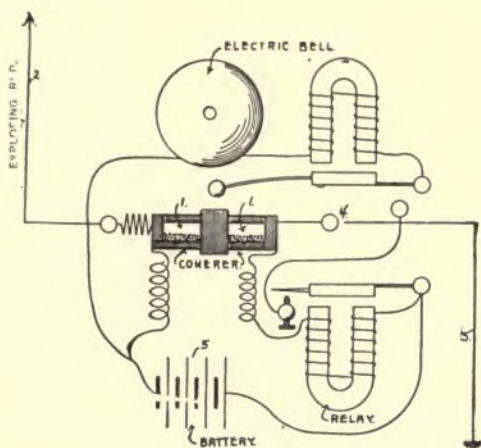

FIG. 190.—POPOFF RECEPTOR.

nected to an exploring rod, 2, or antenna, as it is now termed, the opposite terminal, 3, leading to the earth through the coherer and spark-gap, 4; these oppositely disposed coherer terminals were connected in series with a relay through a cell, 5, and in an auxiliary circuit there was included a bell, the tapper of which served also

to decohere the filings.¹ Thus the first actual long-distance receptor may be classified as a non-syn-tonized system (A) with a resonator having one terminal grounded (C); though no Morse register was used, it had all the elements of the (E) type, except the register itself. The apparatus in the internal circuit was actuated by a voltage-operated detector (*a*) of the coherer type, and this was connected in series with the antenna and ground (*c*), forming an open-circuit resonator (*e*), the whole comprising receptors with non-tuned circuits (*h*). The Popoff receptor formed the foundation for those of every system since devised where Morse registers are used.

MARCONI RECEPTOR (FIRST FORM).—The earliest form of receptor designed by Marconi is shown diagrammatically in Fig. 191.

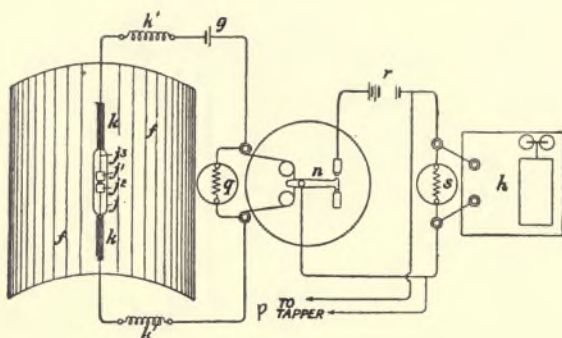

FIG. 191.—MARCONI RECEPTOR. (First Form.)

It consisted of a coherer, *j*, *j*¹, *j*², *j*³, connected with a polarized relay, *n*, and a dry cell, *g*, in series with the non-inductive resistances or choking coils, *k*¹, *k*¹, so that the sparking of the contacts of the relay which sets up oscillations in the local circuit may be annihilated or “choked” before they reach the coherer, and again these choking coils compel the oscillations set up in the resonator system to traverse the coherer instead of wasting their energy in following the alternative path which includes the relay. Non-inductive resistance coils are also inserted in shunt at *q* and *s*, so that there may be no electrical disturbances by the local battery near the coherer, which otherwise would retard the detector in regaining its high resistance after the action of the oscillations. The relay causes the current from the battery, *r*, to pass through the tapper, *p*, and

¹Elektritchestvo, St. Petersburg, July, 1896.

also through the electro-magnets of the sounder, *h*. The tapper or decohering device is adjusted so that it will tap back the filings to their normally high resistance; when the impinging waves on the resonator system are converted into oscillations the coherer permits the current to flow through the circuits, and this causes the delicately poised armature of the relay and tapper to vibrate rapidly and in unison with each other; when the coherer closes the circuit the relay armature is drawn into contact, and, closing the second local or internal circuit, starts the tapper; the tapper in turn, by decohering the filings, stops the action of the current and the operation of the relay. In the sounder first employed and the Morse register since used, the levers are arranged to have a high time constant compared with the armatures of the relay and tapper, and the former, in virtue of its great inertia, cannot, therefore, follow the rapid movements of the latter, so that when a series of waves are received representing a dash in the Morse code the armature or lever of the recorder remains down until the cessation of the

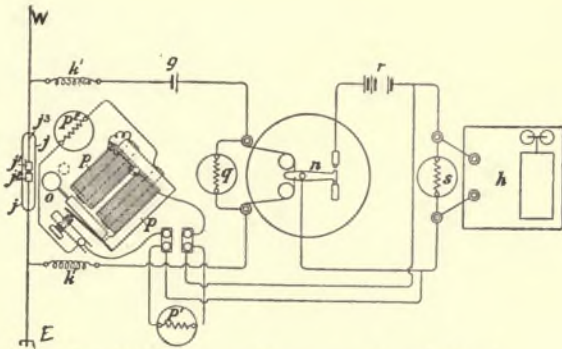

FIG. 192.—MARCONI RECEPTOR. (Second Form.)

waves; a dot is registered in the same way, but, the waves being of shorter duration, the lever is held down a shorter time. In this receptor a parabolic reflector was employed to receive the impinging waves and concentrate them upon a small resonator formed of copper plates, *k k*; it was designed to be used in connection with the Marconi transmitter (Fig. 162). It will be observed that it is in the class of non-syntonzed receptors (A), having an ungrounded

arm (D) and employing a Morse register (E). The indicator is operated by a voltage detector (*a*) of the coherer type, and the resonator is of the closed-circuit type (*f*), the circuit of which is non-tuned (*h*). Theoretically, the choke coils, *k k*, place the resonator in the open-circuit class (*e*), but the general design is that of a closed-circuit system. All receptors giving visual indications by means of Morse registers are constructed upon practically the same lines as the one just described.

MARCONI RECEPTOR (SECOND FORM).—In the second form of receptor designed by Marconi and shown in Fig. 192, the resonator system is formed by an antenna extending into the air and supported by a mast, balloon, or kite, one terminal of which is connected to the coherer, the opposite conductor plug forming connection with the earth at *E*. An open-circuit resonator is thus obtained and practice has indicated this to be best adapted to the requirements of long-distance wireless telegraphy. The arrangement of the tapper



FIG. 193.—MARCONI INSTALLATION AT BABYLON, L. I.

with the extra choke-coils, p^1 , p^2 , are here represented together with the additional connections required to complete the equipment; in all other respects the receiver is the same as that just described. In the photograph shown in Fig. 193 it will be observed that the

apparatus is inclosed in a metal box; the object of this arrangement is to preclude extraneous waves from impinging on the wires of the internal circuits and thus set up oscillations and miniature trains of waves.

LODGE RECEPTOR.—Early in the art Lodge, recognizing the importance of sending and receiving selective messages, designed a system to fulfill these requirements. The receptor illustrated in Fig. 194 consists of a resonator system for the reception of electric waves of a definite length and converting them into oscillators of a given frequency. In nearly all receptors the resonator is merely a counterpart of the oscillator or complementary appliance, having about the same electrical proportions as the oscillator system with which it is so closely allied. The resonator system employed by Lodge is made by connecting two capacity areas, 1, 1', together by an inductance coil, 6; this inductance also serves as the primary coil of a small transformer, the secondary, 7, of which is connected in series with the coherer, 8. The recording apparatus is similar to that shown

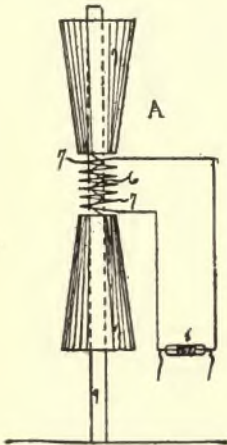

FIG. 194.—LODGE RECEPTOR.

in Fig. 192. The capacity areas are of metal, either zinc or copper, and are cone-shaped. This receptor is in the syntonized class (B) and the post, 9, insulates the capacity areas from the earth so that the resonator is ungrounded (D). A Morse register (E) indicates the message, through a voltage-operated detector (a); the resonator has two circuits operating through a transformer (d); utilizing the properties of both the open-circuit (c) and the closed-circuit resonators (f) and giving it a compound character (g); these circuits are not only tuned (i), but syntonized (j).

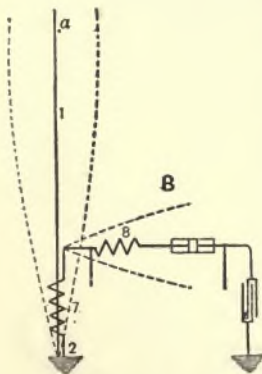

FIG. 195.—SLABY-ARCO RECEPTOR.

SLABY-ARCO RECEPTOR.—The Slaby-Arco multiple-tuned receptor is based on a number of original conclusions bearing on the laws of electrical resonance. In Fig.

195, the antenna is shown at 1, leading to the earth at 2. A second or auxiliary wire representing the same inductance, capacity, and resistance as the antenna is connected with it at the point of contact with the earth or nodal point; in the receptor the wire terminates in the coherer, the opposite terminal leading to earth through the condenser. The internal circuits are shown in Fig. 196; the

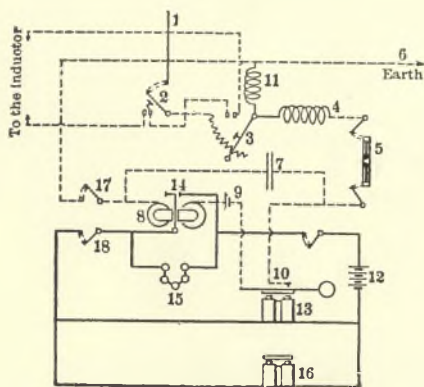

FIG. 196.—INTERNAL CIRCUITS.

antenna is connected with the relay as indicated by the dotted lines, while the heavy lines illustrate the circuit which includes the relay, tapper, and Morse register; 1 is the antenna, 2 a cut-out, and 3, 4, 5, 6, and 11 the circuit comprising the resonator. The relay, 8, is operated by the cell, 9, which leads through the magnets of the tapper, 10, to the coherer, 5, the circuit being completed through the inductance, 4, and the coil connected with the earth terminal, 11, the return leading to the relay. The second internal circuit includes the battery, 12, the tapper, 13, the relay working contact, 14—including the tongue—the polarizing battery, 15, the elements of which are connected in parallel, and the Morse register, 16. The resistance of the Slaby-Arco coherer is about 2,000 ohms and the relay is wound to about the same resistance; it is of the Siemens polarized type. The receptor is syntonized (A) with grounded-arm resonator (C) and operates a Morse register (E); the coherer (*a*) is connected in series with the antenna and ground (*c*) and has resonators of the open circuit type (*c*) and closed circuit type (*f*) both of which are tuned (*i*) and syntonized (*j*).

BRAUN RECEPTOR.—The resonator system of the Braun receptor

is shown in Fig. 197, in diagram. The antenna, *A*, upon which the waves impinge sets up oscillations in the closed resonator formed by the condensers, *c*, *e*, and the inductance coil, *t*, which also acts as

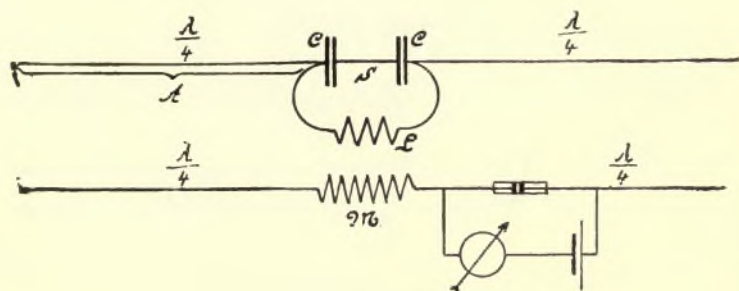

FIG. 197.—BRAUN RESONATOR.

the primary of a small transformer coil. The addition of a second conductor, *B*, equal to $\frac{\lambda}{4}$ the received wave, gives the proper electrical symmetry to the primary open circuit, whereby pure resonance

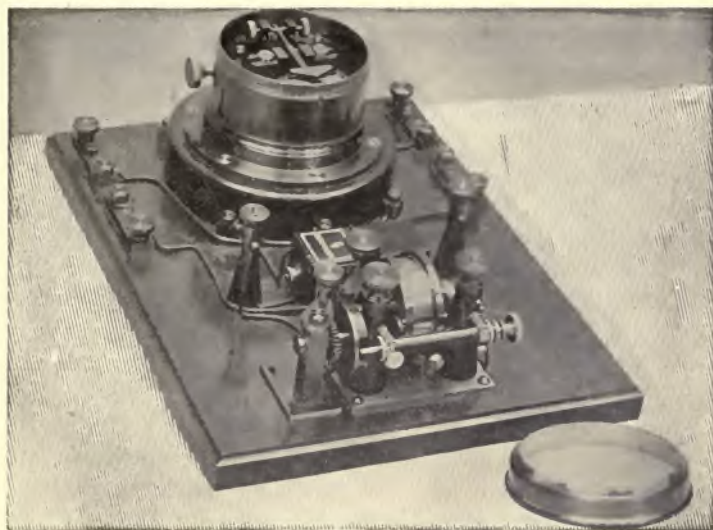

FIG. 198.—BRAUN RELAY, TAPPER AND COHERER.

effects are obtained. The second conductor, *B*, instead of being grounded as is ordinarily the case, is a short piece of wire attached to a cylinder which acts as a capacity replacing both the wire and the

earth itself in so far as the coefficients of either are concerned. The polarized relay, the taper, and coherer are clearly shown in Fig. 198; the relay is of the Siemens type with permanent magnets, the magnet coils of which are wound to high sensitiveness. The taper differs from those of electro-mechanical construction in that it is merely actuated and not operated by an electric current, its energy being imparted by a spring motor. The Braun receptor involves the principles of the syntonized class (B), the resonator system is ungrounded (D), and the receptor indicating the message by means of a register (E); it employs a coherer (*a*) and its resonator operates through a transformer (*d*); the resonators follow the *e*, *f*, *g* classes in that they are open, closed and compound; the circuits are tuned (*i*) and syntonized (*j*). A Braun portable receptor is illustrated in Fig. 199.

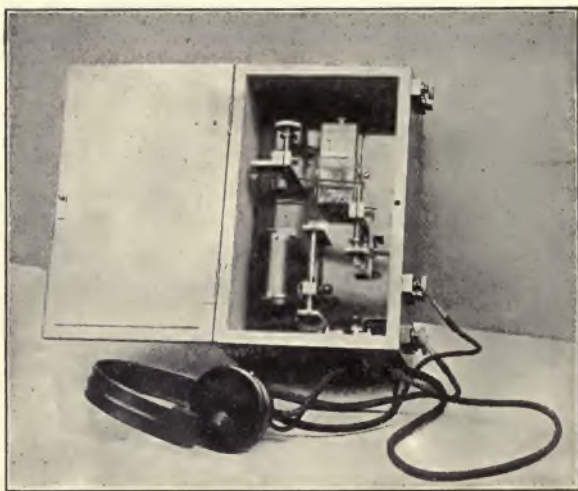

FIG. 199.—BRAUN PORTABLE RECEPTOR.

MARCONI RECEPTOR (THIRD FORM).—In the effort to eliminate the antenna as a factor in the reception of electric waves, Marconi evolved a third form of apparatus, shown in Fig. 200. The receptor consisted of two concentric cylinders of metal with an air-space between them. The inner one is connected with the earth; the outer one is connected to the inner one by a circuit which includes the primary of a transformer coil of special design and a coil for varying the inductance. The capacity is constant and is

determined by the size of the concentric cylinders. The secondary of the transformer coil forms a closed-circuit resonator with a coherer and a relay in circuit. It follows the syntonized class of receptors (B), the resonator has a grounded arm (C) and utilizes a Morse register (E); a coherer (*a*) is in the closed resonator circuit and the inner cylinder connected with the earth places it in the (C) class; the resonator operates through a transformer (*d*) and is of the compound type (*g*); both circuits are tuned (*i*) and syntonized (*j*).

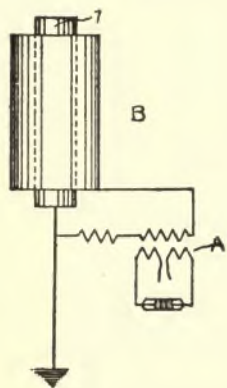

FIG. 200.—MARCONI RECEPTOR. (Third Form.)

GUARINI AUTOMATIC REPEATER. — A wireless telegraph repeater combining in a single instrument a transmitter and a receptor is the invention of Emile Guarini Foresio; the repeater is absolutely automatic in all its functions, and from the instant the enfeebled radiation from a distant station impinges on the antenna through all the succeeding translations from the coherer to the powerful re-energized waves emitted from the same aerial wire no human hand is required to assist it. Fig. 201 is a diagram of the combined circuits representing the receptor and the transmitter, and Fig. 202 is a photograph of the complete apparatus.

A single vertical wire, 1, serves to receive and radiate the waves; a special switch, 2, provides the means for automatically cutting out the aerial wire from the spark-gap, when the receiving apparatus is brought into action and *vice versa*. The inductor, 3, supplies current to the oscillator; a condenser, 4, is shunted across the spark-gap as previously described. The receptor consists of a Siemens relay, 5, placed in series with a Blondel regenerative coherer, 6; the platinum surface contact points of this relay are too small to transmit the current required to operate the induction coil, so a second relay or aerial switch, 2, having a larger carrying capacity, is used. The aerial wire is connected directly to one terminal of the primary winding of a transformer coil, 7, the opposite terminal leading to earth through the metal box, 12; the coil, 7, increases the potential of the oscillatory current in the coherer circuit, in which is included a condenser, 8, serving the

purpose of establishing the proper ratio between inductance and capacity.

Non-inductive resistance coils, 9 and 10, are inserted between the relay, 5, and the coherer, 6; to protect the internal circuits, including the relay and coherer, the whole is inclosed in a metal box, 12, and as an extra precaution a choking coil, 13, is intro-

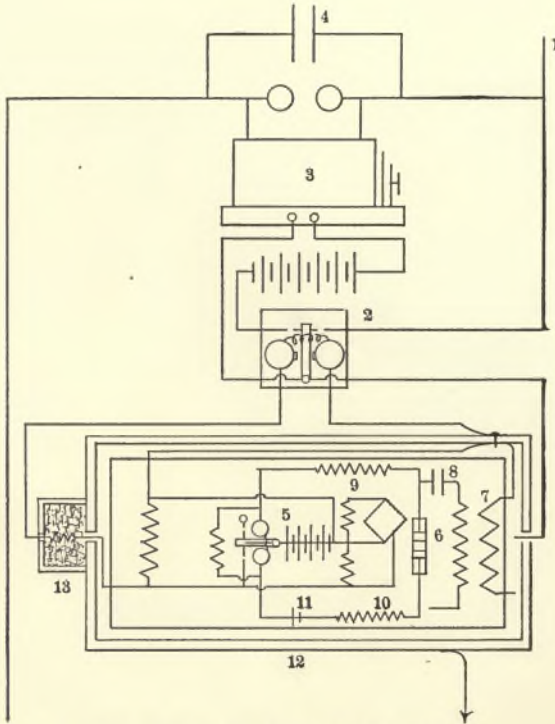

FIG. 201.—GUARINI AUTOMATIC REPEATER

duced to annihilate any oscillations set up in the circuit connecting the aerial relay, 2, and the polarized relay, 5. The action of the repeater is such that when the incoming waves are received, oscillations occur in the open-circuit resonator system formed by the antenna, 1, one side of the relay, 2, the metal box, 12, and the wire leading to earth; the waves acting on the coherer, 6, close the circuit of the relay, 5, which in turn causes the armature of the aerial relay, 2, to be drawn into contact, switching out the resona-

tor circuit and switching in the radiator system when the re-energized waves are emitted. The oscillator and resonator circuits are virtually a unit of the non-syn-tonized type (A) having a grounded arm (C); the message is received by a Morse register (E). The coherer places it in the (a) class, the former being in a closed resonator circuit, operating through a transformer (d)



FIG. 202.—GUARINI AUTOMATIC REPEATER.

having a compound-circuit resonator (*g*); the receptor is non-tuned (*h*). This system of repeating wireless messages was tested between Antwerp and Brussels, a distance of 25 miles.

MARCONI RECEPTOR (FOURTH FORM).—The fourth type of receptor devised by Marconi for selective wireless signaling is shown in the sketch Fig. 203. An aerial wire, *A*, is connected to earth, *E*, through the primary of a transformer, j^1 , and the

variable inductance, g ; the secondary coil of the transformer is connected in series with the coherer, T , and the free terminals of the secondary a condenser, j^3 , the opposite coatings of which connect with a source of e. m. f., and a relay. The condenser increases the capacity of the closed-circuit resonator system, and in the case of a prolonged series of comparatively feeble but properly timed oscillations being received they are stored up until the e. m. f. at the terminals of the coherer is sufficient to break down its high resistance and cause the indicating apparatus to respond in consequence¹. The transformer is especially wound and is described in the succeeding chapter. Classified, this resonator is of the syntonized type (B), having a grounded arm (C), the receptor including a Morse register (E); a coherer (a) operated through a transformer (d) connects an open-circuit resonator (e) in series with antenna and ground (c) with a closed-circuit system (f), forming a resonator of the compound-circuit type (g); these resonator circuits are tuned (i) and syntonized (j). This system was tested between St. Catherines, Isle of Wight, and Poole, in Dorset, England. When electric waves of a certain frequency are used no interference is caused by the working of the Admiralty installations in the vicinity.

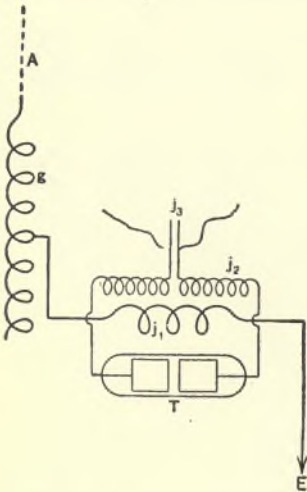

FIG. 203.—MARCONI RECEPTOR.
(Fourth Form.)

FESSENDEN RECEPTOR.—The receptor devised by Fessenden embodies several novel and important features. Its resonator system is closely allied to the oscillator system, since a specific tuning device serves either purpose. The resonator system, of which the tuning devices form the principal part, is shown in Fig. 204, and has for its object the reception of code messages and others where accuracy and positive action are essential. The antenna, 1, is connected through a condenser, 12, with one of the tuning grids, 13; this device is connected with the wave detector or barretter, 14,

The antenna, 1, is connected through a condenser, 12, with one of the tuning grids, 13; this device is connected with the wave detector or barretter, 14,

¹Royal Institution Lecture, Progress of Electric Space Telegraphy. Marconi, June 13, 1902.

the resonator circuit being completed through the tuning grid, X, which leads to earth E. The tuning grids are constructed of one or more pairs of conductors arranged in a box containing oil insulating the wires. By this arrangement the capacity and inductance of the circuit is distributed, instead of bunching these coefficients by coils and condensers, which tends to cut down the effective radiation per oscillation.

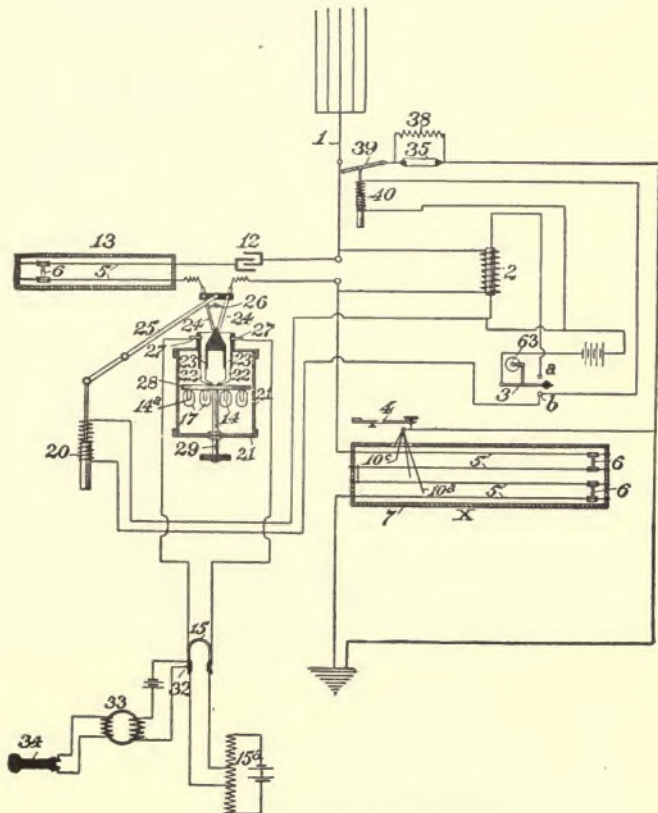

FIG. 204.—FESSENDEN SYSTEM.

The barretter of Fessenden is connected in series with a pair of head telephone receivers, 15, and current is supplied by a pair of elements having a slightly opposed e. m. f., through a non-inductive resistance. The diagram Fig. 204 shows a complete sending and receiving apparatus; 20 to 25 is an electro-magnetic cut-out, and this device is rendered operative through the switch,

a, *b*, 3, the lever, 25, drawing the leading-in wires, 24, in or out of contact as the case may be. The calling apparatus is shown in 32, and comprises a coherer, 35, a transformer 33 and 34, a telephone receiver, a bell or other suitable indicating mechanism. The Fessenden receptor is subject to the following classification: It is a syntonized receptor (B) with grounded arm resonator (C) using a telephone receiver to indicate the signals; its detector is current operated (*b*), and is connected in series with the antenna and earth (*c*), forming an open-circuit resonator (*e*); which is tuned (*i*) and syntonized (*j*). The photograph Fig. 205 shows the new type of



FIG. 205.—FESSENDEN SYSTEM.

liquid barretter and other features of the system. Fig. 206 is a portable Fessenden apparatus.

POPOFF-DUCRETET RECEPTOR.—Like the Popoff-Ducretet transmitter, the receptor designed by them resolves the receiving apparatus into its simplest form, i.e., a single cell, a detector, and a telephone receiver. When in action the coherer, *A*, is attached to the top of a containing box or case, and connection with the dry cell and telephone is made by means of a flexible cord and spring jacks. The coherer, containing grains of carbon, decoheres automatically, so that no tapper is required. The aerial wire is connected to one terminal of the coherer and the earthed wire to the opposite ter-

minal. It is simply a non-syn-tonized receptor (A), having a grounded resonator (C) using a telephone receiver (F) as an indicator, actuated by an auto-coherer (*a*) connected in series with the antenna and ground (*c*), forming an open-circuit resonator (*e*) and non-tuned (*h*). It is shown in Fig. 207.

DEFOREST-SMYTH RECEPTOR.—The receptor illustrated diagrammatically in Fig. 208 and photographically in Fig. 209 is the result of researches by Dr. Lee DeForest and Edwin H. Smythe;

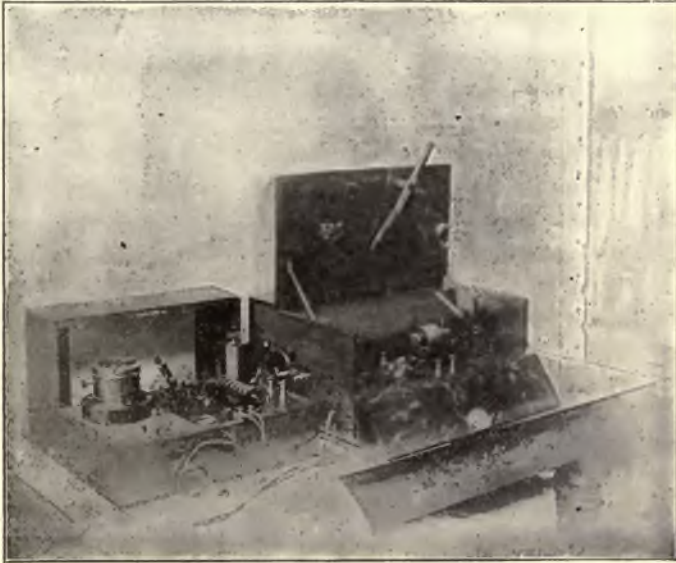

FIG. 206.—FESSENDEN PORTABLE EQUIPMENT.

it employs as a detector an anti-coherer based on electrolytic principles, which responds to the impressed differences of potential in a manner diametrically opposite to that of a coherer. Usually two responders, as these detectors are termed, are connected in series, as shown in the diagram, with the antenna and grounded terminal; 1, 1¹ represent the responders, 2, 2¹ choking coils, 3 an inductive resistance, 4 a source of e. m. f., 5 a condenser, 6 a head telephone receiver, 7 the antenna, 8 the ground wire, and 9, 9 cut-outs for the responders. The internal circuit includes the head telephone receivers, responders, and cells; the internal circuit is normally closed, the current flowing through the telephones all the time the

anti-coherer is not actuated by the oscillations; when the oscillations take place, however, the latter disrupts the electrolytically deposited thread formed by the local current between the electrodes of the responder, when its resistance is instantly increased, the local current ceases to flow, and the diaphragm of the telephone receiver released from the pull of the magnets recovers its normal position, producing a sharp click. This receptor is of the non-syntonzed class (A), has a grounded resonator (C), and utilizes a telephone receiver (F), its detector is voltage-operated (*a*), the resonator is



FIG. 207.—POPOFF-DUCRETET RECEPTOR.

connected in series with the antenna and ground (*c*), is of the open-circuit type (*e*), and is non-tuned (*h*). Messages have been received at the DeForest Coney Island station from the *Etruria*, when the steamer was ninety miles at sea.

CERVERA RECEPTOR.—The receptor of Senor Julio Cervera Bavaria¹ operates through the same aerial and ground wire as the transmitter, but the condensers employed for the latter are cut out by means of a switch. The construction of the receptor is shown in the diagram, Fig. 210; and it will be observed that the antenna, 1, is connected with the earthed terminal, 2, through the primary coil of a small transformer, 3; in the secondary of the transformer,

¹*Electrician*. London. April 18, 1902, p. 1008.

4, is inserted a condenser, 5; the soft iron core, which is also in circuit with the secondary, terminates in the coherer, 7; a variable resistance, 8, is included in the local circuit, connecting the coherer and the relay, 10, and the cell, 9; the battery, 11, is thrown into circuit by the relay, 10, which operates a second or multiplying relay, 12. The battery operating the Morse register is shown at 13, while 14 is the de-coherer battery and 15 the tapper. The sensitiveness of the coherer may be regulated through the winding of the electro-magnet and the resistance, 17; a battery for regulating the electro-magnet, 18, is also inserted in this circuit as well as an ammeter, 19. There are, consequently, four distinct circuits in this receptor, each having its own source of current and fulfilling the following functions: (a) actuating the Morse register, (b) making and breaking the coherer and relay circuit to render decohesion more positive, (c) operating the tapper, and (d) interrupting the circuit of an electro-magnet regulating the coherer. The receptor of Cervera is non-syntonized (A), with grounded resonator (C), and the receptor indicates its message by means of a Morse register (E), it employs a coherer (a) operating through a transformer (d), forming a compound resonator (g) having non-tuned circuits (h). The device is quite complicated, but has been in operation between Tarifa and Ceuta across the Strait of Gibraltar, a distance of 34 kilometers.

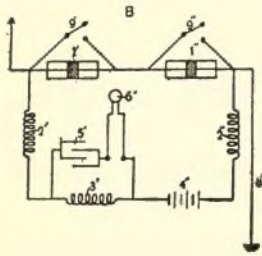

FIG. 208.—DEFOREST RECEPTOR.

BRANLY-POPP RECEPTOR.—The principal feature of this system is the Branly tripod coherer, previously described. This coherer is arranged at the back of the Morse register, Fig. 211, so that a lever operated by the latter serves as a tapper for the detector, thus eliminating the electro-mechanical tapper usually employed. The local current from the cell, *B*, which has an e. m. f. of one-half volt, actuates the spring motor of the register through an internal circuit formed through the screw, *A*, in the lever referred to, making contact with a platinum plate, *P*, leading to a Claude relay, *R*, the circuit being completed through a variable resistance, *v*, and the tripod coherer, *D*; the terminals leading from the relay connect with the Morse register. The receptor is non-syntonized (A), the resonator having one arm grounded (C), the message being indicated by a

Morse register (E); its detector is of the coherer type (*a*) and its resonator formed by a direct connected aerial wire to the coherer and ground (*c*) of the open-circuit type (*e*), and is non-tuned (*h*). The Branly-Popp system is in operation between Cape Gris

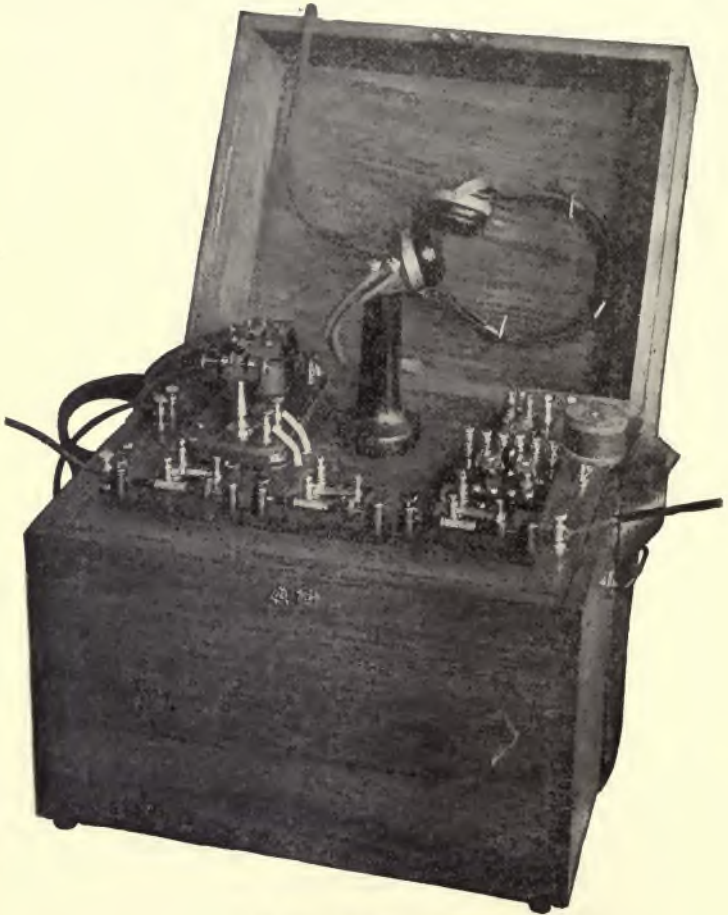

FIG. 209.—DEFOREST RECEPTOR.

Nez and Cape de la Hague. The half-tone, Fig. 212, gives an excellent idea of the completed receptor. In Fig. 213, the receptor is shown connected to recording meteorological gauges which are now being used in France..

LODGE-MUIRHEAD RECEPTOR.—In the new Lodge-Muirhead receptor¹ two distinct resonators have been tested. The first is a
'Elec. World and Eng., Aug. 1, 1903, p. 173. Collins.

simple open circuit, and the second is a compound-circuit system. The open-circuit resonator comprises an antenna, *a*, Fig. 214, lead-

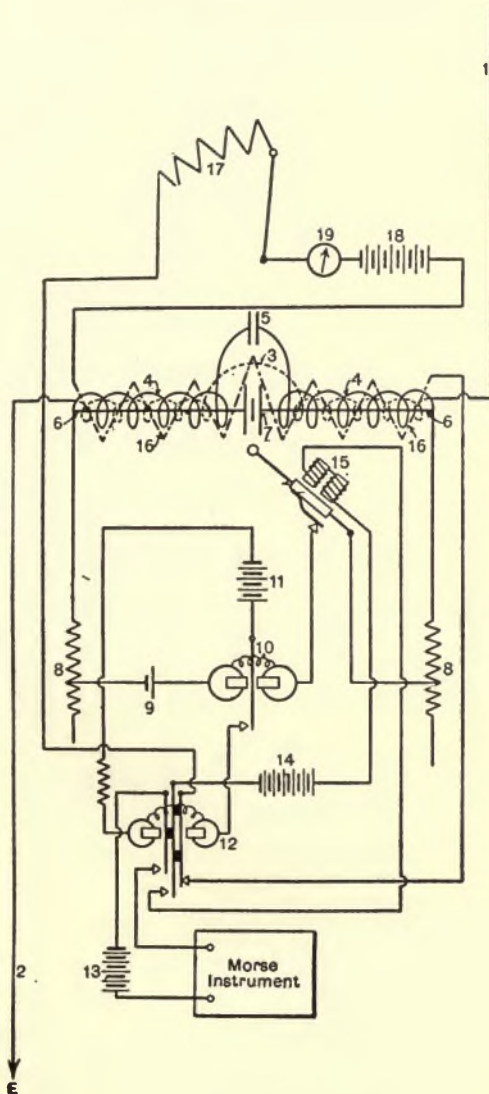

FIG. 210.—CERVERA RECEPTOR.

ing to the earth through the condensers, x and x_1 ; the internal circuits include an inductance, L , a Lodge rotating mercurial coherer,

C , condenser, X_2 , and a siphon recorder operated by a current from the cell, E . No relay is interposed between the coherer and the recorder, r , the action being direct. This receptor is syntonized (B), and, different from the first Lodge system, has a grounded resonator (C), it employs a siphon recorder (E), and a voltage-operated detector (a) is placed in a shunt with the internal circuit of the resonator proper, the aerial wire being connected direct to the earth with the condensers interposed (c); the resonator is of the open-circuit type with tuned resonator and internal circuits (i) producing a syntonized receptor (j).

The compound-circuit oscillator, shown in Fig. 215, is composed of an open-circuit resonator, a , primary of a transformer, tp ,

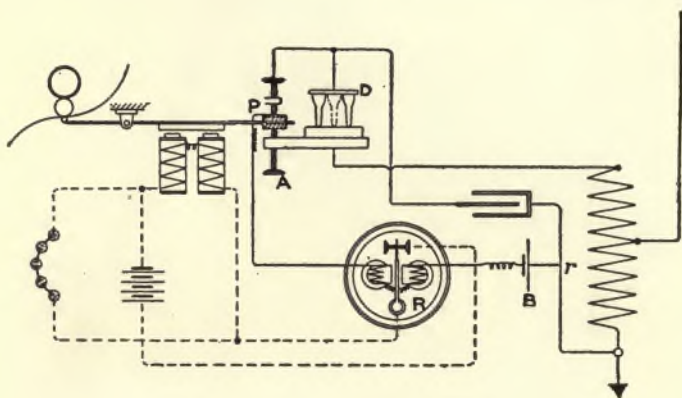

FIG. 211.—BRANLY-POPP RECEPTOR.

which also serves as an inductance and condensers, x_1 , and x_2 ; the latter connecting with the earth; the secondary of the transformer, ts , is in series with the rotating mercurial coherer, c , forming a closed circuit including a cell, E , and a siphon recorder, r ; in shunt with this circuit is a condenser, x_2 , causing the oscillations to surge through the closed circuit with a predetermined frequency until it reaches its maximum amplitude, and excluding these oscillations from the recorder.¹ The complete receptor is illustrated in Fig. 216; the latter A refers to the siphon recorder, B the actuating mechanism, D reversing switch, E voltmeter, and F the transformer. When properly adjusted for sending a message the needle of the recorder is sustained so that if a dash is transmitted a long line is recorded on the tape, while a dot is indicated by

¹British Patent, Lodge and Muirhead. No. 20,069.

a short line. In actual practice the lines may waver, but absolute accuracy is not of importance, as it is just as easy for an operator to translate the recorded script even though there are a number of impulses to each dash. Its fine adjustment is not, however, difficult, but every minute fluctuation of the recorded impulses may be easily noted and the fault traced at once to the transmitter or receptor, as the case may be, and rectified; Fig. 217 is a reproduction of a tape of the siphon recorder. The experimental stations of the Lodge-Muirhead system were located at the works of Muirhead & Co., Elmer's End, Beckingham, Kent, and at Downe, eight and one-half miles distant, with the intervening geological formation

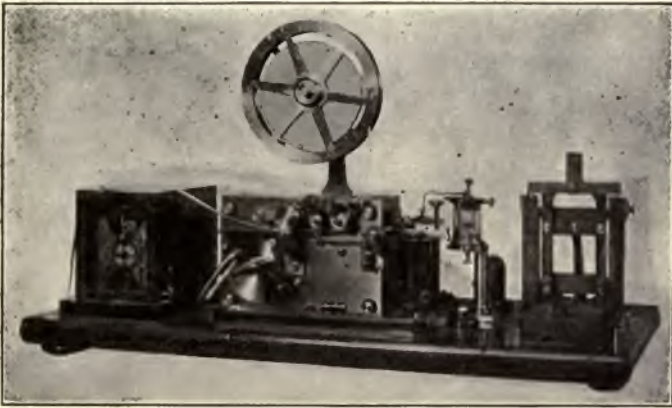

FIG. 212.—BRANLY-POPP RECEPTOR.

of Kentish chalk which offers five times the amount of resistance of the sea, and the distance, therefore, representing about 44 kilometers.

BULL RECEPTOR.—The receptor designed by Anders Bull consists of an open-circuit resonator for mechanically receiving wireless messages, and will be treated in the chapter on Syntonization. It is a syntonized receptor (B) with resonator, having one terminal grounded (C), and employs Morse registers; detectors of the coherer type (*a*) are placed in series with antenna and the ground forming a resonator of the open-circuit type (*f*), the circuits of which are non-tuned (*h*), but the receptor is mechanically syntonized (*k*).

MARCONI TRANSATLANTIC CABLELESS RECEPTOR.—The first signals transmitted across the Atlantic Ocean wirelessly from

Poldhu, Cornwall, were received and indicated at St. Johns, Newfoundland, by an apparatus of extreme simplicity. It con-

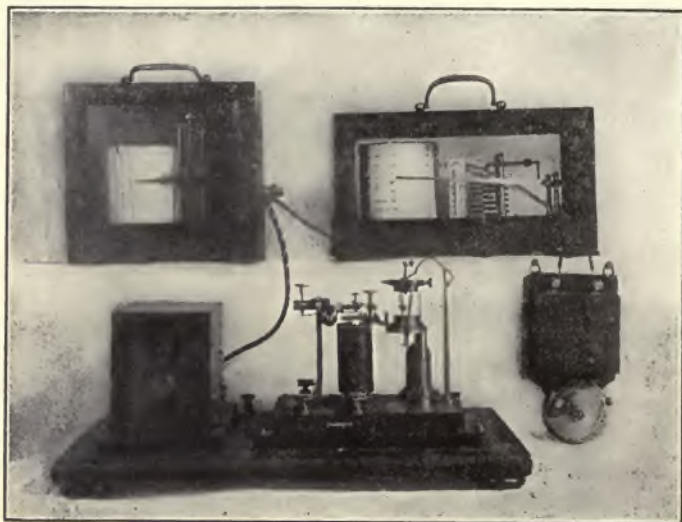

FIG. 213.—BRANLY-POPP METEOROLOGICAL APPARATUS.

sisted of an open-circuit resonator formed of a single aerial wire elevated in the teeth of a storm by a huge Baden-Powell kite. The free terminal of the improvised antenna was connected

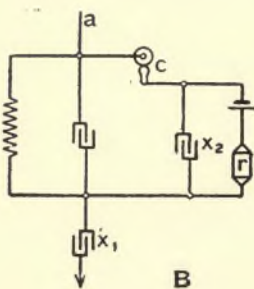

FIG. 214.—LODGE-MUIRHEAD RECEPTOR. (First Form.)

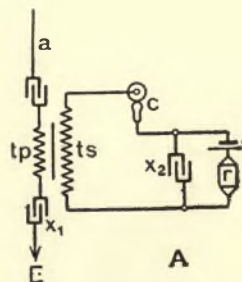

FIG. 215.—LODGE-MUIRHEAD RECEPTOR. (Second Form.)

direct to one of the conductor plugs of a Solari auto-coherer, the opposite conductor plug leading to earth. In series with the coherer there was connected a telephone receiver with a single cell, and all adjusted to a nicety. "S" was the letter translated

into the Morse code represented by three dots and sent out by the Poldhu radiator with an energy equivalent to forty-five horse-power; three faint clicks were heard in the telephone on the shore

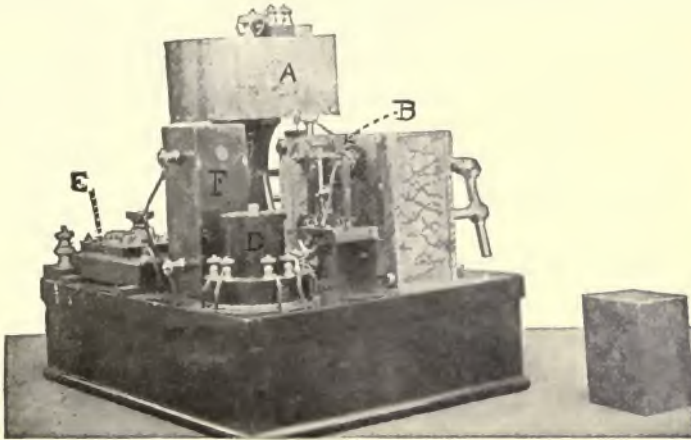

FIG. 216.—LODGE-MUIRHEAD RECEPTOR.

of Newfoundland, 3,000 miles distant, and cableless telegraphy became a fact. In the more recent receptors for the indication of cableless messages, a magnetic detector and many other types of

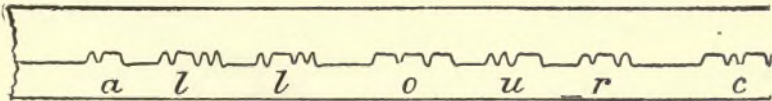

FIG. 217.—TAPE OF A SIPHON RECORDER.

wave responsive devices have been tested. The resonators for the permanent station equipments are the inverted pyramidal forms of wires used as radiators, and are tuned and syntonized with the complementary station with which it is working, so that the best results may be produced.

CHAPTER XVI.

SUBSIDIARY APPARATUS.

The general synthetic arrangement of wireless telegraph systems, comprising the transmitting and receiving apparatus, has been described in detail, while the individual appliances have been

treated more or less briefly. As the finished system depends largely upon the design, construction, and proper adjustment of the various parts, a more complete account may be found useful.



FIG. 218.—MORSE KEY.

An ordinary telegraph key, Fig. 218, will serve to arbitrarily make and break a current of the requisite energy to operate a four-inch coil into Morse dots and dashes; coils of greater proportions require heavier currents and must be provided with suitable keys; these are usually modifications of the regulation type.

MARCONI KEY.—The key adopted by Marconi for the heavy service required of it in sending wireless messages is shown in Fig. 219, and is one in which the lever and contacts assume much larger proportions than the ordinary Morse type. The lever is insulated from the contacts and has a hard rubber handle set at right angles to the lever. The stationary and movable brass contacts are connected in series with a battery and the primary winding of the induction coil. When the key is operated the handle is grasped firmly and depressed, a spring producing the reciprocal



FIG. 219.—MARCONI KEY.

action. A condenser in the base of the key aids materially in cutting down the spark formed on breaking the circuit.

(A) BRAUN KEY.—Professor Braun devised a key enabling an operator to break up a current of fifty amperes continuously without danger to the coil, interruptor, or key itself. The key is so arranged that the principal contact is made after the circuit is closed. On breaking the circuit the contact is opened first and

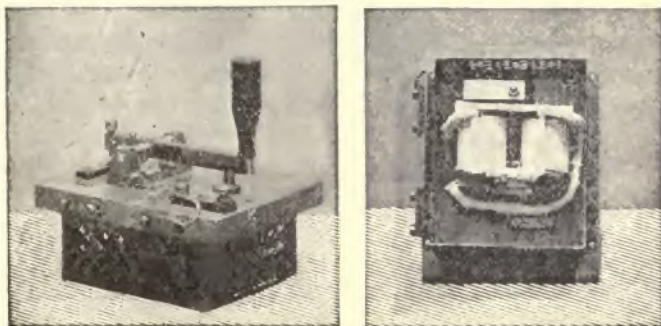

FIG. 220a,b.—BRAUN KEY.

but one path is left for the current, i.e., through the discharger. By this means the break remains nearly sparkless.

(B) BRAUN KEY.—Another method of preventing the fusion of contacts is by fitting the key with a magnetic blowout. Fig. 220, *a*, *b*, shows an exterior and an interior view illustrating the position of the magnets for blowing out the spark formed on breaking

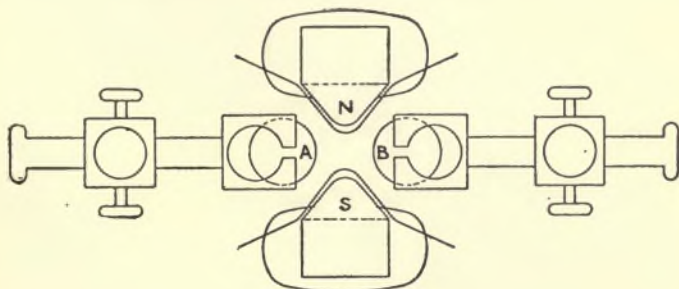

FIG. 221.—MAGNETIC BLOWOUT.

the primary current between the platinum points of the key. This device is based on Davy's discovery of the effect of a magnetic field upon the voltaic arc and its application to other apparatus for preventing injurious discharges has been the subject of much litigation in the United States in the Thomson magnetic blowout

suits. Fig. 221 is a diagrammatic view of a blowout applied to a spark-gap.¹ An electro-magnet, *NS*, is placed with its axis at right angles to the line joining the contacts, *A*, *B*, and produces a strong magnetic field between them. The instant the current is broken the spark is extinguished by the magnetic field. Instead of the magnetic field a blast of air may be used effectively.

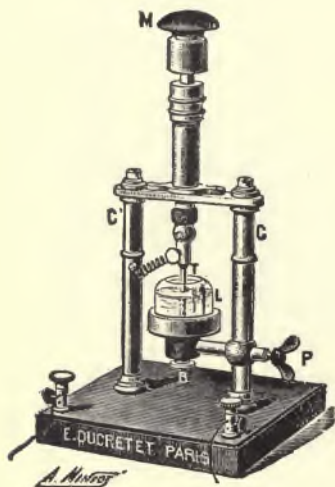

FIG. 222.—DUCRETET KEY.

DUCRETET KEY.—Ducretet, the French instrument-maker, devised the key shown in Fig. 222; it consists of two insulated standards supporting a cup containing mercury; a spring handle is arranged to operate freely through the bar connecting the standards; the handle carries at its lower extremity a metallic point; when the handle is pressed downward the movable metallic point comes in contact

with the mercury and the primary circuit is completed; when the handle is released the spring causes it to resume its normal

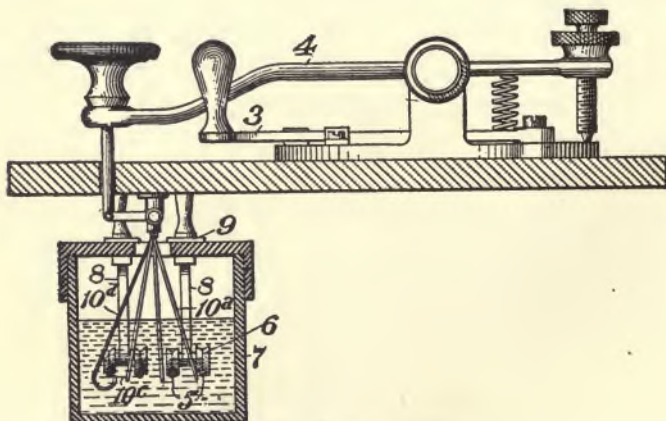

FIG. 223.—FESSENDEN KEY.

position breaking the circuit formed between the point and the mercury.

¹Inventions of Nikola Tesla. Martin, p. 209.

FESSENDEN KEY.—The time constant of the foregoing keys is very high, and to increase the speed Fessenden designed the key illustrated in Fig. 223; to an ordinary Morse steel-lever key is attached a device for throwing the sending circuit in and out of tune. This is accomplished by means of the key, 4, which is

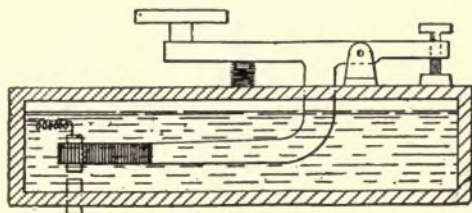

FIG. 224.—DE FOREST KEY.

provided with fingers, 10, arranged to be pressed into contact with the wires so that the circuit is shunted around the tuning grid. This action takes place in an oil chamber.

DEFOREST KEY.—In the DeForest system an ordinary Morse key has a curved projecting arm attached to the lever and ex-

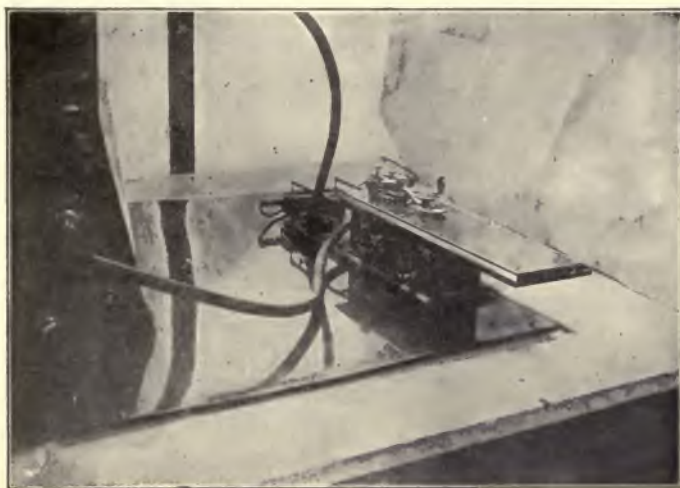

FIG. 225.—DE FOREST KEY.

tending into a compartment containing oil; on the lower end of the arm is a contact having a comparatively small surface and oppositely disposed to it is a stationary metal contact as shown in

Fig. 224. From these contacts well insulated leads connect with the transformer and generator. Only the manual portions of the key are exposed and these are thoroughly insulated since the break takes place under oil. It is illustrated in half-tone in Fig. 225.

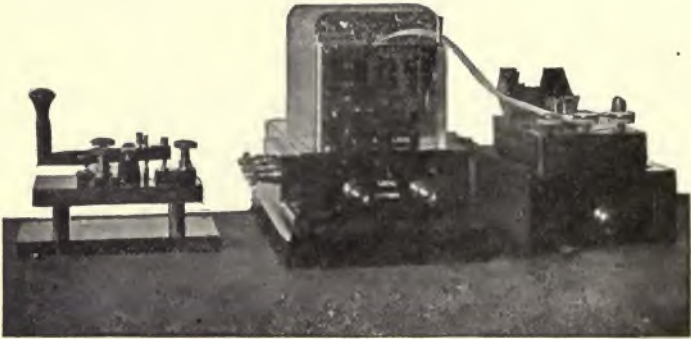

FIG. 226.—LODGE-MUIRHEAD KEY AND PERFORATOR.

LODGE-MUIRHEAD KEY.—In the Lodge-Muirhead system of transmission a large Morse key¹ (see Fig. 226) is usually employed

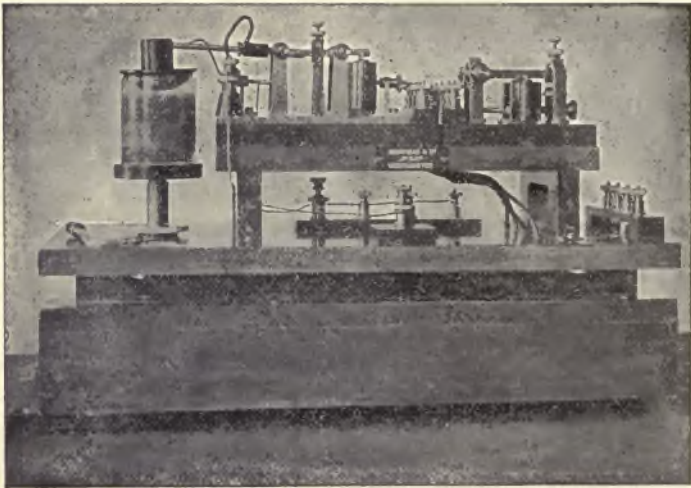

FIG. 227.—LODGE-MUIRHEAD BUZZER.

in connection with a perforator, a device by which a message may be prepared at leisure and despatched with celerity. The operation is simple; a tape is passed through a perforator with a key attached

¹*Elec. World and Eng.*, Aug. 1, 1903. Lodge-Muirhead System.

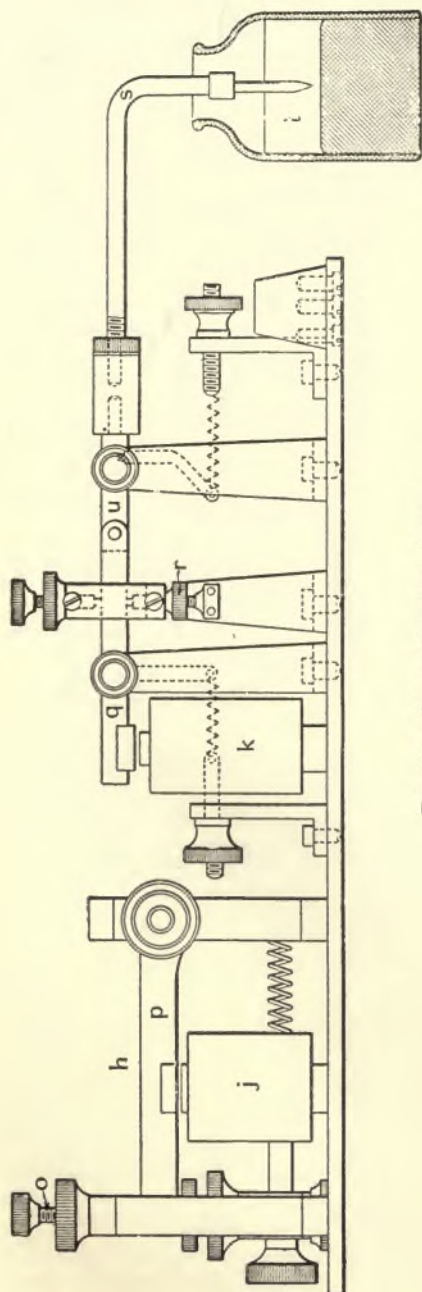

FIG. 228.—LODGE-MUIRHEAD BUZZER.

to it; by manipulating the key, the message is punched in the tape. When it is desired to transmit the message, the tape is passed through the automatic machine in circuit with the source of e. m. f., and the inductor of the coil; the message may be sent as rapidly as desired, a brush passing over the perforations in the tape, closing the circuit. In this way speed and accuracy are attained.

LODGE-MUIRHEAD BUZZER.—In conjunction with the key and automatic transmitting machine a “buzzer” is included in the local circuit; it is shown in the photograph, Fig. 227, and in a side elevation in Fig. 228; the object of this device is to open and close the primary circuit of the induction coil so that a definite frequency is obtained in the local circuit; the buzzer consists of two sounders connected with each other so that they operate alternately. To a copper rod is fastened an arm of aluminum and connects with the armature of one of the sounders; the copper rod has a pointed end dipping into a cup of mercury and making or breaking con-

tact as the lever is drawn up or down; this arrangement interrupts the current about 600 times per minute, so that a similar frequency is set up in the secondary and electric waves are emitted at small but definite periods of time.

CONDENSERS.

In oscillator circuits where high-frequency, high-potential currents surge, condensers having variable capacities are sometimes desirable, especially in syntonistic systems. The Leyden-jar type of condenser is the simplest in construction and the oil condenser the most satisfactory, since the insulating properties of oil are very high while its specific inductive capacity is very low. Experiment has shown that it is desirable to exclude all matter of a gaseous

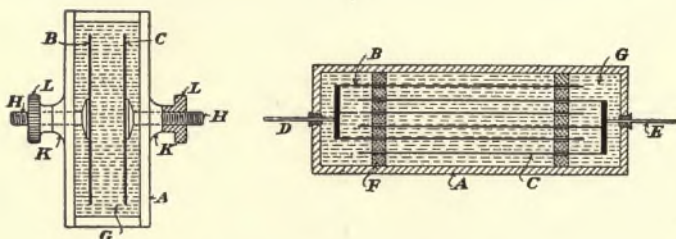

FIG. 229 A. B.—TESLA OIL CONDENSER.

nature adjacent to the dielectric in order to prevent electrostatic bombardment and the untoward effects resulting as a consequence.

TESLA OIL CONDENSER.—An oil condenser designed by Tesla is shown in the sectional drawings, Fig. 229, *A* and *B*. The condenser plates are contained in a suitable case, *A*; the plates, *B*, *C*, are connected to the terminals, *D*, *E*, leading outside the case. To prevent the plates from spreading or coming in contact with each other they are separated by a strip of porous insulating material, *F*; the interior of the case is then filled with the oil, *G*. This type of condenser is highly efficient and will not be affected by high-potential currents. The capacity of the condenser may be varied within certain limits by securing the plates to the adjustable rods, *H*, passing through stuffing boxes, *K*, in the case, *A*; the distance between the plates may be varied by the nuts, *LL*.

BRAUN CYLINDRICAL CONDENSER.—An adjustable condenser, composed of a series of miniature Leyden jars so arranged as to bring within as small a space as possible the greatest capacity area,

was devised by Braun for increasing or decreasing the capacity of his oscillator. The tubes, Fig. 230, are made of glass, have a diameter of 25 mm., are 2 mm. in thickness, and are coated inside and out with tinfoil. They vary in capacity from 0.004 microfarad to 0.005 mf., and the capacity of the system may be easily adjusted by merely slipping them in or out of the rack. In this way the closed-circuit oscillator is tuned to its own natural period as well as to the open-circuit oscillator emitting the waves.

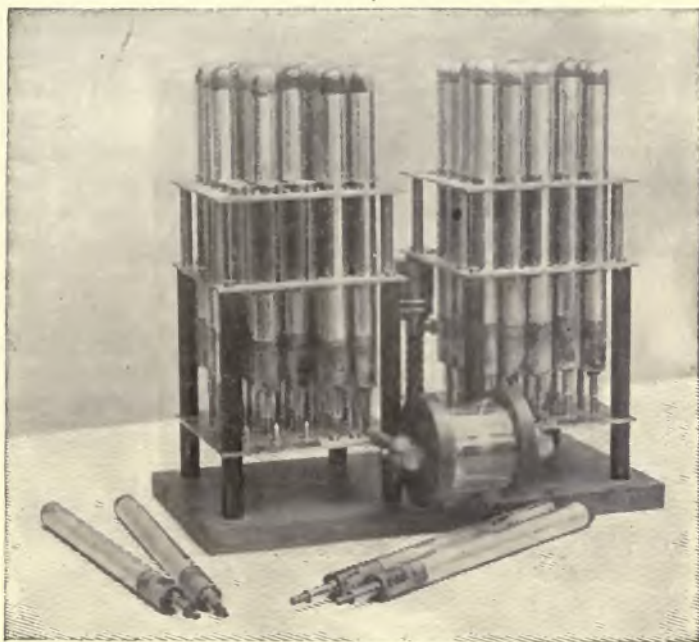

FIG. 230.—BRAUN CYLINDRICAL CONDENSER.

ADJUSTABLE MICA CONDENSERS.—In resonator systems the potential of the oscillations is very low compared with those emitting the waves, and the condensers employed may be made with a dielectric of mica. Mica condensers may be obtained in the open market in any form, capacity, and adjustability desired. Adjustable condensers comprise a number of sections, and by a system of plugs, inserted or removed, the various condenser units may be thrown in or out of circuit as desired. Non-adjustable condensers of a given value are often used in resonator systems where the

capacity of the circuit has been accurately determined, as in the Braun condenser illustrated at A, Fig. 231.

TRANSFORMERS.

BRAUN HIGH-FREQUENCY TRANSFORMER.—The primary winding of the high-tension transformer making the electrical connec-



FIG. 231.—BRAUN CONDENSER AND TRANSFORMER.

tion between the open and closed circuits of the Braun oscillator is designed so that it will give the desired wave length with the



FIG. 232.—BRAUN HIGH-FREQUENCY TRANSFORMER.

greatest capacity. The diameter of the transformer is 20 cm.; and is illustrated in Fig. 232, when the various parts are assembled, and

in Fig. 233 when taken apart. It consists of an inductor of four turns of heavy wire wound outside of a secondary coil formed of thirty or forty turns of fine wire, so that oscillations set up in the closed-circuit oscillator may be stepped up in the open-circuit oscillator emitting the waves. The transformer removed from the jar shows clearly its internal construction, consisting simply of an air-core induction coil with the primary well insulated and its relative position to the secondary reversed; the coils are then immersed in oil. The transformer of the compound resonator system (see *B*, Fig. 231) is very much smaller than the transformer above described, since the impressed potential in the resonator circuit must necessarily be smaller than in the oscillator system.



FIG. 233.—BRAUN TRANSFORMER. (Dissected.)

MARCONI LOW-POTENTIAL TRANSFORMER.—A transformer or *jigger* produced by Marconi for his receptor consists of a primary coil wound with fine wire contrary to custom and the secondary with still finer wire in single layers.¹ It was found that if more than one layer was employed in the device no results were obtainable; this was a disadvantage, since a greater number of turns was required to obtain a higher ratio of transformation between the primary and secondary than unity, as at *A*, Fig. 234. To overcome this obstacle the number of turns of wire on the secondary was increased at the ends, as shown at *B*, Fig. 234, and this transformer giving excellent results, the coil *C*, Fig. 234, was constructed. This particular winding prevents the opposition

¹Discourse by Marconi, Royal Institution, Feb. 2, 1900.

effects of electro-magnetic induction with the electrostatic induction at the ends of the primary.

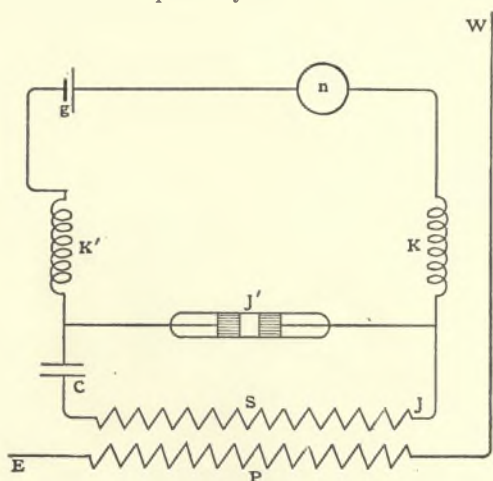

FIG. 234a.—MARCONI LOW-POTENTIAL TRANSFORMER.

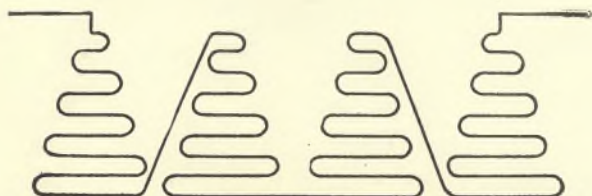

FIG. 234b.—MARCONI LOW-POTENTIAL TRANSFORMER. (Second Form.)

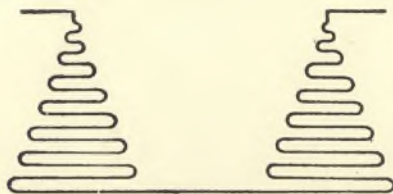

FIG. 234c.—MARCONI LOW-POTENTIAL TRANSFORMER. (Third Form.)

DE-COHERERS.

Devices for tapping back the filings of coherers to their normally high resistance are usually of the vibrating type, that is, they are arranged with an automatic make and break. Single-stroke tappers have been employed, but are not well adapted for the purpose. In a properly constructed tapping mechanism the striking

lever to which the hammer is attached should be short, since it is desirable to give the vibrating element a low time constant, as this



FIG. 235.—MARCONI DE-COHERER.

is one of the essential features in the production of dashes when used in conjunction with a Morse register.

MARCONI DE-COHERER.—In the Marconi tapping device the

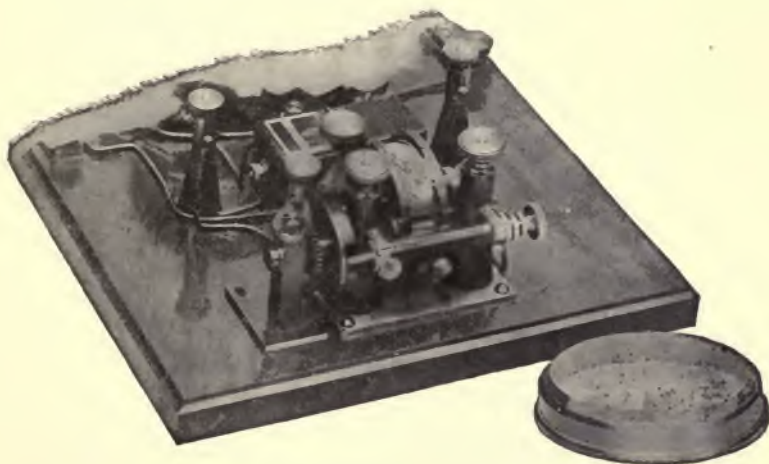

FIG. 236.—BRAUN DE-COHERER.

electro-magnets are set at an angle of 45° on a block of wood; the armature, striking lever, and hammer are arranged beneath, as

shown in the photograph, Fig. 235, so that the coherer is tapped from the under side. The ivory holder with its coherer attached is held in position by means of an adjustable ebonite standard, and the strength of the hammer stroke is regulated to a nicety by screws controlling the standard, the magnets moving the hammer up and down.

BRAUN DE-COHERER.—The Braun electro-mechanical de-coherer is shown in Fig. 236; the mechanism for producing the strokes is

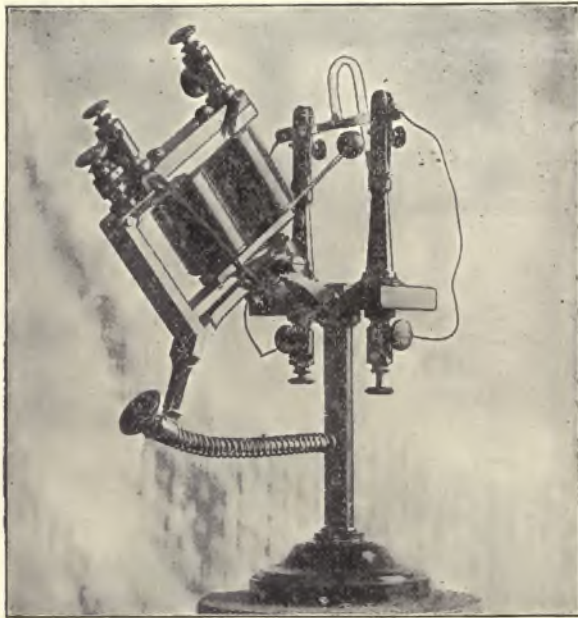

FIG. 237.—GUARINI DE-COHERER.

actuated by a local current, but is operated by a spring motor; this renders the operation of tapping the tube entirely independent of the local current. The force is therefore always uniform and the filings are arranged in the same relative positions each time. When the filings cohere, a trip catch is released electrically and the mechanism is set in motion; when de-cohesion takes place the catch drops and the motor is stopped. The coherer may be easily and quickly placed in electrical connection with the internal circuit by slipping it into place between the opening clutches forming the contacts.

GUARINI DE-COHERER.—The de-coherer employed by Guarini is arranged with a spiral spring and screw, giving a very fine adjustment and permitting strokes to be applied to the coherer of any required strength. The standards for holding the coherer in position are rigid, as shown in Fig. 237. It is a simple and efficient type of electro-mechanical de-coherer.

COLLINS DE-COHERER.—A device to take the place of the electro-mechanical tapper was designed by the author in

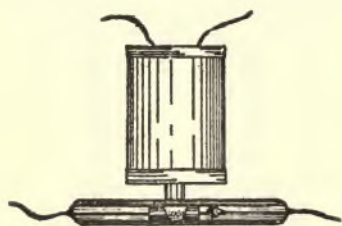

FIG. 238.—COLLINS MAGNETIC DE-COHERER.

1899. In this arrangement the coherer is a little different from those previously described in that the conductor plugs are beveled, forming a V-shaped pocket as shown in Fig. 238; in this are placed some fine Norway iron filings carefully annealed to prevent the retention of magnetism. Over

the tube is an electro-magnet, the terminals of which are connected in series with the coherer and relay. When the oscillations cohere the filings the local current energizes the magnet and the particles of iron are attracted to the polar projection; this causes the circuit to be broken, since the resistance becomes infinite as the gap formed between the plugs gradually widens.

RELAYS.

The relay is employed in wireless for the same purpose that it is in wire telegraphy, i.e., it permits very feeble currents to be augmented by stronger ones. There are two types of relays, (*a*) those having delicately poised soft-iron armatures and (*b*) those having permanently magnetized armatures. The former are known as ordinary relays and the latter as polarized relays. Ordinary relays are wound to resistances of from 50 to 1,000 ohms and polarized relays are wound to as high as 10,000 ohms. Relays of less than 1,000 ohms are useful only in the laboratory or for lecture purposes when applied to wireless telegraphy.

ORDINARY RELAYS.—In wireless telegraphy the relay is usually connected in series with the coherer and cell. When the filings cohere, an armature carrying a contact is attracted by the magnets until the movable contact makes connection with a permanent con-

tact, when a second or local battery will be thrown into circuit which operates the tapper and actuates the Morse register. A screw is provided for moving the magnets toward and away from the armature, as may be observed in Fig. 239; so that the proper adjustment may be obtained. The armature of soft iron is pivoted between two set screws. A spiral spring capable of regulation draws the armature away from the magnets; there are four binding posts, two of which are placed in the circuit including the electro-magnets connecting with the coherer and two in circuit with the local battery, Morse register and tapper. The differential relay is an-



FIG. 239.—ORDINARY RELAY.

other type employed in duplex and quadruplex telegraphy, but it has not yet been used in wireless telegraphy.

POLARIZED RELAYS.—The polarized relay, in virtue of its high sensitiveness, has been adopted by all the leading makers of wireless telegraph instruments where a Morse register indicates the message. The sensitiveness of this type of relay is due largely to the elimination of the retractile spring common to the ordinary relay, and another decided advantage of the polarized relay is that its adjustment, made by means of a single screw, is easily effected and as easily maintained. In the Marconi polarized relay, in the type of receptor designed for use on board ship, there is a delicate retractile spring attached to the armature lever to compensate for the motion of the vessel, but this does not materially affect its sensitiveness.

A polarized relay consists of a permanent steel magnet, N, S , and an electro-magnet, m, m' , with the usual soft iron cores; the lower poles of this magnet are secured to the N pole of the permanent magnet, and therefore both of the upper poles of the electro-magnet, n, n' , will be of the same polarity as N , provided no current is flowing through the coils, m, m' , but when the coherer permits the local current to flow, the N pole of one of the electro-magnets becomes much stronger, which changes its polarity to the opposite sign. A perspective view of the polarized relay without its casing, is shown in Fig. 240;

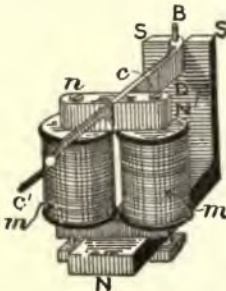

FIG. 240.—POLARIZED RELAY.

the armature lever, c, c' , is pivoted at B and swings between the poles of the electro-magnets, n, n' , but the armature is adjusted so that it approaches a trifle closer to one pole than the other, for if it were absolutely equidistant it would not move, since it would be equally attracted by either pole; the lever rests against an insulated point, D' , Fig. 241, when there is no

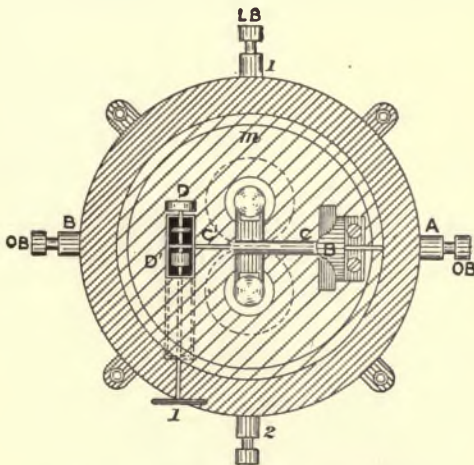

FIG. 241.—POLARIZED RELAY. (Top View.)

current, but it is drawn into contact with the point D when the current energizes the magnets. The contact points are adjustable, so that the lever may be brought into the proper relations with the magnets. Braun's polarized relay is illustrated in Fig. 242 and a standard polarized relay of the Marconi type is shown in Fig. 243; these relays have a high sensitiveness and will operate on one

twenty-thousandth of an ampere; by closing the circuit through the medium of the human body the armature of one of these relays will

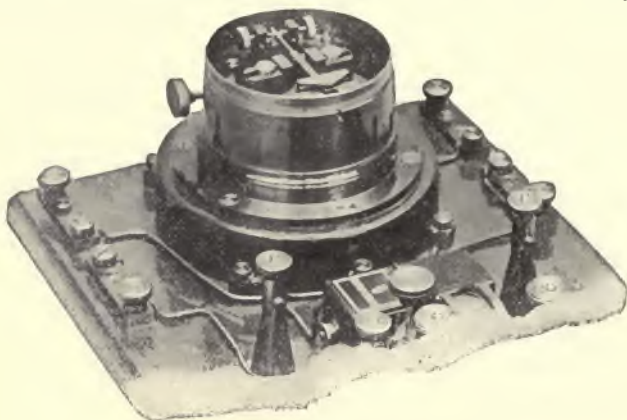

FIG. 242.—BRAUN'S POLARIZED RELAY.

readily respond if its adjustment is maximum, and this is a method employed by operators to test its working properties.

INDICATORS.

There are four different means used for the indication and final translation of the received impulses into a readable alphabet. Enumerated these are (a) the ordinary telegraph sounder, (b) the



FIG. 243.—MARCONI POLARIZED RELAY.

Morse register, (c) the telephone receiver, and (d) the siphon recorder. In the types *a* and *c* the messages are rendered audible and

in *b* and *d* they are indicated visually. The sounder has not found a very wide application, although Marconi once used it, since the reception of messages where voltage-operated detectors require tapping to restore their resistance necessitates a period of time so great that deciphering the code by sound becomes exceedingly difficult; so then a Morse register or a siphon recorder becomes a valuable adjunct, and, regardless of how slowly messages are received, they are easily read. The telephone receiver has been utilized for three reasons: (1) it is the most sensitive receiver known; (2) it will operate with a current of exceedingly limited variability and will therefore work with auto-coherers and current-operated detectors

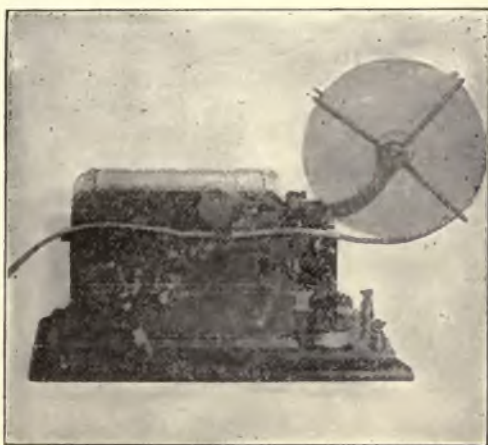

FIG. 244.—MORSE REGISTER.

where the changes are not great enough to operate other indicating devices; and (3) it possesses speed; added to these factors are others, including durability, simplicity, and cheapness.

MORSE REGISTER.—This type of indicator is used in nearly all the receptors designed by English and continental experts in wireless telegraphy, since the factor of time does not enter into the question of reading the etherogram, and besides a permanent record of the dispatch is obtained. The Morse register is usually an electrically actuated, mechanically operated device, and in this case it is self-starting; in the recently designed Marconi recorders the mechanism is started by hand. The electrical parts of a recorder comprise an electro-magnet having an armature connected with the

spring motor, so that when it is attracted by the magnets the mechanism is set in motion and a toothed disk draws the paper tape, supplied from a roll, across a wheel having an inked surface. The armature is also in connection with the disk, and when a current flows through the magnets the inked surface is drawn into contact with the moving tape and impresses upon it a dot or a dash as the case may be. The mechanism is controlled by a weighted vibrating rod and may be regulated so that the paper will move fast or slow as desired. But the tape should move slowly compared with the time period of the vibrations of the decoherer tapper, so that the frequency of the latter produced by the coherer and the lever of the relay will cause the succession of dots to run together on the tape and make a continuous mark as long as the armature is



FIG. 245.—TELEPHONE RECEIVERS.

attracted to the magnets. Fig. 244 is a photograph of an American-made Morse register.

TELEPHONE RECEIVERS.—The subject of telephone receivers has been so exhaustively treated that little need be said relating to their construction. In the ordinary Bell magneto-electric telephone receiver a coil of fine insulated wire is connected in circuit with the wave detector and a chloride of silver or dry cell. A permanent steel bar forms the core for the coil of wire, projecting a few mm. beyond the ends; a disk of turned or japanned iron called a diaphragm is supported firmly at its edges, but is capable of vibrating at its center. Fig. 245 shows a number of different forms of receivers; starting from the right, *a* shows the watchcase form, *b* the commercial Bell receiver, *c* the Swedish type, and *d* the Collins wireless telephone receiver.

SIPHON RECORDERS.—The siphon recorder, invented by Lord Kelvin for indicating the sluggish and feeble signals from long cables, has been adapted to the indication of wireless telegraph

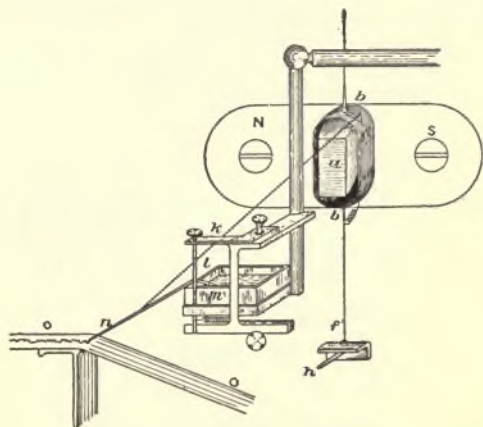

FIG. 246.—SIPHON RECORDER.

messages by Prof. Lodge and Dr. Muirhead. In the siphon recorder the rise and fall of the local current caused by the variations of conductivity of the mercury coherer operates through a rectangular coil of very fine wire, b, b' , as shown in the outline draw-

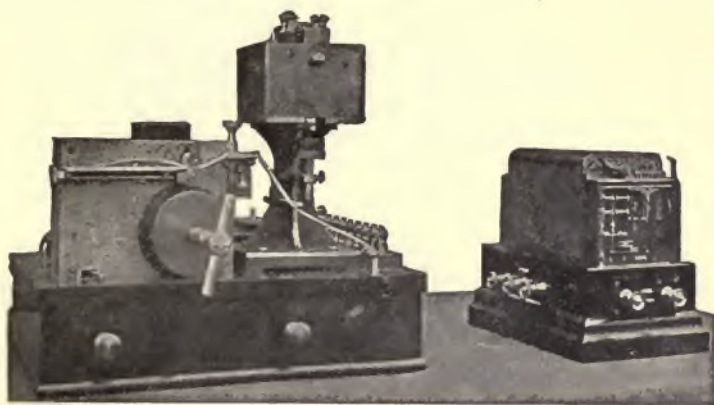

FIG. 247.—LODGE-MUIRHEAD SIPHON RECORDER.

ing, Fig. 246; this coil is suspended by thin wires, f, f' , between the poles of a permanent magnet, N, S . A stationary soft iron core is magnetized by induction and the fluctuation of the cur-

rent swings the coil from right to left. A fine siphon, one end of which dips into the ink, projects the latter on a tape moved by an automatic mechanism, and thus graphically depicts the curve of the current strength flowing through the circuit. The coherer circuit is connected with the suspension wires, f , f' . In the Muirhead recorder the ink is discharged from the siphon by causing it to vibrate. These and other improvements have been

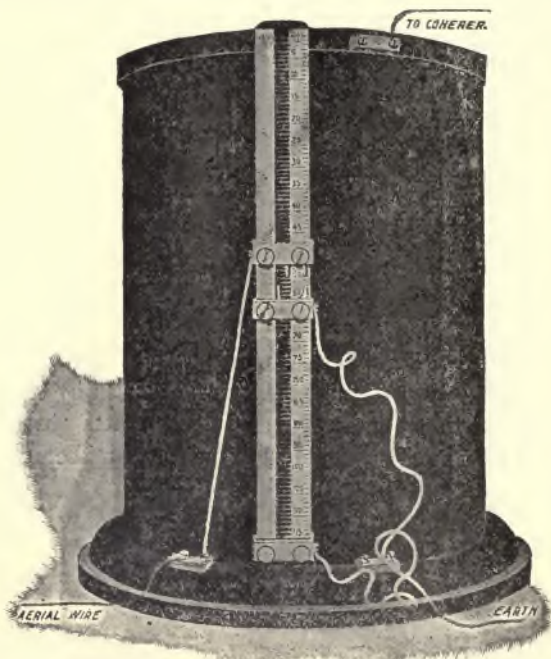

FIG. 248.—SLABY-ARCO TUNING COIL.

added to the original siphon recorder by Dr. Muirhead; the complete instrument is shown in Fig. 247.

TUNING COILS.

In the oscillator of the Slaby-Arco system this is made of a few turns of heavy, bare copper wire wound concentrically on an insulating cylinder containing the Leyden jars. Adjustable contacts are arranged so that the value of inductance may be varied at will. The tuning coil of a resonator system, see Fig. 248, consists of a number of turns of No. 16 B. and S. gauge wound spirally on

a cylinder of wood. Each turn represents a length of one meter, and there are 110 turns, so that the coil may be utilized in tuning any wave length up to 400 meters.

CHOKING COILS.

A salient feature introduced by Marconi to increase the working range and accuracy of his receptors are choking coils; the relation of these coils to the circuits is given in Fig. 249, the object being to cut off the oscillations surging through the resonator so that the full value of potential difference may be impressed on the coherer, as well as to prevent the surging of high-frequency currents in the closed internal circuit, which would result in the emanation of trains of electric waves and a reaction of the coherer. Choking coils

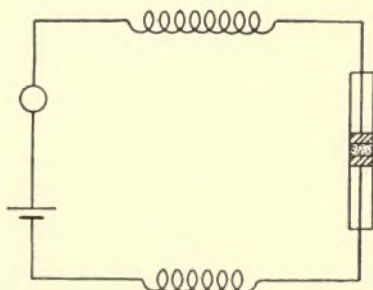

FIG. 249.—CHOKING COIL IN CIRCUIT.

are also placed in the second internal circuit, which includes the tapper and the recording device, so that oscillations set up due to the capacity of the circuits will be annihilated before resultant deterrent electric waves can be set in action. Choking coils are placed in various parts of the internal circuits and the accuracy of indication is greatly improved. Fig. 250 is a full-size illustration of a choking coil; the coils consist of a given length of wire doubled back on itself and then wound on a wooden spool so that both ends terminate on the outside of the spool, forming a non-inductive coil; these coils have an approximate resistance of 4,000 ohms and are wound with silk-covered wire No. 40 B. & S.

POLARIZED CELLS.

Polarized cells are used in the Slaby-Arco and some other systems instead of the choking coils introduced by Marconi, the object of which is to prevent sparking of the relay contacts and so

eliminate the detrimental waves thus set up. A polarized cell consists of a small vessel containing dilute sulphuric acid, in which a pair of platinum wire electrodes are immersed; a battery of four or five of these cells is connected in series across the relay contacts.

SCREENING CASES.

In practice it is usual, where voltage-operated detectors are used, to place the different parts of the receptor, i.e., coherer, tapper, battery, and relay, on a common base, which is then inclosed in

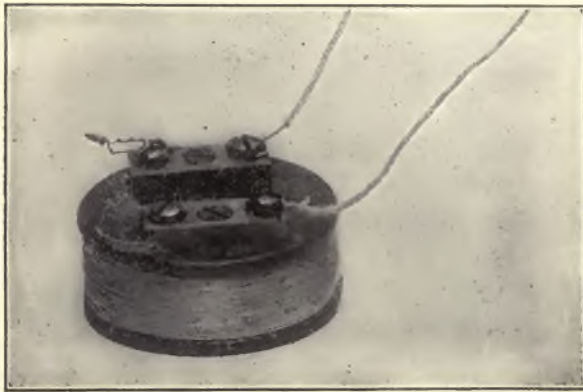

FIG. 250.—MARCONI CHOKING COIL.

a metal case to protect them from the heavy discharges of the nearby transmitter. These cases should be grounded so that oscillations set up in them may be dissipated in the earth.

ALPHABETIC CODES.

There are a number of codes used in telegraphy, the principal ones being the American Morse and the Continental alphabets. The latter is best adapted to the purposes of wireless transmission, since there are no spaced letters; twelve to fifteen words per minute is sufficiently rapid where a Morse register is employed and twenty-five to thirty words per minute is about the speed limit where a telephone receiver is used.

CONTINENTAL WIRELESS TELEGRAPH CODE.

A	B	C	D	E	F
G	H	I	J	K	L
M	N	O	P	Q	R
S	T	U	Y	W	X
Y	Z	WAIT	UNDERSTAND	DONT UNDERSTAND	
PERIOD	INTERROGATION		EXCLAMATION		
1	2	3	4	5	
6	7	8	9		
0	CALL	FINISH			

MORSE WIRELESS TELEGRAPH CODE.

A	B	C	D	E	F	G
H	I	J	K	L	M	N
O	P	Q	R	S	T	U
V	W	X	Y	Z	&	
1	2	3	4	PERIOD	INTERROGATION	
5	6	7	8	COMMA	EXCLAMATION	
9	0			COLON	SEMICOLON	

CHAPTER XVII.

AERIAL WIRES AND EARTHS.

HISTORICAL.

In a patent granted to Thomas A. Edison, dated December 29, 1891, means are shown for transmitting signals without wires by elevating plates of metal on poles or by balloons. The aerial wire was connected to one terminal of a secondary coil with the opposite terminal leading to the earth; while this is perhaps the earliest reference to aerial wires and earth plates, the method does not employ either a spark-gap or a wave detector for oscillatory currents. In Amos E. Dolbear's patent, issued in 1886, no reference is made to the elevation of the capacities he suggested for the equalization of the coefficients of the circuit connected with the earth. In 1895 Isadore Kitsee obtained a patent for signaling without wires and indicated how one terminal of the system was extended vertically to an elevation approximating the height of a vessel's mast. The antenna and earth utilized by Prof. Popoff in his meteorological receptor in 1895 and that by Marconi in his electric wave transmitter, the patent application of which was filed in England in 1896, are the earliest references to the subject of aerial wires and grounds in connection with electric wave wireless telegraphy. In Nikola Tesla's British specification, filed October 21, 1897, he describes a method of producing "a very high electrical pressure, conducting the current caused thereby to earth and to a terminal at an elevation." The various designs for aerial radiators and antennæ employed in different systems will be treated in sequence in the text appertaining to their application in practice.

THEORETICAL.

There are two theories relating to the probable capacity of the earth and several concerning the rôle the earth plays in the operation and propagation of electric wave signals. The true solution of the

problems presented by the earth is practically the key to syntonistic wireless telegraphy. In one of the two theories referred to the earth is considered as a sphere insulated in space; the second and opposition theory assumes the earth with its surrounding envelope of air to be a condenser. Koepsel¹ by a formula in electrostatics for the potential of a charged sphere insulated in space deduced a result showing the earth's capacity to have a low value and comparable with artificial capacities used in wireless telegraph practice.

The second theory advocated by the author treats the earth and air as if they were two concentric spherical shells, the medium between them representing its specific inductive capacity, when their capacity will be the same as in the case of two parallel plates with their surfaces brought in close proximity with each other in the form of a condenser. If, as the first theory postulates, the earth is a single spherical shell insulated in space, its capacity must necessarily be very limited, since a single coating on a glass jar would be incapable of acquiring more than the slightest charge; but if the strata of atmosphere holds a charge opposite to that of the earth, then it may be likened to a complete Leyden jar with its inner and outer coatings, and its capacity would be enormously increased. The importance of knowing absolutely the capacity of the earth cannot be overestimated, but could such conclusions be thus positively ascertained, the density of the charge at a given point could only be taken as a theoretical standard; for, owing to the differences of atmospheric densities, the electric charge may be maximum or minimum at any point at any given instant, and even then of a different sign.

Many different views have been submitted to explain the relation, if any, of the earth to the radiating and receiving systems; among the more prominent may be mentioned the following: (a) that high-frequency currents are projected from the earthed terminal of the oscillator, whence they are conducted by the earth to the resonator; (b) that the earth acts simply as a local capacity for the aerial wires; and (c) that the earth as a capacity having a large value serves to tune the oscillator and resonator, since both being grounded would represent the same capacity. As to the nature of the earth as a conducting medium for electric waves there is also a variance of opinion; by those advocating sliding waves the sea is regarded as opaque to electric waves, and it is claimed that in this it fulfills

¹Koepsel, *Dingler's Polytechnisches Journal*, June, 1903.

Maxwell's law in that salt water is a conductor of electricity. Others voice the opinion that the sea will transmit electric waves, since salt water does not follow the general law for conductors, in that it conducts by electrolytic action. One fact, however, is positively known, namely, that electric waves are much more easily transmitted over salt water than over fresh water or land. Whatever these conditions may be, it is well known that if a metallic conductor, as a lightning rod, be extended upward in the air and its lower terminal connected with the earth, a constant current will flow through it, equalizing in a small measure a difference of potential that is always present. If this conductor is divided and the resulting terminals form an air-gap, the potential difference may be measured by a galvanometer, or if the air-gap is microscopic in size sparks will pass; if a detector of the coherer type is inserted in the gap the filings will cohere under certain meteorological conditions and the restoration of the charge will be indicated. In practice these atmospheric disturbances often produce characters on the tape of the recording instrument, and these untoward indications are called "X's," or stays. The purpose of the aerial wire, on the one hand, is to send out transverse vibrations in the ether in the form of electric waves, and on the other, to receive them; it was ascertained by Dr. Slaby and Prof. Braun that the proper length of the aerial wires should be one-fourth the length of the emitted wave, and therefore the radiator and antenna should have as nearly the same height as possible.

A law relating to the distance over which electric waves may be transmitted with a given height of aerial wire was deduced empirically by Marconi very early in the practice of the art. This law states that with a given current, instruments of standard dimensions and all other factors being equal, the distance to which signals may be transmitted increases as the square of the length of the radiating wire; or, graphically, if a wire 20 feet in height will transmit one mile, a wire 40 feet in height will send waves four miles, and one 80 feet in height will transmit waves sixteen miles, *et cætera*. This general law was mathematically evolved by Prof. Ascoli, who deduced his conclusions in accordance with Neumann's formula and found the reciprocal action to be proportional to the square of the length of one of the two aerial wires if these are of equal length, and in simple inverse proportion of the distance between them.

It would seem that the empirical law of Marconi and the deductions of Ascoli may be subject to modification since Captain Bonomo, of the Royal Italian Navy, has concluded that the distance to which signals may be transmitted is in accordance with the formula $L = 0.15 \sqrt{D}$, where L represents the length of the aerial wires, D the signaling distance in meters and 0.15 is a constant. Where a number of parallel wires are employed instead of a single vertical wire as first used by Marconi this apparent discrepancy is accountably due to a greater radiation of energy and also in virtue of a longer wave length emitted.

The intensity of the oscillations does not diminish with the

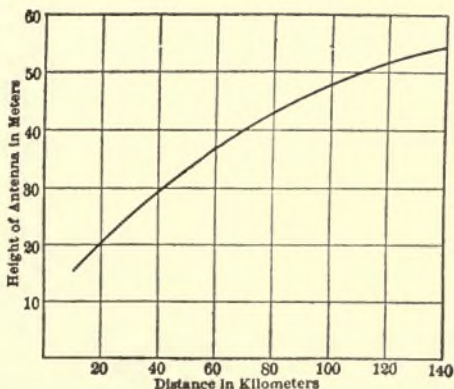

FIG. 251.—CURVE OF ELECTRIC WAVE RADIATION.

increase of distance if the length of the aerial wires is increased in proportion or as the square of the distance; therefore, by doubling the height of the aerial wires the distance of signaling may be four times as great. In a series of experiments carried out by Dr. Slaby to determine with precision the exact height of aerial wire required to transmit messages over a given distance the curve shown in Fig. 251 was plotted. Starting with an initial energy of 746 watts, the curve represents the maximum distance for transmission over bodies of salt water, with the Slaby-Arco standard station apparatus. Considerable latitude has been allowed for meteorological and climatic changes and unfavorable conditions of the year, as, for instance, the heated atmosphere of the summer months. The accuracy of the curve has been tested carefully, and while the sending and receiving

instruments are calibrated in accordance with the curve, their actual working distance may be much greater, as, for instance, it was found possible to obtain messages between the *Deutschland* and Duhmen, a distance of 150 kilometers, whereas the curve gives the working distance as 80 kilometers. The photo-electric effect of sunlight on aerial wires was deduced by Marconi¹ based upon the conclusions reached by Hertz² in 1887, who found that the effect of one electric spark from an induction coil on another had a tendency to diminish the size of the latter, and that this curious result was due to ultra-violet radiation—in which the disruptive discharge is rich—dissipating the charge of electricity stored in the second oscillator system. Righi attributed the effect to the ultra-violet radiation producing convection or the process of dispersing negative electricity, the charge being carried away by the molecules of air. Righi³ also determined that ultra-violet radiation charged wires, when insulated, with positive electricity, and Elster and Geitel have been able to show the dissipating influence of not only sunlight, but of diffused daylight on conductors. This phenomenon was observed at the antennæ by Marconi when he received signals a distance of 2,099 miles from Poldhu, Cornwall, England, on the steamship *Philadelphia*. During the test made on this trip it was ascertained on one occasion that the signals were distinct and clear at night for 2,000 miles, but in daylight the signaling distance was only a fourth as great, or 500 miles.

PRACTICAL.

In practice it is of vital importance to maintain absolute insulation of the aerial wires and earthed terminals of the radiator and resonator circuits, for in utilizing high-frequency, high-potential currents leakage becomes excessive should any portion of the systems come in contact with masts, buildings, or other physical appurtenances. Where the aerial and ground wires are sustained or supported, heavy glass or porcelain insulators are desirable. The wires themselves should be highly insulated, since this protects the oscillatory currents from dissipating their energy in the atmosphere and does not retard the action of the electric waves, for insulators are transparent to them.

¹Progress of Space Telegraphy. Royal Inst. Lecture, Marconi, June 13, 1902.

²Wiedemann's *Annalen*, 31, p. 983.

³*Comptes Rendus*, vol. 107, p. 559.

METHODS OF SUSPENSION.—A simple and efficient method for suspending aerial wires from the yardarm of a mast is shown in

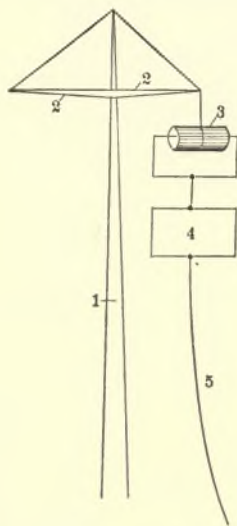

FIG. 252.—SIMPLE METHOD OF SUSPENSION.

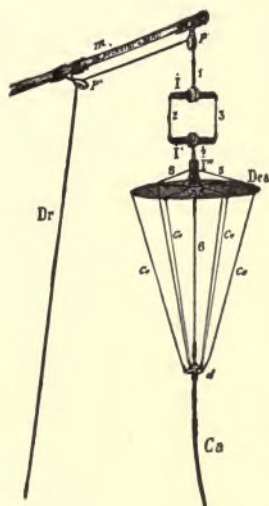

FIG. 253.—DUCRETET METHOD OF SUSPENSION.

Fig. 252; the mast is represented at 1, the yardarm 2, insulator 3, capacity area 4, and wire 5. The insulator is supported by a loop



FIG. 254.—BRAUN LEADING-IN METHOD.

of tarred rope attached to the yardarm, and the capacity area, or wire if it is used direct, is inserted longitudinally in the insulator

as shown. The method illustrated in Fig. 253 was designed by Ducretet and is a superior modification of the one just described. A method to eliminate leakage where the aerial wire leads in the station to the instruments is shown in Fig. 254 and is due to Dr. Braun; it will be seen that the leading-in wire passes through a porcelain bushing inserted in an aperture cut in the window-pane.

FORMS OF AERIALS.—The early Popoff antenna consisted of a lightning-rod, while that employed by Marconi in his first essays comprised a single copper wire leading from the instruments and to a large metal plate which was attached to its upper free terminal

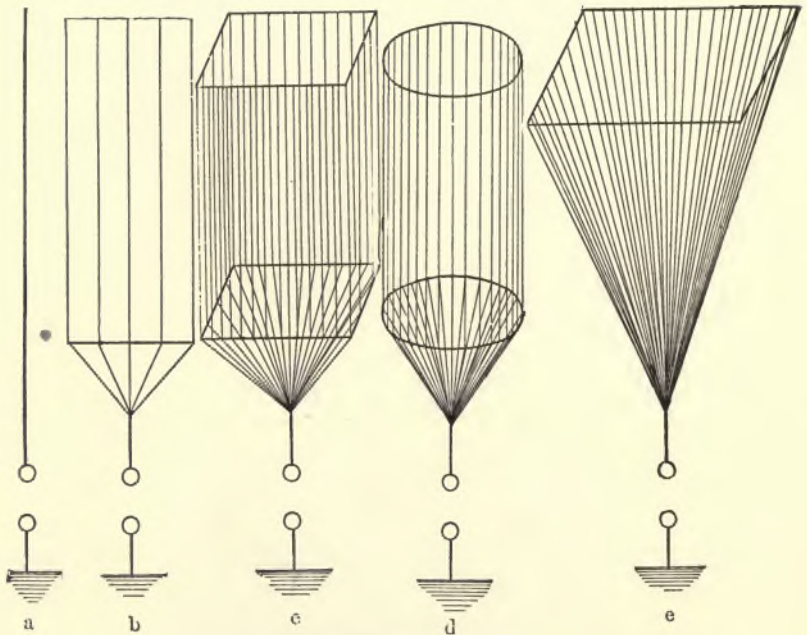

FIG. 255.—FORMS OF AERIALS.

as in Fig. 252. Various forms of aerial wires are shown in Fig. 255; the object of adding to the number of wires is to obtain a greater radiating and receptive surface; referring to the figures, *a* is the ordinary single wire aerial, *b* parallel wires which are in some cases arranged in fan shape, *c* multiple quadrangular aerial, *d* multiple cylindrical aerial, and *e* inverted pyramidal aerial for long-distance transmission. The length of aerials range from 50 to 200 feet. Fleming has pointed out that if an aerial is composed of seven strands of wire, each having a

diameter of No. 22 B. S. G., and a length of 150 feet, and insulated from the earth, its capacity, if held vertically, is 0.0003 microfarads. If a number of wires are placed very closely together, their combined capacity is not nearly equal to the sum of their individual capacities,¹ and therefore the wires should be placed at a considerable distance apart.

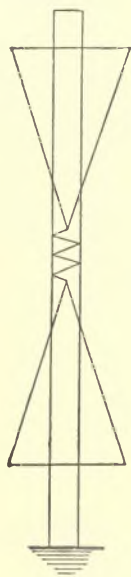

FIG. 256.
LODGE CAPACITY
AERIAL.

LODGE CAPACITY AERIALS.—The earliest form of aerial devised for the purpose of selective signaling is due to Lodge, and is shown in diagram Fig. 256. Two cones of large dimensions were made of metal and insulated from each other and the earth. These served to increase the capacity of the system as well as to radiate and receive the electric waves. The capacity areas were of definite value, but were connected with an inductance coil, so that this factor could be varied at will.

GUARINI SHEATHED AERIAL.—The fact that electric waves are intercepted, reflected, and absorbed by metals led Guarini to devise the sheathed aerial shown in Fig. 257; the aerial wires emitting and receiving the waves were insulated and then encased in a metallic sheath diverging at the top, forming a cylinder of large diameter in which a slot was cut; the purpose

of this arrangement was to reflect the emitted waves in a given direction or to receive them from a given point of the compass. There is a very great loss of energy in this method of transmission, but in specific cases it might be useful. When receiving, all extraneous electric waves are either reflected from the sheath surrounding the aerial wire or transformed into oscillations which are conducted to the earth.

TOMMASI-JEGOU DIFFERENTIAL WIRE AERIAL.—The differential aerial system introduced by Tom-

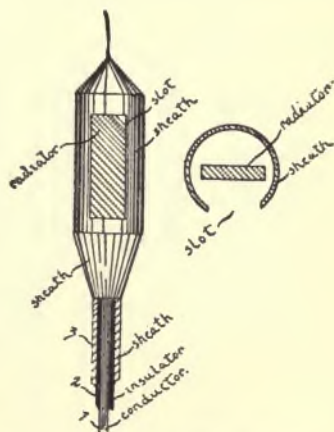

FIG. 257.—GUARINI SHEATHED AERIAL.

¹Cantor Lectures, *Journal of the Society of Arts, London, March, 1903.*

masi-Jegou some years ago was intended to receive various wave lengths simultaneously by employing two or more wires at the transmitting station A, Fig. 258; these radiating wires were of different lengths. At the receiving station B, 5 kilometers distant, the antennæ is equal in length to the shorter one at A, while at the Station C the antennæ is equal to the longest wire at A. By a proper adjustment the indicators were not actuated except when the shortest wire at A is sending to B or the longest one at A to C, except where a definite value of the distance produces a neutral effect on both receivers.

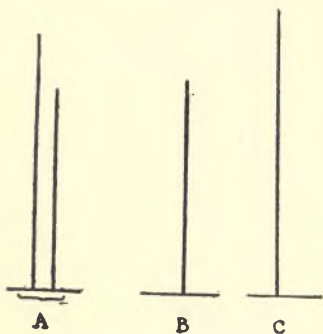

FIG. 258.—JEGOU DIFFERENTIAL AERIAL.

MARCONI AERIAL (SECOND FORM).—The aerials employed by Marconi in his first syntonic system, composed of inner and outer



FIG. 259.—MARCONI CYLINDRICAL AERIAL.

metal cylinders, mark the first attempt to eliminate the high vertical wire as a factor in wireless telegraphy. Marconi has used single

cylinders of four or five meters in height in some of his experiments, and it is stated that messages have been sent and received a distance of twenty miles with their aid. A wireless telegraph automobile designed by this inventor for military purposes is equipped with an adjustable cylinder arranged to fold back on top of the vehicle when not in active service. It is illustrated in Fig. 259.

SLABY-ARCO DIRECT EARTHED AERIAL.—To Dr. Slaby and Count Arco is due the credit of having employed the sending and receiving aerials directly connected with the earth. Before the researches which led to this method it was the common practice to

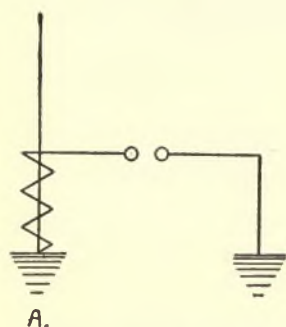

FIG. 260.—SLABY-ARCO DIRECT EARTHED AERIAL.

connect the lower free end of the aerial wire with one side of the spark-gap or coherer and the earth to the complementary side, but it was subsequently found that if the oscillators and wave detectors were connected to the aerial wire at a point where it formed contact with the earth, as in Fig. 260, the potential of the oscillations was equally effective, while the discharge of atmospheric electricity through the detector would be dissipated in the earth at *A*.

In accordance also with the theory evolved, all waves received by the aerial which were not of a predetermined length will pass into

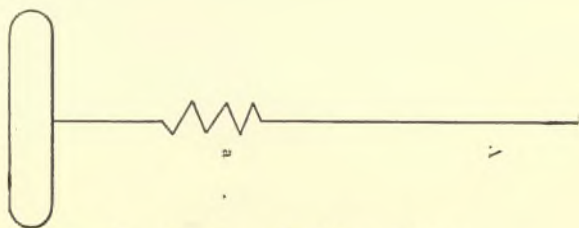

FIG. 261.—BRAUN NON-EARTHED AERIAL.

the earth, since the nodal point is at *A*; the aerial wire should be in this case one-fourth the length of the wave it is desired to receive.

BRAUN ARTIFICIAL EARTH.—In Braun's system the radiator, Fig. 261, *A*, is connected with the primary of a transformer coil, *a*, whose opposite terminal is not earthed, but is attached to a cylinder

of copper or zinc, illustrated in the photographs, Fig. 262. This is one of the striking features of the Braun system and an original departure in commercial wireless telegraphy. It is claimed that this method effectually eliminates the disturbances due to atmospheric electricity. The aerial wire forming the antenna of the resonator is divided by the condensers, *c, c*, and the primary of the transformer coil, *T*, as shown in Fig. 197.

DE FOREST MAST AND AERIAL.—One of the stations of the De

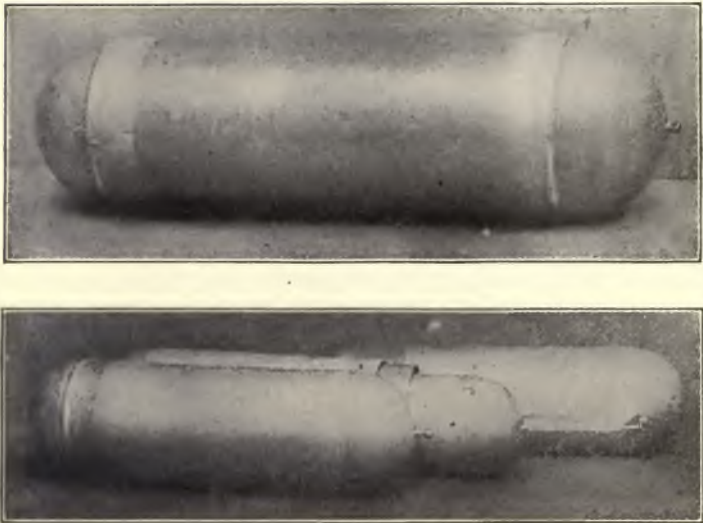

FIG. 262.—BRAUN ARTIFICIAL EARTHS.

Forest system is located at Steeplechase Park, Coney Island. It is equipped with a mast 210 feet in height; it is constructed of four poles set in crosstrees and supported by square bars of iron with a shoulder at one end to sustain the topmast over the head of the lower mast, and are termed fids; the mast is guyed to braces sunk into the sand sixteen feet deep. The guys are of wire rope with hemp rope terminals spliced in about 100 feet from the ground; the object of this combination is to maintain the insulation of the aerial cables, of which there are two supported by a yardarm near the top, and prevent them from coming in contact with the guys. It is illustrated in Fig. 263. A number of other masts, aerials and

stations are shown giving an excellent idea of the individual arrangements. Fig. 264 is a Fessenden New York-Philadelphia, 135 foot aerial; Fig. 265, a Marconi station at Rosslare, Ireland; Figs. 266 and 267, are Slaby-Arco stations at Sappitz and Gross Molen



FIG. 263.—DE FOREST MAST AND AERIAL.

respectively; a Braun-Siemens and Halske equipment at Helgoland is illustrated in Fig. 268, while Fig. 269 shows a French schoolship with Branly-Popp aerials.

FESSENDEN WAVE CHUTE.—In a recent patent granted to Fessenden additional data are given relating to aerials and grounds. This physicist has found it desirable to have a highly conducting surface over which the waves are propagated in the neighborhood of the point where they are generated, and that this highly conduct-

ing surface should extend to a distance from the point of their production at least one-fourth of the length of the wave in air and in the direction toward the station to which it is desired to send the message. The diagram, Fig. 270, illustrates the method for producing the desired results and is termed by Fessenden *a wave chute*; in the figure, 1 is the sending conductor, and 2, 2', 2'' is the grounded conductor leading across buildings and other obstacles to

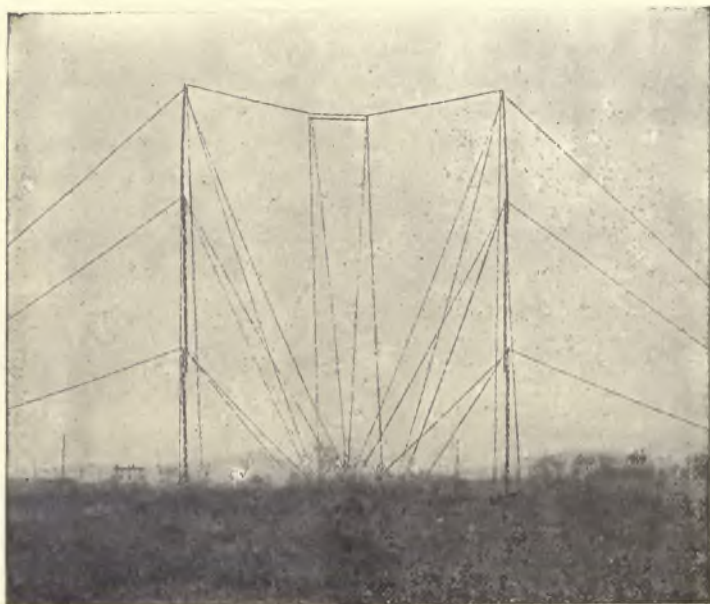

FIG. 264.—FESSENDEN MASTS AND STATION.

$\frac{2}{4}$ beyond the limit of obstructions when the terminals are earthed as shown. The coils 3, 3, 3, 3, forming guys from the mast, have a period of oscillation different from that of the antenna, and this with the grounded conductor or wave chute eliminates the interference of extraneous waves and serves to dissipate atmospheric potentials which occur in ordinary aerial wire systems. In practice Fessenden employs a sending wire having a large capacity and low inductance. The former is regulated by increasing the area of the

aerial wire and the latter by adding to the number of turns of wire connecting the vertical wire with the oscillator.

KITE-SUSTAINED AERIALS.—With the advent of the auto-coherer and current-actuated detectors came portable transmitters and receptors and the kite-sustained aerial wire. Heretofore one of the greatest obstacles in the successful transmission of wireless messages



FIG. 265.—MARCONI MAST AND STATION.

in military operations was the heavy accouterments entailed by the use of masts, as these are much too cumbersome to be transported with the facility necessary in such all-important operations, and instruments without 80- or 100-foot aerials are useless. The kite and the balloon offer the solution. Kites are preferable, except in cases when there is no wind, and then small hydrogen gas-bags are useful. In the Branly-Popp wireless telegraph automobile ambulances, balloons are employed. The exterior and interior of these

ambulances are reproduced in Fig. 271. Various forms of kites especially adapted to the velocity of the wind may be obtained for elevating and sustaining the aerial wires. The aerial is

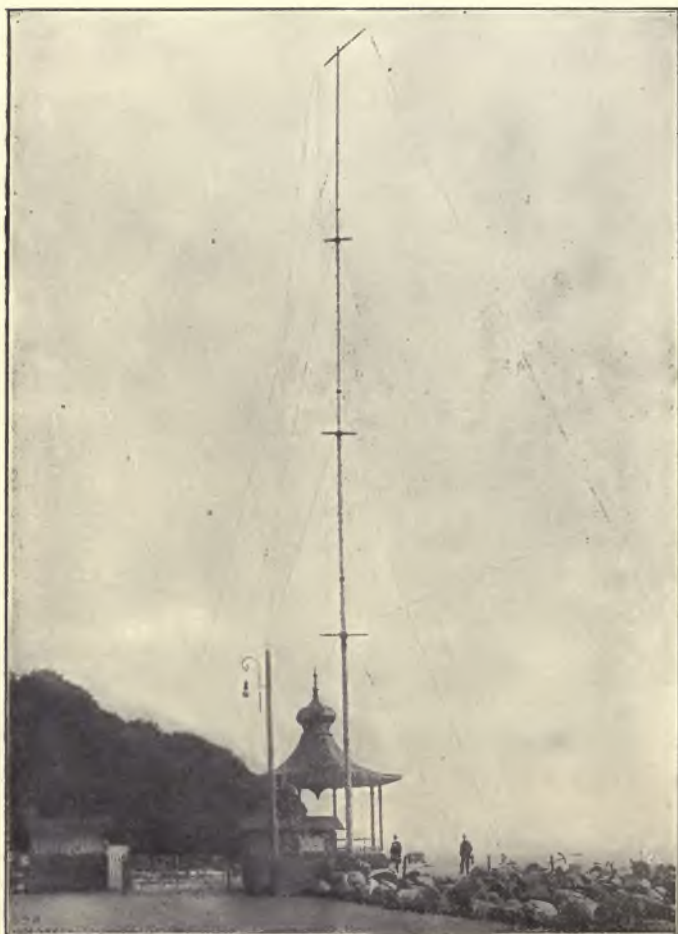

FIG. 266.—SLABY-ARCO MAST AND STATION.

attached to the kite as illustrated in Fig. 272. Aluminum wire, in virtue of its extreme lightness, makes a desirable vertical wire for this purpose. The transmitter and receptor utilize the same

vertical wire for radiating and receiving the waves, the change being made by means of an ordinary switch.

In very light winds the Malay, or, as its improved form is known,

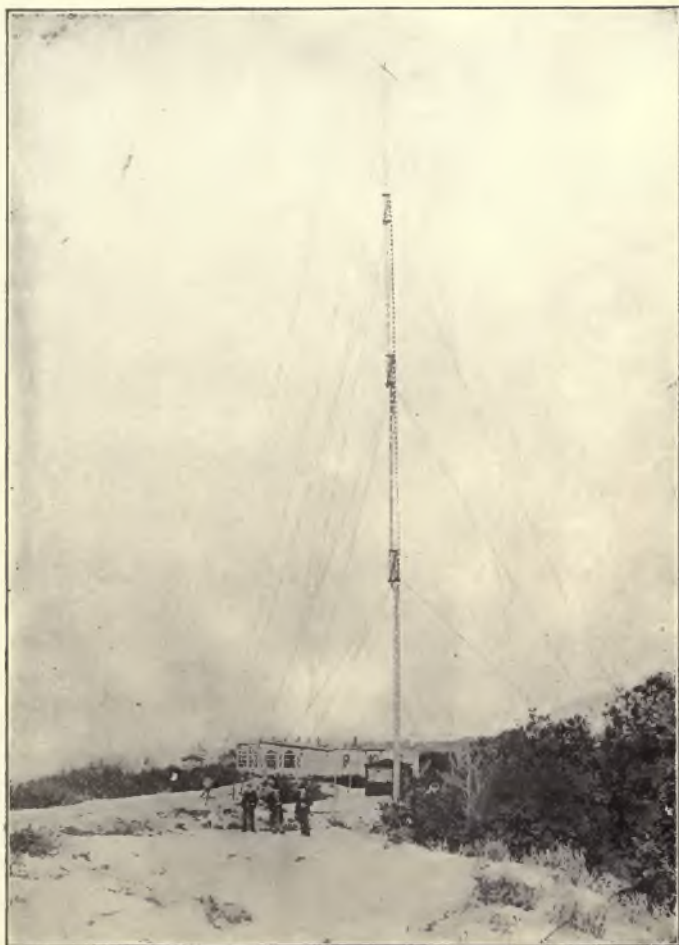

FIG. 267.—SLABY-ARCO AERIAL AND MAST.

the Eddy kite, is largely employed ; it is shown in Fig. 273. These kites are fitted with a "bridle," which is already adjusted. To the ring or loop at the center of this bridle the end of the ball of kite-

cord is secured so that the knot is a firm one. These kites are tailless, may be flown in a very light breeze, and a number of the kites may be connected in tandem and their sustaining properties increased. In winds having a higher velocity the cellular or the American modification of it, known as the Blue Hill box kite,



FIG. 268.—BRAUN-SIEMENS AND HALSKE AERIAL AND SUPPORT.

shown in Fig. 274 in outline, and a photographic reproduction in Fig. 275, may be used. It has a large sustaining surface and may be used in winds of ordinary velocities; in winds having a velocity of thirty or forty miles per hour a box kite having a very small sustaining surface is especially serviceable, since it possesses marvelous stability. Fig. 276 is a complete portable army

equipment constructed by the Braun-Siemens and Halske Company for the German Government; it was placed in charge of



FIG. 269.—BRANLY-POPP EQUIPMENT ON SCHOOL SHIP.

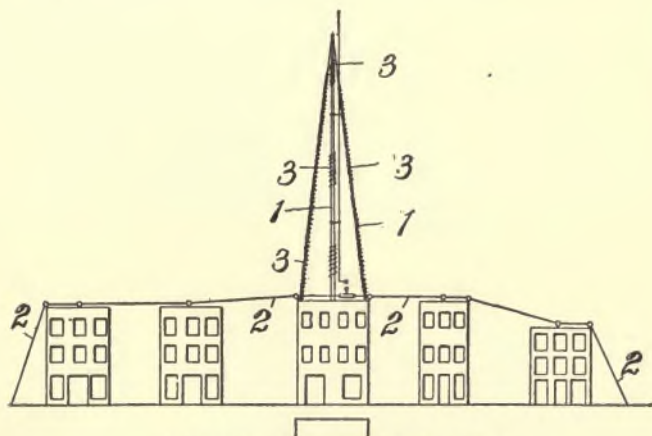

FIG. 270.—FESSENDEN WAVE CHUTE.

the Royal Military Aerostat Battalion; Fig. 277 shows the aerial wire suspended from a kite and the instruments in operation. The transmitting apparatus includes a dynamo direct connected to a

gasolene engine and is arranged on one gun carriage while the receiver is placed on another.

MARCONI CABLELESS STATION AERIAL.—The first trans-Atlantic signals transmitted from the cableless station at Poldhu, England,



FIG. 271.—BRANLY-POPP AUTOMOBILE AMBULANCES.

on December 12, 1901, were received by a single aerial wire suspended from a kite at an elevation of 400 feet at St. John's, Newfoundland; the kites employed during these aerial tests

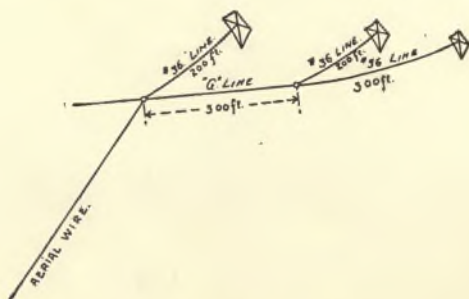

FIG. 272.—KITE SUSTAINED AERIAL.

were constructed on the same general lines as those designed by Major Baden-Powell, consisting of a bamboo frame nine feet in height covered with silk and having a hexagonal form. The aerial wire passed through a window and was attached to a pole, and from

this it led to the kite. The wire leading to earth forming the opposite arm of the resonator was suspended over the cliff from the station at Signal Hill and was connected to heavy plates of

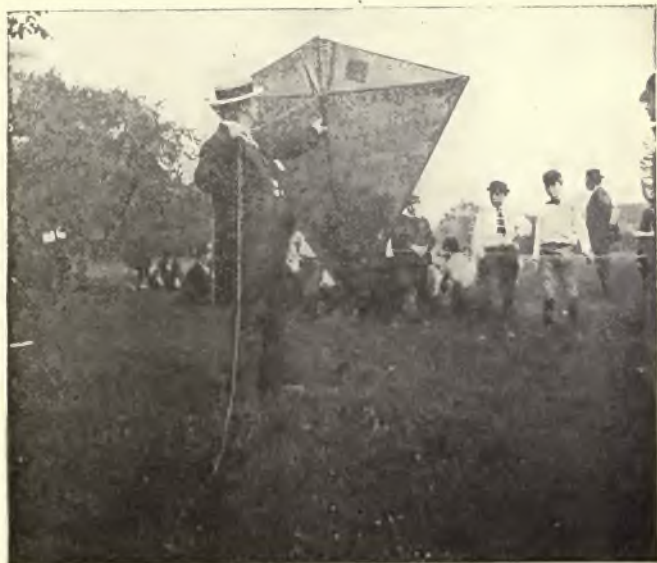

FIG. 273.—EDDY KITE.

copper anchored in the sea. The aerial wires of the transmitting station at Poldhu, England, consisted of 15 vertical wires suspended from masts 210 feet in height and were arranged in a



FIG. 274.—BLUE HILL BOX KITE.

circle. The construction of the multiplex aerials at Glace Bay, Nova Scotia, and South Wellfleet, Mass., cableless stations are designed especially for emitting long and powerful electric waves.



FIG. 275.—STARTING THE BOX KITE.



FIG. 276.—BRAUN-SIEMENS AND HALSKE PORTABLE ARMY EQUIPMENT.



FIG. 277.—ARMY EQUIPMENT IN OPERATION.

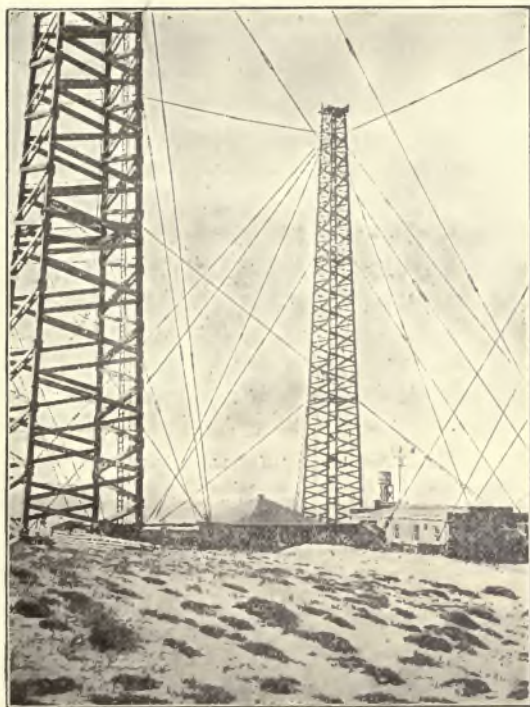

FIG. 278.—MARCONI SOUTH WELFLEET TOWERS UNDER CONSTRUCTION.



FIG. 279.—SOUTH WELFLEET TOWERS COMPLETED.

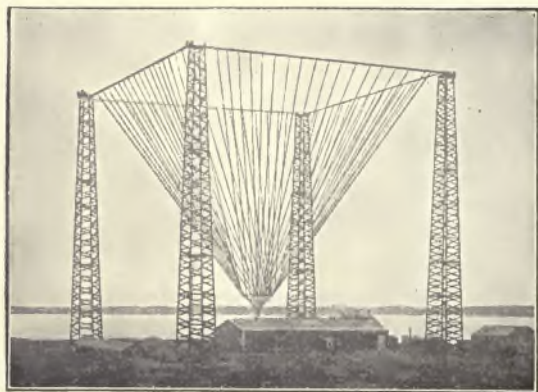

FIG. 280.—MARCONI CABLELESS STATION.



FIG. 281.—THE "CARLO ALBERTA."

Figs. 278, 279 and 280 are photographs of the South Wellfleet station in the course of construction; four wooden standards 210 feet in height are arranged in a quadrangle and are sustained by guy wires; the aerial is composed of 400 wires forming an inverted pyramid; the upper terminals are insulated and the lower ends terminate in a single conductor of large dimensions. The opposite arm of the system is connected with several large metal plates deeply imbedded in the earth to make good contact. For the purpose of testing the range of wireless telegraphy over land and sea, the King of Italy placed the magnificent man-of-war *Carlo Alberto* at Marconi's disposal. It was on this vessel that the greatest achievements of this brilliant young inventor were consummated when he kept in touch with the Poldhu station, while in the Mediterranean and across the Atlantic Ocean.

CHAPTER XVIII.

RESONANCE.

HISTORICAL.

Electrical resonance effects have long been observed in connection with low-frequency alternating currents. Lenz investigated these current waves over fifty years ago¹ and Koosen described the exalting effects of a circuit having a certain capacity and inductance in 1854²; many years ago Siemens Brothers found that the voltage from an alternator was increased in a closed-circuit cable immersed in a tank of water. This phenomenon, which may be termed *simple* electrical resonance in accordance with its acoustic analogue, is sometimes referred to, though improperly, as a *Ferranti effect*, and was noted and carefully analyzed by Fleming in the concentric cables connecting London with Deptford³; and finally in 1894 Pupin evolved a complete theory of alternating-current resonance which he set forth in a paper read before the American Institute of Electrical Engineers.⁴ In 1885 Overbeck determined that a large value of inductance resulted in a circuit having the same period of oscillation,⁵ and in 1887 Hertz obtained *sympathetic* resonance phenomena between mutually reacting circuits;⁶ Hertz plotted resonance curves and Bjercknes obtained similar results and verified the correctness of these curves by experimental measurements in 1891,⁷ and finally Lodge devised his syntonized Leyden jars which required a fine adjustment of their coefficients to effect sympathetic resonance and upon which the whole scheme of syntonization of wireless telegraph apparatus has been founded.⁸

¹*Poggendorf's Annalen*, vol. 76, 1849.

²*Poggendorf's Annalen*, vol. 92, 1854.

³*Journal of the Institution of Elec. Engs.*, vol. 20, p. 362.

⁴*Transactions Institute of Elec. Engs.*, New York, 1894.

⁵Cf. Overbeck. *Weidemann's Annalen*, vol. 26, p. 245, 1885.

⁶Hertz, *Weidemann's Annalen*, vol. 31, p. 421, 1887.

⁷N. Bjercknes, *Weidemann's Annalen*, vol. 44, p. 74, 1891.

⁸*Nature*, Vol. 40, p. 368.

THEORETICAL.

Electric resonance phenomena are strikingly similar to those of acoustic resonance. Electric resonance, like its acoustic analogue, may be simple or sympathetic; in sound, simple resonance is a direct reinforcement of a simple vibration, and may be demonstrated by whistling at a low pitch across the open mouth of a bottle and then raising the pitch until a corresponding frequency of vibration equal to that of the natural period of the bottle is reached, when the latter

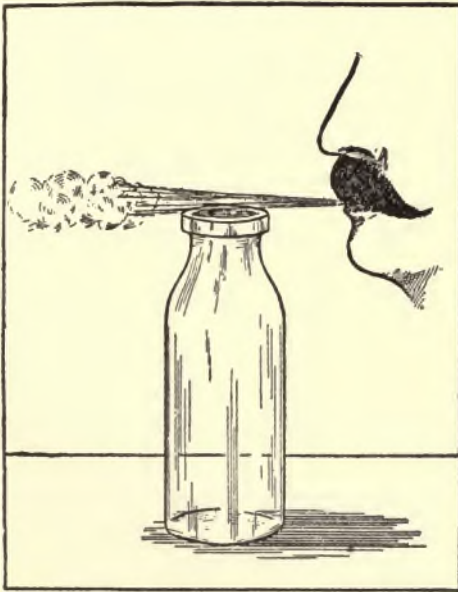

FIG. 282.—SIMPLE ACOUSTIC RESONANCE.

will emit a similar sound and reinforce the note in strength and quality¹ (see Fig. 282). In simple electric resonance an alternating current of high or low frequency flowing through a circuit having inductance and capacity, if the frequency of the alternation or oscillation is proper, will surge through the circuit and its voltage will be augmented by resonance until it may be at least four times

¹*Architectural Acoustics.* Kelly.

greater than its normal value, or, expressed symbolically, if the frequency of the current is N and the capacity of the circuit is C in microfarads and the inductance of the circuit is L in henries, then resonance will take place when

$$N = \frac{1000}{\sqrt{2\pi CL}}$$

The degree of resonance is limited largely by the resisting properties of the circuit and losses due to the imperfect elasticity of the medium. Thus the higher the frequency of the current, the smaller becomes the effect of resistance in the circuit and the more nearly is pure resonance approached. Primary resonance in an ordinary open-circuit oscillator system has been likened by Fleming to that of acoustic resonance in a closed organ-pipe; thus the radiating aerial wire when its current is oscillating with a frequency natural to its dimensions corresponds to the fundamental frequency of an organ-pipe, and the similarity does not end here, for the radiating aerial wire has a very low potential difference and a large current strength at its spark-gap terminal, representing a crest of the current wave and a node of potential, while at the upper and free end of the aerial radiating wire there is a reverse condition of affairs, for here the potential difference is maximum, forming a loop, and the current is now minimum, forming a node, just as there is a very slight difference in the oscillation of the air molecules or pressure and a great alternation of air movement at the mouth of the organ-pipe, while at the upper end of the pipe there is a great variation of the air molecules and a corresponding increase in air movement.

If air at a certain pressure is admitted to an organ-pipe of proper dimensions a primary note will be emitted that is called the *fundamental*; likewise when the primary oscillations of an electric current correspond to the dimensions or natural period of a circuit, waves having a fundamental frequency will be emitted. By varying the pressure of air in an organ-pipe the fundamental note may be substituted and tones of different values will be produced¹, which are the *harmonics* of the fundamental, and so also by impressing upon a radiator or resonator system a current of predetermined frequency, harmonic oscillations will be set up and the waves they emit find their analogue in the overtones of an organ-pipe.

¹This fact was discovered by Daniel Bernouilli, a mathematician.

EXPERIMENTAL.

The loops and nodes of electric oscillations may be exhibited in a very striking manner by an apparatus devised by Dr. Seibt.¹ It comprises an induction coil, 1, Fig. 283, the secondary terminals connecting with the spark-gap, *s*; the oscillator system includes the

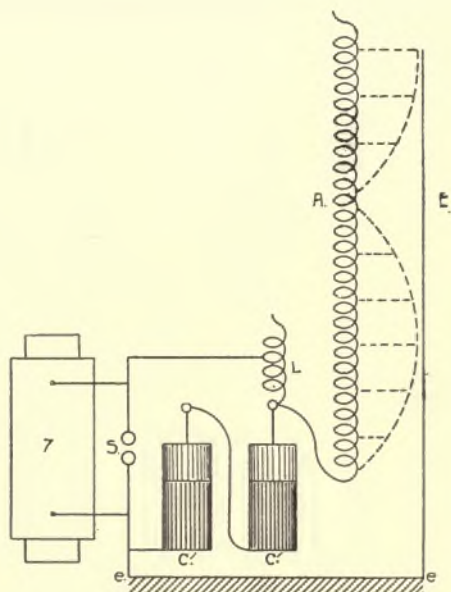

FIG. 283.—SEIBT SIMPLE ELECTRIC RESONANCE APPARATUS.

spark-gap, one terminal of which leads to a variable inductance, *L*; the opposite terminal connects with the outer coating of a Leyden jar, *C*, and to earth at *e*; the jar, *C*, is in series with a second jar, *C*¹, the inner coating of which connects with the inductance, *L*, forming a closed circuit; from the inductance, *L*, there extends vertically a spiral of silk insulated copper wire six feet in length by two inches in diameter supported on a wooden core; parallel with the closely wound spiral of wire is a straight copper wire, *E*, grounded at *e*. If now the apparatus is placed in a dark room and oscillations are impressed on the spiral wire having a frequency corresponding to the natural period of the circuit, a luminous glow will be observed to take place between the spiral and its complementary

¹Cantor Lecture, Society of Arts, London, March, 1903.

straight wire showing visually the difference of potential represented by the wires; and if the oscillators are tuned to the natural period of the circuits, the glow will increase gradually from the bottom to the extreme ends of the wires, where it will be maximum. But if the values or the coefficients are rearranged by varying the inductance and capacity so that the frequency of the oscillations may be increased, a node will be formed at *A*, or one-third of the length of the coiled wire from the top, and the glow or brush discharge will be minimized, shown by the dotted line, indicating that the first harmonic of the fundamental has been reached; by decreasing the capacity and inductance of the circuit the second overtone or harmonic may be produced and observed.

SYMPATHETIC RESONANCE.—In acoustics, sympathetic resonance is the vibration of any musical tone in response to a musical tone

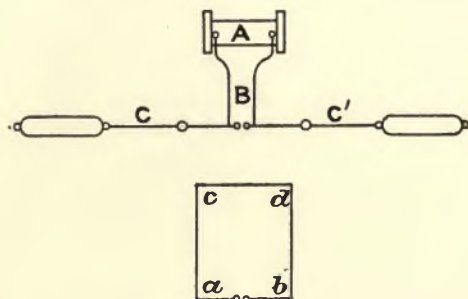

FIG. 284.—HERTZ SYMPATHETIC RESONANCE APPARATUS.

of the same pitch; as an illustration, let a note from a trombone be emitted in front of a pipe organ, when the pipe, having a similar period of vibration, will respond in virtue of their natural periods being equal. Sympathetic electric resonance is the tuning of two circuits so that an oscillating current set up in the first will start a train of high-frequency oscillations of exactly the same period in the second circuit. One of the fundamental laws upon which electric resonance is based is that an oscillating current of definite frequency will set up a greater potential difference in a resonator tuned to the same frequency of oscillation than in one whose natural period of oscillation is different. Hertz produced sympathetic electric resonance by means of the simple apparatus shown in Fig. 284. The oscillator *B C C'* is charged to a sparking potential by the induction coil; *A*, the resonator, *a b c d*, was formed of wire ending in small spheres and separated a distance of a tenth of a milli-

meter. An open-circuit resonator, Fig. 285, was substituted by Hertz for the rectangular closed-circuit resonator just described, and by adjusting the capacity and inductance to a suitable value resonance was obtained as before.

For obtaining the highest degree of resonance between two mutual circuits the oscillator and resonator should be closed, since it has been shown that high-frequency currents are not damped out as rapidly in closed circuits as in open circuits, and therefore the

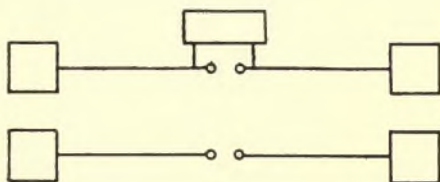

FIG. 285.—OPEN-CIRCUIT RESONANCE APPARATUS.

waves emitted approach more nearly a sinusoidal curve, which is extremely desirable; but, conversely, a train of electric waves from a closed-circuit oscillator has not the powerful and penetrating qualities of waves emitted by the quickly damped oscillations of an open circuit. A closed-circuit apparatus devised by Lodge to illustrate sympathetic resonance is shown in Fig. 286; the radiator consists of a Leyden jar, *a*, connected with an induction coil, *b*; the

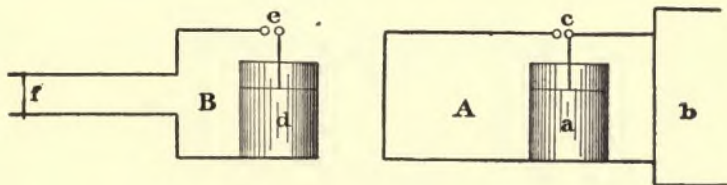

FIG. 286.—LODGE SYNTONIC JARS.

inner and outer coatings of the jar are connected with a loop of wire a meter in diameter and separated by a spark-gap, *c*; the resonator has a Leyden jar, *d*, of equal capacity arranged with an overflow path having a minute air-gap forming the detector; the coatings of the jar are connected by a loop of wire of similar dimensions to those of the radiator, but the closure is made by a wire sliding over the terminals of the loop; now if the first jar is discharged, the second jar, if it is in tune with it, will discharge across the air-gap detector, *e*; the wire slide, *f*, serves to tune the resonator with the oscillator by varying its value of inductance; in this sys-

tem thirty or forty oscillations surge through the circuits on the discharge of radiator circuit.

DETERMINATION OF PERIODICITY.—To determine the periodicity of oscillations occurring in the phenomena of resonance Bjerknes

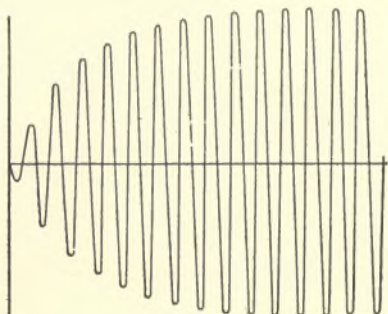

FIG. 287.—RESONANT OSCILLATIONS

plotted the curves in Figs. 287 and 288, showing graphically syntonistic values. The oscillations of an open-circuit radiator or resonator are rapidly damped out, as before stated, in virtue of their transformation into free electric waves; but in a closed-circuit resonator high-frequency currents will continue to oscillate for a

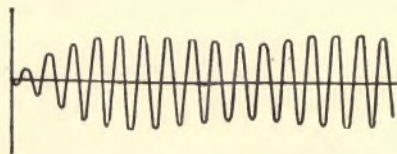

FIG. 288.—PHASE DIFFERENCE OF ELECTRIC OSCILLATION.

considerable time after the co-resonant oscillator has ceased to emit waves. Fig. 287 is a curve showing graphically the amplification of oscillations in a closed-circuit resonator such as Hertz used as a detector after excitation with an oscillator in syntonism with it; in this case the circuits were accurately syntonized with the oscillator, as the increasing amplitude of the swings plainly indicate. In a closed-circuit resonator that is not quite in tune with the oscillator emitting the waves the curve shows the varying difference in phase by the greater and lesser amplitudes. Where the resonator is completely out of syntonism with the oscillator then a counter-action takes place, and however close the oscillator may be to the resonator, there will be no currents set up in it, for each succeeding impinging

wave damps out the feeble impulse of the preceding one, since they are not properly tuned to the coefficients of the circuit.

APPARATUS FOR PLOTTING RESONANCE CURVES.—The resonance curves referred to were plotted by Bjerknæs by means of an open-circuit Hertz oscillator, 1, Fig. 289, a closed-circuit resonator, 2, and a one-sided electrometer, 3; the electrometer was attached to the resonator so that the quadrants of the former were included in the circuit of the latter as shown in Fig. 139; when no current is surging in the resonator system the double quadrants equally attract the needle when it rests at zero potential; but when high-frequency oscillations traverse the circuit the needle is deflected to the right

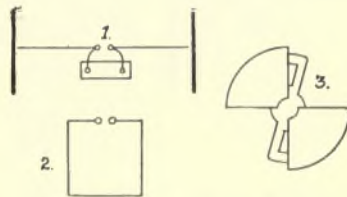

FIG. 289.—BJERKNÆS RESONANCE APPARATUS

and the left, making it easy to determine with considerable accuracy the damping coefficients of the circuit¹.

RELATION OF COEFFICIENTS TO RESONANCE.—The laws underlying sympathetic resonance involve, as they do in primary resonance, the coefficients of capacity, inductance, and resistance, but in this case deal with two mutual circuits. Starting with a capacity and inductance of a given value in the oscillator and resonator systems when resonance obtains, it has been mathematically ascertained and experimentally determined that syntonization remains unaffected if these factors are changed equally in both circuits; again, either the capacity or inductance may be increased or decreased individually in the oscillator without materially altering the resonance effect, provided that like values of the coefficients of the resonator shall be made equal or that the coefficients of the resonator shall represent some multiple or sub-multiple of the oscillator system; the resistance at all times of both circuits should be as low as possible, and for this reason a current-operated detector is preferable to a voltage-operated detector. There are exceptions to the above rule, as, for instance, where the capacity of

¹Decrement of Electric Oscillations. M. V. Bjerknæs, *Comptes Rendus*, June 22, 1871.

a circuit may be decreased by increasing its inductance without destroying the resonance qualities; this is due to the fact that the harmonics of the circuit are based upon the product of its capacity and inductance.

Exceeding care must be exercised in tuning and syntonizing electric circuits for the production of resonance phenomena, and

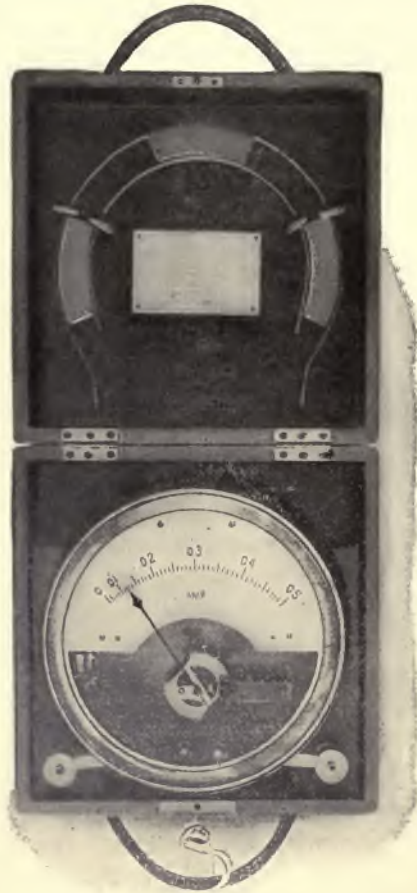

FIG. 290.—HOT-WIRE AMMETER.

the desired results may be much more easily obtained by the variation of capacity than by changing the values of inductance. When resonance is effected a very slight addition or reduction of capacity will be sufficient to throw the co-resonant circuits out of synton

and effectually prevent the resonator from responding to the oscillator.

TUNING CLOSED TO OPEN OSCILLATOR CIRCUITS.—The method usually employed in practice in tuning a closed oscillator circuit to the aerial or open oscillator system is by means of a hot-wire ammeter. Assuming the apparatus to be of the compound circuit type and that the connections have been properly made, a hot-wire ammeter, shown in Fig. 290, is inserted in circuit with the shunt and aerial wire indicated in the diagram, Fig. 291. The sliding contacts 1 and 2 rest on an inductance coil and these are first brought together to cut out the inductance. The primary circuit is then closed by depressing the Morse key while the contacts are gradually separated until the ammeter gives the highest reading.

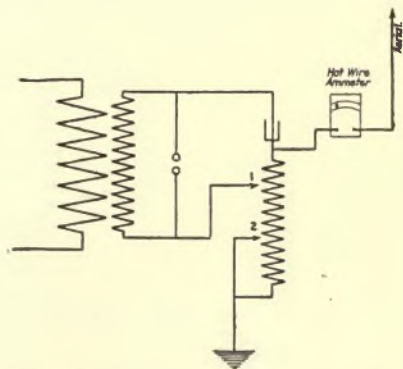

FIG. 291.—TUNING OSCILLATOR CIRCUITS.

When this is determined the speed of the interrupter may be varied, since a higher reading may sometimes be had by a careful adjustment of the make and break device. Occasionally the final position of the sliding contacts may result in an overtone or minor wave length. In the Slaby-Arco transmitters installed on vessels in the United States Navy the wave length used is about 200 meters, which is the length produced by a closed circuit consisting of seven Leyden jars and approximately one turn of inductance.

TUNING RESONATOR CIRCUITS.—With every syntonized receptor system there should be supplied an inductance coil for tuning the open and closed circuits similar to that employed in the oscillator systems. The tuning, however, is accomplished by more or less arbitrary methods. Since the capacity of the coherer is varying constantly, the sliding contacts can only be approximately adjusted.

Then when possible to receive from some transmitter whose wave length is normally that desired to receive by, the operator of the former should transmit a test letter repeatedly at short intervals of time, gradually decreasing the amount of energy, while the operator at the receiving station should adjust his tuning coil until the letter is received to the best advantage, when the relative values of the open and closed circuits and the resonator and oscillator systems will be co-resonant. The aerial wire of the resonator should as nearly equal the length of the oscillator aerial as possible, in order that sharp resonance may obtain.

RESONANCE IN WIRELESS TELEGRAPHY.—The efforts to employ electric resonance in wireless telegraph apparatus so that a transmitter, tuned to a definite period of oscillation and sending out in consequence waves of predetermined lengths only, would set up oscillations in a receptor whose resonator system was tuned to a similar frequency, and therefore in syntony with the oscillator, has called forth many ingenious and striking combinations. Since persistent oscillations are essential to a syntonic system of precision, it is evident that closed circuits are eminently adapted for sympathetic resonance effects, but it has also been pointed out that such closed circuits are exceedingly poor radiators, and therefore quite unsuitable for long-distance wireless transmission; oppositely disposed is the fact that while open-circuit systems emit powerful waves, their damping coefficient is so large that their application to syntonic wireless telegraphy is very limited. These untoward conditions, together with that offered by the unknown factors the earth presents, are problems on which much time and thought have been expended. To overcome these objectionable features many combinations of open and closed circuit systems have been devised in which persistent oscillations would be set up in a closed circuit of an oscillator first, and by transformation be made to oscillate in an open circuit, where they are damped out successively by conversion into electric waves instead of radiating all their energy in two or three swings; a resonator designed on similar lines to those embodied in its complementary circuit radiating the waves is so arranged that the emitted waves impinge on an open-circuit resonator first, and are then transformed into oscillations in a closed circuit, where they surge to and fro many times before their energy is absorbed by the total resistance of the circuit.

CHAPTER XIX.

SYNTONIZATION.

HISTORICAL.

Recognizing the vast importance of a syntononic system of wireless telegraphy whereby a plurality of oscillators and resonators in the same field of force may selectively communicate with any individual station to the exclusion of all others, Lodge invented and patented an apparatus in England in 1897,¹ involving the principles of electrical resonance. This was an open-circuit system having a high time constant, and therefore utilizing long electric waves. The value of closed-circuit systems in resonance phenomena and of open-circuit systems for long-distance transmission now called forth the best efforts of the workers to effect a harmonious combination in which the desirable qualities of both should be retained. Slaby and Arco of Germany devised a system for this purpose in 1898-99, and described it in detail in 1900.² Simultaneously Marconi was working out the principles of a syntononic system by which the persistent oscillations in a closed circuit could be utilized, the high aerial wire eliminated, and the for this purpose in 1898-99, and described it in detail in 1900.² In the same year Braun evolved a system of selectivity based on the proper proportioning of the coefficients of both open and closed circuits, and, reversing the methods above cited, he eliminated the earth and retained the antenna.⁴ In 1902 Fessenden devised an electro-mechanical multiplexing system, the transmitter having acoustic tuning-forks with make and break mechanism adjusted to a certain number of vibrations and the receiver having electro-magnets or telephones with armatures or tongues vibrating at a period

¹British Patent, Lodge, 11,575, 1897.

²Syntonized and Multiplex Spark Telegraphy. General Elec. Co., Dec. 22, 1900.

³Progress of Electric Space Telegraphy. Royal Institution, June 13, 1902.

⁴*Elec. World and Eng.* Braun, Siemens & Halske System. Collins, June 14, 1902.

equal to those of the transmitting forks.¹ A selective system has been produced by Mr. John Stone Stone,² of Boston, in which two simple circuits are associated inductively, each having an independent degree of freedom, and in which the restoration of electric oscillations to zero potential the currents are superimposed, giving rise to compound harmonic currents which permit the resonator system to be syntonized with precision to the oscillator.

A patent issued to Nikola Tesla on March 17, 1903, for a sytonic system of wireless telegraphy describes an apparatus employing two oscillators at the transmitting station, each having its own aerial wire; a single key operates both simultaneously. At the receiving station there are two resonators syntonized to the individual frequencies of the oscillators, and when the circuits are sytonic the relay of the receptor is acted upon, but if one of the circuits is not in accord with the other no signal will result.

A strictly mechanical system of selective wireless telegraphy in which electric resonance is eliminated as a factor has been devised by Anders Bull,³ of Christiania, Norway. The mechanism is operated electrically. By this system three wireless messages have been sent and received simultaneously and selectively, being the first time in the art that mechanical methods have been employed successfully in obtaining selectivity.

PRACTICAL.

Selective wireless telegraphy has been developed along three distinct lines, i.e., electrical, electro-mechanical, and mechanical. In the electrical method the principles of resonance are called into practice; in the electro-mechanical method, tuned circuits are combined with mechanical vibrators, and in mechanical methods mechanism is actuated by impulses from the transmitter operating synchronously with the receiver.

LODGE TUNED SYSTEM.—In the Lodge tuned system of wireless telegraphy, shown in Fig. 293, the method of selective intercommunication consists of producing and detecting a sufficiently prolonged series of rapid electric oscillations so arranged that a particular

¹Letters Patent. Fessenden, 715,203, Dec. 2, 1902.

²Letters Patent. Stone, 714,756.

³*Electrician*, London, 1903. Experiments on Selective Wireless Telegraphy. Anders Bull. Oct. 2.

frequency of oscillation at the sending station may cause an instrument to respond at a distant station tuned to some multiple of that

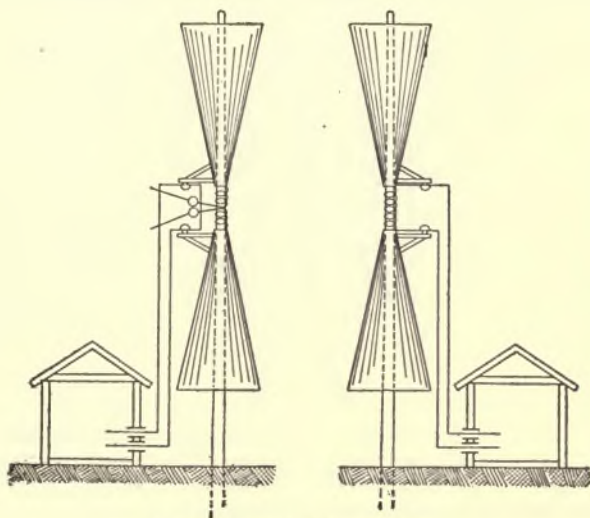

FIG. 293.—LODGE TUNED SYSTEM.

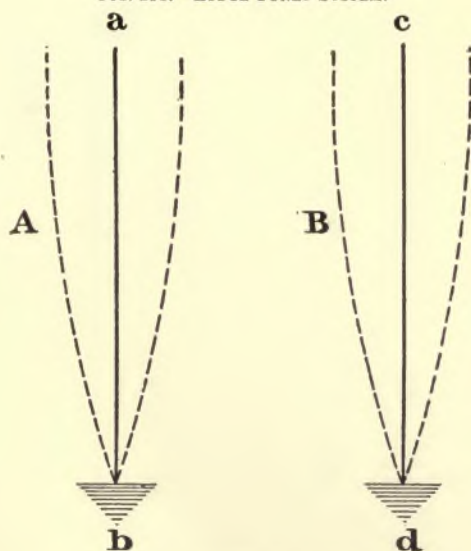

FIG. 294.—SLABY-ARCO MULTIPLE SYSTEM.

frequency. The inductance coil of the radiator, *A*, Fig. 293, prolongs the oscillations, so that the emitted waves have a definite

period. The resonator, *B*, Fig. 293, having the same electrical dimensions as the radiator, the number of oscillations set up in the former is very large, for the feeble impulses are gradually strengthened by cumulative action until the resistance of the wave detector is broken down. A complete set of Lodge's apparatus was shown in operation at the Royal Society Conversazione in London, May 11, 1898, and operated in a manner most satisfactory.

SLABY-ARCO MULTIPLE SYSTEM.—The principles upon which the Slaby-Arco multiple wireless telegraph system is based will be readily understood by referring to the diagram, Fig. 294, where *A* and *B* represent the aerial wires at a distance from each other; when oscillations are set up in *A* of a definite frequency syntonic oscillations will surge through *B*, the amplitude of which will follow a sine wave law between the free terminals, *a*, *c*, and the earthed terminals, *b*, *d*, the amplitude being greatest at *a*, *c*, that is, if the aerial wires are each one-fourth of the wave in length, when the earthed terminals will form the nodal point of the oscillations. Postulating that such is the case, then it is evident that, since the

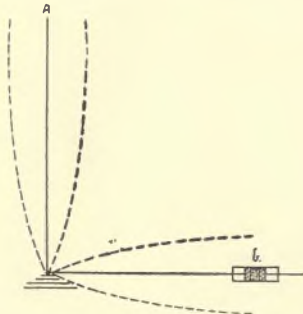

FIG. 295.—POTENTIAL LOOPS AND NODES.

point of greatest amplitude of the antenna is at *c*, *B*, the wave detector, should be placed so that this maximum potential difference may be impressed upon it. But it is not necessary for the coherer to be placed at the free terminal of the receiving antenna, for the same effect is obtainable by connecting a horizontal wire with the vertical air wire at its nodal point, i.e., the earth, and then connecting the free terminal of the horizontal wire to a coherer as shown in Fig. 295, when the amplitude of oscillation at *b* will be exactly the same as at *a*. In practice the coherer is earthed where the oscillation again forms the nodal point of the current wave. The damping coefficient of such an oscillator and resonator is much less than in open-circuit systems, and for this reason the persistency of oscillation is much greater than it would otherwise be, although the aerial wires act as an open-circuit radiator and resonator. The Slaby-Arco system was exhibited before the German Emperor, and two messages, sent from two different stations, were received simultaneously.

MARCONI SYNTONIC SYSTEM (FIRST FORM).—In Marconi's syntonic wireless telegraph system, shown diagrammatically in Fig. 296, the inventor has designed an oscillator in which high-frequency, high-potential currents are not so powerful as in open-circuit oscillators, but it emits long trains of waves instead of strongly damped ones; a syntonic receiver will not respond to the first few feeble

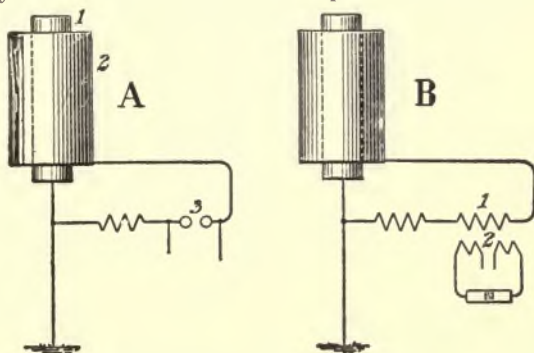

FIG. 296.—MARCONI SYNTONIC SYSTEM.

wave impulses, but the cumulative effect of the train of waves finally breaks down the resistance of the coherer when the indications take place.

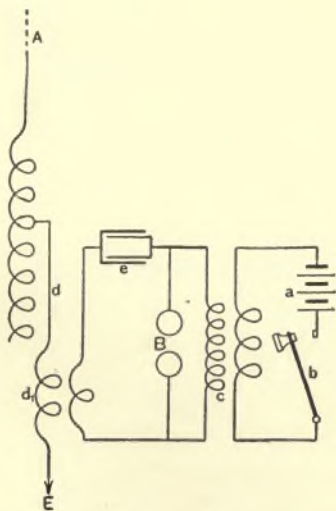

FIG. 297.—MARCONI SYNTONIC SYSTEM. (Second Form.)

In this syntonin system Marconi succeeded in obtaining excellent results with zinc cylinders 7 m. high and 1.5 m. in diameter be-

tween St. Catherine's Point, Isle of Wight, and Poole, 30 miles distant, the signals not being interfered with or deciphered by other stations working in the immediate vicinity.

MARCONI SYNTONIC SYSTEM (SECOND FORM).—In his second form of syntonie apparatus Marconi utilized an open-circuit oscillator formed of the regulation aerial wires and earthed terminals. The frequency of oscillation of the open-circuit radiator can be regulated by increasing or decreasing the number of turns of wire or by placing a variable condenser in series with it, as shown in Fig. 297. The resonator of the receiver, *B*, is similar to that of the oscillator, but leads to the earth through the primary winding of the transformer, the secondary of which is connected to the wave detector. To obtain resonance the open-circuit oscillator must have

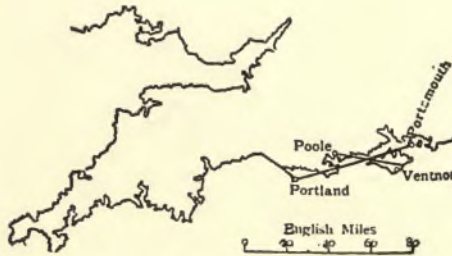

FIG. 298.—MAP OF MARCONI STATIONS.

the same values of inductance and capacity as the open-circuit resonator, which includes the primary winding and the condenser referred to. This system was installed by the English Admiralty between Portland and Plymouth, a distance of 65 miles as the bird flies, and with hills 800 feet high intervening. At Poole and Niton are Marconi stations likewise equipped with this type of syntonie system, the distance being 30 miles. The lines of propagation of these two systems cross each other at the angle shown in the map, Fig. 298, and it was found that when both systems were tuned to a different frequency messages could be sent simultaneously and absolutely independent of each other.

BRAUN RESONANCE SYSTEM.—The arrangement employed by Braun to obtain the maximum number of oscillations per charge with the radiation of the greatest amount of energy per oscillation and its complementary resonator, which is to a certain extent its counterpart, is shown diagrammatically in Fig. 299. In action it operates as follows: the oscillations set up in the closed

circuit are impressed upon the open circuit by the linking of the magnetic lines of force in the transformer coils, when the secondary receives the maximum potential of the high-frequency current which are emitted from the open circuit; the impinging waves on the antenna of the resonator are diametrically opposite to that of the oscillator in that the oscillations are set up in the open circuit first and by conversion are made to surge in the closed circuit, where they are not only persistent, but by simple resonance are amplified in potential until the coherer gives way and the indication results. Braun's system has been tested between Cuxhaven, Germany, and Heligoland, in the German Ocean, 36 miles distant, with excellent success.

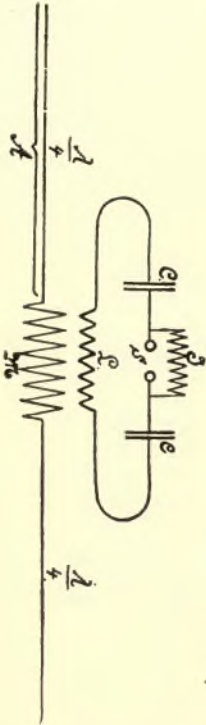

FIG. 299.—BRAUN RESONANCE SYSTEM.

FESSENDEN SELECTIVE SYSTEM.—In addition to and in combination with the tuning devices employed by Fessenden in his transmitter and receiver, based upon the coefficients of the oscillator and resonator, the electro-mechanical apparatus shown diagrammatically in Fig. 300, forms a method of obtaining selective signals independent of the dimensions of the sending and receiving circuits; in the transmitter the radiator, 1, is grounded through the spark-gap, 2, in the usual manner. The primary of the coil is connected in series with the battery, 4, and with two make and break mechanisms, *A*, *B*, operated independently and at predetermined but given rates of speed. The make and break consists of a cup, 5, containing mercury, with a reciprocating pin, 6, alternately making and breaking contact similarly to a mercurial interruptor of this type, the motor, 7, serving to operate it.

The tuning forks, 8, 8, *A*, are adjusted to a given period and correspond to the motor driven interruptor, 5, 6, 7, *A*; likewise the forks, 8, 8, *B*, have a period of vibration corresponding to the motor interruptors, 5, 6, 7, *B*, but the *A* forks are tuned to a different pitch from the *B* forks, e.g., *A* may be adjusted to 256 vibrations per second while *B* may have 384 vibrations per second. The receiver is operated by the Fessenden detector, 11, connected in series

with the antenna and ground; the local circuits, including two or more electro-magnetic mechanisms operating in unison, have the same periods of vibration as those of the transmitter. When a message is sent the key 9 is depressed to make a dot or dash, and during this time the make and break mechanisms send out groups of electric waves, but one of the sets of groups emits waves at the rate of 256 per second and the other at the rate of 384 per second, and these different groups of waves acting on the resonator circuit cause the tongues, 13, of the receiving mechanism to respond synchronically and actuate telephone receivers. Fessenden has very recently dispatched messages between Jersey City and Philadelphia,

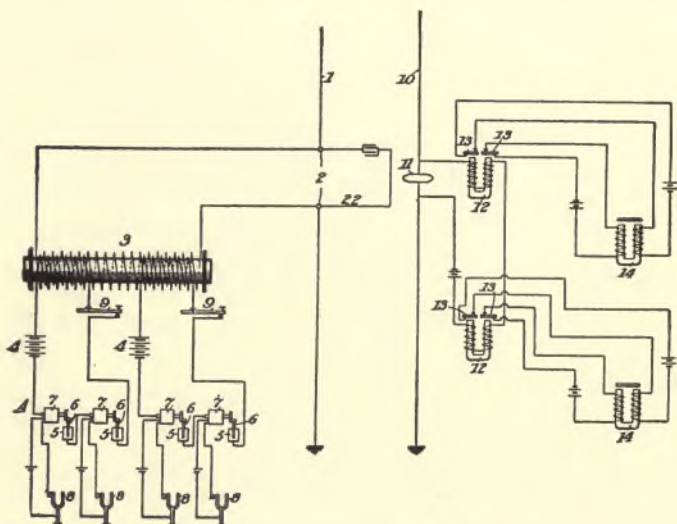

FIG. 300.—FESSENDEN SELECTIVE SYSTEM.

a distance of 90 miles, and nearly all overland, with a minimum of energy.

TESLA DUPLEX SYSTEM.—To eliminate the difficulty of resonators responding to the upper and lower harmonics of other systems in the effective zone, Tesla has designed a duplex apparatus, which he compares to a combination lock; two frequencies are employed at both the sending and receiving stations, and when these act in unison operate a common relay. This is accomplished by generating two sets of oscillations, having different periods surging in independent oscillators and receiving them by means of independent resonators each of which is tuned to its comple-

mentary oscillators; AB , Fig. 301, represents diagrammatically the sending and receiving systems. The radiators, D^1, D^2 , are connected to the terminals of the secondaries of two transformers, S^1, S^2 , the opposite terminals leading to earth, E , as in other systems. The primaries, P^1, P^2 , are in series with the inductances, L^1, L^2 , and the condensers, C^1, C^2 ; the condensers are energized by the generator, S ; shunted across the condensers is the spark-gap, D , consisting of a rotating disk having projections, p, p , as shown, which makes and breaks the disruptive discharge between the electrodes, n, n , inserted in the holders, B^1, B^2 . This discharge disk is connected with the primary circuit at F and may also be led to earth at E , when two independent primary circuits are formed.

The duplex oscillators sending out energy in two different wave lengths are impressed upon the resonators, $e s^1 d^1$ and $e s^2 d^2$,

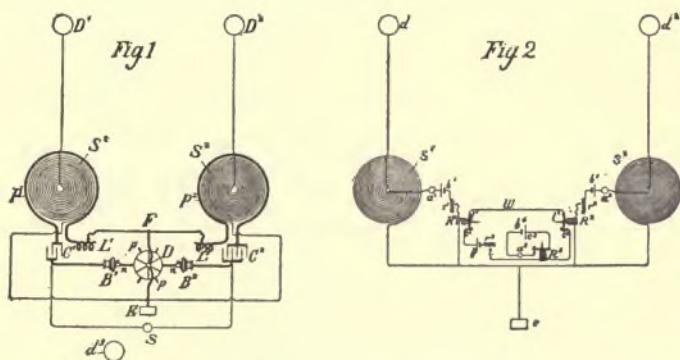

FIG. 301.—TESLA DUPLEX SYSTEM.

syntonized to the sending station so that each responds exclusively to one of the two frequencies at the transmitting station; the electric wave detectors, a^1, a^2 , are placed in the oscillator circuit leading to earth at e ; R^1, R^2 are relays in independent circuits actuated by the resonators, and when these relays operate simultaneously the internal circuit containing a third relay, R^3 , is closed; when the relay R^3 becomes operative it actuates the recording mechanism. This system is said to work very well in the laboratory.

STONE MULTIPLEX SYSTEM.—The invention of Stone for multiplex selective signaling consists of a single vertical wire at the transmitting station radiating electric waves of a single given frequency. The oscillator is of the open-circuit type and is im-

pressed with forced oscillations of a simple harmonic character by means of a series of closed-circuit oscillators acting through the medium of transformers. The receiver is made to respond to the selective frequency of the oscillator by employing a periodic open-circuit resonator and interposing between it and the translating device a series of closed circuit resonators capable of responding to a given and predetermined frequency.

In Fig. 302, *A* and *B* represent the transmitter and receiver respectively. In these diagrams *V* is the aerial wires connected with the earth, *E*, through the medium of the primary of a transformer, 1^2 , thus forming an open-circuit oscillator and resonator. The secondary, 1^1 *A*, forms a closed-circuit oscillator, which includes the inductance, *L*, condenser, *C*, and spark-gap, *S*; the local low-frequency, high-potential circuit feeding the spark-gap is composed

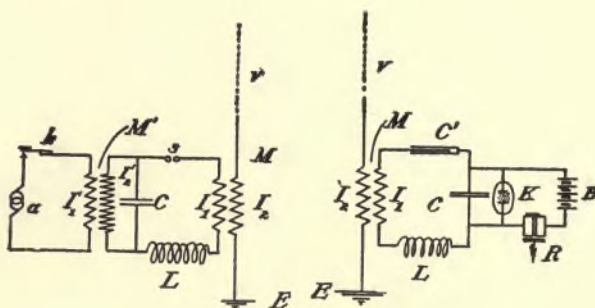

FIG. 302.—STONE MULTIPLEX SYSTEM.

of the secondary of a transformer, 1^2 , and the condenser, *C*; the primary local circuit consists of the inductor of the transformer, 1^1 , the key, *K*, and an alternating current generator, *a*. The receiver, *B*, is a physical counterpart of the transmitter in that its resonator is of the open-circuit type and has combined with it a closed-circuit resonator having a definite period due to the condenser, C^1 , and the inductance, *L*; the local circuit includes the coherer, *K*, the usual battery, *B*, and the relay, *R*.

In action the condenser, *C*, discharges through the closed-circuit resonator, S^1 , *L*, and is of high frequency. The oscillations of this circuit are simple harmonic in character and are unaffected by the inductive association of the open-circuit oscillator because the inductance of the closed-circuit resonator is large when compared with that of the open-circuit oscillator. Now when two oscillators are

inductively associated each has its own degree of freedom, or its natural period of oscillation, and each is modified by the other, as shown in the curve, Fig. 303; but if the coefficients of each circuit

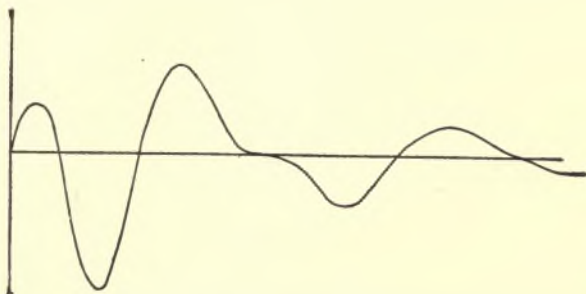

FIG. 303.—MODIFIED PERIOD OF OSCILLATION.

are such that the combined inductance of the two oscillators is large when compared with the mutual inductance between the circuits,

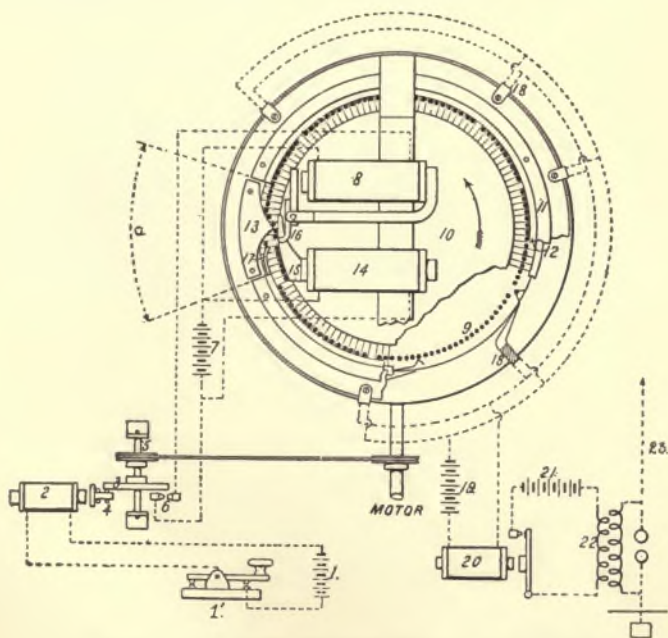

FIG. 304.—BULL SYNCHRONIZED SYSTEM. THE DISPERSER.

the natural period of oscillation becomes practically the same as if the circuits were isolated. The object of this arrangement is to obtain as nearly as possible a pure, simple, harmonic wave and to

reduce to a minimum the minute overtones which cause a departure from the true sine wave. At his stations on the Charles River embankment (Boston), Stone has shown it possible to transmit and receive selective signals when the difference in frequency was not more than ten per cent.

BULL SYNCHRONIZED SYSTEM.—A selective system of wireless telegraphy based on mechanical principles has been invented by Anders Bull. The apparatus comprises a transmitter and a receiver; the transmitter includes an open-circuit oscillator supplied with energy by the usual transformer or induction coil operating through

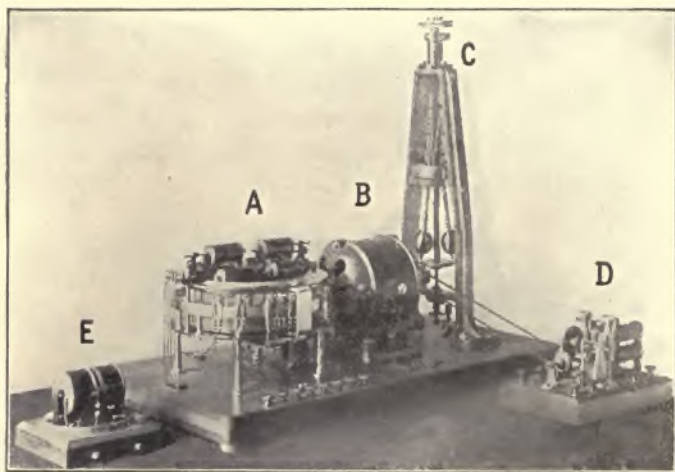

FIG. 305.—BULL SYNCHRONIZED SYSTEM.

an apparatus termed a *dispenser*, likewise the receiver has an open-circuit resonator actuating a number of registers through a mechanism termed a collector. The dispenser is shown diagrammatically in Fig. 304, and in half-tone in Fig. 305. By referring to these figures it will be observed that the dispenser, *A*, is connected by gearing to the motor, *B*, a Siemens and Halske regulator, *C*, controlling its speed. *D* is an electro-magnet automatically controlling a disk, making a specific number of contacts and sending out a similar and predetermined number of series of electric waves.

When it is desired to send a message, the key, 1¹, is depressed and closes the circuit including the battery and electro-magnet, 2, which attracts an armature attached to a clutch carrying a pin as shown. The function of the armature, magnet, and clutch is

shown more clearly in Fig. 306, being a sectional view of the disperser. When the armature is drawn to the magnet, 2, the disk, 3, is released by the clutch, 4, and then revolves at a speed of about 5 r. per second. At every revolution of the disk, contact is made by the springs, 6, and the circuit, including the battery, 7, and the electro-magnet, 8, is closed. The disperser proper consists of 400 steel springs, 9, attached at right angles to the disk and near its periphery; these long, vertical springs have their ends free and pass through slots in a stationary and upper disk, 10; the springs are thus permitted to move in a radial direction only; a ring of brass forming a groove, 11, is fastened to the framework and guides the springs so that with each revolution of the disk, which is once every second, they either slide in the groove, 12, or within its inner circumference. The bronze arc, 13, takes the place

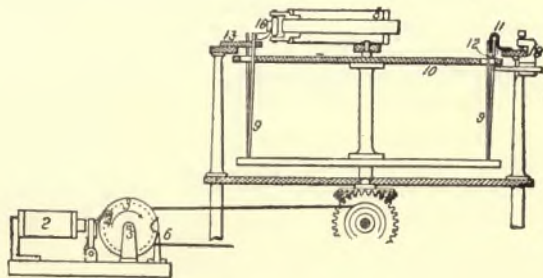

FIG. 306.—DETAIL OF TRANSMITTER.

of a section of the brass ring, 11, and has a finger projecting toward the center of the disk; as the vertical steel springs come in contact with it, they are forced toward the magnet, 14. Attracted by this magnet, the springs slide along until released at the edge of 15, where they are again drawn into the groove or return to the inner part of the ring by their own elasticity according to whether the magnet is or is not energized.

Now in action when it is desired to send a dot the key is depressed for less than a fifth of a second, or the time required for the disk 3 to complete one cycle, and the current flows through the circuit as a single impulse. When a dash is transmitted the key is held in contact until the disk 3 has revolved a number of times, when a corresponding number of electric impulses at one-fifth second intervals flows through the circuit causing the springs to make contact at regular intervals by means of contact points, 18,

and thus closing the circuit in which the battery, 19, and the coil, 20, form a part. As there are a number of these contact points arranged around the frame at prescribed distances, it is evident that the number of series of electric waves emitted will be equal to the number of contact points, and by varying the distance between these points any combination or series of waves may be sent out through the medium of the electro-magnetic key, 20, battery, 21, induction coil, 22, and the oscillator circuit 23.

The collector is similar to the disperser except that receptive devices are employed instead of emitting appliances in the circuits. Fig. 307 is a plan view and 308 a half-tone of the collector. The

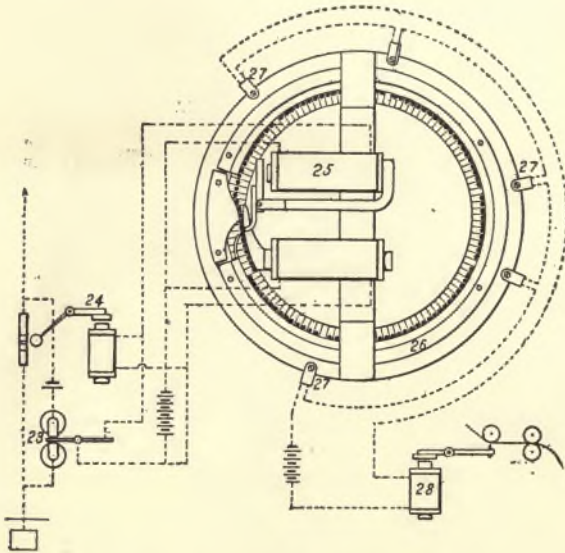

FIG. 307.—BULL SYNCHRONIZED SYSTEM. THE COLLECTOR.

coherer is connected in the open-circuit resonator in the usual manner while the relay, 23, in series with a cell is included in a local circuit with the coherer. The tapper, 24, is in parallel with an auxiliary circuit formed by the armature of the relay in series with the magnet, 25. For every series of electric waves that impinge upon the resonator system one of the vertical steel springs slides into the groove, 26, of the ring. The revolving disks of the disperser and collector revolve synchronously, so that the angular distances of the springs sliding in the grooves will be proportional to the time constant between the series of the waves impinging on the vertical wire.

Since the points are arranged in the same relative positions in both the disperser and collector, and are operated synchronously, contact in both is made simultaneously. The points, 27, are connected in series with the Morse printing register, 28. Now a prearranged series of electric waves will cause the springs to make contact at the same instant when the local collector battery operates the



FIG. 308.—BULL SYNCHRONIZED SYSTEM. THE COLLECTORS.

register. Electric wave series in succession will produce a dash or a series of dots representing a dash.

In Bull's experiments one disperser and one collector were employed, but these were arranged with three sets of contact points, thus permitting any one of three Morse registers, shown in the photograph, Fig. 308, to be operated at will. Three series of waves



FIG. 309.—TAPE OF BULL SYSTEM.

were used, represented in A, Fig. 309, by the dotted lines S^1 , S^2 , S^3 , the horizontal line being taken as time and the wave series by the heavy vertical strokes. The spaces between the light strokes represent intervals of one-fifth second. B illustrates how the wave series are registered when the key of the transmitter is kept closed. I, II, III, are the types of three Morse registers operated independently of each other. The transmitters and receivers

may be set up in different localities and at varying distances with equally good results.

This represents the evolution of transmitting messages through space without wires as well as the wireless transmission of intelligence in the same field of force without interference. Wireless telegraphy has made gigantic strides since its inception a few years ago, especially in the bridging of distance, but its commercial future now rests on the problem of syntonization, and when this shall have been accomplished the possibilities of the new art will be practically unlimited and of untold value.

CHAPTER XX.

WIRELESS TELEPHONY.

The brilliant achievements in wireless telegraphy lead naturally and in sequence to the more difficult proposition of transmitting articulate speech without wires; but wireless telegraphy is infinitely easier of solution than wireless telephony, since an electrical impulse of any character may be utilized as a signal, whereas in the transmission of speech an alternating current having the same phase, amplitude and frequency at either station are necessary. This being the case, it is obvious that electric waves produced by the disruptive discharge are not suitable for wireless telephony,

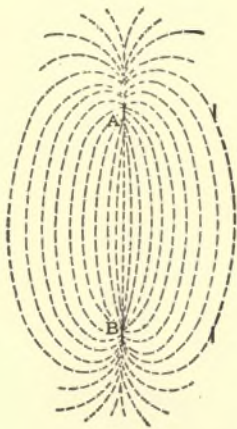

FIG. 310.—ELLIPTICAL LINES OF FORCE.

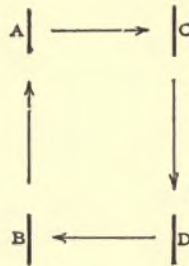

FIG. 311.—CONDUCTIVITY METHOD.

since the decrement of the oscillations producing the waves are periodic and reach 0 in a very small fraction of a second, and are, therefore, quite incompatible with the long, smooth sine wave currents usually employed in telephony. But while electric waves are not adapted to wireless telephony there are several methods by which results may be obtained within certain limitations.

CONDUCTIVITY METHOD.—One of the simplest methods of telephoning without wires is by utilizing the earth as a portion of the sending and receiving circuits, and by leakage or dispersion of the current in the primary circuit through the earth the energy spreads in elliptical lines of force like magnetic lines between the poles of a magnet, as in Fig. 310. This is known as the conductivity method, and when applied to actual transmission two base lines, *AB* and *CD*, are arranged parallel with each other so that the terminals of the sending and receiving circuits are earthed, as shown in Fig. 311, when a current, either direct or alternating, flows through the circuit *AB* the energy is propagated to the circuit *CD* in virtue of the great cross-section of the earth, which is a fairly good conductor. The length of the base lines should be, preferably, twice the length of the distance to which speech is to be transmitted ;

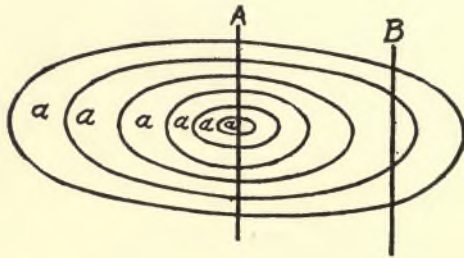

FIG. 312.—INDUCTIVITY METHOD.

it is this limiting feature which has prevented its employment in practice, except, perhaps, in special cases.

INDUCTIVITY METHOD.—A second fundamental method ideal in its mode of propagating energy when articulate speech is considered, consists of a large primary coil of wire with a similar secondary placed at a distance. Let *AB*, Fig. 312, represent two coils of wire placed with their planes parallel with each other, or their planes may be horizontal. On speaking into a telephone transmitter with a battery in series with the coil *A* an undulatory current in rotation through the turns of wire will set up a magnetic flux the lines of which may be great enough to link the coil *B*, i.e., when the lines from the coil *A* thread through the coil *B* an e. m. f. proportional to the rate at which they link with the coil *B* produces by its inductive action a momentary current in the coil including in its circuit the telephone receiver. As the num-

ber of turns of wire and size of the coils and e. m. f. increases the distance between the two coils may be extended.

ELECTRIC WAVE METHOD.—Many experimenters have endeavored to utilize high-frequency, high-potential currents in wireless telephony, but, for reasons previously pointed out, it is not practicable to employ a disruptive discharge to obtain electric oscillations of constant value. Alternating currents, however, of comparatively low frequency will emit electric waves, although such radiations are very feeble; but speech may be transmitted wirelessly if the spark-gap of the oscillator is bridged by an air-gap and a mechanically high-frequency current is employed; the spoken words will be reproduced by inserting a receiver in the resonator circuit. Another method the author has employed is to permit the spark-gap of the oscillator to remain open, causing the current to surge to and fro in it with every reversal in the secondary of the transformer, although it is difficult to determine whether the calculations obtained are the result of an alternating magnetic field

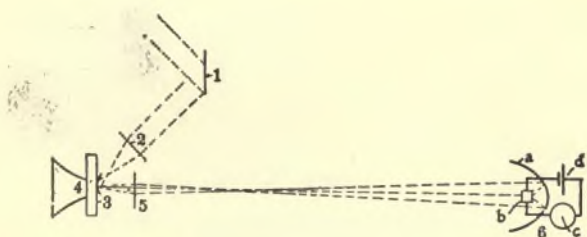

FIG. 313.—BELL RADIOPHONE.

around the radiator or electric waves emanating from it. This method offers some promise, though the effective distance covered has been exceedingly limited.

BELL RADIOPHONE.—The principles upon which Professor Alexander Graham Bell's radiophone for telephoning by a beam of light are well known. In this method a ray of light from either the sun or an arc light is caused to fall upon a plane mirror, 1, Fig. 313, and reflected to the lens, 2, where it is refracted and brought to a point and impinges on the concave mirror, 3, attached to the back of a diaphragm of a telephone transmitter, 4; the light, after reflection from the mirror, 3, passes through a condensing lens, 5, where it is projected to a distance

through space to the receiver, 6. This consists of a parabolic mirror, *a*, having a selenium cell, *b*, placed in its focal line; a battery, *d*, and a telephone receiver, *c*, are connected in series with the selenium cell.

When the radiophone is in action the vibrations of the diaphragm by the voice varies the intensity of the light falling upon the concave mirror and the projected beam of light is gathered in the focus of the receiving parabolic mirror, where the light waves are concentrated on the selenium cell, which varies in resistance

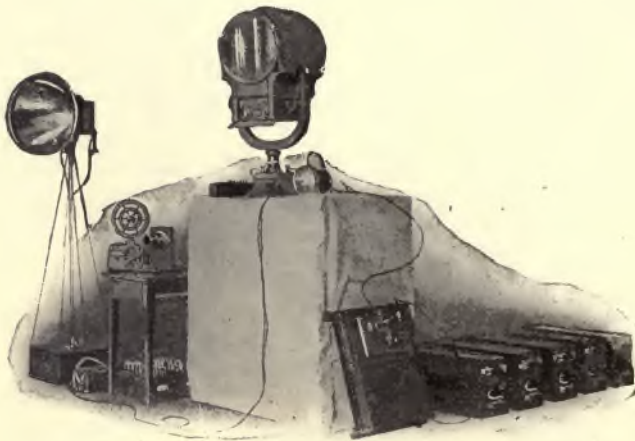

FIG. 314.—RUHMER PHOTO-ELECTRIC TRANSMITTER.

coincidentally with the intensity variations of the light, and every vibration of the diaphragm, change in light intensity and cell resistance is reproduced in the telephone receiver. Speech has been transmitted by this method several hundred feet and is marvelously clear and distinct.

RUHMER PHOTO-ELECTRIC TELEPHONE.—Since Bell's experiments, new discoveries have been made in photo-electric effects, and among the most interesting may be cited the speaking arc, invented by Simon, of Göttingen, Germany, who ascertained that by superimposing an alternating current, induced in the secondary of a small transformer coil by the undulations of the primary in series with a telephone transmitter, as a heavy direct-current operating an arc light the volume and intensity of the flame

varied proportionately, and though these variations were not perceptible to the eye, due to the persistency of vision, they would affect a photographic plate or a selenium cell.

Having in view the object of producing a photo-electric tele-

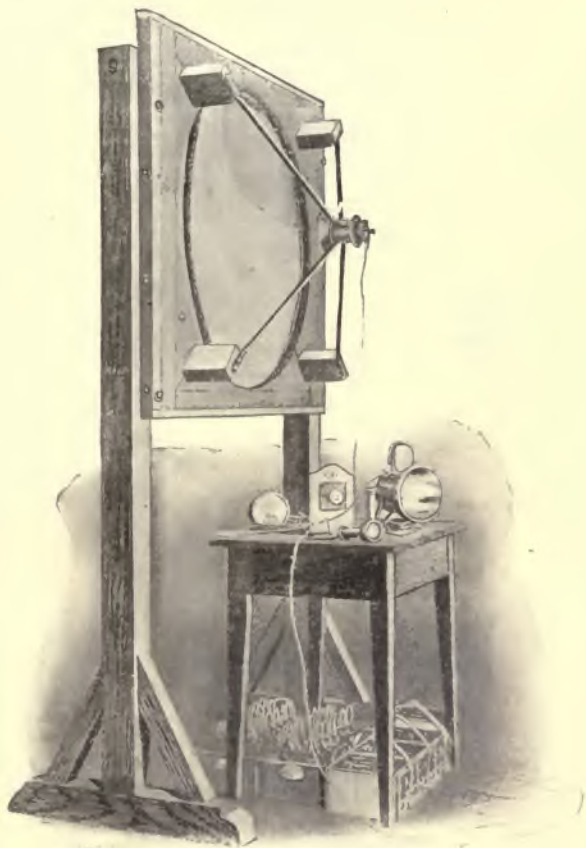

FIG. 315.—RUHMER PHOTO-ELECTRIC RECEIVER.

phone of sufficient penetrative power to be useful, Professor Ernest Ruhmer, of Berlin, devised an apparatus for utilizing the principles involved in Bell's radiophone and the Simon speaking arc. This he did by placing an arc light in the focal line of a parabolic reflector, Fig. 314, having a diameter of 50 cm., and constructed like

a searchlight. The arc is supplied by a storage battery of 52 volts and 8 or 10 amperes when speech was transmitted over a distance of 3 or 4 kilometers. A telephone transmitter is connected in series with a small storage battery of 6 or 8 volts, as shown in the illustration, and the primary of a transformer, while the secondary is connected through a condenser in parallel with the arc-light circuit. The receiver designed by Ruhmer, Fig. 315, consists of a parabolic reflector and having a selenium cell placed in its focal line in series with a pair of telephone receivers and a battery. Selenium



FIG. 316.—RUHMER'S ELECTRIC LAUNCH "THE GERMANIA."

cells, employed before Ruhmer, were made by winding a pair of wires parallel to each other on a flat piece of glass and filling the space between them with fused selenium. Clausen and von Bronk made a cell of this type having a ratio of 10 to 1 in resistivity variations, and a cell by Giltay exhibited a variation ranging between 533,000 ohms in darkness to 26,000 ohms in a light of 400 intensity, but these cells have a high time constant in returning to their original resistance. The cell devised by Ruhmer was given a cylindrical form so that the light might be evenly distributed over its surface by the reflector. The selenium cell was made by winding two fine platinum wires in parallel and separated by 7-10 mm. on a glass tube 33 mm. in length and 20 mm. in circumference and then forc-

ing the prepared selenium in the space between the wires. This preparation consists of heating the amorphous red powder, in which state selenium is found, until it is transformed into a black, gummy mass, when it becomes a very good insulator; it is then applied to the interstices of the platinum wires and baked for twelve hours at



FIG. 317.—RUHMER RECEIVING A PHOTO-ELECTRIC MESSAGE.

a constant temperature of 200° F., when it is annealed by gradually reducing the temperature and crystalline selenium results, having a gray color and assuming the remarkable property of varying its electrical resistance under the influence of light. Such a cell is marvelously sensitive to light variations and has a maximum re-

sistance of 120,000 ohms in the dark and dropping to 1,500 ohms when illuminated by a 16 candle-power lamp. With this equipment Ruhmer conducted his experiments on Wannsee, the transmitter being placed on an electric launch, the *Germania*, Fig. 316, and the receiver on the shore, Fig. 317, at a distance of $1\frac{1}{2}$ kilometers; this distance was gradually increased until a maximum distance of 4 kilometers was reached.

COLLINS WIRELESS TELEPHONE.—Having tested all the above methods for transmitting articulate speech without wires, and finding that each had its especial limitations, the author sought for some method by which the difficulties encountered might be overcome. In experiments with coherers adjusted to their maximum sensitiveness it was ascertained that comparatively low-frequency, high-potential currents alternating through an oscillator would emit waves of sufficient energy to break down the resistance of a detector. It was also found that when mechanically produced high-frequency, high-potential currents are discharged into the earth and there restore the potential level of the circuit, of which the earth forms a portion, instead of free air, new manifestations occur, and among them may be cited the propagation of long sine waves to great distances. The length of the waves depends on the frequency of alternations and the frequency on the coefficients of the transmitting circuit, and these joint factors, finally on the constants of the ether, which are its elasticity and its density.

Since the value of elasticity of the ether is not absolutely known, it has been determined empirically by its reciprocal or dielectric constant, as when ether is associated with gross matter which has a specific inductive capacity. The density of ether closely identified with the atoms of the atmosphere, acts, paradoxically, as though it were greater than in vacuo, and the effect on the particles of matter of which the earth is composed is greater than on the air. The term *bound ether* has been given to ether associated with gross matter. Now matter, gross or transcendental, acts like a solid body if it is struck hard enough, when vibrations will be transmitted by it. Strike the surface of a body of water with a board and it will assume at the instant of impact all the characteristics of a solid; and every molecule of the water will vibrate in consequence; beat the air with an outspread wing with sufficient force and it will resist its movement, if its velocity is great enough, like a solid body, and the ether also acts like a solid body if it is struck hard

enough and an electric discharge is the hammer to strike it with, when transverse vibrations in it occur.

Mechanically high-frequency, high-potential currents cause the earth-bound ether to manifest its presence to a greater distance than in free ether or ether associated with air upon the impact of the former. The action of sound waves furnishes a good analogue; if a bell is struck in water it can be heard many times farther than when it is struck in free air, for the density of water is greater than air; similarly if a bell could be struck in a sea of mercury the sound waves would be propagated to a much greater distance than in



FIG. 318.—COLLINS SENDING A WIRELESS TELEPHONE MESSAGE.

water, since mercury is much more dense than water. The waves the author employed in his wireless telephone are radiated normally in a circle, but it has been found possible to reflect and make them unidirectional within 15° of arc. Fig. 318 is an illustration of a portable equipment devised for testing the telephone in the field, and was employed in the early experiments. Later, three stations, Figs. 319, 320 and 321, were established at Rockland Lake, N. Y. Complete standard station sets were installed at these stations for wireless telephony, as shown in Fig. 322. In the transmitter a primary coil is connected in series with a key, battery, and variator; the terminals of the secondary winding are connected to a circuit cor-

responding to the oscillator of a wireless telegraph system. Bridged across the secondary of the transformer coil is an adjustable condenser, so that the ratio of inductance and capacity may be maintained in their proper relations and the reproduced speech made clear and distinct. The receiver operates through a circuit similar



FIG. 319.—COLLINS WIRELESS TELEPHONE STATION A.

to a resonator and consists, in its simplest form, of a telephone receiver, a battery, transformer, coil, inductance, and capacity.

When in operation and the primary circuit is closed, the current is varied automatically, and mechanically high frequency and high potential currents are set up in the discharging circuit, which emit the waves in the earth; the waves impinging on the receiving circuits surge with the same frequency and have the same amplitude of vibration, though diminished volume of the original currents of the



FIG. 320.—COLLINS WIRELESS TELEPHONE STATION P.



FIG. 321.—COLLINS WIRELESS TELEPHONE STATION C.

emitting circuits. The received impulses are translated by a telephone receiver. The first tests of this system of wireless telephony were made at Philadelphia, Pa., in 1899, when speech was trans-



FIG. 322.—THE "JOHN G. McCULLOUGH"

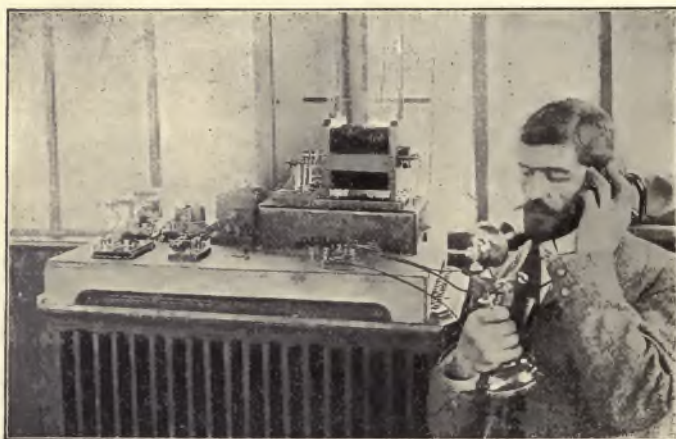

FIG. 332.—COLLINS WIRELESS TELEPHONE.

mitted to a distance of 200 feet; in 1900 words were sent wirelessly across the Delaware River, a mile, and in 1902, with improved apparatus, a distance of three miles was covered between the sending and receiving stations. In the same year proving sta-

tions were established at Rockland Lake, N. Y., *A, B*, Figs. 320 and 321 being a mile apart. This was the first complete wireless telephone system working in both directions and equipped with signaling apparatus.

While these preliminary tests have been made on land, the sphere of the wireless telephone lies in its application to vessels in harbors. Hardly a month passes but that one vessel rams another, due primarily to a misunderstood signal, and this is especially true in foggy weather.

The wireless telegraph is not adapted to this class of work, since it requires a skilled operator who must be constantly at the captain's or pilot's side to interpret the Morse code. The wireless telephone is a first-hand instrument at once simple, reliable, and may be applied to any vessel at a comparatively small cost. Extensive experiments have been in progress during the summer on the Hudson River (New York City), where wireless telephones were installed on the ferryboats *John G. McCullough* and *Ridgewood*, of the Erie Railroad system, pictures of which are given in Fig. 323. Not until the advent of the wireless telephone had there been a single improvement looking toward the safety factor in marine signaling at close range since the invention of the time-honored and hoary steam whistle.

Into the future it is dark and difficult to see! Its misty veil is so drawn that only a little light reaches us through its filtering meshes, and this by the empirical path of experience; therefore we cannot predict. The wireless telegraph, the dream of yesterday, is a reality of to-day; cableless telegraphy, now in its experimental struggles, may eliminate the cable to-morrow. The wireless telephone may never supplant the efficient wire-system, yet stranger things have come to pass in less time than the quarter of a cycle we term a century. The assistance of the telegraph, the cable, the telephone in the advancement of civilization is beyond the wildest speculation of the romancer living fifty years ago. What these modes for the transmission of intelligence have done for mankind in the making the last half of the past century let us hope that wireless methods will do for the first half of the present century. These are but additional links in the universal chain of evolution as designed by the omnipotent Creator.

INDEX TO NAMES.

Allemaud, 37.
 Ampere, 78, 79.
 Apps, 37, 95.
 Arago, 78.
 Arco, *passim*.
 Arons, 148.
 Ascoli, 236, 237.

Bachhoffer, 92, 93.
 Baden-Powell, 252.
 Barker, 93.
 Becquerel, 66, 79.
 Bell, 228, 287, 289.
 Beckeley, 6.
 Bernouilli, 260.
 Bichat, 112, 114.
 Bjerknes, 21, 52, 148, 258, 264, 265.
 Blondel, *passim*.
 Boltzmann, 148.
 Bonomo, 237.
 Boscovitch, 2, 3.
 Bose, 127, 139.
 Botts, 66.
 Bradley, 14.
 Braun, *passim*.
 Branly, *passim*.
 Bronk, von, 290.
 Bull, 164, 183, 186, 207, 270, 280.

Caldwell, 100, 119.
 Callan, 92, 93.
 Calzecchi-Onesti, 136, 137, 141, 145.
 Cardew, 148.
 Castelli, 154.
 Cervera-Baveria, 182, 202, 203.
 Claude, 203.
 Clausen, 290.
 Collins, *passim*.
 Coulomb, 64.
 Cunningham, 114, 115.

Davy, 78, 211.
 De Forest, *passim*.
 De la Rive, 21, 24, 25.
 Dolbear, 234.
 Duane, 27.
 Dubois-Reymond, 79.
 Ducretet, *passim*.

Eccle, 138.
 Eddy, 249.

Edison, 171, 234.
 Edlund, 65.
 Erlung, 10.
 Ewing, 84.

Faraday, *passim*.
 Fedderson, 37, 48.
 Felici, 79.
 Fessenden, *passim*.
 Fitzgerald, 20, 148.
 Fizeau, 14, 79, 94.
 Fleming, *passim*.
 Foote, 102.
 Foucault, 14, 79.
 Franklin, 36, 37.
 Fresnel, 9.

Geissler, 27, 101.
 Gilbert, 47.
 Giltay, 290.
 Green, 64.
 Gregory, 148.
 Grisson, 100, 122, 124.
 Guarini-Foresio, *passim*.
 Guericke, von, 36, 127.
 Guitard, 136.
 Guthe, 139, 142.

Haeckle, 6.
 Halske, *passim*.
 Hawksbee, 36.
 Heardon, 139.
 Heaviside, 21.
 Helmholtz, von, *passim*.
 Henry, *passim*.
 Hertz, *passim*.
 Hewitt, 125.
 Holtz, 127, 129.
 Hopkinson, 55.
 Hughes, 136.
 Hume, 6.
 Huygens, 2, 3, 14.

Ives, 76, 86, 96.

Jaumann, 39, 44.
 Jean, 94.
 Jegou, 241.
 Jenkins, 65.
 Johnson, 87.
 Jones, 7.
 Joule, 66, 69.

- Kelly, 258.
 Kelvin, *passim*.
 Kinraide, 103.
 Kinsley, 143, 144.
 Kintner, 137, 154.
 Kirchhoff, 66, 79.
 Kitsee, 234.
 Kleist, 36.
 Klingelfuss, 88, 89, 90.
 Koepsel, 142, 151, 234.
 Koosen, 258.
- La Grange, 3.
 Lamb, 59.
 Langley, 27.
 La Place, 64.
 Lebedew, 8, 21, 33.
 Lecher, 27.
 Lenz, 66, 79, 258.
 Lodge, *passim*.
- Marchant, 48.
 Marconi, *passim*.
 Martin, 130, 212.
 Matthieson, 66.
 Maxwell, *passim*.
 Mizinro, 90.
 Morse, *passim*.
 Muirhead, *passim*.
 Murphy, 121, 122.
 Musschenbroek, 36.
- Neef, 94, 109.
 Neugschwender, 137.
 Neumann, 79, 236.
 Newton, 2, 13.
- Ohm, 49, 66, 68, 69.
 Overbeck, 258.
- Paalow, 148.
 Page, 92, 94.
 Pierson, 102.
 Plank, 54.
 Plato, 9.
 Poggendorf, 93.
 Poincaire, 21.
 Poisson, 64.
 Popoff, *passim*.
 Popp, 180, 203, 207.
 Poynting, 21.
 Preece, 82.
 Pupin, 11, 258.
- Queen, 42, 105.
- Rayleigh, 55, 86.
 Reiss, 22, 46, 52.
 Righi, 58, 148, 153, 238.
 Ritchie, 79.
 Ritter, 142, 148.
 Romer, 14.
 Rontgen, 15.
 Rubens, 148.
 Ruhmer, 288, 289, 290, 292.
 Ruhmkorff, 37, 79, 94, 169.
 Rutherford, 137, 185.
- Sarasin, 24, 25.
 Savart, 47, 48.
 Schaffer, 137, 153.
 Shaw, 139.
 Siebt, 261.
 Siemens, *passim*.
 Silliman, 92.
 Simon, 175, 288, 289.
 Slaby, *passim*.
 Smythe, 143, 201.
 Spottiswood, 37, 95.
 Sprague, 99.
 Stone, 164, 277.
 Sturgeon, 78, 92.
- Taylor, 33.
 Tesla, *passim*.
 Thompson, Sylvanus, 17, 20.
 Thomson, Elihu, *passim*.
 Thomson, J. J., 21, 59.
 Toepler, 127, 129.
 Tommasini, 142.
 Trowbridge, 27, 37, 48, 139.
 Turpain, 59.
 Tyndall, 13, 48.
- Varley, 136.
- Wagner, 79, 94.
 Watson, 36.
 Weber, 79.
 Wehnelt, 40, 116, 119.
 Wheatstone, 14, 66, 77.
 Wiedemann, 29, 44.
 Willyoung, 116.
 Wilson, 55.
- Young, 14.
- Zehnder, 147.

UNIVERSITY OF CALIFORNIA LIBRARY

THIS BOOK IS DUE ON THE LAST DATE
STAMPED BELOW

JUL 31 1915

AUG 18

FEB 28 1916

AUG 3 1918

DEC 17 1918

OCT 22 1919

NOV 12 1920

DEC 15 1920

FEB 13 1922

SEP 8 1922

MAY 17 1923

NOV 21 1924

JAN 04 1993

FEB 11 1930

APR 30 1930
AUG 5 1939

21 Jan '58 MS

REC'D LD

JAN 16 1933

OCT 09 1992

CIRCULATION

DEC 19 1996¹⁴

6. uss ml

~~191704~~

U. C. BERKELEY LIBRARIES



C041440416

018

195928
Collins
11574
CY

