

THE EXPERIMENTER'S LIBRARY NO. 1

TIPS FOR THE RADIO AMATEUR CONSTRUCTOR

BY

E. VAIL CHURCH



THE E. I. CO. NEW YORK CITY

The
"Experimenter's Library"

25c. Books Covering Every Branch of Radio



Each book is written by a well-known author and contains 48 pages of valuable information, fully illustrated. Cover is in two colors, size 5½ x 7½ inches.



No. 1. Tips for the Radio Amateur Constructor.

No. 2. How to make Practical Radio Receiving Sets.

No. 3. Radio Questions Answered.

No. 4. Radio Frequency Amplification.

No. 5. Loud Talkers and How to Build Them.

No. 6. How to Tune Your Radio Set.

No. 7. 100 Radio Hook-ups.

No. 8. All About Radio Parts.

No. 9. History and Operation of the Vacuum Tube.

No. 10. The Neutrodyne—All About It.

No. 11. How Radio is Received.

No. 12. How to Locate Troubles in Your Radio Set.

No. 13. Reflex Radio Receivers.

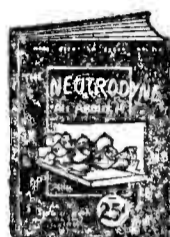
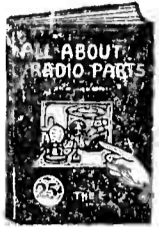

Each **25c.** Postpaid

THE CONSRAD COMPANY, Inc.

Selling Agents

233 FULTON STREET

NEW YORK CITY

"THE RADIO CONSTRUCTOR"
Pattern No. 14

HOW TO MAKE
THE GENUINE STANDARD
Super-Heterodyne



This Super-Heterodyne pattern is one of the largest things ever attempted in the way of blue prints with an instruction booklet.

It consists of two large blue prints, measuring 19½x 44 in. These blue prints are drawn full size so that the builder of this set has no difficulty whatsoever with extra measurements. With this pattern comes a complete 16-page booklet, size 8x12 in. It is the most complete booklet of its kind ever made up. It describes every detail of circuit, and shows how to proceed in the building of the set. It lists the necessary parts required and tells not only how to make and assemble them, but also how to operate the completed set.

Here is an opportunity for every radio receiving set constructor to build one of the largest and finest sets that have so far been developed in radio.

Price \$1⁰⁰ Prepaid

THE CONSRAD COMPANY, Inc.

233 FULTON STREET

NEW YORK CITY

Radio Broadcast Listener's Book of Information and Log Record

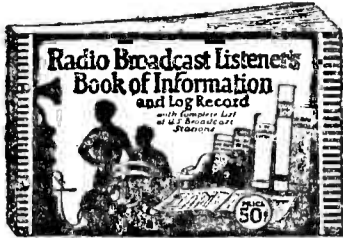

To the countless thousands of enthusiastic broadcast listeners thirsting for information but lacking in technical knowledge, this book is specially dedicated. It describes in every-day understandable language how to select the set for your particular requirement, how to erect the aerial and install your set, how to operate it and the proper method of upkeep and maintenance of batteries etc.

The four main divisions of this book are as follows:

- Part A—Information for the Broadcast Listener.
- Part B—Radio Broadcast Station of the U. S. by call letters.
- Part C—Radio Broadcast Station of the U. S. by States.
- Part D—Log of Broadcast Stations and Station Log Chart.

In part B you will find a complete list of Radio Broadcast Stations with name, location, power, wave-length and sending hours of the Station indexed alphabetically according to their call letters. There are several pages of Log sheets for the keeping of records of the broadcast stations heard and also special tuning charts for making curves of the wave-length and dial settings for a set. Contains 2 pages, size 5 $\frac{7}{8}$ x9 $\frac{1}{4}$ inches, loose-leaf.

Price **50c.** Prepaid

"RADIO NEWS" AMATEUR'S HANDBOOK

Volume No. 1

Chock full of radio constructive and instructive articles from cover to cover. Written by foremost radio authorities, in plain everyday language which everyone can understand. Sections include articles on Receiving Sets and Sundry Apparatus, Transmitters and Accessories, Radio Theory, Vacuum Tube Data, and Practical Hints for the Amateur. A book which also serves as a ready reference and should find a place in the library of every amateur. It contains 244 pages and over 375 illustrations, diagrams and photographs bound in a multi-colored heavy board. Size 6x9 in.

On sale at all leading radio stores. If your dealer cannot supply you, send a dollar bill and the book will be forwarded to you postpaid.

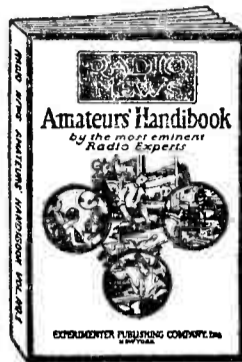

Price **\$1.00** Prepaid

THE CONSRAD COMPANY, Inc.

233 FULTON STREET

NEW YORK CITY

Printed in the United States of America

Copyright by
THE E. I. COMPANY
1924

1st Edition, February, 1924
1st Reprint April, 1924
2nd Reprint, December, 1924

All rights reserved, including that of translation into foreign
languages, including the Scandinavian.

CONTENTS

	<i>Page</i>
CHAPTER I	Choice of Radio Parts..... 5
CHAPTER II	What Type of Set to Build and Why 13
CHAPTER III	The Use of Patterns and Diagrams 18
CHAPTER IV	Tools and Their Use..... 21
CHAPTER V	How to Solder..... 25
CHAPTER VI	The Correct Way to Drill..... 31
CHAPTER VII	Finishing the Panel, Cabinet..... 36
CHAPTER VIII	Mounting Instruments 40
CHAPTER IX	Hints on Wiring..... 42
CHAPTER X	Don'ts 47

Tips for the Radio Amateur Constructor

CHAPTER I Choice of Radio Parts

WHILE it is true that some radio stores charge less than others for certain supplies, it is of the utmost importance that only the best quality of parts be used if the constructor wishes to build an efficient set.

It is therefore advisable to purchase only standard parts of well-known make which have been tested and approved by laboratories such as those conducted by *The Radio News*, *N. Y. Evening Mail*, *The Sun-Globe* and other reliable institutions.

"A chain is only as strong as its weakest link." As this adage fittingly applies to a radio set made up of a number of parts, it is well to remember that just *one* defective piece of apparatus is enough to prevent the proper operation of the entire set.

The following are a few points to keep in mind when making your selections:

Variable Condensers

The distance of air space between all of the plates should be equally uniform. The plates must be smooth and free from any burr or ragged edge.

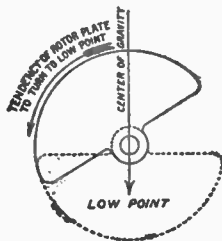
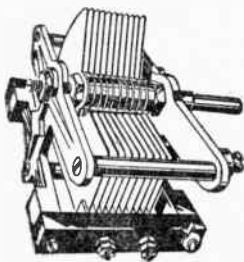

Fig. 1.—The proper tension on the shaft of this type of variable condenser holds the rotary plates in any position.

Turn the rotary plates back and forth as far as they will go and see that the plates make uniform clearance throughout the entire scale. A slight bend or burr on any of the plates will

probably cause them to come in contact with each other and thereby prevent the instrument from working.

There should be suitable means for keeping sufficient tension on the rotor shaft to hold the plates in any position they are set, but at the same time the shaft should rotate smoothly.

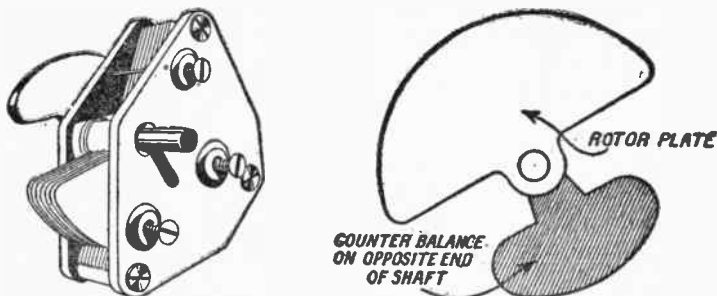

Fig. 2.—Counter-balanced type of variable condenser.

Although the plates are usually made of aluminum and consequently very light, the combined weight amounts to enough to cause them to turn to the low point, because the mass of weight is eccentric (off center). See Fig. 1. The shaft, therefore, should not turn too freely.

There are condensers on the market which have a counter-balance attached to the shaft so that the rotary plates remain

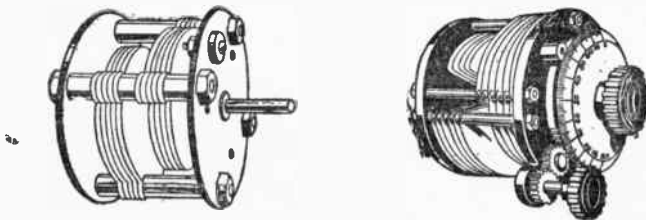

Fig. 3.—Variable condensers of the plate-balanced variety.

steadfast in any position, Fig. 2. There are others which have their plates divided in both halves of 360 degrees, i.e., half the number of plates on one side of the shaft and half on the other. The stationary plates of this type of condenser are also divided, which thus gives an even capacity between both halves of the circle, Fig. 3.

These two latter mentioned condensers are known as **balanced condensers**.

Variometers and Vario-Couplers

There is no doubt that the molded type of variometer and vario-coupler presents a finer appearance than the square wooden type, Fig. 4. However, by actual test, there is little difference in the efficiency of either instrument, provided the wooden type is one which is treated with a waterproof varnish to keep out moisture.

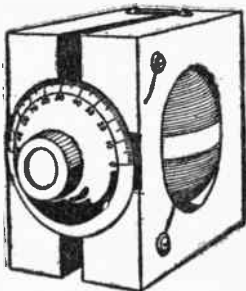

Fig. 4.—A variometer of the wooden type.

There should be very little shellac on the windings, as this causes a distributed capacity effect which is undesirable.

In order that there will be no loose or poor connections, the leads from the rotor winding should make good electrical contact with the terminals on the instrument.

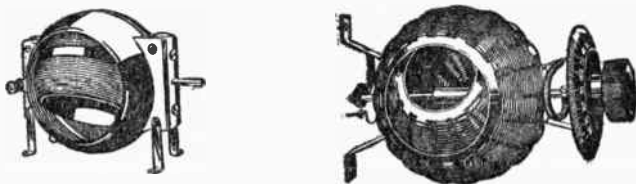

Fig. 5.—Molded and basket-wound variometers.

A good design is one in which the leads are attached to flexible wires called "pig-tails," which pass through a hollow shaft and connect directly to the binding posts. See Fig. 7.

In some instruments, the shaft is made of two separate pieces, one wire being connected to one part and the other wire to the opposite part. In this case, the terminals are connected to the

TIPS FOR THE RADIO AMATEUR CONSTRUCTOR

metallic bearings in which the two ends of shaft rotate, Fig. 8. The resistance of this arrangement depends upon the contact between the shafts and bearings.

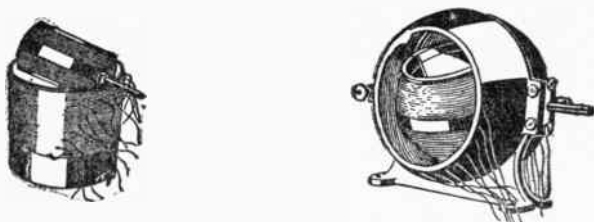

Fig. 6.—To the left is shown a vario-coupler having a wooden rotor and a molded type on the right.

It is, therefore, necessary that suitable means be provided for a uniform spring tension between the bearing and shaft.

Besides the molded and wooden types, there are several excellent designs with the open or skeleton windings—that is, the

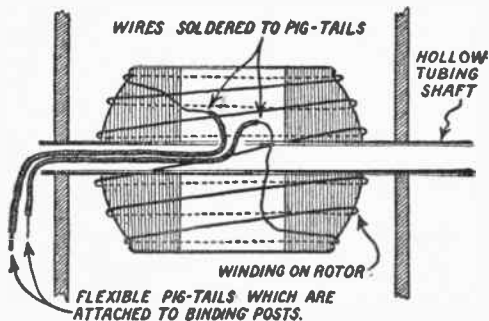

Fig. 7.—Showing how "pig-tail" leads are connected in the rotor or a variometer or vario-coupler.

coils are first wound on forms and then given a light coat of a special insulating preparation to hold the layers together and when dry the form is removed.

Some of these are what is known as the "basket" type, Fig. 5, so-called because of the peculiar style of winding—the wires criss-cross one another similar to the way in which a basket is woven.

Regardless of what type you select, be sure that the current can pass through substantial contacts, for it must be remembered

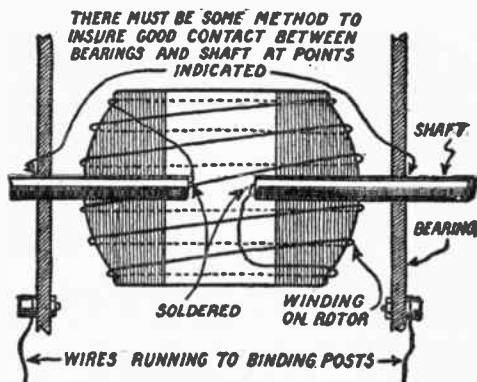

Fig. 8.—A solid metallic rotor shaft divided in two parts with leads from windings connected directly to them.

that the amount of electricity with which we are dealing in radio reception is very, very small, and therefore the resistance of every instrument must be kept as low as possible.

Transformers

It would be easy to write a volume on the subject of transformers alone, but as this chapter is intended solely as a guide in selecting parts, only a few words can be said in regard to the various instruments which go to make up a complete radio set.

There are so many types of transformers on the market, each of which has its advantages, that it is a difficult matter to give any absolute advice on the subject.

Some are shielded, others unshielded. Then there is an open core type and a closed type. Some designs are round, others square. See Fig. 9.

It may seem like dodging the issue, but it is the author's opinion that probably the best advice which can be given is to suggest that you purchase any one of the higher-priced transformers, and let it go at that. A cheap transformer is worse than useless.

With the exception of the vacuum tube, there has probably been more money spent in experimental research work for the development of an efficient transformer than on any other device used for radio transmission and reception.

In the first place, the size, and the shape of the core is extremely important, also the size, and the number of turns of wire

on both the primary and secondary and the position of the windings with respect to each other as well as to the core. In other words, the correct design of a transformer cannot be guessed at, but must be worked out by engineers with years of experience in this class of work.

Another reason why an efficient transformer cannot be produced cheaply is that it is necessary to wind about a mile or more of wire on the secondary, and the size of this wire is about the

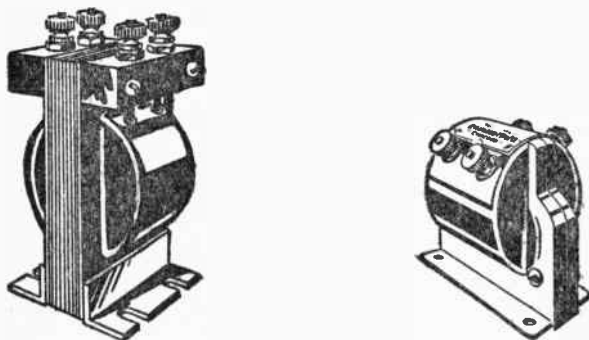

Fig. 9.—Types of audio frequency transformers of various shapes.

same as a human hair. Great care has to be exercised in winding, as the insulation is readily injured and the wire itself is very easily broken.

In a well-built transformer, the coils are impregnated with an insulating compound which is heated to just the right temperature to cause it to flow through all parts of the coil and then it is subjected to a vacuum process to remove any air bubbles which may have formed in the compound.

It can, therefore, readily be seen that a transformer must necessarily be an expensive item and nothing that is "cheap" can possibly compare with a well built and carefully designed instrument.

Sockets

In purchasing a socket, be sure to get one which is solidly built, and above all see that the contacts are rigidly set in place. A poor connection between the prongs on the tube base and the contacts in the socket is one of the chief reasons why a set often refuses to work.

Vacuum Tubes

Occasionally it is possible to obtain a good so-called "bootleg" tube, but it has been the sad experience of most amateurs to find that the "bootleg" tube is a short-lived affair and that it would have been cheaper in the end if they had bought one of a standard quality.

Vacuum tubes may be put in two general classes—the dry cell tube and storage battery tube, and both these may be classed still further as detectors and amplifiers.

Before making your purchase it is well to consider what source of power you expect to use for lighting the filament.

The WD 11 is a dry cell detector and amplifier tube which may be used in a standard socket by means of attaching an adapter to its base. It can also be used with a special WD11 socket, made for this tube.

The WD 12 is a similar tube; the only difference being that it is designed to fit a standard socket. Both of these use a small amount of current and give excellent results, but of course do not have quite as great a range as some of the larger tubes which use more current and operate on a storage battery. The larger tubes consume more current but give greater range.

The U. V. 199 is an especially small tube which operates on dry cells and consumes a minimum of current. It may be used either as a detector or amplifier. A special socket or an adapter to fit a standard socket is also required for this tube.

One of the best detector tubes is the U. V. 200, which is operated on a 6-volt storage battery. The "B" battery voltage should be about 18. It is well worth the trouble to try out several voltages for the plate circuit, as this tube is very critical and therefore requires the voltage to be just right.

When the proper plate voltage is obtained, the results from this tube are most satisfactory and although several later types have been put on the market, the U. V. 200 still remains a very popular tube when a storage battery is used to light the filament.

Rheostats

When purchasing a rheostat, make sure to get one of a proper resistance, i.e., a resistance the manufacturers of the vacuum tube advise to use with the particular tube. If a rheostat of a lower resistance than is called for be used, an additional resistance unit may be connected in the filament circuit of the set.

An ordinary type of rheostat is all that is necessary for amplifier tubes, but much finer adjustment can be made with a venier type for use in connection with the detector tube which requires finer regulation.

Panels

Panels are usually made from one of three different kinds of material. The cheapest of these is plain hard rubber, which is very easy to work.

Due to sulphur used in the manufacture of hard rubber, it has a tendency to become discolored, turning a sort of greenish hue. It is also sensitive to changes in temperature and is apt to warp out of shape easily if subjected to any strain, such as mounting heavy instruments on it.

There is a special composition of hard rubber compound being sold by radio dealers which has been prepared especially for radio apparatus and which the manufacturers claim overcomes the objections to ordinary hard rubber. This material is about as easy to drill and work as the cheaper compound.

The most extensively used material for panels is that which is made by manufacturers licensed to produce the composition originally known as "Bakelite."

There are several firms making this composition, the best-known trade names of which are "Bakelite," "Celeron" and "Formica." This is not as easily worked as hard rubber composition and particular care must be exercised in handling it.

The method of drilling, sawing and working panels, is clearly explained in Chapters VI and VII.

Metal can also be used for panels by providing some means of insulating the instruments from it.

Glass has also been used, principally for exhibition apparatus where it is desired to have all of the instruments visible.

If you are about to build a set, remember that the panel should be purchased after all the other parts have been secured, and measured to determine the exact layout. The same thing applies to the cabinet.

The point is, that you should know exactly what you are going to do before you start to do it. When you have decided just how the instruments are going to be laid out, you will be able to determine the proper size of the panel.

Cabinets

The selection of a cabinet is largely a matter of personal taste and the amateur who possesses ingenuity enough to construct his own set, should have no difficulty in selecting a suitable cabinet to encase it.

It should be designed as nearly dust-proof as possible and the cover should be large enough to allow easy access to all of the instruments in case of trouble.

Unless you have the proper facilities for doing the work, it is a wise plan not to attempt to build your own cabinet.

Manufacturers who are equipped to make lock-corner or dove-tailed boxes can turn out a cabinet which has a finish that is hard to equal.

If you are determined to build your own cabinet, be sure to obtain well-seasoned or kiln-dried wood, free from knots and cross-grain, otherwise the cabinet may become warped and twist everything out of line.

CHAPTER II

What Type of Set to Build and Why

AS THERE are several hundred possible combinations for hooking up a receiving set it would be impossible to attempt to discuss the features of each type in a single chapter of this book. We will therefore mention only a few of the well known and widely used circuits, with which the American amateurs have accomplished such splendid results.

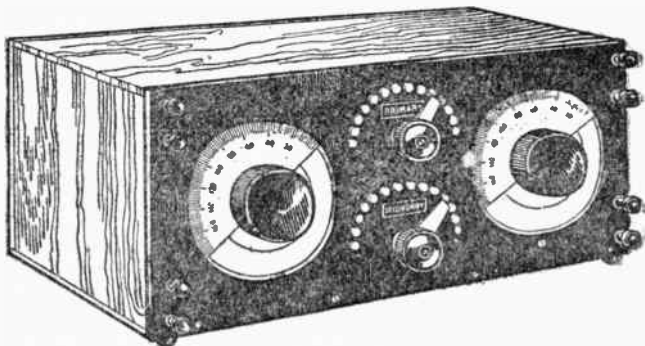

Fig. 10.—A Short Wave Regenerative Receiver

If the novice really wishes to “start at the bottom and build up,” he will select a crystal receiver for his first attempt. Such a set is not only inexpensive, but is also easy to construct, and may later be converted into a single tube receiver by using some of the old parts and adding a few new ones.

Although a crystal detector is seldom able to pick up broadcast stations more than 30 miles distant, it has two decided advantages over most of the vacuum tube receivers.

In the first place a good crystal set is capable of reproducing the original sound without any distortion and without any noises as are often experienced with a tube set. Another advantage of the crystal type of receiver is that no battery is required. “How to Make a Radio-Phone Crystal Set,” published by The Consrad Co., New York, describes how to build a very efficient crystal receiver which may easily be converted into a tube set.

The beginner who starts with a crystal set usually ends up with a four or five tube outfit, very much in the same manner as the man who buys his first auto. He invariably wants something

better. About the time he has learned to drive his Ford well enough to keep it off the sidewalk, he has visions of a Rolls-Royce. So after building a crystal receiver, the next step is a single tube set, and, later on, a multiple tube outfit.

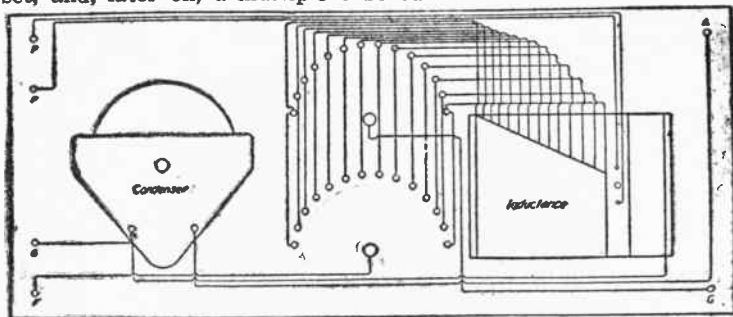

Fig. 11.—Wiring diagram of the Short Wave Regenerative Receiver shown in Fig. 10.

One of the simplest types of tube sets to build is what is known as the Short Wave Regenerative Receiver (single circuit type). Such a set is shown in Fig. 10 and the wiring diagram of the same, Fig. 11.

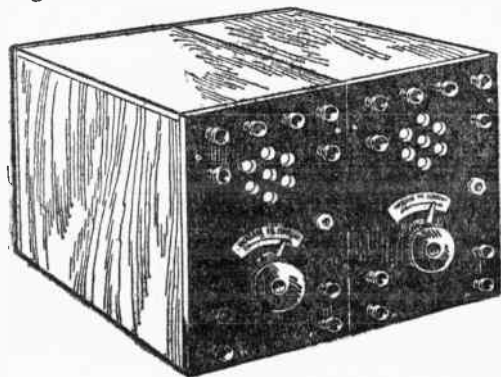

Fig. 12.—Detector and amplifying units for use with the Short Wave Regenerative Receiver.

Due to the winding on the coil, which is of the closed circuit type, the resistance of the antenna or primary circuit is very low and, therefore, it is possible to pick up signals from a very