

THE TECHNIQUE OF RADIO DESIGN

By

E. E. ZEPLER, Ph.D.

*Lecturer in Physics in the University College, Southampton,
and Technical Consultant*

*Sometime Head of the Receiver Development Department
at Telefunken G.m.b.H.,*

Research Engineer at Marconi's Wireless Telegraph Co., Ltd.

NEW YORK

JOHN WILEY & SONS, INC.

LONDON: CHAPMAN & HALL, LIMITED

THIS BOOK HAS BEEN MANUFACTURED IN
ACCORDANCE WITH THE RECOMMENDATIONS
OF THE WAR PRODUCTION BOARD IN THE
INTEREST OF THE CONSERVATION OF PAPER
AND OTHER IMPORTANT WAR MATERIALS.

First published 1943

12/44

Printed in The United States of America

AUTHOR'S PREFACE

THIS book is an attempt to convey to the reader some of the experiences of a radio designer obtained over a number of years in a large works laboratory.

It deals mainly with those problems which are closely linked with the daily routine work of an engineer, both in the development and testing of radio receiving apparatus of all types. Intimate details of many aspects of receiver work are given rather than a comprehensive treatment, general principles being adequately dealt with in the existing excellent textbooks.

The real technique of experimental work starts where unexpected complications occur, where a circuit behaves in a manner not readily predicted from its circuit diagram. The technique of design, on the other hand, consists in foreseeing complications and in being able to work out on paper the electrical circuit and the mechanical construction so that serious trouble is not likely to occur. To develop qualities necessary for such work, i.e. a feeling for the right order of magnitude, a quick grasp of essential facts and common sense in approaching the problems, is the principal aim of this book.

Calculations are always used as a means to an end and derivations of formulae are given mainly to illustrate simple methods of computation. Complicated mathematics are avoided and approximations suitable to the problem in hand have been made whenever possible.

The author wishes to express his thanks to Mr. M. Morgan and Dr. G. L. Grisdale, former colleagues at Marconi's Wireless Telegraph Company Ltd., for useful suggestions in the earlier stages of this work, to Mr. R. H. Garner, Head of Engineering Department, Technical College, Shrewsbury, and Mr. S. W. Punnett of University College, Southampton, for help in proof reading. A particular debt of gratitude is owed to Professor A. M. Taylor, University College, Southampton, for his interest, encouragement and help during the past eighteen months that the author has been working in his department.

E. E. Z.

CONTENTS

CHAPTER	PAGE
PREFACE	v
LIST OF SYMBOLS	vii
SOME USEFUL FORMULAE	ix
1. SOME FUNDAMENTAL THEORETICAL FACTS	1
2. TRANSFER OF ENERGY FROM THE AERIAL	31
3. THE AMPLIFIER STAGE	50
4. PROBLEMS OF DETECTION AND FREQUENCY CHANGING	98
5. SELECTIVITY	130
6. RECEIVER NOISE	153
7. GAIN CONTROL	165
8. THE PRINCIPLES OF SCREENING	183
9. UNDESIREED FEEDBACK	206
10. HUM, SPURIOUS BEATS	241
11. DISTORTION	253
12. PARASITIC RESONANCES	264
13. POWER SUPPLY	269
14. ROUTINE MEASUREMENTS	279
15. FAULT FINDING	296
INDEX	306

LIST OF SYMBOLS

r, R	resistance, also radius in "Some Useful Formulae"
L	inductance
M	mutual inductance
$k = \frac{M}{\sqrt{L_1 L_2}}$	coupling coefficient between the two inductances L_1 and L_2
C	capacitance
f	frequency
f_0	resonant frequency of a tuned circuit $\left(\frac{1}{2\pi\sqrt{LC}}\right)$
ω	$= 2\pi f$
ω_0	$= 2\pi f_0$
$\delta f, \delta\omega$	a change in f or in ω
y	$= \frac{f}{f_0} - \frac{f_0}{f} = \frac{\omega}{\omega_0} - \frac{\omega_0}{\omega} \approx 2\frac{\delta f}{f_0}$, twice the fractional change from resonant frequency
c/s	cycles per second
Kc/s	kilocycles per second = 10^3 cycles per second
Mc/s	megacycles per second = 10^6 cycles per second
λ	wave-length
$X_L = \omega L$	inductive reactance
$X_C = \frac{1}{\omega C}$	capacitive reactance
Q	magnification factor of a tuned circuit. $Q = \frac{\omega_0 L}{r}$ when r is in series with L and C , $Q = \frac{R}{\omega_0 L}$ when R is in parallel with either L or C
d	circuit damping = $\frac{1}{Q}$
Z	impedance which may be resistive, reactive or a combination of both
Z_0	impedance of a parallel tuned circuit at the resonant frequency. Z_0 is resistive = $\omega_0 L Q$
ρ	impedance
μ	amplification factor } of a valve
g_m	
g_m'	dynamic mutual conductance of a valve = $\frac{g_m \rho}{\rho + Z_L}$, where Z_L is the anode load
μH	microhenry = 10^{-6} henry
$p\text{F}$	picofarad = 10^{-12} farad
μA	microampere = 10^{-6} ampere
μV	microvolt = 10^{-6} volt
\approx	approximately equal to

- arrow applied in drawings, usually indicating the path of the alternating current rather than the direction
- db. decibel, indicating a fractional step of approximately 26% in power. It is nowadays often applied to response curves, stage gain, etc., to indicate a voltage ratio of approximately 1 : 1.12. In this case no reference to power is involved, owing to the impedance not necessarily being the same for different voltages. The latter method is not in accordance with the original conception of the decibel scale; it has become popular because it has proved very convenient. The following table gives the approximate relationship :

db.	Power ratio	Voltage ratio
1	1.26	1.12
3	2	1.41
6	4	2
10	10	3.16
20	100	10
40	10,000	100
60	1,000,000	1,000

The number n of decibels expressing a given voltage ratio A is

$$n = 20 \log_{10} A$$

SOME USEFUL FORMULAE

Inductance of a One-layer Coil, Tubular or Pancake Form.

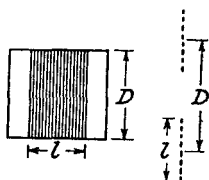

L (in microhenries) = $kDn^2 \times 10^{-3}$, where D is the average diameter and l the winding length in centimetres, n the total number of turns, and where k is to be taken from the graph I.

Inductance of a Multilayer Coil.

L (in microhenries) = $DN^2(k_1 - k_2) \times 10^{-3}$, where D is the mean diameter,

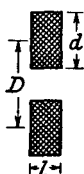

d the winding depth and l the thickness of the coil as indicated in the drawing, all in centimetres. N is the total number of turns, k_1 and k_2 are to be taken from the graph II.

If the coil is wave-wound the inductance is about 10% greater than given by the formula, owing to the increased wire length.

Inductance of a One-turn Loop. *Circular Loop.*— L (in microhenries) = $14.5 \times 10^{-3} D \left(\log_{10} \frac{D}{d} + 0.138 \right)$, where D is the diameter of the circle and d is the diameter of the wire in centimetres.

Square Loop.— L (in microhenries) = $18.5 \times 10^{-3} l \left(\log_{10} \frac{l}{d} + 0.07 \right)$, where l is the side of the square and d is the diameter of the wire in centimetres.

Capacitance between Two Parallel Plates. C (in picofarads) = $A/11.3d$, where A is the area of the plates in square centimetres and d the distance in centimetres, and where d is supposed to be small compared with the lateral dimensions of the plates.

Capacitance between Two Parallel Wires. C (in picofarads per metre) = $\frac{12.1}{\log_{10} \frac{d}{r}}$, where d is the distance between the centres of the wires

and r is the radius of the wires, both measured in the same units.

Capacitance of a Concentric Feeder. C (in picofarads per metre) = $\frac{24.2}{\log_{10} \frac{R}{r}}$, where R is the internal radius of the outer tube and r the external

radius of the inner conductor, both measured in the same units. The dielectric constant in this and the two previous cases is supposed to be unity.

SOME USEFUL FORMULAE

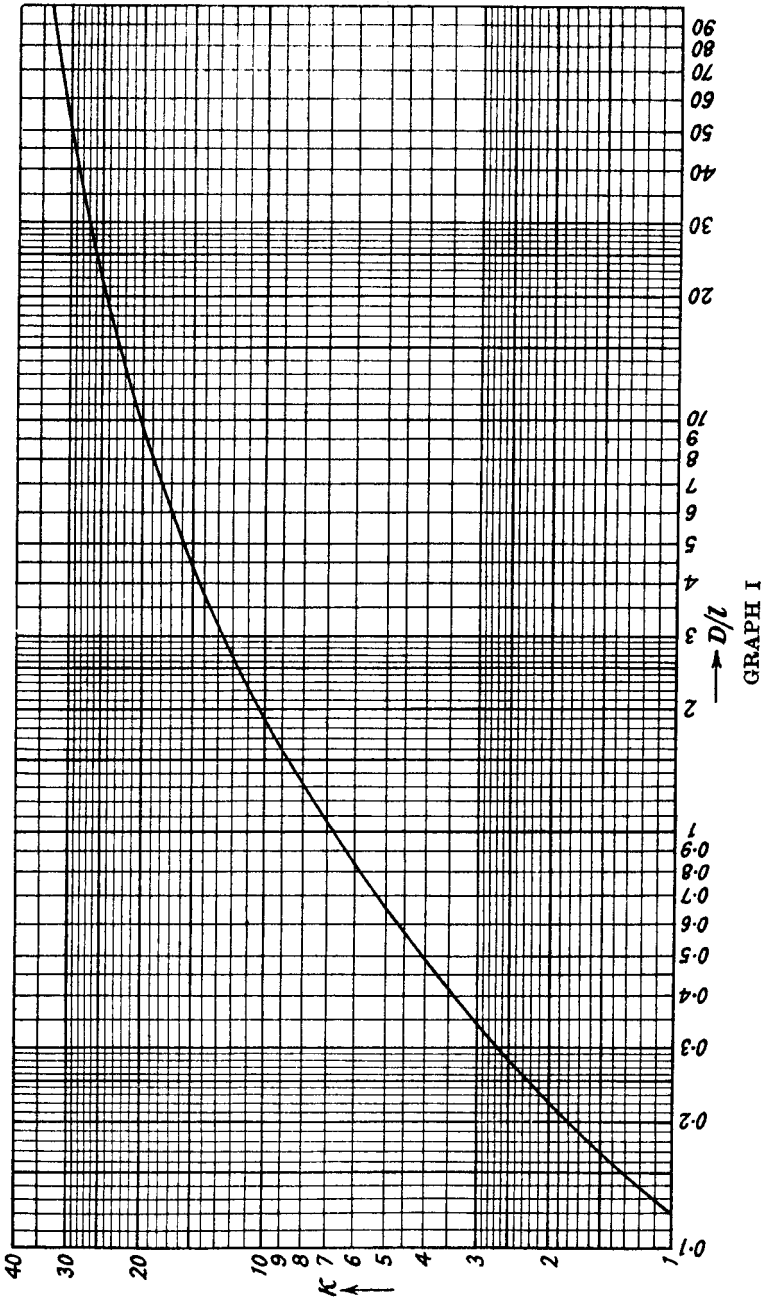

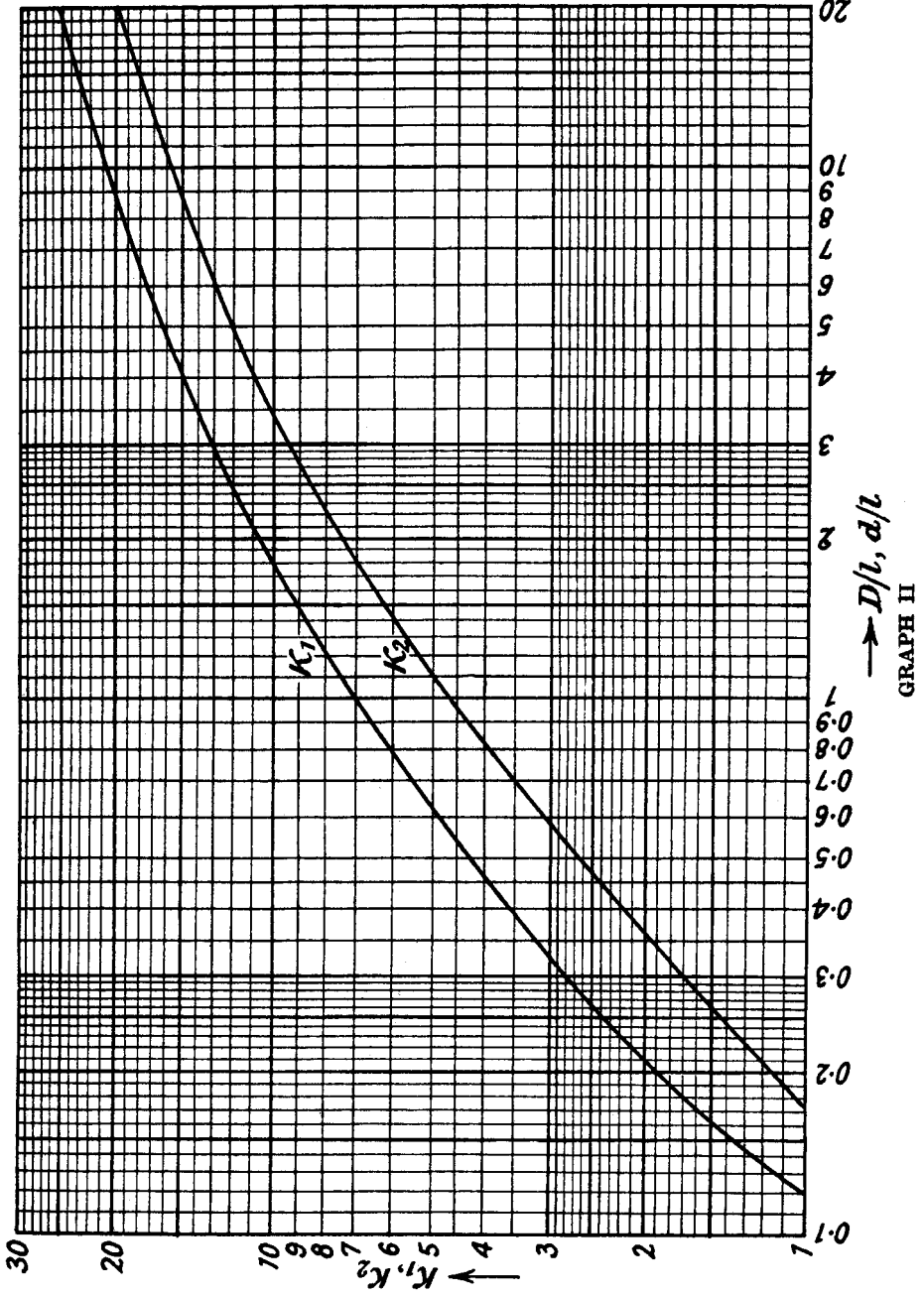

Inductance of Two Parallel Wires.

$$L \text{ (in microhenries per metre)} = 0.92 \log_{10} \frac{d}{r} \left. \vphantom{\frac{d}{r}} \right\} \begin{array}{l} \text{Inductance of a Concentric Feeder.} \\ L \text{ (in microhenries per metre)} = 0.46 \log_{10} \frac{R}{r} \end{array} \left. \vphantom{\frac{R}{r}} \right\} d \text{ and } r \text{ in the same units.}$$

Inductance of a Single Wire.

L (in microhenries) = $4.6 \times 10^{-3} l \left(\log_{10} \frac{l}{d} + 0.276 \right)$, where l is the length and d is the diameter of the wire in centimetres.

Characteristic Impedance of an Open Two-wire Feeder.

$$Z_0 \text{ (in ohms)} = \sqrt{\frac{L}{C}} = 276 \log_{10} \frac{d}{r}.$$

Characteristic Impedance of a Concentric Feeder.

$$Z_0 \text{ (in ohms)} = \sqrt{\frac{L}{C}} = 138 \log_{10} \frac{R}{r}.$$

In these two formulae there is: L the inductance per metre in henries, C the capacitance per metre in farads, d , r and R as given above. The feeder damping is supposed to be zero, in which case Z_0 is resistive.

Input Impedance Z_i of a Feeder. $Z_i = Z_0 \frac{Z + j \tan \frac{2\pi l}{\lambda}}{1 + j \frac{Z}{Z_0} \tan \frac{2\pi l}{\lambda}}$, where l is

the feeder length, Z_0 the characteristic impedance, Z the terminating impedance and λ the wave-length concerned. The feeder damping is neglected. The following facts result almost immediately.

1. $Z = Z_0$, i.e., the feeder is terminated with its characteristic impedance. $Z_i = Z_0$, for any length of feeder.

$$2. l = \frac{\lambda}{4}, \frac{3\lambda}{4}, \frac{5\lambda}{4}, \text{ etc.}, \tan \frac{2\pi l}{\lambda} = \infty.$$

(a) $Z = 0$ (short circuit at the end).

$$Z_i = \infty.$$

(b) $Z = \infty$ (open circuit at the end).

$$Z_i = 0.$$

(c) $Z = R$ (terminating impedance is resistive).

$$Z_i = \frac{Z_0^2}{R}, \text{ } Z_i \text{ being resistive.}$$

$$3. l = \frac{\lambda}{2}, \frac{2\lambda}{2}, \frac{3\lambda}{2}, \text{ etc.}, \tan \frac{2\pi l}{\lambda} = 0.$$

(a) $Z = 0$, $Z_i = 0$.

(b) $Z = \infty$, $Z_i = \infty$.

(c) $Z = R$, $Z_i = R$.

This shows that such a feeder acts as a 1 : 1 transformer, the input impedance being equal to the terminating impedance.

4. $l \ll \lambda$.

(a) $Z = 0$, $Z_i = jZ \tan \frac{2\pi l}{\lambda}$, the input impedance is inductive.

(b) $Z = \infty$, $Z_i = -jZ / \tan \frac{2\pi l}{\lambda}$, the input impedance is capacitive.

CHAPTER 1

SOME FUNDAMENTAL THEORETICAL FACTS

To understand the results treated in this book the knowledge of a series of fundamental laws and facts is required. Though they may be found in any textbook, and though the reader is supposed to be familiar with these subjects, they will be briefly reviewed for reference. As mentioned in the introduction, practical application is given the first place. The results may not always be exact, but they are sufficiently correct for the cases occurring in practice.

Ohm's and Kirchhoff's laws are the foundation on which all the other laws are built. They can be used to derive any result desired. But their application is often laborious where other means may yield the immediate result. It seems necessary, however, to include here a warning. Tempting and elegant as these other means appear, they should be used with caution. Wherever there seems doubt as to their applicability, it may be preferable to go back to the fundamental derivation by Ohm's and Kirchhoff's laws. In paragraph 10 of this chapter an example is given where the seemingly appropriate use of a simplifying circuit leads one astray when the application of the fundamental laws leads easily to the desired result.

1. Inductive and Capacitive Reactance. The reactance of an inductance L for alternating current is $j\omega L$, ω being 2π times the current frequency f , and j indicating that the current $I = \frac{E}{j\omega L}$ lags behind the E.M.F. at the inductance terminals by 90° .

The reactance of a capacitance is $\frac{1}{j\omega C} = -\frac{j}{\omega C}$, the current leading the E.M.F. by 90° .

To obtain the reactance in ohms, L has to be expressed in henries, C in farads. In radio the values 10^{-6} henry = 1 microhenry ($1 \mu\text{H}$) and 10^{-12} farad = 1 micro-microfarad ($1 \mu\mu\text{F}$ or 1 pF) are those used most, and the ohmic values of reactances may be given in terms of μH and pF .

$$\omega L \text{ (ohms)} = 6.28 fL \text{ (} L \text{ in } \mu\text{H, } f \text{ in Mc/s)}$$

$$\frac{1}{\omega C} \text{ (ohms)} = \frac{0.159 \times 10^6}{fC} \text{ (} C \text{ in pF, } f \text{ in Mc/s).}$$

If the wave-length λ is introduced instead of the frequency the formulae become :

$$\omega L \text{ (ohms)} = \frac{1,880L}{\lambda}, \text{ (} L \text{ in } \mu\text{H, } \lambda \text{ in } m\text{)}$$

$$\frac{1}{\omega C} \text{ (ohms)} = \frac{530\lambda}{C}, \text{ (} C \text{ in pF, } \lambda \text{ in } m\text{)}.$$

Example : Given a sinusoidal E.M.F., $f = 300 \text{ Kc/s} = 0.3 \text{ Mc/s}$, E.M.S. value = 10 mV. What is the current if a capacitance of 300 pF is connected across the source of E.M.F. ?

The capacitive reactance is $\frac{0.159 \times 10^6}{0.3 \times 300} = 1,765$ ohms, therefore the current is 5.66 microamps. The wave form of the current is a sine curve.

If the E.M.F. is periodic but of a distorted wave form, it can be divided into its sinusoidal components according to Fourier's analysis and the current determined for each of these. The total current is obtained by adding all the individual sine components. In this case the wave forms of E.M.F. and current are the same for a purely resistive load, they are different if the load possesses an inductive or capacitive component. This follows immediately from the above discussion.

If, on the other hand, a current with a distorted wave form is known and the p.d. across a reactive load is to be found, a corresponding method can be applied.

Its practical importance will be seen in Chapter 10, where the problem of suppressing the harmonics of an oscillator is discussed.

2. Real and Wattless Power. Given an impedance Z and a current I causing a p.d. $E = I \cdot Z$ across Z . The product $EI = I^2 Z = \frac{E^2}{Z}$ is the power dissipated in Z . If Z is ohmic, the dissipated power is real and results in heating up the impedance. If Z is imaginary, the product EI is called the wattless power.

$$\text{For any load :} \quad \begin{aligned} \text{Real power} &= E \cdot I \cos \angle EI. \\ \text{Wattless power} &= E \cdot I \sin \angle EI. \end{aligned}$$

To think in power, either real or wattless, has often the advantage of quickly arriving at results which otherwise require an appreciable amount of calculation. It is easy to see that two different loads which, for a given E.M.F., absorb the same watts are interchangeable, watts being used in the general sense as the sum of real and wattless power. As the watts are the product EI the statement just made

seems self-evident, as it is only another expression for the identity of two impedances. It will, notwithstanding, prove useful.

3. Two Impedances in Parallel. The parallel combination Z of two impedances Z_1 and Z_2 is $\frac{Z_1 Z_2}{Z_1 + Z_2}$. This follows immediately from a power consideration. With an applied E.M.F. E , the power dissipated in Z_1 and Z_2 is

$$\frac{E^2}{Z_1} + \frac{E^2}{Z_2}, \text{ therefore } \frac{E^2}{Z} = \frac{E^2}{Z_1} + \frac{E^2}{Z_2}, \quad Z = \frac{Z_1 Z_2}{Z_1 + Z_2}.$$

The values $\frac{1}{Z}, \frac{1}{Z_1}, \frac{1}{Z_2}$ are called the admittances, and it follows at once that the parallel combination of several admittances is equal to their sum. It will often prove advantageous to work with admittances when circuits with several impedances in parallel are to be investigated.

To obtain the absolute value of an impedance, disregarding its phase, the real and imaginary components have to be separated. The absolute value is the square root of the sum of both squares, according to the well-known rule $|a + jb| = \sqrt{a^2 + b^2}$.

Example: Given an E.M.F. E_1 of 10 volts R.M.S., $f = 1$ Mc/s, and a parallel combination of $L = 200 \mu\text{H}$ and $C = 100 \text{ pF}$, in series with a resistance $r = 2,000$ ohms (Fig. 1). The magnitude and phase of the currents through L , C and r are to be computed.

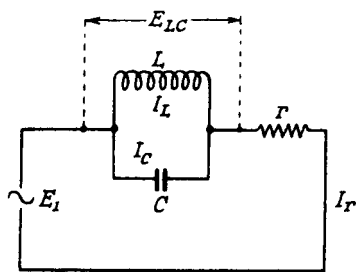

FIG. 1.

$$\omega L = 1,256 \text{ ohms}, \quad \frac{1}{\omega C} = 1,590$$

ohms, their parallel combination being 5,980 ohms inductive.

Total impedance $(2,000 + j5,980)$ ohms = 6,300 ohms in absolute value.

$$I_r = \frac{10}{6300} \text{ amp.} = 1.59 \text{ mA.}$$

$$E \text{ (across } LC) = 1.59 \times 10^{-3} \times 5,980 = 9.5 \text{ volts.}$$

$$\text{Therefore } I_L = \frac{9.5}{1,256} \approx 7.6 \text{ mA}, \quad I_C = \frac{9.5}{1,590} \approx 6 \text{ mA.}$$

I_C is in antiphase with I_L and hence $I_r = I_L - I_C$, according to Kirchoff's law.

The phase angle between E_1 and I_r is arc $\tan \frac{5,980}{2,000} \approx 71.5^\circ$, I_r lagging behind E_1 . I_L is in phase with I_r , I_C is 180° out of phase

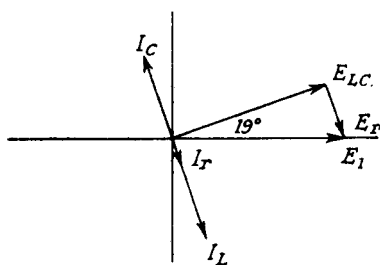

FIG. 2.

with I_L and therefore leading E_1 by 108.5° . The vector diagram of all the currents and voltages is given in Fig. 2. It should not require any further explanation.

4. Equivalence of Series and Parallel Combination. A series combination of a resistance r and an inductance L is equivalent to a parallel combination of a resistance

R and an inductance L' , the relations being :

$$R = r \left[1 + \left(\frac{\omega L}{r} \right)^2 \right]$$

$$L' = L \left[1 + \left(\frac{r}{\omega L} \right)^2 \right].$$

For capacitance and resistance the corresponding relations are :

$$R = r \left[1 + \left(\frac{1}{\omega C r} \right)^2 \right], \quad C' = \frac{C}{1 + (r\omega C)^2}.$$

If r is small compared with ωL or $\frac{1}{\omega C}$ respectively (the usual case in radio frequency), the equations become :

$$R = \frac{(\omega L)^2}{r}, \quad L' = L \text{ and}$$

$$R = \frac{1}{(\omega C)^2 r}, \quad C' = C.$$

If the parallel combination is given and the series combination is to be found the formulae are :

$$r = \frac{R}{1 + \left(\frac{R}{\omega L'} \right)^2}, \quad L = \frac{L'}{1 + \left(\frac{R}{\omega L'} \right)^2},$$

and
$$r = \frac{R}{1 + (R\omega C')^2}, \quad C = C' \left[1 + \left(\frac{1}{R\omega C'} \right)^2 \right]$$

and for R large compared with $\omega L'$ or $\frac{1}{\omega C'}$

$$r = \frac{(\omega L')^2}{R}, \quad L = L'$$

$$r = \frac{1}{(\omega C')^2 R}, \quad C = C'.$$

The relations can be easily proved by writing down the expressions for the series and parallel combination and equating the real and imaginary parts, e.g.

$$r + j\omega L = \frac{Rj\omega L'}{R + j\omega L'} = \frac{Rj\omega L'(R - j\omega L')}{R^2 + (\omega L')^2}$$

$$r = \frac{R(\omega L')^2}{R^2 + (\omega L')^2} = \frac{R}{1 + \left(\frac{R}{\omega L'}\right)^2}, \quad L = \frac{L'}{1 + \left(\frac{\omega L'}{R}\right)^2}.$$

The reversed relations are best derived by working with admittances,

viz.
$$\frac{1}{R} + \frac{1}{j\omega L'} = \frac{1}{r + j\omega L}, \text{ etc.}$$

Using the previously mentioned fact that both combinations dissipate the same power naturally leads to the same results. It may be applied in order to replace the series combination of r and L by the parallel combination of R and L' . If the applied voltage is E , the p.d. across r becomes $\frac{Er}{\sqrt{r^2 + \omega^2 L^2}}$ and the power dissipated in r is

$$\frac{E^2 r}{r^2 + \omega^2 L^2}. \text{ The power dissipated in } R \text{ being } \frac{E^2}{R} \text{ there follows}$$

$$\frac{E^2}{R} = \frac{E^2 r}{r^2 + \omega^2 L^2}, \quad R = r \left[1 + \left(\frac{\omega L}{r} \right)^2 \right].$$

Equating in the same way the wattless powers gives

$$\frac{E^2 \omega L}{r^2 + \omega^2 L^2} = \frac{E^2}{\omega L'}, \quad L' = L \left[1 + \left(\frac{r}{\omega L} \right)^2 \right],$$

as shown before.

Example 1. A series combination $L = 200 \mu\text{H}$ and $r = 10$ ohms is to be replaced by an equivalent parallel combination of R and L' , at frequencies 0.6 Mc/s and 1.5 Mc/s respectively.

At 0.6 Mc/s

$$R \simeq 57,000 \text{ ohms}, \quad L' \simeq 200 \mu\text{H}.$$

At 1.5 Mc/s

$$R \simeq 355,000 \text{ ohms}, \quad L' \simeq 200 \mu\text{H}.$$

Example 2. A parallel combination $C' = 20 \text{ pF}$ and $R = 5,000$ ohms is to be replaced by an equivalent series combination of r and C at a frequency $f = 3 \text{ Mc/s}$.

$$r = 1,100 \text{ ohms}, \quad C = 25.6 \text{ pF}.$$

5. Resonant Frequency, Tuning Problems. The impedance of a series combination of L and C , both non-resistive, is $j\left(\omega L - \frac{1}{\omega C}\right)$.

It becomes zero if $\omega = \omega_0 = \frac{1}{\sqrt{LC}}$. The frequency $f_0 = \frac{\omega_0}{2\pi} = \frac{1}{2\pi\sqrt{LC}}$

is called the resonant frequency of L and C . If L is expressed in μH , C in pF , the resonant frequency is :

$$f \text{ (in Mc/s)} = \frac{159}{\sqrt{LC}}$$

and $\lambda \text{ (in metres)} = 1.88\sqrt{LC}$.

The impedance of L and C in parallel is $\frac{L}{C} \frac{1}{j\left\{\omega L - \frac{1}{\omega C}\right\}}$, and

this becomes infinite for $\omega = \omega_0$.

The impedance of L , C and r in series becomes r for the resonant frequency. Applying an E.M.F. of resonant frequency produces the current $I = \frac{E}{r}$. The voltage across L and C becomes

$$E' = \frac{E}{r}\omega_0 L = \frac{E}{r} \frac{1}{\omega_0 C}$$

If r is small compared with $\omega_0 L$, E' constitutes a gain in amplitude compared with the applied E.M.F. The factor $\frac{E'}{E} = \frac{\omega_0 L}{r} = \frac{1}{(\omega_0 C r)}$ is called the magnification factor Q of the circuit, and $\frac{r}{\omega_0 L} = r\omega_0 C$ is called the circuit damping d .

According to paragraph 4 the series resistance r is in practice equivalent to a resistance $R = \frac{(\omega_0 L)^2}{r}$ in parallel to either L or C .

In this case there is :

$$Q = \frac{1}{d} = \frac{R}{\omega_0 L} = R\omega_0 C.$$

For any frequency $\frac{\omega}{2\pi}$ the current through L , C and r in series is

$$\frac{E}{r + j\omega L + \frac{1}{j\omega C}} = \frac{E}{r + j\omega_0 L \left(\frac{\omega}{\omega_0} - \frac{\omega_0}{\omega}\right)}, \quad \omega_0 \text{ being } \frac{1}{\sqrt{LC}}.$$

If $\frac{\omega}{\omega_0} - \frac{\omega_0}{\omega}$ is called y , the equation becomes

$$I = \frac{E}{r} \frac{1}{1 + \frac{ jy }{d}}, \text{ or } |I| = \frac{E}{r} \frac{1}{\sqrt{1 + \left(\frac{y}{d}\right)^2}} = \frac{E}{r} \frac{1}{\sqrt{1 + (yQ)^2}}.$$

The latter equation represents the resonance curve of the tuned circuit, i.e. its ability to distinguish between E.M.F.s of different frequency. The current is a maximum for $y = 0$ ($\omega = \omega_0$) and falls off with increasing y , y being a measure of mistuning. For frequencies differing from ω_0 by only a few per cent y is approximately

$$\frac{2(\omega - \omega_0)}{\omega_0} = \frac{2 \times \text{percentage mistuning}}{100},$$

as in this case

$$\frac{\omega}{\omega_0} - \frac{\omega_0}{\omega} = \frac{\omega^2 - \omega_0^2}{\omega\omega_0} \approx \frac{2(\omega - \omega_0)}{\omega_0}.$$

For larger differences the phrase percentage mistuning should be used with caution, as the amplitude of the current is different for positive or negative mistuning. The deciding factor is y , and the above formula shows that the amplitude for, say, twice the resonant frequency is the same as for half the resonant frequency.

The resonance curve is best plotted in terms of $\frac{I}{I_{max}}$, the ratio being $\frac{1}{\sqrt{1+(yQ)^2}}$. This form is quite general and very handy.

The following table gives the connection between y and the percentage mistuning, showing clearly that up to about 10% mistuning it will be permissible to use for y simply $\frac{2 \text{ perc. mist.}}{100}$.

Mistuning in %	y	
	$\frac{\omega}{\omega_0} > 1, y > 0$	$\frac{\omega}{\omega_0} < 1, y < 0$
1	0.02	0.02
2	0.04	0.04
3	0.059	0.061
4	0.078	0.082
5	0.098	0.103
6	0.117	0.124
7	0.135	0.145
8	0.154	0.167
9	0.173	0.189
10	0.191	0.21

Fig. 3 shows the resonance curve of one circuit, derived from the formula given above, abscissa and ordinate being drawn in

logarithmic scale. For larger percentage mistuning $\frac{I}{I_{max.}} = \frac{1}{yQ}$, and

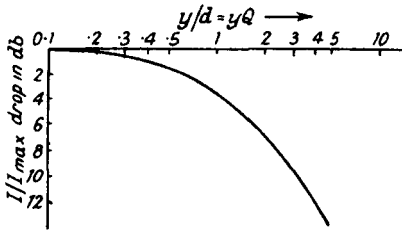

FIG. 3.—Response Curve of One Tuned Circuit.

the curve becomes linear in the double logarithmic scale. This has the advantage that in taking measurements any faults or errors will show up immediately. The curves for two or more non-coupled circuits are obtained by addition of the ordinates.

Example. A circuit is tuned to 1 Mc/s, $d = 1.2\%$. Find the

ratio $\frac{I}{I_{max.}}$ for ± 140 Kc/s mistuning.

For $+140$ Kc/s mistuning, i.e. for $f = 1.14$ Mc/s, $y \simeq 0.26$,

$$\frac{y}{d} = yQ = 21.7, \quad \frac{I}{I_{max.}} = \frac{1}{\sqrt{1+21.7^2}} = 0.046,$$

corresponding to a drop of nearly 27 db.

For -140 Kc/s mistuning, i.e. for $f = 0.86$ Mc/s, $y = 0.303$,

$$\frac{y}{d} = 25, \quad \frac{I}{I_{max.}} = 0.04,$$

corresponding to a drop of 28 db.

A quick and fairly rough estimate would proceed on the following lines applying to either case: mistuning 14%, hence $y = 28\%$, $d = 1.2\%$, $\frac{y}{d} = 23.3$, $\frac{I}{I_{max.}} = 0.043$, showing an error of less than 10%.

Usually in receiver technique it is not the current that is of interest but the voltage across L or C . In the first case the formula

changes to $|E_2| = EQ \frac{\frac{\omega}{\omega_0}}{\sqrt{1+(yQ)^2}}$. The perfect symmetry which holds

for the current exists no longer. As long as frequencies within a few per cent mistuning are concerned the difference is negligible, but above, say, 10%, its influence begins to show. For $y = \pm 1.5$, i.e. frequencies twice or half the resonant frequency, the difference is already 1 : 4. Whereas for low frequencies the volts across L are approaching zero they become E for infinitely high frequencies. In the old days, when the selectivity of receivers was based on one circuit only, this fact used to be of importance. With modern receivers it will prove serious only in exceptional cases, e.g. with

reception in the immediate neighbourhood of a strong transmitter and the consequent danger of cross-modulation at the first valve.

The formula $I = \frac{E}{r} \frac{1}{1+jyQ}$, given at the beginning of this chapter, reveals another feature not yet mentioned. For $y = 0$, i.e. at resonant frequency, I is in phase with E . At other frequencies there is a phase shift ϕ , $\tan \phi$ being yQ . For frequencies higher than f_0 I is lagging, for frequencies lower than f_0 I is leading. A case where phase consideration is of first importance will be shown in paragraph 7 of this chapter.

The impedance of a parallel combination of L and C , with a resistance r in series to L (Fig. 4), is

$$Z = \frac{(r+j\omega L) \frac{1}{j\omega C}}{r+j\omega L + \frac{1}{j\omega C}} = \frac{r}{j\omega C} + \frac{L}{r+j\omega_0 Ly}$$

Usually in the neighbourhood of the resonant frequency the term $\frac{L}{C}$ is large compared with $\frac{r}{j\omega C}$ and the impedance of the circuit becomes $\frac{\omega_0 L Q}{1+jyQ}$; the resonance impedance $\omega_0 L Q$ is called the Z_0 of the circuit. Using this term in the above formula the circuit impedance is $\frac{Z_0}{1+jyQ}$.*

In the vicinity of the resonant frequency a slight change of frequency produces only a small change in amplitude but a large change in phase. For $yQ = 1$, which corresponds to a frequency change $\delta f = \frac{f_0}{2Q}$, the impedance becomes $\frac{1}{\sqrt{2}}$ of the maximum value, whereas the change in phase is 45° . The fact will be found

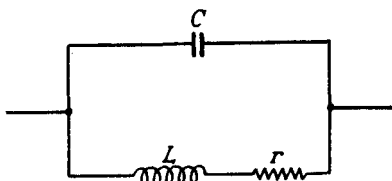

FIG. 4.

* The frequency at which the circuit impedance is purely resistive is $f = \frac{1}{2\pi\sqrt{LC}} \frac{1}{\sqrt{1+(\frac{1}{Q})^2}} \approx f_0$. This value is only of theoretical interest,

as there is always series and parallel damping in R.F. circuits. Compare the discussion on phase in paragraph 7 of this chapter.

of importance when discussing the possibilities of feedback in Chapter 9.

If, for the resonant frequency, r is replaced by an equivalent parallel resistance R , then R is, according to paragraph 4, equal to $\frac{\omega_0^2 L^2}{r} = \omega_0 L Q = Z_0$. This result is obvious as for resonance the parallel combination of L and C becomes infinite and only R remains.

The above formula for the impedance of the parallel tuned circuit contains the same expression in the denominator as that for the current in the series-tuned circuit shown above. If, therefore, a constant current I is flowing into the parallel circuit, the p.d. across the circuit obeys the same law with respect to frequency as does the current for a series combination of L , C and r , and it thus provides the same selectivity features.*

For frequencies far off resonance there is an asymmetry, similar to that shown for the series circuit; it is due to the influence of $\frac{r}{j\omega C}$ in comparison with $\frac{L}{C}$. For high frequencies the p.d. across the circuit tends to zero, for low frequencies it can never fall below $I r$. If the circuit contains parallel damping R only, the symmetry in y is perfect, the circuit impedance being $\frac{R}{1+jyQ}$. (The influence of r and R varying with frequency is neglected.)

The effect of asymmetrical resonance curves in receiver design will be shown later on several occasions.

6. Damping of a More Complicated Circuit. If a tuned circuit contains several resistances, parallel or series, the total damping can be computed as the sum of each single damping. Thus, if there is a series resistance r and a parallel resistance R , and if $\frac{r}{\omega L} = d_1$ and $\frac{\omega L}{R} = d_2$, the total damping is $d_1 + d_2$.

The relation between the corresponding Q values is not quite so simple. If $Q_1 = \frac{1}{d_1}$, $Q_2 = \frac{1}{d_2}$, the resulting Q is $\frac{Q_1 Q_2}{Q_1 + Q_2}$. Due to these facts, working with d will often be more convenient, and d is, therefore, frequently given preference in this book.

If a tuned circuit consists of more than one inductance and one capacitance the damping can always be computed by using the

* Constant current implies a generator having an impedance large compared with that of the parallel circuit at any frequency; a pentode can usually be considered a constant current device.

formulae given under paragraph 4 and realising, on the other hand, that for L and C the total resultant values have to be applied.

Example. (Fig. 5.) $L_1 = 500 \mu\text{H}$, $L_2 = 100 \mu\text{H}$, $C_1 = 150 \text{ pF}$, $C_2 = 600 \text{ pF}$, $r_1 = 50 \text{ ohms}$, $r_2 = 3 \text{ ohms}$, $R = 10,000 \text{ ohms}$. The resonant frequency and the circuit damping are to be determined.

The total inductance is $\frac{L_1 L_2}{L_1 + L_2} = 83.3 \mu\text{H}$, the total capacitance $\frac{C_1 C_2}{C_1 + C_2} = 120 \text{ pF}$. Consequently the resonant frequency is 1.6 Mc/s (paragraph 5).

r_1 can be replaced by a parallel resistance $\frac{\omega_0^2 L_1^2}{r_1} \approx 0.5 \text{ M}\Omega$,

hence $d_1 = 0.166\%$ * ; r_2 is equivalent to about $0.33 \text{ M}\Omega$ parallel resistance, giving a $d_2 = 0.25\%$. The damping influence of R is that of a series resistance of 2.77 ohms , resulting in $d_3 = 0.334\%$. Therefore the total damping is $d_1 + d_2 + d_3 = 0.75\%$ and $Q = 133$.

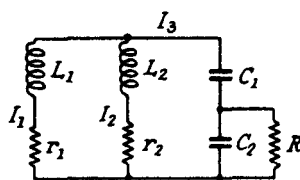

FIG. 5.

A general formulation for the circuit damping can be given as the ratio of real dissipated power to wattless power, i.e. $\frac{\Sigma I^2 r}{\Sigma I^2 \omega_0 L}$

$\frac{\Sigma E^2}{R}$ or $\frac{\Sigma E^2}{\omega_0 L}$. The truth of this statement is apparent when a circuit,

by the above procedure, has been reduced to r , L and C in series or R , L and C in parallel. In the latter case the dissipated power is $\frac{E^2}{R}$, the wattless power is $\frac{E^2}{\omega_0 L}$ or $E^2 \omega_0 C$,

$$d \text{ being } \frac{E^2}{R} \div \frac{E^2}{\omega_0 L} = \frac{\omega_0 L}{R}.$$

7. Phase Conditions. The maximum current through a series combination of r , L and C occurs for the frequency $f = \frac{1}{2\pi\sqrt{LC}}$,

* This result can also be obtained by replacing r_1 by a resistance r_1' in series with C_1 . There is $I_3^2 r_1' = I_1^2 r_1$ and $I_1 = I_3 \frac{L_2}{L_1 + L_2}$; hence

$$r_1' = r_1 \left(\frac{L_2}{L_1 + L_2} \right)^2 \text{ and } d_1 = \frac{r_1'}{\omega_0 \left(\frac{L_1 L_2}{L_1 + L_2} \right)}.$$

the current being in phase with the E.M.F. (paragraph 5). If the series resistance is replaced by a resistance in parallel with the coil or the condenser, the conditions are different, though for a small damping the difference is negligible. For a large damping the frequency at which the current is a maximum is no longer the same as that at which E and I are in phase. This fact can be of importance in direction finding or directional reception where often the tuned aerial is heavily damped in order to obtain a fairly constant phase for a given frequency band. The subject is somewhat outside the scope of this book. It seems, however, of sufficiently

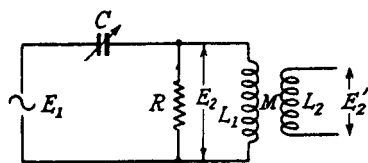

FIG. 6.

wide application to justify its being included in the introductory chapter. The conditions may be studied for two cases.

Example 1. (Fig. 6.) Under what conditions will an E.M.F. be induced in L_2 90° out of phase with E_1 ?

The required phase condition is fulfilled for the resonant frequency $f_0 = \frac{1}{2\pi\sqrt{L_1C}}$, as can be seen from the following equation:

$$E_2 = E_1 \frac{\frac{Rj\omega L_1}{R+j\omega L_1}}{\frac{Rj\omega L_1}{R+j\omega L_1} - \frac{j}{\omega C}} = \frac{E_1}{1 - \frac{1}{\omega C} \frac{R+j\omega L_1}{R\omega L_1}},$$

which becomes $-\frac{E_1 R}{j\omega_0 L_1}$ for $\omega = \omega_0$; hence $E_2' = -\frac{E_1 R}{j\omega_0 L_1} \frac{M}{L_1}$. In practice the frequency ω will be given and the capacitance C has to be adjusted to give correct phase. The above equation shows that the phase is correct when $C = \frac{1}{\omega_0^2 L_1}$, independently of the amount of damping. Therefore it would be possible to gang the circuit with the rest of the receiver in the usual way.

If the circuit tuning is separate, a mistake might easily occur by tuning the circuit to maximum signal strength and assuming the phase condition to be automatically correct. To find the value of C for maximum reception, E_2 must be expressed in absolute value as a function of E_1 .

$$|E_2| = \frac{E_1}{\sqrt{\left(1 - \frac{1}{\omega^2 L_1 C}\right)^2 + \frac{1}{R^2 \omega^2 C^2}}}$$

Differentiating the term under the root with respect to C and equating to zero gives

$$2\left(1 - \frac{1}{\omega^2 L_1 C}\right) \times \left(\frac{1}{\omega^2 L_1 C^2}\right) - \frac{2}{R^2 \omega^2 C^3} = 0,$$

$$\therefore C = \frac{1}{\omega^2 L_1} + \frac{L_1}{R^2} = \frac{1}{\omega^2 L_1} \left[1 + \left(\frac{\omega L_1}{R}\right)^2\right] = \frac{1}{\omega^2 L_1} (1 + d^2).$$

For a damping of approximately 30%, a not unusually high value for the tuned aerial in directional reception, tuning the aerial to maximum input would result in a tuning 5% different from that required, with a phase error of 18°. The correct method would be either to replace R by a series resistance or otherwise to tune first without R to maximum input and then to add R afterwards. In order to obtain the correct amplitude the mutual inductance M between the two coils L_1 and L_2 may be varied.

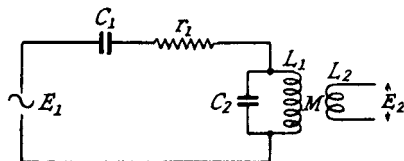

FIG. 7.

Example 2. (Fig. 7.) Under what conditions will E_2 be 90° out of phase with E_1 ?

A simple calculation shows that the phase condition is fulfilled for $C_1 + C_2 = \frac{1}{\omega^2 L_1}$, independent of r_1 . On the other hand, if $r_1 \gg \frac{1}{\omega C_1}$, the amplitude of E_2 will not be affected by C_1 , and a maximum E_2 is obtained by adjusting C_2 to $\frac{1}{\omega^2 L_1}$, resulting in an obvious phase error for E_2 .

If r_1 is replaced by a resistance R parallel to C_2 , a variation of C_2 tunes to maximum E_2 and to correct phase condition simultaneously. If Z is the impedance of L_1 , C_2 and R in parallel, E_2 becomes

$$\frac{E_1 Z}{Z + \frac{1}{j\omega C_1}} \frac{M}{L_1} = E_1 \frac{M}{L_1} \frac{j\omega C_1}{j\omega C_1 + j\omega C_2 + \frac{1}{j\omega L_1} + \frac{1}{R}},$$

showing immediately that the same value of C_2 gives maximum E_2 and the desired phase relation at the same time.

8. Anti-Resonance. Selectivity is usually achieved by providing maximum gain for the desired frequency. Another means, often used in addition, consists in providing maximum loss for the non-desired frequency. The maximum loss may be achieved in many ways: inserting in the current path an impedance which is

a maximum for the undesired frequency (rejector circuit), by-passing the load with an impedance which is a minimum for the undesired frequency (acceptor circuit) or using couplings which are variable with frequency and become a minimum for the undesired frequency (all kinds of bridge circuits). The frequencies of maximum loss are often called the anti-resonance points of the circuit employed.

Anti-resonance points may be used to produce selectivity curves with extremely steep sides (Fig. 8), or they may serve to give pro-

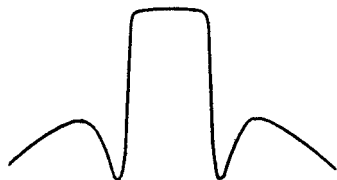

FIG. 8.

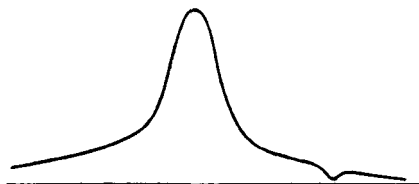

FIG. 9.

tection against a strong signal of very different frequency (Fig. 9). Examples of the type Fig. 9 will be given in Chapter 5; a detailed discussion of the type Fig. 8 is beyond the scope of this book.

9. Thevenin's Theorem. For the problems treated in the following paragraphs Thevenin's theorem will be found a most useful instrument for simplifying complex conditions. It reads as follows :

"The current in any impedance Z , connected to two terminals of a network, is the same as if Z were connected to a simple generator, of which the generated voltage is the open-circuited voltage at the terminals in question and of which the impedance is the impedance of the network looking back from the terminals, when all generators are replaced by impedances equal to the internal impedances of the generators."

The meaning of the theorem may be explained by a simple case. In the circuit Fig. 10a the impedance in question may be $r + j\omega L$,

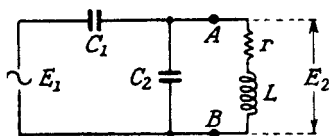

FIG. 10a.

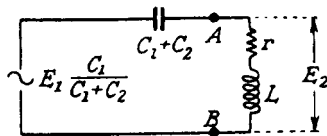

FIG. 10b.

the terminals being A and B . The open-circuited voltage across A and B is $E_1 \frac{C_1}{C_1 + C_2}$, the impedance when looking into AB from the right is that of C_1 and C_2 in parallel. Fig. 10a, therefore,

simplifies to Fig. 10b, from which the voltage E_2 across L follows immediately

$$E_2 = E_1 \frac{C_1}{C_1 + C_2} \frac{r + j\omega L}{r + j\omega L + \frac{1}{j\omega(C_1 + C_2)}}$$

This equation shows that C_1 is part of the tuning in the same way as if the E.M.F. were inserted in series with L . The maximum E_2 occurs for

$$\omega^2 = \frac{1}{L(C_1 + C_2)}, \quad |E_{2(max.)}| = \left| E_1 \frac{C_1}{C_1 + C_2} \frac{r + j\omega L}{r} \right| \simeq E_1 \frac{QC_1}{C_1 + C_2}$$

10. Equivalent Circuit of a Transformer. (Fig. 11a.)

A transformer has two inductances L_1 and L_2 , the coupling factor between L_1 and L_2 being unity and the transformer resistance regarded as negligible. Looking into the transformer from one side, say L_2 , the network between the terminals of L_1 can be replaced

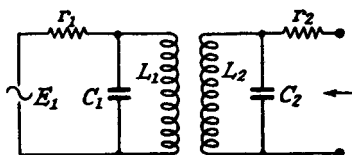

FIG. 11a.

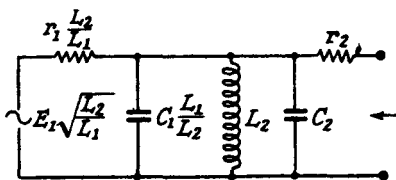

FIG. 11b.

by another similar network across L_2 where all the original impedances are multiplied by the ratio $\frac{L_2}{L_1}$ and all the E.M.F.s by the

ratio $\sqrt{\frac{L_2}{L_1}}$. Using this principle, Fig. 11a simplifies to Fig. 11b.

As the coupling factor is supposed to be unity, the ratio $\frac{L_2}{L_1}$ can be replaced by $\left(\frac{n_2}{n_1}\right)^2$, n_1 and n_2 being the corresponding numbers of turns.

If the coupling factor between L_1 and L_2 is k , $k < 1$, L_1 can be divided into two parts, $L_1 k^2$ and $L_1(1 - k^2)$, $L_1 k^2$ playing the part of L_1 in Fig. 11a and $L_1(1 - k^2)$ being outside. This leaves, as can be readily seen, the mutual inductance and the primary load unchanged. The new circuit can be treated according to Figs. 11a and 11b, thus leading to the three equivalent circuits Figs. 12a, 12b and 12c, which are generally applicable.

It would, of course, be possible instead to divide L_2 into two parts, $L_2 k^2$ and $L_2(1 - k^2)$, and leave L_1 whole, thus arriving at another equally valid transformer circuit. (Compare the circuit Fig. 47, which gives the view from the source.)

The equivalent transformer circuit given in Fig. 12c is extremely useful and enables one to understand easily the working of a transformer and to arrive quickly at the desired results. It seems, for the problems treated in this book, more suitable than the many other equivalent circuits, and has, therefore, been preferred. It has, of course, its limitations. If the effect of capacitance between primary and secondary is to be investigated the substitution by an equivalent Π section will prove the appropriate procedure. In cases

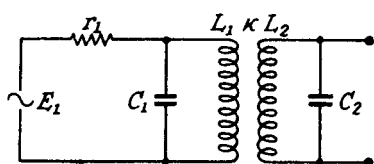

FIG. 12a.

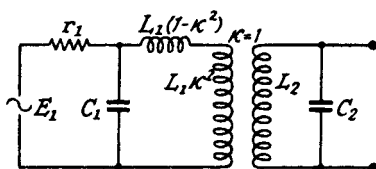

FIG. 12b.

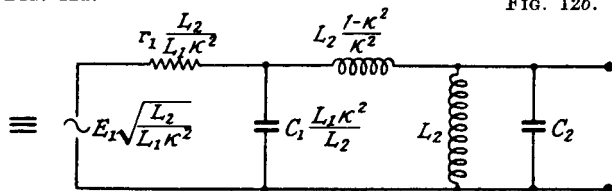

FIG. 12c.

where there exists the slightest doubt as to the validity of the equivalent transformer circuit, it is preferable to derive the required result by using Ohm's and Kirchhoff's laws. An example may prove useful.

Example: An inductance L_0 is coupled to two inductances L_1 and L_2 with the coupling coefficients k_1 and k_2 , the coupling factor between L_1 and L_2 being zero. The case occurs in practice, L_0 being the search coil, L_1 and L_2 the field coils of a goniometer. What is the inductance of L_0 , if L_1 and L_2 are shorted?

If, rather rashly, the equivalent circuit Fig. 12c is used, the effect of the shorted inductances seems equivalent to two inductances $L_0 \frac{1 - k_1^2}{k_1^2}$ and $L_0 \frac{1 - k_2^2}{k_2^2}$ in parallel to L_0 , reducing

$$L_0 \text{ to } L_0 \frac{1 - k_1^2 - k_2^2 + k_1^2 k_2^2}{1 - k_1^2 k_2^2}.$$

Applying the general method gives: (Fig. 13.)

$$\begin{aligned} E_0 &= I_0 j\omega L_0 + I_1 j\omega M_1 + I_2 j\omega M_2 \\ I_1 j\omega L_1 + I_0 j\omega M_1 &= 0 \\ I_2 j\omega L_2 + I_0 j\omega M_2 &= 0. \end{aligned}$$

From these equations it follows that

$$E_0 = I_0 \left(j\omega L_0 - \frac{M_1}{L_1} j\omega M_1 - \frac{M_2}{L_2} j\omega M_2 \right) = I_0 j\omega L_0 (1 - k_1^2 - k_2^2),$$

differing from the above result.

The mistake in using the equivalent transformer circuit is due to the fact that each of the two inductances L_1 and L_2 affects L_0 and, therefore, invalidates the equivalent circuit for the other coil.

The correct result shows, by the way, that the inductance of the goniometer search coil does not change when rotating. If k is the maximum coupling between search coil and field coil and α the angle between L_0 and L_1 , k_1 is $k \cos \alpha$ and $k_2 = k \sin \alpha$, L_0 becoming $L_0(1 - k^2 \cos^2 \alpha - k^2 \sin^2 \alpha) = L_0(1 - k^2)$, independent of α .

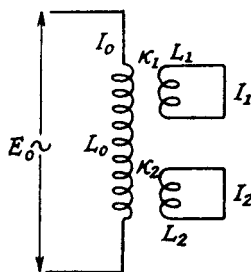

FIG. 13.

11. Matching Problems. Given an E.M.F. E_1 , a source resistance r_1 , in series with a load resistance r_2 , the voltage across r_2 becomes $E_1 \frac{r_2}{r_1 + r_2}$ and the power dissipated in r_2 is $E_1^2 \frac{r_2}{(r_1 + r_2)^2}$. This value is a maximum when $r_2 = r_1$, the power dissipated in r_2 becoming $\frac{E_1^2}{4r_1}$. The value $\frac{E_1^2}{4r_1}$ represents the maximum power which can be derived from a source having the voltage E_1 and the impedance r_1 .

If $r_2 \neq r_1$, an ideal transformer with the turns ratio $\frac{n_2}{n_1} = \sqrt{\frac{r_2}{r_1}}$ gives perfect matching conditions. As the power dissipated in r_2 becomes $\frac{E_1^2}{4r_1}$, the voltage E_2 across r_2 is found as follows:

$$\frac{E_2^2}{r_2} = \frac{E_1^2}{4r_1}, \quad E_2 = \frac{E_1}{2} \sqrt{\frac{r_2}{r_1}} = \frac{E_1}{2} \cdot \frac{n_2}{n_1}.$$

The phrase ideal transformer assumes infinite transformer inductance with no resistance and 100% coupling.

If there is not perfect matching between r_1 and r_2 , i.e. if the turns ratio primary to secondary is t' instead of the optimum

value t , r_1 looks into a resistance $r' = r_1 \left(\frac{t'}{t}\right)^2$, and the power dissipated in r_2 becomes $E_1^2 \frac{r'}{(r_1+r')^2}$. The voltage across r_2 is found from simple considerations of power:

$$\frac{E_2^2}{r_2} = E_1^2 \frac{r'}{(r_1+r')^2},$$

$$E_2 = E_1 \frac{\sqrt{r'r_2}}{r_1+r'} = \frac{E_1}{2} \sqrt{\frac{r_2}{r_1}} \frac{2}{\sqrt{\frac{r'}{r_1}} + \sqrt{\frac{r_1}{r'}}}.$$

$\frac{E_1}{2} \sqrt{\frac{r_2}{r_1}}$, as shown above, is the maximum voltage possible across r_2 , and $\frac{r'}{r_1}$ indicates the amount of mismatching. If we set

$$\sqrt{\frac{r'}{r_1}} = \frac{t'}{t} = A, \quad E_2 \text{ becomes } \frac{E_1}{2} \sqrt{\frac{r_2}{r_1}} \frac{2}{A + \frac{1}{A}} = E_{2opt.} \frac{2}{A + \frac{1}{A}}.$$

The term $\frac{2}{A + \frac{1}{A}}$ is of general validity and applies to all cases where

energy transfer from one resistance to another takes place. The term shows that for a given mismatching the loss is the same whether the source resistance looks into a smaller or larger resistance. (As regards the matching of tuned circuits, see page 30.)

Example: An E.M.F. with the source resistance 10,000 ohms is connected to a transformer with the step-up ratio 1:4. Across the secondary is a resistance of 50,000 ohms. (1) What is the mismatching? (2) What is the E.M.F. across the secondary? (3) What other transformer ratio would give the same E.M.F. across the secondary?

(1) The source looks into $\frac{50,000}{16} = 3,120$ ohms, the mismatching ratio being $\frac{r'}{r_1} = A^2 = \frac{1}{3.2}$.

(2) The E.M.F. across the secondary is

$$\frac{E_1}{2} \sqrt{\frac{50,000}{10,000}} \frac{2}{\sqrt{3.2} + \sqrt{\frac{1}{3.2}}} = 0.95E_1.$$

(3) E_2 is unchanged if $A = \sqrt{3.2}$, i.e. if the source looks into 32,000 ohms. The corresponding transformer ratio is 1:1.25.

The advantage of using the above formula expressing E_2 in terms of the maximum obtainable voltage lies in the fact that it gives immediately the loss due to mismatching and shows how far the result can be improved. A mismatching of, say, 1 : 2 results in a loss of only 6% for E_2 and is usually not serious.

So far, no account has been taken of the finite inductance of the transformer, its winding resistance or its leakage inductance. All these factors affect the performance, as can be readily seen from Fig. 12c. Their practical application is shown in Chapter 3 (The A.F. Transformer Stage).

The problem of energy transfer from a resistance r to a tuned circuit is easily understood by considering the circuit as a parallel combination of L , C and R , where R is equal to the impedance Z_0 of the tuned circuit (paragraph 4). The impedance of the transformer is infinite for the resonant frequency, and the ratio $\frac{E_2}{E_1}$ becomes, under matching conditions, $\frac{1}{2}\sqrt{\frac{Z_0}{r}}$. The damping of the circuit, i.e. the factor governing the shape of the response curve, is naturally affected by the source resistance, the relation being $d = d_0(1 + A^2)$; d_0 is the natural circuit damping and d the damping with the coupling resistance r included. The truth of this follows from the facts dealt with in the paragraphs 5, 10 and 11. For $A = 1$, which is the matching condition, the resistance reflected from the source across the tuned circuit is equal to Z_0 . The circuit impedance is halved and the circuit damping doubled. For $A = 3$, i.e. if the number of turns across r is approximately three times the number required for matching, the reflected resistance is $\frac{Z_0}{9}$, increasing the circuit damping in the ratio 1 : 10. Usually $A > 1$ is called the overcoupled condition, $A < 1$ the undercoupled condition, though the coupling factor itself may not change at all. In cases where the selectivity of the tuned circuit is important one should work with A about $\frac{1}{2}$. The voltage in the secondary circuit becomes 0.8 of the optimum value, and the circuit damping is only 1.25 times the natural value.

A transformer coupling of less than unity results in a leakage inductance in series with the source resistance r (paragraph 10). If its impedance is small compared with r it can be neglected. If it is large there results a mistuning of the circuit as well as an additional damping. The conditions become more complicated and are, in principle, identical with those of a source consisting of a

resistance in series with an inductance the reactance of which is large compared with the resistance. This case is treated extensively in Chapter 2.

The matching conditions can be obtained by tapping the coil instead of using a primary transformer winding if $r < Z_0$, the coil working as an auto-transformer. The coil is to be tapped at such a point that the ratio of turns of total coil to tapping is approximately

$\sqrt{\frac{Z_0}{r}}$; the rule is valid particularly for tubular coils, toroid

coils and coils with an iron-dust core. The turns ratio is thus the same as that used with a transformer of coupling factor unity, which fact is made plausible by the following considerations (Fig. 14). The magnetic field along the tubular coil is fairly constant and therefore the ratio of the voltages is identical with the ratio of turns, as is the case with an ideal transformer. In contrast to the

transformer, the winding connected to r has an inductance which is a larger proportion of that of the total coil than results from the squares of the numbers of turns. But, owing to the coupling factor being less than unity, the mutual inductance between the two is nearly that obtained with an ideal transformer. The mutual inductance determines the matching,

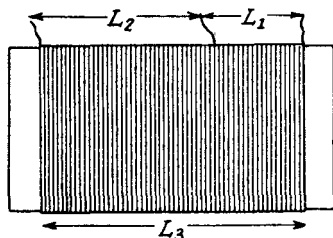

FIG. 14.

the coupling factor influences only the leakage inductance.

Example: A tubular coil of 60 turns is of diameter 4 cm. and length 6 cm. (Fig. 14). The tapping is at 20 turns from the earthed side. If L_1 is the inductance of the first 20 turns, L_2 that of the next 40 turns, and L_3 that of the total coil, the values found from well-known formulae are :

$$L_1 = 16.6 \text{ microhenries.}$$

$$L_2 = 43.1 \quad \text{,,}$$

$$L_3 = 73 \quad \text{,,}$$

The coupling k between L_1 and L_2 follows from the fact that $L_3 = L_1 + L_2 + 2k\sqrt{L_1L_2}$; hence $73 = 16.6 + 43.1 + 2k\sqrt{16.6 \times 43.1}$
 $\therefore k = 0.248$.

The coupling factor k' between L_1 and the total inductance L_3 is found by realising that a current I through L_1 induces in L_3 a voltage which can be expressed either as $Ij\omega k'\sqrt{L_1L_3}$, or as

$I(j\omega L_1 + j\omega k\sqrt{L_1 L_2})$. Equating the two expressions and substituting the numerical values gives $k' = 0.668$.

The coupling part of L_1 is $k'^2 L_1 = 7.4$ microhenries, whereas for an ideal transformer the inductance of $\frac{1}{3}$ tap would be $\frac{7.3}{9} = 8.1$ microhenries.

The mismatching factor is $A^2 = \frac{7.4}{8.1} = 0.91$; the leakage part of L_1 , 9.2 microhenries, can be neglected as its reactance is certainly small compared with $\frac{Z_0}{9}$.

Taking, in this way, the results of various tappings for the above coil, Fig. 15 is obtained showing that for a wide range of tappings the matching properties of the coil are nearly those which would exist if all the turns were 100% linked with each other. It is

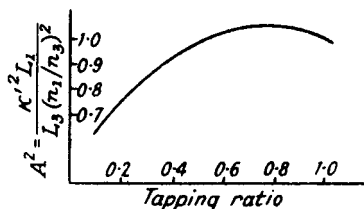

FIG. 15.

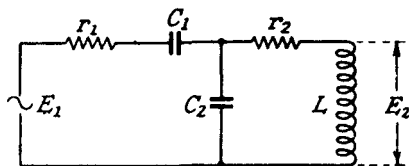

FIG. 16.

obvious that for the half and full tapping the matching would be correct. The loss in secondary voltage as compared with optimum coupling is quite negligible for the whole of the curve.

Optimum energy transfer from a resistance to a tuned circuit can be obtained by other means than a transformer. Fig. 16 gives an example of a capacitive coupling. Using Thevenin's theorem and assuming that $r_1 \ll \frac{1}{\omega_0 C_1}$, $E_2 = E_1 \frac{C_1}{C_1 + C_2} \frac{1}{d}$, d being the total damping of the circuit due to r_1 and r_2 . Using the equivalent circuit, paragraph 4, we replace r_1 by a parallel resistance $\frac{1}{\omega_0^2 C_1^2 r_1}$, causing the damping $\frac{\omega_0^2 C_1^2 r_1}{\omega_0(C_1 + C_2)}$. The total damping is

$$r_2 \omega_0 (C_1 + C_2) + r_1 \omega_0 (C_1 + C_2) \left(\frac{C_1}{C_1 + C_2} \right)^2$$

and

$$\frac{E_2}{E_1} = \frac{C_1}{C_1 + C_2} \cdot \frac{1}{\omega_0 (C_1 + C_2) \left[r_2 + r_1 \left(\frac{C_1}{C_1 + C_2} \right)^2 \right]}$$

If L and ω_0 are given, $C_1 + C_2$ has a fixed value, and hence the optimum value of $\frac{E_2}{E_1}$ results when $r_2 \left(\frac{C_1 + C_2}{C_1} \right) + \frac{r_1}{\left(\frac{C_1 + C_2}{C_1} \right)}$ becomes a minimum,

i.e. when

$$\frac{C_1}{C_1 + C_2} = \sqrt{\frac{r_2}{r_1}}$$

$$\frac{E_2}{E_1} \text{ is now } \sqrt{\frac{r_2}{r_1}} \cdot \frac{1}{\omega_0(C_1 + C_2) \cdot 2r_2}$$

$$= \frac{1}{2} \frac{1}{\sqrt{r_1 r_2}} \frac{1}{\omega_0(C_1 + C_2)} = \frac{1}{2} \sqrt{\frac{Z_0}{r_1}}$$

$$Z_0 \text{ being } \omega_0 L Q = \frac{\omega_0^2 L^2}{r_2} = \frac{1}{\omega_0^2 (C_1 + C_2)^2 r_2}$$

The result is identical with that previously obtained by tapping the coil at the optimum point. If r_1 is larger than Z_0 , a matching by means of capacitive coupling is not possible.

12. Two Tuned Circuits Coupled Inductively with Each Other. Two tuned circuits, coupled inductively with each other, are still the most popular means of obtaining the desired

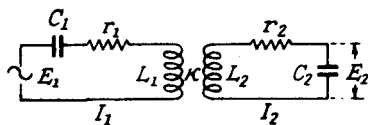

FIG. 17a.

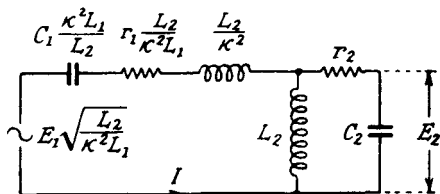

FIG. 17b.

response curve, since they strike a happy compromise between cost and performance. According to their importance they may be treated more broadly.

Using the equivalent transformer circuit and replacing $L_1(1 - k^2)$ by L_1 , which is permissible for the coupling factors occurring in practice ($k < 10\%$), Fig. 17a changes to Fig. 17b.

To understand the behaviour of two coupled circuits it may first be assumed that r_1 and r_2 are zero and that $L_1 C_1 = L_2 C_2$. In that case the series combination of $C_1 \frac{k^2 L_1}{L_2}$ and $\frac{L_2}{k^2}$ has an impedance

$$\frac{j\omega L_2}{k^2} - \frac{j}{\omega C_1} \frac{L_2}{k^2 L_1} = \frac{j\omega_0 L_2 y}{k^2} \left(\text{where } \omega_0 = \frac{1}{\sqrt{L_1 C_1}} \right),$$

which is plotted in terms of y in Fig. 18 as a straight line. The impedance of L_2 and C_2 in parallel is $\frac{L_2}{C_2} \frac{1}{j\omega_0 L_2 y} = -\frac{j\omega_0 L_2}{y}$ and is represented by a hyperbola. It is inductive when the series combination is capacitive, and vice versa. Hence, if the resistances are zero, the current I in Fig. 17b becomes infinite when

$$\frac{\omega_0 L_2 y}{k^2} = \frac{\omega_0 L_2}{y}.$$

This takes place for a value of $y = \pm k$, at the points P and P' in Fig. 18.

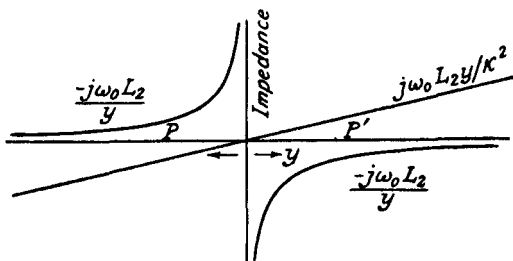

FIG. 18.

It follows that the response curve of two inductively coupled circuits having the same resonant frequency and zero damping has two humps, one on either side of the resonance. When the coupling factor is below, say, 10%, the humps are symmetrical with respect to the resonant frequency, the fractional mistunings being

$$\frac{\delta f}{f_0} = \frac{y}{2} = \pm \frac{k}{2}.$$

If there is damping the conditions are changed, the resistances affecting the impedances in close proximity to the resonant frequency. The calculation may be given as an example of the method employed on such occasions. In Fig. 17a, if the total impedances in each circuit are Z_1 and Z_2 and if the mutual inductance is M , the equations are :

$$\begin{aligned} I_1 Z_1 + I_2 j\omega M &= E_1 \\ I_2 Z_2 + I_1 j\omega M &= 0. \end{aligned}$$

Substituting in the first equation the value $-I_2 \frac{Z_2}{j\omega M}$ for I_1 there follows

$$I_2 \left(\frac{Z_1 Z_2}{j\omega M} - j\omega M \right) = -E_1.$$

Assuming the two circuits to be identical and tuned to the same frequency, there follows

$$I_2 = - \frac{E_1 j\omega M}{Z^2 + \omega^2 M^2} = - \frac{E_1 j\omega M}{(Z + j\omega M)(Z - j\omega M)}$$

and
$$E_2 = - E_1 \frac{\frac{M}{C}}{(Z - j\omega M)(Z + j\omega M)}$$

This shows that the response curve is identical with that of two single circuits tuned to two different frequencies f_1 and f_2 ,

$$f_1 \text{ being } \frac{1}{2\pi\sqrt{(L-M)C}} = \frac{1}{2\pi\sqrt{LC(1-k)}} = \frac{f_0}{\sqrt{1-k}},$$

$$f_2 \text{ being } \frac{f_0}{\sqrt{1+k}}.$$

In case of zero damping there are two peaks at $\frac{f_0}{\sqrt{1-k}}$ and $\frac{f_0}{\sqrt{1+k}}$; this result is naturally identical with that derived above for couplings below about 10%. If, for example,

$$f = \frac{f_0}{\sqrt{1-k}}, \text{ then } y = \frac{1}{\sqrt{1-k}} - \sqrt{1-k} \approx 1 + \frac{k}{2} - \left(1 - \frac{k}{2}\right) = k.$$

To derive the conditions under which peaks occur when the damping is not zero, the equation for E_2 has to be changed by substituting for Z the proper values. As done previously, the expression $j\omega_0 Ly$ is substituted for $j\omega L - \frac{j}{\omega C}$, $\frac{\omega_0}{2\pi}$ being the resonant frequency f_0 and $y = \frac{\omega}{\omega_0} - \frac{\omega_0}{\omega}$.

Hence E_2 becomes

$$\begin{aligned} E_2 &= - E_1 \frac{M/C}{Z^2 + \omega^2 M^2} = - E_1 \frac{M/C}{(r + j\omega_0 Ly)^2 + \omega^2 k^2 L^2} \\ &= - E_1 \frac{M/C}{\omega_0^2 L^2 \left[(d + jy)^2 + \frac{\omega^2 k^2}{\omega_0^2} \right]} = - E_1 \frac{k}{(d + jy)^2 + \frac{\omega^2}{\omega_0^2} k^2}. \end{aligned}$$

To obtain a manageable result this equation requires further simplification. In practice nearly all R.F. or I.F. response curves have a width of only a few per cent of the resonant frequency. Within this range $\frac{\omega}{\omega_0}$ can be regarded as equal to 1. As, on the other hand, the coupling factors used are rarely above 5%, the second term in

the denominator becomes for large mistunings much smaller than the first one, so that even in this case it is permissible to set $\frac{\omega}{\omega_0} = 1$.

$$E_2 = -E_1 \frac{k}{(d+jy)^2+k^2} = -\frac{E_1}{d} \frac{\frac{k}{\bar{d}}}{\left(1+j\frac{y}{\bar{d}}\right)^2 + \left(\frac{k}{\bar{d}}\right)^2}$$

$$\text{or } |E_2| = \left| E_1 \right| Q \frac{kQ}{\sqrt{[1-(yQ)^2+(kQ)^2]^2+4(yQ)^2}}$$

As it will be found presently that $k = \frac{1}{Q}$ is the critical coupling, this formula is of general application. It gives the shape of the response curve as a function of $\frac{k}{k_{crit.}}$ in terms of yQ , i.e. in terms of the ratio $\frac{2 \times \text{fractional mistuning}}{k_{crit.}}$.

Differentiation with respect to yQ gives the maxima or minima of the curve; for differentiation only the term under the root need be considered.

$$2[1-(yQ)^2+(kQ)^2] [-2yQ] + 8yQ = 0,$$

$$\text{whence} \quad -4yQ[1-(yQ)^2+(kQ)^2-2] = 0.$$

First solution: $yQ = 0$.

To know whether for $y = 0$, i.e. at the resonant frequency, the curve has a maximum or minimum, a second differentiation with respect to yQ is necessary. This gives $-4[1-(yQ)^2+(kQ)^2-2] - 4yQ(-2yQ)$, which for $y = 0$ becomes $4(1-k^2Q^2)$.

This expression becomes negative for $kQ > 1$, positive for $kQ < 1$, indicating a minimum in the first, a maximum in the second case. The differentiated function being in the denominator, $|E_2|$ becomes a minimum for $kQ > 1$, a maximum for $kQ < 1$.
Second solution: $1-(yQ)^2+(kQ)^2-2 = 0$

$$yQ = \pm \sqrt{(kQ)^2 - 1}.$$

The above equation has 2 more solutions if $kQ > 1$, resulting in two maxima for E_2 .

$k = \frac{1}{Q}$ is called the critical coupling factor of the two circuits; the above result has the following interpretation.

The resonance curve of two coupled circuits shows a maximum

for the resonant frequency, when the coupling factor is critical or less than critical. For a coupling factor larger than critical the resonance curve has a minimum for the resonant frequency and two maxima, symmetrically on either side of the resonant frequency,

for $y = \pm \frac{1}{Q} \sqrt{(kQ)^2 - 1} = \pm \sqrt{k^2 - \frac{1}{Q^2}}$. For most practical cases it is accurate enough to say that the maxima occur for a

fractional mistuning $\frac{\delta f}{f_0} = \pm \frac{1}{2} \sqrt{k^2 - \frac{1}{Q^2}}$ (see paragraph 5) or,

when k is large compared with $\frac{1}{Q}$, for $\frac{\delta f}{f_0} = \pm \frac{k}{2}$.

The resonance curves of a single and a double circuit are given in Fig. 19, with yQ as abscissa and $kQ = \frac{k}{k_{crit}}$ as parameter for the double circuit. The x and y axes are plotted in logarithmic scale,

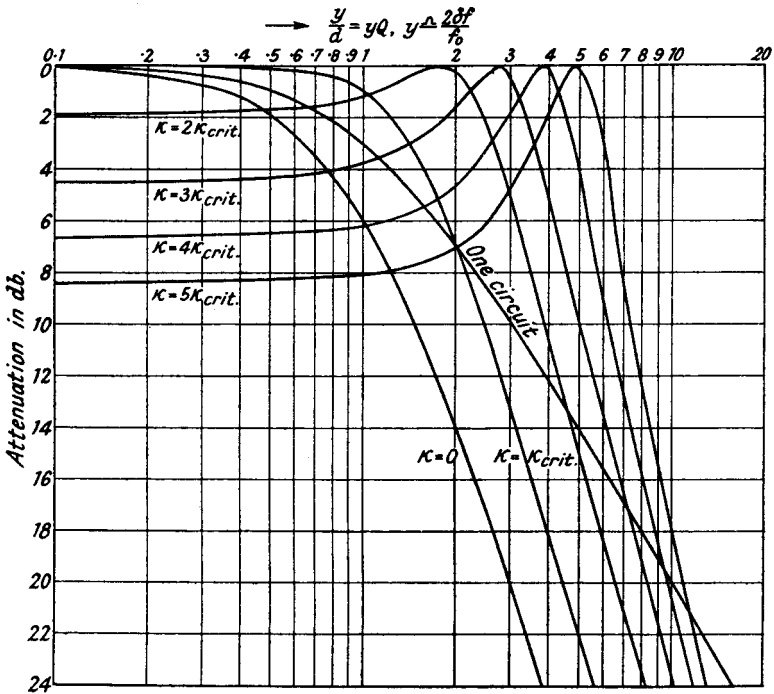

FIG. 19.—Response Curves for a Pair of Coupled Circuits.

which makes the curves linear for large mistunings. Only one side of the curves is given, as they are practically symmetrical in y . For large

mistunings, say more than 20%, it may be realised that interaction between the two circuits becomes negligible and E_2 is approximately $-E_1 \frac{k}{y^2}$, in accordance with the behaviour of two single circuits.

If the two circuits are connected to the anode of an R.F. pentode (Fig. 20) the symmetry in y is no longer perfect. Using Thevenin's theorem, the conditions become practically those of Fig. 17a, but $E_1 = I_a \frac{1}{j\omega C}$, introducing the factor $\frac{1}{\omega}$ in the final equation for E_2 . This asymmetry is unimportant within the range of the usual response curve and need only be considered for large mistunings or under conditions discussed at the end of this chapter.

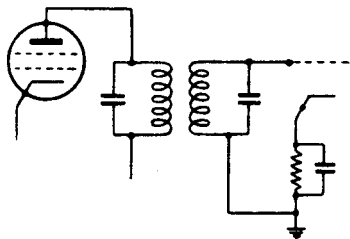

FIG. 20.

Two examples may illustrate the use of Fig. 19.

(1) $f_0 = 1$ Mc/s, $Q = 100$, $k = 3\%$.

The maxima occur for $yQ = \pm\sqrt{8}$, $y = \pm \frac{2.83}{100} = \pm 0.028$,

i.e. for approximately $\pm 1.4\% = \pm 14$ Kc/s mistuning.

(2) $f_0 = 0.3$ Mc/s. An amplifier employs 3 circuits altogether. Find the resonance curve with not more than 6 db. drop for ± 5 Kc/s and a drop of at least 40 db. for ± 20 Kc/s mistuning.

With 3 single circuits, the first condition requires a drop of 2 db. per circuit for ± 5 Kc/s mistuning. According to Fig. 19 a decrease of 2 db. for a single circuit occurs at $yQ = 0.75$; as 5 Kc/s mistuning corresponds to $y = 0.0333$, the Q of each circuit has to be $\frac{0.75}{0.0333} = 22.5$. In this case the response curve falls by 10 db. per circuit for 20 Kc/s mistuning, since $yQ \simeq 3$; the total drop becomes 30 db. altogether, far below the requirement.

The result desired can be obtained, employing the circuits under the following conditions.

One single circuit, $Q = 83$.

One pair of coupled circuits, $Q = 83$, $k = 3.6\%$, corresponding to the curve with the parameter $k = 3 k_{crit}$. in Fig. 19.

For ± 5 Kc/s, ($yQ = 2.77$).

The single circuit causes a decrease of 9.4 db., the coupled pair an increase of 4.5 db., so that the total curve falls by about 5 db.

For ± 20 Kc/s, then $yQ = 11$.

There is for the single circuit a decrease of 20.8 db.; for the coupled pair the drop is

$$25.5 - 4.5 = 21 \text{ db.}$$

∴ the total decrease = 41.8 db., fulfilling the requirement.

In this and similar cases care has to be taken that the resultant curve does not possess, within the passband required, points where the loss is larger than is allowed for at the two ends; this refers in the above case to the band within ± 5 Kc/s mistuning. It is easy to see that in the example given there is no such danger, the curve being fairly flat for the band required.

If a wide and very flat response curve with a sharp cut off on both sides is desired, and if the radio frequency used is relatively low, say, 75 Kc/s, the simplified form of the equation given for E_2 is no longer applicable. Taking the circuit Fig. 20 and assuming the valve impedance to be large compared with the circuit impedance, the accurate expression for $\frac{E_2}{E_1}$ is

$$\left| \frac{E_2}{E_1} \right| = g_m \frac{1}{\omega C} Q \frac{kQ}{\sqrt{\left[1 - (yQ)^2 + \left(\frac{\omega}{\omega_0} kQ \right)^2 \right]^2 + 4(yQ)^2}}$$

as follows from Thevenin's theorem.

The response curve is unsymmetrical for three reasons. First, due to the factor $\frac{1}{\omega}$ before the fraction; secondly, owing to the factor $\frac{\omega}{\omega_0}$ in the denominator, and thirdly, because symmetry is required for an arithmetical mistuning in frequency, positive or negative, and not for a geometrical one as is represented by y . The following example will show how far these factors may count in practice.

Example: A response curve of ± 10 Kc/s width is aimed at with not more than 2 db. loss at the ends, and a sharp cut-off beyond 10 Kc/s mistuning. The resonant frequency is 75 Kc/s, and three pairs of coupled circuits are to be employed. According to the curves in Fig. 19, critical coupling for one pair and 1 : 2 overcoupling for two pairs should fulfil the requirement, if the two humps of the overcoupled pair are approximately at ± 10 Kc/s off resonance. The circuit Q is equal for all three pairs. How is the symmetry at 65 Kc/s and 85 Kc/s?

The humps for a 1 : 2 overcoupled pair of circuits lie at approxi-

mately $yQ = \pm 1.8$. For 65 Kc/s y is -0.286 and for 85 Kc/s it is 0.251 ; taking an average y of 0.268 there follows the necessary

$$Q = \frac{1.8}{0.268} \simeq 6.7, \text{ and } k_{crit.} \simeq 15\%.$$

In order to compare with each other the two points of the resonance curve at 65 Kc/s and 85 Kc/s only the term

$$\omega \sqrt{\left[1 - (yQ)^2 + \left(\frac{\omega}{\omega_0} kQ\right)^2\right]^2 + 4(yQ)^2}$$

need be considered. Its numerical value is for critical coupling :

At 65 Kc/s :

$$2\pi 65 \times 10^3 \sqrt{[1 - (0.286 \times 6.7)^2 + 0.866^2]^2 + 4(0.286 \times 6.7)^2} \\ \simeq 2\pi \times 10^3 \times 278.$$

At 85 Kc/s :

$$2\pi 85 \times 10^3 \sqrt{[1 - (0.251 \times 6.7)^2 + 1.133^2]^2 + 4(0.251 \times 6.7)^2} \\ \simeq 2\pi \times 10^3 \times 290.$$

For $k = 2 k_{crit.}$ the value for E_2 is proportional to

At 65 Kc/s :

$$2\pi 65 \times 10^3 \sqrt{[1 - (0.286 \times 6.7)^2 + 4 \times 0.866^2]^2 + 4(0.286 \times 6.7)^2} \\ = 2\pi 10^3 \times 250.$$

At 85 Kc/s :

$$2\pi 85 \times 10^3 \sqrt{[1 - (0.251 \times 6.7)^2 + 4 \times 1.133^2]^2 + 4(0.251 \times 6.7)^2} \\ = 2\pi 10^3 \times 400.$$

With all three pairs the resonance curve at 85 Kc/s will therefore be lower than at 65 Kc/s by the

factor $\left(\frac{250}{400}\right)^2 \frac{278}{290}$, or approximately $0.38 : 1$.

This asymmetry can be eliminated, in the example given, by employing for two pairs of circuits an inductive coupling as shown

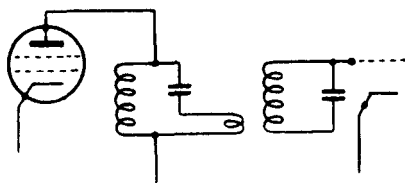

FIG. 21.

in Fig. 21 which has the coupling coil in the capacitive branch of one circuit. The influence for one pair is proportional to $\left(\frac{85}{65}\right)^2 = 1.7$, as follows immediately from the formula used. Applying, therefore, this form of coupling for two pairs would approximately restore

symmetry for ± 10 Kc/s mistuning. It seems more suitable than staggering the circuits, as the latter requires a more complicated procedure in the test department.

A change of r with frequency has been neglected, since it would make the equation too complicated. In fact, the damping consists of parallel and series damping and the change of r with frequency can hardly be predicted.

The stage gain obtained with two coupled circuits follows immediately from the equation given on page 28. At the resonant frequency $y = 0$ and hence

$$\left| \frac{E_2}{E_1} \right| = g_m \frac{1}{\omega_0 C} Q \frac{kQ}{1 + (kQ)^2} = \frac{g_m Z_0}{A + \frac{1}{A}},$$

where $A = kQ = \frac{k}{k_{crit.}}$. The maximum possible stage gain is

obtained for $k = \frac{k}{k_{crit.}}$ and is equal to $\frac{1}{2} g_m Z_0$. For other coupling

factors the stage gain decreases according to the same function as is given on page 18 for matching two resistances. The curves Fig. 19 can be used directly to give the stage gain for various frequencies and modes of coupling, the zero point on the y -axis being approximately $\frac{1}{2} g_m Z_0$.

CHAPTER 2

TRANSFER OF ENERGY FROM THE AERIAL

The receiver aerial can be regarded as a source of E.M.F., possessing an impedance which may be resistive, reactive, or a combination of both. Disregarding at first any practical considerations such as site noise, ganging problems, etc., the obvious task seems to produce as high a potential as possible at the grid of the first receiver valve. The means to achieve this object may vary with the aerial impedance.

If the aerial is purely resistive it will be advantageous to have a tuned circuit across the grid-cathode path of the valve with as high a Z_0 as possible. According to Chapter 1, the maximum input ratio possible is $\frac{1}{2}\sqrt{\frac{Z_0}{r}}$, r being the internal resistance of the aerial, Z_0 the circuit impedance. As has also been shown in Chapter 1, the proper matching condition is realised in the easiest way by using a coil tap so that the ratio of the turns across the aerial to the total turns is $\sqrt{\frac{r}{Z_0}}$.

If the aerial is reactive, e.g. a pure capacitance, the obvious procedure seems to tune it with a series inductance of as high a Q

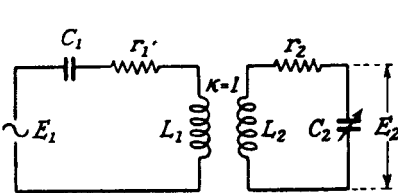

FIG. 22a.

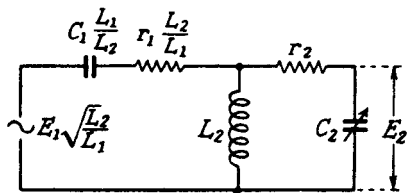

FIG. 22b.

as possible, the input ratio being in this case Q . The question whether it is possible to increase this value by using a step-up transformer from the tuning coil to the grid, leads to a better understanding of the problem and shows the limitations caused by the practical conditions. Both the tuning coil and the grid-cathode path of the valve possess capacitance and contribute to the tuning of the circuit in the same way as does the aerial, thus influencing the value of the tuning inductance. The general solution can be

obtained from Fig. 22a. For simplicity's sake the coupling is supposed to be unity as the result is mainly of theoretical interest. The primary and secondary may have identical damping independently of their respective values.

Using Thevenin's theorem in the equivalent circuit (Fig. 22b),

$$\frac{E_2}{E_1} \text{ becomes } \sqrt{\frac{L_2}{L_1}} \frac{C_1}{C_1 + C_2 \frac{L_2}{L_1}} Q',$$

Q' being the magnification factor of the whole circuit.

Replacing the two resistances in the capacitive branches by one resistance R in series with L_2 , then according to Chapter 1,

$$R = \frac{r_1 \frac{L_1}{L_2} C_1^2 + r_2 C_2^2}{\left(C_1 \frac{L_1}{L_2} + C_2\right)^2}.$$

Correspondingly

$$E_2 = E_1 \sqrt{\frac{L_2}{L_1}} \frac{C_1}{C_1 + C_2 \frac{L_2}{L_1}} \frac{\omega L_2}{r_1 \frac{L_1}{L_2} C_1^2 + r_2 C_2^2} \frac{1}{\left(C_1 \frac{L_1}{L_2} + C_2\right)^2}$$

If we substitute $\frac{\omega L_1}{Q}$ for r_1 and $\frac{\omega L_2}{Q}$ for r_2 the equation becomes :

$$E_2 = E_1 Q \sqrt{\frac{L_2}{L_1}} \frac{1 + \frac{C_2}{C_1} \frac{L_2}{L_1}}{1 + \left(\frac{C_2}{C_1} \frac{L_2}{L_1}\right)^2}$$

$$\frac{E_2}{E_1} = Q \frac{x(1+ax^2)}{1+a^2x^4}, \text{ where } \frac{C_2}{C_1} = a, \sqrt{\frac{L_2}{L_1}} = x.$$

Differentiation with respect to x leads to an equation of 3rd degree with the solution $x = \frac{1}{\sqrt{a}}$,

$$\therefore \frac{E_2}{E_1}(\text{optimum}) = \frac{Q}{\sqrt{a}} = Q \sqrt{\frac{C_1}{C_2}}.$$

The result seems feasible as it amounts to matching the two capacitances C_1 and C_2 . Assuming, in the above case, an aerial capacitance of 200 pF, a secondary capacitance of 20 pF and a Q of 100,

$\frac{E_2}{E_1}$ becomes 316, the total tuning capacitance being 40 pF. Since, without elaborate precautions, the Q for 40 pF is considerably less than for, say, 100 pF, the gain by matching the capacitances will be less than the formula suggests.

For medium and long waves, where the aerial can be regarded as a pure capacitance, the optimum energy transfer from the aerial is of secondary importance and rarely sought. As receivers have to cover a large wave range, and easy operation is mostly of first-rate importance, the aerial coupling is dictated by ganging considerations. A loss in reception is rarely experienced as, with an aerial of appreciable height, site noise is the determining factor, and the use of optimum coupling will not improve the signal to noise ratio.

For short waves where the site noise is less and often below receiver noise the use of optimum coupling is of great importance for good reception. In case of single frequency reception a tuned aerial is used, connected to the receiver either directly or through a feeder, in either case representing to the receiver an ohmic resistance, a problem dealt with at the beginning of this chapter. If reception over a wider wave range is required the task becomes difficult due to the varying impedance of the aerial and the danger of misganging. The problem will be treated later.

Aerial Coupling determined by Ganging Conditions.

Medium and Long Waves. The aerial can be regarded as a capacitance with a series resistance. As mentioned above, an attempt at optimum coupling is not necessary, owing to site noise. Ganging considerations are the overriding factor and the coupling is always kept so loose that the aerial resistance is negligible and the aerial can be treated as a pure capacitance. According to the coupling used, the mistuning influence of the aerial can be that of a parallel capacitance or a parallel inductance in series with a capacitance.

Reflected Aerial as a Parallel Capacitance. There is no danger of destroying the ganging. The reflected capacitance has to be kept small enough so as to enable the first circuit to cover the required wave range. The usual methods are shown in Figs. 23, 24 and 25. Figs. 24 and 25 will fall into this category only if the leakage part of the coupling inductance is small in impedance compared with that of the aerial capacitance. This holds good for Fig. 24, as the coupling of one part of the coil with the whole coil is usually close and, correspondingly, the leakage inductance small.

It holds good for Fig. 25 if the natural frequency of the aerial circuit is well above the frequency range employed.

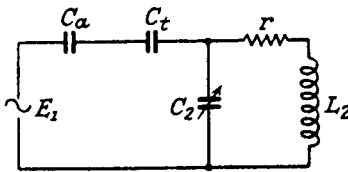

FIG. 23.

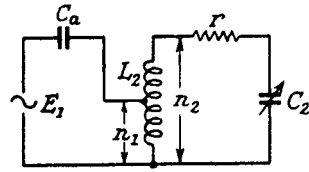

FIG. 24.

The input ratio in Fig. 23 is, according to Chapter 1, $Q \frac{C_1}{C_1 + C_2}$, where C_1 is the series combination of C_a and C_t . The mistuning influence of the aerial is that of a parallel capacitance C_1 . As the minimum capacitance of the ganged circuit is generally between 50 and 100 pF, C_1 has to be of the order of 10–20 pF. Rod aerials, 1–2 m. long, usually do not require tracking.

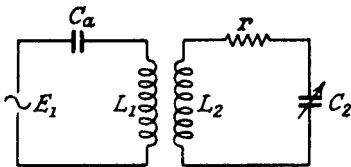

FIG. 25.

The input ratio in Fig. 24 is, according to Chapter 1, approximately

$$\frac{Q \frac{n_2}{n_1} C_a \left(\frac{n_1}{n_2} \right)^2}{C_a \left(\frac{n_1}{n_2} \right)^2 + C_2} = \frac{Q}{\frac{n_1}{n_2} + \frac{C_2}{C_a} \frac{n_2}{n_1}}$$

n_1 and n_2 being the number of turns across C_a and C_2 respectively, and the leakage inductance being neglected compared with C_a .

The reflected capacitance is $C_a \left(\frac{n_1}{n_2} \right)^2$. A comparison between

Figs. 23 and 24 shows that, while permitting the same amount of reflected capacitance C_1 , Fig. 24 gives a superiority in input ratio

by the factor $\sqrt{\frac{C_a}{C_1}}$ or, if $\frac{n_1}{n_2}$ is so chosen as to give the same input ratio as in Fig. 23, the reflected capacitance is much smaller,

being expressed by the approximate relation $C' = C_1 \frac{C_1}{C_{a1} + \left(\frac{C_1}{C_2} \right)^2}$.

$\left(\frac{C_1}{C_2} \right)^2$ is in practice small compared with unity, so that $C' \approx C_1 \frac{C_1}{C_a}$.

The derivation is left to the reader.

Example: The capacitance of the aerial is 200 pF, the capacitance

transferred from the aerial across the first circuit must not exceed 20 pF. The circuit $Q = 100$, $C_2 = 100$ pF. Find the input ratio in the two cases shown in Figs. 23 and 24.

In Fig. 23 the necessary tracker is 22 pF; the input ratio is $100 \times \frac{20}{120} \approx 16.6$.

In Fig. 24 the ratio of aerial tapping to total coil = $\sqrt{\frac{20}{200}} = \frac{1}{3.16}$.

The input ratio is $\frac{100}{\frac{1}{3.16} + \frac{2}{2}} \approx 52.6$.

If, otherwise, the aerial tapping is chosen so as to give an input ratio of only 16.6, by choosing a tap ratio of about $\frac{1}{1.2}$, the reflected aerial capacitance is 1.4 pF, the total tuning capacitance being 101.4 pF. The small value of reflected capacitance is an advantage, as it allows a smaller minimum capacitance and, possibly, a larger range.

As mentioned above, the greater efficiency of Fig. 24 is of little importance, because the site noise is usually the determining factor. There are cases, however, where Fig. 24 will prove of real advantage. One is when, for reasons of economy, the permissible number of valves is small and the necessary overall gain such that it is essential to achieve the highest input ratio which is compatible with ganging requirements. In this case Fig. 24 will, it is true, not give an improved signal to noise ratio, but may yield the required output, while Fig. 23 proves just not satisfactory.

A second case may occur when reception is required with an aerial of high capacitance but very low effective height, as is the case in some types of armoured cars, submarines, etc. Under these circumstances the picked-up site noise will, due to the inefficiency of the aerial, be below the receiver noise, and any increase in input ratio will increase the signal to noise ratio equally.

The circuit Fig. 24 has, however, disadvantages which make its utilisation inadvisable in many cases. Usually a receiver leaves the test-department ganged for an average of, say, 200 pF aerial capacitance. In the above case readjustment of the first circuit would be necessary whenever the receiver is used on an aerial of considerably different capacitance. In Fig. 24 a change in aerial capacitance of, say, 20%, will cause a 20% change in the reflected capacitance, whereas in Fig. 23 it will be considerably less and will depend on the ratio of aerial capacitance to tracking capacitance. When the receiver is used for waves of approximately four times

the aerial length the aerial becomes a very low impedance. The result in Fig. 24 is a complete mistuning of the ganged circuit, in Fig. 23 an almost negligible mistuning effect.

If several receivers are to be used on the same aerial the coupling of Fig. 23 is by far superior, resulting in only slight interference, whereas in Fig. 24 the receiver tuned to shorter waves will short circuit the aerial for long waves.

The conclusion drawn is that the method of Fig. 24 has certain possibilities superior to that of Fig. 23, but there are only few special cases where its full exploitation is permissible and really advantageous.

Common to both couplings is the fact that the input ratio varies considerably over a frequency range. For a constant value of Q it is proportional to the square of the frequency, as follows from the above formulae. For reception this fact has no serious disadvantage, as the gain control, manual or automatic, adjusts the receiver to any given signal strength. Only if a receiver is supposed to give a rough indication of the incoming signal strength (so called *S*-meter) is a fairly constant overall gain desirable.

Reflected Aerial as a Series Combination of L and C .

A constant input ratio is obtained by tuning the aerial to a frequency considerably below the required frequency range and using a comparatively loose coupling (Fig. 26a). Under these conditions

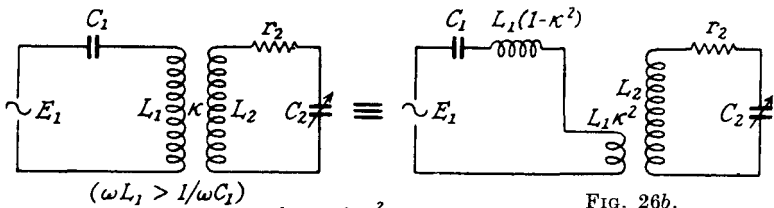

($\omega L_1 > 1/\omega C_1$)

FIG. 26b.

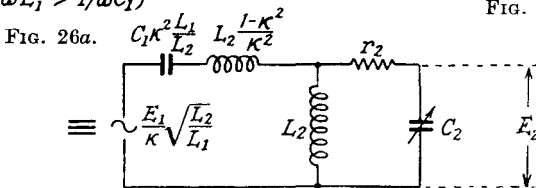

FIG. 26a.

FIG. 26c.

the aerial represents an inductance, the inductive impedance being decreased by the series capacitance of the aerial. Consequently the effect of the aerial upon the tuning is that of a variable parallel inductance which has its smallest value at the low-frequency end

of the range. The combination of C_1 , L_1 and k is dictated by ganging requirements. In practice the reflected aerial inductance is large compared with the tuning inductance and the additional damping of the aerial can therefore be neglected. Under these conditions the equivalent circuit may be used (Fig. 26c). Applying again Thevenin's theorem :

$$\frac{E_2}{E_1} = Q \sqrt{\frac{L_2}{L_1 k^2}} \frac{\omega L_2}{\omega L_2 + \omega L_2 \frac{1 - k^2}{k^2} - \frac{1}{\omega C_1} \frac{L_2}{L_1 k^2}} = Qk \sqrt{\frac{L_2}{L_1}} \frac{1}{1 - \left(\frac{\omega_0}{\omega}\right)^2},$$

where
$$\omega_0^2 = \frac{1}{L_1 C_1}.$$

The formula is valid only for values of $\frac{\omega_0}{\omega}$ well below unity, when neglecting the primary resistance is permissible. The reflected inductance is $\frac{L_2}{k^2} \left[1 - k^2 - \left(\frac{\omega_0}{\omega}\right)^2 \right]$ and the fractional change in inductance is $\frac{\delta L_2}{L_2} = - \frac{k^2}{1 - \left(\frac{\omega_0}{\omega}\right)^2}$. The implications of the for-

mulae given will be seen from the following.

Example: The frequency range is 0.55 – 1.5 Mc/s, $L_2 = 180 \mu\text{H}$, $C_1 = 200 \text{ pF}$, $L_1 = 1,130 \mu\text{H}$, corresponding to a natural aerial frequency of 335 Kc/s, $k = 20\%$.

At 1.5 Mc/s: the fractional change in inductance is

$$- \frac{0.04}{0.95} = - 0.042,$$

increasing the resonant frequency by 2.1%.

At 0.55 Mc/s: the fractional change in inductance is

$$- \frac{0.04}{0.63} = - 0.0635,$$

increasing the resonant frequency by about 3.2%.

The influence of the aerial must cause misganging of the first circuit. If the effect is not greater than that shown in the example, readjusting the circuit at the two ends of the range by means of the inductance and capacitance trimmer will prove sufficient. If the effect is greater, special means are necessary to restore ganging. One is to use for the R.F. stages a transformer coupling similar to that used for the aerial (dealt with in Chapter 3), the other is to insert in the other R.F. circuits a series condenser such that the fractional decrease in tuning capacitance is larger at the low-

frequency end than at the high-frequency end by the same amount as is the fractional decrease in tuning inductance in the first circuit. In a superhet receiver the "padding" condenser of the first oscillator (page 114) has to be decreased correspondingly.

With a circuit Q of 100 in the above example, the input ratio becomes 8.4 at 1.5 Mc/s and 12.7 at 0.55 Mc/s. It would be easy to design the circuit so that the Q drops at the low-frequency end, still further equalising the input ratio. This would have the additional theoretical advantage of obtaining, for a straight receiver, a fairly constant band-width, and for a superhet, where the band-width is determined by the r.f., a fairly constant image protection. As, however, it is easier to obtain a good Q at the low-frequency end of a range, this equalising process consists merely in worsening input ratio and selectivity at the low-frequency end down to the level of those at the high-frequency end. A coupling capacitance between L_1 and L_2 would serve this purpose better, its influence being larger at the high-frequency end. For details, compare the corresponding subject in Chapter 3.

If the first circuit is ganged for an aerial of 200 pF and then used on an aerial with considerably less capacitance, the conditions at the low-frequency end become serious. For 100 pF aerial capacitance the reflected parallel inductance drops to 1,000 μ H, causing a mistuning of 8.5% in frequency as compared with 3.2% for the 200-pF aerial. To reduce this danger the coupling should be looser. For a k of, say, 15%, the mistuning effect is almost halved, the loss in input ratio only about 3 db. (Alternatively a series capacitance of a few hundred pF may be connected in the aerial lead.)

The possibility of using several receivers on the same aerial is ruled out, as the receiver with the higher frequency range will completely upset the aerial tuning for the other receiver. Another drawback consists in the fact that strong interfering stations tuned to the aerial frequency may come through and cause cross-modulation, especially as the r.f. transformer primaries are usually tuned to the same frequency (Chapter 3). The latter difficulty can be overcome by using resistance wire for the aerial coil. It can be easily seen from Fig. 26c that, as the reflected inductance is about 20 times L_2 , any aerial resistance will contribute with $\frac{1}{400}$ of its value to the total damping. There would only remain the fact that resistance wire is less easy to handle than copper wire, not a serious price to pay.

Summing up, it can be said that each of the methods, Figs. 23-26a, has its advantages and disadvantages, and it will be partly

a matter of opinion, partly a question of circumstances, which will be chosen. It may be added that Fig. 26a facilitates, due to the lack of reflected capacitance, the possibility of a large frequency sweep, a point which is slightly in its favour. At present Fig. 26a is the most popular circuit.

Short Waves. Random Aerial. At short waves where the aerial impedance varies greatly with frequency and may be anything between 40 ohms and several thousand ohms, which may be resistive, inductive or capacitive, the aerial coupling has to be very loose to avoid misganging. On the other hand, the site noise is usually small and well below receiver noise. Contrary to the conditions prevailing at medium and long waves, any loss in input ratio may result in loss of efficiency. A compromise between ease of handling and performance is to use a somewhat tighter coupling and provide the first circuit with a knob for tuning correction. The use of a variable aerial coupling, in addition, will give facilities

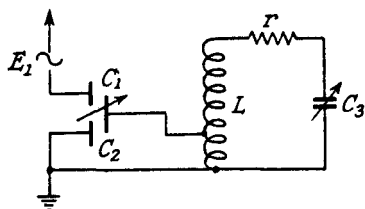

FIG. 27a.

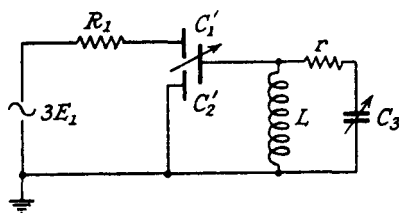

FIG. 27b.

for obtaining the best possible input ratio without unduly complicating the handling. The other alternative, to use the variable coupling without tuning correction, is worth recommendation, as it will, when adjusted to optimum input, automatically correct the tuning near to its required value.

Variable inductive coupling will be, for a receiver with many ranges, mechanically difficult to achieve. A capacitive input potentiometer has been found very useful (Fig. 27a).

The sum C_1 plus C_2 of the two capacitances of the rotor to the stators is constant. For an aerial impedance small compared with the capacitive impedances the circuit looks into a constant capacitance. Any of the methods, Figs. 23-26a, may be used in connection with this variometer. Used together with a tuning correction the input ratios obtained are in most cases very near the theoretical optimum. Even without tuning correction the results are quite satisfactory and usually within 6 db. of the optimum value, the potentiometer functioning as a tuning corrector.

The efficiency of the capacitive potentiometer may be shown with the help of Fig. 27a, assuming three different aerial impedances of 36 ohms $\left(\frac{\lambda}{4}$ aerial), 500 ohms (feeder) and 4,000 ohms $\left(\frac{\lambda}{2}$ aerial). The case of the aerial being a combination of resistance and reactance can be treated in the same way as indicated below. The constants in Fig. 27a may be: $C_1 + C_2 = \text{constant} = 100$ pF, $C_3 = 80$ pF, the Q of the tuned circuit is 100, aerial tapping is at one-third, $f = 15$ Mc/s. The equivalent circuit is given in Fig. 27b, the corresponding values are: $C_1' + C_2' = 11.1$ pF, the aerial impedances = 324, 4,500 and 36,000 ohms respectively, the E.M.F. = $3E_1$. The easiest way of assessing the matching conditions and the input ratio is to calculate the additional damping of the circuit caused by the aerial (see page 19).

1. *The Aerial Impedance is 36 Ohms Resistive.* The best position of the potentiometer is when $C_1 = 49$ pF, $C_2 = 51$ pF, as will be understood from the following results. The equivalent values in Fig. 27b become: $R_1 = 324$ ohms, $C_1' = 5.45$ pF, $C_2' = 5.65$ pF. The damping influence of the aerial is equal to a resistance $324 \left(\frac{5.45}{91.1}\right)^2 = 1.16$ ohms in series with r (page 11). The latter is 1.16 ohms, which results from the fact that the tuning capacitance is 91.1 pF, the frequency is 15 Mc/s and the Q is 100. The matching is perfect, and there is no mistuning.

2. *The Aerial Impedance is 500 Ohms Resistive.* The best position of the potentiometer is when $C_1 = 17$ pF, $C_2 = 83$ pF, the equivalent values in Fig. 27b being: $R_1 = 4,500$ ohms, $C_1' = 1.9$ pF, $C_2' = 9.2$ pF. The matching is perfect (see page 11). The mistuning is about 0.75 pF, due to the fact that the series combination of 1.9 pF and 4,500 ohms is equivalent to a parallel combination of approximately 1.15 pF and 11,600 ohms. A smaller value of C_1 leaves the tuning practically unchanged, the loss from mismatching being negligible.

3. *The Aerial Impedance is 4,000 Ohms Resistive.* R_1 in Fig. 27b is 36,000 ohms. The value of C_1' hardly affects the additional damping, since $\frac{1}{\omega C_1'}$ is always small compared with 36,000 ohms. The aerial therefore acts like a pure parallel resistance causing a damping of 0.32%. The aerial is 1 : 1.77 undercoupled, the mismatching is 0.32, the input ratio = $\frac{2}{0.565 + \frac{1}{0.565}} = 0.86$ of the

theoretical optimum. The mistuning might be anything between 0 and 11 pF, according to the position of the potentiometer. When no tuning correction is employed optimum reception is obtained for the approximate values $C_1' = 1$ pF, $C_2' = 10$ pF, the mistuning being less than 1 pF.

Care must be taken to keep the leads from the coil to the potentiometer as short as possible. Otherwise these leads will resonate with C_2 , thus altering the resonant frequency of the circuit.

A method of aerial coupling, used frequently in modern communication receivers, provides the choice of two different aerial coils. One coil, earthed at one side and loosely coupled with the secondary circuit, is designed for use on a random aerial; the other coil which is not earthed provides matching for a generator resistance of 100 to 200 ohms, a value applying either to a feeder or a dipole. The circuit yields optimum conditions only for spot wave reception and seems therefore inferior to the method described above.

Use of a Feeder between Aerial and Receiver. The use of an aerial some distance away from the receiver has become the popular means of cutting out local disturbances. A feeder as link between aerial and receiver involves considerable loss unless used in connection with appropriate transformers. The effect of such a feeder on reception, with and without transformers, may be seen from the following example.

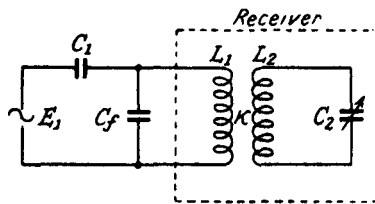

FIG. 28.

Example: A receiver the input of which is that of Fig. 26a is to be connected to the aerial through a feeder of 20 m. length and of 50 pF capacitance per metre. Reception is to be obtained for the two ranges 150–300 Kc/s and 0.55–1.5 Mc/s. The aerial coupling inductance L_1 is 1,130 μ H for the range 0.55–1.5 Mc/s, and 16,000 μ H for the range 150–300 Kc/s; $k = 0.2$ and $C_1 = 200$ pF for both ranges.

If the receiver and the aerial are connected directly through the feeder the circuit can be represented by Fig. 28. The shortness of the feeder permits its being treated as a lumped capacitance C_f . Applying Thevenin's theorem, L_1 looks into a generator having an E.M.F. equal to $E_1 \frac{200}{1,200} = \frac{E_1}{6}$ and a capacitance of 1,200 pF.

Taking into account the change of the resonant frequency of the primary circuit from 335 Kc/s to 137 Kc/s, we obtain the drop in input ratio owing to the feeder with the help of the formula on page 37.

At 0.55 Mc/s:

$$6 \frac{1 - \left(\frac{137}{550}\right)^2}{1 - \left(\frac{335}{550}\right)^2} \approx 9 : 1.$$

At 1.5 Mc/s:

$$6 \frac{1 - \left(\frac{137}{1,500}\right)^2}{1 - \left(\frac{335}{1,500}\right)^2} \approx 6.25 : 1.$$

It is assumed in this case that the secondary circuit has been retuned to offset the effect of the changed resonant frequency of the primary circuit. The results at 150 Kc/s and 300 Kc/s are very similar.

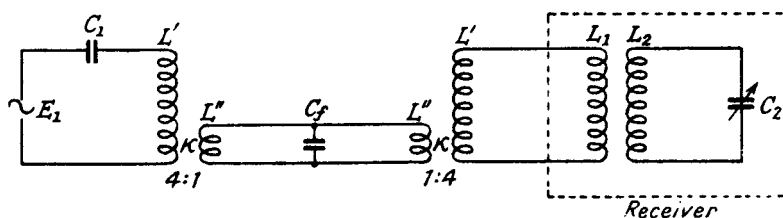

FIG. 29a.

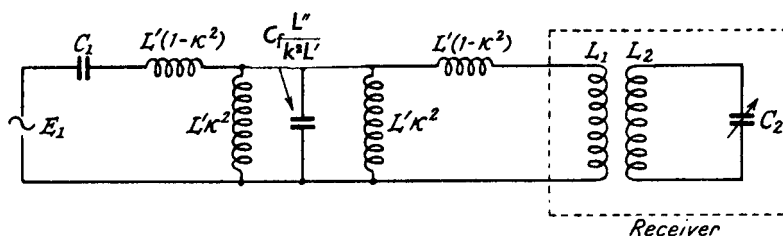

FIG. 29b.

Fig. 29a shows the use of two transformers, one inserted between aerial and feeder and one between feeder and receiver. The data for the two identical transformers are taken from a manufactured type; they are as follows: $L' = 5,000 \mu\text{H}$, $L'' = 294 \mu\text{H}$, $k = 0.97$,

which for radio frequencies is an unusually high value. The very tight coupling is achieved by using an iron-dust core and closely interlinking the two windings. The behaviour of the input circuit can be seen from the equivalent circuit Fig. 29*b*. Under the given circumstances the various values are: $L'(1 - k^2) = 300 \mu\text{H}$, $L'k^2 = 4,700 \mu\text{H}$, $C_f \frac{L''}{k^2 L'} = \frac{C_f}{16} = 62.5 \text{ pF}$. The effect of the feeder has been reduced to that of a parallel capacitance of 62.5 pF as compared with 1,000 pF in Fig. 28. At frequencies where the influence of the transformer inductances can be neglected the attenuation due to the feeder is now below 3 db. The two inductances $L'k^2$ in parallel will cause a loss at lower frequencies when $\frac{\omega L'k^2}{2}$ becomes small compared with $\frac{1}{\omega C_1}$. It is easy to see that at 150 Kc/s this effect is not yet serious, the loss caused by it being of the order of 3 db.

At higher frequencies a serious drop in input ratio is to be expected when the leakage inductance $L'(1 - k^2)$ in series with C_1 has a reactance large compared with that of 62.5 pF. The reasons for this are evident from the above discussion of the circuit Fig. 28. At 1.5 Mc/s the loss will be small as follows from the reactance values of 62.5 pF (1,700 ohms) and 300 μH (2,800 ohms). The importance of an extremely high coupling factor is clearly indicated.

Naturally the secondary circuit is mistuned owing to the changed conditions in the primary circuit. The extent of this mistuning can be assessed with the help of the formula on page 37, without using any of the complicated expressions resulting from a more general solution. The method to be adopted may be seen from the following.

Example: The mistuning influence of the primary circuit in Fig. 29*b* is to be compared with that in Fig. 26*a*, at a frequency of 0.55 Mc/s. Values of the various quantities as given above.

1. Without feeder (Fig. 26*a*). The resonant frequency of the primary circuit is 335 Kc/s, as previously stated. Its mistuning influence on the secondary circuit is an increase in resonant frequency of 3.2%.

2. With feeder (Fig. 29*b*). The series combination of C_1 and $L'(1 - k^2)$ is equivalent to a capacitance of approximately 690 pF, as calculated from the two impedances, viz. $\frac{1}{\omega C_1} = 1,450 \text{ ohms}$, $\omega L'(1 - k^2) = 1,030 \text{ ohms}$, $\frac{1}{\omega C_1} - \omega L'(1 - k^2) = 420 \text{ ohms capaci-}$

tive ; hence the equivalent capacitance is $200 \cdot \frac{1,450}{420} \text{ pF} = 690 \text{ pF}$.

In a similar way the parallel combination of 62.5 pF and $\frac{k^2 L'}{2}$,

$$\text{where } \frac{k^2 L'}{2} = 2,350 \mu\text{H},$$

is found to be equivalent to a capacitance of 27 pF , and thus L_1 looks into a series combination of $300 \mu\text{H}$ and 717 pF , equivalent to an inductance of $182 \mu\text{H}$. The effect of the primary circuit therefore consists in a reduction of L_2 by 3.5% , increasing the resonant frequency by 1.75% . A change of 1.45% in resonant frequency will take place when changing over from the circuit Fig. 26a to Fig. 29b. The influence of this mistuning on the input ratio naturally depends on the Q of the secondary circuit.

On the range $150\text{--}300 \text{ Kc/s}$ the largest mistuning occurs at about 200 Kc/s , this being the resonant frequency of the primary circuit [$2,350 \mu\text{H}$ and $16,000 \mu\text{H}$ in parallel, resonating with $(200 + 62.5) \text{ pF}$, leakage inductances being neglected]. The effective coupling between the two circuits is $0.2 \sqrt{\frac{2,350}{18,350}} \approx 7.2\%$,

the Q factors can be expected to be low because of the band-width required. Hence the mistuning is not excessive and does not seriously affect the input ratio.

Measurements with the above transformer and a feeder of $1,000 \text{ pF}$ capacitance were carried out on a receiver having between L_1 and L_2 a coupling factor of 0.15 . The receiver input circuit was left correctly tuned for reception without feeder. The losses caused by the feeder were below 8 db . over the whole of the two frequency ranges discussed.

The Aerial as an Inductance. The case of the aerial being an inductance occurs in directional reception. The following treatment applies equally to the rotating frame and to the Bellini Tosi system. Whereas in the old days the frame was directly tuned, modern receivers frequently employ, for purposes of easy handling, the untuned frame with tightly coupled input transformer leading to the first tuned circuit (Fig. 30a). To obtain formulae suitable for use it is assumed that the damping of the frame is the same as that of the primary and secondary transformer coil, which is realised in practice. The result, in addition, will show that deviation in damping does not seriously affect the choice of the primary coil.

If the ratio $\frac{L_1'}{L_1} = m$, then $r_1' = mr_1$. The equivalent circuit is given in Fig. 30b.

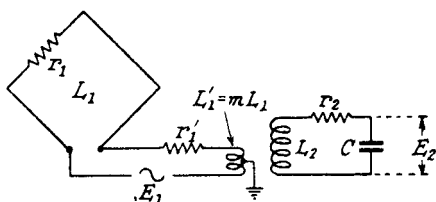

FIG. 30a.

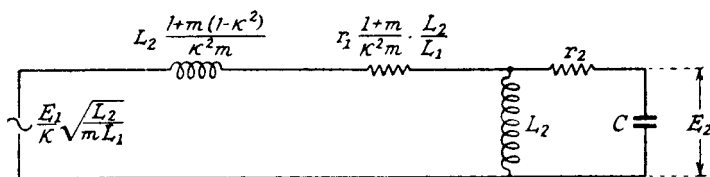

FIG. 30b.

The tuning inductance is

$$L_{eff} = \frac{L_2 \times L_2 \frac{1+m(1-k^2)}{k^2m}}{L_2 + L_2 \frac{1+m(1-k^2)}{k^2m}} = L_2 \frac{1+m-k^2m}{1+m}.$$

The resistance $\frac{r_1(1+m)L_2}{k^2mL_1}$ in series with $L_2 \frac{1+m(1-k^2)}{k^2m}$ can be replaced by a parallel resistance $R_1 = \frac{\omega^2 L_1 L_2 [1+m(1-k^2)]^2}{r_1(1+m)k^2m}$.

The total damping becomes $d_t = \frac{r_2}{\omega L_{eff}} + \frac{\omega L_{eff}}{R_1}$.

$$= \frac{r_2}{\omega L_2} \frac{1+m}{1+m-k^2m} + \frac{r_1}{\omega L_1} \frac{k^2m}{1+m-k^2m} = d \frac{1+m+k^2m}{1+m-k^2m},$$

where

$$d = \frac{r_1}{\omega L_1} = \frac{r_1'}{\omega L_1'} = \frac{r_2}{\omega L_2} = \frac{1}{Q}.$$

$$\frac{E_2}{E_1} = \frac{1}{k} \sqrt{\frac{L_2}{mL_1}} \frac{k^2m}{1+m} \frac{1+m-k^2m}{1+m+k^2m} Q.$$

L_{eff} is determined by the variable condenser and the frequency range and is supposed to be kept constant with variations of m

by a corresponding change of L_2 . If L_{eff} which is known in advance is substituted for L_2 , $\frac{E_2}{E_1}$ becomes :

$$\frac{E_2}{E_1} = Q \sqrt{\frac{L_{eff}}{L_1}} k \sqrt{\frac{m+m^2-k^2m^2}{1+m}} \frac{1}{1+m+k^2m}$$

The result may be discussed for 2 different values of k .

(1) $k = 1$:

$$\frac{E_2}{E_1} = Q \sqrt{\frac{L_{eff}}{L_1}} \sqrt{\frac{m}{1+m}} \frac{1}{1+2m}$$

The function $\sqrt{\frac{m}{1+m}} \frac{1}{1+2m}$ is plotted in Fig. 31, showing a very flat maximum for $m = 0.4$. The optimum input ratio is about $0.3Q \sqrt{\frac{L_{eff}}{L_1}}$.

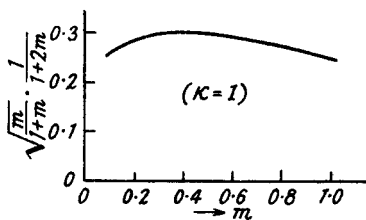

FIG. 31.

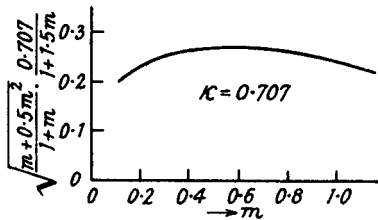

FIG. 32.

(2) $k = 0.707$: (The value is chosen for convenience of calculation)

$$\frac{E_2}{E_1} \simeq 0.707Q \sqrt{\frac{L_{eff}}{L_1}} \sqrt{\frac{m+0.5m^2}{1+m}} \frac{1}{1+1.5m}$$

The function of m is given in Fig. 32. It has a flat maximum for $m = 0.5$, the input ratio becoming $0.26 Q \sqrt{\frac{L_{eff}}{L_1}}$. A comparison with Fig. 31 shows that there is no need to strive after an extremely large coupling factor.

The assumptions leading to the above results are not in full accordance with practical conditions, the discrepancies being :

(1) The damping of the loop circuit will not be the same as that of the tuned circuit.

(2) The damping of the tuned circuit is caused by parallel resistance as well as by series resistance.

Both factors influence the optimum value of m . The flatness of the curves in Figs. 31 and 32 suggests, however, that disregard of these factors will not be of great importance. Actually the

figures of input ratios obtained in practice agree with those calculated from the above formulae within 1 or 2 db. over a large part of the frequency band.

The influence of the damping of the loop circuit on the input ratio can be derived from the above formula giving the total damping of the input system. The damping factor contributed by the loop circuit is $d_1 \frac{k^2 m}{1+m-k^2 m}$, that contributed by the tuned circuit is $d_2 \frac{1+m}{1+m-k^2 m}$. Allowing for $k = 0.707$ and $m = 0.4$, as indicated by Fig. 32, and $d_1 = d_2$, the first term is only one-seventh of the second. Hence to cause the input ratio to be 6 db. below that given by the above formula, d_1 has to be about nine times as large as d_2 . At medium and short waves d_1 and d_2 are of the same order and the values of input ratio and optimum m derived above agree with practical results. It is only at long waves above, say, 2,000 m., where the damping factor of the one-turn loop becomes excessive; Q values of 10–20 are about normal, and the input ratios may be up to 6 db. below the calculated values. In such cases the choice of an m well below the optimum given by the formula is indicated. Furthermore, a low m means only a slight reduction of the secondary inductance which may prove advantageous when the winding space is limited.

The number of turns used for the frame has little effect on its efficiency at medium and short waves. The effective height is proportional to the number of turns, but the inductance is nearly proportional to the square of the number of turns, so that the loss in step-up ratio offsets the gain in the induced voltage. For mechanical reasons a one-turn loop, made of metallic tube, will usually be the best. The diameter of the tube should not be below 2 cm., to keep the frame losses down. Short and thick connecting leads between the loop and the transformer primary, good switch contacts, etc., are essential. At long waves, as mentioned above, the Q of a one-turn frame becomes bad in any case. If, therefore, reception is required only on long waves it pays to employ a frame of about ten turns wound of *litzendraht*. The size of a loop naturally affects its efficiency. The effective height is proportional to the loop area, and the inductance follows approximately the same law. Thus the efficiency is almost proportional to the square root of the area employed.

The mistuning effect due to the frame does not cause any gang-ing difficulties as it can be remedied by a corresponding increase

in the tuning-coil. Towards shorter waves, however, where the capacitance of the loop can no longer be neglected, the ganging becomes difficult; this fact favours the choice of a one-turn loop and a low m .

Occasionally it is necessary to mount the frame some distance away from the receiver. In this case the inductance of the connecting leads may become appreciable and cannot be neglected. The factor m is to be chosen for a loop inductance which is larger than the real value by the inductance of the connecting leads. The loss in reception is proportional to the ratio

$$\sqrt{\frac{\text{loop inductance}}{\text{loop inductance} + \text{lead inductance}}}$$

A large loop inductance, i.e. a frame made of several turns, is advantageous and should be employed if there is no risk of trouble from the resonance of the loop circuit. The use of a low-inductance cable is recommended.

A comparison between the tuned and the untuned loop can only be made if the Q values are known. As a rough approximation it may be assumed that these values are identical for the two different loop circuits and for the secondary circuit. The input ratio of the tuned frame is, in the case of critical coupling, equal to $\frac{Q}{2} \sqrt{\frac{L_2^*}{L_1}}$, about 6 db. above the optimum value obtained in

Fig. 32. As the frame efficiency is almost independent of the frame inductance the tuned frame can be expected to yield results which are about 6 db. above those obtained with the untuned frame. The site noise is assumed to be negligible, as is the case for stations situated in the open country. Thus the tuned frame seems the correct solution for ground stations working on spot frequencies or on limited frequency ranges. The untuned frame, particularly the one-turn loop, seems the adequate solution for portable sets, where ease of handling and quick frequency change are more important than maximum efficiency. Two numerical examples follow, taken from actual practice.

Example 1. A receiver is tuned to 1,000 m. with a capacitance of 200 pF. The inductance of the untuned loop is 4 μ H, the transformer coupling = 70.7% (Fig. 30a), the Q of the primary and secondary circuit is 70.

- (1) What is the optimum input ratio?
- (2) What is the correct value of L_2 ?

* This follows from the facts discussed in Chapter 1, paragraph 11.

- (1) The effective tuning inductance is 1,400 μH , hence

$$\frac{E_2}{E_1}(\text{opt.}) = 0.26 \sqrt{\frac{1,400}{4}} 70 = 340, \quad m \text{ being } 0.5.$$

$$(2) L_2 = 1,400 \frac{1+m}{1+m-k^2m} = 1,680 \mu\text{H}.$$

Example 2. A receiver is tuned to 30 m. with a capacitance of 100 pF. The inductance of the untuned loop is 1 μH , the transformer coupling = 70.7%, the Q of the primary and secondary circuit is 100.

- (1) What is the optimum input ratio ?
- (2) What is the secondary inductance ?
- (3) What is the mistuning caused by an inductance of 2 μH inserted between frame and transformer ?
- (4) What is the input ratio in (3) after the secondary has been altered for correct tuning ?
- (5) Case (1). What is the mistuning effect of 30 pF parallel to the frame ?

(1) 41.5, using a transformer primary of 0.5 μH .

(2) 3.05 μH .

(3) The effective tuning inductance increases from 2.54 to 2.83 μH .

(4) m becomes 0.167, $L_1 = 3 \mu\text{H}$. The input ratio is 20.5.

(5) The effect of 30 pF is equivalent to an increase of the frame inductance from 1 μH to 1.136 μH , causing an apparent m of 0.44 and increasing the effective tuning inductance by 1.5%.

CHAPTER 3

THE AMPLIFIER STAGE

According to special requirements the performance of an amplifier stage may be expressed in various terms, the most frequent being :

1. The ratio of voltage delivered to the grid of the next valve to the voltage at the grid of the amplifier valve, irrespective of absolute magnitude.

2. The maximum power delivered from a valve, irrespective of the voltage needed at the grid.

There are other factors besides, often of great importance, such as maximum power for minimum grid voltage or for a minimum driving power, maximum power for a given battery voltage, etc., which will be dealt with in the later part of this chapter. The two factors summed up under (1) and (2) are, however, the most important criteria for an amplifier stage, and other requirements can be regarded as special cases. According to the frequency range involved the means employed will vary appreciably. In dealing with this subject the scope of this chapter has been limited to the problems occurring in the normal receiver design.

The Voltage Amplifier Stage. The expression used for this heading implies that the voltage rather than the power delivered to the next valve is the measure of performance. If the anode load is given, the voltage and power delivered are closely linked, but if the anode load can be chosen, the output voltage may be found to rise as the power delivered decreases.

Audio Frequency Amplifier. The problem is to obtain an amplification, as constant as possible, over a frequency range which varies, according to circumstances, between about 200 and 2,500 c/s or between 30 and 10,000 c/s. There exist two different ways of achieving this end.

The Resistance and the Choke Coupled Amplifier. *Triodes.* In Fig. 33a the basic circuit of a resistance coupled amplifier is shown. R_1 serves as anode load, C is inserted to keep H.T. away from the following grid, R_2 is the grid leak resistance of the next valve and should be large compared with R_1 . To understand the behaviour of amplifier stages, two different equivalent circuits, shown in Figs. 33b and 33c, are useful. In Fig. 33b the valve is

considered as the source of an E.M.F. $-\mu E_1$ and the source resistance ρ , where ρ is the valve impedance, μ the amplification factor of the valve and E_1 the voltage applied to the grid. In Fig. 33c the valve is considered as a source of a current $I = -g_m E_1$ flowing into a load consisting of the parallel combination of the valve impedance and the actual anode load, g_m being the mutual conductance of the valve. The negative sign indicates that, for a resistive load, anode voltage and grid voltage are 180° out of phase. The present chapter is concerned mainly with amplitudes and the negative sign will therefore be omitted when the phase is not considered. The circuits Figs. 33b and 33c are interchangeable,

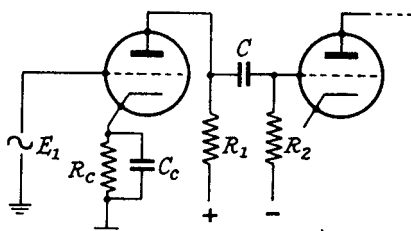

FIG. 33a.

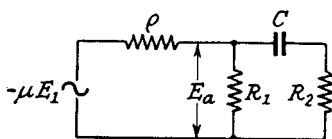

FIG. 33b.

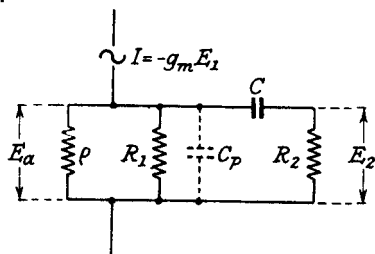

FIG. 33c.

as can easily be verified. According to circumstances, the use of one or the other will prove advantageous. If ρ is small compared with R_1 , the case of a triode resistance coupled amplifier, the use of the circuit Fig. 33b is preferable, as it shows immediately that the maximum gain attainable is μ . If R_1 is small compared with ρ , the case of the tuned radio frequency stage, the circuit Fig. 33c is to be recommended, as it shows immediately that the gain from grid to anode is approximately $g_m R_1$. For this reason g_m is the principal factor of interest in connection with radio frequency pentodes or tetrodes, whereas for triodes designed for voltage amplification μ is the factor of first importance.

The circuit Fig. 33a may be discussed for a simple example, the equivalent circuit Fig. 33b being used to obtain the result.

Example: A triode with the amplification factor $\mu = 20$ and

the impedance $\rho = 10,000$ ohms is used. $R_1 = 50,000$ ohms, $C = 5,000$ pF, $R_2 = 0.5$ megohm. Derive the stage gain $\frac{E_2}{E_1}$ from the grid of V_1 to the grid of V_2 , (1) for intermediate frequencies, (2) for low frequencies.

(1) When $\frac{1}{\omega C} \ll R_2$, E_2 becomes $\mu E_1 \frac{R_{12}}{R_{12} + \rho}$, R_{12} being the parallel combination of R_1 and R_2 . As R_{12} is

$$\frac{50,000 \times 0.5 \times 10^6}{0.55 \times 10^6} = 45,500 \text{ ohms,}$$

$$\frac{E_2}{E_1} \text{ is } \frac{20 \times 45,500}{55,500} \approx 16.4.$$

(2) For lower frequencies E_2 decreases, owing to the increasing influence of C . Its exact effect is best seen by replacing Fig. 33*b*,

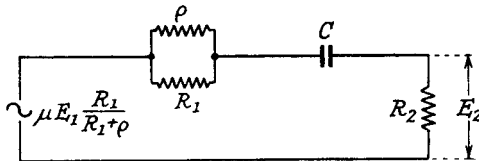

FIG. 34.

according to Thevenin's theorem, by Fig. 34. As the E.M.F. in Fig. 34 is independent of frequency, E_2 decreases when $\frac{1}{\omega C}$ becomes comparable with $\frac{R_1 \rho}{R_1 + \rho} + R_2$. The condition for a loss of 30% is $\frac{R_1 \rho}{R_1 + \rho} + R_2 = \frac{1}{\omega C}$ (see Chapter 1). Since $\frac{R_1 \rho}{R_1 + \rho}$ is usually small compared with R_2 , the condition for 30% drop in gain becomes simply $\frac{1}{\omega C} = R_2$. This takes place in the example when

$$\frac{1}{2\pi f \cdot 5,000 \times 10^{-12}} = 0.5 \times 10^6, \therefore f \approx 63 \text{ c/s.}$$

The shape of the frequency curve is derived from Fig. 34, the parallel combination of ρ and R_1 being neglected in comparison with R_2 . Whence

$$\left| \frac{E_2}{E_1} \right| = \mu \frac{R_1}{R_1 + \rho} \frac{R_2}{\sqrt{R_2^2 + X_C^2}} = \mu \frac{R_1}{R_1 + \rho} \frac{1}{\sqrt{1 + \left(\frac{X_C}{R_2}\right)^2}}, \text{ where } X_C = \frac{1}{\omega C}.$$

$$\therefore \frac{E_2 \text{ at low frequencies}}{E_2 \text{ at intermediate frequencies}} = \frac{1}{\sqrt{1 + \left(\frac{X_C}{R_2}\right)^2}}$$

Convenient points to choose when plotting the curve can be seen from the following table :

$\frac{X_C}{R}$		$\frac{E_2 \text{ at low frequencies}}{E_2 \text{ at intermediate frequencies}}$
0.5	$\frac{1}{\pi C R_2}$	0.895
1	$\frac{1}{2\pi C R_2}$	0.707
2	$\frac{1}{4\pi C R_2}$	0.447
4	$\frac{1}{8\pi C R_2}$	0.242

Towards higher frequencies a decrease in E_2 occurs as a result of the capacitance in parallel to R_1 which is caused by the leads and the valves. The value of this capacitance in an ordinary stage is of the order of 25 pF. Its effect can best be seen from Fig. 33c, the parallel capacitance C_p being shown by dotted lines.

At the high frequencies the reactance of the coupling condenser is small compared with R_2 , and hence E_2 becomes

$$E_2 = g_m E_1 \frac{R \frac{1}{j\omega C_p}}{R + \frac{1}{j\omega C_p}}$$

where R is the parallel combination of ρ , R_1 and R_2 . The frequency curve can be evaluated as before, remembering that for the intermediate range $\frac{1}{\omega C_p} \gg R$. Hence

$$\frac{E_2 \text{ at high frequencies}}{E_2 \text{ at intermediate frequencies}} = \frac{1}{\sqrt{1 + (R\omega C_p)^2}}$$

similar to the formula giving the curve at the low-frequency end.

A loss of 30% in gain occurs when $\frac{1}{\omega C_p} = R = 8,200$ ohms in the above example, whence

$$\frac{1}{2\pi f \ 25 \times 10^{-12}} = 8,200,$$

$$\therefore f = 780 \text{ Kc/s.}$$

This frequency is much higher than is needed for the audio frequency band, and when amplification is extended as far as this, there is risk of radio frequency feedback through the audio frequency amplifier (Chapter 9). Therefore R_1 is frequently by-passed with a condenser chosen so that the audio frequency curve is flat at the high-frequency end only so far as necessary.

If an extension at the low-frequency end is desired far beyond the range given by the above example the coupling capacitance has to be increased. In so doing care has to be exercised in the choice of the condenser employed. An increase in capacitance usually involves a decrease in leakage resistance, and thus there is the possibility of positive voltage being applied to the grid of the next valve. The leakage resistance is likely to change with temperature, etc., and the positive voltage cannot be compensated simply by an increased bias. The leakage resistance can be considered to be inversely proportional to the capacitance for condensers of identical type. For capacitances up to 10,000 pF mica is usually employed as dielectric, and for higher values impregnated paper. The leakage resistance of mica condensers is rarely below a few hundred megohms, which is sufficiently high for keeping away the anode voltage from the next grid. The leakage resistance of paper condensers depends on the impregnating material. In case of wax impregnation, still the most frequent type, the leakage resistance of a condenser of 0.1 μF capacitance may be anything between 5 and 50 megohms, which makes the type unsuitable as a coupling condenser in conjunction with high grid leaks. Specially developed impregnants enable one to manufacture condensers up to 1 μF and more with leakage resistances far in excess of 1,000 megohms. Such types are the appropriate coupling condensers when amplification down to very low frequencies is required.

Increase of the grid leak resistance is limited, apart from the risk of anode voltage being applied to the grid, for reasons connected with the working of the valves. Owing to the presence of positive ions, or because of normal emission of the grid which may become heated from the cathode, a valve tends to produce a current flowing in the grid lead from grid to cathode. If a high grid leak resistance is used the positive voltage thus applied may become appreciable and lead to destruction of the valve. The maximum grid leak permissible varies between several megohms for ordinary small current valves and about 0.1 megohm for power valves.

In Fig. 33a there is a second effect tending to cause loss in

gain at the low-frequency end. The parallel combination of R_c and C_c is a source of negative feedback, as is explained in Chapter 9. If $R_2 \gg R_1$ the anode current of the first valve becomes

$$I_a = E_1 g_m' \frac{1}{1 + Z g_m'}, \text{ where } g_m' = g_m \frac{\rho}{R_1 + \rho + Z},$$

and

$$Z = - \frac{R_c \frac{j}{\omega C_c}}{R_c - \frac{j}{\omega C_c}} = \frac{1}{\frac{1}{R_c} + j\omega C_c}.$$

Example 1 (Fig. 33a). $R_c = 500$ ohms; $C_c = 1 \mu\text{F}$; $g_m' = 1 \text{ mA/V}$, independent of frequency since $Z \ll \rho + R_1$. Determine I_a as a function of frequency.

I_a is inversely proportional to $1 + Z g_m'$, therefore only this term need be discussed.

$$1 + Z g_m' = 1 + \frac{g_m'}{\frac{1}{R_c} + j\omega C_c} = 1 + \frac{g_m' R_c}{1 + R_c^2 \omega^2 C_c^2} - j \frac{g_m' R_c}{R_c \omega C_c + \frac{1}{R_c \omega C_c}}$$

$$\simeq 1 + \frac{0.5}{1 + 10^{-5} f^2} - j \frac{0.5}{3.14 \times 10^{-3} f + \frac{1}{3.14 \times 10^{-3} f}} = A - jB.$$

The ensuing curve can be obtained from the following table :

	$A = 1 + \frac{0.5}{1 + 10^{-5} f^2}$	$B = \frac{0.5}{3.14 \times 10^{-3} f + \frac{1}{3.14 \times 10^{-3} f}}$	$\sqrt{A^2 + B^2}$
1,000 c/s	1.045	0.145	1.055
500 c/s	1.143	0.23	1.166
200 c/s	1.358	0.22	1.37
100 c/s	1.45	0.143	1.45

For higher frequencies $A^2 + B^2$ becomes unity, so the last column gives directly the loss in gain due to negative feedback. At 100 c/s the influence of C_c is almost negligible and the gain is approximately $\frac{1}{1 + g_m' R_c} = \frac{1}{1.5}$ of its normal value.

If R_1 is not purely resistive, g_m' becomes complex and depends on frequency. The effect on the frequency curve can be seen from an example in which R_1 is supposed to be the primary of an inter-stage transformer.

Example 2. In Fig. 33a the anode load is an inductance of which the reactance equals the valve impedance at 100 c/s, $g_m = 1$ mA/V, R_c and C_c as in Example 1.

Hence $g_m' = \frac{g_m}{1 + \frac{jf}{100}}$, and

$$\begin{aligned} I_a &= \frac{E_1 g_m}{1 + \frac{jf}{100}} \times \frac{1}{1 + \frac{g_m}{1 + \frac{jf}{100}} \times \frac{1}{\frac{1}{R_c} + j\omega C_c}} \\ &= \frac{E_1 g_m}{1 + \frac{jf}{100}} \times \frac{1}{1 + \frac{g_m}{\frac{1}{R_c} - \frac{f}{100}\omega C_c + j\left(\frac{f}{100R_c} + \omega C_c\right)}}. \end{aligned}$$

The second term shows the influence of feedback, since I_a without feedback is $\frac{E_1 g_m}{1 + \frac{jf}{100}}$.

Developing the expression in the same way as is done for a resistive load we obtain the following table :

	$\frac{I_a \text{ without feedback}}{I_a \text{ with feedback}}$
1,000 c/s	0.98
500 c/s	0.96
200 c/s	1
100 c/s	1.22

At 500 c/s and 1,000 c/s a slight positive feedback takes place, because both the anode load and the cathode capacitance cause a phase shift of nearly 90° in the same direction.

In summarising the properties of the circuit Fig. 33a as an audio frequency amplifier, the following can be said :

The amplification is of the order of 15-30 and depends mainly on the μ of the valve employed.

The shape of the frequency curve is determined, at the high-frequency end : by the ratio of capacitive reactance between anode and cathode to the total resistance between anode and cathode ; at the low-frequency end : approximately by the ratio of the reactance of coupling condenser to the grid resistance.

It is easy to maintain the amplification up to the highest frequencies required, but the maintenance at the low-frequency end

for a high fidelity amplifier necessitates care in choosing the coupling condenser and the grid resistance.

The magnitude of the anode resistance is not critical so long as it is not less than five times the valve impedance. An increase of R_1 decreases the voltage at the anode of the valve and thus increases the valve impedance, leaving the ratio $\frac{R_1}{\rho + R_1}$ substantially the same. Negative feedback is more easily avoided when R_1 is large; g_m' is lowered whereas, owing to the by-passing condenser C_c , the coupling cathode impedance remains the same. The condenser C_c may be omitted which involves a loss in gain usually not serious. A ratio of anode resistance to valve impedance lying between 5 and 10 is usual.

If R_1 in Fig. 33a is replaced by an inductance the circuit is called a choke coupled amplifier. In contrast to the resistance coupled amplifier the main features of this type are as follows:

In the choke coupled amplifier the voltage at the valve anode is nearly the battery voltage and, therefore, higher output can be obtained.

The choke is an impedance varying with frequency; thus a new factor is added tending to decrease the gain at the low-frequency end. A 30% decrease in gain, caused by the choke impedance only, occurs when $\omega L =$ resistance between anode and cathode. Neglecting the grid resistance, we derive the frequency curve for the anode voltage from Fig. 33b, $|E_a|$ being approximately

$$|E_1| \mu \frac{1}{\sqrt{1 + \frac{\rho^2}{X_L^2}}}$$

Taking into account the influence of C and R_2 , there follows

$$\frac{E_2 \text{ at low frequencies}}{E_2 \text{ at intermediate frequencies}} \approx \frac{1}{\sqrt{\left(1 + \frac{\rho^2}{X_L^2}\right) \left(1 + \frac{R_2^2}{X_c^2}\right)}}$$

Pentode Valves. Radio frequency pentodes employed in resistance or choke coupled amplifiers give a much higher stage gain than is possible with triodes. The method of calculating the gain is identical with that shown for triodes. The anode resistances vary between 0.1 and 0.5 megohm. The anode current must be very small to avoid the voltage at the anode being too low. For a satisfactory working the voltage should be about half the battery voltage or slightly less. The drop in anode current is best effected by low screen grid voltage. The gain obtained is of the order

of 100. Because of the high resistance anode-cathode it is necessary to keep the parallel capacitance small. Thus for a resistance of 0.2 megohm between anode and cathode a parallel capacitance of 70 pF causes a loss of 10% at 5,000 c/s. The "Miller effect" of the following valve has to be taken into account (see page 210).

The Transformer Coupled Amplifier. The *advantages* of the transformer coupled stages, as compared with resistance coupled stages, are .

The maximum A.C. voltage that can be applied to the next grid is higher, which fact makes them the appropriate means of driving power output valves.

The D.C. resistance in the following grid circuit is low; this avoids the disadvantages associated with the resistance coupled stage.

The frequency curve can be delimited very sharply at the high-frequency end.

The *disadvantages* are :

The greater cost.

The increased weight and space; this is of importance in small portable receivers.

Their susceptibility to picking up hum.

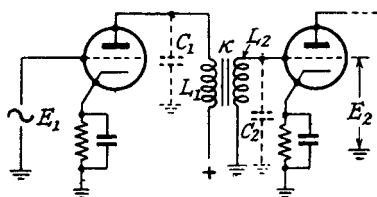

FIG. 35a.

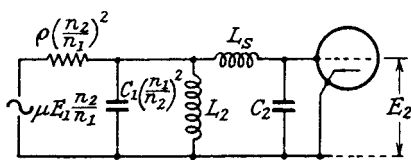

FIG. 35b.

With the help of Fig. 33b of this chapter and the equivalent transformer circuit Fig. 11b in Chapter 1, the transformer stage Fig. 35a can be replaced by the equivalent circuit Fig. 35b. The resistances of the two windings have been neglected; $\frac{n_2}{n_1}$ is the turns ratio secondary to primary, $L_s = L_2(1 - k^2)$ is the leakage inductance. The coupling of audio frequency transformers is always so near unity that it is permissible to set $L_2 - L_s = L_2$ and to consider the turns ratio to be $\frac{n_2}{n_1}$ even after deducting L_s . The turns ratio $\frac{n_2}{n_1}$ is of the order of 4, and therefore $\frac{C_1 n_1^2}{n_2^2}$ can be neglected in comparison with C_2 .

Fig. 35*b* shows that the amplification is $\frac{n_2}{n_1}\mu$ so long as C_2 can be neglected and $\omega L_2 \gg \frac{n_2^2}{n_1^2}\rho$ (which is the same as $\omega L_1 \gg \rho$). The resonance of L_2 with C_2 , which lies usually between 500 and 1,000 c/s, does not appear as the amplitude across L_2 cannot become more than $\frac{n_2}{n_1}\mu E_1$. This is another way of saying that the Q factor of the tuned circuit is less than unity.

The resonance of C_2 with L_s , however, can have a very marked effect and is deliberately used to improve the curve at the high-frequency end. This resonance occurs at a frequency where $\omega L_s \gg \frac{n_2^2}{n_1^2}\rho$ and L_2 can therefore be omitted in Fig. 35*b*

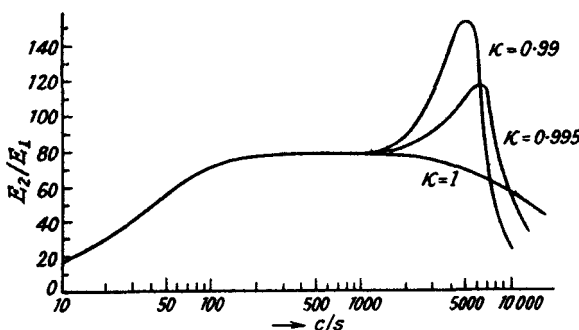

FIG. 36.

when calculating the effect of L_s and C_2 . The circuit becomes then a simple series-tuned circuit containing the resistance $\frac{n_2^2}{n_1^2}\rho$, the inductance L_s and the capacitance C_2 . The resulting curves for $\frac{E_2}{E_1}$ are shown in Fig. 36, assuming $\rho = 10,000$ ohms, $\mu = 20$, $\frac{n_2}{n_1} = 4$, $C_2 = 100$ pF, $L_2 = 500$ henries. Three different values of coupling are given as parameter, $k = 0.99, 0.995$ and 1, the corresponding values of $L_s = L_2(1 - k^2)$ are 10 henries, 5 henries and zero.

It can be seen from the curves that a finite value of L_s is desirable, both for extending the curve up to a desired frequency and for achieving a steep fall beyond the cut-off frequency. The latter is approximately determined by the product $L_s C_2$, and the shape

of the curve at this end by the ratio of $\frac{n_2^2}{n_1^2} \rho$ to ωL_s . Both factors can be chosen within certain limits in order to obtain the desired curve. As the minimum possible value of C_2 is more or less fixed, a large turns ratio is incompatible with a curve extending to very high frequencies. Owing to the importance of C_2 , a knowledge of the stage following the transformer is essential. If the voltage amplification from grid to anode of the next valve is p , the grid-anode capacitance, multiplied by $p+1$, is transferred across grid-cathode (see "Miller effect", page 210). The grid-anode capacitance of a normal triode is of the order of 4 pF; the transferred capacitance may therefore easily be between 50 and 100 pF, which is a large percentage of the total capacitance. If the valve following is a pentode, the "Miller effect" is small and can be neglected.

Wide Band Amplification. In special cases it is necessary to extend the amplification over a much wider band than that which is needed for an audio frequency amplifier. In a resistance coupled stage the cut-off at the high-frequency end is bound to be at a point where the reactance of the parallel capacitance is comparable with the total resistance anode-cathode. To make such a stage work over a large frequency range two factors are essential:

- (1) The total parallel capacitance must be as low as possible.
- (2) The total anode resistance must be as low as is compatible with the required gain.

(1) requires short leads, and in the valves following the amplifier stage low grid-anode capacitance.

(2) requires valves with very high mutual conductance, so that it is possible to employ a low anode resistance. Television pentodes, having a g_m of about 10 mA/V, are obviously the appropriate valves.

Example: A pentode valve has a mutual conductance of 10 mA/V, and an anode-cathode capacitance of 11 pF. It is used as resistance coupled amplifier, and the circuit is that of Fig. 33a. The next valve is of the same type, with a grid-cathode capacitance of 14 pF. The additional capacitance of the leads is 9 pF. The frequency curve is to be extended to 6 Mc/s, allowing for a loss of 1 db. at 6 Mc/s. What is the stage gain attainable?

The total capacitance is 34 pF \equiv 780 ohms at 6 Mc/s. The ratio

$$\frac{\text{amplification at 6 Mc/s}}{\text{amplification at lower frequencies}} = \frac{1}{\sqrt{1 + \frac{R^2}{X_C^2}}}$$

Hence $\frac{1}{\sqrt{1 + \frac{R^2}{X_C^2}}} = 0.89$, where $X_C = 780$ ohms and R is the anode resistance to be found.

$$\therefore R = 400 \text{ ohms.}$$

The stage gain is 4.

An improvement on the circuit of Fig. 33a can be achieved by adding an inductance to tune with the parallel capacitance at the high-frequency end (Fig. 37). A simple calculation shows that the best curve can be obtained when L tunes with C at a frequency where $X_C = 0.707 R$. The curve is then flat up to a frequency 0.707 times the resonant frequency and the loss at the resonant frequency is only 1 db. Hence the following directions are pertinent.

(a) If an absolutely flat curve is desired up to a given frequency f_c ,

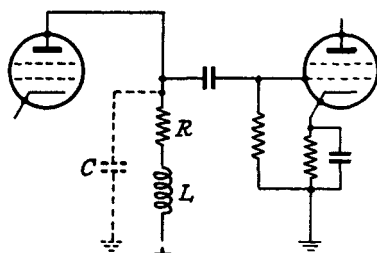

FIG. 37.

choose the anode resistance so that it is at this frequency equal to the reactance of the (unavoidable) capacitance. Then choose an inductance the impedance of which is at the frequency f_c half the anode resistance, thus L resonates with C at a frequency $f_0 = 1.41 f_c$.

(b) If a drop of 1 db. per stage is considered permissible at the given frequency, choose the anode resistance so that it is equal to 1.4 times the capacitive reactance and choose L so that it tunes with C at the given frequency. The gain per stage in the second case is naturally 1.4 times that in the first case.

The proof of the above statements is easy; it may be given for the case of the perfectly flat curve. At the resonant frequency of L and C ,

$$\omega_0 L = \frac{1}{\omega_0 C} = 0.707 R.$$

It then follows that the anode impedance for an arbitrary ω

$$Z = \frac{(R+j\omega L)\frac{1}{j\omega C}}{R+j\omega L+\frac{1}{j\omega C}} = \frac{\frac{L}{C} - \frac{jR}{\omega C}}{R+j\omega Ly} = \frac{(\omega_0 L)^2 - jR\omega_0 L \frac{\omega_0}{\omega}}{R(1+j0.707y)}$$

$$= R \frac{0.5 - j0.707 \frac{\omega_0}{\omega}}{1+j0.707y} \quad \therefore |Z| = R \sqrt{\frac{0.25 + 0.5\left(\frac{\omega_0}{\omega}\right)^2}{1+0.5y^2}}$$

where $y = \frac{\omega}{\omega_0} - \frac{\omega_0}{\omega}$.

$|Z|$ is equal to R at frequencies small compared with the resonant frequency of L and C and for $\omega = 0.707\omega_0$, and rises to about $1.03 R$ for $\omega = 0.5\omega_0$. The phase relations can be derived from the formula given for the anode impedance, whence $\tan \phi = 0.707 \left[\frac{\omega}{\omega_0} + \left(\frac{\omega}{\omega_0} \right)^3 \right]$, the voltage across Z lagging behind the current at all frequencies.

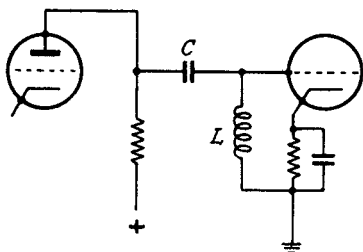

FIG. 38.

For $\omega = 0.707\omega_0$, where the absolute value of the anode impedance is R , ϕ is 37° . If the amplifier is designed for visual reproduction (cathode ray tube) the phase is naturally of importance, in contrast to aural reception. The curves obtained for various values of L are similar to those given in Fig. 36; their derivation may be left to the reader.

An extension of the frequency curve at the low-frequency end beyond the limit given for the audio frequency amplifier can be obtained by means of a circuit shown in Fig. 38. The grid choke L is chosen to tune with the coupling condenser at the required frequency. To avoid the resonance peak rising above the flat part of the curve L has to be chosen so that it tunes with C at a frequency at which $\frac{1}{\omega C} = R$, where R is the parallel combination of the valve impedance and the anode load. As the D.C. resistance in the grid circuit is comparatively small, C can be made larger than usual even with cheap types of condensers, so that it is not necessary to employ an unduly large inductance.

Example: In Fig. 38 a triode with a μ of 40 and an impedance of 40,000 ohms is employed; the anode resistance is 0.2 megohm. Find C and L for a frequency curve flat down to 30 c/s.

The condition is $\omega L = \frac{1}{\omega C} = 33,000$ ohms at 30 c/s, $L = 175$ henries, $C = 0.16 \mu\text{F}$, the stage gain is about 33.

As a choke introduces an appreciable parallel capacitance the gain at the low-frequency end will necessarily cause a loss at the high-frequency end. This method is therefore applicable only in cases where the major aim is to obtain a curve extending to very low frequencies.

A D.C. amplifier is needed if amplification down to lowest frequencies is required and if a perfect reproduction of phase as well as of amplitude relations is essential. This is the case with telegraphic

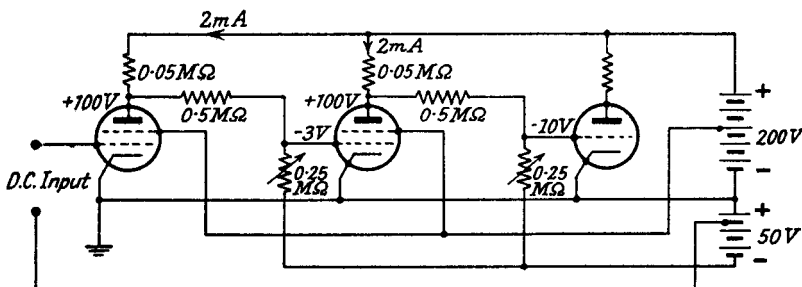

FIG. 39.

recorders, when slow pulses of, say, one second duration are to be amplified. R.C. amplifier stages are not practicable here because of the size of the coupling condenser required. In normal receiver technique D.C. amplifiers are very rare, and an extensive description of the various circuits employed is therefore omitted. One type which is fairly flexible is given in Fig. 39.

The advantage of the circuit is that it requires only one additional battery, even if several stages are employed. Numerical values are given in order to show how the grids obtain the required bias; for this purpose the grid resistances have to be variable. In Fig. 39 the grid resistance of the second valve has to be adjusted to 228,000 ohms to produce a grid bias of -3 volts. The stage gain will be of the order of 15. Small percentage changes in the batteries cause serious alteration of the grid bias. The amplifier requires, therefore, continuous supervision, as is the case with all D.C. amplifiers. The dimensions given in Fig. 39 are a compromise

such as to give a reasonable stage gain and to minimise the danger of slow drift. An increase of the grid resistances increases the stage gain but requires a higher voltage grid battery and increases the danger of slow drift. The impedance of all the batteries has to be very low to avoid feedback; for this reason dry batteries cannot be used.

A further means of widening the frequency range of the response curve is the introduction of *negative feedback*. The price to be paid in this case is a loss in gain, the loss being largest at frequencies where the gain is greatest. The principle of negative feedback may be seen from Fig. 40. The amplifier shown has a gain of A if no negative feedback is applied. If now a percentage βAE_1 , of the output AE_1 , is fed back in antiphase across the input terminals, the input must be increased to $E_1(1+A\beta)$ to maintain the previous output. The gain becomes now $\frac{A}{1+A\beta}$, increasing with increase of A ; but if $A\beta \gg 1$ the gain tends towards $\frac{1}{\beta}$ independent of A .

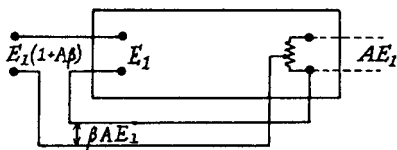

FIG. 40.

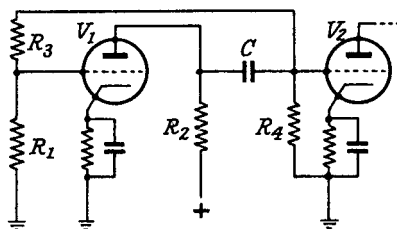

FIG. 41.

In case of negative feedback over several stages there arises, however, the danger of positive feedback for frequencies outside the desired frequency band. In the region of the cut-off frequencies there usually occurs an appreciable change in phase before an appreciable loss in gain takes place, involving the danger just described.

Not every kind of negative feedback improves the frequency curve. The negative feedback shown in Fig. 33a harms rather than improves the response curve for low frequencies. Even if the capacitance C_c is removed the negative feedback does not involve any widening of the response curve. The loss in gain due to the coupling condenser is not affected and the loss at high frequencies because of parallel capacitance is likely to be increased. Since it is the voltage at the next grid that is to be kept constant, a circuit on the lines of Fig. 41 is obviously the appropriate means,

if negative feedback over one stage is to be applied. The factor β in the above formula for negative feedback is $\frac{R_1}{R_1 + R_3}$. If V_1 is preceded by another stage similar to that shown the character of the negative feedback is altered. The impedance between grid and cathode of V_1 is then determined by the anode resistance and the impedance of the preceding valve, rather than by R_1 . The factor β would increase towards lower frequencies, partly upsetting the effect intended. The influence of negative feedback may be shown in one example, in which the phase change is also taken into account.

Example: In Fig. 41 the conditions are as follows :

V_1 is a triode valve with an impedance ρ of 12,000 ohms, and an amplification factor μ of 30. $R_1 = 0.5$ megohm, $R_2 = 50,000$ ohms, $R_3 = 5$ megohms, $R_4 = 0.5$ megohm, $C = 5,000$ pF. Give the ratio of E_2 at the grid of V_2 to E_1 at the grid of V_1 for the low-frequency end, with and without R_3 . The change of grid resistance caused by R_3 and the influence of the biasing resistance of V_1 may be neglected.

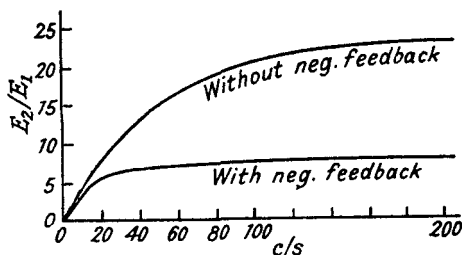

FIG. 42.

Without R_3 , $E_2 = E_1 \mu \frac{R_2}{\rho + R_2} \cdot \frac{R_4}{R' + R_4 - \frac{j}{\omega C}}$, where $R' = \frac{\rho R_2}{\rho + R_2}$.

Inserting values and neglecting R' in comparison with R_4 , we obtain

$$\frac{E_2}{E_1} = 30 \times \frac{50,000}{62,000} \times \frac{5 \times 10^5}{5 \times 10^5 - \frac{j}{2\pi f \cdot 5,000 \times 10^{-12}}} = \frac{24.2}{1 - \frac{j63.7}{f}}$$

$$\therefore \left| \frac{E_2}{E_1} \right| = \frac{24.2}{\sqrt{1 + \left(\frac{63.7}{f}\right)^2}}$$

With R_3 ,

$$\frac{E_2}{E_1} = \frac{24.2}{1 - \frac{j63.7}{f}} \cdot \frac{1}{1 + \frac{24.2}{\left(1 - \frac{j63.7}{f}\right) 11}} \quad \text{and} \quad \left| \frac{E_2}{E_1} \right| = \frac{24.2}{\sqrt{10.3 + \left(\frac{63.7}{f}\right)^2}}$$

The drop in gain is about 1 : 3 ; a drop of 3 db. within the response curve occurs at about 20 c/s, whereas without R_s it occurs at 63.7 c/s. The two curves may be seen in Fig. 42.

Radio Frequency Amplifier. *The Resistance or Choke-coupled Stage.* The use of a resistance or choke-coupled amplifier stage is very rare in normal receiver design. Its principles are contained in the early part of this chapter so that further details are not necessary.

The Untuned Transformer-coupled Stage. What has been said for the resistance-coupled stage also holds good for the transformer-coupled stage, and its principles are indicated in the discussion of the corresponding part of the audio frequency amplifier. The coupling obtained is usually much less than for an audio frequency amplifier, a k of 0.9 being a fairly good value for radio frequency. Consequently the effect of leakage inductance is more pronounced and the width of the frequency band is usually much less in proportion than for audio frequency.

The Tuned Amplifier. The tuned amplifier is the type most frequently used at radio frequency and requires therefore full discussion. It combines amplification with selectivity, the amplification possible being much higher than for the two preceding types.

A tuned circuit acts as a resistance at its resonant frequency, the value of the resistance being $Z_0 = \omega_0 LQ$ (Chapter 1). The

stage gain possible is $\frac{\mu}{2} \sqrt{\frac{Z_0}{\rho}}$, as can be seen from Fig. 33b

and from the result derived in paragraph 11, Chapter 1. In the beginning of radio, triodes were employed for radio frequency amplification and matching between the valve and the circuit was provided by means of a transformer. A normal low impedance triode with $\rho = 3,000$ ohms and $\mu = 10$ is capable of giving a stage gain between 20 and 35 for the medium wave band, reckoning with circuit impedances of 50,000–150,000 ohms. To avoid feedback through the grid anode capacitance of the valve (Chapter 9) the circuit requires neutralisation. To-day radio frequency amplification is almost entirely carried out with tetrode or pentode valves. The small grid-anode capacitance makes neutralisation superfluous if the stage gain is kept within reasonable limits. The stage gain

theoretically possible is $\frac{\mu}{2} \sqrt{\frac{Z_0}{\rho}}$, the same as with a triode. With

a modern R.F. pentode ($g_m = 2$ mA/V, $\rho = 0.5 \times 10^6$ ohms, $\mu = 1,000$) and a circuit impedance of 50,000 ohms, its value is

$500\sqrt{\frac{1}{10}} = 158$. To obtain this stage gain it would be necessary to match the circuit to the valve with a transformer stepping down $\sqrt{10} : 1$ from valve to circuit. In practice such a procedure is not applied for the following reasons:

(a) The capacitance transferred from the valve across the tuned circuit would be ten times the primary capacitance, i.e. of the order of 100 pF, upsetting the tuning intended.

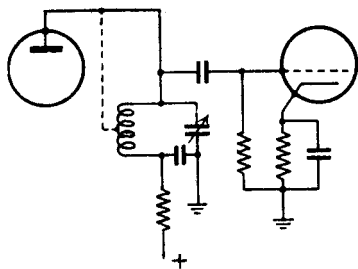

FIG. 43.

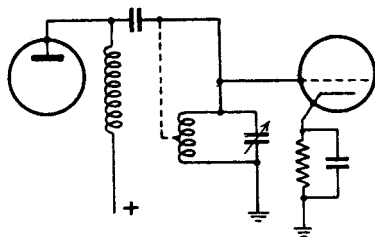

FIG. 44.

(b) Tuning of the primary capacitance with the leakage inductance might cause trouble, if the coupling factor is not very high.

(c) The selectivity would fall because the Q is halved.

(d) The valve would oscillate, for the gain from grid to anode is 500 (see Chapter 9 and Figs. 46a-46c).

For these reasons the coupling used between the valve and the circuit is chosen so that the valve does not look into an impedance larger than the circuit impedance. Figs. 43-45 show various methods of coupling, which are similar in performance but differ from a practical point of view.

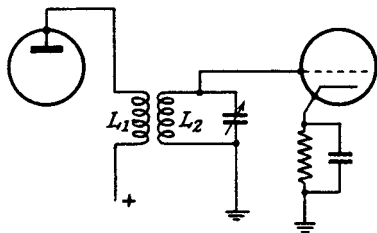

FIG. 45.

In Figs. 43 and 44 the coils may be provided with tapplings (shown with a dotted line) which would enable constant gain to be obtained when switching over from one frequency range to the next. Fig. 43 shows the cheapest method of the three, but it is liable to audio frequency modulation from the anode supply (see pages 232 and 244). It is rarely seen nowadays. Fig. 44 avoids this trouble and is therefore preferable to Fig. 43 in most cases. If used for a

very large frequency range difficulties are incurred because of the various modes of oscillation possible with a large choke (see page 267). Fig. 45 is free from both drawbacks and is used in the majority of cases. When in Fig. 45 the transformer coupling is large and the primary inductance not excessive, the leakage inductance can be neglected. In this case the curve giving the stage gain as a function of frequency shows the same characteristic in the three circuits Figs. 43-45, the gain being proportional to the circuit impedance.

As shown in Chapter I, page 20, the coil tapping works approximately in the manner of an ideal transformer, the impedance transferred to the primary being $Z_0 \left(\frac{n_1}{n_2} \right)^2$, and n_1 and n_2 being the numbers of turns from tapping to earth and of the total coil respectively. The same holds good for Fig. 45 when the coupling is fairly large (above, say, 60%), and the magnetic flux of the secondary passes wholly through the primary. For example, this is the case when tubular coils are employed, when the diameter of the primary coil is only slightly larger than that of the secondary, and when the primary windings do not extend beyond the winding space covered by the secondary.

The gain from grid to anode is then

$$\frac{\text{voltage at the anode}}{\text{voltage at the grid}} = g_m' Z_0 \left(\frac{n_1}{n_2} \right)^2,$$

and the stage gain from grid to grid is

$$g_m' Z_0 \frac{n_1}{n_2}, \text{ where } g_m' = g_m \frac{\rho}{\rho + Z_0 \left(\frac{n_1}{n_2} \right)^2}$$

is the dynamic mutual conductance. Usually, the valve impedance is large compared with the transferred circuit impedance, and g_m' can be replaced by g_m .

In the circuit of Fig. 45, when the coupling factor k is small, as is the case for two-wave wound coils mounted beside each other, the turns ratio no longer gives the required information, and a more accurate formula must be applied. In the case of radio frequency amplification it is important not only to know the actual stage gain, but also the voltage at the anode; this last is desirable in order that feedback may be assessed. An equivalent transformer circuit is therefore given in Figs. 46a-46c, which applies when looking at the circuit from the source, i.e. in this case from the valve. After

the procedure shown in Chapter 1, Figs. 12a-12c, its derivation needs no further comment. Neglecting the leakage inductance and the capacitance from anode to cathode it follows that the anode

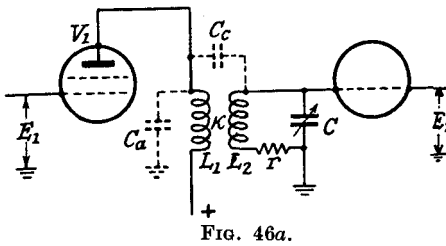

FIG. 46a.

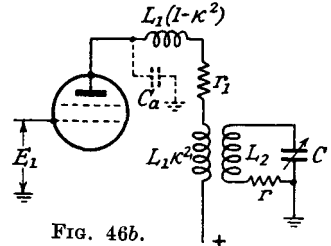

FIG. 46b.

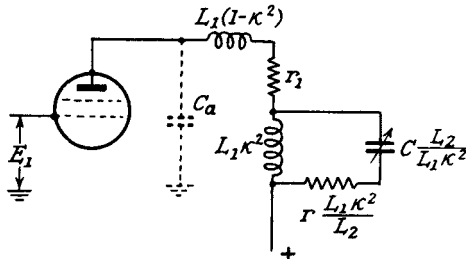

FIG. 46c.

circuit in Fig. 46c tunes to the same frequency as the grid circuit in Fig. 46a ; its impedance is $\frac{\omega_0^2 L_2^2}{r} k^2 \frac{L_1}{L_2} = Z_0 k^2 \frac{L_1}{L_2}$, Z_0 being the impedance of the tuned circuit in Fig. 46a. Under this assumption it follows that :

$$\frac{\text{voltage at the anode}}{\text{voltage at the grid } (E_1)} = g_m' Z_0 k^2 \frac{L_1}{L_2}.$$

$$\therefore \text{Stage gain} = \left| \frac{E_2}{E_1} \right| = g_m' Z_0 k \sqrt{\frac{L_1}{L_2}}, \text{ where } g_m' = g_m \frac{\rho}{\rho + Z_0 k^2 \frac{L_1}{L_2}}$$

can usually be replaced by g_m .

The neglect of $L_1(1 - k^2)$ is usually permissible when L_1 is not much larger than L_2 (see later). The capacitance C_a from anode to cathode is, however, part of the tuning circuit, as follows from Fig. 46c ; its mistuning influence is equal to a parallel capacitance $C_a \frac{L_1 k^2}{L_2}$ across the secondary circuit. This fact is important when a certain frequency range is to be covered and the influence of the various capacitances must be considered.

The influence of the valve impedance on the circuit Q follows

from Fig. 46c, the additional damping being $\frac{\omega_0 L_1 k^2}{\rho}$. This is equivalent to the effect of a parallel resistance $\frac{\rho L_2}{k^2 L_1}$ connected across the secondary circuit. The actual circuit damping is thus

$$\frac{r}{\omega_0 L_2} + \frac{\omega_0 L_1 k^2}{\rho} = \frac{r}{\omega_0 L_2} \left(1 + \frac{\omega_0^2 L_1 L_2 k^2}{\rho r} \right) = \frac{r}{\omega_0 L_2} \left(\frac{\rho + Z_0 k^2 \frac{L_1}{L_2}}{\rho} \right);$$

$\frac{r}{\omega_0 L_2}$ is the natural circuit damping = $\frac{1}{Q}$. Hence

$$\frac{Q \text{ (with valve damping included)}}{\text{natural circuit } Q} = \frac{\rho}{\rho + Z_0 k^2 \frac{L_1}{L_2}} = \frac{g_m}{g_m'}$$

as can be seen from a comparison with the expression given for g_m . (An additional damping caused by the primary winding itself is often experienced when the wire used for the primary is too thick. The effect is due to eddy currents and is avoided by the use of thin wire or *litzendraht*. The ohmic resistance of the thin wire is harmless, as may be seen from the equivalent transformer circuit Fig. 46c, where this resistance would be outside the coil and not part of the tuned circuit.)

Two examples may be included to give an idea as to the importance of the various effects involved.

Example 1. An amplifier stage of the circuit Fig. 45 is employed, the coupling factor between primary and secondary is practically 100%. The ratio of primary to secondary turns is 1:3. The frequency range to be covered is 0.52–1.58 Mc/s, the variation in capacitance being 50–460 pF. The Q factor of the tuned circuit is 100 at 0.55 Mc/s and 1.5 Mc/s. The valve used is a pentode with a mutual conductance $g_m = 1.5$ mA/V and an impedance of 0.5 megohm. The capacitance between anode and cathode is 18 pF and is due to the valve, the leads, the switch and the primary coil.

What is the stage gain at 0.55 and 1.5 Mc/s?

What is the resultant Q at the two frequencies?

What is the mistuning effect of the primary?

At 0.55 Mc/s: The tuning capacitance is $460 \times \left(\frac{0.52}{0.55} \right)^2 = 410$ pF.

The circuit impedance is $\frac{1}{\omega C} Q = 70,500$ ohms. The impedance transferred to the primary is $\frac{70,500}{9} =$ approx. 7,800 ohms. This value is small compared with the valve impedance and can be

neglected. Hence the stage gain is $1.5 \times 10^{-3} \frac{70,500}{3} \approx 35$. The Q is reduced in the ratio of $\frac{500,000}{507,800}$, which can be ignored. The mistuning effect of the primary is equivalent to a parallel capacitance of $\frac{18}{9} = 2$ pF.

At 1.5 Mc/s: The tuning capacitance is 55 pF, the circuit impedance is 193,000 and the circuit impedance transferred is approx. 21,000 ohms. Hence $g_m' = 0.96 g_m$, and the stage gain is $1.5 \times 10^{-3} \times 0.96 \times \frac{193,000}{3} = 92$. The actual Q is 96 and the mistuning effect of the primary is that of a parallel capacitance of 2 pF, the same as for 0.55 Mc/s.

Example 2. Data as for example 1 with the exception that the transformer coupling is 25%. Find the value of the primary L_1 necessary to give the same stage gain, and find the mistuning effect caused by this primary.

To obtain the same stage gain as under (1) it seems feasible to choose the primary inductance L_1 such that $Z_0 k^2 \frac{L_1}{L_2} = \frac{Z_0}{9}$. Hence $0.0625 L_1 = \frac{L_2}{9}$.

$$\therefore L_1 = 1.78 L_2 = 365 \text{ microhenries.}$$

This is, however, correct only if the reactance of the leakage inductance can be neglected in comparison with that of the capacitance

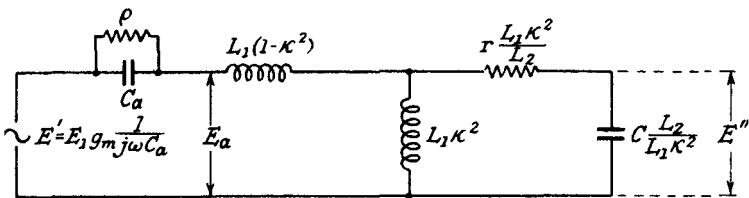

FIG. 47.

anode-cathode. How far this can be done may be seen by replacing the circuit Fig. 46a, in accordance with Thevenin's theorem, by the circuit Fig. 47, in which the effect of ρ may be neglected.

At 1.5 Mc/s: $\omega L_1(1 - k^2)$ is approx. 3,200 ohms, $\frac{1}{\omega C_a} = 5,900$ ohms, so that the effect of $L_1(1 - k^2)$ in Fig. 47 consists in increasing C_a in the ratio $\frac{5,900}{2,700}$. The stage gain rises correspond-

ingly and is 200 (Chapter 1, paragraph 9). The mistuning effect from the anode capacitance is equal to a capacitance of 4.4 pF across the tuned circuit.

At 0.55 Mc/s: the influence of the leakage inductance is almost negligible. The difference in gain between the high- and low-frequency end, already present with large coupling, is greatly increased. Resonance of C_a and $L_1(1 - k^2)$ inside the frequency range covered must be avoided under all circumstances.

Constant Stage Gain. The circuit Fig. 45 may be used to achieve a stage gain fairly constant over any particular frequency range. This is done by using a small coupling factor of about 10% or 15% and a primary inductance which tunes with the primary capacitance to a frequency well below the range covered. The circuit Fig. 47 is in that case equivalent to that of Figs. 26a-26c, the only difference being that in Fig. 47 the e.m.f. is inversely proportional to the frequency. E'' is a fictitious value; it is the voltage that would be obtained across the primary, if the leakage part $L_1(1 - k^2)$ could be separated and if the residual L_1k^2 were 100% coupled with L_2 . Hence the voltage E_2 across the secondary circuit is equal to $E'' \sqrt{\frac{L_2}{L_1k^2}}$; applying Thevenin's theorem one obtains

$$E_2 = E_1 g_m \frac{1}{j\omega C_a} \cdot \frac{j\omega L_1 k^2}{j\omega L_1 k^2 + j\omega L_1(1 - k^2) - \frac{j}{\omega C_a}} Q \sqrt{\frac{L_2}{L_1 k^2}}$$

$$\therefore \left| \frac{E_2}{E_1} \right| = \frac{g_m Q k}{\omega C_a} \sqrt{\frac{L_2}{L_1}} \frac{1}{1 - \left(\frac{\omega_0}{\omega} \right)^2}, \text{ where } \omega_0 = \frac{1}{\sqrt{L_1 C_a}},$$

where $\frac{\omega}{2\pi}$ is the frequency of the received carrier, and where Q refers to the whole circuit, including the damping effect from ρ . The same result follows almost immediately from the formula on page 37, as can be easily verified. The ratio $\frac{E_2}{E'}$, which corresponds to $\frac{E_2}{E_1}$ in Fig. 26c, increases about 1 : 1.5 towards the low-frequency end for a frequency range 0.5-1.55 Mc/s if $\frac{\omega_0}{2\pi} \approx 0.34$ Mc/s; as E' is proportional to $\frac{1}{\omega}$, the stage gain at 0.55 Mc/s is about 4.5 times that at 1.5 Mc/s.

This variation in gain which exhibits the opposite tendency to that discussed above is eliminated by adding a capacitive coupling between L_1 and L_2 (C_c in Fig. 46a); its effect is to increase the transfer ratio from primary to secondary more at the high-frequency than at the low-frequency end. For the values of coupling chosen in practice the voltage at the primary is hardly affected by this fairly small capacitance nor by the secondary circuit; it is therefore permissible to deal separately with this capacitive coupling and then to add its effect to that from the inductive coupling.

The voltage across L_1 in Fig. 46a (or E_a in Fig. 47) is, under this assumption,

$$E_a = E_1 g_m \frac{j\omega L_1 \frac{1}{j\omega C_a}}{j\omega L_1 + \frac{1}{j\omega C_a}} = E_1 g_m \frac{1}{j\omega C_a} \frac{1}{1 - \left(\frac{\omega_0}{\omega}\right)^2},$$

and the voltage applied to the next grid through the coupling capacitance is approximately

$$E_2' = E_a Q \frac{C_c}{C_c + C} = E_1 g_m \frac{1}{j\omega C_a} \frac{1}{1 - \left(\frac{\omega_0}{\omega}\right)^2} \times Q \frac{C_c}{C_c + C}$$

(the reactance of C_c is assumed to be large compared with the impedance of L_1 and C_a in parallel). The total voltage at the next grid, due to inductive and capacitive coupling, is therefore

$$|E_2| = E_1 \left[g_m \frac{1}{\omega C_a} \sqrt{\frac{L_2}{L_1}} \frac{kQ}{1 - \left(\frac{\omega_0}{\omega}\right)^2} + g_m \frac{1}{\omega C_a} \frac{QC_c}{C_c + C} \frac{1}{1 - \left(\frac{\omega_0}{\omega}\right)^2} \right]$$

and the stage gain

$$\left| \frac{E_2}{E_1} \right| \approx g_m \frac{1}{\omega C_a} Q \frac{1}{1 - \left(\frac{\omega_0}{\omega}\right)^2} \left(k \sqrt{\frac{L_2}{L_1}} + \frac{C_c}{C} \right),$$

since $C_c \ll C$. The winding senses of L_1 and L_2 have to be opposite (compare page 78).

The expression before the bracket is at 0.55 Mc/s about 4.5 times as large as at 1.5 Mc/s under the conditions already stated. The coupling condenser has therefore to be chosen so that the expression inside the bracket shows the opposite tendency. The calculation of C_c can be seen from the following example:

Example: In the circuit Fig. 46a the data are $L_1 = 14,000$ microhenries, $L_2 = 212$ microhenries, $C = 410$ pF at 0.55 Mc/s and 55 pF at 1.5 Mc/s, $k = 0.15$, $C_a = 20$ pF, $Q = 100$, $g_m = 1$ mA/V.

(a) Add a coupling condenser C_c so that the stage gain is the same at 0.55 and 1.5 Mc/s.

(b) What is the stage gain at these two frequencies and at 0.9 Mc/s midway between the two, if the Q in the latter case is 100? What is the gain from grid to anode?

$L_1 = 14,000$ microhenries and $C_a = 20$ pF, therefore $f_0 = \frac{\omega_0}{2\pi} = 0.3$ Mc/s. The expression before the bracket is approximately 3.7 times larger at 0.55 Mc/s than at 1.5 Mc/s.

Hence

$$k\sqrt{\frac{L_2}{L_1}} + \frac{C_c}{C(\text{at } 1.5 \text{ Mc/s})} = 3.7\left(k\sqrt{\frac{L_2}{L_1}} + \frac{C_c}{C(\text{at } 0.55 \text{ Mc/s})}\right)$$

$$\frac{0.15}{8.1} + \frac{C_c}{55} = 3.7\left(\frac{0.15}{8.1} + \frac{C_c}{410}\right)$$

$$\therefore C_c = 5.4 \text{ pF.}$$

Stage Gain. At 0.55 Mc/s :

$$\frac{E_2}{E_1} = \frac{10^{-3} \times 14,400 \times 100\left(\frac{0.15}{8.1} + \frac{5.4}{410}\right)}{1 - 0.3} \approx 65.$$

The gain from grid to anode is $\frac{10^{-3} \times 14,400}{1 - 0.3} = 20.6$.

At 1.5 Mc/s :

$$\frac{E_2}{E_1} = \frac{10^{-3} \times 5,300 \times 100\left(\frac{0.15}{8.1} + \frac{5.4}{55}\right)}{1 - 0.04} \approx 65.$$

The gain from grid to anode is $\frac{10^{-3} \times 5,300}{1 - 0.04} = 5.5$.

At 0.9 Mc/s :

$$\frac{E_2}{E_1} = \frac{10^{-3} \times 8,800 \times 100\left(\frac{0.15}{8.1} + \frac{5.4}{153}\right)}{1 - 0.11} \approx 53.$$

In order to show the error resulting from the neglect of L_1 and C_a in parallel, in comparison with C_c , the influence of the parallel combination may now be calculated. At 0.55 Mc/s it is equal to 14 pF and at 1.5 Mc/s equal to 19.2 pF. If Thevenin's theorem is applied to obtain the voltage transferred through C_c , the parallel combination of L_1 and C_a is in series with C_c . The actual stage gain is therefore below the calculated values, the difference being most pronounced at the high-frequency end. If in the formula the modified values for C_c are inserted, the stage gain becomes about 57 at 0.55 Mc/s and 53 at 1.5 Mc/s. This shows that the gain is still almost constant throughout the range.

In practice the Q factor cannot be expected to be constant over the whole range.* It usually is highest in the middle and lowest at the high-frequency end, a fact to be taken into account. The coupling capacitance is made adjustable; it is either a small trimmer or, more frequently, consists of a turn of insulated wire fixed in a position to be found by the test department.

In general, the instructions to be given for such an amplifier stage are as follows. Choose the primary capacitance and inductance so that their natural frequency is not more than about 0.6 times the lowest frequency of the range covered, and use a coupling factor between 10% and 15%.

Determine the factor $\frac{Q}{\omega\left(1 - \frac{\omega_0^2}{\omega^2}\right)}$ for the highest and lowest

frequency of the range (for the standardised broadcast bands the Q values of the ordinary circuits are known and the factor sought

might be determined on paper). If $\frac{Q}{\omega\left(1 - \frac{\omega_0^2}{\omega^2}\right)}$ is A times larger

at the low-frequency end, the coupling condenser has to be approximately $C_c = \frac{k(A-1)}{\frac{1}{C_h} - \frac{1}{C_l}} \sqrt{\frac{L_2}{L_1}}$, where C_h and C_l are the values of

the tuning capacitance C at the highest and lowest frequency.

The mistuning due to the primary follows from Fig. 47; it has been fully discussed for the corresponding case of aerial coupling on page 37. In the above example the influence of the primary is:

At 0.55 Mc/s: The secondary inductance is reduced by 3.2%.

At 1.5 Mc/s: The secondary inductance is reduced by 2.34%.

It has been mentioned already in Chapter 2 that this mistuning influence limits the coupling permissible for a given natural frequency of the primary circuit, because the mistuning varies over the range and requires correction in the oscillator circuit of a superhet. Ganging with the aerial circuit does not cause difficulty if the type of coupling used is of a similar nature (page 37). Differences in the magnitude of the mistuning of one or two per cent are usually not serious, since they can be corrected by means of the variable inductance and capacitance of the circuits.

* If Q is dimensioned so as to give constant band-width, the stage gain is almost constant without an additional coupling condenser (compare page 132).

In the above example the coupling factor between L_1 and L_2 can be increased without undue disturbance if at the same time L_1 or C_a is made larger. The resulting stage gain and the mistuning can be calculated with the help of the formulae given; this may be left to the reader. The stage should be designed so that a coupling capacitance of only a few pF is necessary, as the latter contributes appreciably to the minimum capacitance.

The stage gain calculated in the above example may be compared with that attained if the tuned circuit were connected directly or by means of a 1 : 1 transformer in the anode lead of the amplifier valve. In this case the stage gain is simply $g_m'Z_o$, which would be 162 at 1.5 Mc/s and 66 at 0.55 Mc/s, for a valve impedance of 1 M Ω . The method of tuning the transformer primary to a frequency below the range to be covered therefore levels the gain to a value similar to that obtainable at the low-frequency end with the tuned anode as shown in Figs. 43 and 44. This loss in gain is usually unimportant. Apart from the constancy of gain achieved with the circuit of Fig. 46a the great advantage of this method is that the impedance transferred from the anode is essentially inductive. Thus the frequency range covered by means of a variable condenser is not decreased by the anode capacitance (see page 69).

The stage gain for other frequency ranges follows immediately from the formula given. It may be assumed that the variable capacitance, the circuit Q , the anode capacitance and the ratio $\frac{\text{resonant frequency of the anode circuit}}{\text{lowest frequency within the range covered}}$ are unchanged. In that case, the stage gain is inversely proportional to the frequency for constant condenser setting. For a frequency range 5.5–15 Mc/s the stage gain to be expected will be of the order of 6.

To obtain a good stage gain at very high frequencies with a given valve, a high circuit Q and a small tuning capacitance are essential. The two points may be discussed separately.

Circuit Q. As mentioned in Chapter 1, the circuit Q may be expressed as the ratio $\frac{\omega_0 L}{r}$ where L is the inductance of the circuit and r the series resistance. In point of fact the circuit losses are never due entirely to a series resistance, but are caused by various factors such as dielectric losses, parallel resistances, losses in the valves, in the screening, etc. In analysing these experimentally it is practicable to think in terms of circuit damping rather than of Q (page 10). An example shows its usefulness.

Example: The damping measurements carried out with an R.F. circuit show the following typical results :

	Damping	Q
1. Coil (unscreened) and condenser on deck	0.8%	125
2. As 1, but with the coil in its screening box	0.95%	105
3. As 2, the coil and the condensers connected through the appropriate switch	1.05%	95
4. As 3, mounted correctly on the receiver chassis	1.05%	95
5. As 4, connected to the valve grid	1.2%	83

Such a table is revealing. It shows how a number of small effects add together to increase the natural coil damping by 50%. Usually little can be done to improve the result without an appreciable increase in cost. A number of points may be mentioned which are of importance for the highest frequency ranges.

1. Keep the leads between the coil and the variable condenser as short as possible. Such leads add to the series resistance without contributing much to the inductance.
2. Mount decoupling condensers, if they are part of the actual circuit, so that they fit in the run of the leads.*
3. Mount the coil switch so that it fits well in the leads.
4. Use thick wire (about 1 mm. diameter) for the connecting leads mentioned under 1.
5. Space the turns of tubular coils by about half the diameter of the wire. This avoids dielectric losses from capacitance between neighbouring turns.
6. If spacing is impossible, owing to lack of room, use wire with double cotton cover, in preference to silk cover, even if the diameter of the copper part of the wire has to be correspondingly thinner. The influence of dielectric losses in the wire insulation is very marked at frequencies of about 10 Mc/s or higher and usually greater than that for slight differences in the thickness of the copper.
7. At frequencies above about 10 Mc/s air cored coils are better than those with iron dust cores. The use of iron dust cores for achieving the necessary variation in inductance is permissible.
8. The space allotted to the tuning coils is of importance. The larger the space the better the Q attainable.
9. A radio frequency circuit should be designed for the highest frequency range, as all the above factors carry the more

* Sometimes it is advantageous to apply grid bias by means of a grid leak resistance, thus avoiding a decoupling condenser in the actual resonance circuit. The parallel damping is harmless if only short waves are concerned.

weight the higher the frequency. Usually it pays to carry out beforehand experiments with various wire types. A table as given here is useful as it gives information as to what improvement can be expected from a redesign of the coil.

Amplifiers where Two Coupled Circuits form the Anode Load. The behaviour of coupled circuits, such as are used for normal intermediate frequency amplification, can be seen from Chapter 1, and does not involve any particular difficulty. If a pentode is used with an impedance large compared with the impedance of the circuits, the stage gain is $g_m \frac{Z_0}{\left(A + \frac{1}{A}\right)}$, where $A = \frac{k}{k_{crit.}}$ (page 30).

For critical coupling the amplification is half that for a single circuit; everything else can be learned from the curves Fig. 19 in Chapter 1.

Serious trouble may be experienced in production if due attention is not paid to the influence of capacitive coupling. For normal I.F. filters with a tuning capacitance of 200 pF, a capacitance of 2 pF between the two circuits constitutes a coupling factor of 1%, which is of the same order as the intended inductive coupling. The two couplings are additive if the two coils have opposite winding senses, subtractive if the winding senses are equal. Thus it may happen in production that large variations occur from set to set unless instructions are given as to the way in which the coils are to be mounted. It must be realised that the winding sense of a pancake or wave-wound coil is not defined even though instructions may be given where to connect the inner and the outer end. To avoid this either the winding sense has to be defined or the filter designed so that the capacitive coupling becomes negligible. The latter way is preferable (see Chapter 14 on measuring coupling factors).

The Power Amplifier Stage. When designing a power amplifier stage, several points ought to be clarified before starting. They may be enumerated in the order of their importance.

1. The power required.
2. The distortion regarded as permissible.
3. The cost.

The third point depends on the two preceding ones and requires closer specification. It contains such things as the number and types of valves, the driving power required, the power taken from the power supply, etc. Thus the final choice may depend on

a weighing up of all these factors and hence will be largely a matter of personal judgment.

The subject itself has been extensively dealt with in various textbooks,* to which the reader is referred for more detailed information. Usually the optimum conditions for power valves are given in valve books edited by the manufacturing firms, and the purpose of the following discussion is to convey a clear understanding of the subject and to evolve the basic principles leading up to the final conditions. The treatment is limited to audio frequency amplifiers.

A short summary of the various working conditions may be added to make the reader familiar with the usual technical terms.

Class A1 operation. The valve is operated only on the linear part of the characteristic; the grid voltage is always negative.

Class AB1 operation. The valve is operated down to anode currents below the linear part, and the anode current may be cut off for part of the cycle. The grid voltage is always negative.

Class B1 operation. The valve is operated almost at the point of cut-off, the grid voltage is always negative.

The index 2 instead of 1 indicates that the grid voltage is not restricted to the negative region and that grid current flows during at least part of the cycle. Classes A2, AB1, AB2, B1 and B2 are used only in push-pull as, with a single valve, they would lead to undue distortion. (Class C operation is ruled out in any case.)

Triode in Class A1 Operation. If, as a first rough approach, the valve characteristic is supposed to be a straight line,

Fig. 48 contains the series of $I_a E_g$ curves with E_a as parameter.

The valve impedance ρ under these conditions is the ratio $\frac{E_a}{I_a}$

for any point on the y -axis, where E_g is zero. For given values of E_a and E_g , the anode current I_a is $\frac{E_a + \mu E_g}{\rho}$, where μ is the amplification factor of the valve.

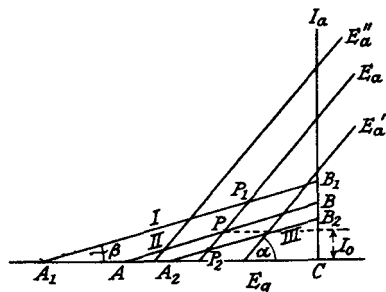

FIG. 48.

The valve load is supposed to have no D.C. resistance, as is approximately the case with transformer coupling. The anode voltage is E_a . The A.C. resistance

* F. E. Terman, *Radio Engineering*, 2nd edition, 1937, pp. 276-345; *Radio Designer's Handbook*, edited by F. L. Smith.

R of the anode load and the grid bias E_g necessary are to be found for maximum power output.

The working point evidently lies on the line having the parameter E_a . For any arbitrary value of R the slope of the load line is $g_m' = \tan \beta = g_m \frac{\rho}{\rho + R} = \tan \alpha \frac{\rho}{\rho + R}$. The condition that the anode current is not to be cut off and that no grid current is to flow at any period, limits the working point to the part of the load line between the I_a and E_g axis. The lines I, II and III represent three load lines for the same anode load, but different grid bias; the working points being P_1, P, P_2 . It is easy to see that among all the lines possible that which will give the highest power output is divided by the working point into equal parts, i.e. for which $AP = PB$. In Fig. 48 this is assumed to be the case for the line II; for line I the swing is limited to P_1B_1 , for line III to A_2P_2 , both of which are smaller than $AP = PB$.

The anode current I_0 at P is found from the following considerations:

$$I_0 = \frac{1}{2}BC;$$

$$E_0 = E_a - RI_0, \text{ where } E_0 \text{ is the anode voltage at the point } B;$$

$$\text{hence } \frac{E_a - RI_0}{\rho} = 2I_0,$$

$$\therefore I_0 = \frac{E_a}{R + 2\rho}.$$

The power output becomes in this case,

$$\frac{1}{2}I_0^2R = \frac{1}{2} \frac{E_a^2R}{(R + 2\rho)^2} = \frac{1}{2} \frac{E_a^2}{R + 4\rho + \frac{4\rho^2}{R}}.$$

The anode efficiency, i.e. the ratio of power output to power taken from the H.T. supply, is

$$\text{A.E.} = \frac{E_a^2R}{2(R + 2\rho)^2I_0E_a} = \frac{1}{2 + \frac{4\rho}{R}}.$$

To obtain the value of R which produces the maximum power output possible the denominator of the above expression is to be differentiated with respect to R , whence

$$1 - \frac{4\rho^2}{R^2} = 0.$$

$$\therefore R = 2\rho.$$

$R = 2\rho$ is thus the optimum value of anode load under the given conditions, and the output is

$$P_{max.} = \frac{E_a^2}{16\rho}.$$

The grid bias necessary to obtain the required current is found as follows :

$$I_0 = \frac{E_a}{R + 2\rho} = \frac{E_a - \mu E_g}{\rho}$$

$$\therefore E_g = \frac{E_a}{\mu} \frac{R + \rho}{R + 2\rho}.$$

For $R = 2\rho$ there follows $E_g = \frac{3}{4} \frac{E_a}{\mu}$.

The power taken from the H.T. supply is $I_0 E_a = \frac{E_a^2}{4\rho}$, and hence the anode efficiency is 25%.

The curve giving the possible output as a function of R has a fairly flat maximum and is symmetrical as regards mismatching. An anode load twice the optimum value has the same output as a load half this value, the output being about 11% below the optimum.

The above results are not accurate, as the valve characteristics are not straight lines; for this reason a new assumption is made which is much nearer the real conditions (Fig. 49). This assumption is as follows :

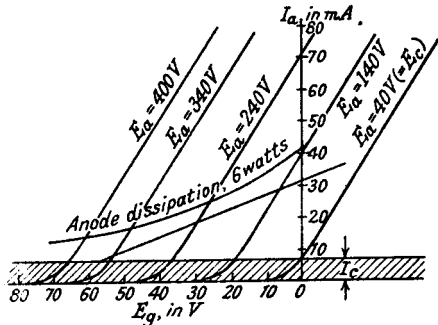

FIG. 49.

The characteristics are supposed to be straight lines down to a current I_c , below which the valve cannot be used because of distortion. The characteristics are identical in shape.

In Fig. 49 a horizontal line may be drawn cutting off the non-linear part of the characteristics. Then the part above this line can be dealt with in the same way as has been done in Fig. 48. In Fig. 49 let E_c be the anode voltage for which the $I_a E_g$ curve cuts the y -axis at the point $I_a = I_c$. It becomes obvious then that the characteristic for an anode voltage equal to E_c in Fig. 49 corresponds with the characteristic for an anode voltage equal to zero in Fig. 48; the parameter of anode voltage for the other curves

decreases correspondingly by E_c . The valid formulae are thus obtained by replacing in the above results the value E_a by $E_a - E_c$. The corrected formulae are

$$R_{opt.} = 2\rho, \text{ as before.}$$

$$P_{max.} = \frac{(E_a - E_c)^2}{16\rho}, \quad E_{g_{opt.}} = \frac{3}{4} \frac{E_a - E_c}{\mu}.$$

The working anode current is

$$I_0 = I_c + \frac{E_a - E_c}{4\rho},$$

and hence the anode efficiency

$$\frac{\text{power output}}{\text{power supplied}} = \frac{(E_a - E_c)^2}{4E_a(4\rho I_c + E_a - E_c)}, \text{ which is less than } 25\%.$$

The formulae for the power output possible and the grid bias necessary as a function of anode load are correspondingly

$$P = \frac{\frac{1}{2}(E_a - E_c)^2}{R + 4\rho + \frac{4\rho^2}{R}} \quad \dots \quad (1)$$

$$E_g = \frac{E_a - E_c}{\mu} \frac{R + \rho}{R + 2\rho} \quad \dots \quad (2)$$

The power output will be limited by various factors: by the anode voltage available, by the anode dissipation of the valve, or by the maximum voltage permissible at the anode. In the absence of a signal the whole power taken from the H.T. supply is dissipated inside the valve and heats the anode. The anode dissipation of a valve is the maximum power that can be dissipated at the anode without leading to a destruction of the valve, and every power valve has a rated value of anode dissipation, which is published by the manufacturers.

If H.T. voltage available is such that, with an anode current appropriate for $R = 2\rho$, the anode dissipation does not exceed the rated value of the valve, $R = 2\rho$ in fact should represent approximately the optimum value. In Fig. 49 this assumption is fulfilled for the load line drawn, which agrees with an H.T. available of 240 V.

When going through the data published by the manufacturers of valves it will be found that the values of R recommended as optimum anode load are usually larger than 2ρ , even when the anode dissipation plays no part in it. The reason is that the valve characteristics are not as given in Fig. 49. There is no clearly

defined minimum current permissible, and the lower bend is less sharp but extends to larger anode currents with increasing bias (Fig. 50). Furthermore, the minimum anode current permissible for a given percentage distortion is smaller for a larger anode load, as will be readily understood. This explains why it is that frequently an anode load three to four times the valve impedance is published as the optimum value, when one would expect only 2ρ .

In the following it may be assumed that the curves in Fig. 49 are the true characteristics of a valve and that for this valve 340 V anode voltage is available. For maximum power output, an anode load equal to twice the valve impedance may be chosen; the bias becomes, according to equation (2), $E_g = \frac{E_a - E_c}{\mu} \frac{R + \rho}{R + 2\rho} = 41$ V, and the anode current is approximately 30 mA. The anode dissipation is in this case $340 \times 30 \times 10^{-3}$

$= 10.2$ watts, whereas the rated value is only 6 watts, as indicated in Fig. 49. Therefore the above working conditions are not permissible. The correct procedure would be in this case to choose first the grid bias which produces an anode dissipation of 6 watts, and then to calculate the appropriate optimum anode load from equation (2). The correct bias is about 48 V, and the corresponding anode load is found from the following formula resulting from (2):

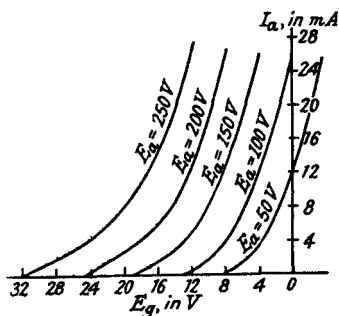

FIG. 50.

$$R = \rho \left[\frac{1}{\frac{E_a - E_c}{\mu E_g} - 1} - 1 \right] \quad (3)$$

In the above case $R = 6.4\rho \approx 20,000$ ohms.

The power output, according to equation (1), is about 1.3 watts. The anode efficiency is 21.7%.

In practice the procedure almost exclusively employed for deriving the optimum working conditions is the graphical method which is based upon the $I_a E_a$ characteristics of the valve. An example may be given in Fig. 51, which, in a series of curves, shows the anode current as a function of the anode voltage with the grid voltage as parameter. The approximate data of the valve can be read from Fig. 51; they are, at $E_a = 100$ V, $E_g = 0$: $g_m = 6$ mA/V, $\mu = 5$ and $\rho = 830$ ohms.

The slope of a load line for any given value of R is determined by the fact that for a change of δI_a in anode current there results a change of $-R\delta I_a$ in anode voltage. Thus, a line connecting the point 200 V on the x -axis with the point 20 mA on the y -axis has the same slope as the load line with 10,000 ohms anode load, a change of 20 mA causing a change of 200 V at the anode.

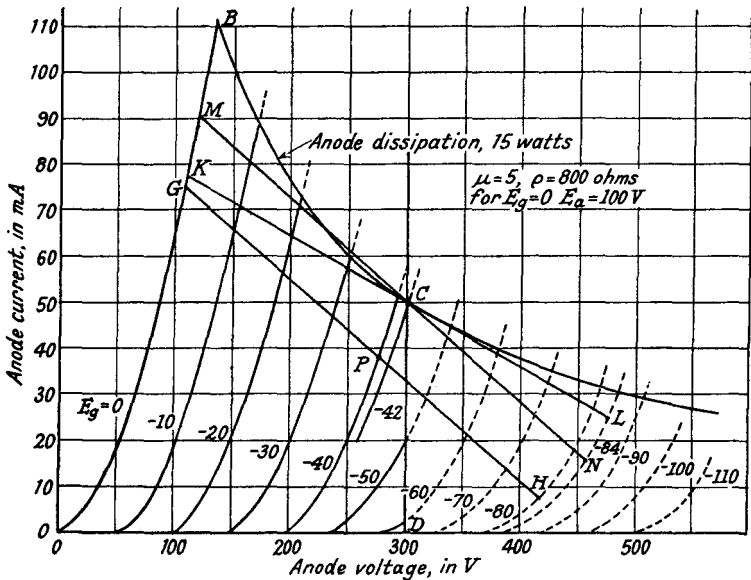

FIG. 51.

The distortion for triodes in A1 amplification is usually expressed in terms of the ratio $\frac{\text{amplitude of 2nd harmonic}}{\text{amplitude of fundamental}}$. This value is determined by the ratio of positive to negative peak in anode current for an applied sinusoidal grid voltage. From a mathematical analysis it follows that the ratio of 2nd harmonic to fundamental is $\frac{I_{max.} + I_{min.} - 2I_0}{2(I_{max.} - I_{min.})}$. This expression can be transformed to

$$\frac{I_{max.} - I_0 - (I_0 - I_{min.})}{2(I_{max.} - I_0 + I_0 - I_{min.})} = \frac{\frac{I_{max.} - I_0}{I_0 - I_{min.}} - 1}{\frac{I_{max.} - I_0}{I_0 - I_{min.}} + 1},$$

where $I_{max.} - I_0$ is the positive
and $I_0 - I_{min.}$ the negative peak of the anode current.

If A is the ratio of positive peak to negative peak, it follows that

$$\frac{\text{amplitude of 2nd harmonic}}{\text{amplitude of fundamental}} = \frac{1}{2} \frac{A - 1}{A + 1}.$$

If, on the other hand, this ratio is fixed and called p , the permissible value of A is given by

$$A = \frac{1 + 2p}{1 - 2p}.$$

A second harmonic equal to 5% of the fundamental ($p = 0.05$) is the usual value on which are based power data published by the valve manufacturers. For this figure the ratio A of positive current peak to negative current peak follows from the last formula

$$A = \frac{1.1}{0.9} = 1.22.$$

The graphical procedure of deriving the optimum working conditions and the maximum power output of a valve represented by the $I_a E_a$ characteristics in Fig. 51 is as follows:

1. Plot in Fig. 51 the curve of maximum anode dissipation and the line of maximum D.C. voltage permissible at the anode.

If BC is the curve of maximum anode dissipation, corresponding to 15 watts, and if CD is the line of maximum D.C. voltage permissible at the anode, corresponding to 300 volts, it is evident that the working point must be inside the area $OBCD$.

2. Try the point C as working point. Draw the $I_a E_a$ curve for a grid bias twice that of C (-84 volts in Fig. 51), and draw various load lines through C . Make sure that in each case the ratio of the two sections of the load line between C and the two $I_a E_a$ curves having the parameters $E_g = 0$ and $E_g =$ twice the bias at C , is not larger than $\frac{1+2p}{1-2p}$, where p is the permissible ratio of 2nd harmonic to fundamental.

3. Try other points in the neighbourhood in the same way.

Of all the load lines choose that for which the power output is greatest, viz. $\frac{(I_{max.} - I_{min.})(E_{max.} - E_{min.})}{8}$ is a maximum.

In the following, approximate figures are given of three trials carried out from Fig. 51.

1st trial: The working point is C , the load line KCL . The ratio $\frac{KC}{CL} = 1.11$, hence the 2nd harmonic content is 2.6%. The power output is 2.4 watts, the anode load 7,000 ohms $\approx 8.8\rho$. The anode efficiency is 16%.

2nd trial: The working point is C , the load line MCN . The

ratio $\frac{MC}{CN} = 1.18$, hence the 2nd harmonic content is 4.1%. The power output is 3.15 watts, the anode load 4,500 ohms $\approx 5.4\rho$. The anode efficiency is 21%.

3rd trial: The working point is P , the load line GPH . The ratio $\frac{GP}{PH} = 1.22$, hence the 2nd harmonic content is 5%. The power output is 2.6 watts, the anode load 4,600 ohms $\approx 5.5\rho$. The anode efficiency is 24.5%.

The trials show that the point C as working point is superior to P , as is to be expected. The value published for the valve is 3.5 watts, which agrees with the result obtained in the second trial, since the value of 3.5 watts refers to a 2nd harmonic content of 5%.

If the equations (1), (2) and (3) are used to arrive at the required results the difficulty becomes apparent. E_c may be anything between 30 and 60 volts. Though the difference seems small, its influence on the choice of R is considerable. Inserting in (3) the numerical values

$$\begin{aligned} E_a &= 300 \text{ V}, E_g = 42 \text{ V}, \text{ we obtain} \\ \text{for } E_c &= 30 \text{ V} : R = 2,000 \text{ ohms}; \\ \text{for } E_c &= 60 \text{ V} : R = 4,800 \text{ ohms.} \end{aligned}$$

The graphical method therefore seems the only practicable way.

The conclusions to be drawn for the use of a triode in class A1 amplification are:

If the H.T. voltage is limited so that the anode dissipation of the valve does not come into consideration, a valve with the lowest impedance will give the highest power output. To possess a low impedance the valve must have a large mutual conductance and a low amplification factor. Correspondingly, the required driving voltage is large. The optimum anode load lies between 2ρ and 4ρ .

If the anode voltage is not limited the valve with the highest anode dissipation gives the largest power output, the latter being of the order of 25% of the anode dissipation. A valve with a large permissible D.C. anode voltage is advantageous as the effect of bottom bend is proportionally smaller the higher the D.C. voltage. The anode efficiency becomes higher and approaches the value

$$\frac{1}{2 + \frac{4\rho}{R}}$$

$E_a = 400 - 500$ volts the anode efficiency will be found to be about 0.8 of this theoretical value. The optimum anode load

is found by the graphical method described with the help of Fig. 51.

Changes of anode current due to rectification have been disregarded as their effect on the result is only slight.

Pentode in Class A1 Amplification. The pentode is fundamentally different from the triode since the anode current is, within wide limits, independent of the anode voltage. At first the discussion of power output may be based upon a hypothetical pentode, i.e. upon an $I_a E_g$ characteristic which is perfectly straight and independent of the anode voltage. In this case the dynamic and the static $I_a E_g$ curves are identical, and the $I_a E_a$ curves are horizontal lines. The grid bias has to be chosen so that the anode current at the working point is half that at zero bias and the anode load has to be such that for the peak of the anode current the anode voltage is zero.

Hence $R = \frac{E_a}{I_0}$ (Fig. 52).

The output is $\frac{1}{2} E_a I_0$ and the anode efficiency 50%.

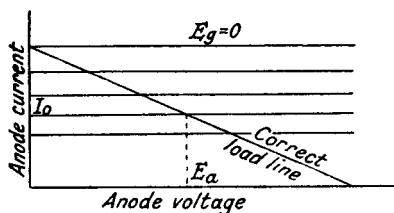

FIG. 52.

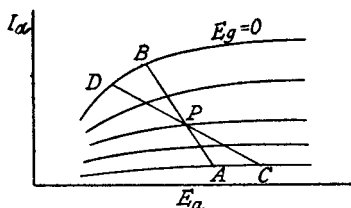

FIG. 53.

The practical conditions differ from these ideal assumptions as follows.

1. The $I_a E_g$ curves are not straight lines.
2. The anode current is not independent of the anode voltage.
3. The power supplied is larger than $I_0 E_a$ because of the additional screen current.

(1) limits the grid swing towards small currents in the same way as is the case in Figs. 49 and 50.

(2) affects the shape of the resultant A.C. anode current and thus the choice of grid bias and anode load.

(3) decreases the anode efficiency.

Owing to the small influence of E_a on I_a the $I_a E_g$ curves are quite unsuitable for discussion. In Fig. 53 a set of $E_a I_a$ curves is given, for a fixed screen grid voltage and with E_g as parameter.

The optimum working conditions are found by graphical

methods, in the same way as for a triode. Again the load line is limited on the one side by grid current, i.e. by the $I_a E_a$ curve with the parameter $E_g = 0$, on the other side by the bottom bend. If the anode load is chosen so that the anode voltage never falls so low that I_a is largely affected by E_a , as is the case for the load line APB , the positive peak is larger than the negative because of the increase of mutual conductance with increasing current. This type of distortion is similar to that of a triode, but its effect is greater. This is because the anode load has no influence upon the dynamic characteristic, as it has in the case of the triode; for the latter valve the anode load is larger than the valve impedance, for the pentode it is very much smaller.

For this reason the anode load is frequently chosen so that the anode voltage falls so much that it has a decreasing effect on the anode current (load line CPD). For $CP = PD$ the positive and the negative peaks become equal and even harmonics disappear. The odd harmonics, however, become strong, particularly the third, owing to g_m being highest at P . Taking an anode load larger than that corresponding to the load line CDP leads to a large increase in screen grid current and may lead to destruction of the valve.

The optimum working conditions are not so clearly defined as for a triode. The possibility of removing the 2nd harmonic at the cost of intensifying the 3rd harmonic indicates that the choice of anode load is, to a certain extent, a matter of compromise and personal judgment. The data recommended by the manufacturers result in a ratio of $\frac{\text{positive peak}}{\text{negative peak}}$ anywhere between 1.4 and unity.

Two formulae recommended for practical use when mainly 2nd and 3rd harmonic are expected are as follows:

$$\frac{\text{2nd harmonic}}{\text{fundamental}} = \frac{A - 1}{A + 1 + 1.41A''(A' + 1)}$$

$$\frac{\text{3rd harmonic}}{\text{fundamental}} = \frac{A + 1 - 1.41A''(A' + 1)}{A + 1 + 1.41A''(A' + 1)}$$

A , A' and A'' are the ratios of instantaneous values of A.C. currents, viz.,

$$A = \frac{\text{pos. current peak}}{\text{neg. current peak}}$$

$$A' = \frac{\text{value of } I_{\text{A.C.}} \text{ at } 0.293E_0}{\text{value of } I_{\text{A.C.}} \text{ at } 1.707E_0}$$

$$A'' = \frac{\text{value of } I_{\text{A.C.}} \text{ at } 1.707E_0}{\text{value of } I_{\text{A.C.}} \text{ at } 2E_0}$$

and $E_0 =$ the standing bias.

The three ratios can be read directly in relative measure on the load lines; the $I_a E_a$ curves for $E_g = 0.293E_0$, $1.707E_0$ and $2E_0$ must be drawn beforehand.

The formula for the 2nd harmonic will be found to give results differing only slightly from those obtained by the use of the formula on page 84.

The working point for maximum power output is usually determined by the data for maximum anode dissipation and maximum D.C. voltage permissible. These are published by the manufacturers. The standing current is approximately 0.4 of the current for $E_g = 0$; this holds good also when an anode voltage is used which is less than the maximum permissible value.

An attempt to obtain a larger output by a decrease in grid bias and correspondingly an increase of anode current, irrespective of anode dissipation, would not be successful, as is evident from the set of $I_a E_a$ curves. This is in contrast to the case of a triode.

The power output is approximately

$$\frac{(E_{max.} - E_{min.})(I_{max.} - I_{min.})}{8}$$

The anode efficiency usually lies between 30% and 35% when the screen current is taken into account, and between 35% and 40% when the screen current is disregarded.

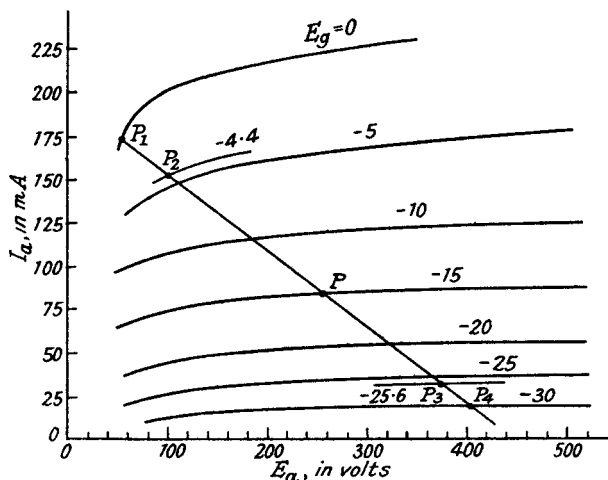

FIG. 54.

A set of $I_a E_a$ curves of a pentode and the load line for optimum operation in class A1 operation may serve as an example from

which to learn the method of calculating power output, efficiency and distortion (Fig. 54). The following figures can be read directly from the graph. Anode load : 2,300 ohms, power output : approx. 7.6 watts. For the calculation of distortion the values needed are

$$A = \frac{P_1 P}{PP_4} = 1.36, \quad A' = \frac{P_2 P}{PP_3} = 1.31, \quad A'' = \frac{PP_3}{PP_4} = 0.8,$$

hence

$$\frac{\text{2nd harmonic}}{\text{fundamental}} = \frac{0.36}{2.36 + 1.41 \times 0.8 \times 2.31} = 7.4\%.$$

(The formula, page 85, gives 7.6 %.)

$$\frac{\text{3rd harmonic}}{\text{fundamental}} = \frac{2.36 - 1.41 \times 0.8 \times 2.31}{2.36 + 1.41 \times 0.8 \times 2.31} = \frac{-0.25}{4.95} = 5\%.$$

(The negative sign merely indicates the phase.)

Comparison between Triode and Pentode in Class A1 Amplification. The main features may be summarised as follows :

In favour of pentodes : The anode efficiency is at least 1.5 times as high as that of triodes. The amplification factor is large and therefore the required driving voltage is small.

In favour of triodes : The distortion is small and consists mainly of even harmonics ; it can therefore be eliminated by push-pull amplification. Loud-speaker resonances are less pronounced with triodes than with pentodes ; this is due to the damping influence of the low impedance triode.

The influence of negative feedback will be briefly discussed at the end of the chapter.

The Push-pull Amplifier. Two valves are arranged in a way indicated in Fig. 55. The cathodes are at the same potential and the grids are excited with

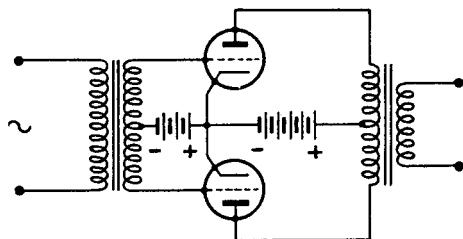

FIG. 55.

voltages of equal amplitude and opposite phase. The two anode currents in the output transformer produce opposing magnetic fluxes and the resulting flux is at any moment the difference of the two.

Thus a resultant static characteristic can be obtained by plotting the two individual characteristics in the way shown in Fig. 56 for a common grid bias. The dotted line is the difference of the two currents and represents the effective current in the output transformer as a function of

voltage induced in the input transformer for zero anode load. It is evident that for two identical valves the effective transformer current is zero at the working point. Fig. 56 can be understood by realising that the grid voltage of one valve increases when that of the other valve decreases, and vice versa. It shows that the bottom bend disappears in the resultant curve and that therefore the valves can be operated down to zero current without undue distortion. Thus class AB and class B amplification are possible, both of which are ruled out for single valves because of distortion. The various types of amplification may be discussed separately.

Triodes in Class A1 Amplification. The advantages to be derived from the use of triodes in class A1 amplification as compared with a single valve are as follows :

Low distortion.

No D.C. saturation of the output transformer.

No A.C. current delivered into the supply and hence less danger of feedback.

No hum picked up from the supply.

The power output is twice that of a single valve, but the anode efficiency is unaltered. Thus there is no advantage from the energy point of view compared with the single valve operation. Both valves work for the whole of the time and hence the valve impedances can be considered as connected in series. The output transformer is to be designed so that the load reflected between anode-anode is twice that required for a single valve (see page 15).

The push-pull stage with triodes in class A1 amplification represents, as far as distortion is concerned, the highest standard possible. Owing to its low anode efficiency it is rarely used.

Triodes in Class B1 Amplification. The exact analysis of two valves working in class B push-pull is difficult. In the following all complicating features have been omitted for the sake of clarity. The results obtained in practice differ little from what is to be expected on the simple theory. The valves are biased almost to cut off, and the anode current of each individual valve is zero for nearly half the cycle. In spite of this fact the distortion is not large as one valve starts working when the other ceases to do so. Drawing the two $I_a E_a$ characteristics in the same way as in Fig. 56

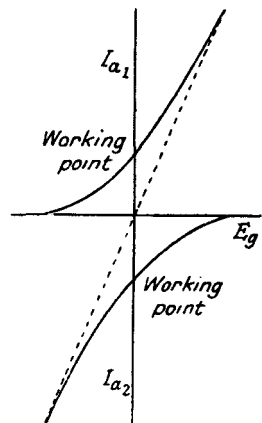

FIG. 56.

shows immediately that in the resulting static characteristic the bottom bend disappears (Fig. 57). But a certain amount of non-linearity still exists owing to the increase in mutual conductance with increasing current. If the two valves are identical this effect cannot produce even harmonics and is, therefore, not so serious.

The efficiency of the amplifier stage is very high owing to the small standing current in each individual valve. The anode efficiency may be calculated with the assumption that the valve characteristics are straight lines, that the working point is the cut-off point (Fig. 58), and that each valve is active during half a cycle and inactive during the other half. Then only one valve need be considered.

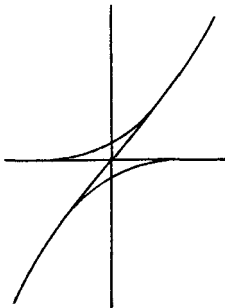

FIG. 57.

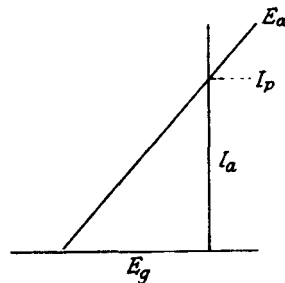

FIG. 58.

E_g is supposed to be a sine wave; its amplitude may be limited by considerations of grid current, i.e. by the y -axis in Fig. 58. The anode current is the half of a sine wave and the instantaneous anode voltage is $E = E_a - IR$, where I signifies the instantaneous anode current and R the anode load. If I_p is the anode current for $E_g = 0$, the relation must be

$$I_p = \frac{E_a - I_p R}{\rho},$$

$$\therefore I_p = \frac{E_a}{\rho + R}.$$

The D.C. current caused by the half wave is

$$I_{\text{D.C.}} = \frac{\omega}{2\pi} \int_0^{\pi} I_p \sin \omega t \, dt = \frac{I_p}{\pi}$$

and the total power supplied is given by the product

$$E_a I_{\text{D.C.}} = \frac{E_a I_p}{\pi} = \frac{E_a^2}{\pi(\rho + R)}.$$

The power output is

$$\frac{1}{4} I_p^2 R = \frac{1}{4} E_a^2 \frac{R}{(\rho + R)^2}$$

The anode dissipation is the difference of power supplied and power output, hence

$$\text{anode dissipation} = \frac{E_a^2}{\pi(\rho + R)} - \frac{1}{4} E_a^2 \frac{R}{(\rho + R)^2}$$

The anode efficiency is the ratio $\frac{\text{power output}}{\text{power supplied}} = \frac{\pi R}{4\rho + R}$.

For a given H.T. voltage, disregarding the anode dissipation, the anode load for maximum output is obtained by differentiating the above equation with respect to R , resulting in $R_{opt.} = \rho$. This is evident in these circumstances since the grid amplitude is fixed.

The power output becomes in this case $\frac{E_a^2}{16\rho}$.

The anode efficiency = $\frac{\pi}{8} = \text{approx. } 39\%$.

If, on the other hand, there were no limit set to the anode voltage and if only the anode dissipation had to be considered, it would be advantageous to choose the H.T. voltage as large as possible. R is then determined by the anode dissipation and will be large compared with ρ . Thus the power output becomes approximately $\frac{E_a^2}{4R}$ and the anode efficiency = $\frac{\pi}{4} = \text{approx. } 78.5\%$.

Triodes in Class B2 Amplification. In actual fact the anode voltage necessary to achieve this high efficiency is greater than is permissible or convenient, and the large output possible is obtained by driving the valves into grid current. Distortion is kept low on the one hand by the push-pull arrangement, on the other hand by methods described on page 257.

When the valves are driven into positive grid current the load resistance and the grid swing are determined by the following factors :

1. The anode voltage must not fall below a minimum value, as otherwise grid current becomes excessive.
2. The anode dissipation must keep within the rated value.
3. The power required at the grid for maximum positive grid voltage must not exceed the value that can be obtained from the previous stage.
4. The distortion due to the flow of grid current must keep within permissible limits.

The resultant curve of grid voltage at the output valve is found by drawing the load line for the preceding valve. The slope of this load line increases as soon as grid current flows in the output valve, corresponding to a smaller anode load. The variation of grid voltage at the output valve, as a function of grid voltage at the previous valve, thus becomes smaller to an extent easily read from the graph (Fig. 59).

Fig. 60, showing the grid current for two different grid volts as a function of anode voltage, makes it clear why the latter must not be allowed to fall below a certain value; an excessive rise of grid current would otherwise result.

The anode load reflected between anode-anode has to be four times the load required for a single valve. This follows from the fact that only one valve is working at a time and that hence the

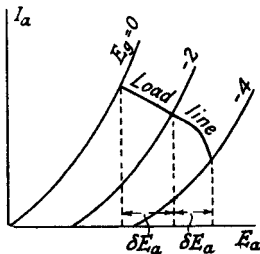

FIG. 59.

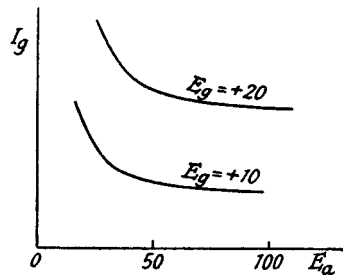

FIG. 60.

output transformer has to be designed so that each valve looks into its proper load. The basic difference in this respect between class A and class B amplification may be learned from Fig. 61.

The line APB is the correct load line if a single valve is used in class A amplification. If, now, a second valve is added for push-pull operation and the transformer changed by doubling the number of primary turns and leaving the number of secondary turns unaltered, each valve still looks into the same anode load. The load line of valve I, however, is altered, as for the same change in anode current the change in anode voltage is twice as much, owing to the additional effect of the second valve II. Instead of working on the load line $A'P'B'$ as should be the case, the valves would work on $A''P'B''$. Therefore the output transformer for push-pull class A amplification must be designed so that each valve looks into a load half the correct value for the single valve, i.e. the load reflected between anode-anode is twice the value necessary for the single valve.

In class B amplification the idle valve does not influence the anode voltage of the working valve and the latter must look into a load which is correct without consideration of the other valve.

Class B amplification requires a high degree of equality between the two valves to avoid distortion. The H.T. supply must have a low D.C. resistance in order to avoid fluctuations of the D.C. voltage as a result of the variations in D.C. current of the push-pull valves. A self-biasing arrangement is ruled out for obvious reasons.

Triodes in Class AB Amplification. Class AB amplification stands somewhat in the middle between class A and class B amplification. The valves are driven so that the anode current falls

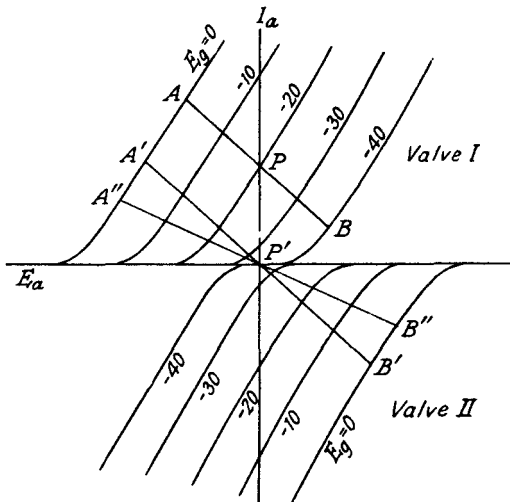

FIG. 61.

to zero or may even be cut off for a short part of the cycle. The arrangement does not demand such a high degree of equality between the two valves as does class B amplification; still, the power output is appreciably more than twice that of a single valve in class A amplification. The load anode-anode is approximately 5-6 times the valve impedance, i.e. each valve looks into a load resistance slightly higher than the valve impedance. The possibility of driving the valves into grid current exists in the same way as for class B amplification. The correct anode load is determined graphically, by consideration of the various factors mentioned for class A and class B amplification. Class AB amplification in push-pull arrangement is the method most frequently used for obtaining high output.

The following table may be taken as a rough guide. The figures are given in relative measure, the output of a single triode being assumed as 1.

TRIODES	
<i>Arrangement</i>	<i>Power Output</i>
Single valve in class A1	1
Push-pull in class AB1	3-4
„ - „ in class AB2	6-9

Pentodes. When pentodes are operated in push-pull the advantages are the same as those which have been explained for triode valves, and need not be repeated here. The ratio of power output of two pentodes in push-pull to power output of a single valve is about half that with triodes because of the greater efficiency of the single pentode. The anode load should be chosen so that with a single valve there would be mainly 2nd harmonic and little 3rd. This is evident since odd harmonics are not eliminated by the push-pull arrangement.

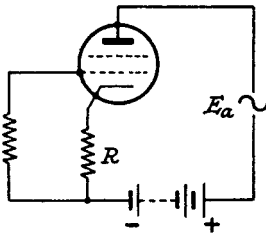

FIG. 62.

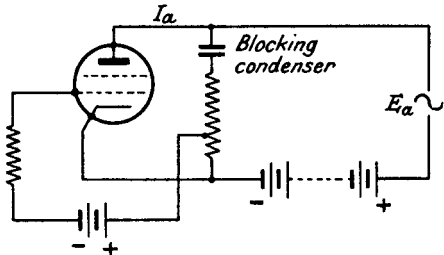

FIG. 63.

The possibility of negative feedback for the power stage has been disregarded. Its effect consists mainly in decreasing the distortion, at the cost of an equal drop in gain. Its application seems appropriate for tetrodes and pentodes, if the quality is to be of a standard similar to triodes. Negative feedback, if correctly used, also decreases the valve impedance and thus makes loud-speaker resonances less dangerous. The effect of negative feedback on the valve impedance may be discussed for two cases.

1. *Current feedback* (Fig. 62). An E.M.F. at the anode causes a current I_a , which in its turn produces an opposing E.M.F. $I_a R$ at the grid. Hence

$$I_a = \frac{E_a - \mu I_a R}{\rho}$$

$\therefore I_a = \frac{E_a}{\rho + \mu R}$, i.e. the valve impedance is increased in the ratio

$1 : \left(1 + \frac{\mu R}{\rho}\right)$. The decrease in gain and in distortion is in the ratio of $\frac{1}{1 + g_m' R}$, where g_m' is the dynamic mutual conductance.

2. *Voltage feedback* (Fig. 63). The fraction βE_a of the anode voltage is fed back to the grid. An E.M.F. E_a at the anode produces a voltage βE_a of the same phase at the grid. Hence the anode current is $I_a = \frac{E_a(1 + \mu\beta)}{\rho}$, equivalent to a drop of valve impedance in the ratio $\frac{1}{1 + \mu\beta}$. The decrease in gain and in distortion is in the ratio of $\frac{1}{1 + \beta A}$, where A is the stage gain.

It is evident that of the two circuits Figs. 62 and 63 the latter is the suitable method.

PROBLEMS OF DETECTION AND FREQUENCY CHANGING

The Diode.

I. The Unmodulated Carrier. The action required from a diode valve is based upon its rectifying features and may be discussed with the aid of Fig. 64. The detector valve D is considered as a short circuit in one direction and as an infinite resistance in the other. For a sinusoidal voltage E_1 the current through R is the half of a sine curve, the peak value being $\frac{E_{1(\text{peak})}}{R}$. The average D.C. value of this current is

$$\frac{\omega}{2\pi} \frac{E_{1(\text{peak})}}{R} \int_0^{\frac{\pi}{\omega}} \sin \omega t \, dt = \frac{1}{\pi} \frac{E_{1(\text{peak})}}{R},$$

and hence the D.C. voltage across R becomes $\frac{E_{1(\text{peak})}}{\pi}$. In actual fact the diode resistance is not zero; its influence can, however, be neglected when it is small compared with R .

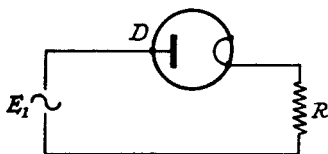

FIG. 64.

As a result of the curvature of the diode characteristic, the resistance R_d of the diode has not a constant value but depends on the working point.

The relations between $I_{\text{D.C.}}$ and $E_{\text{D.C.}}$ are determined by the well-known formula $I_{\text{D.C.}} = KE_{\text{D.C.}}^{\frac{3}{2}}$; for an average diode K is of the order of 0.5×10^{-3} , i.e. a D.C. voltage of 4 volts causes a current of 4 mA. For an applied sinusoidal voltage of 4 volts the average diode resistance is of the order of a few thousand ohms, which is small compared with R in the cases occurring in practice.

The efficiency of the diode can be expressed by the ratio of $\frac{\text{D.C. voltage across the load}}{\text{Peak voltage of the A.C. source}}$; it is approximately $\frac{1}{\pi}$ for the circuit of Fig. 64. The efficiency can be increased by connecting across R a condenser of a value such that during the negative cycle of E_1 the discharge of the condenser through R can be neglected. Under the same assumption as above, viz. that the diode resistance is zero, the condenser is charged to the peak value of

E_1 during the positive cycle and remains approximately at this value all the time. The efficiency of the circuit Fig. 65 is hence about π times as high as that of Fig. 64, which explains why it is used in the majority of cases (compare page 273).

Owing to the fact that the resistance of the diode is not zero during half the cycle, the condenser C is charged to a d.c. voltage below the peak value of E_1 . The short pulses flowing through the diode when the instantaneous value of E_1 is above the d.c. value of C replace the loss of charge during the rest of the cycle. Because of the short duration of these pulses, the resistance of the diode has a far greater influence on the d.c. voltage developed across C than might be expected (compare Chapter 13). It can be shown that for a ratio of $\frac{R}{R_d} = 100$, the d.c. voltage developed is 90% of the peak value of E_1 , and for a ratio $\frac{R}{R_d} = 10$ it is about 60% ;

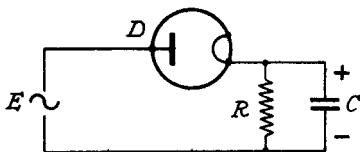

FIG. 65.

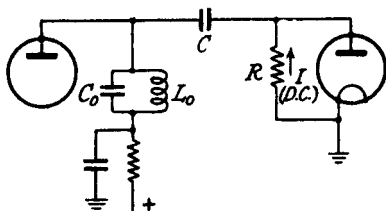

FIG. 66.

this is only an approximation, no allowance being made for the variation of diode resistance with amplitude. Due to this variation the loss in efficiency with decreasing load is less than suggested by the two numerical examples, as can be seen from the graph on page 101. In the following it will be assumed that R_d can be neglected in comparison with R and that the d.c. voltage developed is equal to the peak value of E_1 .

Circuits on the lines of Fig. 65 are utilised in receiver design for obtaining the d.c. voltage necessary for automatic volume control and automatic frequency control (see Chapters 7, 11, and later in this chapter). In cases where the applied e.m.f. contains a d.c. component as well, as in tuned anode circuits, the circuit Fig. 66 is to be used, which blocks the d.c. voltage from the diode.

The process of charging C is identical with that described with the aid of Fig. 65. The two circuits differ, however, in the power taken from the source. In Fig. 65 there is across R a pure d.c. voltage equal to $E_{1(\text{peak})}$, and hence the power dissipated in R is

$\frac{E_1^2(\text{peak})}{R}$, equal to that dissipated in a resistance $\frac{R}{2}$ connected directly in parallel to E_1 . In Fig. 66 the voltage across R is the sum of a D.C. voltage equal to $E_1(\text{peak})$ plus the A.C. voltage E_1 , therefore the total power dissipated in R is $\frac{3E_1^2}{2R}$, equal to that dissipated in a resistance $\frac{R}{3}$ connected in parallel to E_1 . In practice the damping effect in Fig. 66 may be even worse, as the radio frequency resistance is often considerably below the rated D.C. value (see chart Fig. 245, Chapter 14).

Example: In Fig. 66 the data of the anode circuit are $C_0 = 150$ pF, $L_0 = 800$ microhenries, $Q = 115$. Find the Q with the diode circuit included, for $R = 1$ M Ω , using the chart just mentioned.

For a radio frequency amplitude having the peak value E_p across the tuned circuit the power dissipated in R is

$$\text{D.C. : } E_p^2 \times 10^{-6}$$

$$\text{A.C. : } \frac{E_p^2}{2} \cdot 1.25 \times 10^{-6}$$

since the A.C. resistance at 460 Kc/s is about 0.8 M Ω . The total power is $E_p^2 1.62 \times 10^{-6}$, equal to that dissipated in a parallel resistance of 0.31 M Ω . The damping factor d due to this resistance is

$$\frac{\omega L}{0.31 \times 10^6} = \frac{2,300}{0.31 \times 10^6} = 0.74\%$$

The natural damping is $\frac{1}{Q} = 0.87\%$, hence the total damping is 1.61%, corresponding to a Q of 62. Without the use of the resistance chart the Q would turn out to be 64.

II. The Modulated Carrier. Let us assume now that the amplitude of E_1 is slowly increased and decreased. The D.C. voltage across the load varies correspondingly, provided the time constant of C and R is not too great. As shown in Chapter 11, the constant CR can always be chosen so that the D.C. voltage across C (or R) follows the audio frequency variations of a modulated carrier, and hence the diode can be used to produce audio frequency which is a very close reproduction of the carrier envelope. The fact that the diode resistance is not zero and that this resistance varies with voltage is one of the causes preventing a perfect reproduction of carrier modulation. The diode efficiency, i.e. the ratio

D.C. voltage to the R.F. peak, is less than unity and depends on the carrier amplitude. To derive this D.C. value as a function of the diode load and of the carrier strength a graphical method is employed similar to that used in Fig. 51, Chapter 3, for the derivation of the valve load lines. The corresponding series of diode characteristics is shown in Fig. 67 in a form in which they are usually published by the manufacturers.

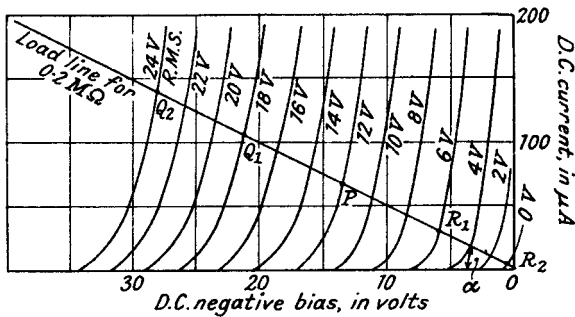

FIG. 67.

These characteristics are, however, different from the corresponding curves of the triode. They give the D.C. current as a function of anode voltage, under the influence of a source of A.C. voltage. The latter is given as parameter, the anode load being zero. Such curves can be obtained experimentally as shown in Fig. 68, employing 50 c/s as A.C. source. They may also be derived graphically if the D.C. characteristic of the diode is known, but the latter method is fairly laborious.

The decreasing steepness of the curves for larger A.C. voltages is explained by the shorter duration of current flow. Fig. 67 can be used to derive for circuits Fig. 65 or Fig. 66 the D.C. voltage

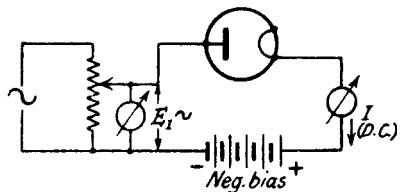

FIG. 68.

across the condenser for any given A.C. voltage and any load resistance. Let us take an arbitrary point P on one of the curves in Fig. 67. This point indicates that with an A.C. voltage of 12 volts R.M.S. and a negative anode voltage of 13.5 volts, a D.C. current of 67 μA is obtained in the circuit Fig. 68. Hence in Figs. 65 and 66 an A.C. voltage of 12 volts will produce the same D.C. of 67 μA in R when the magnitude of R is such that

67 μA produce an IR drop of 13.5 volts; this leads to 0.2 $\text{M}\Omega$ as the correct resistance value. It follows from this that to find the D.C. current through a resistance R (or the D.C. voltage across R) in circuits like Figs. 65 and 66, a straight line is to be drawn in Fig. 67 from the intersection of the x and y -axis; the angle α has to be such that $\frac{1}{\tan\alpha} = R$. The intersection of this line with any of the curves indicates the D.C. voltage obtained on applying the A.C. voltage marked on this curve. On modulating the amplitude of the A.C. voltage, the working point of the diode moves along the load line having the slope $\tan\alpha = \frac{1}{R}$, and the instantaneous D.C. voltages across C or R can be read from the graph, as it is the x -co-ordinate of the working point. Fig. 67 is thus closely correlated with Fig. 51 in Chapter 3, the load line giving in both cases information as to the distortion encountered. An example may be added.

Example: The diode of which the behaviour is represented by the series of curves in Fig. 67 is connected as shown in Fig. 65. The load resistance is 0.2 megohm, the influence of the time constant CR may be disregarded. E_1 is a modulated radio frequency carrier of 12 volts R.M.S. Find the second harmonic contents for 50% and 100% modulation.

Using the formula given on page 85, and taking the ratios

$$A = \frac{Q_1P}{R_1P} \text{ and } \frac{Q_2P}{R_2P}, \text{ in Fig. 67, we arrive at:}$$

<i>Modulation Factor</i>	<i>2nd Harmonic Content</i>
50%	2%
100%	5.5%

The result shows that the distortion of the diode as deduced from the load line is of the same order as that of power output valves. The distortion rises with modulation as the diode works in the curved part for minimum carrier amplitude. The larger the unmodulated carrier the less the distortion, as will be readily understood from Fig. 67. For this reason the carrier amplitude at the diode should not be less than about 10 volts peak. As to further more serious causes of distortion with diodes, see Chapter 11.

Metal oxide rectifiers have features similar to those of a diode. Their back resistance is not infinite, which slightly lessens their efficiency. At audio frequency and often up to 100 Kc/s they work satisfactorily. Used at higher frequencies they often cause

serious losses. Some types, when used in the circuit of Fig. 65 with $R = 0.1$ megohm, gave the following results :

at 100 Kc/s : the parallel damping is that of 30,000 ohms,

at 600 Kc/s : the parallel damping is that of 10,000 ohms.

Information about the properties of such a rectifier should therefore be obtained before considering its use. Measuring the Q of a tuned circuit with and without the influence of the rectifier is the appropriate procedure.

Grid Detection. The grid-cathode path of a triode or pentode valve can be looked upon as a diode. If connected to a source of radio frequency on the lines of Fig. 65 or 66, a negative D.C. voltage is generated between grid and cathode, causing the anode current to decrease. A modulated radio frequency carrier correspondingly produces audio frequency between grid and cathode and this is amplified by the valve. If the audio frequency is measured at the

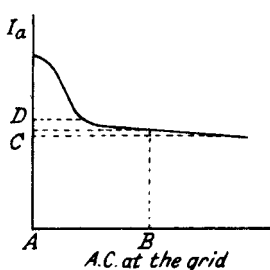

FIG. 69.

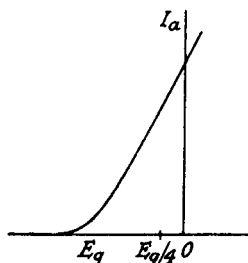

FIG. 70.

grid as well as at the anode of the valve the following is found. The voltage at the grid rises constantly with the carrier in the same way as for a diode, whereas the voltage at the anode only rises for a carrier strength up to one or two volts and then indicates overloading. The reason for this behaviour may be understood from Figs. 69 and 70. In Fig. 69 the anode current of a grid leak detector is plotted as a function of the amplitude of the radio frequency carrier at the grid. Initially the anode current drops owing to the increase in negative grid bias, showing the same type of curve as might be derived in Fig. 67 for a load equal to the grid leak resistance. For a carrier strength of a few volts, however, the anode current becomes almost independent of the carrier strength. This fact is explained from Fig. 70. The working point of the valve moves towards the lower bend because of grid detection and hence a second form of rectification takes place at the anode of the valve. This effect, which is called anode bend detection, tends

to increase the anode current and counteracts the grid leak detection. Thus a modulated carrier of the amplitude AB in Fig. 69 may become almost inaudible if its modulation factor is not above 50% ; the amplitude of the audio frequency current in the anode would be approximately $\frac{CD}{2}$. For a larger modulation factor the audio

frequency amplitude would increase suddenly, but violent distortion would take place. To avoid the effect of additional anode bend detection when the modulation factor just reaches 100%, the carrier strength at the grid must be such that the unmodulated carrier produces a grid bias not more than one-fourth of E_g in Fig. 70. In this case the maximum carrier amplitude reaches E_g during the negative cycle, the working bias being approximately $\frac{E_g}{2}$ at this moment. Consequently grid leak detection mostly works with small grid voltages when the audio frequency amplitude is proportional to the square of the amplitude of the radio frequency carrier. This naturally involves appreciable distortion. The D.C. voltage obtained from a small carrier is only a fraction of the carrier peak. For a 100% modulated carrier of 50 millivolts one may expect about 5 millivolts audio frequency at the grid, the grid leak resistance being 1 megohm. Hence additional damping due to the power dissipated in this resistance becomes negligible if the circuit Fig. 65 is used. Grid current flows during the whole of the cycle and determines the damping effect. The latter is equivalent to a resistance of the order of 0.1–0.2 megohm for indirectly heated valves.

The use of grid leak detection has become comparatively rare. It is still found in small receivers, often in connection with regeneration. Its application may be explained by the cheapness of the circuit, the valve working as a detector, audio frequency amplifier and, in case of regeneration, as a means of providing variable selectivity and oscillations.

Power grid detection is in principle not different from normal grid detection. The valve is merely working with very high anode voltage to give a larger margin before anode bend detection starts. This permits working on the linear part of the grid detector curve and yields good quality ; the grid leak is in this case decreased to about 0.2 megohm to prevent distortion at higher frequencies (page 260). Low μ valves naturally allow a larger grid swing than valves with a high μ . An increase in audio frequency output does not result from the use of a low μ valve if resistance or choke coupling is employed in the anode circuit. Only the use of transformer

coupling makes possible a larger output with the low μ valve, since a transformer with a greater step-up ratio can be used in this case (Chapter 3).

Anode Bend Detection. To obtain anode bend detection the valve is biased to a point near cut-off and the $I_a E_g$ characteristic utilised for rectification. For small inputs the valve is very insensitive because of the small rate of curvature at the lower bend; the distortion is appreciable owing to the square law detection. The most suitable grid amplitude is of the order of 2 volts; the maximum grid amplitude permissible is determined by the fact that grid current must be avoided. If the valve characterised by Fig. 70 is employed for anode bend detection and the standing bias is E_g , a maximum voltage $\frac{E_g}{2}$ of the unmodulated carrier is permissible

when the modulation factor is 100%. Satisfactory working is thus limited to a very restricted range of carrier amplitude, and anode bend detection requires, therefore, a very efficient A.V.C. system.

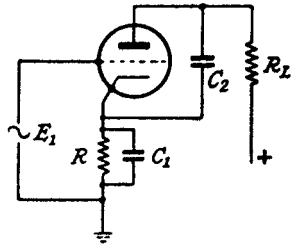

FIG. 71.

If auto bias is applied, the cathode resistance R in Fig. 71 has to be of the order of 20,000–50,000 ohms, because of the small current employed. The method has the advantage of closely limiting the anode current for different valves, but, due to the negative feedback, it involves loss of gain. To by-pass R with a condenser, the reactance of which is small for audio frequency, would be a serious mistake. It would result in distortion similar to that described on page 261. In both cases the cause of distortion is the difference of load line for D.C. and A.C. Hence one has to put up with the loss from negative feedback, or alternatively one has to apply a fixed bias. Average values are: $R_L = 0.2$ megohm, $C_1 = C_2 = 100$ pF. To calculate the efficiency of the valve it is best to replace the signal E_1 by an E.M.F. μE_1 in the anode and then to treat the valve like a normal diode. For ideal rectification and a 100% modulated carrier the ratio of audio frequency voltage at the anode to radio frequency voltage at the grid is μ , if R is replaced by a fixed bias. Due to the fact that the valve impedance is larger than that of a diode and cannot be neglected in comparison with R_L , one may reckon with a ratio of $\frac{\mu}{2}$. Negative feedback from R may reduce the gain to about one-fifth of this value.

A pentode can be used as an anode bend detector in the same way. The anode load R_L is usually small compared with the valve impedance; with ideal rectification, the anode current is the half of a sine curve. The D.C. anode current becomes $\frac{1}{\pi} g_m E_g$ and the anode voltage $\frac{1}{\pi} g_m E_g R_L$, where E_g is the peak value of E_1 . The ratio of audio frequency voltage at the anode to radio frequency voltage at the grid for a 100% modulated carrier is hence $\frac{1}{\pi} g_m R_L$.

Frequency Conversion. The basic principles of the superhet receiver consist in producing a new frequency by mixing the receiver signal with a local oscillator signal in a non-linear device. The process is closely related to the action of a detector valve, and actually any of the above devices might be used for purposes of frequency conversion. A few introductory remarks on the principle of a superhet receiver, its advantages and disadvantages, may be inserted.

The signal of frequency f_1 , and the local oscillation of frequency f_2 , are applied to the frequency converter valve. This valve produces the frequencies f_1 , f_2 , $f_1 \pm f_2$ and various other combination frequencies. The amplifier after the mixer valve is tuned to a frequency f_i which is called the intermediate frequency. Signals are received when they are of such a frequency that they produce the intermediate frequency f_i by combination with the local oscillator. If the oscillator frequency is $f_2 > f_i$ there are two signal frequencies f_1 and f_1' producing with f_2 the intermediate frequency, viz., $f_1 = f_2 - f_i$ and $f_1' = f_2 + f_i$. The mixer valve is not capable of discriminating between these two frequencies, and means of separating them must be provided before the mixer valve by circuits tuned to one of the two frequencies. Modern superhet receivers are tuned to stations by simultaneously altering the frequency of the local oscillator and of the radio frequency circuits before the mixer valve. The means of ganging the oscillator circuit with the radio frequency circuits are described later. The advantages of a superhet receiver over a straight receiver are mainly these:

1. The gain and the selectivity obtained from the intermediate frequency amplifier do not depend on the frequency of the signal.
2. The intermediate frequency can be made lower than the signal frequency, resulting in a higher stage gain and a narrower response curve than is possible at the signal frequency. Even with an intermediate frequency higher than the signal frequency there

exists the possibility of obtaining a narrow response curve by the use of a crystal (Chapter 5).

3. The intermediate frequency circuits are cheaper and take less space than the signal frequency circuits, as there is no need for ganged variable condensers.

4. Owing to the absence of the variable condensers there is less risk of undesired feedback within the intermediate frequency amplifier, and screening is easier.

5. The total radio frequency gain is distributed over two frequencies so that overall-feedback is less dangerous.

As disadvantages may be considered the existence of spurious responses (Chapter 5) and a tendency to increased receiver noise. Both drawbacks can, however, be minimised so that they carry little weight in comparison with the great advantages.

The Usual Methods of Frequency Conversion in a Super-het. The two methods used almost exclusively for deriving the intermediate frequency are as follows :

I. *The use of a radio frequency pentode as frequency converter.*

The signal and the local oscillator voltage are simultaneously applied between grid and cathode of a radio-frequency pentode. The pentode works as an anode bend detector near its cut-off point and the anode is tuned to the intermediate frequency (Fig. 72). If auto bias is

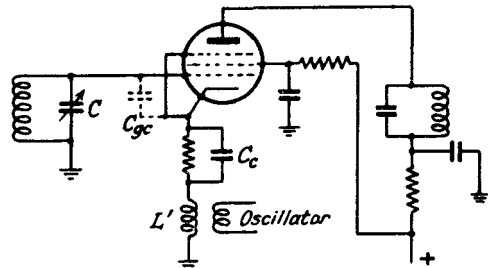

FIG. 72.

employed the cathode resistance is to be chosen so that the pentode works near the cut-off when the oscillator amplitude is injected. The latter should be of a magnitude such that the positive peaks drive the pentode into a region of high mutual conductance, well above the bottom bend. The anode load is small and the valve works similarly to a short-circuited diode. The anode current, in the case of ideal rectification, is the half of a sine curve, its D.C. value being equal to $\frac{g_m E_g}{\pi}$. Consequently the conversion conductance, i.e. the ratio

$$\frac{\text{anode current of intermediate frequency}}{\text{grid voltage of signal frequency}},$$

is at best $\frac{1}{\pi}$ of the mutual conductance ; in practice it will be found about equal to $\frac{g_m}{4}$ for an injected oscillator voltage lying between one and two volts R.M.S. Negative feedback from the cathode resistance is avoided by a shunting condenser C_c , the impedance of which is small for the frequencies concerned. The danger of distortion, described for anode bend detection, does not arise as the signal is small and hence the variation in grid amplitude negligible.

The circuit of Fig. 72 works satisfactorily on medium and long waves when the percentage difference between the oscillator and the signal frequency is fairly large, say above 10%. When this value becomes small and when the oscillator frequency is higher than the signal frequency two main problems arise :

1. The signal coil resonates with the grid-earth capacitance (C in Fig. 72) to a frequency higher than the signal frequency, because the total capacitance of the signal circuit includes the grid-cathode capacitance. The impedance between grid and earth is therefore high at the oscillator frequency and only a small part of the oscillator amplitude induced in L' is applied between grid

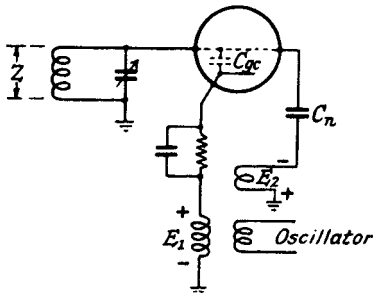

FIG. 73.

and cathode This results in a considerable loss of conversion conductance.

2. Interaction between the signal circuit and the oscillator circuit becomes troublesome.

The two effects can be overcome by neutralisation, as shown in Fig. 73.

If the voltage induced in the cathode lead is E_1 , that in the neutralising coil E_2 , it can be shown by elementary calculation that the voltage applied between grid and cathode is equal to E_1 , independently of Z , when $\frac{E_2}{E_1} = \frac{C_{gc}}{C_n}$, E_2 being in antiphase to E_1 with respect to earth ; the reactances of the coils in series with C_{gc} and with C_n have been neglected in comparison with those of C_{gc} and C_n . The fact that the applied voltage is independent of Z shows that signal circuit and oscillator circuit are decoupled so

that the danger of (2) is removed as well. The neutralising coil is best designed so that $E_2 = E_1$ and consequently $C_n = C_{gc}$.

The method works satisfactorily up to frequencies of about 6 Mc/s and can be recommended for receivers with one frequency range. If applied for several ranges the switching of the neutralising coil and the cathode coil together with the tuning and the reaction coil makes the design almost unmanageable.

At frequencies above 6 Mc/s the method of cathode injection offers considerable difficulties even for one-range receivers. The length of lead between cathode and earth and hence the unavoidable inductance in series with the grid-cathode capacitance increases the apparent C_{gc} and makes it a function of frequency, thus aggravating the ganging problems.

All the difficulties described are considerably increased when the pentode is used as an oscillator as well (Fig. 74), and only the experienced engineer can afford to use this circuit. Above, say, 6 Mc/s the circuit Fig. 74 cannot be expected to work. Three main difficulties may be mentioned.

1. There is a strong tendency to oscillate at frequencies other than the oscillator frequency, since there

exists a great number of parasitic resonances (Chapter 12).

2. The lead from the oscillator circuit to the anode through the I.F. circuit is naturally very long and has appreciable capacitance and inductance. Thus a large capacitance, varying with frequency, is in parallel to the oscillator circuit or to part of it. Once again the ganging problem is aggravated.

3. Reliable oscillation cannot be expected.

If battery valves are used the cathode coupling coil best consists of two interwoven coils, one in each filament lead. This naturally adds to the difficulties.

II. *The use of multi-grid valves (mixer valves).*

The difficulties encountered when using a pentode as a frequency converter do not exist with mixer valves. For this reason the mixer valve is usually employed, unless special conditions, such as the need for restriction in the number of valve types, enforce the use

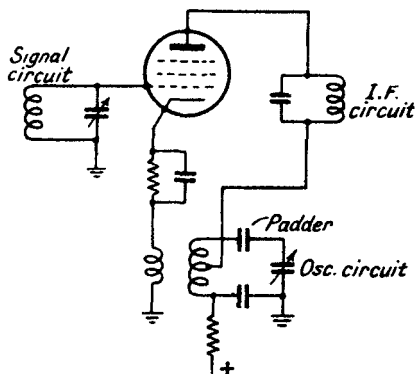

FIG. 74.

of the pentode. There are two basic types of mixer valves, the heptode and the hexode type.

Heptode (Fig. 75). The oscillator signal is injected at the grid nearest the cathode and thus modulates the total current. The signal is injected at the grid No. 4 and influences the distribution of the current between screen grid and anode. Thus the anode current contains a term $\sin 2\pi f_1 t \times \sin 2\pi f_2 t$, where f_1 and f_2 are the frequencies of the oscillator and the signal respectively. This term is equal to $\frac{1}{2}[\cos 2\pi(f_1 - f_2)t - \cos 2\pi(f_1 + f_2)t]$, which shows that the valve can be used as a frequency converter. Due to the valve curvature combination frequencies of harmonics, i.e. $nf_1 \pm mf_2$, are present to some extent and may cause spurious responses (Chapter 5). The heptode is usually employed to generate oscillations as well, the oscillation taking place at the two grids nearest the cathode.

The conversion conductance of a heptode is of the order of 500 micromhos (0.5 mA/V) for optimum oscillator amplitude. The oscillator amplitude should be between 5 and 10 V. Below 5 V the conversion conductance drops; above 10 V the conversion conductance remains fairly constant, but the tendency to produce undesired combination frequencies increases.

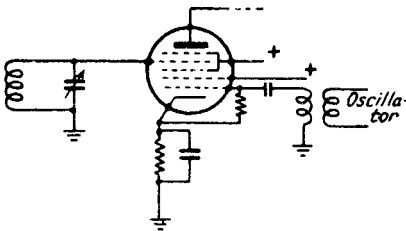

FIG. 75.

When the oscillator and signal frequency differ by only a few per cent, a difficulty arises which is typical of heptodes. The space charge at the signal grid depends on the strength of the cathode current and is modulated with the rhythm of the oscillator frequency. When the alternating voltage at the oscillator grid is positive the cathode current is large and so is the space charge at the signal grid. The detector circuit between signal grid and cathode being capacitive at the oscillator frequency, there is induced at the signal grid a voltage in antiphase with the oscillator voltage at the oscillator grid. Owing to this effect the anode current drops and the conversion conductance may become one-half or even one-fourth of its normal value.

The effect can be neutralised by inserting a capacitance between signal grid and oscillator grid. The size of this capacitance is approximately 1 pF. At very high frequencies a time lag arises between the oscillator voltage and the movement of the space charge

at the signal grid, the time lag being caused by the inertia of the electrons. The correct neutralising method consists, therefore, in connecting a resistance in series with the neutralising capacitance, the resistance being of the order of 1,000 ohms. Above about 20 Mc/s most heptodes cease to work satisfactorily.

Hexode. The principle of a hexode may be seen from Fig. 76.

In contrast to the heptode the signal controls the emission current and the oscillator voltage controls the distribution between anode and screen grid. Hence the oscillator voltage does not affect the space charge at the signal grid and the valve works satisfactorily even for small percentage difference between the signal and the oscillator frequency.

In a triode hexode the oscillator and the mixer valve are placed together in one bulb, with common cathode but separate electron paths for the two systems. Such valves are usually satisfactory, at least up to frequencies of 30 Mc/s.

For hexodes and heptodes the problem of undesired coupling between the signal circuit and the oscillator circuit is of major importance. Such coupling may exist inside or outside the valve. With modern mixer valves the capacitance between the signal and

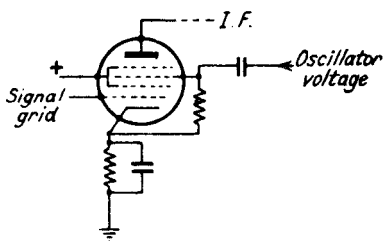

FIG. 76.

the oscillator grid is about 0.2 pF. As a result of this the oscillator frequency is found to vary by 1,000–2,000 c/s at 20 Mc/s, when the signal circuit is tuned through the oscillator frequency. Naturally the effect depends on the tuning capacitances of both circuits and on the Q of the signal circuit. Often the effect is masked by direct coupling owing to the common condenser spindle (Chapter 9). Such coupling is particularly troublesome at high frequencies when the two circuits are only a few per cent apart. The following detrimental effects may arise (this naturally applies to heptodes as well) :

1. Change of oscillator frequency with gain control, i.e. with signal strength in the case of A.V.C. This effect is very serious in the case of c.w. reception with beat frequency oscillation and crystal filter.

2. Change of oscillator frequency with variations of the aerial circuit. Such variations may be caused by wind or by movements of the operator. The effect can be explained by assuming additional

coupling between the aerial circuit and the detector circuit. Such coupling is always existent to a larger or smaller extent because of the common condenser spindle.

3. Incorrect adjustment of the oscillator circuit. Such wrong adjustment is known to occur fairly frequently and a more detailed discussion seems for this reason necessary. Let us assume the first oscillator of a superhet is to be adjusted to the correct frequency range and then to be ganged. For this purpose the signal generator is first connected to the grid of the mixer valve and the oscillator circuit adjusted to cover the required frequency range. The correct procedure for this adjustment may be briefly described. The conventional means available are a variation of inductance and of minimum capacitance (condenser trimmer). The order of adjustments should be as follows :

1. Adjust the circuit at the low-frequency end by means of the coil, the position of the condenser trimmer being of secondary importance.

2. Adjust the circuit at the high-frequency end by means of the condenser trimmer.

3 and 4. Repeat the procedure of (1) and (2) in the same order.

The reason for this is easy to see and needs no explanation. On ranges where the percentage difference between the signal frequency and the oscillator frequency is small, one should never forget to make sure that the oscillator is not adjusted for reception of the image frequency.

The oscillator being correctly adjusted, the signal generator is applied to the grid of the previous valve, or, if no radio frequency valve exists, to the aerial input terminals. Now the detector

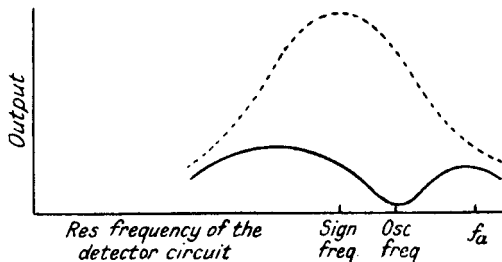

FIG. 77.

circuit is adjusted to maximum reception in the same way. In the case of strong coupling between the oscillator and the detector circuit a large mistuning of the oscillator frequency takes place when the

detector circuit is being tuned within a few per cent of the oscillator frequency. If the mistuning is more than half the band-width of the intermediate frequency a loss in sensitivity takes place. Hence the output as a function of detector circuit tuning often has a shape as indicated in Fig. 77, instead of the dotted curve for zero coupling.

The correct adjustment of the detector circuit becomes indistinct and the testing engineer may adjust the detector circuit to the frequency f_a . There are two simple ways of avoiding incorrect adjustment even for strong coupling, viz.

1. The tuning of the detector circuit, carried out with the individual adjustments of either coil or capacitance, is altered in small steps and the oscillator frequency corrected after each step with the main tuning knob. Thus a set of curves giving the output as a function of the main tuning is obtained, the setting of the detector circuit being the parameter (Fig. 78). The curve having the highest peak indicates the correct setting of the detector circuit.

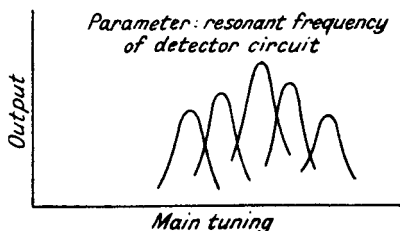

FIG. 78.

2. The signal used for ganging purposes is of the nature of valve noise, containing all frequencies. A buzzer or a noise-producing motor may be employed. If there is sufficient amplification before the mixer valve the noise of the first receiver valve can be used.

The First Oscillator. The first oscillator is one of the most important parts in a superhet receiver. Its correct design offers considerable difficulties when the receiver has to cover a large frequency band employing many ranges. The following problems are likely to be encountered in the course of various developments.

1. Ganging.
2. Stable oscillation.
3. Squegging.
4. Frequency constancy, automatic frequency control.

1. *Ganging.* The frequency difference between the oscillator and the radio frequency circuits must be equal to the intermediate frequency. For one knob control this difference is to be made as constant as possible throughout the frequency range covered. A radio frequency circuit is supposed to cover a frequency range f_1 to f_2 with a given variable condenser. To alter this circuit so that it covers a frequency range $f_1 + f_i$ to $f_2 + f_i$ with the same variable

condenser, so that for equal positions of the condenser the new frequency is larger by approximately the frequency f_i , the following changes are necessary :

The inductance has to be decreased.

A "padding" condenser has to be put in series with the variable condenser.

A capacitance (trimmer) has to be put in parallel with the inductance or with the variable condenser.

These changes are in fact carried out on the oscillator circuit. The new frequency curve obtained does not quite fulfil the demand, but can be made sufficiently near for practical requirements.

Owing to the usually overriding influence of the selectivity of the intermediate frequency amplifier, the receiver is automatically tuned so that the oscillator frequency is larger than the frequency of the required signal by the intermediate frequency. Hence a misganging causes the radio frequency circuits to be mistuned from the signal frequency. The loss in amplification and "image protection" (Chapter 5) can be calculated.

As to the best curve attainable, there exist various opinions. In Fig. 79 the dotted line would be the ideal frequency curve of the oscillator ; the curve AB , having three positions of absolutely correct tracking, gives an indication of what is possible. In Fig. 79 the three points of correct

tracking are chosen so that the four maximum deviations at P_1 , P_2 , P_3 and P_4 are equal. It is also possible to place two of the correct tracking points at the ends, in which case the maximum deviations are bound to be larger than in Fig. 79. It is for this reason that a curve like AB in Fig. 79 is usually recommended. It seems, however, doubtful whether this curve really represents the possible optimum. If, for instance, the frequency range is one to three, and if, as is usually the case, the Q of the radio frequently circuits is largest at the low-frequency end, it is obvious that at high frequencies the deviation permissible is more than three times that at low frequencies. Hence it seems more feasible to use a curve resulting in a frequency deviation largest at the high-frequency end. The only point that might be made against this is that the image protection is least at the high-frequency end and that therefore at the latter any loss in selectivity

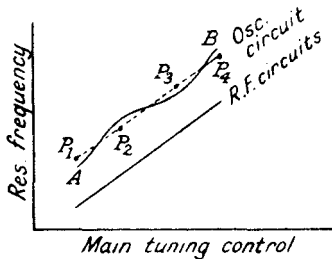

FIG. 79.

due to misganging should be avoided. The purpose of this discussion is to show that the best theoretical curve is a result of the circumstances rather than a foregone conclusion.

The formulae for correct tracking usually given in textbooks are fairly complicated and involve a large amount of calculation. For this reason a formula * may be given here which has proved satisfactory in practice.

The values for the padder and the capacitance trimmer depend on where the two are inserted. The formula given in the following

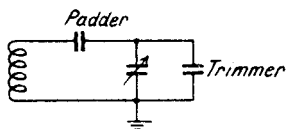

FIG. 80.

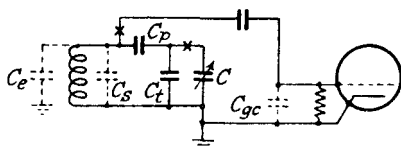

FIG. 81.

is based upon the assumption that the padder is connected in series with the total capacitance of the circuit (Fig. 80).

In actual fact there is always some capacitance not tracked, but by choosing the correct circuit the untracked capacitance can be made so small that its influence is negligible. Figs. 81-83 show three different attempts at achieving the desired result. The crosses in these figures indicate the points where range switching occurs. In the following C_p is the padder, C_t the trimmer, C the variable condenser, C_s the self capacitance of the coil, i.e. the

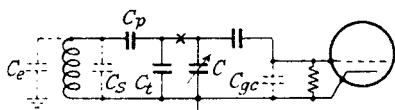

FIG. 82.

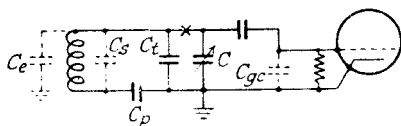

FIG. 83.

capacitance between the turns, C_e the capacitance between earth on the one side and the coil and the attached leads on the other, and C_{gc} the grid-cathode capacitance of the valve. It is obvious that C_s cannot be tracked. The conditions in Figs. 81-83 are:

Fig. 81. C_e , C_s and C_{gc} are not tracked;

Fig. 82. C_e and C_s are not tracked;

Fig. 83. C_s is not tracked;

showing that Fig. 83 best fulfils the conditions assumed in Fig. 80.

Let us suppose now, as is the usual practical case, that there are

* For this I am indebted to Mr. M. Morgan.

given: the frequency range and the capacitance variation of the radio frequency circuits, the intermediate frequency f_i and the three signal frequencies f_1, f_2, f_3 , at which perfect tracking is desired. The three capacitances of the radio frequency circuits at these three frequencies are C_1, C_2 and C_3, C_1 being the smallest. The three oscillator frequencies are $f_1' = f_1 + f_i, f_2' = f_2 + f_i, f_3' = f_3 + f_i$, where $f_1' > f_2' > f_3'$.

Then the expressions for the trimmer and the padder are as follows:

$$C_t = \frac{C_3(\alpha - 1) - C_1(n - 1)}{n - \alpha}$$

$$C_p = \frac{C_1 + C_t}{\frac{n - \alpha}{(n - 1)(1 - p_1)} - 1}$$

where

$$p_1 = \left(\frac{f_3'}{f_1'}\right)^2 \quad p_2 = \left(\frac{f_2'}{f_1'}\right)^2$$

$$\alpha = \frac{1 - p_1}{1 - p_2}$$

$$n = \frac{C_3 - C_1}{C_2 - C_1}$$

Example: The frequency range is 0.55–1.65 Mc/s, the variation in capacitance being 50–450 pF. The intermediate frequency is 0.46 Mc/s, perfect tracking is to be obtained at 0.6 Mc/s, 1 Mc/s and 1.5 Mc/s.

Hence: $f_1' = 1.96$ Mc/s, $f_2' = 1.46$ Mc/s, $f_3' = 1.06$ Mc/s.

$$C_1 = 60.5 \text{ pF}, C_2 = 136 \text{ pF}, C_3 = 378 \text{ pF}.$$

$$p_1 = 0.292, p_2 = 0.555$$

$$\alpha = \frac{1 - 0.292}{1 - 0.555} = 1.59$$

$$n = \frac{317.5}{75.5} = 4.2$$

$$\therefore C_t = \frac{378 \times 0.59 - 60.5 \times 3.2}{2.61} = \frac{223 - 193.5}{2.61} = 11.3 \text{ pF}.$$

$$C_p = \frac{60.5 + 11.3}{\frac{2.61}{3.2 \times 0.708} - 1} = 473 \text{ pF}.$$

Deviations from the theoretical curve caused by the self-

capacitance C_s of the coil can easily be removed by the appropriate corrections at the coil and the trimmer. There is no need to make the padder adjustable.

The circuits Figs. 82 and 83 may give rise to one trouble in particular. It is usual to short circuit some or all idle coils in order to prevent parasitic resonances (Chapter 12). If the idle coil units are shorted between the cross and earth, there still exists a parasitic resonance determined mainly by the coil and the padder. Capacitive coupling through the switch would be harmless since the idle contact is earthed, but inductive coupling between the coils would be serious. In contrast to the usual case the parasitic resonance causing the trouble would be that of the smaller coils, as will be readily understood.

2. *Stable Oscillation.* The problem of producing stable oscillations throughout the whole frequency range, with sufficient safety to allow for the weaker valves, becomes most marked at the highest frequencies, usually above 10 Mc/s. In designing the oscillator it must be realised that tolerances are given for any valve type, and that the mutual conductance of valves varies approximately in the ratio 1 : 1.5. Thus, if an oscillator works satisfactorily with one or even several valves of the same type, this is no proof that it will do so in mass production. It is always useful to possess, of the valve types employed, specimens with the lowest and highest mutual conductance, and to test the receiver with both.

The amplitude condition for the existence of constant oscillations may be derived for the circuit Fig. 84. Oscillations at the frequency

$f = \frac{\omega}{2\pi} = \frac{1}{2\pi \sqrt{LC}}$ will exist when the anode current I_a produces

a grid voltage which in its turn is capable of maintaining the current I_a (see Chapter 9). In Fig. 84 the anode load can be neglected in comparison with the valve impedance and hence there follows :

$I_a = g_m E_g$ inducing the voltage $I_a j\omega M = E_g g_m j\omega M$ in L . There is produced at the grid the voltage $E_g' = E_g g_m \omega M Q$, where Q is the magnification factor of the circuit. The condition for stable oscillations is $E_g' = E_g$.

$$\therefore |M| = \frac{1}{\omega g_m Q}$$

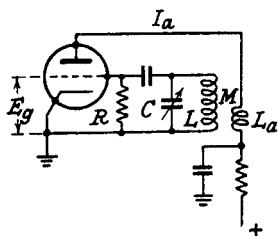

FIG. 84.

Substituting $k\sqrt{L_a L}$ for M and $\frac{1}{\omega^2 C}$ for L , we obtain

$$L_a = \frac{C}{k^2 g_m^2 Q^2} \quad (L_a \text{ in henries, } C \text{ in farads, } g_m \text{ in amps/volt,}$$

$$\text{or } L_a \text{ in } \mu\text{H, } C \text{ in pF, } g_m \text{ in mA/V).}$$

Comparing different frequency ranges and assuming k and Q to be fairly constant, one can see from the formula that the reaction coil L_a has to have constant value for a given capacitance. In actual fact the circuit Q drops towards lower frequencies because of the parallel damping by R and by the grid current; but it is fairly constant above 6 Mc/s. With typical values $C = 300$ pF, $Q = 70$, $k = 0.6$, and $g_m = 0.7$ mA/V for the oscillation part of a mixer valve, L_a becomes 0.35 microhenry.

Naturally one has to allow for the decrease of g_m with increasing amplitude and for variations between different valves. Experience shows that a reaction coil of about three times the inductance calculated gives sufficient margin of safety. From this there follows in the example: $L_a \ll 1.05$ microhenries. As long as L is much larger than this value, the impedance transferred from the anode has little effect on the tuned circuit (see page 16). At very high frequencies, however, the problem becomes serious, as may be seen from the following.

Example: An oscillator on the lines of Fig. 84 is to work for the frequency range 13.4 – 30 Mc/s; $C = 60 - 300$ pF, circuit $Q = 70$ at 13.6 Mc/s, $L = 0.47$ μ H, coupling factor between L and $L_a = 0.6$, capacitance anode-cathode = 12 pF, $L_n = 1.05$ μ H, according to the previous calculation.

The equivalent transformer circuit, page 16, shows that the impedance transferred from the anode in parallel to the tuned circuit is a series combination of about 9.5 pF and 0.84 μ H. At 13.6 Mc/s the influence of the inductance of 0.84 μ H can be neglected as compared with the capacitance of 9.5 pF. At 30 Mc/s the reactance of 9.5 pF is 560 ohms, that of 0.84 μ H is about 160 ohms, hence both in series have a capacitive reactance of 400 ohms, corresponding to a capacitance of 13.3 pF. The effect of the impedance transferred from the anode is thus:

1. A serious increase in minimum capacitance which may make it impossible to cover the frequency range intended.

2. A capacitance transferred which varies with frequency and therefore makes the ganging difficult or even impossible. This problem is aggravated by inductance in the anode leads or between L and C .

From these considerations various points arise which it is important to bear in mind for very high frequencies.

1. Try to make the minimum capacitance of the tuned circuit as small as possible. Every pF saved tells strongly. It increases L and decreases L_a . Thus the capacitance transferred from the anode becomes smaller, which again permits raising L .

2. Make the circuit as good as possible, as a large Q allows the use of a smaller reaction coil.

3. Use a mixer valve of which the oscillator portion has a fairly large g_m , not below 0.7 mA/V.

4. Make all the leads as short as possible. The directions given in Chapter 3, page 77, for the design of the radio frequency amplifier stage, apply here to an even larger extent.

3. *Squegging*. By squegging of an oscillator is understood a state of unstable oscillation, where the oscillator amplitude varies in audio frequency or supersonic rhythm. A brief description of the conditions leading to squegging may be given. An ordinary oscillator, as shown in Fig. 84, starts oscillating with approximately zero grid bias. With increasing amplitude the bias increases because of the D.C. voltage built up by the grid current across the grid leak condenser. This backing off of the valve decreases the average mutual conduction and usually leads to stable oscillation. In case of large feedback the valve is backed off well beyond cut-off, and the angle of current flow is below 180° . The position at which stability is reached is determined by the amplification from grid to anode and by the amount of feedback. The factor g_m in the above formula is now an average value deduced from the ratio of R.F. voltage at the anode to R.F. voltage at the grid. With the valve working well beyond cut-off, the average g_m depends greatly on the amplitude; it increases when the amplitude increases and decreases when the amplitude decreases. Thus with fixed bias a state of stable oscillation would be impossible, the oscillation would either increase or die down. Stability of oscillation at the stage reached is made possible by virtue of the grid leak resistance and condenser. When the amplitude tends to increase, the grid bias increases as well and thus immediately lessens the average g_m ; when the amplitude tends to decrease, the reverse process takes place. In both cases the valve is pulled back to its former state of oscillation.

If, however, the time constant of the grid resistance and condenser is fairly large, a decrease in amplitude is not immediately followed by a drop in bias. The average g_m decreases rapidly and

the oscillation dies down ; it starts again after the negative voltage on the grid condenser has leaked away. A corresponding instability leading to a rise in amplitude is less likely, as the time constant for charging the condenser is much smaller than the time of discharge (see page 181). It would lead the discussion too far to describe the various factors which all determine whether, in spite of the lagging grid bias, stable oscillation can exist. The valve characteristic, the degree of reaction, the grid leak resistance and condenser, and the oscillation frequency, are all of importance. The larger the grid leak resistance and condenser, the greater the tendency to squegg. In addition, this tendency is largest at the highest frequencies, which is understandable from the fact that the rate of decrease in amplitude with time is proportional to the frequency, if the damping is constant.

If an oscillator is to be designed for a frequency range of, say, 15–30 Mc/s, it is easy to guard against squegging. A grid condenser of 50–100 pF and a grid leak of 10,000–20,000 ohms is sufficient safeguard. If, however, a large frequency range is to be covered by the oscillator, difficulties arise. Values like 50 pF and 10,000 ohms cannot be used at longer waves without detrimental effects. The phase shift between the tuned circuit and the grid makes the oscillating frequency dependent on the supply voltage to a degree that might even affect the ganging. There are various possible ways of overcoming these difficulties ; two may be mentioned.

1. Compromise values are to be found for grid condenser and grid resistance. These values must be low enough to prevent squegging at the highest frequencies and large enough to prevent serious phase change between tuned circuit and grid at low frequencies. Values like 100–200 pF and 30,000–50,000 ohms may prove adequate.

2. The grid constants are changed by the range switch. Usually it is sufficient to change the grid resistance, using a value of about 0.1 M Ω at the longer waves.

Method (1) involves a great deal of practical work. Since there seems no way of calculating the possibility of squegging, it is necessary to try out as many valves as possible, to vary the anode voltage and the amount of regeneration. It may be found, for instance, that the oscillator works satisfactorily at the low-frequency end of a range but squeggs at the high-frequency end. Reducing the regeneration often cures the squegging but makes the oscillation too weak for large tuning capacitance. Instead of weakening the

regeneration a resistance may be connected in parallel with the circuit, the additional damping being largest for small tuning capacitance. At frequencies of about 30 Mc/s a resistance of 100 ohms before the grid may be better still; it damps at the high-frequency end without affecting the low-frequency end (see page 11). In addition it prevents parasitic oscillation.

If the frequency of squegging is within the audible band it shows itself by a corresponding note in the output. In the case of its being supersonic the receiver is usually very noisy. When the second oscillator is switched on and the first oscillator squeggs, an unmodulated carrier is received with a series of whistles on tuning through the carrier frequency. This is due to the fact that the wave form of squegging is very distorted; the oscillator possesses many sidebands each of which is capable of generating intermediate frequency in conjunction with the received carrier.

4. *Frequency Constancy. Automatic Frequency Control.* To obtain a high degree of frequency constancy for the oscillator, a number of basic requirements have to be fulfilled, the main points being these:

1. The frequency of oscillation must be as little as possible affected by temperature.

2. The frequency of oscillation must be as little as possible affected by variations of supply voltages, change of valves, etc.

The correct method of fulfilling the requirement (2) consists in coupling the tuned circuit loosely to the valve and in avoiding phase shift of the voltage fed back to the grid. In this case the frequency of oscillation coincides with the resonant frequency of the tuned circuit. At the highest frequencies, where the need for frequency constancy is most urgent, loose reaction is, however, not compatible with stable oscillations, as previously mentioned. Hence in the course of ordinary receiver design little can be done about this except to avoid undesired coupling with the detector circuit (page 111). To fulfil (1) great care is necessary in the choice of the circuit components, of the insulating material, etc. At least some temperature tests should be carried out, as otherwise unpleasant surprises are in store. Not only may large temperature coefficients be found, but also great permanent changes after every variation of temperature. The ordinary type of receiver has a temperature coefficient of about 10^{-4} in frequency per degree centigrade.

When a receiver has been switched on, a rapid variation in frequency is observed for the first twenty minutes, after that a

state of some stability is reached. This effect is due to the increase in temperature causing expansion of the coils and condensers. Hence this initial drift is always towards lower frequencies. The design should be such that the oscillator circuit is exposed as little as possible to the heating effect from other valves.

Automatic tuning control (A.T.C.), at first designed to facilitate the normal tuning and to make push-button tuning possible, is, at the same time, a good preventive of drift. Its principle is similar to that of automatic volume control and may first be explained by means of the block diagram, Fig. 85.

A signal is received which together with the oscillator produces the correct intermediate frequency. In this case no D.C. voltage is produced in the discriminator and the oscillator frequency is not influenced. Now let us assume that the oscillator frequency is changed by δf . Consequently the intermediate frequency varies

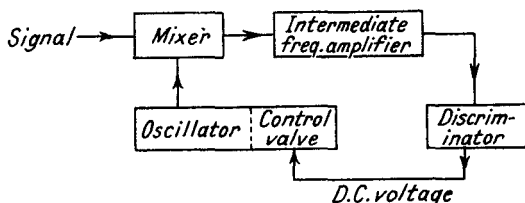

FIG. 85.

by the same amount and produces a D.C. voltage proportional to δf , positive or negative according to the sense of the frequency drift. The D.C. voltage, by means of a special valve, tends to pull the oscillator frequency back to its original value.

Quantitative data are obtained as follows:

A variation δf in the oscillator frequency produces a voltage E in the discriminator when this voltage is not fed back to the oscillator. On the other hand a voltage E fed into the oscillator unit, causes a variation $-A\delta f$ in the oscillator. On these assumptions when the A.T.C. is working, a change of δf in the oscillator frequency without A.T.C. will result in a change $\delta f' < \delta f$ with A.T.C. The value of $\delta f'$ is found as follows. The D.C. voltage produced in the discriminator is $E\frac{\delta f'}{\delta f}$, which effects a frequency variation $-A\delta f'$ in the oscillator. Hence

$$\delta f - A\delta f' = \delta f'$$

$$\delta f' = \frac{\delta f}{1+A}$$

The equation shows that A has to be large compared with unity in order to produce an appreciable improvement.

Two methods for the derivation of D.C. voltage are in use nowadays. The circuit shown in Fig. 86 is called the Round-Travis circuit. I and II are two tuned circuits, one slightly below, the other slightly above the intermediate frequency. For correct tuning the R.F. voltages across the two circuits are equal, therefore no D.C. voltage is fed to the control valve. When the oscillator drifts, the voltage across one circuit is greater than that across the other, so that the D.C. fed to the oscillator circuit is either positive or negative.

The variable- μ control valve V_1 to which this D.C. voltage is fed is connected in parallel to the oscillator circuit, and a portion of the voltage E across the oscillator circuit is fed to the grid of V_1 .

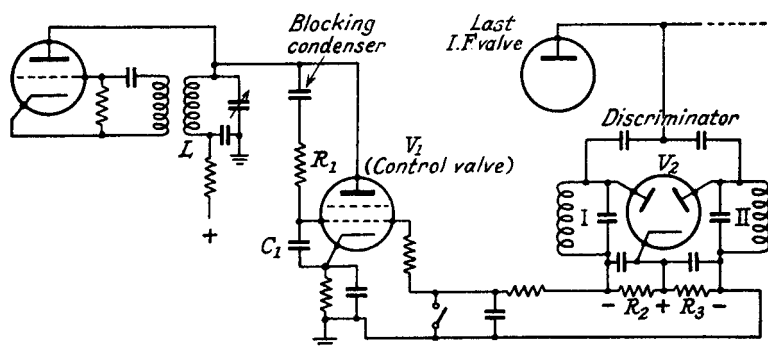

FIG. 86.

The potential divider consisting of R_1 and C_1 is designed so that the voltage at the grid is lagging behind E by nearly 90° , and hence the anode current of V_1 lags behind E by the same amount. Thus the valve V_1 behaves like an inductance; the method of calculating its magnitude may be seen from the following.

Example 1. The frequency of oscillation is 10 Mc/s, $L = 5$ microhenries, $R_1 = 10,000$ ohms, $C_1 = 15$ pF, $\frac{1}{\omega C_1}$ being 1,060 ohms. The mutual conductance of V_1 is 1 mA/V.

For an R.F. voltage E across the oscillator circuit a voltage approximately $\frac{E}{10}$ is applied to the grid of V_1 , causing an anode current $E \times 0.1$ mA. Hence the valve is equivalent to an inductance of 160 microhenries, since the reactance of 160 microhenries is 10,000 ohms at 10 Mc/s. The valve decreases the inductance

of the oscillator circuit by 3.1%, increasing the frequency by about 150 Kc/s. The d.c. voltage applied either to the grid or to the suppressor grid of V_1 varies its mutual conductance and thus its mistuning influence. It is evident that for a drift in oscillator frequency towards lower frequencies a positive voltage must be applied from the discriminator to the valve V_1 . The following example serves to give a quantitative aspect of the behaviour of A.T.C.

Example 2 (Fig. 86). In receiving a signal at 10 Mc/s, 2 volts d.c. are produced across both R_2 and R_3 in case of correct tuning. The intermediate frequency is 460 Kc/s, circuit I is tuned to 455 Kc/s, circuit II to 465 Kc/s. The Q of the two circuits is 130, interaction with previous i.f. circuits is avoided by loose coupling. The values are $L = 5$ microhenries, g_m of $V_1 = 1$ mA/V, $R_1 = 10,000$ ohms, $C_1 = 15$ pF, as in the previous example. A variation of 1 volt in the grid voltage of V_1 alters the mutual conductance in the ratio 1 : 1.25. Find the influence of the A.T.C. on the frequency constancy of the oscillator.

It is necessary to know first the change of amplitude across the circuits I and II as a function of frequency. According to the formula on page 7, the amplitude across the two circuits is proportional to $\frac{1}{\sqrt{1+(yQ)^2}}$. For correct intermediate frequency there follows for either of the two circuits

$$y \simeq 2.17\%, \quad yQ = 2.82 \quad \text{and} \quad \frac{1}{\sqrt{1+(yQ)^2}} = \frac{1}{3}.$$

For a change of, say, 500 c/s in intermediate frequency the factor y for one circuit goes up to 2.38%, for the other circuit down to 1.95%, the values for $\frac{1}{\sqrt{1+(yQ)^2}}$ being $\frac{1}{3.26}$ and $\frac{1}{2.72}$ respectively.

Hence, when the A.T.C. is switched off, the d.c. voltages across R_2 and R_3 become 1.84 and 2.21 volts, and the difference of 0.37 volt would be the voltage applied to the grid of V_1 . According to the assumption made before, 0.37 volt varies the mutual conductance of V_1 and hence also the magnitude of the equivalent inductance by 9%. The mistuning effect due to V_1 which has been said to be 150 Kc/s also varies by 9%, i.e. by 13.5 Kc/s.

The value A of the formula previously given is $\frac{13.5}{0.5} = 27$, and hence the A.T.C. reduces the influence of oscillator drift in the ratio 28 : 1.

The effect of A.T.C. varies over a frequency range. Let us

assume that in the above example the effect of A.T.C. is to be studied at another frequency of the range, viz., for an oscillator frequency of 5 Mc/s. Tuning is supposed to be carried out by the conventional use of a variable condenser, so that the circuit inductance is unaltered. For the same voltage across the oscillator circuit the voltage applied to the grid of V_1 becomes approximately twice as high as it is at 10 Mc/s, because the reactance of C_1 is twice as large. The current flowing through V_1 becomes twice as large, and since ω has decreased to half its value the valve is equivalent to the same inductance, i.e. to 160 microhenries. The percentage mistuning is unaltered, the mistuning in frequency half of what it is at 10 Mc/s. The value of A is 13.5, and hence the correcting influence of the A.T.C. is to reduce the frequency drift in the ratio 14.5 : 1.

The influence of the A.T.C. should not depend largely on the strength of the signal. It, therefore, is to be used in conjunction with a very efficient A.V.C. system. Both A.V.C. and A.T.C. must be designed so that they work for the weakest signal for which reception is required.

If the A.T.C. does not work satisfactorily, the procedure for finding the fault is similar to that given in Chapter 7 for A.V.C. The corresponding tests here would be :

1. Break the connection from the discriminator to the valve V_1 and apply the normal bias to the latter.
2. Measure, best by inserting a microammeter, the D.C. voltage developed across R_2 and R_3 as a function of the signal frequency. The test can also be carried out with intermediate frequency only.
3. Vary the bias of the grid connected to the discriminator by means of a D.C. battery and find its influence on the frequency of oscillation.

In the second of these tests the absence of a D.C. voltage across R_2 and R_3 indicates

- (a) a fault in V_2 , due either to the individual valve, or to a break in an external lead, such as cathode or filament ; or (b) a fault in the preceding stage or in the coupling to the preceding stage.

Testing the circuits I and II for intermediate frequency voltage with a valve voltmeter or an auxiliary receiver (see Chapter 9) will usually prove conclusive as to whether (a) or (b) is responsible.

D.C. voltage across only one of the resistances R_2 and R_3 shows that the fault is to be found with the individual circuit or its coupling link.

In the third test, if the frequency of oscillation is not influenced by a variation of the bias of the control valve, this may be due to

(a) a faulty valve ;

or (b) a fault in R_1 or C_1 .

Measurement of the anode current of V_1 as a function of bias, and further measurement of the oscillator voltage across the grid of V_1 , are the obvious means to be applied. The general directions for fault finding, given in Chapter 15, are to be borne in mind for any such procedure.

Care has to be taken that the D.C. voltage applied to the control valve has the right sense, as otherwise the receiver pulls out instead of pulling in. Thus in Fig. 86 circuit I must be tuned to the higher, circuit II to the lower frequency. Variations in the course of time

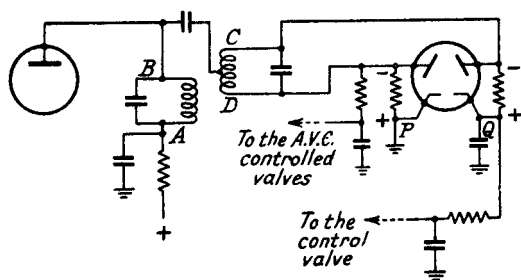

FIG. 87.

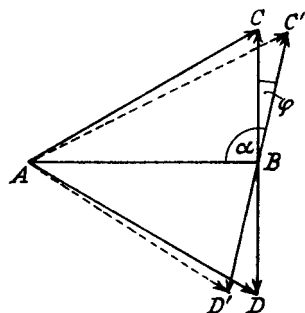

FIG. 88.

of the resonant frequencies of I and II must be allowed for. The further apart the two circuits are tuned, the less will changes affect the A.T.C. For this reason the two resonant frequencies should not be less than $\pm 1\%$ off the intermediate frequency.

Fig. 87 shows the second method used for the A.T.C. discriminator; it is called the Foster-Seeley circuit. It is based upon the fact that in two coupled circuits, which are tuned to the same frequency, the currents produced by a signal of resonant frequency are 90° out of phase, and that the phase angle varies with change of frequency.

When the live side of the first circuit is connected to the centre point of the second, the points C and D have potentials of opposite sign with respect to B . These potentials are shown by vectors in Fig. 88. The point A being at earth potential, the vectors AC and AD represent the potentials between earth and the points C and D . For the resonant frequency of the two circuits the

two vectors are equal. For a frequency off resonance, however, the phase difference between the two currents is no longer 90° , and hence the two potentials from C and D to earth are different (AC' and AD' in Fig. 88). According to the sense of the frequency change one or the other vector becomes larger. The two voltages AC' and AD' are applied to two diodes in a way similar to that shown in Fig. 86. The need for keeping the H.T. from the two diodes makes the circuit Fig. 66 of this chapter the appropriate one. The action of the control valve is the same as in Fig. 86 and needs no further explanation.

Quantitative results are obtained as easily as for Fig. 86. From the equations on page 23 it follows that $\frac{I_2}{I_1} = \frac{j\omega M}{Z}$, where $Z = r + j\omega L + \frac{1}{j\omega C}$, showing that the phase angle between I_1 and I_2 is $\frac{\pi}{2}$ for the resonant frequency. For frequencies off resonance the phase angle is determined by Z . The amplitudes of the voltages AB and BC can be considered constant for small frequency changes, i.e. $BC' = BD' = BC = BD$. If, in Fig. 88, $AB = E_1$, $BC = E_2$, $BD = E_3$, $AC' = E_4$, $AD' = E_5$, it follows that $E_4 = \sqrt{E_1^2 + E_2^2 - 2E_1E_2 \cos \alpha}$, where α is the phase angle between AB and BC' . Correspondingly

$$E_5 = \sqrt{E_1^2 + E_2^2 + 2E_1E_2 \cos \alpha}.$$

The total D.C. voltage set up between P and Q in Fig. 87 is proportional to $|E_4| - |E_5|$. If $\alpha = 90^\circ + \phi$ then for only small values of ϕ , it follows that $|E_4| - |E_5|$

$$\begin{aligned} &\simeq \sqrt{E_1^2 + E_2^2} \left(\sqrt{1 + \frac{2E_1E_2}{E_1^2 + E_2^2} \sin \phi} - \sqrt{1 - \frac{2E_1E_2}{E_1^2 + E_2^2} \sin \phi} \right) \\ &\simeq \frac{2E_1E_2\phi}{\sqrt{E_1^2 + E_2^2}}. \end{aligned}$$

Example: The two circuits in Fig. 87 are tuned to 460 Kc/s, the Q of each is 130. For a carrier of resonant frequency, the voltage across the first circuit is 10 volts, that across whole of the second circuit 8 volts R.M.S.; 14 volts D.C. are produced across each of the two diode resistances. What is the voltage applied to the control valve for a carrier 500 c/s off resonance?

The voltage set up across one resistance at resonant frequency is proportional to $\sqrt{E_1^2 + E_2^2}$, i.e. proportional to $\sqrt{116}$. The

voltage E_x across both resistances for 500 c/s off resonance is proportional to $\frac{2E_1E_2\phi}{\sqrt{E_1^2+E_2^2}}$. Hence

$$\frac{E_x}{14} = \frac{2E_1E_2\phi}{E_1^2+E_2^2} = \frac{80}{116}\phi$$

and as $\tan \phi \simeq \phi = yQ = \frac{2 \times 500}{460 \times 10^3} 130 = 0.282$ (page 9),

$E_x = 2.7$ volts.*

A.T.C. in no way makes the need of frequency constancy superfluous. Its limitation (in that direction) may be seen from the following considerations. If a receiver has been tuned to a station for some time and the oscillator itself has drifted away so that the station is held only by virtue of the A.T.C., a short break in the signal may be sufficient to lose the station permanently. This may happen when the oscillator has drifted away more than half the width of the response curve, so that the carrier will not be received with sufficient strength to pull the set in tune. Even if the drift has been less the receiver may, during the short break in the signal, come within the range of a neighbouring station and be pulled in by the latter. The problem arising in case of strong fading or in reception of telegraphy hence requires considerable frequency stability. In expensive communication receivers a mechanical form of A.T.C. is used. The pulling in of the oscillator is done through a motor-driven device which remains in any set position unless activated by a signal.

The Beat Frequency Oscillator. The beat frequency oscillator is necessary only when reception of telegraphy is concerned. It oscillates usually at a frequency 1 Kc/s off the intermediate frequency. The 1 Kc/s audio frequency beat is obtained in the same diode which serves for demodulation of modulated carriers. In the design several points must be considered.

1. The amplitude of the beat frequency oscillator at the diode should not be less than the signal. Otherwise the output is proportional to the oscillator amplitude and the signal to noise ratio decreases; it becomes that of a modulated carrier of modulation factor equal to the ratio of oscillator amplitude to signal amplitude.

2. The oscillator should be well screened to prevent spurious beats.

* It will be readily understood that the circuits of either Figs. 86 or 87 can be used for demodulation of a frequency modulated carrier; the voltage used above for A.T.C. would be directly the audio frequency.

3. The oscillator must not operate the A.V.C. or A.T.C.

4. The oscillator must be proof against locking.

For the first and third point compare page 182; considerations of A.T.C. do not bring in any new features. Point (2) is being dealt with on pages 247-250.

(4) Locking occurs when a strong signal of approximately oscillator frequency is applied across the oscillator, forcing it to oscillate at this frequency. The tendency to lock is the larger the smaller the frequency difference, and therefore the effect appears usually in the following form. When tuning in a station the beat is heard as long as it is high-pitched and breaks off at some lower frequency instead of continuously approaching zero. Among the various methods of avoiding the effect two may be mentioned.

1. The beat frequency oscillator is designed to oscillate strongly, so that the coupling between the oscillator and the diode circuit can be made small. The method involves the risk of spurious beats as the harmonics of the beat frequency oscillator are strong.

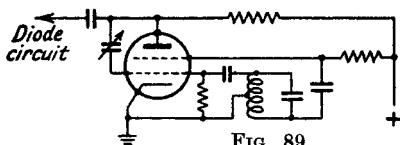

FIG. 89.

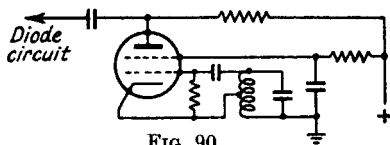

FIG. 90.

2. The use of electronic coupling between oscillator and diode. The principle may be briefly discussed.

Oscillation occurs between grid and screen grid of a tetrode or pentode, and the voltage produced at the anode is used for heterodyning. Coupling between the diode circuit and the oscillator is now due only to the capacitance between anode and screen grid. In many cases this capacitance will prove small enough for practical requirements. Otherwise its influence can be eliminated, as may be seen from Figs. 89 and 90. In Fig. 89 a neutralising condenser is connected between anode and grid. In Fig. 90 the screen grid is at chassis potential so that the capacitance anode-screen grid is made harmless. Capacitance between anode on the one hand and grid or cathode on the other would cause coupling. Hence a pentode of which the suppressor grid is connected internally to cathode is not suitable for the circuit Fig. 90.

The beat frequency between second oscillator and signal is obtained by mixing at the diode which in this case works as a frequency converter. Further problems of the second oscillator are discussed in Chapter 7.

CHAPTER 5

SELECTIVITY

A brief definition of selectivity is difficult and partly a matter of opinion. Speaking in the most general terms, it may be expressed as the sum of all those features which enable a set to receive the desired station without interference from others. The ways in which the other stations may interfere are numerous, and correspondingly the selectivity of a receiver will be based upon quite a number of different facts.

According to the conditions under which the receiver is used the various aspects of selectivity carry different weight and the means applied must necessarily depend largely on these conditions. The usual case is that of a broadcast receiver dealing with stations of which the field strength may vary within a range of, say, one to ten thousand, the nearest station being at least one mile away. Under these conditions the behaviour of a receiver is sufficiently represented by its selectivity curve and, in case of a superhet receiver, by some additional data on spurious responses and cross-modulation.

In the case of a receiver working in the immediate vicinity of a strong transmitter (duplex, etc.), various other aspects are of first importance, e.g. overloading of the first valve, pick-up through channels other than the aerial and, connected with this, an increased danger of spurious responses. In the following an attempt is made to summarise these different features and discuss them according to their importance and frequency of occurrence.

I. The possibility of interference is wholly expressed by the selectivity curve of the receiver, the interfering station being relatively near in frequency to the desired station. This case applies equally to a straight or superhet receiver.

II. The interference is due to spurious responses of the receiver, irrespective of the selectivity curve. The interfering station may differ widely in frequency from the desired station.

III. The interference occurs only in the presence of the desired carrier and is due to cross-modulation.

IV. Additional problems, when reception is carried out in the neighbourhood of a strong transmitter.

1. The interfering carrier enters the receiver through the aerial.

2. The interfering carrier enters through other leads.
3. Disturbances for which the receiver is not responsible.

I. Adjacent Channel Selectivity. The case most frequently occurring in practice is that in which the selectivity curve of the receiver completely describes its behaviour. The feature involved is called the adjacent channel selectivity of the receiver and is one of the most important parts of the receiver performance. The selectivity curve of the receiver is usually obtained by injecting an unmodulated signal from a generator and changing the frequency over the range in the immediate vicinity of the frequency to which the receiver is tuned; the D.C. current from the detector diode may be used as indicator. The input needed to maintain the rectified diode current at a constant value is a measure of the response. For this test the automatic volume control has to be out of action. With the A.V.C. working the current of one of the controlled valves may be used as indicator; the measurement is, however, less accurate. Instead of measuring the rectified diode current in the first case the input may be modulated and the audio frequency output used for indication. In this case there is risk of a wrong result, when the band-width to be measured is not large compared with the modulation frequency. For the usual response curves of at least 6 Kc/s width this method is good enough, if the modulation frequency is 400 c/s or less.

The aim of the designer should be to obtain a selectivity curve of rectangular shape, just wide enough to admit the required carrier and its sidebands, but rejecting all other frequencies. Such an ideal curve can only be approached but not realised. The degree of realisation will depend partly on the skill of the designer, partly on the means employed and will be, in any case, a matter of compromise between price and performance.

The width of the curve is determined by considerations both of quality and of interfering stations. On medium waves broadcast stations are spaced every 9 Kc/s, and a curve wider than ± 4.5 Kc/s is actually harmful, if the field strength of the unwanted station is larger than that of the station required. If the latter is much stronger than the stations neighbouring in frequency it may be desirable to have a response curve wider than ± 4.5 Kc/s. For this reason it is becoming customary to provide receivers with a choice of various band-widths, according to prevailing conditions. In some cases a sharp dip at 9 Kc/s is provided in the audio frequency curve in order to eliminate whistles from neighbouring carriers.

It is naturally much easier and cheaper to obtain a given band-width on a fixed frequency than over whole frequency bands; for this reason the superhet receiver has nowadays almost completely superseded the straight receiver. Occasionally, however, there appear on the market straight receivers with a remarkably good performance, and therefore it seems appropriate to discuss the problem of providing constant band-width and amplification for circuits of variable tuning.

The band-width of a single circuit is proportional to $\frac{f_0}{Q}$, where f_0 is the resonant frequency, $Q = \frac{\omega_0 L}{r}$ the amplification factor of the circuit. To possess constant band-width throughout a frequency range, the circuit must have a Q proportional to the frequency. To obtain with such a circuit an amplification constant over the frequency range two methods are suitable and both have been employed.

1. For a transformer coupled circuit of which the tuning is varied by a change of capacitance, the stage gain is approximately proportional to $\frac{Q}{f}$ if the transformer coupling is purely inductive and the resonant frequency of the primary well below the range covered (page 72). If, therefore, the Q of the circuit is made proportional to the frequency the stage gain is fairly constant over the frequency range. The circuit damping must be provided by a constant series resistance if $Q = \frac{\omega_0 L}{r}$ is to be proportional to the frequency.

2. If a transformer coupling is used and the frequency of the primary is much higher than that of the secondary (page 68) the stage gain is proportional to $Z_0 = \omega_0 L Q$. To obtain a constant Z_0 , the variation of frequency must be achieved by varying L only, and to obtain a Q proportional to the frequency the circuit damping must be provided by a constant parallel resistance. The inductance is best varied by using a movable iron-dust core. The difficulties encountered are due to various factors, the main points being:

(a) In case of variable condenser tuning the circuit Q tends to be smallest at the high-frequency end, and to obtain here a large Q , extreme care in the design is necessary. Ample use of ceramic as insulating material will be found essential for very high frequencies.

(b) High perfection in the alignment of the circuits and correspondingly good "ganging stability" is necessary.

(c) If filter circuits are used to give a more rectangular shape to the response curve the coupling has to vary over the range, according to the variation in Q .

All these points are far less critical in the case of a superhet receiver, which explains why attempts at solving the problem of selectivity with a straight receiver have remained comparatively rare. At frequencies above, say, 1.5 Mc/s narrow response curves cannot be obtained with straight receivers.

Constant Band-width. The use of a great number of single circuits leads to a steep-sided response curve but, on the other hand, makes the top rather pointed and thus attenuates the side bands. The usual and probably the simplest way of achieving a square top is to combine single circuits or pairs of coupled circuits having a coupling factor not larger than critical, with pairs of over-coupled circuits, or with pairs of circuits with "staggered tuning".

The methods to be employed and corresponding examples have been fully given in Chapter 1, so that there is no need to add here further details. The curves in Fig. 19 of Chapter 1 are sufficiently accurate for the usual conditions and only require correction in exceptional cases as shown on page 28. If over-coupled circuits are employed the correct adjustment is best achieved by heavily damping one circuit while tuning the other. Disconnecting the condenser of one circuit when tuning the other is equally possible, the choice depending on personal taste. This procedure is applicable to any of the circuits shown in Figs. 98-100, which follows from their being interchangeable.

Variable Band-width. Theoretically there are numerous ways of achieving a variation in band-width, but only a few of them have proved practicable. The principal methods may be discussed as to their merits and difficulties.

1. Variation in Q . Regeneration.
2. Staggering of the circuit tunings.
3. Variation of coupling factor, with or without simultaneous change of Q .

1. *Variation in Q . The Use of Regeneration and of Crystals.* The widening of the response curve by additional damping of one or several circuits has three drawbacks:

- (a) The gain decreases markedly with increased band-width.
- (b) The adjacent channel selectivity at large band-width is appreciably less than can be obtained when the response curve is widened by more elegant methods.
- (c) The response curve is by no means flat for the pass band.

About ten years ago the application of variable Q was a usual feature in straight receivers. The means of obtaining this object was regeneration, which is a cheap way of increasing both selectivity and amplification. The results that can be achieved are surprisingly good if only moderate quality is needed. This explains why the method has been so popular for many years. It requires, however, great skill in handling if full use is to be made of its possibilities, and for this reason the method is rarely seen in the large type of broadcast receiver. In straight receivers, particularly in communication receivers of the small portable type, regeneration is still frequently applied, either continuously variable or adjustable to a pre-set value by means of a switch. In the latter case no skill in handling is required, but the result is not impressive. This is understandable, as a high degree of regeneration cannot be applied because of variations among valves, and hence the risk of oscillation.

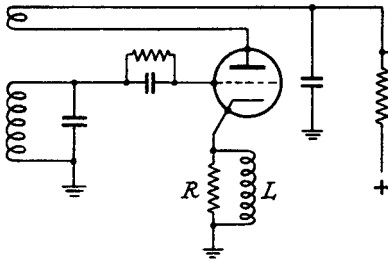

FIG. 91.

In Fig. 91 a circuit is given enabling the use of larger degree of regeneration than is usually permissible. The regenerating valve is a grid leak detector working on intermediate frequency. The cathode resistance R provides negative feedback with the

effect that for a voltage E across the tuned circuit only $\frac{E}{1+g_m R}$ is applied between grid and cathode (see page 172). Thus the anode current becomes fairly independent of g_m , so that differences in valves do not affect the degree of regeneration. The choke L in parallel to R prevents bias being applied to the grid and also eliminates negative feedback on audio frequency. The reactance ωL has to be large compared with R at intermediate frequency.

As the variation of Q is applied to only one circuit, the band-width can be made extremely small without apparently harming the intelligibility. A band-width of a few hundred cycles has been found to permit speech to be satisfactorily understood. The same band-width achieved with band-pass filters would not be permissible as the frequencies outside the pass band are far more attenuated.

The use of a *crystal* for achieving a variable band-width provides

features similar to those just described. But in contrast to regeneration the gain can be made almost independent of the band-width. The conditions are stable and the curves constant over almost any period of time. For this reason the method has become very popular during the last few years.

The principle applied can be seen from Fig. 92. The two circuits I and II are tuned to the resonant frequency of the crystal. For an understanding it is necessary to know that the behaviour of a crystal is that of a series-tuned circuit in parallel with the capacitance of the crystal holder. The capacitance C_n neutralises the effect of the capacitance of the holder, so that the circuits I and II in Fig. 92 are coupled only through a series-tuned circuit. The equivalent L and C of a crystal depend on the mechanical dimensions, the Q is of the order of 10,000. Let us assume that in Fig. 92 the frequency used is 460 Kc/s, that the crystal is equivalent to a series-tuned circuit with the constants $L = 50$ henries, $C = 2.4 \times 10^{-3}$ pF, $R = 14,000$ ohms,

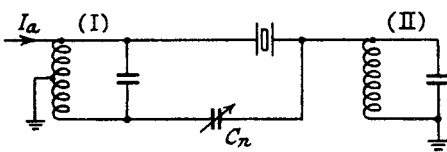

FIG. 92.

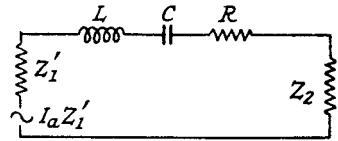

FIG. 93.

yielding a Q of approximately 10,000. Let the circuits I and II be tuned with 170 pF and have a Q of 100, their impedance thus being about 200,000 ohms at resonant frequency. Within about ± 1 Kc/s off resonance this value can be considered as constant, and hence the circuit Fig. 92 can be replaced by that of Fig. 93 for this frequency range, where Z_2 is the impedance of the second circuit and $Z'_1 = \frac{Z_1}{4}$ if the coil of the circuit I is centre tapped.

The Q of the tuned circuit in Fig. 93 is determined by its constants $L = 50$ henries, $C = 2.4 \times 10^{-3}$ pF, $R_{total} = 14,000 + 50,000 + 200,000 = 264,000$ ohms, and is approximately 550. The band-width is 840 c/s for 3 db. drop.

The width of the response curve can be decreased in various ways, e.g. by additionally damping the circuits I and II, or connecting the crystal to lower circuit tapplings, etc. One method found very convenient consists in mistuning the circuits I and II simultaneously, one to a higher, the other to a lower frequency. The amount of mistuning necessary is of the

order of 1% and is best found experimentally. The gain remains fairly constant and drops by not more than 6 db. for a decrease in band-width from 1 Kc/s to 0.1 Kc/s.

At resonant frequency the circuit II is practically in parallel to the half of circuit I, since the crystal resistance is small compared with the impedance of the second circuit. If the first circuit is coupled to the anode of a pentode with a 1 : 1 transformer of unity coupling (Fig. 94), the stage gain may be calculated, assuming a mutual conductance of 2 mA/V, and a valve impedance of 1 megohm.

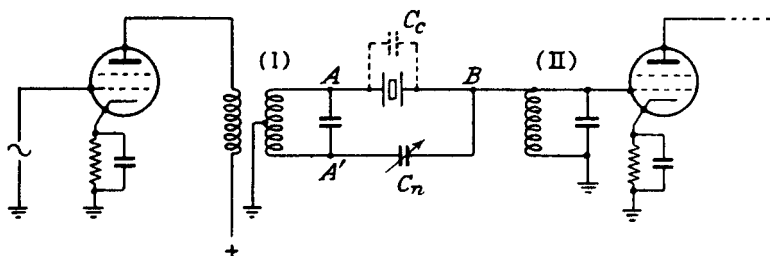

FIG. 94.

The anode load is the impedance of the first circuit in parallel with the transferred series combination of the crystal resistance and the impedance of the second circuit ; it is therefore

$$\frac{200,000 \times 856,000}{1,056,000} = 162,000 \text{ ohms.}$$

Half the voltage produced across the circuit I is delivered to circuit II through the crystal. The dynamic mutual conductance of the valve is $2 \times 10^{-3} \frac{1}{1.16} \approx 1.72 \times 10^{-3}$ amps/volt and the gain from grid to grid becomes

$$1.72 \times 10^{-3} \times \frac{1.62 \times 10^5}{2} \frac{2 \times 10^5}{2.14 \times 10^5} = 130.$$

The capacitance of the crystal holder and of the neutralising condenser mistune the circuits I and II (Fig. 94); this mistuning may be calculated for the case of the first circuit being centre tapped, i.e. when $C_n = C_c$.

Circuit I. An E.M.F. induced in I does not transfer energy to the circuit II through C_c and C_n in case of perfect neutralisation. The point B can therefore be considered as being at earth potential and the mistuning capacitance is $\frac{C_c}{4} + \frac{C_n}{4} = \frac{C_c}{2}$.

Circuit II. The same consideration leads to the points A and A' being at earth potential for an E.M.F. applied across II and the mistuning capacitance is $2C_c$. The facts must be taken into account when the circuit Fig. 94 is designed.

If the neutralising condenser in Fig. 92 or Fig. 94 is omitted the crystal is no longer represented by a pure series circuit because of the parallel capacitance of the holder. The equivalent circuit is that of Fig. 93, but with an additional capacitance in parallel to the crystal. The response curve of the crystal becomes in this case as shown in Fig. 95.

The absorption occurs when the crystal becomes an inductance, the reactance of which is equal to that of the capacitance of the holder. The smaller this capacitance the farther away lies the absorption point. By varying the neutralising condenser the absorption point changes its position, which fact can be used to suppress an undesired carrier. As, however, the width of the response curve increases considerably in the unneutralised state, and since the correct handling is not easy, the method has of late lost in popularity. When using a crystal, circuits are preferred with the crystal capacitance neutralised, resulting in a perfectly symmetrical response curve.

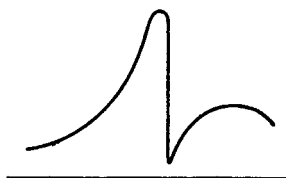

FIG. 95.

2. *Staggered Tuning.* A mistuning of various circuits may be used for widening the response curve. To keep the curve symmetrical an equal number of circuits should be mistuned to either side of the desired frequency, and the Q factors of the circuits concerned should be the same. The equation on page 24 shows that staggering the tuning of two such circuits provides a response curve of the same shape as that obtained from two inductively coupled circuits. The amount of staggering necessary may be seen from the following.

Example: Two identical circuits are tuned to 460 Kc/s. Their Q is 100, the coupling factor is $3 \times k_{crit.} = 3\%$. The same response curve is now to be obtained with the help of staggered tuning.

(a) The two circuits to which staggered tuning is applied are zero coupled.

According to the equation on page 24 a coupling factor of 3% is equivalent to a change in the two inductances of $\pm M = \pm 0.03L$. The mistuning necessary is hence $\pm 1.5\%$ in frequency, equal to ± 6.9 Kc/s.

- (b) The two circuits to which staggered tuning is applied are critically coupled, i.e., $k = 1\%$.

If $\pm\delta L$ is the change in inductance in the two circuits, the denominator of the equation referred to becomes $(Z + j\omega\delta L)(Z - j\omega\delta L) + \omega^2 M_2^2$, where M_2 is the mutual inductance for $k = 1\%$. Equating this with the corresponding expression in the case of $k = 3\%$ when no staggering is applied, one obtains :

$$Z^2 + \omega^2(\delta L^2 + M_2^2) = Z^2 + \omega^2 M_1^2,$$

where M_1 is the mutual inductance for $k = 3\%$.

$$\therefore \delta L = L\sqrt{k_1^2 - k_2^2} = 2.83 \times 10^{-2}L.$$

Thus a staggered tuning of ± 6.5 Kc/s off resonant frequency gives the desired response.

Care has to be taken that the means for achieving staggered tuning do not introduce undesired coupling between the circuits. For this reason the simple circuit Fig. 96 can only be recommended

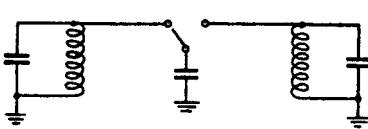

FIG. 96.

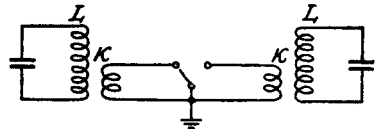

FIG. 97.

if there is no amplification between the circuits. The method indicated in Fig. 97 involves less risk. It should work for intermediate frequency even when the two circuits are separated by one stage (see Chapter 9, page 222). The shorting coils can be mounted near the earth side of the circuits so that capacitive coupling is avoided. The mistuning effect of the shorted coils is equivalent to reducing the tuning coils to $L' = L(1 - k^2)$.

The loss in gain with increasing band-width is larger than results from a variation in coupling. This can be seen from the equation on page 24. The denominator varies equally in both cases, but the numerator is constant for staggered tuning. Thus there is a loss of 4.4 db. for the resonant frequency when the coupling factor is varied from $k_{crit.}$ to $3k_{crit.}$ (Fig. 19, Chapter 1); if the circuits are staggered instead to obtain an equal response curve the loss is 14 db.

Adjusting an intermediate frequency amplifier in case of staggered circuits involves tuning the signal generator to at least three different frequencies and seems rather laborious compared with the simple procedure in case of overcoupling (see page 133 and the next

paragraphs). Nowadays the cathode-ray tube is frequently used for tuning an amplifier. On the one hand this makes the task easier, on the other it demands a trained observer. At ultra-high frequencies the conditions are different. The inductance of the resonance circuits is small and the design of an adequate coupling is likely to cause difficulty; the stage gain is small, so that a large number of amplifier stages is required; finally, the desired bandwidth is often (television) an appreciable proportion of the carrier frequency, so that symmetry of the response curve is not easy to

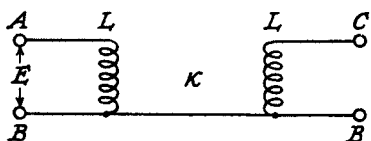

FIG. 98.

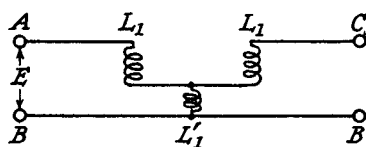

FIG. 99.

achieve (see page 28). All these facts tend to make at these frequencies single circuits in connection with staggered tuning the adequate means for obtaining large band-widths.

3. *Variation of Coupling Factor.* Among the various methods of altering the coupling factor between two tuned circuits only a few are practicable. Varying the mutual inductance of the coils by moving one or both of them leaves the mid-frequency of the response curve unaltered. The two maxima arising in the case of $k > k_{crit.}$ appear, as is desired, symmetrically on both sides of the resonant frequency (page 25).

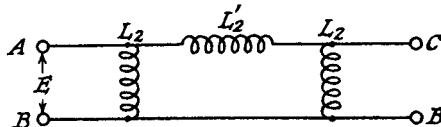

FIG. 100.

To examine the behaviour of the two circuits, should other means of coupling be applied, the three equivalent combinations Figs. 98–100 may be compared. The winding sense in Fig. 98 is assumed to be such that an E.M.F. between AB induces across BC a voltage in phase with the E.M.F.; otherwise L₁' and L₂' must be replaced by capacitances. The relations between the circuits Figs. 98 and 99 are best arrived at by stating the following two conditions.

1. For all three circuits the impedance between A and B must be the same when BC is open.

2. For all three circuits an E.M.F. between *A* and *B* must produce the same potential difference between *B* and *C*,

whence

$$L = L_1 + L_1'$$

$$Ek = \frac{EL_1'}{L_1 + L_1'}$$

$$\therefore L_1 = L(1 - k),$$

$$L_1' = kL.$$

In a similar way the relations between the circuits Figs. 98 and 100 are found to be

$$L_2 = L(1 + k)$$

$$L_2' = L \frac{1 - k^2}{k} = \text{approx. } \frac{L}{k}.$$

From this it can be seen that in Figs. 99 and 100 the addition of L_1' or L_2' alters the mid-frequency by approximately $\delta f = \mp f_0 \frac{k}{2}$, where k is $\frac{L_1'}{L}$ or $\frac{L_2'}{L_2}$ respectively. In case of overcoupling one maximum thus remains at resonant frequency, the other maximum moves to a frequency $(1 \mp k)$ times the resonant frequency. The same

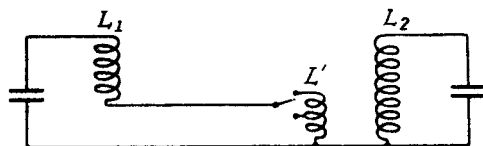

FIG. 101.

consideration applies if L_1' and L_2' are replaced by capacitances, the only difference being that in Fig. 99 a coupling capacitance increases, in Fig. 100 decreases the mid-frequency.

The exceptional behaviour of the circuit Fig. 98 can be understood from the fact that a variation in coupling changes the leakage inductance by an amount equal and opposite to the change in coupling inductance, thus leaving the sum of the two constant.

A constant mid-frequency can naturally be achieved with the circuits Figs. 99 and 100 if the coupling factor is to be varied in steps. It would be necessary to change the two inductances L_1 or L_2 simultaneously with L_1' or L_2' . But such a procedure is laborious and can hardly be recommended.

The method indicated in Fig. 101 is a good compromise. Though the total inductance of the first circuit is altered with variation of

coupling, the change of resonant frequency is so small that it can be neglected in the majority of cases. This may be seen from the following.

Example: In Fig. 101 a maximum coupling factor of 4% is to be obtained between the two circuits. The coupling factor between L' and L_2 may be assumed to be 70%. There follows:

$$0.7\sqrt{L'L_2} = 0.04\sqrt{(L_1+L')L_2} = 0.04L_2.$$

$$\therefore L' = \frac{L_2}{306}, \quad L_1 \simeq L_2.$$

The risk of undesired capacitive coupling (page 78) does not arise as the whole of L' is almost at earth potential.

Inductive coupling through an untuned loop as indicated in Fig. 102 is in principle that of the circuit Fig. 100. This is evident when the equivalent transformer circuit Fig. 12c in Chapter 1 is considered. The coupling obtained corresponds approximately to a direct coupling factor $k = \frac{k'^2}{2}$. For an effective coupling factor of 2% between the two tuned circuits k' has to be 20%.

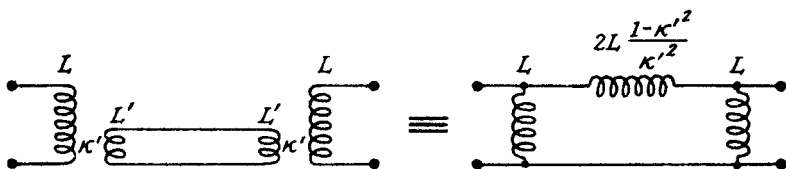

FIG. 102.

When faced with the problem of variable band-width the designer often has to decide on the following two points:

1. Is the variation of band-width to be continuous or are a few steps sufficient?
2. Is the total amplification to be kept constant?

The answer to these questions is naturally a matter of opinion and the following discussion should be looked upon in this light.

1. Experience shows that the advantage of a continuously variable band-width over a band-width varied in steps is small and is hardly sufficient to justify its inclusion in the design if this involves considerable cost. Steps in band-width of, say, 1 : 3 are good enough for most practical cases. By combining a crystal circuit as shown in Fig. 94 with the technique of overcoupling, a range of band-width between 100 c/s and 10 Kc/s can be easily achieved.

2. The receiver gain usually decreases for wide band-widths,

unless means of avoiding this are provided. If the gain is kept constant there will be a great increase in noise output, a point to be borne in mind. Furthermore, the use of a wide response curve is indicated only if the conditions for reception are good, i.e. for strong stations. Both facts suggest that there seems no need to keep the gain constant, and that it is probably more suitable to arrange the gain so that the output noise is constant.

II. Spurious Responses. Spurious responses almost exclusively concern superhet receivers, though straight receivers are not necessarily free from them. A case applying equally to a straight and superhet receiver has been mentioned on page 38. Another case, theoretically possible though not met with in the author's experience, might be caused by involuntary reception of ultra-short waves of a frequency equal to that of the parasitic resonances of the receiver circuits (see page 264).

The main possibilities, applying to superhet receivers only, are enumerated as follows :

1. The image frequency.
2. The intermediate frequency.
3. The frequency half-way between signal frequency and the frequency of the first oscillator.
4. All those frequencies which may produce the intermediate frequency by combination of any of their harmonics with harmonics of the local oscillator.

1. This is the best known case of the group and easy to understand. Let f_1 be the frequency to be received, f_2 the oscillator frequency, f_3 the intermediate frequency, f_3 being equal to $f_2 - f_1$. There is, besides f_1 , always another frequency $f_1' = f_2 + f_3$ which in conjunction with f_2 gives rise to the intermediate frequency f_3 , since $f_2 + f_3 - f_2 = f_3$. The frequency f_1' is called the image frequency. The protection against it is determined only by the radio frequency part; the efficiency of the mixer valve is the same for the image frequency as for the wanted signal. The fractional mistuning between the wanted signal and the image frequency is $\frac{2f_3}{f_1}$; this will be smaller the higher the signal frequency. The image protection can therefore be expected to be least at the high-frequency end of the receiver, unless the intermediate frequency is changed at higher frequency ranges. An example may give an idea of the figures involved.

Example: A receiver is designed for the frequency range 3-30 Mc/s, the intermediate frequency used is 460 Kc/s. Two

radio frequency circuits are employed before the mixer valve, their Q being 80 over the whole range. Find the image protection at 3 and 30 Mc/s.

3 Mc/s : The image frequency is

$$3.92 \text{ Mc/s, } y = \frac{3.92}{3} - \frac{3}{3.92} = 0.54, \quad yQ = 43.2.$$

Hence the total image protection is approximately

$$43.2^2 = 1,860 = 65.4 \text{ db.}$$

30 Mc/s : The image frequency is 30.92 Mc/s, $yQ = 4.83$, and the image protection is approximately $23 : 1 = 27 \text{ db.}$

The result at 3 Mc/s will be found to deviate in practice by a few decibels from the correct value if a circuit like Fig. 10a in Chapter 1 or Fig. 46a in Chapter 3 is employed. This is because

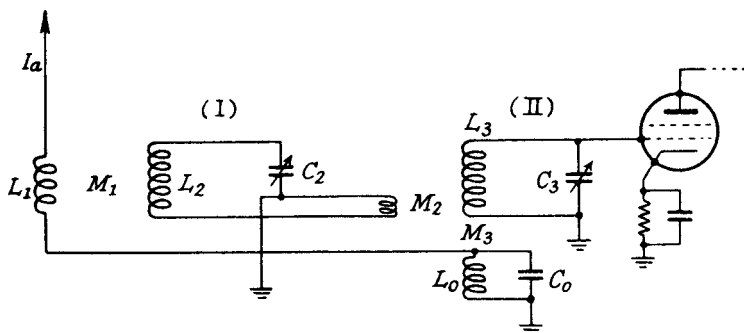

FIG. 103.

no allowance has been made for the resonances of the transformer primary or a term containing ω (page 8). The difference in image protection between the low-frequency end of a range tends to be even larger than has been calculated above, owing to the Q being lowest at the highest frequencies.

If the designer is confronted with the problem of building a receiver of which the image protection is never to fall below a certain value, he will have to turn his attention immediately to the highest frequency required. The means of obtaining the desired protection consists either in employing a sufficiently large number of radio frequency circuits or in using some elaborate circuit giving minimum energy transfer for the image frequency, approximately throughout the whole frequency range required. Such an image suppression circuit naturally complicates the wiring and the switch action and is usually employed only on the medium wave broadcast band where the need is greatest. Fig. 103 shows a circuit which, in

contrast to others, involves little loss for the desired frequency. It requires however, two tuned radio frequency circuits between the aerial and the first valve. The calculation of L_0 , C_0 and M_3 is comparatively easy if the influence of the resistances is neglected. This is permissible when the image frequency differs from the signal frequency by 10% or more. For smaller mistunings the resistance of the first circuit is not small compared with $\omega L_2 - \frac{1}{\omega C_2}$ and thus prevents perfect image suppression. By correct choice of M_3 and the resonant frequency of $L_0 C_0$, maximum suppression can be provided at two frequencies within the range; at the other frequencies the results are satisfactory.

In the following f_1 and f_2 are the two-signal frequencies at which maximum image suppression is desired, f_1 being $< f_2$; f_1' and f_2' are the two corresponding image frequencies and f_0 the resonant frequency of $L_0 C_0$. Interaction at image frequency between the various circuits can be disregarded for obvious reasons, hence it is only necessary to compare the two voltages induced in L_2 . Let I_a be the aerial current of an arbitrary frequency f , then the current through L_0 is

$$I_a \frac{1}{j\omega C_0 + \frac{1}{j\omega L_0}} = \frac{I_a}{1 - \left(\frac{f}{f_0}\right)^2}.$$

The current through L_2 becomes

$$I_a \frac{j\omega M_1}{j\omega L_2 + \frac{1}{j\omega C_2}} = I_a \frac{M_1}{L_2} \frac{1}{1 - \left(\frac{f_s}{f}\right)^2},$$

where $f_s = \frac{1}{2\pi\sqrt{L_2 C_2}}$ will be the frequency of the desired signal.

To obtain maximum image suppression at two signal frequencies f_1 and f_2 , the first condition is that the ratio of the two currents caused in L_0 and L_2 by an input of image frequency is equal at f_1 and f_2 . Using the expressions derived for the two currents:

$$\frac{1 - \left(\frac{f_1'}{f_0}\right)^2}{1 - \left(\frac{f_2'}{f_0}\right)^2} = \frac{1 - \left(\frac{f_1}{f_1'}\right)^2}{1 - \left(\frac{f_2}{f_2'}\right)^2}$$

The expression on the right is known from the design of the receiver. If this expression is called A , there follows

$$f_0 = f_2' \sqrt{\frac{A - \left(\frac{f_1'}{f_2'}\right)^2}{A - 1}}$$

The necessary coupling factor k_3 between L_0 and L_3 depends, apart from the frequencies involved, on M_1 , M_2 , and L_0 ; there are, of course, infinitely many combinations of L_0 and k_3 fulfilling the requirements. Equating, for the frequency f_1' , the two voltages induced in L_3 , we obtain

$$I_a \frac{M_1}{L_2} \frac{1}{1 - \left(\frac{f_1}{f_1'}\right)^2} 2\pi f_1' M_2 = I_a \frac{1}{1 - \left(\frac{f_1'}{f_0}\right)^2} 2\pi f_1' k_3 \sqrt{L_0 L_3}$$

Substituting $k_1 \sqrt{L_1 L_2}$ for M_1 and $k_2 \sqrt{L_2 L_3}$ for M_2 :

$$k_3 = k_1 k_2 \sqrt{\frac{L_1}{L_0}} \frac{1 - \left(\frac{f_1'}{f_0}\right)^2}{1 - \left(\frac{f_1}{f_1'}\right)^2}$$

Example: The frequency range is 0.55 – 1.5 Mc/s, the intermediate frequency is 0.15 Mc/s. Image suppression is to be a maximum at 0.75 and 1.5 Mc/s.

The two image frequencies are 1.05 and 1.8 Mc/s, hence

$$A = \frac{1 - \left(\frac{0.75}{1.05}\right)^2}{1 - \left(\frac{1.5}{1.8}\right)^2} = 1.6$$

$$f_0 = 1.8 \sqrt{\frac{1.6 - 0.34}{0.6}} = 2.61 \text{ Mc/s.}$$

k_3 will be of the order of 1% for the usual values of k_1 , k_2 and L_0 .

Image suppression circuits are comparatively rare. The average receiver relies for selection on two radio frequency circuits, but the use of three circuits is nowadays seen more frequently and may eventually become the standard design. Increasingly great emphasis is placed on obtaining a large Q at the higher frequencies, for reasons clear from the preceding discussion. The use of ceramic as insulating material, at all essential points, is advisable, for parallel damping due to dielectric losses is the dominant factor when the circuits are tuned with a small capacitance.

The image protection of a receiver is easily measured by tuning the signal generator first to the desired frequency and then to the image frequency, and adjusting the receiver input for equal output in both cases. The ratio of the two inputs gives directly the image protection at that frequency.

2. This effect hardly needs any explanation. In contrast to (1) the interfering carrier of intermediate frequency causes receiver output even when the local oscillator is quiescent. The receiver protection consists, as under (1), in the selectivity of the radio frequency part only. The risk may be greater than that in (1) as insufficient protection would spoil a whole range. The almost standardised use of an intermediate frequency of about 460 Kc/s may be understood from this fact, as strong transmitters in the

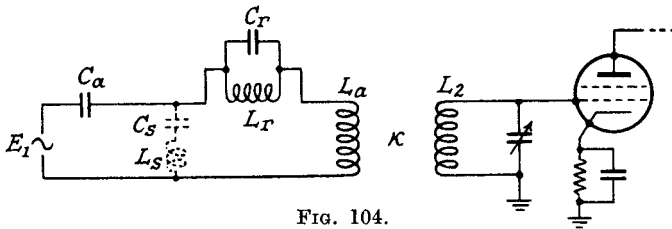

FIG. 104.

neighbourhood of this frequency are rare. There are endeavours to bar transmission in this frequency region, and thus to reserve it for the intermediate frequency of receivers.

There is always the possibility of using a rejector or acceptor circuit tuned to the intermediate frequency. Their effect on an interfering station of intermediate frequency and on the desired station may be discussed by means of an example (Fig. 104).

Example: The frequency range is 0.55–1.5 Mc/s, the aerial capacitance $C_a = 200$ pF, $L_a = 1,100$ μ H, $L_2 = 180$ μ H, $k = 15\%$. A carrier of frequency 460 Kc/s is to be weakened by 20 db. by means of a rejector or acceptor circuit. The influence of this upon the desired frequency is to be discussed.

(a) *Rejector Circuit.* A parallel tuned circuit $C_r L_r$ is inserted between C_a and L_a . The secondary circuit always differs greatly in frequency from 460 Kc/s, and any interaction between primary and secondary can be disregarded when calculating the effect for 460 Kc/s. The current through L_a , in the absence of a rejector

circuit, is $\frac{E_1}{j\omega L_a - \frac{j}{\omega C_a}}$, $\omega L_a - \frac{j}{\omega C_a}$ being approximately 1,500 ohms.

The impedance of the rejector circuit must therefore be about 15,000 ohms. If the Q of the rejector circuit is 100, there follows

$$\omega L_r = \frac{1}{\omega C_r} = 150 \text{ ohms}, L_r = 52 \text{ microhenries}, C_r = 2,300 \text{ pF}.$$

The impedance of the rejector circuit is capacitive between 0.55 Mc/s and 1.5 Mc/s, being equivalent to 690 pF at 0.55 Mc/s and to 2,100 pF at 1.5 Mc/s. The effect, both on the input ratio and on the ganging, can be deduced by means of Fig. 26c, Chapter 2, and the formulæ connected with it. At 0.55 Mc/s the resonant frequency of the secondary circuit is increased by about 0.4%; the change in input ratio is negligible. At 1.55 Mc/s both influences can be neglected.

(b) *Acceptor Circuit.* A series-tuned circuit is to be connected between aerial and earth, equivalent to a pure resistance at 460 Kc/s. In the absence of the acceptor circuit the voltage across L_a is about $2E_1$ for a signal of 460 Kc/s, as the reactance of L_a is 3,180 ohms and that of $C_a = 1,720$ ohms. The series-tuned circuit must reduce the voltage across L_a to $\frac{E_1}{5}$, in order to attenuate the current through L_a to one-tenth of the value without the acceptor circuit. A resistance of about 340 ohms will have the desired effect. If the Q of the acceptor circuit is equal to 100, it follows that $\omega L_s = \frac{1}{\omega C_s} = 34,000$ ohms, $L = 11,800 \mu\text{H}$, $C = 10.2 \text{ pF}$.

At 0.55 Mc/s the impedance of the acceptor circuit is 12,300 ohms, and is inductive. Looking from L_a towards the aerial, the influence of the series circuit at 0.55 Mc/s is equivalent to a reduction of C_a from 200 pF to 177 pF. This is better than in the case of the rejector circuit where C_a is reduced to $\frac{200 \times 690}{200 + 690} = 155 \text{ pF}$.

On the other hand, it is hardly possible to design a series-tuned circuit with 10.2 pF capacitance and a Q of 100, as half the capacitance will be in the coil, involving considerable dielectric losses. Hence one would have to use a tuning capacitance of, say, 20 pF. The input ratio at 0.55 Mc/s is slightly improved as follows from Thevenin's theorem, the voltage across the open circuited acceptor circuit being larger than E_1 . Under the given circumstances the acceptor circuit is probably the slightly better solution.

3. The frequency to be received may be f_1 , the intermediate frequency f_s and the oscillator frequency $f_2 = f_1 + f_s$. There is a frequency $f_1 + \frac{f_s}{2}$ which by mixing with the oscillator gives rise to

$\frac{f_3}{2}$ and its harmonics, the second harmonic being the intermediate frequency. As the mistuning of the interfering station is only $\frac{f_3}{2}$, i.e. only one-fourth of that of the image frequency, the effect may become dangerous, though the mixing efficiency might be poor.

4. The number of possibilities under this heading is theoretically unlimited; there are, however, only a few cases which have proved troublesome in actual practice.

The receiver is tuned to a station of frequency f_1 , where f_1 is within, say, 10% of twice the intermediate frequency f_3 . If δf is the difference between f_1 and $2f_3$, there follows

$$f_1 = 2f_3 \pm \delta f,$$

$3f_3 \pm \delta f$ being the frequency of the first oscillator.

An interfering station of frequency $2f_3 \pm \frac{\delta f}{2}$, i.e. midway between $2f_3$ and the desired station, may give rise to intermediate frequency by mixture of its second harmonic with the fundamental frequency of the local oscillator. Similar effects, though less dangerous, may occur in the neighbourhood of $3f_3$, $4f_3$, etc. If the I.F. selectivity is not very high, these effects are not noticeable, for the output from the interfering station caused by the insufficient I.F. selectivity is the dominating factor. Experience shows that this kind of spurious response is less marked in multigrad valves than in pentodes working with anode bend rectification. It is understandable that the latter method having automatically strong harmonics lends itself more to troubles of this kind than the multigrad valve which, in the ideal case of pure multiplication, does not produce harmonics (Chapter 4).

III. Interference noticeable only in the Presence of the Desired Carrier (Cross-modulation). An undesired signal which is much stronger than the desired signal, but sufficiently far off in frequency to be rejected by the selectivity of the intermediate frequency amplifier, can cause trouble in the earlier stages of the receiver. This may show when both the desired and the undesired carrier are received, the modulation of the undesired carrier being transferred to the desired carrier. The phenomenon is called cross-modulation. Frequencies for which the stage gain of the radio frequency stages is larger than unity are particularly liable to the effect, cross-modulation taking place mainly at the last radio frequency valve or at the mixer. The test which measures the susceptibility of the receiver to this kind of interference is called

the two-signal test. Its description contributes to the understanding of the effect and may therefore be included in this chapter, rather than in Chapter 14.

The Two-Signal Test. In Fig. 105, *A* and *B* are two signal generators, *A* producing the desired, *B* the undesired carrier. The transformer for *A* is necessary because of the earth points of *A* and *B* being the same. The order of tests should be as follows :

Test 1. Modulate *B* 30% with 400 c/s and determine the receiver input necessary for a given output.

Test 2. Switch off *B* and carry out the same test with *A*. Owing to the transformer the value obtained will be different and will indicate the correct calibration for *A* with the transformer included.

Test 3. Adjust the carrier from *A* for an output of, say, 50 mW, and then remove its modulation. Add the modulated carrier from *B* and subsequently mistune it in steps of, say, 10 Kc/s. For each

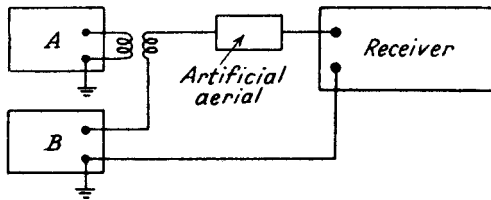

FIG. 105.

of these frequencies determine the amplitude necessary to produce an output of 0.5 mW. In case of cross-modulation this output is caused by the modulation of *B* being transferred to *A*; it must disappear when either the modulation of *B* or the carrier of *A* is switched off. Output not affected by the presence of the carrier of *A* indicates interference of the ordinary kind, i.e. due to insufficient I.F. selectivity. Output remaining when the modulation of *B* is switched off indicates a direct beat between the carriers of *A* and *B* and should disappear on removing either of the two. Owing to the latter effect the two-signal test is usually not carried out for less than 10 Kc/s frequency difference between *A* and *B*.

Taking these figures for various receiver sensitivities, we obtain a series of curves. The strength of the interfering signal is shown as a function of mistuning and the values recorded which give an output 1% in power of that of the desired signal. The results show another aspect of the receiver selectivity and form a valuable addition to the normal selectivity curves.

The extent of cross-modulation depends not only on the selectivity before the valve concerned, but also on the type of valve, and on the conditions under which it is worked. Let us take a case which is not covered by the two-signal test as described above. The interfering station is a continuous wave telegraphy transmitter. Its frequency is such that the beat with the desired station is not troublesome; it produces, however, 2 volts R.M.S. at the grid of one of the R.F. or I.F. valves, e.g. at the grid of V_4 in Fig. 188. If this valve is working with 3 volts grid bias and has a fairly linear characteristic down to minus 6 volts, it will show little effect. In contrast, if working with one volt bias and decreasing in mutual conductance with increasing bias, the valve would be backed off by the flow of grid current and the desired signal would be attenuated at the rhythm of the interfering telegraphy station. A small value of R_2 prevents a large increase in bias but may cause considerable additional damping as soon as grid current flows (page 100). Such damping is proportional to the impedance of the grid circuit and is therefore not too serious for short-wave circuits. A large time constant R_2C_2 might cause decreased sensitivity for a period considerably longer than that of the signal and must be avoided. Values like 10,000 ohms and 0.1 μF for short wave circuits and 100,000 ohms and 0.01 μF in the I.F. amplifier seem a fair compromise.

Similar effects may be produced in the audio frequency part, if R.C. coupled amplifier stages are employed. Large grid leak resistances and large time constants should therefore be avoided as far as possible. This applies especially to communication receivers when reception may be required under very difficult conditions. Thus in the case of the desired and the undesired station both sending telegraphy a wrong design may cause the receiver to be silenced at the rhythm of the unwanted station and make reception impossible. The correct design may result in strong and unavoidable output from the interfering station, but still enable an experienced operator to pick out the wanted station (compare Chapter 7, page 181).

IV. Reception in the Vicinity of a Strong Transmitter.

If reception is carried out in the immediate vicinity of a strong transmitter, a number of new problems arise in addition to those dealt with under I-III.

1. If the voltage induced in the receiver aerial by the local transmitter is several hundred volts—a case often met at medium and long waves on board a ship—the danger of overloading the first receiver valve exists even for large mistunings. Under such

conditions the behaviour of a receiver evidently cannot be deduced from its selectivity curves and the two-signal test applies equally to a straight or a superhet receiver. Cross modulation or complete disappearance of the desired station may take place owing to excessive amplitude at the first grid. A high degree of selectivity between the aerial and the first valve is necessary; if the local transmitter works on a fixed frequency, a rejector circuit may be tried out. Conditions have been experienced where it was necessary to have four tuned circuits between the aerial and the first valve in order to receive stations 10% mistuned from the local transmitter.

If the local transmitter is of ultra high frequency and the receiver used a superhet for medium waves, the danger arises of the transmitter carrier mixing with high harmonics of the oscillator frequency. The interfering transmitter may in this case be heard at small intervals throughout the whole of the receiver range. Filters designed against ultra high frequency will sometimes prove successful between the aerial and the first receiver valve.

2. The possibility of interference through leads other than the aerial is most pronounced when the local transmitter is of a very high frequency. First, the unwanted carrier may reach the mixer valve directly, thus by-passing the radio frequency selectivity; secondly, it may be transferred directly to the detector valve without having to pass through either the radio frequency or the intermediate frequency amplifier. Good screening of the receiver and filtering of all leads entering the receiver may be found necessary. The principles discussed in Chapter 8 have to be borne in mind.

3. The existence of a strong transmitter near by may cause troubles which can only be cured outside the receiver. If, for instance, the transmitter is keyed and the envelope caused by the keying is practically rectangular, side-bands are caused up to 100 Kc/s in width or more. Thus, though the receiver selectivity may be sufficient protection against the transmitter carrier, the side-band frequencies caused by keying come through on the receiver frequency. The effect is most pronounced on medium and long waves, where interference may take place on frequencies 10% or 20% off the frequency of the transmitter carrier. The effect has to be cured at the transmitter by introducing "key click" filters.

Another serious disturbance may be caused by currents induced by the transmitter in surrounding wires, metal bars, etc. If, in the path of these induced currents, there are bad contacts, e.g. caused by two wires touching each other, sparks will be caused at these points. Such sparks act as sources of disturbances covering

the whole range of radio frequencies. Cases are known where a receiver station on board a new ship worked perfectly in the presence of a strong transmitter. After a few months, however, all the stay connections, the railings, etc., became loose and sparking noise was so strong that reception became impossible while the transmitter was working.

CHAPTER 6

RECEIVER NOISE

Receiver noise may be described as any unwanted disturbance which is present when signals are being received, apart from interference from other transmitters or radio equipment. In the early days of wireless reception, radio frequency amplification had not been developed, so that the minimum signal strength that could be received was determined by the efficiency of the aerial and the low frequency amplification possible. To-day it is possible to construct radio frequency amplifiers to meet all practical requirements in the matter of gain. The limiting factor is now the ratio of wanted signal to unwanted noise.

The causes of noise are grouped under six headings, starting with noise introduced at the output end of the receiver and working back to the aerial.

Acoustic Noise. Acoustic noise is any acoustic disturbance reaching the ears of the listener from sources other than the loud speaker or telephones supplying the signal. Important examples occur in aeroplanes and tanks, in which the extraneous noise can be so great as to overload the ear and make it incapable of hearing the wanted signal.

To combat such noise steps must be taken to keep the unwanted noise from the ear, and to make the wanted signal as loud as possible. Telephones covered with sound-proof material and made to fit closely over the ears have been developed for such purposes.

The quality or intelligibility of reception is governed by the ratio of signal sound intensity to noise sound intensity entering the ears. A sensitive ear is no better than an insensitive ear. This is an example of the rule that amplification after the noise has been introduced does not produce any change in the signal to noise ratio, the noise being amplified as much as the signal. In the case of acoustic noise, any amplification in the receiver will be useful, so long as the sound output has not reached the overload point of the ear; 10 to 20 milliwatts in telephones is as much as the ear can stand. The output stage of the receiver must be capable of supplying this amount if acoustic noise is troublesome.

Microphonic Effects. If a receiver is shaken or struck by sound waves, the components vibrate and the vibrations are

transformed into electrical disturbances. These pass through the receiver and manifest themselves as noise at the output of the receiver. Such output is known as microphonic noise.

Valves are the most frequent cause of this noise. When the filament or grid vibrates the relative position of the electrodes changes and the anode current fluctuates. The mechanical resonant frequencies of these electrodes often lie within the band of frequencies amplified by the audio frequency amplifier. The acoustic feedback between the loud speaker and the microphonic component may be sufficient to cause oscillation (Chapter 9). In the case of radio frequency amplifiers the impinging disturbances cause low frequency modulation of the carrier wave that is being received ; demodulation takes place at the detector and audio frequency noise is produced. Microphonic effect in the radio frequency amplifier is less likely to occur than that due to audio frequency valves, especially triode and multi-electrode detectors.

A particular case occurs in superheterodyne receivers. If the plates of the tuning condenser of the oscillator vibrate in any way the oscillator frequency will vary, and if a signal is being received the frequency of the intermediate frequency signal will vary as the oscillator frequency varies. The slope of the selectivity curve of the intermediate frequency amplifier resolves this frequency modulation into amplitude modulation also, and so causes noise at the output. This microphony of the oscillator condenser becomes worse as the oscillator frequency and the selectivity of the I.F. amplifier are increased. The effect will only take place if a carrier is being received. (Compare Chapter 9, acoustic feedback.)

When the microphonic effect occurs in the audio frequency amplifier or detector, the amplification before the microphonic valve must be increased, so as to increase the signal at the point at which noise is introduced. This will improve the signal to noise ratio. If this increase of amplification produces too large an output, the low frequency gain must be reduced. In all cases the audio frequency gain must be decreased until the microphonic noise is reduced to a permissible level, or until the required signal to noise ratio is obtained with the signal output at the desired level.

If a grid leak detector is used and the audio frequency gain is reduced, there will be danger of detector overloading before the required output is obtained (Chapter 4). In such a case the method of detection must be changed or other methods of combating the microphonic effect must be employed. Such methods are the use of non-microphonic valves and the mounting of receiver or valve

bases on rubber. Indirectly heated valves are usually less microphonic than directly heated types, the vibration of the filament in the latter being the principal cause of the trouble. Rigid construction, especially of the filament and grid, is important.

Mains Hum, Bad Contacts, Batteries, etc. The question of mains hum introduced through the mains lead is treated in Chapter 10. Noise caused by bad contacts in the wiring, dry joints in the soldering, old batteries, corroded terminals and faulty components (particularly resistors) is usually easy to find and eradicate (see Chapter 15).

Shot Noise. The anode current of a valve is not absolutely uniform but consists of a direct current component on which is superimposed a random fluctuating current. These fluctuations in the anode current cause noise voltages to be set up across the anode impedance which, after amplification, manifest themselves as noise at the output of the receiver. This is known as shot noise. The noise is distributed uniformly over the whole spectrum used for radio communication, so that the noise energy in any band of frequencies depends only upon the width of the band. Shot noise also extends to the audio frequency band, but the gain in the audio frequency amplifier of a receiver is not normally sufficient to make the noise audible. The shot noise that limits the sensitivity of radio receivers is generated by the radio frequency and intermediate frequency valves.

Random effects cannot be added arithmetically; thus two similar noise voltages (or noise currents) of values A and B result in a combined noise $\sqrt{A^2+B^2}$. From this it follows that noise, if measured in volts, will be proportional to the square root of the band-width, and shot noise will be proportional also to the square root of the anode current of the valve causing it.

Radio frequency noise is measured by comparison with a known standard of radio frequency, such as a signal generator. The noise generated never exceeds a few microvolts for normal band-widths, so that it is to be amplified by the radio frequency and intermediate frequency stages before being measured. Radio frequency noise may be measured (*a*) by rectifying the noise voltages and measuring the direct current output of the rectifier, and (*b*) by applying an outside carrier and passing the carrier and the high-frequency noise to a detector and measuring the audio frequency output, usually after audio frequency amplification. Either of these methods may be used for receiver measurements and both give substantially the same results, but the second is more usual, as it is only necessary

to connect an output meter to the output terminals of the receiver, no disturbance of the receiver wiring being necessary. The measurement of noise is treated in more detail in the chapter on "Routine Measurements".

Shot noise may be expressed as a high-frequency noise component I_n of the direct anode current I_d in the following relationship

$$I_n = k\sqrt{I_d \times \delta f},$$

where δf is the band-width of the receiver in c/s, and I_d and I_n are in amperes; k should theoretically be a constant and have the same value for all valves, but in practice it varies within the limits one to three. For typical modern directly and indirectly heated tetrodes and pentodes k is of the order 0.4×10^{-9} . This means that for such a valve, the anode load being small compared with ρ , the noise current measured over a band of 1 Kc and with the anode current at 1 mA will be 0.4×10^{-6} mA. With an anode load of 10,000 ohms a voltage of $4 \mu\text{V}$ will be produced at the anode of such a valve.

For a signal voltage E_s at the grid, the signal anode current is $g_m E_s$. Thus the ratio of signal anode current to noise anode current is $\frac{g_m E_s}{k\sqrt{I_d \times \delta f}}$. The signal to noise ratio is independent of the anode

load, but will be better for a valve having a high ratio of g_m to $\sqrt{I_d}$. It can be seen from the above expression that the shot noise can be expressed as equivalent noise at the grid of the valve, that is, the noise that would have to be applied at the grid of the valve to produce the same noise at the anode as the shot noise. This equivalent shot noise is

$$E_n = \frac{k\sqrt{I_d \times \delta f}}{g_m} \text{ volts.}$$

As an example, a valve may have a mutual conductance of 1.5 mA/V when taking an anode current of 4 mA. For a 6 Kc/s band-width the equivalent noise at the grid will be $1.3 \mu\text{V}$, k taken as 0.4×10^{-9} . This means that in the absence of any noise a carrier of $1.3 \mu\text{V}$ at the grid would produce the same direct current at the detector of the receiver as the noise alone; alternatively a 100% modulated carrier of $1.3 \mu\text{V}$ would produce the same low frequency output, in absence of noise, as the noise combined with the $1.3 \mu\text{V}$ unmodulated carrier.

To obtain the best signal to noise ratio for a given band-width, a valve with a high ratio of g_m to $\sqrt{I_d}$ should be used. For a

variable- μ valve the optimum ratio is obtained with a low value of grid bias (Chapter 7, Fig. 111); increasing the bias for purposes of gain control decreases the signal to noise ratio for a given signal at the grid, since the mutual conductance falls more rapidly than $\sqrt{I_d}$. The aerial circuit must be designed to give a high signal voltage at the grid, as far as other factors allow. (See Chapter 2.)

Beam valves avoiding the additional noise due to disturbances at the screen grid have a signal to noise ratio about twice as good as the normal pentodes. The k given in the above formula is in this case of the order of 0.2×10^{-9} , equalling the k of triodes.

Multi-electrode mixer valves have a higher shot noise output than ordinary radio frequency amplifiers. This is mainly due to the low mutual (or conversion) conductance of such valves for a given anode current. In addition to this, a mixer has a higher noise constant k . A receiver starting with a mixer valve will have a lower signal to noise ratio than a receiver with one or more radio frequency stages, because the noise of the first valve usually predominates over the noise introduced by subsequent stages. Thus the signal to noise ratio at the first valve is often that of the set as a whole. If the mixer is preceded by sufficient radio frequency gain, the amplified noise of the first valve will drown that of the mixer and the set will have as good a signal to noise ratio as a straight receiver. In the early days of the superheterodyne this type of receiver had a reputation for being noisy. This was because radio frequency amplification was often omitted.

Example: A superheterodyne receiver has a single radio frequency stage giving a minimum stage gain of 15 in the band covered. The radio frequency valve has an equivalent shot noise of 1 microvolt at the grid, and the mixer valve has 6 microvolts noise at its grid, measured with the band-width of the receiver. How much does the mixer noise contribute to the signal to noise ratio of the receiver?

The 1 microvolt noise at the H.F. valve grid is amplified to become 15 microvolts at the mixer grid.

Noise of mixer valve referred to its own grid = 6 microvolts.

Total noise at mixer grid = $\sqrt{15^2 + 6^2} = 16.5$ microvolts. The mixer has therefore increased the noise at its grid from 15 microvolts to 16.5 microvolts, or by 7.4%.

Although the ratio between the noise amplitudes is 6 to 15, the way in which they add makes the mixer noise less important than this ratio would suggest. The gain of 15 is more than sufficient to make the mixer noise negligible. In general, a high frequency

stage gain of 10 is considered necessary to make the first valve noise predominate. At frequencies above 10 Mc/s or so, two stages of amplification are necessary with average valves to obtain this gain (see pages 169–171).

The designer will find it useful to have available, for reference, figures of the shot noise generated by the various valves he uses.

Thermal Agitation. The free electrons in a conductor move about at random and set up in the conductor noise voltages similar to the shot noise of valves. The energy content of the movement is proportional to the absolute temperature of the conductor, so that the noise voltages are reduced if the temperature is lowered. For normal temperatures the noise produced in a resistance R ohms and measured for a band-width δf c/s is given by

$$E = 12.6 \times 10^{-11} \times \sqrt{R\delta f} \text{ volts.}$$

This is the voltage appearing at the ends of an open-circuited resistance; the voltage must be regarded as an E.M.F. in series with the resistance, so that the terminal voltage is reduced if a reactance is connected across the resistance. It must be noted that the noise is produced in the series resistance of any impedance; the reactive part of the impedance does not contribute to the noise. If a resistance is connected across grid-cathode of a valve, the grid-cathode capacitance is in series with the resistance and the noise voltage at the grid is

$$E_g = E \frac{X_c}{\sqrt{R^2 + X_c^2}} = \frac{E}{\sqrt{1 + \left(\frac{R}{X_c}\right)^2}}$$

where X_c is the reactance of the grid-cathode capacitance at the mid-frequency of the band considered.

In the case of a tuned circuit the noise may be regarded as generated in the series resistance of the circuit, and the noise appearing across the tuned circuit near the resonant frequency is determined by the magnification Q of the circuit. The noise across the circuit becomes

$$\begin{aligned} E_p &= 12.6 \times 10^{-11} \times Q\sqrt{r\delta f} \\ &= 12.6 \times 10^{-11} \times \sqrt{Z_0\delta f} \end{aligned}$$

where Z_0 is the parallel impedance of the circuit at resonant frequency. The band-width over which the noise is measured is assumed to be small compared with the band-width determined by the tuned circuit alone. The circuit behaves like a resistive impedance equal to the parallel impedance of the circuit. If the circuit

is connected across the grid-cathode circuit of a valve there is no drop of voltage due to the grid-cathode capacitance, since the latter is included in the tuning capacitance of the circuit.

Example 1. A receiver with a band-width of 6 Kc/s and tuned to a frequency of 1 Mc/s has a resistance of 0.1 megohm connected between grid and cathode of a radio frequency amplifier valve. What is the noise produced at the grid of the valve due to thermal agitation in the resistance, the grid filament capacitance being 10 pF ?

Reactance of grid-cathode capacitance at 1 Mc/s : $X_c = 15,900$ ohms. Noise generated in resistance, measured over 6 Kc/s band-width,

$$\begin{aligned} &= 12.6 \times 10^{-11} \times \sqrt{10^5 \times 6,000} \text{ volts} \\ &= 3.1 \text{ microvolts.} \end{aligned}$$

Noise appearing at the grid

$$\begin{aligned} &= \frac{3.1}{\sqrt{1 + \left(\frac{0.1}{0.0159}\right)^2}} \text{ microvolt} \\ &= 0.49 \text{ microvolt.} \end{aligned}$$

Example 2. What will be the thermal agitation noise when the above grid resistance is replaced by a tuned circuit of $Q = 120$ and inductance $L = 200 \mu\text{H}$, tuned to 1 Mc/s? Reactance of the inductance $= 2\pi \times 200 = 1,256$ ohms. Impedance of the parallel tuned circuit $= 1,256 \times 120 = 151,000$ ohms. Noise voltage generated $= 12.6 \times 10^{-11} \sqrt{151,000 \times 6,000}$ volts
 $= 3.8 \mu\text{V}$.

Example 3. A valve has a mutual conductance of 2.8 mA/V when the anode current is 9 mA. Assuming that the shot noise constant of the valve is 0.4×10^{-9} , what will be the impedance of a tuned circuit connected to the grid-cathode circuit which will produce noise equal to the shot noise of the valve? (It is not necessary to know the band-width for this problem.)

$$\begin{aligned} \text{Equivalent shot noise at the grid} &= \frac{k\sqrt{I_a \delta f}}{g_m} \\ &= \frac{0.4 \times 10^{-9} \sqrt{9 \times 10^{-3}} \delta f}{2.8 \times 10^{-3}} \\ &= 1.35 \times 10^{-8} \sqrt{\delta f} \text{ volts.} \end{aligned}$$

Let Z_0 be the impedance of the grid circuit to generate noise equal to the above shot noise.

Thermal agitation noise = $12.6 \times 10^{-11} \sqrt{Z_0 \delta f}$ volts.

Whence
$$Z_0 = \left(\frac{1.35 \times 10^{-8}}{12.6 \times 10^{-11}} \right)^2 \text{ ohms.}$$

$$Z_0 = 11,500 \text{ ohms.}$$

From the above example it can be seen that with tuned grid circuits having parallel impedances of the order of 10,000 to 20,000 ohms, the shot noise will be of the same order as the thermal agitation noise of the circuit. With grid circuits of higher impedance the thermal agitation noise will predominate over the valve noise. At long wave-lengths the circuit impedances are high and the thermal agitation noise is always greater than the shot noise, but at frequencies above 5 Mc/s the shot noise is usually greater. The actual frequency at which the two are equal varies greatly according to the circuits and valves used, and may be calculated as above.

If, in the absence of site noise (page 163), the dominating receiver noise is due to shot effect in the first valve and if the aerial impedance is resistive, optimum signal to noise ratio is obtained by matching the aerial to the receiver input circuit. If the noise of the input circuit is far in excess of the shot

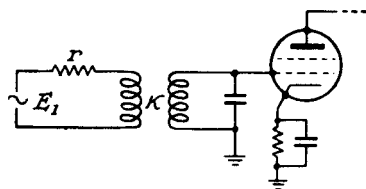

FIG. 106.

noise, optimum signal to noise ratio may be obtained for a coupling larger than that required for matching.

An example will best explain the conditions (Fig. 106).

Example. The aerial has an impedance of 38 ohms, and an e.m.f. of magnitude E_1 is to be transferred to the grid of the valve. The equivalent shot noise of the valve is $1 \mu\text{V}$, the noise of the tuned circuit is $6 \mu\text{V}$. Find the condition for the best signal to noise ratio.

The impedance between grid and cathode is $\frac{Z_0}{1+A^2}$, where A is the ratio $\frac{k}{k_{opt}}$ (page 19). The circuit noise is proportional to $\sqrt{\frac{Z_0}{1+A^2}}$ and therefore the total receiver noise is proportional to $\sqrt{\frac{36}{1+A^2} + 1}$. The transfer ratio for the signal from the aerial to

the first grid is proportional to $\frac{1}{A + \frac{1}{A}}$ and hence the conditions for

optimum signal to noise ratio are obtained as follows :—

$$\frac{\frac{1}{A + \frac{1}{A}}}{\sqrt{\frac{36}{1 + A^2} + 1}} = \sqrt{\frac{1}{A^2 + 38 + \frac{37}{A^2}}} = \text{maximum,}$$

the solution of which is

$$A^2 = \sqrt{37} = 6.1, \quad A = 2.47,$$

equivalent to a coupling approximately 2.5 times the value for perfect matching.

The gain in signal to noise ratio as compared with optimum coupling is only 1.23 : 1, but the above equation shows that in such cases undercoupling might easily lead to a loss of 3 or 4 db. in the ratio signal to noise.

Sharpness of Bearing of a D.F. Receiver. When a receiver for direction finding is to be designed it is possible to compute its performance from knowledge of the receiver noise, provided the site noise can be neglected. This is usually the case, first, due to the small effective height of a frame, and secondly owing to the fact that D.F. receivers are used on sites relatively free from outside noise.

The performance of a D.F. receiver is judged by the sharpness of bearing obtained for a given input, i.e. twice the angle by which the frame must be rotated from the position of minimum reception to make the signal distinguishable from the receiver noise. If the receiver output is measured with an output meter, the band-width of the receiver is of first importance, as will be readily understood. If the width of bearing is taken by aural discrimination, experience shows that the band-width of the receiver is practically without influence, the ear working in this case as a note filter. When a receiver of 6 Kc/s band-width is used, it has been found that the average ear is just able to distinguish between noise and signal when an output meter shows no discrimination whatever. For the same signal it is necessary to reduce the band-width of the receiver to 100 c/s, e.g., by means of a note filter, before the output meter indicates equality between signal and noise. The figures for receiver

noise as given in this chapter and the figures for the input ratio of an untuned loop as given in Chapter 2 are used in the following example to show the method of computing the performance of a D.F. receiver.

Example (Fig. 107): A receiver for direction finding employs a rotating one turn frame of 0.5 sq. m. area. At 3 Mc/s the input

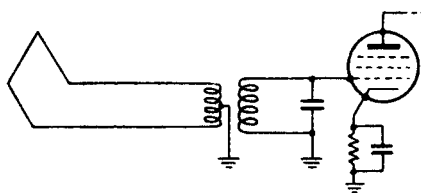

FIG. 107.

circuit has a capacitance of 80 pF, the Q of the tuned circuit and of the loop circuit being 100. The first receiver valve is a pentode having an equivalent noise of $1.4 \mu\text{V}$ for 6 Kc/s band-width. The inductance of the frame is $2.3 \mu\text{H}$.

Find the sharpness of bearing for an unmodulated carrier of $10 \mu\text{V/m}$ field strength, the bearing being taken by aural discrimination.

The input ratio to be expected for a transformer coupling of

70% is found from page 46 to be $0.26Q\sqrt{\frac{L_{\text{eff}}}{L_1}}$, where L_1 is the

inductance of the loop and L_{eff} the effective tuning inductance of the input circuit. Since $f = 3 \text{ Mc/s}$ and $C = 80 \text{ pF}$, L_{eff} is

$35 \mu\text{H}$, and hence the input ratio is $0.26 \times 100 \sqrt{\frac{35}{2.3}} = 101$.

The effective Q of the input circuit is found from page 45 to be 70, and the impedance between grid and cathode is therefore 46,000 ohms. The noise of the input circuit is, for a band-width of 6 Kc/s, equivalent to $2.1 \mu\text{V}$ and the total receiver noise $\sqrt{2.1^2 + 1.4^2} \mu\text{V} \approx 2.5 \mu\text{V}$. For a band-width of 100 c/s (see above) this reduces to $0.32 \mu\text{V}$.

The signal delivered to the first valve must now be calculated.

The effective height of a loop aerial is $\frac{2\pi nA}{\lambda}$, n being the number

of turns, A the area of the frame in sq. m. and λ the wave length in metres. In this example $n = 1$, $A = 0.5$, and $\lambda = 100 \text{ m.}$, and therefore the effective height is approximately 0.031 m. The voltage induced in the loop by a signal of $10 \mu\text{V/m}$ field strength is therefore $0.31 \mu\text{V}$ for a frame position of maximum reception, and the voltage delivered to the first grid is $0.31 \times 101 \approx 31 \mu\text{V}$.

If α is the angle between the frame and the position of minimum reception, the voltage induced in the frame is $0.31 \times \sin \alpha$, and it only remains to find the angle α for which the signal delivered to

the first grid equals the receiver noise for 100 c/s band-width, i.e. $0.31 \sin \alpha \times 101 = 0.32$.

This gives $\alpha = 0.58^\circ$, the sharpness of bearing being $\pm 0.58^\circ$.

Site Noise. Radiated interference such as atmospheric disturbances and man-made static exists at practically every location. Such disturbances cover the whole band of radio frequencies and are known as site noise.

Very little can be done at the receiver to guard against site noise. The most effective method of treatment is the use of special aerial systems which are designed to make the receiver signal as strong as possible compared with the noise picked up.

The level of interference is often very high in the vicinity of buildings because much of the man-made static is conducted along and radiated by mains leads. Filters must be placed in the mains lead before it enters the receiver or power supply unit. Much can be done by the use of aerial systems with screened feeders; an aerial is erected some distance from the receiver, at a place where the site is low (compare Chapter 8, page 201). The aerial is coupled to the screened feeder by means of a transformer or matching network; the feeder should be matched to the first circuit of the receiver at the other end. Parallel wire or concentric tube feeders may be used, the latter being the more efficient. The aerial and feeder system must be designed to work best at the frequency most used. A design to operate over a wide range of frequencies is fairly complex (see Chapter 2).

Ordinary screened feeder aerial systems offer no protection against atmospheric disturbances, which are of constant intensity over wide areas. Directional aerials such as frames and beam aerials can be so oriented as to receive a loud signal from the required station and so improve the signal to noise ratio. If the site noise comes from a particular direction, a not unusual case, the aerial can be arranged to have a minimum of pick-up in that direction.

Interference from ignition systems and some types of atmospheric consist of short pulses of large amplitude. This noise may be reduced by the use of a noise suppressor or limiter in the receiver; this is a circuit which mutes the receiver for the short duration of the noise pulse. It is found that such muting for short periods does not impair reception of the desired signal. Usually the noise suppressor circuit is fed from the last intermediate frequency stage and acts on the first low frequency amplifier of the receiver. Much of the loss of intelligibility caused by these pulses is due to the low-frequency valve grids becoming negatively charged with the

grid current caused by the pulse ; the receiver may remain muted some time after the pulse has passed, due to the time constant of the grid circuit. If a quick acting suppression circuit is used, this grid current is avoided and the set is silent only so long as the pulse lasts (compare pages 150, 180-182).

CHAPTER 7

GAIN CONTROL

Variation of receiver gain is usually obtained by a change of grid bias of one or several radio frequency valves. The use of variable- μ valves gives a smooth and uniform control owing to the exponential character of the $I_a E_g$ curves and permits a relatively large grid swing at lowered sensitivities without undue distortion. If a constant- μ pentode is used and the screen grid voltage derived from a high anode voltage by means of a series resistance, the $I_a E_g$ curve has a shape similar to that of a variable- μ valve. This is due to the fact that the screen grid voltage rises steeply with a decrease of valve current and thus counteracts partly the effect of the increasing grid bias (Fig. 108, curve 2). From this it is often deduced that a constant- μ valve under these conditions is equivalent to a variable- μ valve. This is, however, a fallacy.

The screen grid voltage, when a radio frequency voltage is applied to the signal grid, remains constant independent of its behaviour towards changes of D.C. Thus the dynamic characteristic at any given point (A) of the curve 2 in Fig. 108 is almost identical with the static characteristic 1 at the same anode current (A'). (The influence of the anode load can usually be neglected, as it is small compared with the valve impedance.) Hence the risk of distortion is in no way diminished.

If, however, the condenser earthing the screen grid is designed only for radio frequencies, the dynamic characteristic for an audio frequency voltage at the signal grid will be identical with curve 2 at any point. Thus the possibility of the radio frequency carrier being modulated by audio frequency is reduced (see page 232).

The grid bias necessary for a certain variation in gain is about twice as much for curve 2 as for 1. Such difference exists to the same extent for a variable- μ valve and has to be borne in mind when manual or automatic volume control is designed. The gain

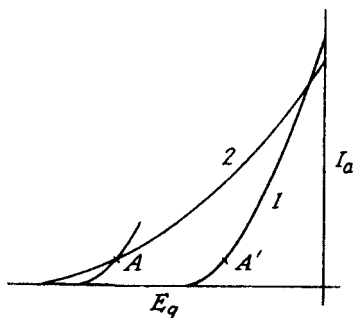

FIG. 108.

of a variable- μ pentode varies by about 4 db. per volt grid bias if the screen grid voltage is derived directly from a battery, and 2 db. per volt if it is derived by means of a series resistance from a source about twice the voltage required. With the usual potential divider one may reckon with 3 db. per volt.

Occasionally volume control is obtained by variation of the screen grid voltage. This method is quite satisfactory, its only

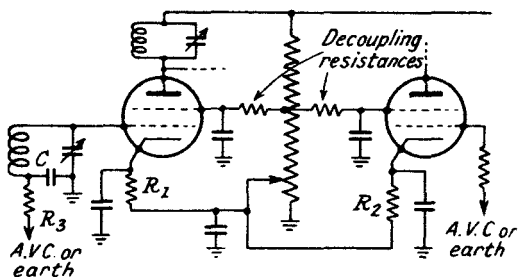

FIG. 109.

disadvantage being the danger of distortion for large grid swings. It should therefore be applied only to valves where the R.F. voltage at the grid is not above, say, 0.5 volt.

In Figs. 109 and 110 two different types of volume control are shown, the regulation in each case being obtained by a change of grid bias.

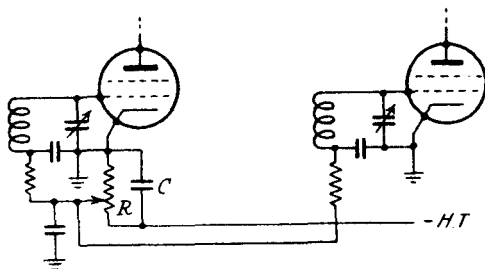

FIG. 110.

In Fig. 109 the cathode potential is raised towards positive voltages so that the screen grid and anode voltages are lowered by the amount of the grid bias. The additional effect on the gain is negligible. The maximum output obtainable is slightly lowered, a factor to be taken into account for the last I.F. valve (see later under 1). To avoid coupling through the common cathode leads, decoupling elements R_1 and R_2 must be inserted when several valves are controlled. The decoupling resistances are to be chosen

so that with the slider at earth potential the bias caused by the individual valve current has the required value.

Fig. 110 shows a circuit which is equally applicable for directly and indirectly heated valves. To guard against undesired feedback, such as modulation of the received carrier by audio frequency, R should be by-passed with a condenser C of approximately $50 \mu\text{F}$. The current through R and hence the bias for the non-controlled valves varies when the R.F. valves are controlled; this problem is discussed under (4) of this chapter. When several receivers are working on the same supply it is preferable to connect a battery in parallel to R . This maintains the total bias at a constant value and minimises interaction between the receivers (Chapter 13).

The design of gain control, manual or automatic, has to allow for a certain number of features essential for a satisfactory working. The main requirements are :

A. For manual control :

1. To work over a desired range of input without undue distortion.
2. To maintain the best signal to noise ratio possible, so long as this ratio is below a sufficiently high value.
3. To leave the tuning of the R.F. and I.F. circuits unchanged.
4. To affect the non-controlled valves not more than is permissible for a satisfactory working.
5. To maintain the best protection possible against cross modulation, when such protection is needed.
6. To work without noise.

B. For automatic control :

- 1-5. As above.
6. To maintain the requisite constancy of output for a given range of input.
7. To have a time constant enabling the receiver
 - (a) to follow quick fadings,
 - (b) to regain its normal sensitivity which has been lowered by a strong interfering signal or noise, immediately the interference is over.
8. To have a time constant which leaves the audio frequency curve unaffected (in case of telephony reception) or which does not allow the noise to rise between signals (in case of telegraphy reception).
(9-11 applying to telegraphy only.)
9. To prevent the first signals, after a pause in the transmission, from being unduly loud.

10. To prevent an interfering signal or noise which otherwise may not be perceptible from working the A.V.C.
11. To prevent the second oscillator from working the A.V.C.

A. Manual Control.

1. Required Range of Control. The danger of distortion is greatest at the last R.F. or I.F. valve, where the amplitude is largest. The best way of approaching the problem is to be seen in the following example.

Example: A receiver employs four valves before the diode; the sensitivity of the receiver is such that, for an input of $5 \mu\text{V}$, 20 volts are delivered to the diode circuit. The gain control is to work between $5 \mu\text{V}$ and 0.1 V input, the first four valves being controlled by a change of grid bias; the standing bias is 3 volts. the gain from the last I.F. grid to the diode circuit is 26 db.

With $5 \mu\text{V}$ input and the receiver working with full gain the amplitude at the last I.F. grid is 1 volt, which is assumed to be permissible. With 0.1 volt input the receiver gain must be reduced by 86 db. to maintain a constant output. It may be assumed at first that all four valves are equally controlled, and that the decrease in gain is 3 db. per valve for 1 volt increase in grid bias. Under these conditions the gain of each valve is decreased by 21.5 db., leaving a gain of 4.5 db., i.e. 1.68 for the last stage. The amplitude at the last grid becomes $\frac{20}{1.68} = 11.9 \text{ V}$; the negative grid bias

becomes approximately $(3 + 7.2) \text{ volts} = 10.2 \text{ V}$. The valve works therefore with appreciable grid current and distortion. Even if grid current should not be caused, the amplitude necessary at the last grid may be found larger than permissible. Curves giving the "signal handling capacity" may be consulted for the requisite information. These curves show, as a function of grid bias, the maximum grid amplitude which is consistent with the maintenance of distortion below a given value.

In the above case it would be necessary to stagger the gain control, i.e. to deliver only part of the total grid bias to the last grid. If, for instance, only half the grid bias is applied to the fourth valve the conditions work out as follows:

The total bias applied to the first three valves is x , to the last valve $\frac{x}{2}$; the resultant gain control in decibels, $9x + 1.5x$, must equal 86,

$$\therefore x = 8.2 \text{ volts.}$$

The additional bias applied to the last valve being -4.1 V, the grid bias becomes -7.1 V; the stage gain decreases by 12.3 db. from 26 db. to 13.7 db., i.e., to a gain of 4.84, requiring an I.F. amplitude of 4.14 V at the last grid; this is regarded as permissible.

If the valves were controlled by screen voltage, leaving the grid bias at -3 V, a staggering 1:2 of the last valve would not be enough, as it would still lead to grid current; a staggering of 1:4 might be correct, leaving just over 2 V amplitude at the grid. (This figure is to be treated with care, as the amplitude permissible at the grid hardly increases with decreased gain. One would do well, in the above case, not to control the last valve at all, if the gain control is effected through the screen voltage.)

2. Signal to Noise Ratio. As pointed out in Chapter 6, noise in the receiver output may be due to various reasons, the most important being valve noise, circuit noise and site noise. According to the conditions prevailing the receiver gain control will require careful designing, unless it is to have a detrimental effect on the equivalent receiver noise.

If the site noise is far in excess of the receiver noise (the usual case with broadcast reception on medium waves in towns), the receiver noise is of no importance. Under such conditions the question of noise need not be taken into consideration in the design of the gain control.

If the site noise is not dominant, the case at short waves with high-class communication receivers, and if within a certain range of input the best possible signal to noise ratio is to be obtained, the design of the gain control becomes of importance. The conditions can best be seen from an example.

Example: Receiver with two R.F. stages before the mixer valve; controlled are the two R.F. valves, the mixer and one I.F. valve. In Fig. 111 the equivalent noise as a function of grid bias is shown for an R.F. pentode and for two different types of mixer valve. The impedance of the input circuit is supposed to be such that circuit noise is negligible (the usual case at very high frequencies).

(1) *Conditions for Mixer Valve Type 1.* The equivalent receiver noise, referred to the first grid, is composed of three parts contributed by the three first valves. The stage gain is supposed to be 4, then the noise of the second valve is to be divided by 4 and that of the mixer valve by 16; hence the noise referred to the first grid is $1.2 \mu\text{V}$ from the first valve, $0.3 \mu\text{V}$ from the second valve, and

0.275 μV from the mixer if the grid bias is -3 volts. The total noise is the square root of the sum of the squares, i.e.,

$$\text{Equiv. Rec. Noise} = 1.27 \mu\text{V}.$$

The sensitivity of the receiver is supposed to be so high, that a signal of 1.27 μV at the first grid produces full output, so that for stronger signals the gain has to be decreased correspondingly.

On receiving a signal of 127 μV the total gain is decreased by 40 db., and the R.F. stage gain drops by 10 db. from 4 to 1.27.

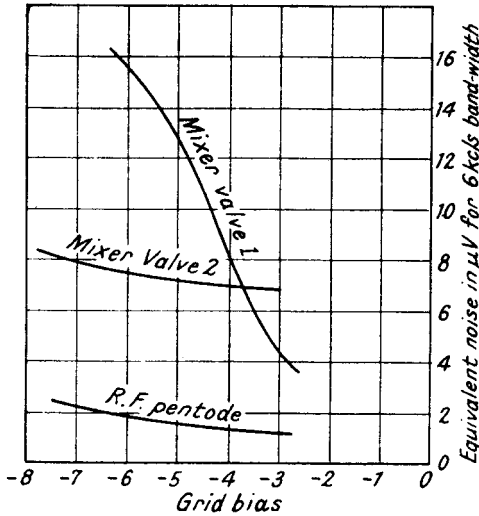

FIG. 111.

The three noise components are in this case (the grid bias being 6.3 volts if, as assumed before, an increase of 1 V in bias decreases the gain of one valve by 3 db.):

$$\text{First valve: } 1.9 \mu\text{V}$$

$$\text{Second valve: } \frac{1.9}{1.27} = 1.5 \mu\text{V}$$

$$\text{Mixer valve: } \frac{16}{1.6} = 10 \mu\text{V}$$

$$\text{Total noise} = 10.3 \mu\text{V}$$

The resulting signal to noise ratio is only 22 db. instead of 40 db., due to the growth of the equivalent receiver noise with decreased gain.

(2) *With Mixer Valve 2.* Equivalent receiver noise with full gain :

$$\text{E.R.N.} = \sqrt{1.2^2 + \left(\frac{1.2}{4}\right)^2 + \left(\frac{7}{16}\right)^2} = 1.31 \mu\text{V.}$$

E.R.N. with the gain down by 40 db. :

$$\sqrt{1.9^2 + \left(\frac{1.9}{1.27}\right)^2 + \left(\frac{7.5}{1.6}\right)^2} = 5.3 \mu\text{V,}$$

the deterioration being 12 db.

The increase in equivalent receiver noise could be prevented by controlling mainly the I.F. part ; this involves, however, dangers treated later in this chapter.

3. Mistuning of the R.F. and I.F. Circuits. Mistuning of the R.F. and I.F. circuits results in the first place from a change of grid-cathode capacitance due to change in space charge. The variation in C is of the order of 1 to 2 pF, its importance depends on the circuit capacitance and on the circuit Q . Adequate cure can be provided by inserting a resistance R between cathode and earth, as shown in Fig. 112.* Its effect may be calculated as follows. If there exists a voltage E between grid and earth, if I is the current flowing through the grid-cathode capacitance, if I_a is the anode current, and if the anode load is small compared with the valve impedance, there follows :

$$I \frac{1}{j\omega C} + (I + I_a)R = E.$$

As $I_a = E_g g_m = I \frac{1}{j\omega C} g_m$, the equation becomes

$$I \left(\frac{1}{j\omega C} + R + \frac{1}{j\omega C} g_m R \right) = E.$$

It shows that the effect of inserting R is

1. A resistance R connected in series with C
2. A capacitance $\frac{C}{g_m R}$ connected in series with C , reducing the capacitance between grid and earth to $\frac{C}{(1 + g_m R)}$.

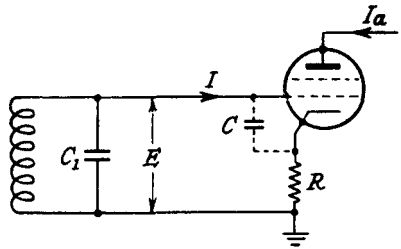

FIG. 112.

* Freeman, "Use of Feedback to Compensate for Vacuum Tube Input Capacitance Variations," *Proc. I.R.E.*, Vol. 26, Nov. 1938.

The effect 2 can be used to prevent a mistuning of the circuit as a result of C being increased by space charge. If C is the grid-cathode capacitance of the non-conducting valve and δC the increase due to space charge, R has to be chosen so that

$$\frac{C + \delta C}{1 + g_m R} = C,$$

$$\therefore R = \frac{\delta C}{C g_m}.$$

The apparent insertion of a capacitance $\frac{C}{g_m R}$ in series with C causes a loss in gain, as the whole of E is no longer applied between grid and cathode. When R is neglected in comparison with $\frac{1}{\omega C}$, the voltage between grid and cathode is $I \frac{1}{j\omega C} = \frac{E}{1 + g_m R}$ and consequently the loss in gain is $\frac{1}{1 + g_m R}$, as is the case with an audio frequency stage using negative feedback (Chapter 9).

This loss in gain can be avoided by connecting the circuit according to Fig. 113, where the total tuning capacitance is between grid and cathode. The resistance R' has to be chosen so that it compensates the now small percentage change of capacitance between grid and cathode, hence $R' = \frac{\delta C}{(C + C_1)g_m}$.

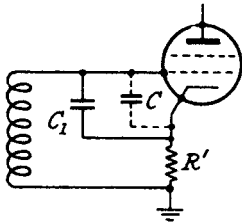

FIG. 113.

The principle of Fig. 113 cannot be carried out for a circuit with variable capacitance

as it would correct only for one position of the variable condenser.

Example: A circuit is tuned with 150 pF to 460 Kc/s. The grid-cathode capacitance is 4 pF when the valve is non-conducting and 5.5 pF when the valve is conducting. The mutual conductance of the valve is 1 mA/V. Determine the value of R in Fig. 112 and of R' in Fig. 113 and the loss in gain in both cases.

$$R = \frac{1.5}{4 \times 10^{-3}} = 375 \text{ ohms. The gain drops in the ratio of } \frac{1}{1.375}.$$

$$R' = \frac{1.5}{150 \times 10^{-3}} = 10 \text{ ohms. The gain drops in the ratio of } \frac{1}{1.01}.$$

The effect 1 constitutes an additional circuit damping, its seriousness depending on the frequency and the tuning capacitance. If C is the grid-cathode capacitance, C_1 the total tuning capacitance,

and f the frequency, the additional damping is for the circuit shown in Fig. 112.

d (added) = $\frac{R}{\omega L} \left(\frac{C}{C_t} \right)^2$ (see Chapter 1, page 11), and for the circuit Fig. 113

$$d' \text{ (added)} = \frac{R'}{\omega L}.$$

R' being equal to $R \frac{C}{C_t}$, there follows $d' = d \frac{C}{C_t}$, which shows that in Fig. 113 the additional damping is much greater than in Fig. 112. In the example given above d (added) works out to be 1.15×10^{-4} , a quite negligible quantity ;

$$d' \text{ (added)} = 1.15 \times 10^{-4} \frac{150}{4} = 0.43\%,$$

which is serious as the natural circuit damping is only of the order of 1%. At short waves the method Fig. 113 is for this reason hardly applicable, the additional damping becoming much higher than in this example.

Change in grid-cathode capacitance may also be due to Miller effect (Chapter 9, page 210). It is usually smaller than the effect caused by space charge and can also be compensated by a cathode resistance. If, with a resistive anode load, the amplification from grid to anode is 50 and if the grid-anode capacitance is 5×10^{-3} pF, the variation in grid-cathode capacitance is 0.25 pF, i.e. only one fifth of the average change caused by space charge.

4. Effect on Other Valves. The change in total feed, when several valves are controlled, may cause a variation in H.T. and thus affect the working conditions of the non-controlled valves. For receivers with many valves and a power output stage the danger is small as the feed of the controlled valves is a comparatively low percentage of the total feed ; sometimes a bleeder resistance is used to obtain a high constancy of H.T. under all conditions.

For receivers designed for a small output the feed of the controlled valves may easily be half the total feed. If the grid bias is taken from a common resistance in the H.T. lead, means are needed to keep the general bias constant. A simple device as given in Fig. 114 may prove useful. The resistances R_1 and R_2 are chosen so that the total grid bias has the desired value for two appropriate positions of the slider, while the resistance R_3 prevents the grid bias from becoming zero.

Example: The total feed with the slider at A is 40 mA ; the feed of the controlled valves is 20 mA, the bias of the controlled

valves being -1 V. The total current of the controlled valves for $E_g = -10$ V is 6 mA, for $E_g = -20$ V about 2mA, in accordance with the exponential character of the $I_a E_g$ curves for variable- μ valves. R_1 and R_2 are to be chosen so that the total bias between B and the cathodes is 20 V both when the slider is at A (total current 40 mA) and when the slider is at B (total current 22 mA).

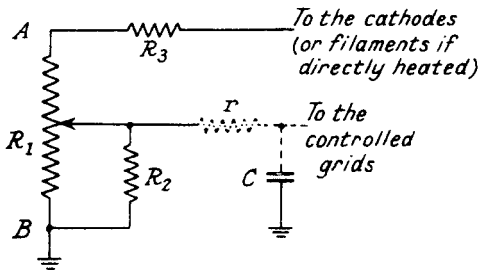

FIG. 114.

R_3 is 25 ohms if the bias of the controlled valves is to be -1 V with the slider at A . The equations for R_1 and R_2 become $\frac{R_1 R_2}{R_1 + R_2} \times 40 \times 10^{-3} = 19$; $\frac{R_1 R_2}{R_1 + R_2} = 475$ ohms, and

$$R_1 \times 22 \times 10^{-3} = 19$$

$$\therefore R_1 = 864 \text{ ohms, } R_2 = 1,055 \text{ ohms.}$$

Checking the other positions will show that the total bias deviates from 20 V nowhere by more than 5%.

5. Cross Modulation. Even if any mistuning treated under 3 is avoided the figures determining the receiver selectivity may be changed by gain control. A change in the selectivity curve, due to a variation of valve damping or feedback, may be disregarded here, as it can be avoided. Susceptibility to cross modulation, however, may vary appreciably, as can be seen from the following.

Example: A receiver, when adjusted to $1 \mu\text{V}$ sensitivity, leads to cross modulation from an interfering signal 1% mistuned and a thousand times the amplitude of the desired signal. If the receiver gain is controlled for an input of $100 \mu\text{V}$ and, for reasons of signal to noise ratio, the control takes place in the I.F. part only, cross modulation can still be expected for $1,000 \mu\text{V}$ undesired input, i.e. a carrier only ten times the strength of the desired station. The effect can be avoided by controlling the R.F. valves; this has, however, a detrimental effect on the signal to noise ratio. For the average receiver no great care is taken to avoid one thing or the other. For high-class communication receivers, however, it may prove useful to leave to the operator the choice of valves to be controlled. If, in receiving a fairly strong station, another still stronger station causes trouble at the mixer grid, the R.F. valves

should have preference of control ; if the receiver noise is the disturbing factor in reception of a weak signal, control should take place in the I.F. part.

6. Noisy Gain Control. Variable resistances, if used for gain control, often cause noise. Similar to the brushes of a motor the points of contact can be regarded as an R.F. generator, with frequencies spreading over the whole R.F. range. Interference is caused mainly by energy transfer through leads, the first receiver stage being the most vulnerable point. Placing the gain control away from the R.F. circuits and earthing the contact through a $0.1 \mu\text{F}$ condenser is usually sufficient to stop the effect. Sometimes an additional resistance R of about 5,000 ohms may prove necessary (r and C in Fig. 114). In principle the same measures might be applied as for the screening of any R.F. source.

The A.F. gain control is rarely the source of noise as it is not in direct connection with the sensitive part of the receiver and no D.C. current flows through the variable contact.

B. Automatic Gain Control.

1-5. The requirements are the same as those discussed for manual control.

6. Constancy of Output with Varying Input. The shape of the A.V.C. curve depends mainly on three factors : the number of controlled valves, the characteristics of the controlled valves and the delay voltage. The various possibilities are best treated in one example which will prove a fairly good guide.

Example : Three amplifier valves and the mixer valve are controlled. The gain of an amplifier valve varies with grid bias by 3 db. per volt, the gain of the mixer valve by 2 db. per volt. The output is to vary by not more than 6 db. for 60 db. input ratio, taken between $5 \mu\text{V}$ and 5 mV. If the detector valve is supposed to work linearly, the above condition means that the amplitude applied to the detector valve is allowed to vary by 6 db. for a change of 60 db. in input voltage.

To obtain an increase of only 6 db. in the amplitude applied to the detector for 60 db. increase in input, the receiver gain has to fall by 54 db. The increase in grid bias necessary to achieve this fall is called x , then x is found as follows :

The gain of one amplifier valve drops by $(3 x)$ db.
 „ „ „ three „ valves drops by $(9 x)$ db.
 „ „ „ the mixer valve drops by $(2 x)$ db.

Hence $11 x = 54$, or $x = 4.9 \text{ V}$.

The value of x determines the choice of the delay volts (Fig. 115). It may be assumed as an approximation, that the D.C. voltage developed across R_1 is equal to the R.F. peak between A and B if no delay voltage is applied, and equal to the difference peak minus delay voltage if the latter has a finite value. If a delay of 4.9 V is applied, A.V.C. starts working for a carrier of 4.9 V peak between A and B and an A.V.C. voltage of 4.9 V is developed when the carrier rises by 6 db. The above requirement for a constancy of 6 db. in output with 60 db. change in input is, therefore, fulfilled in this case by applying a delay voltage of 4.9 V to the A.V.C. diode.

If the A.F. detector valve works not linearly but according to a quadratic law, the amplitude between A and B has to be constant within 3 db. to maintain a 6 db. constancy of output. This necessitates a drop of 57 db. in receiver gain for 60 db. input rise, corre-

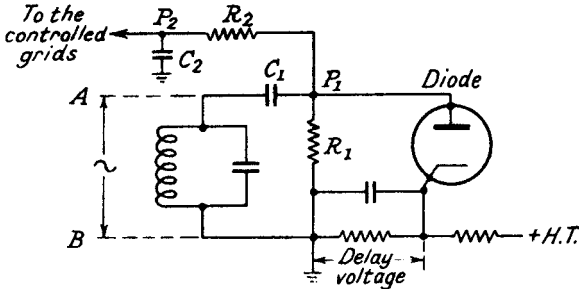

FIG. 115.

sponding to an increase of $\frac{5.7}{1.1} = 5.2$ V in grid bias. The delay voltage is thus to be chosen so that an increase in carrier amplitude between A and B by 3 db. above the value E_0 for which A.V.C. starts, produces 5.2 volts D.C. across R_1 . Hence there follows:

$$0.41E_0 = 5.2$$

$$E_0 = 12.7 \text{ V,}$$

where E_0 is the delay voltage required.

If a receiver proves to be unsatisfactory in its A.V.C. action the following tests should clarify the situation.

1. Break the connection from the A.V.C. diode to the controlled valves and apply instead negative bias by manual control. Measure the volts applied and inject a variable E.M.F. from a signal generator, always keeping the output constant. Assume the curve obtained is as shown in Fig. 116.

2. Receiver as under (1). Inject a variable E.M.F. and measure the A.V.C. volts developed (but not utilised for gain control in this

case) as a function of the input for various grid biases. Unless the design is at fault, e.g. by controlling too strongly the last I.F. valve, the grid bias should not affect the shape of this curve.

In Fig. 117 three such curves are given, showing the D.C. voltage obtained for three different delay voltages. The receiver is assumed

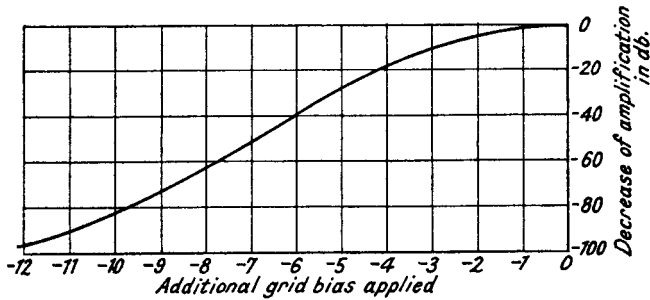

FIG. 116.

to work with full gain. The injected signal is modulated, so that there is audio frequency output at the same time. This output is recorded as well in Fig. 117.

From Figs. 116 and 117 the A.V.C. action to be expected can be easily derived. The calculation necessary is carried out below for a delay voltage of 10 volts.

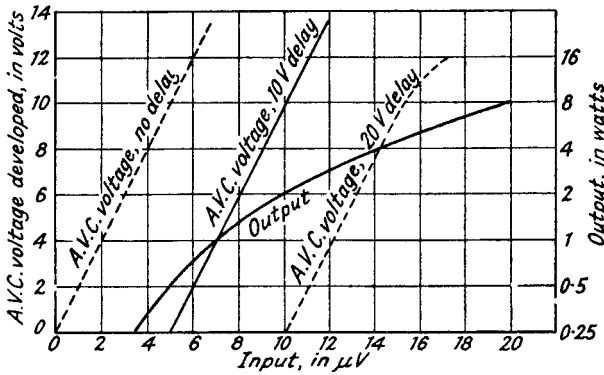

FIG. 117.

From Fig. 117 there follows: when the output is 0.5 watt the A.V.C. just begins to work. The receiver is working with full gain, so that the input necessary for 0.5 watt is $5 \mu V$. When the output is 1 watt the A.V.C. voltage developed is 4 V. From Fig. 116 there follows that with -4 V applied to the controlled valves the gain

drops by 18 db. Hence the input necessary for an output of 1 watt is

$$7 \mu\text{V} \text{ (input necessary with full gain)} \times 10^{\frac{18}{20}} = 55.5 \mu\text{V}.$$

If one or two more points are thus found the whole A.V.C. curve can be plotted; it records the receiver output for any given input at the frequency where the measurements have been taken. Variations in gain over the frequency band would merely affect the point where the A.V.C. action starts, otherwise the curves are bound to be almost identical.

If the A.V.C. curve derived in the above way differs appreciably from that obtained in actual fact, it must be due to the A.V.C. voltage not reaching the grids of the controlled valves. Measurement of the anode currents of the controlled valves for different outputs,

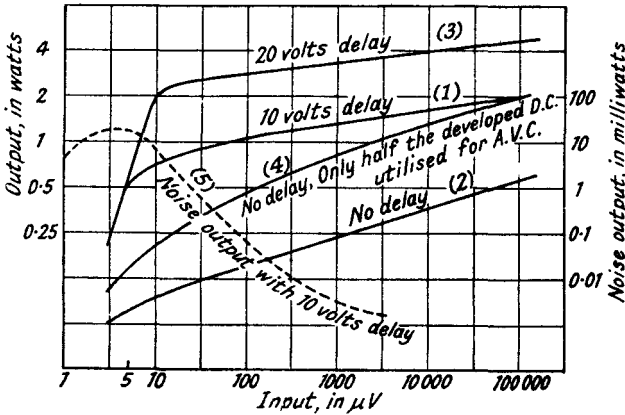

FIG. 118.

both when the A.V.C. is in action and when the grid bias is applied by manual control, will show that the valves are not sufficiently backed off in the case of A.V.C. A break in the A.V.C. lead, a short circuit or leakage resistance, say, from P_1 in Fig. 115 to earth, or something similar is indicated. Some difference between the curve in Fig. 116 and a curve based only upon valve characteristics may be expected if the controlled valves derive their standing bias from a cathode resistance. The voltage across this resistance naturally disappears when the valves are backed off. Thus the additional negative grid voltage actually coming into effect is smaller than the applied voltage by the initial bias of the valves. The fact explains the flatness of the curve Fig. 116 between 0 and -4 V; usually the effect is of little importance.

The influence of the delay voltage may be seen from Fig. 118,

where four different A.V.C. curves are drawn, based upon the delay voltages given in Fig. 117. They should not require any further comment. The diode efficiency is assumed to be approximately 100%, so that doubling the diode input at which the A.V.C. starts working produces a D.C. voltage equal to the delay voltage.

The advantage of a large delay consists in leaving the receiver sensitivity undiminished for small inputs and in keeping the output very constant once the A.V.C. action takes place. It naturally requires a large amplitude at the A.V.C. diode, which may lead to distortion in the last I.F. valve; for this reason a special I.F. valve is sometimes used in which distortion is of no importance (Fig. 119).

The disadvantage of no delay is obvious; it either decreases the receiver sensitivity even for small inputs or its efficiency is not satisfactory. A.V.C. without delay voltage is rare nowadays and used only in cheap receivers.

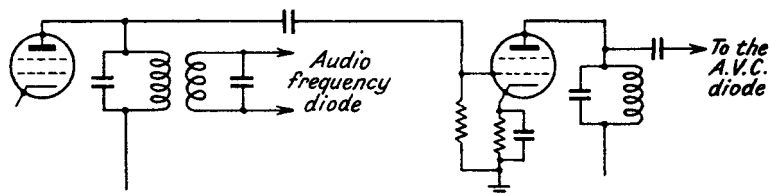

FIG. 119.

If there is D.C. amplification of the voltage caused by the A.C.V. diode, the delay voltage, if employed at the diode, can be divided by the D.C. amplification factor in order to achieve the action previously described; thus for a D.C. amplification of 5, a delay voltage of 2 V at the diode gives the same constancy of output as 10 V without D.C. amplification.

In designing the A.F. part care has to be taken that the full output required can be obtained for any given input. The A.F. manual control has to allow, therefore, for the natural variation in A.F. gain due to differences between individual valves and for the limitations in I.F. amplitude at the diode in accordance with the A.V.C. curve. If the A.V.C. curve is more or less flat (Fig. 118, curve 3), the range of the A.F. manual control need hardly be more than 1 : 3 in gain; if the A.V.C. characteristic is as indicated by curve (2) or (4), the variation in A.F. gain has to be at least 1 : 10 to prevent overloading for the strongest and insufficient output for the weakest inputs.

For high-class receivers the A.V.C. should be designed so that

it starts for all inputs strong enough to be workable. As the magnitude of this input depends on the receiver noise and the site noise, it may vary quite appreciably with frequency or even from one day to the next. It may occur that the A.V.C. action is started by noise; this should not seriously affect the receiver performance unless the design is at fault, causing an effect dealt with under (9) of this chapter.

When taking the A.V.C. curve with a modulated input one should measure the receiver noise simultaneously by taking the output with and without modulation. The receiver output without modulation, i.e. the receiver noise, is given in Fig. 118 for 10 V delay (curve 5). For small inputs the noise rises because of the addition of the carrier, the latter not yet working the A.V.C. For stronger inputs the noise falls, due to the decreased receiver sensitivity. The ratio of curve 1 to curve 5 is the signal to noise ratio; it should be proportional to the input, but for reasons explained before, it increases more slowly and finally becomes almost constant, owing to some residual noise not affected by the A.V.C. The receiver noise may actually rise again with a very strong input due to modulation hum of one of the controlled valves (Chapter 10). If the hum thus introduced is below a level affecting the reception, no steps need be taken to eliminate it.

7. Quick Fadings, Strong Interfering Pulses.

8. Shape of the Audio Frequency Curve, Noise between Signals. The receiver should be able to follow quick fadings, i.e. it should be able to change its sensitivity without time delay according to the strength of the incoming carrier. If, during reception, there is interference either from a strong signal or from noise, the sensitivity is bound to decrease during the time of interference. This state of lowered sensitivity should disappear, however, as soon as the interference. Both requirements given under (7) demand a very short time constant.

There is a limit to the decrease of the time constant dictated by the requirements expressed under (8), since they demand the time constant to be above a certain value. The actual time constant chosen will be a compromise between these various requirements; the conditions are:

(a) *For Telephony.* The A.V.C. voltage must not be able to follow the change in amplitude actuated by the modulation, as otherwise the modulation would disappear in the output or be considerably weakened. The danger is naturally greatest for the low notes and, correspondingly, the value of time constant will

depend on the required audio frequency curve. A time constant of 0.1-0.2 sec. is the usual compromise for the average receiver.

(b) *For Telegraphy.* The sensitivity of the receiver must not increase appreciably between signals, as otherwise the noise would rise and make reception very tiring for the operator. This possibility is characteristic of telegraphy, for the carrier is intermittent, whereas it is continuous in telephony. The requirement for silence between signals demands a longer time constant than is necessary for telephony; a value of 1 sec. is frequently used. In high-class communication receivers various time constants are provided, and it is left to the operator to choose the one most suitable under the prevailing conditions.

In the case of quick Morse, sudden fadings or strong atmospherics, a shorter time constant may prove advantageous; in other cases, e.g. when the noise between signals is the most troublesome factor, a time constant of several seconds is feasible.

9. Time required for desensitising the Receiver. The time necessary to desensitise the receiver should be as short as possible in order to prevent the beginning of the received signal from being unduly loud, whereas a longer time of maintained insensitivity is desired to prevent the noise from rising during intervals. This difference in time constant can be obtained in the circuit of Fig. 115 by a correct choice of the various resistance and capacitance values. Usually in broadcast receivers the time constant R_2C_2 is much larger than R_1C_1 , so that the time of charging C_2 is identical with the time of discharge. If, however, C_1 is large, and if the time constant R_2C_2 is so short that the potential at P_2 follows almost instantaneously that of P_1 , the charging time is determined by C_1 and the diode resistance, the time of discharge by C_1 and R_1 . The latter is much larger than the resistance of the conducting diode, so that the two time constants are quite different, a ratio of 20 : 1 being fairly normal.

10. The Problem of ensuring that A.V.C. is not worked by Undesired Stations or by Noise. Frequently a high-class A.F. filter is used to separate stations, perhaps only 100 c/s apart, when the R.F. selectivity is not sufficient. In applying A.V.C. in the normal way the possibility arises that, though the undesired station is not audible, it causes trouble by working the A.V.C., making the receiver insensitive either for the whole of the time or for successive intervals. The effect cannot occur if the A.V.C. is taken after the A.F. filter. A similar problem exists with regard to noise. The A.F. filter may prevent a recording device being

worked by some intermittent noise as the power output of noise is proportional to the receiver band-width. The noise may, however, work the A.V.C. and thus disturb the required reception. This again is not possible if the A.V.C. is taken after the A.F. selectivity. It seems safe to say that the selectivity for the A.V.C. action should be of the same order as that used for the A.F. output. With modern means of crystal selectivity in the I.F. the danger just mentioned does not exist.

11. The A.V.C. being worked by the 2nd Oscillator. The 2nd oscillator must not work the A.V.C., as it might seriously affect

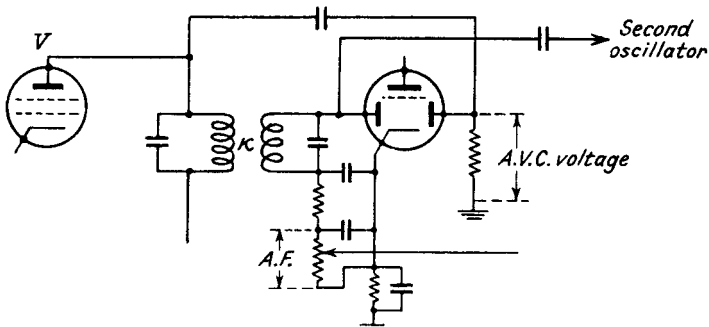

FIG. 120.

the receiver sensitivity even for small inputs. On the other hand, the oscillator amplitude at the A.F. diode should be stronger than the signal in order to obtain the best signal-to-noise ratio possible. Among various circuits fulfilling both requirements Fig. 120 shows a simple solution. To work satisfactorily, the coupling between the two circuits has to be well below the critical value. For a coupling of, say, $k = \frac{1}{3} k_{crit.}$ the signal at the A.F. diode is only one-third of that at the anode of V , the reverse being the case for the oscillator. Thus the oscillator amplitude at the A.F. diode may be well above the signal without danger of its working the A.V.C.

CHAPTER 8

THE PRINCIPLES OF SCREENING

Knowledge of the principles of screening is an indispensable part of radio frequency technique, practical applications being emphasised in the chapter on undesired feedback. The problem of screening consists in confining electric energy within a limited region round its source, which is done by barring all possible ways of propagation. Electric energy can be transferred in three different ways :

1. By means of an electric field.
2. By means of a magnetic field.
3. Through leads conveying an electric current which, in its turn, may produce electric and magnetic fields.

The three means of transferring energy will be treated separately.

1. The Electric Field. In Fig. 121 the two spheres *A* and *B* may be charged by a D.C. source to the potential difference *E*,

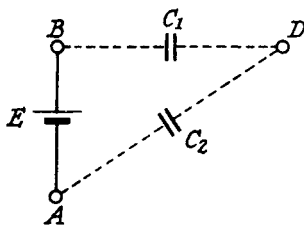

FIG. 121.

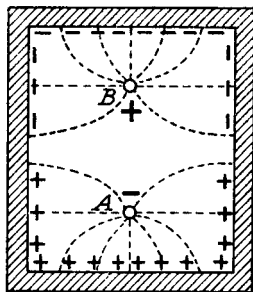

FIG. 122.

where *A* is the negative pole. From the dipole *AB* there originate electric lines of force producing at *D* a potential which bears some relation to the potentials of *A* and *B*. Arbitrarily calling the potential of *A* zero, that of *B* is *E* and that of *D* is $E \frac{C_1}{C_1 + C_2}$, C_1 and C_2 being the capacitances from *D* to *A* and *B*; the result represents only a special case of Ohm's Law, as may be seen by considering the source of D.C. to be replaced by one of A.C.

A and *B* may be surrounded now by a metal box (Fig. 122). The effect of this box on the electric field is determined by the fact that no potential difference can exist between two points of the

box ; otherwise an electric current would flow, levelling out the potential difference. For this reason the electric field caused by the dipole AB produces electric charges on the box which, in their turn, produce a secondary electric field such as to make the sum of initial and secondary fields zero over the whole area of the walls. The field external to the box is consequently zero. As the inner surface of the box is an equipotential surface, points inside the metal are not affected by the field, from which it follows that the electric charges exist on the inner surface only.

The electric lines of force must be orthogonal to the inner surface, as shown in Fig. 122. As no lines of force run outside (they can only exist between two points of different potential) the box is a perfect screen, independently of whether it is connected to A , to B , or to neither of them.

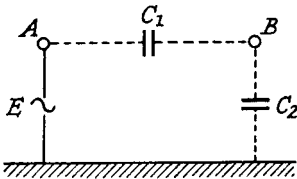

FIG. 123.

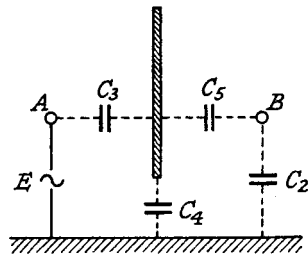

FIG. 124.

If the box contains holes or slots, or even if it is only a construction of wire netting, the screening effect is still almost complete ; such a box is known as a Faraday cage.

The preceding is equally true, if E is an alternating voltage, either A.F. or R.F., provided that the resistivity of the metal is very small. Over the whole of the frequency range this is practically the case for metals like copper, aluminium, etc.

In radio technique one of the two points A and B representing the source of E.M.F. is usually the screening container itself ; the problem of screening consists in preventing the spreading of the electrostatic field either outside the container or to certain points inside, thus preventing them from obtaining a potential different from that of the chassis. If in Fig. 123 the chassis potential is called

zero, the point B will assume a potential $E' = E \frac{C_1}{C_1 + C_2}$, C_1 and C_2 being the capacitances from B to A and to chassis respectively.

A sheet of metal placed between A and B , but not connected with chassis, has no screening effect (Fig. 124). The metal sheet

will obtain a potential $E \frac{C_3}{C_3 + C_4}$, if C_3 and C_4 are the capacitances from the sheet to A and to the chassis. The metal plate, in its turn, produces on B the potential $E \frac{C_3}{C_3 + C_4} \times \frac{C_5}{C_5 + C_2}$, C_5 being the capacitance from the plate to B . The potential thus induced on B may, in fact, be larger than without sheet, particularly when the sheet extends in a direction from A to B .

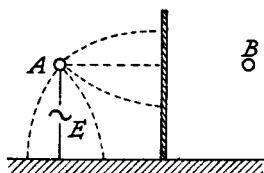

FIG. 125.

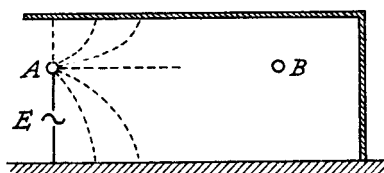

FIG. 126.

If the metal plate is connected with the chassis, it assumes chassis potential and nearly all lines of force extending from A towards B will be diverted to the sheet, which, therefore, represents an almost perfect electrostatic screen (Fig. 125). Even if the metal plate is not placed between A and B , but arranged as shown in Fig. 126, it will have an appreciable screening effect, drawing towards it most of the lines of force which otherwise would go to B .

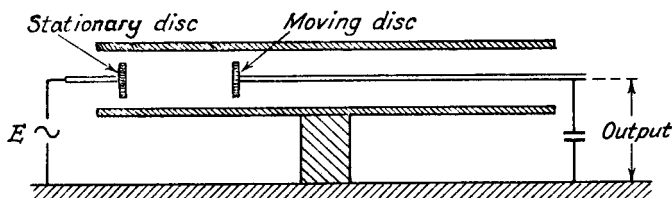

FIG. 127.

This fact is utilised in some signal generators where the output is varied, by sliding inside a metal cylinder at zero potential a disc capacitively coupled to a stationary disc inside the same cylinder (Fig. 127); the moving disc is connected to earth through a capacitance of about 100 pF so that the voltage induced is independent of frequency over a large band. The field from the fixed disc falls off rapidly, due to the influence of the surrounding cylinder; the scale is nearly logarithmic and therefore convenient for calibration. (As to the influence of the metallic connection between the cylinder and chassis, compare Fig. 145.)

If, in Figs. 123-6, the receiver chassis like a Faraday cage surrounds *A* and *B*, it makes no difference whether the chassis is connected with real earth or not. As this is the normal case, the chassis is frequently spoken of as earth, signifying it to be the zero point of reference.

If the receiver chassis is open, or if some leads not at zero potential go outside the chassis, the existence of other earthed surfaces may have an effect. This will be seen from Fig. 128.

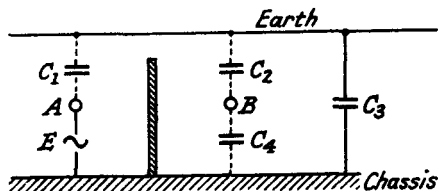

FIG. 128.

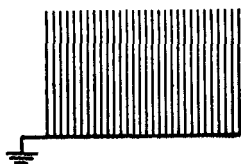

FIG. 129.

If the chassis is not earthed the potential difference between chassis and earth becomes $E \frac{C_1}{C_1 + C_3}$, producing between *B* and the chassis the voltage $E \frac{C_1}{C_1 + C_3} \times \frac{C_2}{C_2 + C_4}$, which will disappear as soon as the chassis is connected with earth. Receiver instability which disappears on connecting the chassis with earth indicates either poor screening or the existence of leads leaving the receiver (supply leads,

telephone leads, etc.), which are not at chassis potential and are elements of coupling because of their capacity to earth. A correctly designed receiver is stable without earth connection.

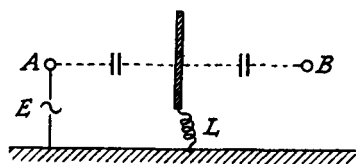

FIG. 130.

or long narrow slots. Thus an arrangement of parallel wires or strips of tin foil, insulated from each other and connected at one side only (Fig. 129), will be as effective as a solid plate. In cases where screening from an electric field is required but eddy currents within the screen are to be avoided, such an arrangement of wires or narrow metal strips is used; it is called a static screen, indicating that no magnetic screening is involved.

At very high frequencies the impedance of the screen or its earthing lead may become comparable with that of its capacitance

to the point *A*. In that case the screen potential will no longer be zero, and the screening effect is not perfect. The conditions are represented by Fig. 130; the effect on the efficiency of screen grids is treated in Chapter 9.

2. Magnetic Field. A constant magnetic field does not produce any E.M.F.; it is therefore not influenced by metals such as copper, aluminium, etc., whose permeability is unity. An alternating magnetic field, however, produces a circular electric field surrounding the magnetic field and proportional to the rate of change of the magnetic flux. If a sheet of metal of approximately infinite conductivity intercepts magnetic flux, then the circular electric field must be zero, and consequently no magnetic flux can pass through the sheet. The primary magnetic flux causes the flow of circular currents which produce a secondary field of such a strength as to make the total flux zero. Thus a flux cannot pass even through holes in the metal so long as the wave-length of the oscillation is very much larger than the diameter of the holes.



FIG. 131.

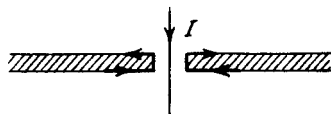

FIG. 132.

At radio frequencies the behaviour of copper, aluminium, etc., as screening materials is almost that of a perfect conductor, and as a consequence there follow several facts, the knowledge of which is essential for the understanding of screening problems. They are :

1. All radio frequency currents flow on the surface only and do not penetrate into the metal (Fig. 131).* A current inside the metal would cause the existence of a surrounding magnetic field which has just been pointed out as impossible.

2. The sum of all radio frequency currents flowing through a hole in a metal plate must be zero, as a finite current would cause the existence of a magnetic field inside the metal. Therefore an R.F. current I in Fig. 132 will give rise to currents flowing on the surface of the surrounding metal, their sum being equal and opposite to I inside the hole.

3. The total magnetic flux through a hole in the metal plate is zero, as otherwise it would result in an electric field inside the metal.

* The arrows in the drawings are to indicate the current path; the direction naturally varies.

From these three facts a number of inferences can be drawn which are of practical importance.

From 1 there follows: If a radio frequency oscillator with all its supplies is surrounded by a solid metal box which has no holes, no electric or magnetic field will be caused outside, no matter whether the box is connected to one point of the oscillator or not.



FIG. 133.

Strong currents will flow on the inner surface of the box, causing a secondary magnetic field such as to make the total field zero outside the box.

From 3 there follows (the implications of 2 are given on pages 200–205): If the screening box has holes, magnetic lines can penetrate through these holes to the outside, though the total flux through them will be zero (Fig. 133). The existence of a flux as shown in Fig. 133 can easily be verified with a small test coil attached to a receiver. There is reception with the coil in the



FIG. 134.

position shown in Fig. 134*a*, but no reception in the case of Fig. 134*b*. If the hole is small, the diameter being a few millimetres, the magnetic flux penetrating to the outside is very small and only perceptible with the test coil quite near the hole; the screening can still be regarded as perfect. Even rows of holes are not serious, as the leakage flux will keep within their immediate neighbourhood.

Long slots, even if they are quite narrow, can be very dangerous, as can be seen from Fig. 135, if the magnetic lines of force are parallel to the slot. If they are at right angles to the slot, the latter will hardly be more harmful than a row of holes.

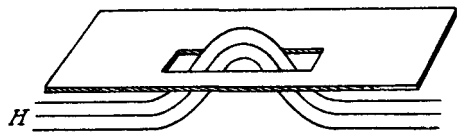

FIG. 135.

Figs. 136*a* and 136*b* give two examples, showing the effect of a slot in a metal cylinder surrounding a solenoid coil. In Fig. 136*a* the slot is harmless, being at right angles to the magnetic lines of force; in Fig. 136*b* it is serious, being parallel to them. It would be equally correct to say that the difference between 136*a* and 136*b*

is due to the fact that in 136*a* the currents induced on the inside of the box can flow unimpeded, whereas they cannot do so in Fig. 136*b*.

The problem of slots arises when boxes are mounted on a chassis, or when a lid is fitted to a box, etc. Unless great care is taken, the contacts along the edge are not reliable and will become worse with time when the surface of the metal has become oxidised. If,

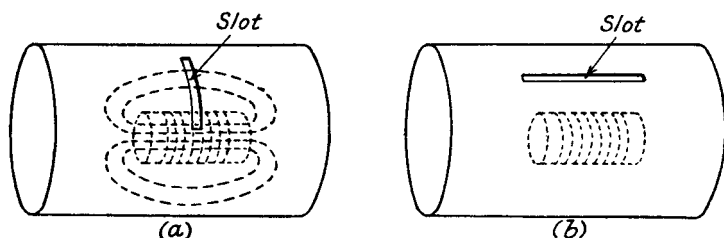

FIG. 136.

therefore, perfect screening is required without the design becoming too bulky or too expensive, the preceding points might be kept in mind when mounting the coil inside the screening can. In Fig. 137 imperfect contact between the can and the chassis is not of great importance; in Fig. 138 it would be risky, due to the slots parallel to the plane of the paper. The danger would be lessened by mounting the coil farther away from the chassis, provided the can is all one piece, with no lid which would cause other slots.

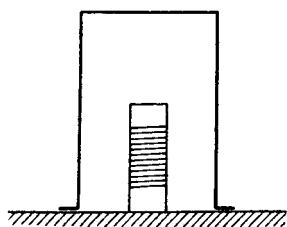

FIG. 137.

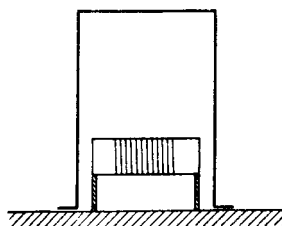

FIG. 138.

In case of boxes surrounding the whole oscillator circuit, including valves, etc., the magnetic flux cannot easily be predicted, and it is necessary to avoid slots altogether, if perfect screening is required. Lids have to be fitted so that good contacts are secured at various points along the edge. Screws are reliable, but make the removal of lids rather laborious. They are used for signal generators and other devices where the removal of lids is required only in case

of repairs. If quick accessibility is desirable, other means are employed. As strong pressure is important, point contacts, at a distance of perhaps 2 cm., are fairly popular. In any case it is recommended that the coils be specially screened; this provides at least two magnetic screens, the result being the product of the two screening effects. Usually it is cheaper to provide two moderately good screens than one very good one, the total effect being the same.

This principle is applied when rooms are screened in which receiver tests are to be carried out undisturbed by outside interference. To admit light and fresh air the screening material is wire-netting. If the wires are well connected with each other, eddy currents caused in the meshes prevent a magnetic field from passing through unimpeded. The efficiency of such wire-netting is naturally inferior to that of a solid metal plate; therefore two cages are used, one enclosed in the other, with a distance of about 10 cm. between them.

The Effect of Resistance in the Screening Material. Due to the fact that the conductivity of metal is not infinite, the currents will not flow as previously assumed on the surface only, but will penetrate into the metal according to an exponential law. The depth at which the current becomes 10% of the surface current is $\frac{15}{\sqrt{f}}$ cm. for copper, f being the frequency in cycles per second.

It shows that for average radio frequency, say 0.5 Mc/s, the depth of penetration is still small, the current decreasing to 10% of its surface value at about 0.2 mm. to 1% at 0.4 mm. depth. At audio frequency, however, the depth of penetration is such that effective screening is impossible within the practical limits. At 1,000 c/s the thickness of a copper box would have to be about 1 cm. to attenuate the current to 1% of its value on the inner surface of the box. The depth of penetration being proportional to the square root of the specific resistance, a screen of aluminium would have to be 1.37 times thicker than one of copper.

Though at radio frequencies copper or aluminium can be regarded as perfect screens in spite of their resistance, this resistance represents a loss of power, increasing the damping of screened coils. The screening box can be considered as a shorted coil, with a damping factor d and a coupling k between can and screened coil. The equivalent transformer circuit treated in Chapter 1 shows that the added damping is k^2d ; this value does, however, not give the full answer, as it takes no account of the change produced in the coil damping by a box of even zero resistance, for more wire is necessary

for the same L with the box than without it. The latter effect depends on frequency and on peculiarities of the circuit. When the circuit damping is mainly due to the coil resistance, it is increased by the box; when the damping is caused mainly by parallel resistance, i.e. dielectric losses, etc., the box has little influence. There are actually cases where screening decreases the coil damping; for instance, when the unscreened coil induces currents in the surrounding chassis and the chassis is made of a high-resistivity metal like iron. The increase in circuit damping caused by losses in the screening box depends on the frequency and the coupling between the coil and the box. The damping factor of the box increases with decreasing frequency and the effect becomes most marked on long waves. As a rough guide it may be said that for frequencies above 0.5 Mc/s a reduction of 10% in L increases the circuit damping by not more than 10%. On long waves, say above 4,000 m., the effect may easily be several times as large.

The method used for magnetic screening at audio frequencies consists in surrounding a coil with a material of high μ , i.e. one of high magnetic conductivity, causing the magnetic lines of force to go almost entirely through the material. The iron cores of A.F. transformers, apart from vastly increasing the inductance, act as a very effective magnetic screen for the reasons just described. In cases where this screening effect is not sufficient the transformers are surrounded by a box of permalloy, mu-metal or other material of high permeability.

To avoid eddy currents resulting in heavy losses the iron cores are made up of laminations provided with a thin insulating skin which leaves the permeability substantially unaltered. For radio frequencies laminations are not sufficient to prevent losses, and the cores are made up of a fine powder consisting of a mixture of iron dust and an insulating compound. Due to the many air gaps between the iron particles the permeability of this mixture is only of the order of 12-15; the inductance is increased by such iron cores approximately in the ratio of 3 : 1. It makes little difference to the inductance whether such cores are provided only inside the coil, or surround it completely, but an outside mantle provides an additional magnetic screen of about 2 : 1 which makes it possible to put the screening can nearer to the coil.

The Influence of Leads leaving the Screening Box. The problem of screening is strongly aggravated by the fact that supply leads are going away from the source of A.C. and thus transfer energy to the outside, unless special means of decoupling are applied.

The principle of employing filters may be assumed to be generally known; the purpose of the following discussion is to make the reader familiar with the practical implications and the dangers involved.

Fig. 139 gives the theoretical diagram of an r.f. source, screened with a single box; the two leads leaving the box are to convey no radio frequency to the outside. The principle underlying perfect screening, as far as the leads are concerned, can be expressed as follows: *Leads leaving the screening box must be at the same potential as the outside of the box.* The principle is obvious, as otherwise electric and magnetic fields would result outside the box. In Fig. 139 the leads outside the box will by no means be at chassis potential for the following reasons.

1. A large current flowing through C_1 via FDE sets up an E.M.F. between D and E ; this E.M.F. exists outside between H and G or between H and the box, the condenser C_3 acting in this case almost as a short circuit.

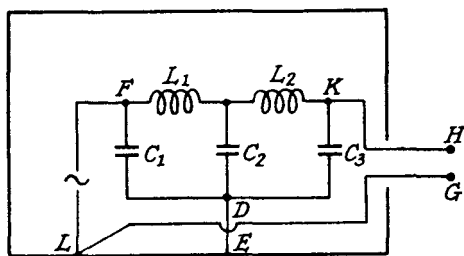

FIG. 139.

2. Mutual inductance between L_1 and L_2 may cause trouble.

3. Capacitance between F and K is likely to be harmful.

4. Currents flowing on the inner surface of the box must be expected; they will induce an E.M.F. in L_2 or in the loop $HKDELG$.

The effects of 1, 2 and 3 may be seen from one example.

Example: The frequency of the source is 6 Mc/s, $L_1 = L_2 = 130 \mu\text{H}$, $C_1 = C_2 = C_3 = 5,000 \text{ pF}$. The attenuation of one filter section is about 1,000, so that the voltage between H and chassis should be 10^{-6} of that between F and E .

Effect 1. Suppose DE is one inch of wire corresponding to about $0.02 \mu\text{H}$, equivalent to 0.75 ohm at 6 Mc/s. The reactance of C_1 is 5.3 ohms capacitive, and hence the voltage between E and D becomes $\frac{0.75}{5.3 - 0.75} = \frac{1}{6}$ of the E.M.F. of the source, completely upsetting the intended effect of the decoupling elements.

Effect 2. The consequences are much less serious than those of (1). The attenuation of one LC section being 1,000, a coupling factor of 0.1% will cause an E.M.F. in series with the voltage set up across C_2 and equal to it in amplitude. (By choosing the

correct winding sense the two voltages can be made to cancel each other, an effect sometimes used if filtering on one fixed frequency is required.) As the coupling factor between L_1 and L_2 may easily be 1% unless they are separately screened, the effect is likely to deteriorate the screening by at least 1:10.

Effect 3. A capacitance of $\frac{1}{200}$ pF would set up a voltage between K and D equal to that coming through the two filter sections. Without proper precautions the capacitance may be of the order of 0.1 pF, diminishing the screening by 1:20.

No numerical value can be given for the effect resulting from (4). It can be expected to be of a magnitude similar to (2) and (3).

The dangers being known, the proper arrangement is merely a problem of design and depends largely on special conditions. In cases when very good screening is required a design like that shown in Fig. 140 used to be employed; its efficiency is based upon two facts: first, the magnetic lines of force have to penetrate

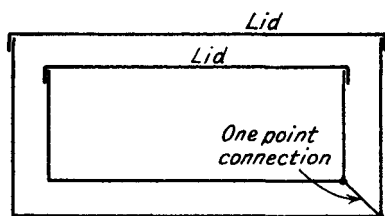

FIG. 140.

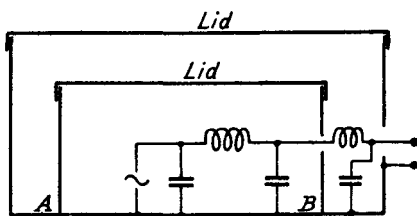

FIG. 141.

through two slots in succession, before they can do harm; secondly, surface currents on the outside of the inner box will not flow on the inside of the outer box, as only one connection exists between them. Magnetic lines of force, however, penetrating through the inner slot, produce currents on the inner surface of the outer box in any case; therefore the precautions seem exaggerated, and experience shows that a design like Fig. 141 is practically as efficient, provided there are no slots at A and B .

Fig. 142 gives another convenient alternative; the components are sufficiently accessible, if those in the left-hand compartment are mounted on the plate P and the plate fastened to the main box, so that a number of good contacts are secured. Designs like Figs. 140 and 141 easily give a screening effect of 10^8 and more, provided the filters are correctly made.

The design of Fig. 142 may be regarded as inferior to those of 140 and 141, unless the partition between the two compartments seals them very efficiently from each other.

Fig. 143 represents a design one stage less efficient than Fig. 142, due to the fact that the slots S_1 and S_2 lead immediately to the outside. It is difficult to give figures, but it may be assumed that a screening effect of 10^6 can be expected, if the source of E.M.F. is represented by a tuned circuit and the coil is unprovided with a separate magnetic screen. A figure like 10^6 for the screening

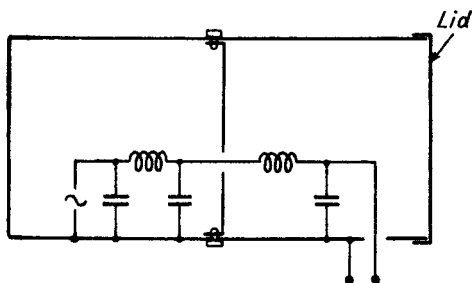

FIG. 142.

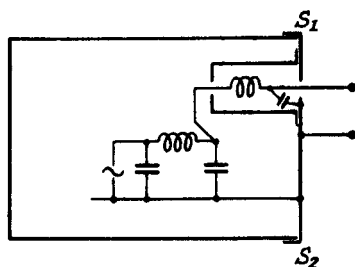

FIG. 143.

effect may be understood to mean that the p.d. between the terminals outside the box will become 10^{-6} of the E.M.F. inside.

The attenuators attached to signal generators show what can be done in a small space with a good design. The degree of attenuation obtained with such devices is of the order of 10^4 to 10^5 . The arrangement is shown in principle in Fig. 144; in fact, the

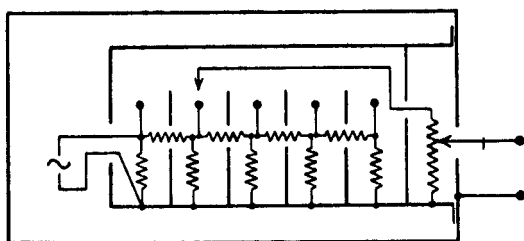

FIG. 144.

various resistances are arranged within a circle, and the moving arm rotates. Capacitances between the fixed contacts, particularly the first and the last, or capacitance between the moving arm and the fixed contacts, have to be avoided at all costs. Potential difference between the attenuator box and the main screening box may upset the system of attenuation (Fig. 145). Due to the capacitance from A to the screening box a current marked by arrows will flow, causing a potential difference between B and C ;

this exists in addition to that obtained at the output resistance, whatever the position of the moving attenuator contact. The effect will be most troublesome for small output and will increase towards higher frequencies, the undesired output being approximately $E \frac{X_{BC}}{X_{C1}}$, where E is the p.d. between A and chassis; the undesired output increases with the square of the frequency, for

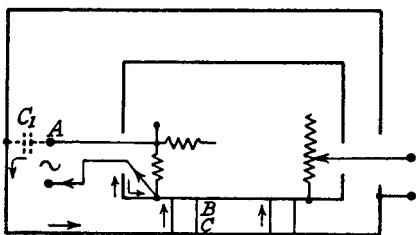

FIG. 145.

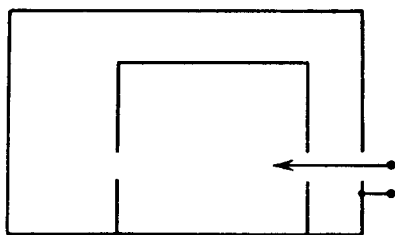

FIG. 146.

BC is an inductance. Studs BC of half an inch length are likely to make an attenuation of more than 10^4 impossible at frequencies of 20 or 30 Mc/s, assuming C_1 equals about 2 pF and BC has an inductance of $2 \cdot 10^{-3} \mu\text{H}$ (3 or 4 studs in parallel).

An arrangement like that in Fig. 146 would do away with this effect but still be bad, as surface currents, flowing in the large box, induce a voltage in the output loop greater than the minimum output required. Both disadvantages are avoided in Fig. 144.

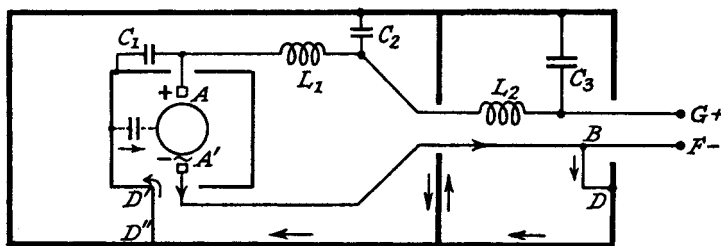

FIG. 147.

Fig. 147 gives the theoretical diagram of a screened motor of which the negative pole is connected to chassis. Unlike previous circuits the negative lead is not omitted. This is in order to avoid contacts in the path of an assumedly heavy D.C. current. A and A' are the sparking brushes, the source of the disturbing E.M.F. One point of the brush A' is connected to the outgoing lead, the

other point to the motor winding which represents for radio frequency a capacitance of a few hundred pF to the motor case. The latter is connected to the screening box through the lead $D'D''$. The negative brush causes an R.F. current marked by the arrows which produces a potential difference between B and D and, therefore, between F and the outside of the box. In addition, the current is likely to induce an E.M.F. in L_2 which causes G to have a potential different from that of the box. The safest way to avoid both effects is to connect the negative brush immediately with the case and to use the box as the output terminal; the difficulty of contacts can be overcome. (Compare page 228.)

If both motor leads have to be insulated from the chassis, filter sections have to be inserted in the negative lead equal to those used in Fig. 147 for the positive lead, thus bringing both outgoing

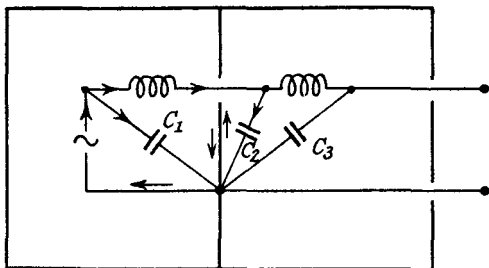

FIG. 148.

leads to chassis potential for radio frequency. The condensers nearest to the brushes (C_1 in Fig. 147) should be connected to the motor case to keep strong R.F. currents away from the main box. Thus the motor frame is utilised as a first partial screening box.

It seems appropriate to say a few words about the so-called one-point earthing. In the old days it used to be strongly advocated and is even to-day frequently claimed as absolutely essential. The principle of the circuit may be seen from Fig. 148. The underlying idea is that currents flowing through the various condensers are led to the same earth point and do not cause currents on the inner surface of the chassis. This is, however, not the case as currents do not flow through the partition, but on the surface back through the same hole through which the conducting wire passes.

It is therefore unimportant to which point of the box the condensers are connected; the nearest point is usually the best, the condenser leads being as short as possible.

Filter Components.

1. Condensers. Condenser leads should be made as short as possible and the type of condenser chosen with care. A condenser represents a series combination of capacitance and inductance, the latter being determined by the leads inside the condenser rather than the arrangement of the tinfoil. In Fig. 149 various types of "non-inductive" condensers are shown with their respective inductances.

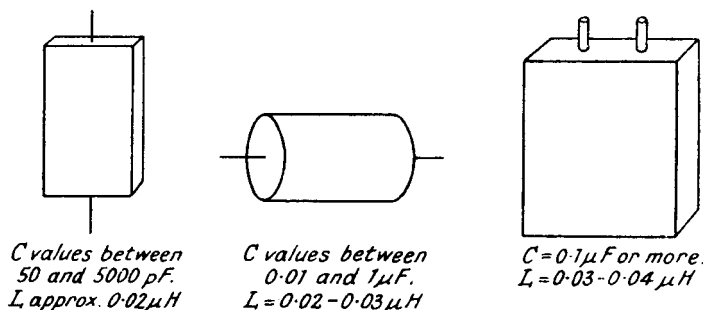

FIG. 149.

The condenser impedance becomes a minimum when the capacitive and inductive impedances are equal, i.e. at the point of series resonance. For 1 μ F condensers of the type given in Fig. 149 this occurs at about 1 Mc/s, for 0.1 μ F at 3 Mc/s. For frequencies higher than the resonant frequency the condensers behave like an inductance, for lower frequencies like a capacitance. In special

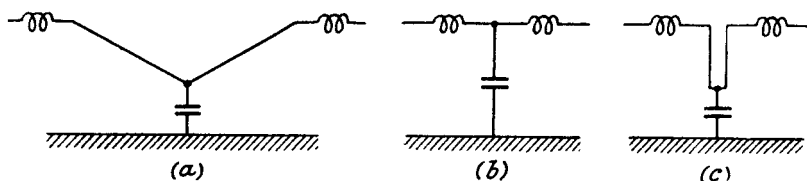

FIG. 150.

cases it may pay to make use of the resonance if filtering on one frequency is desired, but the variations of L and C have to be taken into account.

If long condenser leads cannot be avoided they should be wired up as shown in Fig. 150a, where the length of lead is made harmless. Fig. 150b and even 150c is bad; in the latter the mutual inductance of the two wires is almost as dangerous as if it were one wire.

2. Coils. In designing coils it is important :

1. To realise how far the self-capacitance may be detrimental and how to keep it down if necessary.

2. To avoid, within the frequency range required, spots where the coil impedance becomes very small.

Self-capacitance of the coil constitutes the limiting factor if attempt is made to obtain efficient filtering by the use of extremely large inductances. As an example a type of anode choke is given in Fig. 151 which has been frequently in use in the past, having an inductance of about 100,000 μH and a self-capacitance of 10 to 15 pF ; it is obvious that for frequencies above, say, 200 Kc/s the coil has to be considered as a capacitance. The rather excessive value of self-capacitance is due to the fact that the coil is wound without system. "Wave wound" coils are very much better, the corresponding coil having a self-capacitance of 3 to 5 pF. A thin and deep winding as shown in Fig. 152 is particularly good and may lead to something like 2 pF. Other attempts at small capaci-

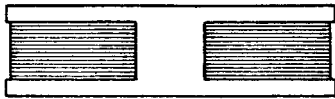

FIG. 151.



FIG. 152.

tance consist in making the coil of several sections, thus putting the capacitances of all the sections in series. The danger of series resonance leading to low impedance at spot frequencies can be overcome by correctly designing the different sections.*

The influence of coil capacitance and condenser inductance may be seen from an example.

Example: A combination of inductance and capacitance is designed for an attenuation of 1:1,000 for a frequency range 0.15-30 Mc/s. The attenuation being usually least at the low-frequency end, L and C are chosen with 0.15 Mc/s in view. An inductance of 10,000 μH and a capacitance of 0.1 μF fulfils the purpose. Allowing for a coil capacitance of 5 pF and a condenser inductance of 0.025 μH , the attenuation at the highest frequency is only 225.

In cases where a heavy direct current limits the inductance to a few hundred microhenries, the capacitance is unlikely to play

* H. A. Wheeler, "The Design of Radio-frequency Choke Coils," *Proc. I.R.E.*, June 1936.

any part, the coil becoming capacitive at frequencies where the attenuation is already much higher than required. The importance of coil capacitance should not be overrated; frequently a choice of a smaller coil and the addition of another filter section instead may prove the cheaper solution.

When using solenoid coils, spots of low-coil impedance and therefore of imperfect filtering are found to occur when the wire-length becomes comparable with the wave-length. The effect can be easily understood from Figs. 153*a* and 153*b*, the latter showing a normal feeder of a length equal to $\frac{\lambda}{2}$. If such a feeder is shorted at the end or terminated by a low impedance, it represents at the input the same low impedance. In Fig. 153*a* the wires of the feeder are replaced by solenoid coils; due to the coupling of the coil turns among themselves the equivalent wire-length is greater than the

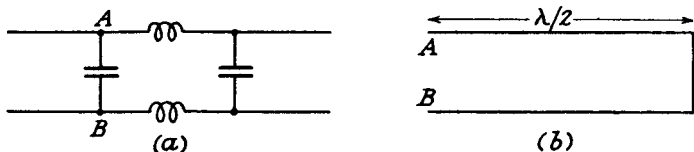

FIG. 153.

geometrical length and a point of low impedance occurs for a wire-length of about $\frac{\lambda}{3}$. In filters one of the two leads is usually earth, i.e. only one coil is employed, and the effect arises for a wire-length of $2\frac{\lambda}{3}$ or multiples of this. If, in this case, the wire-length is never allowed to be greater than $\frac{\lambda}{2}$ the design can be regarded as safe. Multi-layer coils are found to be free from this effect.

A one-layer coil, wound on a normal A.F. lamination core, has proved advantageous in a case where filtering for a large frequency range was required and the D.C. current was several amperes. The inductance is large for the lower frequencies where it has to be large, the permeability of the iron having almost its normal effect (at 15 Kc/s). At the highest radio frequencies, at 20 Mc/s, the coil inductance becomes almost what it is without iron, which is, however, sufficient for these frequencies. The damping effect of the iron at the high frequencies is such that the series resonance just described does not arise.

Condensers of large capacitance, if designed for high voltage,

are expensive and bulky, and the same holds good for large inductance coils if designed for heavy current; hence there follows the obvious rule that, for high voltage and low current, filters with small capacitances and large inductances should be employed, the requirements being reversed for low voltage and high current.

The Screening of Aerials. The principles involved in the screening of aerials can be best understood from Fig. 125 and from the fact that all currents flowing through a hole surrounded by metal must be zero (page 187). Fig. 154 shows a receiver aerial, supposed to be very long and extending through the roof of a house. E is a source of radio interference, usually the mains leads. The aerial may pick up noise due to the electric or magnetic field caused

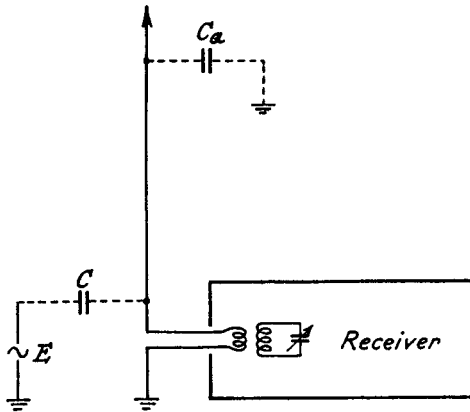

FIG. 154.

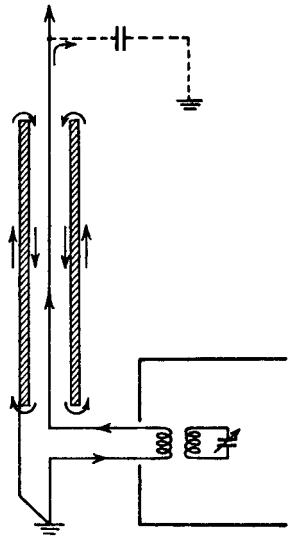

FIG. 155.

by E . Thevenin's theorem shows that the result of the electric field is equivalent to an E.M.F. in the aerial of $E \frac{C}{C+C_a}$, where C_a is the capacitance of the aerial and C the capacitance between the source E and the aerial. An earthed metal cylinder surrounding the lower part of the aerial (Fig. 155) removes most of the detrimental capacitance and, therefore, most of the electric interference.

A magnetic field caused by E and surrounding the aerial induces in the metal cylinder an E.M.F. which would otherwise be induced in the aerial wire directly. This E.M.F. causes surface currents to flow on the cylinder as indicated by the arrows which, in their turn, produce an aerial current, showing that the metal cylinder is

not a magnetic screen. The capacitance between the aerial and the cylinder works like a lumped capacitance parallel to the primary inductance and affects in the same way the pick-up of the signals desired and that of the interference. If this capacitance is small compared with the aerial capacitance, the effective height of the

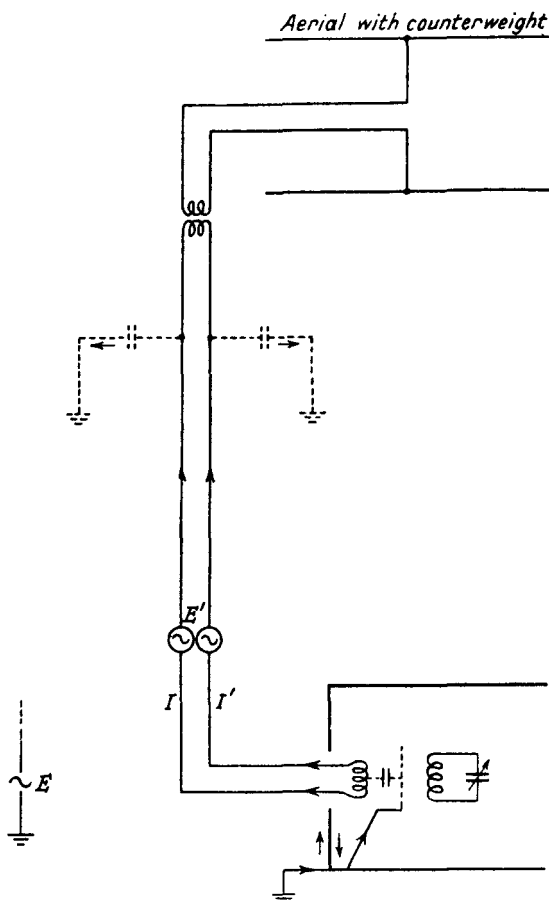

FIG. 156.

aerial is not affected by it, either for signals or for an interfering magnetic field in the immediate neighbourhood. The success of such a cylinder as a screen against interference will depend on the nature of the interference; it may succeed in one case and fail in another. If the cylinder is extended to the top of the aerial so that no aerial wire is outside the cylinder, E cannot cause any

currents on the inside of the cylinder and every reception ceases, for E as well as for the desired stations.

If there is to be protection against both the electric and the magnetic field from E without doing away with the desired reception, a circuit on the lines of Fig. 156 is required (with or without screening cable). Currents equal in magnitude and phase are caused on both wires of the feeder, their effects on the secondary coil cancelling each other out in case of perfect symmetry. The normal reception is not affected, as the receiving wire is that between the aerial and the counterweight. A certain percentage of interference will naturally be picked up by the aerial system, but the latter is supposed to be on the roof of a house, well away from the interfering source.

The static screen between the aerial coil and the secondary circuit prevents pick-up of the undesired E.M.F. due to capacitive coupling between the aerial coil and the secondary circuit. The effect could also be reduced by earthing the middle of the aerial coil, but this increases the currents I and I' , causing risk of undesired reception due to asymmetry of the middle point, unaffected by the static screen. If the secondary circuit is made symmetrical by using a push-pull stage, the static screen is not needed, as will be readily understood.

Given below is an instructive example from actual practice in which quite a number of the preceding principles are involved. The receiver Fig. 157 picks up noise from the mains, with aerial and earth disconnected, the filter proving to have no effect.

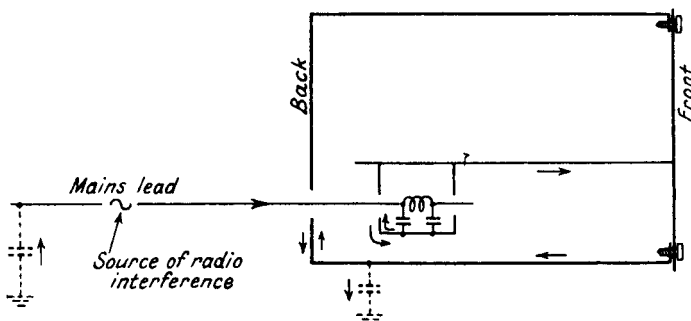

FIG. 157.

The cause of the interference will be understood, if it is pointed out that the receiver is mounted entirely on the chassis, and that the only connections between the chassis and the box are provided by the screws with which the chassis is fixed to the box. An

E.M.F. in the mains lead produces a current flowing into the hole, through the filter condenser to the chassis, from there to the box, back through the hole to the surface of the box, the earth capacitances of the mains and the box closing the circle. The chassis

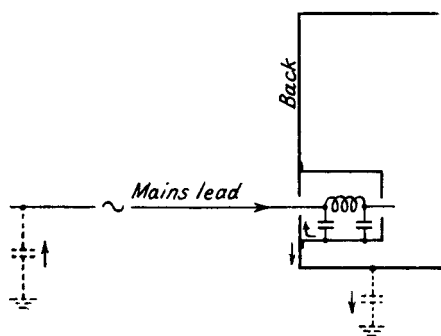

FIG. 158.

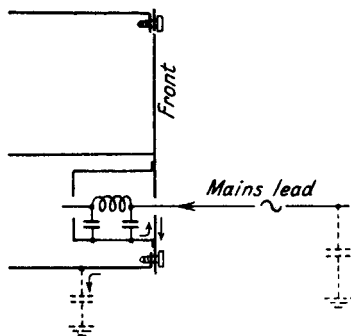

FIG. 159.

current flowing inside the box is the obvious source of interference. From Figs. 158 and 159 two equally successful ways of protection can be seen; in both cases the chassis currents are restricted to the little box containing the filter.

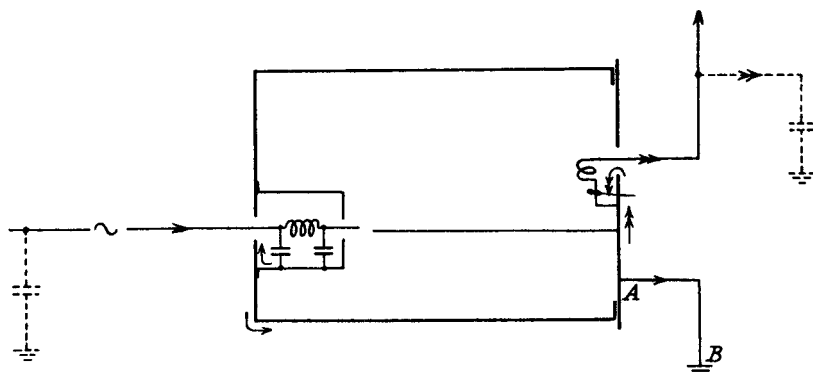

FIG. 160.

The absence of any noise picked up when the aerial and earth are disconnected may be deceptive. Even if there is through the aerial no direct pick-up of interference from the mains, reception will start as soon as the aerial is connected, with or without an earth lead. From Fig. 160 it will be seen that the current caused by an E.M.F. in the mains lead sets up a potential difference between

A and *B*, producing in its turn an aerial current marked by the double-winged arrows.

To check whether the receiver noise is due to this effect or due to normal aerial reception, the aerial may be replaced by a lumped capacitance, connected between aerial terminal and earth. As the earth lead is the coupling impedance, the noise should gradually

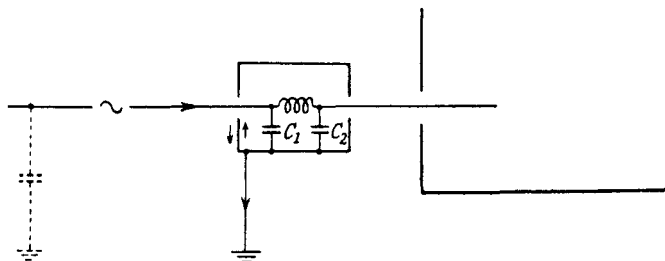

FIG. 161.

diminish by bringing the lumped capacitance nearer and nearer to the earth terminal.

Several methods of avoiding the effect may be discussed.

1. Fig. 161. The filter has been inserted outside the receiver; the method cannot be expected to be successful, as the earth lead common to C_1 and C_2 represents a strong coupling between the two condensers, introducing an E.M.F. into the lead entering the receiver.

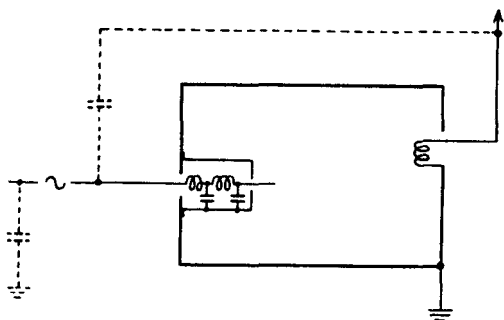

FIG. 162.

2. Fig. 162. A large choke at the beginning of the filter prevents a strong current through the receiver earth lead. The method often fails, due to capacitance between mains and aerial; this capacitance can be a source of trouble when the mains are not earthed through a condenser. The method will be found advantageous in connection with a screened aerial (Fig. 155).

3. Fig. 163. Putting the first filter condenser outside the receiver and earthing it through a separate lead is preferable to 1 and 2 and should bring an appreciable improvement. It is, of course, not a complete cure, as the current flowing through *C* gives

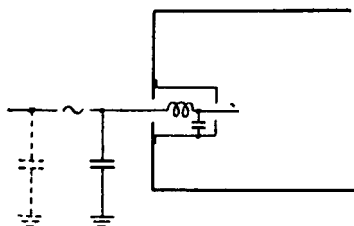

FIG. 163.

rise to an electrostatic and magnetic field, the strength of which depends on the length of the earth lead. Using a roof aerial with counterweight and symmetrical input, as shown in Fig. 156, will always be the best (see Chapter 2 about the use of a feeder).

CHAPTER 9

UNDESIREED FEEDBACK

This chapter deals with those couplings which may lead to (a) damping, regeneration or mistuning of circuits ; (b) distortion and self-oscillation (particularly the latter). A complete knowledge of this subject seems indispensable for any engineer, whether he is engaged on research, testing or service work. Without this knowledge he may find himself spending days on what should not take him more than a few hours.

An exact calculation of the effects of feedback or a reliable prediction is not always possible, as in many cases not even the frequency may be known at which the receiver tends to oscillate. Fortunately, such accuracy is rarely necessary in receiver technique, the reason being that differences in screening have little effect on the price if they are kept within certain limits. In applying means of safeguard it is therefore customary to work with a factor of safety sufficient to cover possible errors of 1 : 5 or more. What really matters is a clear understanding of all the effects involved, a correct feeling for the right magnitude and plenty of experience.

If the principles pointed out in Chapter 8 are kept in mind, the cure of undesired feedback will prove the easier part once the source of feedback has been found. This chapter deals, therefore, mainly with the various sources of feedback occurring in practice and the methods of tracing them.

The following consideration may be taken as a guide. If the amplification between two points of an amplifier is A , oscillation will start if $\frac{1}{A}$ of the amplified E.M.F. is fed back and if the phase of the E.M.F. fed back is identical with the initial voltage. One could, in this case, envisage the feedback being removed and the voltage fed back replaced by an external E.M.F. without anything changed. The slightest difference in phase between the initial voltage and the voltage fed back cannot lead to stable conditions, as the phase difference would increase with every new cycle.

If the voltage fed back is larger than the initial E.M.F. the amplitude will rise until, due to a decrease in mutual conductance, due to grid current, or for some other reason, the amplification falls and prevents a further increase, as is the case with every self-

oscillating transmitter. The larger the amplification between the two amplifier points the greater the danger. The screening and decoupling have therefore to be more severe if the parts to be decoupled are separated by several stages.

Phase conditions need not be taken into account in case of feedback over several stages employing tuned circuits; as pointed out in Chapter 1, a slight change in frequency in the vicinity of the resonant frequency results in an appreciable phase shift without much effect on the amplitude. For this reason there will, in this case, always be a frequency for which the phase condition is fulfilled, the frequency being so near the resonant frequency that the amplification can be regarded equal to that for the resonant point. A discussion of phase conditions will therefore be carried out only if it is essential.

The problems for audio frequency and radio frequency are in principle the same, but in practice the effects are so different that it seems appropriate to treat them separately. The subject may be discussed under the main headings:

- A. Undesired feedback at audio frequencies.
- B. Undesired feedback at radio frequencies.
- C. Feedback leading to combined A.F. and R.F. oscillation.

A. Undesired Feedback at Audio Frequencies.

The various sources of undesired feedback most usual in practice can be summarised as follows:

1. Capacitive coupling outside the valves.
2. Capacitive coupling inside the valves (Miller effect).
3. Inductive coupling between transformers, chokes, etc.
4. Coupling through impedance in a common path, such as batteries, etc.
5. Combination of capacitive and common impedance coupling.
6. Acoustic feedback.

The effects possible are to be discussed with the help of Fig. 164. The circuit diagram shows two A.F. amplifier valves preceded by a grid leak detector and one R.F. stage. Adequate means of decoupling are not provided. No connection is supposed to exist between the filament battery and the rest of the receiver. Fig. 164 is hence to be considered merely as the skeleton of a battery receiver.

Let the amplification from the grid of the detector valve to the grid of V_4 be 1,000, the dynamic slope of $V_4 = 0.5 \text{ mA/V}$, the transferred impedance of the loud-speaker 10,000 ohms, the grid-bias resistance between A and C 500 ohms, and that between B

and C 200 ohms. The impedance between detector grid and cathode for A.F. is made up of three parallel parts: the grid-cathode path of the valve, the 1-megohm grid leak and the 200-pF capacitance. Owing to the grid current, the resistance of the grid-cathode

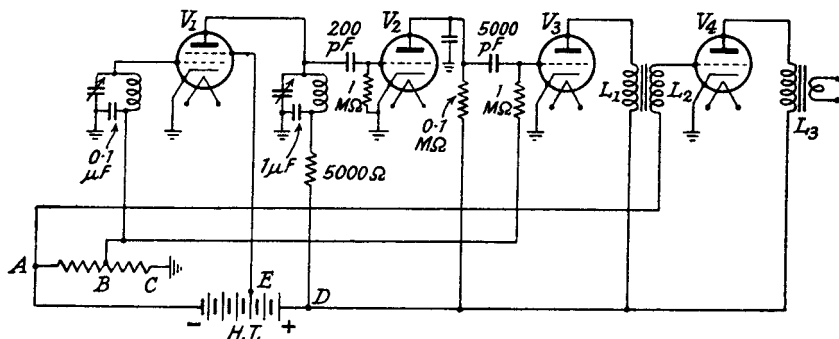

FIG. 164.

path may be anything between 0.1 and 0.4 megohm. The 200-pF capacitance has an impedance of 0.8 megohm at 1 Kc/s. Thus it seems reasonable to reckon with 0.2 megohms as a rough estimate for 1 Kc/s.

1. Capacitive Feedback outside the Valves. As, under the assumptions made, the amplification between the grid of V_2 and the anode of V_4 is 5,000, any capacitance between output anode and detector grid of a 1,000 megohms reactance will be sufficient to cause oscillation. For 1 Kc/s a capacitance of $\frac{1}{5}$ pF will be enough. At higher frequencies the tendency to oscillate may be larger still. Above about 5 Kc/s the danger should become less, as the gain will tend to fall off and the coupling no longer increases, the grid-cathode impedance of the detector valve being determined by the 200-pF condenser.

The phase cannot be predicted without knowing the winding sense and the leakage inductance of the transformer and the various stray capacitances. Changes in phase relation with a variation of frequency will occur at the two ends of the A.F. curve, where the amplification drops due to the influence of the different capacitive and inductive reactances. If the phase condition is wrong for the middle frequencies it will be correct for one of the cut-off frequencies, where large changes in phase occur with little change in amplification.

Capacitance between output anode and the grid of V_3 is far less dangerous, as the gain and the grid-cathode impedance are

lower. The latter is determined by the parallel combination of 0.1 megohm and the impedance of V_2 , which is small compared with the grid-leak resistance. The 5,000-pF condenser can be regarded as a short circuit except at low frequencies, where the capacitive feedback is harmless in any case.

2. Capacitive Feedback inside a Valve. The grid-anode capacitance inside a valve rarely leads to oscillation at audio frequencies. One case from actual practice may be mentioned where this effect took place. The treatment will be more detailed than seems necessary, as the subject is of a general interest and applies to R.F. as well (Fig. 165).

The grid is tuned to 1 Kc/s with 100 pF, and the preceding anode coupled so loosely that the Q of the tuned circuit is 10. The anode load is an inductance L_2 of about 10 henries, the valve impedance 10,000 ohms, the gain from grid to anode 25 at 1 Kc/s, the grid-anode capacitance 3.5 pF.

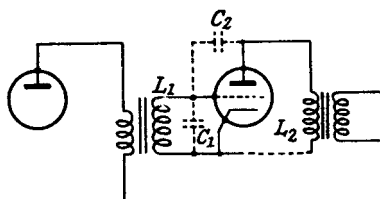

FIG. 165.

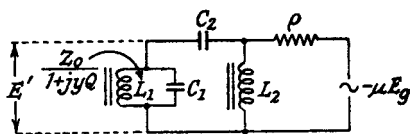

FIG. 166.

For a grid voltage E_g the amplitude E' fed back can be computed from Fig. 166. Using Thevenin's theorem, the equivalent valve circuit (Fig. 33b) and the expression for the parallel tuned circuit on page 9, we obtain :

$$E' = -\mu E_g \frac{j\omega L_2}{\rho + j\omega L_2} \cdot \frac{Z_0}{1 + jyQ} \cdot \frac{1}{\frac{Z_0}{1 + jyQ} + \frac{1}{j\omega C_2} + \frac{\rho j\omega L_2}{\rho + j\omega L_2}}$$

Neglecting the parallel combination of ρ and L_2 as small compared with $\frac{1}{j\omega C_2}$ and simplifying :

$$E' = \frac{\mu E_g Z_0 \omega L_2}{\frac{\rho}{\omega C_2} - \omega L_2 Z_0 - \frac{L_2}{C_2} yQ + j\left(\rho Z_0 + yQ \frac{1}{\omega C_2} \rho + \frac{L_2}{C_2}\right)}$$

The phase will be correct when the imaginary terms disappear.

Substituting for y its value $\frac{\omega}{\omega_0} - \frac{\omega_0}{\omega}$ the equation in ω becomes :

$$\rho Z_0 + \frac{\rho Q}{\omega_0 C_2} - \frac{\rho \omega_0 Q}{\omega^2 C_2} + \frac{L_2}{C_2} = 0, \text{ where } \omega_0 = \frac{1}{\sqrt{L_1 C_1}}$$

$$\frac{\omega^2}{\omega_0^2} = \frac{Q}{\omega_0 C_2 Z_0 + Q + \frac{\omega_0 L_2}{\rho}} = 0.6 \text{ in the above case,}$$

$$\omega = 775 \text{ c/s.}$$

The amplitude condition can be easily assessed. For 775 c/s the impedance of C_2 is $5.86 \cdot 10^7$ ohms, the impedance of the tuned

circuit $\frac{Z_0}{\sqrt{1+y^2 Q^2}} = \frac{1.6 \times 10^7}{\sqrt{1+5.15^2}} = 3.05 \times 10^6$ ohms, $E_a = 25E_g$, and

the voltage fed back becomes approximately :

$$E' = 25E_g \frac{3.05}{58.6} = 1.3E_g,$$

which is just sufficient for oscillation. The oscillation will rise in amplitude until, due to an increase in ρ , the feedback factor becomes 1. The final frequency will consequently be larger than 775 c/s, as follows from the above equation. The complete calculation, comprising ρ and ω as variables, is fairly complicated and is not to be included here.

The fact that oscillation starts at a frequency different from the resonant frequency of the tuned circuit indicates another effect caused by the feedback, viz. a capacitance transferred between grid and cathode. This effect will show up, even if the feedback is not sufficient to start oscillation. Assume L_1 in Fig. 165 to be the secondary of a normal transformer; then something like 0.2 megohm is reflected across L_1 from the preceding valve and the stage does not oscillate. The approximate magnitude of the capacitance transferred can be easily evaluated as follows.

For frequencies between 500 and 3,000 c/s, E_a is $25E_g$ and nearly in antiphase with E_g . A current will therefore flow from grid to anode through the grid-anode capacitance, leading E_g by 90° and 26 times as great as if this capacitance were connected across grid and cathode. Its influence is therefore in the above case that of a parallel capacitance of 91 pF.

Feedback through the grid-anode capacitance of a valve (Miller effect) may result in transferring across the grid-anode path a negative resistance, a positive resistance, a capacitance, or a mixture of resistance and capacitance. Anode load, impedance and amplification factor of the valve are the determining factors.

3. Inductive Coupling between Transformers. Inductive coupling between transformers begins to become dangerous if they are separated by more than one stage with a gain of a few hundred between them. Keeping them well apart (say not less than 5 inches) and placing them at right angles in a symmetrical position will usually prove sufficient. In cases of excessive gain it may be necessary to screen one or both of them with metal of low reluctance, such as permalloy or something similar. Though it may be possible to find a unique position of low coupling without employing magnetic screens, one should not rely on this effect for a receiver series, as various transformers of the same type may behave quite differently.

Any accurate prediction is impossible, as the coupling factor between transformers can only be guessed within an error of 1 : 10. The qualitative effect of inductive coupling may be discussed with the help of Fig. 164.

Let M_1 be the mutual inductance between L_3 and L_1 ; let M_2 be that between L_3 and L_2 and let ρ be the impedance of V_3 . Then a current I through L_3 will induce in L_1 a voltage equal to $Ij\omega M_1$ and in L_2 a voltage equal to $Ij\omega M_2$. For simplicity's sake the current in the output secondary is neglected, as it does not affect the principle to be derived. The voltage induced in L_1 produces a current $I \cdot \frac{j\omega M_1}{\rho + j\omega L_1}$, which, in its turn, induces in L_2 the voltage $I \cdot \frac{j\omega M_1}{\rho + j\omega L_1} \cdot j\omega \sqrt{L_1 L_2}$, the coupling coefficient between L_1 and L_2 being unity. The total voltage in L_2 becomes :

$$E_2 = I \left(j\omega M_2 - \frac{j\omega M_1 \cdot j\omega \sqrt{L_1 L_2}}{\rho + j\omega L_1} \right) = Ij\omega M_2 \frac{\rho}{\rho + j\omega L_1},$$

$$\text{since } \frac{M_1}{M_2} = \sqrt{\frac{L_1}{L_2}}.$$

The negative sign inside the bracket follows from the fact that E_2 must become zero when $\rho = 0$.

The above calculation does not take into account the resonance of L_2 with its parallel capacitance, which usually lies somewhere between 0.5 and 1 Kc/s. With V_3 in its place the tuning does not show up, as L_2 is by-passed with a resistance much smaller than ωL_2 . The decrease in feedback due to the impedance of V_3 will therefore be much more than $\frac{\rho}{\rho + \omega L_1}$ near the resonant fre-

quency of L_2 . The damping influence of V_3 will be a point to be considered later when the source of feedback is being traced.

4. Coupling through Impedances in a Common Path.

The grid-bias resistance in Fig. 164 and the H.T. battery (if the latter has any appreciable impedance) will be a source of serious feedback. The A.F. anode current of the output valve, flowing through the primary of the output transformer, the H.T. battery, and the grid-bias resistance back to its cathode, produces the following feedback effects :

- (a) E.M.F. between E and C applied to the screen grid of V_1 ,
- (b) E.M.F. between B and C applied to the grid of V_1 through the R.F. circuit,
- (c) E.M.F. between D and C applied to the grid of V_2 through the anode circuit of V_1 and the grid-leak condenser,
- (d) E.M.F. between B and C applied to the grid of V_3 ,
- (e) E.M.F. between D and C applied to the grid of V_3 through the anode resistance of V_2 ,
- (f) E.M.F. between D and C causing a current through the transformer primary L_1 and inducing a voltage at the grid of V_4 ,
- (g) E.M.F. between A and C applied to the grid of V_4 .

Feedback (a), (b) and (c) may cause trouble only if, as is the case in Fig. 164, the R.F. anode is tuned and capacitively coupled to the grid of V_2 . Owing to this fact, V_1 acts as an A.F. amplifier as well, the anode load being determined by the parallel combination of the 5,000 ohms resistance and the $1 \mu\text{F}$ condenser. For 50 c/s this combination has an impedance of approximately 2,500 ohms, resulting, for an assumed mutual conductance of 2 mA/V, in an amplification of 5 from grid to anode. As this figure falls with increasing frequency and the transfer from the anode of V_1 to the grid of V_2 rises accordingly, the A.F. "gain" from the grid of V_1 to the grid of V_2 is fairly constant over a wide range. For 50 c/s it is 0.06, i.e. $\frac{1}{16}$ of the voltage fed back to the grid of V_1 will be delivered to the grid of V_2 (the reactance of 200 pF at 50 c/s is 1.66×10^7 ohms and the impedance of the grid-cathode path of V_2 about 0.2 megohm according to the assumption made before). An E.M.F. E_1 at the grid of V_1 produces a voltage of $\frac{1,000}{16}E_1$ at the grid of V_4 , hence an output current

$\frac{1,000}{16} \times 0.5 \times 10^{-3}E_1$ and a voltage fed back to the grid of V_1 of

$$\frac{1,000}{16} \times 0.5 \times 10^{-3} \times 200E_1 = 6.25E_1,$$

which easily causes oscillation. The oscillating frequency may, of course, be higher or lower than 50 c/s, according to the phase conditions.

The danger of the other couplings can be assessed in a similar way. Couplings (a), (b) and (c) disappear on using an R.F. transformer, the other couplings on applying adequate A.F. filters (Fig. 170). Coupling (e) is the most usual among those enumerated under (a)–(g) and is not always easy to cure, for the drop of D.C. volts across the decoupling anode resistance prevents the latter being made very large. The effect may be discussed with the help of Fig. 167.

The impedance common to the anode circuits of V_1 and V_3 is the H.T. battery Z . If Z is negligibly small (the case of no feedback) an E.M.F. E_1 at the grid of V_1 will produce an output

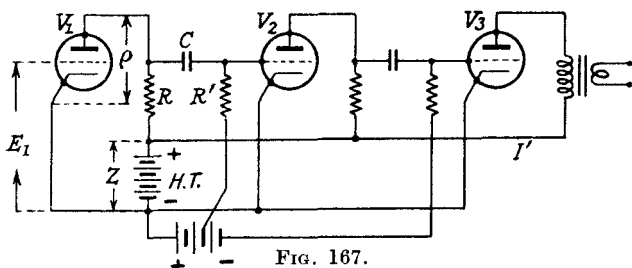

FIG. 167.

current $I = E_1 k_1 k_2$, where k_1 is the gain from the first to the second grid and k_2 is the product of the dynamic slope of V_3 with the gain from the second to the third grid.

When Z acts as the source of feedback, E_1 will produce an output current I' different from I . The voltage produced at the second grid in the absence of feedback is $E_2 = k_1 E_1$; with feedback there will be an additional E.M.F. equal to $I'Z$, which is in series with E_2 . As ρ , the impedance of V_1 , acts as a potential divider in series with R , only the part $I'Z \cdot \frac{\rho}{\rho + R}$ of the voltage across Z will be fed back to the grid of V_2 . The equation in the case of feedback becomes, assuming that Z is small compared with the total impedances in the anode circuits both of V_1 and V_3 :

$$I' = k_2 \left(E_2 + I'Z \cdot \frac{\rho}{\rho + R} \right)$$

$$I' = \frac{k_2 E_2}{1 - k_2 Z \cdot \frac{\rho}{\rho + R}} = \frac{k_1 k_2 E_1}{1 - k_2 Z \frac{\rho}{R + \rho}}$$

(The influence of C and R' can be neglected as unimportant over most of the range.)

The output current caused by E_1 in presence of feedback differs from that without feedback by the factor $\frac{1}{1 - k_2 Z \frac{\rho}{R + \rho}}$, where

k_2 may be real, imaginary or complex, according to the phase of the output current. If k_2 is real and positive and if Z is resistive, which is the usual case with a two-stage resistance coupled amplifier, the voltage fed back adds to E_2 (positive feedback), the relation being

$$\frac{\text{Amplification with feedback}}{\text{Amplification without feedback}} = \frac{1}{1 - k_2 Z \frac{\rho}{R + \rho}}$$

This formula sometimes appears in a different form, containing the stage gain k_1 , the amplification factor μ of the first valve, and the anode load R , giving a superficial reader the impression that

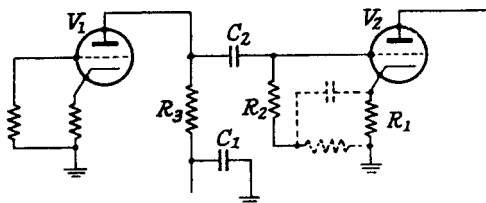

FIG. 168.

each of these values has influence on the feedback. The above formula seems more suitable. It shows immediately why the circuit Fig. 167 may oscillate without the valve V_1 but be stable with it. As ρ is usually not more than

one-fifth of R , the presence of V_1 may reduce the feedback to less than one-sixth.

In Fig. 167 the impedance Z is the cause of other couplings which, however, are weaker than the coupling just treated. The anode current of V_2 feeds back voltage to its own grid through R , as does the anode current of V_3 . In both cases it is anti-feedback. Due to the relatively small gain of one stage, its effect is slight and can be disregarded in practice.

Another anti-feedback of a similar nature, but more important, may be seen from Fig. 168. The resistance R_1 , used for self-biasing purposes, acts at the same time as a source of anti-feedback. (Its stabilising effect on the D.C. current with ageing or change of valves can also be looked upon as negative feedback.) To insert an RC filter between R_1 and R_2 (dotted in Fig. 168) would not help, as the A.F. volts across R_1 would still be applied to the output grid through the parallel combination of V_1 and R_3 in series with

C_2 . The usual cure consists in by-passing R_1 with a condenser large enough for the lowest frequencies required.

Example (Fig. 168). Let V_2 be a triode with the dynamic mutual conductance 1.5 mA/V and R_1 be 1,000 ohms.

1. What is the loss in gain due to negative feedback ?
 2. What by-passing condenser will restrict the loss to less than 3 db. down to 50 c/s ?
1. The gain drops in the ratio of

$$\frac{1}{1 + 1.5 \times 10^{-3} \times 1,000} = \frac{1}{2.5}$$

2. A condenser of 4 μF will prove sufficient. (See the more detailed treatment in Chapter 3.)

5. Combination of Capacitive and Common Impedance Coupling.

A coupling, which may be a combination of the types 1, 2 and 4, will occur in the circuit Fig. 164 due to the fact that the filaments of the valves are not connected with cathode.

Assuming a leakage resistance of 5 megohms between cathode and filament as an average value, a capacitance of 2 pF between both grid and filament of V_2 and anode and filament of V_4 , then the circuit of Fig. 169

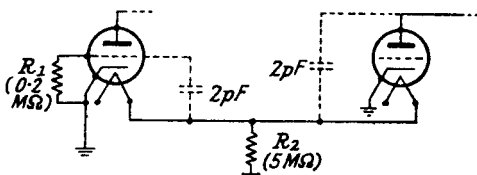

FIG. 169.

shows the resulting effect. The reactance of 2 pF being large compared with 5 megohms for the range considered, the voltage fed back from the anode of V_4 to the grid of V_2 is approximately

$$\omega^2 E_1 \times 2 \times 10^{-8}.$$

The feedback factor becomes unity for $\omega = 0.7 \times 10^4$, and rises rapidly towards higher frequencies. Actually the feedback is limited by the capacitances parallel to R_1 and R_2 . Taking the

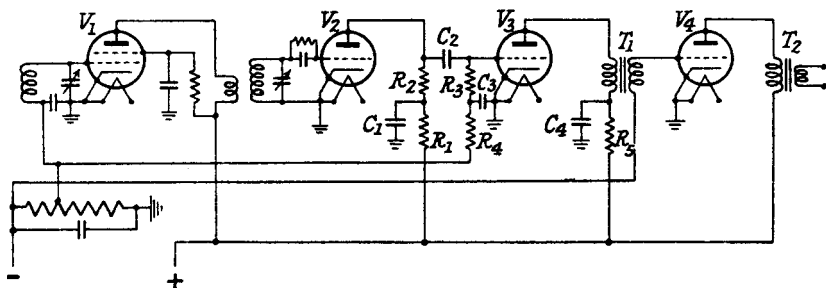

FIG. 170.

former to be 200 pF (as is done in Fig. 164), the latter to be 100 pF, the voltage fed back can never be more than E_1 and would, given the values of Fig. 169, nowhere be sufficient to cause oscillation.

Fig. 170 shows a modification of Fig. 164, the changes being made to avoid the dangers discussed. The grid-bias resistance may be by-passed with a 50 μ F electrolytic condenser. The need for adding a filter in the grid lead of V_3 , as well will depend on the gain and the shape of the A.F. curve.

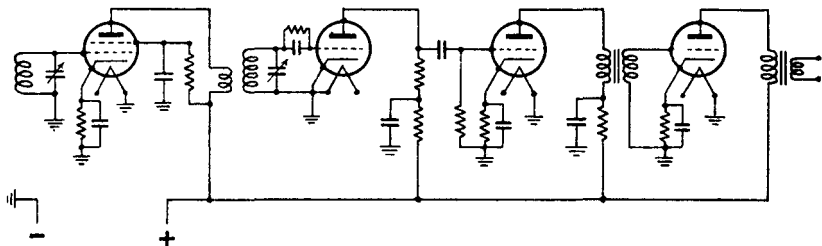

FIG. 171.

Fig. 171 gives an alternative which is usually employed in mains-operated receivers but is not workable with directly heated valves. The condensers parallel to the self-biasing resistance need now only be chosen to prevent negative feedback within one stage.

6. Acoustic Feedback. Oscillation due to acoustic feedback is caused by sound waves from the loud-speaker striking an A.F. valve and, owing to vibration of the electrodes, producing an A.F. current which is amplified and feeds the loud-speaker. Indirectly heated valves are less liable to the effect than directly heated valves, as the filament is mechanically the least rigid element inside the valve.

The means of prevention are, apart from keeping the gain down, purely mechanical, such as placing the dangerous valve as far away from the loud-speaker as possible, using sound-damping material as cover, etc. Oscillation due to acoustic feedback should be easily recognised by its hollow sound, its slow start, and its swelling up and down (compare Chapter 6, page 154).

Methods of finding unknown A.F. Couplings. When dealing with an A.F. amplifier which oscillates from unknown feedback, finding the source of feedback as quickly as possible is the major problem. Ample experience is, of course, the foremost requirement. In what follows, a systematic line of attack is given which should be, even to the less experienced engineer, of appreciable help.

The following considerations are based upon Fig. 170. The circuit is supposed to oscillate at an audio frequency; the cause is to be found. The following tests are recommended:

Remove V_1 . If the oscillation still continues

Remove V_2 . " " " " "

Remove V_3 .

If the oscillation still continues, it is plainly feedback over one stage. Having ascertained that the valve is correctly wired up and not perhaps working as a dynatron due to H.T. at the grid, there remain practically only two possible sources of feedback:

(a) magnetic coupling between T_1 and T_2 ,

(b) capacitance from anode to grid.

The effect of both couplings being vastly increased by removing V_3 , it is appropriate to by-pass the primary of T_1 with a resistance about equal to the impedance of V_3 . It will be found that the oscillation stops, indicating that V_4 in itself does not oscillate in presence of the damping added by V_3 . Trying out larger resistances as by-passes for the primary will indicate the factor of safety and show whether it is necessary to place T_1 and T_2 farther apart or to look for excessive grid-anode capacitance.

The last stage being safe, V_3 is put back. If oscillation starts again, there are two possibilities:

(a) Voltage is fed back in some way to the grid of V_3 .

(b) There is anode supply coupling which causes a current through the primary of T_1 ; this current cannot flow with V_3 removed.

Shorting the grid of V_3 will give some indication. If the oscillation continues it can only be due to (b).^{*} If the oscillation stops it indicates possibility (a), and the next step will be to trace the way in which the voltage fed back reaches the grid of V_3 . There are now three possibilities:

(a) Capacitive coupling.

(b) Anode supply coupling which may cause positive feedback, if the winding sense of T_1 is appropriate.

(c) Coupling through the grid-bias supply.

The following tests are suggested:

Short the resistance R_3 . (This is not the same as shorting the grid to cathode!) If the oscillation stops, feedback cannot be due to the grid-bias supply, as shorting R_3 would only increase it. The

^{*} This could also be proved by replacing V_3 by a resistance of a magnitude equal to the valve impedance, which still allows the flow of the coupling current through the primary of T_1 .

test leaves (a) and (b) as possible sources. By-passing C_1 with a much larger condenser, say, of $10 \mu\text{F}$, should give the final answer. To break the H.T. instead might prove misleading as this, by removing the impedance of V_2 , increases the grid-cathode impedance and, therefore, any existing capacitive feedback.

It should be realised that, unless there is capacitive feedback to the grid of V_2 , this valve will have a stabilising effect, as has been mentioned before; it by-passes R_2 and R_3 with the valve impedance ρ , decreasing thus the grid-cathode impedance of V_2 and diminishing the danger of capacitive feedback to the grid of V_3 . Furthermore, it decreases the volts fed back through the anode supply by the factor $\frac{\rho}{\rho + R_2}$, as pointed out before in this chapter.

Carrying on in this way, if necessary to another stage, should see the end of this investigation, as here V_1 can hardly contribute to the feedback, unlike the case shown in Fig. 164, where such contribution is possible.

Often it may be possible to shorten the procedure described above. The experienced engineer may see at a glance capacitive couplings or trace them by holding earthed metal sheets at diverse points of the receiver. The value of the above method, which may be called logical as opposed to "hit and miss" methods, consists in finding the sources of feedback in a relatively short time, where more hasty attempts may fail.

If the feedback is not sufficient to cause oscillation but results in frequency distortion, the method of finding the cause should be similar to that just described. A very useful method (one among several) is to inject an A.F. signal between the anode and cathode of V_3 and to take the response curve while carrying out changes already described, viz. shorting the grid of V_3 , shorting R_3 , removing V_2 , etc. Care has to be taken that the addition of the signal generator does not affect the existing conditions; the generator lead going to the anode of V_3 should be well screened and should include, besides a blocking condenser of $1 \mu\text{F}$, a resistance large compared with the impedance of V_3 inserted at the receiver end.

Often there may be several couplings, each of which is sufficient to cause oscillation. This fact should not increase the difficulty of the procedure appreciably, as long as the tests are carried out correctly. It would, of course, be wrong to apply a remedy to one of the suspected couplings and, having observed the oscillation to persist, then to remove the remedy and to test the other coupling. Such procedure would never lead to stability, though to the

experienced it may be conclusive for the following reason. Removal of one source of feedback, it is true, does not lead to stabilisation, but it is bound to affect the oscillation by changing its frequency, indicating that the coupling just removed takes a more or less important part in the total feedback.

Mains-operated receivers do not differ in principle from the battery receiver Fig. 170; the anode supply impedance is usually a capacitance of several microfarads representing a coupling reactance which increases towards lower frequencies. The tendency of the circuit to oscillate at low frequency because of the inefficiency of the RC filters is still more pronounced in the case of anode supply coupling.

B. Undesired Feedback at Radio Frequencies.

The variety of couplings possible is very large. They will be treated in the same way as has been done in the case of the A.F. amplifier. The couplings most frequently involved are:

1. Capacitive coupling inside a valve.
2. Capacitive coupling outside a valve.
3. Inductive coupling between coils.
4. Capacitive coupling caused by unearthed leads or by metallic parts going from one compartment into the other.
5. Inductive coupling through untuned loops going from one compartment into the other; this comprises metallic spindles, cathode and filament connections, etc.
6. Coupling through impedances in a common path.
7. Mixture of capacitive and common impedance coupling. This comprises condenser spindle, the spindle of coil drums and switches, cathode connections, filaments, etc.
8. Feedback through the A.F. section, via loud-speaker and aerial.
9. Feedback on harmonics of the I.F. in a superhet.
10. Feedback through the supply leads.

1. Capacitive Coupling inside a Valve. The effect is not different in principle from that discussed in the A.F. part of this chapter but different in magnitude. Whereas feedback trouble due to grid-anode capacitance of a valve is rare on audio frequencies, it is very common on radio frequencies. The difference is due to the use of tuned circuits with a high Q and a low tuning capacitance on R.F., resulting in a much larger feedback factor.

One may discriminate between amplifier stages where only the grid circuit is tuned and those where grid and anode are tuned to the same frequency. The grid anode capacitance necessary to cause

trouble will have to be much larger in the former case than in the latter. The magnitude of the effect when only the grid is tuned may be seen in two examples taken from cases that may easily occur in practice.

Example 1 (Fig. 172). Grid circuit tuned to 1.5 Mc/s with 50 pF, the valve working as a grid-leak detector; $\mu = 10$, $\rho = 10,000$ ohms, grid-anode capacitance $C_c = 2$ pF. The result of feedback through C_c is to be computed.

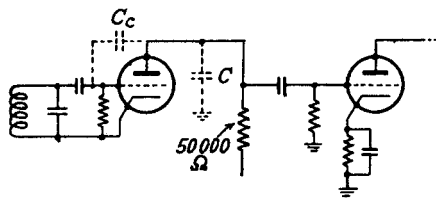

FIG. 172.

It has to be realised that the anode load is not determined by the 50,000 ohms, but by the stray capacitance C which is assumed to be 25 pF, a good average value. If we assume $C_c \ll C$ and repeat the

procedure as done for Fig. 166, there will be an equivalent E.M.F. in the anode $E_a = -\mu E_g \frac{X_c}{\rho + X_c} = -\mu E_g \cdot \frac{1}{1 + \rho j\omega C}$, of which the impedance can be neglected. The current I flowing through C_c from grid to anode is then

$$I = (E_g - E_a)j\omega C_c = E_g \left(1 + \frac{\mu}{1 + \rho^2 \omega^2 C^2} - \frac{j\omega C \mu \rho}{1 + \rho^2 \omega^2 C^2} \right) j\omega C_c.$$

The effect on the grid is the same as if there were added between grid and cathode a parallel combination of a capacitance C_x where $C_x = C_c \left(1 + \frac{\mu}{1 + \rho^2 \omega^2 C^2} \right)$, and a resistance R_x where $R_x = \frac{1 + \rho^2 \omega^2 C^2}{\mu \rho \omega^2 C C_c}$. If ρ is more than $3 \times \frac{1}{\omega C}$, R_x is approximately $\frac{C}{C_c} \frac{1}{g_m}$.

For the assumed values it follows that

$$C_x = \text{approximately } 5 \text{ pF}$$

$$R_x = \text{approximately } 15,000 \text{ ohms.}$$

The parallel resistance R_x represents an additional circuit damping of more than 14%, destroying the selectivity and dropping the gain in the ratio of 10 : 1 if the circuit Q is about 60.

The simplest cure is to add a condenser anode-cathode of 2,000 pF, which reduces the additional damping to about 0.2% and leaves the audio frequencies up to 5 Kc/s almost unharmed.

Example 2. The signal grid of a mixer valve tuned to 410 Kc/s

with 100 pF, circuit $Q = 100$, anode circuit tuned to 460 Kc/s with 150 pF; mutual conductance 0.5 mA/V, ρ large compared with the anode load, grid-anode capacitance 0.3 pF. Determine the effect of feedback.

At the signal frequency the anode circuit is practically inductive, so that the phase condition for oscillation is fulfilled. The anode impedance for 410 Kc/s is about 10,000 ohms, causing a gain of 5 from grid to anode. The voltage fed back to the grid, for an initial E.M.F. of E_1 , is $5E_1Q \frac{0.3}{100} = 1.5E_1$, sufficient to cause oscillation.

With grid and anode circuit tuned to the same frequency, oscillation will take place at a frequency lower than the tuning frequency. If the Q of both circuits is equal (ρ very large) and the reactance of the grid-anode capacitance large compared with Z_0 , as is the case with pentodes, the phase condition is fulfilled for a frequency for which both circuits represent a parallel combination of R and L , where ωL is equal to R (Fig. 173).

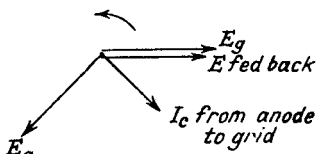

FIG. 173.

This is the case when $\omega = \omega_0 \left(1 - \frac{1}{2Q}\right)$, according to Chapter 1.

The circuit impedance being, for this frequency, $\frac{Z_0}{\sqrt{2}}$, the amplitude condition for oscillation is calculated as follows :

$$E_a = E_g g_m \frac{Z_0}{\sqrt{2}}$$

E fed back = $E_g g_m \frac{Z_0}{\sqrt{2}} \omega C_c \frac{Z_0}{\sqrt{2}}$, where C_c is the grid-anode capacitance. Oscillation will start when $g_m \omega C_c Z_0^2 = 2$.

Example: 1.5 Mc/s, $g_m = 1$ mA/V = 10^{-3} A/V, $C_c = 5 \times 10^{-3}$ pF. The value of Z_0 for which oscillation starts is

$$\sqrt{\frac{2}{g_m \omega C_c}} = 0.2 \text{ megohm, with a gain of 200 from grid to anode.}$$

Tapping the anode circuit 1 : 4 down (dropping the anode load 16 : 1) renders the stage quite safe. It leaves the response curve with a slight asymmetry of 1 db. for ± 7.5 Kc/s as there is anti-feedback for $\omega = \omega_0 \left(1 + \frac{1}{2Q}\right)$. The stage gain becomes 50, due to the 1 : 4 step up from the anode to the next grid.

2. Capacitive Coupling outside the Valves. External capacitive coupling does not differ in principle from 1, as far as one valve is concerned. In the case of the anode being tapped down, capacitance between two consecutive grids is more dangerous than capacitance from grid to anode. Therefore great care should be taken to prevent capacitance between switch elements, leads, etc., of the two circuits.

Capacitive coupling over several stages is naturally much more serious. If the receiver is mounted on an open chassis without partitions, all dangerous leads will have to be screened and special valve caps used. The screened leads used have to be examined on their R.F. qualities, low loss and low capacitance being essential. The usual figure is about 30–40 pF/metre. The technique almost universally adopted is such that trouble due to capacitance over several stages is comparatively rare now. Only when the overall gain at one frequency is very high, say of the order of 10^5 , may capacitive coupling again become a serious factor. Partitions between the critical points will be found insufficient and complete boxing is essential to obtain safe conditions.

3. Inductive Coupling between Coils. Inductive coupling between coils is avoided by proper screening. It should not

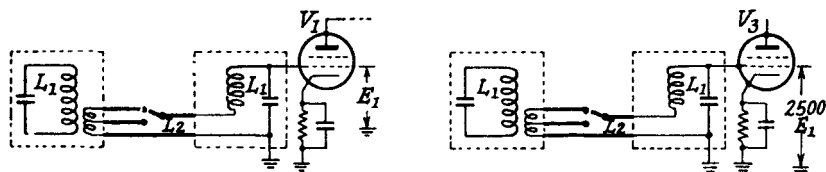

FIG. 174.

be overlooked that the connecting leads from the coil to the condenser or to the switch form an inductive loop which, on short waves, may form an appreciable part of the whole inductance. Such couplings have to be watched, for they may do harm even on medium waves in the case of large amplification. One example from actual practice :

Example : Two pairs of critically coupled i.f. circuits are separated by two stages of amplification (Fig. 174). The gain from the grid of V_1 to the grid of V_3 is 2,500. The circuit inductance is $130 \mu\text{H}$, the circuit Q is 120. The grid coils are connected to a switch for variable band-width, the connecting leads being about 7 cm. long and 1.5 cm. apart. The inductance of the loops is about $0.1 \mu\text{H}$.

If k is the coupling between the loops, L_1 the total inductance and L_2 the loop inductance, E_1 the initial e.m.f. at the grid of V_1 , the resulting voltage fed back is

$$E \text{ fed back} = 2,500E_1k\frac{L_2}{L_1}\frac{Q}{2} = 115kE_1$$

$\left(\frac{Q}{2}\right)$ because of the additional damping from the anode circuit), showing that a coupling factor of 1% would be sufficient to cause oscillation.

4. Capacitive Coupling through Unearthed Leads. The effect can be serious and should always be kept in mind. Filament leads of indirectly heated valves, grid-bias leads unearthed where they run between two decoupling resistances (in Fig. 188 the part which for this reason is earthed through C_1), metallic parts of switches, etc., may be the cause of the trouble. For radio frequency the impedance of such non-earthed parts to earth is usually governed by their capacitance, which will be of the order of 10 to 100 pF. If this capacitance is C_1 and the capacitances from the non-earthed part to two different circuits C_2 and C_3 , there is a coupling equal to a direct capacitance of $\frac{C_2C_3}{C_1}$. This result is based on the assumption that C_2 and C_3 are small compared with C_1 , as will always be the case under practical conditions.

Example: Two circuits have a tuning capacitance of 200 pF, a Q -factor of 120, and are separated by several stages. The amplification is 1,000, and the unearthed filament leads have an earth capacitance of 100 pF. What capacitance between circuits and filament leads will cause oscillation?

If C_x is the unknown capacitance and E_1 the initial voltage, the voltage fed back is approximately $\frac{1,000E_1C_x^2Q}{100 \times 200}$, which is equal to E_1 if $C_x = \sqrt{\frac{1}{8}} = 0.4$ pF. A coupling capacitance of this magnitude may exist inside a valve, so that it would not be sufficient to use screening cable for the filament leads.

5. Inductive Coupling through Untuned Loops. Untuned loops going from one compartment to another may be formed by filament leads, by cathode leads if earthed in both compartments, by a spindle, by the framework of a switch, or by a sheet of metal, etc. The danger will be particularly great if the technique of separate compartments is adopted without special coil screening. Fig. 175a gives an example met with in actual practice.

The condenser spindle, earthed on both sides, forms a loop

which is coupled with the tuning coils. The equivalent circuit is given in Fig. 175*b*. The coupling between the loop and the tuned circuits is sufficiently small to justify disregard of any reflected impedances.

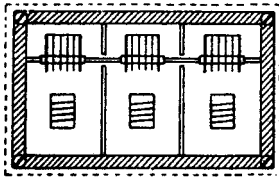
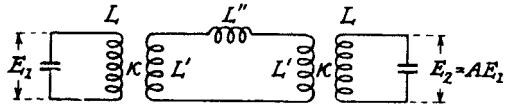
FIG. 175*a*.FIG. 175*b*.

The loop current I becomes, under this assumption,

$$I = E_2 \frac{k\sqrt{LL'}}{L} \frac{1}{\omega(2L' + L'')},$$

causing a voltage E_1' across the first circuit,

$$E_1' = E_2 \frac{k\sqrt{LL'}}{L} \frac{\omega k Q \sqrt{LL'}}{\omega(2L' + L'')}.$$

If we assume, as a rough guess, $L'' = 2L'$, the equation becomes:

$E_1' = E_2 \frac{k^2 Q}{4} = AE_1 \frac{k^2 Q}{4}$, A being the amplification between the two circuits. For $Q = 100$ and $A = 400$, which are average figures for two R.F. stages, the coupling necessary for oscillation is 1%, a value which will easily be exceeded in the design shown in Fig. 175*a*.

Oscillation caused in this way has been known to occur in an I.F. amplifier, even though separately screened iron core coils were employed. The coupling loop was formed by the framework of a multi-wave switch. The overall gain, it is true, was very high, about 10^5 .

If the coils in Fig. 175*a* were mounted so that they showed with their axis towards the reader, a covering plate (shown by dotted lines) might form a coupling loop, if it did not make proper contact with each compartment. The effect is not unusual and should be kept in mind.

6. Coupling through Impedance in a Common Path. If in Fig. 164 the two R.F. circuits are wired up thoughtlessly, a large coupling due to their earthing condensers may result. Using a paper condenser with several capacitances packed together and a common earth point will cause an inductive coupling shown in Fig. 176.

The coupling factor is $\frac{L'}{L+L'}$ which implies that, on switching to a new range by altering L , the coupling factor varies as the square of the frequency, the capacitances being held constant. The magnitude of the coupling may be very great and can easily lead to oscillation within one stage. The phase conditions are similar to those of Fig. 173, the oscillation starting at a frequency $\frac{f_0}{2Q}$ off the resonant frequency f_0 . In case of a tuned anode, as in Fig. 164, the oscillating frequency is higher than the resonant frequency. In case of transformer coupling, the frequency depends on the winding sense and the resonant frequency of the primary.

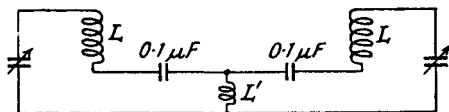

FIG. 176.

Example (Fig. 176). Range 20–60 m., $L = 2\mu\text{H}$, $L' = 0.01\mu\text{H}$, corresponding to about half an inch of earth lead (see under “Some Useful Formulae,” page ix), $Q = 60$. What is the stage gain sufficient to cause oscillation?

If the stage gain at resonance is A , it will be $\frac{A}{\sqrt{2}}$ for the oscillating frequency. For an e.m.f. E_1 between grid and cathode, the voltage fed back is approximately $E_1 \frac{A}{\sqrt{2}} \frac{L'}{L} \frac{Q}{\sqrt{2}} = \frac{E_1 A}{6.7}$. The stage gain necessary is 6.7.

An effect, similar in nature but different in degree, exists in the case of the normal ganged condenser, provided it possesses

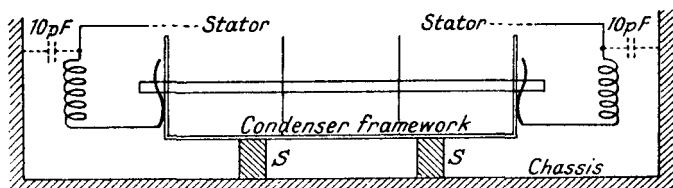
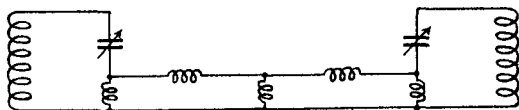

FIG. 177a.

a metal spindle connected with the various rotors. The principle may be understood from Fig. 177a.

The R.F. current from the rotor to the earthed side of the coil will flow mainly through the appropriate contact fork. A fraction of it will flow through the spindle, the other contact forks, and

back through the condenser frame. The equivalent circuit is shown in Fig. 177*b*. The coupling due to this effect is usually small and varies with the contact of the bearings and of the forks. Different tests give results equivalent to an L' of 0.1 to $1 \times 10^{-3} \mu\text{H}$ in Fig. 176. The coupling is often masked by another effect belonging to the next paragraph.

FIG. 177*b*.

7. Mixture of Capacitive and Common Impedance Coupling. The condenser of Fig. 177*a* is usually mounted on the receiver chassis with three or four studs (S). These studs represent an inductance which, though very small, can be the cause of appreciable coupling on very high frequencies. The two circuits have a stray capacitance to chassis of at least 10 pF, and the inductance of the studs may be assumed to be $0.005 \mu\text{H}$. Let the frequency be 30 Mc/s, the total tuning capacitance 40 pF, the Q of the circuits 80. The reactance of 10 pF at this frequency is 530 ohms, that of $0.005 \mu\text{H}$ 1 ohm. If AE_1 is the amplified voltage

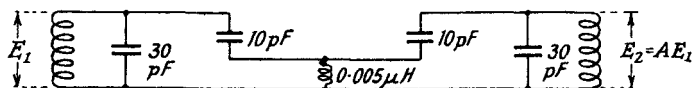

FIG. 178.

across one circuit, it will produce across the other circuit (Fig. 178)

$\frac{AE_1 Q 10}{530 \times 40} = \frac{AE_1}{26.5}$, indicating that a gain of about 26.5 will lead to

oscillation, if the circuits are separated by several stages. The effect can be verified by connecting the condenser frame to the chassis with additional short leads which usually helps to stabilise the amplifier.

A metal condenser spindle, insulated from the rotors and earthed, will introduce the same type of coupling, though to a smaller degree. The magnitude will depend on the capacitance from the stators to the spindle and on the inductance of the lead earthing the spindle. The former is very small as the rotor surrounding the spindle forms a kind of screen. Tests show that by carefully earthing the spindle and avoiding the loop effect treated under 5, a decoupling up to

10^{-4} instead of the above $\frac{1}{26.5}$ is not difficult to achieve, even at frequencies of 20 Mc/s. If perfect screening is required, as in the case of a signal generator, no metal spindle should be allowed to leave the screened compartment.

A coil drum may be the source of the same coupling and this needs, therefore, no special treatment. The coupling currents,

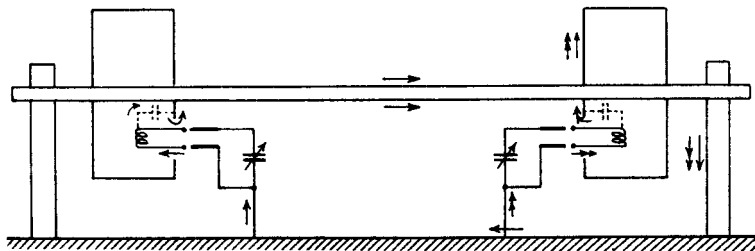

FIG. 179.

caused by the capacitances of the coils to the drum, are shown by arrows in Fig. 179. The two mounting brackets may have a larger inductance than the condenser studs, so that small stray capacitances can cause the same trouble.

Filament leads, cathode leads, etc., may give rise to the same effect, as may be seen from Fig. 180, the coupling currents being

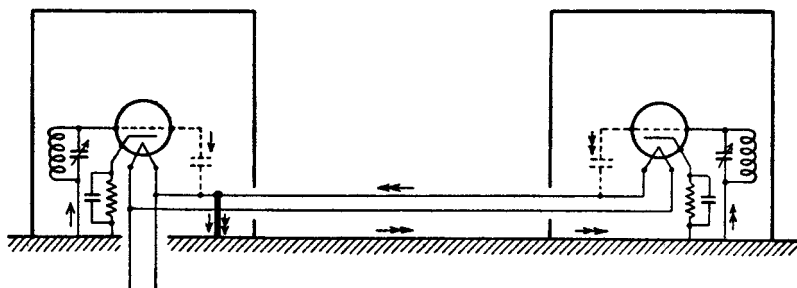

FIG. 180.

marked by arrows. The magnitude of the effect can easily be assessed on the lines given before. If great decoupling is required, Fig. 180 must be modified. Radio frequency chokes in both filament leads and separate earthing in both compartments are indispensable (Fig. 181). One of the two filament connections has now become superfluous, as it is by-passed by the chassis. Whether it should be omitted altogether is a matter of opinion. Omitting

it is perfectly safe from the R.F. point of view, but creates a number of contacts in the path of the filament current. If the chassis is of aluminium these contacts may be of a doubtful nature and do not appeal to everybody. Often it will prove sufficient to connect the filament lead as indicated by the dotted line in Fig. 181, but it should lie close to the chassis to prevent any loop effects.

The chokes should be arranged so that there is no capacitance of the kind shown in Fig. 181 between *G* and *H*, as otherwise

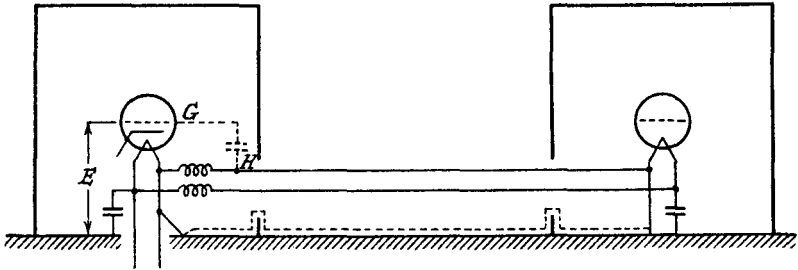

FIG. 181.

a current would flow through this capacitance into the other compartment, through the earthing condenser and back through the chassis. This subject has been discussed before in Chapter 8.

The screen grid of an R.F. tetrode will lose its effect, for reasons just described, when the impedance of its earthing lead can no longer be neglected. For a grid-anode capacitance of 0.005 pF, and a capacitance of 5 pF from screen grid to either anode or grid, further an inductance of 0.02 μ H from screen grid to earth, the

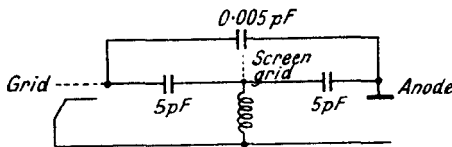

FIG. 182.

coupling due to this inductance will equal the direct coupling, when the voltage at the screen grid becomes one thousandth of the anode voltage (Fig. 182). This happens at about 16 Mc/s. At

30 Mc/s the capacitive-inductive coupling via screen grid will be nearly four times the capacitive, increasing rapidly towards higher frequencies.

With a pentode the effect described is less dangerous as two grids are interposed between grid and anode. With the suppressor grid connected to the cathode inside the valve, however, another effect may become equally serious, as can be seen from Figs. 183a and 183b. The nature of the coupling is identical with that of

Fig. 182, the coupling capacitances are from anode to suppressor grid and from grid to cathode, the coupling inductance is firstly the lead common to cathode and suppressor grid inside valve and socket, and secondly the by-passing condenser from cathode to chassis. This is the reason why in pentodes designed to work on

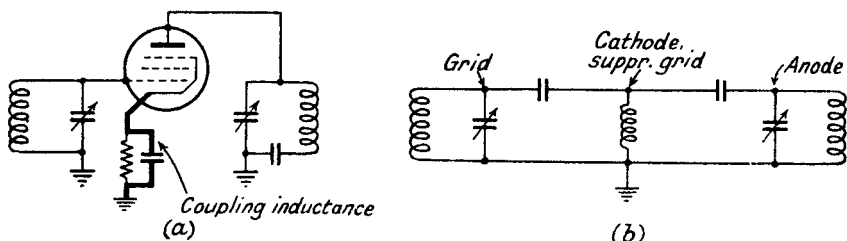

FIG. 183.

ultra short waves the lead from the suppressor grid is brought out to a separate point. It should therefore be connected with chassis and not with cathode.

On ultra short waves, down to 1 m. or less, a new constructive design is necessary. Apart from using acorn valves, the earthing condensers have to be such as to avoid any length of lead outside the valves. An arrangement like that shown in Fig. 184 fulfils this requirement and, in addition, makes the inductance of the wire inside the valve very small because the wire lies so close to the chassis.

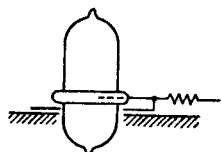

FIG. 184.

8. Radio Frequency Coupling through the A.F. Section of the Receiver. R.F. entering the A.F. section and being fed back from the loudspeaker to the aerial or in some other way can be very troublesome on longer waves, since the anode loads of the A.F. valves represent for R.F. a capacitive reactance rising linearly with the wave-length. Receivers going up to 20,000 m., which is almost audio frequency, require very efficient filters, particularly if the audio response curve is not to be harmed. The filters can be made much cheaper if they are inserted only where they are necessary, i.e. on the long-wave ranges where telephony is not required.

Example: A straight receiver, tuned to 15 Kc/s, works into 4,000-ohms headphones; the amplification from aerial to diode is 1,000, the A.F. amplification from diode to headphones is 1,000 for 1 Kc, with a drop of 10 : 1 in amplification for 15 Kc/s. The

capacitance from headphones to aerial is 1 pF and the aerial capacitance is 100 pF.

An e.m.f. E_1 at the aerial terminals produces $10^5 E_1$ at the headphones, feeding back $10^3 E_1$ to the aerial terminals. The r.f. filter has to be designed for an attenuation of over 1,000 for 15 Kc/s, which proves rather elaborate, if the audio response curve has to be taken into account, but quite simple if only 1 Kc need be considered.

Feedback in some way other than through the output may occur through supplies or through capacitance inside the receiver. Inserting the filter shortly after the diode should dispose of them all. In checking the receiver it may be borne in mind that a.f. transformers often have unexpected resonance points on r.f. frequencies which may lead to oscillation, though the receiver may be quite stable at lower frequencies.

Oscillation based on the collaboration of a.f. valves is usually accompanied by "motor-boating", the rhythm being determined by the comparatively large time constant of the a.f. valves. (See "squegging".)

9. Feedback on Harmonics at the I.F. One of the advantages of a superhet is the possibility of having a large overall gain

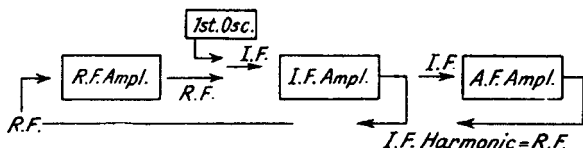

FIG. 185.

without the same danger of feedback as is found in a straight receiver, the reason being that the r.f. gain is spread out over two different frequencies. Overall feedback, however, is still possible when the r.f. part is tuned to a harmonic of the intermediate frequency. The course of feedback can be seen from Fig. 185. The greatest danger usually exists at the 2nd and 3rd harmonic, but even higher harmonics can prove very serious.

Feedback will be particularly great if the i.f. amplifier contains circuits tuned to harmonics of the intermediate frequency. This may happen in an ultra-short wave superhet from, say, 30 to 300 Mc/s, with an i.f. of somewhere between 3 and 6 Mc/s.

As pointed out in Chapter 12, there exists a second resonance determined by the capacitance of the valve and the inductance of the condenser and leads. As these frequencies usually lie between

50 and 150 Mc/s some of the I.F. harmonics are bound to come within a few per cent of these parasitic resonances, involving the danger just described. The appropriate method to be employed is the use of careful screening or of damping resistances in the I.F. grid leads. Regard must be paid to the influence of these resistances on the I.F. performance.

Example (Fig. 186). $C_1 = 100$ pF and $C_2 = 5$ pF. The intermediate frequency = 5 Mc/s, the parasitic frequency = 100 Mc/s. A damping resistance of 50 ohms reduces the Q of the parasitic circuit to 6; this is likely to prove good enough. The damping influence of this resistance for the 5 Mc/s resonance is negligible, as may be shown by considering it to be replaced by an equivalent parallel resistance of 0.7 megohm.

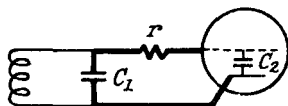

FIG. 186.

10. Coupling through the Supplies. There is no difference in principle from the corresponding couplings treated in the A.F. part of this chapter. Due to the higher efficiency of RC filters on radio frequencies, decoupling should not prove too difficult. The directions given in Chapter 8 have to be observed.

C. Feedback leading to Combined A.F. and R.F. Oscillation.

An R.F. pentode working as a self-oscillating grid leak detector with variable reaction, and having a large A.F. choke in its anode, often tends to start oscillation modulated by audio frequency which disappears with increasing R.F. amplitude. The effect, which is called threshold howl, is annoying as it prevents reception of telegraphy at the point where the valve is most sensitive. By-passing the anode choke with a resistance of about 10,000 to 20,000 ohms removes the effect. Replacing the choke by a

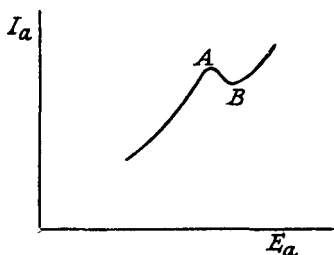

FIG. 187.

transformer and by-passing the primary with 10,000–20,000 ohms is equally successful. In this case the audio frequency gain from the grid of the pentode to the following grid is larger than that with the choke by the step-up ratio of the transformer, a point to be remembered.

Adjusting the reaction immediately before the point of oscillation and plotting the $I_a E_a$ characteristic gives a curve like that shown in Fig. 187. The bend at *A* occurs when oscillation starts,

and here, due to the increased grid current, the anode current decreases below its initial value. Between *A* and *B* the valve is a negative resistance capable of maintaining oscillation at the resonant frequency determined by the A.F. choke and its parallel capacitance. Low μ triodes rarely show the effect, high μ triodes are by no means free from it.

The same effect, based on a different cause, may be obtained when the grid leak detector is followed by A.F. amplification, particularly if no R.F. stage is employed and the detector circuit is coupled to the aerial. It disappears when the A.F. valves are removed and occurs only on very high frequencies, somewhere above 10 Mc/s. The A.F. oscillation—for as such it can well be regarded—is maintained as follows: the oscillating R.F. circuit is, in some undesired way, coupled to an A.F. valve, which thus absorbs a small part of the R.F. energy. An A.F. voltage across the A.F. valve changes its impedance and so modulates the R.F. carrier. The carrier is demodulated at the detector valve, the ensuing A.F. is amplified and causes remodulation of the carrier. The effect can be cured by careful R.F. decoupling, such as by filters, before grid and anode of the A.F. valve.

Since the self-oscillating grid leak detector has become rare, the two effects just described will probably raise little interest to-day. They used to be very troublesome in the old days.

A.F. oscillation in presence of a carrier is quite a usual effect and may occur with any receiver. There are three possible causes:

- (a) Amplitude modulation of one of the R.F. valves through supply coupling,
- (b) Frequency modulation of the first oscillator in a superhet through supply coupling,
- (c) Frequency modulation of the first oscillator through acoustic feedback.

(a) Amplitude Modulation of an R.F. Valve. The effect may occur in a straight or superhet receiver. The A.F. oscillations are maintained as follows:

Audio frequency current, usually from the output valve, produces across the H.T. or grid-bias supply a voltage, which is delivered to the grid or screen grid of one (or several) R.F. valves. A received carrier is modulated, demodulated at the diode, and the audio frequency obtained amplified and fed back again.

Often the effect is not easy to cure. In mains-operated receivers the H.T. impedance is capacitive, increasing towards lower fre-

quencies. The filters designed to prevent A.F. from reaching the grid or screen grids become inefficient at low frequencies, so that increasing the filter capacitances may merely lower the frequency of oscillation. The cheapest method will be to restrict the audio response curve, and to use filters effective for this A.F. range.

If restricting the A.F. curve towards lower frequencies is not permissible because of the requirement of high fidelity, push-pull output may be tried. As its merit depends on the equality of the two output valves, it should be tried out with a large number of valves. The use of "stabilovolts" or of two different H.T. supplies may be used as a last resort.

(b) Frequency Modulation of the First Oscillator. The effect is similar to (a). Audio frequency is fed back to the anode of the first oscillator modulating the oscillator frequency. The frequency modulation is changed by the selectivity curve into amplitude modulation, further procedure being identical with (a). The effect will be most pronounced at high R.F. signal frequencies when reception is on the edge of the selectivity curve. A narrow response as obtained with a crystal will prove very dangerous.

The cure may be as difficult as in the case of amplitude modulation. The means of prevention are the same as those given under (a).

(c) Frequency Modulation of the First Oscillator through Acoustic Feedback. The oscillator frequency may be changed acoustically, through loudspeaker sound waves striking the variable condenser or the oscillator valve. The result is identical with (b) and is also most marked at high R.F. frequencies on the edge of a response curve. A popular practice is to employ at the highest frequencies a carefully designed condenser with widely spaced rigid plates, and to switch over to a normal condenser at the lower frequencies.

Methods of Finding R.F. or mixed R.F. and A.F. Couplings. The subject is among the most complex and intricate problems facing the engineer. The multitude of possibilities makes it difficult to evolve a method as clear as that given for the A.F. amplifier. More margin will have to be left to ingenuity and intuition. Still, it is to be hoped that from the few examples given sufficient knowledge will be derived to tackle the many cases not covered here.

Slight feedback, resulting in distortion of the selectivity curve, will be dealt with later. Feedback leading to oscillation constitutes the majority of cases. The following exhaustive procedure in search

of undesired feedback is based upon the assumption that the receiver is oscillating. The circuit diagram may be represented by Fig. 188.

In the author's experience it has been found a great help for the investigations to use a separate receiver in order to listen to the oscillating frequency. This gives freedom of action in removing various valves from the receiver to be investigated without necessarily losing the signal. Furthermore, it shows, by producing a change in oscillation frequency, even small effects of any measures taken. The auxiliary receiver should have manual gain control and should be entirely free from any pick-up except through the aerial. It should also possess a beat frequency oscillator for obvious reasons.

Let us assume that the receiver shown in Fig. 188 has instability. The auxiliary receiver picks up a strong carrier of I.F. frequency (the second oscillator is out of action). Two facts would account for the I.F. carrier. There may be :

- (a) Oscillation at radio frequency causing I.F. in conjunction with the first oscillator,
- (b) Oscillation at intermediate frequency with or without collaboration of the R.F. or A.F. part.

Without touching any part of the receiver on test a decision between (a) and (b) can be obtained by switching the auxiliary receiver over to the radio frequency in question. The two possible causes, i.e. R.F. and I.F. oscillation, may be discussed separately.

(a) R.F. Oscillation. R.F. oscillation will most probably be due to coupling between the first and second R.F. circuit. This can be verified by removing the first I.F. valve (V_3), earthing the mixer anode through a $1\text{-}\mu\text{F}$ condenser, and finally removing the mixer valve. If the oscillation is stopped by earthing the mixer anode (a very rare case), it indicates either capacitive coupling inside the mixer valve, treated under 1 of the R.F. part, or some excessive external coupling which should be easy to find.

Let us assume that the mixer anode has no part in the oscillation, and that feedback from the screen grid of the mixer valve can be discounted as extremely unlikely, unless some wiring mistake has been made. If, therefore, removing the mixer valve stops the oscillation, it will be due to mistuning of the second R.F. circuit, as can be easily proved by retuning. Thus the effect is localised as oscillation of the first valve.

The next task will be to find the source of coupling between the grid and the anode circuit. The following has been found very useful as it gives the result far more quickly than the usual methods ;

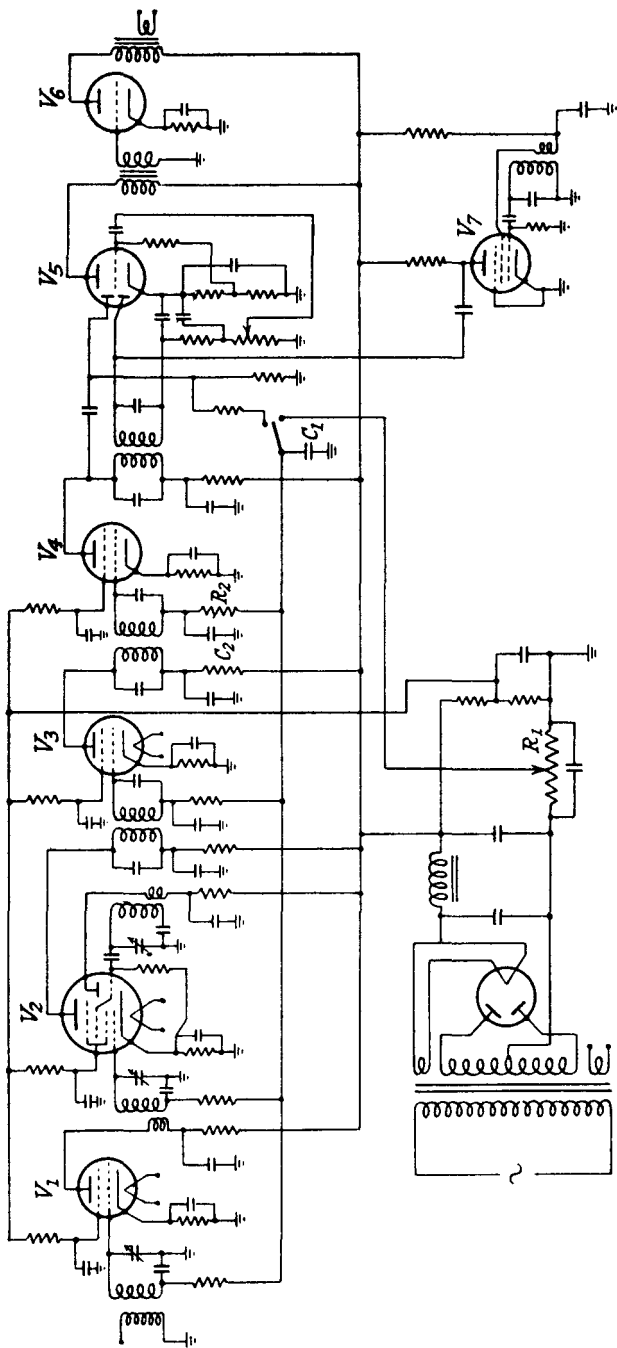

Fig. 188.

moreover, it does not require an auxiliary receiver. The method recommended is as follows.

Make the first valve non-conductive by interrupting the filament current. If this is inconvenient because of series-heated valves, apply about -20 volts to the screen grid. The receiver is otherwise working normally. Connect a signal generator between the chassis and the grid of the first valve and increase its strength until there is a measurable output.

The tuning of the first circuit is now without influence, for the circuit is shorted by the low impedance of the signal generator. The valve, the condenser and the coil can be investigated separately by disconnecting them from each other and applying the signal generator to each of them individually. If the receiver output is kept constant in each case, the input necessary indicates the magnitude of the various couplings in relation to each other (see Fig. 189).

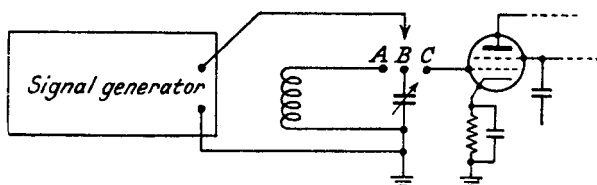

FIG. 189.

If the coupling should be due to the common condenser spindle (Figs. 177a, 177b and 178 of this chapter) the largest output will occur with the signal generator connected to the grid side of either the condenser or the coil. Connecting the signal generator (s.g.) to the condenser rotor would show, by the consequent output, that the coupling is due to potential difference between rotor and chassis. From this it is easy to draw the correct conclusion.

Other couplings possible would show up as follows :

Inductive coupling of the coils. Output exists mainly when the s.g. is connected to A, and disappears when the coil is short-circuited.

Capacitance between stators. Output exists mainly when the s.g. is connected to B, and disappears when the condenser is short-circuited.

Inductive coupling due to the loop formed by the leads connecting coil and condenser. If the coil and the condenser are disconnected at the condenser side, as shown in Fig. 189, there will be output when the s.g. is connected to A. The output remains when the coil is short-circuited, but disappears when the s.g. is applied to

the live side of the coil. Care has to be taken that the s.g. loop itself is not a source of coupling.

Coupling inside the valve, e.g. resulting from a break in the screen-grid earthing lead. Output exists mainly when the s.g. is applied to C . Measurement of the coupling capacitance (see Chapter 14) gives a value far in excess of what it should be. The cause will be easy to find.

The examples given show the flexibility of the method recommended here.

(b) I.F. Oscillation. Let us assume now that I.F. oscillation exists. Tests similar to those described on page 234 should help to localise the effect, show whether the R.F. valve or the mixer valve plays any part, and eventually lead to the identification of two receiver elements as the source of feedback.

In most cases I.F. oscillation will be caused by overall coupling

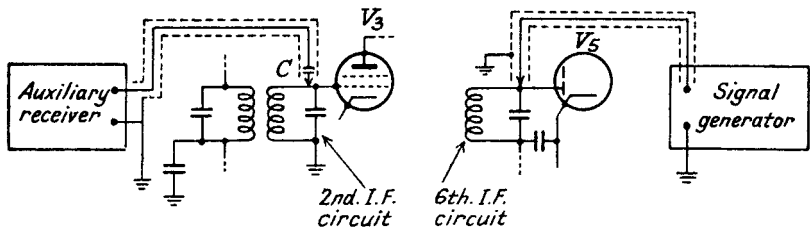

FIG. 190.

from the last pair of I.F. circuits to the first pair. Oscillation within one stage is less frequent and may be found according to the procedure pointed out for the R.F. stage. In case of feedback over several stages this method is hardly applicable. Since the coupling concerned is usually very small and the residual gain low after several valves have been made non-conductive, the signal generator will rarely cause any output.

The auxiliary receiver will often be of help here. Knowing the two circuits which, by their mutual coupling, cause the oscillation (it may be the 2nd and 6th I.F. circuit in Fig. 188), the auxiliary receiver should be loosely coupled to one circuit and the signal generator connected across the other (Fig. 190). The receiver on test is without supplies. Screening the leads, both of the signal generator and of the auxiliary receiver, is to prevent any direct radiation or direct pick-up. The condenser C should be of the order of a few pF to prevent overcoupling or serious mistuning of the I.F. circuit.

When the signal generator note is received it should be ascertained that the reception disappears both with the second I.F. circuit shorted and with the signal generator disconnected from the 6th I.F. circuit. If this is the case it is obvious that reception is due to the same coupling which causes the instability, and it is only necessary now to repeat, on a wider scale, the procedure described for the R.F. valve. All suspicious leads, etc., should be interrupted and the receiver searched for untuned loops and un-earthed metal spindles. If this proves unsuccessful there remain only the possibilities of direct capacitive or inductive coupling, or of currents induced in the chassis (the latter possibility is mentioned under 5). Chassis currents at I.F. frequency are very unlikely if the coils are properly screened; direct inductive coupling is also improbable in that case. For further confirmation, coil and condenser of the 6th I.F. circuit should be separated and the signal generator connected to each of them in the manner described before. This test shows whether the coupling is due to current in the coil or voltage across the circuit. The outcome is conclusive and indicates whether an improvement in capacitive or inductive screening is necessary.

If the overall gain is very high, say 10^5 , and the feedback only just sufficient to cause oscillation, the test may fail due to the signal generator output being too small, if its maximum is not above 0.1 volt. In this case other methods have to be employed, the choice depending on personal taste.

With the signal generator connected as above across the last I.F. circuit the auxiliary receiver aerial may be connected to various leads under suspicion in order to measure at intermediate frequency their potential to earth. If the result is negative, a small search coil between aerial and earth of the auxiliary receiver may be used to investigate, for leakage, the field around the 6th circuit.

A quick and often successful way is to listen to the I.F. carrier note and to touch the leads previously mentioned; they should be at earth potential, but variation of the frequency proves that they are not and are, in fact, the coupling elements sought. Capacitive couplings may be found by putting earthed metal sheets at various receiver points and carefully watching the result. Power of observation is indispensable in all these cases.

Classification of the possible modes of coupling in order of the frequency of their occurrence under the given circumstances will always be found beneficial and time saving; the succession of tests may be chosen accordingly. For instance, the various couplings

might be arranged as follows: 4, 10, 5, 2, 3, if overall I.F. feedback has been established.

A general rule about probability cannot be given. At lower frequencies, say below 600 Kc/s, common impedance coupling due to the inductance of earth leads, e.g. coupling through the condenser spindle, etc. (types 6 and 7), is very unlikely, as will be easily understood. Capacitive coupling through unearthed leads, which is actually a special case of common impedance coupling, may happen at any frequency, as the coupling factor due to it does not depend on frequency. Coupling through the A.F. section, i.e. type 8, is not to be expected above about 3 Mc/s, unless the A.F. valves are placed carelessly near the initial R.F. valves. In conclusion, here are a few more examples.

Example 1. The receiver of Fig. 188 is "motor-boating" when a strong input is applied and the manual volume control well down.

The carrier is received in the auxiliary receiver, and motor-boating is found to disappear when the anode of V_6 is earthed with a 10- μ F condenser. This proves that the effect is caused by A.F. of the output valve being fed back to one or several of the R.F. valves, presumably by voltage developed across the volume control R_1 . Increasing C_1 lowers the frequency of the motor-boating, indicating that the assumption made is probably correct. Bypassing R_1 with a battery of the correct voltage and polarity cures the effect and gives the final proof. The proper means of prevention have been pointed out previously. In case of battery supply the use of a grid-bias battery is advantageous.

Example 2. A receiver circuit as in Fig. 188, but with directly heated valves and battery supply, exhibits at the intermediate frequency oscillation which persists when V_1 is removed. Removing V_2 stops the oscillation, even if the first I.F. circuit is retuned. V_2 is therefore put back and the oscillator grid and the signal grid successively earthed with a large capacitance, in order to find whether voltage is fed back to one of them. The oscillation still persists. The screen grid, investigated next, proves correctly earthed and is harmless. The only possibility left is filament coupling as described on page 248; this is verified by connecting a 1- μ F condenser across the filament, which cures the instability.

Example 3. (From actual practice.) Measurement of the I.F. response of the receiver Fig. 188 by injecting an E.M.F. at the signal grid of V_2 gives a curve much narrower at high gain than at low gain, clearly indicating feedback. The effect disappears when the E.M.F. is injected at the grid of V_3 .

The inference might be made that there is feedback to the first or second I.F. circuit. Applying the E.M.F. to the anode of V_2 through a very small capacitance (it may be best merely to bring the signal generator lead near to the anode) shows no trace of the effect, no matter whether V_2 is in or not. This disproves the inference. As this last test leaves the receiver unchanged the feedback must be brought in by applying the signal generator lead to the grid of V_2 . The ensuing investigation shows that the loop formed by the leads of the signal generator is the source of coupling, magnetic field being picked up from the last I.F. circuit. A cure is not necessary as the receiver is satisfactory in normal use; the effect merely necessitates care when taking the I.F. curve.

Example 4. The I.F. response curve of the receiver Fig. 188 is normal with low gain, but narrow and quite unsymmetrical with high gain.

Overall feedback usually narrows the response curve without causing appreciable asymmetry, the regeneration taking place for a frequency in the immediate neighbourhood of the resonant frequency (see page 207). The above effect, therefore, indicates feedback over one stage, the logical method of tracing it being as follows :

Test 1. Inject I.F. at the grid of V_3 : if the feedback disappears, then

Test 2. Connect the signal generator across anode and earth of V_2 . The effect becomes worse, indicating that the 2nd I.F. circuit takes part in the feedback and that the worsening is due to the removal of damping from the 1st I.F. circuit.

The following tests are to show how the investigation could be carried on in a logical way without drawing the immediate conclusion indicated from the shape of the I.F., viz. feedback of the 1st I.F. stage.

Test 3. Connect a damping resistance of, say, 20,000 ohms across the 5th I.F. circuit and inject the I.F. as in test 2. The feedback still persists, indicating that the 5th and 6th I.F. circuit have no part in it.

Test 4. Inject as in 2 and damp the 4th I.F. circuit with a parallel resistance of 20,000 ohms. The feedback becomes worse, clearly indicating coupling between the 2nd and 3rd I.F. circuit as the source of feedback.

The subsequent investigation is carried out according to the directions given for the 1st R.F. stage and does not require any further comment.

CHAPTER 10

HUM, SPURIOUS BEATS

Hum

Mains hum in a receiver may be due to pure A.F. action or to modulation of a received carrier. The most frequent causes for hum may be enumerated as follows :—

- A. Hum from pure A.F. action ; it can be due to
 1. Insufficient filtering of the H.T.
 2. Capacitive coupling to grids, inside or outside the valves.
 3. Inductive coupling with A.F. transformers, A.F. or R.F. coils.
 4. Leakage between cathode and heater, owing either to poor insulation or to actual emission.
- B. Hum from combined R.F. and A.F. action. This may be the result of :
 1. A.F. modulating the carrier within the R.F. amplifier, usually due to insufficient H.T. filtering.
 2. R.F. picked up from the mains.
 3. R.F. radiated by mercury-vapour rectifiers.

A. Hum from Pure A.F. Action.

1. Insufficient H.T. filtering produces hum of 50 or 100 c/s, according as to whether half-wave or full-wave rectification is used. It may be cured by increasing either the common H.T. filtering or the filtering of individual valves. The latter can often be done with resistance capacitance filters because of the low currents involved.

Hum due to insufficient H.T. filtering may enter the receiver in a way which is very similar to the A.F. feedback (see Chapter 9). In the circuit Fig. 191 the alternating voltage E , which is mainly 100 c/s, causes approximately the following voltages :

$$1. E \frac{\frac{1}{\omega C_1}}{\sqrt{\left(\frac{1}{\omega C_1}\right)^2 + R_1^2}} \text{ at the screen grid of } V_1.$$

$$2. E \frac{\frac{1}{\omega C_2}}{\sqrt{\left(\frac{1}{\omega C_2}\right)^2 + R_2^2}} \times \frac{R_3}{\sqrt{R_3^2 + \left(\frac{1}{\omega C_3}\right)^2}} \text{ at the grid of } V_2; \text{ the}$$

impedance of V_1 is large compared with $\frac{1}{\omega C_2}$ and has therefore been neglected.

$$3. E \frac{\rho_2}{\rho_2 + R_4} \times \frac{R_5}{\sqrt{\left(\frac{1}{\omega C_4}\right)^2 + R_5^2}} \text{ at the grid of } V_3.$$

4. $E \frac{R_L}{\rho_3 + R_L}$ at the primary of the output transformer, where ρ_3 is the impedance of V_3 and R_L the transferred loudspeaker impedance, the primary inductance of the transformer being neglected.

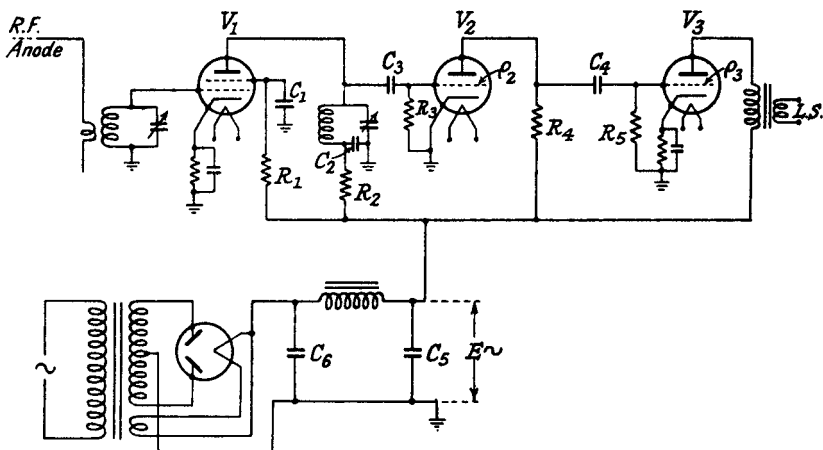

FIG. 191.

The voltage delivered to the screen grid of V_1 may produce hum, this being due to the tuned anode (nowadays unusual) which causes V_1 to amplify A.F. as well as R.F. The anode load is approximately R_2 and C_2 in parallel, as R_3 is large compared with R_2 . This effect has been dealt with in Chapter 9; it does not exist in case of R.F. transformer coupling.

The hum voltage permissible across C_6 depends on special circumstances, so that absolute figures cannot be given. Usually it will be the most economical design to reduce the hum voltage across C_6 to a level required for the anode of the output valve and

to add individual RC filters for the anodes of the preceding valves (compare page 276). The use of the loudspeaker field coil as filter choke and that of a hum neutralising coil is a popular method.

2. Capacitive coupling, usually from heater supply, tends to bring out the higher frequencies of about 200–400 c/s. These are more easily heard than the fundamental, though an output meter may not indicate them. If the coupling exists outside the valves, it can be easily cured by the use of screened cable for the heater leads or by rearrangement of components. Capacitance inside the valves, from filament to the grid, is very small with modern diode-triode valves if the grid is connected to the valve top. There exists, however, capacitance between diode and filament (Fig. 192). The volts caused at the diode and conveyed to the triode grid depend largely on the size of R_2 and C .

Means of prevention are three: restriction in A.F. gain; a potentiometer across the filament with earth connected to the moving point, or a reduction of R_2 . In carrying out the latter it must be realised that the diode in connection with R_2 represents a damping for the R.F. circuit approximately equal to a parallel resistance $0.5 R_2$; for this reason

R_2 should not be less than about $5Z_0$. Naturally the previous circuit affects the value of Z_0 . The maximum value of R_2 is determined, apart from the possibility of A.F. hum, by considerations of distortion, as discussed in Chapter 11.

3. Inductive Coupling. The effect is usually due to coupling between the mains transformer and an inter-stage transformer. This brings out the fundamental because, unlike 2, the voltage transfer is independent of frequency. The A.F. choke nearest to the rectifier may also prove dangerous. Hum due to voltage induced in R.F. coils is rare, but does occur sometimes. Usually the coil connected to the diode or the grid leak detector is concerned, for the A.F. voltages induced are amplified directly. To avoid all these effects it will prove sufficient to mount the mains transformer and the A.F. choke away from the A.F. part of the receiver. In mass production it is not advisable to find the position of minimum coupling by rotation of the transformers, as different transformers

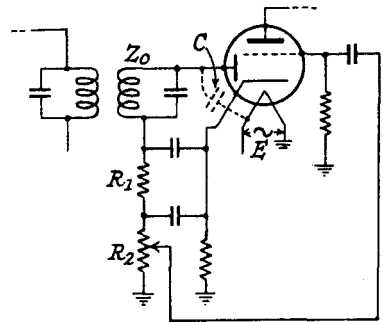

FIG. 192.

of the same type may possess quite a different leakage flux. If the space is restricted, the inter-stage transformer concerned may have to be screened in a box of high permeability material such as perm-alloy or mu-metal.

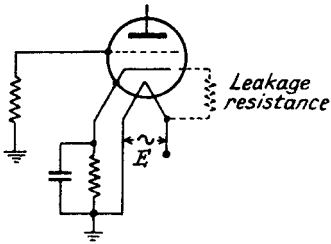

FIG. 193.

4. Leakage between Cathode and Heater. This causes an A.C. current through the bias resistance of a self-biasing valve, as can be seen from Fig. 193. The effect is fairly rare, as the modern valves possess a high resistance between cathode and heater. A large condenser of, say,

50 μF , in parallel with the biasing resistance, can be considered a sufficient safeguard.

B. Hum from Combined R.F. and A.F. Action.

1. Modulation of the R.F. Carrier within the R.F. Amplifier. This is usually caused by the hum frequency reaching the grids or screen grids of R.F. valves, owing to insufficient H.T. smoothing. It is eliminated by appropriate means, either for the common supply or for the individual valves. If the A.F. response, either of the receiver or the loudspeaker, is very poor at the low-frequency end, the modulation hum may not be audible with an unmodulated carrier, but it shows up with a modulated carrier or with a beat frequency oscillator. This is because the received A.F. is modulated with the hum frequency. Speech or music becomes harsh or, in extreme cases, rattling.

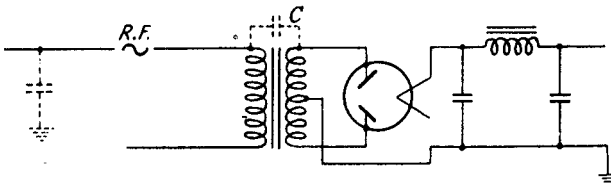

FIG. 194.

2. R.F. Pick-up from the Mains. When stations are received by pick-up from the mains the carrier is sometimes found to be modulated by the mains hum or its second harmonic. The effect may be understood from Fig. 194, two cases being possible.

(a) The radio frequency carrier enters the R.F. part of the receiver through the combination of *C* and the rectifier and then

through some internal coupling between plus H.T. and the R.F. part. In this case the R.F. carrier is bound to be modulated because of the change of coupling caused by the varying rectifier resistance.

(b) The carrier enters the receiver owing to coupling between the mains lead and the aerial, coupling between plus H.T. and the R.F. part assumed to be zero. In this case, modulation of the R.F. carrier is still possible as the mains lead is periodically connected with the receiver earth through the series combination of C and the rectifier resistance. Either a static screen between the primary and secondary of the mains transformer, or chokes in the mains leads, will give protection against self-modulation by the receiver. Modulation by other receivers on the same mains may still occur if they are not adequately guarded. The appropriate cure consists in preventing reception through the mains leads altogether. This also may avoid reception of man-made noise from motors, etc. The means of prevention have been fully discussed in Chapter 8, pages 200–202.

3. R.F. Radiated by a Mercury-vapour Rectifier. Mercury-vapour rectifiers tend to oscillate with radio frequency, modulated by the mains frequency. If this is picked up by the receiver it causes hum as pointed out under 2. Surrounding the rectifier with a metal box and filtering all the leads leaving the box is the obvious cure. The effect makes the vacuum rectifier preferable in all cases where its current rating is adequate.

Methods of Finding the Sources of Hum. Tracing the sources of hum is usually very much easier than finding undesired feedback, and the methods employed hardly differ from those described in the previous chapter. Frequently the hum note makes it possible to draw a quick inference, provided the ear is sufficiently trained. With a 50 c/s mains and full-wave rectification the following may be used as a rough guide :

50 c/s hum—If existing without R.F. carrier, A3 (with the mains transformer as source), or A4. If arising only when an R.F. carrier is received, due probably to modulation by another apparatus employing half-wave rectification.

100 c/s hum—If existing without R.F. carrier, A1 or A3, in the latter case the A.F. filter choke being the source.

If arising only when an R.F. carrier is received, B1, B2 or B3.

200 c/s hum or higher—A2.

The method of shorting valve grids, removing valves, etc., as used in Chapter 9 for the detection of A.F. feedback, applies equally here. Hum reaching a grid from the H.T. or induced in a transformer may increase when the previous valve is removed. This is analogous to the increase of A.F. feedback in similar circumstances (Chapter 9).

The source of *modulation hum* may be traced by listening in with the auxiliary receiver at various stages to find where modulation of the carrier starts. If hum exists only with one or two stations and disappears on tuning in to other stations or to the signal generator, then R.F. pick-up from the mains is indicated as the cause. A mercury-vapour rectifier as source of hum should likewise be traced with the auxiliary receiver, the latter being provided with a small search coil.

Spurious Beats

Only those beats are dealt with in this chapter which are due to undesired coupling inside the receiver and not due to pick-up of external carriers, the latter effect being treated in Chapter 5.

Feedback on harmonics of the intermediate frequency may lead to instability, as shown in Chapter 9. If feedback exists but is not

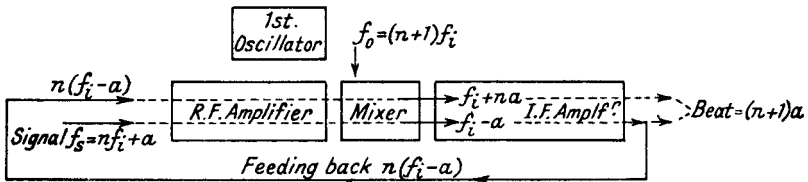

FIG. 195.—The receiver is tuned to nf_i .

strong enough to cause oscillation, it may show up by a beat when a station is received, the frequency of which is approximately a multiple of the intermediate frequency. Calling the intermediate frequency f_i , the signal frequency f_s , the oscillator frequency f_o , and assuming the receiver to be tuned to a frequency nf_i , we can see the behaviour of the receiver from Fig. 195. It shows that the beat frequency caused by a station of frequency $nf_i + a$ is $(n+1)a$, i.e. the beat changes $n+1$ times as fast as the frequency of the signal or the tuning frequency of the receiver, when either of them is varied. This makes it easy to recognise the effect. Often several beats are audible, varying with different speed; this can be understood from

Fig. 195 by assuming that the n th harmonic of $(f_i + na)$ is fed back again, beating with the signal frequency. The beat frequency in this case is $(n^2 + 1)a$ and the strength is usually less than that of the beat $(n + 1)a$.

If the receiver is not exactly tuned to nf_i , i.e. if the oscillator frequency is, say, $(n + 1)f_i + \delta f$, beats arise for a signal frequency in the neighbourhood of $nf_i + \frac{n}{n + 1}\delta f$. A signal of this frequency produces by mixing with the oscillator the intermediate frequency $(n + 1)f_i + \delta f - \left(nf_i + \frac{n}{n + 1}\delta f\right) = f_i + \frac{\delta f}{n + 1}$; the n th harmonic of this is equal to the signal frequency, so that in this particular case the beat frequency becomes zero. As long as oscillator frequency minus signal frequency falls within the i.f. pass-band, beats may occur, i.e. as long as $\delta f < \frac{(n + 1)}{2}b$, b being the width of the i.f. pass-band.

Example: $f_i = 460$ Kc/s; the width of the i.f. curve is 10 Kc/s. How far from 2,300 Kc/s has the receiver to be tuned to be free from the effect described?

Answer. About ± 30 Kc/s.

With the conditions just discussed beats of a frequency equal to that derived above can be caused by the 1st oscillator signal reaching the detector valve and beating with the $(n + 1)$ th harmonic of the i.f. produced. The effect is similar to that treated under (2) below.

Spurious beats may be found without any signal when the 2nd oscillator is working. They may be due to two causes.

(1) Harmonics of the 2nd oscillator are being fed into the r.f. part and produce beats when the receiver is tuned to one of these harmonics. The 2nd oscillator acting as an external signal, the frequency of the beat changes at the same rate as the receiver tuning.

(2) The fundamental of the 1st oscillator reaches the detector valve and beats with the harmonics of the 2nd oscillator.

The beats caused by the two effects are identical, as can easily be verified. If f_1 and f_2 are the frequencies of the 1st and 2nd oscillators, a beat frequency f_a arises from the first cause when $f_1 - nf_2 = f_2 \pm f_a$; the frequency $f_2 \pm f_a$ is amplified by the i.f. amplifier since f_2 is almost identical with the i.f. The beat due to the second effect is $f_1 - (n + 1)f_2$, which is also f_a when the first condition exists.

1. Harmonics of the 2nd Oscillator entering the R.F. Part of the Receiver. Whereas the effect (2) is rarely dangerous, the prevention of spurious beats caused by (1) is one of the difficult

problems of a superhet and requires careful design. To make the task of screening easier, the oscillator is to be designed so that the harmonics are weak. Due to the usually distorted wave form of the anode current the source of harmonics is the oscillator anode, and the circuit should therefore have a low anode impedance for the harmonics; thus the Colpitt circuit is preferable to the Hartley circuit. As the harmonic content of a weak oscillator is very much smaller than that of a strong oscillator, circuits as shown in Figs. 89 and 90, Chapter 4, are popular. They permit the use of weak oscillations without the risk of "locking" (page 129).

The following example, taken from practical experience, is to give an idea of the actual figures involved and the filtering means necessary in extreme cases. In the circuit Fig. 196 a triode is employed as the second oscillator, the valves are assumed to be directly heated.

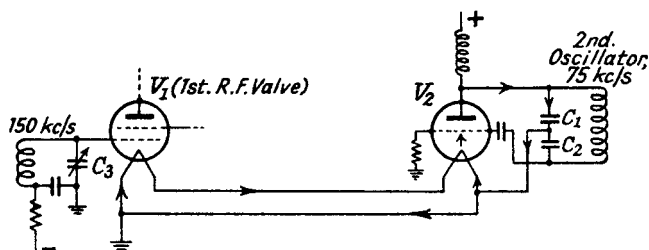

FIG. 196.

Example: In Fig. 196 the oscillator works on 75 Kc/s, indicating an intermediate frequency of 74 or 76 Kc/s. The filament resistance of each valve is 20 ohms, the E.M.F. measured between anode and earth of V_2 is 0.1 volt at 150 Kc/s, $C_1 = C_2 = 5,000$ pF. The tuning condenser of the radio frequency circuit has a capacitance $C_3 = 100$ pF, the circuit being tuned to 150 Kc/s; the grid-cathode capacitance of V_1 is 5 pF, the circuit Q is 100. What are the means necessary to restrict the amplitude delivered at 150 Kc/s to the grid of V_1 to $1 \mu\text{V}$, if the existence of the other valves and of the filament battery is disregarded? (The E.M.F. between anode and earth of V_2 is easily measured by connecting the auxiliary receiver first across C_1 and then to a signal generator, the latter being adjusted to give the same output.)

The current of 150 Kc/s through C_1 is $470 \mu\text{A}$, part of which flows through the filament of V_1 . It is sufficiently accurate for practical purposes to assume that all the emission occurs at the middle of the filaments and that likewise the capacitance from the

filament to the grid is concentrated in the middle. On this assumption one-fourth of the current through C_1 flows through the filament of V_1 , causing a p.d. of $\frac{470 \times 10^{-6}}{4} \times 10V = 1.17$ mV between its mid-point and earth. The voltage between the grid of V_1 and earth becomes

$$1.17 \times 100 \times \frac{5}{105} = \text{approx. } 5.6 \text{ mV.}$$

The filter used must produce an attenuation of about 5,000, which can be obtained by a condenser of $1 \mu\text{F}$ capacitance across each of the filaments and a choke of $600 \mu\text{H}$ inserted in the lead connecting the non-earthed filament ends. The ohmic resistance of the choke has to be very small to avoid any serious drop in the filament volts; about 0.5 ohm may be regarded as permissible. As R.F. losses are of no importance, it may be found useful to wind the choke on a small laminated iron core.

The voltage between anode and earth of the 2nd oscillator being 0.1 V, the H.T. filter should be designed for an attenuation of about 10^5 , which is safe in view of the fact that the coupling between H.T. and the 1st R.F. circuit is only slight. A choke of $100,000 \mu\text{H}$ and a condenser of $1 \mu\text{F}$ fulfils this purpose; the self-capacitance

of the choke is harmless, so long as it is not much in excess of 10 pF. The anode current is small, so that it may be possible to use a T section made up of two 10,000 ohms resistances and a $1\text{-}\mu\text{F}$ condenser, the means chosen being always a matter of personal taste (keep in mind the possibility of parasitic resonance, page 268).

The screening box should contain the valve, the tuning circuit and the filter elements. Capacitance between the anode and the remote side of the filters is not dangerous, as may be verified by a simple calculation.

It has been tacitly assumed above that the oscillator is the only source of harmonics. Very often, however, the A.F. diode to which the oscillator is coupled, the A.F. volume control and the A.F. amplifier are almost as dangerous as the oscillator. It is, therefore, often advisable to include the diode in the screening box and by a filter prevent the harmonics from entering the A.F. amplifier (Fig. 197).

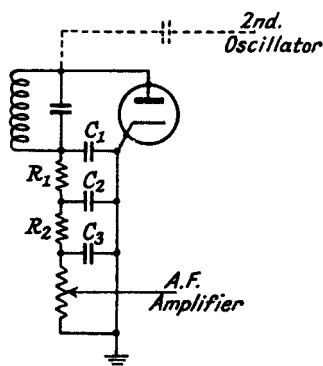

FIG. 197.

The filter components usual for an I.F. of 460 Kc/s, i.e. $C_1 = C_2 = C_3 = 50$ to 100 pF, and $R_1 = R_2 = 50,000$ ohms, would be quite inadequate in the above case. The capacitances cannot be increased, for reasons explained in Chapter 11, so that the resistances may have to be replaced by chokes of the order of $100,000 \mu\text{H}$. Sometimes it will prove useful to design at least one of the chokes so that it tunes with its own capacitance, thus providing a rejector circuit for 150 Kc/s.

2. The Fundamental of the 1st Oscillator beating directly at the Detector Valve with Harmonics of the 2nd Oscillator. Beats caused by direct coupling between the first oscillator and the detector circuit are rare and suggest a major fault in design. The effect may, however, be expected if the number of I.F. circuits is small and due care has not been taken in the design of the I.F.

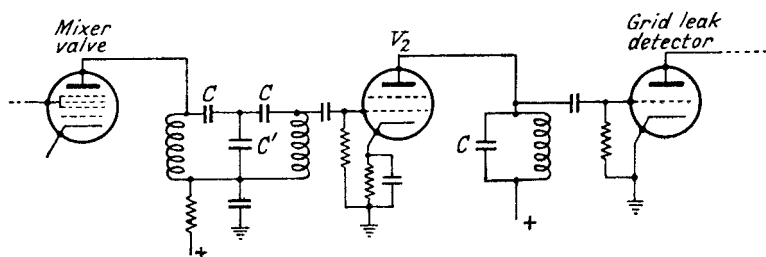

FIG. 198.

stages. An example is given in Fig. 198, based upon figures met with in practice.

The I.F. employed is 100 Kc/s, $C = 200$ pF, $C' = 10,000$ pF. The first oscillator works at 300 Kc/s, causing an a.c. current of 0.1 mA at the mixer anode, i.e. 0.112 mA through C' , and producing about 6.7 mV at the grid of V_2 . If the mutual conductance of V_2 is 1 mA/V, 20 mV are delivered to the following grid, easily producing a strong beat with the 2nd harmonic of the beat oscillator.

If an increase in the number of I.F. circuits is not desirable, an improvement can be obtained by changing the mode of coupling, as is indicated in Fig. 199. Simple calculation shows the improvement to be of the order of $1:81$. For higher harmonics the gain in filtering increases, the ratio in filtering efficiency between Figs. 198 and 199 being $1:256$ for 400 Kc/s.

Another trouble, due to the first oscillator signal getting through the I.F. amplifier to the detector valve, may be met with when the I.F. employed has a much higher frequency than the signal frequency.

Some types of all-wave receivers using an I.F. of, say, 460 Kc/s and going as low as 15 Kc/s in signal frequency are bound to have difficulties of this kind, even if more I.F. circuits are employed. The frequency of the first oscillator differing by only 3% from the

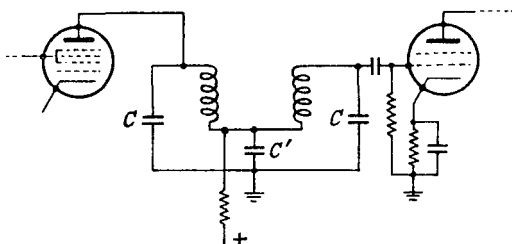

FIG. 199.

I.F., the oscillator signal may come through in great strength and either cause spurious beats or even overload one of the valves which follow the mixer valve. The effect necessitates a high I.F. selectivity or the choice of another I.F. for the lower signal frequencies.

Tracing the Source of Spurious Beats. The methods to be employed are in no way different from those given in the previous chapter. The use of the auxiliary receiver will again prove helpful, especially when the conditions are complicated.

The following tests will be found to give information fairly quickly, when the beats are caused without an external signal.

Test 1. Short the signal grid of the mixer valve.

If the beat persists it is almost certainly caused by the 1st oscillator delivering a voltage at the detector valve. In this case

Test 2. Remove one I.F. valve.

The test shows whether the voltage from the 1st oscillator is delivered to the detector valve through the I.F. amplifier or through direct coupling.

Disappearance of the beat on shorting the mixer grid (the usual case) indicates a harmonic of the 2nd oscillator being fed into the R.F. part of the receiver; by subsequently shorting the grids of the R.F. valves or mistuning the various R.F. circuits the point where pick-up occurs is found. Let us assume that the oscillator harmonic is picked up by the aerial circuit, which is the general case. The consequent procedure is identical with that described in the previous chapter for the case of overall I.F. feedback and need not be repeated in detail. Coupling the auxiliary receiver to the aerial circuit in the way shown in Chapter 9, Fig. 190, and tuning it to the harmonic concerned is the obvious method. On the other hand, the 2nd

oscillator coupling to the diode circuit may be interrupted in order to find whether the harmonic is conveyed from the oscillator directly or through the diode and perhaps the A.F. part of the receiver.

The other method described in Chapter 9, which consists in testing the area around the 2nd oscillator with the auxiliary receiver, is equally applicable here. Connecting the aerial of the auxiliary receiver to the leads leaving the oscillator compartment shows which of them conveys the harmonic frequency; the test may even be used to obtain quantitative figures by connecting the aerial to a signal generator for comparison and adjusting the signal generator for the same receiver output. Such a test shows whether the volts are what they should be as computed from the filter data or whether some fault in the filter system is to be assumed. The latter method, if applied to the diode compartment, will prove useful in tracing the source of beats produced by a signal in the absence of the second oscillator.

DISTORTION

Difference between the shape of the A.F. receiver output and the A.F. imposed on the received carrier can be called distortion. The forms of distortion most frequently occurring in practice are—

1. Frequency distortion, real and apparent.
2. Phase distortion.
3. Amplitude distortion.
4. Distortion due to loudspeaker resonances.

Frequency distortion occurs if the various A.F. frequencies are reproduced with an energy ratio differing from the original input. It is due to the amplification not being constant over the A.F. range concerned, and may be caused either in the R.F. part, in the diode, the A.F. part or in the loudspeaker. It makes the receiver output sound either of higher or lower pitch than the original or, if high and low notes are equally cut off, less rich in quality. It rarely becomes seriously objectionable to the general public and experience shows that it is one of the minor points affecting the sales of receivers.

The frequency requirements for reproduction vary with the type of transmission ; for speech a band of 200–2,500 c/s is almost standardised ; for music the band may be anything between 100–3,000 and 30–15,000 c/s. The lack of frequencies above, say, 3,000 c/s, changes the timbre of instruments, and makes a violin sound more like a flute, etc., while with speech the lack of higher frequencies becomes noticeable through the sibilants being less pronounced and hard to distinguish.

The lack of high notes can be due to :

1. Too narrow R.F. or I.F. response curves.
2. Too large diode capacitances (C_1 , C_2 , C_3 in Fig. 200).
3. Too large parallel capacitances in the A.F. part of the receiver.

The lack of low notes may be due to :

1. The coupling condensers of the resistance coupled A.F. stages being too small.
2. The inductances of the A.F. transformers being too small.
3. Anti-feedback increasing towards the lower frequency end.
4. The time constant of the A.V.C. being too small.

All these effects have been treated in other chapters, particularly in Chapter 3, and need no further explanation. The method of

tracing the sources of frequency distortion may be seen from Fig. 200. In the case of an unsatisfactory response curve, carry out the following test :

1. Disconnect the A.V.C.
2. Inject a modulated carrier between *G* and *H* and vary the modulation note over the range required. If the curve is satis-

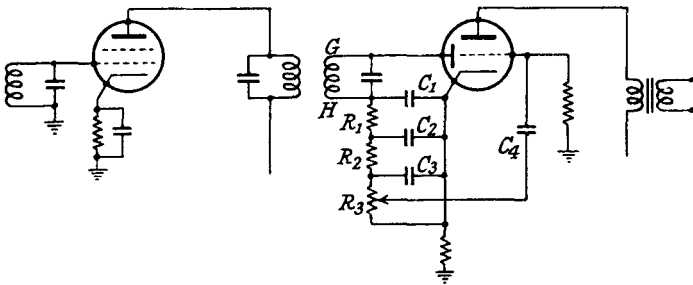

FIG. 200.

factory the diode and the A.F. amplifier are ruled out as sources of distortion, and the fault has to be located in the R.F. part by injecting subsequently at previous points. Care has to be taken that the signal generator is tuned to the middle of the receiver response curve, as otherwise the A.F. curve obtained is deceptive, indicating a wider I.F. response than really exists.

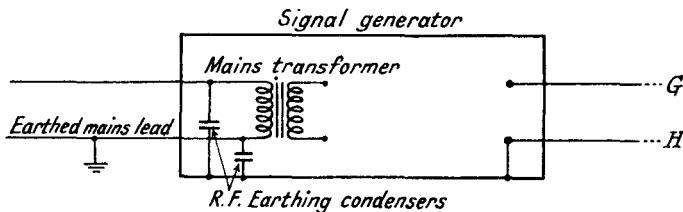

FIG. 201.

Injecting at *GH* may sometimes cause trouble due to the signal generator being wired according to Fig. 201, causing half the mains voltage to exist between its chassis and real earth, and introducing a strong 50 or 100 c/s note. In such and similar cases the use of an R.F. transformer is a convenient way out of the difficulty.

As the signal output will be naturally very small, there is possibility of its being masked by the 50 or 100 c/s receiver hum. Injecting instead at the previous grid, or using an output L.C. filter to eliminate the low notes may be tried in that case. The latter

means would be permissible as injecting R.F. between G and H only serves to investigate the diode action, the subsequent part of the receiver being measured with A.F. The diode circuit can only affect the high notes, according to the size of R_1 , R_2 , R_3 , C_1 , C_2 , C_3 , so that the output filter does no harm. A magnitude of R_1 and R_2 equal to 50,000 ohms, of R_3 equal to 0.5 megohm and $C_1 = C_2 = C_3 = 50$ pF is sufficient in most cases to prevent frequency distortion.

If a signal generator with a variable modulation note is not available the influence of the R.F. part can usually be judged from the shape of the response curve; the investigation of the diode circuit as just described should hardly be necessary and instead the values of R_1 , R_2 , R_3 , C_1 , C_2 , C_3 of Fig. 200 may be checked. The same applies to the A.V.C. system, details of which are found in Chapter 7.

Phase Distortion. Phase distortion may cause appreciable change in the shape of the A.F. curve, as can be seen from Figs. 202a

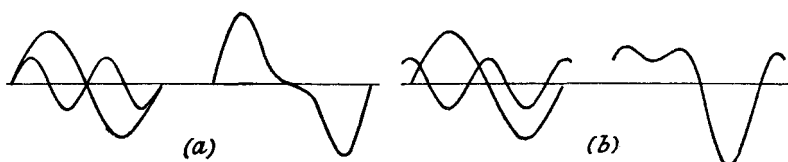

FIG. 202.

and 202b, where a frequency and its 2nd harmonic are added, the phase of the harmonic differing by 90° in the two cases. Experience shows, however, that the human ear does not react to phase distortion, as otherwise music would sound different with varying distance from the source of sound (compare Chapter 3, page 62).

Amplitude Distortion. Amplitude distortion is due to non-linear links within the course of amplification; it may introduce harmonics and combination notes. If, for instance, 200 and 260 c/s are received, amplitude distortion may cause in the output the existence of the harmonics of 200 and 260, but also the sums and differences between the two notes or between any of their harmonics, i.e. apart from 400, 600, 800 . . . 520, 780, 1,040 . . . etc., also 60, 460, 140, 320, etc.

The addition of harmonics is usually not so serious (unless it is excessive), as it only changes the timbre of the fundamental; combination notes, however, constitute a very grave distortion, as will be readily understood, causing the output to sound objection-

able. Effects producing high order harmonics cause relatively strong combination notes ; it is, therefore, not sufficient to know the total harmonic content of one single note, but also the relative strength of the various harmonics. It has been suggested that the amplitude of each harmonic should be multiplied by the number of its order to obtain a result more in accordance with the actual effect than is the total percentage harmonic content.

In Figs. 203-5 three frequent types of distortion are indicated, the y -axis giving the output current as a function of the input voltage, the quiescent point being the intersection between the x - and the y -axis.

Output to input ratio of the type shown by Fig. 203 causes predominantly second harmonic, the percentage of combination notes being small. The output seldom sounds really objectionable. The type Fig. 204 causes mainly third and higher odd harmonics.

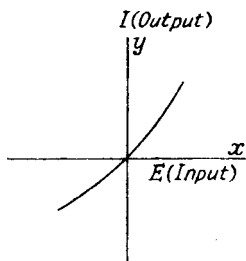

FIG. 203.

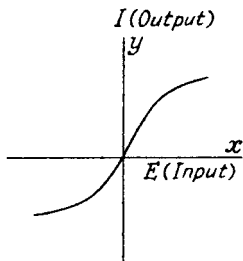

FIG. 204.

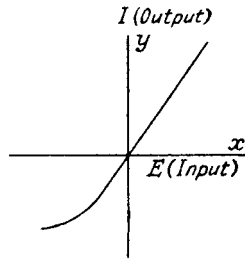

FIG. 205.

The percentage strength of combination notes may become serious. One-sided sharp cut-off (Fig. 205), though only occurring at the peak of the curve, constitutes a grave form of distortion and must be prevented. It tends to originate strong combination notes, so that the ear objects violently, in spite of a relatively low percentage of total harmonics.

The most usual sources of amplitude distortion are :

1. Valves.
2. A.F. transformers.
3. Rectifiers.
4. Loudspeakers.

1. Valves. Valves may cause distortion due to :

- (a) Grid current.
- (b) Curvature of the anode current characteristic.
- (c) Oscillation in R.F.

In the case of grid current, the shape of the curve given by the

voltage between grid and cathode already deviates from the required shape, independent of the anode current characteristic. This type of distortion is represented by Fig. 205. It is explained by the fact that during part of the time the anode load of the previous valve (V_1 in Fig. 206) is lowered owing to the resistance of the grid-cathode path of V_2 (see Fig. 59). The degree of distortion depends on the ratio of the impedance between A and earth to

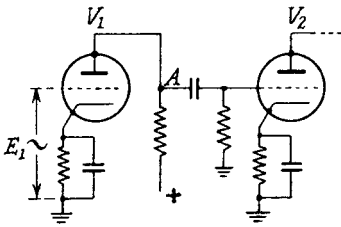

FIG. 206.

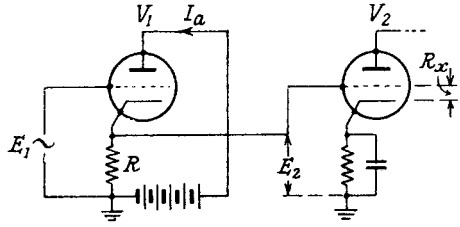

FIG. 207.

the impedance of the grid-cathode path of V_2 , when the latter is conducting.

It is obvious that the distortion is negligible if the resistance of the grid-cathode path of V_2 is always large compared with the impedance between A and earth. On this fact is based the circuit of Fig. 207, which is usually combined with push-pull to drive the output valves far into the region of positive grid current, resulting in a very large power output (see Chapter 3).

For an exciting voltage E_1 as shown in Fig. 207, the expression for I_a becomes

$$I_a = \frac{(E_1 - I_a R)}{\rho + R} \mu,$$

ρ being the impedance of V_1 .

Hence
$$I_a \left(1 + \frac{\mu R}{\rho + R} \right) = E_1 \frac{\mu}{\rho + R},$$
 and

therefore
$$E_2 = I_a R = \frac{\mu E_1 R}{\rho + R(1 + \mu)} \simeq \frac{E_1 R}{R + \frac{\rho}{\mu}} = \frac{E_1 R}{R + \frac{1}{g_m}}$$

The equation indicates that the circuit of Fig. 207 can be replaced by the equivalent circuit of Fig. 208. Hence the distortion remains harmless so long as the resistance R_x of the grid-cathode path of V_2 is several times $\frac{1}{g_m}$; the latter being of the order of a few hundred

ohms, the danger of distortion is widely removed, especially as the existence of even harmonics is avoided by the push-pull arrangement. The amplification of V_1 is about unity, and this stage acts purely as a buffer to make possible a large output from V_2 without undue distortion (cathode follower).

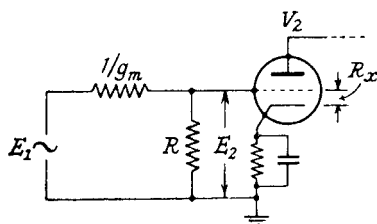

FIG. 208.

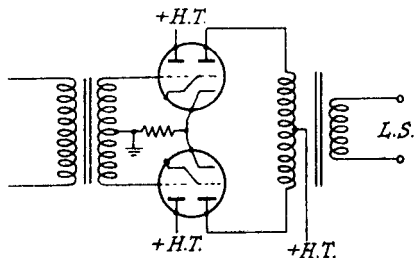

FIG. 209.

R can be omitted and R_x used as sole anode load for V_1 ; a push-pull stage on these lines is shown in Fig. 209.

The effect (b), i.e. curvature of the anode current characteristic,

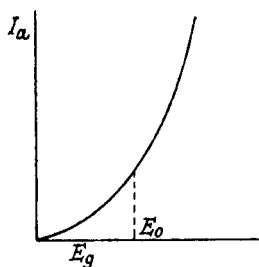

FIG. 210.

can be best judged from the load-lines, as indicated in Chapter 3. A single triode in class A amplification causes distortion of the type Fig. 203, a single pentode in class A amplification type Fig. 203 or Fig. 204. If the anode load is reactive the load-line becomes an ellipse and distortion may occur when a purely resistive load of equal magnitude would be satisfactory.

In the case of modulated R.F. amplification the distortion due to the curved valve characteristic is smaller than for audio frequency of equal amplitude. This may be understood from Fig. 210, assuming a valve characteristic $I_a = KE_g^2$. In the case of an A.F. amplitude the grid voltage becomes $E_0 + E_1 \sin mt$ and the 2nd harmonic is generated, whereas in the case of modulated R.F. expressed by $E_0 + E_1(1 + A \sin mt) \times \sin \omega t$, the A.F. envelope is not affected and only the 2nd R.F. harmonic arises, as can be verified by a simple calculation. If the anode load is a tuned circuit the voltage of 2nd R.F. harmonic becomes negligible and no distortion arises. The fact is of practical importance, since the valve characteristic can be expressed in form of a power series. Usually figures are available for R.F. pentodes giving the maximum grid amplitude

for a 100% modulated carrier and a stated percentage harmonic content.

Distortion in the last I.F. valve may become serious if the shape of the response curve at the grid is as drawn in Fig. 211. With two tuned circuits in the anode, the resultant curve might be rectangular and the quality perfect if the valve characteristic were linear. Because of the curvature of the characteristic, however, distortion is bound to increase, due to the fact that the modulation factor of the carrier as delivered to the grid may be far in excess of 100%. An effect of this nature is to be avoided.

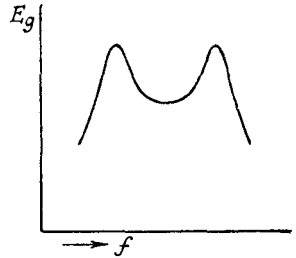

FIG. 211.

Serious distortion occurs if an A.F. valve is oscillating at a radio frequency. Output valves show a strong tendency towards this effect, owing to their high mutual conductance; the subject is dealt with in Chapter 12.

2. A.F. Transformers. A.F. transformers, if the flux exceeds saturation point, represent a non-linear link and may lead to distortion. The effect necessitates care in the choice of the output transformer and knowledge of its rated value of maximum resultant current.

3. Rectifiers. There are essentially three ways in which rectification may lead to distortion:

- (a) Due to the time constant CR being too long.
- (b) Due to the resistive diode load being different for A.C. and D.C.
- (c) Due to the diode representing a load varying with R.F. amplitude (Delayed A.V.C.).

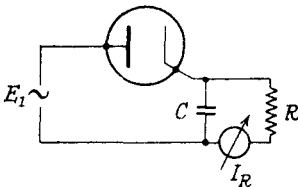

FIG. 212.

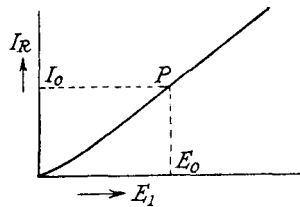

FIG. 213.

(a) If in Fig. 212 E_1 is varied in amplitude, there ensues a D.C. current I_R as a function of E_1 , the relation being given in Fig. 213.

(C is supposed to be so large that the R.F. amplitude across it is practically zero.) The curvature for small values of E_1 is due to the increase of diode resistance for small voltages. If E_1 is an R.F. carrier of the amplitude E_0 which is slowly varied sinusoidally, the D.C. value of I_R becomes I_0 , also varying sinusoidally in magnitude, slight distortion occurring only for a modulation factor approaching 100%.

When the modulation frequency of E_1 is increased there may arise a state, when the time constant of R and C is not small enough for the course of E_1 to be accurately followed. This happens mainly when E_1 is decreasing and C discharges through R only, the resistance of D becoming very high. The shape of I_R , instead of being sinusoidal, is marked by the dotted curve in Fig. 214, indicating distortion.

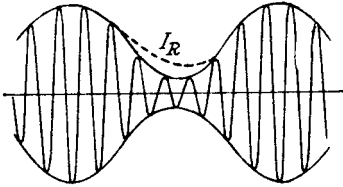

FIG. 214.

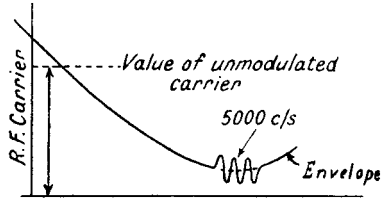

FIG. 215.

To enable the D.C. voltage across C in Fig. 212 to follow the envelope of an A.F. modulated R.F. carrier the condition is

$$RC < \frac{\sqrt{1 - m^2}}{2\pi n m},$$

n being the modulating audio frequency and m the

modulation factor. (The derivation of the formula, in slightly different form, is given in Terman, *Radio Engineering*, 2nd edition, 1937, page 428.) The formula shows that for a modulation factor of 100% the time constant RC should be zero, owing to the fact that at the point $E_1 = 0$ the percentage rate of amplitude change,

i.e. $\frac{dE_1}{dt} \frac{1}{E_1}$, is infinite. A large modulation factor need not be anticipated on high notes which considerably affects the time constant necessary to avoid distortion, as may be seen from the following example.

Example: Maximum modulation factor 90%, 80% on lower notes, 10% on 5,000 c/s. The danger of distortion caused by the 5,000 c/s is greatest when the amplitude is at 0.2 of its average value as the result of the modulation by lower notes (Fig. 215).

During that time the amplitude can be regarded as constant, modulated only by the 5,000 c/s causing a temporary modulation factor of 50%. The time constant, as far as 5,000 c/s are concerned, need only be chosen for an m of 0.5, i.e.

$$RC = \frac{\sqrt{1 - 0.25}}{2\pi \cdot 5,000 \times 0.5} = 0.55 \times 10^{-4},$$

corresponding to a condenser of 100 pF and a resistance of 0.5 megohm. Assuming a modulation factor of 90% on 5,000 c/s would lead to the much smaller required time constant of 0.15×10^{-4} .

(b) The case of the resistive load differing for A.C. and D.C. may be seen from Fig. 216; it occurs in most receivers. (See, for instance, Chapter 9, Fig. 188; the A.F. volume control and the grid leak of V_s correspond to R_1 and R_2 in Fig. 216 of this chapter.) In Fig. 217 the curve AP gives the direct current through R_1 as a function of the R.F. amplitude E_1 , provided E_1 is changed slowly;

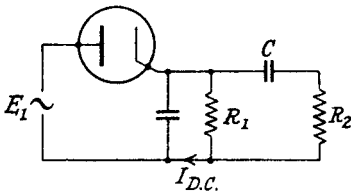

FIG. 216.

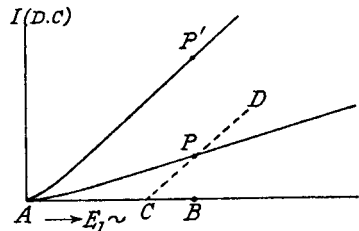

FIG. 217.

the curve AP' represents the same function for a resistance $R' < R$, where R' is supposed to be equal to the parallel combination of R_1 and R_2 . If, in the circuit of Fig. 216, E_1 is a carrier of the magnitude AB (Fig. 217) modulated with an audio frequency at which $\frac{1}{\omega C}$ is small compared with R_2 , the slope of the A.F. load line is that of the curve AP' and the point P moves on the line CPD , causing violent distortion for a modulation factor larger than $\frac{BC}{AB} = \frac{R'}{R}$. To avoid this distortion up to high modulation factors R_2 has to be much larger than R_1 ; a ratio of not less than 1:10 gives good quality up to $m = 90\%$. If C in Fig. 216 is connected to the midpoint of R_1 , corresponding to the A.F. volume control being half-way down, a ratio of $\frac{R_2}{R_1} = 2$ would be sufficient to avoid distortion up to 90%. R' becomes in this

case $\frac{\frac{R_1}{2} + \left(\frac{R_1}{2} \times 2R_1\right)}{\left(\frac{R_1}{2} + 2R_1\right)} = 0.9 R_1$. In cases where the magnitude

of the grid leak resistance is limited to 2 megohms for the sake of the valve the receiver should be designed so that the A.F. volume control is never needed at the maximum position.*

(c) The diode acting as a load varying with amplitude. The principle may be seen from Fig. 218. The R.F. amplitude across the tuned circuit is $E_1 \frac{Z}{R_1 + Z}$, so long as the peak value across Z is below the delay voltage E' . For peak amplitudes larger than E' diode current flows, imposing a load parallel to Z . If the R.F. voltage across Z is plotted as a function of E_1 , a curve as sketched in Fig. 219 is obtained, and distortion of the modulation envelope

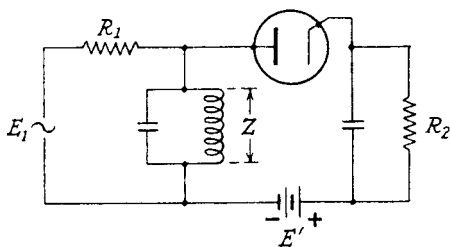

FIG. 218.

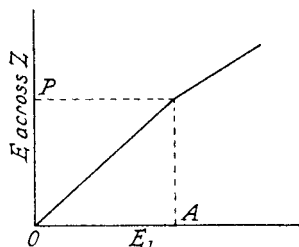

FIG. 219.

results if the carrier amplitude moves to and fro over the point A ; this in the normal state for almost all stations received, for an efficient A.V.C. system keeps the carrier constant within a few decibels of OP . The distortion depends on the ratio Z to R_2 and is sufficiently small if Z is not larger than 50,000 ohms and R_2 is 1 megohm or more; the magnitude of the delay has little influence. (See K. R. Sturley: Distortion produced by Delayed Diode A.V.C., *The Wireless Engineer*, January 1937.) Using two diodes in push-pull on lines indicated by Fig. 236 would not be an improvement; it only cuts out the even harmonics of the R.F. without removing the distortion of the envelope. There are possibilities of avoiding this

* Compare Fig. 67, Chapter 4, from which the distortion can be read for any ratio $\frac{R_2}{R_1}$, showing that the distortion increases even for modulation factors $< \frac{BC}{AB}$.

distortion altogether, one of which is shown in principle in Fig. 220. Without I.F. carrier the triode current may be such that $30V$ exist across R_2 , the cathode being at a potential of $+10V$ to earth. As the point P is at $-3V$ there is a delayed D.C. voltage of $13V$ preventing the flow of current through this diode. An I.F. carrier at the tuned circuit causes a voltage across R_1 , decreasing the triode current until the second diode becomes conducting. The grid voltage of the controlled valves becomes in this case equal to the cathode potential of V , the diode impedance being small compared with R_3 . The maximum negative bias possible in Fig. 220 is $-20V$. Any decoupling filters are omitted to show the principle more clearly.

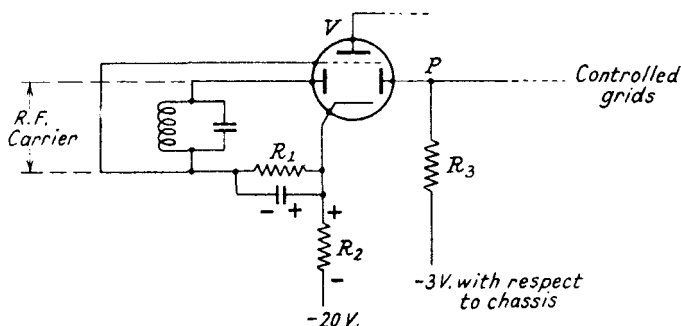

FIG. 220.

4. Loudspeakers. Distortion due to loudspeaker resonances appears as frequency distortion under normal conditions. Only in case of transients, overloadings, etc., does it lead to amplitude distortion. The damping of the loudspeaker by the output valve helps appreciably and output triodes are from this point of view preferable to pentodes.

If faced with the problem of *finding the source of amplitude distortion*, the use of a special receiver of a quality above suspicion will prove of great value and frequently help to save time. When the receiver is loosely coupled to the diode circuit it immediately gives information as to whether the R.F. part is responsible; furthermore, its A.F. amplifier may be loosely coupled to various points of the A.F. amplifier on test.

Watching the feed of various valves with and without a strong input is another method often used, but it is not always conclusive and should not be relied upon overmuch.

PARASITIC RESONANCES

By parasitic resonances may be understood all those resonances of circuits, components, etc., which are not intended and are apt to cause trouble in various ways. Oscillation at the undesired frequency, absorption effects impairing sensitivity and selectivity, sudden drops in efficiency of screening at those resonant frequencies are the most usual phenomena observed.

Parasitic Oscillations. 1. Tuned R.F. circuits connected across a valve have invariably a second resonance (Fig. 221) determined by the valve capacitance and the inductance of the condenser leads, the condenser acting almost as a short circuit and the tuning coil as an infinite impedance. The ensuing frequency is naturally very high and, with the usual lay-out, above 30 Mc/s. Anode and grid being tuned similarly there is a tendency to oscillate. In triodes the feedback occurs by reason of the grid-anode capacitance ;

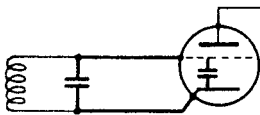

FIG. 221.

in pentodes the coupling is due to the fact that at the high frequencies concerned the screen grid and suppressor grid are no longer at zero potential, because of the inductance of the earthing leads (Chapter 9, Fig. 182). Audio frequency valves, particularly the output valve because of its high mutual conductance, are also liable to parasitic oscillation, usually manifesting itself by distortion. Oscillation between grid and screen grid, or, in mixer valves, between almost any of their numerous grids, has been met in practice.

Stopping resistances near one of the two electrodes concerned is the usual cure, care being necessary that the stopper does not harm the performance (Chapter 9, page 231). If the highest frequency of the receiver range is within 1 : 2 of the parasitic resonance, the stopping resistances may produce an appreciable damping at the desired resonant frequency. Care should be taken in the design to keep the leads between the valve and the tuning condenser as short as possible. The connecting lead to the tuning coil is, from this point of view, not so important as the coil is not part of the parasitic circuit.

2. Another quite usual case of parasitic oscillation may be seen

from Fig. 222, showing a normal triode oscillator. The tuned circuit is loosely coupled to the anode either for purposes of obtaining maximum power or of stabilising the frequency against alterations of supply, changes of valves, etc.

There are now two modes of parallel resonance between anode and cathode. First the one intended, and secondly the frequency

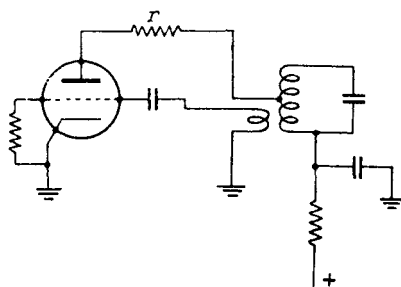

FIG. 222.

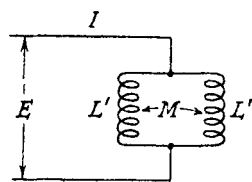

FIG. 223.

determined by the valve capacitance and the inductance of the two parts of L in parallel. In the latter case, the condenser C can be regarded as a short circuit. The parallel combination L_x may be computed for the simple case of centre tapping (Fig. 223); it must be realised that M is negative. The equations for E and I are the following :

$$E = \frac{I}{2}(j\omega L' - j\omega M) = \frac{I}{2}j\omega L'(1 - k)$$

$$\frac{I}{2}j\omega L'(1 - k) = Ij\omega L_x$$

$$\therefore L_x = L' \frac{1 - k}{2}.$$

As the inductance L of the whole coil is $2L'(1+k)$, (M being positive in this case), there follows $L_x = \frac{L}{4} \frac{1 - k}{1 + k}$. For a tubular coil, k is of the order of 0.25 and L_x is about one-seventh of the total L . Changing the tapping decreases L_x , the general formula being

$$L_x = L \frac{1 - k^2}{\left(\sqrt{\frac{L_1}{L_2}} + \sqrt{\frac{L_2}{L_1}} + 2k\right)^2},$$

L_1 and L_2 being the two parts of the coil.

Oscillation at the parasitic frequency can again be cured by a damping resistance in the anode lead (r in Fig. 222). Another

method which avoids any additional damping consists of moving the grid coil in Fig. 222 towards the live end of the tuning coil. The feedback for the parasitic frequency becomes zero or negative, the wanted feedback being unaltered.

3. Valves connected in parallel or in push-pull are particularly liable to parasitic oscillations. One example among many is shown in Figs 224*a* and 224*b*.

By simply strapping together the grids and anodes respectively, without any other external L or C , two resonance circuits come into existence, formed by the L of the connecting leads and the inter-valve capacitances. The valves work in push-pull for this parasitic resonance; the feedback is provided by the grid anode capacitances.

The possibilities of parasitic oscillations are great in complicated circuits. The simplest advice is to keep as far as possible to circuits

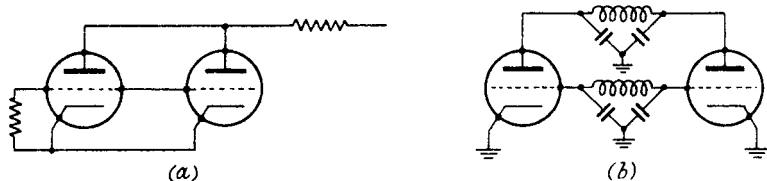

FIG. 224.

of which the behaviour can be readily foreseen. Otherwise damping resistances, in Fig. 224*a* between the two anodes or the two grids, will greatly reduce the danger.

Whenever a circuit behaves erratically—for instance, when an oscillator sometimes stops oscillating for no apparent reason—one should always look out first for parasitic oscillations and carry out the investigation accordingly. The simplest method is always to insert damping resistances in the leads suspected.

Other Cases of Parasitic Resonance. An idle coil has a resonant frequency determined by the coil inductance, the self-capacitance and, usually, the capacitance of the coil trimmer. If coupled in some way to the coil used, the idle coil is bound to cause trouble if the parasitic resonance falls within the range of the coil employed. The coupling may be inductive or, more frequently, capacitive. The coupling capacitance may exist, owing to the coil switch, even in case of complete separation. Fig. 225, showing the function of a modern switch, indicates that the capacitance between the moving disc and the coil contacts is an unavoidable element of coupling. For this reason these switches can be made

to short circuit all the idle coils or merely those of which the resonant frequency falls within the range employed.

Even shorted coils have resonances which can be compared with the resonances of shorted lines. To make these resonances fall within the range, the interfering coil has to be very much larger than the coil in use. As both ends of the shorted coil are at earth potential a capacitive coupling as shown in Fig. 225 would be harmless. Such resonances are, however, dangerous when there is strong inductive coupling, as is the case when one large coil is used with tappings for various ranges. This method has almost disappeared in the present radio technique, though it used to be quite common in the old days (compare also Chapter 4, page 117).

Chokes, in *parallel* to a resonance circuit, may cause trouble, due to resonances just described. If these chokes are to work for a large frequency range, say, more than 1 : 30, it is difficult to avoid these resonances. The usual multi-layer anode chokes

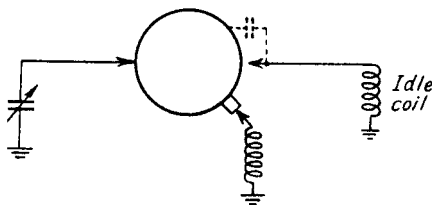

FIG. 225.

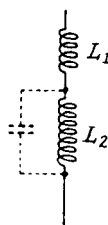

FIG. 226.

(Chapter 8, Fig. 151) with about 3,000 turns and an inductance of about 0.2 henry have been found to possess such resonances at about 300 Kc/s and at higher frequencies.

Amplifier circuits may show excessive damping, oscillator circuits a sudden jump in frequency at these resonances.

Two Coils in Series. To safeguard against the effect just mentioned, two chokes in series are sometimes used (Fig. 226), L_2 intended to cover the lower and L_1 the higher frequency ranges, where L_2 may possess parasitic resonances. As L_2 , due to its size, will behave like a capacitance over a large range of radio frequencies, the possibility of a series tuning of L_1 with the capacitance of L_2 exists. Similar effects may occur when only one choke is used which is made up of several sections. Due to differences in L and C the danger of series resonance will always exist and must be carefully watched.*

* H. A. Wheeler, "The Design of Radio-frequency Choke Coils," *Proc. I.R.E.*, June 1936.

Two Condensers in Parallel. The use of two condensers in parallel for earthing purposes, etc., is always dangerous, as they form a resonance circuit, the L determined by the loop, the C by the series combination of the two capacitances. Taking, for example, the combination of $0.1 \mu\text{F}$ with $5,000 \text{ pF}$, arranged as in Fig. 227, the resulting resonant frequency will be of the order of 15 to 20 Mc/s.

The resonance of a condenser with the inductance of the supply leads may prove troublesome, as may be seen from the following example, which occurred in actual practice. In trying to avoid

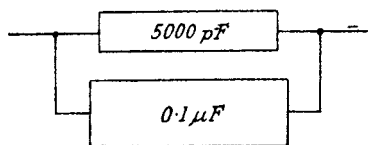

FIG. 227.

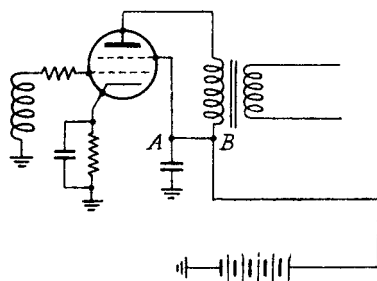

FIG. 228.

spurious beats of the 2nd oscillator of frequency 85 Kc/s, it was found that the 5th harmonic in particular was much louder than the rest. It was traced to a resonance of the inductance of the H.T. battery leads and a $1 \mu\text{F}$ condenser earthing the screen grid of the output valve (Fig. 228).

A resistance of 50 ohms between A and B was sufficient cure. As the H.T. lead went through the whole receiver it represented a coupling between the 2nd oscillator and the first R.F. circuit. Parasitic resonances of this type are not infrequent: they must be expected when filters are terminated with a condenser as shown in Chapter 13, page 271.

CHAPTER 13

POWER SUPPLY

Particular features of interest arise in the design of a power supply for the H.T. voltage of a receiver. The following discussion is therefore limited mainly to this subject. Important points to be aimed at are :

(a) Good regulation, i.e. constancy of voltage with varying current.

(b) Absence of audio frequency and radio frequency components in the voltage supplied.

(c) Low output impedance of the source of supply in order to reduce the risk of undesired feedback.

The various sources of power supply may be discussed with these in view.

Wet Batteries. The internal resistance of wet batteries is very small, and hence the regulation is almost perfect. A.F. or R.F. frequencies are not existent unless caused by contacts which have become bad from corrosion. Feedback at audio frequencies is not likely to occur. At radio frequencies the inductance of the leads connecting the batteries with the receiver will be the coupling element rather than the battery resistance. Since, however, the H.T. leads of radio frequency valves are usually provided with filters as a matter of routine, the problem of feedback at radio frequencies need not be considered. Frequently the grid bias is derived from a resistance in a common H.T. lead (Chapter 7, Fig. 110). In this case there exists the possibility of feedback through this resistance, and a condenser of about $50 \mu\text{F}$ should be connected in parallel. Even then feedback on very low frequencies is not entirely ruled out (see Chapter 9).

The use of wet batteries is limited nowadays to large central stations employing many receivers for commercial service. The receivers often work from the same L.T. and H.T. batteries. In this case it would be wrong to derive the bias from the voltage drop caused by a resistance when directly heated valves are employed. Fig. 229 shows that all these resistances would be in parallel and hence a variation of anode current in one receiver would affect all the others. In such cases a wet battery should be used as source of the common grid bias.

Even then trouble is often experienced, a strong output in one receiver being heard in all the others. Comparing the conditions for A.F. oscillations within one receiver as discussed in Chapter 9, it will be understood that cross-talk from one receiver to another may take place even when the means of decoupling are quite sufficient to prevent oscillations within the individual receivers. A simple cure for this effect is to insert a choke-capacitance filter in

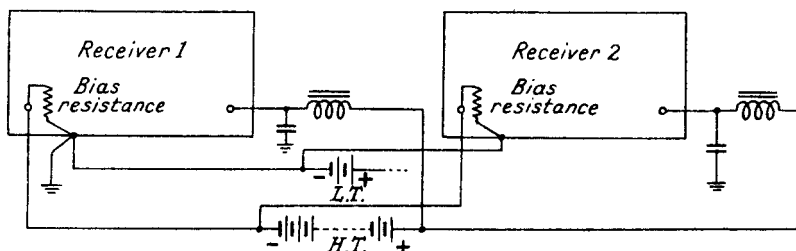

FIG. 229.

each of the H.T. leads, as indicated in Fig. 229. Values such as 20 henries and $2 \mu F$ will prove sufficient.

Dry batteries for H.T. and grid bias are used mainly in small portable sets. On ageing their resistance increases up to a few hundred ohms, and this fact should always be borne in mind (compare the questionnaire, page 305).

Rotary Converter, Vibrator.

A rotary converter or a vibrator as source of H.T. is often used for military equipment in cars, aeroplanes, etc. The actuating source is an L.T. battery which at the same time serves as filament supply. Grid bias is obtained from a resistance in the common H.T. lead, and for reasons of economy directly heated valves are frequently employed. The problems arising in this case may now be discussed.

The negative pole of the filament supply is the common earth point and should be connected to the chassis of both the receiver and the power supply. The negative pole of the H.T. has to be insulated from the chassis because of the need for grid bias. According to the directions given in Chapter 8, the circuit diagram of such power supply is likely to be on the lines indicated in Fig. 230.

The R.F. chokes L_1-L_6 in connection with the condensers C_1-C_9 , are to prevent any of the leads which leave the power supply box from having an R.F. potential different from that of the box, i.e. from

the common earth potential. The choke L_7 and the condensers C_8 and C_9 are to prevent an A.F. ripple across the H.T. or across the common grid bias. Therefore approximate values of the various components are: $C_1-C_7 = 0.1 \mu\text{F}$, $C_8, C_9 = 1-2 \mu\text{F}$, L_1-L_6 equal to a value such that at the lower radio frequencies concerned the reactance is at least twenty times the reactance of $0.1 \mu\text{F}$; $L_7 = 20$ henries. Resonance of C_7 with the battery leads may prove harmful, in which case C_7 may be omitted or its value altered.

If the directions given in Chapter 8 are kept in mind, radio frequency interferences should not be experienced. The circuit Fig. 230, however, will be found to exhibit the following disturbing effects.

1. A strong audio frequency current flows from the source of H.T. through the parallel combination of C_1 and C_3 in series with

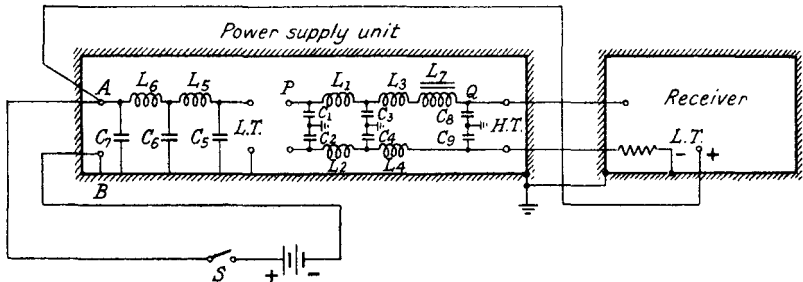

FIG. 230.

the parallel combination of C_2, C_4, C_9 , the R.F. chokes being practically short circuits. The A.F. voltage thus caused across C_9 will be about one-fifth or one-tenth of that across the source and will cause trouble either through the H.T. or through the grid-bias supply.

2. The low-tension side of the generator, acting as a source of audio frequency, produces a potential difference between the terminals A and B, which thus becomes a source of audio frequency in the receiver filament supply.

There are various ways of avoiding these two effects. Fig. 231 shows a method which does away with the need for an audio frequency choke in the L.T. supply and has proved satisfactory under normal circumstances. The symmetry of the R.F. decoupling of the H.T. source has been abandoned in order to avoid p.d. between - H.T. and earth. The plus filament terminal of the receiver is

connected not to A but to the L.T. battery terminal, and the connection between the minus point of the L.T. battery and the D.C. power supply is made of short thick wire. This is done because the resistance of the leads connecting the battery to the power supply proves to be far more harmful than the very low resistance of the battery. A short positive lead is often ruled out because of the switch S which may be mounted away from the battery and power supply. The R.F. filtering of the H.T. becomes worse since the two

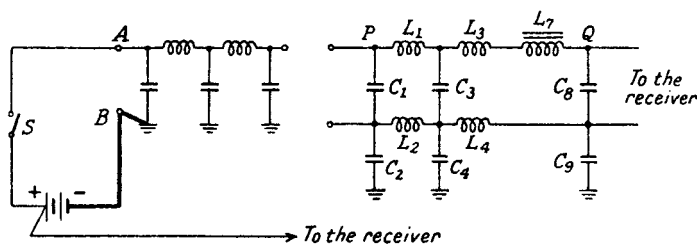

FIG. 231.

radio frequency currents between earth on the one side and plus and minus H.T. on the other side flow through C_2 . Remembering that the sum of two noise voltages is the square root of the sum of the squares (Chapter 6), the potential difference between P and earth in Fig. 231 is about $\sqrt{5}$ times that between the corresponding points in Fig. 230. Thus the p.d. between Q and earth is about 11 times larger than in Fig. 230. Usually this increase is not serious

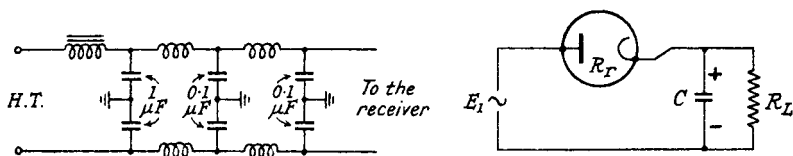

FIG. 232.

FIG. 233.

unless R.F. filtering is required down to fairly low frequencies. In such cases another method may be employed. This consists in inserting the audio frequency choke before the R.F. filters (Fig. 232). By-passing the grid-bias resistance with an electrolytic condenser of about $50 \mu\text{F}$ is always a great improvement.

D.C. Power from A.C. Supply. The basic principle involved in deriving D.C. from an A.C. source may be learned from Fig. 233. At first it is assumed that the resistance R_r of the rectifier valve is

negligibly small. In that case the condenser C is charged during the positive cycle of E_1 to peak value. During the negative cycle the valve is not conducting and C discharges through R_L until, during the next positive cycle, the instantaneous value of E_1 rises to the potential across C . Then a new current pulse through the valve again charges C to the peak value of E_1 . The voltage variation across C hence approximates to the curve shown in Fig. 234, the dotted line indicating the e.m.f. of the a.c. source. The action is identical with that of a diode as described in Chapter 4.

The output voltage therefore contains, beside the desired d.c. value, a large number of a.c. components, the lowest being the frequency of the source E_1 . The d.c. value is about half-way between the maximum and minimum voltage shown in Fig. 234, the amplitude of the fundamental frequency is approximately half that difference. The larger R_L or C is made, the higher is the

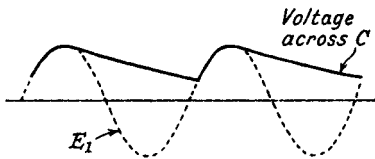

FIG. 234.

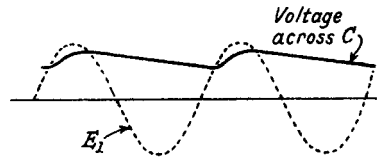

FIG. 235.

d.c. voltage and the smaller the a.c. components, until the d.c. value approaches the peak value of E_1 and the a.c. components disappear.

In practice this never takes place, as the resistance R_v of the rectifier valve is not negligible. Its finite value prevents the condenser C from being charged to the peak value of E_1 because of the voltage drop in the valve. Hence the potential difference across C varies with time as indicated in Fig. 235, the shape of the curve depending on R_v , C and R_L . For large values of R_L the rectifier valve is conducting only during a small part of the cycle. This fact strongly influences the regulation of the power supply, as can best be seen from the following simplifying assumption.

Let us assume that E_1 consists of periodical rectangular pulses of the value E_1 and that the rectifier valve is replaced by an ohmic resistance R_v . The condenser C in parallel with R_L is supposed to be so large that a pure d.c. current flows through R_L . If $\frac{\phi}{2\pi}$ is the fraction of each cycle during which the e.m.f. is active, the

D.C. voltage E_2 across C is derived by means of the following equation :

$$\frac{E_2 2\pi}{R_L} = \frac{E_1 - E_2}{R_r} \phi$$

$$\therefore E_2 = E_1 \frac{R_L}{R_L + R_r} \frac{2\pi}{\phi}$$

This shows that, from the point of view of D.C., the source is equivalent to an E.M.F. of value E_1 and an internal resistance $R_r \frac{2\pi}{\phi}$.

For a circuit as shown in Fig. 233 the fraction of the cycle during which the rectifier valve is conducting increases with increasing load current, so that the curves denoting the D.C. voltage across R_L as a function of I_L can be expected to have the greatest slope for the smallest I_L (compare Fig. 237).

The circuit Fig. 233 can be improved by using two rectifiers in order to utilise both half cycles of the source. Fig. 236 gives the

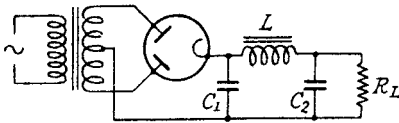

FIG. 236.

diagram of a *full-wave rectifier circuit with capacitance input*.

The two rectifiers are combined in one bulb, the cathode being common to both. The regulation is nearly twice as good as in the circuit Fig. 233, and the D.C. voltage is hence slightly higher. The A.C. ripple across C_1 is about half that for a half-wave rectifier, only half the time being left for the discharge of C_1 . The fundamental ripple frequency is twice that of the A.C. source, therefore it is much easier to obtain a smoothed D.C. voltage than in the case of the half-wave rectifier circuit Fig. 233. In the circuit Fig. 236 the ripple across C_2 will be one-eighth of what it would be if half-wave rectification were employed. Against this may be set the fact that many receivers, particularly communication receivers, have a response curve cutting off sharply below 100 c/s, so that for the usual A.C. supply of 50 c/s the circuit Fig. 236 may cause a larger and more troublesome output than the circuit Fig. 233, identical means of filtering being employed.

In Fig. 237 a series of continuous curves shows the D.C. voltage across C_1 as a function of the voltage of the A.C. source ; load current is the parameter so that the distance between the almost straight lines indicates the regulation. This distance decreases

with increasing load current, in accordance with the explanation given above. Taking the average value of regulation between the various lines, the effective D.C. resistance of the source of supply becomes

I_L in mA	R_{DO}
0-30	2,300 ohms
30-60	1,500 "
60-90	1,200 "
90-120	800 "

Taking the actual D.C. resistance of the rectifier valve as the ratio $\frac{E}{I}$ for an applied D.C. voltage E_1 , the resistance of the valve is found to be about 300 ohms for a current of 50 mA. The D.C. resistance is approximately proportional to $\frac{1}{\sqrt[3]{I}}$ as follows from the well-known relation $I = KE^{\frac{3}{2}}$. Increasing C_1 in Fig. 236 to

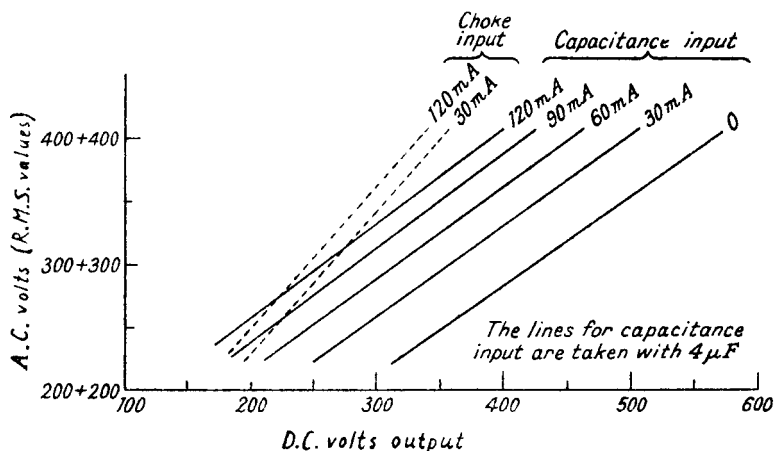

FIG. 237.

8 or 16 μF increases the D.C. voltage by about 30 volts and slightly improves the regulation. The D.C. voltage across C_2 is smaller than that across C_1 by the voltage drop across the choke L . The resistance of the usual chokes is of the order of a few hundred ohms and in determining the regulation of the circuit Fig. 236 this resistance must be taken into account.

The amplitude of the fundamental ripple frequency $2f$ across C_1 in Fig. 236 is expressed with sufficient accuracy by the formula

$$\text{R.M.S. voltage of fundamental ripple frequency} = \frac{150 I}{2fC},$$

where I is the D.C. current in mA, where f is the frequency of the A.C. source and C is expressed in μF . For a mains frequency of 50 c/s the formula becomes E_{Ripple} (in volts R.M.S.) = $\frac{1.5 I \text{ (in mA)}}{C \text{ (in } \mu\text{F)}}$

The ripple voltage of the second harmonic is one-tenth of that of the fundamental and can usually be neglected. The calculation of both D.C. and ripple voltage across C_2 is easy and may be seen from an example.

Example: The circuit Fig. 236 is to be designed so that a D.C. voltage of 300 V and a ripple voltage of 0.2 V is obtained at the output. The frequency of the A.C. supply is 50 c/s, the load current 100 mA, the choke available has an inductance $L = 20$ henries and a resistance of 300 ohms.

The voltage drop across the choke being 30 V, the D.C. voltage across C_1 must be 330 V. From Fig. 237 it follows that the correct A.C. voltage across the transformer secondary is $340 + 340$ V R.M.S., the capacitance of C_1 being 4 μF . The ripple voltage across C_1 is

$$\frac{150}{4} = 37.5 \text{ V R.M.S.}$$

The ripple voltage across C_2 becomes

$$\frac{37 \times \frac{1}{\omega C_2}}{\omega L - \frac{1}{\omega C_2}} = \frac{37}{\omega^2 L C_2 - 1}$$

Hence
$$\frac{37}{\omega^2 L C_2 - 1} = 0.2 \quad \therefore C_2 \simeq 23 \mu\text{F}.$$

It would naturally be more economical to choose both C_1 and C_2 about 10 μF , resulting in the same ripple across C_2 and a slightly increased D.C. output voltage.

Rectifier Circuit with Choke Input. The regulation, particularly for small load currents, can be considerably improved by using a circuit as shown in Fig. 238. Its action can be best understood by first assuming that the inductance of the choke is infinite. In this case no A.C. current can flow through the choke, i.e. a steady D.C. current flows through

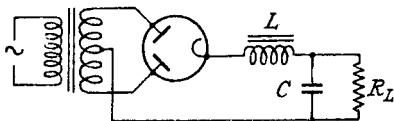

FIG. 238.

the rectifier, which, therefore, is conducting all the time. The regulation becomes that of a D.C. source having an internal resist-

ance equal to that of the rectifier valve for the load current concerned.

The D.C. voltage at the output is equal to the D.C. component of the E.M.F. minus the voltage drop in rectifier and choke. The form of the E.M.F. is a sine wave of which the negative cycle is reversed because of the alternating action of the two rectifiers. The D.C. component of such an E.M.F. is $\frac{E_{peak}}{\pi} \int_0^\pi \sin x dx = \frac{2}{\pi} E_{peak} = 0.9 E_{R.M.S.}$. Hence the D.C. voltage at the output is

$$0.9 E_{R.M.S.} - I(R_r + R_{choke}),$$

indicating the regulation mentioned above.

In actual fact a variable D.C. current will flow through the rectifier valve because of the finite value of the inductance. In order to obtain a continuous flow of current through the rectifier valve the maximum value of the A.C. currents must never be larger than the D.C. value. Neglecting all the harmonics and remembering that the amplitude of the fundamental is two-thirds of the D.C. component, the condition for a continuous flow of current is approximately $\frac{\omega L}{R_L} = \frac{2}{3}$, the rectifier resistance being neglected in comparison with the load resistance.

For a receiver taking a variable current from the supply, L has to be designed for the smallest current. For the usual cases an inductance of 10–20 henries will be found sufficient. In Fig. 237 the dotted lines give the approximate regulation with choke input, the choke resistance being neglected. For large load current the D.C. output voltage is nearly the same as that for capacitance input; but for small currents and high transformer voltages the capacitance input gives a much higher D.C. output, at the cost of very poor regulation. The effective rectifier resistance for choke input is of the order of a few hundred ohms, to which must be added the resistance of the choke or of two chokes if a second filter section is required. It is therefore essential to use chokes of small resistance if the advantage of the choke input circuit is to be fully utilised.

The ripple across C in Fig. 238 is calculated in the way shown for the capacitance input circuit, remembering that the A.C. component of the E.M.F. has a fundamental frequency equal to twice the frequency of the source and has an amplitude two-thirds that of the D.C. component or 0.6 of the R.M.S. value of the source.

The Swinging Choke. The regulation of the choke input can be made almost perfect by choosing the choke so that for

minimum current required the core of the choke is near saturation. In that case the inductance of the choke falls markedly with increasing load current so that the circuit becomes then practically a capacitance input circuit. The circuit requires a second choke-capacitance filter for the final smoothing, as will be readily understood. The output impedance of such power supply for ordinary A.C. currents from the receiver is the reactance of the terminating condenser, in the same way as for the preceding power supply circuits. Hence the possibility of coupling through the H.T. supply is not diminished though the D.C. regulation may be perfect. Only for couplings at a few cycles per second where the reactance of the output condenser becomes larger than that of the smoothing choke would perfect regulation remove, at the same time, the risk of supply coupling.

If a stage working in class B amplification is fed from the power supply, the current in the absence of a signal may be too small for the purpose of saturation. In that case a bleeder resistance is to be connected across the output of the power supply. Its value depends on the choke employed and the minimum receiver current.

Mercury-vapour rectifiers have a very low impedance and possess an almost constant voltage drop of 15 V for currents varying within wide limits. They must be used in connection with choke input as otherwise the heavy current pulses would lead to their destruction. Mercury-vapour rectifiers are apt to cause radio frequency disturbances (see Chapter 10) and must therefore be adequately screened. They prove in long use more delicate than high-vacuum rectifiers and are for these reasons rarely used in receivers. In power supplies for A.F. amplifiers and transmitters they are frequently used since radio frequency disturbances are not likely to prove harmful. The D.C. voltage derived from an A.C. source of R.M.S. value E with mercury-vapour rectifier and choke input is simply

$$0.9 E - 15 - IR_{choke}$$

The problem of hum, either from the filament or H.T. supply, is dealt with in Chapter 10. The filter circuits to be used for the H.T. depend on the receiver; their design is easy and has been shown in the preceding paragraphs. On the whole it may be said that the design of a power supply is the easier part of receiver work. It does not require great experience or deep knowledge of the principles involved; usually it is sufficient to study the data recommended in books.

CHAPTER 14

ROUTINE MEASUREMENTS

Several factors play an important part when measurements are to be carried out. They may be summed up as follows :

1. The measuring equipment available.
2. The accuracy required and the accuracy to be expected.

In this chapter a number of measurements are described, partly to point out the possibility of errors in the case of carelessness, partly because they have been found suitable in practice and may not be generally known. They are accurate enough for the majority of cases occurring in receiver development and testing and do not require any unusual equipment. No claim is made as to their being preferable to the many methods not mentioned here. The following apparatus is supposed to be available :

R.F. signal generator.

A.F. generator.

Receiver, well screened against direct pick-up and manually controlled (the screen necessary may be obtained by putting the receiver in a metal box).

Output meter.

Calibrated variable condenser.

List of Quantities to be Measured.

1. Inductance of an R.F. coil, capacitance of variable condensers.
2. Inductance of an A.F. coil, with or without D.C. saturation.
3. Q factor.
4. Coupling factor of coils.
5. Input impedance of valves.
6. Input ratio of receivers (transfer ratio from the aerial to the first grid).
7. Stage gain.
8. Very small capacitances.
9. Efficiency of filters.
10. Equivalent receiver noise.

Measurements like receiver sensitivity, selectivity, image protection, etc., are not treated here, being regarded as generally known. They are briefly discussed in the chapter on fault finding.

1. **Inductance Measurement of an R.F. Coil ; Comparing Coils and Condensers for Ganging Purposes.** The usual method, underlying many inductance measurements, employs a calibrated R.F. oscillator with a large output, a known capacitance and a valve voltmeter, and uses as indicator the resonant frequency of the known capacitance and the unknown inductance.

If such equipment is lacking, a signal generator in connection with a receiver may be used in a way shown in Fig. 239.

Receiver and signal generator are to be tuned to a frequency resulting in a convenient value of C . If C is above 500 pF, the self-capacitance of the coil can be neglected ; for smaller values of C two measurements should be carried out to eliminate the

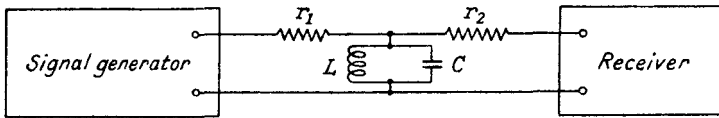

FIG. 239

influence of the coil capacitance. If C_1 and C_2 are two respective values of C , f_1 and f_2 the corresponding frequencies, C_x the coil capacitance and L the coil inductance, the relations are

$$\left(\frac{f_1}{f_2}\right)^2 = \frac{C_2 + C_x}{C_1 + C_x}, \quad f_1 \text{ being larger than } f_2.$$

Setting $\left(\frac{f_1}{f_2}\right)^2 = A$, there follows $C_x = \frac{C_2 - AC_1}{A - 1}$.

C_x , in this case, would be the self-capacitance of the coil plus the stray capacitance of the attached leads. The inductance L is best calculated from the smaller of the two frequencies, an error in C_x having less influence. Convenient formulae are

$$L = \frac{0.282\lambda^2}{C_2 + C_x}, \quad \text{or} \quad L = \frac{2.54 \times 10^4}{f^2(C_2 + C_x)},$$

where L is expressed in microhenries, C_2 and C_x in picofarads, f in megacycles/sec. and λ in metres. For the sake of accuracy $\frac{C_2}{C_1}$ should not be made less than 2 ; C_1 can be made zero, in which

case there follows $C_x = \frac{C_2}{A - 1}$. It will rarely be necessary to use a capacitance C so small that the influence of C_x need be con-

sidered. The accuracy obtainable depends on the calibration of the signal generator and the variable condenser rather than on the error in adjusting C (or the signal generator) to the resonant frequency. The latter is found best by adjusting to two positions giving an equal drop in output as compared with maximum output and taking the mean of the two. To avoid excessive damping of the tuned circuit and hence inaccuracy in adjustment, r_1 and r_2 are to be made at least five times as large as the impedance of the tuned circuit. With the present quality of equipment available the accuracy of measurement can be expected to lie between $\pm 1\%$ and $\pm 2\%$. If various coils are to be equalised for ganging purposes or to be compared as regards deviations from each other, the method is perfectly satisfactory, the result being as accurate as is needed in practice.

The ganging of variable condensers can be done in the same way, by connecting a coil of which the inductance need not be known across each of the condenser sections in turn and finding the resonant frequency as above. Care has to be taken that the leads from the coil to the condensers are short and of equal length in each case to avoid differences in stray capacitance or loop inductance, the latter being important when measuring with small coils. It has to be realised in any case that at frequencies above, say, 6 Mc/s the inductance of the loop connecting the variable condenser and the tuning coil plays an important part in the ganging and has to be taken into account.

2. Inductance Measurement of an A.F. Choke, with or without D.C. Saturation. The accuracy required is usually not more than $\pm 10\%$. If an audio frequency oscillator is available, a simple and quick way is shown in Fig. 240.

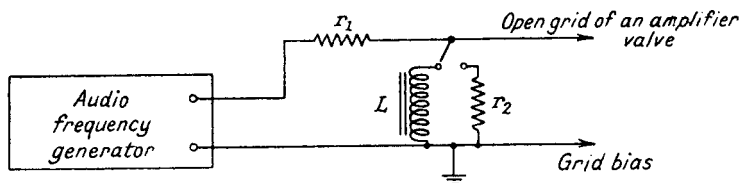

FIG. 240.

The resistances r_1 , r_2 and the measuring frequency are known and the latter adjusted so that there is equal output with either r_2 or L connected across the A.F. amplifier valve; from this L can be computed. As the accuracy of the measurement depends on the ratio of r_1 to ωL , a first test should be carried out to find the

approximate magnitude of L ; for the final measurement the following points should be observed :

1. Choose the measuring frequency so that the parallel capacitance of L does not affect the result.
2. Choose r_1 large compared with the reactance of L ($\ll 10\omega L$).
3. Choose r_2 so that the output is approximately the same with either L or r_2 , and finally adjust the frequency for identical output.

The practical aspects may be seen from the following example.

Example: A tentative test shows L to be of the order of several hundred henries. As the parallel capacitance of the choke can be expected to be about 100 pF, the resonant frequency of L lies between 500 and 1,000 c/s. A measuring frequency of 100 c/s is therefore fairly safe, the parallel capacitance of L only affecting the result by a few per cent. Course of the measurement :

First test. Choose $f = 100$ c/s, $r_1 = 5$ megohms, $r_2 = 0.5$ megohm. The output may be, for example, 0.5 watt with L and 0.7 watt with r_2 .

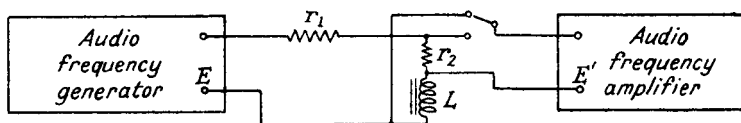

FIG. 241.

Second test. The frequency is slowly increased until the output is identical with either L or r_2 . For the example cited this may be supposed to happen at 120 c/s. As the current through r_1 is 10% higher with L than with r_2 (due to the phase relations L hardly affects the total impedance), it follows that

$$\omega L = 0.45 \text{ megohm}, \quad L = \frac{0.45 \times 10^6}{2\pi \times 120} = 596 \text{ henries.}$$

A difference of current with either L or r_2 does not arise if the test is carried out according to Fig. 241, where in the case of equal output follows immediately that $\omega L = r_2$. However, without knowing the circuit of the apparatus used, a certain risk arises because the two earth terminals E and E' are not at the same potential. If, for instance, E and E' happen to be connected to real earth through 5,000 pF, L is by-passed with 2,500 pF, which is certain to falsify the result. Even without such earthing condensers one has always to reckon with the capacitances between the two chassis and earth. The slight additional calculation required

for the method of Fig. 240 is more than offset by the lack of any such risk.

An input impedance of the A.F. amplifier comparable with ωL leads to a wrong result, in the same way as in Fig. 240.

As a check on the measurement Fig. 240 or as an alternative measurement the following method may be used, which is to be seen from Fig. 242; it is the equivalent of the method used for the R.F. coil. A known capacitance C is connected across L , and the generator frequency is adjusted to maximum output. It has to be ascertained that the maximum is due to the resonance of L and C , which may be done by taking the A.F. curve without C . To obtain a fairly sharp resonance curve r_1 and r_2 ought to be at least $20 \omega L$, and C should not be less than 5,000 pF in order to eliminate the influence of the coil capacitance.

If the resonant frequency with 5,000 pF becomes inconveniently low the test may be carried out with two smaller values of C , as was pointed out for the R.F. coil. In the above example the

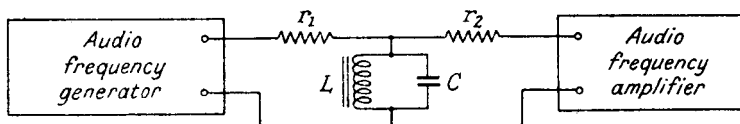

FIG. 242.

resonant frequency with 5,000 pF would be about 90 c/s, a quite feasible value, provided the response curve of the A.F. amplifier extends far enough. Values of 10 megohms for r_1 and r_2 are appropriate, adding about a total of 7% to the natural damping of the circuit.

If no audio frequency generator is available the preceding methods are still applicable, but the measurement becomes more laborious, the measuring frequency being obtained from the mains by means of a convenient transformer.

For the measurement in Fig. 240, various resistances have to be combined, in parallel and in series, to obtain a value of r_2 similar to ωL , and in computing L the difference in output has to be taken into account.

For the test Fig. 242 the resonance has to be found by changing C in steps, using various fixed condensers between, say, 100 and 5,000 pF.

Example: The previous choke, $L = 595$ henries, is to be measured, with the help of the A.C. mains. The method of Fig. 240, with values

of $r_1 = 10$ megohms and $r_2 = 0.2$ megohm, may result in an output of 0.4 watt with L and 0.47 watt with r_2 . Neglecting the 2% difference in current flowing through r_1 in the two cases gives

$$\omega L = 0.2 \times 10^6 \sqrt{\frac{0.4}{0.47}}, \quad L = 586 \text{ henries.}$$

Choke with D.C. Saturation. The D.C. current is best applied by means of a pentode, which is far more convenient than a normal ohmic resistance, as it has a high A.C. impedance without requiring

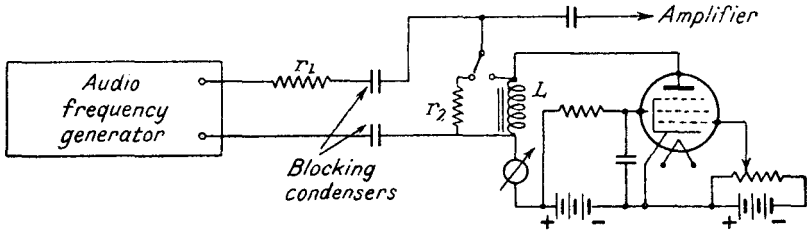

FIG. 243.

a correspondingly high D.C. voltage. The D.C. current desired will determine whether an R.F. or an A.F. output pentode is to be employed. As chokes designed for a high D.C. current usually have a small L , the impedance of the output pentode should prove high enough (Fig. 243). The valve impedance being known, its influence can be found by a simple calculation.

3. Q Measurement of R.F. Circuits. If a Q meter is not available, the Q may be measured as follows. The circuit is connected between the signal generator and the receiver input ter-

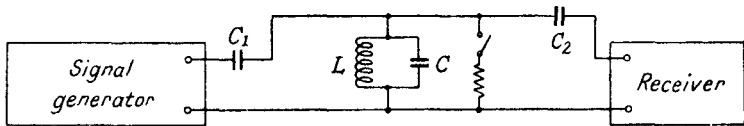

FIG. 244.

minals as shown in Fig. 244. The capacitances C_1 and C_2 are a few picofarads each to prevent additional damping from the signal generator or the receiver.

The voltage taken from the generator for a given output is determined :

1. With the circuit on test without additional damping,
2. With the circuit when a known damping is added.

The additional damping may be applied by means of parallel or series resistances, the former being more convenient.

If d is the natural circuit damping sought, d_1 the added damping, E and E_1 the respective input volts, it follows that

$$\frac{E_1}{E} = \frac{d+d_1}{d},$$

$$\therefore d = \frac{d_1}{\frac{E_1}{E} - 1}, \quad Q = \frac{1}{d}.$$

Example: $C = 200$ pF, $L = 37\mu\text{H}$, $f_0 = 1.85$ Mc/s.

Input with the circuit alone is $10 \mu\text{V}$.

Input with 10,000 ohms parallel resistance is $55 \mu\text{V}$.

$$d_1 = \frac{\omega_0 L}{R} = 4.3\%$$

$$d = 0.96\%, \quad Q = 104.$$

The real values of the additional resistances must be known for the test frequency; for this reason a chart is appended giving average values for present types, the deviations being covered by

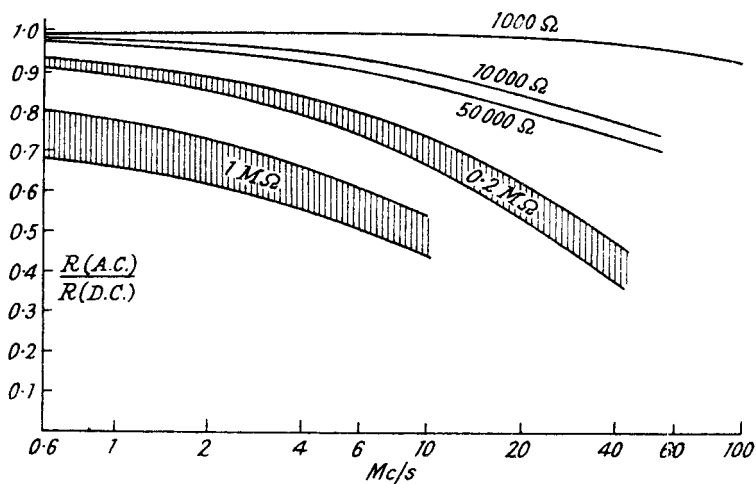

FIG. 245.

the shaded area (Fig. 245). The choice of an additional damping very much in excess of the natural damping (say, 10 times) is recommended. This makes the measurement more accurate and, at the same time, brings the R.F. value of the parallel resistor nearer its D.C. value.

The accuracy attainable is easily of the order of $\pm 10\%$, as the resistances can be measured with a simple voltage current test.

4. Coupling Factors of Coils and of Circuits. The method

to be recommended depends on the existing conditions and varies correspondingly.

A common method is to connect the two coils in series and to measure the total inductance, first with the mutual inductance adding and the second time subtracting. If the inductance of the two coils is L_1 and L_2 , the series combinations become :

$$\begin{aligned} L' &= L_1 + L_2 + 2M \\ L'' &= L_1 + L_2 - 2M. \end{aligned}$$

From these it follows that

$$M = k\sqrt{L_1L_2} = \frac{L' - L''}{4}$$

and

$$k = \frac{L' - L''}{4\sqrt{L_1L_2}}.$$

This fairly reliable method fails, however, if the percentage difference between L' and L'' is very small. This happens when the coupling factor between the coils is small, when one coil is much larger than the other, or when both conditions prevail. An example may be given :

Example: $L_1 = 100L_2$, and $k = 1\%$.

There is : $L' = L_1 + L_2 + 0.02\sqrt{L_1L_2} =$ approximately $101.2L_2$

$L'' = L_1 + L_2 - 0.02\sqrt{L_1L_2} =$ approximately $100.8L_2$.

The difference of 0.4% in L will often lie outside the accuracy of the apparatus employed. Furthermore, the method cannot be recommended for the measurement of coupling factors of the order of 1% , even if the coupling coils are of equal size, as disturbances due to undesired capacitive coupling do not show up (treated later). In any case the method is rather cumbersome, being based on four different measurements, viz. the knowledge of L_1 , L_2 , L' and L'' .

A simpler method, working satisfactorily for coupling factors larger than about 10% , is as follows. According to Chapter 1 an inductance L is decreased to $L(1 - k^2)$ by shorting the other coil, k being the coupling factor between them. If, therefore, the frequencies of the tuned circuit with and without coupling coil shorted are f_2 and f_1 ,

$$k = \sqrt{1 - \left(\frac{f_1}{f_2}\right)^2}$$

It is important for this test, especially if the two coils are widely different, to tune the larger coil, as otherwise when open circuited, the resonance of the large coil and its self-capacitance might falsify the result.

Another method, working equally well for large and small

coupling factors, may be seen from Fig. 246. With the help of a signal generator, a receiver and an output meter the input necessary for a given output is determined for the following three cases :

1. The signal generator is connected across A and B .
2. The signal generator is connected across L_1 , and L_2 connected across A and B .
3. The signal generator is connected across L_2 , and L_1 connected across A and B .

If the three corresponding inputs are E_1 , E_2 and E_3 , the relations are :

$$\frac{E_1}{E_2} = k \sqrt{\frac{L_2}{L_1}}, \quad \frac{E_1}{E_3} = k \sqrt{\frac{L_1}{L_2}}$$

Multiplying the two equations, it follows that

$$k = \frac{E_1}{\sqrt{E_2 E_3}}. \quad \left(\text{If } L_1 = L_2, \text{ then } E_2 = E_3 = E_0 \text{ and } k = \frac{E_1}{E_0} \right).$$

The result is correct only if L_1 and L_2 look into an infinite impedance when connected to the receiver, i.e. if the current through r is in each case proportional to the e.m.f. induced across

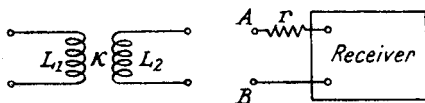

FIG. 246.

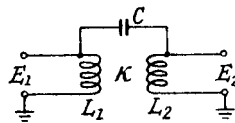

FIG. 247.

AB , and if the signal generator impedance is small* compared with the reactances of L_1 and L_2 . For this reason, r should be at least five times the impedance of the larger of the two coils. For small coupling factors there exists the danger of pick-up due to capacitance between the signal generator and the receiver input terminal. Its existence is ruled out if the input disappears on shorting A to B .

The accuracy may be expected to be of the order of $\pm 10\%$, depending on the calibration of the signal generator.

If k is about 1% or less, the case for tuned filter circuits, small capacitances between L_1 and L_2 may constitute an additional coupling comparable with the inductive coupling factor, increasing or decreasing it according to the winding sense. The influence of the capacitive coupling varies with frequency, as may be seen from

Fig. 247. Without C , the voltage E_2 becomes $\pm E_1 k \sqrt{\frac{L_2}{L_1}}$; C adds

* This is usually the case.

another voltage $E_2' = \frac{E_1 j\omega L_2}{j\omega L_2 + \frac{1}{j\omega C}} = -\omega^2 L_2 C E_1$, if ωL_2 is small

compared with $\frac{1}{\omega C}$ (as is usually the case).

Generally the effect shows up when the measurement is repeated with the connections of one coil reversed, the coupling factor being found to be different. This test may, however, be misleading due to capacitance between the earthed sides of the coils, or the live side of one coil and the earthed side of the other; both of these are harmless under normal conditions but might effect the result with one coil reversed.

For this reason it is better to carry out the above test, with the coils connected as in practical use, for two different frequencies the ratio of which is at least 1 : 2. If the coils are required for one spot frequency, one of the two measurements should be carried out

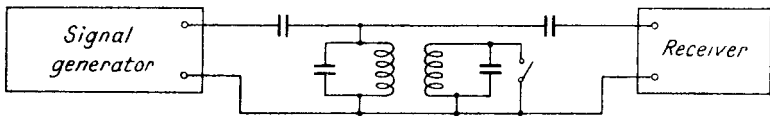

FIG. 248.

for this frequency, the other measurement for half the frequency. If the coils are designed for a frequency range, the two test frequencies may be near the two ends of the range required. The capacitive coupling varies in the ratio of 1 : 4 for a frequency change of 1 : 2, while the inductive coupling remains constant; hence the tests should prove conclusive.

When testing I.F. filter circuits it is of importance to know the coupling factor in terms of critical coupling rather than in absolute terms. A very convenient and quick way of obtaining this result is given in Fig. 248.

One coil, together with its tuning condenser, is connected across the input terminals of a receiver through a capacitance of a few picofarads, to avoid interaction with the receiver circuit, and coupled to a signal generator also through a capacitance of a few picofarads, to avoid additional damping from the signal generator. The input necessary for a given output is determined

1. With the other circuit shorted,
2. With the other circuit tuned to maximum absorption, i.e. for maximum input necessary for the same output.

If the two inputs are E_1 and E_2 , there follows from Chapter 1

$$\frac{k}{k_{crit.}} = \sqrt{\frac{E_2}{E_1} - 1}.$$

The same method can be employed to check the matching between an aerial and the aerial circuit and for other such cases. It does not, however, show whether the coupling is affected by unintended capacitance as described above.

5. Input Impedance of Valves. The input impedance of valves, the knowledge of which is of great importance on short waves, may be measured in a way similar to that given in Fig. 248.

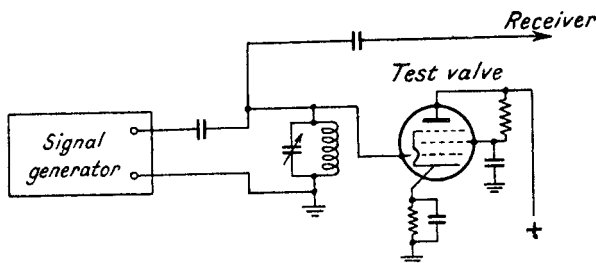

FIG. 249.

The circuit in Fig. 249 is tuned to the frequency for which the valve impedance is to be determined. The reactance and the circuit Q are supposed to be known, hence also the circuit impedance Z_0 which is equal to $\omega_0 LQ$. The coupling to the receiver and to the signal generator is so loose that additional dampings are ruled out.

The input necessary for a given output is measured when the test valve is, and is not, conducting, the circuit being tuned to maximum output in each case. If the input voltage necessary is E_1 with the test valve non-conducting and E_2 with the valve conducting, the relations are

$$\frac{E_1}{E_2} = \frac{Z_0 R}{(Z_0 + R) Z_0},$$

where R is the input impedance to be found,

$$\therefore R = Z_0 \frac{E_1}{E_2 - E_1}.*$$

Z_0 should be made as high as possible to obtain good accuracy.

* The input impedance of normal R.F. pentodes or mixer valves is between 10,000 and 20,000 ohms at 30 Mc/s, being inversely proportional to the square of the frequency. For acorn valves the values are approximately 10 times as large.

The advantage of the method is that the valve impedance is measured at amplitudes similar to those under working conditions. It has to be ascertained that the signal generator output is picked up by the receiver only through the tuned circuit and not directly, which can be proved by shorting the circuit and seeing that the output disappears. The method can be used to separate the damping effect of the test valve due to its electronic nature from that due to dielectric losses in the socket.

6. Transfer Ratio from the Aerial to the First Grid. The signal generator is to be connected first across the input terminals of the receiver of which the input ratio is to be measured, and then across grid and cathode of the input valve. (Carrying out the measurement for different positions of the manual control shows whether there is feedback in which the input circuit is involved.) The following points have to be watched :

1. When the signal generator is connected across the input terminals of the receiver, the signal generator impedance has to be

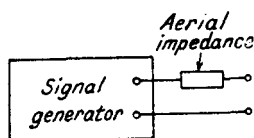

FIG. 250.

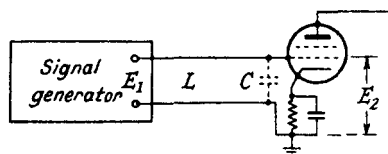

FIG. 251.

equal to the aerial impedance for which the receiver is designed (see Chapter 2). This is achieved by putting this impedance in series with the signal generator as shown in Fig. 250, which is permissible if the generator impedance can be neglected, as is usually the case.

2. Care has to be taken that the grid bias of the first valve is not shorted when applying the E.M.F. to the first valve directly, and in this case,

3. That the signal generator voltage is identical with the voltage delivered to the first grid ; this applies mainly when working on short waves.

The condition 3 is not fulfilled when the reactance of the valve capacitance is comparable with that of the inductance of the leads connecting the receiver and the signal generator.

Example (Fig. 251). Frequency 30 Mc/s, $C = 10$ pF, $L = 0.5 \mu\text{H}$, corresponding to about 1 m. of concentric cable of diameter 1 cm.

E_2 is approximately $1.22E_1$, resulting in a measured input ratio equal to 0.82 of the true value.

It is, therefore, recommended, when measuring at such high frequencies, that the connecting leads from the signal generator to the receiver be kept as short as possible. If the signal generator is fitted with an output cable of appreciable length, it is feasible to terminate it with a resistance small compared with the impedance of the input valve. The resistance, in its turn, is brought as near as possible to the receiver valve (Fig. 252).

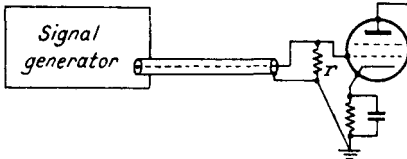

FIG. 252.

The added resistance alters the signal generator output, but does not harm the measurement which is based upon relative input values. To meet the danger of the relative calibration of the signal generator being affected by r , this resistance should be made about ten times as high as the terminating resistance of the generator. A value of 100 ohms for r is correct for most signal generators.

A similar difficulty may occur to an even greater extent when measuring the input ratio of an untuned loop (Chapter 2). The usual procedure is shown in Fig. 253. An E.M.F. is induced in the loop and the input valve connected in turn to AB and CD , the

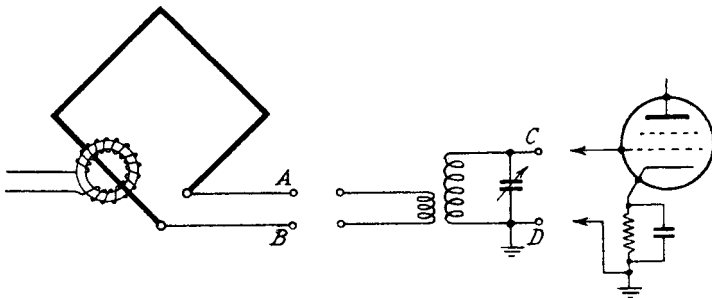

FIG. 253.

loop being connected with the input transformer in the latter case. The ratio of the two inputs necessary for a given output is the input ratio sought. The method fails when carried out at frequencies where the inductive reactance of the loop is comparable with the capacitive reactance of the loop plus the valve, for reasons just described. The difficulty can be avoided by changing the method of measurement. When using a toroid coil, as shown in Fig. 253, the voltage induced in the loop is very nearly $\frac{1}{n}$ of the generator

output, n being the number of turns of the toroid coil. Having ascertained this transfer ratio from the signal generator to the loop at lower frequencies, the following two tests are to be carried out :

1. The receiver valve is connected to the input circuit, the loop to the input transformer, and the toroid coil to the signal generator. If the generator output is E_1 for a given receiver output, then approximately $\frac{E_1}{n}$ is induced in the loop.

2. Connect the signal generator directly to the grid of the input valve. The generator output being E_2 for the same receiver output, the input ratio from the loop to the first grid is then $\frac{E_2 n}{E_1}$.

Errors due to unequal current distribution in the toroid coil can be made small by keeping the wire length below $\frac{\lambda}{10}$. On the other hand, the reactance of the coil must not be less than about five times the output resistance of the signal generator.

7. Stage Gain. Keeping in mind the points mentioned for the previous measurement, little difficulty should be found in determining the stage gain. If the value obtained is larger than is to be expected, feedback is indicated ; this is dealt with according to the directions given in Chapter 9. If the value obtained seems too low, various causes may be responsible (Chapter 15).

One peculiar difficulty may be encountered when measuring the stage gain from the grid of an R.F. valve to the mixer grid. As pointed out in Chapter 4, the conversion conductance of some types of mixer valves is decreased under certain conditions by the existence of the signal grid circuit. In that case the mixer valve works with reduced conversion conductance when the signal generator is connected to the grid of the preceding R.F. valve, and with normal conversion conductance when the signal generator is connected to the mixer grid. The stage gain measured is smaller than the actual stage gain, though the amplifier stage is working satisfactorily. (See page 303.)

8. Very Small Capacitances. The expression "very small capacitance" may indicate a capacitance between two points, which is of the same order as or smaller than the capacitances between the points and earth. It is obvious that in such a case the method indicated under 1 in this chapter fails, since the earth capacitances form a more or less deciding part of the total capacitance measured. The grid-anode capacitance of a pentode represents an extreme case,

the earth capacitances being about a thousand times as large as the capacitance to be found.

The following method, which may be understood from Fig. 254, is easy to carry out and has been found to yield reliable results. It requires, apart from a signal generator and a receiver, a known capacitance of, say, 1 pF. The receiver is connected to the signal generator either through the known capacitance or the capacitance to be measured. The input terminals of the receiver are connected through a capacitance of the order of 100 pF, which prevents the capacitance between *A* and earth from having any serious effect; capacitance from *B* to earth is harmless due to the low impedance of the signal generator. The input necessary for a given output

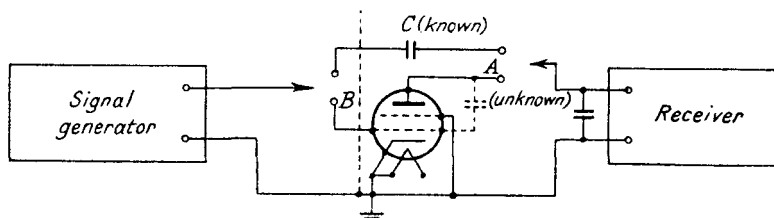

FIG. 254.

is inversely proportional to the inserted capacitance; therefore, if E_1 is the input voltage with the known capacitance C , and E_2 the input voltage with the unknown capacitance C_x , there follows

$$C_x = C \frac{E_1}{E_2}.$$

It has to be ascertained that there is no leakage transfer from the signal generator to the receiver which is proved to be the case if there is no output in the absence of inserted capacitance. Any frequency within the medium wave-band will prove satisfactory, and two different frequencies may be used as a check. The measurement of capacitances down to 10^{-3} pF has been found to present little difficulty, if some care is taken. If the input to the receiver proves too small, the input terminals of the receiver may be connected through a parallel tuned circuit of variable capacitance, the latter being adjusted to maximum output in each case.

9. Efficiency of Filters. Filters designed for noise suppression on motors, etc., can be tested as indicated in Fig. 255. The signal generator and the receiver are slowly tuned over the whole range required and the receiver is connected in turn to *A* and *B* through a small capacitance which prevents resonance of the filter

condensers with the receiver aerial coil. The difference in input necessary for a given output indicates directly the filter attenuation. It is of importance to make sure that the receiver pick-up is really due to the voltage across the filter condenser C_3 when the receiver aerial is connected to B ; this is done by shorting the condenser which should eliminate the input.* The precaution is necessary for the following reason. Due to the fact that the signal generator and the filter are not in the same box, there is generated between the two earth points E_1 and E_2 a voltage, causing a current via E_3 and E_4 through the earth capacitances of the signal generator and the receiver. This current produces an E.M.F. between E_3 and E_4 in series with that across C_3 . It is therefore important, if measurements are to be made at frequencies above, say, 10 Mc/s, to have the

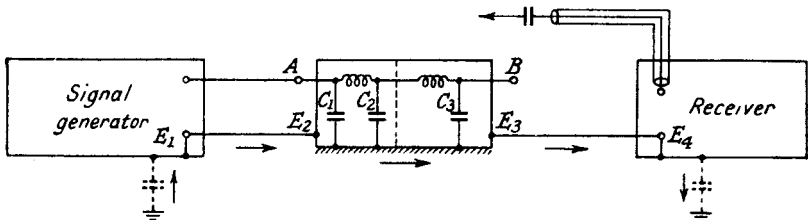

FIG. 255.

connections as short as possible between E_1 and E_2 and between E_3 and E_4 ; a common earth-plate is the safest way. The receiver aerial lead is screened to prevent capacitive coupling from the output leads of the signal generator.

10. Equivalent Receiver Noise. The equivalent receiver noise (E.R.N.) is usually expressed in terms of a 100% modulated input which, in the absence of noise, would produce the same output as does the noise in conjunction with the unmodulated carrier. The output from the modulated carrier being proportional to the modulation factor, the comparison test can be carried out with a modulation factor smaller than 100% and the figure obtained multiplied by the modulation factor.

Example: With a 100% modulated carrier the test gives equality between signal and noise for $0.5 \mu\text{V}$ input, showing an E.R.N. of $0.5 \mu\text{V}$. With a 20% modulated carrier, equality will exist for $2.5 \mu\text{V}$ input, resulting in an E.R.N. $2.5 \times 0.2 \mu\text{V} = 0.5 \mu\text{V}$, as before.

* Due attention must be paid to the possibility of resonance between the condenser and the shorting lead (Chapter 12).

Equality between signal and noise exists if the output consisting of signal and noise is reduced by 3 db. on removing the modulation (see Chapter 6 on addition of different noise outputs).

A fundamental difficulty often arises when trying to measure the E.R.N. In the case of receivers with a high input ratio from the aerial to the first grid, the input necessary to obtain equality between signal and noise may easily be below the smallest signal generator output available. The difficulty may be overcome in various ways.

1. By adding an attenuation section of, say, 1 : 10 between the signal generator and the receiver (Fig. 256).

2. By using a very small modulation factor.

3. By taking the measurement not for equality between signal and noise, but for a ratio of 10 or 20 db.

Method 1 may be carried out by shunting the signal generator with a series combination of 90 and 10 ohms. The impedance of the generator is usually about 8 ohms, so that the arrangement

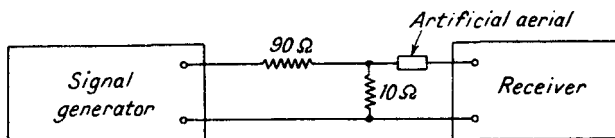

FIG. 256.

leaves the effective impedance of the generator substantially unchanged. The new calibration may be checked with larger output, where a comparison is possible between the outputs with and without the added resistances.

The method of adding an attenuation outside the signal generator may fail due to insufficient screening of the generator. To ascertain whether it is permissible, the 10 ohms should be shorted to see if the signal disappears.

Method 2 is quite convenient but requires a signal generator with variable modulation factor.

Method 3 may give a wrong answer if the receiver sensitivity is so high that a signal stronger than the receiver noise overloads the receiver output valve. This would necessitate reducing the receiver gain, which may result in degrading the ratio of signal to noise (see Chapter 7) and thus give an incorrect answer.

It is to be expected that one of the three methods will work satisfactorily. If this is not the case, the gain of one of the later I.F. stages may be decreased and then method 3 carried out.

CHAPTER 15

FAULT FINDING

Fault finding is a subject closely connected with various problems of radio design. For this reason special cases of fault finding have been discussed in previous chapters whenever occasion arose. In the following, a more general method of treatment is adopted and instructions are given to enable the reader to cope with all faults which are likely to occur in the course of his daily routine work.

The faults can be divided into those which cause the receiver to break down more or less completely and those which only impair the performance to a certain degree. It is the latter type which is the harder to find, as its effects are less obvious. The safest method in such cases is always to measure the receiver performance stage by stage and so to narrow the field of investigation. A number of practical examples will be discussed which should make the reader familiar with the methods to be adopted. First a list is given of the principal faults that may be expected in practice.

List of the most Frequent Faults.

Valves. Loss of emission, leakage between cathode and heater, contact between two electrodes.

The simplest way of proving that a suspected valve is at fault is the substitution of another valve. Before carrying it out, however, one should make sure that there are not causes which, having led to the destruction of the old valve, would also harm the new one. Such causes might be too high anode or filament voltage, the lack of grid bias resulting in too large an anode current, etc.

Resistances. Open circuit, short circuit, intermittent circuit (causing noisiness).

When the resistance is in an H.T. path, measuring the voltage at both sides reveals whether the resistance has approximately its correct value. Short circuit results in an equal voltage at both ends, open circuit in zero reading at one end. Measurements with an ohm-meter are equally conclusive. If an ohm-meter for high-resistance values is not available, a voltage-current test may be carried out. Resistances above 0.1 megohm may be measured with 100 volts without risk of burning them out. If a resistance is suspected of noisiness it is best replaced by another. Sometimes

the noise shows up when the resistance is tapped, but a negative result is not conclusive.

Fixed Condensers. Open circuit, short circuit, wrong capacitance value.

If open circuit is suspected, putting another condenser in parallel and watching the effect on the receiver is the simplest way. Short circuit can easily be proved with an ohm-meter. A capacitance value so far out as to cause trouble need only be reckoned with when the condenser contributes appreciably to the resonant frequency of a circuit, e.g. in the case of a padding condenser. A capacitance measurement is recommended for confirmation.

Condenser Trimmers. Short circuit, open circuit, wrong capacitance value.

On turning the adjusting screw of a trimmer the capacitance value does not always rise (or fall) continuously. Owing to

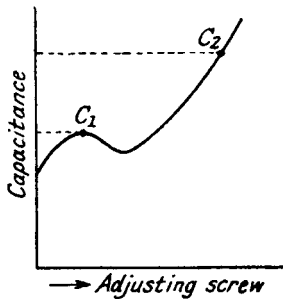

FIG. 257.

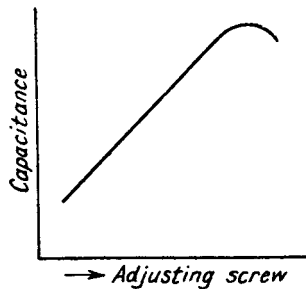

FIG. 258.

mechanical faults, such as a bent plate, the capacitance curve may have a shape as shown in Fig. 257. Let us assume now that the capacitance value required for resonance is C_2 . When the trimmer happens to be adjusted at minimum value and is tuned for maximum output, such a maximum is obtained at the capacitance value C_1 . Thus there is the risk of the trimmer being adjusted to C_1 , resulting in a loss of selectivity and gain. One should therefore always tune a trimmer through its whole capacitance range when ganging a receiver. There are also cases where such maximum or minimum of capacitance occurs at one end without the curve turning back again. The danger of a wrong adjustment is then even higher still. If a circuit is tuned with a trimmer of a characteristic as shown in Fig. 258 and the required capacitance is larger than the maximum value of the trimmer, one will almost certainly adjust the circuit to a wrong resonant frequency. An easy method

of ascertaining whether the adjustment is correct is by leaving the condenser at the position of maximum output and varying the coil.

Variable Condensers. Short circuit, wrong capacitance curve.

A shorting of plates usually occurs only at some positions of the condenser, the receiver becoming either dead or extremely noisy. An ohm-meter may be used for testing, the coil being disconnected from the condenser. A faulty capacitance curve which causes misganging is best detected by a comparative capacitance measurement as mentioned in Chapter 14.

Coils. Open circuit, shorted turns, excessive damping, wrong inductance.

Open circuit shows up on measuring the resistance of the coil; for discovering shorted turns an inductance measurement is the appropriate method. Excessive losses may be caused by dampness of the insulating material, by a layer of metallic dust, etc., which can be removed by cleaning or heating. When using *litzen-draht* a break of several strands is often responsible for a bad Q . In the latter case a resistance measurement is usually sufficient to reveal the fault. A coil may be adjusted to a wrong inductance value for the same reason as has been described for the capacitance trimmer. When, for instance, a coil with a movable iron-dust core is employed, the inductance is a maximum with the core in the middle of the coil. In a case where the inductance necessary for resonance is larger than the maximum value of the coil, moving the core through the middle position gives the impression of correct tuning and hence there is a risk of faulty adjustment. The possibility of such an error is avoided by providing an adequate stop to the movement of the iron core.

Switches. Bad contacts.

The result of bad switch contacts is either decreased sensitivity, owing to an increase in circuit damping, or noisiness. In extreme cases a complete open circuit may occur. For tracing a bad contact a gentle tapping or slight pressure at the points suspected is usually revealing. An increase in noise or a change in amplification is a clear indication that the contact on test is not reliable. A measurement of the contact resistance is another way of obtaining information. Modern multi-range switches, employing a rotating disc with two contacts in series, have a resistance between 0.005 and 0.01 ohm. The measurement of such small values is not quite simple but can be done with a Wheatstone meter bridge. Care is necessary as otherwise additional resistances in the wiring may be misleading.

Transformers. Open circuit, shorted turns.

Faults in transformers used for amplification affect the receiver performance so strongly that they are easy to locate, no special comments being necessary. A shorting of turns in the mains transformer causes excessive heat and low voltages. Open circuit in one-half of a transformer used for full-wave rectification causes lower H.T. voltage and frequently 50 c/s hum. The fault can be traced by inserting a D.C. ammeter at the two anodes of the rectifier.

Wiring. Open circuit, short circuit between two wires or between one wire and chassis.

Open circuit or a bad contact may be due to imperfect soldering. Shorting between two wires or between wire and chassis may be due to faulty insulation and is not infrequent. Such faults are usually easy to trace.

Intermittent Faults. The faults enumerated above sometimes exist only temporarily, in which case the difficulty of tracing them may be considerably increased. Careful handling is necessary to maintain the receiver in its faulty state. If the fault has disappeared one may make it come back by tapping various components, exerting pressure at different points of the chassis, etc.

An almost amusing incident may be reported from actual practice. A receiver was stated to be down in sensitivity and was therefore sent to the test department. There the receiver was measured, found up to requirements and sent back to the customer.

After four weeks' time the same complaint was raised and for the second time the receiver was found satisfactory and sent back again. Eventually, after a third complaint, an experienced service engineer was sent to investigate the receiver on the spot. He found the sensitivity very low and the tuning of one R.F. circuit hardly noticeable (Fig. 259). On touching the grid point of the circuit the receiver became normal, and, in order to continue the investigation, it was necessary to wait until the fault turned up again. Then it was found that the disappearance of the circuit resonance persisted after removing the valve and the grid bias. Touching the grid point of the circuit after some time had now no effect. The resonance returned, however, on shorting the block condenser C_0 , and disappeared when the short circuit was removed. The explanation of the fairly intricate effect is as follows :

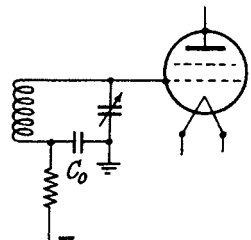

FIG. 259.

In the condenser C_0 which had a capacitance of $0.1 \mu\text{F}$, contact

between the tinfoil and the terminals was obtained by mechanical pressure. The surface of the tinfoil became oxidised and the condenser was almost open-circuited. On touching the grid with a finger the charge set up upon the condenser by the grid bias was removed. The discharging current through the human body was sufficient to cure the condenser for some weeks. Fortunately the usual faults are much easier to trace than this one.

In the following a number of examples are given, in order to show the procedure to be adopted. The receiver is represented by the skeleton circuit diagram, Fig. 260. Only one frequency range is shown for the sake of simplicity.

Example 1. The receiver gives no output. Touching the grid of V_5 produces no hum whatever. Anode voltage and anode current of V_5 are normal. Switching the receiver off does not produce the usual click in the loudspeaker. The following possibilities would be consistent with the facts :

- (a) Short circuit in the primary of the output transformer.
- (b) Short circuit or open circuit in the secondary of the output transformer.
- (c) A faulty loudspeaker.

If another loudspeaker is at hand its substitution will probably be the quickest way to settle the question whether loudspeaker or transformer is at fault.

Example 2. No output. No response when the grid of V_4 is touched, or when A.F. voltage is applied to the grid or to the anode of V_4 , but normal sensitivity for an A.F. voltage at the grid of V_5 .

Conclusion : Either C is open circuited or there is short circuit between the anode of V_4 and earth. In the latter case a voltmeter attached to the A.F. generator should measure zero output voltage. In any case a resistance measurement may be carried out. When measuring voltages at the anodes of valves it must be realised that a correct answer cannot be expected unless an electrostatic voltmeter or a valve voltmeter is used. The normal voltmeter consumes current and thus causes an additional voltage drop across the anode resistance. A good voltmeter has an ohmic resistance of 1,000 ohms per volt. If such instrument is used on a 300 or 500 V range, the measurement is good enough for most cases. If necessary, the instrument can easily be provided with a calibrated external series resistance which naturally decreases its sensitivity but increases the reliability under the conditions described. Measuring the anode current to derive the voltage drop across the anode resistance is another convenient method.

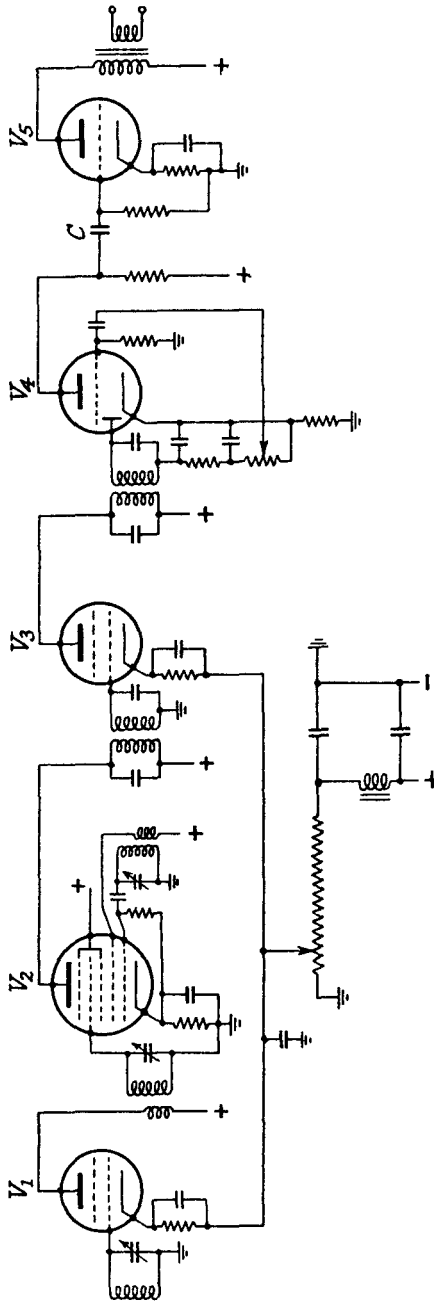

FIG. 260.

Example 3. Weak signals. Sensitivity at the grid of V_4 down by about 1:2. The stage gain from the grid of V_3 to the diode is approximately half the correct value; the same applies to the gain $V_2 - V_3$.

The fact that the gain of all stages measured is too small suggests that the supply is responsible. The anode voltages are higher, the total current smaller than normal. A fault in the heater supply is indicated and a measurement of the heater voltage proves it to be lower than required.

Example 4. No signals.

As usual, the sensitivity of the receiver is tested, starting from the grid of V_5 . The tests eventually show normal sensitivity when intermediate frequency voltage is applied to the grid of V_2 , but no output when radio frequency is applied. Evidently the oscillator does not work and the subsequent tests serve to find the cause. The voltage at the oscillator anode is measured first and found normal. Then the tuned circuit is measured with a Q meter.* The resonant frequency proves to be correct, but the Q is very low. Disconnecting the circuit from the grid-leak condenser restores the Q to its normal value. A faulty grid-leak resistance is indicated and the assumption may be proved by direct measurement of the resistance.

Example 5. No signals on the two higher-frequency ranges, normal sensitivity on all the other ranges.

Obviously the A.F. and I.F. part are satisfactory and the preliminary experiments need not be carried out. As in the preceding example, the oscillator is found to be at fault on the two ranges. The Q is again found to be small, particularly at the low-frequency end of the highest range. This fact suggests the presence of additional series resistance, as parallel resistance would have the opposite effect. Such series resistance might be caused by the contact fork of the variable condenser or by the range switch. The Q becomes normal on by-passing the switch with a short wire, which finally locates the fault.

Example 6. The stage gain from the grid of V_3 to the diode is found to be too low. The loss in gain may occur between grid and anode or between anode and diode. In the first case, a fault in the valve, in the supply or in the anode circuit is indicated; in the second case the coupling between the two circuits, the diode circuit or the diode resistance are the most probable sources. The generator voltage is applied first between grid and earth, then

* If not available, see the test given in Chapter 14.

between anode and earth of V_3 . The amplification grid-anode, which should be $g_m'Z_0 \frac{1}{1 + \left(\frac{k}{k_{crit.}}\right)^2}$ (see page 19), proves to be down

by the same factor as that from grid to diode. This suggests that the valve is not working satisfactorily. A convenient method of measuring the mutual conductance of the valve is carried out by placing 1,000 ohms in parallel with the anode circuit and measuring again the amplification grid anode. The resistance is small compared with the impedance of the I.F. circuit and the gain should be simply 1,000 g_m . The test shows that the mutual conductance is inadequate. Substituting another valve restores the correct stage gain.

Example 7. The range investigated is 1.2–3 Mc/s. The intermediate frequency is 120 Kc/s. The stage gain of V_1 is normal at 1.2 Mc/s but too low at 3 Mc/s. This proves the valve to be satisfactory. A Q -measurement at 3 Mc/s, both with a Q -meter and by measurement of the image protection (page 143), shows the circuit to be as required. For further information the signal generator is connected to the grid of V_2 through a capacitance $C_c = 5$ pF and the circuit retuned. The input ratio which should be $Q \frac{C_c}{C_{total}}$ proves to be down by the same factor as the stage gain.

The result suggests an effect which has been discussed on page 110. Hence the anode current of the mixer valve V_2 is measured with and without the detector circuit being shorted. The anode current is found to rise considerably when the circuit is shorted. This shows that the effect described is the cause of the apparently low stage gain. A neutralising condenser between the oscillator grid and the signal grid of V_2 should be sufficient cure.

Example 8. The receiver is on manual control. Immediately after interference from a very strong source, for instance from atmospheric noise, the sensitivity is low and recovers only slowly its normal value after 10–20 seconds. This effect is typical for an open grid. The strong interference causes a flow of grid current in the faulty valve, and a large grid bias is produced which leaks away slowly after the interference is gone. The fault can be located in various ways; watching the individual valve currents is reliable, though not always the shortest way. An open grid may be caused by a faulty grid resistance, a faulty transformer or a break in the lead.

Example 9. Intermittent noise over the whole of the frequency range.

Shorting the aerial makes no difference, nor does connecting the grid of V_1 to earth. Shorting the grid of V_2 greatly reduces the noise. The residual noise is not affected by shorting the grids of V_3 and V_4 . Shorting the grid of V_5 makes it almost inaudible. This behaviour shows that the noise does not originate in an individual stage but is likely to come from the supply. The receiver sensitivity is now reduced by the manual control and the aerial is connected through a condenser of a few pF capacitance to various leads under suspicion. The noise is strongest at the common H.T. lead, but markedly weaker at the rectifier. Intermittent contact in the H.T. path or high leakage resistance between H.T. and earth would account for the effect. The fault is likely to be between the A.F. choke and the receiver.

The method to be adopted depends on the circumstances and on personal taste. If the wiring and the components are accessible, the quickest way will be first to inspect the H.T. wire and to look for a faulty point, secondly to replace the components under suspicion by others. If the wiring is fairly inaccessible one may use an auxiliary receiver as described in Chapter 9. The aerial of the auxiliary receiver is connected to the common H.T. and picks up the noise. Subsequently the H.T. leads branching off to the various valves are disconnected, and in this way the field of investigation can be quickly narrowed down.

Further examples may be derived from Chapters 4, 7, 9, 10 and 11. They comprise faults in automatic tuning control and automatic volume control, receiver instability, hum, spurious beats and distortion. Ample use of an auxiliary receiver is made in Chapter 9, to which the reader is referred for information. On the whole the methods employed are always the same. Thus the reader should be able to find his way even when conditions differ widely from those discussed in this book. In conclusion, a suggestion may be put forward which has proved useful in practice.

Questionnaire.

It is often found that important points of receiver design are overlooked or forgotten and the designer is therefore recommended to use a questionnaire when the receiver development is approaching its end. Such a questionnaire is based on past experience and naturally varies with the occasion. In the following a list of questions is given as an example. The reader may extend it or pick out some special points according to his judgment.

1. Is there risk of short circuit between different wires or between a wire and chassis ?

2. Is there undue microphonic effect when the receiver is shaken ?

3. Is the calibration unchanged after frequent switching, shaking, etc. ?

4. Is the beat note steady ? (Carry out a vibration test.)

5. Is the receiver performance unchanged after heavy shaking ? Is the resonant frequency of the R.F. and I.F. circuits unaltered ?

6. Is the overlapping between the ranges sufficient to allow for the usual changes in condenser sweep ?

7. Is the receiver stable with increased H.T. ? How far is the receiver response affected by it ?

8. Is the receiver stable with 500–1,000 ohms in the common H.T. lead ? (The test applies to battery receivers, to allow for ageing of dry-batteries.)

9. Does the first oscillator squegg ? (Try different valves and vary H.T. and L.T.)

10. Does the receiver motor-boat with very strong input and correspondingly decreased gain ? (Try the receiver with manual and automatic volume control.)

11. Are response curves and image protection the same with low and high gain ?

12. Is there risk of feedback from loudspeaker or phones to aerial ? (Bring them close together and watch the effect.)

13. Is the response the same with and without A.V.C. ?

14. Is the receiver stable when tuned to a harmonic of the intermediate frequency. Are there whistles, either from feedback of the I.F. carrier or from the second oscillator ?

15. Are the oscillations of the local oscillators strong enough to allow for variations in valves, supplies, etc. ?

16. Is the second oscillator locked by a strong signal ?

17. Does the first oscillator produce a field outside the receiver, and is the receiver likely to be used under conditions where radiation is not permissible ? (Measure the oscillator voltage produced between aerial and earth and assume that one-tenth of this value may be induced in a neighbouring aerial within 10 m. distance.)

INDEX

- A**ceptor circuit, 14, 147
- Acorn valves, 229
- input impedance of, 289
- Acoustic feedback, 154, 216, 233
- Acoustic noise, 153-155
- Adjacent channel selectivity, 14, 131-142
- Admittance, 3
- Aerial,
- loop, *see* Loop aerial
 - reflected impedance of, 33-49
 - as capacitance, 33-36
 - as inductance, 44-49
 - as series combination of capacitance and inductance, 34-39
 - screening of, 200-205
 - several receivers on one, 36, 38
 - transfer of energy from, 31-49, 290-292
 - constancy of, 36-38
 - ganging considerations in, 33-44
 - on medium and long waves, 33-38
 - on short waves, 39-41
 - measurement of, 290-292
 - noise considerations in, 33, 39, 160-161
 - theoretical optimum of, 31-33
 - through capacitive coupling, 33-36
 - through capacitive potentiometer, 39-41
 - through feeder, 41-44, 163, 200-202
 - through inductive coupling, 34-39, 41
 - through mixed capacitive and inductive coupling, 34-41
- Alignment, *see* Ganging problems
- Amplifier stage, 27-30, 50-97
- power, 78-97
 - class A, 79-91
 - class AB, 95-96
 - class B, 91-95
 - pentode, 87-90, 96-97
 - neg. feedback in, 97
 - push-pull, 90-96
 - voltage, 50-78
- Amplifier stage, voltage,
- audio frequency, 50-60
 - choke coupled, 57
 - negative feedback in, 55-57, 64-65, 214-215
 - resistance coupled, 50-58
 - resistance coupled, with grid choke, 62-63
 - transformer coupled, 58-60
 - radio frequency, 27-30, 66-78
 - resistance or choke coupled, 66
 - tuned transformer coupled, 27-30, 66-78
 - constant stage gain in, 72-76
 - influence of circuit Q in, 76-78
 - measurement of stage gain of, 292
 - mistuning influence of
 - primary in, 69-72, 75
 - with two coupled circuits in anode, 27-30, 78
 - untuned transformer coupled, 66
 - wide band, 60-62
- Amplitude distortion, *see* Distortion
- Anode bend detection, 105-106
- Anode dissipation, 81-86, 89, 93
- Anode efficiency, 80-83, 85-87, 89-93
- Anti-resonance, 13-14, 137, 143-147
- Asymmetry of resonance curve, 8-10, 27-30, 240
- Automatic frequency control, 122-128
- Automatic gain control (A.V.C.), 175-182, 253-254
- choice of time constant in, 180-181
- Automatic tuning control, 122-128
- Auto-transformer, *see* Transformer
- Auxiliary receiver, use of,
- in finding source of distortion, 263
 - in finding source of feedback, 234, 237-239
 - in finding source of hum, 246
 - in finding source of noise, 304
 - in finding source of spurious beats, 248, 251-252

INDEX

- B**and-pass filter, 22-30, 78, 133
 for variable band-width, 137-142
 Band-switching, of oscillator, 115
 Beat frequency oscillator, 128-129, 182
 Bleeder resistance, 278
 Buffer stage, 257-258
- C**apacitance, of choke coils, 198-199
 Capacitive coupling, between inductively coupled coils, 78, 141, 287-288
 Capacitive reactance, 1-2
 Cathode follower, 257-258
 Chassis, acting as receiver earth, 186
 Choke coils, for filters, 198-200
 for R.F. amplifier stage, 67-68
 Class A, AB, B-amplification, *see* Amplifier stage
 Coefficient of coupling, measurement of, 285-289
 Condensers, inductance of, 197-198
 Constant band-width, in straight receiver, 132-133
 in superhet, 133
 Constant stage gain, 72-76, 132-133
 in straight receiver, 132-133
 Conversion conductance, 107-108, 110
 Coupled circuits, 22-30
 asymmetry in response of, 28-29
 Coupling, between first oscillator and detector circuit, 110-113
 Coupling condenser, in resistance coupled stage, 54
 Coupling, undesired, *see* Feedback
 Critical coupling, 25
 Cross-modulation, 148-151, 167, 174-175
 influence of, on choice of gain control, 174-175
 Cross-talk, 270
 Crystal, for variable band-width, 134-137
 Cumulative grid detection, 103-105
- D**amping factor, of circuits, *see* Q -factor
 D.C. amplifier, 63-64
 Delay voltage, in A.V.C., 175-179
- Depth of penetration, of R.F. current, 190
 Detection, 98-106, 259-263
 anode bend, 105-106
 diode, 98-103
 distortion in, 102, 259-263
 power absorbed in, 99-100
 of frequency modulated carrier, 128
 grid, 103-105
 Diode, *see* Detection
 Directional reception, phase in, 12-13
 Distortion, 253-263
 amplitude, 255-263
 due to anode bend detection, 105
 due to delayed A.V.C., 262-263
 due to diode, 101-102, 259-263
 due to grid current, 93-94, 256-258
 due to grid detection, 103-104
 due to loudspeaker, 263
 due to parasitic oscillation, 259
 due to transformer, 259
 due to valve characteristic, 84-92, 256, 258-259
 influence of negative feedback on, 96-97
 methods of finding, 263
 frequency, 253-255; *see also* Frequency response curve
 methods of tracing, 254-255
 phase, 62, 255
 Dynamic mutual conductance. 68
- E**arth connection of chassis, influence of, 186
 Eddy currents, in R.F. coils, 70
 Electron-coupled oscillator, 129
 Electrostatic screening, 183-187
 Energy transfer,
 from aerial, *see* Aerial
 from resistance to resistance, 17-19
 from resistance to tuned circuit, 19-22
 from tuned circuit to tuned circuit, 22-30
 Equivalent circuit of transformer, *see* Transformer
 Equivalent circuit of valve, 51
 Equivalent receiver noise, measurement of, 294-295

INDEX

- F**ault finding, 296-305
 of audio frequency feedback, 216-219
 in automatic gain control, 176-178
 in automatic tuning control, 125-126
 in components, 296-299
 of distortion, 254-255, 263
 examples of, 300-304
 of hum, 245-246
 of intermittent troubles, 299-300
 of R.F. or mixed R.F. and A.F. feedback, 233-240
 of spurious beats, 251-252
- Feedback**,
 negative, in A.F. amplifier stage, 55-57, 64-65, 214-215
 in output pentode, 96-97
 undesired, 206-240
 at audio frequencies, 207-219
 due to acoustic influence, 216
 due to capacitance inside valve, 60, 209-210
 due to capacitance outside valve, 208-209
 due to impedance in common path, 212-214, 269-270
 due to inductive coupling between transformers, 211-212
 due to mixed capacitive and common impedance coupling, 215-216
 methods of finding, 216-219
 at radio frequencies, 219-240, 246-252
 due to A.F. amplifier, 229-230
 due to capacitance inside valve, 219-221, 228-229
 due to capacitance outside valve, 222
 due to harmonics of intermediate frequency, 230-231, 246-247
 due to impedance in common path, 224-226
 due to inductive coupling, 222-223
 due to metal spindles, 225-227
 due to mixed capacitive and common impedance coupling, 226-229
 due to supplies, 231
 due to unearthened leads, 223
 due to untuned loops, 223-224
 methods of finding, 233-240
- Feedback**, undesired, at radio frequencies and audio frequencies simultaneously, 67, 167, 231-233
 due to amplitude modulation of the received carrier, 232-233
 due to frequency modulation of the first oscillator, 233
 threshold howl from, 231-232
- Feeder**, between aerial and receiver, 41-44, 48, 163, 200-202
- Filament coupling**, 227-228, 239, 248-249
- Filter components**, 197-200
- Filters**, for radio frequency, 192-196
 measurement of efficiency of, 293-294
- Foster-Seeley circuit**, 126-128
- Frequency constancy**, of oscillator, 121-128
- Frequency conversion**, 106-113
 with heptode, 110-113
 with hexode, 111-113
 with pentode, 107-109
- Frequency distortion**, *see* Distortion
- Frequency modulation**, 128
- Frequency response curve**,
 of choke coupled A.F. stage, 57
 of choke loaded resistance coupled stage, 61-62
 of resistance coupled A.F. stage, 52-57
 of resistance coupled stage with grid choke, 62-63
 of transformer coupled A.F. stage, 59
 of tuned R.F. circuit, 7-10, 26
 of two coupled circuits, 26-30
- Full wave rectifier circuit**,
 with capacitance input, 274-276
 with choke input, 275-278
- G**ain control, 165-182
 automatic, 175-182, 253-254, 305
 change of common H.T. with, 173-174
 distortion from poorly designed, 168-169, 180
 manual, 165-175
 mistuning of R.F. circuits with, 171-173

- Gain control, signal to noise ratio affected by, 169-171
- Ganging problems,
in circuits coupled to aerial, 33-41, 44-49
in circuits coupled to feeder, 41-44
in detector circuit, 112-113
in oscillator circuit, 113-117
- Goniometer, constancy of search coil inductance with rotation, 17
- Grid bias, change of, for gain control, *see* Gain control
- Grid-cathode capacitance, change of, 171-173
- Grid current, distortion caused by, 93-94, 256-258
providing bias in oscillator, 119
- Grid detection, 103-105
- Grid leak resistance, magnitude of, 54, 104
- H**eterodyne detection, 128-129
- Heptode mixer valve, 110-113
- Hexode mixer valve, 111-113
- Hum,
from A.F. action, 58, 241-244, 271-272
from combined A.F. and R.F. action, 244-246
methods of finding source of, 245-246
- I**mage frequency, 142-146
- Image suppression circuits, 143-146
- Impedance of parallel tuned circuit, 9-10
- Impedances, in parallel and in series, 3-5
equivalence of series and parallel combination of, 4-5
- Inductance, of fixed condenser, 197
of short cable, 290-291
- Inductances, in parallel, 265
- Inductive reactance, 1-2
- Input impedance, of valve, 210, 289-290
- Input ratio, from aerial to first grid, 34-37, 39-40
constancy of, 36-39
measurement of, 290-292
- Interference,
from near-by transmitter, 150-152
from other stations, 130-150
from outside noise, 163-164, 169, 200-205
- K**ey clicks, 151
- L**eakage inductance, in transformer, *see* Transformer
- Leakage resistance, cathode-heater, 244
of coupling condenser in A.F. amplifier stage, 54
- Load-line, 84-90, 94-95
of diodes, 101-102
- Locking, of oscillator, 129
- Loop aerial, comparison between tuned and untuned, 48
influence of capacitance in untuned, 48-49
influence of long connecting leads in untuned, 48
sharpness of bearing with, 161-163
- Loudspeaker resonances, 96, 263
- M**agnetic screening, 187-191
- Magnification factor of circuit, 6, 74-78
- Matching,
of aerial to first circuit, 39-41
of resistance to tuned circuit, 19-22
of two resistances, 17-19
of two tuned circuits, 22-30
- Measurements, routine, 279-295
of coefficient of coupling, 285-289
of efficiency of filters, 293-294
of equivalent receiver noise, 294-295
of ganged condensers, 281
of inductance of A.F. choke, with and without D.C. saturation, 281-284
of inductance of R.F. coil, 280-281
of input impedance of valve, 289-290
of *Q*-factor, 284-285
of stage gain, 292

INDEX

- Measurements of transfer ratio
 aerial—first grid, 290–292
 of very small capacitances, 292–293
- Mechanical stability of circuits, 121, 132, 305
- Mercury vapour rectifier, 278
 hum from, 245–246
- Metal oxide rectifier, 102–103
- Microphonic effects, 153–155
- Miller effect, *see* Feedback, through capacitance inside valve
- Mismatching, 17–21
- Mixer valves, 107–113
- Modulation hum, 244–246
- Motor-boating, 230, 239
- Mutual inductance, measurement of, 285–289
- N**egative feedback, *see* Feedback
- Noise, receiver, 153–164
 acoustic, 153–155
 from bad contacts, etc., 155, 175, 303–304
 influence of, on choice of aerial coupling, 33, 35, 39, 160–161
 influence of, on design of gain control, 169–171
 influence of, on sharpness of bearing, 161–163
 measurement of, 178, 180, 294–295
 shot, 155–158, 169–171
 site, 163–164, 169
 suppression circuits, 163–164
 thermal agitation, 158–161, 169–171
- O**scillator,
 beat frequency, 128–129, 182
 design of, 119
 effect of reaction coil on frequency of, 118
 electron-coupled, 129
 frequency constancy of, 121–128
 ganging of, 113–117
 squegging of, 119–121
 stable oscillation in, 117–121
- P**adding condenser, 38, 114–117
- Parasitic oscillations, 109, 264–266
- Parasitic resonances,
 of chokes, 68, 199, 267
 of chokes in series, 267
 of circuits connected to valve, 230–231
 of condensers in parallel, 268
 of condensers with supply leads, 268, 271
 of idle coils, 117, 266–267
- Phase relations between voltages and currents, 1, 3–4, 9, 11–13
- Phase shift, in oscillator, 120–121
 in wide band amplifier, 62
- Power amplifier, *see* Amplifier stage
- Power grid detection, 104–105
- Power supply, 269–278
 from A.C. source, 272–278
 from dry batteries, 270
 from rotary converter, vibrator, etc., 270–272
 from wet batteries, 269–270
- Q**-factor, of circuits, 6, 74–78
 definition of, 6, 11
 of circuit in anode of valve, 70–71
 of more complicated circuit, 10–11
 variation of, 133–137
- R**eactance, 1–2
- Receiver noise, *see* Noise
- Reception, in vicinity of strong transmitter, 150–152
- Rectifier circuits,
 for demodulation, *see* Detection
 for power supply, 272–278
- Reflected impedances, 15, 33–49, 67, 70–71, 75
- Regeneration, use of, 133–134
- Regulation curve, of A.C. power supply, 273–278
- Rejector circuit, 14, 146–147
- Resonance, series and parallel, 5–10
- Resonance curve, of tuned circuit, 7–10, 26
 of two coupled circuits, 22–30, 139–141
- Resonant frequency, 5–10
- R.F. resistance, of normal fixed resistors, 285

- Ripple, in power supply, 272-278;
see also Hum
- Rotary converter, for power supply,
270-272
- Round-Travis circuit, 123-126
- Routine measurements, 287-295; *see also* Measurements
- S**creen grid voltage, change of, for
gain control, 166, 169
- Screening,
of aerials, 200-205
electrostatic, 183-187
filter components for, 197-200
influence of leads on, 191-196
losses caused by, 190-191
magnetic, 187-191
of motor, 195-196
principles of, 183-205
of receiver from near-by trans-
mitter, 150-151
- Second channel interference, 142-146
- Selectivity, 130-152
adjacent channel, 131-142
effect of cross modulation on,
148-150
effect of near-by transmitter on,
150-152
effect of spurious responses on,
142-148
- Self-capacitance, of filter coils, 198-
199
- Sharpness of bearing, of D.F. receiver,
161-163
- Shielding, *see* Screening
- Shot noise, 155-162, 169-171
- Signal handling capacity, 168
- Signal to noise ratio, 156-163
influence of, on choice of aerial
coupling, 33, 35, 39, 160-161
influence of, on design of gain
control, 169-171
influence of, on sharpness of bear-
ing, 161-163
measurement of, 178, 180, 294-295
- Site noise, 163-164
- Skin effect, *see* Depth of penetration
- S-meter, 36
- Spurious beats, 246-251
method of tracing source of,
251-252
- Spurious responses, 38, 142-148
- Squegging, 119-121
- Stability,
mechanical, of circuits, 121, 132,
305
of oscillation, 117-121
- Stabilovolt, 233
- Stage gain, *see* Amplifier stage
- Staggered tuning, 24, 137-139
- Static screen, 184-187, 201-202
- Stay noise, 151-152
- Superhet receiver, advantages and
disadvantages of, 106-107
- Swinging choke, 277-278
- T**hermal agitation noise, 158-161,
169-171
- Thevenin's theorem, 14-15
- Threshold howl, 231-232
- Transformer,
audio frequency, 58-60
auto-, 20-21,
in aerial coupling, 34-36, 39-41
in R.F. amplifier stage, 67-68
equivalent circuit of, 15-17, 22-23
in aerial coupling, 36-49
in A.F. amplifier stage, 58-60
in R.F. amplifier stage, 68-74
leakage inductance in, 15-16, 34,
36, 42-49, 59, 69-74
tuned radio frequency, 66-78
untuned radio frequency, 66
- Tuning correction, for aerial circuit,
39
- Two-signal test, 149
- U**ndesired feedback, 206-240; *see also* Feedback
- V**ariable band-width,
by crystal, 134-137
by regeneration, 134
by staggered tuning, 137-139
by variation of coupling, 139-142
by variation of Q -factor, 133
- Variation of coupling factor, 139-142
- Vibrator, for power supply, 270-272
- Voltmeter, for measuring D.C. at
anode, 300
- Volume control, audio frequency, 179
- W**ide band amplifier, 60-62, 139