

RADIO
for
EVERYBODY
by
AUSTIN C. LESCOUBOURA



SCIENTIFIC AMERICAN PUBLISHING CO

RADIO *for* EVERYBODY

*Being a popular guide to practical radio-
phone reception and transmission and to the
dot-and-dash reception and transmission
of the radio telegraph, for the layman
who wants to apply radio for his pleasure
and profit without going in'o the special
theories and the intricacies of the art.*

By AUSTIN C. LESCARBOURA
Managing Editor, Scientific American

SCIENTIFIC AMERICAN PUBLISHING COMPANY
MUNN & COMPANY
NEW YORK
1922

Copyright 1922
By
SCIENTIFIC AMERICAN PUBLISHING Co.

All Rights Reserved

The right of translation into all languages,
including the Scandinavian, is reserved.

Printed in the United States of America
by the Andrew H. Kellogg Co., New York

PREFACE

CLOTHES and books — good clothes and good books, to be sure — have something very much in common. Both must be made to fit a very definite type of person in order to prove satisfactory. So, in building or making a suit or a book for a given type of person, it is necessary first of all to study that type, take all the necessary measurements, learn what the likes and dislikes happen to be, and in every way study the type to be fitted. Then, with all these special facts in hand, there remains the task of building or making a suit or book to fit the type we have selected or the type that has selected us.

This work is not a ready-made product; at least, that is not the way I have gone about putting it together. I spent some time studying the reaction of the general public to radio, following the inauguration of the first radio-phone broadcasting stations. I installed a radio-phone

receiving set in order to study this new art and its practical application at first hand. Indeed, the manuscript for this book was written on the very table on which I have my radio receiving set; and as urgent as this work has been in order to have it appear within the shortest possible time to be of greatest service to the public, I am free to confess that I have been unable to resist the temptation of donning the head 'phones and listening in on the radio-phone concerts at odd moments. So the work, you can rest assured, has been inspired by actual contact with the new art and with the persons seeking to gain a practical knowledge of this new art. The hundreds and thousands of inquiries which have found their way to the editorial rooms of the SCIENTIFIC AMERICAN alone, not to speak of conversations with persons met in and out of business, have been an invaluable guide in planning this work to fit the new radio layman.

Radio-phone broadcasting has changed the aspects of radio. A year or more ago, radio appealed to the boy and young man in search of some intricate, mysterious, time-consuming hobby in which to invest spare moments and inventive ability. These radio amateurs, as they are called, care more for the construction and

wiring and theoretical functioning of their receiving and transmitting equipment than they do for the actual signals they handle. They look upon radio as an engineering study. The radio-phone music and dot-dash messages are, in many instances, purely incidental.

But our present radio-phone concerts have brought a new element into radio. What with talks by prominent men, weather forecasts, crop and market reports for farmers, bed-time stories for children, shipping news, fashion talks, health chats, musical selections and other features which can now be received every day and evening right in the home, radio has become a means to an end. That end is the entertainment and educational value of the radio-phone broadcasting service. And the public is becoming more and more interested in that end, and with radio only so far as it is necessary in order to secure the radio-phone service.

However that may be, the radio-phone service is a radio proposition. It calls for radio apparatus and some knowledge of radio communication as a whole, just as the owner of an automobile should have a general knowledge of the mechanism of the automobile, even though it is not necessary to delve deeply into the minute

construction of his machine and into the expansive field of automotive engineering. What is required is practical and helpful information about the mechanism with which the desired results are obtained.

This work has been written with that very thought in mind. It has been built or made for the layman who wants to enjoy radio-phone concerts and talks and bulletins to the utmost, but does not want to take up time and trouble studying the intricacies of radio engineering. It aims to give the essential information without the theory and mathematics. It has much of interest to the beginner who is going to build or buy a radio set; it can teach not a few things to the radio devotee who possesses a radio receiving set and wants to learn more about his set and better sets; it may possibly have something of interest for the radio amateur who has progressed pretty far along in the art, although I am frank to say that for the dyed-in-the-wool radio amateur and the radio engineer, this book is no doubt too elementary.

I take this opportunity of thanking the radio fraternity as a whole for its co-operation. More particularly, I wish to thank Mr. Pierre H. Boucheron for going over the more technical

parts of this book; the General Radio Company, the Westinghouse Electric and Manufacturing Company, the Radio Corporation of America, the Pacent Electric Company, and C. Brandes, Inc., for their practical co-operation in enabling me to obtain much of the following data at first hand.

In reading the following pages of this little book you will, I hope, obtain as much pleasure from its practical application as I have had in gathering the material together and writing it for you.

THE AUTHOR.

New York,
April 10th, 1922.

CONTENTS

CHAPTER I.	
THE ELEMENTS OF RADIO RECEPTION AND TRANSMISSION	1
CHAPTER II.	
RADIO-PHONE BROADCASTING—WHAT IT IS AND WHAT IT MEANS	39
CHAPTER III.	
DOT-AND-DASH BROADCASTING: FROM MARKET NEWS TO TIME SIGNALS	73
CHAPTER IV.	
RECEIVING EQUIPMENT AND THE INTERCEPTION OF RADIO WAVES	93
CHAPTER V.	
OPERATING THE RADIO RECEIVING SET AND MASTERING THE TELEGRAPH CODE	143
CHAPTER VI.	
MAKING BIG SOUNDS OUT OF LITTLE ONES, OR THE GENTLE ART OF AMPLIFYING	177
CHAPTER VII.	
TRANSMITTING THE DOT AND DASHES OF THE DAMPED RADIO TELEGRAPH	205

persons no doubt care more about the arrangement and delicate manipulation of the components of their receiving sets than they do about the kind of messages that are picked up. Listening to a radio-phone service, they are thinking all the while in terms of decrement and modulation and continuous wave transmitters, and in many instances they do not even know what has been said or played at the end of the performance! Their's is a real interest in radio for the art's sake, but they are decidedly in the minority.

Today, be it remembered, the radio-phone service belongs to everybody. It is intended for the public at large. And by the same token that branch of radio activity for which it stands must be kept devoid of technicalities as far as possible if it is to expand and gain still further favor. Devotees of the radio-phone look upon the broadcasting service just as they would the phonograph. When they purchase a phonograph they do not have to learn how the records are made, what makes one record better than another, what the rate of vibration is for the various instruments recorded on a given record, what is the wave form of each instrument as impressed on the record, and so on. Their interest starts and ends with the desire to hear music. And, notwithstanding the intricacies of the radiophone, they look upon the radiophone in exactly the same way.

RADIO WITHOUT A STRUGGLE—CAN IT BE DONE?

Let us have no illusions on the subject. Radio is a difficult and intricate branch of engineering; indeed, it represents the highest technique in applied electricity. Hence it becomes impossible to give real, helpful information on radio reception and transmission, yet steer clear of such formidable terms as variometers, condensers, regenerative circuits, logarithmic decrement, damped and continuous oscillations, and so on. However, it can all be explained in a simple and elementary way, and it must be done. That, precisely, is the purpose of this book.

Starting out with the very rudiments of the art, you, the reader, are to be introduced step by step to the various phases of the radio art until you have mastered the essential elements of the subject. Then, should you desire to delve deeper into this most interesting of hobbies, you can readily turn to the more advanced works which are now available in large numbers.

To begin with, radio communication, whether it be the radio-phone or the radiogram, is based on a *cause* and an *effect*, separated by a greater or less distance. The *cause* is the transmitter, which sets up certain disturbances or waves in space which travel in all directions until they reach the distant point and create the desired *effect*, which is the result obtained with the receiving set.

In the instance of the radio-phone service, the cause is the radio-phone broadcasting station. There are a number of such stations located in various parts of the United States; indeed, virtually every section of the country is now served with music, news of the day, weather forecasts, crop and market reports, and so on. The radio-phone station sets up disturbances or waves in space which travel in all directions. These disturbances or waves may be intercepted at any point within the range of the station, and when so intercepted can be brought to suitable receiving instruments and reconverted into the original sounds of the music or talk, as the case may be, so as to give a faithful rendition to the radio audience. That is the effect.

Now, just how the disturbances are set up and how they travel through space is still a problematical matter. Until Einstein came along and upset many of our pet theories with which we had explained so many things during several generations past, it was usually held that a radio transmitter set up vibrations or wave motions in ether. Ether is the name given to a hypothetical substance held to exist everywhere, even in a vacuum. But with the ether explanation rendered more or less obsolete by the said Einstein, as well as by certain astronomi-

cal experiments which have produced interesting and telling results by way of confirming Einstein's theories, our pet radio explanation has been rather shattered.

Still, for all practical purposes we can state that certain kinds of waves of an electromagnetic character are produced by a radio transmitter, and that these waves travel through space at 186,000 miles per second. These waves, too, have much the same characteristics as the waves which we call light, except as regards their wave length and as regards their frequency of vibration. Whereas the waves of visible light have a length to be measured in millionths of a millimeter, and a frequency of vibration of billions per second, the waves used in radio work are seldom less than 100 metres in length, and may be as long as 20,000 meters or more in the case of long-distance, high-power transmitters such as span the Atlantic. At the same time the frequency of radio waves is to be measured in millions down to thousands per second. These radio waves pass through space and pretty much through everything that stands in their way. They pass through stone walls, frame buildings, mountains, forests, and so on. Certain things, particularly masses of metal such as a huge steel structure, absorb a considerable volume of the radio waves, especially those of short wave length, but there is always a sufficient volume left to affect all receiving sets within range.

The radio waves are everywhere, yet cannot be seen or felt. Without a receiving set it is impossible to tell if the air is permeated with radio traffic or whether it is absolutely barren. So far as is known, even the strongest radio waves have no direct effect on any of the five senses, which are the sole avenues whereby we appreciate anything that is external to ourselves. Directly, we cannot feel, hear, smell, taste or see the radio waves. While it is true that the eye is a detector of electromagnetic waves such as light consists of, still, the unaided eye can only detect the very short waves of visible light which, as already mentioned, are minutely short and are

all contained within the narrow limits of a single octave; and while by means of certain luminous screens known as fluorescent screens the range of visibility can to some extent be increased, no such method will render visible even the shortest of the waves used in radio.

RADIO AND THE POND OF STILL WATER

Other methods have had to be developed to detect radio waves. These methods intercept the radio waves and convert them into some form of energy which will come within the scope of our senses. The receiving set presents the usual means of converting radio waves into sound waves which affect the human ear.

Now let us consider a pond of still water as space, in order to follow the formation and propagation of radio waves. When a pebble is thrown into the smooth water it starts a series of concentric ripples or waves, which spread out indefinitely with a speed of a few hundredths of a yard per second. Similarly, the electro-magnetic disturbance set up by a radio transmitter spreads out in all directions in ever increasing circles, at the astounding speed of 186,000 miles per second—virtually instantaneous, in the practical sense. As the waves spread out over the pool, little bits of straw or grass may be seen to move as the waves reach them. These bits of straw or grass may be compared with the radio receiving stations which are also affected as the radio waves reach them.

It will be noted that the waves in the pond grow weaker as they extend farther and farther away from the point where the pebble was thrown into the water. The same thing occurs in radio; as the waves spread farther and farther away from the transmitter, they become weaker until they no longer have sufficient power to actuate a receiving set. Here, then, is an important point to bear in mind. The waves become weaker with distance. Thus at a short distance from a powerful transmitter, a relatively crude receiving set can be employed to

detect the powerful waves. At a greater distance, the same relatively crude receiving set no longer responds to the attenuated waves. At a still greater distance the waves are so weak that they do not produce proper response in better receiving sets, and it becomes necessary to resort to some form of amplifying device for the purpose of building up the strength of the waves in order to obtain the proper degree of audibility.

All of which indicates that the question of distance in radio communication is governed by several factors. Beginners in radio will insist on being informed how far this receiver will work and how far that transmitter can send, and they are always disappointed when told that questions such as these are not answerable. First of all, a receiving set cannot determine the distance over which it will receive. From a powerful transmitter it may receive over a distance of 1,000 miles, but from a small amateur transmitter it may receive over a distance of only 25 miles. It is the transmitter, then, that determines the receiving range. On the other hand, the transmitter may actuate a high-grade receiving set at a distance of 1,000 miles, but a cheap set will not be actuated at a greater distance than 100 miles. Again, atmospheric conditions have much to do with the range. Under ideal conditions the distances covered may be three times the usual spans. Hence in all questions of receiving or transmitting ranges, it is necessary to take the receiving set, the transmitter, and the atmospheric conditions into consideration in order to obtain a satisfactory answer. There is no definite range for any given instrument; specific conditions at any given moment decide the range. Otherwise, all statements of ranges must be approximations of a very crude sort.

THE IMPORTANT QUESTION OF WAVE LENGTH

Returning to the pool of water, it will be noted that the waves in spreading out from the transmitter maintain a certain distance between themselves. If the distance from the crest of one wave to the crest of another is

measured, we obtain the wave length, as in $a-b$ in the accompanying sketch. In the case of the waves in water, the wave length is determined by the size of the stone, the wave length being greater when a larger stone is dropped into the water. In radio, however, the wave length has nothing to do with the size of the transmitter, although it is true that short wave lengths are employed for the smaller amateur transmitters, and longer wave lengths for the commercial stations, especially the huge transatlantic stations. While the waves are larger and therefore more powerful when a large transmitter is employed, the wave length is determined by other factors as will be explained further on.

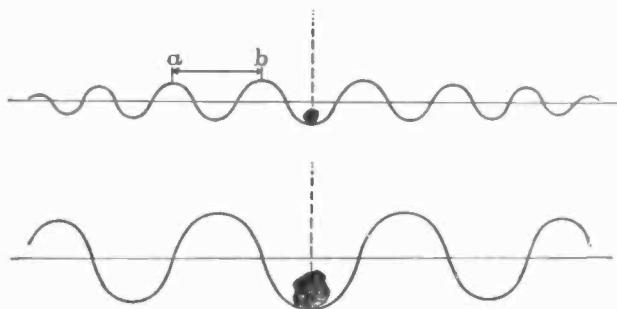

What happens when a pebble and a large stone are dropped in still water. Note how the pebble causes small waves, and the large stone large waves. Measured from crest to crest, such as $a-b$, we obtain the wave length of the waves.

The wave length determines the tuning of the transmitter and receiver alike. Tuning is such a confusing term to the layman, yet nothing could be simpler to understand. Tuning is nothing more than the adjusting of a receiver or transmitter to a given wave length, so that it will receive that wave length, in the case of the receiver, and transmit that wave length, in the case of the transmitter. Thus a transmitter is adjusted to

200-meter wave length. The waves emitted by that transmitter are of 200 meters wave length. As they travel through space in all directions, they are intercepted by receiving sets. However, only those receiving sets that are tuned to 200-meter wave length receive the signals from the transmitter in question. Other receiving sets, tuned to a shorter or longer wave length, do not respond. On the other hand, if another transmitter is sending at the same time on a 600-meter wave length, then the first batch of receiving sets, adjusted to 200-meter wave length, will not respond to this second transmitter but will keep right on receiving from the 200-meter wave length transmitter. Other receivers, adjusted to the 600-meter wave length, will receive from the second transmitter, and so it goes.

It is tuning that has made practical radio communication possible. Were it not for tuned waves, it would be impossible for more than one transmitter to operate in a given area, for the simple reason that confusion would result if other transmitters operated at the same time. Now, with tuned waves, several transmitters can operate at the same time, and the receiving sets can be adjusted so that only the desired transmitters are intercepted and heard. Thus the radio broadcasting stations generally operate on 360-meter wave length. Amateur transmitters are by law limited to 200-meter wave length or less. Commercial stations operate on higher wave lengths. By dividing the wave length field into various classes, a minimum of interference results between transmitters. One can spend an entire evening listening to a radio-phone broadcasting station with hardly any interference from radio telegraph stations, thanks to the 360 meter wave length reserved for radio-phone service.

Another question which rather confuses the beginner in radio is whether there is a limit to the number of receiving stations that can listen in to a transmitter. As a matter of fact, there is no limit—at least in practice. Any number of receiving stations can be operating at the

same time, picking up the signals or music from one transmitter. Furthermore, the transmitting operator cannot tell how many receiving sets are listening to what he is sending. He simply sends, and there is no telling how far his signals are going or how many persons are listening in.

DAMPED AND UNDAMPED WAVES—WHICH?

The waves dealt with so far in the pool of water are highly damped. Which means, in plain language, that

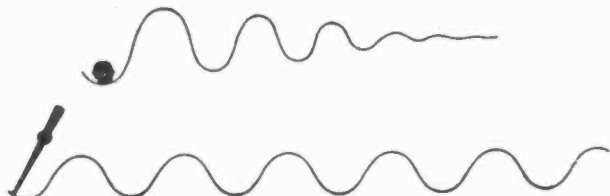

The difference between damped or discontinuous waves, and undamped or continuous waves in water. Dropping a pebble into water causes damped waves, while using a puddle steadily produces continuous waves.

they die down quickly. The pebble is dropped in the pool of water, and the waves created reach but a short distance away before they have virtually disappeared. In order to keep up a disturbance in the water, it is necessary to drop one pebble after another, so as to create a steady supply of waves, represented by groups or trains. Each group or train soon dies down, and is followed by the next one, and so on.

In radio, we have the same condition when the usual spark transmitter is employed. The group or train of waves starts out strong but soon dies down, and a second train of waves must be started, only to die in the same manner. Such damped waves may be likened to the action of a pendulum. When the pendulum is given a push, it swings from side to side, but each swing is a trifle shorter than the preceding one, until the pendulum comes to a dead stop. Its action is damped, in other

words, and corresponds precisely to the action of damped radio transmitters.

Of late years the undamped transmitter has gained much favor in radio. Unlike the damped transmitter, the undamped type produces a steady flow of waves. There are no groups or trains. It is just as though a paddle were used in the pool of water, said paddle being worked back and forth so as to produce a steady series of waves, all of the same size and strength, with a uniform wave length maintained throughout. Or again, as though the pendulum were given a fresh push at each swing, so as to restore the initial energy, and in that manner it would not die down just so long as the energy was supplied.

Undamped wave transmitters are employed in many commercial and amateur transmitters. They are also known as continuous wave transmitters or CW transmitters for short. Radio telephony is always carried on by means of a continuous wave or undamped wave transmitter. In the case of the undamped wave telegraph transmitter, the steady flow of waves is altered into short and long trains to represent the dots and dashes of the telegraph code. In the case of the radio telephone, however, the steady supply of waves is modulated or varied by means of a telephone microphone, such as the transmitter of the usual telephone instrument, in order to impress the characteristics of music or speech on the continuous waves.

Electricity may be made to vibrate or oscillate and it is this vibration or oscillation that creates radio waves. Current from a storage battery or dry battery flows steadily and only in one direction. Current flows out of one terminal of the battery, through the circuit, and back to the other terminal of the battery. That is direct current. However, there is another form of current known as alternating current, which is generated by machines known as alternators, and by other methods. Alternating current does not flow steadily, nor does it maintain the same

direction of flow. At one instant the alternating current is flowing through the circuit in one direction, and the next instant it is flowing in the opposite direction, only to change back to the first direction the next instant, and so on. Each complete change of direction is known as a cycle. Commercial alternating current, which is generally used for lighting and power purposes in most sections of the country today, is known as 60-cycle current; that is to say, it has gone through 60 cycles of change in one second, each cycle consisting of a rise in positive voltage from 0 to the maximum voltage and a fall to zero, and then a reversal with a negative rise in voltage from 0 to the maximum voltage, and back to 0 again, and a repetition of the performance for the next cycle.

Vibrating or oscillating currents of this kind are necessary to produce radio waves. However, the rate of vibration or oscillation, or the frequency, to use the radio term, must be of a much higher order than the 60-cycle frequency of lighting and power circuits. Thus the 200-meter wave length of the usual amateur transmitter represents 1,500,000 cycles per second, while the 10,000-meter wave length of a highpower station represents 30,000 cycles per second. It will be noted that the frequency or number of cycles per second determines the wave length. The frequency, on the other hand, in both the receiver and the transmitter is determined by two factors, known as inductance and capacity.

Inductance is the length of conductor in a circuit, so far as the layman is concerned, and we must keep to simple explanations in this work if we are to live up to its title. Thus if we have 100 feet of wire in a circuit, we have four times as much inductance as in the same kind of wire 25 feet long. Inductance, for the sake of convenience, is generally arranged in the form of a spiral or a helix for the transmitter, using heavy conductor since the current being handled is rather a powerful one; for receiving purposes, on the other hand, the inductance is in the form of insulated wire wound

on tubes or wound in compact spools or coils for ready handling.

The capacity is the ability of the circuit to store electricity. Capacity is generally represented by a condenser, which is a reservoir or storage for electricity. In fact, the condenser is a real reservoir or storage for electricity. The storage battery is something entirely different, although it does serve to store electricity. It accomplishes this end by causing certain chemical changes, and these chemical changes in turn generate electric current which may be drawn from the battery until it is restored to its original chemical condition, or completely discharged. Thus the current proper is not stored: it only serves to create certain chemical conditions. For most practical purposes, however, the storage battery is the only means available for storing ordinary current.

The condenser is always made up of sheets of brass, aluminum, copper or tinfoil, separated by some non-conductor of electricity, referred to as the dielectric. A certain number of metallic sheets are connected to one side of a circuit, while the same number of metallic sheets are connected to the other side. The non-conducting material or dielectric separates two sets of sheets. Between the sheets of metal there is created a static pressure. This pressure accumulates or becomes greater until the condenser, no longer capable of retaining the pressure, discharges the accumulated electricity back through the circuit of which it forms part. The discharged current flows through the circuit from one set of plates to the other, and recharges the condenser with the opposite polarity. No sooner is the recharging accomplished, when the condenser discharges again, this time in the opposite or original direction, of course, and so it goes, until the charge, getting weaker with each discharge, is entirely spent. All this can take place in a fraction of a second. Thus the discharge from a condenser takes the form of a vibrating current or oscillating current, which is the basis of radio waves.

THE ANTENNA OR AERIAL

Let us return for a moment to our pond of still water. Instead of a pebble, let us use a hinged paddle which can be moved back and forth to create waves. This paddle then becomes the agency for transferring power to the pool, which is the medium for distributing the waves. In radio the energy for creating the waves is generated by the transmitter, and a system of elevated and insulated wires, known as the aerial, serves to impart the energy or waves into space. An aerial or, as it is more popularly called in the case of the receiving end of radio, an antenna, is employed at the receiving end to intercept the waves and to bring the energy down to the receiving set. The receiving antenna may be likened to a hinged paddle at some remote point from the first paddle creating waves in water. The receiving paddle is provided with a bell. As the waves travel over the pond and finally reach the receiving paddle, they cause the paddle to sway and this action, in turn, rings the bell. This action is precisely that of the receiving antenna and the actuating of the receiving set.

Aside from the aerial or the antenna, a ground connection is required in radio communication. The ground side means a good connection with any object that runs into the ground, such as a water pipe or a gas pipe, or even some object which is eventually connected with the ground, such as steam-heating pipe. In the country, where such pipes are not available, a good ground may be secured by fastening a wire to a bucket which is dropped into a well or other body of water. Again, an iron rod may be driven down into moist soil, or a large sheet of copper or galvanized iron may be buried in moist soil. However, the securing of a good ground, as well as the construction of the aerial or antenna, is reserved for other chapters.

In reality, the aerial and the ground form a condenser. The aerial and the ground are the plates of the condenser, while the space between is the non-conductor or insulator or dielectric, whichever you wish to call it. To

create radio waves it is necessary to have two surfaces separated by a distance of from ten to several hundred feet and to create between them an electric pressure which changes its direction first toward one surface, then toward the other. In other words, we must have a condenser effect. The current must change direction several thousand times per second. The aerial and the ground afford just such an arrangement, and between these we create an electric pressure of from one to 20,000 volts by means of a suitable transmitting equipment, which starts waves radiating out in all directions. These pressure waves are, however, only part of a radio wave. From any wire in which current is flowing electro-magnetic waves are radiated; therefore, radio waves are made up of both electro-magnetic and pressure electro-static waves. The creation of these waves may be compared to the action of hurling the pebble into the pond of still water, as already explained. The amperes (the measure of current flow) put into the aerial corresponds to the size of the pebble, while the volts (the pressure or potential of an electric current) are equivalent to the force with which the pebble is hurled. The larger the pebble and the greater the force behind it, the bigger the splash and the consequent waves. The more amperes of current flowing in the aerial circuit and the greater the pressure in volts between the aerial and the ground, the stronger the waves radiated and the farther they will travel.

ELEMENTS OF RADIO COMMUNICATION

So far, so good. In order to make use of radio waves for the practical purposes of sending messages and then receiving them at a distant point, it is necessary:

(a) To produce regular electrical disturbances in a circuit which starts the waves. These disturbances are electrical currents which reverse rapidly in direction, or vibrate, so to speak. In radio parlance this characteristic is known as oscillating, and we speak of transmitting

circuits as oscillating circuits, and of transmitters as oscillators. The rapidity of the reversal determines the wave length, as we have already learned.

(b) To get the waves into surrounding space, through which they travel with great speed. This is done by means of the transmitting aerial, which will be described further on.

(c) By means of these waves, to set up electric currents in a receiving circuit at a distant station. The device which these waves strikes as they come in, and which turns them over to the receiving circuit, is called the receiving antenna or aerial.

(d) To change these currents so that they may be detected by suitable apparatus. The operator usually receives the messages through sounds in a telephone receiver.

There are various ways in which radio waves may be set up. The simplest consists of a spark coil, such as the type employed in automobile ignition systems; a condenser represented by the aerial and the ground, and a spark gap arranged as shown in the accompanying diagram. The spark coil has two windings, namely, a primary and a secondary. To the primary coil, which consists of a relatively small number of turns of wire wound about the iron core of the coil, are connected the battery supplying the initial current and the vibrator or interrupter, which breaks up the current flow from the battery. The secondary consists of a large number of turns of wire wound over the primary winding. In the nature of electrical things, when current is passed through the primary, a high voltage current is produced in the secondary winding. The primary current may be only six volts, but the secondary winding produces perhaps 5 to 10,000 volts. This stepping up of the voltage is a necessary part of radio transmitting. Transformers are larger devices intended for stepping up the voltage of heavy currents.

At any rate, high voltage current is produced in the secondary winding. The interrupter causes the secondary

to flow first in one direction, and then in the other, as the primary current is interrupted. The secondary current, flowing for a moment in one direction, charges the condenser, consisting of aerial and ground. However, the capacity of the condenser is limited, and when it is charged to overflowing, it releases its energy which jumps the spark gap in the form of a fat spark, only to pile up on the other side of the condenser. Again the condenser is filled to overflowing, and it discharges once more, this time causing the current to flow in a direction

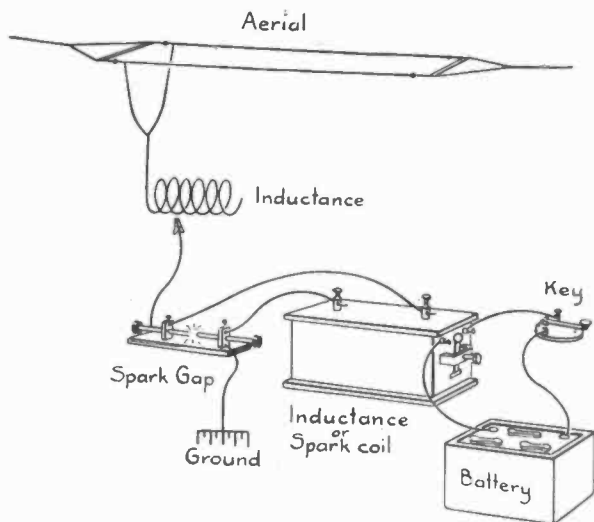

The essentials of transmitting radio signals, comprising a spark coil, aerial, ground, spark gap, key, and battery, as well as an inductance coil for tuning purposes.

opposite to that of the first time, and again the condenser is charged. Thus the discharges take place back and forth, but far faster than it takes to explain their action here. Indeed, the discharges travel back and forth with the speed of light, but gradually diminish in strength until

the charge is exhausted. Every time the vibrator in the primary circuit makes or breaks the current in the primary, one of these trains of alternating current or oscillatory current is started. Since they die down rapidly, they are known as damped oscillations. Each one of these trains produces a single tick in the distant receiving station telephone, and it is the rapidity with which these trains follow one another that characterizes the "spark" or sound of a transmitter. If we increase the capacity or the inductance in the transmitting circuit, we increase the wave length, just as the increasing of the length or the weight of the pendulum affects its rate of swing.

In actual practice the transmitter is connected to the aerial and ground. The oscillations charge the aerial and the ground, which act just as a huge condenser, as already explained. The longer the aerial, the longer the wave length of the aerial by itself. This is known as its natural wave length, as distinguished from what its wave length may be raised to or lower to by external capacity and inductance. The waves travel out from the aerial through space, and through the ground to the various receiving stations.

These waves can be intercepted at any point within range of the transmitting station. Obviously, the waves become weaker as they travel out from the transmitter. A short distance away, the waves may be intercepted by an inexpensive and relatively crude receiving set, but at a greater distance, when the waves are considerably weaker, a more elaborate and more sensitive receiving set must be employed.

For receiving the waves, an antenna and a ground connection are necessary. The first step is to tune the antenna-ground circuit so as to bring it into harmony or resonance with the desired waves. When this is done, the waves flow down from the antenna to the ground. They may be diverted into suitable receiving apparatus by the simple arrangement shown in the accompanying illustration. However, even when they are diverted in this

manner, they are of frequencies of the order of several thousand cycles, and will not produce any sounds in the usual telephone receiver because they are beyond the range of audibility. But remember, the waves are in trains or groups. By making use of a device that can convert these trains or groups into direct current—current flowing in only one direction, we secure a series of impulses flowing in one direction. The device which accomplishes this purpose is known as the detector. The current flowing through the telephone receiver is smoothed out into single impulses of a frequency corresponding to the

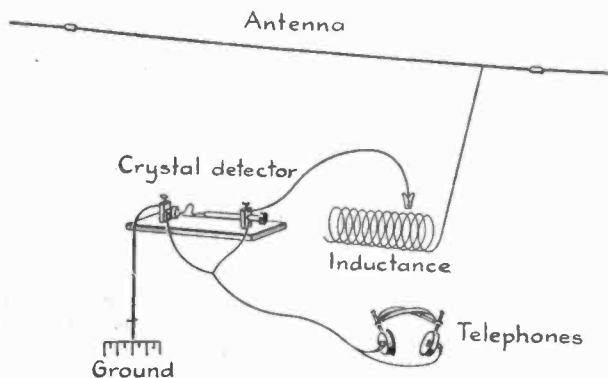

The essentials of receiving radio signals, comprising the antenna, inductance coil for tuning, crystal detector, telephones, and the ground.

speed of the vibrator or current supply at the transmitting end. Thus the diaphragm of the telephone is actuated at an audible frequency.

In the case of undamped waves, which are produced in a different manner and received by more elaborate receiving equipment, it is also necessary to bring the intercepted waves down to audibility. In the reception of continuous wave radio telephony, however, the waves are modulated or altered by the impressed telephonic characteristics, and while the receiver may not make the actual

waves themselves audible because of their high frequencies, it does make audible the fluctuating potential of the waves and reproduces the sounds uttered at the transmitter. In other words, it does not concern itself with the carrier waves, but only with the sounds carried.

FITTING THE RADIO APPARATUS TO THE TASK IN HAND

In entering upon radio as a hobby, the beginner is confronted with a question of choice of apparatus. Thus he can buy the parts and build his own receiving set and transmitter; he can buy the separate pieces of apparatus.

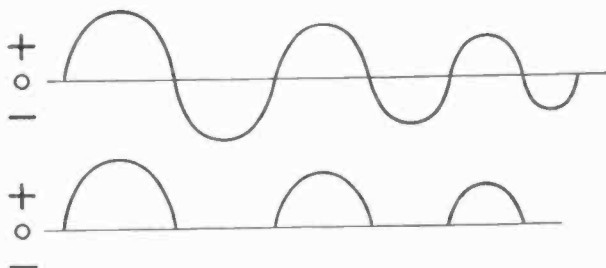

Diagrammatic explanation of why a detector detects radio waves. The high frequency current produced by the intercepted wave is shown in the upper half of the diagram, while the lower half shows how the detector, being a one-way conductor, only permits half the current to flow through, therefore making it a direct current, which affects the telephone receiver. Certain factors cause the individual pulsations of a wave train or group to slur into one note in the telephone receiver. Therefore, there is one sound for each train or group of waves.

all finished and ready to be connected with other instruments so as to form a complete set; or he can buy a complete receiving set and sending set, all wired, ready to be used. Latterly, because of the popular interest in radio, there have appeared various types of phonograph-like receiving sets, in which the radio mechanism is so simple that virtually no knowledge of radio is required.

If the layman is only interested in receiving radio-
phone service, and does not care to be troubled with even

an elementary knowledge of radio, then by all means the simplest type of apparatus is urged. In that event it is well to purchase a complete receiving set, already wired, as self-contained as possible, which only needs to be connected to the aerial and ground for immediate results.

If the layman wishes to do a little experimenting and little by little master the details of radio communication, then it may be well for him to purchase separate radio units, each one finished but so arranged as to permit its use with other units for all kinds of purposes.

Finally, if the layman wishes to build his own receiving set not only because of the experience gained but also on the grounds of economy, then the various parts can

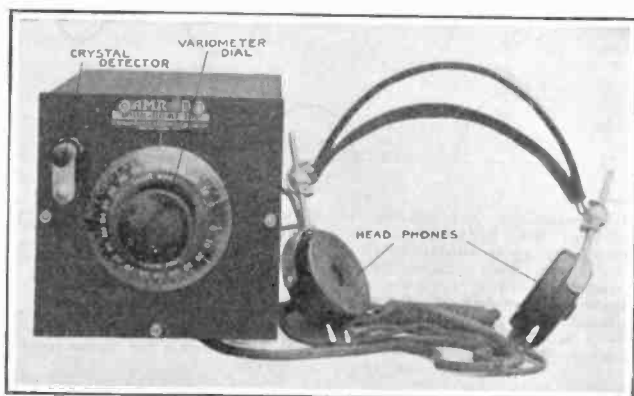

A simple receiving set, consisting of a variable inductance, a crystal detector, and a pair of telephones. Such a set will receive radiophone concerts over 25 miles and perhaps more with good conditions obtaining.

be purchased and assembled. Some manufacturers today offer all the parts for a complete receiving set, thus facilitating work of this kind.

For transmitting work, the same applies. However, it is well to say here that transmitting is something quite different from receiving. Anyone can receive, without

licenses or other formality; but one must obtain licenses for transmitting. The transmitting station must be licensed by the Department of Commerce, as explained in another chapter, and the operator of such a station must pass an examination in sending and receiving in order to obtain an operator's license, without which one is barred from transmitting work. So, all in all, the layman had best confine his efforts to receiving only until some subsequent time when he can afford to put in the necessary time to master the various details of radio in order to pass the Government test and obtain his operator's license.

The growth of radio-phone broadcasting has created a demand for simple receiving sets with the minimum of controls and adjustments. Thus there have appeared receiving sets made in the form of phonographs which represent an effort to cater to the desires of persons who want the radio-phone service with all the radio left out, so to speak. These sets must be developed to a high state of perfection in short order, but for the present they must be looked upon as being somewhat premature attempts. In fact, much of the receiving apparatus which is now on the market is designed for radio communication work rather than for radio-phone broadcasting work, and this applies particularly to those sets making use of large horns for throwing the sound out into a room, in place of the head 'phones. The time must come when such sets will be designed with special attention given to the acoustical properties of the various components, just as the better types of phonographs have been consistently developed through unceasing experimentation and research until they have been taken out of the talking machine class.

For short ranges, inexpensive radio receiving sets can be obtained. There are sets selling as low as \$15.00, which give passable results with the broadcasting station but ten miles or so away. For \$25.00 there are several receiving sets available which give good reception of radio-phone service up to 25 miles or more. These sets

are quite simple, having only one or two controls for varying the wave length, and a simple detector of the so-called crystal type. Such a detector, as will be explained further on in the chapter dealing with receiving apparatus, requires no battery current.

Stepping beyond the 25-mile range, we come to the better kinds of receiving sets with more elaborate tuning devices and the so-called vacuum tube detector. This detector, unlike the simple crystal detector, requires two

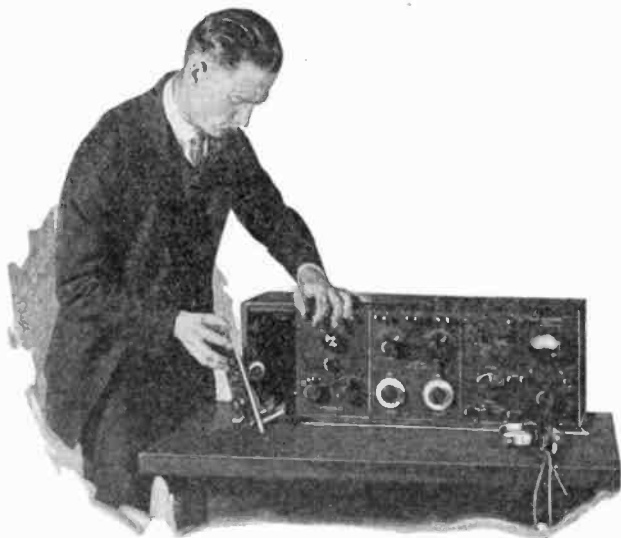

The interchangeable panel idea is quite popular at present. Each component of a receiving set is mounted on a standardized panel, and as many panels as are desired can be used at one time with or without cabinets. The idea is quite similar to the sectional bookcase, which grows with one's needs.

batteries for its operation. It must have a low-voltage battery, giving from $1\frac{1}{2}$ to 6 volts, depending on the type employed, and a high-voltage battery giving from 15 to $22\frac{1}{2}$ volts. The low-voltage battery is known as

A or filament battery, because it operates the filament just as in the case of an ordinary electric light, while the B battery or plate battery has to do with the intricate workings of the tube. In one type of receiving set selling for \$75.00, and quite effective for ranges up to 75 miles, a special $1\frac{1}{2}$ -volt tube is employed which can be operated on a single dry cell. Otherwise, the usual vacuum tube requires a storage battery because it draws over one ampere of current at a voltage of 6.

Passing on to ranges over 100 miles, a still better set is required. We now reach a point where radio begins to cost real money. Figuring on the basis of \$1.00 per mile, which is the figure generally quoted by conservative radio men, we come to sets of elaborate design costing upwards of \$100.00, with numerous accessories bringing the total cost up to \$200 and \$300. These sets are generally used in connection with what is known as an amplifier, which is a device for building up the weak signals or music or talk. The amplifier may be obtained in the one-step, in the two-step, or in the three-step models. Generally, the two-step model is employed, for the reason that it gives an amplification of several hundred times the original signal strength, and does not cause too many foreign noises. Amplifiers make use of vacuum tubes, which in general appearance are very much like the detector tubes. They differ only in the vacuum content of the tube. Since the amplifiers magnify all sounds and irregularities in a circuit of which they form part, it stands to reason that everything is amplified together. For this reason the amplifier should only be used when the signal strength is quite low and must be increased for proper reception. Furthermore, amplifiers must be used in connection with loud-speaking telephones. It is often necessary to use the usual two-step amplifier, and then a separate amplifier for the loud-speaker when extremely loud music or talk is required for a large hall.

At this point it becomes necessary to study the various

terms encountered in radio work, as well as the accompanying diagram giving the various symbols showing how the different pieces of apparatus are designated in the wiring diagrams that follow. The author had wished to avoid all wiring diagrams, but found that there was no other manner in which specific information concerning the arrangement of radio apparatus, could be given. Simple transmitting and receiving sets could be shown in more pictorial form, but when the more advanced equipment is to be shown we must resort to the conventional wiring diagrams. However, a little attention given to these symbols will enable even the layman to master the art of reading a radio wiring diagram, and he then becomes competent to read any wiring diagram to his very substantial benefit.

The most common terms employed in everyday radio work are as follows:

Aerial—One or more wires insulated from and suspended at a certain height above the ground and used to radiate energy in the form of electric-magnetic waves produced by a transmitter. When used for receiving purposes, the correct name is antenna, though both terms are used interchangeably for either reception or transmission.

Alternating Current, (Abbreviated A. C.)—An electrical current whose direction of flow is constantly changing during a period of time. Thus, when we speak of a 60-cycle alternating current, we mean one that completely reverses its direction of flow sixty times per second. Alternating current plays a prominent part in many phases of the radio art.

Ammeter—An instrument used for measuring the flow of current in amperes through a given circuit. An ammeter is invariably connected in series with a given circuit, so that the current has to flow through it. Sometimes, the current is passed through a heavy conductor placed across the ammeter proper. such a

Alternator		Grid leak and Condenser	
Ammeter		Inductance	
Aerial		Variable Inductance	
Arc		Key	
Battery		Resistance	
Buzzer		Variable resistance	
Condenser		Switches	
Variable Condenser		Single pole Double throw	
Connection of wires		Double pole Single throw	
No connection		Double pole Double throw	
Coupled coils		Reversing	
Variable coupling		Telephone Receiver	
Detector		Telephone Transmitter	
Galvanometer		Transformer	
Gap, plain		Vacuum Tube	
Gap, quenched		Variometer	
Generator, D.C.		Voltmeter	
Ground			

Standard symbols used in radio wiring diagrams. These symbols should be mastered so that the radio devotee can understand wiring diagrams and follow out their instructions.

conductor is known as a shunt, and permits of handling heavy currents.

Ampere—The standard electrical unit of current flow.

Amplifier—This term is used in referring to either an amplifier tube or an amplifier receiving unit. It is the device which builds up or magnifies the waves or sounds in a radio receiving set. (See vacuum tube.)

Amplitude—In radio work, this refers to the highest point reached by a wave or oscillation, *i. e.*, the crest of each wave. A wave may, therefore, have a high or low amplitude according to the initial energy which created it.

Antenna—See aerial.

Armstrong Circuit—See Regenerative Circuit.

Atmospherics—Also known as static, strays, X's. "The noises of space." Natural electrical discharges occurring in the ether and in reality miniature lightning storms. Since these discharges travel through the same medium as radio waves, they are readily picked up by receivers and prove very troublesome at times. It is comparatively difficult to tune out these disturbances for they have no definite wave length.

Audio Frequencies—Frequencies corresponding to vibrations which are normally audible to the human ear. All frequencies below 10,000 cycles per second are termed audio frequencies. (See radio frequencies.)

B Battery—The battery used for supplying the plate current for the vacuum tube. This battery generally runs from 15 volts to 22½ volts.

Broadcasting—As applied to radio work, this stands for the simultaneous sending of intelligence either by radio telegraphy or telephony from a given central point for the benefit of a great number of receiving stations located within the broadcasting station's range.

Capacity, (abbreviated C)—Capacity as used in radio work plays a very important part. The unit of elec-

trical capacity is the Farad, but the farad being too large for practical radio work, the micro-farad (abbreviated m. f. d.—one millionth of a farad) is used. Thus we speak of a receiving or transmitting condenser having a capacity of .001 mfd, or one thousandth part of a microfarad.

Cascade Amplification—This refers to high amplification of received radio signals, wherein several vacuum tubes are employed in cascade fashion which means that one amplifies the sounds or waves and passes

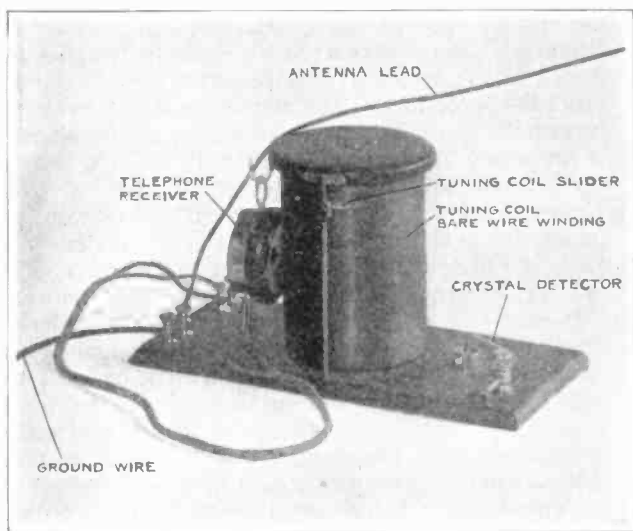

Receiving set of simple construction, making use of a tuning coil with single slider, a crystal detector, and a single telephone receiver. This set may be used for short distances.

them on to another, which amplifies the sounds and passes them on to another, and so on. Thus, we may speak of a three-step (cascade) amplifier.

Choke Coil—A coil wound to have great self-induction or choking effect when in the path of alternating cur-

rent. Choking action when introduced in a radio circuit is called impedance.

Circuit—In radio and electrical work the path in which an electric current flows is called a circuit. A circuit may be open or closed or oscillating.

Close Coupling—A tuning coil, set of coils, or a transformer is said to be close-coupled when the primary and the secondary are very close together, thereby causing much mutual inductance. Coupling permits of the transference of energy from one circuit to another. Therefore, the closer the coupling, the greater the transference of energy and the interplay of the circuits. The primary of any coupler or transformer device is the winding which carries the initial current; the secondary is the winding which receives its current from the primary. In a coupler the primary is connected to antenna and ground, and the secondary is connected with the detector circuit.

Condenser—Two or more sheets of metal separated by an insulator called the dielectric. A condenser is used in radio work for collecting electrical energy, and for bringing circuits into tune or resonance.

Counterpoise—One or more wires stretched immediately above the earth, but insulated from the earth. The counterpoise wires are usually directly beneath the regular aerial. This device is employed in transmission and reception when a good ground connection is not available. The counterpoise is used in aircraft radios, where a ground connection would be out of the question. It is also used extensively in continuous wave transmission.

Continuous Wave, (Abbreviated C. W.)—A form of electro-magnetic wave used extensively in radio work. C. W. waves have a constant amplitude and by the same sign no damping effect, as distinguished from the older form of discontinuous waves which are soon damped out. C. W. makes possible long-distance amateur radio telegraphy, as well as radio telephony.

Coupler—A device for transferring radio energy from one circuit to another. Ordinarily, the primary winding of the coupler is connected with the antenna



Receiving set made in the form of a phonograph; in fact, this cabinet may be used as a phonograph or radio telephone receiving set at will. The radio set makes use of the phonograph horn.

and ground, and the secondary with the detector circuit. Couplers are of several different types, such as the loose-coupler and vario-coupler.

Crystal Detector—Certain metallic crystals when introduced in a radio receiving circuit have the property of rectifying the incoming signal oscillations, which

are high frequency alternating currents, into direct current, so that the resultant intermittent direct current will work a sensitive telephone receiver.

Detector—Any apparatus which transforms the oscillations received by the antenna into visible or audible indications.

Direct Current, (abbreviated D. C.)—An electric current flowing continuously in one direction. In a two-wire circuit, for example, direct current always flows from the positive source to the negative return. Therefore, direct current always has a readily determinable polarity, while alternating current (A. C.), which is constantly reversing its polarity while flowing through a circuit, has no apparent polarity.

Electron—The ultimate particle of negative electricity, which plays a fundamental part in the constitution of matter as well as in the electric current. Radioactive emanations, electric discharges, etc., consist of streams of electrons, ejected at immense velocities from the atoms of which they formed part; and ordinary electric currents are in some way an electronic phenomenon.

E. M. F.—Electromotive force or electrical pressure or potential, the unit of which is the volt.

Ether—A hypothetical medium of great elasticity and extreme minuteness, supposed to pervade all space as well as the interior of solid bodies. It is the medium through which light, heat and radio waves have heretofore been said to be transmitted. The Einstein theories have shattered the ether theory for the moment, however, although many radio men still cling to it in explaining radio transmission.

Flat-Top Aerial—One whose suspended wires are stretched parallel to the earth.

Frequency—In alternating currents, the rapid reversal of the current through a circuit. Thus, we speak of a 60-cycle current as one which has sixty complete reversals per second or a frequency of 60 cycles. (See

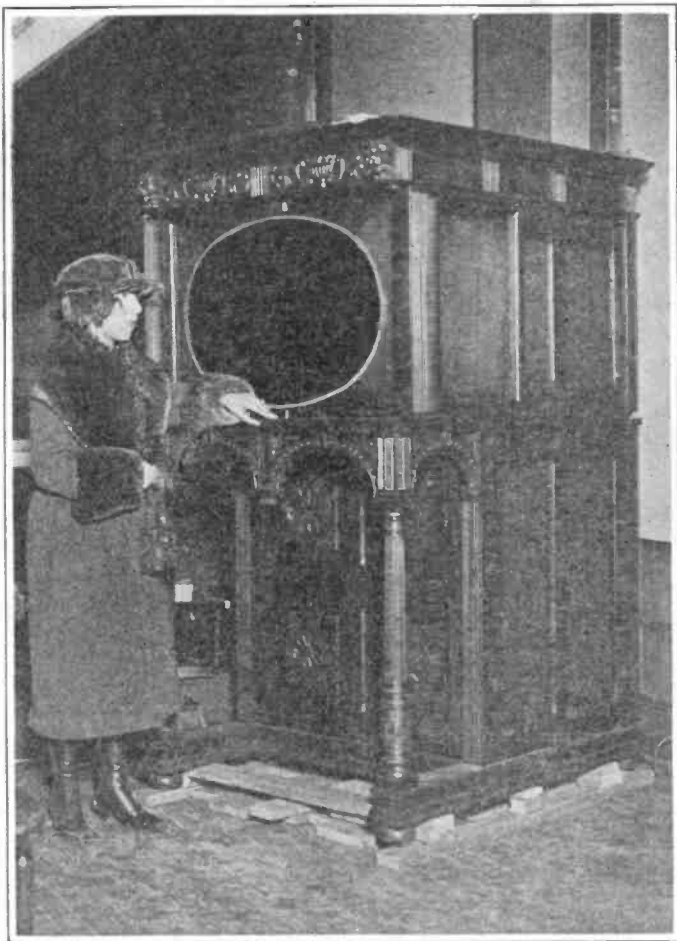

A huge radio receiving set and loud-speaker, made in the form of a huge cabinet. Such a receiving set gives loud enough music to fill a large hall or motion picture theatre.

Alternating Current and Audio and Radio Frequencies.)

Grid Leak—A very high, non-inductive, resistance connected across the grid condenser or between the grid and the filament of a vacuum tube to permit excessive electrical charges to leak off to an external source, thus furnishing stable control under all operating conditions.

Ground, (or Earth which is the term used in England)—In radio work the ground is the other side of the wave distributing system. It functions in connection with the aerial or antenna of most sending and receiving systems as a large condenser. The term "ground" is used for any connection with the earth, river or sea. (See counterpoise.)

Harmonics—In radio, harmonics refer to the incidental waves mostly noticeable in undamped or C. W. wave operation. These harmonics differ in length and frequency to the true and original operative wave of such transmitters. The first harmonic is three times that of the true frequency, or one-third the wave length of the aerial; the second harmonic is five times the true frequency or one-fifth the wave length; the third harmonic is seven times the true frequency or one-seventh the wave length. At times, amateurs will hear the harmonics of high power long wave stations while their tuners are set for much shorter waves. This accounts for the reception of a radio-phone station at two entirely different points on the tuner of the receiving set.

Henry—The unit of inductance.

Hertzian Waves—Electro-magnetic waves named after the discoverer, Prof. Heinrich Hertz, in 1887. These waves are the basis of radio communication.

Hook-up—A diagram showing the wiring of any wireless receiving or transmitting set. Diagrams of this kind make use of certain conventional symbols to represent the various pieces of apparatus.

Hot Wire Ammeter—An instrument used in radio transmission work for measuring the current in amperes by means of a wire that expands in proportion to the heat generated by the current passing through it.

Impedance—This is the term applied to the resistance offered by a coil of wire to a current flowing through it due to the counter-electromotive pressure, irrespective of the actual resistance of the conductor in ohms. Counter-electromotive pressure is developed in certain forms of inductance, and this counteracts the flow of current to a greater or less degree. Impedance may be said to be the result of reactance.

Inductance, (abbreviated L)—Inductance, like capacity, plays a very prominent part in radio circuits. It is the transfer of an electric or magnetic current from an electrified or magnified body to a non-electrified or non-magnetized body by close proximity but without actual contact. The unit of inductance is the Henry. In radio work the mil-Henry and the micro-Henry are the more practical terms used.

Insulator—A non-conductive material through which electricity will not pass.

Kilowatt, (abbreviated K. W.)—One thousand watts, a unit used in measuring large amounts of electricity.

Loop Antenna—A small frame wound with a number of turns of wire used in reception and thus eliminating both outdoor antenna and ground connections.

Loose-Coupler—(See Coupler.)

Loud-speaker—Any receiving device designed to reproduce signals or speech loud enough to be heard without the use of the conventional telephone receivers.

Megohm—One million ohms.

Microfarad, (abbreviated mfd.)—One millionth part of a Farad and the practical unit of capacity.

Microphone—A device for converting sounds into electrical equivalents in a given circuit. In other words, the microphone transfers sounds to a given electrical circuit by causing certain variations in the flow of

electricity. It is the instrument used in both wire and radio telephony to transmit speech, and generally consists of a mass of loosely packed carbon grains held between carbon blocks, and subjected to varying pressure by the vibration of the diaphragm.

Milliampere, (abbreviated M. A.)—The thousandth part of one ampere.

Natural Frequency—The natural wave length obtained with any aerial or circuit without the introduction of other elements.

Ohm—The unit of electrical resistance.

Ohm's Law—The fundamental law of electricity. It states that the current in amperes flowing through a circuit is equal to the pressure in volts divided by the resistance in Ohms.

Oscillations—Alternating currents of very high frequencies are called electrical oscillations. If the amplitude of a series of oscillations is constant, the oscillations give rise to continuous or undamped waves; but if the amplitude is not constant and is of a decaying nature, as in the spark method of transmission, we obtain damped waves.

Potential—Term applied to voltage or electrical pressure. (See EMF and Volt.)

Radiation—The transmission of energy through space in the form of electro-magnetic waves. By the radiation of a transmitter is meant the volume of high frequency current which is being delivered to the aerial for propagation in the form of waves.

Radio Frequencies—Frequencies corresponding to vibrations not normally audible to the human ear. All frequencies above 10,000 cycles per second are termed radio frequencies. (See Audio Frequencies.)

Reactance—See Impedance.

Rectifier—An apparatus which converts alternating current (A. C.) into pulses of direct current (D. C.) Tungar, Rectigon and Kenetron apparatus are employed for rectifying purposes. Certain metallic

crystals also have rectifying action when used as detectors in reception.

Regenerative Circuit, (also known as the Armstrong circuit) a radio circuit comprising a vacuum tube so connected that after detection and rectification, the signal introduced in the plate circuit is led back to or caused to react upon the grid circuit, thereby increasing the original energy of the signal received by the grid and greatly amplifying the response to weak signals. In reception, the leading back or feeding back of plate energy to the grid for further strengthening is usually accomplished by means of a small coil placed close to the secondary of the receiving tuner. This small coil is frequently called the "tickler."

Resistance—Opposition to the flow of an electric current through a conducting medium. All metals have more or less electrical resistance. Copper is used universally for both electrical and radio work on account of its low resistance, comparatively low cost and ready supply. Silver is a better conductor, but it is too expensive. The unit of resistance is the Ohm.

Resonance—A very important function of radio circuits. Resonance in a given circuit is said to exist when its natural frequency has the same value as the frequency of the alternating electromotive force introduced in it. The current is then in tune with the natural period of vibration of the circuit. The theory of electrical resonance is the same as that of acoustics, readily demonstrated by the tuning forks, where one tuning fork will not respond to another unless it is of the same key or pitch. Bringing a circuit into resonance means bringing it into tune with another circuit or transmitter.

Rheostat—A variable resistance usually employed to control or regulate current flow.

Selectivity—In radio work, the ability to select any par-

ticular wave length to the exclusion of others; the fineness of tuning, in other words.

Sharp Tuning—Where a very slight change of a tuner or tuning system will produce a marked effect in the strength of signals. The sharper the tuning, the greater the selectivity.

Storage Battery—Battery which can be recharged at intervals whenever it is run down; a storage battery is employed to supply current for operating vacuum tube filaments.

Static, (See Atmospherics)—Disturbances of an electrical nature which are created by natural causes and which interfere materially with radio work. When static is exceptionally bad it may be impossible to receive radio telegraph signals or radio-phone service through the heavy crashes and frying sound of the static.

Transformer—Any device used in electrical and radio work for the transference of energy from one circuit to another, with or without a change in the voltage as desired. Thus we have Power Transformers, Amplifying Transformers, Telephone Transformers, Oscillation Transformers, Tuning Transformers, etc. All transformers have a primary and a secondary winding. The primary winding receives the initial current, which it passes on to the secondary winding, with the same voltage, a higher voltage, or a lower voltage, according to the ratio which the primary and secondary windings bear to one another.

Tuning—The act of altering capacity or inductive values or both in a radio circuit so as to bring the circuit into resonance with an external source of similar character. In radio receiving, the greatest signal strength is possible only when the combined inductance and capacity values of the receiver match those of the transmitter.

Undamped—A train of high frequency oscillations of constant amplitude such as continuous waves or C. W.

Vacuum Tube, (abbreviated V. T.)—In radio work this

term is applied to a glass tube exhausted of air and containing essentially a filament for the creation of electrons; a plate, positively charged, to which the electrons are attracted; and a grid, consisting of a helix of fine wire, inserted between the filament and the plate, for controlling the amount of electronic flow. This action of the vacuum tube plays three leading functions in radio work, namely, detection, amplification, and generation of high-frequency electro-magnetic waves.

Vario-Coupler—(See Coupler.)

Variometer—An instrument which serves to vary the inductance and wave length value of any circuit in which it may be used. It consists of a set of fixed windings and a set of movable windings, the latter being rotated on twin axis in the usual construction. When both sets of coils carry the current flow in the same direction, the variometer has the maximum inductance value or wave length. When the coils are turned around so that the current flow in both sets of coils is in opposite directions, the coils are said to be "bucking" each other and the inductance and wave length value are at a minimum.

Velocity of Waves—Radio, electricity and light waves travel through space at the speed of 186,000 miles per second, or 300,000 meters per second.

Volt, (abbreviated V.)—The unit of electric pressure.

Voltmeter—An instrument for measuring the voltage of a current flowing through an electric circuit.

Watt, (abbreviated W.)—The unit of electric power. To find power in Watts multiply voltage by amperage. 746 Watts equals one horsepower. 1,000 Watts equals one kilowatt (K. W.)

Wave Length—Radio waves in their passage through the ether, travel in undulating wave form similar to the waves at a seashore. When the wind is blowing hard and steady the distance between each wave crest is comparatively long while if the wind is blowing more

mildly and in short spurts, the distance between wave crests is accordingly shorter and we have short waves. In radio, substitute the wind for the transmitter and you have the same action, so to speak. Wave length is, therefore, closely related to frequency, *i. e.*, long wave lengths have low natural frequencies while short wave lengths have greater natural frequencies. In general, short wave lengths are used for short distance low-power work, while long wave lengths are employed for long-distance, high-power work.

The foregoing list by no means covers all the terms which will be encountered in radio, but it covers the more common and perhaps least understood terms confronting the layman at the very outset. As one gets along ever so little in the radio art, one accumulates a vocabulary of radio terms quite readily and with no effort.

After all, radio is a subject which one soon masters. It is relatively simple after the essentials are clearly understood. Furthermore, in no other line of endeavor will one find so much good fellowship and so many opportunities of receiving a helping hand. In all parts of the country there are radio amateurs who are ever ready to extend a helping hand to the novice, and one will do well to get in touch with the radio amateurs of the vicinity at the earliest possible moment. They are the greatest asset the novice has at his disposal. Furthermore, the radio and electrical dealers handling radio equipment are always ready to extend all possible co-operation and information to those in need of radio aid. It is part of their service; for, in purchasing radio apparatus, one is seeking a definite service rather than so much equipment.

The reader is advised to keep in touch with radio developments by reading the various periodicals devoted to the subject, as well as the radio sections of the various newspapers now paying special attention to the greatest hobby of the age. A real fund of valuable information can be picked up in this manner, especially after acquiring the very necessary fundamentals of the art, the imparting of which is the purpose of this book.

Chapter II.

RADIO-PHONE BROADCASTING— WHAT IT IS AND WHAT IT MEANS

“**L**ADIES and gentlemen, we take great pleasure in introducing Mr. Percy Grainger, the famous pianist and composer, who will entertain us this evening with several of his favorite pianoforte selections. After that, please stand by until 9.55 for the re-transmission of the Arlington time signals —”

A concert? No. A vaudeville performance? Hardly. A musicale in the home of a society leader? Not this time.

It is merely a bit of radio-phone service taken at random. Another time it might be Mme. Lydia Lipkovska, court singer to the late Czar of Russia, or Miss Valentina Crispi, violinist, or Miss Sophie Tucker, famous delineator of dinky and character songs. Again it might be Governor Edward I. Edwards of New Jersey, with his latest message, or Ed. Wynn and the entire company of “The Perfect Fool,” representing the first attempt to broadcast an entire theatrical performance; or Walter Camp, foremost authority in American athletics.

THE RADIO VOICE AND ITS AUDIENCE

Still again, at a different hour of the day, it may be the news of the moment, carefully selected and clearly heralded word by word; marine news, weather reports, children’s bedtime stories, health talks, business talks,

fashion talks, agricultural reports, Babson's statistical service, or the official time signals. For the radio-phone service is unlimited in its scope of subjects, just as it is virtually unlimited in the size of its audience.

But what is the radio-phone service? Where is it obtainable, and how? What does it cost? Why is it free?

Typical questions, these, at a time when radio is at the height of popularity. Only a short while back, the hobby of radio was indulged in by boys and young men, with occasionally a full-grown man, who, perhaps, were more fascinated by the technicalities of the radio art than by the actual feat of communication through space. Yet it is true that these enthusiasts, then as now, were carrying on radio conversations among themselves by means of the dot-and-dash language of the telegraph code; but it was certainly evident that they spent a goodly part of their time arranging and rearranging their radio transmitters and receivers in their insatiable ambition to span greater distances.

Then came the radio-phone service, not as an occasional thing to startle the radio amateurs already engaged in sending and listening to the dot-dash messages, but as a regular established practice. A subsequent development brought about a definite operating schedule and a pre-determined program, so that now the person with a radio receiving set knows what is in store for him tonight, tomorrow night, or even next Sunday evening. Radio-phone programs are printed and mailed to persons on the mailing list of the various organizations doing this kind of work.

In various cities throughout the country there are radio-phone broadcasting stations now in operation, which send out all kinds of information, talks, and music. With the proper type of receiving equipment it is now possible for any one to receive the radio-phone service from the nearest station, and, if there are several stations within receiving range, it is often possible to receive several radio-phone services, one by one, with absolute selectivity, although they may be operating simultaneously. That is to say,

with the apparatus properly tuned, one station may be heard; then, by slightly altering the tuning, another station may be picked up, and so on. Further tuning may pick up an amateur radio-phone transmitter or a commercial



The radio-phone receiving set finds a ready place in every progressive home. Many an hour can be spent listening to the musical programs, news of the day, weather forecasts, talks by prominent men, and other radio-phone broadcasting features.

station operating or "talking" in the dot-dash-dot language of the Continental telegraph code, or again a powerful transatlantic station transmitting its messages at an extreme rate of speed, thanks to automatic transmitters at

one end and the photographic or phonographic recorders at the receiving end.

Radio-phone broadcasting stations are sharply tuned; in fact, all radio-phone transmitters are sharply tuned; for, as we shall learn further on, this is one of the cardinal points in favor of the continuous wave transmitter, which is the basis of the radio-phone. Thus the utmost selectivity is obtained at the receiving end, and interference is reduced to a minimum. Indeed, the day is not far distant when a broadcasting station will be sending various services simultaneously, ranging all the way from a sermon to a jazz dance piece, and from a talk on economics to a fashion chat. The listener will merely have to tune his or her receiver to any one of several wave lengths in order to obtain the desired service at that time.

BACK TO THE HUMBLE BEGINNING

There is no end of romance in the story of the radio-phone, radio telephone, or wireless telephone, whichever you please to call it. It is an invention that came back, so to speak, in a big way after an ignominious career. Such a wonderful thing—this idea of speaking through space without wires, cables, tubes or other physical connections—was almost certain to fall in the hands of unscrupulous promoters, long before the serious, honest experimenters had had an opportunity of evolving something more than a crude, laboratory demonstration. So a dozen years ago we find the radio telephone nothing more than a crude device, making use of a sputtering, uncertain electric arc as the generator of the high-frequency energy. This high-frequency current, so uncertain as to be almost hopeless, was modulated or varied by means of some form of carbon microphone. This instrument, as any one familiar with its construction must know by now, is quite unsuited to the handling of heavy currents. It consists of little more than a mass of tiny carbon granules held between two carbon members. The passage of a heavy current through such a mass causes the carbon granules to fry or bake because of the heat developed through the imperfect contacts.



The kiddies take to radio quite as readily as the grown-ups. Several of the radio-telephone broadcasting stations are sending out special programs for the children, such as fairy tales, nursery rhymes, children's songs, and so on, twice a week or more. In this case the receivers from a pair of regular head-phones have been separated so as to accommodate two kiddies, while the third kiddy has another set of head-phones.

It was the good fortune of the author to participate in wireless telephony back in 1908 and 1909, with a transmitter of the Telefunken type made in Germany. A series of experiments were being conducted for the United States Signal Corps, with a view to proving the practicability of radio telephony in military communication. The distance to be spanned was some 18 miles, or the air line between Fort Hancock, Sandy Hook and Fort Wood, Bedloes Island, in the very shadow of the Statue of Liberty overlooking New York harbor. The high hills of Staten Island intervened, making communication between the two points all the more difficult.

For the transmitter we were using ten electric arcs, arranged in series and supplied with a 550-volt direct current. Each arc consisted of a copper tank, filled with water, and a large carbon button. The ten arcs were arranged in two banks of five arcs each, and each bank was struck or started at the same time by pressing a single handle controlling five arcs at a time. Three sensitive ammeters indicated the state of each circuit—the input circuit, the closed oscillating circuit, and the antenna circuit. The main object in this little game of wireless telephony was to get the three circuits, as reported by the meters, to behave—and what a job! No sooner was one circuit tamed, so to speak, so that the needle of its meter remained practically stationary, when attention would have to be given to the other two circuits whose meters were playing all kinds of antics. Then, at the moment when by mere chance all three meters were more or less steady, we were ready to talk.

There was little to say, because if we were heard at the receiving end, it was more of a miracle than anything else. So we simply shouted numbers into the huge horn connected with the carbon microphone—"One, two, three, four," and so on, followed by "Fort Wood, Fort Wood; how do you get me now? One, two, three, four," and so on again, until the meters began their antics once more. Occasionally we played a phonograph, just as did so many other radio telephone workers in the pioneer days.

The microphone was a renewable affair. The German builders of the apparatus, with all their characteristic thoroughness and fine workmanship, made the microphone in the form of simple cartridges which fitted into a holder at the small end of a long but narrow cardboard horn. Each microphone did not last much longer than five minutes after which it was little more than plain junk. While the author never knew the exact cost of these microphone cartridges, it is a safe bet that they cost at least \$2.00 each. Imagine wasting a \$2.00 microphone for every five minutes of uncertain telephonic communication!

INSURMOUNTABLE OBSTACLES THAT WERE FORGOTTEN

What of the results? Rotten, absolutely rotten! In all the long months of untiring efforts to work over the short eighteen-mile span between Fort Hancock and Fort Wood, the voice and the phonographic music only got through a half-dozen times, and then only for a few moments so that odd bits of conversation or music were heard by the Signal Corps officers gathered at the receiving end.

There were many workers engaged in solving the wireless telephone problem. Most of them used the arc generator, following in the footsteps of the Danish scientist, Poulsen. Some used high-frequency alternators, but the design of these early machines was such as to give a low degree of efficiency. Nothing like reliable communication seemed possible, for the technical obstacles were far too great and too numerous.

But all the while certain stock promoters were reaping a harvest. To them, the wireless telephone presented an exceptional opportunity. The ever-credulous public liked the word pictures of the wireless telephone as painted by the clever stock salesman. The story of the Bell telephone was to be duplicated, but on a larger scale; wireless telephones were to be installed in every home; wires and cables were to be done away with; every one would carry a wireless telephone about in one's vest pocket or hand-

bag, so as to ensure immediate communication with any one else, and so on. What a vivid picture, to be sure! Even at this late day, with the marvelous development that has taken place in wireless telephony, such a picture is quite out of keeping with what we can reasonably expect for decades to come. In fact, so long as the present system of wireless telephony is in force, it is doubtful if we can ever realize all the remarkable things that were promised to the gullible stock purchasers of but a decade or more ago.

Of course there were proofs. There had to be something for the public to take interest in this latest scientific development, especially to the extent of parting with so much hard-earned money. Thus there was a demonstration of the radio telephone between two of our cities. Everything worked to perfection. The results were absolutely wonderful. The public was enchanted, nothing less; but the true scientists and radio workers were completely baffled. Then, when certain interests were closely investigated, an unpaid bill for the leasing of a telegraph line between said two cities on a certain date, came to light. Needless to say, the date corresponded with that of the successful test of the wireless telephone. The inference is obvious.

Another time, it was a German company's turn to make a demonstration for the German army. The test was to be between Berlin and another city over one hundred miles away. Although nothing of much consequence had ever been done with this particular German wireless telephone system, on this occasion it worked like a charm. An inquisitive German officer, seeking some explanation for the sudden upward jump in the radius covered by the wireless telephone, not to forget the remarkable clearness and loudness of the received conversation, suddenly discovered a telegraph line running direct between the transmitting station and the receiving station. There was no physical connection between the two, please be sure to note; but the transmitting aerial was parallel to and but a short distance away from the telegraph line at one end, while the



At the transmitting end of the radio-phone broadcasting, showing how a singer and her accompanist are placed with relation to the special microphone transmitter. Successful broadcasting stations have spent a good deal of time studying microphones and acoustics in order to obtain the best results with their musical numbers.

receiving antenna was parallel to and but a short distance away from the direct telegraph line at the other end. As far as wireless waves are concerned, there could be little gained by having a direct connection. It was scarcely more than straight wire telephony, except for the short jump at either end. In fact, this form of wireless telephony has, strangely enough, come to be used during the past year or two for transmitting telephone messages over high-power transmission lines. It is also used in wire work in a somewhat modified form, being known as "wired wireless," as will be explained farther on.

WHEN A RIVAL BECAME A PARTNER

And skipping over the numerous attempts to make something out of this remarkable laboratory toy, the wireless telephone, we come to the time when the American Telephone and Telegraph Company took an interest in the vacuum tube perfected by Lee de Forest, as is explained elsewhere in this work. In the vacuum tube the telephone engineers realized that they had found a solution to many of their problems. The vacuum tube is nothing short of an electrical acrobat; it can do all sorts of tricks which no other electrical device has ever been able to perform. Thus it is a wonderful alternating current generator; feed it direct current and it gives forth alternating current of a wide range of frequencies. It is this characteristic which makes it available for wireless transmission purposes. Feed it alternating current, and it delivers direct current. This characteristic, just the reverse from the preceding one, makes it available as a rectifier for charging storage batteries, and, some day in the near future, as a substitute for the elaborate and costly rotary converter units now necessary in electrical transmission work, for converting alternating current used in high-voltage transmission, back into direct current of suitable voltage for commercial use. Feed it high-frequency alternating current, such as radio waves, and it converts them into audible pulsating currents which affect telephone receivers and thus are converted into audible sounds. That is how it is used as a detector.

Feed it ever so slight a fluctuating current, and it will control or modulate or modify a far more powerful current; thus we have the weak current moulding a powerful current, and it is this feature which gives us the amplifier. It is this characteristic, too, that makes the vacuum tube the finest telephonic relay ever devised. It is used in long-distance telephone communication, so that the voice currents, when greatly attenuated after traveling over hundreds of miles of wire, are brought to the grid member

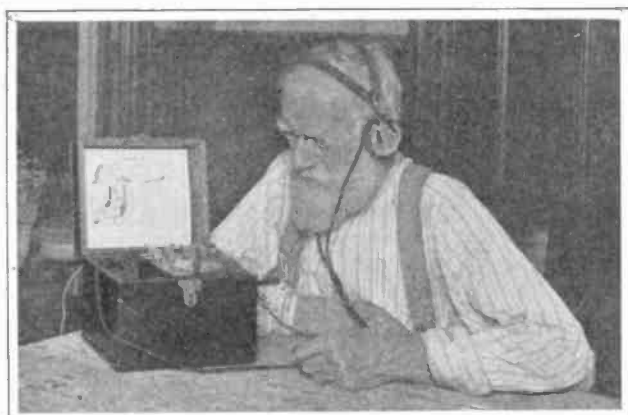

The farmer, using an inexpensive radio receiving set, can now keep in touch with the outside world. He hears the latest musical "hits," and he receives weather forecasts, crop reports, and other information of real value.

of the vacuum tube, and there serve to control a fresh and far more powerful current which starts off on the next lap of the journey, only to reach another vacuum tube when it in turn has become weak as a result of a long stretch. Again, the vacuum tube, because of its modulating characteristic, is the link between the carbon microphone or telephone transmitter of the ordinary kind, and the powerful currents of the radio telephone transmitter. At a stroke it eliminates all the troubles that seemed im-

possible of solution back in the early days of the wireless telephone.

It was in 1915 that definite progress was first recorded in the history of the wireless telephone, for it was during the latter part of that year that the engineers of the American Telephone and Telegraph Company succeeded in telephoning by wireless between Arlington, Va., and the Eiffel Tower, in Paris, or over a distance of three thousand miles. Over three hundred vacuum tubes were employed to generate and modulate the high frequency current employed to span the Atlantic expanse. During the same tests the voice was carried through space all the way to Pearl Harbor, in the Hawaiian Islands, or a distance of almost five thousand miles.

Do not forget that the stock promoters, back in the days when wireless telephony seemed so impossible to the really wise men, were telling us that the wireless telephone would be the great rival of the wire telephone. The wire telephone would certainly be put out of business in due course. Yet it was only when the engineers of the wire telephone came to take an interest in wireless telephony that this art made real progress. What is more, they developed wireless telephony to something practical; and the wireless telephone, in turn, gave wire telephony the vacuum tube and other valuable devices which made long-distance telephony practical. So instead of proving rivals, these two great means of communication have come to be partners, and always will remain partners.

THE RADIO LINK IN OUR TELEPHONE SYSTEM

Came the war, with still greater progress. Radio telephony on a small scale had to be perfected, because instant communication had to be made available between airplane units and the ground posts. When the United States entered the war, the best radio talent was put to work on this problem, with the result that the radio telephone in small units as well as large units, became a reality. Today it is possible to obtain a radio telephone of 5-watt rating capable of transmitting over a distance of five to fifteen



The "announcer" of a radio-phone broadcasting station, and the receiving operator. The announcer speaks into the microphone transmitter which he holds in his hand. Alongside of him is the radio-phone transmitting apparatus, with the vacuum tubes for generating and modulating the radio waves. This is WJZ, the Newark radiophone.

**WEEKLY PROGRAM
RADIO-PHONE SERVICE**

WESTINGHOUSE ELECTRIC & Mfg Co.
STATION W J Z. NEWARK, N. J.

MON., DEC. 12th. TO SUN., DEC. 18th. 1921.

This program can be heard by any one with suitable radio receiving apparatus within a radius of 100 miles of Newark.

The service is absolutely free.
Tune Instruments for 360-meter waves.

REGULAR CONCERT

DAILY, 8:20 to 9:25 P. M.

MONDAY - - - Mme. May Peterson, Prima Donna Soprano, Opera Comique, Paris

TUESDAY - - - Os-Ke-Non-Ton, Indian Baritone; Messrs. Bertram Haigh and Ralph Brown, French horns; Miss Anita Wolf, Pianist

WEDNESDAY - Mme. Gretchen Hood, Prima Donna Soprano, Theatre de la Monnaie, Brussels

THURSDAY - - Miss Helen Davis, Soprano; M. Cliff Young, Pianist

FRIDAY - - - Westminster Orchestra

SATURDAY - Darce music

SUNDAY - - Miss Ethel Mackey, Soprano and Miss Mary Emerson, Pianist. Sacred Music

OTHER FEATURES

General News - - Newark Sunday Call News Service, daily, 7:55 P. M.

Children's Hour - - "Man-in-the-Moon" stories, by Miss Josephine Lawrence

© Newark Sunday Call

Tuesday and Friday, 7:00 P. M.

Hourly News Service - - Newark Sunday Call; weekdays, every hour from 11:00 A. M. to 7:00 P. M. on the hour

Radio Amateurs' Night - - Thursday 7 P. M.

J. B. WALKER editor Scientific American

Weather Forecast (Official Gov't) - - Daily, 11:00 A. M., 5:00 and 10:03 P. M.

Marine News - - Marine Engineering Service, weekdays (except Saturdays), 2:05 P. M.

Official Arlington Time - - Daily, 9:55 P. M.



(Program subject to change)

One of the first programs of the radio-phone broadcasting service. Compare this program with one of the present programs reproduced on facing page.

miles, as well as a 500-watt transmitter capable of spanning 500 miles or more. The war made radio telephony what it is: it was not an ill wind, for it blew some good.

Today, the radio telephone is part and parcel of our wire telephone system, and it is fast becoming as practical in its true field as the latter. Indeed, were it not for the high cost of this form of communication, it would be quite within the scope of present achievement for any telephone subscriber to call up a relative or friend on an ocean liner several hundred miles out at sea, the voice being carried over the usual telephone line to the central office, through trunk lines to the distant radio transmitter, and thence transmitted through the air to the steamer. Two-way conversation could be effected, as with our usual telephone system. The radio link,

RADIO TELEPHONE BROADCASTING PROGRAM

New York City District

SUN., FEB. 12th, TO SUN., FEB. 19th, 1922

This program can be heard by any one with suitable radio receiving apparatus within a radius of several hundred miles of New York. The service is absolutely free. *Listen* instruments for hobbyists' waves.

Sunday

3 P. M.—Radio-Chapel services, "The Spirit of Lincoln in a Radio-Unified World", by Rev. Edgar Swan Wiens, D.D., assisted by the quartette—Mrs. Win. M. Rockwell, Mrs. M. S. Powell, Fred P. Taylor and George Reubaud; F. F. Eudham, organist—from the Unitarian Church, Montclair, N. J.

4 P. M.—"Abraham Lincoln", an address by Rev. Robert Scott Ingalls, of Newark, N. J.

4.30 P. M.—"My Country 'Tis of Thee", "Star Spangled Banner"; also several popular selections, including "Ty Tee", "All That I Need is You"; played by Paul Whiteman's Orchestra, from the Palais Royal, New York. Arranged through the courtesy of Leo Feist, Inc.

7.00 P. M.—Sacred Music played by the Aeolian Orchestrelle.

8.00 P. M.—"Listen to Me", "Sweet Lady", "Hawaiian Blues", and several other selections from Carlleton's Tangleline, by members of the Tangerine Company, accompanied by the Casino Theatre Orchestra. Arranged through the courtesy of Leo Feist, Inc.

Monday

2.20 P. M.—Ray Miller's Record Orchestra, assisted by Cliff "Ukelele Ike" Edwards.

8.15 P. M.—Miss Ethel Gow, contralto, who appeared in English Opera and Concert, and in Oratorio in England, under the direction of Sir Henry Wood.

8.45 P. M.—Gustav O. Hornberger, cellist of the Kaltenborn String Quartette, who appeared in concert with the leading orchestras of Europe as solo cellist under Von Bulow, Rubinstein, Weingartner and Richard Strauss. Mr. Hornberger will play a programme of selections by Golttermann, Chopin, and Moskowski.

Tuesday

7 P. M.—"Man-in-the-Moon" stories for children.

7.45 P. M.—"Tuberculosis, Influenza and Common Colds", a preventive lecture by Dr. Charles J. Hatfield, Managing Director of the National Tuberculosis Association.

8.00 P. M.—An address on radio by Paul F. Godley.

8.20 P. M.—A second recital to the radio-phone audience by Mme. Gretchen Hood, Prima Donna Soprano, Theatre De La Monnaie, Brussels; also of the San Carlo Opera Company, and prominent concert singer. Her program includes "Seger-bella" from Carmen, Bizet, and a group of ballads. Courtesy of Aeolius Company.

8.45 P. M.—"Clic Gelida Manina" from the Opera Boheme, Bucchini, etc.; by Charles Harrison, Tenor Soloist, Fifth Avenue Brick Presbyterian Church, for four years; studied with Frederick Bristol.

9.20 P. M.—Songs and readings by Mr. and Mrs. E. E. Holle, of Newark, N. J.

Wednesday

8.15 P. M.—Descriptive recital with music, of Verdi's opera, "Il Trovatore."

Thursday

7.45 P. M.—"Modern Health Problems", an address by Dr. Royal S. Copeland, Commissioner of Health, New York City.

8.00 P. M.—"What is a Rotary Club and What Are its Relations to the Public" by Allan Smith,

THURSDAY (continued)

Ex-President of the Newark Rotary Club. Also a rotary song by Andrew Krenrich.

8.20 P. M.—Classical music.

8.20 P. M.—A program of songs by Janet Bush-Hecht, contralto soloist, First Congregational Church, Montclair, N. J., and a prize winner in a Newark Music Festival Contest. The program includes "In Flanders Fields", "Would You," "Bubbles", and "Joyous Youth", composition, of Mabelanna Corby, who will be the accompanist for these and other selections. Courtesy, Aeolian Company.

Friday

7.00—"Man-in-the-Moon" stories for children.

8.15 P. M.—"Party Night", when several well-known artists of vaudeville and the musical comedy stage will entertain with songs and monologues.

Saturday

7.00 P. M.—Irv Pages Cornell Orchestra, Cornell University, composed of the following: Irv Page, banjo; Geo. Cox, banjo; Lyman Breeze, banjo; Sam Bird, traps and drums; Jack Wallace, saxophone; and Paul Miller, corno, banjo and violin.

7.45 P. M.—"Fashion Talks to Women", Marjorie Wells, N. Y. World.

8.00 P. M.—The "Daily Dozen" exercises address, by Walter Camp, foremost authority in American athletics.

8.20 P. M.—Dance Music by the Fernwood Dance Orchestra of Newark, N. J.

8.20 P. M.—Popular and character songs by Aileen Stanley, soprano, well-known in vaudeville circles.

9.45 P. M.—"Hello Prosperity", "Don't Leave Me Mummy", etc., by Max Histr, dramatic tenor, known from Coast to Coast.

Duo Art Piano Recital.

Sunday

3 P. M.—Radio-Chapel Services, Rev. Clarence H. Wilson, D.D., Glen Ridge Congregational Church.

4 P. M.—"Boys of the World", an address by C. R. Scott, State Secretary of Boys' Work, Y. M. C. A., Newark, N. J. Music by quartette including Miss May Korb, soprano soloist, South Park Presbyterian Church; Miss Marian Adams, contralto soloist, Church of the Redeemer; Bruce Campbell, tenor, and Louis Burke, baritone, Clifton Avenue Reform Church.

6 P. M.—Program of classical music by Mrs. Robt. Baldwin, violinist and Mrs. Ernest H. Harder, pianist.

7.45 P. M.—Sacred Music recital by the Aeolian Orchestrelle.

8.00 P. M.—Ed Wynn and the entire company of "The Perfect Fool", now playing at Geo. M. Cohan's Theatre, New York. For the first time in the history of radio an attempt will be made to broadcast an entire theatrical performance. Arranged by the N. Y. Globe.

OTHER FEATURES

Musical Program weekdays, every hour from 11 a. m. to 6 p. m., on the hour.

"FASHION TALKS TO WOMEN", Marjorie Wells, N. Y. World Saturday 7.45 P. M.

WEATHER FORECAST (official) - Daily, 11.00 A. M., 11.20, 4.00 and 10.21 P. M. sharp.

SHIPPING NEWS weekdays 8.00 P. M. (excepting Sat.) by Marine Engineering and Shipmate Ass.

BABSON'S Statistical Service, Monday, 6 P. M.

OFFICIAL ARLINGTON TABLE 6.00 P. M.

AGRICULTURAL REPORTS, Official, daily 11.00 A. M. and 4.00 P. M.

"MAN-IN-THE-MOON" stories by Miss Josephine Lawrence (Newark Sunday Call).
(Program will be announced daily by radio phone 7.45 P. M.)

A typical printed program of a single radio-phone broadcasting station. Such programs are mailed out to interested parties in order that one may know what to look for every evening of the forthcoming week.

as the radio telephone service is called when used in this manner, is destined to become commonplace within the next few years.

Now the foregoing is no mere flight of fancy. It is a matter of record that the American Telephone and Telegraph Company recently conducted a series of experiments with radio links and the trans-continental telephone line. Telephonic communication was established between the steamship "Gloucester," cruising off Deal Beach, N. J., and Santa Catalina Island, situated some thirty miles off the California mainland in the vicinity of Long Beach. The telephonic communication, in this case, passed from the "Gloucester" to Deal Beach, N. J.; from Deal Beach to New York via telephone line; from New York to San Francisco via trans-continental telephone line; from San Francisco to Los Angeles via telephone line; from Los Angeles to Long Beach via telephone line; and from Long Beach by radio to Pebbly Beach, on Santa Catalina Island, and from Pebbly Beach to the Avalon exchange. From ocean to ocean via radio, telephone line, radio again and telephone line, through all the various circuits without appreciable distortion!

The first commercial radio and connecting land toll line is the Santa Catalina Island and California radio link, which was set in operation the latter part of 1920. Radio telephone service between Santa Catalina and the mainland to connect up with the Bell system exchanges was installed at the request of the local telephone company. Catalina is one of the great tourist resorts in California. It attracts thousands of visitors daily throughout the year, who, heretofore, when they left the California mainland, remained completely isolated from the rest of the world until they returned to the mainland, except for the much overloaded naval radio telegraph station on the island.

That this radio link, which bridges the 31½-mile gap between the island and the mainland, is not in the experimental stage may be gathered from the fact that it handles hundreds of messages each day. The large amount of



Another radio-phone broadcasting station showing the announcer and the receiving operator. The transmitting apparatus appears at the left, behind the panels and kerrill work. This is KYW of Chicago.

commercial traffic with scarcely any interruption which the Avalon-Los Angeles toll circuit has carried since its inauguration is ample proof of the practicability of toll lines containing radio links, where, due to physical conditions, direct-wire connections are impracticable.

It is virtually impossible to delve deeply into the intricacies of the Avalon-Los Angeles radio link and wire circuit, since it involves the most elaborate telephone and radio engineering practice extant. Suffice it to state that the circuit consists of a little more than one mile of wire line from the Avalon central office to Pebbly Beach, a $3\frac{1}{2}$ -mile radio link to Long Beach, and 25 miles additional wire circuit to Los Angeles. This combination wire and radio circuit is operated as a unit, providing through telephone and signalling from Avalon to Los Angeles. At Avalon the circuit may be connected to any local subscriber's line, and at Los Angeles to any local subscriber's line, through local exchanges, or with other long-distance lines reaching practically any subscriber in the Bell system.

The radio link is a duplex system: one message may be sent in each direction simultaneously. For transmitting, a fair-sized aerial is employed, while for receiving a loop antenna is used at each end. These loops are of the solenoidal or helical type, six feet square, and consist of only four or five turns each. To make the duplex operation a success, it goes almost without saying that exceptional measures had to be taken, otherwise the transmitter at one end would drown out the incoming signals on the loop antenna but a short distance away. The elimination of such interference was attained by the use of different carrier frequencies for transmission in the two directions.

Great things can be expected of the radio link. Whereas it would otherwise be necessary for a person, desiring to telephone by wireless, to have a radio telephone transmitter of his own or to visit a radio telephone station, it now becomes possible to employ a distant radio telephone transmitter through any Bell system telephone. It is only

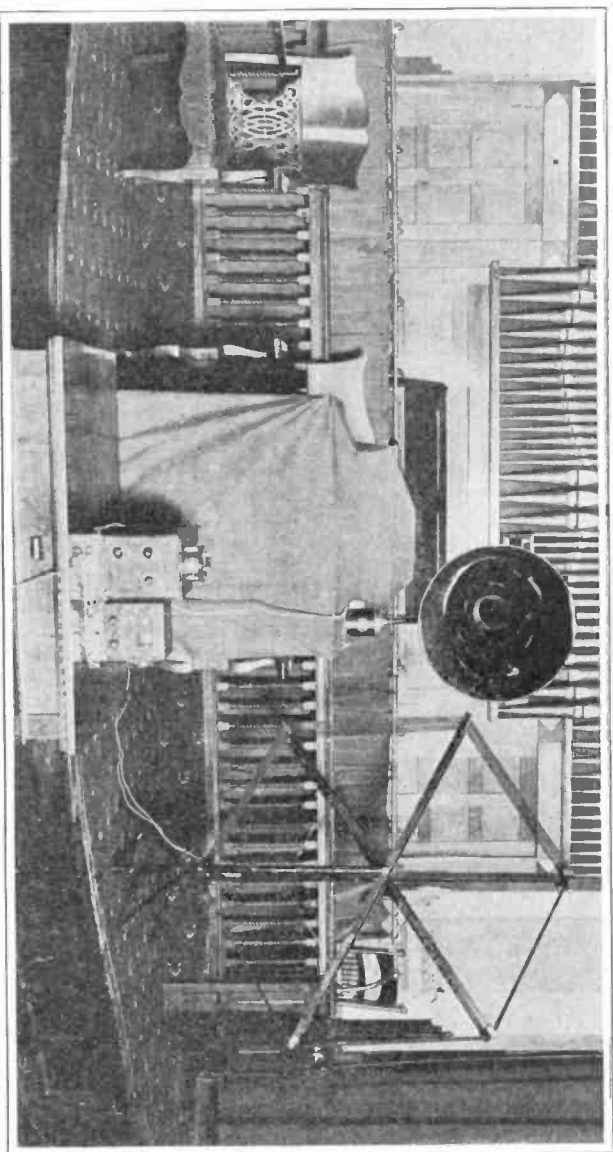

Radio receiving set installed in a Pittsburgh church in order to receive the church services and sermon from another church in the absence of the pastor. Note the loop antenna at the right, and the loud-speaker in the center.

a matter of time when we shall talk over our telephone lines to our friends at sea, thanks to the radio link, although this service will always of necessity be expensive.

HOW RADIO-PHONE BROADCASTING CAME ABOUT

But the average reader of this book will no doubt be more interested in the radio-phone broadcasting development, which is a later-day phase. Before this broadcasting service became a regular thing, there were spasmodic efforts to send out musical programs, made by several radio companies, but these were intended rather as tests than as entertainment for tens of thousands of listeners. The present form of radio-phone broadcasting dates back to the latter part of 1920, when the Westinghouse Electric and Manufacturing Company inaugurated the first radio-phone concert through its Pittsburgh station. Only a small number of persons heard the musical numbers sent out by KDKA, the Westinghouse station in Pittsburgh. The phonograph was the only source of music, and the operator's announcements sufficed for lectures and talks. The novelty of the feat was sufficient, of course, for the public had not yet been pampered, so to say. Problems arose over the manner and method of broadcasting, which had to be solved by experiment. There were many times during the first few weeks of broadcasting when the concerts were anything but pleasant to the ear. Then, as time passed on and through experience the operators found out for themselves the kind of phonograph records which transmitted clearly and those which did not, what to avoid in the way of speech, what pleased the public and what raised its ire, and the various other little details which made or marred a radio performance, the concerts began to pick up not a little.

During this experimental stage letters began to trickle in from various parts of the country, telling of the reception of music and talks from KDKA. At first, returns were small, and mostly replies from established stations, which are always on the lookout for new developments in radio. These stations, by the way, lose no time in

corresponding with other stations they hear. After a time letters began to come from persons who had only recently purchased receiving sets, perhaps after hearing the concerts at one of the amateur stations. These laymen increased in a steady stream and their number even at this writing increases steadily by leaps and bounds, Radio manufacturers are months behind in their production.

Practically all the broadcasting by KDKA was pioneering work. For instance, take the case of the radio church services. When the station was started, there was no program developed for Sunday evening. It was suggested that church services be tried. There was no precedent for this method of radio transmitting and consequently it was not known whether church services would broadcast well or, indeed, if the churches would consent to this method of handling their services. After some persuasion, however, permission was received from Calvary Episcopal Church of Pittsburgh, to broadcast its services. A district telephone line was installed between the church and the radio station for this purpose.

Four microphones were installed in the church, to catch the voice of Edwin J. Van Etten, rector of the church, the choir, the chimes, and the organ, and the entire services were first sent out January 2nd, 1921. No one thing ever broadcasted by the radio station has been so popularly received. Letters poured in by the score to the Radio Division, telling of the pleasure and benefit of this new department in radio. Newspapers all over the country carried editorial announcements of the fact that church sermons were being broadcasted from Pittsburgh through the medium of the radio-phone. This was the first effort of its kind; and it made the radio-phone safe for the future.

FROM CANNED MUSIC TO THE REAL THING

After a time, when the church services were well known to all radio enthusiasts because of the clearness of transmission, the Westinghouse Company was requested by

members of the Herron Avenue Presbyterian Church to install a receiving set and loud speaker to take the place of a long absent pastor. This was done, and the church assembled for an Episcopal service. But it listened to a sermon preached about fourteen miles away. This service, it goes without saying, was also a record, a milestone, if you please, since it was the first time two congregations in separate churches had ever worshipped to one service, when a distance of miles separated them. It was also the first time that a metallic horn ever took the place of a flesh-and-blood minister. Again, this feat, almost in the miracle class were it not for the fact that we have come to expect such marvelous things from modern science, attracted the attention of the press, with the result that more people than ever began to take an active interest in the radio telephone.

In the meantime phonograph records comprised most of the evening musical programs. It was decided to do away as much as possible with the "canned" music and substitute real singers and musicians. Talent was not hard to obtain for this work, in most cases volunteering its services. Human voices began to come over the radio telephone instead of records, and were an agreeable change. Again an improvement was made in radio broadcasting—another milestone. Not satisfied with having merely local talent, the Radio Division of the Westinghouse organization entered into an agreement with the managers of the local operatic concerts, with the result that when stars of the first magnitude came to Pittsburgh, their efforts, vocal and instrumental, were and are being broadcasted over hundreds of miles.

Not only in opera, but in the world of sport, the radio-phone service has been introduced. Casting about for features that would enliven the evening programs, it was decided to broadcast, as an experiment, blow-by-blow returns of a boxing match held in Pittsburgh. A private wire was installed from a boxing club to the radio station, and a man prominent in sporting circles engaged to render a round-by-round version of the progress of the

fight. So KDKA was the first broadcasting station ever to send out fight returns. Afterwards, the Dempsey-Carpentier bout in Jersey City, N. J., was broadcasted by a Radio Corporation station round by round.

But operatic engagements and boxing bouts do not cover the entire gamut of public interest. So to the existing features there were added the news of the day, weather forecasts, agricultural reports, and other items of general interest, not to forget the occasional addresses by prominent men.

In order to perfect the transmission of music and speeches by radio, the Westinghouse engineers have made considerable researches of the different frequencies of both. A studio has been built especially for the artists who sing, so that the radio-phone reproduction will be accurate. The studio in East Pittsburgh consists of a room 20 by 30 feet, completely lined with burlap and devoid of windows, so that there will be no reflection of sounds. A report is made of every song, where the singer stands, how far away from the transmitters, and other incidental details. This report is checked up later with a receiving station and from this data considerable information has been obtained regarding the transmission of various kinds of music. This is only by way of showing how the new art has had to be developed, step by step.

EXTENDING THE BROADCASTING AREA

So successful did the East Pittsburgh radio-phone station prove and so great was the interest shown by the public and reflected by the unprecedented and even undreamed of demands for radio receiving equipment that the Westinghouse organization set to work opening up other broadcasting stations. At Newark, N. J., on the roof of the Company's plant, there was installed a powerful broadcasting transmitter known as WJZ. Down on the first floor of the building there is an attractive studio, equipped with various musical instruments and hung with curtains to make it sound-proof. In this studio artists have been singing and playing, while speakers have

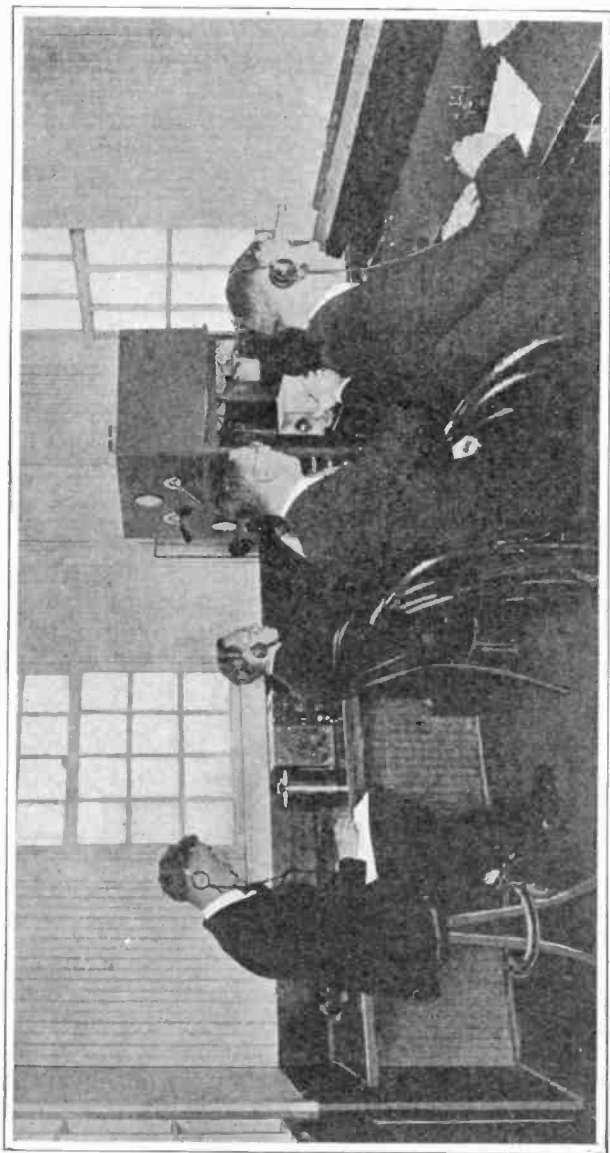

Still another radio-phone broadcasting station, showing the announcer and the receiving operators. This is KDKA of East Pittsburgh, Pa., the forerunner of all other radio-phone broadcasting stations in the United States.

delivered their messages, for the benefit of the greatest audience ever gathered at one time. It is estimated that over 300,000 persons hear the concerts and talks broadcasted by the Newark radio-phone station, and that the effective area covered by this service takes in one-tenth of our total population. The service of this station can be heard by anyone within a radius of 100 miles of Newark, though as a matter of fact reports of the reception of the musical numbers and talks have come from Canada, Wisconsin, Florida, Cuba, and 600 miles out at sea.

Then there is the Springfield station, known as WBZ, which supplies New England with the Westinghouse radio-phone service. Another station has been established in Chicago, known as KWY, and is intended for the Middle West and the Western States.

The Westinghouse programs are of a high order and provide a wide variety of entertainment. Thus the Newark station, WJZ, every evening from 8:20 to 9:15 broadcasts a concert with well-known operatic or concert stars frequently singing or playing in person. At 8:00 a digest of the day's news is sent out. An especially popular feature is the "Man-in-the-Moon" fairy tales for children. As this is written these bedtime stories are sent out on Tuesdays and Fridays at 7:00 p. m. The stories delight the youngsters all over the reception area. At many of these parties the children are ushered into a darkened room just before 7:00 p. m., and each is handed a telephone receiver connected with the receiving set. An illuminated moon lends atmosphere to the occasion. Suddenly, out of the silence, comes a voice—"Hello children, are you listening? This is the Man-in-the-Moon" talking. What do you suppose I saw today?"—and a wonder-story follows, interspersed with musical selections.

In addition, news bulletins are given out during the day, every hour on the hour; the official Government weather forecast is sent out three times a day; and the official Arlington time signals are made available for amateur receivers at 9:55 p. m., with the final dash at

10:00 sharp. Other features, such as election returns, bulletins of championship baseball and football games via direct telephone line from the fields, lectures by famous scientists, and so on, are given from time to time. These details are announced in advance over the radio-phone and are given in weekly programs issued by the Company. Indeed, it is the certainty of the present radio-phone service that makes it so interesting. One can look forward to some definite evening because the musical program of that evening happens to be of most interest. It is very much like going to a concert or vaudeville; for, while the actual performance cannot be seen, although it is clearly heard, this obstacle is perhaps more than counter-balanced in many instances by the fact that the audible side of the performance is brought right into the home.

The Springfield station, in addition to many of the foregoing-mentioned features, sends out a periodical talk to farmers about market and stock conditions. The complete transmission of grand opera from the Chicago Opera Company productions has been the feature of the recently established station on the Commonwealth Edison Building in Chicago. It is possible that the radio-phone in time will be as popular in the home as the phonograph is today. But its destiny rests entirely in the hands of those who supply the broadcasting service, to be sure.

Aside from the Westinghouse organization, there are other broadcasting stations. During the pioneer days of broadcasting the Radio Corporation of America's station at Roselle Park, N. J., known as WDY, did excellent work. At the time of this writing this station has been discontinued, leaving much of the broadcasting in the Middle Atlantic States to WJZ. The Roselle station was known for its operatic concerts, which included a lecture on the opera of the evening, together with the best selections from that opera. Then there were the radio parties, which were made up of songs, talks, dialogues, monologues and other vaudeville features.

There are various other organizations devoting a goodly part of their efforts to broadcasting radio-phone

news and concerts. In fact, as things stand at present it is safe to state here that virtually every part of the United States is covered by one or more stations. To give a list of stations is virtually impossible, for in an art that is so new there are bound to be frequent changes. Hence no attempt is being made to offer a list, because it would be hopelessly obsolete by the time it got into print. The reader is referred to the radio periodicals and to the daily newspapers that have radio sections, for the last-minute information on radio-phone stations.

As it is, the WJZ or Newark station of the Westinghouse organization is shortly going out of existence as this is being written. Word has gone out to the effect that the American Telephone & Telegraph Company, which is a factor in the Radio Corporation of America combine, is about to open a radio-phone broadcasting station on the roof of its 24-story building on Walker Street, New York City. Steel towers 100 feet high will support the aerial, and the station will be far more powerful than WJZ which it is replacing.

WITH AN EYE TO THE FUTURE

This radio broadcasting station will be unique in many respects. The distributing station is to be equipped with the latest developments of the Bell system, including the use of electrical filters and new methods whereby, as the business grows, several wave lengths can be sent out simultaneously from the same point, so that the listening station may receive at will any one of several services sent out at the same time.

The telephone organization will provide channels through which any one with whom it makes a contract can send out his own programs, just as the company leases its long-distance telephone wire facilities for the use of newspapers, banks, and other concerns. There have been many requests for such a service, not only from newspapers and entertainment agencies, but also from department stores and a great variety of business houses, according to a telephone official.

The station when completed will cover a territory within a radius of from 100 to 150 miles of New York City, and under particularly favorable conditions may be able to operate over a greater territory. It is estimated that more than 11,000,000 persons reside in the territory to be covered by the new plant.

This is a new undertaking, true, and the fact is fully appreciated by the telephone organization. If there should appear to be a real field for such service and it can be furnished sufficiently free from interference in the ether from other radio services, it will be followed as circumstances warrant by similar stations erected at important centers throughout the United States by the American Telephone and Telegraph Company. As these additional stations are erected, they can be connected by the toll and long-distance wires of the Bell system so that from any central point the same news, music or other program can be sent out simultaneously through all these stations by wire and radio with the greatest possible economy and without interference.

While it is entirely possible, as has been demonstrated, to talk across the continent or even for much greater distances over water by radio when all atmospheric conditions are favorable, such long-distance radio telephone transmission at present is not dependable and is not to be compared from a standpoint of service or economy with the transmission which is provided over wire. However, for a broadcasting service, which involves only one-way transmission, where the same message is given simultaneously to a great number of people within reasonable distances of the transmitting station, radio telephony offers a promising field for development.

Heretofore, the broadcasting services have been sent out at considerable expense by the companies operating radio-phone stations, without charge to the sender or the receiver of the messages or music. However, it is absolutely obvious that the interest created in radio has been multiplied thousands of times by the radio-phone service, and there has sprung up a demand for radio receiving

apparatus that has exceeded the wildest expectations. Radio manufacturers in many instances are months behind in their deliveries, and their greatest problem is production. This, mind you, at a time when practically every other line of business is searching every nook and corner for a buyer!

However, it must be obvious that this gratuitous service cannot continue indefinitely. A time must come when the radio market will be pretty well saturated, and it will no longer be attractive for companies to furnish free radio-phone service. No doubt by then the Government will be furnishing all kinds of news, such as agricultural reports, weather forecasts, official time signals, commercial reports, and so on by radio-phone, but there will still be a demand for musical entertainment.

So, the way it seems now, the radio-phone service of the future must be a cross between a special publicity service and a free program. There will be free service, the same as now; there will be musical numbers, news of the day, weather forecasts, and so on; but in addition there must be an occasional talk on the offerings of the leading department store, a subscription-getting chat by the editor of a large magazine, a campaign speech by a candidate for public office, and so on. It will be the toll charged for such broadcasting service that will pay for the radio-phone concerts and news. It must come to that, sooner or later.

Already department stores and others have planned and are going ahead with radio-phone transmitters, with the object of sending out entertainment, news, and their own particular brand of publicity. Interesting as this work may be, there is always a grave danger that it may be overdone. For, let it be remembered, there is only a limited amount of radio traffic that can be borne on the ether highways. It wouldn't take many radio-phone transmitters in any one locality to crowd each other so hard that a hopeless tangle would ensue. That is why the thought of radio-phone transmission, which is unfortunately so persistent with many amateurs and business or-

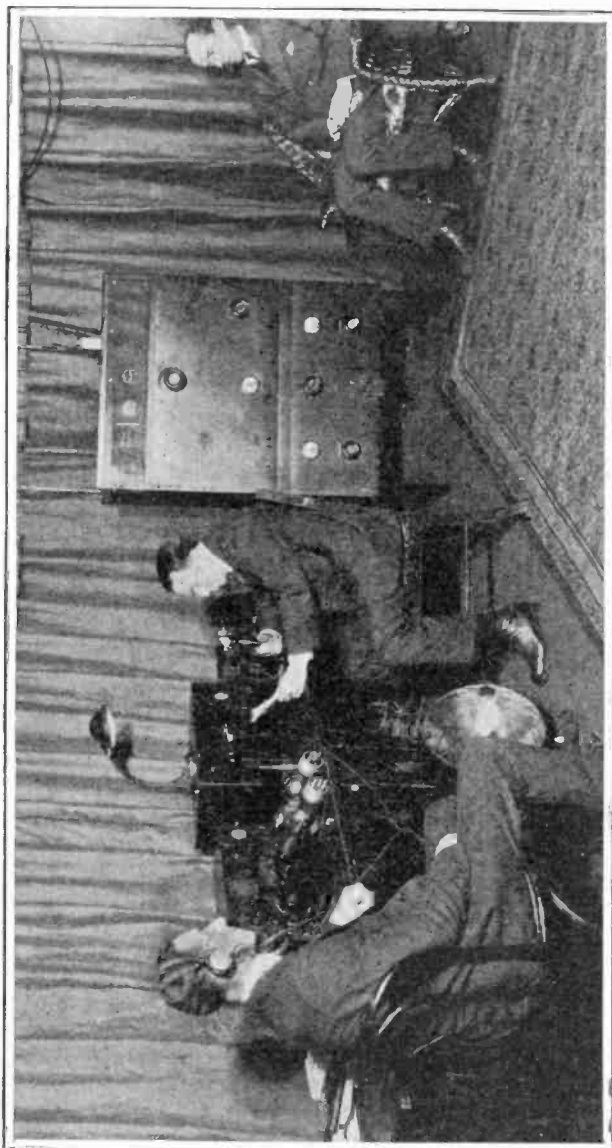

A corner of a radio-telephone broadcasting studio. Note how the walls, as well as the ceiling, are draped with curtains in order to absorb the sound waves and do away with troublesome sound reflections. The transmitting apparatus is enclosed in the cabinet shown in the center background. This is KDY of Roselle Park, N. J.

ganizations, must be discouraged, particularly in crowded areas. The ether must be kept free and clear for the better class of radio-phone services. It must and will be a survival of the fittest, for the Government must step in and see that only those with a real service to offer are permitted to travel the ether highways, so long as our present knowledge of the art affords but a limited number of available wave lengths with which to operate.

AND AT THE RECEIVING END

The radio-phone service of the present or the future is available to everyone provided with a suitable receiving set. All that is necessary is some kind of aerial, which for this purpose may be a single wire, elevated 20 or more feet off the ground, and running longer than 100 feet if possible. About 150 feet is the best length, and there is no decided advantage in running a longer wire for the reason that the wave length of the radio-phone services is generally around 360 meters, and it is best to have the natural wave length of the aerial as near this value as possible. With a much longer wire, it becomes necessary to insert a condenser in series, and this only reduces the efficiency of the aerial by that much. Hence 150 feet of wire is recommended. Aside from this simple aerial, a ground connection is necessary. For this purpose a connection may be made to a steam radiator pipe, water pipe, gas pipe, or to any object which is known to be connected with the ground in an efficient manner. In the country, where steam pipes, gas pipes and water pipes are not available, a good ground may be obtained by running a wire to a zinc or copper plate, and then burying the plate some six feet under the ground, in moist soil. Again, a wire may be connected to a pail which is lowered into a well or into a brook or lake.

As will be explained in detail further on, the receiving set to use depends entirely on the distance between the receiving station and the broadcasting station. Thus within a 25-mile range, a simple receiving set will do. Beyond this range and up to 50 or 75 miles, a better re-

ceiving set must be used, and it calls for a storage battery or large dry battery to operate the vacuum tube detector which then replaces the crystal detector used for shorter ranges. For still greater ranges, a vacuum tube detector and a vacuum tube amplifier unit must be employed, and the set then begins to mount up into considerable money. Even for short ranges, where a loud-speaking telephone is desired, an amplifier must be employed, for it is the amplifier which builds up the radio waves so that they can be converted into loud sound waves and heard throughout a larger room, thus doing away with the necessity of wearing the usual head 'phones.

There is nothing more fascinating than listening to the radio-phone concert and service. One turns the tuning handle of the receiving set: short and long buzzes, following each other in a lazy sort of way, indicate some amateur radio telegraph transmitter at work. The tuning handle is turned a little more, and a peculiar moaning sound is heard. Turned still more, the sound becomes a weak voice or music, and a final turning of the handle brings in the radio-phone loud and clear. The tuning is exceedingly sharp. A slight turn one way or the other throws out the radio-phone altogether.

The author, using a 60-foot wire as an aerial, running between the second floor of his house and a large tree, has been listening to the Newark broadcasting station evening after evening. In an airline, some forty miles separate him from the WJZ station, yet the radio-phone comes in loud and clear, using the vacuum tube detector only. With one stage of amplification, the sound is greatly increased, and with two stages it becomes possible to use a loud-speaker so that the radio-phone is to all intents and purposes on a par with the phonograph, and the head-phones become unnecessary. Still more remarkable, with certain atmospheric conditions it is possible to pick up the Pittsburgh radio-phone station just as loud as Newark, although under normal conditions Pittsburgh is only a trifle as loud as the nearest station.

It is well to mention here that the radio-phone receiver

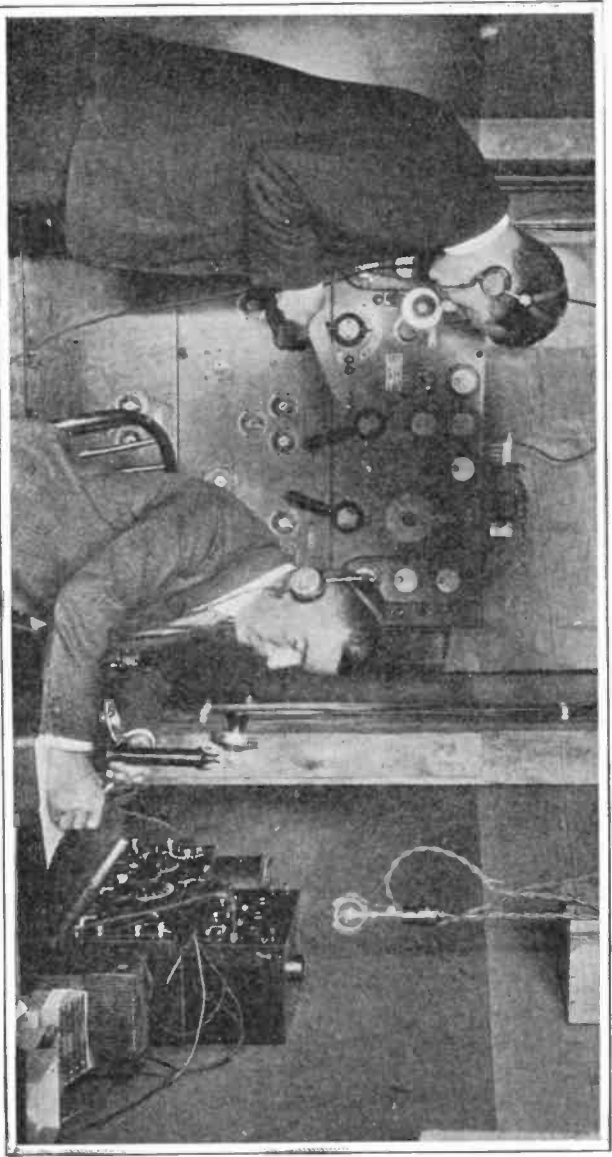

Broadcasting the results of a boxing contest round by round. The radio-telephone is at its best in work of this kind, and special efforts are being made to report all athletic events of surpassing interest in this manner. This photograph was made at the time of the Dempsey-Carpenter fight.

is subject to that *bête noir* which is dreaded by all radio men, namely, static, or atmospheric electricity. Static asserts itself by making all kinds of noises in the telephone receivers, ranging all the way from a frying sound to a loud scratch, which are most disagreeable and interfere materially with the radio-phone service. During the winter, the static is almost negligible, this being especially true during cold, dry winter nights. During the summer, however, especially with the super-sensitive radio receiving sets now employed, static is quite troublesome, although it is seldom sufficiently heavy to break up the radio-phone reception altogether.

The radio-phone is one of the greatest inventions of the age. It brings right into our homes the very information which we desire, and the best there is in music. Not so long ago an entire musical comedy was broadcasted, and the listener could almost visualize the performance. Even the dances were broadcasted, the actors wearing special shoes so that the sounds of their dancing could be transmitted. Imagine what the radio-phone means to the farmer, far removed from the city, yet at last in daily touch with the metropolis! And there are many others who know or should know how the radio-phone now makes life more interesting and more enjoyable.

Chapter III.

DOT-AND-DASH BROADCASTING: FROM MARKET NEWS TO TIME SIGNALS

TO the layman, of course, the radio-phone broadcasting is the only thing that counts. The dots and dashes that are picked up are meaningless. It may be interesting to note the different kinds of radio telegraph transmitters that can be picked out of the air; perhaps there is some interest in noting their relative strength; but from a truly practical standpoint, they have little value to the layman who has not as yet mastered the telegraph code.

However, aside from the radio-phone broadcasting service, there is an excellent radio telegraph broadcasting service now available in practically every part of the United States. It is known as the radio market news service of the United States Bureau of Markets and Crop Estimates and represents an effort on the part of the Bureau to make its market news more immediately available and more effective than it can be made in any other way. Ever since the inauguration of the first market news service on fruits and vegetables in May, 1915, the specialists of the Bureau have given continuous study to the problem of supplying market news on agricultural commodities to those who may have use for such information as quickly as possible after it can be obtained. The market news services of the Bureau cover live stock and meats; dairy and poultry products; fruits and vegetables;

hay, feed and seeds, and some other commodities associated with these four general groups. The information is supplied to and is utilized by producers, shippers, dealers, brokers and commission men, manufacturers, warehousemen, demonstration and extension workers, banks, transportation agencies, chamber of commerce, buying and selling organizations, and other commercial, extension and educational agencies.

GETTING THE NEWS TO THE PUBLIC

It is the function of the Bureau of Markets and Crop Estimates to gather or assemble market information from reliable sources and distribute it in such a way as to make it available to the greatest possible number who wish to use it. In performing this function it utilizes and cooperates with all agencies possible. It affiliates with State agencies which may or may not have similar functions with respect to the State as the United States Bureau of Markets and Crop Estimates has to the Federal Government. It utilizes the railroads for information relative to shipments and movements. In one way or another, it assembles information from every available source where such information can be obtained.

In utilizing radio communication as a means of disseminating crop and market information, the Bureau of Markets and Crop Estimates is taking advantage of one of the agencies which has certain possibilities possessed by none that has been used in the past. This new method makes it possible for all who wish this information to help themselves to it, if they will but equip themselves to receive it in the form in which it is sent. The advantages of broadcasting information by radio are (1) that the information can be intercepted or copied by means of suitable equipment at any point within certain approximate limits, whether or not such point is connected by railroad, telegraph or any other of the ordinary means of communication, and (2) that the transmission of the news is instantaneous. These two factors in radio communication make it possible for any one, whether he is located in a

congested city or in the country a hundred miles from the railroad or telegraph wire, to receive the information with equal dispatch. Radio transmission can be effected either by the international telegraph code, using dots and dashes, or by radio-phone. The radio-phone will probably present the most good to the greatest number. For the present, and for some time to come, so it seems, the radio telegraph mostly is used for this work. This necessitates, for the time being, at least, a knowledge of the Continental telegraph code, which can be readily acquired if one is but willing to devote a few months to intense study and practice. In another chapter we shall have more to say regarding the code and how it can be mastered.

GETTING THE CROP AND MARKET REPORTS

Crop and market reports sent out broadcast by radio can be received by any agency having suitable equipment. With the development of broadcasting by radio-phone, there is sure to be a demand for receiving equipment from many sources. Not much greater technical knowledge will be required to receive the reports by radio than to use an ordinary telephone.

In general, at present the broadcasted reports are being utilized by various marketing agencies in giving to farmers the national crop and market reports combined with local market information which is distributed in other ways, by county farm organizations or other local agricultural agencies acting as centers of information for the county or locality, and by banks, shipping associations, commercial exchanges, commercial clubs and newspapers, all of which may serve as agencies for secondary distribution of the reports. In addition, the reports may be received direct by farmers, country elevators, dealers, shippers, and many others who will use the information in the transaction of their business. The extent to which this latter class will receive market reports direct remains to be seen. It is certain, however, that the State and county radio receiving stations will be developed rapidly because of the economical reception and distribution of crop and market

reports through them. Certain individuals or a small group of individuals may find it advantageous to solicit the aid of radio amateurs in the community. This should be arranged for very carefully to ensure that the amateur is capable of receiving a true copy of the reports as broadcasted.

THE RADIO MARKET NEWS SERVICE IN THE MAKING

Since the radio market news service was begun experimentally by the United States Bureau of Markets, on December 15, 1920, it has developed very rapidly, so that at the present time the national market news is not only being distributed by the United States Bureau of Markets and Crop Estimates, but other agencies are extending the distribution of the national crop and market reports as well as local market reports. The service was started by the United States Bureau of Markets at Washington, on the date already mentioned. One report was sent out at 5:00 p. m. each day from that station. This was continued for four months to determine the practicability of the method. When it became apparent that this method would not only be practical but also more economical and efficient for certain kinds of distribution than any other agency, the Bureau of Markets took up the matter with the Post Office Department and accepted their offer to utilize the radio stations of the Air Mail Service in the dissemination of crop and market reports. At the present time, the larger part of the radio market news service of the Bureau is handled through the Post Office radio stations. Many of the agricultural colleges giving instruction in radio communication in connection with their departments of physics or electrical engineering, either alone or in cooperation with the State marketing agencies, have set up programs of broadcasting. These began with the dissemination of weather reports from the Kansas State Agricultural College in 1916. Crop and market reports are now being broadcasted from several other colleges. Some privately owned stations are also broadcasting the information by radio-phone or by radio telegraph.

The map on page 79 shows the location of the stations now broadcasting. The leased wire connections of the Federal Bureau are also shown. The leased wire service of the Bureau of Markets and Crop Estimates was established in 1916 and during the past six years as many as 17,600 miles of leased wire and 61 branch offices have been in operation. The leased wire has been used to carry reports from the markets, shipment information and reports from shipping points as to supply and demand, and f. o. b. prices. Even in its most extended form, the leased wire with the largest number of branch offices was never able to reach more than a small percentage of the people interested.

The function of the leased wire will not be changed or curtailed by the establishment of the radio method, but will still be the nucleus of an effective system employing wired telegraph and telephone as well as radio telegraph and telephone.

The Air Mail Radio Service of the Post Office Department was established primarily to give communication between the flying fields, in connection with the transportation of mail by airplanes. These stations have to be available for service a large part of the day but have considerable time which is not necessarily occupied in the business of the mail service. The market reports are sent out on schedules which are adapted to the unoccupied time at the stations. This incurs merely a nominal expense to the Post Office Department and inasmuch as the market information is obtained for other uses by the United States Bureau of Markets and Crop Estimates, the service as constituted at present incurs practically no additional expense to this Bureau. Because of the necessity of using stations not intended primarily for broadcast transmission but rather for interstation traffic it is not possible to organize as effective and complete a service as could be furnished by a chain of stations equipped solely for radio broadcast transmission. It is thought desirable, however, to take advantage of every facility at hand in order to obtain experience in handling market

news by this method and be ready to install a more effective service should special facilities be made available at a later date.

THE FORM OF CROP AND MARKET REPORTS

Certain types of market information can be put into a form for rapid transmission by use of standard forms and code letters. This does not involve the ordinary use of code words and the necessity of coding and decoding the messages received, but it does make necessary the sending and receiving of the reports on special forms. Inasmuch as the sender and the receiver use identical forms, it is possible by the use of code letters preceding each blank space in which information is to be copied, to transmit rapidly a large amount of information prepared in standardized form. By the use of such special forms and regular transmitting schedules a very effective service can be developed. This field has only been touched upon and great improvements undoubtedly will be developed in the handling of information in this way.

The receiving of reports by telegraph codes, using dots and dashes, makes it necessary that receiving operators understand the international (Continental) code and be able to copy at least 15 words a minute. Wherever radio telephone communication is established, it is necessary only that the operator be able to adjust the radio receiving equipment properly, since the telephone reports are reproduced in the radio receiving equipment just as they would be in a wall or desk telephone. Wherever it is desired to utilize the reports sent out by radio telephone, for publication or further distribution, they can be received and copied by a stenographer. At the present time only a few special forms of reports have been developed for use in radio broadcast communication. Others will be developed from time to time as the service grows and modifications of the present forms undoubtedly will be made.

In the forms already in use, two-letter code symbols are used to designate the information sent. These are used in two different ways: (1) A two-letter symbol is placed

at the beginning of the blank space which is to contain a certain type of information. The operator simply sends the two code letters and the information occupying the blank space. For example, in sending "New Jersey sacked Irish Cobbler potatoes per 100 lbs. in consuming markets, New York (SR) \$1.75-2.10," the operator would send only "(SR) \$1.75-2.10." Code letters are also used to designate certain options or alternatives to indicate types of information. For example "Demand for Wheat, Milling, Strong (DK) —, Fair (DL) —, Poor (DM) —." The operator would send (DK), (DL), or (DM), as indicating one of the three alternatives and the receiving operator would put a check mark in the blank space following the letters received. Fractions are avoided wherever possible, but when necessary are sent as follows:

\$1.50 is sent as 1R50.

\$1.50½ is sent as 1R50 and 1 DN 2.

⅞ of 1 cent is sent as 7 DN 8 cents.

65⅞ cents is sent as 65 and 7 DN 8 cents.

All this, it will be noted, is to avoid confusion and error, for if there should be any doubt about the figures, it goes without saying that the entire value of the reports would be rendered worthless.

A QUESTION OF CO-OPERATION

A number of States, through State bureaus of markets and State extension departments, are co-operating with the Federal Bureau of Markets and Crop Estimates in organizing their States to receive and utilize radio crop and market reports. In some cases they have established regular information centers which serve as distribution points for sending out the information through other channels. In other cases progressive agricultural counties have installed receiving equipment in connection with farmers' organizations so that the information will be available to the county agent for further extension either through the daily newspapers, telephone exchanges, or other agencies. For the present it is probable that the larger application of the radio service will be through

organizations or institutions which will obtain operators and equipment to receive the reports and distribute them or make them available to individuals or groups or organizations of producers. As the radio-phone comes into more general use, many of those engaged in producing or marketing farm products will undoubtedly obtain equipment to receive the reports directly as no special trained operator will then be necessary. In several States radio-phone equipment is being utilized so that the reports which are received in code over the leased wire or by wireless may be re-transmitted by radio-phone for the benefit of producers in the State.

There are many technical problems in connection with radio telegraphy and radio telephony that have to be considered in the dissemination of broadcast reports. The questions of wave length and kind of transmission are both very important. Although the amateurs are restricted to the use of 200 meters or less for transmission, a large percentage of them are equipped to receive messages over a much wider range of wave lengths. Questionnaires sent to a limited number of amateurs having radio transmitting sets show that about 50 per cent are now equipped to receive messages transmitted on wave lengths between 150 and 3000 meters. At first thought it would seem best to have the market reports transmitted on a short wave, but the lower wave lengths lack carrying power. The shorter waves have additional objections owing to interference. Since amateurs are licensed to transmit on the shorter waves, it would be very difficult for the one receiving market news to get solid copy—a complete and accurate copy of the message as sent—if several nearby amateurs were transmitting at the time the Post Office station was transmitting. Because of the greater transmitting range and the decreased interference, wave lengths of 2500, 3000 and 4000 meters are being used at the present time.

The stations from which the market reports are now being sent by radio, the type of transmitting sets, the wave lengths used, and the time at which the several reports are sent are given in the transmitting schedule that follows:

BROADCASTING SCHEDULE

Post Office Department Air Mail Radio Service

<i>Station and Call Letters</i>	<i>Nature of Reports</i>	<i>Form Used</i>	<i>Time of Transmission</i>	<i>Type of Transmission</i>
WASHINGTON, D. C.	Grain and Live Stock Fruits and Vegetables	43 60	Eastern Time 7:30- 8:00 p.m. 8:00- 8:30 p.m.	2500 meters arc (undamped)
CINCINNATI, Ohio	Live Stock Receipts Chicago Live Stock St. Louis Live Stock Cincinnati Grain Cincinnati Fruits and Vegetables	41 20 20 40 61	Central Time 9:30- 9:45 a.m. 11:00-11:30 a.m. 12:00-12:30 p.m. 2:00- 2:30 p.m. 3:00- 3:30 p.m.	4000 meters arc (undamped)
K D Q C	Chicago Live Stock St. Louis Live Stock	Press Press	4:00- 4:15 p.m. 4:30- 4:45 p.m.	
OMAHA, Neb.	Live Stock Receipts Chicago Live Stock Omaha Live Stock Kansas City Live Stock Grain	42 20 20 20 40	Central Time 9:00- 9:15 a.m. 11:00-11:30 a.m. 12:00-12:30 p.m. 1:00- 1:30 p.m. 2:00- 2:15 p.m.	2500 meters arc (undamped)
K D E F	Chicago Live Stock Kansas City Live Stock Omaha Live Stock	Press Press Press	4:30- 4:45 p.m. 7:00- 7:15 p.m. 7:30- 7:45 p.m.	

<i>Station and Call Letters</i>	<i>Nature of Reports</i>	<i>Form Used</i>	<i>Time of Transmission</i>	<i>Type of Transmission</i>
NORTH PLATTE, Neb.	Live Stock Receipts Chicago Live Stock Chicago Live Stock Kansas City Live Stock Omaha Live Stock	42 20 Press Press	Central Time 9:30- 9:45 a.m. 12:00-12:30 p.m. 5:00- 5:15 p.m. 8:00- 8:15 p.m. 8:30- 8:45 p.m.	4000 meters arc (undamped)
ROCK SPRINGS, Wyo.	Live Stock Receipts Chicago Live Stock Chicago Live Stock Kansas City Live Stock Omaha Live Stock	42 20 Press Press	Mountain Time 9:00- 9:15 a.m. 12:00-12:30 p.m. 4:30- 4:45 p.m. 8:00- 8:15 p.m. 8:30- 8:45 p.m.	3000 meters arc (undamped)
ELKO, Nev.	Live Stock Receipts Chicago Live Stock Chicago Live Stock	42 20 Press	Pacific Time 8:30- 8:45 a.m. 12:00-12:30 p.m. 4:00- 4:15 p.m.	3000 meters arc (undamped)
K D E J	Live Stock Receipts Chicago Live Stock	42 20 Press	Pacific Time 9:00- 9:15 a.m. 1:00- 1:30 p.m.	3200 meters arc (undamped)
RENO, Nev.	Live Stock Receipts Chicago Live Stock	42 20		

Notice of any changes in this schedule will be broadcasted in connection with the radio reports for one or more days prior to the date such changes become effective.
Copies of the forms indicated may be obtained by addressing the U. S. Bureau of Markets and Crop Estimates, Department of Agriculture, Washington, D. C.

The arc stations, it is interesting to note, usually have a greater transmission range than the spark stations. Furthermore, it should be borne in mind that spark stations transmit damped waves and the arc stations transmit undamped or continuous waves. This information is necessary for the selection of the proper receiving sets, and more will be said about this matter in the chapter on receiving apparatus.

WHY RADIO TELEGRAPHY IS USED AT PRESENT

The subject of radio telegraph and radio telephone transmission has been touched upon before. All things being equal and in readiness, radio telephone transmission would be the logical method to use. At present, however, it might be quite difficult to purchase reliable, high-power radio telephone equipment on the commercial market, so claim the authorities; furthermore, if the Bureau of Markets and Crop Estimates had waited until the high-power telephone transmitter had become commercially available it would not have made the year or more of gratifying history which the service now has. After the broadcasting of market news by radio telegraph was shown to be practical it was decided to use the radio transmitting stations of the Air Mail Service which were already installed and in operation. This forms the first chain of information-disseminating radio stations without the delay and cost of constructing new ones. It is probable that these and other like ones will remain the master stations for some time.

Furthermore, when the Bureau of Markets and Crop Estimates is successful in its work of getting the various States, country and private organizations to equip themselves to receive the radio telegraph market reports, great advancement will have been made, for those stations will be ready to rebroadcast the reports by radio telephone when that system can be installed. In other words, a radio receiving station that will pick up the telegraph messages from the ether will, without any alteration, pick up the radio telephone messages as well.

The Bureau of Markets and Crop Estimates is undertaking to establish on an efficient basis the radio market news service. There undoubtedly are many obstacles in the way of making it an immediate, complete success, but so far as these have been considered up to the present time, they are not insurmountable and it is thought that with the radio operators located over the country who are trying to receive the reports, it may well be that the Bureau will be able in a very short time to put the service on an entirely practical, substantial basis.

At the present time the Bureau is entirely dependent upon the co-operation of the Post Office Department in the dissemination of the reports and they are giving their heartiest assistance to the Bureau in this work. It will be some time before receiving stations will be distributed all over the country, receiving the reports regularly. A great many of the licensed amateur operators are receiving the reports and many of them are fully competent to do this. However, it cannot be considered as on a permanent basis until the State and county agencies have made provision for equipment and regular operators to receive the reports regularly. These are all controllable factors. The apparently uncontrollable factor which must be given consideration is the one of natural conditions, such as weather, strays and dust storms. These will be real obstacles, which in some localities and in some seasons will be found worse than in others. During midsummer, radio reception during daylight hours may be frequently interrupted. In fact, it may be impossible to receive the reports at times.

It will not be necessary for our immediate needs to discuss the probable reasons for these peculiar atmospheric conditions which interfere with radio reception. It is a fact, however, that frequently during the summer months the strays may completely drown out the radio signals picked up by the receiving set. The idea that higher amplification will relieve the situation is erroneous. The amplifier usually amplifies the strays along with the incoming signal, so the amplified signal is often less intelligible than the signal received on a simple detector. The

use of high-power transmitting stations is an advantage in this respect.

During storms it sometimes is not only impossible to receive any messages, but it may be unwise, especially if the storm is accompanied by lightning discharges. At such times the antenna should be grounded to protect the apparatus and no attempt made to receive radio messages. Although dust storms are not generally prevalent, they are to be reckoned with. Occasionally the transmitting range of a station will be limited in a certain direction owing to an intercepting dust storm. There are yet other difficulties, such as fading of signals, which must be encountered, but some of these are avoided by using the long

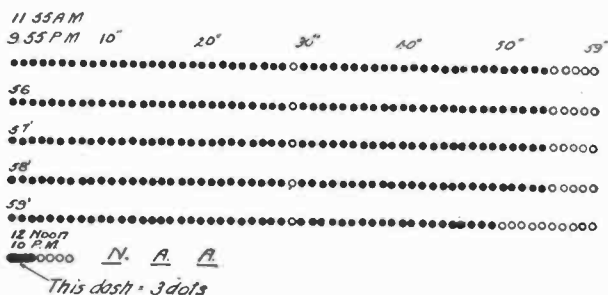

Diagrammatic explanation of the official Navy time signals as sent out by the Arlington station. These signals are re-transmitted by several of the broadcasting stations. Each black dot represents a transmitted dot, while the white dots represent spaces. The time signals start five minutes before 12 o'clock noon and 10 o'clock P. M. and follow the schedule here depicted, terminating with a dash on the hour, followed by a four dot space and the call letters "N A A."

waves. However, after taking all of these things into consideration it is quite probable that a high percentage of completeness may be anticipated in handling this kind of service.

FROM GENERAL NEWS TO TIME SIGNALS

Then there are other radio telegraph broadcasting services available to the owner of a receiving set. The most important of these is the broadcasting of time signals and

weather bulletins by the high power naval station at Arlington, Va. The time signals and weather bulletins are sent out twice daily on a wave length of 2500 meters, at 11.55 a. m. and 9.55 p. m. The signals begin at these times and the final dash is sent at 12 noon and 10 p. m. and are astronomically correct for the meridian of 75 degrees west of Greenwich.

The signals are sent out as follows: Beginning at 11.55 a. m. or 9.55 p. m. a dot is sent every second for the first thirty seconds, then one second is skipped, and beginning with the thirty-first second to the fifty-fifth second the dots are again sent, one each second. The last five seconds of the first minute are skipped, and the signals begin again at exactly the beginning of the fifty-sixth minute. The same schedule is maintained through the fifty-seventh and fifty-eighth minutes right through until the fiftieth second of the last minute is attained. Then comes a silence or blank for ten seconds, and the next dash is exactly 12 o'clock noon or 10 o'clock in the evening, as the case may be. The general scheme of the time signals is perhaps made clearer by studying the accompanying chart. This time is absolutely accurate and is employed by ships at sea for the setting of chronometers, and by progressive jewelers and others desiring an accurate time service. The signals are transmitted at Arlington, to be sure, but the dots originate in a master clock at the Naval Observatory.

No sooner are the time signals over than the Arlington station sends out the weather bulletin in code—a code, however, which is quite simple to understand. A weather bulletin, as sent out by Arlington, runs as follows:

QST de NAA, USWB, S01081—T02261—
DB0251 — H00844 — C01261 — K00441—
P1242.

All of which means, when reduced to plain English, that the letters stand for K—Key West, Fla.; S—Sidney, Nova Scotia; T—Nantucket, R. I.; DB—Delaware Breakwater; H—Cape Hatteras, N. C.; C—Charleston, S. C.; P—Pensacola, Fla.; B—Bermuda. The first three figures

following the letter are the barometer reading at the various places. Taking the first set of figures sent out, S01081, the figures 010 represent the barometer reading of 30.10 inches, and the next figure represents the direction of the wind, which happens to be NW in this case, since the numerals begin with 1 for North, 2 for NE, 3 for E, 4 for SE, and so on, as shown in the accompanying diagram, reading around the compass in the same direction as travel the hands of a clock.

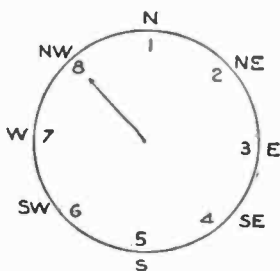

How numerals are used to indicate the points of the compass in connection with the direction of wind numerals used in the Arlington weather bulletins.

The last numeral means the velocity of the wind, and the following table gives the figures and their values in statute miles (1.15 nautical miles) per hour:

0—Calm	0 to 3 miles per hour
1—Light air	8 miles per hour
2—Light breezes ...	13 miles per hour
3—Gentle breezes ..	18 miles per hour
4—Moderate breezes	23 miles per hour
5—Fresh breezes...	28 miles per hour
6—Strong breezes...	34 miles per hour
7—Moderate gale...	40 miles per hour
8—Fresh gale	48 miles per hour
9—Strong gale	56 miles per hour
10—Whole gale	65 miles per hour
11—Storm	75 miles per hour
12—Hurricane	90 miles per hour

Now, therefore, take the code signal K00441. The K, it will be noted, stands for Key West; the figure 004 states that the barometer stands at 30.04 inches; the next figure indicates that the direction of the wind is South East, and the last figure, 1, represents the velocity of the

wind, which in this instance is light air, or a breeze having a velocity of only eight miles an hour.

The Arlington time signals and weather bulletins are sent on a wave length of 2500 meters. The call letters of this station are N A A, which are signed immediately after the final dash in the time signals. Fortunately, the weather bulletins are sent at a slow, even speed, so that a person with only a slight training in the telegraph code can copy down the letters and figures. It is well to mention here that the bulletins are sent out by automatic transmitter, so that the dots and dashes are perfectly formed.

Certain radio-phone broadcasting stations give out the time signals by radio-phone. This is accomplished by receiving the time signals from Arlington on a long-range receiving set, and then amplifying these signals until they are sufficiently loud in a telephone receiver which is held up to the transmitter microphone for retransmission via the radio-phone. In this manner the persons in the vicinity of the radio-phone broadcasting station can receive the time signals without having to tune up to the long wave length of the Arlington station. Furthermore, the radio-phone broadcasting stations receive the weather bulletins and broadcast them in plain English, which requires, of course, absolutely no knowledge of the telegraph code.

Time signals and weather bulletins are broadcasted by other naval stations. Thus the Great Lakes station NAJ, transmitting on 1512 meters, sends out time signals at 10 p. m. (90th meridian time). Also, North Head, Wash., San Francisco, Cal., and San Diego, Cal., transmit the time signals at 10 p. m. (120th meridian time), followed by the weather bulletins. The Pacific coast stations broadcast the information first on their usual working wave length, next on 952 meters, and finally on 600 meters. Reports from these stations are preceded by "USWBSF," the first four letters standing for "United States Weather Bureau" and the last two for San Francisco.

Weather reports from the Pacific coast stations are broadcasted at 8 a. m., noon, 4 p. m., and 8.00 p. m. Cape

Blanco broadcasts Tatoosh, North Head and Eureka weather after local report. At 8 a. m. and 8 p. m. Eureka broadcasts the 6 a. m. and 6 p. m. weather conditions at Farallones; Farallones, in turn, broadcasts the 6 a. m. and 6 p. m. weather conditions at Eureka, and 7 a. m. and 7 p. m. weather conditions at the Farallones.

Aside from the Atlantic coast abbreviations already given, the following are also necessary:

GREAT LAKE REGION

Duluth	DU
Marquette	M
Sault Ste. Marie.....	U
Green Bay	G
Chicago	CH
Alpena	L
Detroit	D
Cleveland	V
Buffalo	F

PACIFIC COAST REGION

Tatoosh	T
North Head	NH
Eureka	E
San Francisco	SF
San Diego	SD

Aside from the time signals and weather bulletins, there are various press broadcasting services operating from time to time. Some of these have the amateur very much in mind, and in consequence transmit the press items at a slow rate of speed. All in all, there is quite as much interesting news and general information to be obtained through the radio telegraph broadcasting as there is by radio-phone, although it goes without saying that the first can be received by any one without training of any kind, while the second presupposes at least a working knowledge of the dot-and-dash language of the telegraph.

FROM RADIO TELEGRAPH TO RADIO-PHONE

As this is being written word comes to us to the effect that Government information is shortly to be broadcasted

by radio-phone, this service taking the place of the present radio market news service of the United States Bureau of Markets and Crop Estimates, as described early in this chapter. A radio-phone has recently been installed on the top floor of the United States Post Office Building in Washington, D. C., and sufficient power is now available to broadcast Governmental messages to the public over a wide area. Governmental information—data assembled by the various departmental bureaus relating to farming, fruit-growing, lumbering, mining, and general knowledge—is being distributed throughout the United States. Congress is being urged to establish a "Bureau of Communication" in the Post Office Department, appropriating \$500,000 annually for its maintenance, thus designating a clearing house for the broadcasting of knowledge of a varying nature by radio, catering to the diverse interests of 110,000,000 citizens.

The abandonment of radio telegraphy in favor of radio-telephony as a vehicle for the transmission of weather and market information, which service was introduced April 15, 1921, marks the advent of a hitherto unprecedented popularity for the distribution of Governmental data by radio communication. Radio telegraphy, after eight and one-half months of practical application, proved to be too specialized in nature, involving, as it does, a knowledge of the international telegraph code for use as a medium of circulating weather forecasts and the fluctuating tendencies of the markets. Hence the decision to adopt radio telephony as the distributing vehicle, the operation of the radio-phone being little more complicated than the use of a common telephone, a sewing machine, or phonograph. It is contemplated that instant and almost universal popularity will be accorded the latter system.

The present installation in the Post Office Department Building at Washington is the first unit of its kind to be placed in operation, and claims to novelty may be advanced with regard to its mechanism. This wireless telephone puts 14 amperes into the antenna at 1160 meters wave length, which is a goodly amount of radio energy, as radio transmitters go. The modulation of the voice is

said to approach perfection. Preliminary tests have succeeded in flinging the voice, so to speak, as far west as Bryan, Ohio, and southward to Atlanta, Georgia, distances exceeding 1,000 miles. The transmitter is quite flexible, so that the service may be varied to suit varying operating conditions if necessary.

Contingent upon the will of Congress in appropriating the requested \$500,000 for establishment of a "Bureau of Communication," the service will be extended in its reach as well as expanded in nature. Isolated areas, as well as frequented points in the United States, will be visited by this hurry-up method of spreading the news. At present there are eight radio stations, as already described, originally established in conjunction with the transportation of mail by airplane, used as distributing agencies of market and weather reports. These are located at Washington, D. C.; Cincinnati, Ohio; Omaha and North Platte, Neb.; Rock Springs, Wyo.; Elko and Reno, Nev. Radio-phone stations in prospect, by reason of the expansion of the service, will be located in Georgia, Texas, California, Montana, Illinois and at some point in the New England States. A survey being conducted by the Post Office Department will determine the exact locations of these information-distributing stations.

The Post Office Department voices the belief that the widespread dissemination of Governmental knowledge will not only prove of economical value to a varied citizenry of the United States, but will serve as a leavening process in Americanizing the increasing element of foreign population in our midst. The Post Office Department will not only give circulation to market news and weather forecasts, in the event that Congress sanctions an enlargement of the service, but the different Government bureaus will be drawn upon for facts pertaining to discoveries and developments that will serve the diverse interests of the farmer, miner, rancher, fruit-grower, forester and lumberman. Then, too, the public in general can appropriate to advantage much of the information circulating through space by reason of its practical value and entertaining quality.

Chapter IV.

RECEIVING EQUIPMENT AND THE INTERCEPTION OF RADIO WAVES

THERE is nothing complicated about radio reception. The apparatus may be of the simplest sort, if the distance to be spanned is relatively small; virtually no experience is required, for anyone can turn the few knobs and adjust the detector; no licenses are required, and anyone can intercept radio waves without formality of any kind; and the cost is low, considering the wonderful possibilities of a radio receiving set. It is only when one desires to span great distances and to have the dots and dashes or the radio-phone music amplified so as to be heard throughout a room, without the use of the usual telephone head set, that the cost mounts up. Even so, the cost is still no greater than that of a good phonograph, and certainly less than half the cost of a low-priced automobile. After all, it is a question of what is expected of the receiving equipment, and successful results demand that the receiving equipment be fitted to the requirements.

ESSENTIALS OF RADIO RECEPTION

No matter how simple a receiving set may be and how modest the requirements, there are certain essentials which must be provided. Thus we have:

First—One or more wires elevated from the ground and properly insulated, to form the antenna or the aerial. The purpose of the antenna, or aerial, is to intercept the radio waves and to convey them to the receiving apparatus.

An alternative to the aerial is the loop, which is simply a large frame with several turns of wire, which may be used indoors with fair results.

Second—A good connection with the ground, which may take the form of a connection with a gas, water, or steam pipe. In the absence of any one of these pipes, such as in remote country districts, a good ground may be obtained in other ways, as described further on. Again, the ground may take the form of an insulated network of wires, placed below the aerial but elevated from the ground by a few feet. Such a ground is known as a counterpoise, and is frequently used. No ground is required when a loop is employed instead of an aerial.

Third—A means of altering the wave length of the aerial circuit and the receiving apparatus, so as to intercept and detect any desired radio waves to the more or less complete exclusion of undesired waves. Tuning is accomplished by a wide variety of instruments and methods, as will be explained.

Fourth—A means of changing the frequency of the incoming waves from radio frequency to audio frequency so that they may be heard. The instrument that accomplishes this result is known as the detector, and is of the crystal type or the vacuum tube type.

Fifth—A companion instrument to the detector, which takes the audio frequency current delivered by the detector, after the latter has converted the radio frequency into audio frequency current, and makes it audible to the human ear. This instrument may be any form of telephone receiver, ranging from the single receiver to the head set and to the loud-speaker.

The first step, then, is to consider the aerial or antenna for receiving purposes. While the same aerial or antenna may be used for both receiving and transmitting purposes, as a general thing these purposes are by no means interchangeable if really efficient results are desired. Thus the ideal antenna for receiving—antenna, by the way, is a happier term for the receiving end than aerial, the latter applying more particularly to transmis-

sion work—is a single wire, insulated at both ends, elevated some 20 or more feet from the ground and measuring 150 feet in length. A shorter wire makes for a lower efficiency, while a longer wire, strange as it may seem, also detracts from the receiving efficiency. The reason for this is that the wave length of the aerial should be as nearly as possible that of the radio waves to be intercepted. Otherwise, in the case of a shorter wire, it is necessary to add inductance in order to bring up the wave length, and such inductance means some loss of energy. Furthermore, a shorter wire will not intercept as much of the radio waves as a longer one. Now, on the other hand, a longer wire intercepts more of the radio

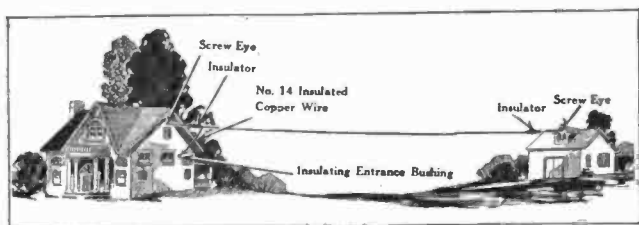

How a receiving antenna may be installed in the country. The single wire may be run from the house to a barn, tree, clothes pole or other support.

wave, but it is necessary to use either a variable or fixed condenser in series with the antenna in order to bring down the wave length, and such practice means a loss of energy. Of course, we are considering the receiving set on the basis of amateur and radio-phone reception. If one desires to receive the long-wave commercial stations, a longer wire is quite satisfactory. Indeed, for the best kind of work it may be well to have several antennæ, arranged for various classes of service.

THE AERIAL AND THE GROUND FOR RECEIVING

As for the kind of wire to use, there is considerable latitude; indeed, in this general subject of antennæ for receiving purposes there are no fixed rules to go by.

Various kinds of wire are used, among these being plain aluminum wire, which has the advantage of being exceedingly light and quite low in cost; plain copper wire, which, of course, is an excellent conductor, although somewhat costly, especially in the larger sizes; hard-drawn copper wire, which has all the advantages of plain copper, plus greater strength; copper-clad steel wire, which has great strength coupled with good conductivity; stranded phosphor-bronze wire, which has long been the standard aerial wire in commercial and Government work; and annunciator or bell wire, which is insulated. The last-mentioned

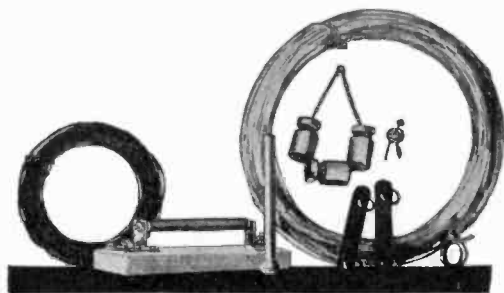

Materials with which to erect the antenna, comprising a coil of bare copper or copper-clad steel wire, insulators, ground clamp, insulated wire for lead-in, porcelain tube to insulate lead-in passing into building, and a lightning arrester.

wire may sound freakish and merely an improvisation; but as a matter of fact the insulation makes little difference. Why? Simply because if the insulation were not there, the space immediately surrounding the copper wire would be taken up by air, and the air is about as much of an insulator as the usual cotton and paraffin insulation. Hence it makes little difference one way or the other, and annunciator or bell wire recommends itself in many instances because it is so easy to obtain. A pound of No. 18 wire is sufficient for a good single-wire antenna.

Aluminum wire is not recommended very enthusiastically by the author. Back in the early days of amateur

radio, when we used to spend our hard-earned money by the cent rather than by the dollar, aluminum wire was widely employed because a good many feet of it came with each pound. However, it has not the conductivity of copper by a good margin, and even when using No. 14 size it is not as good as No. 18 copper. Furthermore, it is difficult to solder aluminum wire joints, yet they should be soldered. If the joints are not soldered, water gets into them and oxidizes the aluminum wire. The oxide takes the form of a white crust, and is of such high resistance that it reduces the efficiency of the antenna materially. Hence aluminum wire should not be used except where cost is a prime essential, and even so, a small sized copper wire is preferable.

Copper-clad steel wire is almost as good as solid copper, and costs considerably less. It is the kind of wire that is supplied with the usual antenna equipment as sold by wireless dealers. Hard-drawn copper wire of No. 12 or No. 14 guage is satisfactory for antenna construction; however, stranded silicon bronze or phosphor bronze wire is more durable and will stand greater strains.

Now then, having selected the wire, the next step is to erect the antenna. Supports are sought, since for receiving purposes the height of the antenna is not so important and the antenna may be supported by any suitable object, such as a house, tree, flag-pole, clothes-pole, and so on, making masts or supporting towers unnecessary. If possible, the wire should be horizontal, which means that the supports at both ends must be of the same height.

It is necessary to insulate the antenna wire. This is done by placing little porcelain knobs or porcelain cleats, such as are used in exposed electric light wiring, at each end of the wire, as shown in the accompanying sketch. Such improvised insulators will serve quite nicely for ordinary installations, but if the antenna is apt to be subjected to considerable strains from high winds as well as coatings of ice, it may be well to substitute regular antenna insulators. These take the form of special moulded electrose insulators, with heavy galvanized rings

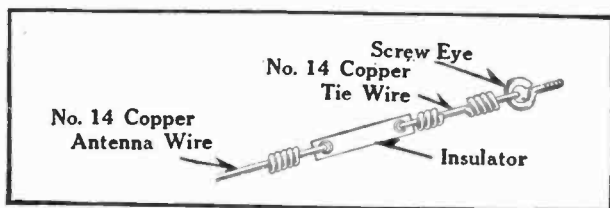

Simple way to insulate and fasten the farther end or free end of a single wire antenna.

moulded right into the brown insulating material. The insulator proper is provided with many deep grooves, so as to lengthen the surface of the insulator and therefore increase its resistance to leakage or loss. Small electrose insulators will do for the receiving station, if placed at the ends of each antenna wire, between the wire and the support.

Another popular form of antenna insulator is one made

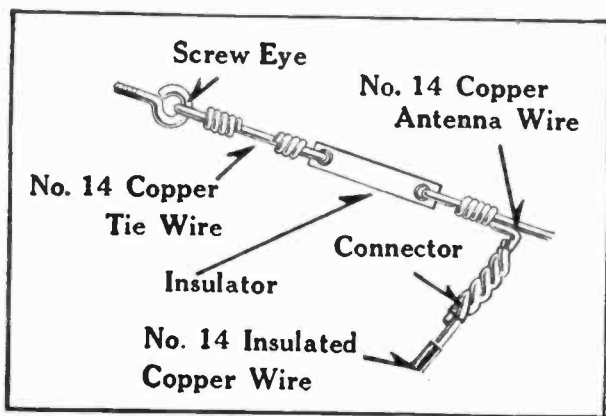

How the nearer end or lead-in end of the antenna is fastened and insulated. The lead-in wire is fastened to the antenna wire by means of a connector, or is soldered so as to insure a perfect and lasting joint.

of micarta, with a metal lined hole at each end. This kind of insulator is supplied with an antenna equipment now on the market, and has the advantage of considerable mechanical strength with good insulating properties.

In the country the erection of the antenna is a simple matter, for there are virtually no restrictions such as one encounters in the crowded city. Thus the antenna wire may be run from the roof of the house to the roof of the barn, or even from the second floor of the house to the roof of the barn. If no barn is available, then the farther end of the wire may be supported by a clothes-pole or tall tree.

The author, while this book is being written, is using a small antenna consisting of a single wire about 60 feet long, running from the third floor of a frame house to a tree in the yard. The antenna, made of No. 18 annunciator or bell wire, is about 40 feet high at one end, and certainly not over 10 feet at the farther end. While this antenna is an improvised one and is to be replaced by a single length of hard-drawn copper wire, some 150 feet long, running from the house to a taller tree than the present one, it has proved quite satisfactory for receiving the radio-phone service from the Newark station, about 45 miles distant, and the radio-phone service from the Pittsburgh station, considerably more than 400 miles distant. However, the less efficient the antenna happens to be, the better must be the receiving equipment. The Pittsburgh station ordinarily is received by the author with one stage of amplification, and when the atmospheric conditions are unfavorable, two stages of amplification must be employed. The Newark station is generally heard with the vacuum tube detector alone, although one stage of amplification makes it more enjoyable.

In the city, the antenna presents a problem. What with congested conditions and a none too obliging landlord, the radio enthusiast is often forced to resort to a little strategy. The author, only recently a resident of the suburbs, traveled a rather thorny path in pursuit of radio while residing in New York City. One antenna after

another was removed by a highly militant janitor, carrying out the instructions of an overbearing landlord. The antennae took all kinds of forms, ranging from single wires

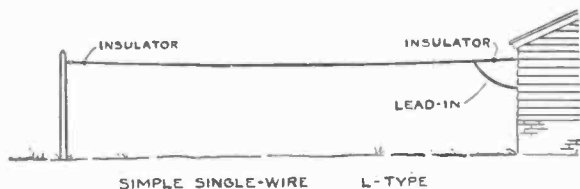

How the L-type single wire antenna is installed. Such antennae should not be shorter than 60 feet and not longer than 150 feet for best results in the reception of short waves such as are used in amateur and radio-phone work.

running from one house to another across a court or large open space, to a number of wires supported on poles or supported by the dumbwaiter houses on the roof. Finally, the author simply ran a single wire down a chimney, from the roof to the cellar, a distance of about 75 feet. This wire was never detected, and it was tapped in the kitchen of the apartment, through a flue that led into the chimney. A poor antenna at best, it served to receive the Newark radio-phone service some 15 miles distant.

All sorts of improvisations may be resorted to when an outdoor antenna is not practical. A metal bedstead, the

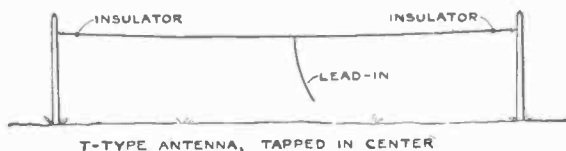

Arrangement of a T-type single wire antenna. When the antenna runs longer than 150 feet, it may be desirable to tap it in the center for the lead-in, provided the lead-in can be dropped straight down to the receiving apparatus.

telephone line with a fixed condenser in series, the bell wiring of the house, the fire-escapes, an indoor antenna of any shape and size—all these improvisations are possible for nearby signals.

So far, only single wire antenna have been dealt with. The wire is tapped at one end by another length of wire leading to the receiving instruments. This second wire is called the lead-in, and it is preferable to have it of insulated wire, so that if it touches a wall or roof coping or other object there will not be the leakage that would occur with bare wire.

But supposing the antenna is stretched over a greater distance than say 125 or 150 feet, and the receiving station must be located near the middle of the span, then what? Simple enough. The antennae so far described are called the L-type, because the antenna proper and the lead-in form an inverted L shape. If the antenna is to be 200 or

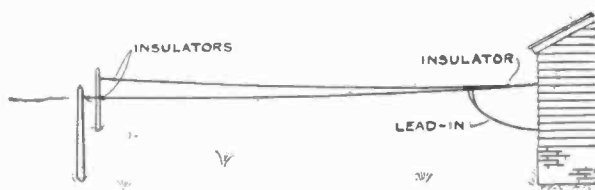

V-TYPE ANTENNA

The V-type antenna, consisting of two wires of about equal length, diverging to two different supports.

300 feet long, then the tap is taken at the center, and to all intents and purposes the antenna is equivalent to two single wires 100 or 150 feet long. In other words, the wave-length of the long wire is halved by tapping it at the center. This type of antenna is known as the T-type. Another modification of this type is the V-type, in which two wires of about the same length run from the lead-in, at one end, divergingly to two more or less separated supports at the farther end. This form of antenna has the same wave-length as the average of the two wires, and is more efficient than a single wire.

Then there is the umbrella type which must be employed where a stretch of over 40 feet is not to be had. In this case a tall pole must be used as the center support, and the wires numbering six to ten, radiate downward in all

directions, being insulated at the top and bottom ends. The lower end of each wire should be 20 feet from the base of the pole, so as to obtain as much spread as possible. The lead-in wire is taken from the top, the various wires being connected together and spliced to the lead-in wire. The erection of the umbrella type is somewhat complicated, as compared with the simple single wire antennae, and is therefore not recommended for receiving purposes except in cases of absolute necessity.

For receiving purposes, a multi-wire L-type or T-type antenna is not necessary, hence a description of the multi-wire antenna—or more properly called aerials, since they are to be used for transmitting—will be left for the chapter dealing with transmission.

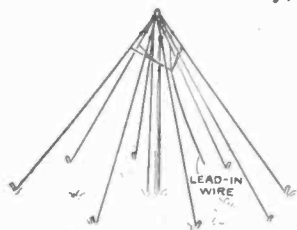

UMBRELLA TYPE ANTENNA

The umbrella type antenna, which is only employed when it is impossible to obtain a sufficient span for the antenna. This type is quite popular in transmission work.

The lead-in connects the antenna with the receiving instruments. One of the problems is to bring the antenna through the wall or window into the station, no matter where it may be located. Some amateurs prefer

to bore a hole through the glass pane of a window, but this is a somewhat tedious job and one that is apt to end in a disaster unless there is considerable skill behind it. A better plan is to cut a board in order that it will fit in the window frame below the partly raised window, so as to keep out the air. The window is brought down on the board. A hole is made in the board and provided with a porcelain tube insulator, through which is passed the lead-in. The lightning switch or arrester can be mounted on the board, if desired.

Then there is the ground connection, which is highly important. Indeed, the effectiveness of the antenna system depends largely upon the character of the ground connection. The most practical ground connection is the water

supply system. Where this is not available, pipes connected with the heating or gas system may be used, although these are to be regarded with some suspicion. Sometimes a non-conducting length of pipe is inserted in the gas line before it reaches the earth, so that it is not a true "ground" connection. However, the results obtained soon disclose whether the pipe is grounded or not.

At any rate, the pipe selected is scraped with a knife

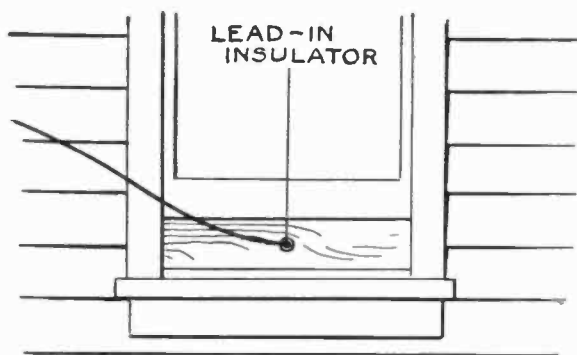

A convenient manner in which to bring the lead-in wire into the house. A board of about the same width as the window frame is inserted at the bottom or top of the window frame, and the window is then pushed against it so as to shut out the air in cold weather. The lead-in passes through a hole in the board, which may be insulated. Thus the window can be raised or lowered without trouble.

or rubbed clean with sandpaper until it is bright, and connection is made by means of ground clamps, which can be obtained at any electrical supply store, or by wrapping ten or more turns of copper wire about the cleaned section of the pipe, good and tightly so as to make firm contact. No. 14 wire is preferable for the ground lead, although anything up to No. 20 will do. Naturally, the insulation is removed from the wire at the point where it makes contact with the pipe. If possible, the wire should

be soldered, for one cannot take too much pains with the ground connection. More receiving troubles originate with a poor ground connection than from any other source, for the good and sufficient reason that this end of the installation seems so simple that it is often slighted. Too much is taken for granted. However, if no solder is used, then it is well to wind insulating or friction tape about the connection, so as to hold it firmly in position and to prevent corrosion between the copper wire and the pipe.

Where the above-mentioned means of ground connection are not available, wires or plates may be buried in the earth and connected to the apparatus. Such wires or plates should include an area of at least 30 square feet, buried in damp soil. Another method is to attach the ground wire to a metal bucket which is then lowered into a well, a brook, a pond or a lake.

DOING AWAY WITH THE GROUND CONNECTION—THE COUNTERPOISE

There are places where a ground connection is out of the question. Take, for instance, desert country, where the soil is sandy and without moisture of any kind. Or again, take rocky country, where there is just a thin layer of soil over solid rock. Obviously, a ground is out of the question. It then becomes necessary to resort to what is known as the counterpoise, which consists of at least the same number of wires as the antenna, suspended beneath the antenna and used in place of the usual ground connection. The counterpoise wires should be elevated but a few feet from the ground, and just as carefully insulated as the antenna wires.

In aircraft, the counterpoise form of ground is employed. It must be evident that no ground connection is possible when the machine is in flight. So the antenna consists of one or more wires which are paid out while the machine is in flight, and which trail behind some 100 or more feet in length, while the ground is represented

by a counterpoise made up of all the metal fittings and stay wires and control cables of the machine.

The counterpoise is especially efficient and almost necessary in conjunction with continuous wave transmission, as will be described farther on when we come to transmitting equipment.

When the summer comes along in such localities where thunder storms are common occurrences, it is necessary to give some consideration to lightning. The antenna,

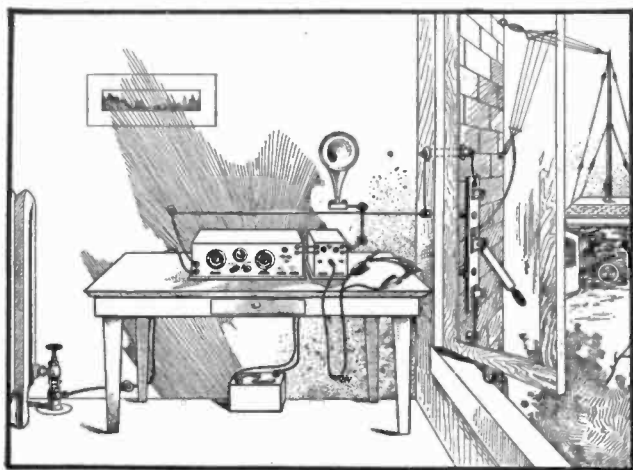

How the lightning switch is installed. It should always be installed on the outside of the building, with the ground wire going as straight as possible. The blade of the switch is connected with the antenna, one jaw is connected with the receiving set, and the other is connected directly to the ground. Thus the antenna may be connected with the receiving set or "grounded."

after all, presents but a small target to lightning, but even so it is well not to take chances. Just as electric power lines and telephone and telegraph lines must be protected against lightning, so must the antenna be provided with some protective device. The Fire Underwriters require the installation of a lightning switch or protective device,

and this should be done as a precautionary measure. The approved type of lightning switch is a single-pole, double-throw, 600-volt, 100 ampere, knife switch, mounted on a composition base. The slate base so often provided with such switches is not satisfactory, because it absorbs moisture and causes quite a little leakage of the radio currents when used in this manner. Lightning switches are required to be mounted on the outside of the building, and the ground connection may be made to an iron pipe driven several feet into the ground. This connection should be made with weatherproof copper wire, No. 6 B. & S. gauge or larger. It may well be worth while for the radio enthusiast to mount the switch on electrose pillars, since these offer the maximum insulation, and the pillars, in turn, can be mounted on a stout oak board.

However, where only receiving apparatus is being used—and we are dealing with receiving apparatus only in this chapter—lightning protection may be obtained by the use of a vacuum-gap protective device. This device should be installed in place of the lightning switch and should be permanently connected to both the antenna and ground wires. The vacuum-gap lightning protector is made in several different types both for indoor and outdoor installation. The outdoor type is preferable, because the shortest possible route to the ground should be provided for any possible lightning charge. All radio supply houses handle the various types of vacuum-gap lightning protector.

USING THE LOOP IN PLACE OF ANTENNA AND GROUND

Interesting results may be obtained by using a loop in place of the usual antenna and ground, although it is well to remember that the loop is by no means as effective as an outdoor antenna. A loop consists of a suitable wooden frame on which are wound a number of turns of bare or insulated wire. The frame should be suspended or mounted in such a manner as to permit of being swung in all directions. The loop receives best when it is pointing edge on towards the transmitter, and it is this characteristic of the

loop which makes it interesting. It indicates the direction of the transmitter being intercepted, and this forms the basis of the radio compass which has found such wide use in modern navigation.

Loops are of two general types: there is the spiral loop, which is of the flat type, inasmuch as all turns are in the

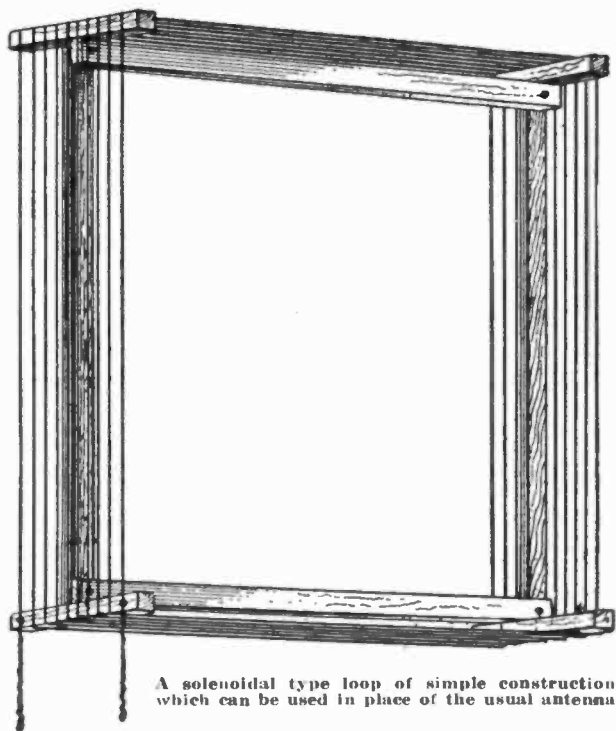

A solenoidal type loop of simple construction, which can be used in place of the usual antenna.

same vertical plane and each turn encloses an area smaller than the preceding turn; and there is the solenoid loop, in which the coils are all of the same dimensions, spreading out horizontally so as to form a square helix. A loop only three feet in diameter is sufficiently large to pick up

radio-phone broadcasting stations a few miles distant, and larger loops may be employed at greater distances. Transatlantic reception is effected by means of loops, which have the advantage of reducing atmospheric disturbances and other interference to a minimum. However, loops

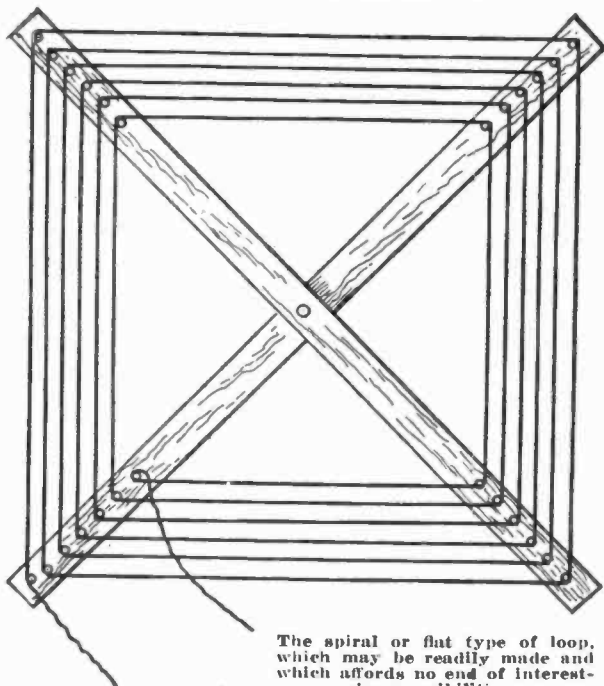

The spiral or flat type of loop, which may be readily made and which affords no end of interesting possibilities.

do not begin to prove as effective as outdoor antennae, hence amplifiers must be resorted to when using loops. Since the number of turns comprising any loop depends largely on the wave length desired and the dimensions of the frame, it is best to decide the exact number in each case by experimentation. To this end the loop should be made with bare wire so that one can tap any number of

turns, or the insulated wire should be bared at certain points so as to permit of tapping. More will be said about loops in the chapter on operating the receiver.

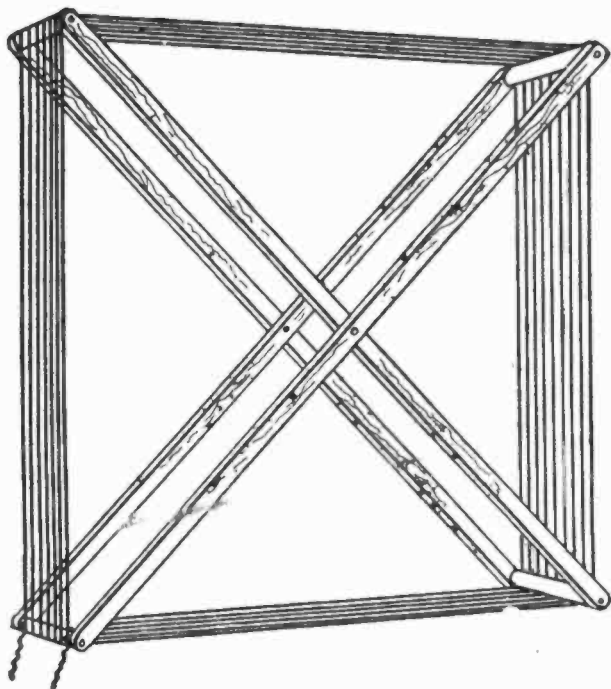

One of the neatest forms of loop. The turns of wire are spaced about one inch apart for the best results.

THE IRREDUCIBLE MINIMUM AMONG RECEIVERS

With the antenna and ground accounted for, the next step is to consider receiving equipment. The simplest receiving equipment comprises a detector and a single telephone receiver. The detector, as we have already learned, is a device which changes the frequency of the incoming waves from radio frequency to audio frequency

so that they may be heard in the telephone receiver. Let us consider the simplest kind of detector.

Nothing could be less complicated or less expensive than the crystal detector. It makes use of one of several different kinds of mineral crystals which possess the desirable characteristics. The most popular crystal body today is galena (lead peroxide), a silvery gray mineral which breaks in squares with mirror-like surfaces. Resting on the galena crystal is a fine piece of wire, and it is

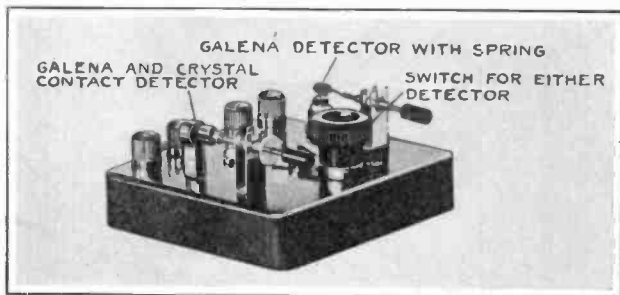

A crystal detector unit. In this case two detectors are mounted on the same base, with a switch for selecting either detector.

the contact between the crystal and the wire which does the rectifying of the high frequency radio energy, of the order of 20,000 to 6,000,000 changes of direction per second, to impulses of varying strength traveling in one direction only, and therefore capable of operating a telephone receiver. Sometimes another crystal is employed in contact with the galena, in place of the wire.

Now with all crystal detectors the matter of adjustment is an important one. Unfortunately, the crystals are not uniformly sensitive. Here and there on a given surface there are sensitive spots, and these must be sought out. Hence when using a crystal detector the wire member must be shifted about on the surface of the galena crystal until a sensitive spot is found. Once a sensitive spot is found, the detector need not be readjusted for some time.

However, if it is jarred the sensitive contact may be lost, and readjustment is then necessary.

While the crystal detector is far more sensitive than the earlier forms of detector employed during the pioneer days of radio communication, it is not nearly as efficient as the vacuum tube type, which will be described further on. However, the crystal type is inexpensive and may be used with the simplest kind of equipment. It requires no batteries of any kind.

The simplest receiving set, therefore, consists of the antenna and ground connected to a plain crystal detector, with a telephone receiver in parallel; and no attempt is made to tune such an arrangement. At short distances from a powerful radio-phone or radio telegraph station, a crude receiving set of this kind serves quite nicely. Indeed, from France comes the little receiving set which may be carried about in one's pocket. It comprises a telephone receiver, on the back of which is mounted a crystal detector. Such an arrangement is used in Paris for receiving time signals from the powerful Eiffel tower, and even radio-phone concerts are picked up at considerable distances outside the French metropolis, when using this diminutive receiver. Instead of using a single wire resting on the galena crystal, this device has ten wires resting on ten different places on the crystal, and a switch is provided so that the operator can select any one of the ten wires. Obviously, one or more of the wires are almost certain to be resting on a sensitive spot; if not, the crystal can be shifted slightly, so as to give ten new spots. This idea is truly ingenious, and works out very well in practice. The little set is provided with tiny spools containing the necessary connecting cords and clips, so that one can hook up to any suitable ground and to anything that will act as an antenna. The framework of a large awning, the fire escape, an iron bedstead, an umbrella—all these and other similar metallic objects may be used for receiving messages from powerful stations but a very short distance away.

SIMPLICITY COMBINED WITH EFFICIENCY

With no provision made for tuning, a receiving set must perform be of a low order of efficiency. Furthermore, all signals come in at the same time, if several transmitters are working in the immediate vicinity. By providing the simplest kind of tuning device, the efficiency of the crystal detector and telephone receiver is immediately improved.

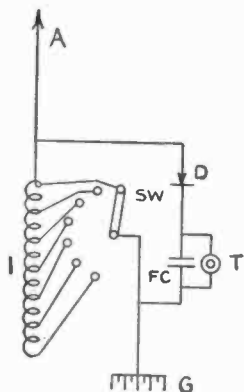

The simplest receiving set that will give fair results, using a rough tuning coil, crystal detector, fixed condenser and telephone.

There are several simple types of tuning devices. One of these is the inductance coil, which consists of a large number of turns of copper wire, wound in a single layer on a solid mandrel or tube, and provided with some means for varying the number of turns of wire which are used. A switch may be employed, with contact points so arranged as to represent say every ten turns of wire, in order that ten, twenty, thirty, forty and so on turns may

be obtained at will. Again, two switches may be used, one switch working by groups of ten or twenty, while the other switch cuts in one turn at a time. In this manner a relatively fine adjustment may be obtained. If 68 turns represents the proper adjustment, the first switch is turned to the point connecting with 60 turns, and the second switch is turned to the eighth turn of wire. This arrangement is found in certain of the present-day receiving sets.

Another means of varying the number of turns of an inductance coil is a sliding contact, which moves over the bared section of the wire. Such a device is termed a tuning coil, and is illustrated on page 117. Bare or insulated wire may be used on the tuning coil, so long as the adjacent turns are insulated one from the other, and

the proper contact is afforded between slider and wire.

There are several ways of connecting the tuning coil, a typical one being indicated in the accompanying diagram. It will be noted that the best arrangement calls for two sliding contacts or "sliders" as they are termed, and

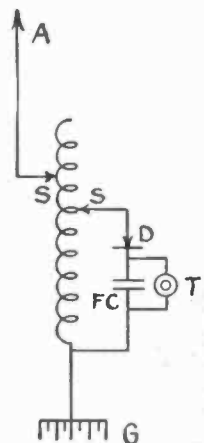

A two-slide tuning coil arranged for tuning the antenna-ground circuit and the closed detector circuit.

that in this instance the detector is really in a separate circuit from the antenna-ground circuit. It will be noted that this two-circuit arrangement is by far the most efficient, and in the most advanced types of receiving equipment the two circuits are even separated from each other, so that there is no physical connection between the two. A small fixed condenser is placed across the telephone receiver, as indicated, in all crystal detector circuits of this general category.

The tuning coil, with its sliding contacts which do not always make perfect contact, has more or less become obsolete. In its place we now find more delicate devices which give a finer adjustment, since the continuous-wave transmitters now widely employed in radio telephony and in radio telegraphy are exceedingly sharply tuned and even

a fraction of a turn of inductance makes a considerable difference. So present practice favors another form of tuner known as the variometer.

The variometer, which is shown in the accompanying illustration, comprises a fixed set of coils and a movable set of coils. As the knob of the variometer is turned, the relationship between the fixed and the movable coils is altered. When the variometer dial is set at 180, or whatever may be the maximum dial reading, the coils are so arranged that the current will flow in the same direction in each set of coils, thus adding wave length to the circuit

in which the variometer is placed. When the dial is set at 0, the two sets of coils are so arranged that the current will be flowing in opposite directions in both sets of coils, and the coils are then said to be in opposition or "bucking" each other. In that condition the inductance is greatly reduced, and the wave length is therefore at a minimum. Hence a considerable range of wave-length values may be obtained with very fine adjustment by the turning of the variometer knob. There are no loose contacts to bother

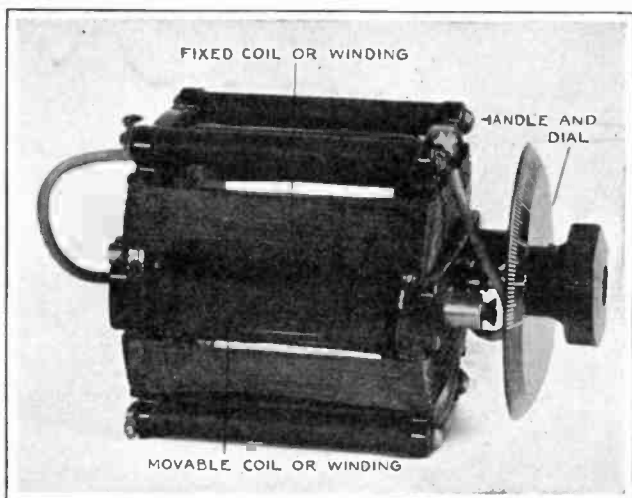

The mechanism of the variometer. This instrument consists of two sets of coils, one fixed set and one movable set.

with, and the rotary action is far more convenient than the movement of sliders along a tuning coil.

In the inexpensive receiving sets now being offered to the public, the tuning is effected by several methods. The lowest priced sets use merely an inductance with taps taken off at regular intervals and connected to the points of a

switch. This rough tuner is placed across the detector and telephone. Since the telephone offers too much resistance to the passage of high-frequency current to the detector, a small fixed condenser is placed across the telephone. Such a set, it must be evident, is satisfactory for short distances only, and cannot tune with any degree of accuracy so as to throw out undesirable stations and concentrate on any given station.

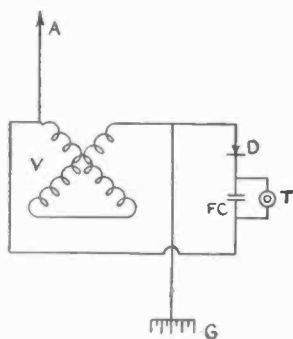

Wiring scheme for a single variometer and a crystal detector. This arrangement produces excellent results.

The sets selling for \$20.00 or \$25.00 are of a better grade, being provided with either a two-slide tuning coil, with the sliders arranged in the form of swinging arms so as to be operative by means of knobs, or a variometer. A crystal detector is supplied with such sets, as well as a pair of telephone receivers. A finer adjustment may be obtained with such arrangements than can possibly be obtained with the simpler sets, and of course the results are accordingly ever so

much better. Sets of this kind may receive radio-phone service over a distance of 25 miles or less, and with good conditions obtaining the range may be increased to 50 miles. The Newark radio-phone broadcasting station received word some time ago that an amateur in Albany some 120 miles distant, was receiving the radio-phone music with a crystal detector, and this case is perhaps not so unusual. However, freak conditions are not to be depended upon, and when a definite distance must be spanned day after day, the receiving set should be considered on the basis of minimum performance. Radio telegraph stations carry much farther than radio-phone, so that these same sets may receive radio telegraph signals over 100 miles distant.

THE MISSION OF THE VARIABLE CONDENSER

So far, we have only dealt with inductance as a means of tuning. Inductance makes for greater wave length: the more inductance is placed in a circuit, the greater the wave length. There is another device for varying wave length, and that is capacity, which was described in the first chapter. Capacity is presented by a condenser, which

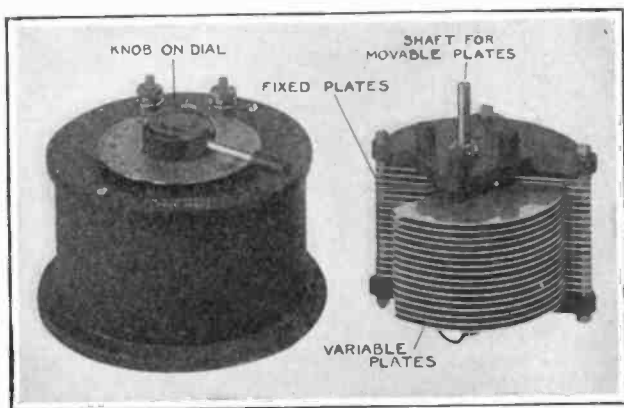

Outside and inside views of a variable condenser, showing its simple mechanism for varying capacity.

may be of the fixed or variable kind. For the present we are interested in the variable kind. Various forms of variable condenser are available, some with fixed and movable plates, the movable plate being hinged so that it can be moved toward or away from the fixed plate; others with a set of fixed plates and a set of movable plates that slide in grooves and pass in between the fixed plates without touching them; still others with a delicate means of increasing or decreasing the distance between a fixed and a movable plate; and, finally, the rotary type, in which there is a set of fixed plates and a set of rotary variable plates which glide in and out of the fixed set without

touching them. The maximum capacity is secured when the plates are nearest to each other or when the plates are entirely meshed, as the case may be.

There is a simple rule that applies to the use of variable condensers in affecting wave length. When the condenser is in series, the wave length is reduced considerably, and fine variations may be obtained by adjusting the condenser. When the condenser is across or in parallel with inductance,

it augments the wave length in proportion to the amount of capacity use.

The value of the variable condenser comes in the fine adjustment of which it is capable. Thus the inductance units may be relatively crude, yet the variable condenser connected in series or in parallel with the inductance will serve as the finishing touch. It is much like a weighing operation, in which weights of several pounds are placed on the scale, while the delicate balancing is accomplished by a sliding beam weight. It is for this reason that in many radio receiving sets the inductance is varied in pretty big steps, while the finishing off, so to speak, is left to one or more variable condensers or even variometers, since the variometer is also capable of fine adjustment.

The crystal detector is limited to short distances and to weak or moderate audibility in the telephone receivers. It is out of the question to ask for a loud-speaker in connection with a crystal detector. Again, a fairly large aerial must be used in connection with a crystal detector, unless one is situated within five to ten miles of a radio-telephone broadcasting station, or within thirty miles of a radio telegraph station. Hence, sooner or later, and rather sooner than later, the radio enthusiast gets around to the vacuum tube detector, even though it does mean storage batteries and dry batteries, as well as more elaborate receiving equipment. But the results are so much more



A typical two-slide tuning coil.

satisfactory with the vacuum tube detector that there is scarcely any comparison between such a set and the crystal type.

THE VACUUM TUBE AND WHAT IT DOES

The vacuum tube is the most interesting as well as the most useful device which has been developed during the progress of the radio art. Without going into the history of this device, it may be said that Edison originally discovered the peculiar behavior of an incandescent lamp filament by inserting an extra wire in a lamp bulb. He discovered the fact that when a lamp filament is cold, no current can be passed across the vacuum between the filament and the extra wire or plate inserted in the vacuum. However, the moment the filament is brought up to incandescence, a current can be passed across the vacuum gap between the filament and the plate; but the current can only be passed in one direction, since this device is a uni-directional or uni-lateral conductor of electricity. Thus the vacuum tube, as this device is called, may be used to rectify alternating current, since it allows the current to flow in one direction only and therefore converts alternating current into pulsating direct current. This principle is employed in certain storage battery recharging outfits, as well as in the detection of radio signals.

What really takes place in the vacuum tube is subject to a good deal of theorizing, and bulky volumes have been prepared on the subject. It is not within the province of this book to deal with theories, but suffice it to state that the white hot filament gives off millions of infinitesimal electrically charged units known as electrons. These electrons travel from the filament to the relatively cool wire or plate placed in the vacuum tube, and thus form a bridge over which one-way traffic of outside electric current is permitted. Depending on the number of electrons, the bridge is of greater or less capacity, and therefore accommodates more or less traffic.

Now in the present-day vacuum tube there is a traffic

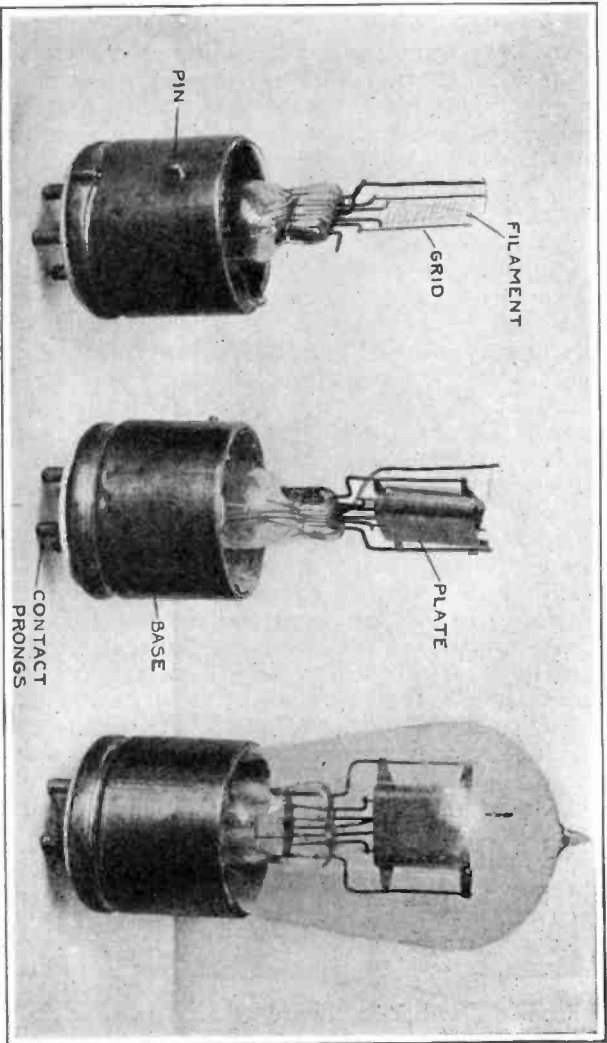

One of the several types of vacuum tubes used for detecting and amplifying purposes in receiving sets. Vacuum tubes for receiving purposes operate on a 110-volt storage battery and a 22½-volt dry battery for the plate circuit.

officer, so to speak, who decides how much traffic shall pass over the electronic bridge. It was Dr. Lee de Forest, the radio pioneer and inventor, who discovered how the traffic could be regulated, and introduced what we are pleased to call a traffic officer for the purpose of an analogous explanation. This third member, known as the grid, surrounds the filament and comes between it and the plate, so that the electrons must pass through the grid in order to reach the plate. Any charge which is impressed on the grid immediately affects the electronic flow, allowing a greater or less flow; and, consequently, the external current being passed over the electronic bridge, between the filament and the plate, is likewise altered by the grid charge—our little traffic officer, as it were. The grid consists of a piece of wire bent in zig zag form or again as a perfect helix or flattened helix, surrounding the filament and separating the latter from the plate.

The vacuum tube is a most sensitive device. The slightest charge impressed on the grid controls faithfully and instantly a rather strong current flowing between filament and plate. In this manner it becomes possible to control a strong current by means of a weak current. The incoming radio waves are led to the grid, where they serve to control the electronic flow, and this in turn controls the flow of current through the tube to the telephone receivers. The arrangement is such that the radio waves are converted into audible sounds in the telephone receivers—loud, clear signals, such as never could be obtained with a crystal detector.

The vacuum tube can be used for a great many different things. It is a rectifier of alternating current; that is, it converts alternating current of almost any frequency and of any strength within its capacity into direct current. It can, conversely, convert direct current into alternating current of a wide range of frequencies. It permits of controlling a powerful current with a weak current; this feature is the basis of the amplifier, since the character-

istics of a weak current are impressed on a current several times as powerful, therefore giving that much louder response in a telephone receiver. This characteristic is also the basis of the telephone repeaters, now employed in long-distance telephony. Vacuum tubes permit of rebuilding attenuated telephone currents at any desired interval of line, so that a greater distance may be spanned. The vacuum tube, of various capacities ranging from the small 5-watt tube to the large 250-watt tubes, can also be used for transmitting purposes, but that is another story which is left for later on.

THE "A" BATTERY AND THE "B" BATTERY OF VACUUM TUBES

Now the use of any vacuum tube involves a battery for heating the filament, which is the "A" battery but is more commonly referred to as the filament battery, as well as a high-voltage or "B" battery which serves to pass current across the electronic bridge from the filament to the plate, when the filament is heated for the device to be actuated, whether it be a telephone receiver, an amplifier circuit, a recorder or other instrument. The filament battery, in the case of the more common vacuum tubes, is a 6-volt battery although there are special vacuum tubes which operate on lower voltages. A special tube used on certain Westinghouse receiving sets operates on a single dry cell, or about 1.4 volts at the outside, and draws but $\frac{1}{4}$ ampere of current. The usual vacuum tube, such as the Radiotron, requires close on to 6 volts and a trifle over 1 ampere. Another standard tube, known as the A-P tube, requires not more than 5 volts and about .7 ampere. This means that dry cells are quite extravagant in this connection, since with a drain of about one ampere, any dry cell will not last very long. If dry battery must be used, it is well to employ two sets of five cells each, the two sets being connected together. In other words, the five cells of each battery are arranged in series, with the carbon of one cell connected to the zinc of the other,

and then the end carbons of both sets are connected together for one side of the combined battery, and the zincs of both sets are connected together for the other side of the combined battery. This virtually means a battery of twice the life of a single battery, although the voltage remains the same. The name of this arrangement of batteries is series-parallel.

Still, there is nothing that really takes the place of the storage battery in operating vacuum tubes. This is especially true where more than one vacuum tube is being used, such as when using one or two stages of amplification, as is explained in the following chapter. The storage battery may be of any standard type, although since the heavy demand for radio equipment began some few months back, there have appeared several special storage batteries particularly intended for radio work. These storage batteries are characterized by all-rubber cases, eliminating the possibility of leakage from cell to ground or from cell to cell, and doing away with one of the most frequent causes of noisy sets. Furthermore, such batteries are of a smaller ampere-hour capacity than those used for automobile starting and lighting service, thus making them lower in cost and more convenient to handle and recharge.

A storage battery must be recharged when it runs down. In a subsequent chapter we shall consider the care and recharging of the storage battery. Suffice it to state that where a radio set employs several vacuum tubes, so that the drain on the storage battery is considerable, it pays good dividends to install some form of recharging apparatus. In this manner the storage battery may be recharged whenever necessary, at a minimum of expense and without losing valuable time.

Aside from the storage battery for the filament, a "B" battery must be provided. This battery must be a high-voltage one. In the early days of vacuum tubes a number of flash-lamp batteries were connected together so as to obtain the necessary current, but today there are special dry "B" batteries put up in compact units of $22\frac{1}{2}$ volts

each. These "B" battery units come in a small size and a large size. If the receiving set is to be used at regular intervals, it is the part of better judgment to buy the larger size. A single "B" battery unit is necessary for a vacuum tube detector circuit, and two units are necessary if an amplifier is also used with headsets, and three or four units if a loud-speaker is employed, as will be explained in the next chapter devoted to amplifier circuits.

The dry "B" batteries come in two types, aside from

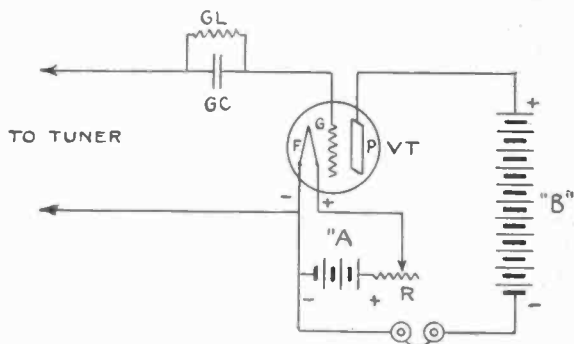

Principle of vacuum tube's operation: GL—Grid leak; CC—condenser; F—filament; G—grid; P—plate; VT—vacuum tube; "A"—Storage battery for operating vacuum tube filament; R—rheostat for filament current; "B"—high voltage "B" battery or plate battery, and telephones.

the two sizes. There is the fixed voltage type, in which two leads or terminals give the full voltage of the battery, and there is a variable voltage type, in which lugs, binding posts, or holes and plugs permit of using a number of different voltages. The variable type is especially useful in using certain types of vacuum tube with which the "B" voltage must be carefully adjusted. When it comes to amplifier tubes, the "B" voltage may be anything from 45 volts up.

There are also available special low-capacity high voltage

storage batteries, which may be used in place of the dry battery units when a set is subjected to extensive use. Such storage batteries may be readily recharged and their

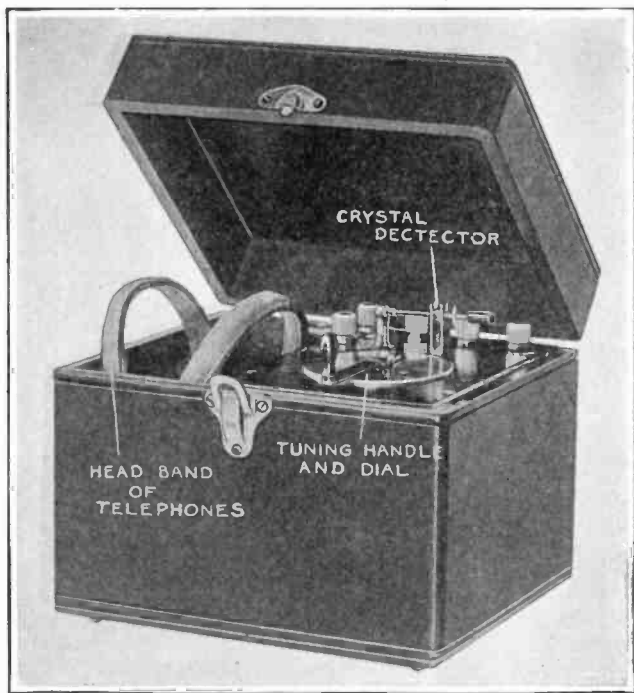

Inexpensive receiving set making use of a variometer tuner and a crystal detector. Such a set is good for a range of 25 miles, perhaps a little more, when receiving radio-phone programs.

operating cost must of necessity be lower than when using dry batteries, which, when discharged, are worthless and must be thrown away.

Often the question is asked: Why is it not possible to use the usual lighting current for operating vacuum tubes.

The fact of the matter is that we are dealing with delicate fluctuations in the vacuum tube. If the filament voltage should vary even in the slightest degree, the electronic flow would likewise vary and cause a corresponding noise in the telephone receivers. Therefore, for absolutely quiet operation it is necessary to employ a steady and positive flow of current such as can only be supplied by a battery. Lighting current, whether of the alternating or direct variety, could readily be reduced down to six volts, but in either case there is a distinct "hum" which would be constantly heard in the telephone receivers and which would drown out the delicate radio signals. Hence lighting current is out of the question.

A VACUUM TUBE FOR EVERY PURPOSE

It is well to remember that all vacuum tubes are not identical, nor are they absolutely interchangeable. They may look alike if they are of the same size and kind, but there may be slight differences in internal dimensions and degree of vacuum or gas content which are not apparent even upon close examination.

Thus the type now in most general use is classed as a soft or gas content tube and requires a critical adjustment of both the "B" or plate voltage and the "A" or filament current. Tubes of this type are extremely sensitive when properly adjusted. The variation of the filament current is accomplished by means of a variable resistance or rheostat placed in series with the filament lighting battery. In some receiving sets the rheostat may be calibrated in ohms or even in plain divisions, but in most sets it is not calibrated at all, a simple arrow indicating in which direction to turn the knob in order to increase the voltage or brighten the filament. The "B" or plate voltage, on the other hand, is variable in steps of $1\frac{1}{2}$ volts, by means of a variable voltage "B" battery as already described. The proper terminal or lug or plug hole of the "B" battery is found by experiment, and no further adjustment is required for a long time to come. The majority of vacuum

tube detectors operate best on "B" voltages between $16\frac{1}{2}$ and $22\frac{1}{2}$, and this range is covered by the variations provided on the various types of variable plate batteries.

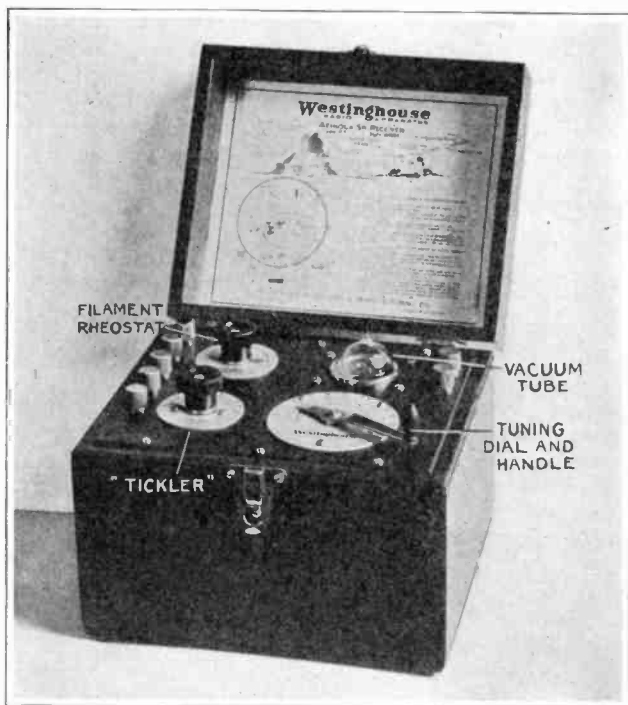

A medium-priced receiving set making use of a special vacuum tube which operates on a single dry cell, instead of a 6-volt storage battery.

However, there is no harm in using a fixed voltage "B" battery, except that the best results are not likely to be obtained except if the tube should happen to be one that works best on $22\frac{1}{2}$ volts.

Amplifier tubes, which look just like the detector tubes and cannot be told apart except by testing their electrical characteristics, are not critical in adjustment when compared with detector tubes, and they will operate successfully on plate voltages of 40 to 80 volts. Where a detector and two-stage amplifier combination is used, three or four $22\frac{1}{2}$ volt units may be connected in series, and connections to the receiver are made in a manner which permits the use of the full voltage on the amplifier tubes, while a variable portion of the same battery is used for the de-

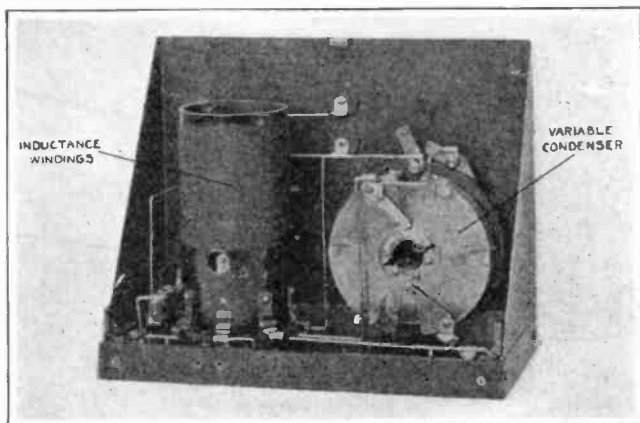

Rear view of a simple receiving set which makes use of a simple inductance and a variable condenser, as well as a crystal detector.

detector tube. Where extremely loud signals are desired plate voltages of 100 or over may be used without damaging the amplifier tubes, but the use of this voltage increases tube noises and is therefore not desirable when receiving signals with the telephone head set. However, this information is only included here as part of the receiver problem, and more will be said about amplifying tubes in the next chapter devoted exclusively to amplifiers.

A detector tube which does not prove to be critical as to plate voltage and filament current is usually defective. A good detector tube will give greatly increased signal strength with a certain plate potential and filament bril-

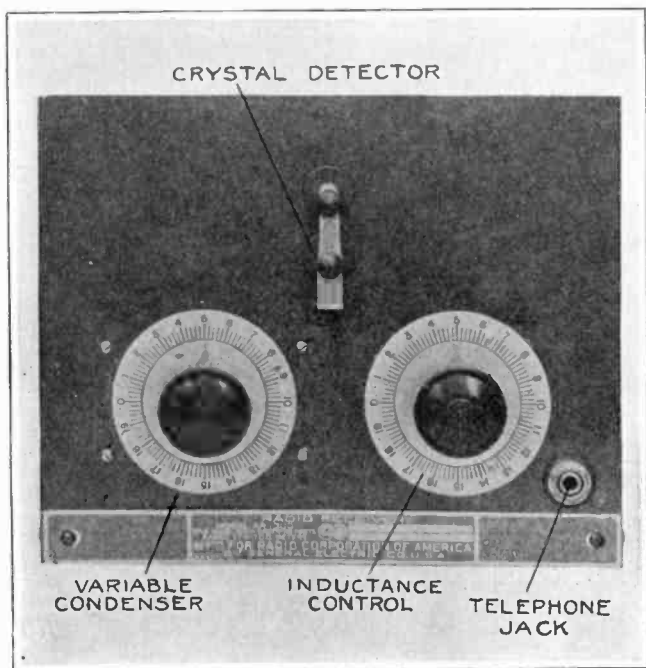

Front view of receiving set shown on page 127. The cabinet of this set is made of metal instead of the usual wood.

liancy. An amplifier tube which requires a critical plate voltage or filament current adjustment will not give satisfactory results as an amplifier. Tubes of this character will generally be found useful as detectors. In certain receiving sets which include an amplifier, it is sometimes

found that amplifier tubes are recommended for use throughout, for the reason that the wiring provides for a common plate voltage and filament current adjustment. Such practice may simplify the construction and operation of the set, true, but from the standpoint of efficiency, it is mighty poor business. A soft or gassy tube, known as a detector tube, should be used for the detector, and a hard tube should be used for amplifying. These tubes, while they may look alike, are by no means interchangeable, except where the best results are not expected or demanded.

Having been introduced to the vacuum tube in a general way, we can now return to receiving sets once more. The vacuum tube can be used in place of a crystal detector in almost any circuit, and in such applications it will prove a considerable improvement over the latter. Then, by using special vacuum tube circuits, especially of the so-called regenerative variety, which will be described later on in this chapter, the sensitiveness of the vacuum tube is so much superior to the crystal detector as to make a comparison quite out of order.

The wiring scheme already shown gives the fundamentals of vacuum tube hook-ups when used as a detector. It will be noted that a small fixed condenser and an extremely high resistance, known as a grid leak, are placed in series with the tuner. Furthermore, the polarity of the connections is of utmost importance.

PRIMARY AND SECONDARY CIRCUITS AND HOW THEY ARE COUPLED

So far, the circuits have been of the simplest type, with a physical connection between the aerial-ground circuit and the closed circuit, known as the oscillating circuit, in which the detector is placed. Now for reasons which need not be explained here, since this work does not attempt to concern itself with the theories or the mathematics of radio but rather with the application of the results, many sets make use of distinct aerial-ground and oscillating

circuits, with no physical connection between them. Transference of energy between the former and the latter is effected by means of two windings which are brought into more or less close inductive relation. In one form these windings are known as a loose-coupler, in another they

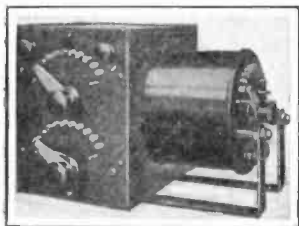

Loose-coupler of the old type which has now become more or less obsolete.

form a vario-coupler, still another arrangement calls for compact coils held in hinged holders so that they may be swung towards or away from each other.

The loose-coupler is the forerunner of the vario-coupler and the compact coil arrangement. It consists of a large tube on which are wound many turns of wire, which is the primary and is connected with the antenna and the ground, and a smaller tube, which slides in and out of the large tube and is wound with many turns of wire. Some means, such as a slider or a multi-point switch, is generally employed to vary the number of active turns in both the primary and secondary of the loose coupler.

In keeping with modern practice, which has done away with sliding arrangements in favor of rotary adjustments, the vario-coupler has become the standard device for coupling the primary and secondary circuits of a receiving set. The vario-coupler has a tube wound with many turns of wire, forming the primary or antenna-ground circuit, and a wooden ball or composition frame, which is mounted on a rotatable shaft and is also wound with many turns of wire to form



Vario-coupler, which has taken the place of the old type loose-coupler.

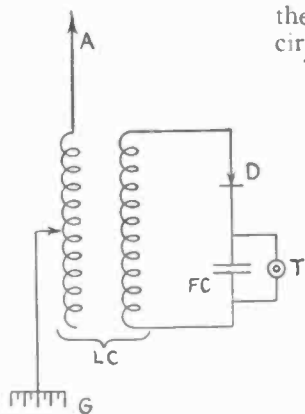

How a loose-coupler or vario-coupler is introduced in a crystal receiving set. In this instance the primary is adjustable.

played. The radio amateur soon learns to arrange and rearrange his receiving equipment until he obtains the best results—if he is ever satisfied.

INDUCTANCE IN SMALL PACKAGES

The tuning coil has more or less become obsolete, and in its place we find more compact forms of inductance. One of these later-day forms is a single layer of wire wound on a tube, after the fashion of the tuning coil, but having a multi-point switch connected with various numbers of turns. instead of a slider. Then there are the compact inductance coils, such as the Duo-

the secondary or the oscillating circuit member.

The accompanying diagrams indicate better than words how the loose-coupler, vario-coupler, or inductance coil mounting may be employed in connection with a vacuum tube or a crystal detector. Obviously the vacuum tube is to be used wherever possible. There are also given several circuits in which fixed inductance units, vario-meters and condensers are em-

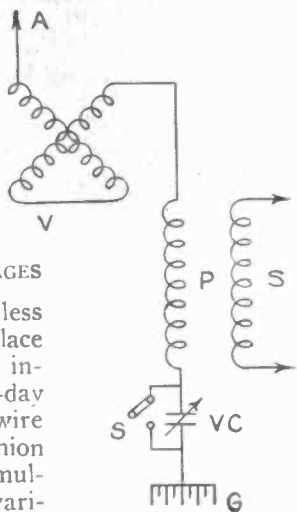

Using a loose-coupler or vario-coupler in connection with a variometer and a variable condenser for increasing or decreasing the antenna circuit wave length.

Lateral and the Honeycomb types, which, while fixed as regards their wave length values, are used interchangeably so that the operator can readily shift from one coil to another and thus vary the wave length in big steps, depending on a variometer or a variable condenser for the finer tuning.

Second only to the development of the vacuum tube, the concentrated inductance has marked a new era in radio. Prior to the war there were in general use the huge, bulky, single-layer inductance coils then so closely identified with

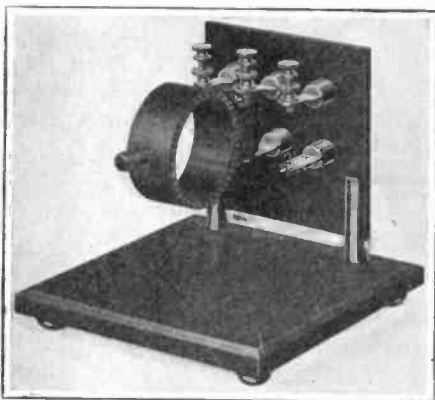

One style of mounting which takes two or three compact inductance coils for a loose-coupler, and tickler coil combination when using a regenerative circuit.

long-wave reception. Compact receiving sets, simple adjustments, and the neatness that goes with small units, were not to be thought of because of the bulkiness of the inductance then employed.

The demand for compactness and simplicity, together with the far greater efficiency and practicability, on the part of the warring nations, called for a radical change in inductance designs. As a consequence, so-called bank-wound coils were employed to an increasing extent, followed soon after by the present types of concentrated inductances. Today practically all receiving sets with a long-wave capacity are provided with these compact inductance units since a long wave length can be obtained in a very small space.

Special mountings have come into use for these compact

inductance coils. The usual method is to mount the coils on a block by means of a fiber band which passes around the coil to hold it in place. The block, in turn, is provided with bayonet plugs so that it can be readily plugged into a circuit. A loose-coupler arrangement is effected by means of a stand which permits of moving the coils towards or away from each other, and, in some cases, even turning one of the coils from the vertical to the horizontal position.

Another form of compact inductance is known as the spider-web inductance. This consists of a sheet of insulating material in which radial slots have been cut, and the wire is wound spirally in and out of these slots, so as to make a flat or pancake inductance unit. Such inductance units can be used as a loose-coupler by having one fixed and the other hinged.

THE QUESTION OF TELEPHONE RECEIVERS

Little or nothing has so far been said regarding the telephone receivers, yet here is an important member of any receiving set. In fact, no matter how elaborate a receiving set may be, if the receivers are not of the best available type, the results are not as good as they might be.

Radio telephone receivers are not just ordinary telephone instruments. They are far more sensitive than anything which is ever used in regular wire telephony. First of all, they are constructed with the utmost care; secondly, they have windings of very fine wire, as compared with the relatively large wire used in the ordinary telephone receiver. Thirdly, the diaphragm of the usual wireless receiver is far thinner and therefore more delicate than that used in the ordinary telephone receiver. Fourthly, in certain types of wireless receivers the two receivers of a head set are matched in tone, so that both ears receive precisely the same sounds. This feature makes for the utmost response on the part of the ears, and therefore the best signals.

No matter how inexpensive a receiving set may be, it

is poor business to economize on the telephone receivers; for it is a fact that a receiving set is no better than its telephone receivers. The telephone receivers, after all, are the final link in the chain of reception; they comprise the agency which actually conveys the radio signals or music or what not to the operator's ears, and as such they can add to or detract from the receiving set as a whole.

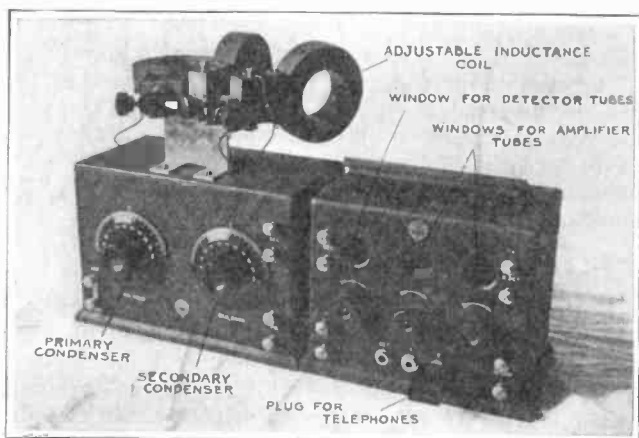

Receiving set in which three compact inductance coils, adjustably mounted on top of cabinet, permit of variable coupling and regenerative action. The unit at right is the vacuum tube detector and two-stage amplifier.

Of radio telephone receivers, there are various types and special merits are claimed for each type, as might well be expected. However, there is one fact that applies to all types, and that is the care with which a really good receiver must be constructed. That is why the better offerings cost considerably more than others; and it will generally be found that the better offerings are well worth the extra cost. If the radio amateur does not feel he can afford the better kind of telephone receivers, he can at least start with an inexpensive pair, and later on go to the better kind, experiencing thereby considerable pleasure

in the increased range and clearer signals or telephone messages which he obtains with his receiving equipment.

Certain types of receivers have been carefully matched for tone and pitch, and respond loudly to signals over a wide range of frequencies, especially those of high pitch, thus permitting reception that would not be possible with inferior head sets that do not respond to signals of high frequency. Other types have two solenoids wound on the pole pieces of a laminated permanent magnet which acts upon an iron reed fastened to a conical aluminum diaphragm. The reed is adjustable and, therefore, the

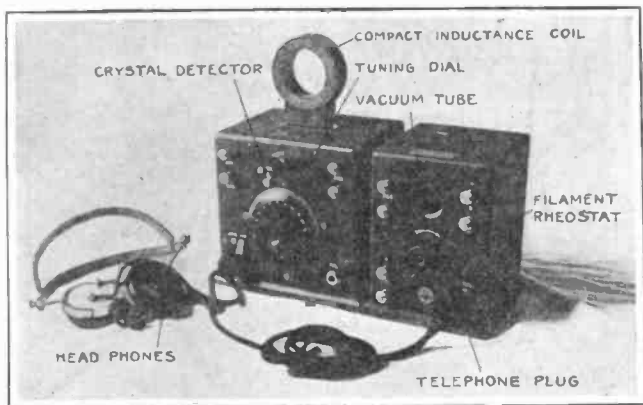

Receiving set making use of compact inductance coils for rapidly changing the wave length range in erg steps. The unit at right is the vacuum tube detector.

reed note can be made identically the same in both ear pieces to coincide with the spark frequency of incoming signals or what is known as the beat frequency. An adjustment screw is mounted on the back of each receiver case and is designed so that excess adjustment cannot be made. The diaphragm is of unusual design, being of a conical shape with greater thickness toward the center. This design is said to result in improved reproduction.

There is still another type of wireless telephone receiver in which a solenoid winding is mounted in such a manner with relation to the long permanent magnet within the

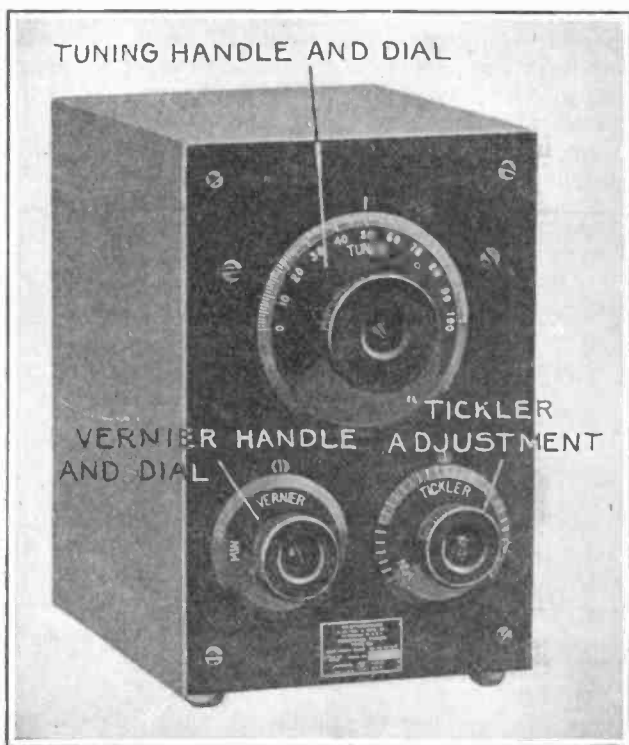

A single circuit tuner making use of a variometer and a variable condenser, as well as a tickler for regenerative effects. The general tuning is done with the first handle, the fine tuning with the lower left-hand knob, and the regenerative effect is controlled with the lower right-hand knob.

case as to actuate an armature which connects with a mica diaphragm. The slightest current variations throughout

the solenoid windings will actuate the armature which in turn vibrates the diaphragm.

With all receiving sets, whether of the crystal or the vacuum tube type, it is generally impossible to use a loud-

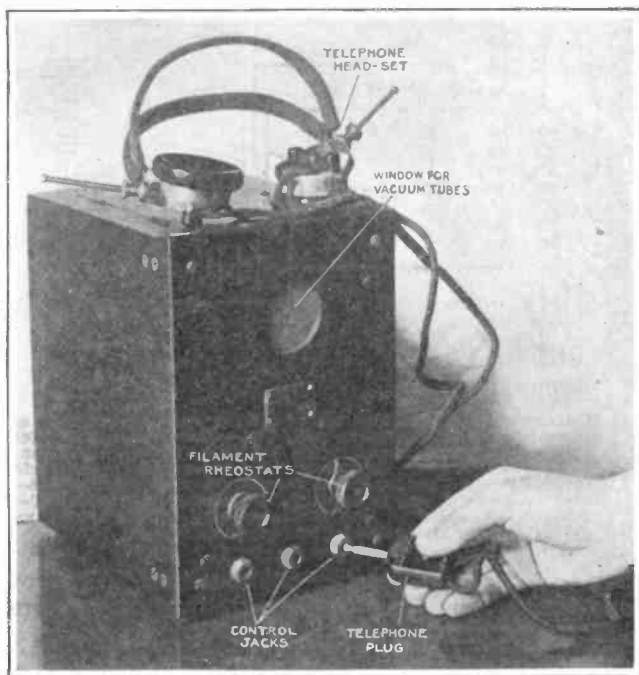

Companion unit to tuner shown on preceding page. This unit is the vacuum tube detector and two-stage amplifier. The two knobs are the rheostat controls for the detector and amplifier tube filaments. The telephone plug may be inserted in one of three holes or jacks, if detector only, one stage or two stages of amplification are desired.

speaking telephone—an instrument equipped with a horn that projects loud sounds throughout a large room, thus making the use of telephone head sets unnecessary. A loud-speaker must be operated by means of an amplifier,

and this phase of radio reception will be described in the next chapter. It occasionally happens that nearby transmitters are received so loudly that they may be heard some distance away from the telephone receivers. Under such circumstances, it is obviously possible to attach a

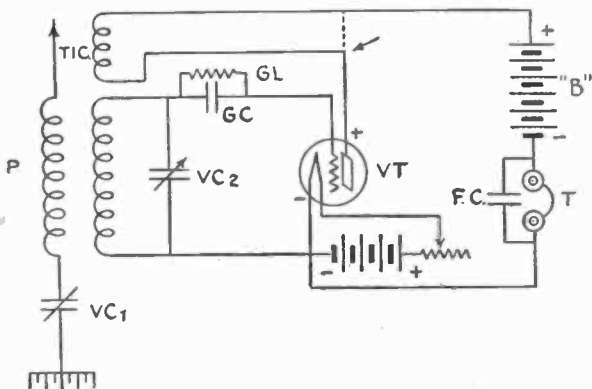

Regenerative set making use of tickler coil. P—primary of vario-coupler; TIC—tickler coil; VC1—variable condenser for varying antenna-ground wave length; VC2—variable condenser for varying secondary of vario-coupler; GL—grid leak; GC—grid condenser; VT—vacuum tube detector; B—high voltage or plate battery; FC—fixed condenser; T—'phones. The dotted line indicates how wiring would run for an ordinary, non-regenerative set.

horn to a telephone receiver and thus have an improvised loud speaker, but this is certainly the rare exception rather than the general rule.

REGENERATIVE RECEPTION OR SELF AMPLIFICATION

So far, the various receiving layouts or hook-ups have brought the radio frequency energy right to the detector, which in turn rectified it and passed it on to the telephone receivers. Now if the energy which is about to be passed on to the telephones is partly re-impressed on the grid of the vacuum tube, it will add materially to the voltage of the incoming signal. This will naturally give a greater charge on the grid, and consequently a greater variation

of plate current, which in turn means louder signals. In this manner the sensitiveness of the vacuum tube is greatly increased; indeed, it is operating as a detector and an amplifier combined. This practice is known as the regenerative or feed-back reception.

But how is the plate energy re-impressed on the detector? There are two methods in general use for obtaining the regenerative effect. The first makes use of what is known as the tickler—an extra coil which is brought near the inductance or winding of the detector or oscillating circuit. Thus the simplest type of regenerative receiver consists not of two compact inductance coils but of three coils, adjustably mounted, as shown in the diagram on

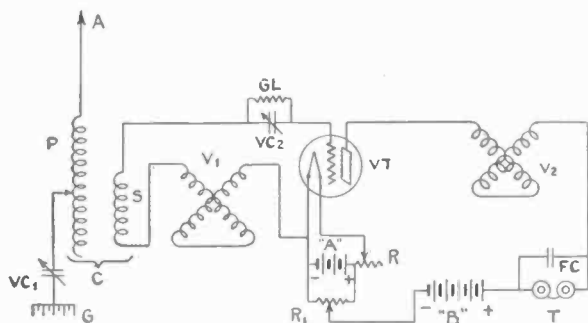

Another method of obtaining regenerative results. A—antenna; P—primary; S—secondary, of the vario-coupler C; VC1—variable condenser in antenna-ground circuit; V1—varlometer; GL—grid leak; VC2—variable condenser as grid condenser; VT—vacuum tube detector; V2—plate variometer for feed back; FC—fixed condenser; T—telephones; "B"—high voltage or plate battery; R—filament rheostat; R1—high voltage battery rheostat.

page 138. The first coil is the primary, connected with the aerial-ground circuit as already mentioned, and the second is the secondary, connected with the detector. The third is the tickler, and is connected in the plate circuit, as indicated by "TIC" in the wiring diagram. The adjustment between the tickler coil and the secondary coil is of great importance, for the regenerative effect must

often be regulated to obtain the best results, as will be explained in the chapter on operating radio stations.

The tickler coil also comes in handy when receiving undamped signals, which, as explained in our first chapter, do not affect the simpler types of receiving sets and therefore cannot be detected. With the tickler it becomes possible to adjust the coils in such a manner that the detector begins to oscillate; in other words, it is generating high frequency current on its own account. If this high frequency current is modified until it varies but slightly from the frequency of the incoming radio wave, then there will be heard in the telephone receivers the difference between the two frequencies. For instance, if the incoming radio wave is 100,000 cycles frequency, the detector circuit can be adjusted to 102,000 cycles frequency, and there will then be heard in the telephone receivers a note of 2,000 cycles, which is clearly audible. The note detected is known as the "beats," and can be varied in tone according to the adjustment of the circuit and the incoming frequency. Obviously, this method gives almost any note desired, therefore the transmitting stations received in this manner do not have a characteristic note such as is obtained by other methods of transmission and reception.

Another method of receiving undamped waves, such as are sent out by arc stations, is to employ a "tikker." Such practice is only resorted to with a plain receiving set, such as one using a crystal detector, with no provision for setting up local oscillations so as to obtain "beats." This is merely some means of breaking up the incoming high-frequency wave energy so that it becomes audible and therefore can be detected in the telephone receiver. One method is to use a small pulley mounted on an electric motor, and to have a wire resting in the groove of the pulley. When undamped waves or CW signals, as they are called, come through such an arrangement, they are received in the form of short or long scratchy sounds, because of the tikker's interruptions. However, a tikker is in reality an imperfect contact and as such it takes away from the strength of the incoming undamped or CW

signals. Therefore the regenerative arrangement is to be preferred.

Two other methods in general use for regenerative reception are shown in the accompanying diagrams. It will be noted that instead of a tickler coil, use is made of a variometer in the plate circuit. This variometer serves to tune and feed back into the grid the added voltage of the plate circuit.

All regenerative sets are delicate to operate, for the regenerative effect gives rise to all kinds of noises in the telephone receivers ranging from a hissing steam sound

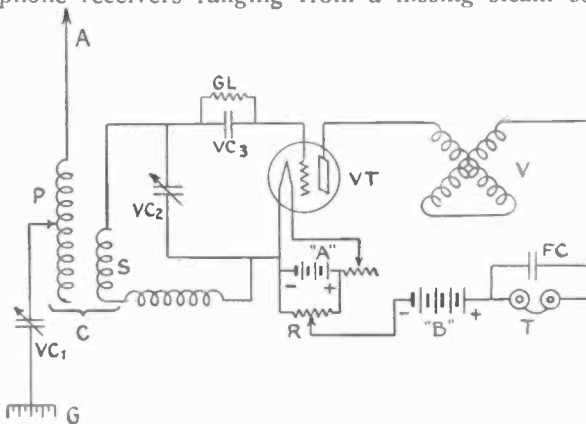

Still another method of regenerative operation: A—antenna; P—primary; S—secondary, of vario-coupler C; VC1—variable condenser in antenna-ground circuit; VC2—variable condenser; VC3—variable condenser used as grid condenser; GL—grid leak; "A"—filament battery; VT—vacuum tube detector; V—plate variometer; FC—fixed condenser; T—telephones; "B"—high voltage or plate battery; R—plate battery rheostat; G—ground. Note the extra inductance coil of few turns, developed by experiment.

to the babel of sounds that might be expected in a monkey house riot. The operation of such a set is considerably more involved than the plain receiving equipment, but on the other hand the self-amplifying feature greatly adds to the results. Furthermore, it is necessary to use metallic

shields between the operator and the components of the regenerative set, since the capacity of the body of the operator materially affects the delicate adjustments of the regenerative set. Most of the better regenerative instruments are provided with metallic shields inside the cabinets, so as to reduce the body capacity trouble to a minimum. In other instruments the dials are of metal and are grounded to act as shields.

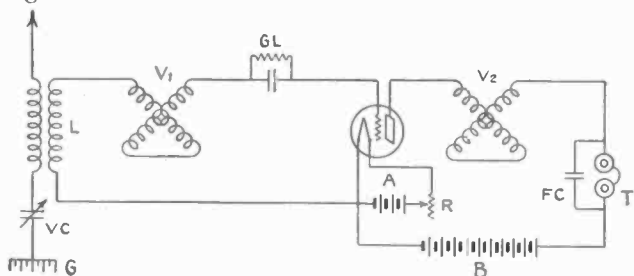

Another method of obtaining a regenerative receiver. L—loose-coupler or vario-coupler; VC—variable condenser in primary circuit; V1—variometer in grid circuit; GL—grid leak; A—filament battery; R—filament rheostat; B—"B" or plate battery; FC—fixed condenser; T—telephones; V2—plate or "feed-back" variometer; G—ground.

There is virtually no end to the different arrangements which can be followed in receiving radio signals. The wiring diagrams shown in the foregoing pages are only intended as a preliminary guide, and are offered as suggestions to the beginner. As one becomes more proficient and versed in the radio art, one soon learns other arrangements which may prove more interesting and efficient.

Chapter V.

OPERATING THE RADIO RECEIVING SET AND MASTERING THE TELEGRAPH CODE

THE day may arrive when the radio receiving sets, capable of receiving clear, loud music from *distant* points, will be reduced to the simplicity of the phonograph. For the present, however, simplicity exists only in the inexpensive receiving sets, which are intended for the reception of radio telephone and telegraph signals at short range. When it comes to receiving sets for ranges of 25 miles or more, good results can only be obtained with elaborate apparatus. And the more elaborate the apparatus becomes, the greater the care and skill required for its successful operation.

Take the simple receiving sets, for example. There is little or nothing to master in the way of operation. Such sets generally have a multi-point switch for controlling the wave length, and a crystal detector. The crystal detector must be accurately adjusted for the utmost sensitiveness, and this requires a little care. The crystal used in such a detector is not of uniform sensitiveness throughout, hence the little metal point or the fine wire, making contact with the crystal, must be shifted about until a sensitive spot is obtained.

At almost any hour of the day there is a radio telegraph station working within range of the simplest receiving set, unless the latter happens to be located in some very remote spot. In that event, the simple set should not

have been selected in the first place, for its radio telegraph range, as a rule, is certainly no more than 50 to 100 miles, while its radio-phone range is less than 25 miles. In this connection it is well to point out that many persons have been and are buying little \$15.00 receiving sets for use in some remote part of Canada or Texas or Montana or some other section far removed from the existing radio-phone broadcasting stations, and are surprised and bitterly disappointed at not receiving the music and talks which they have read so much about. Most radio manufacturers are careful not to sell their instruments under such circumstances, for they realize that disappointments of this nature only result in giving the public a wrong impression of radio, which may persist despite all future efforts to explain why they failed in their first attempt.

At any rate, if a person is located well within the range of radio telegraph and radio telephone stations, the crystal detector can be readily adjusted. While listening with the telephone receivers, the operator shifts the little point or wire about on the crystal. If there is a radio telephone or telegraph station working within range, one soon hears the music or talk or again the short and long buzzes, as the case may be. There may be no transmitter operating at the time, and no sounds will be heard. For this reason, it is sometimes necessary to use some simple form of tester to determine the sensitiveness of the detector, without depending on actual signals.

IS THE CRYSTAL DETECTOR SENSITIVE?

When the crystal detector is adjusted properly, it should respond to disturbances other than actual radio waves. Thus in the city, where there are electric light wires, telephone lines, trolley cars, elevators and other electrical appliances and machinery, the detector should respond to the electromagnetic waves given off by electrical machinery of all kinds within range. In other words, if the detector remains absolutely silent, then it is evident that no sensitive spot has been found; but if it causes clicks, scratchy sounds, buzzes and other noises to

be heard in the telephone receiver, then it may be taken for granted that the detector is satisfactorily adjusted. Sometimes the sensitiveness may be tested by turning on and off a nearby electric lamp. This should produce a loud click in the telephone receiver. However, if a hum is heard, this should not be considered as an indication of the sensitiveness of the detector adjustment. Indeed, the hum is caused by what is known as induction, given off by an alternating current line. This hum may be picked up when the point or wire is not even pressing on the crystal; so that, far from indicating a



A combination receiving and CW transmitting set of the inter-panel type, with the various units standardized so that they can be assembled to form any desired arrangement for the amateur station.

sensitive detector, it should indicate that the detector members are not even in proper contact.

For those desirous of making sure of their crystal detector adjustment, it is perhaps best to use what is known as the buzzer test. This calls for a small buzzer, such as is used in bell circuits. The buzzer is connected in the usual manner with a push button and cell of dry battery, but a wire is brought from one side of the buzzer interrupter to the ground lead of the receiving set to be tested. Then, when the buzzer is operated, the electro-

magnetic waves given off by the buzzer interrupter are impressed on the radio receiving set and the detector can be adjusted for sensitiveness in the same manner as though the operator were listening for a radio transmitter. The buzzer test is still used in some forms of elaborate receiving sets which include a crystal detector, for the reason that it serves as a positive indication of the sensitiveness of the crystal detector.

For the general run of radio receiving, however, a buzzer test is hardly necessary. If a crystal detector set is being used well within the range at which such apparatus is operative, the detector can soon be adjusted while listening to actual transmitters. However, if the crystal detector receiving set is being used beyond the usual range, then it may be necessary to use some form of buzzer test in order to make certain that the detector is adjusted to the utmost sensitiveness.

As for the tuning of simple sets, there is little to be said. The switch handle or the tuning handle is moved about until the desired transmitter is intercepted. With any aerial up to 150 feet long, the simple set should give excellent results. However, in the event that the aerial is over 150 feet long, or that a long lead-in wire has had to be used in order to connect the antenna with the receiving set, it may so happen that the natural wave length of the antenna circuit is greater than that of the desired radio-phone or radio telegraph waves. In such instances a fixed or variable condenser should be placed in series with the antenna or the ground, thus reducing the wave length.

While it is desirable to keep receiving sets as simple as possible, especially where laymen who will always be laymen are concerned, good results, more particularly at a considerable distance from the transmission station, can only be obtained with fine tuning facilities. Fortunately, one soon becomes used to tuning a receiving set, no matter how many handles may be involved in the tuning operation. Even with a tuning coil, the operator soon learns just where to place the single or double sliders

in order to pick up any given radio telephone or radio telegraph station. With a loose-coupler tuner, the oper-

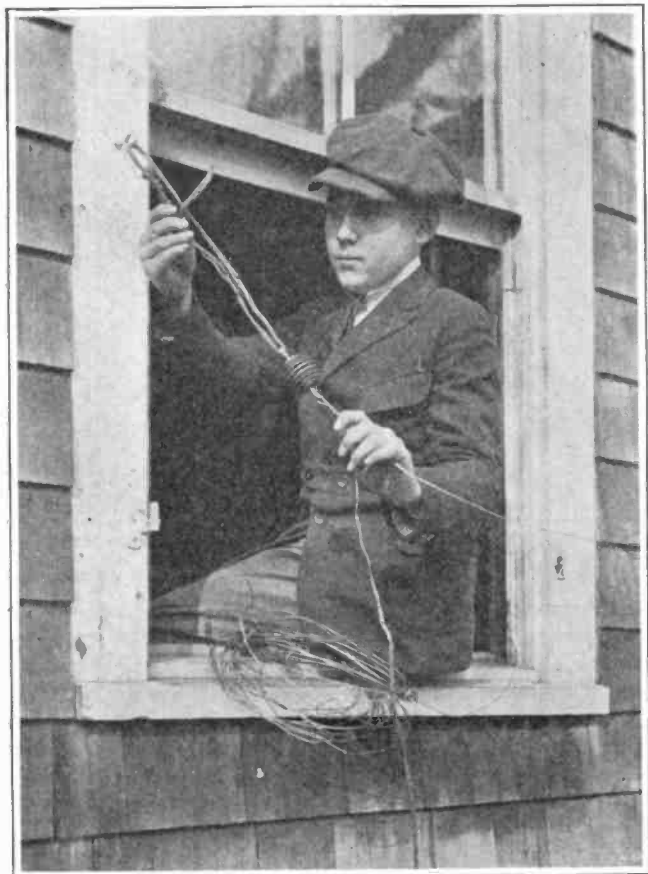

Nothing is simpler than erecting the antenna for receiving purposes. A single wire, with insulators at either end, is run between the house and a barn, tree, or clothes pole. Then a tap is taken off the near end of the antenna and brought into the house. This is known as the lead-in.

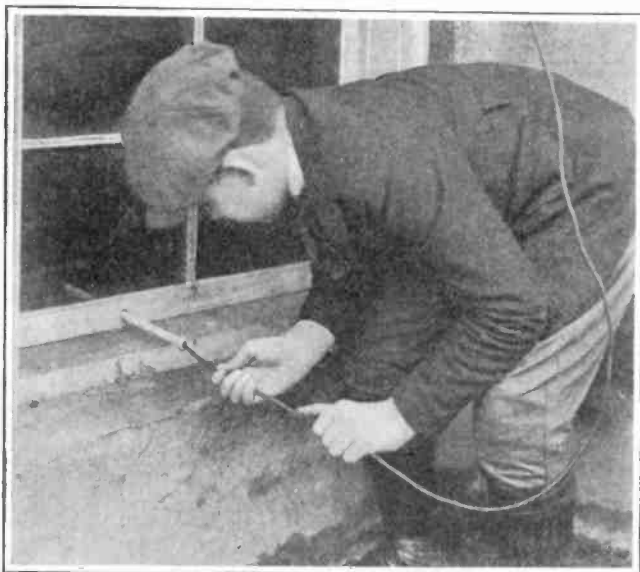

It is best to pass all wires through porcelain tubes when they enter the house, as shown here, even though the wires may be heavily insulated. It is an additional precaution well worth taking.

ator soon learns how to adjust the primary and secondary circuits, and how much coupling to use. With condensers or variometers, the operator becomes familiar with the adjustments of the various dials for picking up any desired transmitter. Indeed, some instruments are provided with dials that have plain subdivisions, without numbers of any kind, or even with plain pointers and blank backgrounds; yet the operator soon learns just where to place the dials or pointers in order to obtain the desired results.

At first, the operation of a radio receiving set is apt to be a little complicated and possibly disappointing, for the reason that the operator may not obtain the best results immediately. But at the end of an hour or two the operator readily masters the various adjustments and knows

just where to place the dials and pointers in order to pick up the transmitters which he wants to listen in on. Furthermore, it is interesting to note that any extensive change in the antenna varies the relative adjustments of the receiving set. Thus if the operator is accustomed to a given antenna, the changing of the proportions of that antenna or its height will upset the previous tuning values and the operator will have to learn his adjustments all over again. However, much of the fun that is afforded by radio comes in learning how to tune the receiving set and in searching for new transmitters.

INSTALLING THE RECEIVING SET

In a way, the few pointers regarding the installation of the receiving set should come ahead of the foregoing

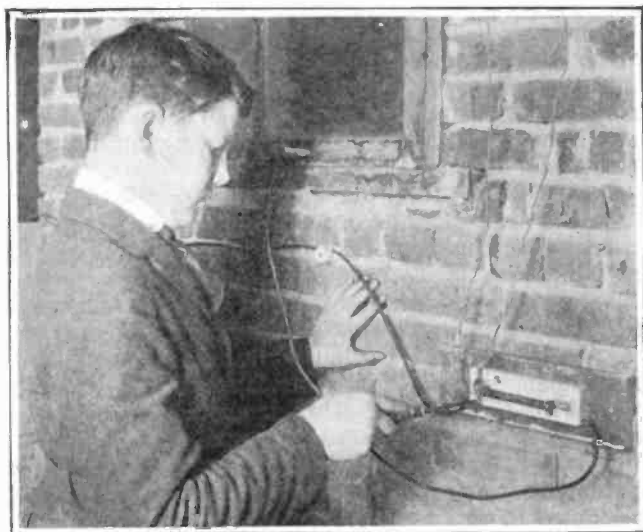

The vacuum gap type of lightning arrester is widely employed for receiving stations only. It is automatic in its operation, being always ready for action, no matter whether the receiving set is being used or not.

data on the operation of the simple receiving sets. But as a matter of fact one need pay little attention to the installation of the simple sets, for the reason that their simplicity limits their efficiency, so that the finer details of installation hardly apply to them. When it comes to elaborate vacuum tube receiving sets, it may be well to give a little thought to the installation for the purpose of obtaining the utmost efficiency.

To begin with, the receiving apparatus should be so placed as to permit of the shortest possible leads from the receiver to the point where the antenna lead-in enters the building. Sufficient space should be provided between the instrument and the edge of the desk or table to allow the operator to rest his forearm when adjusting the controls. Right here we can draw a comparison with the simpler sets, which have a single knob or perhaps two knobs on top of the case or on the side, the adjustment of which does not have to be so delicate as to call for the resting of the forearm. In the case of elaborate vacuum tube apparatus, however, the turning of a knob a hair's breadth may make for all the difference between distorted music or talk, or perfect reception.

The antenna lead from the lightning switch should pass through the wall or window within a porcelain tube or special lead-in insulator. We have already read of the board which can be placed in the window frame so that the window may be raised or lowered without interfering with the lead-in passing through the board placed at the top or the bottom of the window frame. If the lead-in is not insulated itself—heavily insulated wire is generally employed for this purpose—then it should be supported away from the walls by means of small wall insulators. The ground connection lead does not require any special insulation; ordinary No. 14 rubber covered copper wire is well adapted to this purpose.

FROM BED SPRINGS TO FIRE ESCAPES AND TO LOOPS

There are times when one cannot install the usual type of antenna for receiving purposes. In such an event one

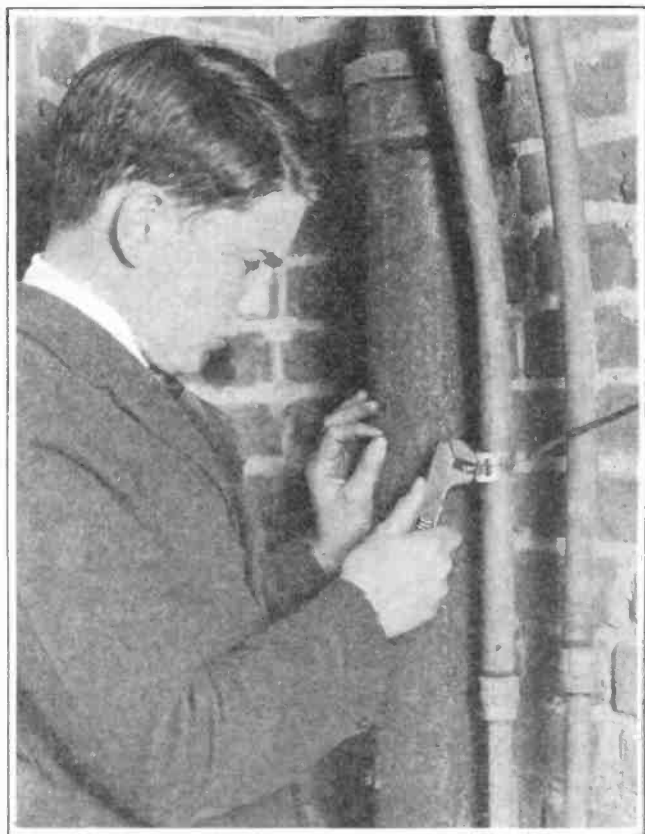

Too much pains cannot be taken with the ground connection. The ground may seem simple enough—and it is; but one should use a good ground clamp whenever possible, and connect it with the cold water pipe for best results, as shown here.

need not give up the idea of radio, for almost anything will serve for an antenna especially when receiving from nearby stations. Excellent results may be obtained with a piece of wire about 40 feet long, just strung back and

forth in a room or placed behind the picture moulding so as to be out of sight. We know of a man who uses an antenna for receiving from the Newark broadcasting station at a distance of 250 miles, and, on occasion, from Pittsburgh, some 650 miles away. The same man receives the signals of Nauen, Bordeaux, and other European high power stations with the same antenna.

The usual fire escapes found in the city make excellent antennæ. However, care must be taken in

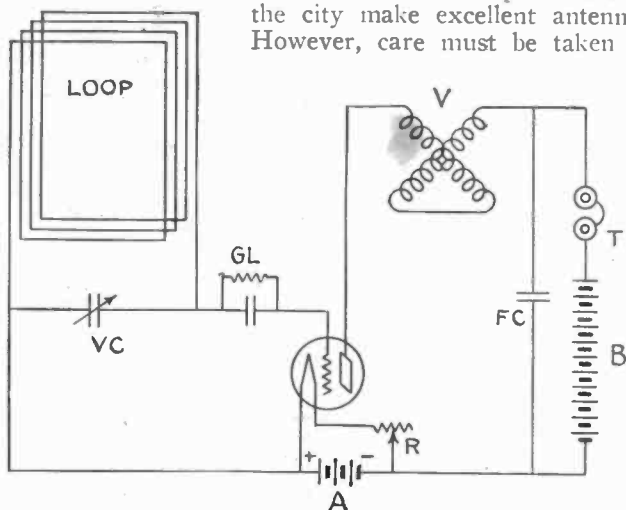

Simple vacuum tube hook-up for use with a loop antenna. Note that VC is a variable condenser; GL—grid leak; V—variometer acting as the “feed back” inductance; T—telephone receivers; B—“B” or plate battery; FC—fixed condenser; R—rheostat for filament current; A—filament battery. This arrangement will operate over short distances. For greater range a radio frequency amplifier must be used

scraping the paint off clean in order to make a good connection with the metal. Sometimes a gas pipe makes an excellent antenna, while the water pipe is used for the ground. If nothing better presents itself, a metal bedstead or bed spring serves as an antenna, with good results. Indeed, the problem of the antenna need never

trouble the radio devotee, for the reason that with the sensitive receiving equipment of today most anything will serve as an antenna when working over short distances.

Then we have the loop, which takes the place of antenna and ground connection. The loop is connected in the same way as would be the secondary of a vario-coupler or loose-coupler. A condenser is placed across the loop terminals so as to vary the wave length. A typical loop hookup is given in the accompanying wiring diagram, which, it will be noted, makes use of a plate variometer as the feed-back in order to obtain regenerative action. A loop outfit of this kind gives good results over reasonable distances, although it does not cover the same distance as would the same equipment when used with a good antenna. However, during the summer months when there are many lightning storms and when static is at its very worst, the loop presents an interesting means of reception. To begin with, the loop is safe from lightning even at the height of a lightning storm, since it can be used indoors. Furthermore, the loop does not pick up static as does the usual antenna, for the reason that it does not make use of a ground connection. But it is well to remember that a loop intercepts but a small portion of the usual energy intercepted by a good antenna. Therefore, for best results a radio frequency amplifier, such as described in the chapter on amplifiers, should be employed in order to build up the wave energy intercepted. The loop is a directional receiver—it receives best when pointed end on towards the transmitter. Many interesting experiments can be performed with a loop.

Elaborate receiving sets presuppose the use of the vacuum tube detector, for no really efficient radio reception at considerable distances can be obtained without this form of detector. With the introduction of the vacuum tube, however, the operation of a receiving set becomes a trifle more complicated than with the crystal detector, for while the latter does not give forth sounds of its own and is virtually silent except for the wireless telegraph and radio telephone waves, the vacuum tube creates plenty of noises

of its own in addition to the desired signals and telephone messages and music. A person passing from a simple crystal set to a vacuum tube set may be disappointed at first, because the vacuum tube makes so much noise and has to be tamed occasionally, so to speak, in order to subdue it, especially when using the utmost regenerative action. But when the vacuum tube is once adjusted properly, the clarity of the received messages or music, together with the strength of such messages or music, is so far ahead of the crystal detector as to make a comparison a sheer waste of time.

Vacuum tubes should not be put in place until it has been ascertained that all battery connections have been correctly made. This will avoid the accidental destruction of the tubes. The tubes, which cost upwards of \$5.00 each, may be burnt out just as any electric lamp can be burnt out by applying excessive voltage on the filament. There are on the market little fuses which fit on the connecting pins of any vacuum tube, and it may be the part of good judgment to provide one's vacuum tubes with these little fuses as a measure of protection. At any rate, if all battery connections are checked over and found to be correct, it will avoid the accidental destruction of the tubes whether fuses are provided or not.

The filament lighting battery, which is generally a storage battery, may be placed on the floor directly beneath the apparatus and the wires connecting this battery with the apparatus should be at least No. 14 B. & S. copper wire, properly insulated. Dry battery, consisting of four cells, may be used with a single standard detector tube, but it is expensive practice and not very satisfactory.

The condition of a storage battery may be tested by means of a hydrometer or a voltmeter. The hydrometer is an instrument which measures the specific gravity of the storage battery liquid or electrolyte, to give it the technical name. The cap or plug of each cell of storage battery is removed, and the hydrometer tube is inserted in each cell. Squeezing the rubber bulb of the hydrometer,

and then releasing it, causes the electrolyte to rise in the glass tube of the hydrometer. The specific gravity can be

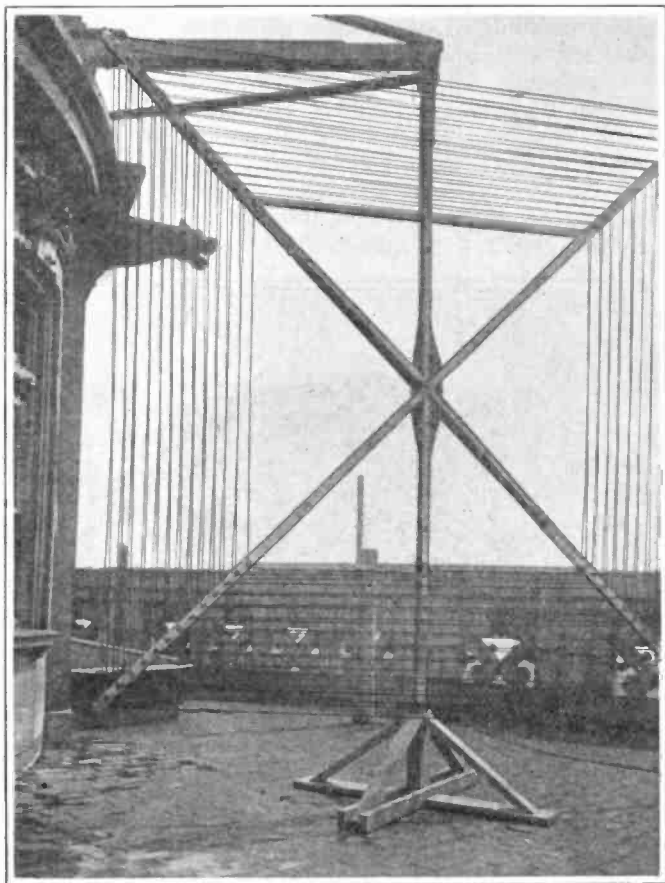

Large loop antenna employed for the reception of trans-Atlantic messages by a New York newspaper. The loop is mounted so that it can be orientated or pointed towards the transmitting station.

readily determined, and the relative charge of the cell obtained in this manner, by means of the bob or float.

One popular form of hydrometer now on the market has three colored balls in the glass tube, instead of the usual bob with buckshot, which may be a little confusing to the layman. If all three balls of this new hydrometer stay up when the electrolyte is introduced, the battery is fully charged. If the white ball goes down or sinks, the battery is all right. If the green goes down, the charge is lean. If the red goes down, the charge is dead. This hydrometer affords a simple test for any storage battery.

When using a voltmeter, it is necessary to have an

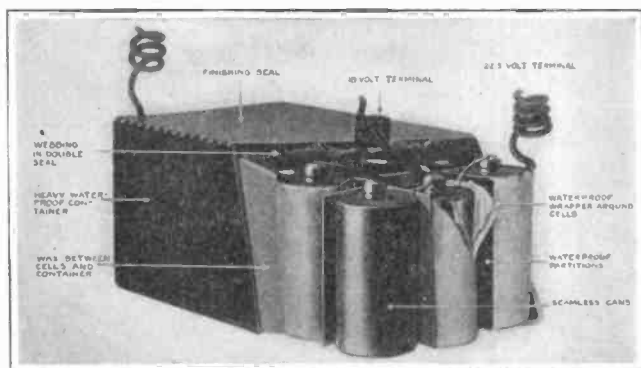

The construction of a "B" battery, showing the separate cells, the waterproof partitions, the special insulation, the terminals, and the method of sealing the entire battery.

instrument especially intended for the purpose, which measures from 0 to 3 volts, or 0 to 5 volts. The fully charged cell registers 2.2 volts. When the voltage drops to 1.8 volts per cell, the battery should be recharged. To allow the cell to drop below 1.7 volts is bad practice, for it hastens the wear and tear on the battery.

Storage batteries are rated in ampere hours. Generally speaking, a 20-ampere-hour battery will furnish a current of 1 ampere for 20 hours, 5 amperes for four hours, and

so on. If a vacuum tube detector alone is being used, then a 20-ampere-hour capacity is sufficient. If amplifiers are employed, a 60-ampere-hour storage battery should be used. Vacuum tubes of the standard type require about 1 ampere each, so that a 60-ampere-hour battery should operate a receiving set of detector and two-step amplifier for about 20 hours, after which the battery must be recharged.

Storage batteries may be recharged by means of a simple home recharger, or can be sent to a nearby garage or battery service station. The home recharging sets are designed for direct or alternating currents. The latter class are of two general types, namely, the vibrating reed type and the vacuum tube rectifying type. The former has a vibrating reed which rectifies the alternating current and steps it down to a suitable charging current. The vacuum tube rectifying type has a special vacuum tube which rectifies the current. A transformer steps down the current. The author has used a vibrating reed recharger with excellent results, and at a cost of but a few cents for each charge. In fact, in the long run a recharging set pays for itself many times over, since the regular price of recharging a battery is 50 cents to \$1.00 in most service stations, while the cost with a home recharging set is a matter of 10 to 20 cents, depending on the size of the battery and the length of charge.

The plate batteries, which are the high voltage batteries, will be most accessible if placed directly back of the receiver so that the wires can be readily brought to the proper binding posts of the receiver and amplifier units. Of late a number of B storage batteries have appeared on the market. It is claimed that the storage battery type is more economical in the long run than the dry battery, and that it furnishes a more uniform and less noisy current, which is an important consideration in vacuum tube work. These batteries run about 22 or 24 volts per unit, and two units can be used for amplifier operation. They can be readily recharged, since their ampere hour capacity is 2 or less.

All receiving sets and amplifier units are provided with jacks or binding posts for one pair of telephone receivers. If the jack is used—the jack is simply a metal hole or socket in which fits a plug fastened on to the cords of a telephone receiver—only one telephone receiver or head set can be used at a time. However, there has recently appeared on the market a multiple plug, which is inserted in the jack in the usual manner and which provides two

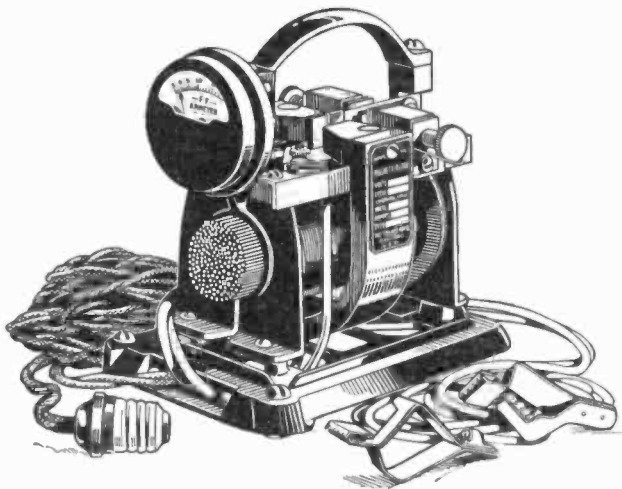

Vibrating type of rectifier and stepdown transformer outfit for recharging storage batteries on the usual alternating current supply line. The vibrating reed, which appears under the handle, rectifies both sides of the alternating current so that direct current is obtained. The volume of direct current is indicated by the ammeter.

holes or jacks for two head sets or for a head set and a loud-speaker, each instrument being provided with the proper plug. Furthermore, there is also available a multiple jack which may be mounted on an instrument or on a table near the instrument. The multiple jack presents three jacks all connected in series and so constructed that one, two or three plugs can be inserted. As each plug

is inserted, it connects itself automatically in series with the circuit, while the unused jacks are short-circuited so that the circuit will remain closed except for the jack or jacks being used. The use of these devices is to be recommended where more than one person is to listen in. Of course, where binding posts are used for the telephone connection, two pairs of telephone receivers can be clamped under the binding posts.

When the telephone receivers are connected directly with a vacuum tube detector, they may be arranged in parallel, but when they are used with a one or two-step amplifier, they should be arranged in series because of the high voltage used. In the latter case they are arranged with one tip of each telephone set going to one of the binding posts, while the two remaining tips of the telephone sets are connected together, thus putting the sets in series. The use of the multiple jack or multiple plug simplifies this matter and makes positive and noiseless connections.

A FEW POINTERS ON OPERATING THE RECEIVING SET

With the fifty-seven varieties or more of receiving sets now on the market, it would be impossible to give precise directions on the operation of each set. However, the vacuum tube receiving sets fall into a few general classes, so that broad instructions on each class are certain to fit every individual case with due allowance made for the peculiarities of each particular set.

The simplest vacuum tube set is of the single circuit type, in which no loose-coupler or vario-coupler is used. Furthermore, no regenerative action is employed, which greatly simplifies the operation but also makes the set less sensitive than it might be. Such a set makes use of a tuning coil or variometer, and perhaps a condenser. The inductance may be fixed, in the form of a compact inductance unit, with a condenser in series or in parallel to vary the wave length. However that may be, the adjustment of wave length comes down to the one or two components, and is soon restored in each case.

The operation of the vacuum tube requires a little care. The filament rheostat must be varied until the best signals are obtained, after tuning them in to the utmost strength. Generally the signals are loudest and clearest when the filament rheostat is moved up to a point just before the hissing sound is heard in the telephone receivers. With most vacuum tubes, the plate voltage is critical for best results, so that the B battery should be varied in order to obtain the loudest and clearest signals. Either a B battery of the variable voltage type can be employed, or a rheostat can be placed in series with the battery and the plate circuit. For the very best results, a potentiometer should be used with the B battery for the most accurate adjustments. The potentiometer is a resistance placed across the source of energy, while hooking up to one side and using a sliding contact to take current off the resistance at any point, thus making for very delicate control as compared with the simple series resistance of the usual rheostat.

The use of the regenerative arrangement complicates the operation of a set not a little but it also makes for louder signals than could ever be obtained with a simple circuit. Regeneration is obtained either by means of a tickler coil or by a grid variometer, as a general thing. Take the case of the tickler coil, which controls the amount of regenerative or feed-back action. First the detector tube is adjusted until it is as near silent as possible, yet responds to the spark signals. This is generally before the point where the tube becomes noisy, although at times the temperamental tube works best when the rheostat has been moved past the noisy point and into another zone of relative silence. Then the tuning handle or handles are adjusted so as to bring in the desired signals or telephone messages. Furthermore, by means of the tickler handle, the quality of the reception can be improved if necessary. If too much tickler action is used, the signals or the radio-phone are apt to be mushy and distorted because of excessive regeneration. Finally, the

signals or radio-phone are refined by turning the vernier adjustment, if the set is provided with such a device. The vernier is simply an auxiliary tuner which deals with much finer variations than the main tuner. It is necessary in the best types of receivers, because regenerative circuits are extremely sensitive and sharply tuned for the best results.

Generally, when using the regenerative method of reception, a radio-phone station denotes its presence by a whistling sound as the tuner is varied. By moving the tuner back and forth over the entire range of wave lengths, whistling sounds may be detected at certain points. Then the tuner is finally adjusted so as to get in between these whistling sounds, where there is a silent zone. It is in this zone that the radio-phone music or talk is heard. At other times these whistling sounds are due to continuous wave or undamped wave transmitters, which, like the radio-phone, make use of the same kind of waves and therefore have the same characteristics.

Once adjusted, a regenerative receiving set will maintain its adjustment fairly well. Occasionally, the vernier or the tuner may have to be readjusted, especially if the character of the music, if one is listening in to a radio-phone concert, is changed materially. The filament rheostat may also be altered at times to improve the strength or the clarity of the music.

When it comes to two- and three-circuit receiving sets, the tuning requires more care, otherwise the operation is the same. Again the tickler adjustment, starting at zero, is gradually increased until a position is reached just below the oscillating point. The oscillating condition is indicated by a soft hissing sound in the telephone. The final adjustments are made with the vernier or verniers. Sometimes it may be found necessary to adjust the tuner and the tickler at the same time in order to maintain the proportion necessary to keep the receiver on the verge of the oscillating condition, which is the most sensitive one. The adjustment of the coupler will also be found most important, more so when one is endeavoring to cut

down interference to a minimum. After all, the main advantage of the two- and three-circuit receivers, over the single circuit regenerative receivers, is that they provide real means of eliminating troublesome interference.

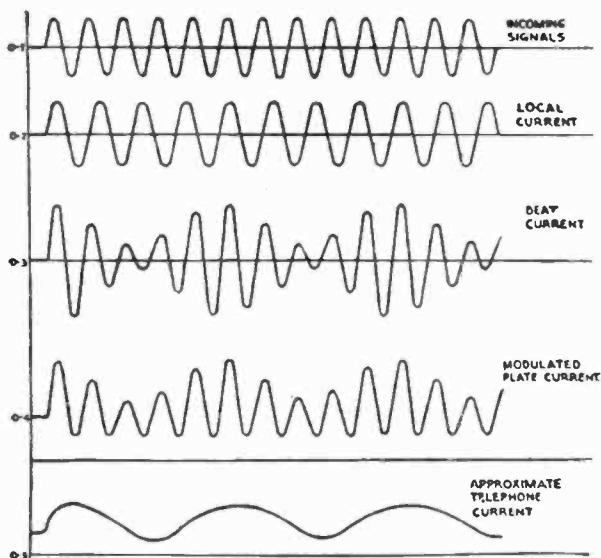

How CW waves are detected with an undamped receiving arrangement. The CW wave is shown to represent the incoming signals. The local circuit, employing a vacuum tube, is made to oscillate, producing its own wave or local current, which differs but slightly from the frequency of the incoming signals. This slight difference sets up a "beat current." This beat current, in turn, modulates the plate current as shown, which is pulsating direct current, having been rectified from the alternating beat current. Finally the telephones slur the modulated plate current variations into the large pulsations indicated.

SPARK SIGNALS AND C W SIGNALS

The reception and amplification of spark signals will be most satisfactory when the regenerative action is controlled to a degree which will produce maximum amplification without causing an oscillating condition in the

circuits. When the oscillating condition is reached, which is indicated by hissing noise, the tone of the spark signal will be destroyed and reception through interference will become virtually impossible. The tone of a spark transmitter, which means a damped wave transmitter, may be altered when adjusting the receiver from the plain detector action to the oscillating condition. That accounts for the fact why a transmitter, which is heard as a series of flute-like dots and dashes one moment, becomes a mushy but extremely loud series of dots and dashes the next. The flute-like sounds are the real sound values of the sparks, while the mushy sounds are the false sound values given to them by the oscillating action of the detector.

What are known as continuous wave signals, including the interrupted continuous waves and the modulated continuous waves, all of which are explained in the chapter further on dealing with continuous wave transmission, as well as the radio-phone, may be received in like manner, but a special condition may be obtained by allowing oscillations to take place in the receiver, producing the exact frequency of the incoming wave length. This is known as the "zero beat" method and in this condition amplification is greatly increased due to the augmented feed-back of energy from the plate to the grid circuit. It is only possible to make use of this method while the incoming frequency remains constant, and its successful application requires considerable skill.

In the reception of continuous waves the plate circuit feed-back or tickler action is to be increased to a point where oscillations are constantly taking place and this condition must be maintained throughout the entire tuning operations.

The most successful means for reducing spark interference while receiving modulated continuous wave signals, including radio-phone, is the use of the zero beat method described above. This will cause the spark signal to become distorted and suppressed while greatly increasing the amplification of the desired signal. As the oscillating condition is a prerequisite in the reception of

continuous wave signals, it follows that spark signals are more readily suppressed than are the modulated continuous wave signals. Where the carrier wave length of the modulated continuous wave signal and the wave length of the undesired signal are almost identical, it may be possible to suppress the undesired signal by changing the frequency of the desired signal to the point where the carrier wave frequency of the modulated continuous wave signal is beyond audibility. The coupler adjustment also makes for additional freedom from spark interference. The elimination of continuous wave signals while receiving spark signals is easily accomplished by reducing the plate variometer or tickler dial settings until the oscillations cease, unless the continuous wave station is very powerful and located nearby.

FROM RADIO-PHONE TO DOTS AND DASHES

Sooner or later, and better sooner than later, the radio enthusiast turns to dots and dashes because, after all, the radio telegraph still dominates the air as far as the volume of traffic is concerned. While the music and the radio-phone talks may be most interesting to the laity, the fact remains that many things of great importance are being missed if one does not understand the telegraph code.

Formerly, the Morse telegraph code was largely employed in radio telegraph work in this country. At that time the Marconi land stations and ship installations used the Continental code, which is the present code, while the other radio organizations as well as the Government and amateur stations used the Morse code, which is the code used on our telegraph lines. However, in order to have a uniform code with the rest of the world, the Continental code was finally adopted as the standard radio code. This code differs from the former Morse code in the fact that it has no spaces between the letters themselves. In the Morse code, for instance, the letter C is represented by dot dot space dot. The letter R is just the reverse, namely, dot space dot dot. Now, since there are spaces between the letters themselves, it stands to reason that the space

DEPARTMENT OF COMMERCE
BUREAU OF NAVIGATION
RADIO SERVICE

INTERNATIONAL MORSE CODE AND CONVENTIONAL SIGNALS
TO BE USED FOR ALL GENERAL PUBLIC SERVICE RADIO COMMUNICATION

1. A dash is equal to three dots.
2. The space between parts of the same letter is equal to one dot.
3. The space between two letters is equal to three dots.
4. The space between two words is equal to five dots.

A . —
 B — . . .
 C —
 D — . . .
 E .
 F . . — . .
 G — . . .
 H
 I . .
 J . — — — —
 K — . .
 L
 M — —
 N — . .
 O — — — —
 P —
 Q — . — — —
 R
 S
 T — —
 U
 V
 W —
 X —
 Y —
 Z — — . . .

Å (German)
 Å or Ä (Spanish-Scandinavian)

 Æ (German-Spanish)

 È (French)
 Ñ (Spanish) — — — — —
 Ü (German) — — — — —
 U (German)

1 . — — — — —
 2
 3
 4
 5
 6
 7
 8
 9 — — — — —
 0 — — — — —

Period
 Semicolon
 Comma
 Colon
 Interrogation
 Exclamation point
 Apostrophe
 Hyphen
 Bar indicating fraction
 Parenthesis
 Inverted comma
 Underline
 Double dash
 Distress Call
 Attention call to precede every transmission
 General inquiry call
 From (de)
 Invitation to transmit (go ahead)
 Warning—high power
 Question (please repeat after)
 interrupting long messages
 Wait
 Break (Bk.) (double dash)
 Understand
 Error
 Received (O. K.)
 Position report (to precede all position messages)
 End of each message (cross)
 Transmission finished (end of work) (conclusion of correspondence)

between the dots and dashes forming a single letter must be shorter than those between letters, and it is this feature which makes the code more complicated and more liable to error than the Continental code, which has no spaces within the letters themselves.

The Continental code may be readily mastered with a little patience. The best method to proceed in learning the telegraph language is to learn the code letters not so much by remembering the dot and dash combinations as by learning the sounds. In other words, when an operator listens to a telegraph message he does not notice the dot and dash combinations of each letter and then translate these combinations into the proper letter or numeral. Instead, he catches the certain sound or combination of each letter or numeral, and automatically his trained mind reads off the message in letters. The trained operator never thinks of the letters in dots and dashes, just as the reader, in reading this line of type, does not notice the letters in each word but recognizes words as complete units by their general appearance. In writing, the same is true. The rapid writer does not think of each letter as he writes; his words are his units, and he writes as he thinks.

Therefore, the code must be learned by means of some instrument which simulates radio dots and dashes. For this purpose a simple buzzer operated by a battery and a telegraph key, may be used. Again, one can purchase a regular practice set, which has buzzer and key combined in one unit. A very ingenious little practice set is shown in the accompanying illustration, which contains a battery, buzzer, telegraph key, and a lamp for visual signals.

The first step, once the practice set is at hand, is to learn the code letter by letter. The code is given in the chart on page 165. Note that A is a dot and a dash. This is translated into a short snappy push on the telegraph key followed by a longer push. The key should be held with the index and middle fingers of the right hand resting lightly but firmly on top of the knob, with the

thumb in light contact at the side or beneath the rim of the key knob. All characters should be made by wrist motion, with the elbow stationary, and all muscles of the arm and fingers should remain perfectly flexible. One of the most difficult things for the beginner to learn is proper wrist motion, which is so essential to good transmitting. The beginner should never start with the key knob close to the table, due to the fact that this will interfere with the forearm and free wrist movement. Transmitting involves a downward pressure on the key of short or long duration, it being unnecessary to do any elevating of the

key as this is provided for by the spring compression under the key.

The beginner should first learn to recognize the letters of the Continental or International code instantly when heard, without conscious effort. In order to acquire this knowledge he should start to send at a slow rate of

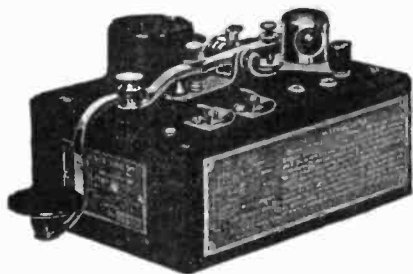

Buzzer practice set employed in learning the radio code. This little set is also provided with a small lamp which gives visual code signals when desired.

speed, remembering that a dash is equivalent in duration of time to that taken for making three dots. When operating the key, listen to the sound produced by the buzzer, or, if the practice set has a visual indicator such as a lamp, watch the flash produced by the blinker, as it is called. In a surprisingly short time smoothness and speed in both sending and receiving will be developed. In some practice sets a head receiver is worn so that the buzzes are heard in the same manner as though they were received from a radio telegraph transmitter.

Taking the telegraph code, the beginner should start with the first four letters, mastering them in turn. Thus,

the beginner will note by studying the code chart that dah de dah de—and not dash dot dash dot—is C, instantly, and that dah de de de is B. In other words, he learns what sounds represent each letter, and he does not stop to figure how many dots and dashes he has heard. It is left to the mind to perform two functions for each letter, namely, to think of the symbol and then the letter. It will be found that as the code is mastered, the letters will form in the brain automatically, and when this stage is reached the speed can be greatly increased.

After mastering the first four letters, the beginner goes on to the next four. With these mastered, he repeats all the letters from the beginning again, and then passes on to the next four, and so on. It may require several evenings to memorize all the letters and numerals, and finally one can go on to the various punctuation marks and other characters. To recognize the symbols instantly, even when they are sent at slow speed, takes much longer, of course. Sending is much simpler than receiving.

With all the symbols memorized, the beginner should sit down by the hour and translate newspaper articles or magazine articles or any other "copy" into the Continental code, using the practice set. In this manner he trains his ear to the various sounds, and after all the mastering of the code is just that, nothing more.

The next step is one which presents two alternatives: Either the beginner can get in touch with some other beginner and spend some time each week transmitting messages back and forth to each other by means of a buzzer practice set, or the beginner can listen in on his receiving set to the amateur transmitting stations, endeavoring to pick up letters here and there. The second method is not apt to produce immediate results, for the reason that much of the traffic is entirely too fast for the beginner. However, certain radio telegraph broadcasting stations have the beginner very much in mind these days, and transmit at a very slow speed in order to furnish practice for the beginner. There are automatic machines



A group of young men learning the radio code. A telegraph key, high-pitch buzzer, and a couple of dry cells serve to simulate radio signals in the telephone receivers worn by the students and the instructor. The instructor sends out the messages, which are copied down by the students. At first the messages are simple and are sent at a slow rate of speed, but by degrees the speed is increased and the messages become more involved.

which send messages at any desired speed for training the beginner. This is an excellent self-instructor.

One method of learning the code is to attend a radio school. The schools, thanks to their wide experience, have perfected methods of training beginners which produce early results. But in the main one can teach one's self if sufficient patience is exhibited. Listening to radio telegraph stations and attempting to jot down on paper as many letters as are recognized finally results in copying more and more letters and words until perfection is attained.

Aside from the telegraph code, there are certain abbreviations that have been inaugurated by the International Radio Convention. The list of these abbreviations is presented on the facing page, and while it may not necessarily be memorized, it is well to remember the more important ones.

WHEN AND WHERE A RADIO LICENSE IS NECESSARY

Having mastered the code and become a radio operator of more or less ability, a person can consider a transmitting set. Otherwise a transmitting set is out of the question, unless one has a licensed operator to run it. The owner of an amateur transmitting station must obtain a station license before it can be operated if the signals radiated therefrom can be heard in another state, and also if such a station is of sufficient power to cause interference with neighboring licensed stations in the receipt of signals from transmitting stations outside the state, which means that virtually all transmitters must be licensed. These regulations cover the operation of radio telephone stations as well as radio telegraph stations.

Station licenses can be issued only to citizens of the United States, its territories and dependencies.

Transmitting stations must be operated under the supervision of a person holding an operator's license, and the party in whose name the station is licensed is responsible for its activities.

DEPARTMENT OF COMMERCE
BUREAU OF NAVIGATION
 RADIO SERVICE

INTERNATIONAL RADIOTELEGRAPHIC CONVENTION
LIST OF ABBREVIATIONS TO BE USED IN RADIO COMMUNICATION

ABBREVIATION	QUESTION	ANSWER OR NOTICE
PRB	Do you wish to communicate by means of the International Signal Code?	I wish to communicate by means of the International Signal Code.
QRA	What ship or coast station is that?	This is
QRB	What is your distance?	My distance is
QRC	What is your true bearing?	My true bearing is degrees.
QRD	Where are you bound for?	I am bound for
QRF	Where are you bound from?	I am bound from
QRG	What line do you belong to?	I belong to the Line.
QRH	What is your wave length in meters?	My wave length is meters.
QRJ	How many words have you to send?	I have words to send.
QRK	How do you receive me?	I am receiving well.
QRL	Are you receiving badly? Shall I send 20% for adjustment?	I am receiving badly. Please send to for adjustment.
QRM	Are you being interfered with?	I am being interfered with.
QRN	Are the atmospherics strong?	Atmospherics are very strong.
QRO	Shall I increase power?	Increase power.
QRP	Shall I decrease power?	Decrease power.
QRQ	Shall I send faster?	Send faster.
QRN	Shall I send slower?	Send slower.
QRU	Shall I stop sending?	Stop sending.
QRU	Have you anything for me?	I have nothing for you.
QRV	Are you ready?	I am ready. All right now.
QRW	Are you busy?	I am busy (or: I am busy with). Please do not interfere.
QRX	Shall I stand by?	Stand by. I will call you when required.
QRY	When will be my turn?	Your turn will be No.
QRZ	Are my signals weak?	Your signals are weak.
QSA	Are my signals strong?	Your signals are strong.
QSB	Is my tone bad?	The tone is bad.
QSC	Is my spark bad?	The spark is bad.
QSD	Is my spacing bad?	Your spacing is bad.
QSF	What is your time?	My time is
QSG	Is transmission to be in alternate order or in series?	Transmission will be in alternate order.
QSH	Transmission will be in series of 5 messages.
QSI	What rate shall I collect for?	Collect
QSK	Is the last radiogram canceled?	The last radiogram is canceled.
QSL	Did you get my receipt?	Please acknowledge.
QSM	What is your true course?	My true course is degrees.
QSN	Are you in communication with land?	I am not in communication with land.
QSO	Are you in communication with any ship or station (or: with)?	I am in communication with (through).
QSP	Shall I inform that you are calling him?	Inform that I am calling him.
QSQ	Is calling me?	You are being called by
QSR	Will you forward the radiogram?	I will forward the radiogram.
QST	Have you received the general call?	General call to all stations.
QSU	Please call me when you have finished (or: at o'clock)?	Will call when I have finished.
*QSV	Is public correspondence being handled?	Public correspondence is being handled. Please do not interfere.
QSW	Shall I increase my spark frequency?	Increase your spark frequency.
QNX	Shall I decrease my spark frequency?	Decrease your spark frequency.
QSY	Shall I send on a wave length of meters?	Let us change to the wave length of meters.
QSZ	Send each word twice. I have difficulty in receiving you.
QTA	Repeat the last radiogram.
QTE	What is my true bearing?	Your true bearing is degrees from
QTF	What is my position?	Your position is latitude longitude.

* Public correspondence is any radio work, official or private, handled on commercial wave lengths.

When an abbreviation is followed by a mark of interrogation, it refers to the question indicated for that abbreviation.

(1-4980)

List of abbreviations now employed in radio communication for the purpose of saving time and trouble.

The Government licenses granted for amateur stations are divided into three classes as follows:

Special Amateur Stations, known as the "Z" class of stations, are usually permitted to transmit on wave lengths up to approximately 375 meters.

General Amateur Stations, which are permitted to use a power input of 1 kilowatt and which cannot use a wave length in excess of 200 meters.

Experimental Stations, known as the "X" class, and school and university radio stations, known as the "Y" class, are usually allowed greater power and also allowed the use of longer wave lengths at the discretion of the Department of Commerce, which has charge of the granting of licenses and the enforcement of the radio laws.

All stations are required to use the minimum amount of power necessary to carry on successful communication. This means that while an amateur station is permitted to use, when circumstances require, an input of 1 kilowatt, this input should be reduced or other means provided for lowering the antenna energy when communicating with nearby stations in which case full power is not required.

Malicious or wilful interference on the part of any radio station or the transmission of any false or fraudulent distress signal or call is prohibited. Severe penalties are provided for violation of these provisions.

Special amateur stations may be licensed at the discretion of the Secretary of Commerce to use a longer wave length and higher power than general amateur stations. Applicants for special amateur station licenses must have had two years' experience in actual radio communication. A special license will then be granted by the Secretary of Commerce only if some substantial benefit to the science of radio communication or to commerce seems probable. Special amateur stations located on or near the sea coast must be operated by a person holding a commercial license. Amateur station licenses are issued to clubs if they are incorporated, or if any member holding an amateur operator's license will accept the responsibility for the operation of the apparatus.

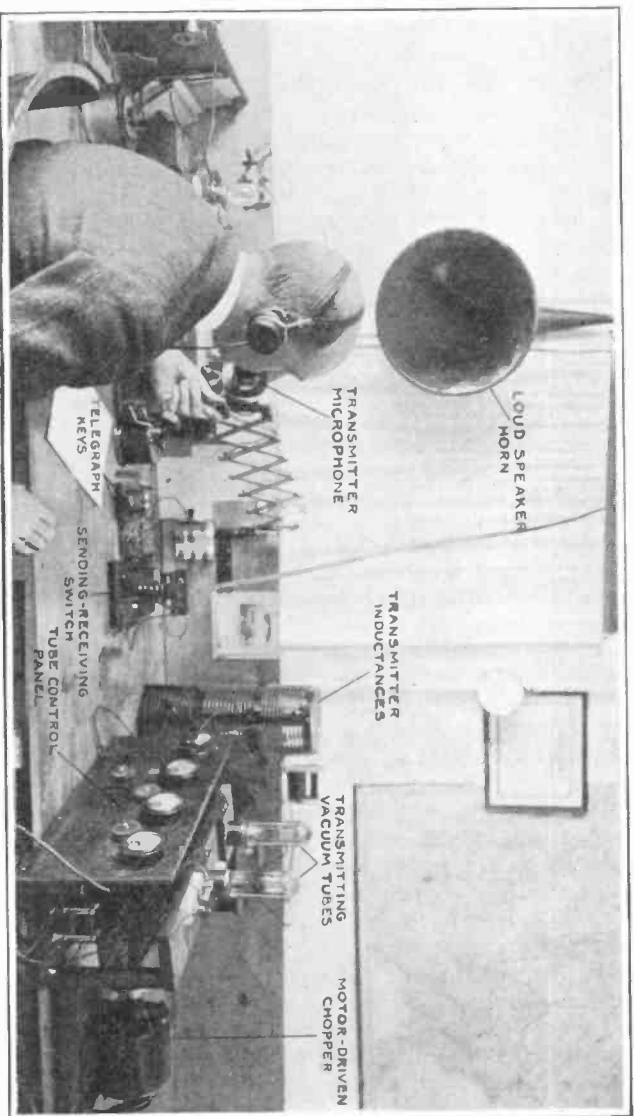

Typical amateur receiving and sending station of the CW type. Note the nice wide table which gives plenty of room for the operator's arms, his papers, and so on. The telephone transmitter is mounted on a lazy tongs support, so that it can be brought to the desired position for speaking.

Applications for operator's and station licenses of all classes should be addressed to the Radio Inspector of the district in which the applicant or station is located. or, if this is not known, to the Bureau of Navigation, Department of Commerce, Washington, D. C. The accompanying map indicates the territory covered by each radio district.

Each district has a Radio Inspector, whose address is given below:

First District.....	Boston, Mass.
Second District	New York City
Third District	Baltimore, Md.
Fourth District	Norfolk, Va.
Fifth District	New Orleans, La.
Sixth District	San Francisco, Calif.
Seventh District	Seattle, Wash.
Eighth District	Detroit, Mich.
Ninth District	Chicago, Ill.

Once more, let it be clearly understood that no license is required for a receiving set only or for the operator of a receiving set. However, all persons are required by law to maintain secrecy in regard to any messages which may be overheard. This is a blanket law, of course, intended to safeguard the interests of those transmitting and receiving private dispatches and special press reports, and does not apply to broadcasted telegraph and telephone service.

Persons who wish to operate a transmitting set must apply to the radio inspector of their district for the necessary form and, at an appointed time, undergo an examination which covers their proficiency in receiving and sending telegraph messages, as well as in the theory and practice of radio. Operator's licenses are of the amateur and commercial grade, depending on the proficiency of the person examined. There is no fee or charge for either an operator's or a station license.

Every person engaged in any form of radio communication should have a copy of a pamphlet, "Radio Communication Laws of the United States," which can be

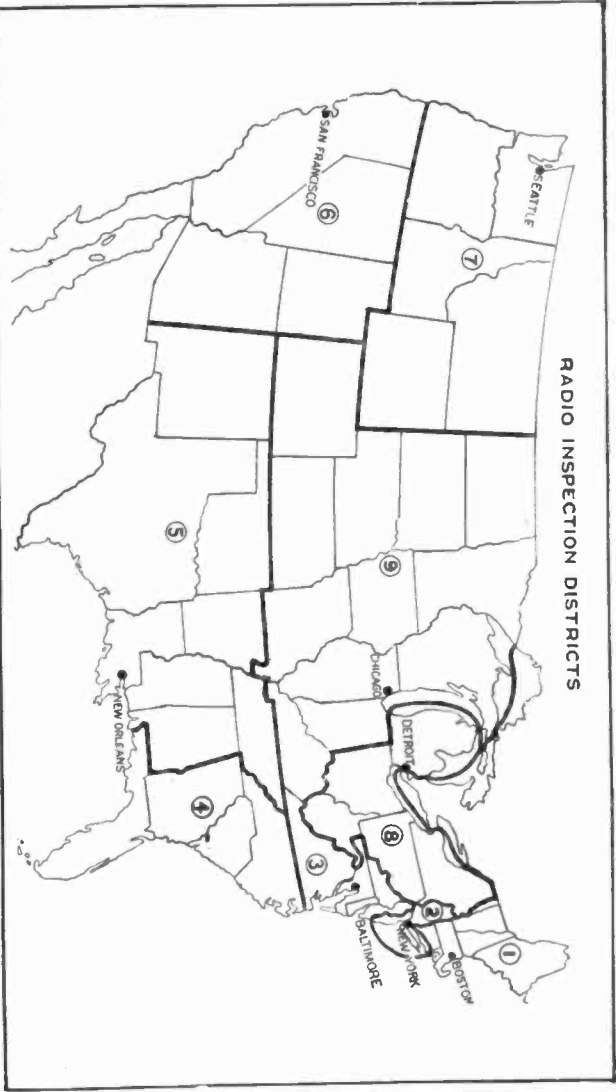

Radio inspection districts of the United States and their number. Thus the first district takes in practically all of the New England States, and so on. Applicants for operator's and station licenses should apply to the radio inspector in their respective districts.

secured by sending fifteen cents (not in stamps) to the Superintendent of Documents, Government Printing Office, Washington, D. C.

The laws regulating the operation of private radio stations in Canada are different in several respects from those in force in the United States. For instance, a station which is used only for receiving must have a station license. For authoritative information, inquiry should be made of the Deputy Minister of the Naval Service, Ottawa, Ontario.

CALL LETTERS AND WHAT THEY MEAN

All radio transmitters have call letters. Just as automobiles carry license plates with the State and a number plainly marked on them, so do all radio transmitting stations use call letters consisting of two or three or four letters and numerals. If one station wishes to call another station, it calls by means of the call letters of the desired station. The Government assigns call letters at the time the station license is granted. Every radio amateur should have a copy of the pamphlets "Amateur Radio Stations of the United States," and "Commercial and Government Radio Stations of the United States." The price of each of the pamphlets is fifteen cents, and orders should be sent to the Superintendent of Documents. These pamphlets contain lists of the amateur, and commercial and Government stations in the United States, and of the call letters assigned to the stations. A new edition of each pamphlet is published on June 30 of each year. A monthly publication called the "Radio Service Bulletin" is issued which contains information regarding changes in the radio regulations and traffic.

Chapter VI.

MAKING BIG SOUNDS OUT OF LITTLE ONES, OR THE GENTLE ART OF AMPLIFYING

MUCH of the present success of radio depends on the amplifier apparatus now in use. The amplifier is the instrument which makes possible the magnifying of weak signals or sounds in an electrical circuit. An incoming radio-phone wave may be so weak that the sounds cannot be heard in the telephone receiver, yet throw in one step or stage of amplification and immediately the sounds are loud and clear. The music or the talk assumes a depth and roundness that has been lacking when receiving with the ordinary detector circuit. Throw in another step of amplification or two steps in all, and the sounds are so loud that they can be heard when the telephone receivers are laid on the table. Or, a loud-speaking device may be hooked up and immediately the sounds are heard throughout the room without the aid of the telephone receivers.

The amplifier has served to increase the range of all transmitters to an unbelievable extent. Thus with a given transmitter in the old days of crystal detectors, the usual range might have been say 100 miles. Today, thanks to the regenerative receiving circuit already described, which amplifies the signals considerably, and also thanks to a two-step amplifier, the same transmitter may operate a thousand miles with ease. Not that the transmitter is any the more powerful or more efficient than it was

formerly, but the receiving set, because of the regenerative arrangement and the amplifier, responds when the waves are that much more attenuated or weakened.

FROM TRANSATLANTIC RADIO TO TRANSCONTINENTAL TELEPHONE

The amplifier is responsible for many of our recent achievements. For instance, the recent spanning of the Atlantic by twenty-nine amateur transmitters, using one kilowatt or less and a wave length below 200 meters, would have been impossible were it not for the highly efficient receiving equipment and amplifier employed by the American observer stationed in Scotland for the purpose of picking up the weak signals. An ordinary set would not respond to such signals, and the transmitters would be said, under such circumstances, to be incapable of spanning the 3,000 miles or more of space between America and Scotland.

Yet with the proper receiving set and super-amplifier, the transmitters were found to span the intervening space with a varying degree of success. Which only serves to prove once more that no matter how weak the transmitter may be, its waves are propagated through space and keep on going farther and farther away with virtually no end. It may seem fantastic to believe that the waves from a little amateur transmitter when once started keep on going through space for years and years, until they may reach the moon and the distant planets; but such must be the case. The whole problem is one of having a receiving set sufficiently sensitive to respond to the attenuated waves, and then an amplifier which can build up the signals to audibility.

The amplifier principle is used in telephone work. The trans-continental telephone would not be the success which it is were it not for the vacuum tubes now employed as amplifiers or repeaters. After going through many hundred miles of wire and becoming attenuated as a result, the weakened telephonic currents are passed through vacuum tubes in order to impress their characteristics on other circuits, which in turn have fresh and

powerful currents ready for another jump of several hundred miles. These currents, in due course, become attenuated in their turn, and again resort is had to vacuum tube devices. The vacuum tube has proved to be the most reliable form of telephonic relay or repeater ever

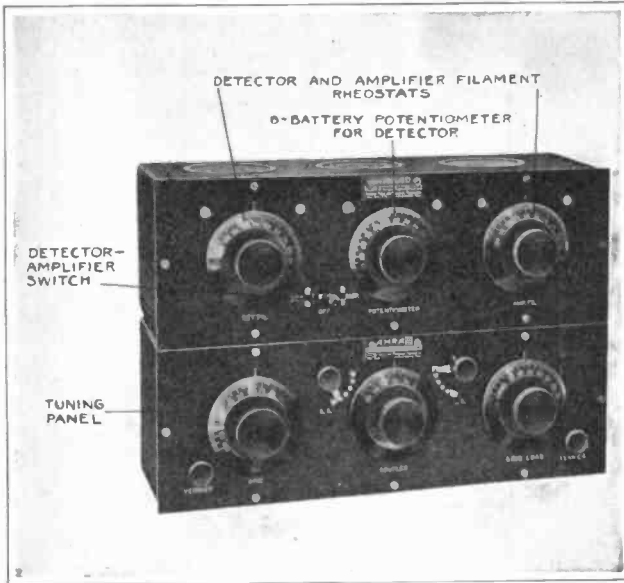

Combination tuner and detector-amplifier set made up of two units mounted one above the other as shown. This comprises an excellent receiving set, with detector and two-stage amplifier completely self-contained.

developed, working with virtually no distortion when properly designed and handled.

In the previous chapter we had something to say regarding the action of the vacuum tube. We learned of the flow of electrons or ions from the hot filament, and how this flow of electrons or ions formed a one-way bridge for the B battery current connected with the tele-

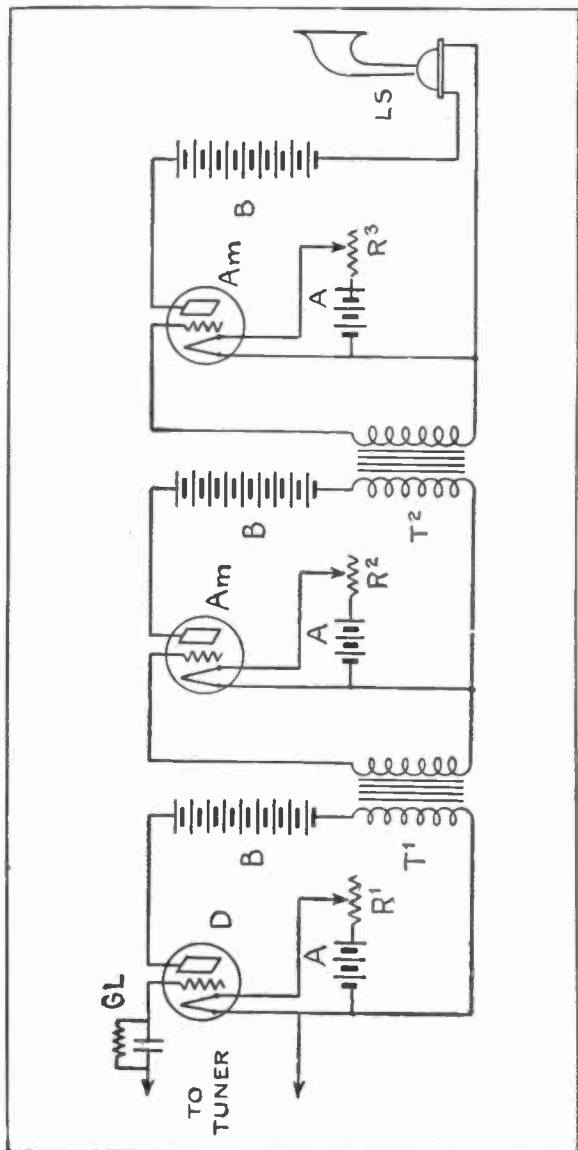

General scheme of connections for all audio frequency amplifiers. In this case a vacuum tube detector and two stages of audio frequency amplification are shown. GL—grid leak; D—vacuum tube detector; A—filament battery; R1, 2 and 3—filament rheostat; B—plate or “B” battery; T1, 2 and 3—interval or amplifying transformers; Am—amplifier tubes; LS—loud speaker. In actual practice the filament and B batteries are used for all three tubes, but in this and other hookups separate batteries are shown to simplify the diagrams.

phones. And the grid, as we learned, is the control for the traffic over this one-way bridge. In the case of the amplifier tube, the grid is again employed as the control. Instead of using a pair of telephone receivers in the plate circuit of the receiving set, the two leads or "output" terminals are brought to the amplifier apparatus, as shown in the accompanying diagram. The first step is to pass the receiving circuit current through the primary of a special amplifying transformer. Such transformers are available in many different styles but all serve the same general purpose. They are sometimes called intervalve transformers. The secondary of the transformer is brought to the grid and to the filament of the amplifier tube, as shown. The plate circuit of the amplifier tube contains a B battery of higher voltage than the detector B battery, and the telephone receivers. However, if another stage or step of amplification is desired, then the plate current from the first tube is brought to the primary of a second amplifying transformer, and the secondary is connected with the grid and filament as before. This second amplifier bulb has a B battery and a pair of telephone receivers or the loud-speaking device, as the case may be. A third step may be added in the same manner. Three steps or stages of amplification are considered the limit in actual practice, for the reason that beyond that point the adjustment of the circuits becomes too difficult for satisfactory work. Please note that the same filament and B battery may be used for the detector and the amplifier tubes, but for the sake of simplicity most of our diagrams show separate batteries being used for each tube.

Whereas the amplifier tubes and detector tubes may look alike, they are quite different as far as the electrical characteristics are concerned. Amplifier tubes are not critical in adjustment when compared with detector tubes and they will operate successfully on plate voltages of 40 to 80 volts. Where a detector and two stages of amplification are used, three 22½ volt units may be connected

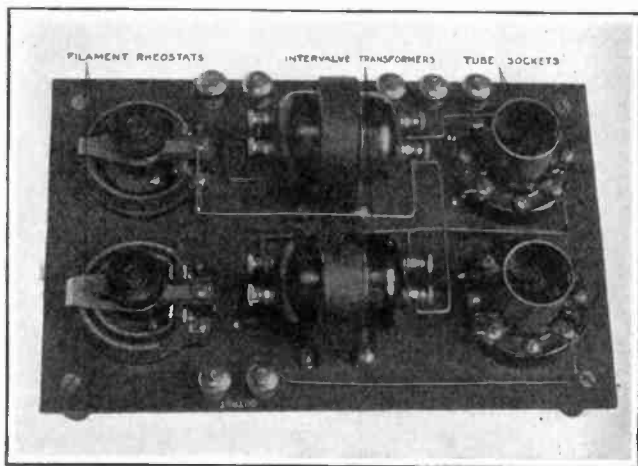

Simple mounting for a two-stage amplifier, comprising the filament rheostats, the interval or amplifying transformers, and the tube sockets.

in series and connections to the receiver made in a manner which permits the use of the full voltage on the amplifier tubes while a variable portion of the same battery is used for the detector tube, say anywhere from 16 to 22 volts. Where extremely loud signals are desired the plate voltage may be 100 or over; and while such high voltage will not damage the amplifier, it will increase tube noises, and is therefore not desirable when receiving signals with the telephone head set. No more than 45 volts is required even with several pairs of head phones. An amplifier tube which requires a critical plate voltage or filament current adjustment will not give consistently satisfactory results as an amplifier. Tubes of this character will generally be found useful as detectors.

AUDIO OR RADIO FREQUENCY—WHICH?

The amplifying arrangements described so far, and for that matter the greater part of the amplifying apparatus

now available and in regular use, is known as the audio-frequency type. It is called the audio frequency type for the reason that it is handling currents of frequencies well within the audible range. There is another type of amplifier known as the radio-frequency type, which, up till the present time, has been rarely used. However, at this writing the radio frequency type is rapidly coming into general use for long-range reception, as well as in connection with loop antennæ and diminutive antennæ of all kinds. In the case of *audio-frequency* amplification, the amplifying is done *after* the signals have been passed through the detector and rectified so as to produce audio-frequency currents, while with the *radio frequency* ampli-

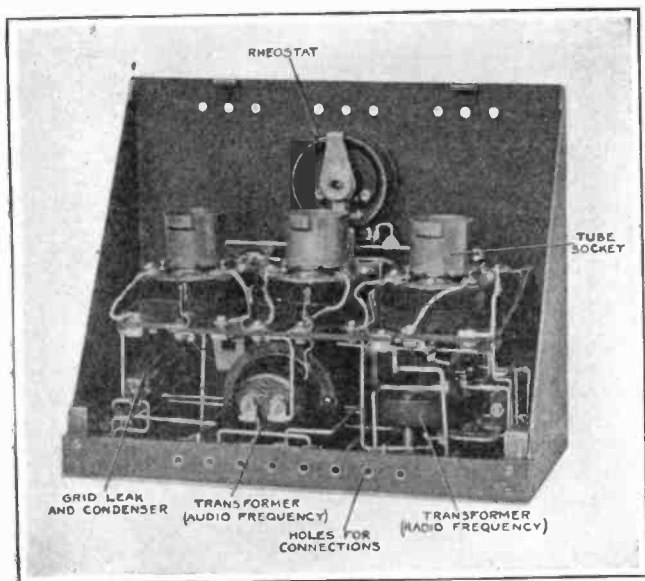

Components of a combination radio frequency amplifier, vacuum tube detector, and audio frequency amplifier, mounted in a neat steel cabinet.

fer the waves are amplified *before* they are passed to the detector.

The advantage of the radio-frequency amplifier lies in the fact that it amplifies only the wave and not the many little irregularities and imperfections which exist in the usual receiver and amplifier equipments. Furthermore, most detectors have a critical point at which they

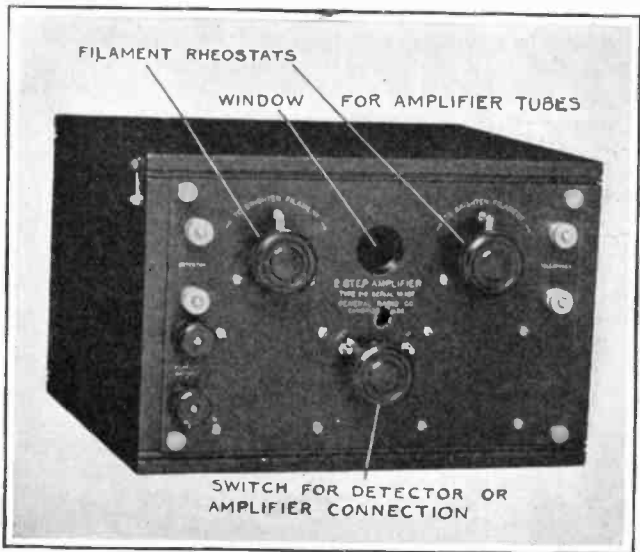

Two-stage audio frequency amplifier, with filament rheostat handles, switch handle for connecting the detector alone, or one stage or two stages of amplification into the circuit, as well as the input, output, and filament current binding posts mounted on the front panel.

begin operating. Signals which come in weaker than the critical point of the detector make no impression on the detector, and are therefore lost entirely. No matter how many steps of audio-frequency amplification may be piled up behind the detector, the signal which has failed to

actuate the detector will certainly not be heard. With radio-frequency amplification, on the other hand, there is virtually no critical point, and even the weakest signal is built up to the desired degree before it is passed on to the detector, there to be rectified to audio-frequency current, which, if desired, can be passed on through one or more stages of audio-frequency amplification in order to build up the signal strength.

In extreme long-distance work, it is not uncommon to

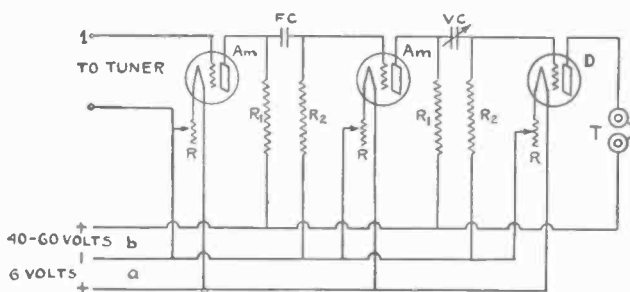

Resistance type of radio-frequency amplifier. The set of wires b are for the plate battery current, with the polarity indicated, while the a set indicates the filament battery current. The wire marked 1 is the grid wire from the tuner. R are the filament rheostats; R₁, 2 are resistances; Am are amplifier tubes; D is the detector tube; FC—fixed condenser; T—telephones; VC—variable condenser.

find two stages of radio-frequency amplification, followed by a detector and two stages of audio-frequency amplification.

When using a loop antenna, it is usually necessary to employ radio-frequency amplification unless one is near the desired transmitter. The radio-frequency amplifier builds up the wave energy before passing it on to the detector, and in that manner enables one to hear signals which would not affect the detector otherwise. After all is said and done, it is really the radio-frequency amplifier which makes for extreme sensitiveness in the receiv-

ing set, and enables almost unbelievable distances to be spanned, while it is the audio-frequency amplifier which makes for loud signals and for the successful operation of loud-speaking devices.

The simplest type of radio-frequency amplifier is known as the resistance-coupled type, and is shown in the wiring diagram on page 185. In this arrangement the amplifying transformers are replaced by suitable resistances and condensers, the amplified energy being passed from one circuit to the other by means of the resistance coupling. This method is preferable in many instances because of its simplicity and because of the fact that the radio or the audio frequency can be amplified at will.

If the grid condenser is eliminated on some of the tubes in a multi-stage amplifier, as shown in the diagram on page 185, then the incoming radio frequency is amplified before it is rectified, and after it is rectified by going through the detector tube it is then amplified again at audio frequency in order to obtain volume of sound. Amplifying at radio frequencies, although it is rather difficult to do so at times, has numerous advantages and the experimenter is urged to try amplifying at radio frequencies wherever possible since one of the principal advantages of this method is that radio frequencies are inaudible to the human ear and the amplifying action is therefore carried on without unpleasant noises to the listening operator.

By using special transformers the transformer method can be applied to radio frequency amplification, reducing it to something almost as simple as the audio-frequency amplifier. There have been introduced of late special radio frequency transformers which function over the wave length band of 200 to 5,000 meters, and which have been designed particularly for the short wave band of 200 to 500 meters. These transformers mark a real step forward in the art, and must make for the wide application of the radio frequency method of amplifying. This method of amplification doubles and triples the receiving ranges; it makes signals audible that cannot be received

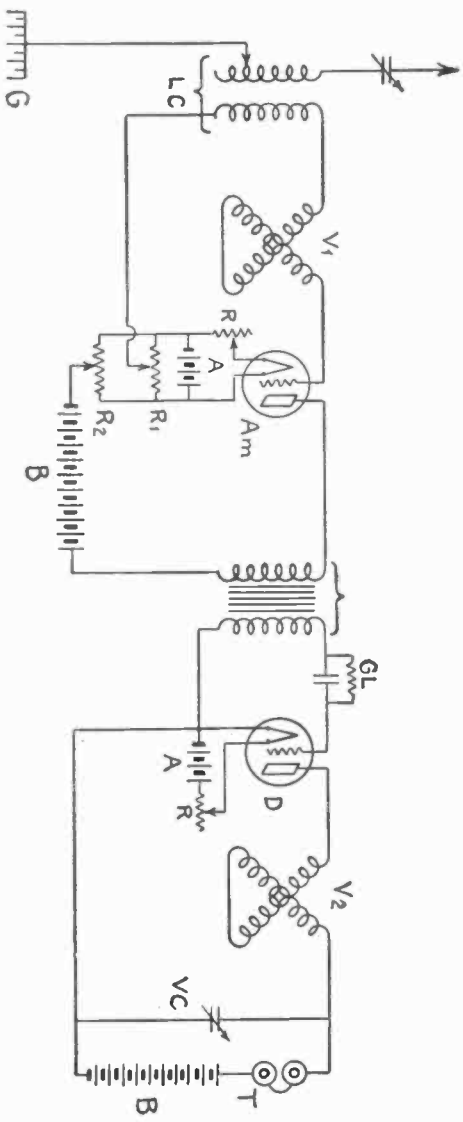

One-step radio-frequency amplifier and vacuum tube detector arranged with the regenerative hook-up. LC—loose-coupler or vario-coupler; V1—variometer in grid circuit; G—ground; R—filament rheostats; R1 and R2—additional rheostats; A—filament battery; Am—ammeter tube; D—detector; V2—variometer in plate circuit, for feed-back; VC—variable condenser; T—telephone; B—plate battery.

with other types of amplifying circuits; it is vastly superior to any other method of amplifying telephone speech; it eliminates tube noises; it increases selectivity; it increases signal audibility at each stage at least twenty times; it makes possible the use of small loops or frame antenna to receive as well as with high antennæ; and it gives a 20-watt amateur radio telephone set the transmitting range of a transmitter of several times the power.

Please note that radio-frequency amplification can be used in connection with any existing receiving set, even if said set is of the simplest and most elementary type.

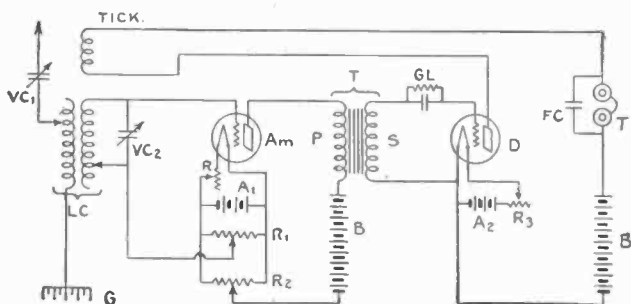

Another radio-frequency arrangement. VC1—variable condenser in aerial-ground circuit; LC—loose-coupler or vario-coupler; VC2—variable condenser across secondary; Am—amplifier tube; R1, 2, 3, 4—rheostats; PS—primary and secondary of intervalve or amplifying transformer T; GL—grid leak; D—detector; B—plate battery; A 1 and 2—filament battery; FC—fixed condenser; T—telephones; TICK—tickler coil; G—ground.

For radio-frequency amplification builds up the wave strength before it is passed on to the detector, so that in every sense of the word it is as though the receiving set were moved a considerable distance towards the transmitter. Thus a crystal detector can be used in conjunction with the radio-frequency amplifier, for after the wave strength has been built up by the radio-frequency amplifier, it is rectified by the crystal detector. Then, if desired, the rectified current from the crystal detector can be amplified by means of audio-frequency amplifiers.

Sometimes the crystal is employed in this manner, for the reason that it is silent in its operation and is not apt to introduce noises into the circuit.

WHEN AND WHERE TO USE AN AMPLIFIER

Most receiving sets are complete without an amplifier. In other words, the amplifier is something apart from the regular receiving set; it is an accessory; it can be added at any time to the usual run of receiving sets. So the question arises as to when and where an amplifier should be employed.

The amplifier of the audio-frequency type, which is the type generally used, should be employed when loud signals are required. Take the case of the radio-phone service, for instance. At a reasonable distance the music and talk come in good and clear, but it cannot be denied that the music and talk are generally thin, so to speak. The music or the talk has no depth, no sense of realism. It seems to be in one plane, just like the motion picture is in one plane when viewed on the ordinary screen. It lacks the depth so necessary for realism, even though it may be quite loud. At least those are the author's observations, as well as those of many persons who have listened in on his receiving set. However, the moment the amplifier is used, even with one step, there is introduced a loudness and clarity, as well as depth, which make for realism. These features are particularly noticeable in the case of a radio chapel service, where the minister may be preaching and is followed by the choir. Without amplifiers, the voice of the minister and the voices of the choir are on the same plane, but with the amplifier we obtain a sense of depth and the entire rendition sounds as though it were in a large church.

So the amplifier, then, makes for better results, let alone loudness. Fortunately, an amplifier is not such an elaborate piece of mechanism. It consists merely of a vacuum tube of the amplifier model, a filament rheostat, a transformer, and the necessary batteries and connections. Like the vacuum tube detector, it requires a filament

battery and a high-voltage B battery. When telephone head sets are to be used, only 45 volts is required for the B battery. In that case two B battery units of $22\frac{1}{2}$

volts each are connected in series, and a tap is taken from the connection between the units and brought to the detector in order that the detector will not have more than $22\frac{1}{2}$ volts, while the amplifier will have the full voltage. It is well to mention here that a variable voltage battery should

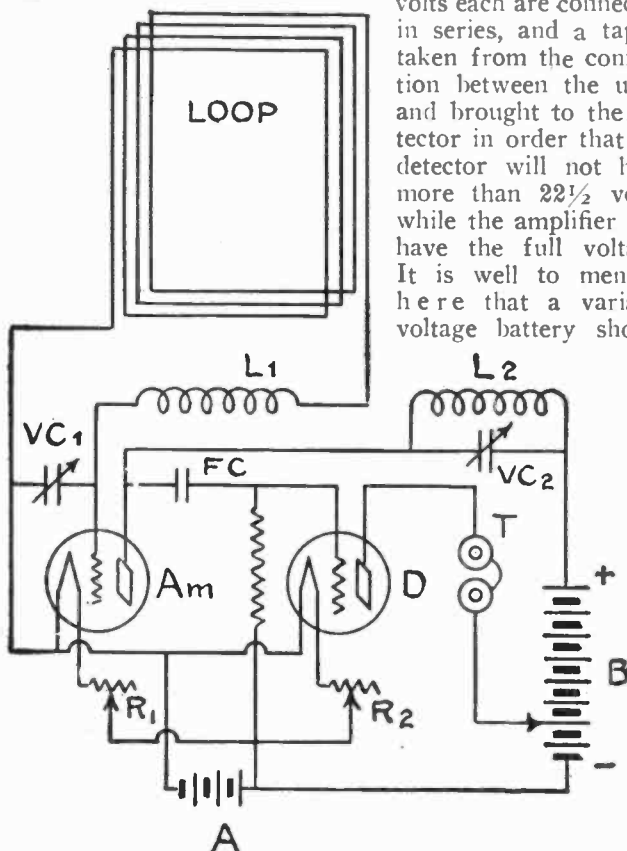

How the radio-frequency amplifier is used with the loop antenna for long distance reception. VC 1—variable condenser across loop terminals; L 1 and L 2—Inductance coils; VC 2—variable condenser; FC—fixed condenser; Am—amplifier tube; D—detector tube; T—telephone receivers; B—plate battery; A—filament battery; R 1 and 2—filament rheostat. Note the extra resistance.

be used for the detector, since a good detector tube has a critical voltage adjustment for the B battery, and a fixed voltage battery for the other unit. Some battery manufacturers are now supplying a combination B battery of 45 volts, with part of the battery made variable so as to obtain the critical B battery voltage for the detector.

Amplifier units can be purchased at a reasonable cost. They come in one-stage and two-stage models, and in some instances a three-stage model can be obtained, although this model is rare for the reason that its adjustment calls for considerable skill as compared with the one and two-stage models. Then again, there are units available in which the detector is included. Thus one can obtain a detector and one-stage model, and a detector and two-stage amplifier model.

Fortunately, the same storage battery is employed for the detector and the amplifier tubes, just as the B battery is used for all the tubes of one set. This simplifies the problem and makes for economy.

A soft or gassy tube, known as a detector tube, should be used for the detector, while hard or highly exhausted tubes should be used for the amplifiers. However, in some sets where a single rheostat may be employed for the detector and amplifier tubes, and a rigid B battery voltage is used on all tubes, it is sometimes good practice to use amplifier tubes throughout, including detection. This is not the most efficient practice, but it makes for simplicity, since amplifier tubes do not require the delicate manipulation and adjustment that are called for with soft or gassy tubes. Of course, the sensitiveness when using amplifier tubes throughout is bound to be greatly reduced, for it is the delicate adjustment of the gassy tube which makes it so highly responsive to weak signals.

THE QUESTION OF LOUD SPEAKERS

Sooner or later the radio enthusiast wants to do away with head 'phones in order that the radio-phone service



Loud-speaker attachment that fits on the tone-arm of any phonograph so that the usual horn of the phonograph is used to amplify the sounds.

may be used for dancing or even for entertaining a roomful of persons. In that event some form of loud-speaker must be used.

The simplest form of loud-speaker is one which makes use of the existing receivers, without extensive alterations of the receiving and amplifying arrangements. There are horns available which may be fitted to the regular telephone head set. These horns are provided with soft rubber pieces or even

with clamps, so that the regular head set may be held in place while the sounds from both receivers travel up through a horn and are amplified so as to be audible some distance away. These devices are excellent in a limited way, and their main attraction is the fact that they can be used without alteration of any kind.

However, where something of a more ambitious nature is wanted, it becomes necessary to use special loud-speakers. The simplest loud-speakers are those which make use of a single telephone receiver of the same general type as those used with head bands, as well as a special horn. There are all kinds of devices of this general class, ranging from horns of pressed paper or wood pulp, made in the general form of the channels of the human ear, and pressed copper reflectors, as well as horns of a more conventional design.

One of the most popular forms consists of a specially designed metal horn mechanically attached to the mechanism of a special telephone receiver, in which the standard mica diaphragm has been replaced by a strong corrugated metal diaphragm which will stand practically any amount of abuse without damage. A large amount of experimental work was carried on by radio experts before final decision was made on the horn and it is believed that the design furnishes as fine a quality of reproduction as can be obtained except through the use of a very elaborate sound chamber such as is found in high-priced phonographs.

The loud-speaker in question, which is shown in the accompanying illustration, will work satisfactorily from a two-stage audio-frequency amplifier and, using good amplifying tubes, 150-200 volts may be used without damage to the instrument. By good tubes is meant, in this case, especially "hard" tubes. The usual amplifying tubes are operated on 45 volts, and this voltage will produce only weak results with the usual loud-speaker. If more B battery is added, such as by connecting a third and even a fourth unit to the usual B battery, the results may be poorer with the regular amplifier tubes.

Some radio workers use the 5-watt transmitting tubes as amplifiers, in which case



One of the several loud-speakers now available for home use. This model may be used in connection with any two-stage amplifier.

voltages up to and even exceeding 100 volts may be applied. In such an arrangement it is well to try the 5-watt tube in the second stage of amplification, and to use the regular amplifier tube in the first stage.

One form of loud-speaker which is proving very popular is a simple telephone receiver of special construction which may be attached to the tone arm of the usual phonograph. In this manner one saves the cost of a special horn, and at the same time one has the pleasure of hearing the regular phonograph do duty as a radio receiver. The results with such an arrangement are very good, and the volume may be made extremely great by using sufficient voltage on the telephone.

Loud-speakers require plenty of voltage, and there is no getting away from this fact. The simple devices which take the the regular head sets or single receiver operate off the regular amplifier output without changes of any kind; but when it comes to filling an entire room with loud music or talk, the problem becomes quite complicated and certainly expensive.

All of which brings us up to the problem of real loud-speakers such as are used in the most ambitious kind of radio reception, as well as for public speaking and other work. Hence this subject is worthy of treatment at length, including a little back history. Loud-speakers of this kind are known as electrodynamic receivers.

THE EARLY DAYS OF THE ELECTRODYNAMIC RECEIVER

In 1911 two inventors, E. S. Pridham and P. L. Jensen, were actively affiliated with the development of arc radio transmission and reception at Napa, California. During the course of work, they made a very exhaustive study of various methods for the reception of rapid radio signals. Naturally enough, the development of what is known as the string galvanometer was carried out, and it was while conducting these experiments that several new and improved receiving devices were built. Among them was the first step in the development of the electro-

dynamic receiver, now well known for its loud-speaking characteristics.

This early type was built along the lines of a modern voltmeter, with a revolving coil in a magnetic field attached by lever action to a diaphragm. This, however, was not a success as a telephone receiver, and while it



Special power amplifier, used in connection with extra powerful loud-speakers such as are employed for projecting the radio-phone entertainment in a large hall. This amplifier is used in addition to the usual amplifier of the receiving set.

did reproduce the voice with remarkable distinctness, it was not nearly loud enough, or even as loud as the ordinary electromagnetic type. While this instrument was not important in itself it was to be taken into consideration as the forerunner of the practical electrodynamic reproducer of today.

After many experiments with the revolving coil, the idea was definitely given up and a new line of experiments started. The next instrument developed was the true electrodynamic loud speaker or receiver, although it was not known at that time that it had loud-speaking characteristics. Two very large electromagnetic structures were made, and a small coil of fine wire wound on mica about three inches long by one inch wide, and very flat and thin, was also introduced. This coil was suspended in the air gap of the two electromagnets, rigidly attached to a diaphragm. The coil was located in such a way that both the three-inch sides of the flat coil were in a strong magnetic field of the proper polarity when the magnets were energized. Both sides of the diaphragm were enclosed and ear tubes led out, one side for each ear. The total weight of the receiver was about sixty pounds.

At once it was found that this new receiver had different internal characteristics than the electromagnetic type of reproducer. In spite of the great weight of movable parts attached to diaphragm alone, about two ounces for the movable coil, it was found that the new instrument gave better speech reproduction from weak impulses than the ordinary receiver. Overtones were held, consonants and sibilant sounds were reproduced perfectly; in short, the quality of the speech was a revelation. But in spite of the fact that this instrument responded to impulses weaker than those necessary to affect the electromagnetic type of receiver, its loud-speaking qualities were still undiscovered; in fact, they were not yet developed in this particular instrument.

A number of experiments were performed with this instrument which were at that time nothing short of remarkable. The two inventors realized that there were great possibilities in the principle and proceeded to try out the new type against existing telephones. On a trip through the East in August, 1913, one of the inventors remained in Denver, Colorado, while the other proceeded

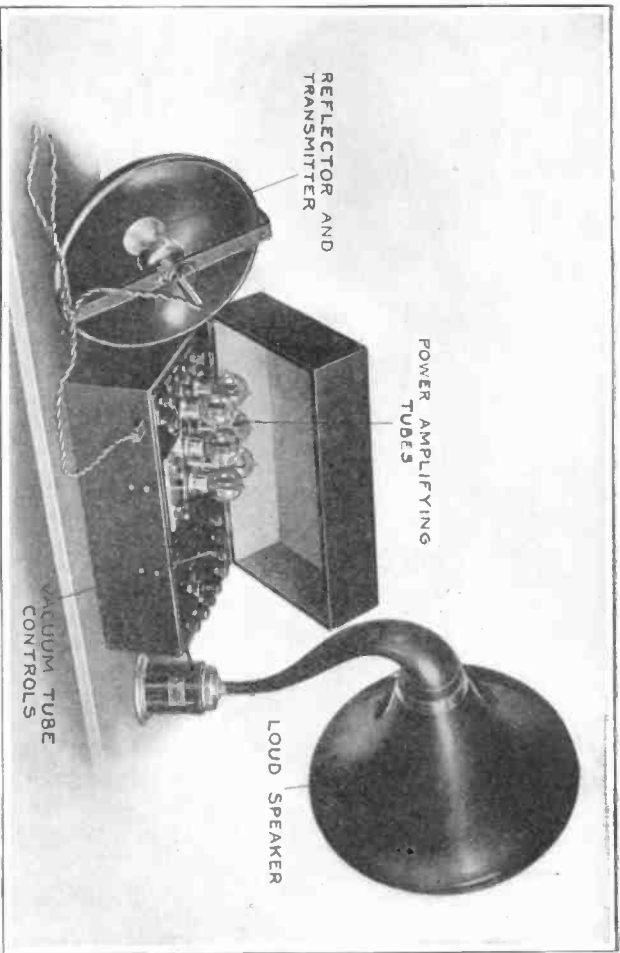

Loud-speaker equipment, comprising a special reflector and transmitter, power amplifier, and loud-speaker horn. This outfit may be used for public speaking, and has been employed for addressing tens of thousands of persons. It may also be used in connection with a radio receiving set.



A popular small sized type of loud-speaker employed with the usual two-stage amplifier of the radio receiving set. A 6-volt storage battery is used to energize the field coils.

to New York City. Arrangements were then made to get a through telephone connection from New York to Denver. Such arrangements, however, were not favored by the telephone companies as articulate speech was not possible over that distance of straight wire. It must be remembered that this was before the day of vacuum tube repeaters and that line conditions were very bad over long distances. After three days the connection was made, and although the inventors were warned by the telephone companies that they would not be able to understand each other, very satisfactory speech was carried on using the electrodynamic telephone. At the same time, nothing could be understood over the receiver as ordinarily used. This test proved to the inventors that their device had merit, and that the next problem was to so condense and re-

design their receivers so that it would be commercially practical, for complete it weighed 60 pounds.

This original receiver had a moving coil wound to 70 ohms resistance, so that it might be interchanged with the ordinary 70-ohm magnetic receiver. This amount of wire, however, was one of the things which made up the weight of the moving parts, and in order that these moving parts might be made as light as possible, the moving coil was cut down to 20 ohms resistance and a proper induction coil supplied to fit it. The coils were still wound flat on a mica sheet, but in order to reduce still further the weight of the complete instrument, one of the electromagnets was done away with and the little coil was found to function perfectly with only one side of the coil in the magnetic field. This type was finally developed, and was the first of the electrodynamic receivers to be commercially successful, out of all the types which had been developed by the inventors thus far. This type was brought out in July, 1915.

Immediately the resistance of the movable coil was reduced, it was found that the receiver had loud-speaking characteris-



Another type of loud-speaker, larger than the one shown on the facing page and intended for a medium-sized hall.

tics, and still retained its perfection of reproduction of speech. It was then realized that no loud-speaker could be expected to give forth loud speech unless sufficient modulated current was supplied to it, so it became necessary for the inventors to turn their attention for a time to the development of a transmitter for use in conjunction with the electrodynamic receiver. A transmitter was

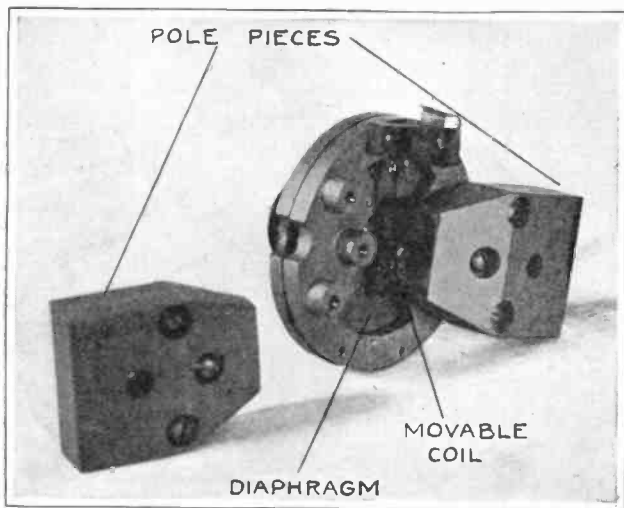

The mechanism of the electrodynamic type of loud-speaker, consisting of the pole pieces of the electro-magnet, the movable coil, and the diaphragm.

accordingly built that would pass a little over one ampere of modulated voice current and deliver that amount to the induction coil supplying the movable coil, attached to the diaphragm. It was found that this transmitter in conjunction with the electrodynamic receiver would give a volume of sound that was enormous and which would carry for blocks even though the original speech was no louder than a person would ordinarily talk. This, then,

was the final stage in the electrical design of the electrodynamic receiver, and whatever subsequent improvements were made were along the mechanical rather than on the electrical characteristics of the apparatus.

LIMITATIONS OF THE ORDINARY TELEPHONE RECEIVER

The ordinary telephone receiver such as is used on our present-day telephone lines operates on the electromagnetic principle. The voice current passes through a winding on a permanent magnet, changing its flux intensity and consequently its pull on a diaphragm placed directly over the pole ends. Its weakness lies in the fact that if the diaphragm is placed at a distance away from the pole pieces the magnetic influence is greatly lessened, and if placed too close the diaphragm hits the poles. A compromise position is selected whereby the diaphragm is placed at such a distance from the poles to allow it some motion before hitting the poles, and yet near enough to get a fair magnetic pull. Another weakness is that the diaphragm is under tension always and has to be made stiff to withstand this tension. All types of receivers using the electromagnetic principle will give forth sound only up to a certain point and then the diaphragm will hit the poles.

In the electrodynamic receiver the diaphragm is in no way directly concerned with the magnetic flux. There are no pole pieces to interfere with motion, which may be as great as the elastic limit of the diaphragm. A large horn attached immediately above the diaphragm provides the air column for the diaphragm to move. In the present instrument the field is magnetized to a point approximating 20,000 lines per square centimeter with a current of .66 amperes flowing in the field coil. The movable coil, with a resistance of 20 ohms will take care of approximately 10 watts of modulated current as supplied by an amplifier through the proper step down coil and will give off sound accordingly. When it is remembered that only an extremely small fraction of a watt is necessary to pro-

duce an audible signal, some idea may be realized of the volume of sound generated by this instrument, produced by the flow of ten watts. It must be remembered also that due to the electrodynamic principle involved, all of the incoming energy is transferred into air vibrations, and that the instrument is not only capable of producing loud responses to large inputs, but also is superior for clear articulate response to very small currents and is fully as sensitive if not slightly more so in this respect than the best design of electromagnetic receivers.

Commercial development of this type of receiver proceeded along several interesting and different lines. For receiving telephone speech alone, without loud-speaking characteristics, with a 70-ohm coil, a receiver was built using permanent magnets to be used on ships and in marine stations where communication was difficult. This type of electrodynamic telephone, using a double ear tube arrangement from the diaphragm, has become standard equipment of United States Navy destroyers for marine telephone communication and is being used on hundreds of merchant vessels for the same purpose, in conjunction with the anti-noise transmitter. The receiver can easily be made water-tight and its clearness of reproduction makes it indispensable for talking to the noisy engine room of any vessel.

A phonograph attachment was developed and placed on the market in 1916 and consisted of an electrodynamic receiver of the loud-speaking type, and its horn, a control box containing the proper induction coil and switches to control the current of the device, and a transmitter tone arm. Many and varied were the experiments necessary to determine the proper location of the transmitter on the phonograph tone arm in order that needle scratch be eliminated, and yet perfect reproduction of the music be maintained. This equipment was also supplied with a hand transmitter in order that speech might be amplified by the same instrument. The voice and music from a phonograph can thereby be amplified enormously for outdoor use.

MAKING THE SPEAKER'S VOICE CARRY FOR MILES

Power vacuum tube amplifiers were built and at present the apparatus is such that voice, words and music have been transmitted through the air for over ten miles under favorable conditions and a very satisfactory arrangement made whereby speakers need not hold the transmitter in the hand, the amplifier being so sensitive that it will pick up impulses through a collecting horn and amplify them for the assembled audience. At the same time the electrodynamic receiver was modified mechanically and the flat coil changed into a circular one, still, however, moving in a strong magnetic field, and unchanged electrically.

For radio signal amplification and broadcasting, the receiver is identical with the exception that the step-down coil is wound to adapt itself to the receiving circuits of a wireless receiving set. With ordinary radio type vacuum tube amplifiers signals are received in such volume as to make the use of head phones unnecessary, and also allow these signals to be heard by large numbers of people. It is especially popular in the reception of radio telephone speech and music.

The public and commercial history of this electrodynamic receiver, is very interesting. The inventors could have done no better when they called the device the "great voice," deriving the name magnavox from the Latin words magna and vox. It is truly the great voice and has had a profound influence in public affairs during the last few years. Its initial bow to the public was made Christmas Eve, 1915, at the Municipal Christmas Tree Celebration at San Francisco, California. That it fulfilled the expectations of the inventors may be fully realized in the words of the San Francisco Bulletin of the following day—"The slender tone of a single violin plainly heard a mile away; Tetrizzini's voice on a phonograph record resounding from end to end of the vast stadium; the words of Thos. W. Hickey reading Lincoln's Gettysburg address reverberating like the roar of a giant; a piano solo resembling the chimes of Westminster Abbey, played by a Co-

lossus of Rhodes—these things made possible by the new invention.”

After this first demonstration, attended by 50,000 people, the electrodynamic receiver has officiated at nearly every large gathering of public importance since the war, where speakers needed amplification of the voices. During the war no demonstrations were made because of the great pressure of government orders in the factory. Several notable examples are as follows: Ex-President Wilson spoke at San Diego to 50,000; at Reno to 6,000 in three different theatres at the same time. The Prince of Wales spoke to thirty thousand also at San Diego. The Victory Loan was opened by an aviator delivering a speech by radiophone and magnavox to 30,000 at Washington, D. C. President Harding and his political opponents used the electrodynamic loud speaker constantly during their campaign to talk to crowds varying from 40,000 to 100,000 in the case of ex-Governor Cox at Sheepshead Bay. Many other instances may be cited where this apparatus has made it possible for a single speaker to address enormous crowds.

The electrodynamic principle involved in the construction of these loud-speakers is perhaps the only satisfactory principle by which a loud-speaker may be constructed to give great volume from one instrument. There is practically no limit to the sound which can be given off by the electrodynamic receiver, and this volume of sound is directly proportional to the input of modulated voice current. At present the instrument will satisfactorily take care of 10 watts of power through the movable coil and would take care of more if an amplifier were built to give more than this amount in its output. With 10 watts in the receiver coil, however, an individual has no trouble in speaking well over a mile distinctly and can talk to as many people as can conveniently assemble.

Chapter VII.

TRANSMITTING THE DOT AND DASHES OF THE DAMPED RADIO TELEGRAPH

FOR those who are satisfied to listen to what others have to say and make absolutely no reply, a receiving set is all that is required. And the great majority of radio enthusiasts never go beyond the receiving stage, because they are satisfied to receive the radio-phone concerts and news, as well as the dot-dash messages of Government, commercial and amateur stations alike. When the radio enthusiast desires to do a little "talking" on his own account—when he tires of listening to others or when he wants to be able to take a hand in any discussion that may be taking place in the ether—he must resort to a transmitter of some sort or other for generating the waves that serve to affect the apparatus in distant receiving stations. He may wish to send in dots and dashes, or again, he may desire a radio telephone transmitter in order that he may actually talk and have his voice heard at distant points; but in either event he must go through the formalities of obtaining a station license as well as an operator's license, both of which were unnecessary when he confined his efforts to receiving. In this chapter we shall deal only with the simple radio telegraph transmitters, leaving the more advanced types and the continuous wave apparatus, which makes radio telephony possible, for the next chapter. Please note, however, that most radio amateurs are now turning to the C. W. type transmitter, and that spark or damped wave sets must soon become obsolete.

WHAT THE RADIO TRANSMITTER DOES

Electromagnetic waves, by means of which radio communication is carried on, are produced by the transmitting apparatus. Power must be supplied by some kind of electric generator or battery; this power must be converted into high frequency currents by means of an oscillator or wave generator; and the high frequency currents must be introduced into an aerial system consisting of the aerial and the ground connection, in order that the radio waves may be propagated in all directions through space.

Now the radio waves, as we have already learned, may be of the damped or the undamped variety. Damped

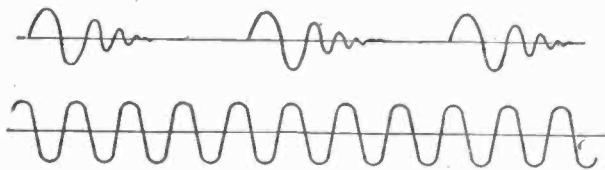

A schematic comparison between damped and undamped waves. The damped waves, shown above, consist of wave groups or wave trains, while the undamped or CW waves are of uniform height and wave length and without a break.

waves consist of groups or trains of oscillations repeated at regular intervals, the amplitude or voltage of the oscillations in each train decreasing continuously as shown in the accompanying diagram, where the center line indicates 0 potential, and the length of the line the lapse of time. The number of these waves or trains per second is some audible frequency. When such waves strike a receiving apparatus, as we have already learned, they cause a tone in the telephone receiver. Signals are produced by means of a sending key, which lets the trains of waves go on for a short time (producing a dot) or for a longer time (producing a dash). The operator manipulates the key in order to form the dots and dashes which represent the desired letters, numerals, punctuation and other characters of a dispatch.

The principles of damped and undamped waves are the same in many respects, so that much of what is told regarding damped wave apparatus applies to undamped waves as well. Particular attention is first given to damped waves, as the apparatus is simple and easily adjusted and has long been employed.

Damped oscillations or waves are produced when a condenser discharges in a circuit containing inductance. The condenser is discharged by placing it in series with a spark gap and applying a voltage that is high enough to break down or spark across the gap. Such an arrangement is presented in the diagram on page 208, where a transformer, supplied with current from a generator or battery, charges the condenser placed across its terminals until the condenser charge has been built to a point where the spark gap breaks down. It is as though one were stretching a rubber band, thus storing up considerable mechanical energy, until the breaking point was reached. Then, as the rubber band snapped, all the stored up energy would be discharged. When the spark gap breaks down the pent up energy of the condenser is discharged. Unlike the rubber band, however, the charge in the condenser discharges across the gap and recharges the condenser in the opposite direction to almost the same extent as before, followed by another discharge which again charges the condenser in the original manner but of still less extent, followed by still another discharge, and so on with the current going back and forth just as does any pendulum which has been given a push, until its swings or oscillations become weaker and weaker and the pendulum comes to rest.

In discharging, which only requires the fraction of a second, the current passes through the inductance and sets up electric oscillations which are damped out or, to put it another way, soon reach zero. These discharges, which follow each other in such rapid succession, form the groups or trains at regular intervals.

Now the standard generator frequency for most radio

work today is 500 cycles per second. This causes the condenser to charge and discharge 1,000 times per second, or once for each positive and once for each negative maximum if the spark gap is of such a length as to break down

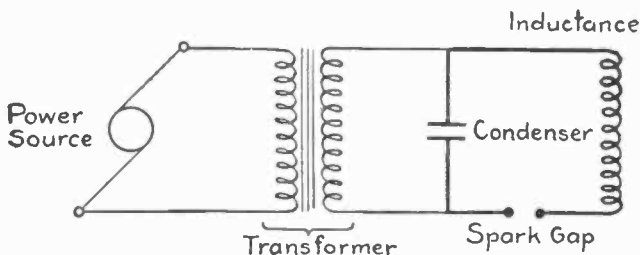

The simplest kind of damped radio wave generator, consisting of a power source, an induction coil or transformer for stepping up the current, a condenser, a spark gap, and an inductance. The charging and discharging of the condenser through the inductance and across the spark gap sets up the oscillations or radio waves.

at the maximum voltage given by the transformer. The number of sparks per second is called the spark frequency. With the standard spark frequency of 1,000 per second the amount of power the set sends out is considerably greater than it would be at the low rate of 60 cycles per second, because the transmitted radio waves are more nearly continuous. The radiated wave trains strike a receiving antenna more frequently and their amplitude does not need to be as great to produce the same effect as stronger waves received at longer intervals of time. The higher frequency produces a tone in the receiving telephones that is more easily heard, because the ear is more sensitive to sound waves of about 1,000 per second and also the tone is more easily heard through atmospheric disturbances. A 60-cycle supply may be used if the number of sparks per second is increased by the use of a rotary spark gap giving several sparks per cycle, as will be described further on.

THE SIMPLEST OF TRANSMITTERS

Nothing could be simpler than the arrangement shown in the accompanying diagram. Indeed, in the pioneer days of radio such a hook-up was employed for covering distances up to 100 miles with a 10-inch spark coil, and back in the crude beginnings of amateur radio most amateurs made use of a spark coil and the plain aerial arrangement here shown. In those days the transmitters were gaged by the inch; that is to say, the amateur talked of his transmitter by referring to the sparking distance of his coil. Thus he had a two-inch, three-inch, 10-inch and so on set, according to his monetary resources or constructive ability as the case might be.

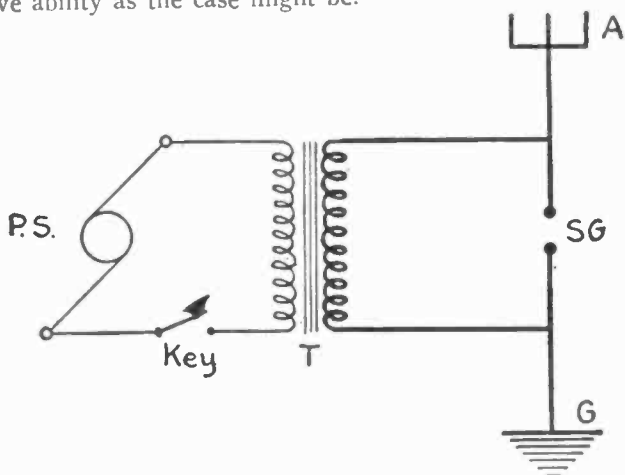

The simplest form of damped radio transmitter, consisting of a power source, telegraph key for making long and short signals of the radio code, a transformer for stepping up the current, a spark gap, and the aerial and the ground. In this arrangement, known as the plain aerial transmitter, the aerial and ground comprise the condenser.

The arrangement shown in the diagram comprises a source of power, a means of raising the low voltage to a high one, say of 20,000 volts, which is sufficient to spark

across a one-inch gap between needle points, a simple spark gap, a telegraph key for making and breaking the primary circuit, and the aerial and ground connection. When the key is pressed the power supply passes through the primary of the induction coil or transformer, as the case may be. When the current is broken, or when the direction of the current is changed as in the case of alternating current which is used with a transformer, the secondary current flows out into the aerial and ground, which act as a condenser, accumulating the charge. When the charge reaches a certain point it can no longer be contained in the aerial-ground condenser, and consequently it discharges across the spark gap, setting up oscillations in the aerial circuit.

Simple as such a system may be, it is hardly permissible in general practice for the good reason that the waves emitted are of such broad wave length that they cannot be readily tuned out at the receiving end. Any amateur of long experience can tell you stories

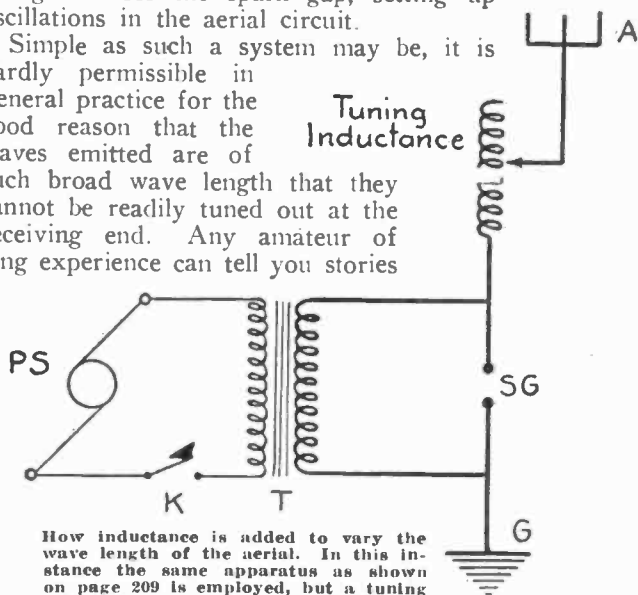

How inductance is added to vary the wave length of the aerial. In this instance the same apparatus as shown on page 209 is employed, but a tuning inductance, known as an aerial inductance or loading coil, is added.

of the days before the present radio laws, when it was possible with even a one-inch coil and other simple ap-

paratus to prevent the most powerful stations from carrying on their business, if the amateur transmitter happened to be located a short distance away. The one-inch coil simply monopolized the ether in its immediate vicinity. It came in loudly at almost any point on the tuner, so that it could not be tuned out in order to receive a signal from a distant transmitter. However, it does not carry for any distance, so that outside of deliberate interference it was of no real value. Furthermore, one of the first things which the radio law accomplished was to put an end to these broadly tuned transmitters and in their place insisted on transmitters whose emitted waves must be sufficiently sharp so as to have them interfere as little as possible with other waves.

The plain aerial arrangement, as this layout is called, has other advantages aside from its simplicity. Its effectiveness comes in when the sending operator wants all possible stations to hear him immediately, as for instance when a ship is sending out a distress call. At such a time interference is a desirable thing, because the distress call must be heard by every possible receiving station within range. With the regular sharply tuned waves, a receiving operator may never hear the signals for the reason that his receiver is adjusted for another wave length and is too sharply tuned to respond to a sharply tuned wave. The broadly tuned wave, on the other hand, can be heard with almost any receiving set adjustment. The plain aerial has also a definite advantage in military activities for the purpose of drowning out or "jamming" the enemy's signals. For amateur purposes, however, the plain aerial arrangement is a thing of the past.

A modification of the plain aerial arrangement is shown on the preceding page, which has a tuning inductance in the aerial circuit so that wave length of the emitted waves may be varied to some extent. Placing a condenser in the aerial or ground lead also varies the wave length, but instead of increasing it, as is the case with inductance, it decreases the wave length.

THE TRANSMITTING AERIAL

In transmitting the aerial problem is far more involved than it is for receiving. As we have already learned, a single wire of almost any length or even a bed-spring



Inverted L-type aerial, with the lead-in taken off at one end.

or fire-escape or other mass of metal will do for an antenna in connection with a good receiving set, but the aerial of a transmitting set must be properly constructed if satisfactory results are to be obtained.

To begin with, a single-wire aerial is unsatisfactory for transmission purposes. Two or more wires must be used, and four wires or more give the best results. Then

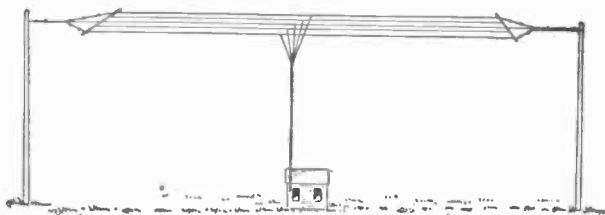

T-type aerial, with the lead-in taken off the middle of the aerial span.

the height is important; the aerial should never be less than 25 feet above the ground or roof, and preferably 50 feet or more.

In the accompanying diagrams several types of transmitting aeriels are shown. The most common is the inverted L-type, with the lead-in at one end. The T-type should be used when the span is greater than 100 feet

in order to reduce the natural wave length of the aerial. The umbrella aerial should be used when one is working in a crowded space and there is no room for the usual types of aerials. The umbrella aerial makes use of a single tall mast, with wires radiating downwards in all directions. The lower ends of the wires should be at least 20 feet away from the base of the mast.

The construction of the transmitting aerial is considerably more involved than that of the receiving antenna. It must be larger and therefore stronger, and it must be better insulated because it is handling high-voltage currents. The drawing on page 215 gives a few pointers

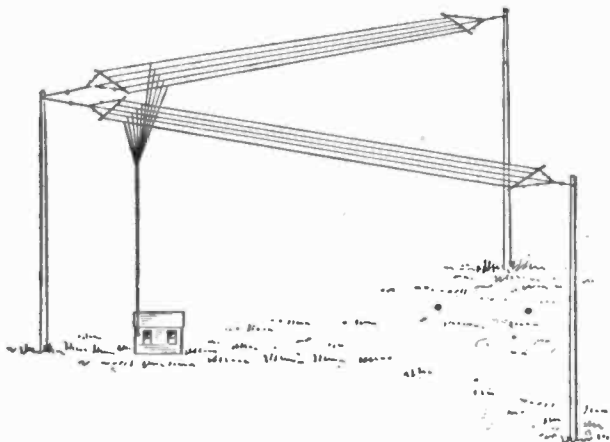

The V-type aerial—a rare type which should only be employed when a sufficient span cannot be obtained, thus making a double aerial of this kind desirable.

concerning the construction of a good, substantial multi-wire aerial for transmitting purposes. Note that the ends of each wire are insulated with hard rubber rods provided with screw-eyes at each end, or with regular electrose insulators. As a further precaution, insulators may be inserted in the ropes or wires supporting the spreaders, as the sticks supporting the wires are called. Pulleys

are provided on the supports of the aerial, so that the latter may be raised or lowered at will for inspection and repairs. Guy ropes or wires are arranged with insulators for the purpose of keeping the aerial perfectly flat, despite wind and the unequal sag of the wires. The lead-in wires are taken off each wire of the aerial, brought down a considerable distance to a point where they converge into one lead-in cable, just before entering the station. The special electrose lead-in insulator shown makes a very neat lead-in arrangement. It will be noted that this insulator is provided with a brass rod passing through it, both ends of the rod being equipped with nuts and lugs for making connections.

The strop or egg insulator is a popular form of insulator for the reason that it possesses great strength and good insulating properties. Furthermore, in the event of mechanical failure, it will be noted that the two wires or ropes passing through different holes in this insulator merely come together, so that the mechanical arrangement still holds fast even if the insulation arrangement may be broken down.

The same aerial may be used for receiving and transmitting. In former days the same aerial was always used for both purposes. The aerial, in such a case, is designed with the transmitting end in view, since any good transmitting aerial gives good results with a receiving set. In order that the same aerial may be used for both purposes, a send-receive or aerial change-over switch is employed. This switch is connected with the aerial and with the receiving and the transmitting sets in such a manner that when it is thrown one way, the aerial is connected with the receiving set, and is used for receiving, and when it is thrown the other way, it is connected with the transmitting set and is ready for transmitting. Obviously, it would not do to have the receiving set connected with the aerial at the same time as the transmitter, since the latter, with its powerful output, would cause damage to the delicate receiving apparatus.

Many amateurs today prefer to use a separate aerial and antenna for transmitting and receiving. The aerial and antenna are connected with a single switching device in such a manner that only one of them can be used at a

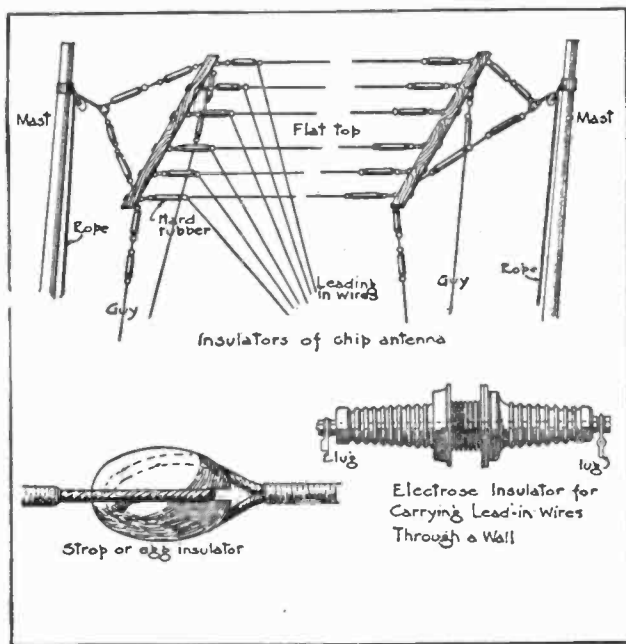

Constructional details of a good flat-top transmitting aerial, the strop or egg type insulator, and the electrose lead-in insulator.

time, so as to preclude operating the transmitter while the receiving set is connected with its antenna but a short distance away.

In transmitting work a good ground is necessary, for the best results. A ground that is imperfect or of high resistance will take away from the transmitting range in no little degree.

TRANSMITTERS THAT ARE SHARPLY TUNED

Single-circuit transmitters are not permitted under the present radio laws, for the reason that the waves emitted are not sufficiently sharp. Too much cannot be said in favor of the radio laws in this direction; any

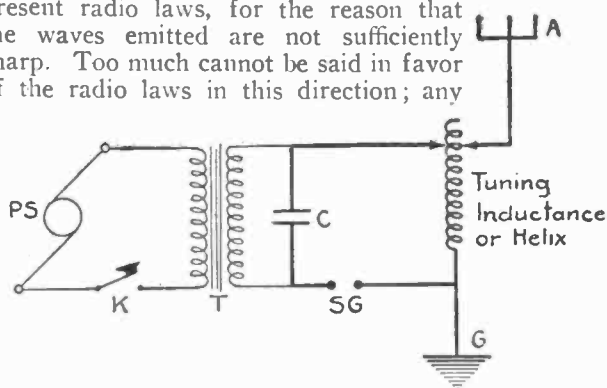

Simple transmitter arrangement for producing fairly sharp waves of the damped variety. PS—power source; K—telegraph key; T—transformer; C—condenser; SG—spark gap; A and G—aerial and ground; and the tuning inductance or helix.

one who has been listening in to the radio-phone service must have experienced the annoyance of some spark station breaking in on the music. It is only by assigning certain wave length bands to the various classes of transmitters, and insisting that their waves be kept sharply tuned within narrow tolerances, that interference can be reduced to a minimum.

In order to emit sharp waves which come within the stipulations of the radio laws, it is necessary to produce the oscillations in a closed circuit which is directly or inductively coupled to the aerial or "open" circuit. Such an arrangement is shown in the diagram on page 217, where the induction coil or transformer serves to charge the condenser, which discharges across the spark gap and through the inductance. The inductance, it will be noted, forms part of the "closed" or oscillating circuit and also part of the aerial or "open" circuit. Thus it serves as an auto-transformer, as a single coil transformer is called. Any number of turns of this inductance which is made

up of a number of turns of heavy wire or strip, may be cut into the closed circuit and into the open circuit, so as to establish the proper ratio between the circuits. The positions of the spark gap and the condenser are sometimes interchanged, bringing the spark gap across the transformer. There is practically no difference in the operation, as a result of such a change.

In connecting up the various components of a transmitting set, heavy wire, certainly not less than No. 12, insulated or bare, should be used. It is preferable to use copper strip, if possible, since it has a greater surface area and the currents with which we are now dealing travel on the surface rather than through the entire conductor. The conductors should be neatly run from one connection to the next, and arranged so as not to come near one another because of the danger of sparking. Furthermore, the conductors must be kept as short as possible, for in a transmitting set the inductance represented by a few feet of conductor is sufficient to make the wave length of the oscillating circuit so great as to be well beyond the permissible 200-meter wave length of ama-

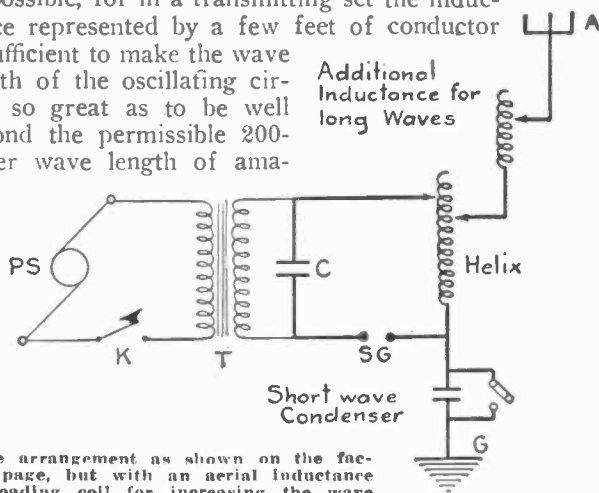

Same arrangement as shown on the facing page, but with an aerial inductance or loading coil for increasing the wave length, and a ground series condenser for reducing the wave length, of the aerial-ground circuit.

teur transmission. So the components must be placed close together, and connected with the shortest possible conductors. This also applies to the connection with the aerial, which should be made as short and as direct as possible, in order to secure high efficiency and keep within the wave length requirements.

In order to determine the proper number of turns for the closed and the open circuits, the usual method for the amateur is to use a measuring device known as a hot-wire ammeter in the aerial circuit, for the purpose of measuring the aerial current. Approximate results may be obtained by the use of a low resistance lamp, such as a small automobile lamp or even a pocket flashlamp bulb. The lamp is used in place of the hot-wire ammeter, the maximum current in the aerial being indicated by the maximum brightness of the lamp filament. If the current is apt to be too great for the lamp, it

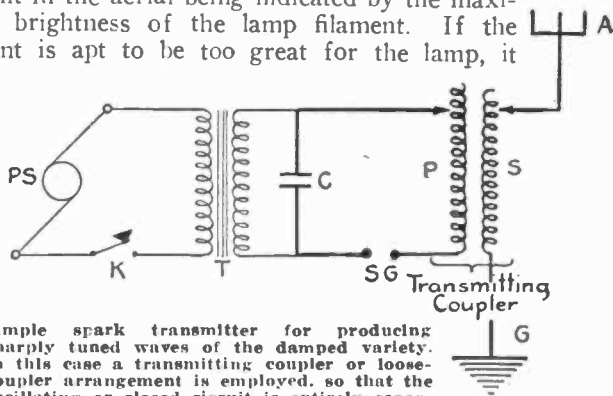

Simple spark transmitter for producing sharply tuned waves of the damped variety. In this case a transmitting coupler or loose-coupler arrangement is employed, so that the oscillating or closed circuit is entirely separated from the open or aerial-ground circuit. The primary P and the secondary S comprise the transmitting coupler.

should be shunted by a few turns of wire. The ammeter and lamp must be eliminated or even short-circuited except when actually needed, in order to keep the resistance of the aerial circuit down as low as possible.

In actual practice, the closed circuit is first adjusted to the desired wave length, which can best be determined by

the use of an instrument known as a wave meter. Then the aerial circuit is adjusted until the lamp or hot-wire ammeter indicates the maximum output, proving that the two circuits are in resonance. Most of the progressive radio clubs—and there are radio clubs in practically every part of the country—have wave meters for the use of their members. The best method of tuning, aside from waiting for the radio inspector to tune the transmitter when he comes to inspect it, is to call upon the local radio club for aid in this direction.

One method largely employed by amateurs in tuning their transmitters is to adjust their oscillating circuit and then the aerial circuit for maximum output, after which they ask a radio friend to listen in on his receiving set to the test signals and to determine whether they are higher or lower in wave length than those of other amateur stations known to be tuned to a wave length below 200 meters, which is the maximum set for amateur transmission. This latter method, however, is not very accurate.

In most instances it is best to wait until the radio inspector comes to the station in order to check up the transmitted wave length. The inspector, being provided with a wave meter, sees to it that the station is emitting a wave within the set limits and also that the wave is sufficiently pure or sharp to comply with the law.

At this point it is well parenthetically to point out that the transmitter problem may be materially simplified by purchasing a complete transmitter in one unit. Today the practice is to make the transmitter apparatus into one simple unit in the form of a panel, the controls and meters being placed on the front face, and the various components at the rear. Such a transmitter has wave length adjustments and hot-wire ammeter, as well as other controls which simplify the tuning and general operation.

If a complete transmitter is not employed, then it is necessary to purchase separate pieces of apparatus and to arrange them in some suitable manner. Any radio supply house will gladly furnish the necessary technical assistance

in the installation of a radio transmitter. Then again, if one has cultivated the friendship of the radio amateurs in the general vicinity, one can obtain all the necessary help in this direction.

So much for the directly-coupled set which we have so far discussed, and the tuning of a transmitter. There is another arrangement known as the loose-coupled set, which is shown in the diagram on page 219. Here the closed and the open circuits are not connected directly, but are inductively coupled. Such an arrangement makes for sharper waves and a high degree of efficiency. The coupling may be varied so as to obtain the best results, the adjustment depending largely on the type of gap employed.

THE QUESTION OF TRANSMITTING CONDENSERS

The most common types of condensers used in radio transmitting circuits employ mica or glass as the dielectric, with tinfoil or thin copper as the conducting coatings. Compressed air and oil condensers are sometimes used in professional work, but they are balky and certainly well outside of the province of the amateur. For very high voltages the condenser plates are sometimes immersed in oil to prevent brush discharge. Brush discharge is the leakage of current which takes the form of tiny purple streamers or sparks about the edge or any conductor of high voltage current. For moderate voltage a coating of paraffin over glass plates, especially at the edges of the metal foil, will satisfactorily reduce brush discharge. Today, however, the amateur is indeed fortunate in that his condenser problem is solved by purchasing one or the other of the several manufactured condensers which come in compact molded units, or in wooden or metal cases. A condenser of suitable size can be obtained in one unit or built up of several units.

The transmitting condensers mostly used today are of the mica insulated type. These condensers have been found to be superior to any other type. Each mica condenser is composed of several sections or units enclosed

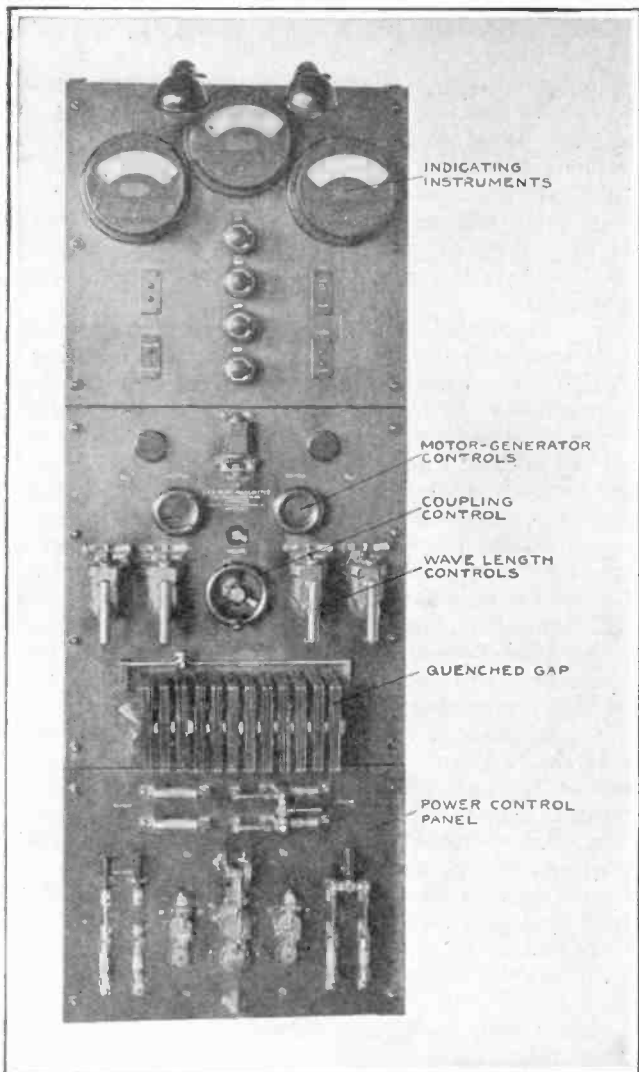

Panel type damped wave transmitter, such as is employed on board steamers. This transmitter makes use of a quenched gap, which is mounted on the front of the panel. (See page 223.)

in a common casing of aluminum or wood, depending upon the capacity and voltage. Each of these sections or units comprises alternating sheets of mica and foil, over a thousand in number. The sections or units thus constituted are piled on top of one another in the aluminum casing, and each section or unit is separated from the next by a sheet of mica. The sheets of mica are larger than the sheets of foil, so as to avoid any brush discharge at the edges.

Air, moisture, and small vacuum pockets must be eliminated from each section or unit, hence an insulating adhesive of special composition, having the required dielectric properties, is forced through the entire condenser. The moisture and air are expelled, and the vacuum pockets are filled with this adhesive, which is deposited in a thin layer on each of the thousand sheets of mica. Next a melted wax compound is poured into the aluminum casing, so as to fill any empty spaces between the condenser sections or units and the case.

Before the wax has hardened a pressure plate is placed on the topmost section or unit. After the cover is screwed on, this plate presses all the sections together. Because they are pressed together, the sections cannot move about. It is highly important that the spacing between the metal foil and the mica be kept constant—an end secured by the use of the pressure plate. A post passes up through the cover of the case and serves as one terminal, the case serving as the other when metal is used for the case.

The efficient use of the space inside the condenser—the active surfaces taking up the larger part of this volume—is, of course, a big factor in making the mica condenser a fractional part of the size of the glass plate or Leyden jar condensers of equal capacity. The Leyden jar condensers are the bottle-like contraptions with an inside and outside tinfoil coating, seen in physics laboratories and in connection with X-ray and electro-therapeutic apparatus. Yet the mica condenser has 2,000 square inches of active surface as compared with 175 square inches for a glass dielectric condenser of equivalent capacity and voltage.

Since the mica condenser consists of over a thousand sheets of mica and foil, the full voltage across the transformer is minutely subdivided. Hence the potential that does act across a single unit is so very small that there is

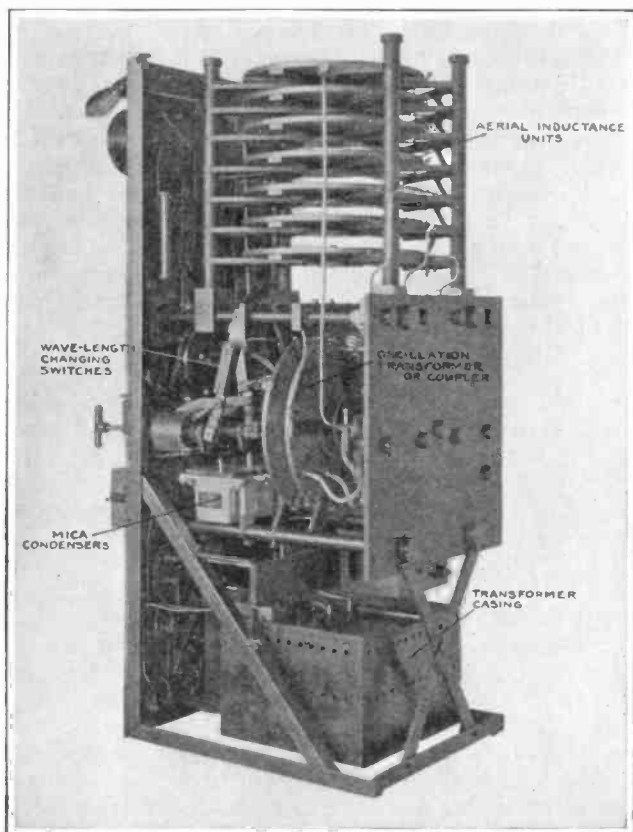

Panel type damped wave transmitter, the front view of which appears on page 221. Simple as the front view may seem, it will be noted that the transmitter is quite complicated with most of its mechanism mounted at the rear of the panel.

no destructive brush. The losses in the dielectric increases greatly with the voltage. Therefore, if the voltage of each section in the condenser is reduced markedly, the problem of preventing the brush discharge is met. It is better to control several hundred volts in this manner than twenty-thousand volts individually.

When the spark gap of a transmitter is broken down by the high voltage it becomes a conductor, and readily allows the oscillations of the condenser discharge to pass. During the interval between discharges the gap cools off and quickly becomes non-conducting again. If the gap did not resume its non-conducting condition, the condenser would not be charged again, since it would be short-circuited by the gap, and further oscillations could not be produced. The restoration of the non-conducting state is called "quenching." A device called the quench gap is described further on.

SPARK GAPS OF ALL KINDS

A plain spark gap usually consists of two metal rods so arranged that their distance apart is closely adjustable. The gap must be kept cool, so that the discharge will not arc and to this end the rods are often provided with cooling fins. The length of the gap which can be employed is limited by the voltage that the transformer is capable of producing, the ability of the condenser dielectric to withstand the voltage, and the fact that for readable signals the spark discharge must be regular. If the gap is too long, sparks will not pass, or only at irregular intervals. If the gap is too short, it may arc and burn the electrodes. Even if no arc takes place, the voltage is reduced by too short a gap and this results in reduced power and range. The length for smooth operation can usually be determined by trial.

It is found that a short gap between cool electrodes is quenched very quickly, the air becoming non-conducting almost immediately after it has broken down, or as soon as the current falls to a low value. This action is also improved if the spark gap is enclosed in an air-tight cham-

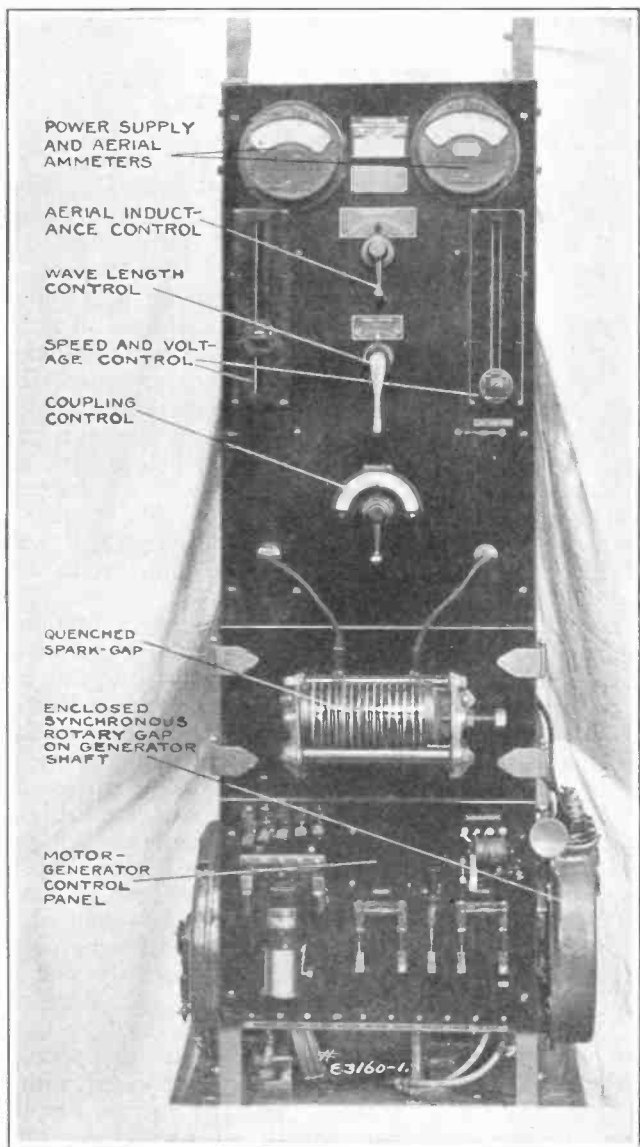

Another type of damped wave transmitter, such as is used on board ship. In this instance there are two methods of obtaining the oscillations or waves. There is the quenched gap mounted on the front of the panel, and the synchronous rotary gap mounted at the right.

ber. The standard form of quenched gap, as such a gap is called, consists of a number of flat copper or silver disks of large area, say three or four inches in diameter at the sparking surfaces, with their faces separated by a space about the thickness of a piece of heavy paper. To provide the necessary total length of gap for high voltage charging, a number of these small gaps are put in series, so that the spark must jump them all, one after the other. The disks are separated by rings of mica or paper. The larger gaps handling considerable power are kept cool by means of a small fan or blower. But all quenched gaps are provided with projecting fins for radiating heat, and in some designs air spaces are provided between the pairs of disks which form the successive gaps. The number of gaps is determined by the voltage, allowing about 1,200 volts per gap. Eight or ten gaps are sufficient in most transmitters of this type.

The quenched gap is not used in sets having a supply frequency as low as 60 cycles per second. The sparks obtained at that frequency are found to be irregular and not of a good tone. For this case, a rotary gap is used, as will be explained. For 500-cycle supply the quenched gap is adjusted to break down at the maximum value of the applied voltage; that is, with its total length so adjusted as to give one spark for each half cycle of the applied current. Discharges at other times are not possible, and as a result of this regularity a clear note is obtained. One advantage of the quenched gap is that it aids the production of a so-called pure wave—one which is sharply tuned. It has also the advantage of being noiseless in operation, on account of the very short gaps and the enclosure of the spark.

A 500-cycle current supply may be obtained by using what is known as a motor-generator—a motor operating off the usual supply current, directly connected with a 500-cycle alternating current generator which supplies current for the radio transmitter. Such motor-generator sets may be obtained in a wide range of capacities for the smallest as well as the largest transmitters.

A rotary gap consists of a wheel with projecting points or knobs, with a stationary electrode on each side of the wheel. The spark jumps from one stationary electrode to one of the moving points, flows across the wheel, and then, after leaping the corresponding gap on the other side, passes out at the second stationary electrode. The number of sparks per second is thus determined by the speed of the wheel which is motor-driven, so that signals of high pitch can be produced. An advantage of the rotary gap is the prevention of arcing, because of the motion of the wheel and the fanning effect, and because the electrodes brought successively up to the spark gap have time to cool in their idle intervals.

There is still a more elaborate form of spark gap which is seldom found in amateur work but which might as well be mentioned here, since we have covered practically all forms of transmitters of the damped wave category. This more elaborate form is known as the synchronous rotary gap. The wheel of the rotary gap is mounted on the shaft of the motor-generator set which furnishes the alternating current. The mounting is such that the spark points or electrodes are brought opposite each other at just the moment when the alternating current voltage in the condenser reaches its maximum value, positive and negative. Thus 500 cycles will produce 1,000 sparks per second. This regular occurrence of the discharges gives smooth and efficient operation, as well as a pure musical tone. A rotary gap that is not so timed with the alternating current supply is called non-synchronous.

Attempts to produce a high pitch spark with a 60-cycle source by means of a synchronous gap giving, say, exactly six sparks per half cycle have not given satisfaction, because the applied voltage is not the same at the time of the different sparks, and while the note is of high pitch, it is not musical. It has been found better to use a non-synchronous gap in such case, producing a large number of sparks per second and letting them occur wherever they may happen during the cycle. The irregularities will

somewhat balance up. While the tone is not strictly musical, it can be made of high pitch. The non-synchronous gap is best used if nothing but a 60-cycle or other low frequency source is available. Such a low frequency, however, is being avoided in modern apparatus, the standard frequency being 500 cycles per second. But for the amateur who cannot go to the expense and trouble of a small motor-generator set for generating a 500-cycle current, the rotary gap will be found quite satisfactory on 60-cycle supply.

Chapter VIII.

THE RADIO TELEPHONE TRANSMITTER AND THE CW TELEGRAPH TRANSMITTER

THE transmitters described in the previous chapter are of the damped or discontinuous variety. They are suitable for radio telegraph purposes, although the continuous or undamped wave type has proved to be so much better than the former that more and more radio amateurs have turned to this latter method. The continuous wave transmitter carries farther with a given amount of power; the equipment is in many respects simpler; it is silent in operation; it can be interchangeably used for radio telegraph or radio telephone.

We have already learned that damped waves are sent out in trains or groups, and that the oscillations in each train or group die down or are damped rapidly. The undamped or continuous waves, known as CW for short, are not damped, nor do they die down. The waves are continuous just so long as the transmitter is operated. The only change in the amplitude or potential of the waves is when they are modified by means of a telegraph key to form the dots and dashes of the telegraph code, by means of a buzzer to give what is known as modulated C. W., or by the voice modulations for radio telephony.

THE VACUUM TUBE IN A TRANSMITTING ROLE

Thanks to the recent development of the vacuum tube as a generator of high frequency oscillations, it now

becomes possible to produce continuous oscillations or CW on a small as well as large scale. This fact has resulted in the production of compact, continuous wave transmitters which may be used for radio telephony or radio telegraphy by the amateur. In fact, at this writing the CW transmitters now being offered are no more complicated in their operation than the receiving sets; in truth, at a glance one could not tell a small CW transmitter apart from a vacuum tube receiving set.

Let us consider a typical radio telephone and telegraph transmitter now on the market. All the controls and apparatus necessary to operate this transmitter are mounted on two panels, each measuring 9 inches by $4\frac{1}{2}$ inches. The left panel contains the grid, plate, and the antenna inductances and their control switches; a compact inductance unit serving as a choke coil; a send-receive transfer switch; and variable antenna condenser. The right-hand panel contains tube receptacles, standard modulation transformer, filament rheostat, radiation ammeter, grid leak, grid stopping condenser, and filament insulating condenser. These various terms will become clearer as we read more about the elements of a CW transmitter.

Using a 100-volt "B" battery on the plates, this set radiates .1 to .2 ampere and the range is 10 to 15 miles. With 350 volts impressed on the plates .3 to .4 ampere will be radiated, giving a range of 25 to 30 miles. With 500 volts plate voltage, the aerial ammeter reading will be .5 to .6 ampere, or sufficient to cover 35 to 50 miles.

By the addition of a buzzer and key, modulated continuous wave transmission is possible and the above ranges, which are for the radio-phone, are doubled. Adding a key only, provides continuous wave communication, tripling the ranges. However, with the key only, the waves are absolutely continuous, or what is known as straight CW, and do not serve quite as well for amateur purposes as the interrupted or modulated CW, which may be detected with any type of receiving set within range. The straight continuous wave can only be detected with a

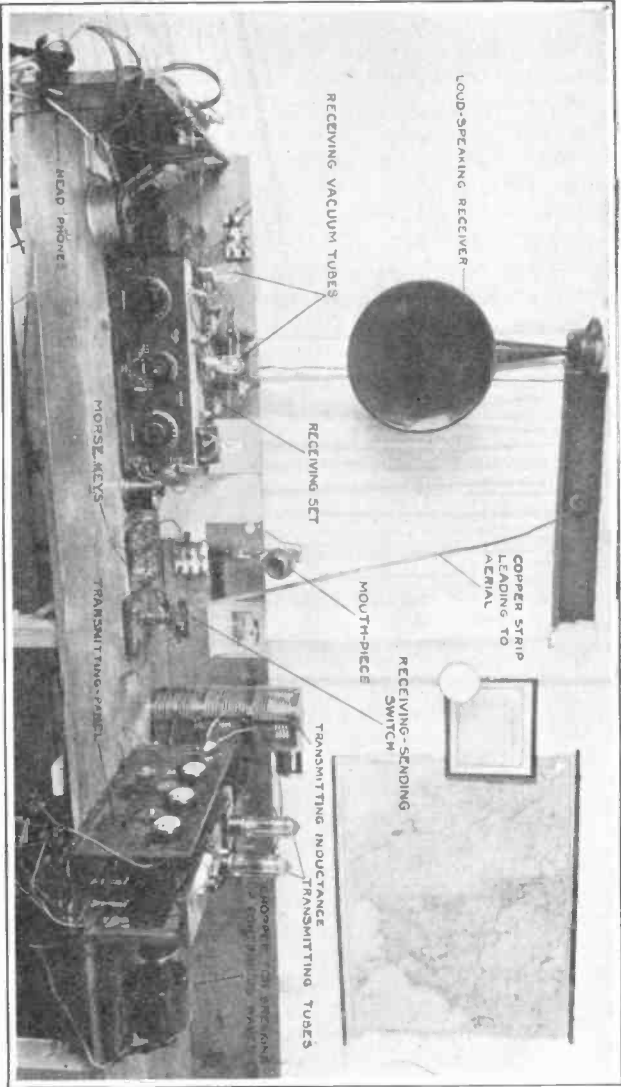

Amateur continuous wave transmitting station, showing the arrangement of the various transmitting and receiving instruments. The CW transmitting apparatus is more compact and neat, let alone less troublesome than the damped spark transmitters.

receiving set intended for and adjusted for continuous wave reception, as explained in previous chapters dealing with receiving sets.

A six-volt storage battery lights the filaments and provides current for the microphone, while the plate current can be obtained from a rectifier unit and transformer operating on alternating current supply, or any motor-generator set. Any manufacturer of radio-phone transmitters will explain just what equipment and accessories are required for this kind of work. It is too involved to be treated in this popular work.

Then there are the larger types of radio-phone transmitters. A relatively simple cabinet set, with a panel measuring 13 inches by $11\frac{1}{4}$ inches, and 8 inches deep, may be relied upon for uninterrupted, dependable transmission over distances up to 60 miles. Variable controls have been reduced to a minimum and operation could not be further simplified in many of the offerings of this class. On the face of the panel are the plate current milli-ampere radiation meter, two filament rheostat knobs, the send-receive switch, a switch for changing from speech to modulated CW or straight CW, antenna condenser switch and motor control switch. On the rear of the panel are filter condenser, constant current coil, high frequency choke coils, grid condenser, plate condenser, filament insulating condenser, antenna condenser, grid leak, four tube receptacles, modulation transformer, antenna inductance, and microphone resistance.

To supply the plates with a potential of 350 to 500 volts, a 32 or 110-volt dynamotor (a single motor and generator unit) or a 32 or 110-volt motor-generator (a motor and a generator connected together) is required, while for the filaments and microphone a 10-volt storage battery is necessary. The 32-volt potential is mentioned because certain rural districts make use of this low voltage in their isolated plants that supply lighting current.

So much for the complete sets of low and moderate power. When it comes to more ambitious ranges, running into the hundreds of miles, a much larger transmitter

must be considered. Following the panel idea, there are one-half, one-kilowatt, two-kilowatt, and larger CW telegraph and telephone transmitters. The various controls and meters are mounted on the panel, while the various components are mounted at the rear, both on the reverse side of the panel and on iron brackets and shelves.

WHY CW IS POPULAR

In time it is believed that virtually all radio amateur stations and, for that matter, commercial stations, will be using CW or undamped wave transmitters for these reasons:

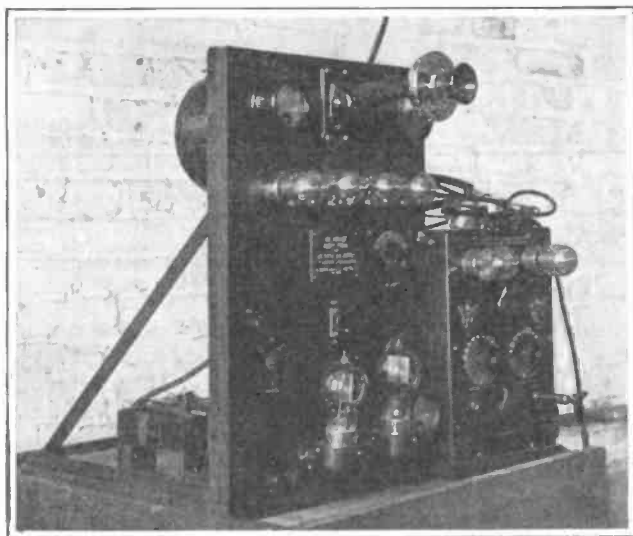

Typical radio-phone transmitter, which is provided with rectifying tubes so that it can be operated on an alternating current lighting circuit.

(1) Radio telephony is made possible on a small or large scale. (2) Extremely sharp tuning is obtained and consequent reduction of interference between stations working close together. A slight change of adjustment

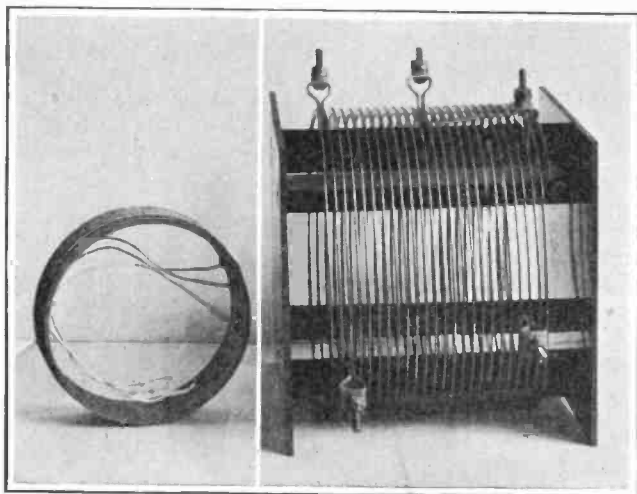

Typical CW transmitting equipment, showing its simplicity. The coil at the left is a grid coil, while the instrument at the right is a transmitting helix, made up of a number of turns of flat copper strip. The clips are for the purpose of making the necessary connections at any points on the helix in order to obtain the proper wave length values.

throws a receiver out of tune, and the operator may pass over the correct tuning point by too rapid a movement of the adjusting knobs, so sharp is the continuous wave transmitter. (3) Since the oscillations go on continuously instead of only a small fraction of the time, as in the case of damped waves, their amplitudes need not be so great and hence the voltage applied to the transmitting condenser and aerial are much lower. This means that the problem of installation is reduced to a minimum and the installation of such a set is made relatively simple. (4) With damped waves the pitch or tone of received signals depends wholly upon the number of sparks per second at the transmitter. With undamped or continuous waves the receiving operator controls the tone of the received signals, and this can be varied and made as high or as low as possible in pitch to distinguish the signals from

atmospheric disturbances and to suit the pitch to the operator's ears and to the sensitiveness of the telephone receivers. These advantages, freedom from interference caused by other stations, the use of high tones and low voltages, and the greater freedom from strays combine to permit a higher speed of telegraphy than could otherwise be obtained.

HOW CW TRANSMITTERS WORK

Persistent, continuous or undamped waves, whichever you wish to call them, can be generated by several distinct methods, each having its advantages and disadvantages, as follows:

(1) The arc or Poulsen method, so named after its Danish inventor. Oscillations of radio frequency are

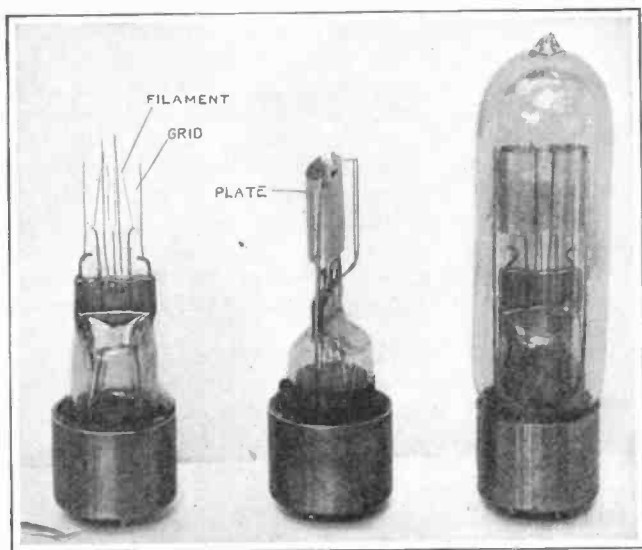

A 50-watt transmitting tube, showing its principal elements. Like the amplifier and detector tubes, it comprises a filament, grid, and plate.

obtained by means of an electric arc burning in an atmosphere of hydrogen and in a strong magnetic field. The arc method produces undamped waves of rather long wave length, and is ordinarily operated on 500 volts direct current. It has been discovered that an electric arc between proper electrodes, shunted by an inductance and a condenser, will produce continuous oscillations through the shunt circuit, and such a circuit is used to excite an aerial circuit for transmitting purposes. Depending on whether a telephone microphone or key is employed, the arc generator may be arranged for radio telephony or telegraphy. Needless to say, the arc is unsuitable in many ways for amateur radio purposes, because it is too elaborate to begin with, the oscillations are of too great a wave length, and the arc cannot be constructed for small powers yet produce efficient results.

(2) The high frequency alternator method, which is practically an alternating current generator of special design having a great number of poles revolving at a high speed, in order to obtain the necessary high frequency. A standard General Electric Company two-kilowatt high frequency alternator designed for a frequency of 200,000 cycles or 1,500 meters wave length must be revolved at a speed of 20,000 revolutions per minute. This is a very high rate of speed. Imagine a speed seven or more times as fast as the turning of the average electric fan! Again, needless to say, this is not a good method for the average amateur.

Skipping over several other highly technical methods, we come to the vacuum tube oscillator method, which is brought about by using what is known as the Armstrong "feed back" or regenerative system, which has already made our acquaintance in the previous chapters dealing with receiving systems and methods. This kind of CW transmission is brought about by placing an inductance in series with the plate, and this, in turn, is placed in inductive relation with the grid, causing the plate current to act on the grid and producing oscillations of a frequency

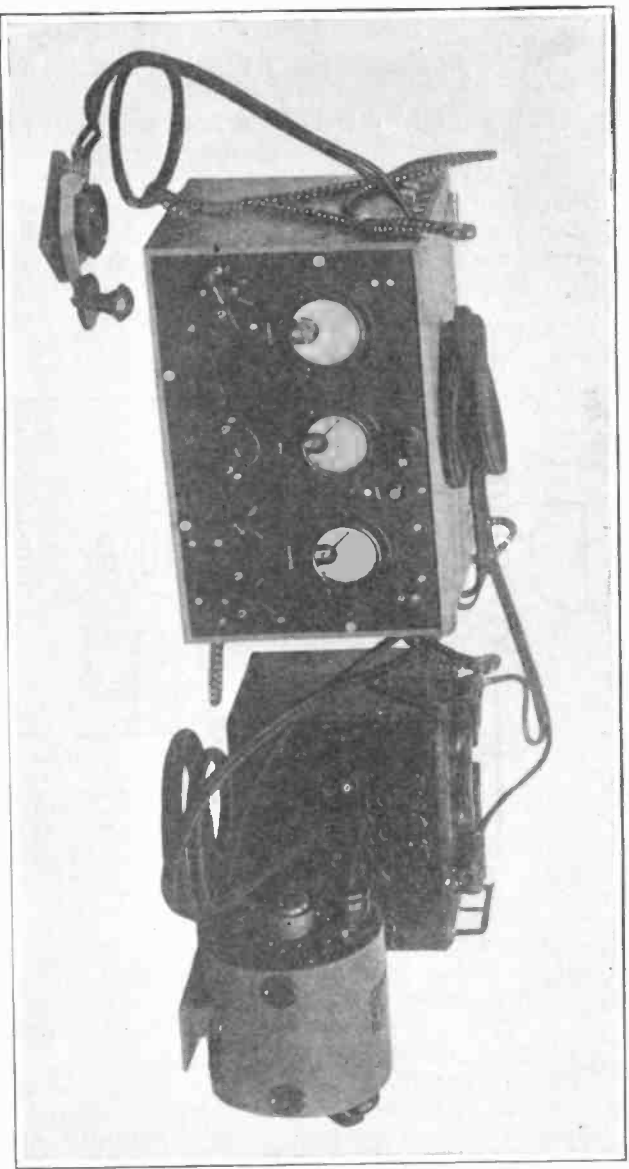

A compact CW transmitting set complete with storage battery and high voltage dynamotor. Sets of this kind have been developed for airplane use, where every ounce of weight counts. The key, shown in the left foreground, is of the non-arcing type, so as to minimize danger aboard airplanes.

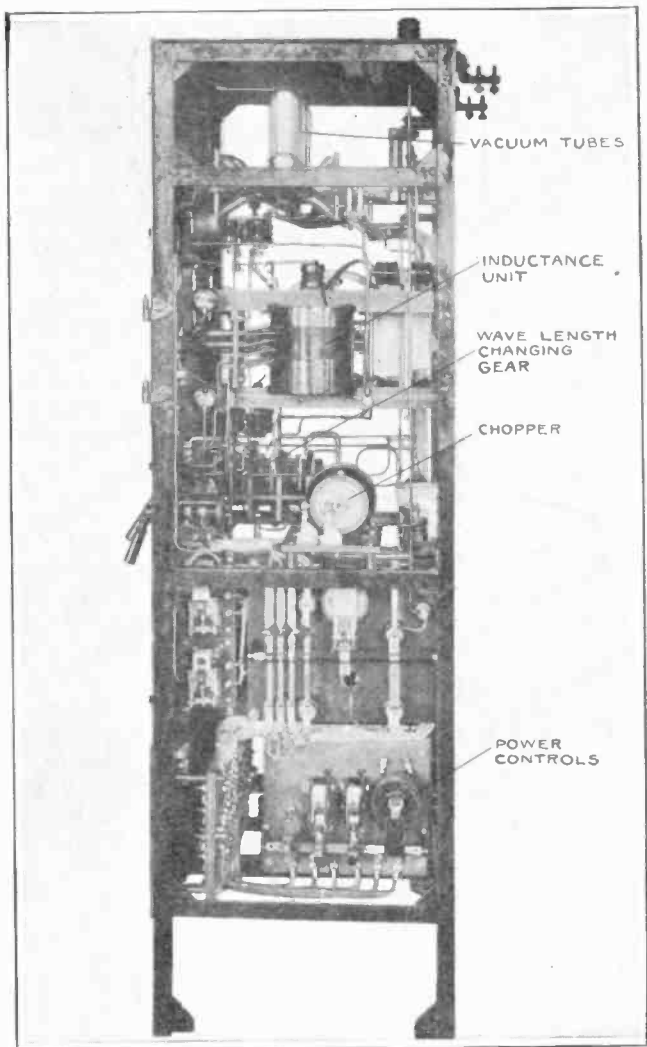

Mechanism of a commercial CW telegraph transmitter, using several 50-watt tubes and a chopper for producing modulated continuous waves.

systems. Even leaving aside the consideration of cost, in most instances the undamped wave generators other than the vacuum tube operate best on long wave lengths which are barred to the amateurs. However, the fact remains that the vacuum tube makes an excellent generator—one that is quite flexible, too, since its power can be increased merely by connecting more bulbs in parallel.

Placing the key across a few turns of the oscillation transformer, so that the CW transmitter is tuned and

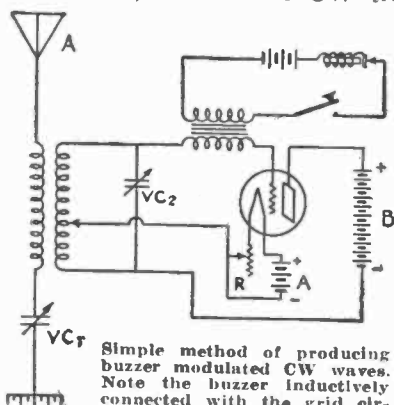

Simple method of producing buzzer modulated CW waves. Note the buzzer inductively connected with the grid circuit. A—aerial; VC1—variable condenser in aerial-ground circuit; VC2—variable condenser in oscillating circuit; R—filament rheostat; A—filament battery; B—plate battery.

detuned with the operation of the key, is often done. It will be recalled that the sharpness of undamped waves is quite marked at the receiving end, so that it follows that when the set is detuned, even to the extent of two turns of the secondary of the oscillation transformer, the waves are not heard at that moment. In this manner it is possible to make dots and dashes with an ordinary telegraph key

even when handling considerable transmitting power, since little power is broken by the contacts.

Another method of CW transmission is to use modulated persistent waves by having a transformer in the grid circuit and a buzzer and key in the primary winding of same, as shown in the accompanying diagram. The note emitted is similar to the tone of the buzzer used, and such signals can be received on any type of receiving set as distinguished from the straight CW waves which

cannot be heard with the ordinary crystal detector working in a damped wave receiving circuit.

What is known as a chopper is also used to break up the continuous waves in order to make them audible with any type of receiving set. The chopper is simply a motor-driven commutator or circuit breaking device, which breaks a circuit a given number of times according to the speed at which it is revolved. The chopper can be placed in series with the grid resistance and its rate of rotation will then determine the note of the CW signals, and make them audible to any receiving set.

The matter of the aerial is a very important consideration in CW transmission, for the reason that the waves are so sharply tuned that the slightest change in wave length affects the reception of the waves. Thus if the aerial should sway with the wind and change the distance between its wires and the ground, the wave length of the transmitted waves will also be varied, ever so slightly to be sure, but enough to give some trouble at the receiving end.

For this reason special aerials are often used in CW transmission. Instead of using the flat-top aerial, with the wires side by side supported on spreaders at either end, the cage type of aerial is often employed. This aerial has hoops or rings at each end instead of the usual spreaders, and the wires are arranged on these hoops or rings so as to form a round or cage-like aerial which is supported in the usual manner. The cage type of aerial is more constant in its electrical characteristics and is therefore more satisfactory in CW work. Furthermore, to ensure still greater rigidity, the counterpoise form of ground is also employed to a large extent in CW transmission.

The necessity for a rigid aerial system is, obviously, more essential when the dots and dashes or the telephone modulation is obtained through a change in wave length, than when the dots and dashes and telephone modulation are caused by a change in amplitude or voltage.

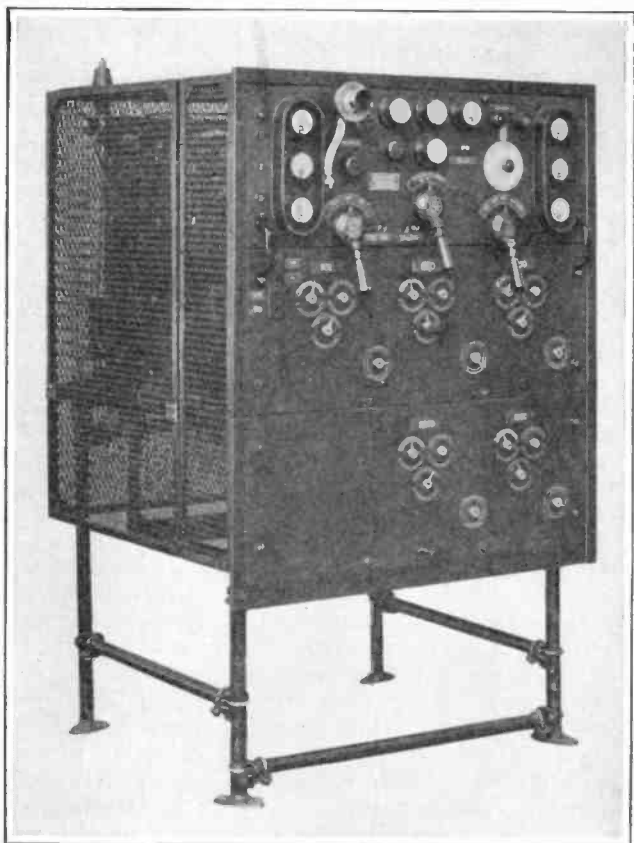

CW telegraph and radio-phone transmitter of the panel type, with the various controls and meters mounted on the front face. Transmitters of this type are being used in several of the radio-phone broadcasting stations.

The general subject of CW transmitters is such a large one that we cannot afford to go deeper into it at this time. Then again, it is very well covered by more advanced works, and certain radio companies have brought out ex-

ceptionally complete and explicit literature on CW transmission.

RADIO TELEPHONY REDUCED TO ITS SIMPLEST FORM

If one is satisfied with a range of but a few miles, a CW transmitter may be readily assembled, and it can be almost as easily used for radio-phone work as for radio telegraph.

First of all, the radio amateur must obtain the proper vacuum tube. So far we have spoken of the vacuum tube detector and the vacuum tube amplifier tubes, but now we come to the transmitting tubes.

The standard transmitting tubes now available on the market come in 5-watt, 50-watt and 250-watt sizes. For our present purpose the 5-watt is the most popular, since we are dealing with low power. Two 5-watt tubes in parallel will put from one and one-quarter to one and three-quarter amperes in the amateur's aerial. Using one of these tubes as a modulator and the other as an oscillator, for experimental radio telephony, distances up to 40 miles can be

covered, and at least four times that distance when the two tubes are connected in parallel for CW telegraphy. Four or five 5-watt tubes can be worked in parallel with increased range. The 5-watt tubes are also used as power

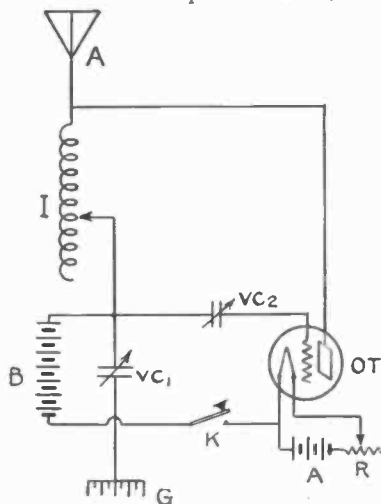

A simple continuous wave telegraph transmitter, making use of a single 5-watt tube. This set transmits straight CW. A—aerial; I—aerial inductance; B—high voltage battery; VC1—variable condenser; G—ground; K—telegraph key; VC2—grid condenser; OT—oscillating tube; A—filament battery; R—filament rheostat.

amplifiers in radio receiving circuits. The energy amplification obtained therefrom is particularly useful for the operation of loud-speakers.

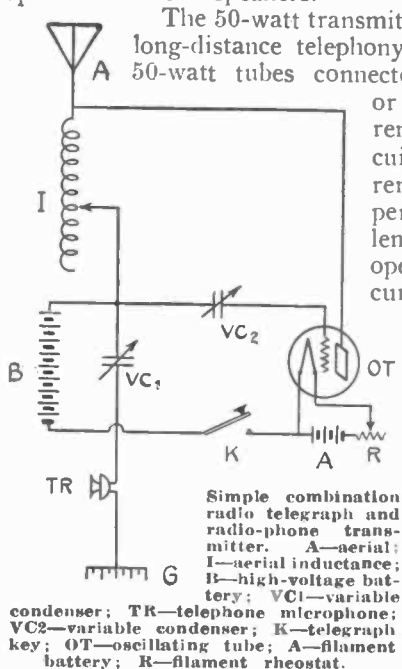

The 50-watt transmitting tube is intended for long-distance telephony and telegraphy. Two 50-watt tubes connected in a self-rectifying or in a straight direct-current plate excitation circuit will give aerial currents of three to four amperes at amateur wave lengths. A single tube operated from a direct-current source or a rectified alternating current source will put two and a half to three amperes in the amateur's aerial. Hundreds of these tubes are already in use in amateur transmitting stations throughout the country, and distances up to 1,900 miles have been covered by using in an appropriate oscillating circuit.

The 250-watt tube is the most powerful tube of the series now on the market for experimental and general transmission purposes. This tube is equipped with a special filament which gives exceptionally long operating life.

Let us return to the 5-watt tube and to the simple transmitter, which is more in the province of this book than the more powerful, more elaborate transmitters. A simple radio-phone transmitter may be readily built or rather assembled by the radio enthusiast, who wishes to do a

little talking on his own account and is willing and ready to secure his operator's and station licenses.

The first step is to obtain a 5-watt transmitting tube. Then we need two 22½-volt B battery of the same kind as we used for the receiving sets. On one battery a 5-watt tube, under good conditions, will transmit 5 to 10 miles. Then we need a variable condenser of 0.001 mfd. maximum capacity, which is connected in the ground circuit, and another variable condenser with a maximum capacity of 0.0005 mfd. which is placed in the grid circuit. A suitable CW helix or inductance is also required. This last-named piece of apparatus may be purchased already made, or it can be constructed of heavy copper wire made into a coil with the turns separated ¼ to ½ inch apart. Clips are used to make connections with any desired part of the helix or inductance. A six-volt storage battery, vacuum tube socket, filament rheostat, and a telegraph key complete the outfit. A microphone can be substituted for the key and the set converted into a short-distance telephone transmitter. If possible, a hot wire ammeter

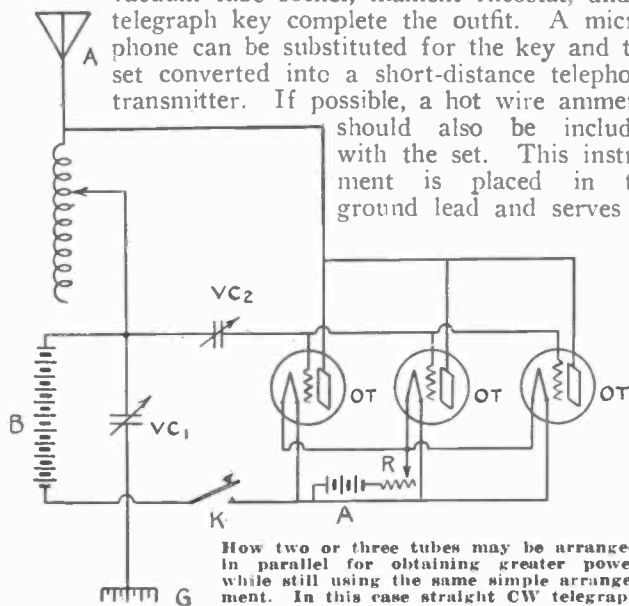

How two or three tubes may be arranged in parallel for obtaining greater power while still using the same simple arrangement. In this case straight CW telegraph is obtained.

should also be included with the set. This instrument is placed in the ground lead and serves to

indicate when the transmitter is adjusted to maximum efficiency.

Tuning the set is accomplished in very much the same manner as with the damped wave transmitter. With the filament of the tube lighted and the set oscillating properly, the series and the grid condensers are varied until a maximum output is indicated by the ammeter. However, this method does not indicate just what the wave length may be, and one may be overstepping the 200-meter limit. It may be well to have nearby amateurs listen in and say whether the emitted wave appears to be below 200 meters, and also when the transmission is at its best.

The output of the transmitter can be increased by using a higher voltage on the plate. By means of additional B battery units, the voltage can be increased to 90 volts. It must be remembered in this connection that the energy for the waves is taken from that source. Just so long as the tube does not glow with a blue haze, the B battery voltage can be piled on, increasing the efficiency and the range. Another scheme is to use two or three tubes in parallel, with the grids connected together and also the plates. Only one B battery is required for all the tubes.

Much could be said here regarding modulator tubes, which permit of modulating heavy transmitting currents by means of ordinary carbon microphones through the medium of vacuum tubes known as modulator tubes, and magnetic modulators. Then there are filter reactors, rectifiers, filters, microphone transformers, and other devices which enter into the more elaborate CW transmitters, but for further information along these lines we must look to more advanced works specializing in CW transmission.

Chapter IX.

THE UNUSUAL USES OF RADIO ON LAND AND SEA AND IN THE AIR

RADIO has many uses aside from the broadcasting of entertainment and news and the linking of widely separated points. In fact, it seems as though we have done little more than scratch the surface of its vast possibilities, and that the inventive talent of today must lead us to still greater and more startling achievements in the application of radio.

In the early days of radio, too much was expected of it. There was much promise of the transmission of power by radio in order that airships and automobiles and street cars and ocean liners might be operated by distant power plants without the agency of wires or cables. Yet we know today that the transmission of power by radio is still a remote possibility; we know that, starting with one kilowatt at the transmitting end, we obtain less than a thousandth of a watt, or one millionth of the original power expended at the receiving end. The radio method of transmitting power is a most inefficient one, and only if we hit upon some entirely new principle of transmission and reception can we hope to make anything of the idea of radio transmission of power.

However, whatever radio wonders may have been expected in the early days have been more than realized, even though the present achievements may be along entirely different lines.

THE MARVELS OF RADIO CONTROL

One of the most promising fields of unusual radio, if we may call it such, is the one given the broad name of radio control. This means the controlling of machinery and other things at a distance through the use of radio. Thus small vehicles and boats controlled by radio have attracted no little attention wherever they have been shown.

Mysterious as these things may be, there is really nothing very complicated about them. This does not mean to say that anyone can construct a successful radio-controlled car or boat with little trouble, because there is a good deal of experimental work to be performed before such a delicate assembly can be made to work properly; but the principles are public property and may be employed by anyone of an inventive turn of mind.

The principle of radio control rests on the transmission of certain signals or radio waves which affect a detector in the same manner as the usual receiving set. Instead of rectifying the intercepted wave energy for a pair of telephone receivers or for a loud-talker, however, the detector in this case passes its output over to a delicate relay, which is a device that is actuated by a source of delicate current so as to open and close the circuit of a more powerful local current. The more powerful current can therefore be made to do whatever work is desired. So, if we press the key of a transmitter, tuned to the right wave length, the machinery to be controlled intercepts the signal and operates its relay, which in turn closes the local current circuit for the performing of any desired task. However, such a simple system gives only one command, so to speak, and since a number of different tasks must be commanded by means of the remote control, some other agency must be introduced of multiplying the number of commands that can be issued.

There are several ways in which a number of different things can be commanded or controlled by remote control. The simplest method is to use a revolving contact drum.



The radio-phonc in the typical American home. The loud-speaker used in this instance makes it possible to enjoy the radio-phonc concerts and talks without the necessity of wearing head receiver, except for accurate tuning and long distance work.

as it is termed, on which are arranged metal strips which can make various combinations of electrical connections and which come into action one by one as the drum is revolved. This drum is revolved continuously at a predetermined speed, or step by step. In the latter case one combination of connections after another is brought into action by means of an electro-magnetically operated ratchet device, which functions through the closing of the relay contacts. Every time a signal is sent out by the transmitter, the relay of the receiving device closes the circuit, current is sent through the combination that happens to be effective at that moment, and the drum is then given a one-step turn to the next combination as the signal stops. The next signal sent through repeats the same performance, but with the combination then effective being used.

Now the combinations can be arranged to do all kinds of different things. Supposing we are dealing with a model submarine, controlled by radio. The first combination on the drum starts the motors; the second steers the craft to the left; the third brings the rudder to the normal position; the fourth steers to the right; the fifth causes the driving motors to drop to half speed; the sixth deflects the diving rudders so that the craft submerges; the seventh brings the craft back to the surface again; the eighth stops the motors.

But supposing we want the craft to steer to the right, when the combination then effective is the seventh, or the one that brings it back to the surface, what then? Simple enough. We simply send out one short snappy signal after another without appreciable pause between them, so that the craft does not have time to respond to any one of the controls, brought into play in rapid succession until we reach the desired control, when we stop and the craft obeys. Generally, some indication is provided so as to show just what combination happens to be operative at any given moment. Little colored lights can be used to indicate when the start of a cycle of combinations is at hand, and the operator knows just how

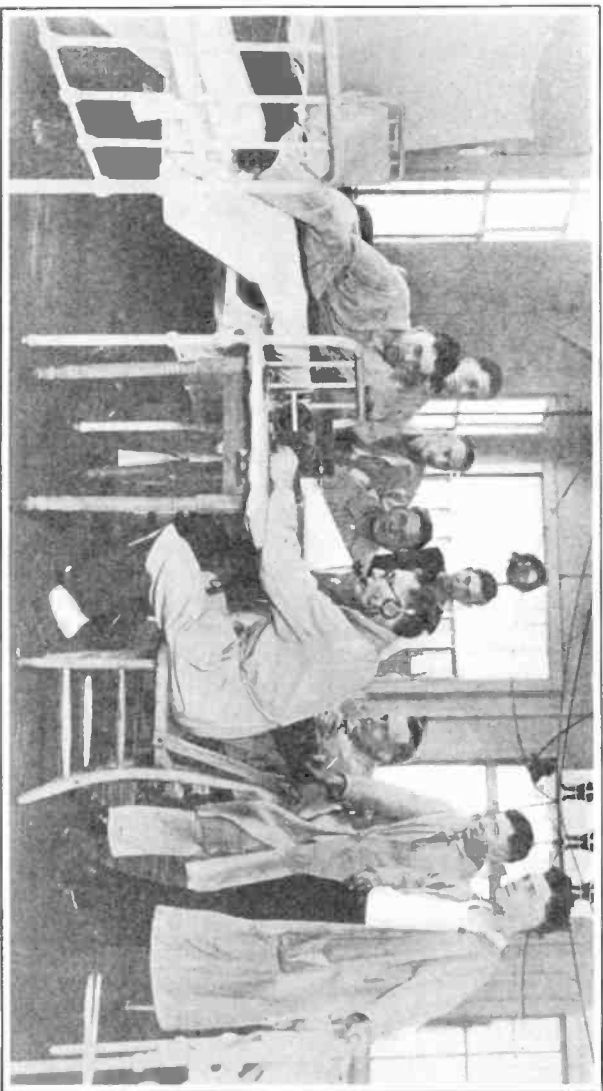

In the hospitals the radio-phone has proved a great boon. It brings cheer to the unfortunates as nothing else ever did. Here are the doughboys in one of the Army hospitals, enjoying a radio concert.

many signals to send in order to reach the desired control.

Another method is to use a steadily revolving drum aboard the vehicle or boat to be controlled. A watch, carefully synchronized so that its large hand will turn at the same speed as the revolving drum, is used by the operator. In this manner the operator, while watching his synchronized indicator, knows just the right moment to press the key in order to take advantage of any desired conditions for any desired command.

THE RADIO COMPASS AND WHAT IT MEANS

Something has been said regarding the use of loops for receiving purposes. A loop consists of a wooden frame with a number of turns of wire. The loop is used in the same manner as would the secondary of a coupler in a receiving circuit, with a variable condenser or variometer to vary its wave length. No ground is employed. The loop receives signals loudest when it is pointing end on towards the transmitting station, and this fact has brought the radio compass into existence.

The radio compass is nothing more than a loop receiving set. Thus the loop, which is mounted in such a manner as to be readily swung about on its vertical axis, is orientated until signals are picked up and a line can then be drawn on a corresponding map to indicate the direction from which the signals are coming. However, the loop indicates only the general line along which the signals are being received, and there is no telling whether they come from one end of the loop or the other. However, in most instances the operator knows whether it is in one direction or the other, and he only requires the directive line.

The radio compass generally consists of two or more radio compass stations on shore, at the entrance to a harbor or some other point. A ship, wishing to know its exact bearings, calls up the radio compass stations, and these stations, by orientating their loops, secure two directive lines for the ship. Since the radio compass stations are located a certain distance apart, forming the

base of an imaginary triangle, and since a pair of stations obtain an angle reading formed by the direction of the received signals and the base line, it is a simple matter with a known base line and two angles to construct an

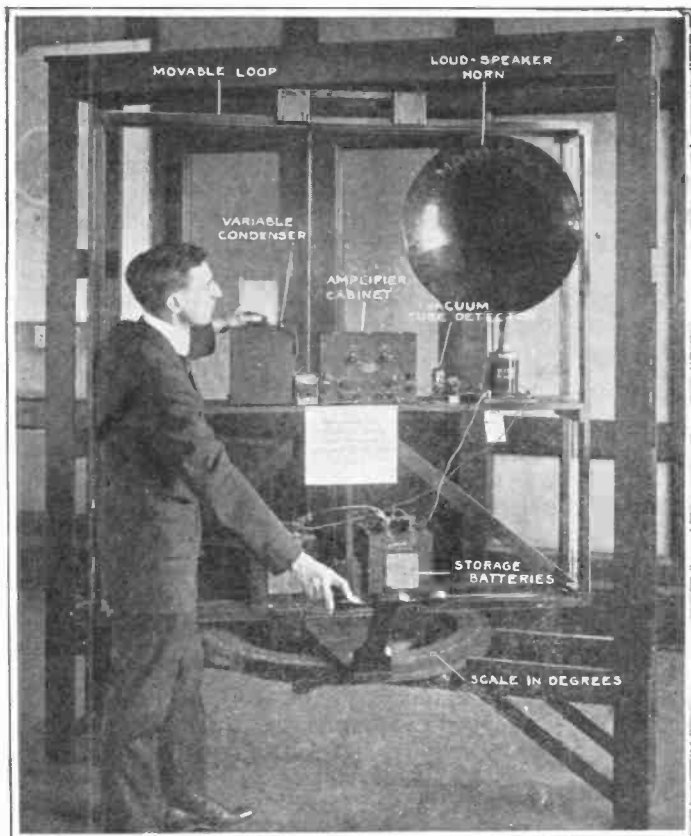

The radio compass which is employed as an aid in navigation. A number of turns of wire are wound about the large wooden frame which is rotatably mounted in the stationary frame, so that it can be orientated.

imaginary triangle, the apex of which is the location of the ship. The radio compass stations then call up the ship and give the navigator his exact position.

During the war the radio compass was employed for locating enemy radio transmitters. The Germans employed the radio compass to guide their Zeppelins through the blackness of the night in their raids on London and Paris. That is why the Zeppelin flew with such rare precision over enemy territory and sea, and back to their flying fields.

More recent developments in the radio compass have brought about a simpler method. Now the loop is carried on the ship, and the operator obtains directional readings from two shore stations whose locations are known, so that with a given apex angle and a known base line, it becomes possible to reconstruct an imaginary triangle and to determine the exact position of the ship.

WIRED WIRELESS

For some time back it has been possible simultaneously to transmit several telegraph messages over a single telegraph circuit. Also, certain attempts have been made to develop a system of tuned or syntonic multiplex telegraphy. But it has remained for the man who is at present Chief Signal Officer of the United States Army, Major General Squier, to develop a system of communication known as wired wireless, which makes it possible to carry on as many as ten or more two-way simultaneous telephone conversations over one electrical circuit. It was in 1910 that Major General Squier (then Major), by a bold and ingenious adaptation of the fundamental principles and apparatus previously employed in radio telegraphy and telephony, developed the multiplex system which bears his name, and therefore established a distinct branch of the art of communication.

The fundamental principle of the Squier system is the application of high frequency electrical resonance, or tuning as it is understood in radio work, to wire communi-

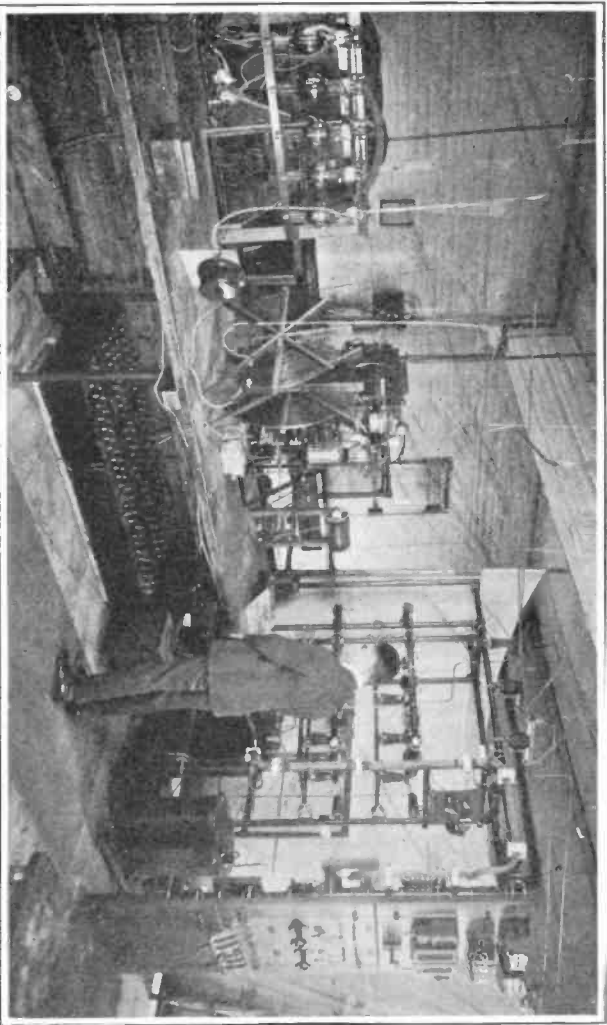

A radiophone broadcasting station which has very much the appearance of an electrical laboratory. Note the large oscillating tube in the center of the picture, and the five tubes at the left. This is WGY, the Schenectady broadcasting station of the General Electric Company.

cations. Previous attempts to solve the multiplex problem had been based largely on electro-mechanical resonance. The system employs the elements of the radio telephone installation, the essential difference being that in place of the connections to earth and the usual antenna, we have, in this case, connections to the two wires constituting a physical pair. The two fundamental factors, then, in the Squier system of multiplex, are the utilization of electrical resonance and the use of a receiving device which delivers to the telephone receiver a varying undirectional current corresponding to the voice current supplied to the modulating device at the transmitting station. Whether the frequency of the carrier current is low or high does not modify the basic principles involved. In this system electro-magnetic waves of predetermined length are guided by the metallic circuit, instead of radiating in all directions from an antenna. While there undoubtedly is a certain amount of radiation from the physical line, the over-all efficiency of the guided-wave system, as wired wireless is also called, is obviously materially higher than in the case of a free-wave system. This has been thoroughly confirmed by experience.

It is reported that in general, guided-wave transmission gives a more nearly perfect reproduction of the voice than does wire telephony. In ordinary telephony there are three inherent causes of distortion, to wit: the microphone, the telephone receiver, and that due to the line. The first two are, of course, present in the high frequency system. The distortion due to the line is, however, absent.

Another important aspect of communication is secrecy. When used as a direct private line of telephonic communication, as in the case of leased lines between business houses in different cities or for press work, we have in this method a system of communication which accords a high degree of secrecy. Common experience indicates how little real privacy obtains when employing the ordinary telephone. While radio telephone has a distinct

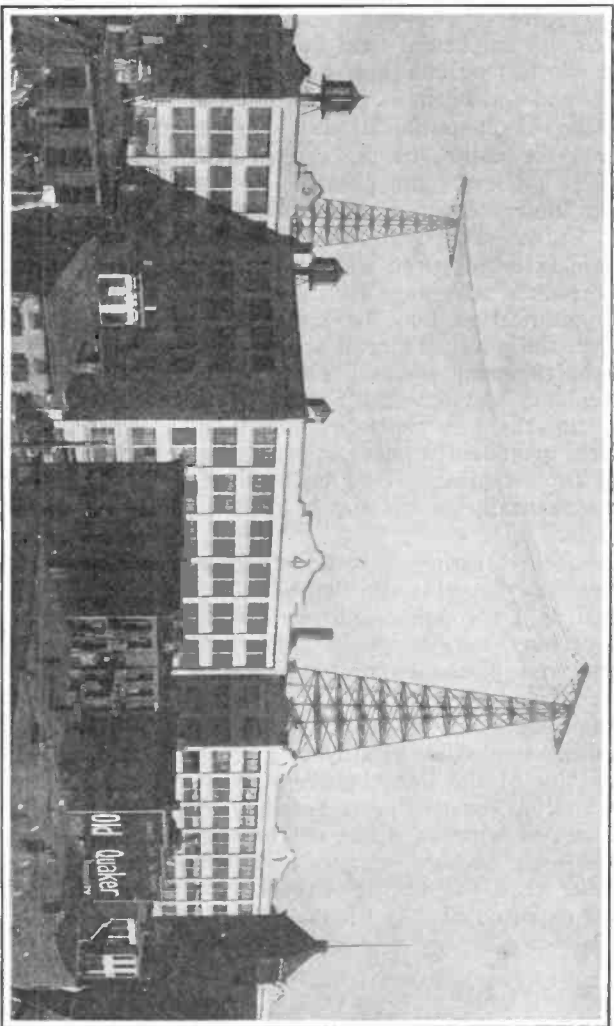

A commercial radio telegraph station located in New York and employed for maintaining communication with ships. The steel towers and steel cross-arms serve to support the aerial wires.

and very important field in communication at sea, it obviously has serious limitations when employed for strictly personal and business purposes. While there is no known means of communication which cannot be tapped, yet from the nature of the system direct guided-wave telephony possesses the greatest element of secrecy of any telephonic means of communication, according to Chas. A. Culver, Ph.D., to whom the author is indebted for these facts on wired wireless.

Another advantage of the guided-wave system is that communication may be maintained between two points when the physical circuit which serves as a guide for the high frequency waves is out of commission for ordinary telephone service. Both wires of the physical pair may be cut, the line short-circuited, and at least one of the wires grounded without interrupting communication over the super-channel. This has been repeatedly demonstrated and naturally means much in emergency service of all kinds.

Another feature to be noted in connection with guided-wave telephony is the flexibility of the system. When used as a through trunk channel, a given set of equipment may, as previously indicated, be instantly shifted from one physical circuit to another. Further, the entire guided-wave equipment may be quickly transported from one point on a physical system to another, thus making it possible readily to increase the traffic-carrying capacity of the lines between points where a temporary congestion exists, due to seasonal or other causes.

Guided wireless is but another achievement of modern radio—but another instance of how radio has collaborated rather than fought the wire telephone and telegraph, as was expected of it in the early days of the art.

Chapter X.

RADIO IN WORKING CLOTHES, OR THE APPLICATION OF RADIO TO EVERYDAY BUSINESS

IF radio has a legitimate place in the home in the way of amusement and education, it has an even greater place in everyday business, especially that kind of business which extends out beyond the narrow confines of our immediate city and State and country and even continent. Radio is a logical method of long-distance communication. It is alone in the ship-to-ship communication field, and it takes its place beside the telegraph and cable systems in our present scheme of things.

Little need be said about the marine end of radio. Suffice it to remind ourselves that virtually every ship that carries passengers and any freighter of consequence are equipped with radio. No greater factor was ever introduced in maritime circles than radio, for ships are no longer out of touch with the world for days at a time. With the highly efficient ship installations as well as the powerful land stations, a ship is rarely isolated.

RADIO WORLD-WIDE CHAINS IN THE MAKING

While radio may be used for short distances in place of telegraph lines, its real forte lies rather in long-distance work, side by side with the usual cables. It has been employed for inter-city work with some degree of success; but if all inter-city communication were conducted

by radio instead of by the usual telegraph system it is obvious that the problem of interference would assume gigantic and finally prohibitive proportions.

All the leading nations have fully realized the value

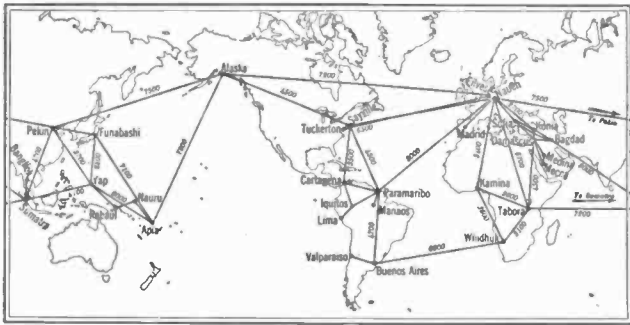

Germany's scheme of 1913 for world communication. A study of this network indicates that it is clearly influenced to a great extent by military as well as commercial considerations. The World War caused the permanent abandonment of this scheme.

of radio as a means of long-distance communication. The recent war taught all nations that cables and telegraph lines can be severed, but the radio system cannot be interrupted. The nation with powerful radio stations is always assured of communication with the outside world.

A number of world schemes of radio communication have been proposed in the past, and some of them are in the process of present realization. The earliest one is shown in the accompanying map. For this and the other maps shown in the following pages, as well as for much of the data on this phase of radio, the author is indebted to Alfred N. Goldsmith, Director, Research Department, Radio Corporation of America, and to the *Journal* of the American Institute of Electrical Engineers, in which Mr. Goldsmith's data appeared. The accompanying map, in which the distances are given in kilometers (a kilometer is roughly $3/5$ of a mile) repre-

sents the extremely ambitious German scheme of 1913 and is clearly influenced to a great extent by military as well as commercial considerations. The length of some of the jumps from station to station, taking into consideration the transmitting powers and the types of receiving apparatus then available, indicate that only partial or occasional service over the longer spans could have been expected, and then only at low speeds. It also appears that each station was to handle several channels and therefore presumably to divide its time between its various correspondent stations. This type of service is more suited to press and propaganda work and light traffic than it is to the more exacting high-speed commercial requirements. This plan was not carried far before the war brought about its complete destruction.

Our next map represents the first British Imperial schemes for radio communication, the so-called "All-Red Chain." It dates from 1913, and was the plan of the British Marconi Company which submitted it to the British Government for approval. It was adopted, and some work was done along the lines indicated when the war intervened. The changes caused by the war and

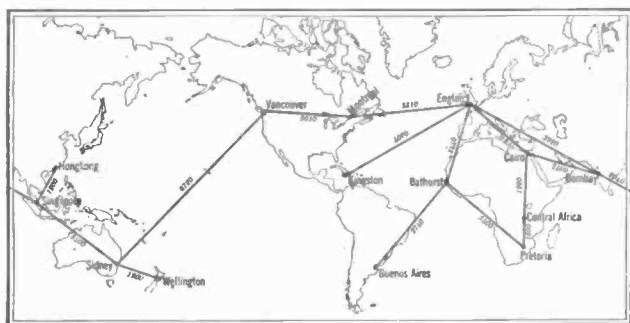

The British Imperial communication scheme of 1913, the so-called "All-Red Chain." This scheme was adopted and some work was done along the lines indicated when the war intervened. The distances were too great, however, and the scheme was abandoned.

other causes led to its discontinuance and to rather serious differences between the British Government and the Marconi Company. Afterwards the claims of the Marconi Company were in part allowed and suitable financial com-

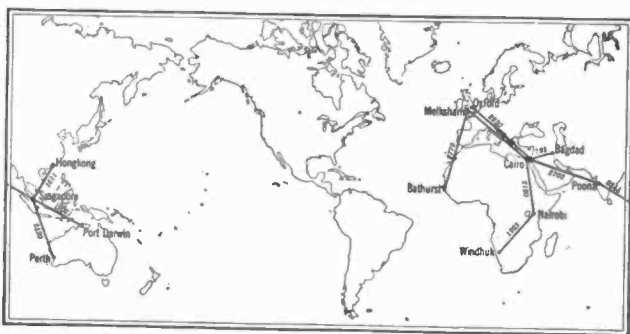

British Imperial scheme of 1919 for radio communication. This is a less ambitious but more practical scheme than that of 1913. London is connected with distant points by means of short spans and relays, so that the distances are entirely feasible.

pensation paid by the British Government for the loss of the original contractual profits. The plan itself included two routes from England to Australia with only two relays. It was a scheme involving large spans. London was the main center from which most of the communication to distant points radiated directly.

In 1919 and 1920 a British Government Committee reconsidered the entire project of the Imperial radio scheme and recommended the less ambitious scheme shown in our next map. Here the Western Hemisphere is apparently neglected. London is not connected directly (without relays) to the more distant points, the average span is shorter, and the terminal points chosen are indicated apparently only in part by commercial considerations. This system will be Government-owned and operated, which may account for the nature of this plan, which is now being carried out. Only a very small portion of this plan has been carried out thus far.

Another very ambitious plan is due to France and is given in the accompanying map. It, too, is not planned entirely along commercial lines. Furthermore, it is clear that the French stations are intended to divide their time between a number of terminal stations and that extremely long spans are planned. Of the stations shown on the French plan, several are built and several more are in process of construction. A considerable portion of this plan will, however, still have to be worked out in the future. It is noticeable that both the present French plan and the original German plan lay more stress on South American traffic than does the present British Imperial scheme.

OUR SCHEME FOR WORLD-WIDE RADIO

Then we come to our own pet scheme for world-wide radio—America's plan. It differs in several important respects from the preceding plans. In the first place, every station shown thereon is either in operation or under construction, and by far the greater portion of the stations are those already in operation. Furthermore, for the sake of clearness, the large contemplated expansions of this plan are not shown on the map, although they will add

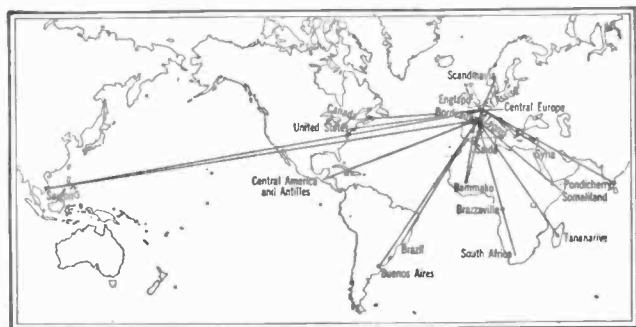

The French communication scheme. The French stations are evidently intended to divide their time between a number of terminal stations and the spans are extremely long. However, work is progressing on several large stations for this world-wide scheme.

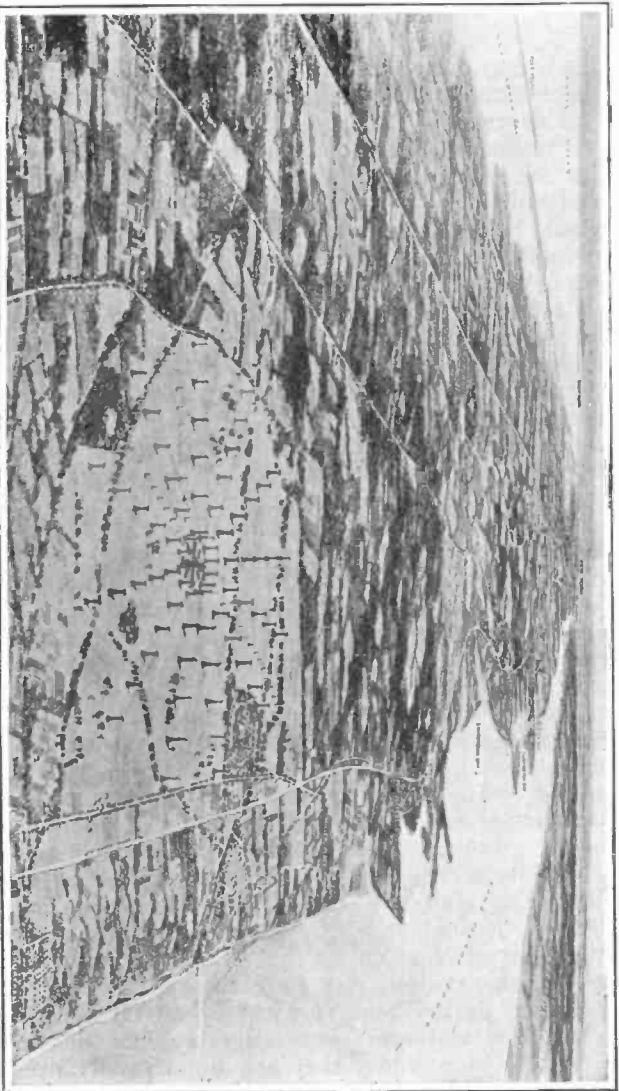

Bird's-eye view of the huge Radio Central wireless station at Rocky Point, Long Island, some seventy miles east of New York City. This station, as its name implies, is a group of transmitters, operated as separate units but comprising one huge station. There are to be seventy-two steel towers arranged as the spokes of the wheel.

the twenty-four hours of the day, the days of the week, or the months of the year. There are very pronounced peaks, and depressions or lull of traffic found to exist. Thus, the traffic between two countries will generally be heaviest for the hours during which daylight is common to both, and will drop to a minimum during the week end. It would be desirable to handle the peak of the load without permitting traffic to pile up, but this may not always be feasible for reasons of economy, both of equipment and of necessary personnel. This has led to the attempt to secure a high load factor for communication circuits by encouraging some of the users of the service to accept a certain delay in the delivery of their messages which are then sent at a reduced rate. Thus we find in addition to normal messages, which are sent in the order in which they are received, the "deferred" messages which are sent at the earliest opportunity when traffic has slackened sufficiently to permit their introduction. "Night letters" and "week end letters" are sent during the periods indicated, and are obviously intended to fill an otherwise dull period in the circuit. On some circuits, "urgent" messages are accepted which take priority over all others, and require the payment of a considerably increased rate. As a general rule, the minimum number of classes of messages required to maintain an acceptable load factor is desirable not only because of the increased routine in handling traffic of many different classes but also because of the confusion in the public mind and the possible dissatisfaction which results when the type of service rendered in any given case is not clearly understood in advance.

The huge radio stations for inter-continental work are interesting studies. One of these stations is the Radio Central, located at Rocky Point, Long Island, some 70 miles east of New York City. However, the actual operation of this station takes place from New York City, the dots and dashes being formed by an operator in New York City and sent over telegraph lines to the Radio Central station, where they are automatically transferred

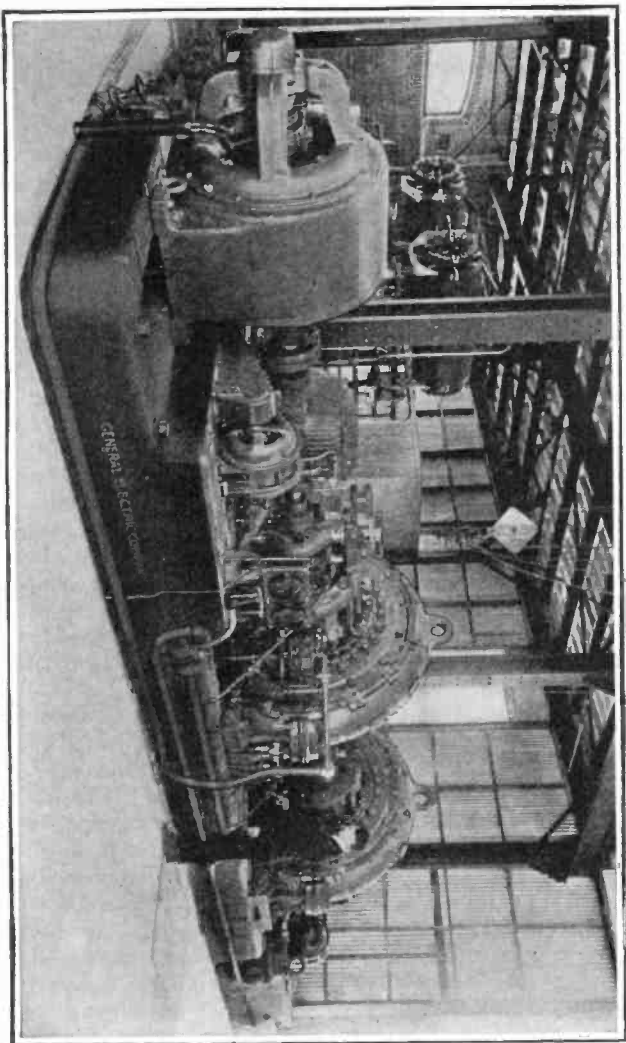

An Alexanderson 200-kilowatt high-frequency alternator as employed at the Radio Central wireless station and in other American long-distance stations. This machine generates high-frequency current and therefore takes the place of the usual spark oscillator.

to the powerful radio transmitter, consisting of a number of 200-kilowatt high-frequency generators. Radio Central is in reality several stations in one. It comprises a number of separate transmitters so as to ensure simultaneous communication with a number of stations abroad.

OPERATING A TRANS-ATLANTIC STATION AT A DISTANCE

It has always been a problem to control several hundred kilowatts of power at frequencies of 20,000 cycles per second by breaking it up into the dots and dashes of the telegraph code at speeds as high as 100 words per minute or more. When it is considered that this is equivalent to starting and stopping the flow of power fifty times per second, accurately and faultlessly, and that the initial control power is merely the few watts that can be drawn from the terminals of a telegraph line, the magnitude of the problem becomes evident. By the development of high-speed power relays and the new "magnetic amplifier," the problem has been very elegantly solved. The magnetic amplifiers at the Rocky Point station enable the powerful transmitters to be operated at long distance, so to speak. These ferromagnetic devices accurately modulate or control the flow of power from the alternators to the radiating system or aerial wires.

To radiate the large amounts of power required to bridge transoceanic stretches, a large and lofty radiating system or aerial is required. The main tower at Tucker-ton (N. J.) is 850 feet high. At the New Brunswick (N. J.) station a row of 400-foot masts stretching 6,000 feet from the station support the "multiple tuned" aerial system. The latest form of aerial is that employed at the Radio Central station. It consists of a line of 410-foot towers with 150-foot spreaders at the top of each, and stretching a mile and a half from the station building. Twelve such rows of towers, each fed by its own high-frequency alternators and constituting in effect a separate transmitting station, will enable the Radio Central station to be used for simultaneous communication with an

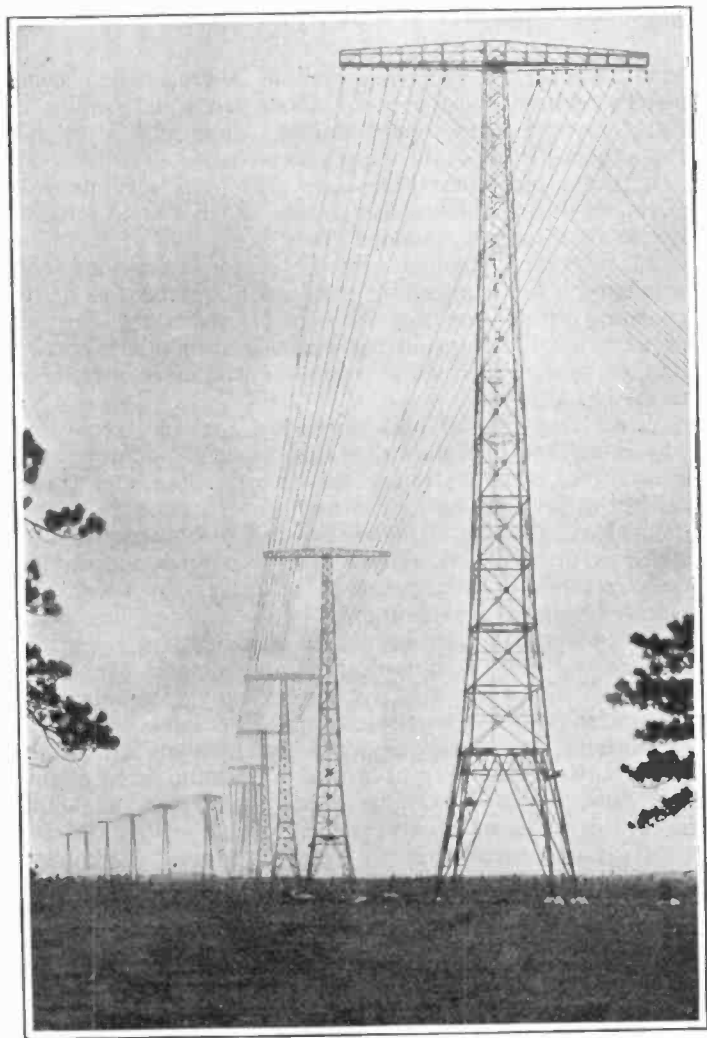

Twelve of the seventy-two steel towers comprising the aerial supports of the Radio Central wireless station. Each tower is 410 feet high, while the cross-arm measures 150 feet from tip to tip.

equal number of receiving stations abroad when completely realized. An area of about ten square miles is being devoted to this giant station, which will be by far the largest in the world when completed.

In radio reception there have also been very marked advances during the last few years. Each row of apparatus in its especially shielded cases is capable of handling one transoceanic channel. Each operator is provided with a telegraph key controlling the transmitter on the corresponding circuit, so that he can, if necessary, "break" or interrupt the transmitting operator to obtain a correction or other information from the station which he is receiving.

When reception at high speed was desired, recording was sometimes accomplished on modified phonographs which were run rapidly and the records were later transcribed at lower speeds by a number of operators. This method of receiving at high speed has been superseded by modern forms of ink recorders especially developed for radio reception. Photographic recorders, in which the received signals are photographed as a wavy line on a paper ribbon, have also been used in high speed reception.

Wire and radio communication, according to Mr. Goldsmith, should work hand in hand in any comprehensive scheme of world communication. The land wires and cables have very clearly demonstrated their great capabilities and usefulness; but radio communication, even at this early state in its development, has shown that it should be considered as an integral element of any well-considered plan for communicating all over the globe. Today approximately 15 per cent of the traffic across the Atlantic from the United States is handled via radio, which is a hopeful showing for a new art, to be sure. To the extent that there is harmonious and intelligent co-operation between the various communication systems, we may hope for the satisfactory solution of the problem of giving every person on earth rapid and reliable communication.

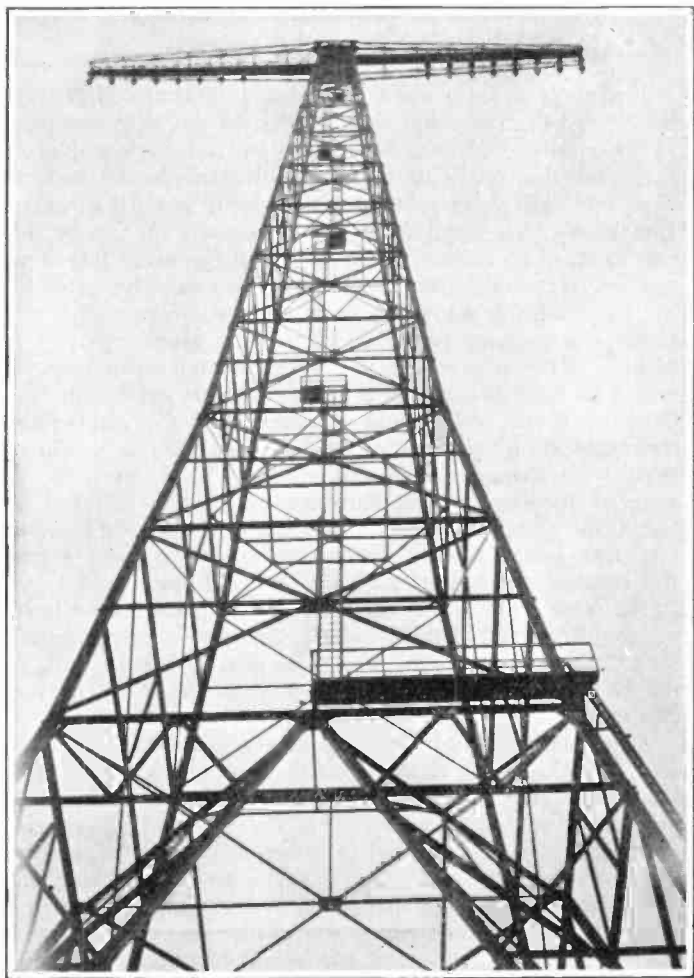

Looking up at the top of one of the steel towers of the Radio Central wireless station. The cross-arm at the top serves to support the sixteen wires which form the aerial.

WHEN WIRE AND WIRELESS WORK TOGETHER

Fortunately, there are no physical limitations to prevent the interconnection by skilled persons of wire line and radio circuits. Messages received by radio telegraphy or radio telephony can be automatically transferred to wire lines and over them relayed to any point reached by them. Conversely, telegraph or telephone signals on a wire line can be used to control radio telegraph or radio telephone transmitters. So that any wire system may be extended by the addition of radio relays and, reciprocally, any radio system may be extended by the addition of wire relays. This process of adding wire and radio links or relays to each other can be carried on to practically any desired extent and should constitute an element in the communication systems of the future. On a moderate scale it is being carried out commercially today in the case of messages from European countries received by the Radio Corporation of America at its receiving stations on Long Island and in New Jersey. From these points the messages are automatically relayed over wire lines to the New York traffic office of the company in the heart of the financial district, where the receiving operators take down the messages by ear, if sent at hand speed, or the messages are automatically written down by ink recorders if received at high speed.

A similar transfer of telephone signals to and from wire lines has been demonstrated as a commercial proposition in highly successful fashion by the American Telephone & Telegraph Company, in the Avalon-Los Angeles radio toll circuit, in which regular radio telephone messages are sent by radio over a $31\frac{1}{2}$ air gap without the subscribers realizing that their conversation is being handled in any other manner than by wires. Experiments have been carried on with the steamship Gloucester and the Deal Beach radio-phone experimental station, and persons have talked over the regular telephone instrument in their home to the ship at sea. More recently, still more spectacular experiments have been carried on with

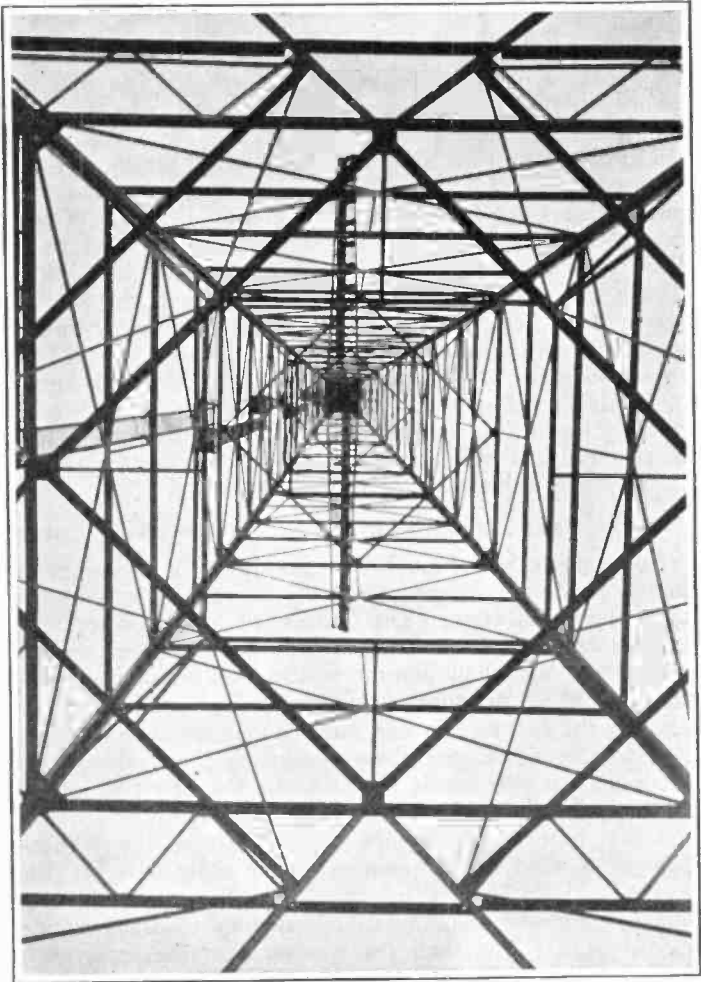

Looking up through the center of one of the steel towers. While this steel work may appear delicate because of its simplicity, it possesses great strength because of the diagonal bracing.

the steamship "America" while 400 miles out at sea. It is only a matter of time when we shall be able to 'phone to the ship at sea with the same ease that we call up long-distance points.

Certain countries, such as the United States, are so situated geographically as to serve naturally as important relay centers for inter-continental communications. Communications from Europe to South America, and from Europe to the Far East naturally pass over the United States. In view of the rapid rate at which the power, required to bridge a certain distance reliably by radio, increases with distance for spans of more than a few thousand miles, it is advantageous, holds Mr. Goldsmith, to establish relay points in the United States whereby communications from Europe to the regions named will be received in the United States and thence automatically or otherwise relayed to their destinations.

THE TRAFFIC CAPACITY OF THE LONG-DISTANCE ETHER

Some doubt may have been entertained by engineers as to the traffic-carrying capacity of the ether for long-distance communication. The figures for long-distance telegraphy can be at least roughly estimated without serious difficulty. We shall assume continuous wave transmission, with an appropriate form of key modulation in sending the dots and dashes, and without any tone modulation whatever. Under these conditions, and taking into account both side bands produced as the result of actual transmission, it has been found that a speed of 100 words (or 500 letters) per minute corresponds to the occupation of a band of frequencies in the ether roughly 100 cycles wide. This is on the basis that the radio-frequency generator maintains its frequency constant during transmission. We shall also assume that the receiver is sufficiently selective to exclude all signals on frequencies outside of this 100 cycle band. Under these conditions, we may say roughly that on each cycle per second of available ether frequencies we can transmit one word

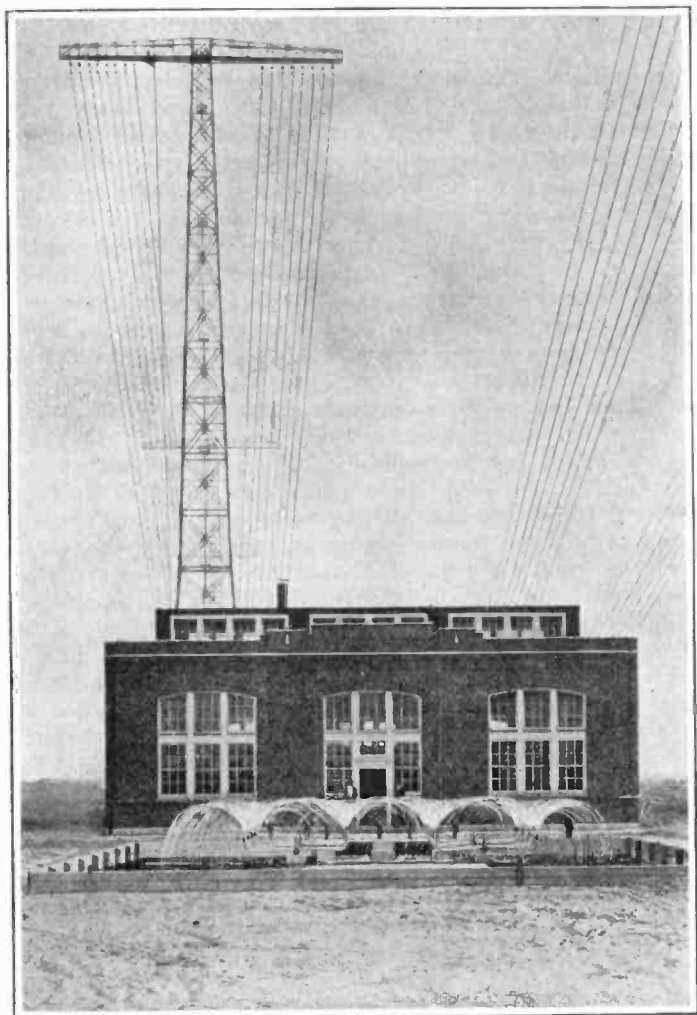

The power plant and station building of the Radio Central wireless station. In the foreground are the «sprays and cooling basin for cooling and condensing purposes, forming part of the power plant operation.

per minute. Assuming further that long-distance traffic will be handled in the range of wave lengths between 6,000 meters and 40,000 meters, a reasonable assumption on the basis of present-day practice—and also a conservative one—we shall have available a band of ether frequencies of from 50,000 to 7,500 cycles per second, or 42,500 cycles in all. According, we can ultimately transmit at least 42,500 words per minute via radio over long distances, or no less than 61,200,000 words per day. If we extend the range of available wave lengths for long-distance communication below 6,000 meters through the further reduction of atmospheric disturbances; if we eliminate one of the side bands resulting from transmission; and if we assume the possibility of using the same wave length for transmission at several points of the earth's surface with directional discrimination between several transmitters at the receiving station, the already enormous daily message-carrying capacity of the ether will be greatly increased. As a matter of comparison, we may state that the figure of 61,200,000 words per day is roughly 150 times the actual traffic sent across the Atlantic Ocean by cable and radio at the present time.

A number of perfectly reasonable requirements must be met by transmitting and receiving stations in order to realize the ultimate capacity mentioned above, according to Mr. Goldsmith. The transmitters must have strictly constant generator frequency consistent with their key signaling speed and the receivers must be highly selective for a correspondingly narrow range of frequencies and yet follow the signals accurately. Even today radio engineers are confident that these results will shortly be obtained by carefully chosen technical expedients.

The nature of world communication makes it international in character. Both wire lines and radio waves know nothing of national boundaries, a fact which is sometimes resented by the nations, particularly during hostilities. It is this essentially international character of long-distance communications, particularly of the unguided

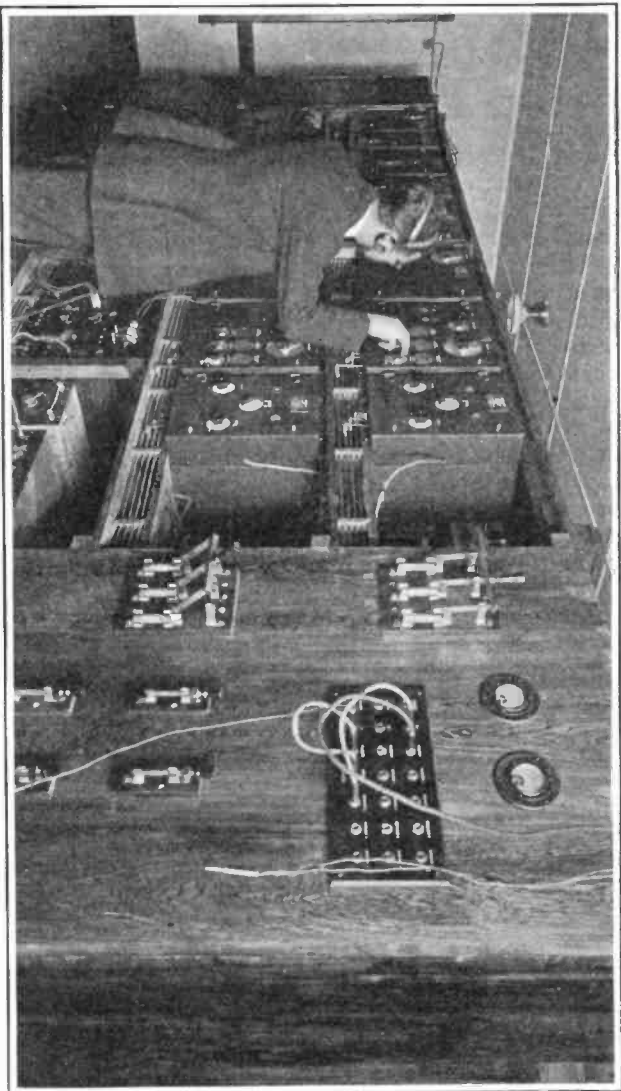

Adjusting the tuners of the receiving sets employed for the Radio Central wireless station. This receiving station is located at Riverhead, Long Island, twelve miles away from the transmitting station, and like the latter is connected by hand line to the operating headquarters or traffic office in New York City.

variety, which has led to the international regulation of radio communication. In 1912, the London Radio Convention was agreed to by most of the nations of the world and given force by corresponding national legislation in each case. These regulations of the London Convention were fairly general in character and covered the most essential points only. Thus there was left considerable and proper leeway for each nation to settle its own national problems in communication according to local needs and the nature of local institutions. It would seem that some such policy is wise, especially where important matters of truly international scope clearly require settlement in the interests of effective communication and to avoid inevitable disputes. Beyond this point which is defined without much difficulty by the experts in the art, regulation becomes burdensome and tends to retard the progress of the radio art and to discourage initiative.

For the rapid growth of world communication, as far as a radio is concerned the degree of regulation of the art by the various governments should be restricted to the enforcement of the international regulations together with such control of the nationality of the owners and personnel of the radio companies as may be deemed necessary for national security. The entire field of unguided communication, as Mr. Goldsmith calls radio, is so new and is developing so rapidly that great harm can be done by well-meaning but injudicious legislators and officials. Like all pioneer arts, its successful and speedy development depends on wide freedom of experiment by enterprising investigators and encouragement of effort on the part of wide-awake companies.

Chapter XI.

HOW TO CONSTRUCT SIMPLE RADIO RECEIVING SETS FOR RADIO-PHONE PROGRAMS

AND now for those who wish to construct their own simple receiving outfits, here is a chapter devoted to their particular interests.

First of all we shall describe an entire receiving station, including antenna as well as a crystal detector receiving set. This station will enable one to hear the messages sent from medium-power transmitting stations within an area about the size of a large city, and to hear high-power stations within 50 miles, provided the waves used by those stations have wave frequencies between 500 and 1500 kilocycles per second, which, translated into plain English, means wave lengths between 600 and 200 meters. Much greater distances are often covered, especially at night. If a person constructs the coil and other parts as indicated, the total cost of this set can be kept down to about \$6.00. If, however, a specially efficient outfit is desired, the cost may be about \$15.00.

THE ESSENTIAL PARTS OF RECEIVING STATION

The set about to be described has been designed by the Bureau of Standards at the request of the States Relations Service of the United States Department of Agriculture, for the use of boys and girls radio clubs.

There are five essential parts to this receiving station.

as well as any other receiving station, namely: the antenna, lightning switch, ground connections, receiving set proper, and telephone receivers. The received signals come into the receiving set through the antenna and ground connection. In the receiving set they are converted into an electric current which produces the sounds in the telephone receivers. The telephone receiver is either one or a pair of telephone receivers worn on the head of the listener. A number of telephones may be used with such a set, but a loud-speaking device, which does away with headphones, is not practical with a simple set of this kind.

The purpose of the lightning switch is to protect the receiving set from damage by lightning. It is used to connect the antenna directly to ground when the receiving station is not being used. When the antenna and the connection to the ground are properly made and the lightning switch is closed, an antenna acts as a lightning rod and is a protection rather than a source of danger to the building.

The principal part of the station is the receiving set proper. In the set described in the following paragraphs it is subdivided into two parts, the tuner and the detector, and in more complicated sets still other elements are added.

THE ANTENNA, LIGHTNING SWITCH AND GROUND CONNECTIONS

The antenna is simply a wire suspended between two elevated points. Wherever there are two buildings, or a house and a tree, or two trees with one of them very close to the house, it relieves one of the need of erecting one or both antenna supports. The antenna should not be less than 30 feet above the ground and its length should be about 75 feet. (See Fig. 1.) While this figure indicates a horizontal antenna, it is not important that it be strictly horizontal: It is in fact desirable to have the far end as high as possible. The "lead-in" wire or drop-wire from the antenna itself should run as directly as possible to the lightning switch. If the position of the adjoining buildings or trees is such that the distance between them is

greater than about 85 feet, the antenna can still be held to a 75 foot distance between the insulators by increasing the length of the piece of rope (D) to which the far end of the antenna is attached. The rope (H) tying the antenna insulator to the house should not be lengthened to overcome this difficulty, because by so doing the antenna "lead-in" or drop wire (J) would be lengthened.

Details of Parts—The parts will be mentioned here by reference to the letters appearing in Figures 1 and 2.

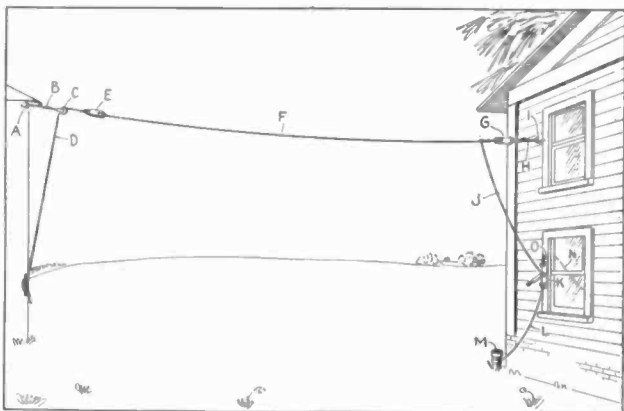

Fig. 1.—Construction of antenna for reception purposes. A—screw eye; B—rope; C—pulley; D—rope; E—insulator; F—antenna; G—insulator; H—rope; I—screw eye; J—lead-in wire; K—lightning switch; L—ground wire; M—ground pipe; N—lead to receiving set; O—insulating tube.

A and I are screw eyes sufficiently strong to anchor the antenna at the ends.

B and H are pieces of rope $\frac{3}{8}$ or $\frac{1}{2}$ inch in diameter, just long enough to allow the antenna to swing clear of the two supports.

D is a piece of $\frac{3}{8}$ or $\frac{1}{2}$ inch rope sufficiently long to make the distance between E and G about 75 feet.

C is a single block pulley which may be used if readily available.

E and G are two insulators which may be constructed of any dry hardwood of sufficient strength to withstand the strain of the antenna; blocks about $1\frac{1}{2} \times 2 \times 10$ inches will serve. The holes should be drilled as shown in Fig. 1 sufficiently far from the ends to give proper strength. If wood is used the insulators should be boiled in paraffin for about one hour. If porcelain wiring cleats are available they may be substituted instead of the wood insulators. If any unglazed porcelain is used as insulators, it should be boiled in paraffin the same as the wood. Regular antenna insulators are advertised on the market, but the two improvised types just mentioned will be satisfactory for an amateur receiving antenna.

F is the antenna about 75 feet between the insulators E and G. The wire may be No. 14 or 16 copper wire either bare or insulated. The end of the antenna farthest from the receiving set may be secured to the insulator (E) by any satisfactory method, being careful not to kink the wire. Draw the other end of the antenna wire through the other insulator (G) to a point where the two insulators are separated by about 75 feet, twist the insulator (G) so as to form an anchor as shown in Fig. 1. The remainder of the antenna wire (J) which now constitutes the "lead-in" or drop-wire should be just long enough to reach the lightning switch.

K is the lightning switch. For the purpose of a small antenna this switch may be the ordinary porcelain base, 30 ampere, single-pole double-throw battery switch. These switches as ordinarily available have a porcelain base about 1 by 4 inches. The "lead-in" wire (J) is attached to this switch at the middle point. The switch blade should always be thrown to the lower clip when the receiving set is not actually being used and to the upper clip when it is desired to receive signals.

L is the ground wire for the lightning switch; it may be a piece of the same size wire as used in the antenna, of sufficient length to reach from the lower clip of the lightning switch (K) to the clamp on the ground rod (M).

M is a piece of iron pipe or rod driven 3 to 6 feet into

the ground, preferably where the ground is moist, and extending a sufficient distance above the ground in order that the ground clamp may be fastened to it. Scrape the rust or paint from the pipe before driving in the ground.

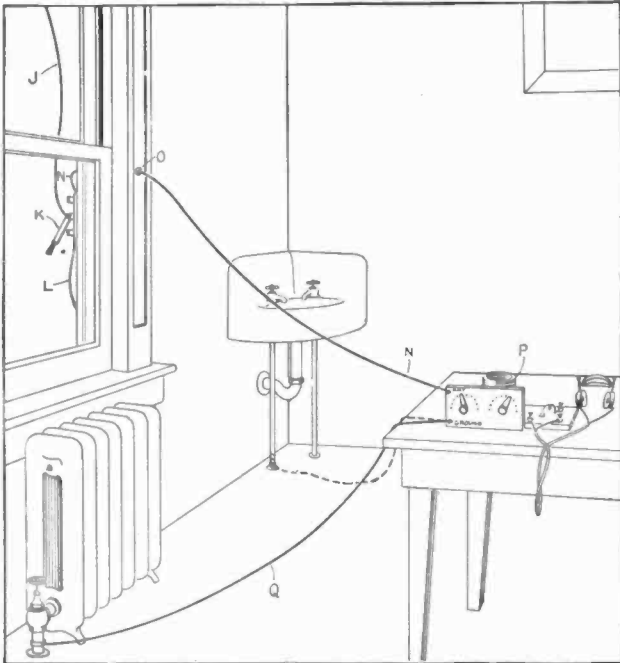

Fig. 2.—Arrangement of receiving instrument and connections with antenna and ground. J—lead-in wire; K—lightning switch; L—ground wire; N—lead to receiving set; O—insulating tube; P—receiving set; Q—ground for receiving set.

N is a wire leading from the upper clip of the lightning switch through the porcelain tube (O) to the receiving set binding post marked "antenna."

O is a porcelain tube of sufficient length to reach through the window casing or wall. This tube should be mounted in the casing or wall so that it slopes down

toward the outside of the building. This is done to keep the rain from following the tube through the wall to the interior.

Fig. 2 shows the radio receiving set installed in some part of the house.

P is the receiving set which is described in detail below.

N is the wire leading from the "antenna" binding post of the receiving set through the porcelain tube to the upper clip of the lightning switch. This wire, as well as the wire shown by Q, should be insulated and preferably flexible. A piece of ordinary lamp cord might be unbraided and serve for these two leads.

Q is a piece of flexible wire leading from the receiving set binding post marked "ground" to a water pipe, heating system or some other metallic conductor to ground, except M, Fig. 1. If there are no water pipes nor radiators in the room in which the receiving set is located, the wire should be run out of doors and connected to a special "ground" below the window, which shall not be the same as the "ground" for the lightning switch. It is essential that for the best operation of the receiving set this "ground" be of the very best type. If the soil near the house is dry it is necessary to drive one or more pipes or rods sufficiently deep to encounter moist earth and connect the ground wire to the pipes or rods. This distance will ordinarily not exceed 6 feet. Where clay soil is encountered this distance may be reduced to 3 feet, while in sandy soil it may be increased to 10 feet. If some other metallic conductor, such as the casing of a drilled well, is not far away from the window, it will be a satisfactory "ground."

TUNER, DETECTOR AND TELEPHONE

At least the telephone will have to be purchased. The tuner and certain accessories can be made at home.

Tuner (R, Fig. 3)—This is a piece of cardboard or other non-metallic tubing with turns of copper wire wound around it. The cardboard tubing may be an oatmeal box. Its construction is described in detail below.

Crystal Detector (S, Fig. 3)—The construction of a crystal detector may be of very simple design and quite satisfactory. The crystal, as it is ordinarily purchased, may be unmounted or mounted in a little block of metal. For mechanical reasons the mounted type may be more satisfactory, but that is of no great consequence. It is very important, however, that a very good tested crystal be used. It is probable also that a galena crystal will be more satisfactory to the beginner.

The crystal detector may be made up of a tested crystal, three wood screws, short pieces of copper wire, a nail, set screw type of binding post, and a wood knob or cork. The tested crystal is held in position on the wood base by three brass wood-screws as shown at I Fig. 3. A bare copper wire may be wrapped tightly around the three brass screws for contact. The assembling of the rest of the crystal detector is quite clearly shown in Fig. 3.

Phone (T, Fig. 3)—It is desirable to use a pair of telephone receivers connected by a head band, usually called a double telephone headset. The telephone receivers may be any of the standard commercial makes having a resistance of between 2000 and 3000 ohms. The double telephone receivers will cost more than all the other parts of the station combined but it is desirable to get them, especially if one plans to improve his receiving set later. If one does not care to invest in a set of double telephone receivers a single telephone receiver with a head band may be used; it gives results somewhat less satisfactory.

Accessories—Under the heading of accessory equipment may be listed binding posts, switch arms, switch contacts, test-buzzer, dry battery and boards on which to mount the complete apparatus. The binding posts, switch arms and switch contacts may all be purchased from dealers who handle such goods or they may be quite readily improvised at home. There is nothing peculiar about the pieces of wood on which the equipment is mounted. They may be obtained from a dry packing-box and covered with paraffin to keep out moisture.

DETAILS OF CONSTRUCTION

The following is a detailed description of the method of winding the coil, construction of the wood panels, and mounting and wiring the apparatus.

Tuner—See R. Fig. 3. Having supplied one's self with a piece of cardboard tubing 4 inches in diameter and about $\frac{1}{2}$ pound of No. 24 (or No. 26) double cotton covered copper wire, one is ready to start the winding of the tuner. Punch two holes in the tube about $\frac{1}{2}$ inch from one end as shown at 2 on Fig. 3. Weave the wire through these holes in such a way that the end of the wire will be quite firmly anchored, leaving about 12 inches of the wire free for connections. Start with the remainder of the wire to wrap the several turns in a single layer about the tube, tightly and closely together. After ten complete turns have been wound on the tube hold those turns snugly while a tap is being taken off. This tap is made by making a 6 inch loop of the wire and twisting it together at such a place that it will be slightly staggered from the first tap. This method of taking off taps is shown quite clearly at U, Fig. 3. Proceed in this manner until six twisted taps have been taken off at every ten turns. After these first seventy turns have been wound on the tube then take off a 6 inch twisted tap for every succeeding single turn until ten additional turns have been wound on the tube. After winding the last turn of wire anchor the end by weaving it through two holes punched in the tube much as was done at the start, leaving about 12 inches of wire free for connecting. It is to be understood that each of the eighteen taps is slightly staggered from the one just above, so that the several taps will not be bunched along one line on the cardboard tube. See Fig. 3. It would be advisable, after winding the tuner as just described, to dip the tuner in hot paraffin. This will help to exclude moisture.

Upright Panel and Base—Having completed the tuner to this point, set it aside and construct the upright panel shown in Fig. 4. This panel may be a piece of wood approximately $\frac{1}{2}$ inch thick. The position of the several

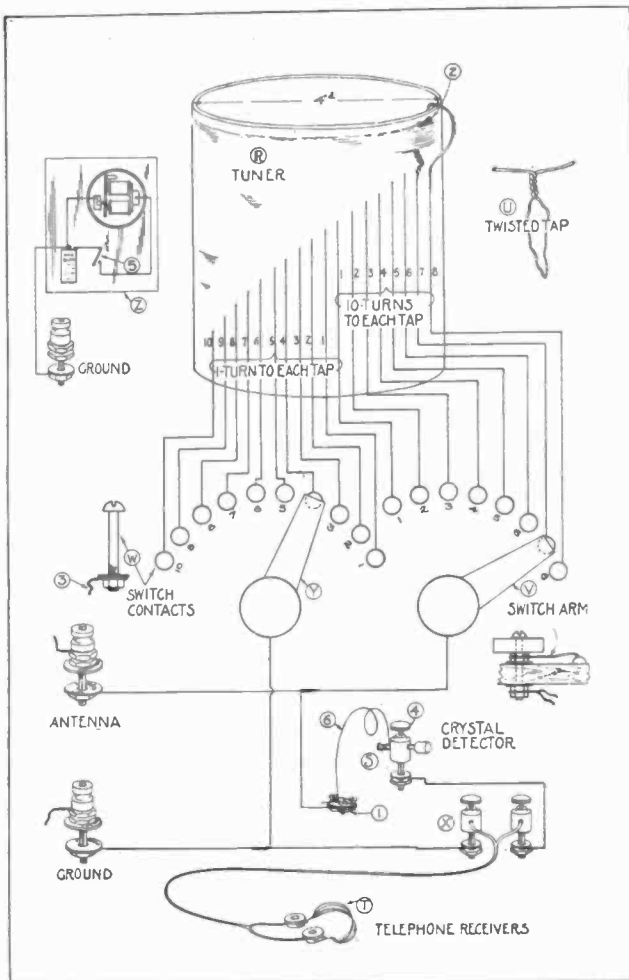

Fig. 3.—Constructional details of the simple radio receiving set designed by the U. S. Bureau of Standards for the use of hymen.

holes for the binding posts, switch arms and switch contacts may first be laid out and drilled. The "antenna" and "ground" binding posts may be ordinary $\frac{1}{8}$ inch brass bolts of sufficient length and supplied with three nuts and two washers. The first nut binds the bolt to the panel, the second nut holds one of the short pieces of stiff wire, while the third nut holds the antenna or ground wire as the case may be. The switch arm with knob shown at V, Fig. 3, may be purchased in the assembled form or it may be constructed from a thin slice cut from a broom handle and a bolt of sufficient length equipped with four nuts and two washers together with a narrow strip of thin brass somewhat as shown. The switch contacts (W, Fig. 3) may be of the regular type furnished for this purpose or they may be brass bolts equipped with one nut and one washer each or they may even be nails driven through the panel with an individual tap fastened under the head or soldered to the projection of the nail through the panel. The switch contacts should be just close enough that the switch arm will not drop between the contacts but also far enough apart that the switch arm can be set so as to touch only one contact at a time.

The telephone binding post should preferably be of the set screw type as shown as X, Fig. 3.

INSTRUCTIONS FOR WIRING

Having constructed the several parts just mentioned and mounted them on the wood base, one is ready to connect the several taps to the switch contacts and attach the other necessary wires. Scrape the cotton insulation from the loop ends of the sixteen twisted taps as well as from the ends of the two single wire taps coming from the first and last turns. Fasten the bare ends of these wires to the proper switch contacts as shown by the corresponding numbers in Fig. 3. One should be careful not to cut or break any of the looped taps. It would be preferable to fasten the connecting wires to the switch contacts by binding them between the washer and the nut as shown at 3, Fig. 3. A wire is run from the back of the binding

post marked "ground" (Fig. 3) to the back of the left-hand switch-arm bolt (Y), thence to underneath the left-hand binding post marked "phones." A wire is then run from underneath the right-hand binding post marked "phones" to underneath the binding post (4, Fig. 3), which forms a part of the crystal detector. A piece of No. 24 bare copper wire about $2\frac{1}{2}$ inches long, one end of which is twisted tightly around the nail (the nail passing through

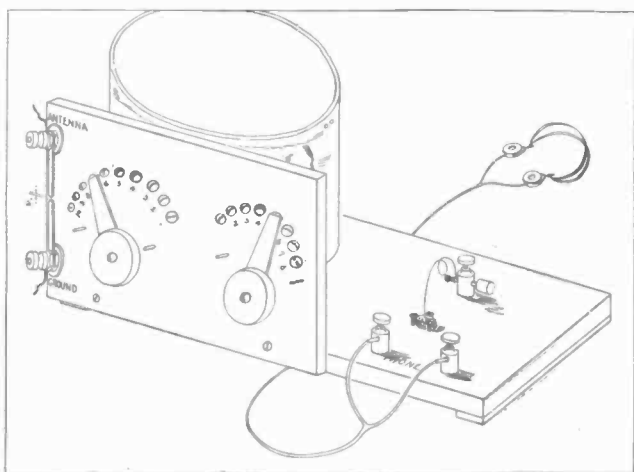

**Assembled receiving set, ready for use. This little set will receive over distances of 25 to possibly 35 miles from radio-
phone broadcasting stations.**

binding post 4) the other end of which rests gently by its own weight on the crystal (1). The bare copper wire which was wrapped tightly around the three brass wood-screws holding the crystal in place is led to and fastened at the rear of the right-hand switch-arm bolt (V), thence to the upper left-hand binding post marked "antenna." As much as possible of this wiring is shown in Fig. 3.

DIRECTIONS FOR OPERATING

After all the parts of this crystal-detector radio receiving set have been constructed and assembled the first essential operation is to adjust the little piece of wire, which rests lightly on the crystal, to a sensitive point. This may be accomplished in several different ways; the use of a miniature buzzer transmitter is very satisfactory. Assuming that the most sensitive point on the crystal has been found by method described in paragraph below, "The Test Buzzer," the rest of the operation is to get the radio receiving set in resonance or in tune with the station from which one wishes to hear messages. The tuning of the receiving set is attained by adjusting the inductance of the tuner. That is, one or both of the switch arms are rotated until the proper number of turns of wire of the tuner are made a part of the metallic circuit between the antenna and ground, so that together with the capacity of the antenna the receiving circuit is in resonance with the particular transmitting station. It will be remembered that there are ten turns of wire between each of the first eight switch contacts and only one turn of wire between each two of the other contacts. The tuning of the receiving set is best accomplished by setting the right-hand switch arm on contact (1) and rotating the left-hand switch arm over all its contacts. If the desired signals are not heard, move the right-hand switch arm to contact (2) and again rotate the left-hand switch arm throughout its range. Proceed in this manner until the desired signals are heard.

It will be advantageous for the one using this radio receiving equipment to find out the wave frequencies (wave length) used by the several radio transmitting stations in his immediate vicinity.

The Test Buzzer—(Z, Fig. 3)—As mentioned previously, it is easy to find the more sensitive spots on the crystal by using a test buzzer. The test buzzer is used as a miniature local transmitting set. When connected to the receiving set as shown at Z, Fig. 3, the current produced by the buzzer will be converted into sound by the

telephone receivers and the crystal, the loudness of the sound depending on what part of the crystal is in contact with the fine wire. To find the most sensitive spot connect the test buzzer to the receiving set as directed, close the switch (5, Fig. 3) (and if necessary adjust the buzzer armature so that a clear note is emitted by the buzzer), set the right-hand switch arm on contact point No. 8, fasten the telephone receivers to the binding posts marked "phones." loose the set screw of the binding post slightly and change the position of the fine wire (6, Fig. 3) to several positions of contact with the crystal until the loudest sound is heard in the phones, then tighten the binding post set screw (4) slightly.

APPROXIMATE COST OF PARTS

The following list shows the approximate cost of the parts used in the construction of this radio receiving station. The total cost will depend largely on the kind of apparatus purchased and on the number of parts constructed at home.

Antenna—

Wire—Copper, bare or insulated, No. 14, 100 to 150 feet, about	0.75
Rope— $\frac{3}{8}$ or $\frac{1}{2}$ inch	2 cents per foot
2 insulators, porcelain	0.20
1 pulley	0.15
Lightning switch—30 ampere battery switch.	0.30
1 porcelain tube	0.10

Ground Connections—

Wire (same kind as antenna wire).	
1 clamp	0.15
1 iron pipe or rod	0.25

Receiving Set—

$\frac{1}{2}$ pound No. 24 copper wire double cot- ton covered	0.75
1 cardboard box.	
2 switch knobs and blades complete	1.00
18 switch contacts and nuts	0.75
3 bindings posts—set screw type	0.45

2 binding posts—any type.....	0.30
1 crystal—tested	0.25
3 wood screws, brass, $\frac{3}{4}$ inch long.....	0.03
Wood for panels (from packing box).	
2 pounds paraffin	0.30
Lamp cord.....	2 to 3 cents per foot
Test buzzer	0.50
Dry battery	0.30
Telephone receivers	4.00 to 8.00*
Total	11.00 15.00

*Still more efficient and expensive telephone receivers are available at prices ranging to about \$20.00.

If nothing but the antenna wire, lightning switch, porcelain tube, crystal, telephone receiver, bolts and buzzer are purchased this total can be reduced to about \$6.00.

A SIMPLE VACUUM RECEIVING SET

Using the same antenna, ground connection and lightning switch as already described, the more ambitious radio enthusiast may readily construct a simple vacuum tube receiving set which will give better results than the crystal detector set although it is considerably more complicated.

This set, which is shown completely assembled in the accompanying drawing, comprises a loose-coupler tuner, provided with primary and secondary switches, primary and secondary variable condenser, grid leak, vacuum tube, vacuum tube socket, filament rheostat, filament battery and high voltage or plate battery. If necessary, most of the material may be home made, with the exception of the vacuum tube, grid leak, vacuum tube socket, batteries, filament rheostat and telephone receivers.

The first step is to construct the loose-coupler tuner. This consists of a primary and a secondary winding, each one being tapped off at every ten turns and the taps being brought to the switch points of the primary and secondary switches. The primary is a mailing tube measuring five or six inches in diameter, on which is wound 100 turns of No. 20, 22 or 24 B. & S. gauge double cotton or double

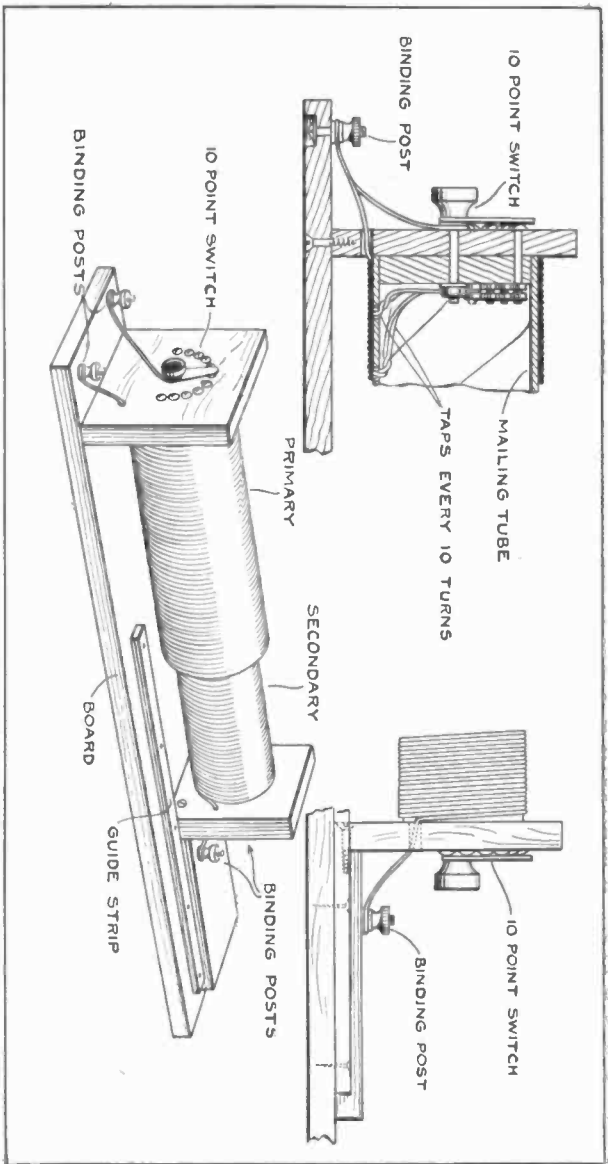

Construction details of the loose-coupler tuner employed for the simple vacuum tube receiving set. This instrument may be made by anyone possessing ordinary household tools.

silk covered wire, with the adjacent turns side by side. At every ten turns the wire is looped and twisted together so as to form a tap, the loop being passed through a hole in the mailing tube and the tap brought over to its respective switch point, to which it is connected after the primary is ready for assembling. The final turn of the primary is passed through two holes close together so as to hold the winding firmly in place, and the end brought to the last switch point. When the primary is completely wound, it is mounted on a block of wood which acts as the support. It is left largely to the builder as to how the primary is mounted. One method is to use a round piece of wood of about the same diameter as the inside measurement of the mailing tube. This block is nailed on the end piece and the mailing tube is slipped over the block to which it can be firmly glued or tacked. The taps have, of course, been scraped and connected with their respective switch points.

Now for the secondary. This is constructed in virtually the same manner, using a smaller mailing tube which fits inside the primary tube. The winding is of the same sized wire for the sake of simplicity, and taps are taken at every ten points and brought to their respective points of a ten-point switch. The mounting of the secondary must be carried out in the same manner as the primary, except that the latter has a stationary support, nailed firmly on the base board of the loose-coupler, while the former has a movable support. The movable support is made up in the manner indicated in our drawing, so that the secondary can be moved in and out of the primary, between guides.

This completes the loose-coupler. The next step is to construct variable condensers, which are necessary for fine tuning. Inasmuch as the loose-coupler tunes only in big steps of ten turns at a time, it is necessary to employ variable condensers in order to effect sharp tuning so essential in the satisfactory reception of radio-phone service.

The simplest variable condenser to construct is probably the so-called book type, which is illustrated in our drawing.

This consists of two pieces of wood, which are fastened together by means of an ordinary hinge, so that they may be moved toward each other or drawn apart, as the case may be. A small wooden strip or even a nail prevents the two pieces from coming into actual contact. On each strip of wood is mounted a piece of sheet aluminum or copper, which acts as one of the condenser plates. Binding posts are used in the manner indicated to make proper

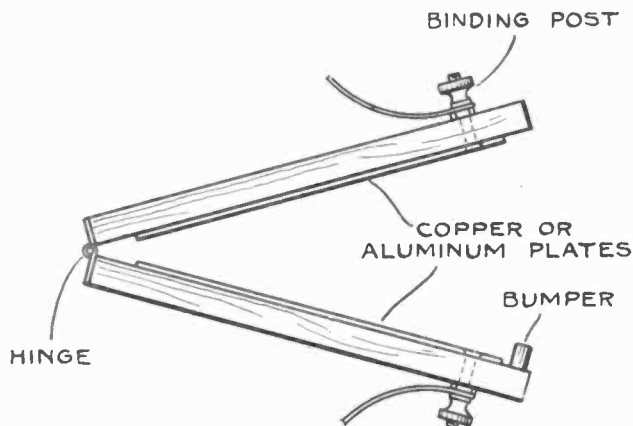

Top view of book type of variable condenser, consisting of two boards hinged together, two pieces of copper or aluminum sheeting, arranged as shown.

connections. The capacity of such a condenser is increased by moving the plates close together and lessened by moving them farther apart.

ITEMS THAT MUST BE BOUGHT

The grid leak consists of a very high resistance unit. This is obtained by drawing a pencil line on a sheet of paper, and clamping this pencil line between two heavy copper washers so that the grid current for the vacuum tube must flow through this exceedingly high resistance. However, the grid leak has to be constructed with con-

siderable accuracy, so that it may be the part of better judgment to purchase a grid leak at any radio supply store. It is a matter of 50 or 75 cents, and it is certain to be correctly designed and constructed.

The vacuum tube must be purchased, of course, and aside from the telephone receivers and batteries, it represents the most expensive single item for such a set. The tube must be a detector tube, also known as a gassy tube, and costs either \$4.00 or \$5.00, depending on the type employed. A vacuum tube socket must also be purchased, at a cost of anywhere from 50 cents to \$1.50, depending on the type selected.

A vacuum tube requires two batteries, namely, the filament battery of six volts and the B or plate battery of $22\frac{1}{2}$ volts. A 6-volt storage battery gives the best service for filament current, because the heavy drain of the vacuum tube filament soon wears out any dry battery. Still, if the reader is going to construct his own set it is almost certain that he will not want to go to the expense of purchasing a storage battery, hence dry batteries must be used. Four or five cells of dry battery may be used, although it will increase the life of the dry cells a great deal if two sets are employed, connected in what is known as series-parallel. That is to say, four or five cells are connected in series, with the carbon of one coil going to the zinc of the next cell. Then, the zinc of one battery is connected with the zinc of the other battery, and the carbon of one battery with the carbon of the other battery. This arrangement gives a battery of twice the amperage or current, and the drain caused by the tube is not so serious.

The filament rheostat may be made, although it will hardly pay when simple rheostats can be purchased for one dollar or less. The rheostat serves to control the filament current, which must be accurately regulated for satisfactory results, since the vacuum tube is a delicate piece of mechanism.

The B or plate battery must be purchased. This battery

comes in a compact block, either in the large or the small size. There are two types of B battery, namely, the fixed voltage and the variable voltage types. The latter is recommended, since it permits of regulating the plate voltage applied to the vacuum tube, and this is a most important consideration with many vacuum tubes.

The telephone receivers must be bought, and it is well to invest in good receivers. If there is anything that tends to make or undo a radio receiving set it is the telephone receivers. Inexpensive receivers are certain to prove the most expensive in the long run, because the

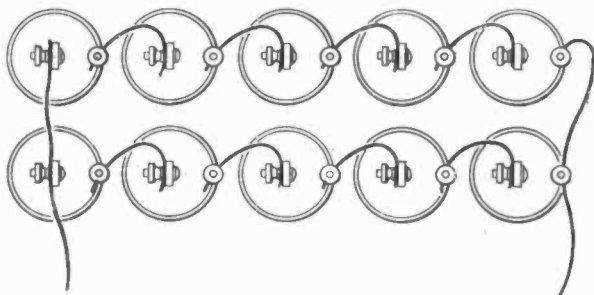

Arrangement of dry cells in series-parallel, in order to obtain a steadier voltage and a longer life from the dry battery used with vacuum tubes.

owner of such receivers may soon tire of them and ask for something better, only to find that his inexpensive receivers have no market value and must therefore be junked.

With all the various components constructed and purchased, ready for use, they are assembled as shown in our assembly drawing. To operate the set, the primary switch is placed on the middle switch point and the variable condenser in the aerial-ground or primary circuit is varied slowly. Meanwhile, the secondary switch is also placed on the middle switch point, and the secondary condenser is also varied. When the desired signal or radio-*phone*

service is intercepted, the switches and variable condensers are rapidly adjusted until the best results are obtained. All the while, of course, the vacuum tube is lighted and the filament rheostat is carefully adjusted for the loudest yet clearest sounds.

Such a set will work satisfactorily over a range of 50 miles, although it is not as satisfactory as one using the Armstrong regenerative or feed-back circuit, which is somewhat more involved and is described further on in simple form for home construction purposes. However, the various radio supply houses are now offering the various components for regenerative receiving sets, as well as amplifier units. An excellent receiving set may be constructed by purchasing a vario-coupler, two vario-meters, grid leak and grid condenser, and the various other accessories such as the rheostat, vacuum tube and socket, binding posts, and so on, connected as shown in our chapter on receiving sets.

For really good results, as far as a home-made set is concerned, it is necessary to employ the regenerative arrangement. This arrangement, as has already been described elsewhere in this work, is virtually a self-amplifier, and adds a great deal to the efficiency of the receiving set.

One of the very best yet simple receiving arrangements which has come to the attention of the author and which he has constructed for his own experimental use, is shown in the accompanying drawings. It is a very simple form of two-circuit receiving set, using a plate variometer for the feed-back or regenerative agent.

First of all, it is necessary to construct the main tuning member, which is simply a mailing tube measuring $3\frac{1}{2}$ inches in diameter by 4 inches long, on which two windings are carefully wound. The first winding consists of twenty turns of No. 20 B. & S. gauge double cotton covered wire, wound close together, of course, while the second winding, starting one-eighth away from the end of the first winding, consists of 40 turns of same sized wire, also wound close together. The windings should be held

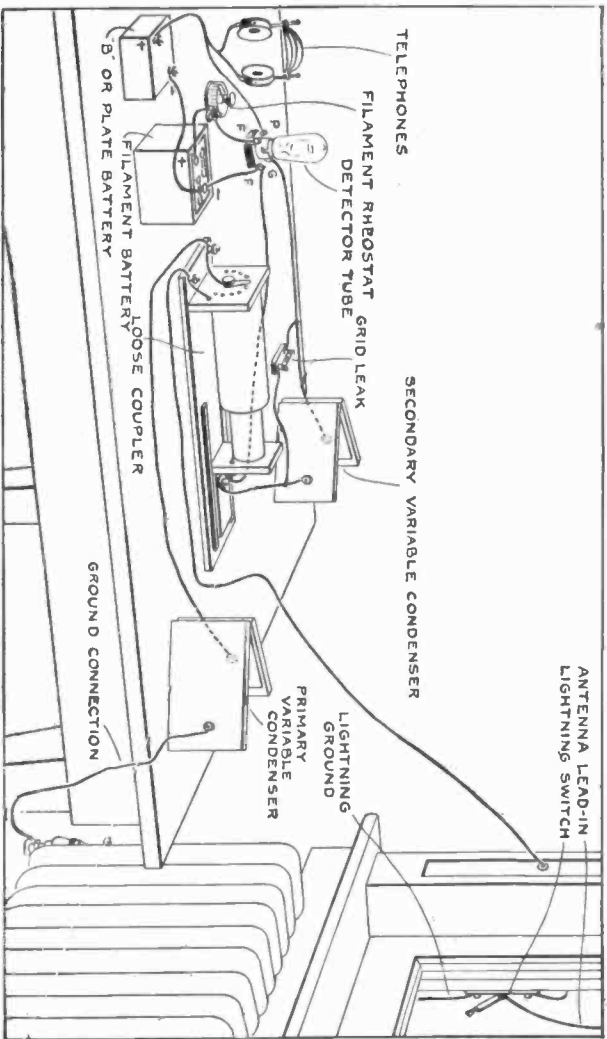

Assembly of vacuum tube receiving set and how it is connected with the ground and antenna. The location and connections for the lightning switch and lead-in insulator are also shown.

in place simply by making holes in the cardboard tube and passing the ends of the windings through these holes. Under no circumstances should the windings be varnished

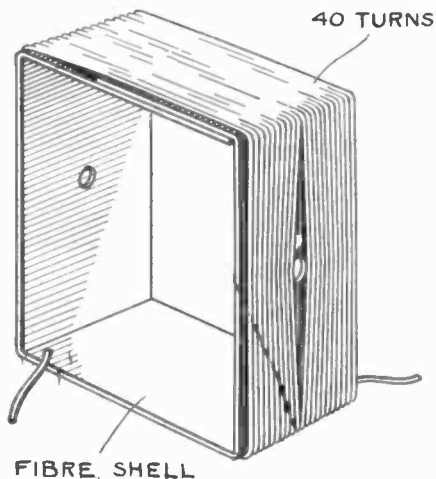

How the fixed winding of the variometer is made. A frame work is built up with sheet fiber on a square form, and held together with shellac or glue. The winding is placed on this form, as shown.

or shellacked, as this introduces certain undesirable characteristics. Both windings are fixed, their wave length values being altered by variable condensers as shown in the accompanying wiring diagram.

The variable condensers may be of the home-made variety, using the book type already referred to in the previous set. Two such condensers will be necessary, and it is well to make them of good size so that they will have ample capacity. One condenser is placed across the primary winding—or in series with it if the wave length of the antenna-ground circuit is to be reduced—while the other is placed across the secondary winding.

A fixed condenser must be constructed. This consists of nothing more formidable than a number of sheets of tin foil separated by pieces of paraffined paper. A good condenser may be made by cutting ten pieces of tin foil so that they will measure one inch wide by three inches long and cutting eleven pieces of paraffined paper so that they measure one and one-quarter inches wide by two and one-half inches long. The paraffined paper and the tin foil sheets are assembled in staggered order as shown in the accompanying sketch. The pile of tin-foil and paraffined paper can be placed between two pieces of cardboard and held together by means of a rubber band or piece of thread wrapped around the cardboard end pieces.

The grid leak had best be purchased, for it is a rather

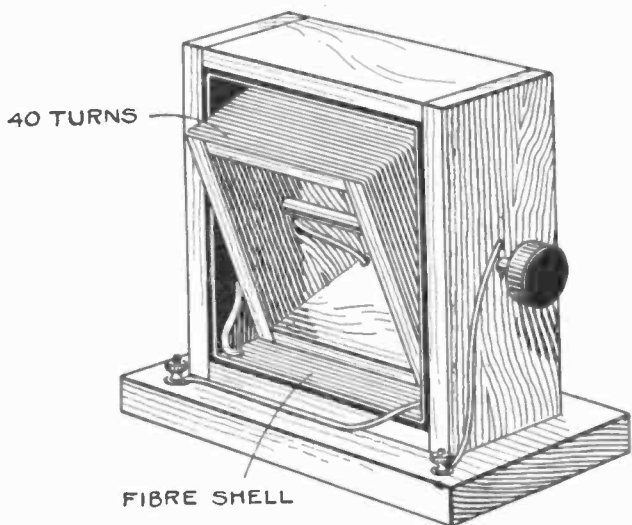

Completed variometer, showing the movable coil partly turned. The fixed and the movable windings are connected in series, so that the current must pass through both of them, one after the other.

difficult thing to make even though it does not consist of more than a pencil line drawn on a piece of good paper and clamped between two copper washers. If the constructor wishes to build the grid leak as well as other parts of the set, he is welcomed to try it, although it would seem that since this item costs but 50 cents to buy it ready made—and properly made—it is best not to waste time and effort in trying to construct a grid leak.

Then we come to the filament rheostat. Here again, it is best to purchase a manufactured filament rheostat, which may run all the way from 75 cents to \$2.00, depending on how well it is made. The tube socket must also be purchased, representing an outlay of from 75 cents to \$2.00, depending on the type selected.

The "A" battery is the filament battery, and consists of either a dry battery, preferably composed of ten dry cells arranged in series multiple as depicted on page 297, or a 6-volt 20-ampere-hour storage battery. The "B" battery is the high-voltage battery for the plate circuit. It consists of a single block of battery supplying $22\frac{1}{2}$ -volt current. The telephone receivers may be a single receiver or a regular head-set, according to taste—and pocketbook. Finally, there is the variometer used as the feed-back device.

The variometer had best be purchased, for it is a difficult instrument for the home constructor to tackle. Of course, a variometer may be constructed, because it consists simply of a fixed winding and a corresponding turnable winding. But the point in the case is to make a variometer that will work properly, and that requires a little experience and skill.

However, if the builder insists on constructing the variometer, he may do so. A simple design is shown in the accompanying sketch. It consists of a stationary wooden frame, built up in the manner indicated, and a movable frame. Now the stationary winding is placed on a form made of fiber strip, shellacked together to make it strong. This frame, with its winding, is placed inside the stationary frame. The movable winding, on the other

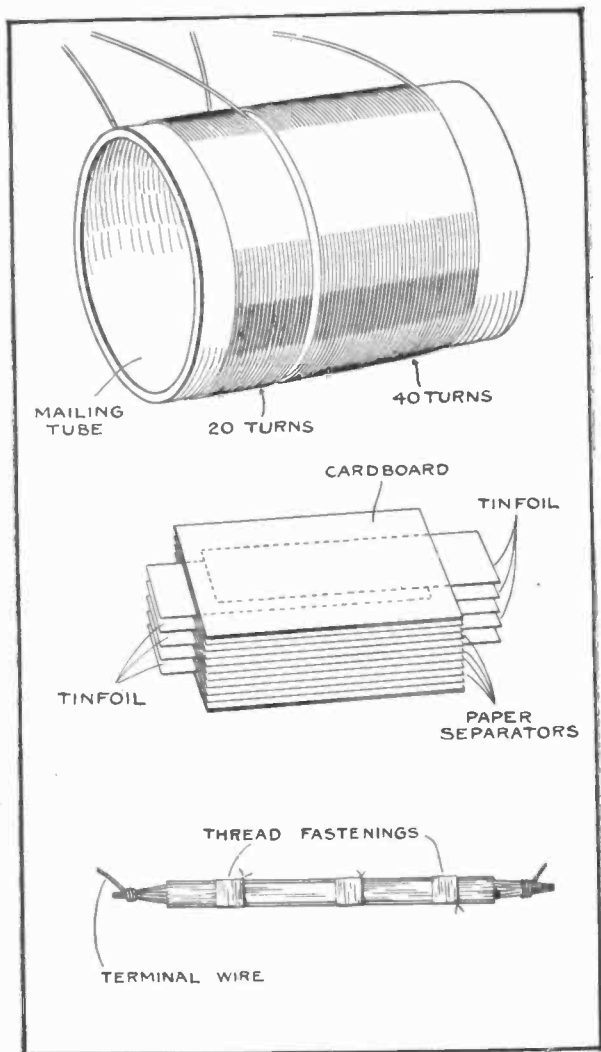

How the fixed coupler is made, and the construction of the small fixed condenser. The first drawing shows the mailing tube with twenty turns and forty turns for the primary and secondary windings. The second drawing shows the assembly of the fixed condenser. The third shows a side view of the assembled condenser.

hand, is wound on the movable form, as indicated. Each winding should consist of 60 turns of No. 20 double cotton covered wire. No nails should be used in making this instrument, glue or wooden pegs being used throughout. A suitable shaft should be provided, so that the movable coil can be turned by means of a handle. A dial can be drawn, with graduations from 1 to 100, or a dial

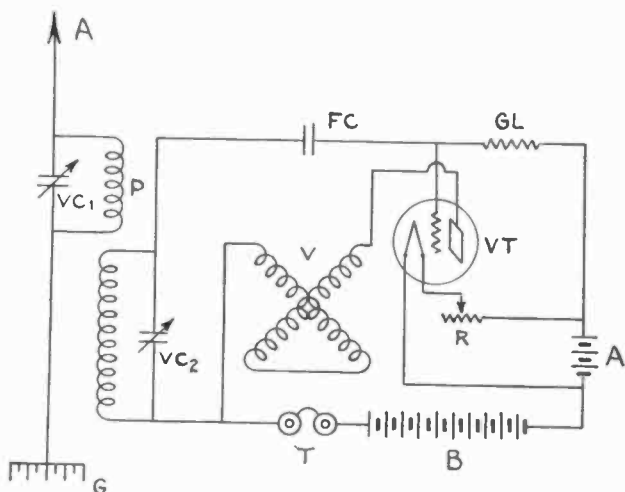

How the various components of the simple regenerative set are connected together. A—antenna; G—ground; P—primary; S—secondary; VC1—primary condenser; VC2—secondary condenser; FC—fixed condenser; GL—grid leak; VT—detector tube; A—filament battery; B—"B" or plate battery; R—rheostat; T—telephone receivers; V—variometer for feed-back.

and handle can be purchased from any radio supply house. However, after all is said and done, the best results will be obtained by purchasing a variometer, since this is a rather difficult instrument to construct—and construct right.

The set is arranged as shown in our assembly drawing. It is a simple set to operate and permits of extremely sharp tuning. The regenerative arrangement makes for

excellent results, so that this set will receive from radio-phone broadcasting stations over 100 miles away under favorable circumstances, without an amplifier. With an amplifier, which may be readily constructed by purchasing the necessary components and assembling them in the manner indicated by the wiring diagrams in the chapter dealing with amplifiers, the range may be materially increased.

Some companies are now offering complete receiving sets in knockdown form, so that the purchaser can wind the coils and assemble the components himself, thus saving considerable money and gaining practical knowledge in radio construction. These sets are highly recommended to those who desire to build their own apparatus yet wish the best type equipment now available.

Chapter XII.

THE RADIO TELEPHONE OF TODAY AND TOMORROW

ASIDE from the broadcasting of interesting programs, the radio telephone has other and very important uses. It must become a part of the regular wire telephone system; indeed, it already forms part of our telephone system, although only in an experimental way.

THE RADIO LINK

There is genuine romance in the story of the radio telephone. A dozen years ago it was a crude laboratory toy, with little prospect of ever becoming a practical, workaday thing. It was handicapped with a most unsavory reputation, because it had been made the catspaw of fraudulent stock-selling enterprises. The very publicity which had been accorded in unstinted measure had done untold harm, for the general public had come to expect too much of this young and quite unwieldy means of communication.

The radio telephone started out as a competitor of the wire telephone, although in truth it could never hope to rival the more conventional system. Yet the radio telephone only started on its practical career when the telephone engineers—the very men against whom this newer form of communication was to compete—took an interest in certain radio equipment, particularly vacuum tubes, and

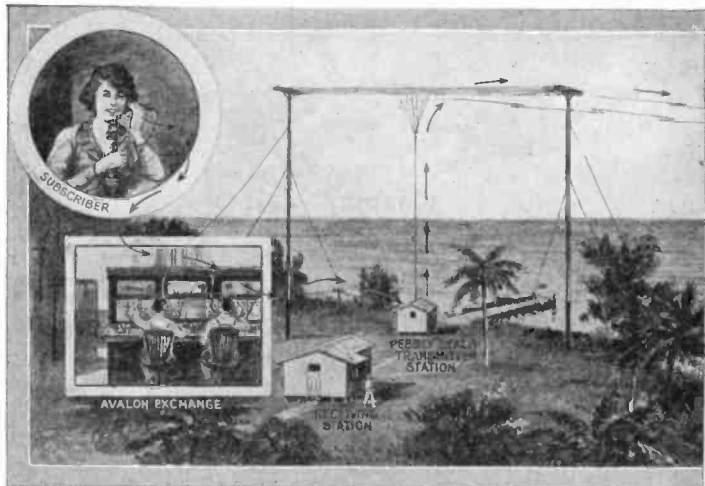

General scheme of the radio link as used between the California main phone system with that of the Santa Catalina Island and making arrangement, so that two messages can be

developed them to a practical point. Today, the radio telephone is not a competitor of the wire telephone: it is an accessory. It became practical through the efforts of the telephone engineers, but in turn it has made wire telephony possible over longer distances and with greater clearness than could ever have been possible with the former equipment.

The radio telephone today is part and parcel of our wire telephone system, and it is fast becoming as practical as the latter. Indeed, were it not for the high cost of this form of communication, it would be quite within present accomplishments for any telephone subscriber to call up a relative or friend on an ocean liner several hundred miles off shore, the voice being carried over the usual telephone line to the central office, through trunk lines to the distant radio transmitter, and thence transmitted through the air to the steamer. The radio link, as the radio telephone

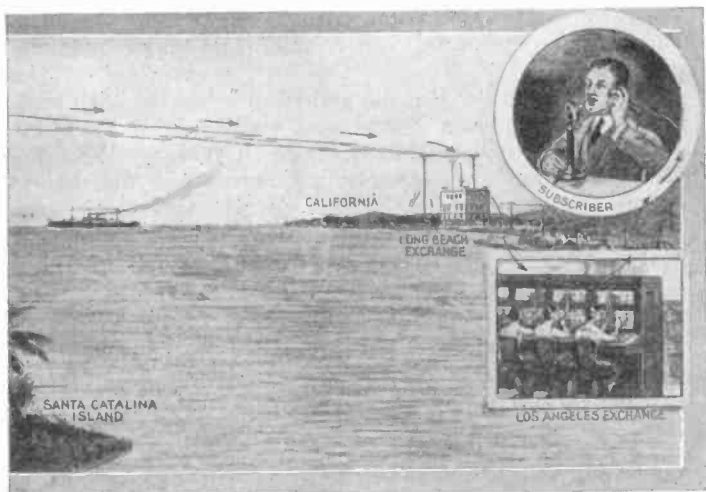

land and the Island of Santa Catalina, connecting the mainland tele-
them a single system. The radio link in this installation is a duplex
handled at one time, or one in each direction.

service is called when made a part of the usual wire tele-
phone system, is destined to become commonplace within
the next few years.

Now the foregoing is not a mere flight of fancy. It
is a matter of record that the American Telephone &
Telegraph Company recently conducted a series of experi-
ments with radio links and the transcontinental telephone
line. Telephonic communication was established between
the steamship "Gloucester," cruising off Deal Beach, N.
J., and Santa Catalina Island, situated some thirty miles
off the California coast in the vicinity of Long Beach.
The telephonic communication, in this case, passed from
the "Gloucester" to Deal Beach, N. J.; from Deal Beach
to New York via telephone line; from New York to
San Francisco via transcontinental telephone line; from
San Francisco to Los Angeles via telephone line; from
Los Angeles to Long Beach via telephone line; from Long

Beach by radio to Pebbly Beach, on Santa Catalina Island. From ocean to ocean via radio, telephone line and radio again!

The first commercial radio and connecting land toll line is the Santa Catalina Island and California radio link, which was set in operation well over a year ago. Radio telephone service between Santa Catalina and the mainland to connect up with the Bell System exchanges was installed at the request of the local telephone company. Catalina Island is one of the great tourist resorts in Cali-

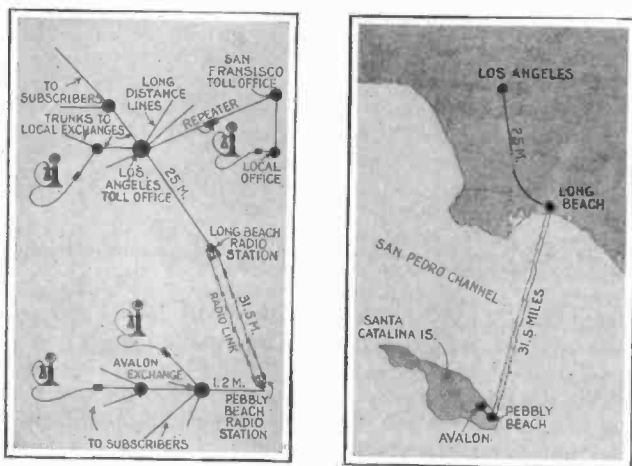

Map and diagram showing the radio link between the California mainland and Santa Catalina Island, and the wire systems at either end, all of which function as a single unit when connected together in this manner.

fornia. It attracts thousands of visitors daily throughout the year, who, heretofore, when they left the California mainland, remained completely isolated from the rest of the world until they returned to Los Angeles, except for a much-overloaded naval radio telegraph station on the island.

That this radio link, which bridges the 31½-mile gap

between the island and the mainland, is not in the experimental stage may be gathered from the fact that it handles hundreds of messages each day. The large amount of commercial traffic with scarcely any interruption which the Avalon-Los Angeles toll circuit has carried every day since its opening, is an ample proof of the practicability of toll lines containing radio links, where, due to physical conditions, direct wire connections are impracticable.

MECHANISM OF THE RADIO LINKS

It is virtually impossible to delve deeply into the intricacies of the Avalon-Los Angeles radio link and toll circuit, since it involves the most elaborate telephone and radio engineering practice. Suffice it to say that the diagram at the left of page 310 shows schematically the Avalon-Los Angeles circuit, consisting of a little more than one mile of wire line from the Avalon central office to Pebbly Beach, a $31\frac{1}{2}$ -mile radio link to Long Beach, and 25 miles additional wire circuit to Los Angeles. This combination wire and radio circuit is operated as a unit providing through telephone and signalling from Avalon to Los Angeles. At Avalon the circuit may be connected with any subscriber's line and at Los Angeles to any local subscriber's line, through local exchanges, or with other long-distance lines reaching practically any subscriber in the Bell System.

The difficulties overcome to surmount interference from radio stations along the Pacific Coast and a naval station on Catalina Island, together with the many sets on ships, were many, we learn from the engineers of the American Telephone & Telegraph Company and the Western Electric Company, who installed the radio link. Practically uninterrupted service now has been made possible, however, and the quality of the transmitted speech is almost perfect; so much so, in fact, that a user of the telephone service that includes the radio link notices virtually no difference in the service.

Among some of the technical obstacles it was found necessary to overcome before satisfactory operation of the

radio link was possible was the problem of housing the receiver and transmitting apparatus in the same building or in close proximity. This was accomplished by properly shielding all leads, shielding the receiver to prevent cross-talk from the transmitter, and the use of specially designed filter circuits for the receiver.

The radio link is, in truth, a link. It functions as part of the regular telephone system with little or no extra complication, so far as the everyday operation and use of the system is concerned. Operators are located at the central offices in Los Angeles and Avalon, operating ordinary telephone switchboards. They handle the radio link traffic in the same manner as if the wire circuits were being handled. They ring up in the same way by the operation of the usual ringing key. In fact, the installation of a voice frequency ringing system, which permits the use of a ringing key at the regular exchange switchboards in Los Angeles and Avalon, for signalling gave rise to some trouble and necessitated some changes in design before it was successfully placed in operation. This was due to the fact that the apparatus was rushed for the installation before it had been given a thorough field trial by the engineering department of the Western Electric Company.

The radio link is a duplex system; that is to say, one message may be sent in each direction simultaneously. For transmitting, a fair-sized aerial is employed, as indicated in bird's-eye view on pages 308 and 309, while for receiving a loop antenna is used at each end. These loops are of the solenoidal type, six feet square, and consist of only four or five turns each. To make the duplex operation a success, it goes almost without saying that exceptional measures had to be taken, otherwise the transmitter at one end would drown out the incoming signals on the loop antenna but a short distance away. The elimination of such interference was attained by the use of different carrier frequencies for transmission in the two directions. Filters, amplifiers and repeaters are employed in large numbers, the basis of all this equipment being the improved vacuum tube. An interesting feature of the receiv-

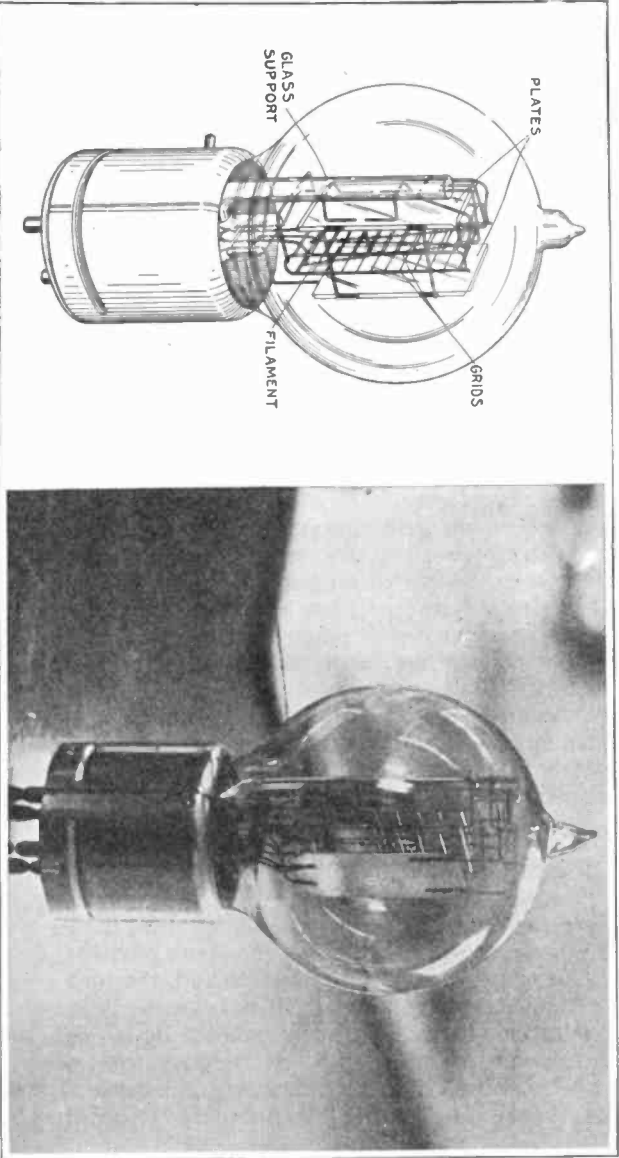

Vacuum tube employed in telephone work. In its general design this type of tube varies slightly from the detector and amplifier tubes employed in radio reception. Double plates and grids are employed.

ing apparatus is the provision of relays which close a buzzer alarm circuit when the filament of any vacuum tube fails.

The radio transmitter employed at either end makes use of a circuit in which the oscillations are generated directly in the antenna circuit. The modulation of the radio carrier frequency is accomplished by what is known as the "constant current system," in which both oscillator and modulator tubes are of 50 watts rating. These tubes are of the coated filament type, having relatively low filament power consumption and very constant operating characteristics. The transferring of the speech current from the telephone line to the radio link is an elaborate process. Briefly, it may be described in this manner: The speech current is applied to a speech amplifier tube, through an input transformer. The output of this amplifier is impressed on the grid circuits of the two parallel modulator tubes through a transformer. The action of these modulator tubes is that of an amplifier and their output voltage is impressed on the plate circuits of the two oscillator tubes by means of a reactance, which is common to the modulator and oscillator plate circuits. This modulation of the oscillator plate potential results in speech frequency variation of the amplitude of the antenna current. The frequency of the antenna current when not modulated is nearly that corresponding to the free period of the antenna circuit.

A RECORD TO BE PROUD OF

Since the radio link is the only telephone channel between the island and the mainland, it was very heavily overloaded from the day of opening until the cessation of the summer tourist traffic in the latter part of September, 1920. Due to the methods employed, the high grade circuit, and so on, a great deal more traffic is handled over this circuit than is generally handled by a single toll line.

A record of all of the interruptions to service is kept at both of the stations together with the cause of the delay, its duration, and other information. It is interesting to

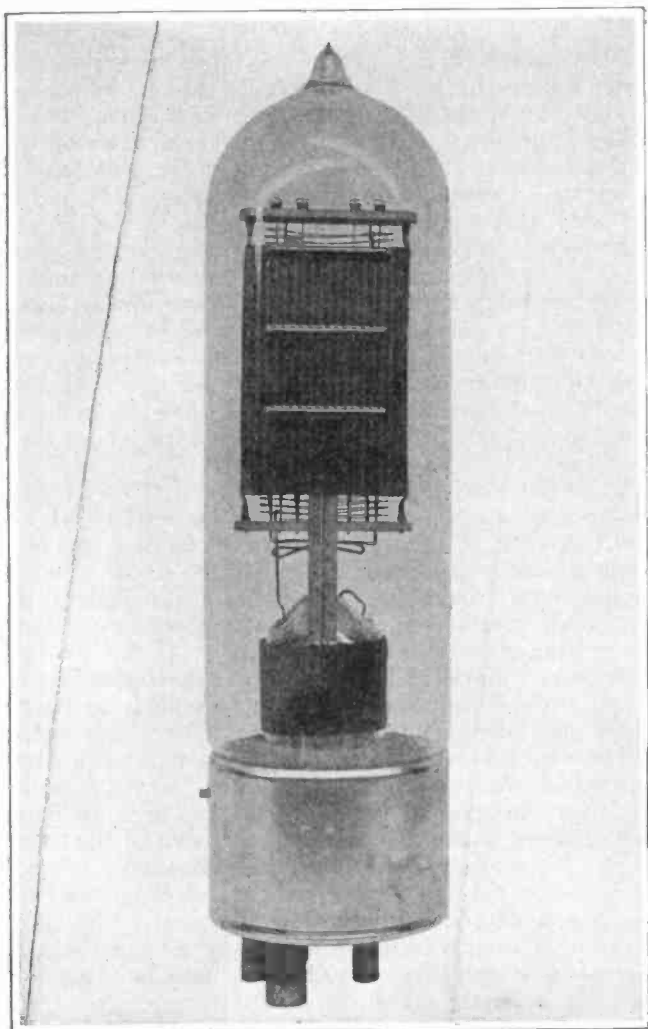

Vacuum type employed in radio transmission, especially for the sending end of the radio link.

note that although the circuit was open to commercial service during the worst of the static season, subscribers had but little or no difficulty in using the circuit. Transmitting frequencies of 400 and 470 meters were chosen for the stations after an extensive survey of the ether, so that the telephone would cause the least interference to and be interfered with the least by radio stations in the vicinity. Some trouble was experienced from the Avalon spark station located about one mile from the receiving station. Avalon transmits on 300 meters, while the Pebbly Beach station had its receiving apparatus tuned to 470 meters. Upon investigation it proved that the wave emitted by the spark transmitter was a broad one, and that when the wave is kept sharp and within certain definite limits of purity, so to speak, little or no trouble is experienced from this station.

The circuit, due to the choice of sites, directional characteristics of the loop antennas, and selectivity of the radio receivers, is quite free from interference and it is only occasionally that an interfering spark signal is heard. The harmonics from the Poulsen arcs installed at the Naval Radio Stations at San Diego and Englewood, California, have given rise to some trouble. If the arc harmonic beats with the radio carrier and side frequencies of the radio telephone station at either an audible or nearly audible rate, the quality of the speech over the circuit may be affected materially. This is in effect the same result which obtains when speech signals are received on an ordinary heterodyne receiver when the local oscillator is not adjusted to the same frequency as that of the transmitter. Although this trouble can be eliminated as soon as it is discovered by shifting the carrier frequency of the radio telephone transmitter a few thousand cycles, it is obvious that in the future, when many stations may be expected to be operating, this difficulty must be eliminated in a more elaborate manner.

The radio link also provides for a full duplex radio telegraph circuit, capable of sending and receiving messages in two directions at the same time. Ordinary telegraph

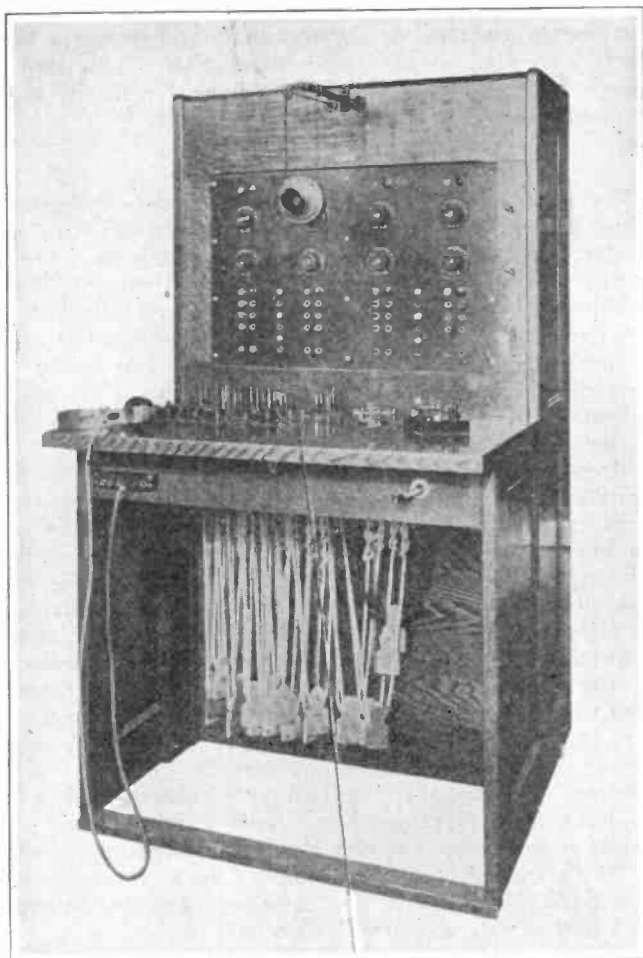

Special form of switchboard and radio controls for connecting the radio link with the regular telephone system.

instruments are used at the terminals and ordinary telegraph lines lead to the radio installation. This duplex telegraph service operates simultaneously with the radio telephone with no interference whatsoever.

THE RADIO LINKS AT SEA

The day is not far distant when every passenger steamer at sea will be just as much within reach of the regular telephone system and just as much an integral part of that system as the modern city apartment. There is nothing new in this prophecy: it has been talked about and virtually promised ever since radio telephony came into existence a decade and a half ago. But today we are making very substantial progress toward the early realization of telephony from ship to shore, along with all the other things promised for radio telephony.

Already we are telephoning to sea over the regular telephone lines. Experiments are being carried on, and while much remains to be done in the way of perfecting and refining the various details of this combined telephone and radio telephone system, the results indicate that the idea is feasible and most likely practical. A person talks over the regular telephone line and listens in the same manner as usual. The other person on board ship also speaks in the usual manner. Aside from occasional interference from other radio transmitters, especially radio telegraph, there is nothing to indicate that the conversation is other than an ordinary telephone conversation.

Recently an official of the Bell System was called to the telephone at his residence in New Canaan, Conn., to answer a call from Captain Rind, who was on his ship the "America" of the United States Line as it approached New York. At the time, the "America" was still 24 hours from port, or about 370 miles distant.

"Hello, this is Captain Rind."

"Captain, this is Mr. Thayer of the telephone company. I'm up in New Canaan. I understand you are three or four hundred miles at sea."

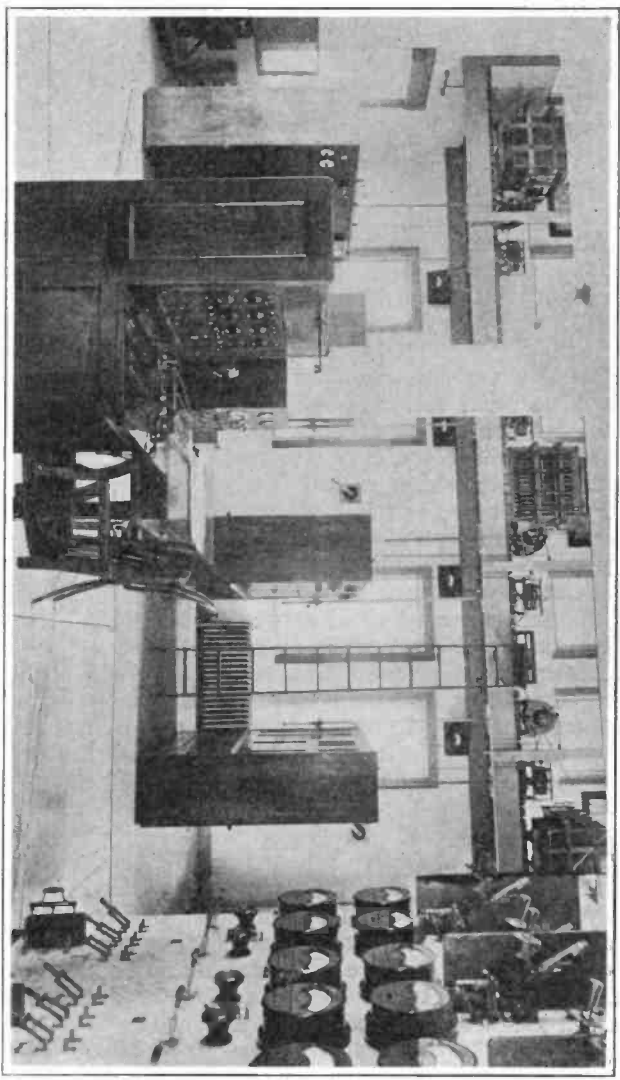

Typical radio installation employed for the radio link. This is an interior view of the Deal Beach station of the American Telephone & Telegraph Company.

"Yes, we were 370 miles from Ambrose light at 7:30. We expect to dock tomorrow evening at 7 or 8."

"What kind of a trip are you having?"

"We're having a good trip for this time of the year."

"Well, I'm glad to have had the pleasure of speaking to you. I think it is fine that we can meet and talk this way."

That was how the conversation ran. Over 100,000 persons heard the conversation; for the radio link, connecting the wire telephone system with the ship radio set, makes use of radio waves that may be intercepted and heard with the usual radio receiving set. It may be that at some future date some combination of wave lengths will be employed to make the radio telephone link more or less private; but for the time being the conversations are more or less public because of the large number of amateur receiving sets within range.

Preliminary to her last voyage to Europe, the steamship "America" had been equipped with a radio telephone set. Throughout the eastward trip tests were carried out between the ship and the radio telephone station of the Bell System located at Deal Beach, N. J., some 33 miles south of New York in an air line. These tests were overheard night after night by numerous radio amateurs along the North Atlantic coast, and led to many questions concerning their purpose. Similar inquiries were anticipated upon the return of the ship and it was thought desirable by the telephone officials to advise the public by means of a demonstration before representatives of the press.

The evening of March 5th was selected as the time for this demonstration, since the ship was scheduled to be then between 350 and 400 miles from port, a distance considered to be the fair working range, under normal atmospheric conditions, for the radio transmitters both on board ship and at Deal Beach. The success of the demonstration proved that the time had been well chosen; for, with the exception of 10 or 15 minutes during which the wireless waves were subject to "fading," as the radio engineers say,

telephoning between the ship and shore proceeded without the slightest difficulty.

TYING SHIPS AND SHORE BY TELEPHONE

The schematic drawing on pages 322 and 323 gives a general idea of how these experiments in ship-to-shore telephony have been carried on. The reader will note that two separate stations are being used on the Jersey coast, Deal Beach being the transmitting station and Elberon the receiving station. For those who are more technically inclined, it might be pointed out that the wire circuit was operated on the four-wire principle between Walker Street and the radio stations, and on the ordinary two-wire principle from Walker Street to New Canaan. A hybrid coil and balancing network, such as forms an essential part of all telephone repeaters, established the union between the two- and four-wire circuits.

The steamship "America," belonging to the United States Shipping Board fleet, is a 28,000-ton vessel engaged in passenger service between New York, Cherbourg, and Bremen. On the trip of which we are writing she carried a large booking of passengers who, during the progress of the tests, not only manifested considerable interest in them but also expressed in no uncertain terms their willingness to talk with persons on shore should they be given the opportunity. These passengers, in turn, had many friends in this country who were equally anxious to communicate with them; indeed, the engineers in charge of the Deal Beach station reported an avalanche of more telephonic calls than they took time to count from parties who wanted permission to talk with friends on board. One of these requests actually came by telephone from as far west as Chicago.

The demonstration not only brought out the possibilities of ship-to-shore communication, but also illustrated its shortcomings—shortcomings which are, in large measure, characteristic of radio in all its forms. At regular intervals throughout the test, which lasted for over an hour, intelligible communication with the ship was prevented by

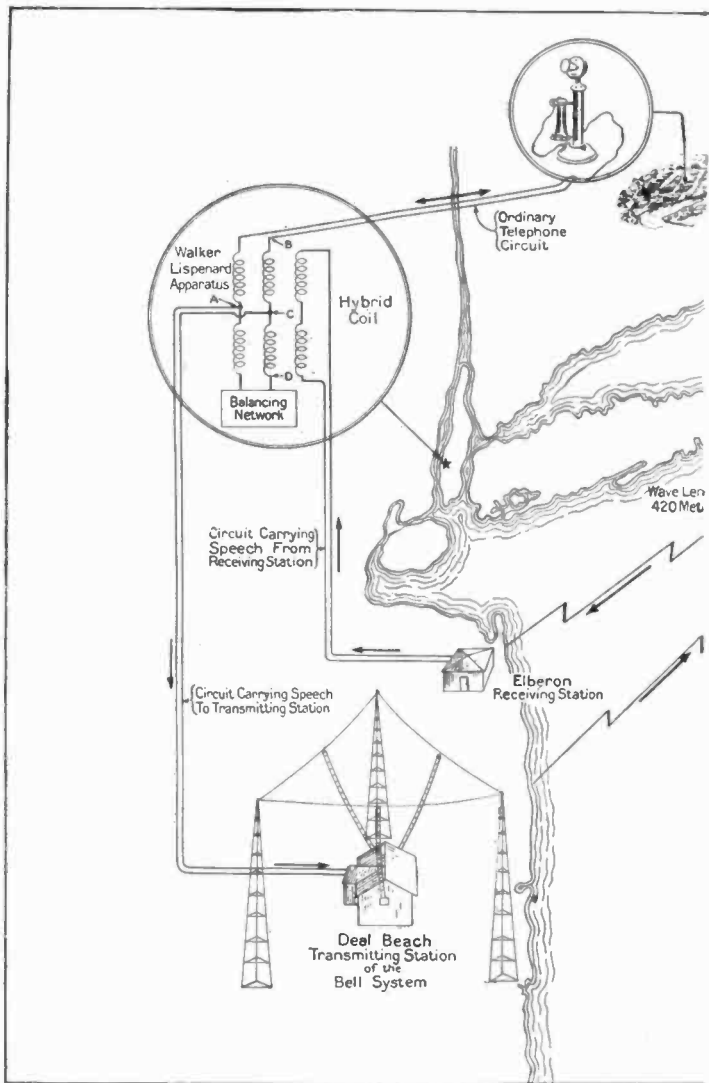

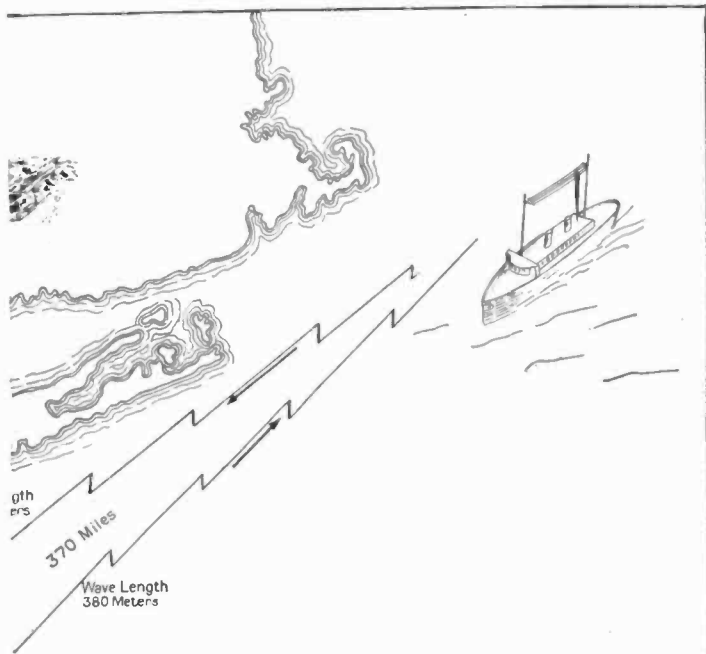

General scheme of the radio link as employed to couple up a ship with the wire telephone system. This particular diagram applies to the experiments conducted by the American Telephone & Telegraph Company between the steamer "America" and the Deal Beach station. The arrangement in the large circle represents the coupling system at the test room in the New York headquarters of the telephone company. Two-way communication is maintained with the radio link, by using a transmitting and a receiving station at the land end, as depicted.

interference from spark stations, most of which were on vessels at sea, the spark stations near New York very generously having stopped their sending during the period of demonstration. The elimination of interference between stations, all engaged in carrying commercial business, is one of the important technical problems of radio still waiting solution.

Another limitation of the radio telephone was forcibly brought out by the number of telephone calls which came in from persons who said they had simple radio sets in their homes and were listening in on the whole conversation between the speakers on shore and on the ship. A telephone message, once it has been given to the radio transmitter for propagation through the air, is virtually public property, and as upwards of one-half million radio amateurs throughout the country know, it is the simplest matter in the world to listen in on such a message. However, there are ways in which secrecy may ultimately be obtained for the radio link of a telephone system.

Moreover, atmospheric conditions exert a marked influence upon the ease with which a radio message travels through space. These conditions vary greatly from day to day and from hour to hour. This can well be illustrated by the observations which have been made in connection with the radio link of the telephone system operating between Long Beach, California, and Catalina Island. The distance between the mainland and the island is 30 miles, and the sets have been made sufficiently powerful to transmit speech across this distance under the most unfavorable conditions. On the other hand, it has been found that this amount of power is sufficient under exceptionally favorable conditions to make these messages readily audible in New Zealand, 5,000 miles away. One of the most difficult radio problems the telephone engineers have encountered is the transmission of a fixed quantity of current over the telephone lines in spite of the extremely variable intensity of the radio signals which are to be relayed over these lines.

Another atmospheric phenomenon which is a source of

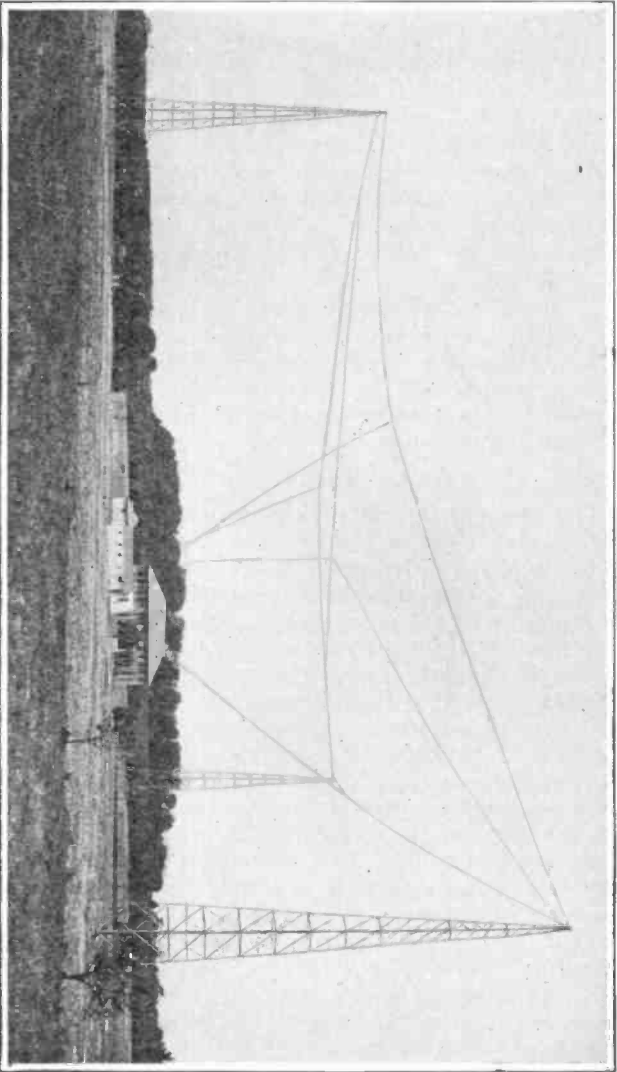

General view of the aerial and the station buildings of the transmitting station of the American Telephone & Telegraph Company at Deal Beach. This station has been used in connecting the land telephone system with ships at sea.

most serious disturbance to radio transmission and which thus far has baffled all attempts to eliminate it, is the so-called "static." Fortunately, for the demonstration we have just described, there was very little static present. Its occurrence varies greatly with the season of the year, and in the northern hemisphere is particularly troublesome during summer. Indeed, there are hours and even days together when all but the strongest radio signals are obliterated.

The radio link—the spanning of space between bits of regular telephone system—must come. The difficulties in the way of everyday, practical ship-to-shore communication are numerous and formidable, but they are certain to be brushed aside just as so many other obstacles in radio have been overcome.

AND WHAT OF THE FUTURE?

To say that the radio link between land units and between land units and ships at sea, is here in a practical and workaday way would be to exaggerate the facts in the case. Much remains to be done, as any one who has listened in to the experiments must realize. The interference from other radio stations, the static, the fading away of a transmitter—all these features hamper radio telephony to a marked degree and must be very much ameliorated before we can hope for a system that will be as positive and reliable as our present wire telephones. Of course, for short spans, like the Long Beach-Avalon radio link, for which a good deal of power is employed in view of the short distance, the results are really reliable; but then the radio link must be capable of spanning many hundred miles, especially in telephoning to sea, if it is to be made of some commercial value.

The question of secrecy is an important one, for nobody cares to be talking to a relative or friend while one hundred thousand other persons are listening in. Just so long as the messages stay on the wires, they are private, but at the present stage of radio telephony the moment these same messages are passed through the radio trans-

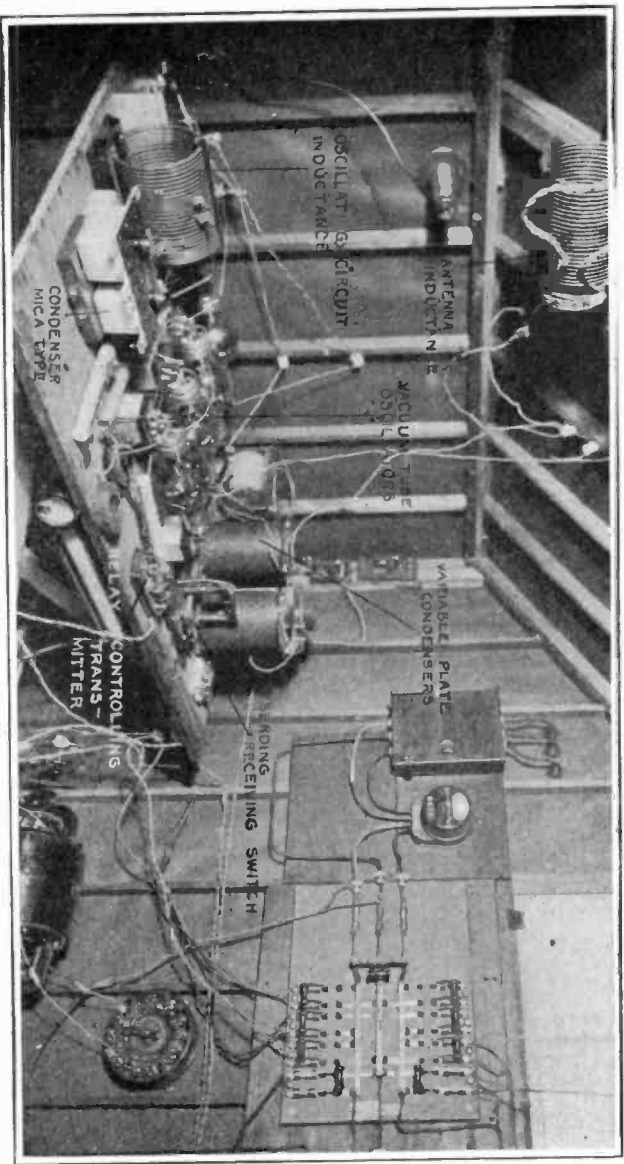

A continuous-wave transmitter which is representative of the more advanced amateur radio stations of today. The simplicity of the CW transmitter, together with its sharpness of tune, makes it more and more popular with the amateur. This particular installation was used in spanning the Atlantic during recent amateur tests.

mitter they become public property. However, this question of secrecy can be solved—and it will be solved, in the very near future. There are several ways in which this end can be attained. Perhaps the ultimate solution will be obtained by a system of double or triple waves employed simultaneously for the transmission of speech so that unless a person has a receiving set which intercepts a certain combination of waves, only a small and almost unintelligible part of the conversation will be detected. It is also quite possible to use a device at the transmitting end which continually alters the wave length of the transmitted radiophone waves, while the receiving set is also provided with a means of altering its wave length in step with the transmitter.

As for static, it will be with us for many years to come. There have been many so-called static eliminators introduced from time to time, and we are assured over and over again that this arch enemy of radio has been banished for all time. But the fact remains that despite all kinds of static eliminators said to be practical and available, we continue to be troubled by static in our commercial and amateur work alike.

The wire telephone was not perfected overnight, and we cannot expect the radio telephone, which dates back to but a few years in point of real, practical development, to evolve into perfected communication overnight. Then the problems of transmitting through space are considerably more numerous and involved than those of the wire telephone. It is going to take time, but the day must come when the radio telephone will be an everyday convenience.

INDEX

"A" Battery	121
Abbreviations, Radio	171
Aerial	13, 24
Aerial and Antenna, Separate	215
Aerial and Ground	14, 95
Aerials, Types of	212-215
Air-Mail Radio Service	77
Amateur Stations	172
Alternating Current	24
Ammeter	24
Ampere	26
Amplifier	26, 195
Amplifying Tubes	127, 193
Amplifier, Two-Stage	182
Amplifier Units	191
Amplifiers, When and Where to Use	189
Amplitude	26
Announcer, The	51
Antenna	13, 280
Antenna in City	99
Antenna, Various Types	101, 102
Antenna, Erecting	95, 147
Antenna Materials	96
Arlington, Va., to Paris, Experiments	50
Atmospherics	26
Audio Frequencies	26
Audio or Radio Frequency—Which?	182
Audio Frequency Amplifier	184
Avalon-Los Angeles Link	272, 311
Battery A	121
Battery B	26, 121
Battery, Storage	122, 124
Beats	140
Bed Springs, Use of	150
Boat, Radio-Controlled	250

Boxing Contest, Transmission of.....	71
Broadcasting	1, 26, 59, 61
Broadcasting Schedule	82
Broadcasting Station	55, 68
Bureau of Markets and Crop Estimates.....	85
Business, Radio in.....	259
Buzzer Practice Set.....	167, 190
Buzzer Test	146
Cage, Aerial	241
Call Letters	176
Capacity (Abbreviated C).....	12, 26, 27
Cascade Amplification	27
Choke Coil	27
Chopper	241
Circuit	28, 129
Close Coupling	28
Code, International	165
Code, Learning	166, 168
Coil, Loading	113, 116
Combination Set	145
Communication, Telephonic	54
Compact Inductance	130, 132, 134
Compass, Radio	252
Concentrated Inductance	132
Concert, Radio-Phone	70
Condensers	12, 28, 220, 222
Condensers Transmitting	220
Condenser, Variable	116
Congress and Radio.....	92
Connections, Simple	28, 112, 113
Continuous Wave (Abbreviated C. W.).....	28
Counterpoise	28, 104
Cost of Sets and Parts.....	21, 291
Coupler	29
Crops and Market Reports.....	75, 79
Crystal Detector	29, 110, 144, 285
C W and C W Signals.....	140, 162
C W Waves, Buzzer Modulated.....	240
C W, Popularity of.....	233
C W Transmitters.....	235, 238
Damped and Undamped Waves	9, 207
Department Stores and Radio.....	67
Detector	30
Detector, Crystal	110
Detector Tube	128
Dielectrics	220
Direct Current (Abbreviated D.C.).....	30

Distance in Radio Communication	6
Dry Batteries	123, 297
Electrical Symbol	25
Electrodynamic Receiver	194, 200
Electron	30
E. M. F.	30
Ether	30
Experimental Stations	50, 172
Filament Battery	121, 154
Flat-Top Aerial	30
Frequency	30
Future of Wireless	65
Government Use of Radio	91
Grid, Employment of	181
Grid Leak	32, 300
Ground	32, 95, 102, 151
Ground for Transmitting	215
Guided Wave Transmisson	256
Harmonics	32
Head Sets	135
Henry	32
Hertzian Waves	32
Hook-Ups	32, 152
Horn, Metal	193
Hot Wire Ammeter	33
Hydrometer, Use of	154, 156
Impedance	33
Inductance (Abbreviated L)	33
Inductance Coils	135
Installing the Receiving Set	149
Instruments, Cost of	23
Instruments, Range of	23
Insulator	33, 98, 214
Insulator, Lead-in	103
Jamming Signals	211
Kilowatt (Abbreviated K.W.)	33
Lead-in Insulator	103
Lightning	105
Lightning Switch	105, 282
Long Island Radio Central	265
Loop Antenna	33, 106, 107, 153
Loose-Coupler	130, 131, 292
Loud-speaker	33, 192, 194, 197, 198, 199
L-Type Antenna	101
Magnavox	204
Map of Radio Inspection Districts	175
Marine Type of Transmitter	225

Market News Service	75, 76
Megohm	33
Mica Condenser	223
Microfarad (abbreviated mfd.)	33
Microphone	33
Milliampere (abbreviated M.A.)	34
Modulator Tubes	246
Music, Transmission of	61
Natural Frequency	34
News, Distributing the	74
Night-Letters	266
Ohm	34
One Step Radio Frequency Amplifier	187, 188
Operating the Radio Receiving Set	143
Operation, Pointers on	159, 160, 161
Oscillating or Vibrating Currents	11, 34
Plate Battery	121
Phonograph Attachment	192, 202
Post Office Department and Radio Service	77, 82
Potential (See EMF and Volt)	34
Primary and Secondary Circuits	129
Programs, Wireless	52, 53
Radiation	34
Radio Apparatus, Fitting	19
Radio Communication, Elements of	14
Radio Communication Laws	174
Radio Compass	252
Radio Control	248
Radio for Farmers	49
Radio Frequencies	34
Radio Frequency Amplifier	183, 184, 186, 190
Radio in the Home	41
Radio Inspection Districts	174, 175
Radio License	170, 172
Radio Link	50, 56, 307, 311, 318
Radio-Phone	1, 40
Radio-Phone, Broadcasting	39, 58
Radio-Phone to Dots and Dashes	164
Radio Reception	93
Radio School	170
Radio Signals	16, 18
Radio Telegraphy, Use of	84
Radio Telephony in Simple Form	243
Radio Transmitter, What it Does	206
Radio Waves	15
Range of Instruments	23
Reactance (See Impedance)	34

Receiving Equipment	20, 93, 109, 126
Receiving Set, Simple	111
Receiving Station	57
Reception, Radio	93
Rectifier	34
Rectifier and Stepdown Transformer	158
Regenerative Circuit	35
Regenerative Reception	138, 142
Regenerative Set	138
Remote Control	248
Resistance	35
Resonance	35
Rheostat	35
Rocky Point Station	266
Rotary Gap	227
Secondary and Primary Circuits	129
Selectivity	35
Self Amplification	138
Sets, Receiving	111
Sharp Tuning	36
Sharp Waves	216
Signals, Radio	16
Sliders	113
Solenoidal Loop	107
Spark Gaps	224, 227
Spark Interference	163
Spark Signals and C W Signals	162
Spiral Loop	107
Standard Symbols	25
Static (See Atmospherics)	26, 36
Stepdown Transformer	158
Storage Battery	36, 122
Storage Batteries, Rating of	156
Storage Batteries, Recharging	156
Storms	105
Studio, Broadcasting	68
Symbols, Standard	25
Telephone Receivers	133
Telephone Receivers, Limitations of	201
Telephone System and Radio Link	50
Tickler Coil	138, 140
Tikker	140
Time Signals	86, 89
Traffic, Long Distance	274
Transatlantic Radio to Transcontinental Telephone	78
Trans-Atlantic Station, Operating	268
Trans-Continental Telephone	66

Transformer	36, 186
Transmission, Code	80
Transmitter	17
Transmitter Layout	230
Transmitters Sharply Tuned	216
Transmitting Condensers	220
Transmitting Tubes	243, 245
T-Type Antenna	102
Tuner	136, 284
Tuning	8, 36
Tuning Coil	117
Tuning Inductance	211
Tuning, Simple Sets	146
Tuning Transmitters	42, 219
Umbrella Type Antenna	101, 102
Undamped Transmitter	10
Undamped Waves	9, 36
Undamped Wave Transmitter	10
Vacuum-gap, Lightning Protector	106
Vacuum Tube	36, 37, 118, 121, 125, 154, 292, 299, 313, 315
Vacuum Tube, Amplifier	127
Vacuum Tube as Transmitter	229
Vacuum Tube Oscillator Method	236
Variable Condenser	116, 295
Vario-Coupler	130
Variometer	37, 113, 114, 301
Velocity of Waves	37
Vibrating or Oscillating Currents	11
Voice Carrying	203
Voice, Radio	39
Voice, Transmission of	60
Voltmeter	37
Voltmeter, Use of	156
V-Type Antenna	101
Watt (abbreviated W)	37
Wave Length	7, 37
Wave Lengths, Questionnaire on	81
Wave Meters	219
Wave Transmitter Damped	221
Waves, Damped and Undamped	9
Waves, Transmitting	17
Weather Reports	88
Wire and Wireless Work Together	272
Wired Wireless	254
Wireless Telephony, Early	44
Wiring	115, 288
World Communication	278